

APRIL 1955

TWO SHILLINGS

# Wireless World

Radio · Electronics · Television

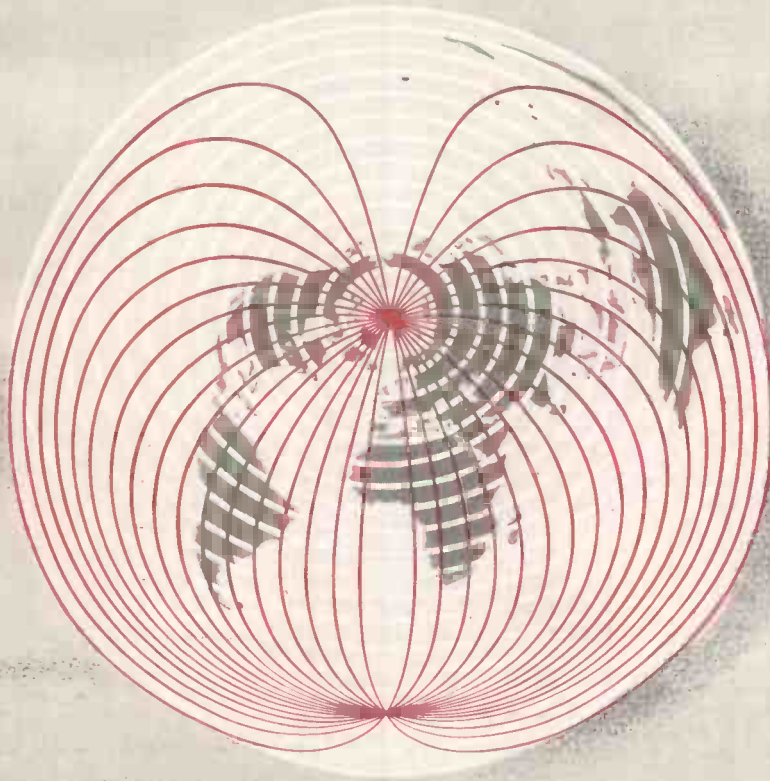

**FORTY-FIFTH YEAR OF PUBLICATION**

# TELEVISION



# EUROVISION



In the impressive link-up of national television services, large numbers of BICC Multi-Unit Cables and Polypole Couplers were used throughout Europe. They were employed with both V.H.F. link equipment and T/V cameras. These cables and couplers are designed to provide a robust trailing cable system to withstand the hazards of outside television service. For further information please ask for Publication T.D.T.15.

**BICC** multi-unit cables  
and polypole couplers

BRITISH INSULATED CALLENDER'S CABLES LIMITED  
21 BLOOMSBURY STREET, LONDON, W.C.1



# Wireless World

RADIO, ELECTRONICS, TELEVISION

*Managing Editor:*

HUGH S. POCOCK, M.I.E.E

*Editor:*

H. F. SMITH

APRIL 1955

## ***In This Issue***

|   |     |
|---|-----|
| Editorial Comment .. .. .   | 151 |
| Tape Selector Mechanism. <i>By J. R. Price and R. A. Frewer</i> ..                      | 152 |
| Tubeless Television? .. .. .  | 153 |
| Alternative London Television .. .. .   | 154 |
| World of Wireless .. .. .   | 155 |
| Components Show .. .. .   | 158 |
| Design for an F.M. Tuner. <i>By S. W. Amos and G. C. Johnstone</i> .. .. .              | 159 |
| Short-wave Conditions .. .. .   | 163 |
| D.C. Stability of Transistor Circuits. <i>By Francis Oakes</i> ..                       | 164 |
| Waveguides as Microwave Links .. .. .   | 168 |
| Propagation on Bands I and III. <i>By F. R. W. Strafford and I. A. Davidson</i> .. .. . | 171 |
| Interference Suppression. <i>By R. Davidson</i> .. .. .                                 | 173 |
| Letters to the Editor .. .. .   | 176 |
| Testing Precision Oscillators. <i>By M. P. Johnson</i> .. .. .                          | 179 |
| Phase-to-Amplitude Modulation. <i>By Bryant D. Virmani</i> ..                           | 183 |
| Geophysical Research. <i>By R. L. Smith-Rose</i> .. .. .                                | 188 |
| Distortion. <i>By "Cathode Ray"</i> .. .. .   | 191 |
| Output Transformer Design. <i>By R. F. Gilson</i> .. .. .                               | 195 |
| Books Received .. .. .  | 196 |
| April Meetings .. .. .  | 197 |
| Random Radiations. <i>By "Diallist"</i> .. .. .   | 198 |
| Unbiased. <i>By "Free Grid"</i> .. .. .   | 200 |

VOLUME 61 NO. 4

PRICE: TWO SHILLINGS

FORTY-FIFTH YEAR  
OF PUBLICATION

PUBLISHED MONTHLY (4th Tuesday of preceding month) by ILIFFE & SONS LTD., Dorset House, Stamford Street, London, S.E.1. Telephone: Waterloo 3333 (60 lines). Telegrams: "Ethaworld, Sedist, London." Annual Subscription: Home and Overseas, £1 7s. 0d. U.S.A. \$4.50. Canada \$4.00. BRANCH OFFICES: Birmingham: King Edward House, New Street, 2. Coventry: 8-10, Corporation Street. Glasgow: 26B, Renfield Street, C.2. Manchester: 260, Deansgate, 3.



# VALVES, TUBES & CIRCUITS

## 28. A NEW 25W AUDIO OUTPUT PENTODE

The EL34 is an indirectly-heated octal-based output pentode which is now being added to the Mullard range of audio valves. It has a rated anode dissipation of 25W and the high mutual conductance of 11mA/V. This valve covers all applications requiring powers between 11W (single valve) and 100W (push-pull), and is equally suitable for high quality domestic amplifiers and public address equipment. It has a comparatively small diameter for a 25W output pentode: the straight-sided envelope rises directly from a foot less than 38mm in diameter. The maximum overall length is 113mm and the maximum seated height 98mm.

Two triode-connected EL34's operated in push-pull for a domestic amplifier give an output of either 14W at less than 1% total harmonic distortion with a line voltage of 430V, or 16W at 3% distortion with a line voltage of 400V. For public address equipment two EL34's may be operated in pentode push-pull, again using cathode bias, and with a line voltage of 375V the available output is 35W at 5% total harmonic distortion. For even higher powers fixed bias may be used with anode voltages of up to 800V; the power output when the anode voltage is 800V is 100W at 5% distortion.

A single EL34 operated in Class A gives an output of 11W at 10% distortion with a line voltage of 265V.

A special technique has been devised to enable the EL34 to operate at high anode voltages whilst retaining a single-ended octal-based construction. The valve envelope is made completely of glass, with a conventional pressed glass foot, and clamped into a metal ring which holds together the glass and the plastic material of the octal base. The stiff wire leads projecting from the glass envelope line up exactly with the pinning in the octal base; during manufacture these leads are passed straight inside the octal pins, without crossing over outside the bulb, and so the risk of flash-over is very much reduced. For high voltage operation the valvholder of course must also be able to withstand the high tension.

Such a small valve as the EL34, dissipating a large amount of power at the anode and screen grid as heat, needs reasonable ventilation. It should be mounted vertically, and the air should be able to circulate freely. The distance between two EL34's should be at least 40mm, and the distance from the cabinet and other components at least 30mm. Wirewound resistors, mains transformer, and rectifier should not be in the immediate vicinity.



| Abridged Data                       |   |            |
|-------------------------------------|---|------------|
| <b>HEATER</b>                       |   |            |
| V <sub>h</sub>                      | 6.3   | V          |
| I <sub>h</sub>                      | 1.5   | A          |
| <b>TYPICAL OPERATING CONDITIONS</b> |   |            |
| Single valve                        |   |            |
| V <sub>b</sub>                      | 265   | V          |
| V <sub>a</sub>                      | 250   | V          |
| V <sub>g2</sub>                     | 265   | V          |
| V <sub>g3</sub>                     | 0   | V          |
| V <sub>g1</sub>                     | -13.5   | V          |
| I <sub>a</sub>                      | 100   | mA         |
| I <sub>g2</sub>                     | 14.9  | mA         |
| g <sub>m</sub>                      | 11  | mA/V       |
| r <sub>a</sub>                      | 15  | kΩ         |
| μg <sub>1-g2</sub>                  | 11  |            |
| R <sub>a</sub>                      | 2   | kΩ         |
| V <sub>in</sub> (r.m.s.)            | 8.7   | V          |
| P <sub>out</sub>                    | 11  | W          |
| D <sub>tot</sub>                    | 10  | %          |
| <b>Pentode Push-Pull</b>            |   |            |
|                                     | Self Bias   | Fixed Bias |
| V <sub>b</sub> (a)                  | 375   | 800        |
| V <sub>b</sub> (g <sub>2</sub> )    | 375   | 400        |
| R <sub>g2</sub> (common)            | 470   | 750        |
| I <sub>a</sub> (o)                  | 2 x 75  | 2 x 25     |
| I <sub>a</sub> (max. sig.)          | 2 x 95  | 2 x 91     |
| I <sub>g2</sub> (o)                 | 2 x 11.5  | 2 x 3      |
| I <sub>g2</sub> (max. sig.)         | 2 x 22.5  | 2 x 19     |
| V <sub>g1</sub>                     | -22.5   | -39        |
| R <sub>k</sub>                      | 130   | —          |
| R <sub>a-a</sub>                    | 3.4   | 11         |
| V <sub>in</sub> (g-g) (r.m.s.)      | 42  | 47         |
| P <sub>out</sub>                    | 35  | 100        |
| D <sub>tot</sub>                    | 5   | 5          |
| <b>Triode Push-Pull (Self Bias)</b> |   |            |
| V <sub>b</sub>                      | 400   | 430        |
| R <sub>k</sub> (common)             | 220   | 250        |
| I <sub>a</sub> (o)                  | 2 x 65  | 2 x 64     |
| I <sub>a</sub> (max. sig.)          | 2 x 71  | 2 x 67     |
| V <sub>g1</sub>                     | -29   | -32        |
| R <sub>a-a</sub>                    | 5   | 10         |
| V <sub>in</sub> (g-g) (r.m.s.)      | 44  | 48         |
| P <sub>out</sub>                    | 16  | 14         |
| D <sub>tot</sub>                    | 3   | <1         |
| <b>LIMITING VALUES</b>              |   |            |
| V <sub>a</sub> max.                 |   | 800        |
| P <sub>a</sub> max.                 |   | 25         |
| V <sub>g2</sub> max.                |   | 425        |
| P <sub>g2</sub> max.                |   | 8          |
| I <sub>k</sub> max.                 |   | 150        |
| <b>BASE</b>                         |   |            |
|                                     |   | Octal      |
| Pin:—                               | 1 2 3 4 5 6 7 8   |            |
|                                     | g <sub>3</sub> h a g <sub>2</sub> g <sub>1</sub> NC h k |            |



Reprints of this advertisement and additional information may be obtained free of charge from

MULLARD LTD., Technical Service Department, Century House, Shaftesbury Avenue, London, W.C.2

## Transistor Symbols

**J**UDGING by our correspondence columns, there has been for some time a feeling that existing graphical symbols for transistors are unsatisfactory, and fail to convey a useful picture of the working of the device. We think this is probably because the base is almost invariably represented graphically by a heavy line, thus suggesting that it is analogous to the cathode of a thermionic valve. Colour is lent to this false idea because most transistor circuits show the base earthed. In fact, of course, it is the emitter which is analogous to the cathode and the earthed-base circuit is the transistor counterpart of the earthed-grid valve circuit.

To avoid this kind of confusion it seems imperative that any heavy line that looks like the graphical representation of a valve cathode should not be used in symbols for anything but the emitter. But to use such a line for the emitter would confuse those accustomed to the present symbol, in which it represents the base. Clearly, a radically different symbol is needed, and a possible solution would be to adopt the general idea suggested by P. M. Thompson in *Wireless World* for July, 1954 (p. 325). Mr. Thompson there described the system of symbols used by the Canadian Defence Research Establishment, in which transistor symbols are based on the conventional rectifier symbol.

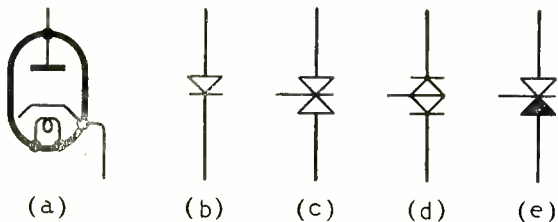

In the rectifier symbol, which is universally employed for any kind of two-electrode semi-conductor device having asymmetrical conductivity, the convention is that the bar represents the cathode of the equivalent thermionic diode and the triangle the anode (see (a) and (b) in the Figure). The junction transistor comprises two semi-conductor

junctions back-to-back, and it seems logical to adopt a pair of rectifier symbols, also back-to-back, as at (c) and (d). As shown, the bottom element of these basic transistor symbols is intended to represent the emitter, the top the collector and the middle one the base. By analogy with (b) if conventional current flows out of the emitter when the base is positive to it, the symbol takes the form of (d) and represents an *n-p-n* transistor. Consequently (c) represents a *p-n-p* transistor, operating with negative base and collector and having current flowing into the emitter.

These symbols as shown have one serious defect, in that they do not distinguish between emitter and collector. It is essential to be able to identify the two easily in order to trace a circuit rapidly. In any complex valve circuit, for example, one generally starts by identifying the input and output circuits by their connection to grid and anode and one should be able to do the equivalent in a transistor circuit. Fortunately, the difficulty is easily overcome by thickening or blacking-in the emitter element of the symbol as at (e) and (f) and it is these symbols that *Wireless World* suggests might be adopted for junction transistors. The symbols can be extended on the same lines for multi-electrode transistors.

In support of this system of symbolism, it may be urged that it represents the "historical" approach towards a new device; the user is going from the known to the unknown. And, if anyone raises the objection that a transistor is not a rectifier, the answer seems to be that the basic symbol here advocated primarily represents a semi-conductor junction. One such symbol, then, stands for a junction acting as a rectifier; two in conjunction may fairly indicate an amplifying transistor.

A related question—that of the appropriate reference letter or letter symbol to denote a transistor in circuit diagrams or lists of parts—was raised by E. A. W. Spreadbury in our March issue. At this stage of development, however, there seems to be some doubt whether it is necessary or desirable to introduce a special symbol; the transistor might be allowed to share the letter V with the valve without risk of confusion or ambiguity.

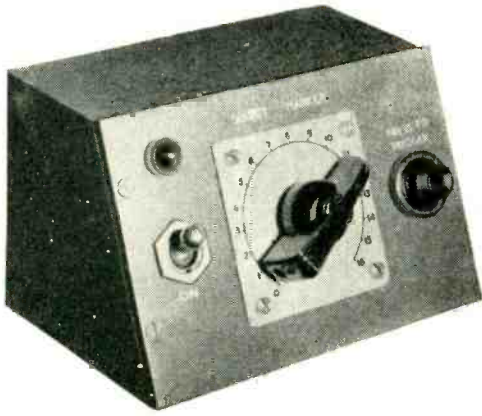

Complete selector unit, housed in case with sloping panel.

IT may seem a simple matter to those who are unaccustomed to the use of tape recorders to pick out a three-minute tune from several recorded on a half-hour reel of tape. However, people who own a tape recorder know from bitter experience how easy it is to overshoot by two or three yards. Paper markers solve this problem to a limited degree, but even so are far from satisfactory.

The device\* to be described enables any given section to be selected with a high degree of precision. It consists of a specially designed switch, through which the tape passes, and a selecting mechanism. The tape may be divided into as many sections as is desired, the one required being chosen by means of the selecting mechanism, the number of sections being limited only by the number of positions on the selector.

At the beginning of each section a piece of adhesive

\* Provisional patent 33963/54.

Selector with front removed. A, escapement adjusting screw (6BA); B, escapement; C, escapement return spring; D, ratchet wheel attached to H; E, actuating spring; F, solenoid which is mounted in slots to adjust height. G, arm attached to H which closes contacts S (Fig. 1); H, control knob spindle.

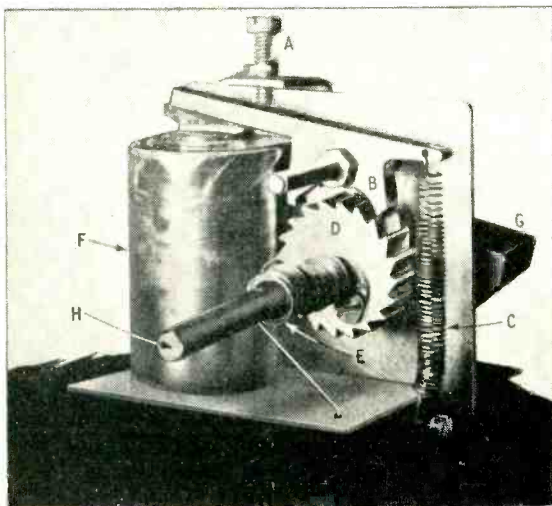

# TAPE SELECTOR MECHANISM

## A Useful Accessory for Magnetic Tape Recorders

By J. E. PRICE and R. A. FREWER,

B.Sc.(Eng.), Grad.I.E.E.

tape about half an inch long is affixed to the back of the recording tape in order to thicken it by about four times. The modern plastic adhesive tapes are very suitable for this application. Since this type of tape is very thin, it has been found necessary to use four layers, the top layer being rather longer than the other three. The overlap thus formed gives a "streamlined" effect and aids the tape in passing the felt pressure pads. During a period of about six months no deterioration in either the pressure pads or the recording tape has been noticed.

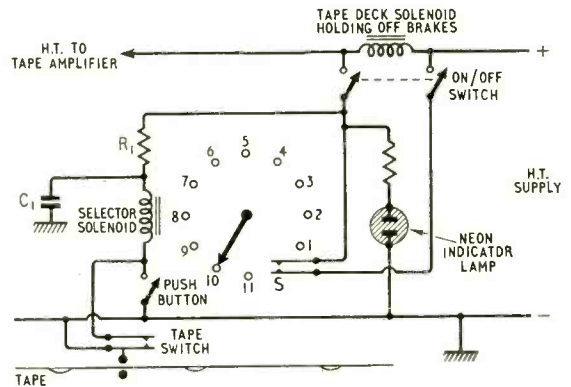
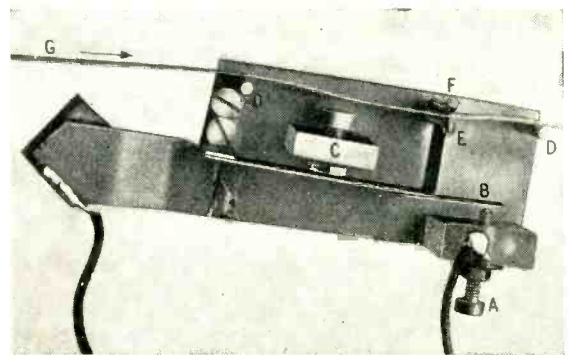
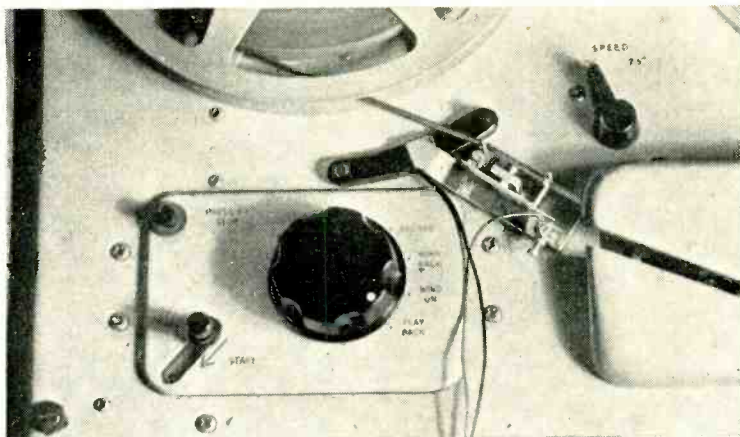

Fig. 1. Circuit diagram showing connections of tape switch and selector mechanism.



Tape switch. A, contact adjuster screw (6BA); B, contact spring; C, pillar spacing adjuster; D, tape guides; E, moving pillar attached to B; F, stationary pillar; G, tape, normal direction shown by arrow, coated side facing away from switch.

The recording tape is passed between two pillars which are forced apart by the thickened portion, thus causing a pair of contacts to be closed. The initial spacing of the pillars is at least twice the thickness of the tape in order to allow any joins to pass through. For use on half-track machines the switch could readily be modified so that only the lower half passes between the two pillars. For ease of loading the pillars are opened slightly at the top in the form of a Y. After consideration of many other types the present design of tape switch was chosen on account of its simplicity, freedom from contact bounce, high rate of response and in particular its complete freedom from any possibility of wear on the tape.



Tape switch as fitted to a "Wearite" tape deck.

The selector itself consists of a spring-loaded ratchet which is initially set to the number of the section required. Each pulse then allows the selector to fall back one position until it reaches zero, when a short-circuit is applied across the solenoid in the tape deck, thus causing the brakes to be applied. The selector may also be operated manually by a push-button switch. Since the selector solenoid simply releases the holding-back mechanism the power required is very small, and has been reduced still further by use of a capacitor C, which charges through R, and discharges through the selector solenoid when the tape switch is closed giving a current pulse of short duration.

The selector switch is capable of very rapid operation, due to the lack of inertia of the moving parts, and the mechanism is capable of responding at much higher speeds than are met with on any existing wind-on mechanism; thus the speed of response depends, to a large extent, on the efficiency of the tape recorder brakes.

This device is very useful when, for example, a number of three-minute tunes are recorded on one reel of tape. Contacts at either end of the recording tape can be arranged so that the brakes are applied

when a few turns of tape are left on the reel, thus obviating the continual irritation of re-threading prior to playback after rewinding the complete tape. Also the mechanism can be used with equal ease in both directions so that if it is desired to hear again a particular section the mechanism is set to 1 and the tape is rewound.

It would be almost indispensable for recorded sound effects in the theatre. Anyone who has stage-managed a play will appreciate the almost limitless possibilities of tape recording in this field, but when sound effects become numerous, and have to be repeated, confusion can be caused only too easily. This device enables any particular sound effect to be selected at will, in a very short space of time, thus limiting extraneous noise due to unnecessary operation of the recorder controls, and enabling every effect to be reproduced dead on time and in exactly the right place. By reducing the spacing of the pillars on the contact switch, this device may be adapted for use as a detector of joins in a reel of tape. This may be a useful industrial application. Finally, dare we mention it, by the use of this device it would become possible to use tape recorders in that modern teenager's delight, the "Juke Box."

## Tubeless Television?

**S**OME publicity has been given recently to various devices which, it is claimed, may replace the cathode ray tube for picture presentation in the television set of the future. The devices so far known depend for their operation on the phenomenon of electroluminescence. This was discovered in 1936 by Professor G. Destriau, of Paris, but his results were disregarded until about 1948, when various laboratories began to examine them further. Destriau found that the application of an alternating electric field across a thin layer of phosphor crystals resulted in the emission of light pulses at twice the frequency of the applied field. The light output of the layer increases as the frequency or the applied voltage is raised, over a considerable range, but the exact form of the relationship between these factors is rather complex. There is a threshold field below which no light is emitted. Special phosphors are used for electroluminescence but their base materials are usually zinc cadmium sulphides, as found in conventional cathode ray screens.

So far, the efficiencies of electroluminescent cells have proved to be very low. The higher figures quoted are about 5 lumens of green light per watt, which must be compared with 30 lumens per watt for a normal white phosphor under 10 kV electron bombardment.

Recently a new phenomenon allied to electroluminescence has been discovered by Professor Destriau and by D. A. Cusano in America. A d.c. field has been found to enhance the luminescence of a phosphor excited by ultra-violet radiation or x-rays, and gains of 50 times in brightness have been claimed. The decay time after removal of the stimulating radiation is several seconds.

Two types of "light amplifier" depending on the effects mentioned above have already been demonstrated. In one, developed by R.C.A., a layer of electroluminescent phosphor is sandwiched between a transparent conducting electrode and a photo-conducting electrode. An alternating voltage of 1-5 kc/s is applied to the two electrodes. When the photo-conductor is illuminated its impedance falls

sufficiently to allow the a.c. field to excite the phosphor. Gains of the order of 10 times are claimed, but no figures of the actual screen brightness are available. The second type, developed by General Electric, dispenses with the photo-conducting layer. A direct voltage of the order of 100 volts is applied to a layer of zinc sulphide 10 microns thick on a conducting glass support. Ultra-violet falling on the phosphor excites luminescence, which is enhanced by the applied field. Ten visible quanta are claimed to be emitted for one incident quantum of ultra-violet. Again no figure for the actual screen brightness is quoted.

Both these devices can be made to perform in a similar way to the well-known image convertor. As far as television is concerned, however, they do not appear to hold much promise. There is little to be said for their use in place of the normal viewing screen in projection systems, even allowing for a considerable reduction in the energy of the projected picture. The second type is ruled out on account of its excessive decay time, while the first would demand picture storage from frame to frame in the projection tube, since it would be unable to follow the instantaneous brightness of the normal scanning spot. This is because the upper limit of brightness of an electro-luminescent layer (determined by the dielectric breakdown

strength of the phosphor) is too low. Some measure of storage could perhaps be obtained by allowing feedback of the electroluminescent light to the photo-conductor but this would lead to other practical difficulties.

There is a third device, not yet known to have been demonstrated, which, on paper at least, comes nearer the goal of tubeless television. This uses an electroluminescent layer having electrodes in the form of closely spaced wires stretched vertically on one side and horizontally on the other. The volume of phosphor at the point of intersection of a vertical and a horizontal wire constitutes one picture element, and emits light when an a.c. voltage is applied to those wires. The formidable problems of producing such a screen and devising means for switching to each picture element do not yet appear to have been solved. Owing to the limitation on brightness mentioned above, this device will also require means of storing the signals from frame to frame.

In view of these facts one may conclude that the familiar cathode ray tube will remain with us for some time yet. It may, however, take new forms; for example, the development of a flat, wall-mounted cathode-ray tube approximately 3 inches deep has already been claimed by Willys Motors in America.

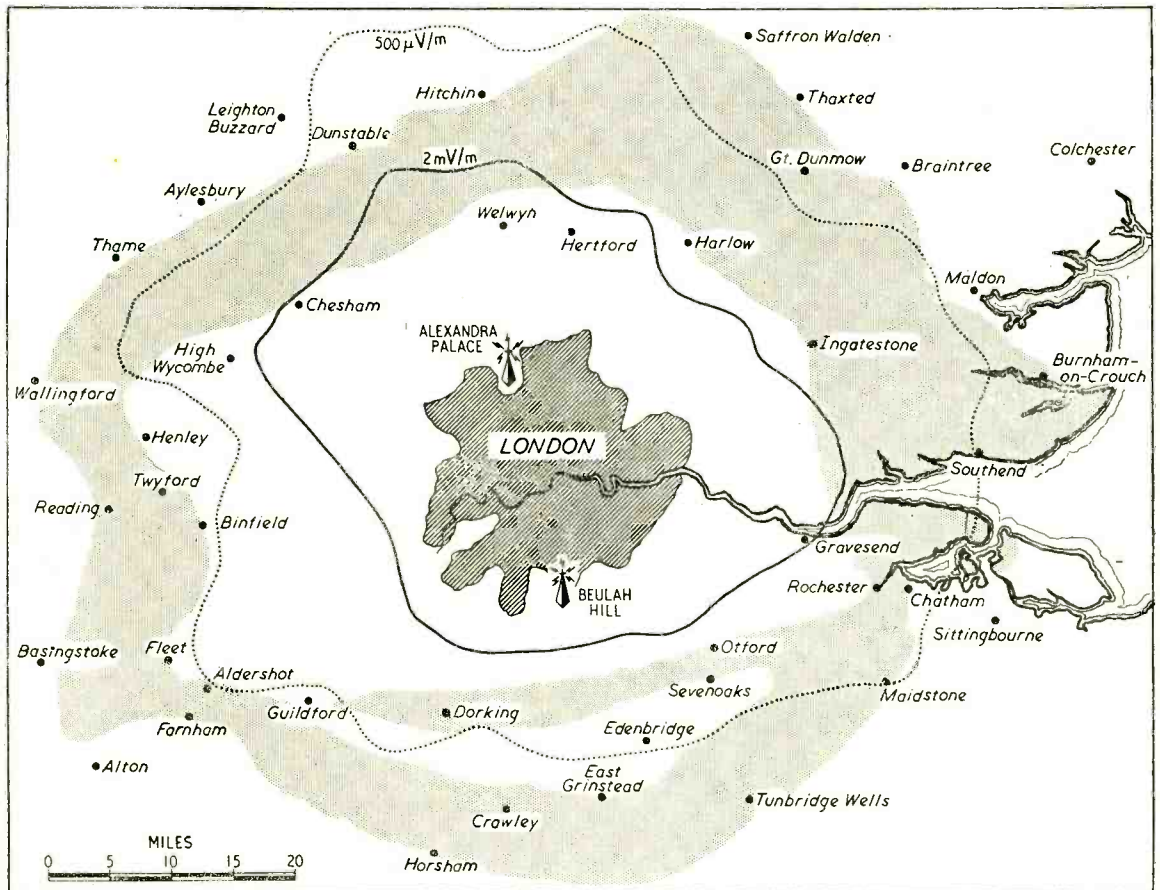

**ALTERNATIVE LONDON TELEVISION.** On this recently issued map showing the estimated coverage of the temporary I.T.A. transmitter being erected at Beulah Hill, Croydon, we have superimposed the 2 and 0.5 mV/m contours of the Alexandra Palace transmitter. For the Croydon transmitter the area between the same (estimated) field strength contours is shown shaded. The I.T.A. transmitter will have an e.r.p. of 60 kW whereas the Alexandra Palace transmitter has an e.r.p. of only 34 kW. The height of the aerials above sea level are: Alexandra Palace 600ft, Croydon 550ft. The permanent I.T.A. transmitter will have a much taller mast and an e.r.p. of three or four times that of the temporary station which will be in service for about eighteen months.



# WORLD OF WIRELESS

## Organizational, Personal and Industrial Notes and News

THE FAMILIAR Decca separate half-cheeses for transmission and reception have, in the new Decca 212, given place to a single parabolic cylinder scanner of about 4ft across. As it is intended primarily for small vessels, in which it is essential to reduce top weight, the r.f. unit has been separated from the scanner unit.



### V.H.F. Sound Broadcasting

A REGULAR three-programme service of v.h.f. broadcasting will be introduced by the B.B.C. from Wrotham on May 2nd. The estimated coverage of the station is given on the map on page 161.

The frequencies to be used by Wrotham are 89.1 Mc/s (Light), 91.3 Mc/s (Third) and 93.5 Mc/s (Home). The e.r.p. of each transmitter will be 120 kW and the transmissions will be horizontally polarized.

Wrotham has been in operation experimentally since 1950; first with both a.m. and f.m. transmissions and latterly using f.m. only. It closed down on March 5th for nearly five weeks to permit the installation of a third transmitter, which will radiate the Home Service. This transmitter differs from the two already installed in that it is built as two separate units for parallel operation, and for the first few weeks of the new service only one of these units will be used.

The closing down of the Wrotham station for five weeks just prior to the inauguration of the f.m. service would have been an embarrassment to the industry and the retail trade in London. In response to a request, therefore, from the British Radio Equipment Manufacturers' Association, the B.B.C. is radiating a low-power (1 kW) test transmission from Alexandra Palace on 93.8 Mc/s daily from 9 a.m. to 11 p.m. until Wrotham restarts.

### April Shows

DURING this month three exhibitions are to be held in London—R.E.C.M.F. (19th-21st), Physical Society (25th-28th) and A.P.A.E. (27th-28th). A list of exhibitors at the R.E.C.M.F. components show, which is to be held at Grosvenor House, Park Lane, W.1, is given on page 158.

The Physical Society exhibition of scientific instruments and apparatus is this year being held in the Royal Horticultural Society's New Hall, Westminster, S.W.1. There will be 136 exhibitors, including manufacturers and Government and industrial research organizations. On each of the first three evenings at 6.15 there will be a discourse, the subjects being: "The Free Electron as a Tool in Scientific Research," "Memory Systems in the Brain," and "Recent Developments in Luminescence and its Applications." The exhibition opens at 2.0 on the 25th and at 10.0 on subsequent days. It closes on the first three days at 8.0 and on the last day at 5.0. Admission is by ticket, obtainable on application to the Society, 1, Lowther Gardens, Prince Consort Road, London, S.W.7.

The annual exhibition organized by the Association of Public Address Engineers will be held at the Horseshoe Hotel, Tottenham Court Road, W.1, on April 27th (10.0-8.0) and 28th (10.0-6.0). There will

be 18 exhibitors and there will again be half-hourly demonstrations of equipment throughout each day. Admission is by trade card or on production of this issue of *Wireless World*.

### Interference Suppression

IN July, 1950, the Postmaster General appointed an 18-member committee to investigate interference caused by refrigerators, and twenty months later appointed another committee (of 21 members) to consider the question of interference from small electric motors.

Their recommendations are now embodied in two Statutory Instruments\* laid before Parliament on March 1st by the P.M.G. They prescribe limits of noise voltages and fields which, from September 1st, must be complied with by *manufacturers* of electric refrigerators and by *users* of electric motors. The limits laid down are those given in British Standard 800: 1954. For both motors and refrigerators the noise voltage at the supply line terminals of the equipment must not exceed 1500  $\mu$ V in the 200-1605 kc/s band and 750  $\mu$ V in the 40-70-Mc/s band. The radiated field strength from motors, measured at not less than 33ft, must not exceed 100  $\mu$ V/m and 50  $\mu$ V/m, respectively, in these bands.

The question of making the regulations for small motors apply to manufacturers is to be reviewed during the next two years.

\*"The Wireless Telegraphy (Control of Interference from Electric Motors) Regulations, 1955," No. 291, and "The Wireless Telegraphy (Control of Interference from Refrigerators) Regulations, 1955," No. 292. H.M.S.O.; 6d net each.

### B.S.R.A. Convention and Show

THE ANNUAL convention and exhibition organized by the British Sound Recording Association opens at the Waldorf Hotel, Aldwych, London, W.C.2, on May 20th at 7.0 with a recital of magnetic recordings of film music. The exhibition of recording and reproducing equipment will be held from 10.30 to

7.0 on the 21st and from 10.0 to 6.0 on the 22nd. Admission is by catalogue (1s 6d), obtainable at the door.

## PERSONALITIES

At the annual general meeting of the Parliamentary and Scientific Committee in February, **Dr. S. Whitehead**, M.A., D.Sc., M.I.E.E., F.Inst.P. (director of E.R.A.), was re-elected joint honorary secretary. The committee comprises members of both Houses of Parliament (at present 44 Peers and 119 Members) together with representatives from 94 scientific and technological institutions. It holds lectures and discussions on subjects of national interest with a scientific content, particularly those subjects which may come before the Lords or Commons. Dr. Whitehead is a past-chairman of the international committee on radio interference (C.I.S.P.R.) and has acted as deputy chairman of the P.M.G.'s committees on radio interference from ignition systems and from small motors.

**D. C. Birkinshaw**, M.B.E., M.A., superintendent engineer of B.B.C. television, is going to the United States in company with one of the television drama producers to study television techniques and organization. They leave on March 26th and will be away three weeks.

**W. R. Fletcher**, B.Sc.(Eng.), A.M.I.E.E., who joined the B.B.C. in 1936 as an assistant maintenance engineer at the Lisnagarvey, Northern Ireland, station, has been appointed engineer-in-charge at Brookmans Park. He succeeds **D. Hamilton-Schaschke**, who has become resident engineer, British Far Eastern Broadcasting Service, Singapore. After serving at a number of the Corporation's stations, including the short-wave transmitter at Rampisham, Dorset, where he was senior maintenance engineer, Mr. Fletcher was seconded for two years to the Ceylon Broadcasting Service. In 1951 he was appointed resident engineer of the B.F.E.B.S., Singapore.

**D. H. Ray**, B.Sc., M.I.E.E., the new head of the Engineering Department of the Mid-Essex Technical College, Chelmsford, has been assistant head of the Electrical Engineering Department of the College of Technology, Birmingham, for some years. During the war he was released from the Army to assist in the training of radio mechanics at the College of Technology, where he took a permanent appointment after the war. He is a member of the C. & G. advisory committee on radio and television servicing.

On the death of a cousin the family honours have devolved upon **R. F. Payne-Gallwey**, who becomes the fifth baronet. Sir Reginald is chairman of the Radio Industries Club.

This year's president of the Radio Society of Great Britain is **H. A. Bartlett** (G5QA) who has been a member of the council for the past three or four years. His special interest is long-distance working.

## OUR AUTHORS

**Francis Oakes**, who is with the Ferguson Radio Corporation where he is in charge of transistor applications research, writes on the d.c. stability of transistor circuits in this issue. Educated in Vienna, he came to this country in 1939 and became a naturalized British subject in 1947. Before joining Ferguson's he was assistant chief of the electronics laboratory of the Morgan Crucible Company where he led a team of graduates working on a number of projects, including research into properties of materials, and on the development of carbon resistors.

**M. P. Johnson**, author of the article in this issue describing a method of testing precision oscillators, received the B.A.Sc. degree from the University of Toronto in 1936. He then came to this country and joined the General Electric Company at Coventry as a graduate apprentice. He later went into the transmission laboratory, where he is now in charge of a section dealing primarily with precision master oscillator development and negative feedback amplifiers.

## OBITUARY

**Donald Macadie**, M.B.E., the inventor of the original d.c. multi-range amps-volts-ohms meter, which later became known as the Avometer, has died at the age of 83. After his retirement from the Post Office in 1933 he devoted a considerable part of his time to the activities of the Automatic Coil Winder and Electrical Equipment Company which he helped to form in 1923 to manufacture the Macadie coil winder and the Avometer.

**Cyril H. Ford**, chief engineer of E.M.I. Sales and Service, Ltd., has died at the age of 58. He was originally with Marconi's at Chelmsford and transferred to the Marconiphone Company in 1922. In 1931 he became chief engineer of the Service Department at Hayes on the formation of Electric and Musical Industries, Ltd. He was a member of the exhibition technical committee of the R.I.C.

## IN BRIEF

**Broadcast Receiving Licences** current in the United Kingdom at the end of January totalled 13,903,950, including 4,307,772 for television and 263,741 for car radio. The number of television licences increased during the month by 151,783.

The tenth **Annual Electronics Exhibition** organized by the Northern Division of the Institution of Electronics, will be held at the College of Technology, Sackville Street, Manchester, from July 14th to 20th. On the first day the show will open at 2.0 p.m., but on subsequent days at 10.0 a.m. It will close daily at 10.0 p.m., except on Saturday when it closes at 6.0 p.m. There will be two main sections, one covering scientific and industrial research and the other manufacturers' products. Tickets are obtainable free from the organizing secretary, W. Birtwistle, 78, Shaw Road, Rochdale, Lancs.

In order to meet the increasing demands for **Mobile Radio** in the United States the Federal Communications Commission proposes reducing the channel spacing and making more stringent standards for equipment. According to a report in *Wire and Radio Communications* the spacing in the 25 to 50-Mc/s band is to be reduced from 40 kc/s to 20 kc/s, and in the 152 to 162-Mc/s band from 60 kc/s to 15 kc/s. In this country the spacing is 50 kc/s and 100 kc/s respectively in the 72 to 88 and 156 to 184 Mc/s bands.

**Colour Television Lectures.**—A course of eight lectures on "The Science of Colour Applied to Colour Television" by Professor W. D. Wright will be given on Tuesdays and Thursdays at 4.30 p.m. (from April 26th) in the Physics Department of Imperial College, Imperial Institute Road, London, S.W.7. Application for admission to the course, for which the fee is two guineas, should be made to the Registrar, Imperial College, Prince Consort Road, London, S.W.7.

**New Zealand Television.**—Our New Zealand contemporary, *Radio and Electrical Review*, reports that an Australian company (Rola Company Pty., Ltd.) and its New Zealand associate (Loudspeakers, Ltd.) are applying for permission to introduce into Australasia the Zenith system of subscription television—Phonevision.

The twenty-sixth edition of the **Trader Yearbook** (1955) is a veritable mine of information on the radio industry. In its 304 pages it includes directories of trade organizations, manufacturers and trade names, a buyers' guide and a considerable amount of technical information including some 300 valve base diagrams, abridged specifications for current television and sound receivers and a list of i.f.s used in post-war sound receivers. The Yearbook is obtainable by post from the Trader Publishing Company, Dorset House, Stamford Street, London, S.E.1, price 13s.

Sargrove Electronics ask us to point out that the **Direct-Reading Capacitance Meter** illustrated on p. 141 of our March issue was a development version; the final model is unlikely to be in full production for some months.

The Post Office has allocated the call-sign G9AED to the temporary experimental **Band III Television** transmitter which Belling & Lee are erecting on Beulah Hill, South London. The 250-watt transmitter, with its 16-dipole aerial giving an e.r.p. of 1 kW, is planned to be brought into service on April 1st. It will radiate a series of static patterns on 194.75 Mc/s, the vision frequency allocated to the London I.T.A. station.

Further changes in the licensing regulations governing the **Radio Control of Models** have been announced by the Post Office. Licensees will now only be required to check the transmitter frequency as often as may be necessary to ensure that it is operating within the authorized band and, in addition, the equipment may be operated by anyone under the personal supervision of the licensee.

An eight-page programme, giving explanatory notes and full details of the records to be played at the lecture-demonstration on **Sound Reproduction** by G. A. Briggs at the Royal Festival Hall on May 21st, is being produced. Copies, price 1s post free, will be available from Wharfedale Wireless Works, Ltd., Bradford Road, Idle, Bradford, after the middle of April.

The lectures given by Sir Edward Appleton, Professor G. W. O. Howe and Dr. J. Thomson at last year's I.E.E. meeting to celebrate the **Jubilee of the Thermionic Valve** are being published as a book by the Institution. It will also include an appreciation of Sir Ambrose Fleming and Lee de Forest by C. F. Booth (G.P.O. assistant engineer-in-chief). The book, entitled "Thermionic Valves 1904-1954," is available to non-members, price 9s.

The chairman of the new council of the **Technical Publications Association** is C. E. Cunliffe, manager of the Publicity and Publications Department of A. C. Cossor, Ltd.

## INDUSTRIAL NEWS

Associated-Rediffusion, Ltd., the programme contractors who will provide the material for the weekday transmissions from the I.T.A.'s London transmitter, have ordered most of their studio and O.B. equipment from **Marconi's**. The equipment includes complete installations for three 3-camera studios, one 2-camera studio, two 3-camera O.B. vehicles and master control gear. The company has recently acquired Adastral House, Kingsway, London (to be renamed Television House) and have studios at Wembley and a theatre at Walham Green.

What is believed to be the first post-war exhibition of **Imported Electronic Equipment** and components is being organized jointly by Rocke International, Ltd., and B. & K. Laboratories, Ltd. The exhibition, which will be held from April 25th to May 6th at 59, Union Street, London, S.E.1 (near London Bridge station), will include instruments from America and the Continent. Tickets for the display, which is open from 9.0 until 7.30 (Monday to Saturday), are obtainable from Rocke International at the above address.

**Industrial Television Equipment** is to be provided by Marconi's for the Windscale plutonium factory of the U.K. Atomic Energy Authority at Sellafield, Cumberland. It will be used for observing at a safe distance conditions which are dangerous to examine at close quarters.

To extend the radio-telephone service for the county's ambulances the Essex County Council has ordered from **Pye Telecommunications** a fixed station and 45 mobile transmitter-receivers. The fixed transmitter will be installed at Hainault and be remotely controlled by line from the Ilford ambulance depot.

An electro-optical camera, specially designed by **Winston Electronics**, of Hampton Hill, Middlesex, for the United States Government, was amongst the cargo on the first flight of the new transatlantic freight service inaugurated by Airwork, Ltd. The sequential image converter has been designed to enable photographs of 0.1 $\mu$ sec exposure to be taken at 0.5 $\mu$ sec intervals. It will be used at the Aberdeen proving ground—a weapon-testing centre.

The contract for planning the whole of the temporary I.T.A. station at Croydon has been awarded to **Marconi's**, who are supplying the vision and sound transmitters, aerial and 200ft mast. Work has begun on the temporary buildings for the station, which is scheduled to open in September.

**Intercommunications Equipment Company**, of 286-288, Leigh Road, Leigh-on-Sea, Essex, inform us that their marine R/T equipment (HA/66/RTA) has received the G.P.O. Certificate of Type Approval. The 50-watt transmitter operates on eight crystal-controlled frequencies within the band 1.4-8 Mc/s and, in addition to covering the same band, the receiver also covers medium and long waves.

**New Marconi House?**—A new office building is to be erected by the English Electric Company on the site of the old Gaiety Theatre adjacent to Marconi House, Strand, the London office of the Marconi Company, which is in the English Electric group.

**Pye-Polygon Agreement.**—Pye, Ltd., have formed an association with the Polygon Record Company and announce that the business of the Polygon Record Co. (1954), Ltd., will be conducted from 66, Haymarket, London, S.W.1, the address of the Nixa Record Co., Ltd.

The multiplicity of television aerials on the living quarters at the Tower of London have been removed by order of the Ministry of Works and a communal aerial system has been provided. This has been installed by **E.M.I. Sales and Service** and feeds into a four-stage distribution amplifier. The output of 2V r.f. is fed into two "ring mains" of coaxial cable which encircles the whole of the Tower, providing a signal for individual members of the residential staff.

A feature of the **Marconi Marine** equipment installed in the new Grimsby steam trawler *Joseph Knibb* is the recently introduced "Gannet" R/T gear. The receiver has a rotating-loop aerial enabling the set to be used for direction finding as well as for communications.

On behalf of the United States Navy Department the Hazeltine Electronics Corporation has awarded three

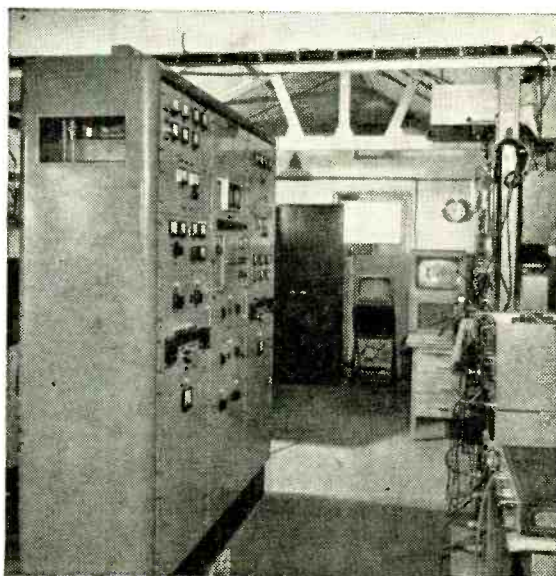

THE FIRST of 20 low-power television transmitters ordered from Standard Telephones & Cables by the B.B.C. is being used at the temporary station at Tacolneston, Norwich. The combined sound and vision transmitter is shown on the left in this photograph. The vision transmitter produces a peak-white power of 0.5 kW. All the 20 transmitters are for operation in Band I, some being used at temporary sites and others as standby equipment at permanent stations.

British companies contracts valued at over \$26M for the development and production of **Military Electronic Equipment** for N.A.T.O. countries. The contracts received by B.T.H., G.E.C. and Ferranti are valued at \$11.5M, \$10.5M and \$4.25M, respectively.

Thorn Electrical Industries, Ltd., manufacturers of **Ferguson** sound and television receivers, have purchased ground at Enfield, Middlesex, on which they are erecting another factory. The new site is within a few hundred yards of their present factory.

**Clare Instrument Company**, which was formed twelve months ago by J. de Gruchy, a contributor to *Wireless World* on instrument technology, has moved from Rickmansworth, Herts, to 8, South Street, West Worthing (Tel.: Worthing 3407). The London office remains at 39, Victoria Street, S.W.1 (Tel.: Abbey 1816).

**John Ould, Ltd.**, of 389, Fifth Avenue, New York, 16, U.S.A., has been formed to operate as a sales organization for British electronic and allied equipment. Their appointment as sole concessionaires for the United States was recently announced by W. Bryan Savage, Ltd., and Pamphonic Reproducers, Ltd.

A **Tape-to-Disc** recording service is provided by "Deroy" Sound Services, of Little Place, Moss Delph Lane, Aughton, Ormskirk, Lancs. Masters and pressings of both 78 r.p.m. and microgroove discs are supplied.

The title of **Hadley Sound Equipments, Ltd.**, of Cape Hill, Smethwick, Staffs, has been changed to **Hadley Telephone and Sound Systems, Ltd.**

The telephone number of **Superior Radio Supplies** in the advertisement pages of this issue, which went to press in advance of this section, should be Elgar 3644.

## COMPONENTS SHOW

THE RECORD number of 142 exhibitors will be participating in the twelfth annual exhibition of components, valves and test gear which opens at Grosvenor House, Park Lane, London, W.1, on April 19th for three days. The show opens at 10.0 each day and closes at 6.0 on the first, and at 9.0 and 5.0 respectively, on the two fol-

lowing days. Admission is restricted to wearers of an official badge obtainable, by engineers and technicians in the "user" industries and the Services, on application to the organizers, the Radio and Electronic Component Manufacturers' Federation, 22, Surrey Street, London, W.C.2. This year's exhibitors are listed below.

|   | Stand No. |   | Stand No.  |   | Stand No. |
|---|-----------|---|------------|---|-----------|
| <b>A.B. Metal Products</b>              | 41        | General Electric Co.                        | 135        | Reslosound                                  | 50        |
| A.K. Fans                               | 123       | Goldring Manufacturing Co.                  | 17         | Rola Celestion                              | 77        |
| Advance Components                      | 30        | Goodmans Industries                         | 47         | Ross, Courtney & Co.                        | 104       |
| Aerialite                               | 85        | Gresham Transformers                        | 70         | <b>Salford Electrical Instruments</b>       | 34        |
| Aero Research                           | 99        | Guest, Keen & Nettlefolds                   | 115        | Sankey, Joseph, & Sons                      | 128       |
| Allan Radio, Richard                    | 8         | <b>Hallam, Sleigh &amp; Cheston</b>         | 117        | Scott, Geo. L., & Co.                       | 118       |
| Antiference                             | 56        | Hassett & Harper                            | 141        | Simmonds Aerocessories                      | 140       |
| Associated Electronic Engineers         | 92        | Hellermann                                  | 89         | Sims, F. D.                                 | 133       |
| Automatic Coil Winder Co.               | 72        | Henley's Telegraph Works Co.                | 136        | Spear Engineering                           | 121       |
| <b>B.I. Callender's Cables</b>          | 57        | Hunt (Capacitors)                           | 23         | Stability Radio Components                  | 51        |
| Bakelite                                | 127       | <b>Igranic Electric Co.</b>                 | 12         | Standard Insulator Co.                      | 142       |
| Belling & Lee                           | 16        | Imhof                                       | 25         | Standard Telephones & Cables                | 5, 62     |
| Bird, Sydney S., & Sons                 | 53        | Insulating Components & Materials           | 122        | Static Condenser Co.                        | 112       |
| Bray, Geo., & Co.                       | 109       | <b>Jackson Bros.</b>                        | 74         | Steatite & Porcelain Products               | 38        |
| British Electric Resistance Co.         | 35        | J-Beam Aerials                              | 80         | Stocko (Metal Works)                        | 131       |
| British Mechanical Productions          | 76        | <b>Langley London</b>                       | 130        | Stratton & Co.                              | 60        |
| British Moulded Plastics                | 2         | London Electrical Co.                       | 36         | Suffix                                      | 48        |
| British Physical Laboratories           | 78        | London Electric Wire Co.                    | 61         | Supply, Ministry of                         | 91        |
| Bulgin & Co.                            | 21        | Long & Hambly                               | 31         | Swift, Levick & Sons                        | 139       |
| Bullers                                 | 1         | <b>Magnetic &amp; Electrical Alloys</b>     | 110        | Symons, H. D., & Co.                        | 113       |
| <b>Carr Fastener Co.</b>                | 75        | Mallory Batteries                           | 97         | <b>Taylor Electrical Instruments</b>        | 19        |
| Clark, H., & Co.                        | 116       | Marconi Instruments                         | 103        | Telcon-Magnetic Cores                       | 111       |
| Collaro                                 | 10        | Marrison & Catherall                        | 132        | Telegraph Condenser Co.                     | 54        |
| Colvern                                 | 55        | McMurdo Instrument Co.                      | 39         | Telegraph Construction & Maintenance Co.    | 66        |
| <i>Communications &amp; Electronics</i> | 93        | Measuring Instruments                       | 102        | Telephone Manufacturing Co.                 | 33        |
| Connollys (Blackley)                    | 9         | Micanite & Insulators Co.                   | 101        | Thermo-Plastics                             | 11        |
| Cosmocord                               | 79        | Minnesota Mining & Mftg. Co.                | 126        | Transradio                                  | 124       |
| Creators                                | 105       | Morganite Resistors                         | 15         | Truvox                                      | 28        |
| <b>Daly</b>                             | 100       | Mullard                                     | 65, 94, 95 | Tucker Eyelet Co.                           | 81        |
| Dawe Instruments                        | 73        | Multicore Solders                           | 69         | Tufnol                                      | 129       |
| De La Rue & Co. (Plastics)              | 83        | Murex                                       | 137        | <b>Vactite Wire Co.</b>                     | 7         |
| "Diamond H" Switches                    | 6         | Mycalex Co.                                 | 3          | Vitavox                                     | 43        |
| Dubilier Condenser Co.                  | 45        | <b>N.S.F.</b>                               | 49         | <b>Walter Instruments</b>                   | 86        |
| Duratube & Wire                         | 52        | Neill, James, & Co.                         | 90         | Wego Condenser Co.                          | 18        |
| <b>Edison Swan Electric Co.</b>         | 42        | <b>Oliver Pell Control</b>                  | 134        | Welwyn Electrical Laboratories              | 63        |
| Egen Electric                           | 37        | <b>Painton &amp; Co.</b>                    | 46         | Weymouth Radio Mftg. Co.                    | 13        |
| Electro Acoustic Industries             | 40        | Parmeko                                     | 27         | Whiteley Electrical Radio Co.               | 14        |
| Electronic Components                   | 108       | Partridge Transformers                      | 24         | Wiggin, Henry & Co.                         | 138       |
| <i>Electronic Engineering</i>           | 98        | Permanoid                                   | 88         | Wimbleton Engineering Co.                   | 87        |
| Electrothermal Engineering              | 120       | Plessey                                     | 67, 68     | Wingrove & Rogers                           | 59        |
| English Electric Co.                    | 106       | Pye   | 96         | Wireless Telephone Co.                      | 71        |
| Enthoven, H. J., & Sons                 | 58        | <b>Radio Instruments</b>                    | 84         | <i>Wireless World and Wireless Engineer</i> | 107       |
| Erg Industrial Corporation              | 119       | Reliance Electrical Wire Co.                | 26         | Woden Transformer Co.                       | 20        |
| Erie Resistor                           | 29        | Reproducers & Amplifiers                    | 32         | Wright & Weaire                             | 82        |
| Ever Ready Co.                          | 125       | <b>Salford Electrical Instruments</b>       | 34         | <b>Zenith Electric Co.</b>                  | 4         |
| <b>Ferranti</b>                         | 44        | Sankey, Joseph, & Sons                      | 128        |   |           |
| Fine Wires                              | 114       | Scott, Geo. L., & Co.                       | 118        |   |           |
| <b>Garrard Engineering Co.</b>          | 64        | Simmonds Aerocessories                      | 140        |   |           |
|   |           | Sims, F. D.                                 | 133        |   |           |
|   |           | Spear Engineering                           | 121        |   |           |
|   |           | Stability Radio Components                  | 51         |   |           |
|   |           | Standard Insulator Co.                      | 142        |   |           |
|   |           | Standard Telephones & Cables                | 5, 62      |   |           |
|   |           | Static Condenser Co.                        | 112        |   |           |
|   |           | Steatite & Porcelain Products               | 38         |   |           |
|   |           | Stocko (Metal Works)                        | 131        |   |           |
|   |           | Stratton & Co.                              | 60         |   |           |
|   |           | Suffix                                      | 48         |   |           |
|   |           | Supply, Ministry of                         | 91         |   |           |
|   |           | Swift, Levick & Sons                        | 139        |   |           |
|   |           | Symons, H. D., & Co.                        | 113        |   |           |
|   |           | <b>Taylor Electrical Instruments</b>        | 19         |   |           |
|   |           | Telcon-Magnetic Cores                       | 111        |   |           |
|   |           | Telegraph Condenser Co.                     | 54         |   |           |
|   |           | Telegraph Construction & Maintenance Co.    | 66         |   |           |
|   |           | Telephone Manufacturing Co.                 | 33         |   |           |
|   |           | Thermo-Plastics                             | 11         |   |           |
|   |           | Transradio                                  | 124        |   |           |
|   |           | Truvox                                      | 28         |   |           |
|   |           | Tucker Eyelet Co.                           | 81         |   |           |
|   |           | Tufnol                                      | 129        |   |           |
|   |           | <b>Vactite Wire Co.</b>                     | 7          |   |           |
|   |           | Vitavox                                     | 43         |   |           |
|   |           | <b>Walter Instruments</b>                   | 86         |   |           |
|   |           | Wego Condenser Co.                          | 18         |   |           |
|   |           | Welwyn Electrical Laboratories              | 63         |   |           |
|   |           | Weymouth Radio Mftg. Co.                    | 13         |   |           |
|   |           | Whiteley Electrical Radio Co.               | 14         |   |           |
|   |           | Wiggin, Henry & Co.                         | 138        |   |           |
|   |           | Wimbleton Engineering Co.                   | 87         |   |           |
|   |           | Wingrove & Rogers                           | 59         |   |           |
|   |           | Wireless Telephone Co.                      | 71         |   |           |
|   |           | <i>Wireless World and Wireless Engineer</i> | 107        |   |           |
|   |           | Woden Transformer Co.                       | 20         |   |           |
|   |           | Wright & Weaire                             | 82         |   |           |
|   |           | <b>Zenith Electric Co.</b>                  | 4          |   |           |

# Design for an F.M. Tuner

## I—Underlying Principles of Receivers for the New B.B.C. Service

By S. W. AMOS,\* B.Sc. (Hons.), A.M.I.E.E., and G. C. JOHNSTONE,\* B.Sc. (Hons.)

**I**N anticipation of the B.B.C. frequency-modulated service, due to start in May with regular programmes initially from Wrotham, the authors have constructed a suitable tuner for feeding high-quality audio amplifiers. The tuner, for which constructional details will be given in next month's issue, includes a built-in mains unit and is designed to use readily available components. Underlying principles and general design features are discussed in the present article.

The B.B.C. proposes initially to employ carrier frequencies spaced at 200 kc/s intervals in the frequency range 88.1-94.5 Mc/s. This range is, however, only part of the range (Band II) allocated by international agreement to v.h.f. sound broadcasting. The full extent of the band is from 87.5 Mc/s to 100 Mc/s, and whilst at present the frequencies in the range 95 Mc/s to 100 Mc/s are used by police and other services, it is quite conceivable that in time frequencies in the upper part of the band will be employed for broadcasting purposes; thus the desirable receiver coverage is 87.5 Mc/s to 100 Mc/s.

The tuner's sensitivity should be such that at any point within the service areas the three local B.B.C. transmissions can be received. As the three transmitters will be of approximately equal power the field strengths at the receiving aerial will be approximately equal. For the purposes of classification the service area of each transmitter is divided by the B.B.C. into two regions; these are the first-class service region (field strength greater than 1 millivolt per metre) and the second-class service region (field strength between 250 microvolts per metre and 1 millivolt per metre). The significant difference between these two regions is that within the latter area some trouble from ignition interference may be experienced.

The receiver input voltage  $V$  is related to the field strength  $E$  at the aerial by the expression  $V = \frac{E\lambda}{2\pi}$ ,

where  $\lambda$  is the wavelength. In deducing the expression it was assumed that the aerial is a half-wave dipole, that matching is perfect throughout, and that feeder losses are negligible. For Band II  $\lambda$  is approximately  $\pi$  metres and the above expression may be simplified to  $E/2$ . Thus at the edge of the second-class service area the signal at the receiver terminals will be of the order of 125 microvolts.

However, this figure cannot be used as a basis for receiver design without some further qualification. The maps published by the B.B.C. give the average field strength at an aerial height of 30 feet. For lower aerials the field strength is less, being approximately proportional to height. Moreover, the field strength within a building is likely to be appreciably below the outdoor value, and tests indicate that this drop under unfavourable conditions may be of the order

of 30 db. Thus at the edge of the second-class service area, with a picture-rail aerial, in a ground-floor room, at the side of a building remote from the transmitter, the signal at the receiver terminals may be as low as  $4 \mu\text{V}$ . With such a small input the signal-to-noise ratio is likely to be barely acceptable, but this figure indicates the order of sensitivity required for a tuner destined for universal use.

Before the general form of the tuner can be considered, it is necessary to decide the type of discriminator to be used. The most popular ones are the Foster-Seeley and the ratio detector. The choice is governed by considerations of linearity and amplitude modulation rejection. The Foster-Seeley discriminator is capable of better linearity than the ratio detector but requires careful design and adjustment to obtain it, whereas the linearity of the ratio detector is not greatly affected by small variations of circuit parameters. As an indication of the distortion of the two, the Foster-Seeley can give less than 1% harmonic distortion at 75-kc/s deviation, whilst the ratio detector for the same deviation may give approximately 3%.

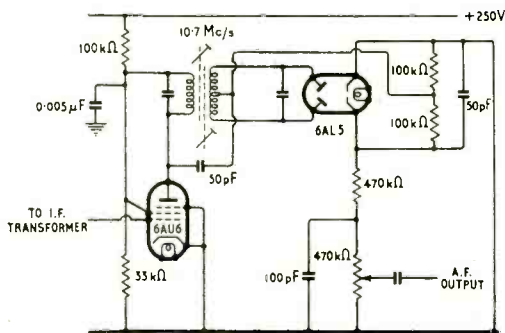

Typical Foster-Seeley discriminator.

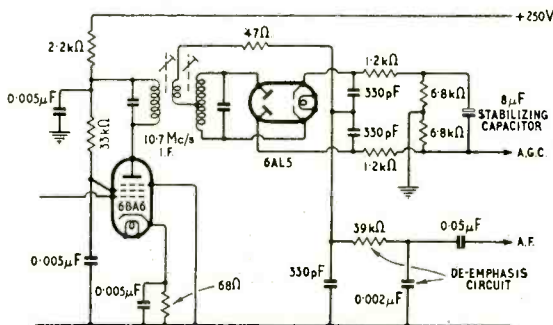

The f.m. ratio detector; a de-emphasis circuit is included also in the Foster-Seeley discriminator.

\* B.B.C. Engineering Training Department.

The chief difference between the two detectors is in their amplitude modulation rejection properties. The Foster-Seeley circuit is balanced, and thus gives good amplitude modulation rejection at its centre frequency; elsewhere its response to a.m. is proportional to the difference between the signal and centre frequencies. The ratio detector is also balanced at the centre frequency, but by virtue of the action of the stabilizing capacitor, its response at other frequencies is very much less than that of the Foster-Seeley circuit. For this reason it is usual to precede a Foster-Seeley discriminator by an amplitude limiter. Whilst such a limiter is not essential before a ratio detector, it can be employed to give additional rejection at high signal levels. The limiter used with a Foster-Seeley discriminator requires approximately 1 volt of signal at its *input* for limiting, whereas the ratio detector requires a signal of approximately 1 volt at the diode for limiting. Since the stage preceding a ratio detector may operate at full gain one i.f. stage can sometimes be saved by adopting this detector; in a particular design this may well be the deciding factor. On balance it was decided that the ratio detector was better suited for use in the tuner to be described.

## Receiver Amplification

With a ratio detector the gain required from the aerial terminals to the detector is of the order of  $10^3$ ; with a Foster-Seeley discriminator this is the order of gain required prior to the limiter grid. The major portion of this gain must be obtained from the i.f. amplifier, but there will be a useful contribution from the frequency changer and r.f. amplifier. The necessity for an r.f. amplifier is not immediately obvious, because its gain will be considerably less than that of the same valve used as an i.f. amplifier. In spite of its low gain, the stage is necessary for the following reasons. The noise factor of a mixer stage is almost always considerably larger than that of an r.f. amplifier; since the signal-to-noise ratio of the tuner is determined almost entirely by that of its first stage, it is clear that this stage should be an r.f. amplifier for best signal-to-noise ratio.

Moreover the stage reduces feedback from the local oscillator to the aerial. Such feedback can cause interference to other receivers, and must be held to a low level. It has been suggested that in order to minimise such interference the maximum oscillator voltage appearing at the aerial terminals (loaded by an aerial or dummy load) should be less than 200 microvolts within Band II, and less than 500 microvolts at other frequencies. With the additive type of mixer usually employed at v.h.f. the local oscillator may provide up to 3 or 4 volts output at the grid of the mixer and the reduction of this voltage to the specified limits at the aerial terminals calls for careful design. With the multiplicative type of mixer, this problem is less acute because the input grid is screened from the oscillator grid. Finally, the increased selectivity conferred by the r.f. stage provides increased protection against image channel interference and i.f. break-through.

In order to calculate in detail the gains of the various stages of the tuner we must consider the circuit of each stage in greater detail. Three types of r.f. stage are commonly employed. These are the single pentode, the earthed-grid triode and the cascode (a combination of earthed-cathode and earthed-grid triodes in cas-

cade). The behaviour of the cascode is generally similar to that of a pentode, having an overall mutual conductance equal to that of its constituent triodes. Due to the absence of partition noise, it has, however, a lower noise factor than the corresponding pentode. Except under conditions of extremely low field strength it is doubtful if the better signal-to-noise ratio justifies the employment of a cascode circuit in preference to an r.f. pentode.

The earthed-grid triode r.f. stage is **not** generally favoured at frequencies as low as 100 Mc/s because it suffers from a number of disadvantages. First, the gain available from the aerial input circuit is low, due to the low input impedance ( $1/g_m$ ); secondly, the noise factor is higher than that of a cascode and comparable with that of the r.f. pentode; thirdly, it offers insufficient protection against oscillator feedback to the aerial, the output and input circuits being linked by the anode a.c. resistance of the valve.

There thus seems little advantage in departing from a simple pentode r.f. stage. In general, because of the damping of the first tuned circuit by the aerial resistance and the input resistance of the r.f. stage, there is no point in having variable tuning in this circuit; it is normally sufficient for the circuit to be resonant at the mid-band frequency. The damping resistance due to the valve will be of the order of 2 to  $6k\Omega$  and is in parallel with the dynamic resistance of the tuned circuit. If we assume a total tuning capacitance of 15 pF (i.e., the sum of the valve input capacitance, strays and a small amount of lumped capacitance) and a Q value of 50, the natural dynamic resistance of the tuned circuit is approximately  $5k\Omega$ . This is reduced by valve damping to 1.5 to  $2k\Omega$  and the aerial feeder impedance must be matched to this resistance to secure maximum voltage transfer and correct feeder impedance termination. With a 75-ohm feeder, the impedance ratio is about 1:25 and the voltage step-up ratio consequently about 5. Thus the total damping resistance from all sources is approximately  $1,000\Omega$ , which, for a tuning capacitance of 15 pF, gives a working Q value of approximately 10. The response is then 3 db down at each end of the band, relative to the response at the mid-band frequency.

## R.F. Stage

The gain from grid to anode of the r.f. stage, is intimately linked with the input resistance of the mixer stage, which is usually low, of the order of 2 to  $3k\Omega$ . With this value there is some advantage to be gained by having variable tuning for the anode circuit, and with an additive type of mixer, variable tuning is essential to present a relatively constant impedance to the oscillator. The size of the tuning elements is determined largely by the requirements of the oscillator circuit, with which the anode circuit must be ganged. In general, this necessitates a tuning capacitance of the order of 20 to 30 pF, and hence gives a natural dynamic resistance in the region of 2.5 to  $5k\Omega$ . The total load presented to the r.f. stage is thus 1 to  $2k\Omega$ , giving a stage gain of approximately 10 with a valve having a mutual conductance of 6 mA/V. The gain from aerial input to mixer grid is thus about 50, and the gain required from the mixer and i.f. stages is  $2 \times 10^3$ . With a triode mixer, the input resistance is rather difficult to predict, because Miller effect plays a large part in determining it; under certain circumstances it may even be negative.

The combination of oscillator and separate mixer is

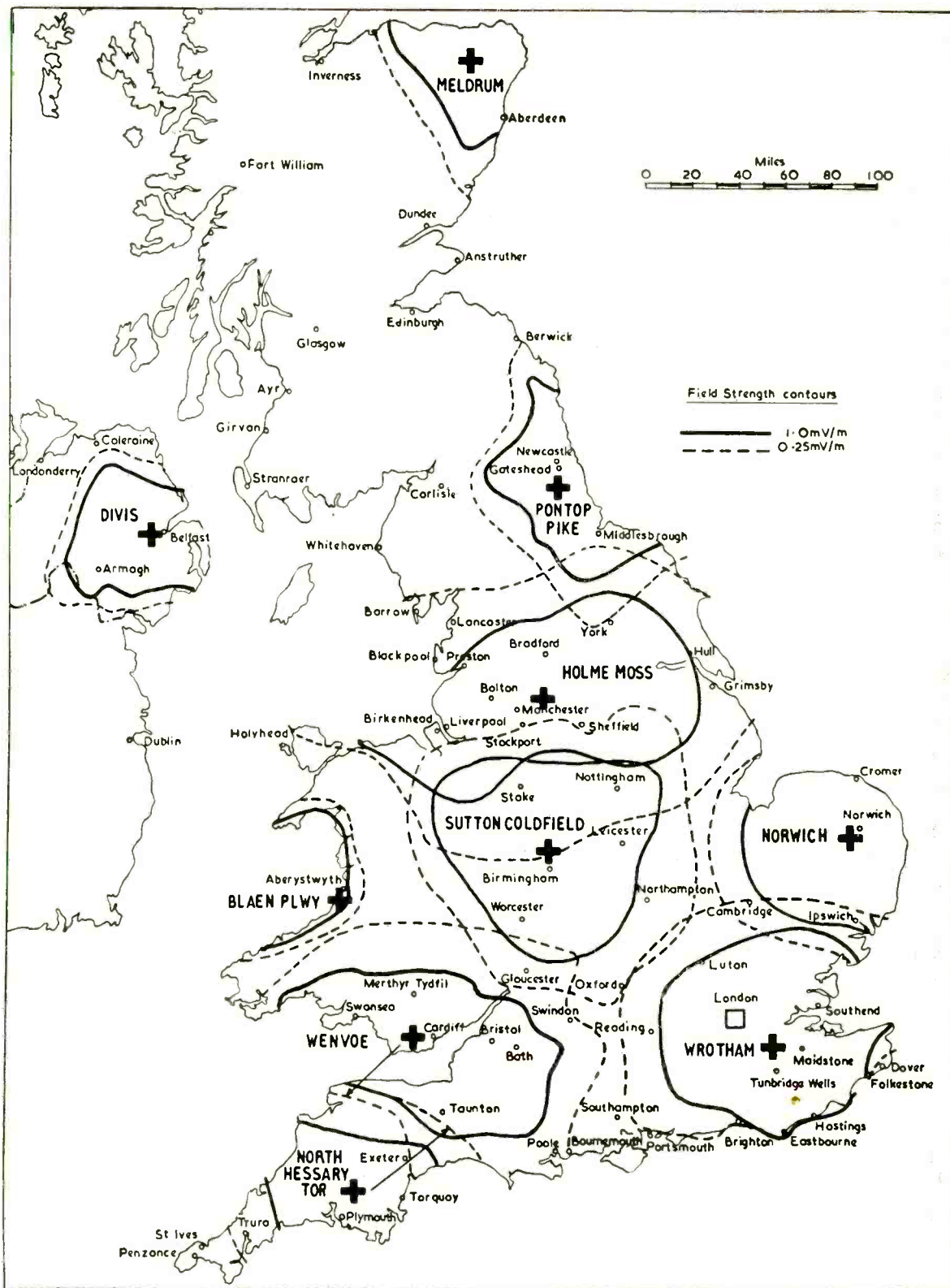

Estimated coverage of the first ten f.m. stations to be brought into service is shown on this map reproduced by courtesy of the B.B.C. The frequencies of the three transmitters at each station were given on page 56 of our February issue.

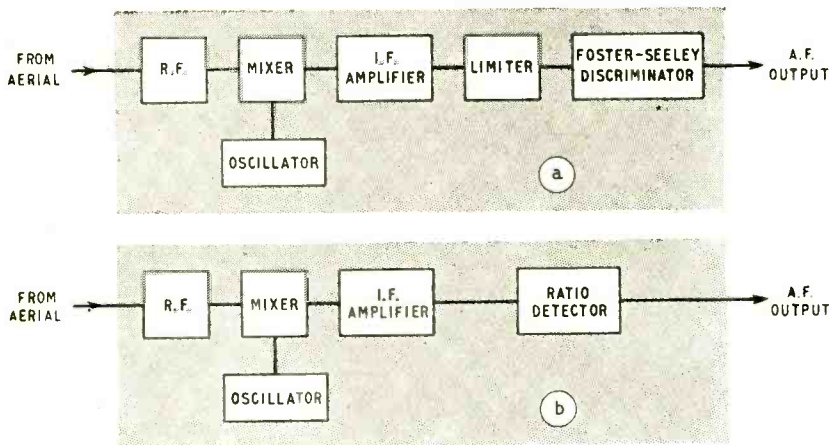

Block diagrams showing the main differences between (a) f.m. receiver with Foster-Seeley discriminator and (b) with a ratio detector.

usually preferred to the multiplicative mixer, because the former gives an appreciably higher conversion conductance (about 2 to 3 mA/V compared with 0.5 to 1.0 mA/V). The oscillator may be a Hartley, Colpitts or Reinartz type but there are two factors which restrict the choice. First, it is desirable that one "pole" of the tuning capacitor should be earthed; this eases ganging problems. Secondly, the cathode of the oscillator should preferably be earthed; with the cathode divorced from earth, the cathode-heater capacitance forms a significant part of the total tuning capacitance, and there is a risk of microphony and hum induction due to movement of the heater with respect to the cathode.

## Receiver Bandwidth

The component values in the oscillator circuit are a compromise between the extremes of a large tuning capacitance, to "swamp" valve capacitance variations, and a small value, to give a high dynamic resistance and hence maximum assistance to the maintenance of oscillation. A reasonable compromise value of tuning capacitance is 30 pF.

The mixer and i.f. amplifier are required to give a voltage gain of approximately  $2 \times 10^3$  and have to satisfy certain selectivity requirements. The channel spacing of 200 kc/s would appear to impose fairly stringent requirements on receiver selectivity to minimize adjacent-channel interference. However, for any given locality the transmitters employing adjacent channels will be remote geographically and it is doubtful if any appreciable adjacent-channel interference will result. The bandwidth of the i.f. amplifier is thus determined largely by the harmonic distortion tolerable, the local-oscillator frequency drift and threshold effect.

The phenomenon of threshold effect is peculiar to all forms of angular modulation and there is no comparable effect in amplitude modulation. In brief, when the amplitude of an interfering signal exceeds that of the wanted signal, there is an abrupt deterioration of the signal-noise ratio. For ignition interference and random noise, the peak value of the noise signal is proportional to the square root of the receiver bandwidth and to preserve the signal-to-noise ratio at the highest possible value, the receiver bandwidth should

be the minimum consistent with adequate bandwidth for the wanted signal. For a signal with a deviation of 75 kc/s, the sidebands extend well beyond the apparent swept limits of  $\pm 75$  kc/s and thus it is usual to assume a minimum bandwidth, between the 3-db loss points, of 180 kc/s. To allow for oscillator frequency drift this is usually increased to between 200 and 250 kc/s.

The r.f. circuits of v.h.f. receivers have bandwidths measured in Mc/s rather than kc/s and the receiver selectivity is almost entirely determined by the bandwidth of the i.f. amplifier. As an indication of

the performance likely to be achieved by a practical i.f. transformer we will assume each winding to have a Q-value of 50 and the coupling factor to be unity ( $kQ = 1$ ). At an operating frequency of approximately 10 Mc/s the response is 0.6 db down at 75 kc/s from resonance and 7 db down at 200 kc/s from resonance. With a coupling factor of unity the response in the passband for Q-values exceeding 50 tends to be unsatisfactory and it is usual to employ coupling factors between 1 and 1.5 which give small "rabbit's ears" and maintain reasonably flat response in the passband.

The overall bandwidth depends on the number of i.f. transformers employed and this, in turn, is determined by the total number and the stage gains. The gain per stage is given by  $g_m R_d n / (1 + n^2)$  where  $n$  is the coupling factor ( $=kQ$ ),  $R_d$  is the dynamic resistance of either tuned circuit alone (assuming both the same) and  $g_m$  is the mutual conductance of the i.f. valve. With  $n$  between 1 and 1.5,  $n/(1 + n^2)$  varies between 0.5 and 0.446. This is a very small variation and thus the stage gain depends almost entirely on  $R_d$  and  $g_m$ .  $R_d$  is given by  $\omega QL$  and, for maximum gain,  $Q$  and  $L$  should be large. An upper limit to the value of  $L$  is set by the minimum value of tuning capacitance which can be employed; whilst it is possible to tune by valve and stray capacitance alone, this is undesirable because valve capacitances vary, particularly when an a.g.c. voltage is applied, causing appreciable change in the shape of the i.f. response curve. In general the lowest minimum value of lumped capacitance is of the order of 15 to 20 pF; even with these values appreciable detuning may occur. Where the highest stage gain is not of prime importance, 50 pF may be taken as a suitable value of lumped tuning capacitance.

The Q-value of the inductor depends upon many factors, amongst which are wire size, coil-former dimensions, and screening-can dimensions. By careful design, Q-values of the order of 100 at 10 Mc/s can be realized; if the lumped tuning capacitance is 20 pF, and valve and stray capacitance total 10 pF, a stage gain of about 200 can be obtained from a valve with a mutual conductance of 8 mA/V. This may be taken as representative of the upper limit of gain per i.f. stage and with such component values instability would probably occur. In practice, Q-values in the region of 70 to 80 are more likely to be obtained and with a tuning capacitance of 50 pF the stage gain is in the region of 70.



With an i.f. transformer of this kind having 50-pF tuning capacitors the gain of an additive-pentode mixer is about 20; the i.f. amplifier is thus required to contribute a gain of about 100 to give the required overall gain. This gain could be obtained from a single i.f. stage but it is preferable to use two stages. Where a ratio detector is employed the last i.f. stage can then be operated as a high-level limiter. This improves a.m. rejection for large inputs whilst giving useful gain for small input signals.

### Oscillator Frequency

The general form of the receiver is determined as described above but there are a number of additional features of an f.m. receiver to which attention must be paid. For example, should the oscillator frequency be above or below that of the signal? The lower value permits better oscillator stability because a larger tuning capacitor can be used; the higher value gives less likelihood of second-channel interference. In order to discuss the choice further, it is necessary now to consider the precise value of the intermediate frequency.

One of the unfortunate features of an f.m. receiver is that harmonics of the intermediate frequency are generated in late i.f. stages and the discriminator; this is due to the pulsating nature of the current in such stages. These harmonics can reach early stages of the receiver and may cause whistles and/or the appearances of "dead" carriers. To minimize this, the i.f. should be so chosen that its harmonics do not lie in the band to be received. Where the band is 88 to 108 Mc/s (as in the U.S.A.) the i.f. must be above 21.6 and below 22 Mc/s to satisfy this requirement. At such frequencies, it is difficult to achieve adequate selectivity. A lower limit to the value of the i.f. is set by the requirement that the frequency shall be greater than half that of the band to be received, to ensure that there are no image signals within the band itself. This minimum value for 88 to 108 Mc/s is 10 Mc/s and a frequency which seems to be favoured as the best compromise is 10.7 Mc/s. This i.f. has the disadvantage that the oscillator frequency can fall within

the received band; for example, when the receiver is tuned to 88 Mc/s, if the oscillator frequency is 98.7 Mc/s, any oscillator radiation can cause interference to local receivers tuned to 98.7 Mc/s. Alternatively if the oscillator frequency is 10.7 Mc/s below the signal frequency and the receiver is tuned to say 98.7 Mc/s interference may be caused to receivers tuned to 88 Mc/s. Interference can thus occur over a range of frequencies at either end of the band, and for the British Band II, this range is 1.7 Mc/s. This difficulty could be overcome by adopting an i.f. of say 12.5 Mc/s, but there remains the problem of image interference and oscillator harmonics falling in this band.

With an intermediate frequency of 10.7 Mc/s, the two image channel bands are 66.1 to 78.6 Mc/s and 108.9 to 121.4 Mc/s. The former band includes the vision carrier of television channel 5 and a number of relatively high-power police and public service transmissions in the band 70 to 80 Mc/s. The band 108.9 to 121.4 Mc/s includes aircraft communication channels, which are less likely to cause interference.

With the oscillator above the signal frequency there is a possibility of the oscillator second harmonic causing interference in Band III; with the oscillator below, the harmonics fall clear of Band III. Summarizing, there is a possibility of interference with Band III television receivers when the oscillator frequency is high, and the possibility of image channel interference when the oscillator frequency is low. Provided these effects are minimized, receivers can be satisfactorily operated with high or low oscillator frequencies. But possibly on balance the choice would be for a higher oscillator frequency.

Oscillator radiation can be a serious problem and can occur in three distinct ways: (a) from the wiring or chassis due to circulating currents (b) from the aerial (c) from the mains lead. For all three classes of interference, limits have been laid down by the B.S.I. for television receivers and doubtless similar limits will be laid down for v.h.f. frequency modulated sound receivers. Clearly the design of any v.h.f. tuner should be such as to conform at least with these limits.

## SHORT-WAVE CONDITIONS

### Predictions for April

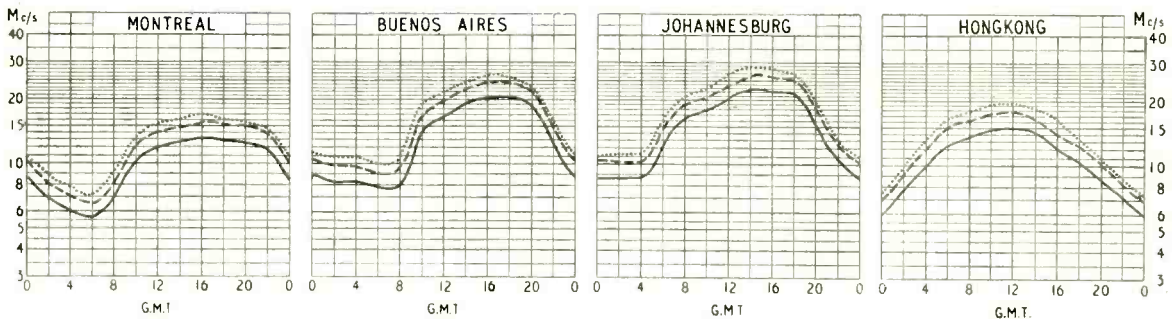

THE full-line curves given here indicate the highest frequencies likely to be usable at any time of the day or night for reliable communications over four long-distance paths from this country during April.

Broken-lines curves give the highest frequencies that will sustain a partial service throughout the same period.

- ..... FREQUENCY BELOW WHICH COMMUNICATION SHOULD BE POSSIBLE FOR 25% OF THE TOTAL TIME
- PREDICTED AVERAGE MAXIMUM USABLE FREQUENCY
- FREQUENCY BELOW WHICH COMMUNICATION SHOULD BE POSSIBLE ON ALL UNDISTURBED DAYS

# D.C. Stability of Transistor Circuits

By FRANCIS OAKES\*, M.Inst.E., A.M.Brit.I.R.E., Assoc. I.E.E.

## Basic Formulæ and Design Data for Junction Types

A TRANSISTOR can be regarded as a combination of two diodes, one of them, biased in the forward direction, representing the emitter-base junction, the other, biased in the reverse direction, representing the base-collector junction. Transistor action, due to minority carrier injection, allows the reverse current of the base-collector junction to be controlled by the forward current through the emitter-base diode. Apart from this conduction by minority carriers, a leakage current flows across the base-collector junction due to impurities in the collector. This current, referred to as  $I_{co}$ , is not controlled by the emitter current, and unfortunately, increases rapidly with rising temperature.

**Direct-current Relationships.**—At any transistor operating point for which the emitter potential is positive, and for which the collector potential is negative with respect to the base, the current  $I_e$  (conventional) flowing into the emitter is equal to the sum of the currents  $I_c$  and  $I_b$  flowing out of the collector and base respectively. This can be expressed in the following forms:

$$I_e = I_c + I_b \quad \dots \quad (1)$$

The collector current, on the other hand, is made up of the flow of minority charge carriers transferring a current  $\alpha I_e$  from the emitter and by the impurity current  $I_{co}$ . The factor  $\alpha$  which is referred to as the emitter direct-current amplification factor is a positive number, somewhat smaller than unity for junction transistors. The impurity current  $I_{co}$  is the current which will flow from the base to the collector when there is zero current flowing into the emitter. These circumstances may be represented in the equation

$$I_c = \alpha I_e + I_{co} \quad \dots \quad (2)$$

Substituting this expression for  $I_c$  into equation (1), the base current can be obtained in terms of  $I_e$  and  $I_{co}$ :

$$I_b = I_e (1 - \alpha) - I_{co} \quad \dots \quad (3)$$

**Influence of  $I_{co}$  upon  $I_b$ ,  $I_c$  and  $I_e$ .**—When interpreting these expressions for application to practical design or to circuit analysis, it is important to realize that  $I_{co}$  is a fixed quantity which is determined by the particular transistor and by the temperature of the collector junction. Furthermore, that of the remaining three currents  $I_b$ ,  $I_c$  and  $I_e$ , only one can be chosen at will, for a given current amplification factor  $\alpha$ . In other words, if an operating point is chosen in a region of the static characteristic plane where  $\alpha$  is of a certain desired value, the circuit must be so designed that suitable current conditions are fulfilled for all three transistor currents. For instance, if the emitter current has been suitably chosen and is supplied by a constant current generator and, because

of bad design, the base current cannot adjust itself to a sufficiently small value as indicated by equation (3), the operating point will be forced into a region of low current amplification. This can be seen in Fig. 1. Operating points for comparatively high base currents are found only in the shaded area. Thus, it is of interest to express each of the direct currents in terms of each of the remaining two, the emitter-to-collector current amplification factor  $\alpha$  and the base-to-collector current amplification factor  $\alpha'$ . The latter is given by:

$$\alpha' = \frac{\alpha}{1 - \alpha} \quad \dots \quad (4)$$

A graph for easy conversion is shown in Fig. 2. Equation (2) immediately yields:

$$I_e = \frac{I_c - I_{co}}{\alpha} \quad \dots \quad (5)$$

From equation (3) it follows that:

$$I_e = \frac{I_b + I_{co}}{1 - \alpha} = (1 + \alpha')(I_b + I_{co}) \quad \dots \quad (6)$$

Substituting  $I_e$  from equation (5) into equation (3), yields:

$$I_b = \frac{I_c (1 - \alpha)}{\alpha} - \frac{I_{co} (1 - \alpha)}{\alpha} - I_{co} \quad \dots \quad (7)$$

Therefore

$$I_b = \frac{I_c}{\alpha'} - \frac{I_{co}}{\alpha} \quad \dots \quad (8)$$

Thus,

$$I_c = \alpha' I_b + \frac{\alpha'}{\alpha} I_{co}$$

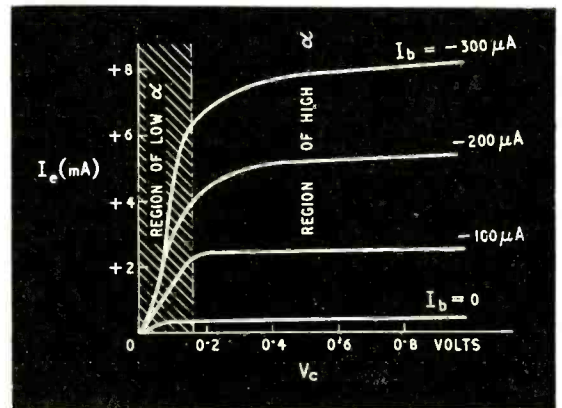

Fig. 1. Emitter currents for constant base currents in a junction transistor.

\*Ferguson Radio Corporation.

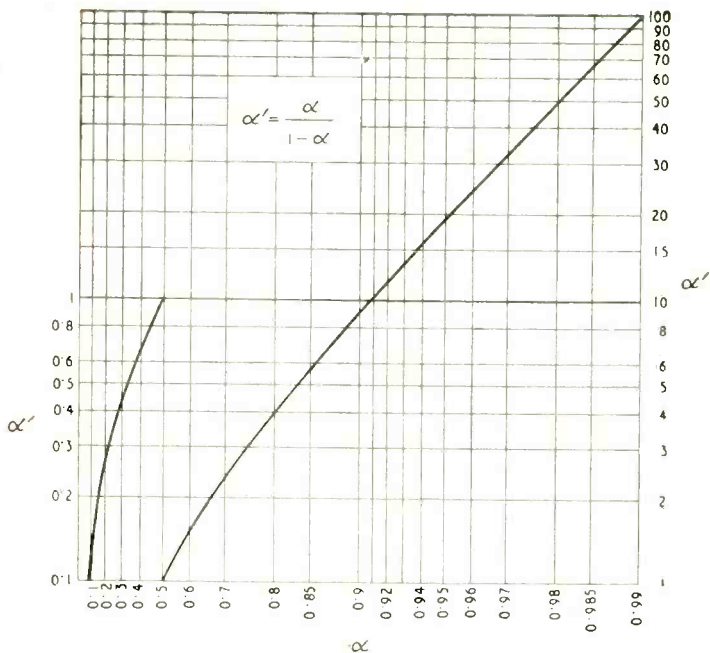

Fig. 2. Correlation curve for transistor current amplification factors

But since:

$$\frac{\alpha'}{\alpha} = \frac{1}{1 - \alpha} = 1 + \alpha' \dots \dots \dots (9)$$

$$I_c = \alpha' I_b + (1 + \alpha') I_{co} \dots \dots \dots (10)$$

or:

$$I_c = \frac{\alpha I_b + I_{co}}{1 - \alpha} \dots \dots \dots (11)$$

These relationships are set out in the table given below.

**Amplified Leakage Current and Collector Current "Run-Away."**—Some important implications follow from these equations. When a transistor is operated in grounded-base connection, the emitter current is simply flowing across the base-collector diode reverse resistance. It therefore appears as a leakage current of magnitude  $I_{co}$ , being a part of the current flowing through the collector. If, however, the transistor is operated with a grounded emitter, the base current controlling the collector current, the portion of the emitter and collector current due to the flow of impurity current is  $(1 + \alpha') I_{co}$ . This means, that with a good transistor giving a large current amplification  $\alpha'$  the leakage current flowing in the emitter and collector paths will be increased

**CURRENT CONVERSION TABLE**

| →     | $I_b$                                | $I_c$   | $I_e$                       |
|-------|--------------------------------------|---|-----------------------------|
| $I_b$ | $I_b$                                | $\frac{I_c}{\alpha'} - \frac{I_{co}}{\alpha}$ | $(1 - \alpha) I_c - I_{co}$ |
| $I_c$ | $\alpha' I_b + (1 + \alpha') I_{co}$ | $I_c$   | $\alpha I_c + I_{co}$       |
| $I_e$ | $(1 + \alpha') (I_b + I_{co})$       | $\frac{1}{\alpha} (I_c - I_{co})$             | $I_e$                       |

very considerably. The same holds good for the grounded collector connection provided that the base current is controlling the other two currents.

An interesting case is that of a transistor connected across a voltage source, emitter positive, collector negative and with the base terminal left disconnected. The base current is thus zero and the emitter and collector currents are identical and equal to:

$$I_c = I_e = \frac{I_{co}}{1 - \alpha} = (1 + \alpha') I_{co} \dots (12)$$

as follows from equations (6) and (10).

This shows that a transistor which will pass a leakage current  $I_{co}$  when connected across a voltage source via its base and collector terminals will take a current  $(1 + \alpha') I_{co}$  when connected via its emitter and collector terminals. Since  $(1 + \alpha')$  can easily be of the order (or in excess) of 30, it can be seen that an  $I_{co}$  of only a small fraction of a milliampere can be responsible for an augmented leakage current capable of destroying the transistor. In amplifier and oscillator circuits, the transistor is often connected in grounded-collector or grounded-emitter configuration, and the base direct current is usually held substantially constant. Under

normal operating conditions, the leakage current  $I_{co}$  is initially quite small, but increases as a result of warming up through normal collector dissipation. The increased  $I_{co}$  in turn raises the collector current by an amount  $(1 + \alpha') I_{co}$  which can now become quite appreciable, and in turn contributes to raise the collector temperature. The process is cumulative and the collector current "runs away" exceeding the safe limit and destroying the transistor.

**Transistor Circuit Stability.**—Since the influence of the impurity current upon the collector current cannot be neglected, it is important to ensure that this influence will not exceed the safe or permissible limits. The intrinsic current can rise to many times its original value for a temperature rise of 20° or 30°C, and for instance, if a transistor is operated near its maximum permissible collector dissipation, any increase in collector current due to the increase in leakage current at raised temperature will have to be held within close limits.

A stability factor can be defined as:

$$S = \frac{\partial I_c}{\partial I_{co}} \dots \dots \dots (13)$$

which is the rate of change of collector current produced by a change of impurity current. For stable operation, S should be as low as possible, and good stability can usually be obtained by suitable circuit design at the expense of power economy.

As can be seen immediately from the current relationships set out in the table, the stability factor for the grounded-base amplifier where the emitter current controls the other currents,

$$S = 1 \dots \dots \dots (14)$$

and for the grounded-emitter amplifier,

$$S = (1 + \alpha') = \frac{1}{1 - \alpha} \dots \dots \dots (15)$$

This indicates that the grounded-emitter amplifier will be more seriously affected by variations in  $I_{co}$

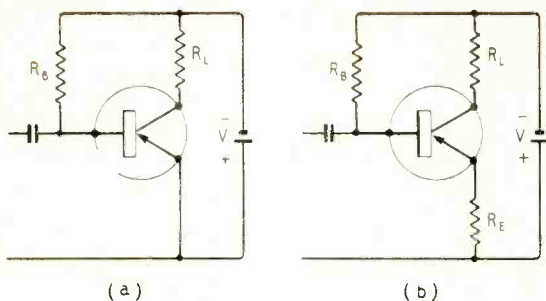

Fig. 3. Simple transistor amplifier (a) without stabilization, (b) with stabilizing resistor

due to temperature changes or other reasons. It is possible however to stabilize the collector current against such effects by the application of negative feedback. In applications where the loss in a.c. gain produced by such feedback would be detrimental, bypass condensers have to be used to reduce the feedback action to a permissible level at the operating frequencies.

A simple practical amplifier circuit is shown in Fig. 3, by way of illustrating the principle of stabilization. Fig. 3(a) does not contain a stabilizing resistor;  $R_B$  represents the base bias resistor,  $R_L$  the load. Under normal operating conditions, the emitter-to-base voltage is so small that it can be neglected, therefore the voltage across the bias resistance  $R_B$  is practically equal to the battery voltage. Hence

$$I_b = \frac{V}{R_B} \dots \dots \dots (16)$$

$$I_c = \alpha' \frac{V}{R_B} + (1 + \alpha')I_{co} \dots \dots \dots (17)$$

and

$$S = \frac{\partial I_c}{\partial I_{co}} = (1 + \alpha') = \frac{1}{(1 - \alpha)} \dots \dots \dots (18)$$

Equation (18) is of course identical with equation (15).

If the stabilizing resistance  $R_E$  is included as shown in Fig. 3(b), the voltage across  $R_B$  is no longer equal to the battery voltage, but equals the difference between this and the voltage drop across  $R_E$ . Thus, an increase in  $I_{co}$  will produce an amplified leakage current through the emitter. This in turn will drop additional voltage across the stabilizing feedback resistor  $R_E$ . This additional voltage reduces the voltage available

across the bias resistor  $R_B$  thereby cutting down bias current and reducing the collector current. In this way, the increase of collector current on account of  $I_{co}$  is reduced.

$$I_b R_B = V - I_e R_E \dots \dots \dots (19)$$

Using the conversion table,  $I_b$  and  $I_e$  can be expressed in terms of  $I_c$ .

$$\left(\frac{I_c}{\alpha'} - \frac{I_{co}}{\alpha}\right) R_B = V - \frac{R_E}{\alpha} (I_c - I_{co})$$

$$I_c \left(\frac{R_B}{\alpha'} + \frac{R_E}{\alpha}\right) = V + I_{co} \left(\frac{R_B}{\alpha} + \frac{R_E}{\alpha}\right)$$

$$I_c \left(\frac{1 - \alpha}{\alpha} + \frac{R_E}{\alpha R_B}\right) = \frac{V}{R_B} + I_{co} \left(\frac{1}{\alpha} + \frac{R_E}{\alpha R_B}\right)$$

$$I_c = \frac{\frac{\alpha V}{R_B} + I_{co} \left(1 + \frac{R_E}{R_B}\right)}{1 - \alpha + \frac{R_E}{R_B}} \dots \dots \dots (20)$$

$$S = \frac{\partial I_c}{\partial I_{co}} = \frac{1 + \frac{R_E}{R_B}}{1 - \alpha + \frac{R_E}{R_B}} \dots \dots \dots (21)$$

Equations (20) and (21) show that the collector current is reduced by negative feedback, which depends on the ratio of stabilizing feedback resistance to base bias resistance.

Curves correlating the stability factor with this ratio are shown in Fig. 4. As the ratio  $R_E/R_B$  approaches zero, the stability factor rises towards the value without stabilization expressed in equations (15) and (18). These curves give a good picture of the stabilizing action of the circuit in Fig. 3.

Supposing this amplifier has to operate at a current of 4mA with a collector voltage of 1 volt, and with a load d.c. resistance of 125 ohms, then the circuit could be powered by a 1.5-volt cell without stabilization, i.e. as shown in Fig. 3(a). If the current amplification under these conditions is equal to  $\alpha' = 32$  corresponding to  $\alpha = 0.97$ , a stability factor  $S = 33$  would result. Assuming  $I_{co}$  at room temperature to equal  $5\mu A$ , than a  $20^\circ C$  temperature rise at the junction could raise  $I_{co}$  by about  $50\mu A$ . This would increase the collector current by 1.65mA. If the maximum permissible collector dissipation is 5mW, the margin of safety would then be reduced to half. The load drops 0.7 volts, leaving 0.8 volts at 5.65mA, i.e.

(Continued on page 167).

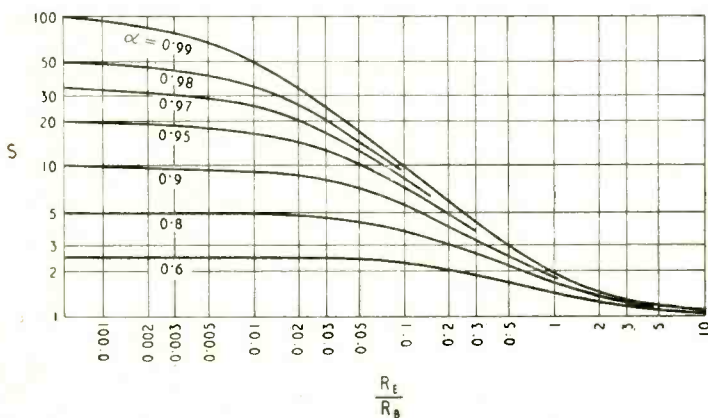

Left: Fig. 4. Stability factor  $S$  as a function of  $\frac{R_E}{R_B}$  for different values of current amplification factor  $\alpha$ .

Below: Fig. 5. Potentiometer-stabilized amplifier.

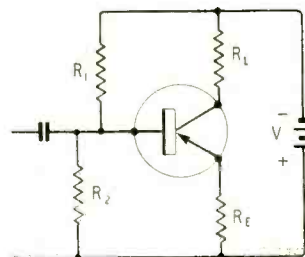

4.5mW to be dissipated by the collector, as compared with 4mW at room temperature.

If a second cell is used, raising the battery voltage to 3 volts, a stabilizing feedback resistor  $R_E$  dropping 1.5 volts at room temperature can be inserted. Since the current to be carried is 4 mA, the value of this resistance will be 375 ohms. It will dissipate approximately the same amount of power as the transistor. The feed resistance  $R_B$  has to supply a base current of:—

$$I_b = \frac{I_c}{\alpha} - \frac{I_{co}}{\alpha} = 0.12\text{mA.}$$

Allowing for the voltage drop of 1.5 volts,  $R_B$  has to be 12,500 ohms. The resistance ratio  $R_E/R_B$  therefore equals 0.03. From the curves, the stability factor is found as  $S = 17$ .

Thus, the collector current will change by  $850\mu\text{A}$  for a  $50\mu\text{A}$  change in impurity current. The collector voltage will be reduced by 0.425v., due to the voltage drop across  $R_L$  and  $R_B$  (totalling 500 ohms). The collector will thus operate at 4.85mA with only 0.575 volts—rather a serious reduction—from collector to emitter. The collector dissipation is thus reduced to 2.79mW, i.e. to less than for the cold condition when  $I_{co}$  was negligible. This will be accompanied by a loss in signal-handling capability due to the reduced collector-to-emitter voltage. A better compromise would be possible by a reduction in  $R_E$ , but this would necessitate a value of battery voltage which might prove inconvenient, lying between the steps available by connecting cells in series.

An alternative method of stabilization is therefore illustrated in Fig. 5. Here, improved stabilization is obtained by use of the potentiometer arrangement consisting of the resistors  $R_1$  and  $R_2$ . If the internal resistance of the battery can be neglected, the resistances are effectively in parallel, and the stability factor for

this circuit is therefore again given by equation (21), provided that

$$\frac{1}{R_B} = \frac{1}{R_1} + \frac{1}{R_2} \quad (22)$$

Thus, also

$$S = \frac{1 + R_E \left( \frac{1}{R_1} + \frac{1}{R_2} \right)}{1 - \alpha + R_E \left( \frac{1}{R_1} + \frac{1}{R_2} \right)} \quad (23)$$

Allowing an additional current drain across the potentiometer  $R_1 - R_2$  to dissipate about the same amount of power as the transistor, i.e. 4mW, this would imply a current drain of 1.33mA.  $R_2$  drops 1.5 volts, and therefore equals 1130 ohms.  $R_1$  also drops 1.5 volts, but carries the base current in addition to the 1.33mA, totalling 1.45mA, and therefore equals 1010 ohms. Their parallel value therefore is  $R_B = 540$  ohms,  $R_E/R_B = 0.7$  and therefore, the stability factor  $S = 2.3$ . This is a considerable improvement with an additional 50% power consumption compared with the improvement by the use of  $R_E$  alone, without the potentiometer bias supply.

The temperature change under consideration will raise the impurity current by  $50\mu\text{A}$  as before. This, however, will result in a rise of collector current of only  $115\mu\text{A}$  with additional drop in voltage of 0.0575 volts produced jointly by  $R_E$  and  $R_L$ . The collector dissipation is thus  $(4 + 0.115)(1 - 0.0575) = 3.87\text{mW}$  i.e. less than cold, and with the signal-handling capacity virtually unchanged.

**Conclusions.**—The basic principles outlined above can be applied to the design of more complex circuits. Where transistors are used in tandem, arrangements can be made for a transistor operating at a lower power level to stabilize a transistor operating at a higher power level, and at the same time to provide useful amplification.

## WORLD'S JOURNALS

OVER 160 journals from more than 20 countries are scanned regularly by the compilers of the Abstracts and References section of our sister journal *Wireless Engineer*. Each month abstracts from, and references to, some 300 articles are included in the section, which is compiled by the Radio Research Organization of the Department of Scientific and Industrial Research.

The 60-page annual index to the Abstracts and References, including both subject and author sections, is included with the March issue of *Wireless Engineer*, which is obtainable from our publishers, price 6s.

## New Music

*Designed to generate any tone produced by the human voice or any musical instrument this electronic synthesizer, built under the direction of Dr. Harry F. Olson in the Princeton Research Laboratories of the Radio Corporation of America, also places at the disposal of musicians a medium of expression in which new tones and rhythms can be composed and performed without the intermediary of traditional methods of music making. The photograph, left, shows Dr. Olson at the keyboard.*



# Waveguides as Microwave Links

## POSSIBLE ALTERNATIVE TO RADIO AND LINE COMMUNICATION

**T**HE demand for channels of communication expands so rapidly that the organizations whose duty it is to provide them must continually be ready with new supplies. Hitherto these have always been available by drawing on higher and higher frequencies. Each doubling of the upper frequency limit brings in about as many new channels as all those already in use. But we are now reaching the stage at which such resources will no longer be acceptable. Radio waves of the millimetre order (i.e., above 30,000 Mc/s, or 30 kMc/s) are seriously obstructed by rain, clouds and other kinds of weather. This may be all very well for storm-detecting radar, but not for communication. Even at frequencies several times lower, propagation of radio waves in the open is appreciably affected by such influences. Meanwhile, the alternative of a coaxial line also fails because its attenuation increases fairly steeply with frequency. The same applies to waveguides—with one exception. The Bell Telephone Laboratories have recently published an account of theoretical and experimental exploration of this exception,\* and they conclude that it has interesting possibilities.

A most important characteristic of waveguides is that propagation along them can take place in a number of different modes. These modes are divided into two main classes, according to whether there is a lengthwise component of electric field, in which case they are called E modes (in America, TM), or of magnetic field, when they are called H or TE modes. The two classes are subdivided according to

the numbers of half-cycles of field pattern in two cross-sectional dimensions. Below a certain critical frequency, corresponding to a wavelength of the order of twice one of these dimensions (or a sub-multiple thereof), propagation ceases. The critical frequency for a given cross-section depends to some extent on the mode, and by taking advantage of this fact and by choosing a suitable shape for the guide, it is possible to eliminate all modes but one. This is the usual practice with waveguides as now used for such purposes as connecting a transmitter to its aerial—at most, perhaps, 100ft away. Hitherto, the idea of using waveguides for long-distance transmission has not been favourably considered, because at frequencies low enough for the attenuation not to be excessive the guide has to be so large as to be uneconomic. At 4 kMc/s, for example, the loss in even a theoretically perfect guide is 40db per mile, which is quite useless. At 1 kMc/s the figure is 2db per mile, which would be satisfactory were it not that the guide would have to be more than 6in wide and would be usable only for a narrow band of frequency.

Past theory had indicated that for one exceptional mode (and its multiples of the same type) the attenuation would *decrease* with rising frequency, which, of course, is just what is wanted. At first this seemed too good to be true, and even when the theory was checked it was still reckoned that it would not be so in practice, owing to the necessity for perfect uniformity of cross-section. This particular mode is the  $H_{01}$  (or  $TE_{01}$ ) in a cylindrical guide. The reason for its peculiarity is that the electric lines of force are concentric circles, as shown in Fig. 1(a) and (b), and

\* S. E. Miller. "Waveguide as a Communication Medium," *Bell System Technical Journal*, Nov. 1954, pp. 1209-1265.

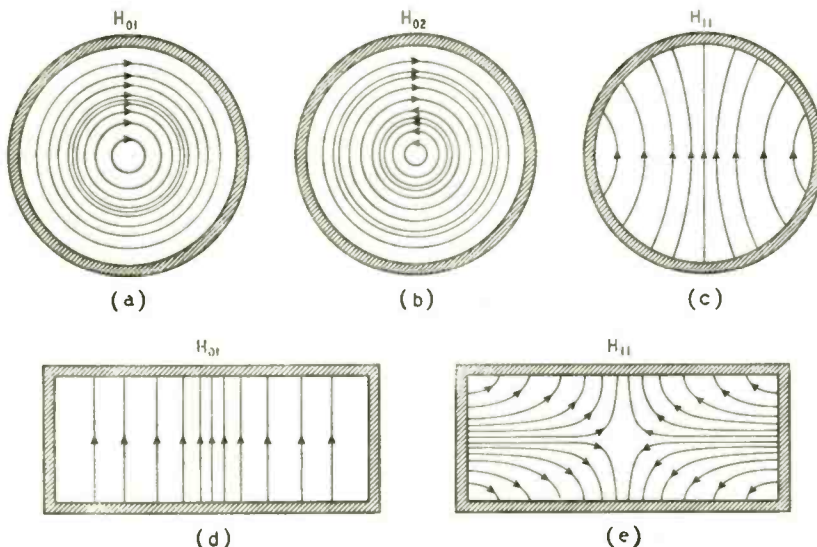

Fig. 1. The  $H_{01}$  mode in a cylindrical waveguide (a), together with its multiples such as  $H_{02}$  (b),  $H_{03}$ , etc., has the unique feature that the lines of electric force (shown in these diagrams) take the form of closed concentric loops, not touching the guide walls as in other modes such as (c), (d) and (e), and consequently loss decreases with increase of frequency. In E modes, the magnetic field patterns are similar to the electric patterns shown here.

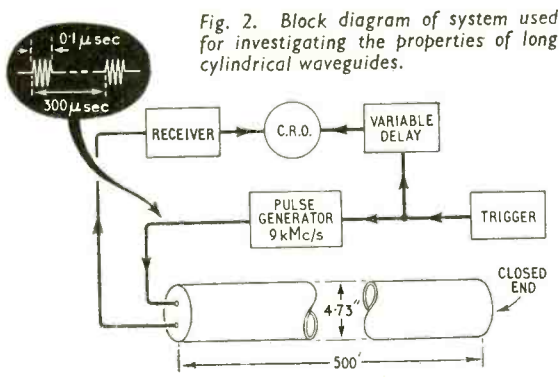

Fig. 2. Block diagram of system used for investigating the properties of long cylindrical waveguides.

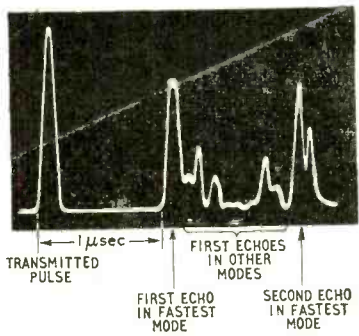

Fig. 3. The first two or three microseconds of the oscilloscope display, showing the transmitted pulse and reflections.

consequently no longitudinal currents are induced in the guide walls as with other modes. The only wall currents are those needed to confine the wave to the interior of the guide, and the loss from that cause decreases with frequency. Taking 2db per mile as a reasonable figure for attenuation and 2in diameter as a reasonable size of pipe, the frequency for these conditions is 50 kMc/s, at which the wavelength is 6 millimetres, and the maximum usable bandwidth about 500 Mc/s.

As already hinted, this attractive prospect is somewhat clouded by practical difficulties. One, the need for generating and dealing with 6-mm waves, can safely be left to development. A less obvious snag is that owing to the wavelength being so much smaller than the diameter of the guide (as is necessary in order to achieve the low loss) propagation is not restricted to this one mode. Energy at 50 kMc/s can in fact travel along a 2-in guide in many different modes. At first sight this might seem to be an advantage, because each mode can be regarded as a separate channel, like a wire in a multi-core cable. But unfortunately even slight curvature or non-uniformity of the guide causes part of the energy in one mode to change to another, which would cause mutual interference between channels working on the same frequency. Seeing, however, that owing to the greater attenuation of the other modes only the  $H_{01}$  would be likely to be employed, it might not appear to matter very much if a small proportion of the  $H_{01}$  energy were lost to other modes, provided it was not enough to add seriously to the 2db per mile. Moreover, the signal energy converted into another mode is always liable to be converted back again farther along. If all modes had the same velocity, this would partly offset the loss. But as it happens they have not, so by the time energy is converted back into the  $H_{01}$  mode it is out of step with the parent signal and so distorts or confuses that signal.

In order to study the practical possibilities the Bell Telephone Laboratories set up a 500-ft straight cylindrical waveguide. The highest frequency for which suitable measuring equipment was then available was 9 kMc/s ( $3\frac{1}{2}$ cm), for which the inside diameter of guide corresponding to a theoretical 2db loss per mile is 4.73in. The guide of this diameter was aligned to within  $\frac{1}{16}$ in of a straight throughout its length, and its cross-section was cylindrical within about 0.008in.

The experimental procedure, indicated in Fig. 2, was to inject short pulses at one end of the guide, and receive echoes from the other end (closed by a metal plate) for oscillographic display on a time base. A variable delay was provided in order to extend the observation to pulses received after a large number of journeys to and fro along the guide. Each pulse, lasting 0.1 microsecond, occupied 100ft of guide while in transit, and the first echo was received 1μsec after the initial blip corresponding to the send-off from the generator. Fig. 3 shows this first stage of events as seen on the screen. The clear space between the pulse received direct from the transmitter and the first echo from the far end shows that the pipe was sufficiently free from imperfections to cause no appreciable reflections from anywhere along its length. The clutter of echoes following on the heels of the first home is made up of modes having lower velocities. There are about 40 possible modes for this guide and frequency, but the resolution of the 0.1μsec pulse is not good enough to allow them all to be picked out.

A continuation of the display, in Fig. 4 (a), shows that most of these modes die out after a few reflections, whereas the mode giving the prominent first echo in Fig. 3 was still going strong enough to be well above noise level after 200 return trips, amounting to 40 miles. The attenuation can easily be measured by comparing amplitudes of blips, and was found to be about 3db per mile. This could only be the  $H_{01}$  mode, for which the theoretical figure in this

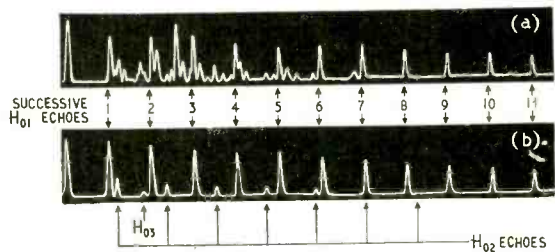

Fig. 4. A more extended view of pulse echoes, (a) without, and (b) with, a mode filter in the experimental waveguide.

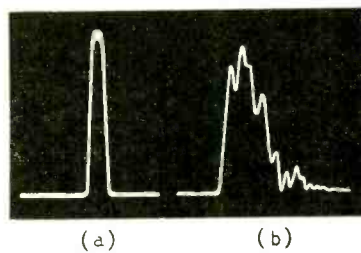

Fig. 5. (a) Shape of pulse as received without distortion, and (b) with distortion due to energy that has been travelling for part of the distance in different modes having lower velocities.

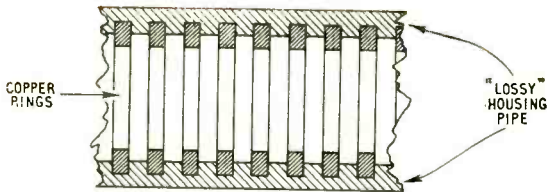

Fig. 6. Spaced-ring waveguide construction, forming a continuous mode filter, especially helpful for reducing curvature losses.

size and material of guide is 1.9db, all the other modes having much greater rates of attenuation. The possibility of transmitting signals over long distances by waveguide was thus demonstrated.

The next experiment was to introduce a mode filter, with the result shown in Fig. 4 (b). The only responses now to be seen, other than the first circular electric of  $H_{01}$  series, are a series of seven identifiable by their velocity as the second circular electric or  $H_{02}$  (Fig. 1 (b)) and one little specimen of the third circular electric or  $H_{03}$ .

So far, matters look very well (except for the practical difficulty of installing a pipe say 40 miles long, dead straight and perfectly cylindrical throughout, within close tolerances). But the results just described, in which even long-distance responses differ little from Fig. 5 (a), are the best of a very mixed bag. Some of the others were more like (b). It was found that varying the length of the guide no more than about a foot, by means of a piston at the far end, could make differences as drastic as these. Further investigation showed that the distortion evident in

Fig. 5 (b) was caused by mode conversion, as already described, and that what the piston did was to vary the distance between conversion and reconversion points, causing either reinforcement or cancellation.

A large proportion of the Bell Telephone report is devoted to a study of this mode conversion problem and what it might be expected to amount to in a 50-kMc/s 2-in guide. An important part of the problem is the effect of bends, which cause energy to be converted from  $H_{01}$  to  $E_{11}$ . One method of preventing this is to use an elliptical pipe for the bend. Another is to devise a guide that attenuates the  $E_{11}$  mode without unduly increasing the loss of  $H_{01}$ . One type of such a guide consists of copper rings held in an insulating pipe, as shown in Fig. 6. In a more easily manufactured variation of this, the conductor is a continuous helix. It must not be imagined that even with these aids the bends can be sharp. The sort of curvature envisaged for the spaced-ring or helical guide is a bending radius of 2,000 feet! This is calculated for a 2-in guide at 48kMc/s, and would double the normal dissipation loss. It appears, however, that there are other methods for negotiating sharp bends, and the author of the report concludes that waveguides have a future as multi-channel links. It is suggested that a 2-in pipe could provide 500-Mc/s channels from 35kMc/s to 75kMc/s, at which the theoretical attenuation per mile is 3db and 1db respectively. The 500-Mc/s bandwidth seems to be somewhere near the maximum: if so, it would presumably exclude present systems of television, especially as even that limitation of bandwidth assumes such an amount of distortion as would make it desirable to use a distortion-tolerant type of modulation, such as pulse-code and regenerative repeaters at 25-mile intervals.

## Commercial Literature

**Low-frequency Transformers** (operating down to 2c/s); hermetically sealed input types with balanced windings, internal screens and Mumetal cases. Note from Avis & Baggs, 11-13, Gosbrook Road, Caversham, Reading, Berks.

**Audio Amplifier** (8-10 watts), with frequency response of  $\pm 0.25$ db between 20c/s and 30kc/s, and associated pre-amplifier and control unit with volume and tone controls, recording compensation, etc. Booklet on the RD Junior from Rogers Development Co., 116, Blackheath Road, Greenwich, London, S.E.10.

**Permanent-bit Soldering Iron**, claimed to last indefinitely and to require no filing. Available with  $\frac{1}{8}$ -in,  $\frac{3}{16}$ -in,  $\frac{1}{4}$ -in and  $\frac{3}{8}$ -in bits. Also permanent tips for fitting as caps to ordinary bits. Leaflets from Light Soldering Developments, 106, George Street, Croydon, Surrey.

**Stabilized H.T. Supply**; dual channel design for giving positive and negative potentials with respect to earth and other facilities. Voltages are variable while current is 0-250 mA per channel. Leaflet from Joyce, Loeb & Co., Vine Lane, Newcastle-upon-Tyne 1.

**Non-corrosive Flux** having a chemical structure with resistance to water and low electrical conductivity. Historical review of development in this field and description of testing methods by Dr. W. Rubin on a leaflet from Multicore Solders, Maylands Avenue, Hemel Hempstead, Herts.

**R.F. Induction Heater** (12kW) with output coupling arrangements enabling it to be used with either fixed or remote work stations. A process timer is included, while the cooling equipment is self-contained. Leaflet from E.M.I. Factories, Hayes, Middlesex.

**Unit Cabinet System** intended for high-quality sound reproduction equipments. Also amplifiers, tuners, loudspeakers, gramophone motors, pickups, tape recording equipment and other accessories. Catalogue from the Classic Electrical Company, 352-364, Lower Addiscombe Road, Croydon, Surrey.

**Information-storage Magnetic Recorder** (Ampex model 306) for industrial and scientific applications. Uses frequency modulated carrier system and has frequency response of 0 to 5 kc/s with tape speed of 30 inches per sec. Equipments with anything from one to 14 tracks. Leaflet from Rocke International, 59, Union Street, London, S.E.1.

**Power Amplifier** with 50 watts output and frequency response at this power of 15c/s to 20kc/s  $\pm 1$ db. Harmonic distortion at 1,000 c/s claimed to be 0.002%. This and four other new instruments made by Krohn-Hite (Cambridge, Mass., U.S.A.) described in a leaflet from Rocke International, 13 East 40th Street, New York 16, N.Y., U.S.A.

**Insulated Resistance Wires** with a new epoxy-based enamel coating called Diamel which is claimed to have durability, high breakdown voltage and resistance to solvents and heat with freedom from pinholes. Details in a booklet "Electrical Resistance Materials" from Johnson Matthey & Company, 78-83, Hatton Garden, London, E.C.1. Also another booklet on precision-drawn seamless tubes.

**Television Frame Output Windings**, complete with laminations ready to clamp into existing shroud; available at present for a certain number of receivers. Note from Direct TV Replacements, 134-136, Lewisham Way, New Cross, London, S.E.14, with a new catalogue containing technical servicing information, price 1s including postage.

**Oscillograph C.R. Tube** (type 4EP1) incorporating post deflection acceleration, giving high deflection sensitivity (about 1mm per volt) with good brightness. The final acceleration voltage of 2kV can be increased to 8kV for high writing speeds. Note from Electronic Tubes, Kingsmead Works, High Wycombe, Bucks.

**Transistor Hearing Aid** operating from a 1.5-volt carbon pen-cell battery (or others) and measuring  $2\frac{1}{2}$ in  $\times$  2in  $\times$   $\frac{1}{4}$ in. Is claimed to run for a year at 8 hours a day on six pen cells. Leaflet from Bonochord, 48, Welbeck Street, London, W.1.



# Propagation on Bands I and III

## Direct Practical Comparison

By F. W. R. STRAFFORD, M.I.E.E., and I. A. DAVIDSON, B.A.

**W**ITH the advent of Band III television transmissions in this country, a large number of problems arise connected with the propagation of television signals at frequencies of the order of 200 Mc/s. If co-siting of the transmitters is adopted, then the strength and variations of the Band III signal must be considered in relation to that of Band I, as in most areas that will have a Band III signal, a Band I signal will also be present.

A preliminary investigation has been made of the relative behaviour of the signals on the two bands, using a transmission of 180.4 Mc/s radiated by the B.B.C. from the Sutton Coldfield mast. The signal was horizontally polarized, and therefore the experiment will not necessarily give an exact picture of propagation with a vertically-polarized signal, which has been chosen for the Band III service. However, useful information was obtained up to a range of about 30 miles from the transmitters. The 180.4-Mc/s transmission was beamed in a south-easterly direction, and all the observations were made within a few degrees of the centre of the beam.

Details of the two transmissions are given in Table 1.

Two receivers were used for the purpose of making the measurements and were installed in a mobile research laboratory. The outputs from the receivers were fed to a pen-recorder, enabling a continuous record to be made on both 61.75 Mc/s and 180.4 Mc/s. The receiver sensitivities were checked throughout by suitable signal generators. Initially the levels were adjusted so that on an open site, free from reflections and within visual range of the mast of the transmitters, the outputs of the two receivers were equal, thus compensating for the differences in the radiated power; i.e., 100/1. The mobile unit then toured through a number of differing types of sites, such as built-up and rural areas, at various distances from the transmitters, and at each site a record was taken with the mobile unit moving slowly. The receiving aerials were at a mean height of 25 feet from the

ground. It was therefore possible both to estimate the relative strengths of the signals at each site, and also to investigate the importance of local variations of the field strength at the two frequencies.

A vertical dipole was used on Band I, and either a horizontal dipole or a horizontal "Yagi" array on Band III. The records show that two distinct types of fluctuations in signal strength are present—rapid and slow.

### Rapid Variations

Fluctuations in the signal received by a dipole aerial when moved over short distances occurred on all the records. These are of a periodic nature, the rate of fluctuation being about three times greater on the Band-III transmission, as would be expected since the fundamental frequencies are similarly related. An example of this type of typical variation is shown in Fig. 1 and is a tracing of a typical pen-recording.

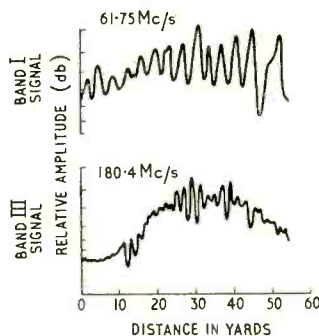

Fig. 1. The rapid fluctuations with distance due to local reflections are shown here. The marks on the decibel scale are 1 db apart, but are unevenly spaced because of the characteristics of the recorder.

In all cases a local reflecting object could be identified as the cause. The periodicity of the variation depended on the relative direction of the transmitting station with respect to the reflecting object, but generally possessed a wavelength of between  $\lambda/2$  and  $\lambda$ ; i.e., 7 ft. 6 in. to 15 ft. on Band I and 2 ft. 6 in. to 5 ft. on Band III. It was further established that these fluctuations were originating from a local reflector. By substituting a directional array in place of the dipole aerial, the fluctuations were completely removed. The distance of the reflecting object was in most cases sufficiently near to the receiver not to cause any noticeable ghost images. This was determined on Band I by viewing the picture, and on Band III by examining the trailing edge of the square modulation pulses.

### Slow Variations

In addition to the rapid variations in the presence of reflecting objects, the signal level on both frequencies showed slow variations, even under open site conditions. These variations were non-periodic, the

Table 1

|                              | Band I                                | Band III    |
|------------------------------|---------------------------------------|-------------|
| Modulation                   | Television waveform                   | Square wave |
| Frequency                    | Vision 61.75 Mc/s<br>Sound 58.25 Mc/s | 180.4 Mc/s  |
| E.R.P.                       | 100 kW                                | 1 kW        |
| Polarization                 | Vertical                              | Horizontal  |
| Aerial height (above ground) | 750 feet                              | 600 feet    |

distances between successive maxima ranging between 15 and 60 yards on both bands. The amplitude was also similar on both bands, but there was no definite correlation between them. Examples of this type of fluctuation are given in Fig. 2 (a) and (b), showing that they are quite random with distance on both bands.

The variations were present both in built-up areas and in open country, and no definite objects, such as trees or buildings, could be found to explain them. Furthermore, the variations were independent of the type of receiving aerial that was used. The most probable explanation is absorption and diffraction of the signal by ground irregularities, quite small changes in ground height or variations in its conductivity, or dielectric constant, being sufficient to explain them.

The effect of these variations is twofold. When considering the service area for a given type of receiving aerial, it is possible to calculate the minimum field strength required, assuming such factors as the forward gain of the aerial and the sensitivity of the receiver. For 90 per cent coverage of a given area, however, because of the slow variations in the signal level, the mean field strength must be greater than the calculated minimum level. From the records it has been calculated that this difference is approximately 6 db for satisfactory reception in 90 per cent of receiver locations. Secondly, in fringe areas, the variations cause large differences in the signal/noise ratio over distances of about 30 feet, and hence between adjacent houses.

### Mean Level

At each site the mean levels of the two signals were determined from the records, the amplitude of the signal being averaged over distances up to  $\frac{1}{4}$  mile. No absolute measurement of the signal was made, since comparison only was required. In each case the

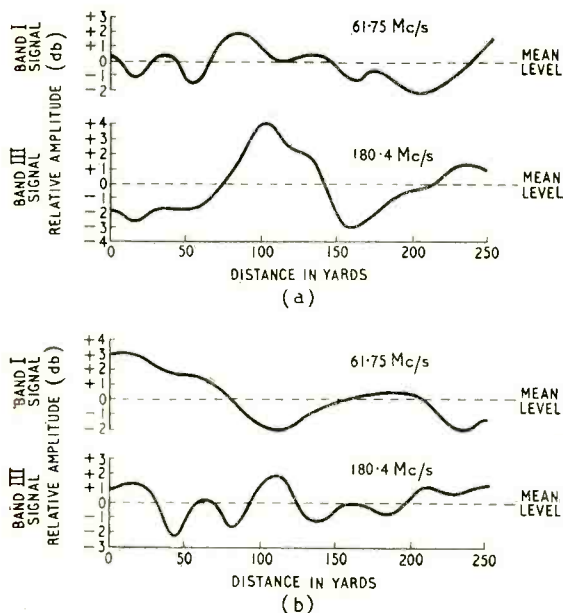

Fig. 2. Two examples (a) and (b) of slow fluctuations are shown here

level was determined relative to the signals obtained on a reflection-free site within visual distance of the transmitting aerial as previously explained. These results are given in Table 2.

Table 2

|   | Distance from Transmitter (miles) | Site          | Field strength relative to that of site "A" |                  |
|---|-----------------------------------|---------------|---|------------------|
|   |                                   |               | Band I (db)                                 | Band III (db)    |
| A | 12                                | Open country  | 0   | 0                |
| B | 19                                | Built up area | -9 } *<br>-16 }                             | -14 } *<br>-21 } |
| C | 19                                | Open country  | -10 } *<br>-5 }                             | -16 } *<br>-15 } |
| D | 34                                | Open country  | -12   | -34              |

\* Taken at two nearby sites in the same area.

It can be seen from this table that, compared with Band I, the Band III signal drops more rapidly as the distance from the transmitter is increased. The measurements at 34 miles correspond to the horizon distance and, at this range, a small hill reduced the Band III signal to the noise level of the receiver.

From the foregoing practical, but admittedly intensive tests, the theoretical prediction of increased propagational losses with increasing frequency has been verified. Workers in various countries have also verified this prediction\*, but their results have invariably been plotted in terms of median field strengths, whereas the television aerial installer is far more interested in the house-to-house problem.

### In Conclusion

Probably the most interesting conclusion which may be drawn is that when one is in a region of weak signal strength in a built-up area, the compulsory requirement of a multi-element directional aerial automatically makes it unnecessary for the site to be "probated" to find the best location for its installation. This is explained under "Rapid Variations." On the other hand, in regions of high average signal strength where a simple non-directional dipole may suffice to provide adequate input to the receiver, it does not matter much whether the aerial is located in a trough of signal field strength due to reflections, since adequate signal is still likely to exist at that point. Of course, it is assumed that no long-distance reflections are present likely to cause a displaced image or ghost, in which case a directional aerial would obviously be required.

The results also show that, in terms of square miles of service area, independent of population considerations, a single Band-III transmission can never be so effective as a similarly located Band-I transmission unless the former is either (a) delivering far more power from its aerial or (b) possesses a much higher mast or, preferably, both.

\* See for example: J. A. Saxton. "Basic ground-wave propagation characteristics in the frequency band 50-800 Mc/s." *Proc. I.E.E.*, Pt. III, July 1954.

# Interference Suppression

## *Techniques for Dealing with Small Commutator Motors*

By R. DAVIDSON,\* B.Sc., A.Inst.P.

As reported elsewhere in this issue, regulations have now been made for the control of interference from domestic and industrial apparatus driven by small electric motors. This article reviews the general principles of suppression and describes some of the latest methods that are being used on such apparatus.

**M**ANY readers will be familiar with the basic principles of interference suppression, but for those who are new to the subject these principles will be briefly re-stated. The supply current to a commutator motor is discontinuous and the discontinuities cause radio-frequency currents to flow in the motor and its associated wiring. These r.f. currents have a wide frequency spectrum and may cause interference to both sound and television reception. The currents and their associated energy may be propagated in several ways, but the majority of interference results either from direct radiation from the motor to the aerial of the receiver or by propagation along the mains wiring and subsequent radiation to the receiver aerial. Interference by direct radiation is usually comparatively local, but interference resulting from propagation along the mains wiring, and subsequent radiation, may occur at considerable distances from the source. Since interference resulting from both these modes of propagation is received via the receiver aerial little can be done to abate interference at the receiver, and suppression measures must be taken at the source. If these measures are concentrated on preventing the flow of radio frequency currents into the mains wiring it is usually found that the direct radiation from the appliance is also reduced to tolerable limits. Interference is suppressed at the source by taking one or more of the following steps.

(i) Fitting capacitors between supply lines and the frame of the appliance to reduce the impedance between these points and thus by-pass the asymmetric component of the radio frequency currents, i.e. the component flowing from the appliance along the lines and back to the appliance via earth. This component is the cause of interference in the majority of cases.

(ii) Connecting capacitors between supply lines to reduce the impedance between lines and thus by-pass the symmetrical component of the radio frequency currents, i.e. the component flowing from the source along one supply line and back to the source via the other supply line.

(iii) Fitting inductors in series with the supply lines to increase the impedance of the lines at radio-frequencies and reduce both asymmetric and symmetrical components.

The types of capacitors or inductors to be used and their positioning relative to the source of interference will depend on the frequency bands over which suppression is required. Here it must be stressed that, except in special cases, components employed for suppression over the low frequency sound broadcast

bands will not be effective at television frequencies, and separate components will be required here. Furthermore, different techniques are used for suppression over the two frequency ranges.

A very wide range of suppressor components is now available both for incorporation into appliances by manufacturers and for fitting to existing appliances by retailers and the general public. Suppression over the sound broadcast frequencies (150 kc/s—1.6 Mc/s) can be achieved by fitting suppressors either within the appliance in the supply lead at the plug, or permanently at the supply point, but due regard must be taken of the safety regulations governing the maximum values of capacitance which may be fitted in the various positions. (These values are fully detailed in the revised British Standard Specification No. 613 which will be published shortly.) Within the appliance it is usual to fit capacitors of  $0.01\mu\text{F}$ – $0.1\mu\text{F}$  across the lines and up to  $0.005\mu\text{F}$  between lines and frame for sound-broadcast suppression. These capacitors are available in paper dielectric as combined units in tubular form or potted in moulded boxes. Separate capacitors are available in paper dielectric or with high permittivity (high "K") ceramic dielectric, the last-mentioned usually in the form of discs. High "K" ceramic capacitors are very compact and have low self inductance, but are subject to considerable changes of capacitance with temperature. Users should, therefore, ascertain that the capacitance value will not rise above the maximum permitted

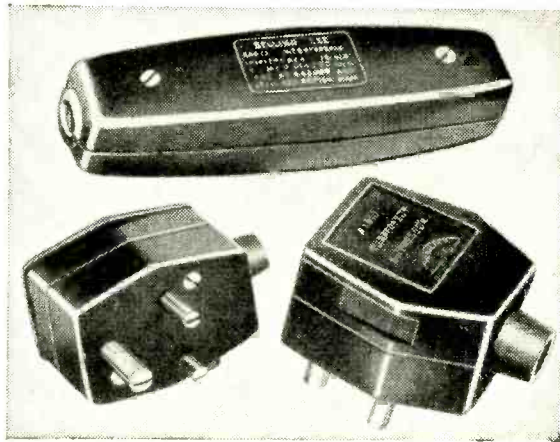

Fig. 1. Cord grip suppressor (top) and (below) plug suppressors. These can be fitted by the user.

\* Dubilier Condenser Company.

value within the temperature range likely to be experienced inside the appliance, nor fall below the minimum capacitance necessary for effective suppression. Radio frequency chokes are available for incorporation inside appliances in wavewound form on iron dust or ferrite cores, as toroids on ferrite cores, or in rectangular form on flaked iron cores. The last-mentioned two types, using closed cores, require few turns on the windings and are especially suited for the heavier current applications.

Two types of radio suppressor which may be conveniently fitted by the user of an appliance are the cord-grip suppressor and the plug suppressor (see Fig. 1). In the cord-grip type capacitance values similar to those which may be fitted within the appliance are used. In the plug suppressor the maximum capacitance values permissible are  $0.005\mu\text{F}$  between line and earth,  $0.1\mu\text{F}$  between line and neutral and  $0.05\mu\text{F}$  between neutral and earth, but it is usual to supply plugs with capacitors only in the last two positions.

For suppression at Band I television frequencies components must be fitted either within the appliance (preferably close to the brushes) or in the supply lead within about 9in of the appliance. Radiation of interference from the lead becomes excessive if suppression is attempted at greater distances from the appliance. Fortunately the components required are very small and can usually be housed within the appliance. Very

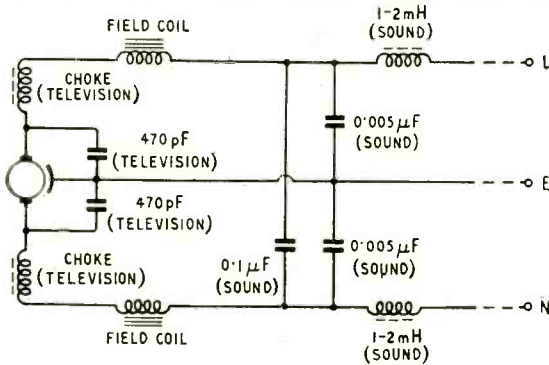

Fig. 2. Full suppression of small motors for sound broadcast and television bands where unsuppressed noise levels are high.

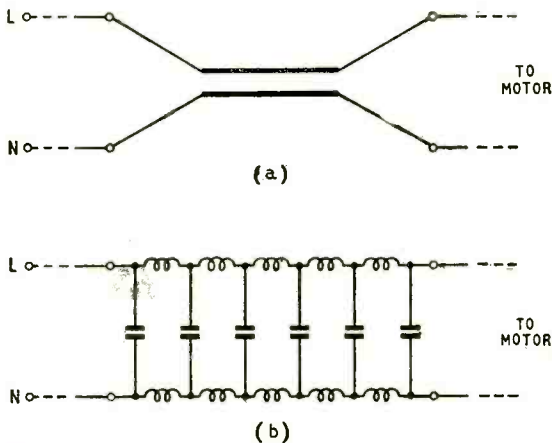

Fig. 3. (a) Four-terminal lead-through capacitor and (b) its equivalent circuit.



Fig. 4. Lead-through capacitor ( $0.005\mu\text{F}$ ) for suppressing interference on Band I from electric drills, etc.

effective suppression is achieved on many commutator motors by fitting 470-pF capacitors from brushes to frame and small self-resonant dust-core inductors in the brush leads or incoming mains leads. For those who wish to fit television suppressors outside the appliance, small cord-grip suppressors incorporating inductors are available for wiring into the mains lead close to the appliance.

The new regulations which have been made call for suppression to within the limits laid down in British Standard Specification No. 800, "Limits of Radio Interference," which covers the frequency bands 200 kc/s—1605 kc/s and 40 Mc/s—70 Mc/s. For motors generating high levels of interference on both sound radio and television bands it may be necessary to fit all the suppressors shown in Fig. 2, which gives typical component values.

Recent developments in the suppressor field, some using novel techniques, have fortunately simplified the suppression problems for certain types of appliances. For wide-band suppression of interference from appliances which have a strong symmetrical component of interference, and this includes at least one type of sewing-machine motor, the four-terminal lead-through capacitor has been introduced.\* In this suppressor the supply leads are connected to the two plates of a rolled paper capacitor at one end of the winding and the appliance leads to the plates at the other end of the winding. It is arranged that the supply current has to traverse the whole of the winding so that good capacitive coupling between lines is achieved over a wide frequency range, and the inductance of the winding is placed in series with the supply leads to aid asymmetric suppression (see Fig. 3). With this construction a comparatively large capacitance can be used to provide suppression at sound frequencies, whilst still being effective at television frequencies, provided the capacitor is fitted close to the source of interference.

Two developments in single-pole lead-through capacitors should be mentioned as they have rendered possible simple high-frequency suppression of two classes of appliance which hitherto were most difficult to suppress—electric drills and similar appliances and low voltage d.c. motors. Most readers will know by now that lead-through capacitors properly fitted are effective up to frequencies well beyond the television Band III and do not suffer from the disadvantages of conventional capacitors† which have appreciable self

\*British Patent No. 727496.

†"R.F. Characteristics of Capacitors." *Wireless World*, August, 1952.

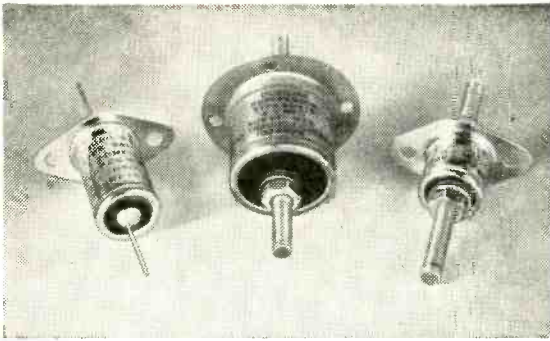

Fig. 5. Group of metallized paper lead-through capacitors suitable for low-voltage d.c. motors (left 2 $\mu$ F, middle 4 $\mu$ F, right 0.5 $\mu$ F).

inductance. A small 0.005- $\mu$ F lead-through capacitor has been introduced which is designed to be particularly effective for suppression of Band I interference from electric drills and similar metal-cased appliances, and measurements show that it will also be effective on Band III. This capacitor is illustrated in Fig. 4.

Low voltage d.c. motors usually have low impedance field and armature windings and require high capacitance values to achieve suppression. For suppression at both sound broadcast and television frequencies a lead-through construction is essential, and to meet these two requirements a range of metallized paper capacitors is now available with capacitances up to 4 $\mu$ F at 150 V d.c. working. Some examples of this range are illustrated in Fig. 5. Lead-through capacitors behave as high-attenuation transmission lines and the peaks and troughs in their impedance-frequency characteristic are predictable from the dimensions of the capacitor winding. By using metallized paper the attenuation of the plates is very much increased, and at a certain critical frequency at which, it is believed, all radio-frequency reflections from the equivalent transmission line back on the supply line are completely attenuated, an extremely low effective by-pass impedance is achieved. This effect is illustrated in Fig. 6 which also shows the very low overall impedance obtainable with this type of capacitor. Over the dotted portion of the graph between 30 and 36 Mc/s no signal whatever was detectable on the suppressed line from the capacitor when a signal of 0.25 volt was injected on the line to the capacitor. A receiver capable of measuring 2.5 $\mu$ V input voltage was used for this test.

The use of 470-pF capacitors for tele-

vision suppression of small motors was mentioned earlier. A single unit is now available comprising, in effect, three 470-pF capacitors in delta connection which measures only  $\frac{1}{2}$ in  $\times$   $\frac{1}{2}$ in and has three connecting leads. The two outer leads are connected one to each brush of the motor with the central lead to the frame of the motor. It is simpler to fit than separate capacitors and has been found to give, in many cases, several decibels more suppression than that obtained with separate components. The circuit diagram of this unit, used in conjunction with television inductors on a small motor, is shown in Fig. 7.

Mention should be made of combined filter units for both sound broadcast and television suppression which, although not novel, have been improved in efficiency and compactness in the last few years. These units are particularly suitable for the larger appliances such as cine-projectors and accounting machines and are usually fitted in the supply leads immediately inside the housing of the appliance.

No review would be complete without strong emphasis being placed on the safety precautions which must be observed when fitting suppressors either within appliances or in the supply lead or the supply plug. The requirements of B.S.613 are such as to ensure that suppressor components used in the various positions are of a sufficiently high grade and have sufficiently high margin of safety at the operating conditions that failure is most unlikely. These requirements must be rigorously observed, especially in positions where component failures may lead to risk of shock to the user of the appliance. For similar reasons the recommended maximum values of capacitance for various circuit positions must equally be observed. For instance the maximum capacitance which may be connected between lines and frame inside a portable appliance not doubly or fully insulated is 0.005 $\mu$ F. Larger capacitances will pass sufficient current at the supply frequency to cause unpleasant shock if the frame of the appliance is unearthed. Many people complain of a sensation of shock from the frame of a correctly suppressed appliance using 0.005- $\mu$ F capacitors and operated with the appliance unearthed. Such people should not blame the suppressor or the manu-

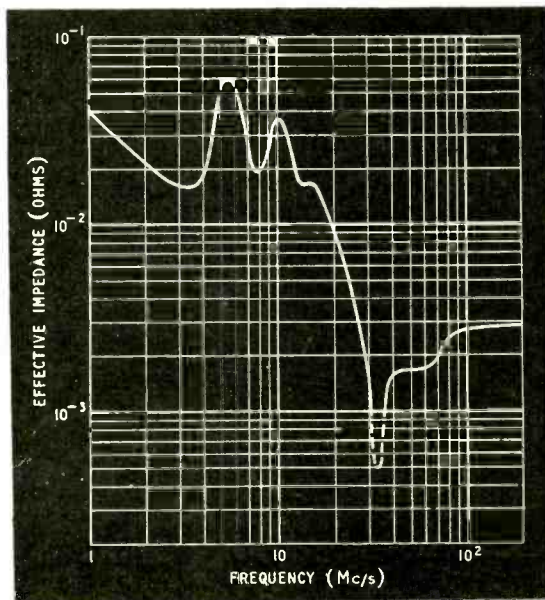

Left:—Fig. 6. Impedance/frequency characteristic of 4 $\mu$ F metallized paper lead-through capacitor (Dubilier type SBN13).

Below:—Fig. 7. Use of three 470-pF capacitances in a single unit for suppression at television frequencies.

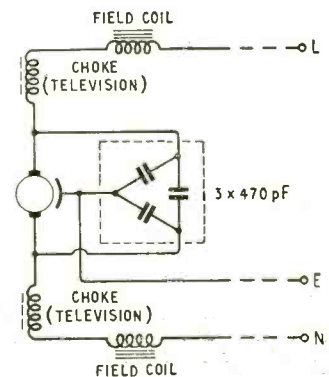

facturer who fitted it but should, in their own interests, use the earth lead with which such appliances are provided and connect it to the supply through a properly installed 3-pin plug and socket rather than through a 2-pin one. Space does not permit details of all the safety recommendations for the fitting of suppressors but readers are urged to make sure that suitable components are employed whenever they are installing suppressors and that the wiring is most carefully checked.

There are various sources of expert guidance on suppression problems. The Code of Practice on the general aspects of radio interference abatement (to be published shortly by the British Standards Institution), and the relevant British Standards listed therein, give very great assistance. Manufacturers of suppressor components provide technical data on their suppressors and advice on their use and in many cases are able to carry out interference suppression tests.

## LETTERS TO THE EDITOR

*The Editor does not necessarily endorse the opinions expressed by his correspondents*

### *Frequency Allocation*

I HAVE been reading with great interest your recent editorial comments on the present unsatisfactory state of frequency allocation in this country.

For the past twelve months I have been engaged in negotiations with the G.P.O. on the subject of re-accommodating in the spectrum users of mobile radio who are to be displaced from their present positions by the advent of Band III television. It would, of course, be wrong for me to comment on this work while it is still under discussion, but I have seen enough of the general problem of frequency allocation to enable me heartily to endorse your view that better machinery must be found for the administration of radio frequencies if their immense benefits are to be fully enjoyed by the community in peace, and if we are to have a sound basis of frequency allocation for defence.

I have sought many people's advice on this subject and it seems to me that the best proposal I have so far come across is that the task of allocation should be allotted specifically to one Minister, and to one without departmental responsibilities, such as the Lord Privy Seal. There is a precedent for such an arrangement in that atomic development and radio research are being administered in this way, presumably because the Minister in charge is not departmentally concerned with conflicting interests.

I do not think it would be difficult to conceive of a permanent impartial body working under the Minister which would undertake as its first task an impartial investigation of the present frequency position and the merits of the various conflicting claims being made for space in the spectrum.

It would clearly be essential that the first part of such an examination should be devoted to the relative merits of civil and military claims. I do not see why we should accept the suggestion that military claims for frequencies should be regarded as sacrosanct and not subject to justification. Frequencies, after all, are only a raw material in peace or in war and Service departments should be required, just as much as civil users, to give specific assurances of economic utilization. I cannot accept the proposition that security considerations are any serious bar to satisfying this condition.

A further conclusion I have formed as a layman is that the subject of frequency allocation is not nearly such a difficult one as we have been led to believe.

The Post Office, of course, have a vast fund of experience on interference suppression and are also able to help with advice.

In conclusion some reference must be made to future prospects. This year full-time f.m. broadcasts on Band II and low power television broadcasts on Band III are due to commence. Existing Band-I suppressors will be adequate in most cases for Band II. Until full-power transmissions are available on Band III it is impossible to be dogmatic about interference conditions on this band and it is generally agreed that further work on suppression techniques is required at these frequencies. It can be said, however, that measurements to date on a number of types of domestic appliances fitted with efficient Band-I suppression have shown that radiated and mains-borne noise levels on Band III are sufficiently low that such suppression is also expected to be adequate on this band in many cases.

The problem appears to me to be simply that of dividing a cake and not of cooking it. There have been too many technicians engaged in the task and too few persons skilled in the established arts of arbitration. For this reason I feel that the chairman of the suggested investigating body should be one of Her Majesty's judges.  
House of Commons. L. P. S. ORR.

### *Quality on V.H.F.*

A MOMENT'S thought on the chances of better quality from existing receivers via f.m. shows how masterly was the condensation of facts by Mr. Bishop in his letter in the December, 1954, issue.

The radio industry produces receivers capable of giving the most intelligible listening from the general reception conditions prevailing. These conditions have normally demanded the suppression of more than half of the B.B.C.'s transmitted frequency range on long and medium wavelengths. It is the fault neither of the B.B.C. nor of the set designers that the reproduction of the higher frequencies is inadequately provided for in the majority of radio sets in use today.

Only the complete redesign of the audio amplifiers, speaker units, etc., used in these sets will allow the frequency range available via the f.m. service to be reproduced, and enable us to appreciate to the full the general high standard of transmission by the B.B.C.

F.M. attachments to existing receivers can only provide a silent background, which may expose some frequencies previously masked by interference.

High Cross, nr. Uckfield, Sussex. C. E. WATTS.

### *Diplexers for Reception*

THE use of a filter network for combining the output from two television transmitters operating on sound and vision frequency respectively and conveying it to a radiating system via a single feeder is well known and, of course, is an established practice of the B.B.C.

With the advent of Band III television it will often be necessary to use this selective process in the reverse sense and I see no reason why the term diplexer, which has been used to describe the transmitter combining network, should not equally apply to the receiving counterpart.

For this reason I would like to make an attempt to define a diplexer as follows:—

"A diplexer is a combined low-pass/high-pass filter for

the purpose of conveying energy from two sources of differing frequencies to a common sink impedance such that there is minimum interaction between the individual sources of energy. The linearity of such a system permits that it may be used in the reverse sense."

Putting this in a simplified manner and applying it in the practical sense to Band I/Band III television reception, we may substitute the following definition:—

"A diplexer is a combination of tuned filters designed in such a manner that the output from two aerials operating on differing frequencies (e.g., Band I/Band III) can be connected to a single input (a television receiver) without interaction.

"A diplexer can also be used in reverse; i.e., a single aerial responsive to Band I and Band III can, by a single feeder be connected to a receiver having individual Band I and Band III input connections."

It is interesting to observe that the use of this term appears to be quite common in the United States where such arrangements are already in use for connecting Band IV receiving aerials to existing Band I/III combined aerials.

Perhaps some of your readers may have some better suggestions.

Belling & Lee, Ltd., F. R. W. STRAFFORD  
Enfield.

## As She is Spoke

MR. PAWLEY, in your March issue, asks for a suitable abbreviation for "television recording," and I would like to suggest that what they make is a "replica" or a "reproduction." The programme would then be "transmitted from a reproduction."

Mr. Scroggie, in his letter, finds no justification for the use of a word describing a process, to represent the result; the term "recording" as used above. Tape recorder language is also burdened with this term, for an understandable reason. The public is accustomed to the use of a "record" in relation to gramophones and seems to accept the term as describing a disc carrying a reproducible message; one goes "to buy a record of so-and-so." Were you to describe a tape recorder as capable of making a record, the public may assume it makes discs; by saying it makes a "recording" that possible confusion is ameliorated. But a happier term would be welcome; could one suggest a "magneprint"?

Editorial approval appears to be extended to the proposed E.M.I. use of the term "tape records" for ready-recorded magnetic tapes and with some amusement one recalls that mother used to safeguard the laundry with tape records—strictly embroidered autograph tape.

To avoid confusion is not simple. One need but wonder what youngsters whose school musical instruction was given on the "recorder" think when offered a "recorder" at, say, 100 guineas, and how they may wonder what tape has to do with the English flute.

The growth of language is quite illogical. A magnetic tape recorder makes a "record" by close analogy with, but more directly than, a typewriter; yet we type a "letter," never a "record" and we keep a "duplicate," a "carbon copy" or a "stencil," which last serves a "duplicator" though, in fact, it is a "multiplier."

W. D. ARNOT

Bristol Magnetic Recorder Company,  
Bristol, 3.

I AM afraid I cannot agree with Mr. Scroggie that the use of the word "recording" as a noun constitutes a misuse of the English language.

It is very convenient to refer to the quality of a recording, meaning ambience, frequency response, absence of distortion, etc., and to the quality of a record which would cover surface noise, swinging, and all other mechanical aspects.

Surely a recording is made on tape and is then transferred to disc, and must be referred to as a recording,

whereas a record is something you can pick up and throw into the waste-paper basket if you don't like it.

Wharfedale Wireless Works, Ltd., G. A. BRIGGS.  
Idle, Bradford.

## Neon Timers

I HAVE followed with interest the correspondence on this subject and would like to comment on the observations of N. J. Wadsworth, in the January issue, regarding the design of photographic exposure timers. The actinic intensity of a tungsten filament lamp has been found to vary as the fifth power of the supply voltage and timers have been designed already\* in which the exposure interval is made inversely proportional to the fifth power of the supply voltage.

Cold cathode trigger tubes are considered preferable to neon stabilizers for this application. The trigger tube is cheaper and its striking voltage is likely to be more stable than that of the neon tube.

When compensation is obtained solely by using an un-stabilized condenser-charging voltage, this must be made only a few per cent greater than the striking voltage of the neon or trigger tube. Any variation in the striking voltage then becomes serious. Also, with supply voltages falling below the nominal value by more than about 7 per cent, the timer becomes seriously over-compensated. The cure is then worse than the disease.

These difficulties are overcome by using two forms of voltage-sensitive correction simultaneously. The circuit shown here is based on this principle and is scarcely more

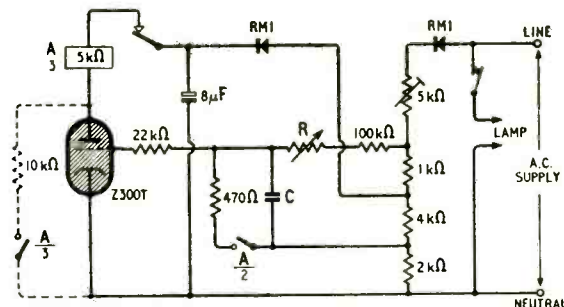

complex than those you have published already. The timing resistor, R, may have any value between 1 and 10 megohms and the timing condenser, C, is conveniently 4 to 20μF. The 5-kΩ preset control must be set to give time intervals equal to 0.6CR at the nominal supply voltage. With supply voltage variations from +15 to -20 per cent of the nominal value, the intensity-time product then changes by no more than ± 5 per cent. Compensated timers of this kind are useful for repetition work, particularly where high-contrast materials are used.

Methods of producing a substantially constant intensity-time product by judicious proportioning of the circuit and valve parameters have been investigated in the laboratories of Ilford, Limited and are the subject of British Patents 656,275 of 1948 and 667,296 of 1949.

Physics Research Laboratory, D. M. NEALE.  
Ilford, Limited, Brentwood, Essex.

\* "Photographic Exposure Timers providing compensation for Supply-Voltage Variations." R. J. Hercocck and D. M. Neale. Proc. I.E.E., Vol. 99, Part II, No. 71, Oct., 1952, pp. 507-515.

## Recovering Hidden Signals

YOUR contributor James Franklin (March issue) speaks of the correlation function as "one of the latest methods of analysing electrical signals—or indeed variations in time of almost any kind." Moreover, "Actually it was invented by G. I. Taylor in 1920, but only recently has it come into prominence and been used in a practical sort of way."

Possibly your contributor does not regard mathe-

mathematical use as "practical," so the fact that this function has been studied and developed by mathematicians since the days of Fourier at latest may leave him cold. The integral involved, the "product by composition" is fundamental to functional analysis, integral equations, transforms and the like and its importance has been recognized for well over a century.

In the more "practical" fields of finance, commerce, meteorology, economics and optics it has been used and taught as a standard instrument for investigating time series, certainly for most of this century.

Perhaps Young (1813) just can be claimed as a candidate for priority in the field of optics and also, much later, Rayleigh. However, Sir Arthur Schuster applied the correlation function to the same problems as your contributor in various papers at the turn of the century. These are well known, in the sense that they are cited in many modern textbooks, including those for communications engineers. One in 1899 dealt with hidden periodicities in meteorological data, others with the coherency of white light. The method was that described by your contributor, using functions of real variable only and therefore confined to the past of the data. The real "latest developments" came after 1930, when Wiener and others extended the method to complex variables.

Your contributor, however, is by the nature of his apparatus concerned only with the real-variable correlation function. If he finds it "the latest method," this is because he, not the function, is the later arrival.

Farnborough, Hants.

R. A. FAIRTHORNE.

### Voltage Multipliers

I READ with interest "Cathode Ray's" article on voltage multipliers (March 1955) and should like to make two comments.

1. The circuit of Fig. 10 can be used as a trebler. All that is necessary is to earth the top end of G, not the bottom end. The rule that can be derived from this is:— If you add any stages of multiplication to a circuit of this type do this always on the supply side (this will obviate the need for reversal). This can also be seen quite clearly in "C.R.'s" Fig. 12. You can, for instance, remove  $C_1$  and  $D_1$ , still taking your output from the right-hand side, and the multiplication factor will be 5 instead of 6. Similarly, you can add a stage between the bottom end of the ladder and G in Fig. 12.

2. Sometimes voltage multipliers are used with a supply of unidirectional pulses of short duration (such as line flyback pulses). In this case  $D_1$  and  $C_2$  in Fig. 10 would produce no step-up of voltage, and  $D_2$  may be replaced with a resistance, a typical value (in a line flyback circuit) being  $1M\Omega$ . The only disadvantage is an increase in source impedance, but the deterioration is generally considered insufficient to warrant the use of a rectifier in place of R.

London, N.W.2.

G. N. E. PASCH.

### Special Quality Valves

THE article in your December issue refers to the use of a wiring jig to hold the contacts of miniature valveholders in their correct positions during chassis wiring. Such a jig is very desirable to ensure mechanical alignment of the contacts but it has been found that this procedure can lead to poor electrical contact between the holder and the valve pin. In certain miniature valveholders which use brass contacts, the heating-cooling cycle caused by soldering (with the jig or valve pin in position) usually results in an appreciable loss of contact pressure. In a limited number of cases this is sufficient to produce a very "noisy" contact. No such difficulties have been found when using beryllium-copper contacts.

Nottingham.

A. T. DENNISON.

### Electronics on the Farm

I CAN assure Mr. Taylor that "the hoary old stager" can be substituted by a unit operating from a wireless battery, but I assume from his letter that he has not tried one of these units. If he will do so I think that he will find that the contact trouble to which he refers will disappear.

Units using neon tubes as a switch and also units using electronic circuits are manufactured, but I believe they are all mains operated and they are also of necessity more expensive.

Line test units are marketed and may be bought independently of the unit, and they are of such design that they can be left permanently connected to the fence line. One particular testing device is so arranged that the actual value of the output from the pulse unit can be measured.

May I suggest to Mr. Taylor that when choosing a pulse unit he should consider output characteristics since some of the types of unit on the market give a large voltage and consequent large spark on open circuit, but when connected to a fence of average insulation resistance they may give a relatively poor shock to an animal having a contact resistance of the order of 10,000 ohms, due to the inherent regulation of the unit.

Orpington.

C. W. ROBSON.

MOST of the electric fences on the market work off a standard 120-volt h.t. battery, and these are fairly big and bulky items to store away, even in so-called "portable units," and are, as far I can find, the highest voltage type on the market.

I have made and operated quite a few fences on the resistance-capacitance principle, and found them very satisfactory and reliable. With neon types, one is up against snags at once. The major one is that the striking voltage is far too high for the standard battery to give any length of service; with the RC type I have still had the fence working with the battery reading 45 volts on load. The ideal is, of course, the cold-cathode trigger type, but I have only used these on mains-operated units, extensive searchings having failed to find a manufacturer who makes one that can strike or be triggered as low as 60 volts.

Incidentally, Mr. Taylor will find that a piece of grass about six inches long (if wearing boots, and shorter if in Wellingtons) will only give a slight tingle in the fingers if held to the fence. Much cheaper than neons or having to walk the full length of a twenty-acre field to see if the unit is on or off.

Truro, Cornwall.

D. A. BOND.

### Viewers' Strike?

I COULD hardly agree more with Mr. Niall (February issue), and wish him every success if he wants to organize a viewers' strike. I assume it is his intention that viewers will cease to view when their licences expire.

I shall then achieve the Four Freedoms. Freedom from timebase harmonics which ruin all B.B.C. reception in TV hours. Freedom from re-transmission of the TV sound programme in the 3.5 Mc/s amateur band. Freedom from various r.f. oscillators on various short-wave broadcast bands. And freedom from rough notes sliding up and down the 14 Mc/s amateur band.

I am in favour of TV suppression—the total suppression of those ill-designed or ill-adjusted models which cause such widespread interference to almost anything except TV.

The possession of a TV set ought not to give one the right—as it seems to do—to moan about interference from others, yet cause interference oneself. Why not try it on the other foot for a change?

"First cast out the beam from thine own eye."

Workshop.

H. S. CHADWICK (G8ON).



# TESTING PRECISION OSCILLATORS

## Automatic Recording of Frequency Stability

By M. P. JOHNSON,\* E.E.(Toronto), A.M.I.E.E.

CARRIER frequencies used in multi-circuit carrier telephone systems must be kept stable if no undue frequency translation of the received audio is to occur. On modern British coaxial cable carrier systems it is usual to derive all carrier frequencies from a master oscillator operating at 124 kc/s. Such an oscillator normally has a frequency drift of less than 2 in  $10^7$  per month and a frequency temperature deviation of less than 2 in  $10^8$  per  $30^\circ\text{C}$ . An extremely precise source of frequency is needed for the development and testing of oscillators of this stability and it is very desirable that the source should be continuously available. An attractive possibility adopted by the author's firm was to measure automatically and record against the National Physical Laboratory transmission on 2.5 Mc/s from station MSF at Rugby. It was ascertained that over the 10 miles from Coventry, where the development was carried out, to the Rugby station MSF ground wave reception was dominant and Doppler effect was negligible.

There are several methods available for displaying the frequency difference between the standard and test sources. For example, needle-like pulses can be produced from the difference frequency and the mean value of these is then proportional to the difference frequency. Alternatively the difference frequency can be passed as a constant current through an inductance and the voltage across the inductance is then proportional to the difference frequency. Another method is to charge a capacitor at a rate corresponding to the cycles of the difference frequency and use suitable linearizing circuitry to produce a voltage proportional to the frequency difference. Circuits dependent upon waveform can, in general, be difficult, especially at low difference frequencies. Those dependent upon pulses developed by differentiating circuits are subject to false operation when noise is present, as is the case with radio signals. Moreover, with some of these

methods long time constants are necessary to obtain a reasonably steady d.c. output to the recording instrument, and this results in a poor response to short-term variations.

The method we actually chose is free from these difficulties and from linearity problems. A count of the difference frequency is made over regularly recurring gating periods and an output current is obtained that is proportional to the count and hence to the difference frequency. Thus the recorded reading is the average of its own gating period only. This independence of previous readings is not easily obtained with the other methods.

Actually the difference frequency is counted for 116 seconds. The recording meter connected to the counter is arranged to respond linearly to the count and so a linear scale of difference frequency is obtained. A count of 58 causes a full-scale meter deflection. This corresponds to a difference frequency of one cycle per two seconds or 0.5 c/s in 2.5 million c/s, which is a frequency difference of 20 parts in a hundred million, or 20 in  $10^8$ . The meter records the frequency difference at the end of the first count and continues this reading until a different count causes it to change. Four seconds after the first count, the counter commences a second 116-second count without altering the pen recorder reading. At the end of this 116-second count the pen recorder changes, if necessary, to suit the new frequency difference and this process is repeated throughout the normal operation of the equipment. As 58 counts give a full-scale reading, the meter can record any of 58 discrete readings across the paper chart.

The equipment may be set to operate at counting times of 116, 232, or 464 seconds. In each case a count of 58 yields a full-scale reading on the meter.

\* G.E.C. Telephone Works.

Fig. 1. Block schematic of the automatic measuring and recording equipment.

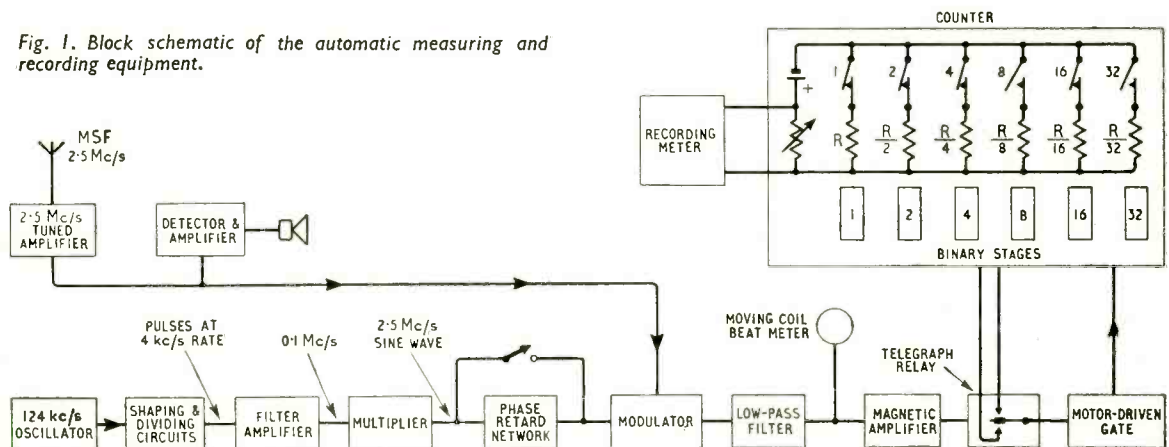

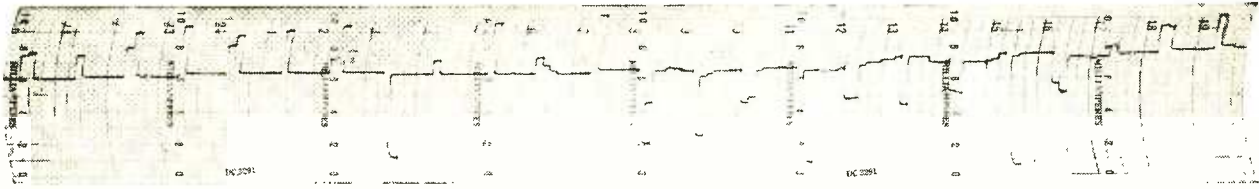

At 116 seconds the full-scale reading corresponds to a frequency difference of 20 parts in  $10^8$ . At 232 seconds it corresponds to 10 in  $10^8$  and at 464 seconds to 5 in  $10^8$ .

The general arrangement of the measuring equipment is shown in Fig. 1. The 124 kc/s master oscillator frequency is translated by division and multiplication to 2.5 Mc/s for comparison with the 2.5 Mc/s radio signal. The two are then combined in a modulator which gives the difference frequency without a d.c. component. This difference frequency is amplified and applied to a telegraph relay, which operates the counter during the counting period, which is controlled by the gate operated from a 50-c/s synchronous motor. This gate actually consists of a telephone relay spring-set mounted on a slotted cam which is driven at 1 revolution per two minutes through a gear train by the motor. The counter (a binary type) contains relays which switch parallel resistors into a circuit supplied with a constant voltage so that a current is obtained in the circuit proportional to the total count in each period. A moving pen recorder then displays this output current. Frequency differences of 5, 10 and 20 parts in  $10^8$  can be displayed with full-scale deflection on the meter by using time intervals of approximately 8, 4 and 2 minutes respectively for the gating period, as already mentioned.

The 2.5-Mc/s receiver comprises five stages, each tuned to 2.5 Mc/s. Audio monitoring for announcements and noise checks is obtained from a detector and amplifier in parallel with the output to the modu-

lator. In the chain associated with the local 124-kc/s oscillator a two-valve tuned multivibrator is used in the first place to perform a division of 124 kc/s to 4 kc/s. It is preceded by a two-stage shaping circuit and also followed by a pulse shaping circuit which gives 4- $\mu$ sec pulses at a repetition rate of 4 kc/s. (This output is, of course, rich in harmonics of 4 kc/s). These pulses are fed into a three-stage filter amplifier which selects the 25th harmonic, namely 100 kc/s. The resulting sinusoidal output is applied to a frequency multiplier, in which an input Class-A stage drives hard a Class-C stage tuned to 2.5 Mc/s. The frequency multiplier is then followed by a two-valve filter amplifier tuned to 2.5 Mc/s to supply the modulator.

The low-pass filter which follows the modulator reduces any signal leakage back to the aerial and thus helps to prevent loop singing. A magnetic amplifier is used to amplify the resulting difference frequency. It has a reasonable zero stability and thus enables a positive drive to be applied to the telegraph relay. The actual difference frequencies for full scale deflection of the recording meter on each of the three ranges are 0.125 c/s, 0.250 c/s and 0.500 c/s. At such frequencies it is not easy to achieve a perfect sine wave free from noise, and for this reason the telegraph relay was chosen, in preference to valve trigger circuits, because it is probably easier to adjust against false operation.

The counter uses cold cathode valves (Osram type CCT5) in six binary stages to give a total count of 63. Of this, 58 counts are used to give full-scale deflection on the recording meter. Each binary stage

Fig. 2. Typical records from the equipment with full-scale reading of 20 parts in  $10^8$ ; (a) drift rate of one oscillator, (b) frequency/temperature performance of another oscillator. Troughs in the traced line are due to 5-minute breaks in the MSF transmission.

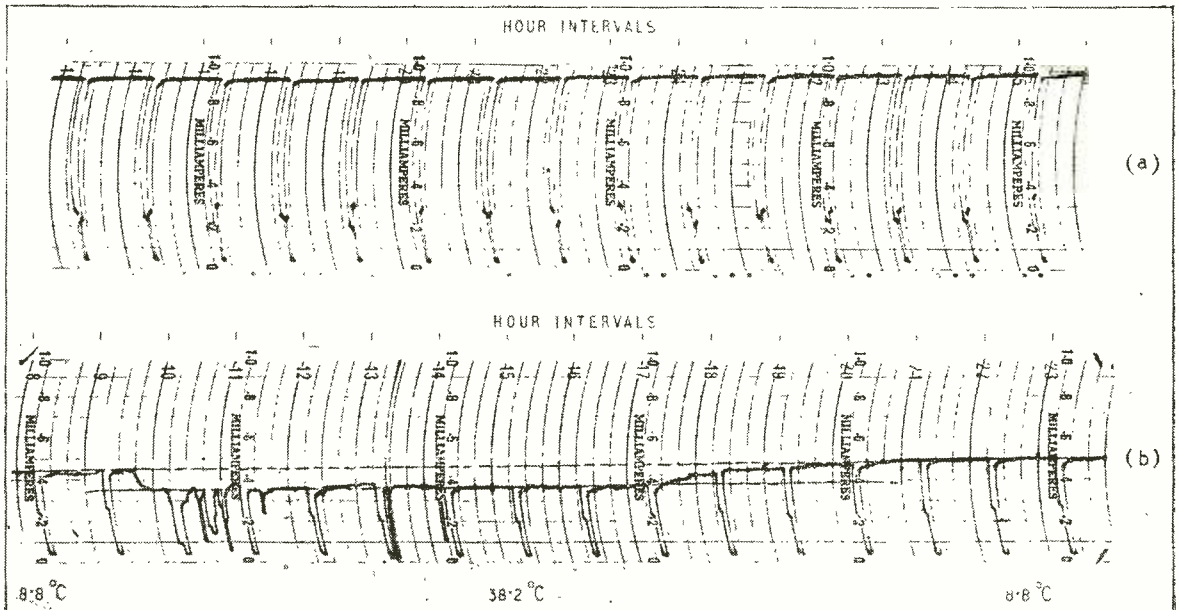

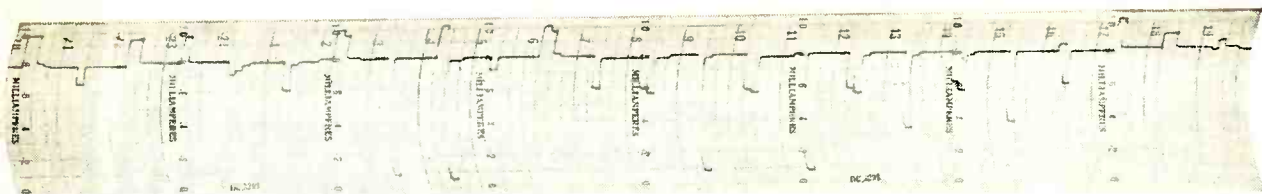

Fig. 3. Record obtained from the equipment over a period of 48 hours. The full-scale reading is 5 parts in  $10^8$ . The five-minute breaks in the MSF signal are again clearly defined while the "pulses" rising above the normal trace are due to interference from a local transmitter during these breaks.

has associated with it a telephone relay and at the end of the first count the appropriate binary stages operate their relays and so give rise to a current which is proportional to the count. For example, in Fig. 1, the relay contacts are shown operated for a count of 23. The relays do not release unless a subsequent count demands it. A switch and two more binary stages enable the normal gating time of 116 seconds to be extended to 232 or 464 seconds. A four-second interval is allowed between readings at the 116-second gating rate.

It is necessary at times to establish whether the oscillator under test is higher or lower in frequency than the standard source. A simple method of doing this is to use a centre-zero moving coil meter to indicate the beat frequency and a phase retarding network connected as shown in Fig. 1. An inductive or phase retard network connected in series with a circuit introduces a phase lag which has at the moment of connection the effect of slowing down the wave applied to it. It appears as if the frequency were momentarily decreased. Thus an oscillator whose frequency is higher than MSF with a difference frequency of a 10-second cycle will appear to have its frequency decreased, and the 10-second swing on the beat meter of Fig. 1 will momentarily, but quite clearly, slow down. If the frequency were below MSF, the difference frequency would be increased and the 10-second cycle would be shortened to give a momentary acceleration of the beat meter.

Of course, there are bound to be certain small inaccuracies in the measurement system, but if a stabilized mains voltage is used and a radio path free from interference is assumed, these are not too serious. The gating or counting period is controlled by the motor which is synchronized with the 50-c/s mains frequency. Variations of the mains frequency will consequently affect the counting time of 116 seconds and multiples of it. This will directly affect the count and, of course, the pen recorder reading. The error due to this cause should not normally exceed 1%, i.e. the count itself would have an error of 1%. Care has been taken with the cutting of the cam and arrangement of the spring-set operation so that the counting-time variations due to these are less than 0.1%. In counting systems such as this where a fixed gating period is used an error of 1 is always possible in the count. At full scale this would be 1/58 or 1.7% and at 10% of full scale it would be 17%. Errors in the recording meter circuit might be 2% resulting from drift in the voltage source and 1% due to resistor tolerances. Excluding inaccuracies in the recording meter, a total error of 6% could occur at full scale and 21% at 10% of full-scale reading. On the range 0-20 in  $10^8$  the 21% error would give an incremental error of 4 in  $10^8$ , which is acceptable.

Fig. 2 shows some typical records obtained from the equipment. The sudden troughs in the line at

hourly intervals are caused by the 5-minute cessation in the MSF transmission at 15 minutes past the hour. Fig. 2(a) shows the drift rate of a particular oscillator under stability investigation. The frequency/temperature performance of another oscillator is displayed in (b). Table I shows the worst errors

Table I

| Manual Reading parts in $10^8$ | Percentage error in pen reading | Actual error parts in $10^8$ |
|--------------------------------|---------------------------------|------------------------------|
| 0.86                           | 30                              | 2.6                          |
| 5.36                           | 3                               | 1.6                          |
| 15.7                           | 1                               | 1.6                          |
| 20.1                           | 0.5                             | 1.0                          |

observed on a chart run for about ten minutes at each of the listed readings. A full-scale sensitivity of 20 parts in  $10^8$  was used. Checks were made by timing with a stopwatch a sufficient number of beats on the beat meter to enable the frequency difference to be determined to an accuracy of better than 0.5%.

The equipment described has now been in operation for about six months. For routine maintenance it is returned at two-weekly intervals. If this is done little trouble is experienced from spurious readings due to faulty adjustment or electrical interference. For example, the chart of Fig. 2(b) was taken at an early stage in the development when spurious readings were more common. In spite of this the performance is reasonably defined. A run of 72 hours with no spurious reading is not unusual. Fig. 3 is representative of the equipment in its present state.

Observations to date have indicated that no deviations that have been observed could be attributed to Doppler effect.

From the charts, the short-term stability and the long-term frequency stability of an oscillator over the preceding 24 hours or longer may be calculated in several minutes. To obtain these results to the same accuracy by manual methods would have required human effort for 24 hours or longer.

It is often necessary to check the frequency/temperature performance of an oscillator before the quartz is fully aged. The frequency deviation due to temperature must be separated from that due to ageing. To do this, a continuous chart run is taken for a sufficient length of time at the initial temperature, then continued while the oscillator is held for a sufficient time at the second temperature, and continued further while the oscillator is returned to, and held again at, the initial temperature. The initial temperature drift lines may be quickly extended on the chart, and their mean distance from the line at the second temperature is the required frequency/temperature deviation. Apart from this simple calculation, it is only necessary

to set the automatic temperature controller to the required temperature after the appropriate time has elapsed. This, too, could of course be made automatic. In contrast, it is a long and tedious process to obtain the frequency/temperature performance by manual methods.

Oscillators of the performance mentioned in the first paragraph of this article may have supply-voltage coefficients of frequency of less than 1 part in  $10^8$ . These coefficients are measured during initial adjustment and, except under fault conditions, require very infrequent checking. Nine combinations of supply voltages are possible. The corresponding nine coefficients of frequency are all measured in a matter of half an hour by obtaining the period of one cycle of the difference frequency at 2.5 Mc/s, by use of a stopwatch or an automatic electronic timer. These methods are preferred for speed and accuracy. If the counting method of Fig. 1 were used, the gating time of 8 minutes would be necessary and this would require at least 72 minutes for measuring the nine coefficients.

The automatic recording method of Fig. 1 is being used for production testing of precision oscillators. Each oscillator under test is sampled in turn and its

frequency difference is printed on a multi-channel recorder.

It would be helpful if a shorter gating time could be used without worsening the accuracy. The following suggestion for obtaining the difference frequency is therefore of interest.

Let the oscillator frequency be  $(124 \times 10^3 + \delta)$  c/s. If this is multiplied by 20 and modulated by 2.5 Mc/s, the frequency  $[2.5 \times 10^6 - 20(124 \times 10^3 + \delta)]$  c/s would result. If this in turn were multiplied by 125 and again modulated by the 2.5 Mc/s signal, the final difference frequency would be  $125 [2.5 \times 10^6 - 20(124 \times 10^3 + \delta)] - 2.5 \times 10^6$  c/s =  $-2500\delta$  c/s. (The negative sign indicates that the final difference frequency is below the standard.) By contrast the signal modulation scheme yields a final frequency difference of

$$\frac{625}{31} (124 \times 10^3 + \delta) \text{ c/s} - 2.5 \times 10^6 \text{ c/s} = \frac{625}{31} \delta \text{ c/s.}$$

The double modulation scheme is therefore  $2500 \div \frac{625}{31} = 124$

times more accurate, and consideration could be given to reducing the gating time.

Finally, the author would like to thank John H. Beesley for his effective paper design of the counter.

## New Valve Voltmeters

### *A Versatile D.C./A.C. Instrument and an Amplifier-type A.C. Millivoltmeter*

IN the type E7555 valve voltmeter recently developed by Mullard, the d.c. amplifier is designed to be virtually independent of mains fluctuations and valve ageing. The circuit is a balanced type with two EF86s connected as a "long-tailed pair" and directly coupled to two cathode followers. The output from the cathode followers is connected to the grids of the EF86s and gives virtually 100 per cent negative feedback and high stability. Both positive and negative potentials with respect to earth can be measured.

For a.c. inputs a probe unit is provided with a double diode valve, one half for rectification and the other for balancing. A frequency response level from 30 c/s to 100 Mc/s is claimed. On the lowest range

full-scale deflection on the 5-in meter is given by 0.5V peak (a.c. or d.c.). Maximum voltage is 15,000 in type E7555/2 and 500 in E7555/3.

At frequencies up to 50 kc/s the probe input resistance is  $3.5M\Omega$ , falling to  $8.5k\Omega$  at 45 Mc/s. The effective input capacitance is constant at 9pF.

The type E7556 meter incorporates a three-stage feedback amplifier, preceded by a cathode follower. A diode rectifies the amplifier output and the d.c. component is registered on a 5-in mirror scale meter. The limits of measurement of a.c. voltages are 0.5mV to 300V, with a total error less than 4 per cent. The frequency range is 20 c/s to 1 Mc/s. On the lowest range (10mV f.s.d.) the input resistance is  $1.5M\Omega$  at 20 kc/s and  $0.75M\Omega$  at 1 Mc/s, with an input capacitance of 15pF. The corresponding values for ranges of 3V f.s.d. and above are  $1.9M\Omega$ ,  $0.7M\Omega$  and 6pF. A calibrating voltage of 10mV is provided at mains frequency from a bridge circuit with lamp stabilizing elements.

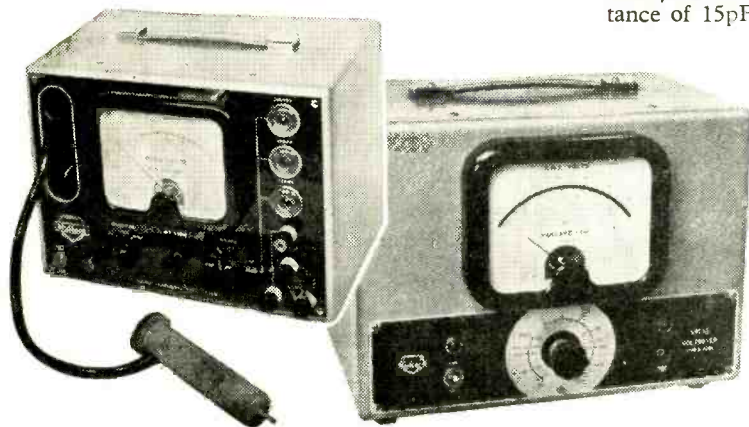

Two new valve voltmeters made by Mullard (Equipment Division). On the left is the type E7555 balanced d.c. meter, with a.c. probe, and on the right the amplifier type a.c. meter (E7556) reading from 0.5mV to 300V.

# Phase-to-Amplitude Modulation

Variable Frequency Transmitter Based on Polyphase Oscillator

By BRYANT D. VIRMANI\*

ONE of the less familiar methods of achieving efficient operation in a transmitter is known as phase-to-amplitude modulation. It was first described by Henri Chireix, a French radio engineer, in 1935† and has since been used in quite a number of transmitters, most of them on the Continent. The principle of operation is based on the fact that when two r.f. carriers of the same frequency and amplitude are phase modulated differentially and then combined the result is an amplitude-modulated carrier. For example, if the modulation causes the two carriers to be 180° out of phase they cancel each other and produce a trough in the a.m. output, and if the modulation causes them to be in phase they add together to produce a maximum in the a.m. wave. Thus, when the phase displacement is varied between 0° and 180° it produces corresponding variations between maximum and zero in the amplitude of the combined carrier wave.

This scheme makes for high efficiency in two principal ways. First of all, the phase modulation is done at low level, which avoids the need for a high-power modulating amplifier. Moreover, this low-level modulation can be used, if desired, with high-efficiency class-C r.f. amplifiers, which normally require high-level anode modulation. Secondly, the valves in the two phase-modulated r.f. channels can be driven to their maximum limits and will remain in that condition all the time, giving the maximum possible efficiency, because there is no variation in carrier amplitude produced by the modulation—only a variation in phase. The result of these two features is that for a given r.f. power output the phase-to-amplitude transmitter is much more economical in its consumption of electrical power than other comparable transmitters. Moreover, it occupies a smaller space and weighs a good deal less. The author, in fact, claims a saving in power consumption and in weight of anything from 40% to 70% and a saving in physical size of 30% to 70%, compared with a conventional class-C anode-modulated telephony transmitter.

Another method of achieving efficient operation which has a certain point of similarity with the

phase-to-amplitude system is a well-known technique for obtaining single-sideband suppressed-carrier transmission. Here the economy results from the fact that no power is wasted in transmitting the redundant carrier and redundant sideband. The point of similarity with the phase-to-amplitude system is the use of two r.f. carrier components with a phase displacement (90° for s.s.b.) between them. (In the output the two sets of sidebands which result from modulating these r.f. carrier components are combined, and the phases are such that one sideband is balanced out and the other is augmented.) In fact, both the phase-to-amplitude system and the single-sideband technique require two r.f. carriers of the same frequency and amplitude with a certain phase displacement between them. In practice these carriers are usually derived from the same source through a phase-shifting network of capacitors and resistors—but the great disadvantage here is that the network is frequency-sensitive and consequently the frequency of the transmitter cannot be varied without changes in the circuit.

This particular disadvantage has been overcome in a 400-watt a.m. transmitter designed by the author which can be operated with either phase-to-amplitude

\* Polyphase Electronics (Toronto, Canada).  
† H. Chireix. "High Power Outphasing Modulation," *Proc. I.R.E.*, November, 1935.

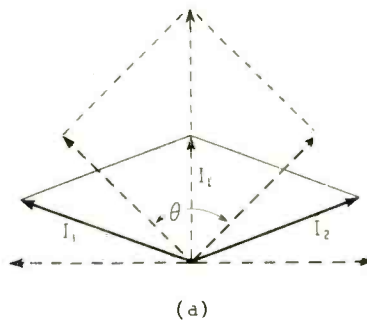
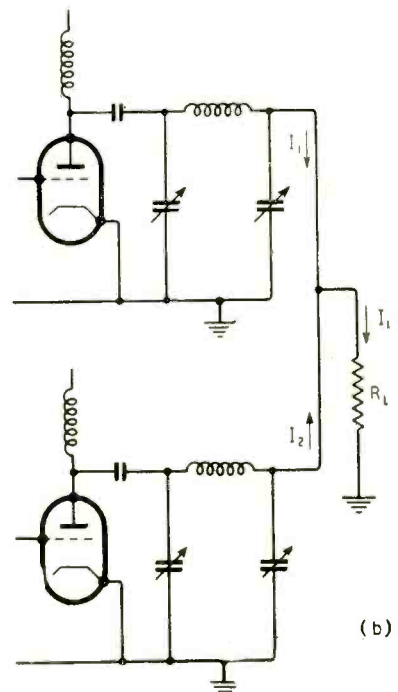

Fig. 1. (a) Vector diagram illustrating the principle of phase-to-amplitude modulation. The two phase-modulated currents  $I_1$  and  $I_2$  are combined to produce an amplitude-modulated current  $I_1$ . (b) Output stage of a phase-to-amplitude modulation transmitter, showing how the phase-modulated components are actually combined in a common load.



modulation or single-sideband suppressed-carrier—and therefore allows the similarity to be exploited to some extent. The conventional oscillator and phase-shifting network has been replaced by a polyphase oscillator, which not only gives the required phase-displaced outputs directly, but retains the correct phase displacement when the frequency of oscillation is varied. The result is possibly the first transmitter in which single-sideband operation has been achieved using a variable frequency oscillator.

Before describing the transmitter in detail it will be as well to look more closely at the phase-to-amplitude system of modulation and at the polyphase oscillator. A fairly recent version of the phase-to-amplitude system was devised by Webster for use in a 5-kW transmitter.\* Here the principle of operation (Fig. 1(a)) is based upon two r.f. vectors,  $I_1$  and  $I_2$ , with a phase difference of  $135^\circ$  in the carrier condition. They are phase modulated up to a maximum limit of  $\pm 22\frac{1}{2}^\circ$  by a push-pull audio amplifier. The resultant phase difference between the two channels could be  $180^\circ$  or  $90^\circ$ , depending upon which channel initially lags or leads the other.

When the two channels are  $180^\circ$  out of phase no voltage will appear across  $R_L$ , the common load shown in the circuit Fig. 1 (b). This condition constitutes, in effect, a short circuit of the output ends of both quarter-wave networks shown in (b). Then, due to the impedance-inverting qualities of the quarter-wave networks, the source ends of these networks appear as very high impedances and very little energy is supplied from the valves.

When phasing conditions are reversed, 100% positive peak modulation is obtained. Each channel then supplies energy to the load  $R_L$ . Owing to the effect of two sources of r.f. power feeding  $R_L$  the resistance "seen" by each channel at the output end of the quarter-wave network varies from zero to four times the load resistance required to obtain the correct carrier power. Then, again due to the impedance-inverting qualities of the quarter-wave networks, the power amplifiers themselves "look" into a load resistance which varies from an extremely high value to approximately one quarter that encountered at the  $135^\circ$  carrier condition. It is impossible to over-modulate because over-modulation will bring the two r.f. channels less than  $180^\circ$  apart, which is the condition for positive modulation.

### Ninety-degrees System

Another version of the principle is due to Perthel† who takes two r.f. channels with a phase difference of  $90^\circ$  in the carrier condition and modulates each channel up to a maximum limit of  $\pm 45^\circ$  by a push-pull audio amplifier. He connects the anodes of the final amplifier valves in push-pull. The phase difference due to modulation at the grids of the final amplifier could be zero or  $180^\circ$ . When the two channels are  $180^\circ$  out of phase full power output is delivered. But when the grids swing to a phase difference of zero degrees, the voltages developed at the anodes cancel out since the anodes are connected in push-pull. If the anodes are connected in parallel instead, the same results are obtained by completely reversing the phasing conditions at the grids.

To obtain two vectors with a phase difference of

\* N. D. Webster, "Economic 5-kW A.M. Transmitter," *Electronics*, May, 1951.

† B. Perthel, "An Unusual Phone Transmitter," *Radio and Television News*, August, 1951.

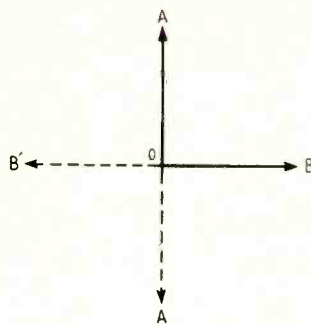

Fig. 2. Vectors illustrating the phase relationships of the four outputs from a four-phase oscillator such as the one in Fig. 3.

either  $135^\circ$  or  $90^\circ$ , phase-splitting circuits are conventionally employed, but, as was mentioned above, these are frequency sensitive. Therefore the systems of Webster and Perthel operate either on a spot frequency or over a very narrow range of frequencies. They are unsuitable for applications requiring a variable frequency oscillator to cover a very wide frequency range of the order of 1:10 or more in several bands.

In Webster's phase-to-amplitude modulation system, the reactance modulator valves operate linearly over a relatively narrow range of phase angles, so frequency multiplication by a factor of three is used to secure the eventual phase swing of  $\pm 22\frac{1}{2}^\circ$ . Moreover, to split an r.f. channel into two component vectors with a phase difference of  $135^\circ$ , using conventional phase-splitting circuits, it is necessary to use special measuring equipment. Furthermore, two quarter-wave networks ganged together are a little more difficult to adjust for best results than the simple push-pull circuit to be described.

The choice of two r.f. channels with a phase difference of  $90^\circ$ , as used by Perthel, is more profitable than Webster's system. The use of  $90^\circ$  vectors places at our disposal two additional types of transmission, namely, single-sideband (as already explained) and phase modulation. The carrier will be phase modulated if the two r.f. channels are swung in the same direction by a single-ended audio amplifier instead of a push-pull one. For c.w. or f.s.k. the modulator grids of the two channels may be driven by a keyed d.c. voltage.

In order to take advantage of the versatility offered by the Perthel system and adapt it for use directly with a variable frequency oscillator, all frequency-sensitive phase-splitting elements must be avoided. The logical solution of the problem lies in the use of a two-phase oscillator to generate two r.f. channels, with a phase difference of  $90^\circ$  as shown by the vectors OA and OB in Fig. 2. Now, in order to phase-modulate OA and OB by a pair of reactance modulator valves two additional channels,  $OB'$  and  $OA'$ , in phase quadrature to OA and OB respectively, must be made available—and the reason for this is as follows. A reactance modulator valve is the equivalent of a capacitance or an inductance shunted across an oscillating tuned circuit. If the value of this shunt element is varied, the phase or frequency of the circuit (depending on the manner in which the reactance valve is connected) will also vary. Now the reactive voltage and current in a capacitance or inductance are in phase quadrature, so in order to make the valve simulate this condition the voltage applied to its grid must cause the anode current to be  $90^\circ$  out of phase with the anode voltage. In other words, the grid and anode voltages must be  $90^\circ$  out of phase. Obviously, then,

to get the required four vectors shown in Fig. 2, we must generate four-phase oscillations with a variable frequency oscillator. Such an oscillator must be very simple to adjust and operate and must be capable of working over a very wide frequency range in a phase locked condition.

### Polyphase Oscillator

A circuit which satisfies these requirements is shown in Fig. 3—that is, the two valves V1 and V2 on the left-hand side. Each of these valves is a separate oscillator, but they both operate on the same frequency and are, in fact, locked together. The coupling between them in the common tuned circuit is such that they both settle down to a "mutual agreement" to differ by 90° in phase. Why is this so? The two inductors  $L_1$  and  $L_2$  are responsible for the coupling and they both carry oscillatory currents of the same frequency and magnitude. According to the laws of electromagnetic induction,  $L_1$  induces a voltage of opposite polarity in  $L_2$  and vice versa. When the sine wave in  $L_1$  is at peak value, it is inducing a maximum voltage of opposite polarity in  $L_2$ , thereby suppressing any sine wave which might normally be building up in the last-mentioned inductor. As the sine wave voltage in  $L_1$  begins to drop below the peak point, the opposing voltage induced in  $L_2$  also begins to drop, so giving  $L_2$  a chance to build up its sine wave voltage, which will reach its peak value when the voltage in  $L_1$  has dropped to zero. In this way

the two similar inductively-coupled oscillators mutually settle down to oscillate with a phase difference of 90°. Thus the output from the pentode anode of V1 is represented by the vector OA in Fig. 2 and the corresponding output from V2 by the vector OB.

The individual oscillators are actually modified versions of the two-terminal oscillator devised by Crosby\* in which the required 360° phase shift round the loop is obtained by two valves instead of one valve and a transformer. In Fig. 3 the two valves of each oscillator are formed by a pentode section, with the screen grid acting as anode, and a triode section; the anode of the pentode being used merely to electron-couple the oscillator to whatever it is feeding (in this case a reactance modulator valve). The oscillators can be varied over a very wide frequency range by the gauged tuning capacitors, and they can be crystal controlled if required by connecting a crystal between the two cathodes of either V1 or V2.

Thus, if the pentode anode of V1 produces an output which can be represented by vector OA in Fig. 2, the cathode of the same pentode will produce the vector OA', which is 180° out of phase. Similarly, if the pentode anode of V2 gives OB in Fig. 2 then the cathode will give OB'. Considering now the phase-modulator section of Fig. 3 (the right-hand side), the voltages represented by OA and OB are fed to the anodes of the reactance valves V3 and V4 respectively

\* M. G. Crosby. "Two-terminal Oscillator," *Electronics*, May, 1946.

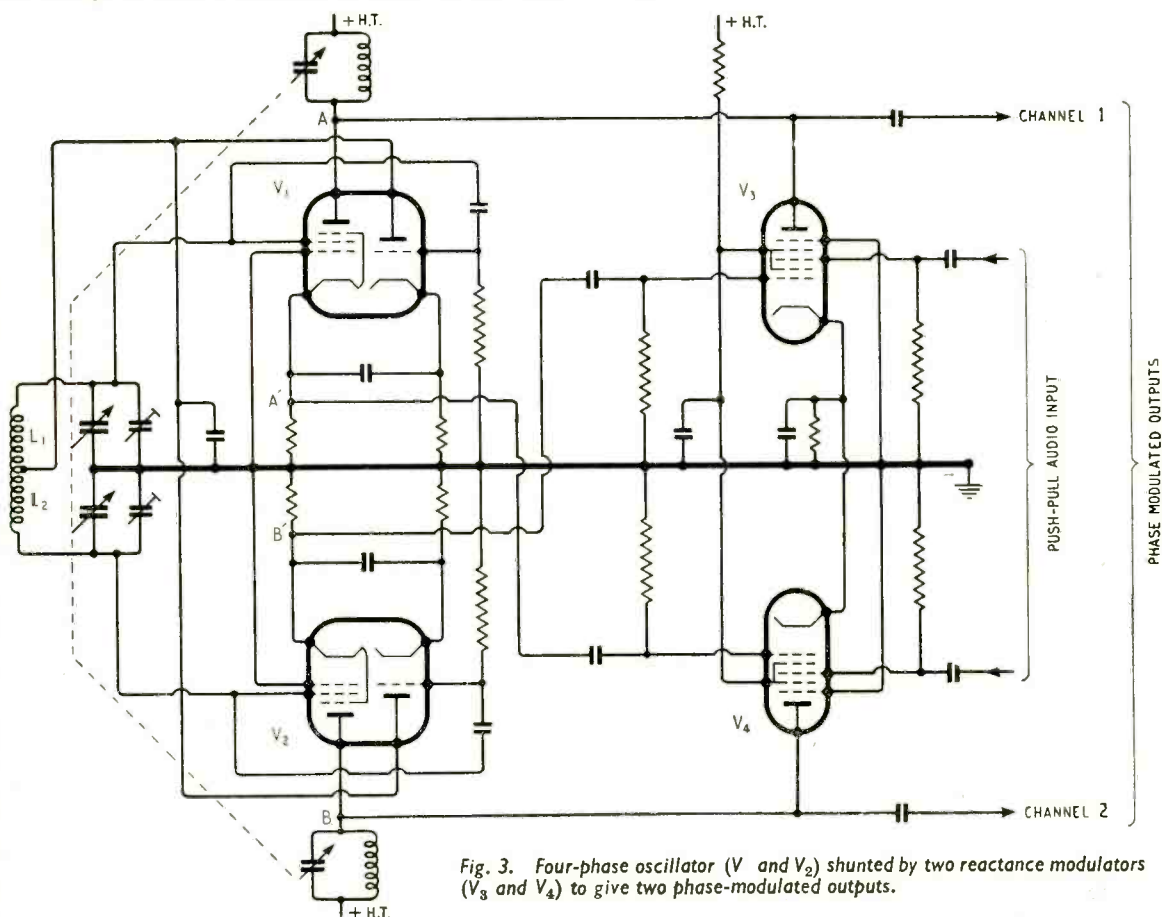

Fig. 3. Four-phase oscillator (V1 and V2) shunted by two reactance modulators (V3 and V4) to give two phase-modulated outputs.

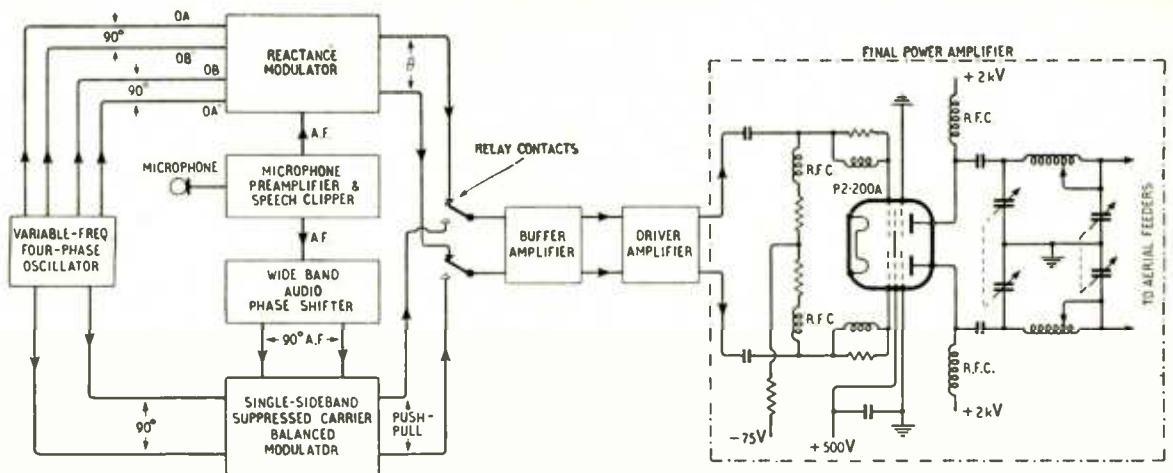

Fig. 4. Schematic (with simplified power amplifier stage) of complete variable-frequency 400-watt transmitter giving a choice of phase-to-amplitude modulation or single-sideband operation.

and the voltages  $OB'$  and  $OA'$  to the respective grids. Thus  $V3$  has a voltage on its anode corresponding to  $OA$ , with an anode current, lagging by  $90^\circ$ , corresponding to  $OB'$ . This is equivalent to a reactance shunted across the tuned-circuit output load of  $V1$  and its effect is to control the phase of the output signal from  $V1$ . De-tuning at the resonance point produces quite a rapid change of phase. The value of the reactance is controlled by the a.f. voltage applied to  $g_2$  of  $V3$  which thereby controls the phase of the oscillator output. Similarly,  $V4$  has  $OB$  on its anode and  $OA'$  on its grid and it operates to vary the phase of the signal coming from  $V2$ .

Thus the conventional frequency sensitive phase-splitting elements have been completely eliminated. The anodes of the two reactance valves and their respective grids remain always in true phase quadrature over the entire tuning range of the oscillator, whatever that may be. The reactance modulators are actually capable of swinging the phase of each r.f. channel linearly  $\pm 90^\circ$ , so that the two channels could be combined to produce a total swing of  $\pm 180^\circ$ .

### Complete Transmitter

The circuit schematic of the complete transmitter is shown in simplified form in Fig. 4. Since the reactance modulators are each capable of swinging the phase linearly  $\pm 90^\circ$  and we need only half of it, no frequency multipliers have been used. The transmitter has been designed to cover in three bands a frequency range of 3.5 to 8, 13 to 30 and 26 to 56 megacycles. The principal application in mind at the time of designing was for the amateurs in Canada and other countries where power output is limited by licence regulations to 500 watts. Since there is no amateur band between 7.5 and 14 Mc/s, no provision was made to cover it.

Fourteen crystals have been provided and they serve as band-edge markers for the seven amateur bands of 80, 40, 20, 15, 11, 10 and 6 metres. As the transmitter was designed to cover a wide frequency range, it was considered highly desirable to provide automatic amplitude control of the oscillations. This was done by means of diodes incorporated in each of the four 6AS8 valves used in the four-phase oscil-

lator. The oscillators operate strictly in class A and generate good sine waves free from harmonics over the entire range of the transmitter.

The reactance modulator valves are triode heptodes type 6AJ8. The anodes of the heptodes are tied in parallel to the anodes of the oscillator valves, which are used for electron coupling as in Fig. 3. The quadrature voltages for the control grids of the heptode sections are obtained from the oscillator cathodes as already described. The triode sections of the 6AJ8s are connected as see-saw push-pull audio amplifiers and the amplified audio voltages at their anodes are fed into the reactance modulators through a transmission selector switch. The first position of this switch is for amplitude modulation, in which case the grids of the heptode reactance modulators are driven in push-pull. The second position is for phase modulation, and here the grids are connected in parallel so that the two r.f. channels swing together in the same direction. In the third position of the switch, the control grid of one of the a.f. amplifier triodes is earthed and therefore no audio signal is applied to the reactance modulators. Consequently the two channels cannot swing in phase. Simultaneously, when the switch is on this position, a relay operates and causes the contacts shown in Fig. 4 to connect the buffer amplifier to the single-sideband push-pull output.

Because of the inherent non-linear characteristics of the phase-to-amplitude system of modulation, it is necessary to pre-distort the audio signal in the interests of high quality transmission. For this purpose germanium diodes are inserted in the grid circuits of the triode a.f. sections of the reactance modulators; the amount of pre-distortion being adjusted by potentiometers which are shunted across them. The audio section is actually built on the unit system, and if the transmitter is needed for short-wave broadcasting the audio amplifier can be replaced in less than two minutes by another one of high quality type suitable for broadcasting purposes. The oscillator tuning coils are also plug-in types and so can be changed if the transmitter is required to cover a different frequency range.

When it is desired to transmit c.w. telegraphy or test the phase swings of the two r.f. channels the



transmission selector switch is set on the second position. Here the third grids of the heptode reactance modulators are connected to a source of d.c. potential through the contacts of the keying relay. When the key is up, and the transmission selector switch is on the first position, the heptode grids are applied with d.c. potentials of polarities which cause the r.f. channels to swing to a phase difference of zero degrees. Then, because the final power amplifier anodes are connected in push-pull, no power output results. When the key is pressed, the polarities on the heptode grids are reversed and the two r.f. channels swing to a phase difference of  $180^\circ$ , in which condition the final power amplifier delivers full power to the aerial. When the selector switch is on the second position, the d.c. potentials swing the r.f. channels in the same direction, resulting in phase excursions which are equivalent to frequency shift keying.

The four valves used in the single-sideband suppressed-carrier balanced modulator circuit are triode heptodes type 6AJ8. The single-sideband output is push-pull and can be connected to the buffer amplifier by the relay contacts as shown in Fig. 4. The grids of the 6AJ8s receive phase quadrature r.f. voltages from the four-phase oscillator. The triode sections of the valves are connected in see-saw phase inverting circuits and the control grids of these triodes receive phase quadrature audio voltages over a frequency range of 130 to 3,600 cycles and  $\pm 1^\circ$  from a wide-band phase shifting circuit (half 12AU7). Upper or lower side-bands can be selected by a switch.

In the audio section, speech from a crystal microphone is passed through a pre-amplifier stage (6AU6) and the output is limited by a cathode-coupled speech clipper stage using a 12AU7 double triode. Since clipping generates harmonics, the clipper stage is followed by a band-pass filter, which is responsive over the speech band only. The filter terminates in two parallel-connected potentiometers. The output (slider) of one is connected through a switch to the reactance modulator. The output of the other potentiometer goes to the grid of an amplifier stage which has a wide-band phase-shifting network connected between its anode and cathode. This provides two audio frequency components with a phase difference of  $90^\circ \pm 1^\circ$  over a frequency range of 130 to 3,600 cycles, which are fed to the single-sideband modulator.

A voice-operated send-receive switch has been added as a refinement for neat and fast two-way communications, and there is also a 1,000-c/s oscillator for testing and adjusting the transmitter and for transmitting tone-modulated telegraph signals.

Returning now to the r.f. section of the transmitter, the buffer amplifier comprises two 6BX6s used as class-A voltage amplifiers and the output of these can be controlled by a potentiometer in the grid circuits. The amplified outputs of the 6BX6s drive the control grids of a dual power tetrode type AX-6360 (QQE03/12), which operates in the class AB<sub>1</sub> condition. The final amplifier valve is a type P2-200A. It is a dual power pentode made by Société Française Radio Electrique of Paris and it operates in the class AB<sub>2</sub> condition with a grid bias voltage of -75 volts and an anode voltage of 2kV in continuous commercial service. It may be loaded to an input of 680/700 watts approximately. The previous valve drives the P2-200A to full output with an ample reserve of driving power. Normally about 400 watts

is taken out of the valve, leaving about 75 watts in reserve. The output tank circuit is of the double  $\pi$  type, which has been designed to match any output impedance from 50 to 1,200 ohms. The anode tuning capacitors are a ganged pair of vacuum types and the rotary inductors are each 10 microhenries. For balancing the feeders a single r.f. ammeter is used with two external thermocouples, one on each feeder, and a double-pole double-throw toggle switch connects the meter to one or the other.

In the whole transmitter there are only three tuning controls: (a) oscillator frequency, (b) final anode tuning, (c) aerial loading. The operation of the transmitter has been reduced to extreme simplicity and it can be fully modulated by a carbon microphone without a pre-amplifier. The complete equipment, including all power supplies, has been packed into a vertical panel space of  $24\frac{1}{2}$  inches on a 19-inch standard width rack, and sits right on the operating desk alongside the communications receiver.

## "CLEAN" VALVES

CERTAIN types of receiving valves have grids wound as closely as 500 turns to the inch, with electrode spacings of the order of one-thousandth of an inch. It is not hard to see that the performance and life of such valves can be impaired by the presence in the air, during the assembly process, of particles of dust and other solid impurities. These become attached as whiskers to the electrodes and cannot be removed entirely by any subsequent process. To improve the reliability of certain special valves of the type under consideration, "dust free" assembly shops have been built at the research laboratories of the General Electric Company.

One such assembly shop, shown in the sketch, comprises an area 20ft x 11ft divided into one "L"-shaped room and one smaller rectangular room with a small entrance lobby separated from the working part by an airlock. The lobby serves as a dressing room for the working staff.

Housed in a gallery above the work rooms is a heating and ventilating system which delivers fresh air, warmed when necessary, at the rate of 1,000 cuft per minute and filters out all particles of dust larger than 5 microns in diameter (1 micron = 0.001 mm). A complete change of air is effected every  $2\frac{1}{2}$  min.

To prevent dust and "lint" being carried in by the operator's clothing, close-fitting nylon overalls, caps and special slippers are worn by the working staff and in-and-out traffic is reduced to a minimum.

Provision is made for extra filters to be installed which, should the need arise, would remove all foreign particles in the air over 0.2 micron. It is said that since these special workrooms have been in use a marked improvement has taken place in the quality of the valves assembled under these "clean" conditions.

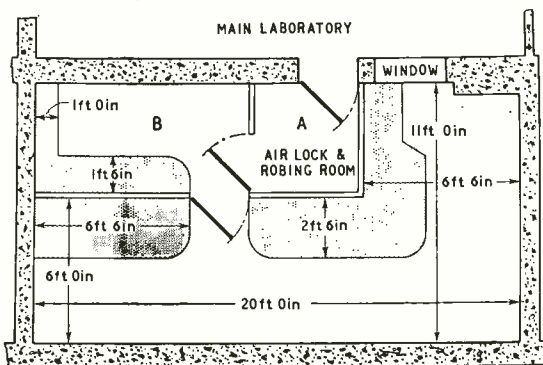

Plan of the G.E.C. dust-free valve-assembly rooms.

# Geophysical Research

## International Investigation of Phenomena Affecting Radio Transmission

By R. L. SMITH-ROSE,\* C.B.E. D.Sc., Ph.D., F.C.G.I., M.I.E.E.

**M**OST readers of *Wireless World* will be aware of the fact that scientists throughout the world are beginning preparations to participate in the International Geophysical Year, which is the term given to the period from July 1st, 1957, to December 31st, 1958. This will be the third time that physicists interested in the study of the earth and its atmosphere have conducted a detailed programme of world-wide experiments and observations during a "year."

**International Polar Years.**—The first enterprise of this nature was during 1882-83 and was termed an International Polar Year; it was followed 50 years later by a second co-operative effort under the same name. These, as their title indicates, were concerned specifically with investigating the special phenomena associated with the earth and its atmosphere in the polar regions. It was not normally possible to obtain frequent and regular scientific measurements in these regions, so expeditions were organized for conducting extensive observations on the earth's magnetic field, and on atmospheric conditions, including aurora.

During the second Polar Year (1932-33), radio technique was available for investigating conditions in the ionosphere at high latitudes, and a successful expedition was conducted under the auspices of the International Scientific Radio Union (U.R.S.I.), which appointed a Polar Year sub-committee with Sir Edward Appleton as chairman and Sir Robert Watson Watt as secretary.

In addition to the manning of special expeditions of this nature, a large number of countries arranged for detailed studies at observatories not in polar regions on specially selected "international days" as well as generally throughout the year. The British work was carried out in close co-operation with the D.S.I.R. Radio Research Station, and R. Naismith and W. C. Brown, who are still members of the staff of this station, were among those who spent the second Polar Year in Norway observing ionospheric conditions within the Arctic Circle. This particular programme of work gave a major impetus to the development of ionospheric research in Great Britain, and disclosed the close relationship between magnetic storms and abnormal conditions in the ionosphere.

**International Geophysical Year.**—It may now be asked why the title of this international effort has been changed, and why it is being arranged at half the interval between the first two "years." The reduction in the period from fifty to twenty-five years is an indication of the rate at which scientific research is advancing. New methods of investigation have been devised and the older ones considerably improved. The radio technique which was very limited in 1932 has now been extended to automatic methods of sounding the ionosphere and studying the effects of auroral discharges, as well as to techniques for detecting the incidence of meteors in the atmosphere

and for measuring winds in the ionosphere. In 1932 the conditions in the ionosphere were relatively quiet, being associated with a minimum of solar activity; during the 1957-58 period sunspots are expected to be large and to occur frequently. This is important since many solar and terrestrial phenomena depend upon this sunspot activity, as those concerned with radio transmission and reception over long distances are only too well aware.

In recent years interesting and unexpected phenomena in the ionosphere have been shown to be associated with the earth's magnetic equator, so that observations are required at low as well as at high latitudes. Furthermore, there appears to be certain differences in the phenomena observed in Arctic and Antarctic regions, so that it is clearly desirable that the new investigation should cover the world as a whole; and this is indicated in the new title. The science of geophysics covers the study of all phenomena associated with the earth's surface and interior and also with its atmosphere. The radio scientist is mainly interested in the latter, since it is the lower atmosphere, or troposphere, which determines the propagation of very short waves over moderate distances, and the upper atmosphere, or ionosphere, which controls the transmission of short radio waves over great distances. The study of the effects of the troposphere and ionosphere on propagation must be conducted in association with research in meteorology, geomagnetism and solar physics. And it is in an active spirit of co-operation that scientific workers in all these fields will be engaged all over the world during the forthcoming international geophysical year.

While some observations will be conducted by automatic recording methods, and are thus virtually continuous, the major portion of the work during the I.G.Y. will be concentrated at certain periods, known as Regular World Days. In addition to these "days" periods of ten consecutive days, to be known as Special World Intervals, will be arranged quarterly at the solstices and equinoxes.

**Radio Investigations.**—Radio research will play a very important part in the general scheme of this international geophysical year. Efforts are being made by various countries to increase the number of stations which use vertical sounding technique for measuring the characteristics of the ionosphere.

As will be seen from the accompanying map, there are about eighty such stations in operation throughout the world. Seven of these are controlled directly or indirectly by the D.S.I.R. Radio Research Organization; they are at Inverness, Slough, Singapore, Khartoum (Sudan), Ibadan (Nigeria), Port Stanley (Falkland Islands), and Port Lockroy (Antarctica). Normally these and most of the other stations take their observations at hourly intervals; but on the World Days described above, this procedure will be intensified to record the ionospheric conditions more frequently and if possible at five-

\* Radio Research Organization, Department of Scientific and Industrial Research.

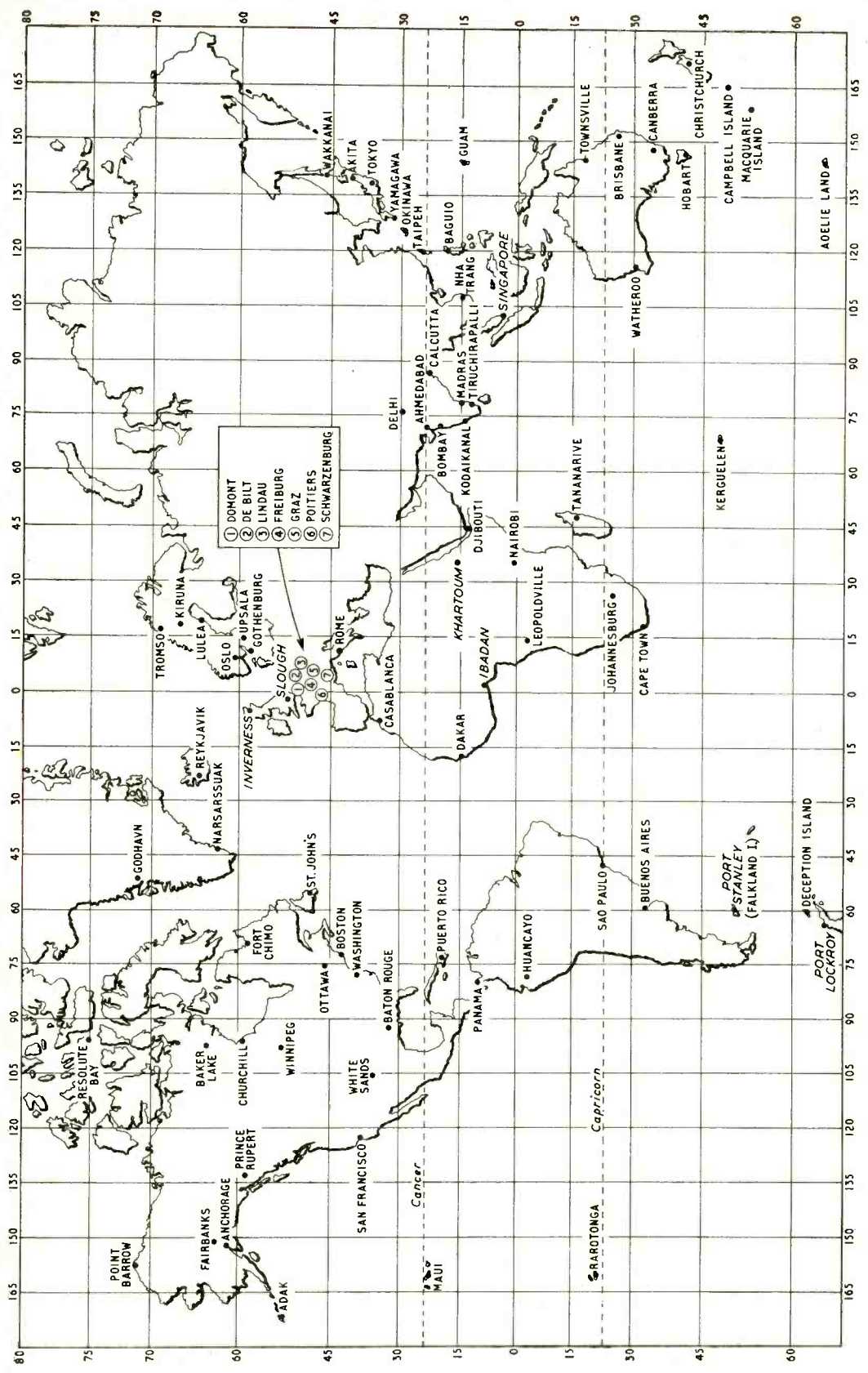

Disposition of the eighty-odd ionosphere sounding stations which will be participating in investigations conducted during the international geophysical year. The stations which come under the jurisdiction of the Department of Scientific and Industrial Research are shown in italics. Their regular observations will be intensified during the I.G.Y.

minute intervals. The work of these observatories is to measure, mainly by automatic methods, the height and density of ionization of the various regions of the ionosphere. In addition, measurements are made of the amount of absorption of energy suffered by the radio waves in travelling up to the ionosphere and back again to earth. At many of these stations the intensity of the earth's magnetic field is also continuously recorded, as this factor plays an important part in determining the state of the ionosphere for radio transmission.

For correlation with this radio work, all the necessary information on solar activity will naturally be obtained from the astronomical observatories, including the modern installations of the radio astronomers.

Several methods have been developed in recent years for detecting irregularities or disturbances in the ionosphere and the manner in which they travel horizontally and vertically. Observations will be made in this country and elsewhere by direct ionospheric sounding at spaced receiving points. Radio astronomy will also contribute to this investigation. The radiation from radio stars scintillates due to its passage through the upper part of the ionosphere, and observations of this scintillation are to be made in polar and equatorial regions, to provide further information on the irregularities of the ionosphere. Closely associated with this work will be the direct study of meteors, which in their passage through the atmosphere create a trail of ionization detectable by radio-echo technique. Observations on such meteors will be carried out by a chain of stations in the northern and southern hemispheres.

A relatively new technique for investigating conditions in the ionosphere over distant and even inaccessible localities, is that known as "back-scatter." In this method radio waves are transmitted at a low angle of elevation to be reflected by the ionosphere to a distant place on the earth's surface. Some of the energy is scattered from the ground at this place, or travels back over the same path to be received at the point of transmission. By studying the received echo on different frequencies and in different directions, valuable information about the ionosphere is obtained to supplement that from the vertical incidence recordings.

A field in which radio physicists and meteorologists have a common interest is that of atmospheric noise originating in thunderstorms and lightning flashes. A world network of stations measuring the strength of this noise on various radio frequencies has been in operation for some years past and this work will be continued during the international geophysical year. In some countries a group of direction-finding stations is used to locate the sources of these atmospheric disturbances; while in others an investigation is being made into the dependence of the waveforms of atmospherics on the distance and direction of transmission. During the I.G.Y., programmes involving close co-operation will be arranged to ensure the simultaneous observation in various places of special phenomena, such as the "whistler" type of atmospheric.

In collaboration with the meteorologists the radio scientists are seeking a knowledge of the variation with height of the refractive index of the atmosphere. It is proposed that this should be obtained by measurements made on masts up to a few hundred feet, supplemented by observations carried out in balloons, free or captive, up to at least 5,000 and, if possible, up to 30,000 feet.

**Central Planning Control.**—We have so far dealt with the investigations of direct radio interest that will form part of the whole programme of scientific work to be conducted during the year. The general planning of the programme in all fields is being carried out by a committee responsible to the International Council of Scientific Unions, which is the co-ordinating body for the various scientific unions concerned with astronomy, geodesy, magnetism, meteorology and radio. Professor S. Chapman is president of this international committee on which are representatives of the committees in the various countries collaborating in this vast enterprise.

Sir Edward Appleton is chairman of the special committee of the International Scientific Radio Union (U.R.S.I.) set up to advise on the radio work undertaken during the I.G.Y., and J. A. Ratcliffe is chairman of the British National Committee for Scientific Radio which represents this country on U.R.S.I. Among the members of the British committee for the I.G.Y. specially interested in radio research are Dr. W. J. G. Beynon, Professor A. C. B. Lovell, Professor H. S. W. Massey and the writer.

With the co-ordination of scientific effort thus obtained in radio and the allied fields, we may look forward to considerable advances in our knowledge of the various phenomena associated with radio propagation.

---

## Club News

**Barnsley.**—At the April meetings of the Barnsley and District Amateur Radio Club, D. Westwood (G8WF) will speak on "The Whys and Wherefores of Q" (15th) and C. T. Malkin (G5IV) will speak on propagation (29th). Meetings are held at 7 p.m. at the King George Hotel, Peel Street, Barnsley. Sec.: P. Carbutt (G2AFV), 33, Woodstock Street, Barnsley, Yorks.

**Chelmsford.**—Meetings of the Chelmsford group of the British Amateur Television Club are held at 10, Baddow Place Avenue, Gt. Baddow, Essex, on the second Thursday of each month. Sec.: M. W. S. Barlow (G3CVO); address above.

**Cleckheaton.**—On April 6th D. Westwood (G8WF) will speak on modulation to members of the Spen Valley and District Radio and Television Society. Meetings are held at 7.30 p.m. at the Temperance Hall, Cleckheaton. Sec.: N. Pride, 100, Raikes Lane, Birstall, Yorks.

**Coventry.**—"Civil Communications" is the subject of a talk by G. Brown (G5BJ) to be given at the meeting of the Coventry Amateur Radio Society on April 25th. Lecture meetings are held on alternate Mondays at 7.30 p.m. at 9, Queens Road, Coventry. Sec.: K. G. Lines (G3FOH), 142, Shorncliffe Road, Coventry, Warwicks.

**Romford.**—Weekly meetings of the Romford Radio Society are held on Tuesdays at 8.15 p.m. at R.A.F.A. House, 18, Carlton Road, Romford. On April 12th Louis Varney (G5RV) will deal with the suppression of television interference. Sec.: N. Miller, 55, Kingston Road, Romford, Essex.

**Southend.**—Judging in the annual contests for the Pocock and Hudson Cups for home-constructed gear takes place on April 1st. Sec.: J. H. Barrance (G3BUJ), 49, Swanage Road, Southend-on-Sea, Essex.

---

## An Apology

WE regret that due to an unforeseen delay in the despatch department of our printers the publication of our last issue was postponed for a few days.

# DISTORTION

By "CATHODE RAY"

## What Do We Really Mean By It?

IF there had been any doubt about there being a great many people intensely interested in what our American friends call "hi fi," that doubt was dispelled last autumn by Mr. Briggs when he sold the full capacity of the Royal Festival Hall (sitting and standing) in the first four days, on an announcement that he was going to demonstrate loudspeaker reproduction in comparison with direct musical performances. It has been necessary to arrange a second house. And I remember being mightily astonished when the Editor told me how many copies of the Williamson amplifier reprint had been sold. All this being so, there is naturally a demand for some scale of measurement for comparing one piece of sound-producing equipment with another. The advertisement copy writers' "perfect reproduction," "no trace of distortion," "impeccable fidelity," "thrilling tone," etc., cut no ice at all with *Wireless World* readers. They very rightly want some definite figures of performance.

So most of the advertisements nowadays say "distortion at 12 watts output is not more than 0.3%," or whatever it may be. That is certainly an improvement in principle, but we may be forgiven for asking some questions. Is 0.3% good, bad or indifferent? If another make of amplifier distorts 0.3% at 12 watts can its fidelity be assumed to be the same? If it were 0.1% how much better would it sound? And if it were 1%—or 5%—how much worse?

Twenty-five to thirty years ago people were already taking quite a lot of interest in this matter of fidelity of sound reproduction, but the data then consisted of a graph of output against frequency—what is usually called a frequency characteristic. If it was in an advertisement, the scales were chosen so as to make the graph look as nearly as possible like a horizontal line drawn with a ruler. The thing was then described as "distortionless." To the best of my recollection, percentages were not mentioned. "Distortion" was generally understood to mean frequency distortion—the unequal amplification of different frequencies. The reason for this was that the most obvious shortcoming of the very early gear was its frequency

characteristic, which consisted of a violent peak in the middle or upper middle, and very little else.

So far as amplifiers were concerned, it was a fairly easy development to obtain their frequency characteristic curves and to improve their design so as to flatten out the peak into a nearly level plateau extending over the useful frequency range. And so began an era in which high-fidelity enthusiasts vied with one another in smoothing out the last fraction of a decibel (a unit which by then had come into vogue) often regardless of the vastly greater irregularities in the characteristics of the loudspeaker and the room in which it was heard. There is a good reason for aiming at a very level amplifier characteristic, but even now some enthusiasts may not realize that it is not the avoidance of frequency distortion as such (for on that count a peak of the order of one decibel is quite unimportant) but the obtaining of maximum undistorted output. If one narrow band of frequencies is amplified 1db more than others, as shown in Fig. 1, the whole level of output has to be lowered 1db (e.g., from 10 watts to 8 watts) in order to avoid overloading. In other words, moderate frequency distortion is bad, not as frequency distortion but as a potential cause of overloading or non-linearity distortion.

### Non-Linearity

As time went on and gross frequency distortion was eliminated, the possibilities of appreciable improvement of sound by further levelling out of frequency characteristics dwindled. "Distortion" ceased to be frequency distortion and became non-linearity distortion (commonly but illogically called "non-linear distortion"). Now this is where we must be clear about the meanings of terms. "Non-linearity" means lack of straightness or proportionality of a characteristic, expressed as a graph. The particular characteristic understood in this connection is the input/output characteristic of any part of the equipment. Ordinary resistors are linear, because the voltage across them is directly proportional to the

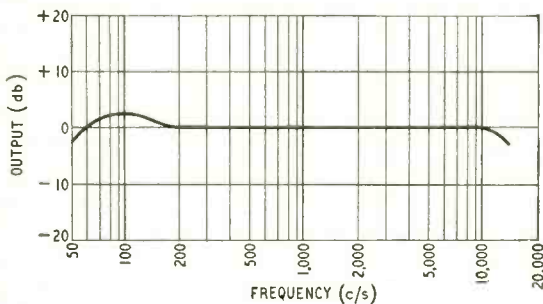

Fig. 1. Example of frequency distortion that is quite negligible as such, but should be avoided if the maximum undistorted power output is desired.

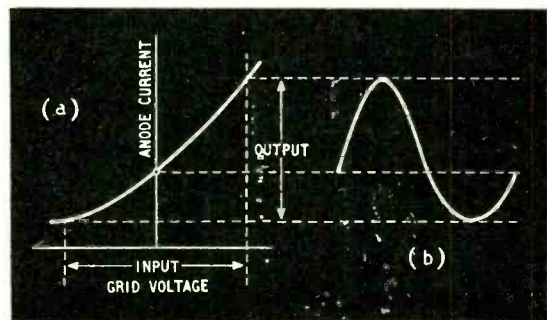

Fig. 2. Typical valve characteristic (a) with the curvature somewhat exaggerated we hope, showing the resulting distortion of a sine wave (b).

current through them; in other words, they obey Ohm's law. Valves and iron-cored coils do not. Fig. 2 (a) shows a typical sample of anode-current/grid-voltage characteristic. If the grid bias is set so that the working point is O, an input signal of sine-wave form will make the voltage swing equally on both sides of O as shown, and obviously the waveform of the output current so caused (b) is distorted, the positive half-cycle being bigger than the negative.

### Harmonic Distortion

This is the effect we are now going to study. It is sometimes called "amplitude distortion," but that term has been allotted to a different effect, which may or may not happen at the same time as waveform distortion. Whereas waveform distortion is a result of non-linearity during each individual cycle, amplitude distortion means that the output level as a whole is not directly proportional to the input level. It is possible with a characteristic of the Fig. 2 (a) type, which obviously distorts the waveform, for the output to be proportionate to the input, the opposite disproportionateness of positive and negative half-cycles cancelling out and resulting in no amplitude distortion.

One of the first things we learn about non-linearity is that it creates harmonics. This has been explained so often that I needn't go into it fully. The usual line is to add together various sine waves whose frequencies are harmonically related (i.e., exact multiples of one particular frequency, the fundamental or first harmonic) and find that the results are distorted waveforms, some of which resemble those obtained by non-linearity. For example, in Fig. 3 a double-frequency or second harmonic (b) is added to a fundamental (a) and the result (c) is very like the output of Fig. 2. That is the synthetic method. Then there is the analytic method of breaking down a distorted wave (graphically or by experiment) into a fundamental and harmonics. It is then explained that the characteristic tone of each musical instrument depends on the amounts of the various harmonics it emits, relative to the fundamental, and that if these proportions are altered, either by frequency distortion or by adding harmonics by non-linearity, the characteristic tone is distorted.

True enough. But by now we are supposed to have got rid of frequency distortion that could drastically alter the proportions of harmonics; such frequency distortion, for example, as poor high-frequency response, which would tend to suppress them. And while such distortion might make a clarinet sound like a flute, it couldn't (even if it took place) account for the appalling sounds that result from severe overloading. The fact that the sounds produced by musical instruments listened to with pleasure contain a generous series of harmonics is evidence of that. An amplifier advertised to give 10% harmonic distortion would hardly find favour with "hi-fi" connoisseurs, yet what is 10% compared with the 50% or more generated by well-regarded pianos? If the only effect of non-linearity were to create harmonics, we should be at a loss to explain how such unpleasant reproduction comes with quite moderate harmonic distortion percentages.

It is now generally agreed that it is *not* the harmonics that are responsible for the worst of the unpleasantness. In *Wireless World* for May 19th, 1938,\* I described a simple experiment for demonstrat-

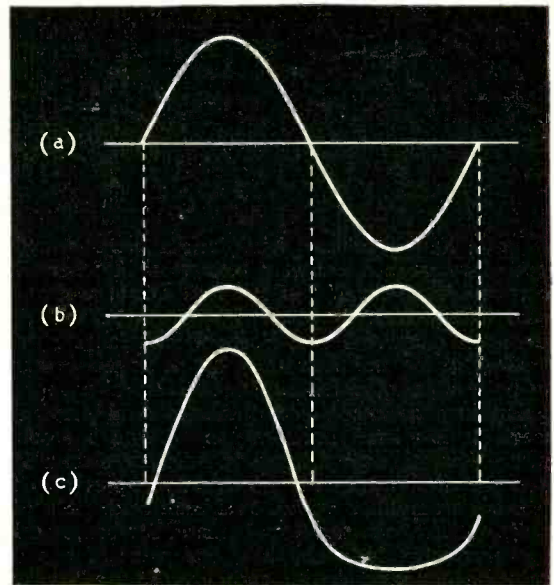

Fig. 3. Showing how the distortion in Fig 2(b) can be made synthetically by adding together a second harmonic to the original (fundamental) waveform.

ing this. On the assumption that copies of that issue may not be lying around to hand, I will briefly recap. A receiver is arranged with two separately-adjustable sine-wave input signals and an output meter. The low frequency, say 100 c/s, is adjusted to be 10 times the voltage (and therefore 100 times the power) of the other signal, say 533 c/s. In spite of this the 533-c/s note sounds about as loud as the 100 c/s, because the ear is so much more sensitive at the higher frequency. At first each signal can be heard as a clear pure note, as it was when alone. But at a certain setting of the main volume control a roughness of tone becomes noticeable; and at a still higher setting the higher note becomes indistinguishable, the whole output degenerating into a harsh rattling kind of hum.

If now the 100 c/s is switched off, the 533-c/s note is heard with perfect clarity. That is only to be expected, because it is weak enough to be well below the point of serious distortion. What might not be expected however is that when the 533 c/s is switched off the 100 c/s becomes quite clear and altogether different from its sound when both signals are on. This is so, notwithstanding that switching the 533 c/s off reduces the output power by only 1%, which by itself is not enough to make an appreciable difference to the amount of distortion. An increase of much more than 1% in the power of the 100 c/s alone has no such devastating effect as switching on the weak 533 c/s.

### Intermodulation

The obvious conclusion is that some kind of distortion is taking place when both signals are being handled together by the amplifier which is not present with only one. Here again we come to a well-worn chapter in radio theory, of which Fig. 4 should be sufficient reminder. (a) is the undistorted two-signal input, and (b), assuming distortion of the kind shown in Fig. 2, is the distorted output. At the positive peaks of the "strong-low" signal the "weak-high" signal is

\* "Debunk'ng Harmonic Distortion."

amplified more than at the working point O, and at the negative peaks it is amplified less. So the weak signal is amplitude-modulated at the frequency of the strong. This can be seen more clearly if the strong signal is taken away (c). The said chapter of radio theory explains how this process introduces new frequencies, not necessarily multiples of either of the input frequencies, but "sum and difference frequencies." The Fig. 2 kind of characteristic, which creates mainly second-harmonic distortion of the low-frequency signal ( $f_1$ , say) causes the high-frequency signal ( $f_2$ ) to wax and wane once per low-frequency cycle, and the frequencies created by modulation are mainly  $f_1 \pm f_2$ , known as the simple sum and difference or second-order intermodulation frequencies. In our experiment they would be  $533 \pm 100 = 433$  and  $633$  c/s.

This distortion is the kind that one gets with a triode output valve, and which a push-pull circuit is used to balance out. If a pentode is used, or the push-pull system is over-driven, both positive and negative peaks tend to be affected in the same way. The result is that the third harmonic is the strongest, and third-order modulation frequencies,  $f_1 \pm 2f_2$ , 333 and 733 c/s in our experiment.

Generally distortion consists of a mixture of second and third, with smaller proportions of higher numbers, but most practical cases fall into one of two main classes, in which either second or third predominates.

### Obvious ?

So far we have talked about the 100 c/s modulating the 533 c/s, but not the other way about. Why? Well, if one man fought another ten times as strong he might inflict something on him, but it would usually be negligible compared with what he received. In

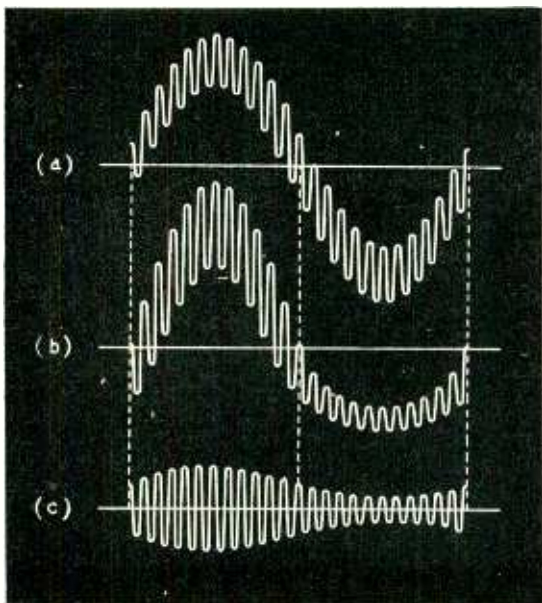

Fig. 4. When a higher-frequency but weaker sine-wave tone is added to the low-frequency signal at the input, the waveform of the combination is as at (a). After suffering distortion of the Fig. 2(a) type it comes out like (b), and by taking away the low frequency the damage to the higher frequency can be seen more clearly (c).

the same way we have neglected the modulation of the strong signal by the weak, though it does exist and is why the process is called *intermodulation*. When two signals going through the mill together are equally strong, each modulates as much as it is modulated.

I said that the experiment made it obvious that intermodulation, not harmonic distortion, is responsible for nearly all the unpleasantness. That conclusion can hardly be doubted so far as the particular conditions of the experiment are concerned. But it is always risky to draw quick conclusions about the connections between physical causes and the resulting impressions on the senses. If a physical force acts on a lifeless object, the effect conforms to a simple equation covering all such events. But the impressions a human being receives as a result of physical causes often seem to bear no predictable or clear relation to them. A race of stone deaf men, though they might master the science of physical sound, could never discover what it was like to hear. Even where there does at first seem to be a clear connection, it may be misleading. For instance, it might seem definite enough that the higher the frequency of a sound the higher the pitch of what is heard. But even there it is not safe to assume that the two things run perfectly parallel, for it is found that the pitch of a note of constant frequency varies slightly with its intensity.

Still less safe is it to draw hard and fast conclusions about the relationship between unpleasantness of sound and the distortion that causes it. Our particular "obvious" conclusion—that intermodulation accounts for nearly all the unpleasantness caused by non-linearity distortion—when I expressed it in 1938 was immediately challenged. And it certainly is unwise to draw such a sweeping conclusion on the basis of one simple experiment. Does it hold for all different combinations of frequencies? And does it hold for typical programmes?

One typical programme is speaking. But speech is an extremely difficult type of sound to study for unpleasantness. Music is much easier, so we shall assume music is our staple diet of listening (whether as the food of love or not is unimportant just now). There do seem to be some clear-cut rules about combinations of musical sounds. One of them is this: that the smaller the whole numbers in which the ratio of the frequencies of two sounds can be expressed, the more harmonious the combination appears to the listener. To take one extreme, the ratio with the smallest possible numbers is 1:1, which means that both sounds have the same frequency, so are heard as one sound, without any disharmony or indeed any distinction at all between them (assuming, of course, that they are coming from the same source). The next simplest ratio is 2:1, which means that the frequency of one note is twice that of the other. Musicians say that it is an octave higher. Although of course the two notes are easily distinguishable when heard separately, they blend so smoothly together that most untrained listeners are unaware that more than one note is being played. People are said to be singing in unison even though the women are singing all their notes twice the frequency of the men. This being so, it should be pretty safe to say that even 100% second-harmonic distortion, if it consisted only of the creation of second-harmonic or octave-higher frequencies, could not cause harshness in the sound. It would certainly make the music sound "brighter" and as this would be different from the original it would have to be classed as "distorted," though to

some ears it might be considered an improvement. The effect on a single sustained note can easily be tried if one has two a.f. signal generators that can be synchronized an octave apart and the higher one brought up from zero level. The effect is identical with that obtained with a single note through an amplifier which can be made to give pure second-harmonic distortion. The same effect on real music can be produced in organs, by bringing in a coupler that adds octaves to all the notes played. This is *not* the same, however, as playing the music through the distorting amplifier, because that adds difference tones as well.

And that, of course, is the crux of the whole matter. But before going into it, let us continue a little longer with our lesson in the theory of harmony. As a non-musician I shall have to be careful; but, on the other hand, musicians themselves seem quite unable to talk our language of frequencies, etc., so fail to tell us clearly what we want to know.

The next simplest ratio might be said to be 3:1. But in music the scale starts all over again at the end of an octave, and so a note 3 times the frequency of another may be regarded as  $1\frac{1}{2}$  times the note an octave higher; consequently our next ratio is really  $1\frac{1}{2}$  or 3:2. And the musicians would agree, I think, that this is the next most important "interval" to the octave, by virtue of which they name it the dominant. The original (lower) note they call the tonic, by the way. And when tonic and dominant are played together, we are conscious of hearing something more complicated than a single note, or even the "brightened" note made up of the 2:1 combination; yet it is undoubtedly "in tune" and harmonious. So is a 3:1 combination, such as a fundamental and third harmonic, because the harmonic lies in this "dominant" relationship to an octave higher than the fundamental, which as we have seen (or rather heard) is almost equivalent to the fundamental.

### Harmonics and Harmony

It would seem, then, that the creation of third harmonics would by itself introduce no harshness or discord, nor perhaps even unpleasantness except to the musical connoisseur who would resent unison passages for flutes being given a harmonic accompaniment. The general effect would be to make the balance of tone still "brighter" and also somewhat "richer" by the addition of the new harmonics. "Nasal" is a description that is sometimes used to refer to the double effect.

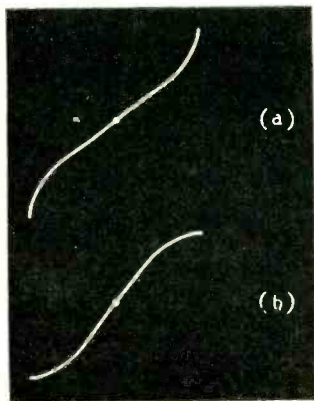

Fig. 5. Here, for comparison with the square-law characteristic of the triode, shown in Fig. 2 (a), are two varieties of the cube-law characteristic, typical of pentode valves and iron-cored coils.

Fourth harmonics are two octaves higher than the fundamental, and as regards harmony are therefore less conspicuous than third harmonics. The only serious effect would be if they were strong enough to make the music sound two octaves higher than it was supposed to be, but in practice this would hardly be so. Any distortion that produces fourth harmonic also produces much stronger second harmonic.

A similar principle holds with the odd harmonics; fifth is accompanied by much stronger third. But how do we expect the fifth to sound in relation to the fundamental? Relative to two octaves above the fundamental, its ratio is 5:4. And I think the musicians would still be with us if we declared that this

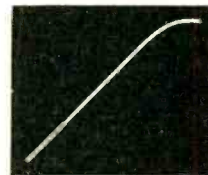

Fig. 6. When the characteristic has a sudden bend, like this, the higher harmonics are created at appreciable strength.

is the next easiest on the ear, after octave and dominant. Sol-fa practitioners identify it as "me" above "doh." If all four notes we have now considered are played together—doh, me, soh, doh—the combination is still harmonious and pleasant. It is, in fact, the "common chord." But I suspect that a musician would consider it a bit thick, in more senses than one, if every single note of his composition were replaced by this four-note combination; which is virtually what would happen if all harmonics up to and including the fifth were added. However, although it would not be a faithful reproduction of the composer's intentions, the non-musical hi-fi expert, without being able to compare it with the original, might (I suggest) be unable to recognize it as "distortion" in his sense of the word.

And so we could go on. Sixth harmonics are like thirds except for being an octave higher. But when we come to the seventh, the ratio to the next lower octave above the fundamental is 7:4. According to my untutored reckoning, this is B flat in relation to C. I don't know how it is rated by the musicians, but it sounds pretty discordant to me, even though my musical taste tends towards the modern. The eighth harmonic is three octaves above the fundamental, so may sound rather squeaky but certainly not discordant. The ninth, which after deducting the whole octaves is like sounding "doh" and "ray" together, is aggressively discordant. As we go higher up the series of *odd* harmonics the numerical ratio becomes more awkward and the musical sound more discordant. The even harmonics are not quite so, because the number can be simplified by dividing by 2, perhaps more than once, and that is musically equivalent to the interval of an octave, which harmonically hardly counts. Take the 12th harmonic; in relation to two octaves above the fundamental its ratio is 12:4, which simplifies to 3:2, and that, as we have seen, is a very easy harmony. But the 14th can only be simplified to 7:1, so it is the lowest discordant even harmonic.

What decides which harmonics are produced, and how much? As one can find out by making the same sort of comparison as Fig. 2 with Fig. 3, using different input/output (or "transfer") characteristics, (Continued on page 195)



or, more elegantly, by mathematics,\* it is the shape of the transfer characteristic that is responsible. The two most important are the square-law, with its smooth one-way bend shown in Fig. 2, which produces second harmonic, and the cube-law, with its S bend (but still smooth) shown in Fig. 5, which produces third harmonic. The sharper and more irregular the bends, the higher the harmonics created. The characteristics of valves worked under reasonable conditions are usually one or other of the first two (though less exaggerated) or a combination of both, and harmonics are therefore nearly all second or third or both. And we have seen that these are not in the least discordant. But if a valve runs into grid current at the signal peaks, or for any other

\* See "Relationships between Amplitudes of Harmonics and Intermodulation Frequencies," by M. V. Callendar and S. Matthews, in *Electronic Engineering*, June, 1951, p. 230, where the results are conveniently tabulated.

reason has a characteristic with an abrupt corner, such as Fig. 6, the resulting harmonics are distributed well up the scale, including perhaps appreciable amounts of the discordant numbers. Incidentally, a practical way of seeing the shape of the transfer characteristic of an amplifier is to connect the input voltage across the X plates of an oscilloscope and the output voltage (phase-shifted if necessary to close the loop) across the Y plates.

It seems that unless the characteristic is so unsuitable that it brings in at least the seventh among the odd harmonics and the 14th in the even series, there should at any rate be no harshness, if harmonics were all that happened. However, there are intermodulation products to be reckoned with. And I am afraid that if we started to reckon with them at all seriously just now it would take up too much space. We shall have to put it off until next month.

# Output Transformer Design

*For Amplifiers Employing Negative Feedback*

By R. F. GIBSON\*

**I**T is relatively easy to design a feedback amplifier with a flat response and good inherent stability to cover a range of 9 octaves. It becomes increasingly difficult, however, as the range is extended another one or two octaves, largely owing to instability troubles caused by the output transformer.

The basic requirements for a.f. transformers for use with negative feedback amplifiers, providing low-distortion power outputs, are well known but may be briefly recapitulated as follows:—

High primary inductance.

Low primary/secondary leakage inductance.

High-frequency resonance at a frequency where the loop gain of the feedback section of amplifier is less than unity.

Some additional considerations of practical importance are:—

Economical design.

Adequate electrical insulation.

Suitable choice of core material.

Moderate  $I^2R$  losses.

Consideration of these requirements will show that the design features must effect as good a compromise as possible between several conflicting requirements, e.g., high primary inductance means a large number of primary turns which necessitates a large  $I^2R$  loss or a large winding space. A large winding space requires a highly sectionalized winding to keep down leakage inductance. This precludes economical design and increases the difficulty of maintaining adequate electrical insulation.

One way of reducing primary turns is to use a high permeability core material, but this solution is often ruled out on the score of cost.

The ordinary grades of silicon iron have a relatively low distortion coefficient but suffer from the disadvantage of very low permeability at low flux densities. This has a serious disadvantage when considered in relation to feedback amplifiers. Briefly, the very low primary inductance at zero signal level necessitates the amplifier designer using otherwise unnecessarily long time constants in his l.f. couplings to keep away from the  $180^\circ$  phase shift associated with a 12-db slope which would result in low-frequency instability. No doubt many readers will have had painful experience of this trouble.

## Instability

One major cause of h.f. instability is resonance "inside" the range of significant loop gain, resulting in a reversal of feedback polarity within the pass band of the amplifier. This is usually produced by the increased leakage inductance associated with a large number of turns in conjunction with high interwinding capacitances.

The foregoing remarks may appear to give a somewhat gloomy picture of the performance of an output transformer in a high-quality feedback amplifier. Fortunately, it is possible, by careful and adequate design, to obtain a performance which, in fact, leaves little to be desired, and some of the basic requirements of such a design will now be discussed.

1. *Core material*: There appears to be no better material at present available than silicon steel. There are, however, several varieties of this material the relative merits of which will be discussed later.

2. *Winding space to core cross-section ratio*: without going into the mathematics of this problem it may be stated that economic considerations inevitably lead

\* R. F. Gibson, Ltd.

to the choice of a small window to core ratio; this choice also helps considerably in easing the problem of obtaining a high resonant frequency and low leakage inductance.

3. *Efficiency*: Once a small window space has been decided upon it will be found that the weight of copper which can be fitted into it is small and therefore it becomes fairly safe to assume that the  $I^2R$  losses will not be unreasonable, providing the primary wire gauge is large enough to handle the r.m.s. value of standing d.c. plus audio-frequency current without overheating and the  $I^2R$  loss ratio between primary and secondary is reasonably near 1 : 1.

4. *Primary Inductance*: An empirical formula which has been found useful in determining the primary inductance is—

$$L = \frac{R_l \times V\beta}{2 \times 10^3} \dots \dots \dots (1)$$

where  $L$  is in henries,  $R_l$  = anode-to-anode load (ohms) and  $V\beta$  is the feedback voltage ratio. In the case of push-pull EL84's with 26 db feedback,

this works out at  $\frac{8000 \times 20}{2 \times 10^3}$

5. *Flux density*: Again a simplified equation—

$$N = \frac{10^3 \sqrt{WR_l}}{KfA} \dots \dots \dots (2)$$

where  $N$  = number of primary turns,  $W$  = V.A input to primary,  $R_l$  = anode-to-anode load in ohms,  $f$  = frequency of bottom distortion limit,  $A$  = cross sectional area of core (sq. in.) and

$K = \begin{matrix} 1.6 \text{ for intermediate grade} \\ 1.7 \text{ for high grade} \\ 3.3 \text{ for "Unidi" material}^\dagger \\ 3.5 \text{ for "C" cores} \end{matrix} \left. \vphantom{\begin{matrix} 1.6 \\ 1.7 \\ 3.3 \\ 3.5 \end{matrix}} \right\} \text{ laminations}$

This formula gives a practical answer for ratings up to 25W if the core area is in the region of  $\frac{\sqrt{W} \times 30}{(0.5 + K) \times f}$

Empirical data plus a consideration of general requirements will then enable a suitable core to be selected.

Going back to a choice of a suitable core material, we have available, intermediate grade silicon steel, high-grade silicon steel and oriented-grain silicon steel, the last mentioned being available in the form of either laminations or "C" cores. "C" cores are expensive and show only a small advantage over "Unidi" laminations both as regards the coefficient in equation (2) and the primary inductance to  $AN^2$  ratio. Oriented grain material does however show a very marked advantage over the other grades of silicon steel and in the case of laminations is reasonably economical provided that it is obtained in the form of "no waste" E and I laminations.

It now remains to select a core size which can be made to satisfy the requirements of equations (1) and (2) and the clause concerning temperature rise. In the case of a 12-watt transformer using push-pull EL84's, the "no waste" size 4, having a 1in. wide core and a  $1\frac{1}{2}$ in.  $\times$   $\frac{3}{4}$ in. window, fits the requirements when built into a square stack.

The simplest winding arrangement which will provide a level response up to 30 kc/s is as shown in Fig. 1. and this provides a d.c. resistance balanced with respect to  $A_1$  to h.t. and  $A_2$  to h.t. The inter-

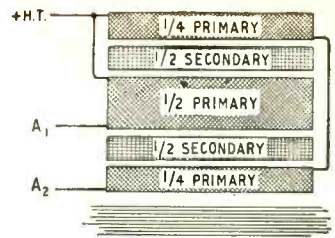

Fig. 1. Simple method of sectionalizing which gives adequate coupling

winding capacities are unbalanced but the overall coupling factor is good enough to take care of this. It should be noted that the winding layout shown is not suitable for a transformer having primary taps for the so-called "ultra-linear" circuit. One way of providing correct screen couplings is to transpose the primary and secondary windings.

Tests carried out on a transformer designed according to the foregoing data show that the expected results are well maintained in practice. The actual readings obtained were:—

Primary d.c. resistance 340Ω; secondary 0.98Ω; leakage inductance 24mH; initial inductance of primary, better than 130 H.

The measured performance is as follows:—  
± 1 db from 25 c/s to 42 kc/s and the distortion limit on a sine wave trace is 28 c/s to 35 kc/s at 12 watts output from secondary, these figures being slightly over 1 octave better than can be obtained on the same size of core with intermediate grade laminations.

## BOOKS RECEIVED

**Television**, by V. K. Zworykin, E.E., Ph.D., and G. A. Morton, Ph.D. Revised second edition covering fundamental physical principles, complete systems for monochrome and colour and details of camera and display tubes. Pp. 1037+xv; Figs. 698. Price 40s. Chapman and Hall, 37, Essex Street, London, W.C.2.

**Radio and Television Engineers' Reference Book**. Edited by E. Molloy and W. E. Pannett, A.M.I.E.E. Compendium of descriptive information, data and servicing hints in all branches of radio communication, contributed by 36 specialists. Includes chapters on sound reproduction and distribution, disc and magnetic tape recording. Pp. 1542+xx; Figs. 1117. Price 70s. George Newnes, Ltd., Tower House, Southampton Street, London, W.C.2.

**Ibbetson's Electric Wiring**. Edited by C. R. Urwin, A.C.G.I., A.M.I.E.E.; W. F. Parker, M.I.E.E., and F. G. Thompson, M.Sc. (Eng.), A.M.I.E.E. Ninth edition of this textbook of theory and practice for practical wiremen and students. Pp. 296+viii; Figs. 119. Price 11s 6d E. and F. N. Spon, Ltd., 15, Bedford Street, London, W.C.2.

**Fundamentals of Transistors**, by Leonard M. Krugman. Summary of design procedure and formulæ for the principal transistor circuit configurations, with an introductory chapter on basic semi-conductor physics. Pp.140; Figs. 110. Price 21s. Chapman and Hall, 37 Essex Street, London, W.C.2.

**Radar Pocket Book** by R. S. H. Boulding, B.Sc., M.I.E.E. Basic information on radar systems, components and circuits for the use of operators, installation and maintenance engineers. Pp. 176+viii; Figs. 156. Price 15s. George Newnes, Ltd., Southampton Street, London, W.C.2.

<sup>†</sup> Geo. L. Scott and Co., Ltd.

## APRIL MEETINGS

### Institution of Electrical Engineers

London.—April 5th. "High Speed Electronic-Analogue Computing Techniques" by Dr. D. M. MacKay at 5.30.

April 20th. "A Study of the Long-Term Emission Behaviour of an Oxide Cathode Valve" by Dr. G. H. Metson at 5.30.

April 21st. Kelvin lecture "Transistor Physics" by Dr. W. Shockley at 5.30.

April 22nd. Discussion on "Technical Training in North-West Germany" opened by Dr. K. R. Sturley at 6.0.

All the above meetings will be held at Savoy Place, W.C.2.

**Mersey and North Wales Centre.**—April 4th. Annual general meeting followed by "Special Effects for Television Studio Productions" by A. M. Spooner and T. Worswick at 6.30 at the Liverpool Royal Institution, Colquitt Street.

**North-Eastern Radio and Measurements Group.**—April 4th. Annual general meeting followed by "Thermionic Valves of Improved Quality for Government and Industrial Purposes" by E. G. Rowe, P. Welch and W. W. Wright at 6.15 at King's College, Newcastle-upon-Tyne.

**Northern Ireland Centre.**—April 5th. Faraday lecture "Courier to Carrier in Communications" by T. B. D. Terroni at 8.0 at the Sir William Whitla Hall, Queen's University, Belfast.

**South Midland Radio Group.**—April 25th. Annual general meeting followed by "A Transatlantic Telephone Cable" by Dr. M. J. Kelly, Sir Gordon Radley, G. W. Gilman and R. J. Halsey at 6.0 at the James Watt Memorial Institute, Great Charles Street, Birmingham.

**Southern Centre.**—April 1st. "Cold Cathode Valves" by J. R. Acton at 6.30 at the South Dorset Technical College, Weymouth.

### British Sound Recording Association

London.—April 22nd. "Romance and History of the Gramophone" by P. Wilson at 7.0 at the Royal Society of Arts, John Adam Street, W.C.2.

**Portsmouth Centre.**—April 13th. "Tape Recording, 1948-1955" by C. Hardy at 7.15 at the Central Library, Guildhall, Portsmouth.

**South-Western Centre.**—April 13th. "High Fidelity" by P. D. Collings-Wells (Goodmans) at 7.45 at Callard's Café, Torquay.

### Television Society

London.—April 1st. "A Flying-spot (Mechau) Telecine System" by J. L. Bliss (B.B.C.) at 7.0 at the Cinematograph Exhibitors' Association, 164, Shaftesbury Avenue, W.C.2.

April 21st. "Progress in Colour Television" by L. C. Jesty (Marconi's) at 7.0 at the C.E.A., 164, Shaftesbury Avenue, W.C.2.

**North-Western Centre.**—April 27th. "Progress in Colour Television" by L. C. Jesty (Marconi's) at 7.30 at the College of Technology, Manchester.

### Society of Instrument Technology

London.—April 26th. "Magnetic Amplifiers as Industrial and Laboratory Aids" by R. J. Russell-Bates at 7.0 at Manson House, Portland Place, W.1.

**Newcastle Section.**—April 20th. "Electronic Computers" by A. St. Johnston (Elliott Bros.) at 7.0 at Stephenson Building, King's College, Newcastle-upon-Tyne.

### British Institution of Radio Engineers

London Section.—April 13th. Discussion on "The B.B.C. v.h.f. Frequency-Modulated Sound Broadcasting Service" opened by Dr. K. R. Sturley and F. T. Lett at 6.30 at the London School of Hygiene and Tropical Medicine, Keppel Street, W.C.1.

April 27th. "Suppressed Aerials for the Aircraft h.f. Band" by K. J. Coppin at 6.30 at the London School of Hygiene and Tropical Medicine.

**North-Eastern Section.**—April 13th. Annual general meeting and "The Manchester University Universal Computer" by E. T. Warburton at 6.0 at Neville Hall, Westgate Road, Newcastle-upon-Tyne.

**South Wales Section.**—April 27th. "Some Technical Problems in Sound and Television Broadcasting" by Dr. K. R. Sturley at 6.30 at the Glamorgan Technical College, Treforest.

**Scottish Section.**—April 14th. An evening of films with an exhibition of electronic apparatus at 7.0 at the Institution of Engineers and Shipbuilders, 39, Elmbank Crescent, Glasgow, C.2.

### Physical Society

**Acoustics Group.**—April 22nd. "Sound Absorption in Porous Structures and Suspensions" by Professor R. Morse at 5.30 at Imperial College, London, S.W.7.

### Incorporated Practical Radio Engineers

**Midlands Section.**—April 6th. "Projection Television" by R. Lightwood (Phillips) at 7.30 at the Crown Hotel, Broad Street, Birmingham.

## SERVICING EXAMS

REPORTING on last year's servicing examinations organized by the Radio Trades Examination Board and the City & Guilds, the examiners draw attention to the "lack of knowledge of basic principles as they affect servicing." In the intermediate exam. for radio service work (C. & G.) only 129 (19%) of the 659 home candidates obtained a first-class pass and 241 (36%) second-class passes. Of the 244 overseas candidates only six obtained first-class passes and 63 a second-class pass.

Of the 370 candidates who sat for the R.T.E.B. Radio Servicing Certificate examination 144 passed and 96 have to re-enter for the practical test. The many failures in the practical test were said to be due to two main reasons: (1) incorrectly connecting a coaxial cable and (2) dry joints. Incidentally failure in the soldering test fails the candidate in the whole of the practical examination.

Only 104 candidates entered for the R.T.E.B. Television Servicing Certificate exam. Fifty-five passed and 20 have to retake the practical test. Summarizing the results of this examination the examiners state that considering it is the final in the servicing series conducted by the R.T.E.B. the standard of work was not very high.

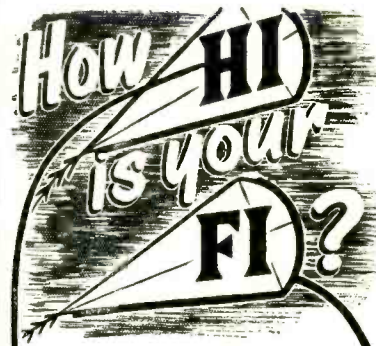

You may well ask—no one has so far clearly defined just what is this High Fidelity we hear so much about.

Is price the criterion? If so, the sky's the limit!

What about power output? Do you really need 15 or even 10 watts? Or is it possible that to operate one good speaker in your home, 3 or 4 watts may be ample if the quality is right? That's the secret.

To come down to earth, here is a High Quality Amplifier that has everything you need. The TRIX model T41, with Bass and Treble boost, separate Control Panel, High and Low gain inputs to suit every pick-up, inverse feed-back, is also compact and convenient. And the price—£16.10.0.

Small wonder that the TRIX T41 is already highly successful in world-wide export markets including the U.S.A., Canada and New Zealand. It will prove to you too that the name TRIX is synonymous with Peak Performance in record reproduction.

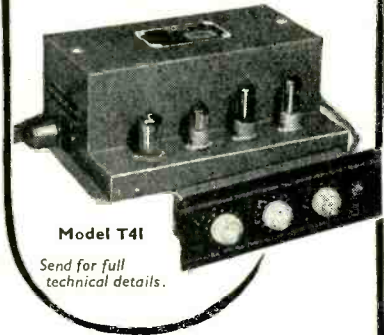

Model T41  
Send for full technical details.

### STOP PRESS!

Extract from MONTREAL STAR, February 5, 1955. Review of MONTREAL RADIO FAIR

"For pure musical enjoyment three particular sets of equipment attracted my attention. The first, in the economy class for both size and price, was the . . . TRIX . . . combination."

### The TRIX ELECTRICAL Co. Ltd.

1-5 MAPLE PLACE, TOTTENHAM CT. ROAD, LONDON, W.1. Phone:

MUSEum 5817

Telegrams and Cables: TRIXADI O WESDO, LONDON

# RANDOM RADIATIONS

By "DIALLIST"

## Is "Piping" the Solution?

THE B.B.C.'s scheme for country-wide f.m. transmissions may eventually provide us with interference-free-broadcast reception; but I see no similar way in sight of dealing with the problem of TV interference. Unless some means can be found of suppressing at the source the many different kinds of interference I'm inclined to believe that the only way out is to establish master receiving stations at sites remote from roads, factories, overhead power lines and so on, and to "pipe" the signal to viewers' homes. This is already being done, of course, in quite a number of the larger towns, and it is proving to be a very successful method. I don't see that either manufacturers or dealers need be afraid of it. Were piped TV more generally available, there's no doubt that there'd be a big jump in the number of licences taken out; and that would mean good business. What I have in mind is something like this. The company owning the master receiving station simply delivers a signal of guaranteed quality and strength to the customer's house in return for a weekly or monthly fee. The customer buys the receiver of his choice from his dealer, who installs and subsequently services it. As E. J. Gargini showed in his "Piped Scanning Waveforms" in the February issue of *W.W.*, the receiver can be a very simple affair, which should be much cheaper than the normal set. And that might be the key to the production of receivers of really excellent performance at "popular" prices.

## Putting Up With It

IT'S surprising that non-technical owners of television receivers should so often be content with very poor pictures. A few evenings before this was written I dropped in on some nearby friends and found them looking-in. The very first thing that hit me in the eye was a prominent light vertical line. Yes, the set was ringing heartily; and every dark object had an additional white outline. But that wasn't all: there were dark horizontal bars due to sound-on-vision. They were obviously so delighted with the set's performance that I just hadn't the heart to suggest that anything was amiss. I don't think they even noticed the effects

that shouldn't have been there. Again, I remember seeing in the house of other friends a picture in which everything near the top had a pronounced bend to the left. "It's always been like that," said my host; "but we've got used to it and it doesn't worry us as a rule." He seemed to think that it was just one of those things and was surprised when I told him that any competent service man should be able to put it right without spending much time on the job.

## Indoor Aerial Oddities

WHAT queer effects indoor aerials can produce when used for either sound or television reception. In one room of my home there's a broadcast receiver served by a wire running along the picture rail. Just occasionally it picks up telephone conversations between my house and another not far away. Sometimes, again, there is a noticeable change in the volume when a light in another room is switched on or off, due probably to pick-up and re-radiation by part of the electric wiring. As for indoor aerials for television, there's no saying what they *won't* do. In one house that I know reception is quite good with the aerial in one precise position;

but move it a mere six inches to right or left and both sound and picture almost disappear. The queerest case I've ever come across was that of a building in which the only place an indoor aerial would pick up an adequate signal was the basement. One firm which makes vast quantities of indoor and outdoor TV aerials tell me that they've had more than one similar case.

## Expensive Switching

EVERY TV receiver instruction book ought to contain a warning about the risks taken when a set is switched off and then switched on again before it's had time to cool down. I expect you know people who do it quite often because they've found that it's one way of clearing certain intermittent faults for the time being. If it's switched on when still well warmed up, the set gets the father and mother of an electrical kick in the neck, for the conditions which normally ensure a more-or-less gradual build-up of heater and other voltages are absent.

## The Intermittent Fault

THERE must, I suppose, have been more naughty words used over intermittent faults than over any other shortcomings of broadcast receivers. The most evil of all kinds is that which clears itself so quickly that you've no time to poke round with measuring instruments or an oscilloscope before it's gone. The best



## "WIRELESS WORLD" PUBLICATIONS

|  | Net Price | By Post |
|--|-----------|---------|
| RADIO LABORATORY HANDBOOK. M. G. Scroggie, B.Sc., M.I.E.E. 6th Edition   | 25/-      | 26/3    |
| STUDIO ENGINEERING FOR SOUND BROADCASTING. B.B.C. Engineering Training Manual by members of the B.B.C. Engineering Division. General Editor J. W. Godfrey. | 25/-      | 25/6    |
| SHORT-WAVE RADIO AND THE IONOSPHERE. T. W. Bennington, Engineering Division, B.B.C. Second Edition   | 10/6      | 10/10   |
| INTRODUCTION TO VALVES. R. W. Hallows, M.A. (Cantab.), M.I.E.E., and H. K. Milward, B.Sc. (Lond.), A.M.I.E.E.  | 8/6       | 8/10    |
| WIRELESS WORLD TELEVISION RECEIVER MODEL II: Complete constructional details with notes on modernizing the original design                                 | 3/6       | 3/9     |
| RADIO INTERFERENCE SUPPRESSION as Applied to Radio and Television Reception. G. L. Stephens, A.M.I.E.E.  | 10/6      | 10/11   |
| SOUND RECORDING AND REPRODUCTION. A B.B.C. Engineering Training Manual. J. W. Godfrey and S. W. Amos, B.Sc. (Hons.), A.M.I.E.E.                            | 30/-      | 30/8    |
| ADVANCED THEORY OF WAVEGUIDES. L. Lewin  | 30/-      | 30/7    |
| FOUNDATIONS OF WIRELESS. M. G. Scroggie, B.Sc., M.I.E.E. 5th Edition   | 12/6      | 13/-    |
| TELEVISION RECEIVING EQUIPMENT. W. T. Cocking, M.I.E.E. 3rd Edition  | 18/-      | 18/8    |

A complete list of books is available on application.

Obtainable from all leading booksellers or from

ILIFFE & SONS LTD., Dorset House, Stamford Street, London, S.E.1.

hope in such cases is to think out from the symptoms the only parts of the set in which there could be a fault and to go through them with a fine-toothed comb. As a desperate measure the substitution, one at a time, of components which might be guilty may be tried. The intermittent fault which occurs when the set has warmed up and stays in evidence until it is cooler is less maddening to deal with, though I'm not going to suggest that locating it is always easy. Eliminating, as before, the places where it could not be, you narrow down the field of search and, if you're lucky, you have a good chance of pinning it down sooner or later—it'll probably be later rather than sooner, if my experience goes for anything!

### Alternative TV

VIEWERS in the London and Sutton Coldfield areas have a respectable chance of discovering whether or not they're likely to be able to receive the alternative television programmes, and, if reception seems probable, of discovering what sort of Band III aerial will be needed. A test-signal (of low power, admittedly, but still a test-signal) is going out fairly regularly on 180.4 Mc/s from Sutton Coldfield and, from April 1st, on 194.75 Mc/s from the temporary transmitter set up by Belling & Lee in South London. Much less fortunate are those who live in the north. The only thing the I.T.A. seems so far to have decided for that area is that it isn't going to use the Holme Moss aerial mast. It seems likely that there will be two transmitters, one for the eastern and one for the western part of the area; but where they're going to be hasn't been decided at the time of writing.

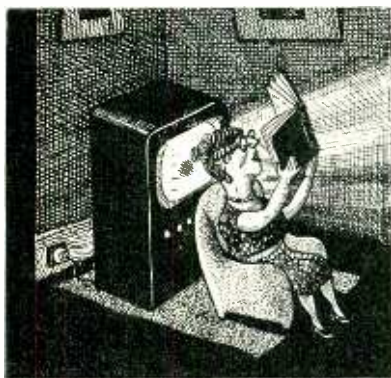

"I think we need a new tube, George."

# LILLIPUT EDISON SCREW

## BULGIN

### FIRST AGAIN

WITH THESE  
MINIATURE  
LAMP-HOLDERS

TO  
B.S.98/ES

Illustrations approx. actual size.



L.E.S.22



L.E.S.4



L.E.S.133



L.E.S.14



L.E.S.6

ONE of the most recent Bulgin developments is this entirely new series of "Lilliput Edison Screw" pilot-lamp holders, complete with miniature brackets not "live" to poles; two silver-plated solder-tags fitted.

Manufactured to the same high standards as their MES companion models, and conform to B.S.98/ES.

| List No.  | Details   |
|-----------|---|
| L.E.S.22  | No bracket  |
| L.E.S.4   | 2 x .116" ø @<br>3/32" crs.   |
| L.E.S.133 | 2 x .116" ø @<br>1/16" crs.   |
| L.E.S.14  | 2 x .116" ø @<br>1/16" crs., starting<br>1/8" from Socket<br>centre |
| L.E.S.6   | 2 x .116" ø @<br>3/32" crs.   |

### LILLIPUT SIGNAL-LAMPS

Designed to accept M.E.S.-cap bulbs (made by Hivac, Philips, Vitality) this compact fitting is ideal for incorporation in equipment where space is at a premium, or in a miniature apparatus. List No. D.675/1 has choice of 5 different translucent lenses, while L.E.S.1/1 has no lens-cap. Full details in Catalogue 194/WW, price 1/- post free.



# BULGIN

The Choice of Critics

**A. F. BULGIN & CO. LTD., BYE-PASS RD., BARKING, ESSEX**  
Telephone: RIPpleway 5588 (Private branch exchange)

# UNBIASED

By FREE GRID

## Static or Kinetic?

WITH the example of George Washington ever before them, the Americans have always been such sticklers for truth that I cannot imagine how they ever came to use such a misnomer as the word "static" to describe what we always call atmospherics—or Xs if we belong to the older generation.

Surely if the electrical energy—

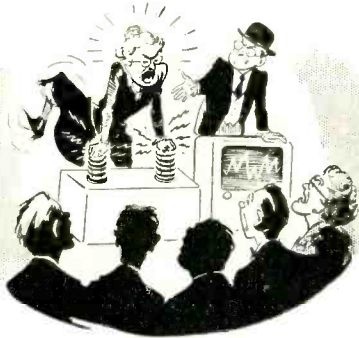

Certainly not static

be it natural or man-made—which causes noises in our loudspeakers and snowstorms on our television screens were indeed really static or motionless it would cause no trouble. This can quite easily be proved by standing a fully charged capacitor near a sensitive receiver.

This potential energy or static will cause no trouble no matter how great the capacitance of its container or how high the voltage of the charge. But if you convert it to kinetic energy by inviting your mother-in-law to bridge its terminals with her hands you will at once get all the trouble you can cope with, as I once proved to my own satisfaction. Surely then we should speak of man-made kinetic rather than static?

## Connoisseur's Corner

MOST people who have met female film stars face to face after having been accustomed to seeing them on the screen are conscious of bitter disappointment. The reason is that these glamour girls when seen in the flesh don't possess anything that is particularly attention-compelling to distinguish them from their fellow females. In other words, the screen reproduction is a lot better than the original, or at any rate seems so. To use the modern jargon, the operative word here is "seems," for our critical faculties are so drugged by constantly looking at them on the screen that we grow to prefer all

the shallow artificiality there portrayed.

My analogy is not a very good one, I'm afraid, but I find that much the same sort of thing happens when I ask people to listen to my high-fidelity receiver. It is as near perfect in its reproduction as it is possible to get and yet people are so used to the false tones—if that be the correct expression—imparted to speech and music by their ordinary sets that mine sounds disappointing. They are, as it were, drugged by constantly listening to indifferent reproduction and are thus like a confirmed toper who is unable to appreciate the delicate quality of a vintage port when it is set before him.

It looks, therefore, as though people need to be broken in gradually to high quality. I wonder if it would not be advisable for manufacturers to market hi-fi/lo-fi receivers in an effort to raise the rabble to real radio reproduction. A two-way switch should be fitted so that in the "lowbrow" position it would connect a fat capacitor across the loudspeaker and give the musical masses the mellow bellow they have been drugged to love.

## Who'll Take My Money?

NOW that one of our largest recording companies has decided to issue tape records side by side with the conventional disc type I suppose we can look forward to the eventual appearance of radiograms and playing desks fitted with the necessary additional gear. We already have three speeds for discs and it is to be hoped that similar complications will be avoided in tape records.

I shall welcome the appearance of these "tapeograms" as I think it may prove the thin end of the wedge, the other end of which will be the coming of "all-in" 'grams able to record B.B.C. programmes for consumption when desired. At present we have to instal such equipment in untidy bits and pieces.

I am still bothered about the ethics of recording broadcast programmes despite the recent assurances of the Editor regarding the legality. I personally would be willing to pay a small fee to the composers, starving in their miserable garrets, but who'll take my money?

I put this question to some G.P.O. representatives recently when they spent the evening outside my house in one of the new TV detector vans. All I received was a suspicious stare from one of them as he licked his pencil and continued designing an

attenuator from the formulæ given in the reference section of his 1955 W.W. Diary.

## The Curse of Kissing

KISSING is not the sort of thing which one associates with doctors as there can scarcely be a more potent carrier of infection. I was, therefore, somewhat surprised to hear a doctor discuss the matter in a recent B.B.C. talk.

The only thing that interested me in the doctor's talk was his statement that he knew a married couple who caused an electric spark to jump from one to the other each time they kissed. Apparently this is not an isolated phenomenon, for when this statement was published in the Press several letters subsequently appeared which showed it to be quite common.

Quite frankly, however, I was still unconvinced and determined to investigate the matter myself; not by personal experiment—ugh!—but by going to places where couples congregate and taking with me a sensitive portable receiver. No sooner had I slipped on my headphones in the local cinema and switched on than I was startled by a truly appalling spate of interference. From my seat I could see in the dim light several offenders whose osculatory efforts coincided with the bursts of Xs in my phones.

On my way home I took a short cut through the local park and I soon found out the value of the d.f. properties of the frame aerial and had no difficulty in locating my



Potent kisses

quarry. Can any of you learned legal luminaries tell me if the P.M.G. has the power to make regulations to deal with this menace without further legislation. From a technical point of view I don't think it is possible to suppress this interference unless kissing is only permitted in specially screened apartments.

Model 8  
**20,000 ohms  
 per volt** plus  
**AUTOMATIC Overload  
 Protection**



**£23 : 10s.**

Size  $8\frac{1}{8}'' \times 7\frac{1}{4}'' \times 4\frac{1}{2}''$   
 Weight  $6\frac{1}{2}$  lbs. (including leads)

Produced in response to a demand for a high sensitivity version of the world-famous Universal AvoMeter, this model incorporates the traditional design features of its predecessors, so highly valued for simplicity of operation and compact portability.

It has a sensitivity of 20,000 ohms per volt on all D.C. voltage ranges and 1,000 ohms per volt on A.C. ranges from 110 V. upwards. A decibel scale is provided for audio frequency tests. In addition, a press button has been incorporated which reverses the direction of current through the moving coil, and thus obviates the inconvenience of changing over test leads when the current direction reverses. It also simplifies the testing of potentials, both positive and negative, about a common reference point. A wide range of resistance measurements can be made using internal batteries, separate zero adjustment being provided for each range.

It is of importance to note that this model incorporates the "AVO" automatic cut-out for protection against inadvertent overloads.

**For your Valve Characteristic Meter or Valve Tester**

Owing to the very large number of valves which have been issued within the last two years, no further amendments will be issued for the original "Avo" Valve Testing Manual. A new, completely revised and fully up-to-date Valve Data Manual is now available from the Company at 15/- post free.

| D.C. VOLTAGE | D.C. CURRENT | A.C. VOLTAGE | A.C. CURRENT | RESISTANCE              |
|--------------|--------------|--------------|--------------|-------------------------|
| 2.5V.        | 50μA.        | 2.5V.        | 100mA.       | First indication 0.5Ω   |
| 10V.         | 250μA.       | 10V.         | 1A.          | Maximum indication 20MΩ |
| 25V.         | 1mA.         | 25V.         | 2.5A.        | 0—2,000Ω } using        |
| 100V.        | 10mA.        | 100V.        | 10A.         | 0—200,000Ω } internal   |
| 250V.        | 100mA.       | 250V.        | —            | 0—20MΩ } batteries      |
| 1,000V.      | 1A.          | 1,000V.      | —            | 0—200MΩ } using         |
| 2,500V.      | 10A.         | 2,500V.      | —            | external                |
|              |              |              |              | batteries               |



**THE AUTOMATIC COIL WINDER & ELECTRICAL EQUIPMENT CO. LTD.**  
 WINDER HOUSE · DOUGLAS STREET · LONDON S.W.1 Telephone VICTORIA 3404-9

# 7.5 to 250 Mc/s

ON FUNDAMENTALS  
IN FIVE RANGES

**SINE AND  
SQUARE WAVE  
MODULATION**

**R.F. OUTPUT  
1  $\mu$ V to 100 mV**

Again Advance lead the way—this time with a V.H.F. Signal Generator covering 7.5 to 250 Mc/s, a range that embraces Bands 1 and 2 and also the impending Very High Frequency Television Transmissions on Band 3. Moreover, this instrument is available at a price well within the reach of every service man. In the traditional Advance manner, this instrument is designed for simple operation and with a versatility that not only fulfils present needs, but anticipates the even more exacting requirements to deal with the television test problems of tomorrow.

Below are some outstanding features :-

- WIDE RANGE—7.5 to 250 M/cs
- SINE AND SQUARE WAVE MODULATION
- RELIABLE ATTENUATION
- LOW LEAKAGE—less than 3 microvolts
- TRULY PORTABLE—weighs only 17 lbs
- COMPETITIVE PRICE

# Advance

**MODEL Q1**  
V.H.F. SIGNAL GENERATOR

## £45

(List price in U.K.)



The Q1 provides the ideal complement to the Model E2. These together give complete coverage from 100 kc/s to 250 Mc/s.

Full technical details available in Folder W23 on request.

We are exhibiting on

**STAND 21**

The PHYSICAL SOCIETY EXHIBITION  
April 25th—28th

**STAND 30**

R.E.C.M.F. EXHIBITION  
April 19th—21st



# FOR AIR, LAND AND SEA U.H.F. STATIONS

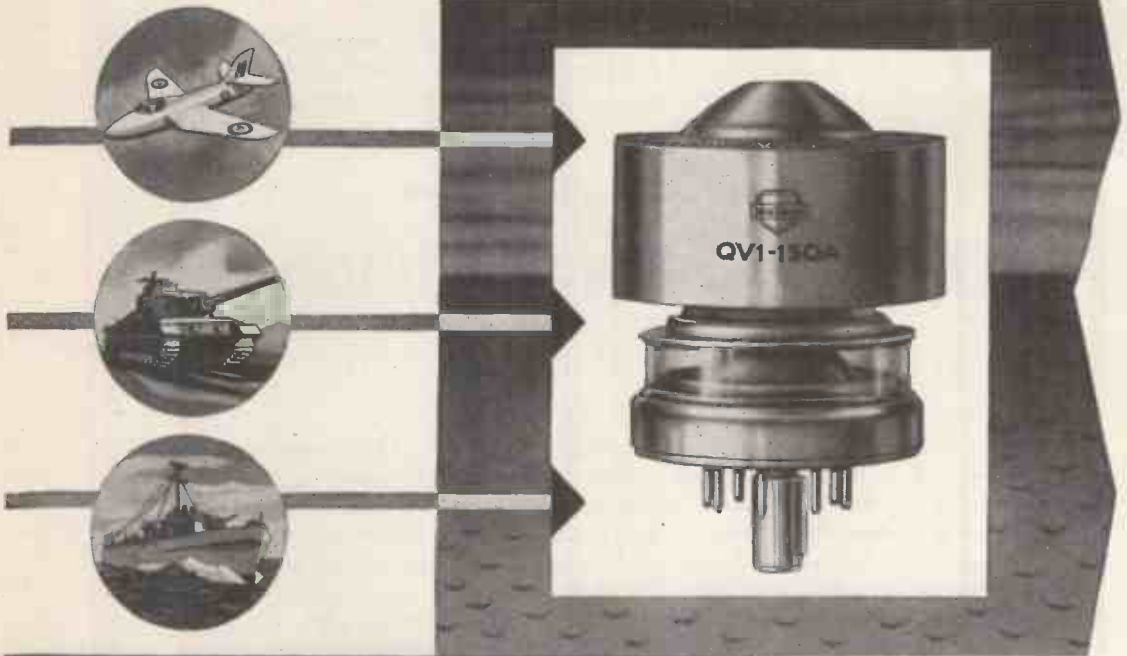

## QV1-150A POWER TETRODE

The new Mullard QV1-150A is an external anode tetrode of exceptionally small dimensions, completely interchangeable with the popular American 4X-150A. It is forced-air cooled and will operate with excellent efficiency and power gain at frequencies as high as 500 Mc/s.

Although the maximum d.c. anode voltage is 1.25kV, the performance of the QV1-150A is little reduced at half this figure and recommends it for both fixed and high power mobile transmitting equipments.

High permissible anode dissipation, high current density and very favourable ratio of mutual con-

ductance to capacitance particularly suit this new tetrode for wide-band applications.

The modified loctal base of the QV1-150A is so arranged that, when equipped with its special socket, forced-air cooling is facilitated and coaxial or linear circuits may be used. Excellent circuit separation is achieved at U.H.F. by a disc-seal screen-grid connection located between anode and base which is by-passed to cathode by a capacitor built into the socket.

Further information on this and a wide range of other transmitting valves may be readily obtained from the address below.

| Typical Applications                                   | Va (kV) | Pload (W) | f(Mc/s) |
|--|---------|-----------|---------|
| <b>R.F. POWER AMPLIFIER</b>                            |         |           |         |
| Class "B" (Television Service)                         | 1.25    | 200       | 216     |
| Class "C" Telegraphy and F.M. Telephony                | 1.25    | 156       | 165     |
|  | 1.25    | 112       | 500     |
| Class "C" Anode Modulated                              | 1.0     | 112       | 165     |
| <b>A.F. POWER AMPLIFIER AND MODULATOR (two valves)</b> |         |           |         |
| Class "AB1"  | 1.25    | 310       | A.F.    |
| Class "AB2"  | 1.25    | 425       | A.F.    |

| HEATER |      | LIMITING VALUES |          | BASE |
|--------|------|-----------------|----------|------|
| Vh     | 6.0V | Va max.         | 1.25 kV  | B8F  |
| Ih     | 2.6A | pa max.         | 150 W    |      |
|        |      | Vg2 max.        | 400 V    |      |
|        |      | pg2 max.        | 12 W     |      |
|        |      | f max.          | 500 Mc/s |      |



There are those who consider that there is little to choose in the range of power amplifiers now available—perhaps because the power amplifier is usually considered the “easy” part in the search for audio perfection. Why is it then that leading engineers are so enthusiastic about the QUAD II design?

## ... on feedback and linearity

They like the unique integrated feedback to provide complete stability independent of phase changes in the load current . . . the method used for eliminating the loop gain outside the audio range without prejudice to the input signal . . . the way that feedback is again used to provide optimum design stage by stage and to control the effective time constants. They like its use yet again to provide a unique self-balancing phase changer without the usual asymmetry to the H.T. line. They like, too, the fact that the specification is fully met with commercially tested valves without matching or alignment of any kind. They extol the conservative ratings and restoration from overload (several nation-wide broadcasting corporations officially uprate the output to 20 watts, since with this degree of overload, distortion is still well within their acceptance figures).

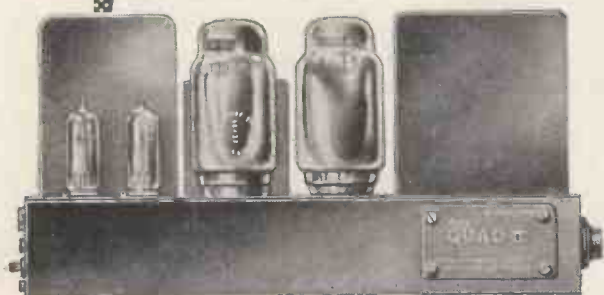

Good engineering for the best performance\* also results in greater efficiency. Compare the size of the QUAD with any other amplifier of approaching specification. Note the size of the output transformer which results from optimum choice of flux and core material to suit design requirements.

\* The unique output stage design principles are discussed in *Wireless World*, September, 1952.

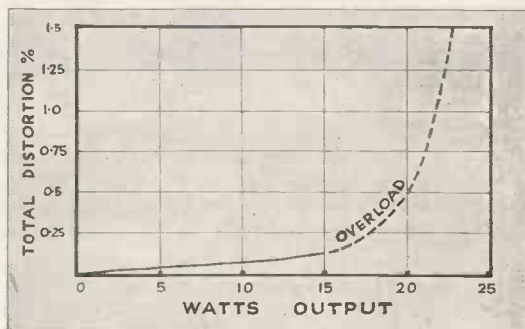

Linearity and overload of the QUAD II amplifier

The QUAD II power amplifier is primarily designed as part of the complete QUAD II amplifier. The power amplifier is also supplied separately as a quality standard when with a suitable input transformer it can be fed direct from a 600 ohm line.

The QUAD II is available throughout the world. Fully stocked servicing organisations are now operating in Canada, throughout U.S.A., Panama, Canal Zone, Trinidad, Jamaica, Venezuela, Australia, Malaya, Singapore, Japan, Hong Kong, Burma, India, Ceylon, Pakistan, South Africa, Portugal, Italy, France, Switzerland, Belgium, Norway and Sweden.

**ACOUSTICAL**  
MANUFACTURING CO LTD

**ACOUSTICAL MANUFACTURING CO. LTD., HUNTINGDON, ENGLAND**

# A COMMON factor in UNCOMMON PERFORMANCE



Ferrograph A



Ferrograph Model YD



Equipment YDC



## THE WEARITE TAPE DECK

The reputation of the 'Tapedeck' is so well-known and so firmly established as to call for no extravagance in describing its many virtues. Indeed, it forms the basis of the recorder instruments in common use in the Defence Services of the United Kingdom and many other countries, as well as being the choice of broadcasting Authorities throughout the World.

**FERROGRAPH 2A** A reasonably inexpensive instrument approaching professional standards with a specification commending it to those engaged in educational and cultural pursuits.

**FERROGRAPH MODEL YD** A triple-speed instrument designed mainly for use in the scientific and industrial fields. Principally intended for operation from and into 600 ohm lines, a high gain stage has been provided, however, to allow for recording direct from normal microphones.

**EQUIPMENT YDC** A simultaneous dual-channel Recorder-Reproducer offering special facilities for analytical research into medical, aeronautical and scientific problems. Any two activities capable of translation into electrical phenomena within the frequency and phase shift limitations can be recorded and replayed simultaneously.



*Originators of Tapedecks*

# WRIGHT & WEAIRE LTD

131 SLOANE ST., LONDON, S.W.1

Phone : SLOane 2214/5 & 1510



# H.F. WAVE ANALYSER TYPE 853

*(Selective Measuring Set 30 kc/s—30 Mc/s)*

## CAN BE EMPLOYED

- (a) To measure insertion gain and loss
- (b) To measure field strength and interference
- (c) For harmonic analysis
- (d) As a selective Voltmeter
- (e) As a Bridge Detector
- (f) As a Heterodyne Wavemeter

THIS instrument is a selective measuring set of great versatility operating over the frequency range 30 kc/s—30 Mc/s. It consists essentially of a stable high-gain selective amplifier, operating on the heterodyne principle and incorporating H.F. and L.F. attenuators. The output, in the form of an audio frequency, is applied to a meter circuit and to headphones.

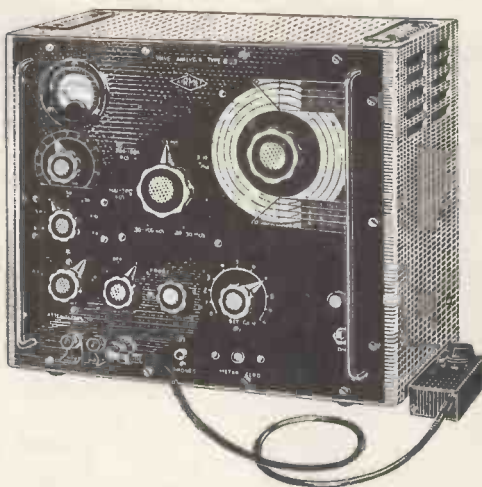

Special features are the high sensitivity (1 microvolt up to 20 Mc/s), wide attenuator range (120 db), high accuracy of attenuation ( $\pm 0.1$  db overall on L.F. attenuator), high selectivity, low noise level and continuous coverage over the whole frequency range.

## SPECIFICATION

**Frequency range:** 30 kc/s—30 Mc/s in 7 ranges.

**Amplitude range:** 30 kc/s—20 Mc/s:  $1\mu\text{V}$  to 120 db above  $1\mu\text{V}$ , 20 Mc/s—30 Mc/s:  $4\mu\text{V}$  to 120 db above  $4\mu\text{V}$ .

**Selectivity:** 3 kc/s bandwidth.

**Harmonic measurement:** 2nd harmonics 70 db down and 3rd harmonics 90 db down can be measured.

**Attenuators:** R.F. Attenuator 0—60 db in 20 db steps, L.F. Attenuator 0—60 db in 10 db steps and a 10 db variable attenuator.

**Input Impedance:** 75 ohms. A high input impedance probe unit is also provided.

*Full details of this or any other Airmec products will be forwarded gladly upon request.*

# AIRMEC LIMITED

HIGH WYCOMBE BUCKINGHAMSHIRE ENGLAND

Cables: Airmec, High Wycombe

Tel.: High Wycombe 2060

**PROFIT  
BY  
EXPERIENCE**



*There is  
over  
30 years' experience  
behind  
the*  
**Mullard  
EF80**

The Mullard EF80, high slope R.F. Pentode, is the most widely used valve of its type. This is as much due to its remarkable dependability as to its extremely efficient performance. Designed primarily as an R.F. or I.F. amplifier in television receivers, it is also suitable for use as a video amplifier, mixer or synchronising pulse separator.

The dependability of all Mullard valves is the logical outcome of Mullard advanced quantity production techniques, many of which are unique.

When ordering this type, BE SURE TO SPECIFY MULLARD.

**PROFIT BY THE EXPERIENCE  
OF THIS SERVICE ENGINEER**

Mr. F. Wade, Service Manager of Messrs. Brown, Muff & Co. Ltd., Bradford, says:

*"With my company's goodwill at stake, Mullard valves are my choice every time. Mullard dependable performance means everything to the service engineer."*



**Mullard**

**THE MASTER VALVE**

BLACKBURN · FLEETWOOD · GILLINGHAM · HOVE · LYTHAM-ST. ANNES  
MITCHAM · PADIHAM · RAWTENSTALL · WADDON · WANDSWORTH · WHYTELEAFE



**MULLARD LTD., CENTURY HOUSE, SHAFTESBURY AVENUE, LONDON, W.C.2.**

**POST THE COUPON TODAY  
FOR OUR BROCHURE ON THE  
LATEST METHODS OF HOME  
TRAINING FOR OVER  
150 CAREERS AND HOBBIES**

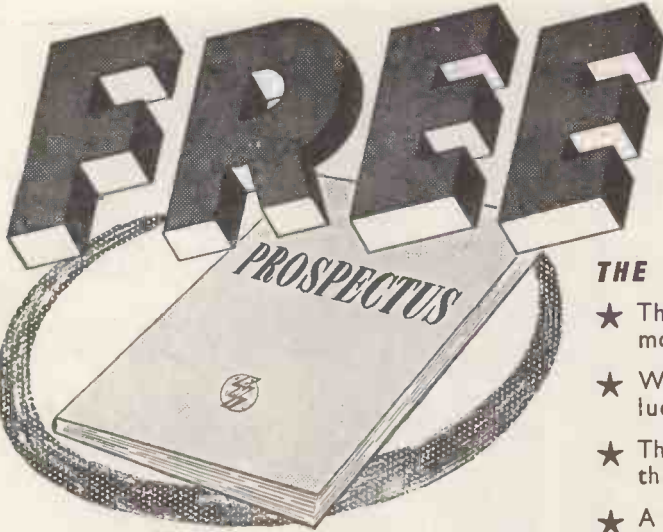

**THE ADVANTAGES OF E.M.I. TRAINING**

- ★ The teaching methods are planned to meet modern Industrial requirements.
- ★ We offer training in all subjects which provide lucrative jobs or interesting hobbies.
- ★ The student is taken carefully and thoroughly through his chosen subject.
- ★ A tutor is personally allotted by name to ensure private and individual tuition.
- ★ Free advice covering all aspects of training is given to students before and after enrolment with us.

**NEW**

**LEARN THE PRACTICAL WAY  
— COURSES WITH EQUIPMENT**

With many courses we supply actual equipment thus combining theory and practice in the correct educational sequence. The equipment, specially prepared and designed, remains your property. Courses include: Radio, Television, Electronics, Draughtsmanship, Carpentry, Photography and Commercial Art, Amateur S.W. Radio, Electricity, Languages, Mechanics, etc.



Equipment supplied upon enrolment and remains your property.

**PRIVATE AND INDIVIDUAL TUITION IN YOUR OWN HOME**

|                          |                                   |                              |                             |
|--------------------------|-----------------------------------|------------------------------|-----------------------------|
| Accountancy              | Customs & Excise Officer          | M.C.A. Licences              | Secretaryship               |
| Advertising              | Draughtsmanship                   | Mechanical Engineering       | Shorthand & Typing          |
| Aeronautical Engineering | Dressmaking                       | Motor Engineering            | Sound Recording             |
| Automobile Engineering   | Economics                         | Photography                  | Structural Engineering      |
| Banking                  | Electrical Engineering            | P.M.G. Licences              | Tele-communications         |
| Book-keeping             | Electronics                       | Police Production            | Television                  |
| Building                 | Fashion Drawing                   | Public Speaking              | Time & Motion Study         |
| Business Management      | Heating & Ventilating Engineering | Radar                        | Tracing                     |
| Carpentry                | Industrial Administration         | Radio & Television Servicing | Welding                     |
| Chemistry                | Journalism                        | Radio Engineering            | Writing                     |
| Civil Service            | Languages                         | Refrigeration                | Workshop Practice           |
| Civil Engineering        | Marine Engineering                | Retail Shop Management       | Works                       |
| Commercial Subjects      | Mathematics                       | Salesmanship                 | Management and many others. |
| Commercial Art & Drawing |                                   | Sanitation                   |                             |

Also courses for University Degrees, General Certificate of Education, B.Sc.Eng., A.M.I.Mech.E., L.I.O.B., A.C.C.A., A.C.I.S., A.M.Brit.I.R.E., A.M.I.I.A., City & Guilds Examinations, R.S.A. Certificates, etc.

**Courses from 15/- per month**

**POST THIS COUPON TODAY**

Please send without obligation your FREE book.

**E.M.I. INSTITUTES Dept. 127k,  
Grove Park Road, London, W.4.**

NAME \_\_\_\_\_

ADDRESS \_\_\_\_\_

SUBJECT(S) OF INTEREST \_\_\_\_\_

(We shall not worry you with personal visits)

APRIL

1c38a

**EMI**

**INSTITUTES**

**THE ONLY POSTAL COLLEGE WHICH  
IS PART OF A WORLD-WIDE  
INDUSTRIAL ORGANISATION**

# THE ASTONISHING ACHIEVEMENTS OF PLASTICS IN INDUSTRY

Plastics in electricity, in textiles, transport,  
commerce and cars, and a host of new fields

Learn what plastics can do for you in your business  
by visiting the 3rd British Plastics Exhibition and Convention—  
at Olympia, London, from June 1-11.

There you will see, in colourful and all-embracing array,  
everything the British plastics industry has to offer—the latest  
materials, machines and moulding presses—the  
whole range of finished articles from curtains to car bodies.

## BRITISH PLASTICS EXHIBITION & CONVENTION

This will be the biggest, the most comprehensive,  
the most valuable Exhibition of British plastics ever staged.

A Convention, held simultaneously, provides for a  
discussion on technical advances throughout this ever-growing  
industry. This is an Exhibition you MUST see. Mail  
the enquiry form to-day for full information and free season ticket.

*The biggest and most practical  
exhibition of British plastics ever presented.  
Plan your visit NOW!*

Exhibition staged every second year by the journal "BRITISH PLASTICS"

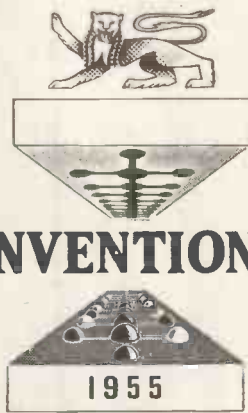

**OLYMPIA  
LONDON  
JUNE 1-11**

• • • • •  
• Please send me the 1955 Exhibition Brochure, Convention details, free season ticket, etc.  
• NAME \_\_\_\_\_ DATE \_\_\_\_\_  
• FIRM \_\_\_\_\_  
• ADDRESS \_\_\_\_\_  
• \_\_\_\_\_  
• \_\_\_\_\_



**MAIL THIS TO-DAY!**

TO:  
EXHIBITION MANAGER  
BRITISH PLASTICS  
DORSET HOUSE  
STAMFORD STREET  
LONDON, S.E.1



## FLEXIBLE REMOTE CONTROL OUTFITS

Our experience in the industrial field has indicated that there is a definite need for this type of outfit offering facilities for making prototype flexible remote controls as required.

The three gauges of Remote Control flexible shafts in these outfits cover the range of torque loadings required for • volume controls • all types of wave change switches • condensers • all controls likely to be met in electronic, radio and television equipment.

These outfits are reasonably priced and comprise:

- No. 117 (.117 in. dia.) for remote controls up to 3 in. in length.....£6.10.0
- No. 130 (.130 in. dia.) for remote controls up to 7 in. in length.....£7. 0.0
- No. 150 (.150 in. dia.) for remote controls of a heavier type up to 12 in. in length.....£7.10.0

The S. S. White Company will be pleased to advise which Outfit is most suitable for specific applications.

A detailed Parts List is available upon request.



BRITANNIA WORKS, 25-31 ST. PANCRAS WAY, LONDON, N.W.1. Telephone : EUSton 5393



# MINIATURIZATION

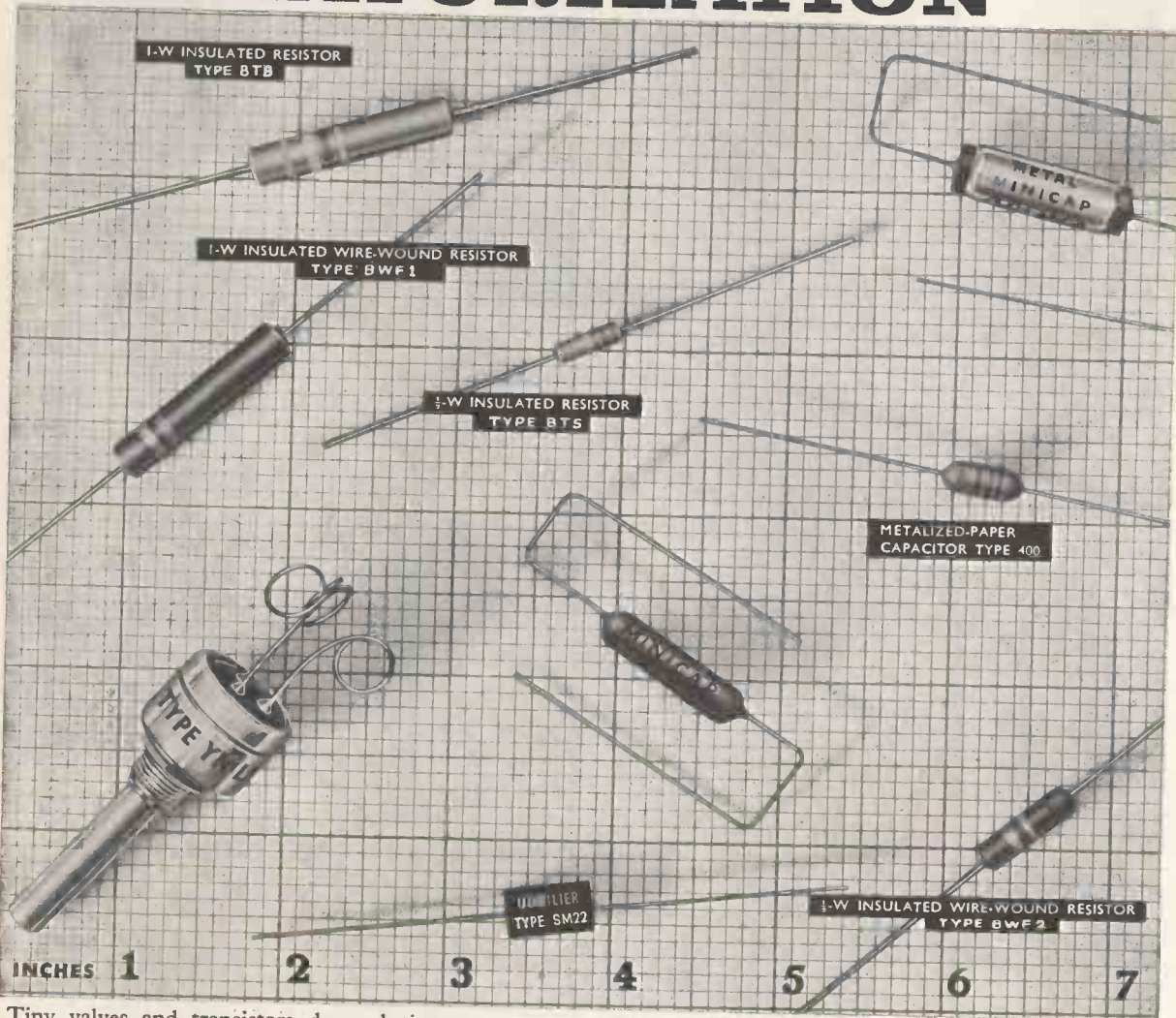

Tiny valves and transistors demand tiny components to accompany them. Whether you are working on television for Bands III and IV, Band II Radio, computers, industrial electronics or test gear, these components will undoubtedly interest you. Deserving of special mention are the tiny BTS type  $\frac{1}{2}$ -W. resistor measuring only  $\frac{3}{8}$ "  $\times$   $\frac{1}{8}$ " and the type 400 metallised paper capacitor in its melt-proof cover. For those of you concerned with tropicalization, BTS, BTB and BWF2 resistors, YN-potentiometers and metal 'minicap' capacitors

will be of special interest. To those of you engaged on Government contracts we should like to mention that the metal 'minicap' capacitor and the type BTS and BTB resistors are type-approved.

Send for samples and catalogues by dropping us a line on your company's letter-heading.

**R.E.C.M.F.**  
You will see these latest developments on Stand No. 45.

Research and development engineers will be especially welcome on our stand where we shall be delighted to discuss your capacitor and resistor problems.

# DUBILIER

DUBILIER CONDENSER CO. (1925) LTD., DUCON WORKS, VICTORIA ROAD, NORTH ACTON, LONDON, W3  
Te ephone: ACOrn 2241. Telegrams: Hivolcon, Wesphone, London. Marconi Int. Code.

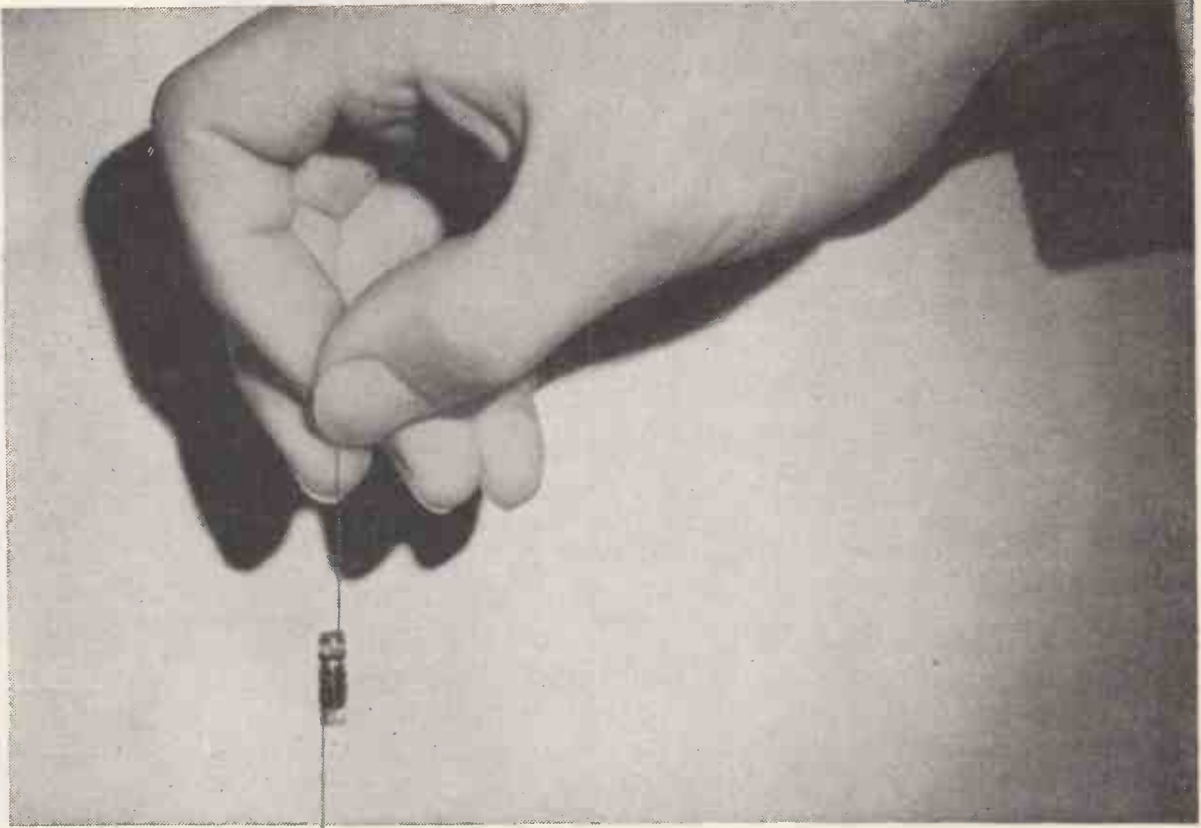

More  
pF  
per  
in \*

## Suflex Polystyrene Capacitors

put a quart of capacitance into a pint of space. If you have a problem which demands a capacitor of excellent electrical performance and the smallest possible size, you may well find the solution if you contact **Suflex**

# SUFLEX

*Limited*

LONDON

\* for example,  
100 pF in a capacitor  
 $\frac{1}{4}$ " long,  
about  $\frac{1}{16}$ " dia.

The Suflex range of good electrical products includes  
Polystyrene capacitors • Silicone/varnished insulating sleeving •  
Plastic sleeving • Plastic covered wire • PVC/Nylon lacing cord •  
Glass/Nylon dial drive cord • Copper wire braids • Cotton braids

35 BAKER STREET, LONDON W.1. Telephone: WELbeck 0791 Cables: Suflex, London



# "Antex" plus "Addex" pulls in both

Since, initially, Band 1 and Band 3 transmitters will not be co-sited in London and Holme Moss, many receivers will be situated between the Band 1 and Band 3 transmitters and the signals will arrive from approximately opposite directions. Here a different method of fitting the "Addex" Type "X" kit to the "Antex" aerial should be used to provide reception from opposite directions. The method can only be used with the patented "Antex" aerial with its special construction and cannot be applied to "H" or other types of aeri-als.

The conversion uses only half an "Addex" kit (two rods), providing a gain on Band 3 equal to an "H" array without affecting normal Band 1 reception.

The acceptance angle of the adapted array is quite broad and can be used at sites not directly between transmitters, by beaming the aerial to favour the weaker transmission. If beaming the aerial at one transmitter brings it to an angle of more than 60° in relation to the other it may be advantageous to use the standard "Addex" fitting (using four rods).

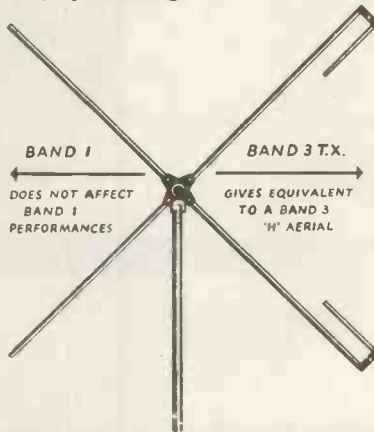
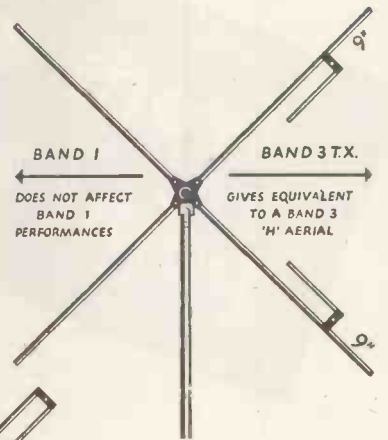

The above illustration shows the "Antex" array with 2 "Addex" units positioned to receive Channel 1 signals from Band 1 and Band 3 transmitters situated in opposite directions from the receiver.

Right is an illustration of an "Antex" array with 2 "Addex" units fitted at the ends of aerial rods to provide Channel 2 reception for Band 1 and Band 3 transmissions arriving from opposite directions.

STAND No. 56 R.E.C.M.F. EXHIBITION APRIL 19-21

# ANTIFERRENCE LIMITED

Sales Division: Bicester Road, Aylesbury, Bucks. Tel: Aylesbury 1467/8/9



'Frequentite' is the most suitable insulating material for all high frequency applications. Seventeen years ago we introduced the first British-made low-loss ceramic, and consultation with us before finalising the design of new components is a wise precaution.

**STEATITE & PORCELAIN PRODUCTS LTD.**

Head Office: Stourport-on-Severn, Worcestershire. Telephone: Stourport 111. Telegrams: Steatins, Stourport



# HIGH FIDELITY

## for small rooms . . .



**AXIOM 102**  
 Frequency coverage .....40/15,000 c.p.s.  
 Fundamental Resonance ...65 c.p.s.  
 Flux Density.....16,000 gauss  
 Nett Weight .....4 lb.  
 Price..... £9.18.2 inc. Tax

### *The World's finest* **7-WATT** **LOUDSPEAKER**

The GOODMAN'S AXIOM 102 Loudspeaker is the ideal low-powered single unit for the smaller domestic High-Fidelity installations. It provides a wide angle of coverage at high frequencies with a power handling capacity of 7 watts.

**Goodmans**

**LOUDSPEAKERS WITH A MESSAGE OF PERFECTION**

**POST THE COUPON NOW** for full details of the Axiom 102 and our other High-Fidelity Loudspeakers, crossover systems and bass reflex chambers.

**GOODMANS INDUSTRIES LTD.**  
 AXIOM WORKS · WEMBLEY · MIDDX. · WEMBLEY 1200  
 U.S.A. AGENTS: ROCKBAR CORPORATION INC.  
 215 East 37th Street, New York 16

**TO: GOODMANS INDUSTRIES LTD.**  
**AXIOM WORKS, WEMBLEY, MIDDLESEX.**

*I am interested in:*

NAME .....

ADDRESS .....

.....

WW/4/55 *Please write in block capitals.*

# RELAYS



## SERIES 1265 SEALED D.C. Operation

Standard coil voltages  
up to 50 Volts D.C.

This relay employs the solenoid principle with contacts operated through a lever movement. The balanced design is an important advantage under high acceleration, and the contacts will carry 20 amps at 24 Volts D.C.

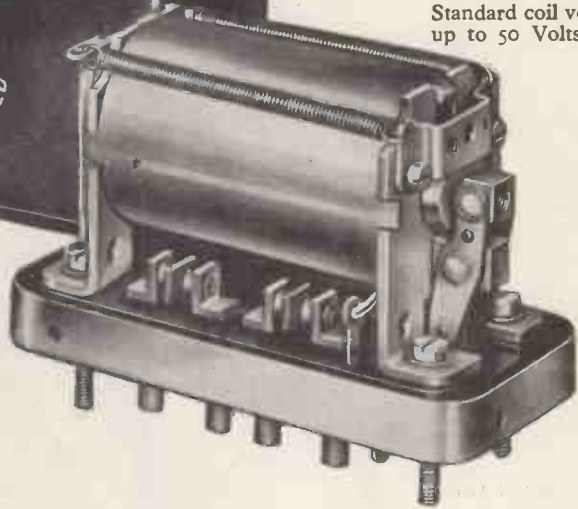

## Two small types for **BIG** loads

Both the relays illustrated combine strength with high current carrying capacity, and are designed to ensure long, trouble free life. Made from highest quality materials throughout, they may be the answer to your switching problem, especially if space is restricted.

### SERIES 151 A.C. Operated

An exceptionally small relay in proportion to the contact rating of 15 Amperes, a feature is the heavy overload it is capable of withstanding for short periods, rendering it particularly suitable for such applications as starting low voltage D.C. motors. Coils are available in all standard voltages up to 250v. A.C. and 140v. D.C.

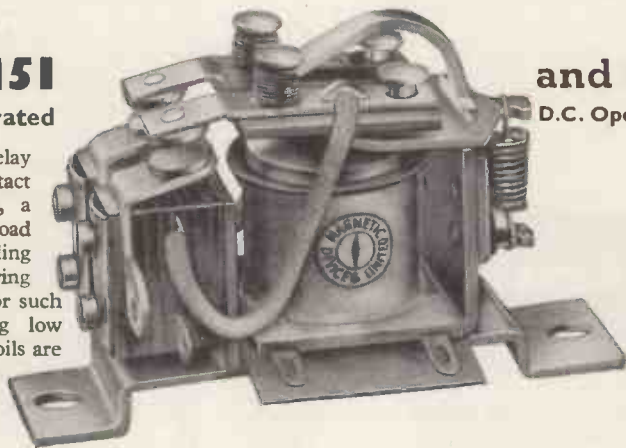

### and 156 D.C. Operated

Telephone Newmarket 3181



**MAGNETIC DEVICES LTD**  
NEWMARKET

# For SPEEDY delivery of precision QUARTZ Crystals

Specialists in the  
manufacture of  
Frequency Control  
Quartz Crystals with-  
In the range 2,000  
to 20,000 Kc/s

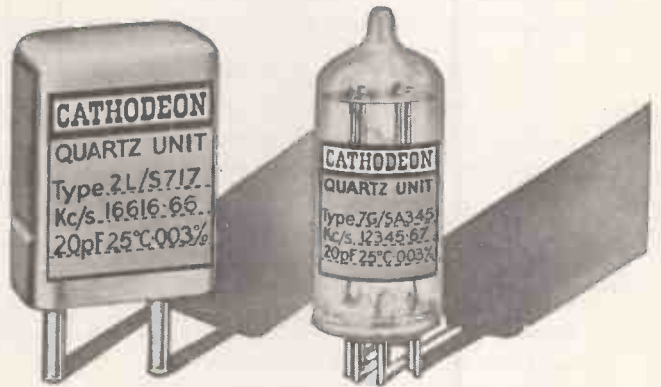

## *Special Urgency Service*

Small urgent orders can now  
be executed within days, at  
competitive prices.

Ask for full details.

Tel. LINTON 223

**CRYSTALS LIMITED**

LINTON • CAMBRIDGESHIRE

**CATHODEON**

## VISUAL VALVE TESTER

*This equipment displays on a cathode-ray tube a family of  $I_a/V_g$  curves for any receiving type thermionic valve. Eleven curves corresponding to eleven different grid voltages are presented simultaneously and a calibrated graticule permits rapid comparison with published data.*

*Nine standard valve bases are provided, with facilities for connecting others, and the various valve electrodes are connected to the requisite supplies by a multi-button switching board.*

*This permits any electrode to be connected to any supply without damage and also enables electrodes to be paralleled for test purposes.*

*All external parameters  $V_a$ ,  $V_s$ ,  $V_h$ ,  $V_g$ , are continuously variable over a wide range and current and voltage values are metered.*

*Full technical data is available on request.*

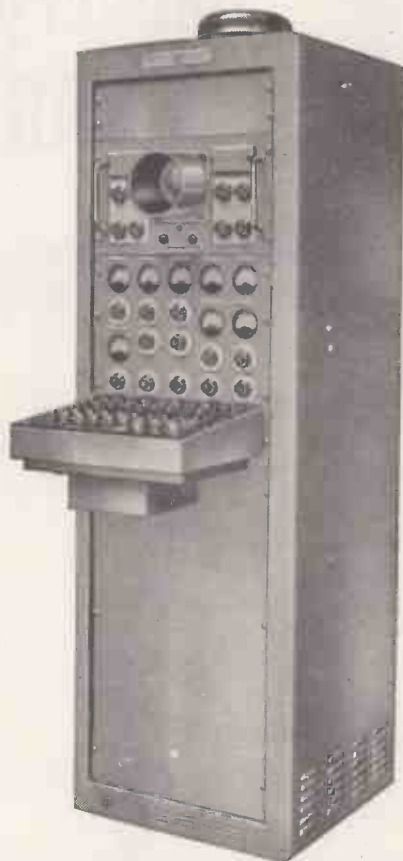

## CINEMA TELEVISION LTD

A COMPANY WITHIN THE J. ARTHUR RANK ORGANISATION

WORSLEY BRIDGE ROAD · LONDON · S.E.26  
HITHER GREEN 4600

**SALES AND SERVICING AGENTS:**

Hawnt & Co. Ltd., 59 Moor St. Birmingham, 4

Atkins, Robertson & Whiteford Ltd., 100 Torrissdale Street, Glasgow, S.2

F. C. Robinson & Partners Ltd., 122 Seymour Grove, Old Trafford, Manchester, 16



# ELAC closed field...



## ... LOUDSPEAKERS

These loudspeakers have been designed to provide minimum magnetic interference together with high acoustic efficiency. ELAC Elliptical and round loudspeakers are used in most of the leading Television and Radio receivers.

PRICES INCLUDING P.T. FOR LOUDSPEAKERS LESS TRANSFORMER AS FROM NOV. 1st, 1954.

|                       |                     |              |                |                     |              |
|-----------------------|---------------------|--------------|----------------|---------------------|--------------|
| 7" x 4"<br>Elliptical | Flux 6,500<br>Gauss | <b>21/10</b> | 6½"<br>PM. 6G  | Flux 6,500<br>Gauss | <b>21/10</b> |
| 3½"<br>PM. 3G         | Flux 6,500<br>Gauss | <b>19/10</b> | 8"<br>PM. 8D   | Flux 7,500<br>Gauss | <b>29/1</b>  |
| 5"<br>PM. 5G          | Flux 6,500<br>Gauss | <b>20/6</b>  | 10"<br>PM. 10D | Flux 7,500<br>Gauss | <b>34/4</b>  |



**ELECTRO ACOUSTIC INDUSTRIES LTD.**

Stamford Works, Broad Lane, Tottenham, N.15

# OSMOR

## radio products Ltd.

(Dept. W.63) 418 BRIGHTON RD, SOUTH CROYDON, SURREY. Telephone Croydon 5148/9

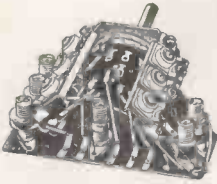

These really powerful units in compact form give quality and performance right out of proportion to their midget size and modest cost. Osmor "Q" Coilpacks have everything that only the highest degree of technical skill can ensure—extra selectivity, super sensitivity, adaptability. Size only 1½ x 3½ x 2½ with variable iron-dust cores and Polystyrene formers. Built-in trimmers. Tropicalised. Prealigned. Receiver-tested and guaranteed. Only 5 connections to make. All types for Mains and Battery superhets, and T.R.F. receivers. Ideal for the reliable construction of new sets, also for conversion of the 21 Receiver, TR.1196, Type 18, Wartime Utility and others. Send to-day for particulars!

### SEPARATE COILS

4/-

A full range is available for all popular wavebands and purposes. Fully descriptive leaflets and connection data available. New simple one hole fixing. Just note these "5 Star" Features. \* Only 1 in. high. \* Packed in damp-proof containers. \* Variable iron-dust cores. \* Fitted tags for easy connection. \* Low loss Polystyrene formers. L. or M.W. T.R.F. REACTION COIL TYPE QR 11-12, 4/9. A range of coils for F.M. Receivers shortly available. Coils now available for reflex circuits.



### OSMOR STATION SEPARATOR

The Separator may easily be tuned to eliminate any one station within the ranges stated and fitting takes only a few seconds. Sharp tuning is effected by adjusting the brass screw provided.

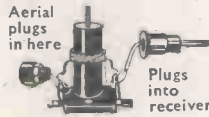

#### TYPE METRES

|   |              |
|---|--------------|
| 1 | 141-250      |
| 2 | 218-283      |
| 3 | 267-341      |
| 4 | 319-405      |
| 5 | 395-492      |
| 6 | 455-567      |
| 7 | 1450-1550    |
| 8 | 410-550 k/c. |

**7/6**  
COMPLETE

### CHASSIS CUTTER



| Type | Hole Sizes     | Prices |
|------|----------------|--------|
| 1    | 1 in. x 1¼ in. | 19/6   |
| 2    | ¾ in. x 1½ in. | 18/9   |
| 3    | ¾ in. x 1¾ in. | 22/6   |
| 4    | 1¼ in. x 2 in. | 27/3   |

100-ton high tensile bolt now supplied with No. 2. Illus. details on request.

I.F.s. 465 k/c. Permeability-tuned with flying leads. Standard size 1½ in. x 1¼ in. x 3½ in. For use with OSMOR coilpacks and others, 14/6 pair. Midgec I.F.s 465 k/c. ¾ in. x ¾ in. x 2½ in., 21/- pair. PREALIGNED, 1/6 extra, both types.

**FREE!**

Send 5d. (stamps) or fully descriptive literature including "The really efficient 5-valve Superhet Circuit and Practical Drawings," 6-valve ditto, 3-valve (plus rectifier) T.R.F. circuit, Battery portable superhet circuit, Coil and Coilpack leaflets, Chassis Cutter leaflet, and full radio and component lists, and interesting miniature circuits, etc.

**DIALS—VARIOUS DIALS CALIBRATED TO COILS**  
Metal dials, overall size 5½ in. square. Cream background, 3-colour Type M1, L.M.S. waves. M2, L. & M. waves. M3, M. and 2 S. waves. Price 3/6 each.  
Pointer 1/6; Drum, Drive, Spring and Cord, 3/2.  
Type A glass dial assembly, measuring 7 in. x 7 in. (9½ x 9½ overall). Mounts in any position. Choice of two 3-colour scales, 24/6. P. & P. 1/6.

WE ENDEAVOUR TO KEEP ABREAST OF THE TIMES BY BUILDING THE VARIOUS CIRCUITS PUBLISHED IN "WIRELESS WORLD," "PRACTICAL WIRELESS," "RADIO CONSTRUCTOR" ETC. WE KEEP STOCKS OF THE COMPONENTS SPECIFIED.

# FM

Frequency Modulation comes to stay in May! OSMOR does its share in the design of coils and a really first-class circuit of complete receiver and tuner. Free circuit and point to point wiring diagram, and full constructional information. (5d. in stamps.)

# FM

A LIST OF FIXED CAPACITIES AS REQUIRED FOR SWITCH TUNING AVAILABLE ON APPLICATION

**SUPER "Q" for CUP**

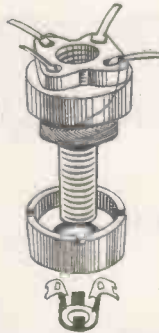

**MAX. SELECTIVITY COILS**

★ TERRIFIC PERFORMANCE

★ MAGNETICALLY SCREENED

M.W. Q A51

L.W. Q A52

ONE HOLE FIXING

**The NEW Osmor 'SWITCH-PACK' now ready 48/-**  
COMPLETE & PRE-ALIGNED, FULL CIRCUIT INCLUDED inc. P.T.  
(State which three stations required—2 M.W.—1 L.W. or 3 M.W.)

OUR TECHNICAL DEPT. WILL BE PLEASED TO ANSWER (BY LETTER ONLY) ANY ENQUIRY RELATING TO CIRCUITS IN WHICH OSMOR COILS OR COIL PACKS ARE USED OR ARE INTENDED TO BE USED.

TRADE ENQUIRIES INVITED

**NO INTERACTION**

*Identical Amplifiers  
20 mV/cm at 4 Mc/s*

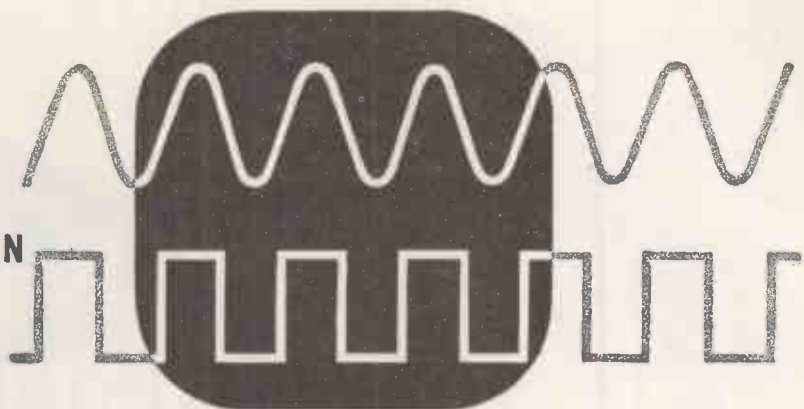

# dual-trace oscilloscope

**BY MULLARD**

After considerable research and development Mullard introduce the L.101 oscilloscope—a well-engineered and reliable instrument with dual trace facilities, and accurate time and voltage calibration.

Two separate amplifiers and a high speed electronic switch operating during the fly-back cycle are used to display two input signals on a conventional cathode ray tube. This arrangement provides a complete uninterrupted sweep on each channel alternately, and ensures freedom from interaction between the two amplifier channels.

The two amplifiers are identical and have a constant bandwidth of 4 Mc/s irrespective of sensitivity. They are aligned for good transient response and have a rise time of 0.1µsec. Each amplifier has a maximum sensitivity of 20 mV peak-to-peak/centimetre.

A Miller time base is employed, which may be free-running, synchronised or triggered. Its velocity is continuously variable between 0.1µsec/cm and 10msec/cm. Both time and voltage may be measured by the nul method and a well-regulated power supply preserves calibration accuracy.

Further information on the operation and performance of this new oscilloscope and other Mullard instruments is readily obtainable from the address below.



# Mullard



SPECIALISED ELECTRONIC EQUIPMENT

MULLARD LIMITED · EQUIPMENT DIVISION

CENTURY HOUSE · SHAFTESBURY AVENUE · LONDON · W.C.2

(M1456)

It pays  
to use

**Cyldon**

VARIABLE

**Capacitors**

and **Inductance Tuners**

for  
TELEVISION and AUTO-RADIO

for  
**Precision,  
Stability &  
Long Life**

**SYDNEY S. BIRD  
& SONS LTD.**

Designers and users of radio and electronic equipment know that they can rely implicitly on the efficiency and dependability of "Cyldon" Capacitors and Tuners. They know too that the exceptionally wide variety of types in the standard "Cyldon" range covers most day-to-day requirements, but that when special types are needed the full resources and specialised experience of the manufacturers are entirely at their disposal.

Contractors to Ministry of Supply, Post Office,  
and other H.M. Govt. Depts.

CAMBRIDGE ARTERIAL RD., ENFIELD, MIDDX.

Telephone: Enfield 2071-2 Telegrams: 'Capacity, Enfield

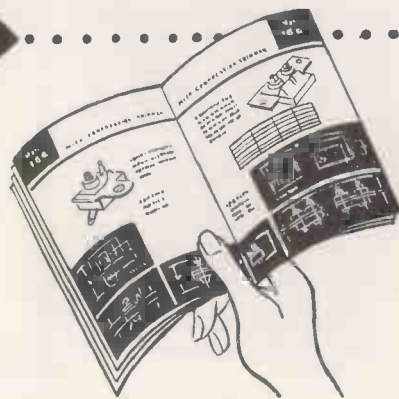

Equipment manufacturers are invited to write for literature covering Cyldon "Teletuners" (Catalogue TV.1953) and Cyldon Trimmers (Catalogue T.1951), together with details of our complete range of Variable Capacitors and list of Agents for Home and Overseas.



# International Favorite: RCA TV

Two reasons why RCA is No. 1 in  
World TV: RCA experience . . . RCA service

- ARGENTINA
- BRAZIL
- CANADA
- CUBA
- DENMARK
- DOMINICAN REPUBLIC
- FRANCE
- GERMANY
- HAWAII
- ITALY
- JAPAN
- MEXICO
- PHILIPPINES
- PUERTO RICO
- SWEDEN
- SWITZERLAND
- THAILAND
- UNITED STATES
- VENEZUELA

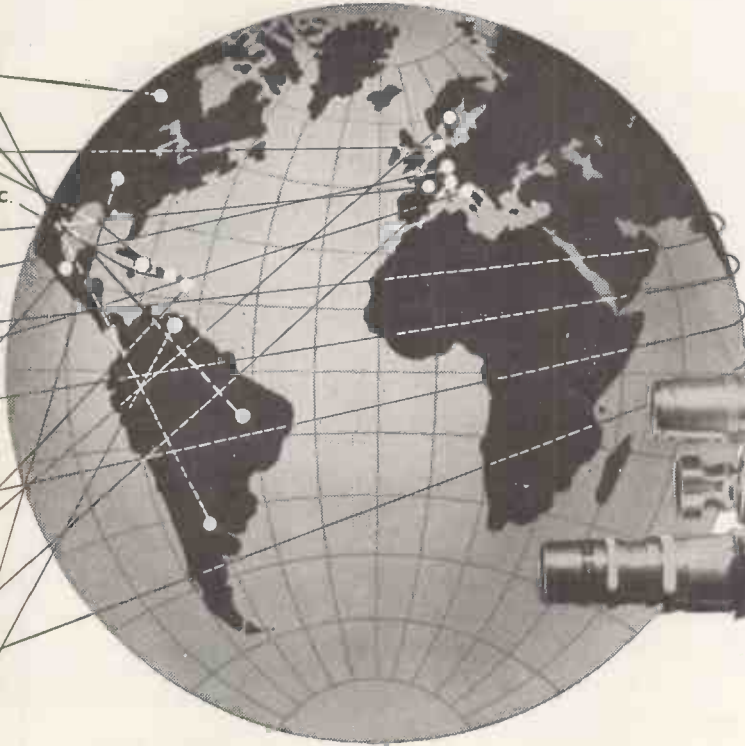

From one dependable source—RCA—you may order anything from a power tube to a complete television network . . . and be certain you are getting the finest.

RCA's breadth of TV experience is unequalled. For this company pioneered both black-and-white and compatible color television. In the United States, RCA transmitter equipment *and* home receivers are first in sales. RCA owns and operates five TV stations. It is affiliated with 182 others—the famous NBC network. To date, a total of 282 RCA television

transmitters have been installed in the United States and in other countries. The familiar RCA monogram is found on telecasting equipment in the studios of 18 countries beyond U. S. borders. And the list is steadily growing.

The reason is RCA's unmatched combination of experience in every phase of television plus its impressive reputation for service. This great reservoir of television experience and service facilities is at your command. For further information, see your RCA distributor or write to the address below.

TRADEMARK(S) • REGISTERED  
MARCA(S) REGISTRADA(S)



RCA INTERNATIONAL DIVISION

**RADIO CORPORATION of AMERICA**

RCA BUILDING

30 ROCKEFELLER PLAZA, NEW YORK, N.Y., U.S.A.

*This*  
**ALUMINIZED**  
*Picture tube gives*

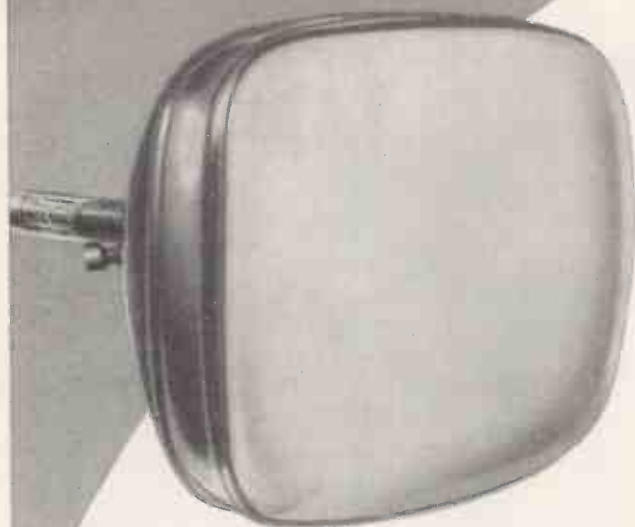

**60% brighter pictures**  
**more contrast**  
**extra tube life**

**A**N Ediswan Mazda aluminized picture tube gives a picture 60% brighter and more contrasty than is possible with an ordinary tube.

In addition, Ediswan aluminizing protects the screen from ion burn and, with the new Ediswan ion trap tetrode gun to protect the cathode, tube life is increased.

Ediswan production methods, which include the special in-line vacuumizing system, ensure a higher, more uniform standard of lasting efficiency. For complete satisfaction demonstrate and recommend Ediswan Mazda aluminized picture tubes.

**EDISWAN**  
**M A Z D A**

**ALUMINIZED CATHODE RAY TUBES**

THE EDISON SWAN ELECTRIC COMPANY LIMITED,  
 155 Charing Cross Road, London, W.C.2 and Branches.

*Member of the A.E.I. Group of Companies.*

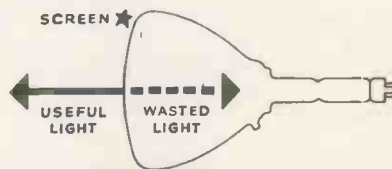

**WITHOUT ALUMINIZING**

*Without aluminizing, tubes waste half their light (see diagram above). To counteract this the brilliance must be increased and the tube life is shortened.*

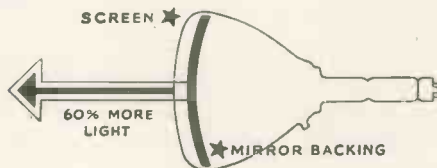

**WITH EDISWAN ALUMINIZING**

*Ediswan aluminized tubes have a mirror backing to the screen. All the light is thus thrown forwards giving brighter, clearer pictures and extra life.*

**NATION WIDE SERVICE**

6 fully equipped cathode ray tube service depots provide better, quicker tube testing should the need arise. Stocks of tubes are available in 26 Ediswan Offices. Only Ediswan give such complete backing to the Trade.

RV9

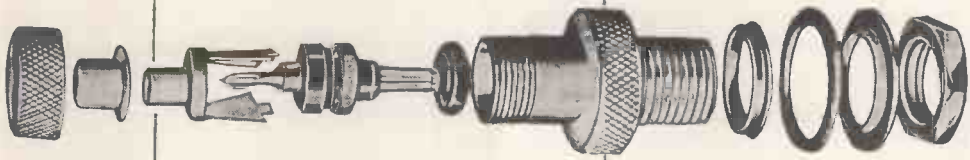

# MINIATURE

## CO-AXIAL SEALED PLUGS AND SOCKETS

**TYPE APPROVED—  
COMPLYING WITH R.C.S. 322  
PRESSURE SEALED AND  
100% TESTED  
USED WITH UNIRADIO 32  
OR 43 CABLE**



732560  
732557



732561  
732558



732564  
732563



732562  
732559

A.I.D. & A.R.B. - APPROVED

EXNING RD., NEWMARKET

**POWER CONTROLS**  
LIMITED

PHONE: NEW 3181/2/3



*By Appointment to the Professional Engineer*

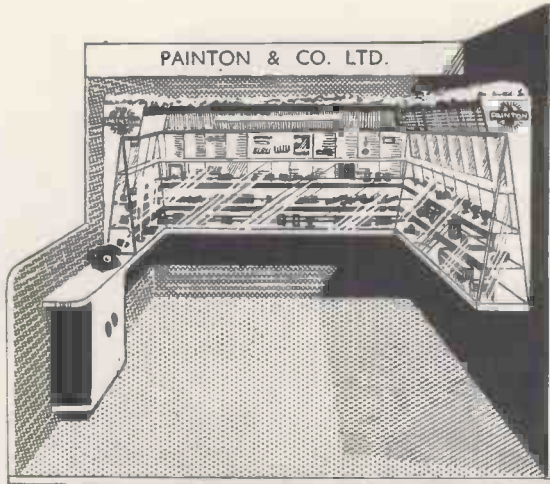

A cordial invitation is extended to you to visit our Stand No. 46 during your attendance at the 1955 R.E.C.M.F. Exhibition. The complete range of Painton Components will be displayed including . . .

. . . the commercial version of the new PAINTON "MULTICON" SERIES of plugs and sockets and untors, a selection of which are illustrated here.

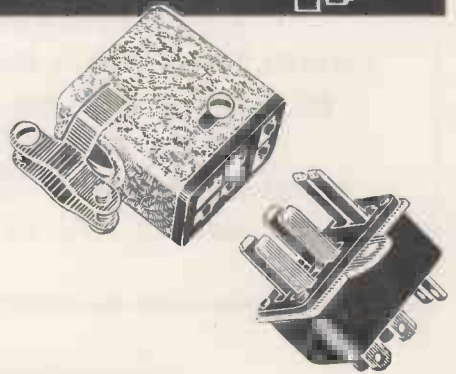
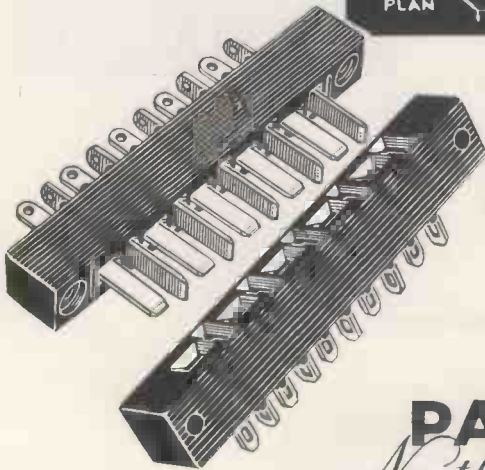
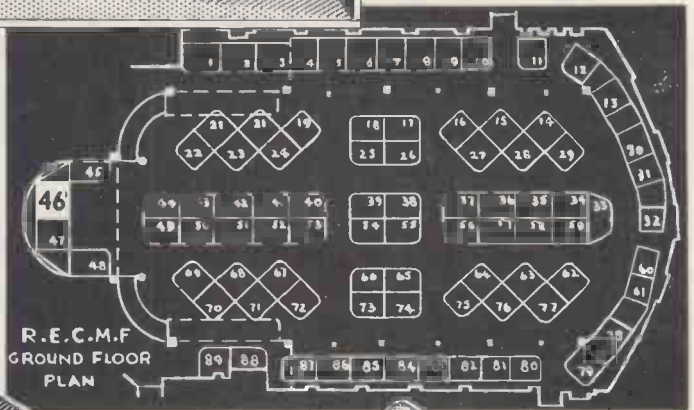

**PAINTON**  
*Northampton England*



# Designed for Continuous Service

ATE/TMC Transmission equipment is designed to offer an operating administration the maximum facility in the performance of maintenance routines. Jack-in panel frames fitted with quickly detachable functional units ensure the most rapid form of servicing yet devised. You are invited to apply for a copy of "Unit Construction Practice" which describes the technique employed.

## AUTOMATIC TELEPHONE & ELECTRIC CO. LTD.

Radio and Transmission Division, Strowger House, Arundel Street, London, W.C.2. Telephone: TEMple Bar 9262. Cablegrams: Strowgerex London. Manufacturers:—AUTOMATIC TELEPHONE & ELECTRIC CO. LTD., Liverpool and London. TELEPHONE MANUFACTURING Co. LTD., St. Mary Cray, Kent.



# miniature HT RECTIFIERS for domestic RADIO and TELEVISION receivers

## FEATURES

- Withstand overloads such as charging current of deformed electrolytic capacitors
- Instant starting — no warming-up period
- Unlimited instantaneous overload
- Practically indestructible in service.
  - No limit to size of reservoir capacitor
  - Simple wiring — two connectors only.
  - Simple mounting — no valve holder
  - Small size . . . low weight
  - Low heat dissipation
  - Low cost

| TYPE                            | RM0       | RM1       | RM2       | RM3       | RM4       | *RM5      |
|---------------------------------|-----------|-----------|-----------|-----------|-----------|-----------|
| Maximum ambient temperature     | 35°C      | 35°C      | 35°C      | 35°C      | 40°C      | 40°C      |
| Maximum output current (mean)   | 30mA      | 60mA      | 100mA     | 120mA     | 250mA     | 300mA     |
| Maximum input voltage (r.m.s.)  | 15mA      | 30mA      | 60mA      | 90mA      | 125mA     | 150mA     |
| Maximum peak inverse voltage    | 350V      | 350V      | 350V      | 350V      | 700V      | 700V      |
| Max. instantaneous peak current | Unlimited | Unlimited | Unlimited | Unlimited | Unlimited | Unlimited |
| Weight                          | 0.82 oz.  | 1 oz.     | 1.4 oz.   | 2 oz.     | 4.5 oz.   | 4.75 oz.  |

\* For use in voltage doubler circuits the peak inverse and maximum input voltages are halved, current output being as for half wave operation.



*Standard Telephones and Cables Limited*  
Registered Office: Connaught House, Aldwych, London, W.C.2  
RECTIFIER DIVISION: Edinburgh Way, Harlow, Essex

# Record Today...

## for TOMORROW'S PLEASURE

# Editor

SUITCASE  
TAPE RECORDER

### TWO-SPEED TAPE RECORDER

Easy to carry—easy to look at. Suitable for pre-recorded tapes. The "Editor" is the smallest mains operated fully automatic two speed portable tape recorder with 7in. spools on the market. Twin track heads; INDEPENDENT BASS AND TREBLE CONTROLS FOR RECORDING AND PLAYBACK. For A.C. mains 200-250 v.

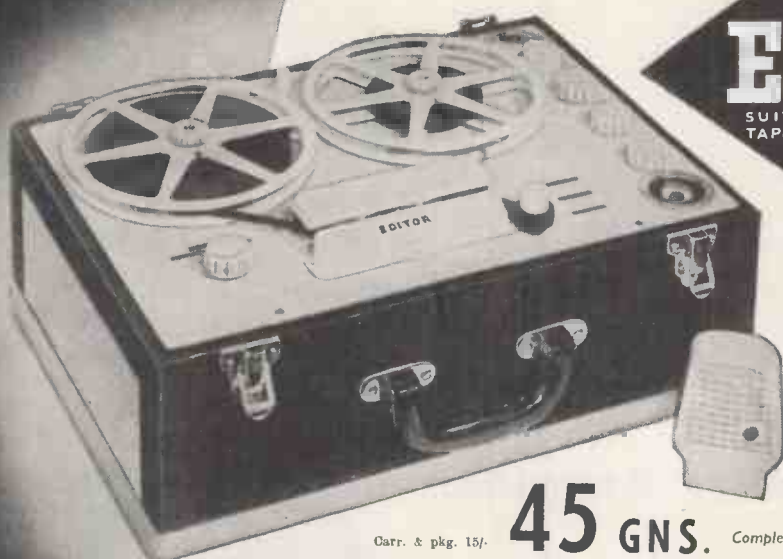

Carr. & pkg. 15/-

## 45 GNS.

Complete with High Fidelity microphone and 1,200ft. spool of tape.

### EDITOR SUPER

## 55 GNS.

Carr. & pkg. 15/-

Complete with High Fidelity microphone and 1,200ft. spool of tape.

A de luxe version of the "Editor" incorporating MIXING and MONITORING facilities and single knob control super tape deck. Two hours' recording. IDEAL FOR USE WITH PRE-RECORDED TAPES. For A.C. mains 200-250 v. In all leather or padded simulated crocodile suitcase.



Or supplied complete and ready for use with High Fidelity Crystal Microphone and One Hour spool of tape for £31.4.6.

Carr. & pkg. 12/6

## 26 GNS.

Insist on a British-made Tape Recorder!

# E. & G. MAIL ORDER SUPPLY CO.

The Radio Centre

33, Tottenham Court Road · London · W.1 · Tel. MUS 6667

#### Buy on the M.O.S. PERSONAL CREDIT PLAN

Send 10 per cent deposit with your order, balance spread over any period up to 18 months (24 months for £50 minimum value).

All proprietary brands of equipment advertised in this journal are available from us under the M.O.S. Personal Credit Plan.



#### The Tape Recorder for Every Home!

The smallest lowest-priced tape recorder giving a full hour's playing time. Completely self-contained for recording: PLAYS BACK THROUGH ANY RADIO OR AMPLIFIER, making possible Hi-Fi reproduction through your own favourite system.

Single knob control for all functions. High fidelity twin track recording heads. Powered by specially designed motor. Frequency response between 60/9,000 c/s. Overall size 12½in. x 10in. x 4½in. For A.C. mains 220/250 v.



# The most successful amplifier design of the year... The **Osram** 'nine - one - two'

**High Quality Amplifier  
and Reproducer**



Hailed with enthusiasm by home constructors and music lovers throughout the country. Designed to do full justice to the best of modern L.P. recordings, the Osram '912' sets a startlingly new standard of realism in domestic sound reproduction. The versatile tone control system with its variable treble slope also enables old and worn, but often treasured, records to be played with the maximum of musical enjoyment.

## How to build the Osram '912'

Osram '912', 9 octaves, 12 watts, ultra-linear output stage, base and treble tone controls, variable treble slope, stage-by-stage wiring instructions.

**PRICE 3/6**

From your dealer or by post 3d. extra from Osram Valve and Electronics Department.

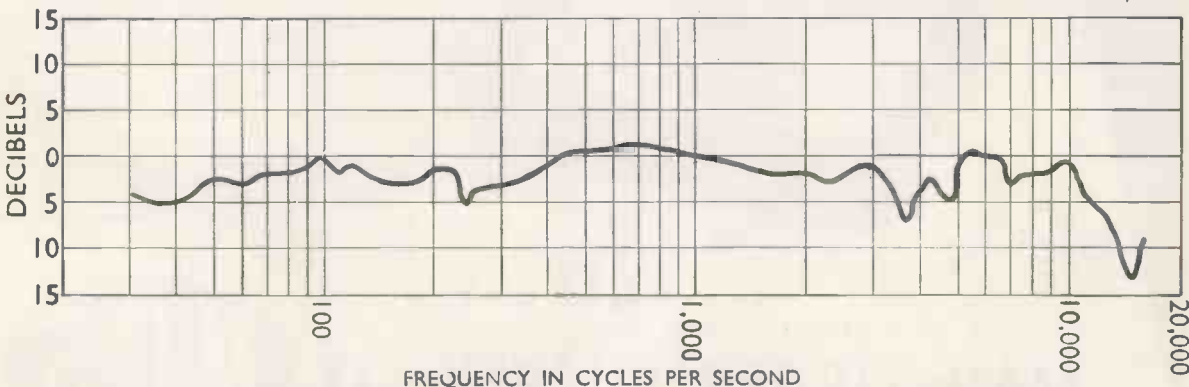

Overall frequency response of the complete equipment, comprising L.P. record, specified pick-up, Osram 912 amplifier and G.E.C. Metal Cone Loudspeaker in octagonal loaded-port cabinet.

THE GENERAL ELECTRIC CO. LTD., MAGNET HOUSE, KINGSWAY, LONDON, W.C.2

## **A PERIODIC CYCLE . . .**

Before the age of electronics this (we are told) was how the gentleman of leisure often enjoyed himself. From this elevated position he could spin along the quiet lanes and byways drinking in the pure fresh air and the delights of nature spread before him.



## **SIC TRANSIT . . .**

Traffic conditions today make it very difficult to find pleasure in travel for its own sake. Electronics has given us a new way in which to enjoy our leisure—by drinking in the pure delight of good music, faithfully reproduced on High Fidelity equipment supplied by Classic.

## **TAKING A FIRM GRIP ON OUR HANDLEBARS . . .**

May we point out that we at Classic have very little leisure to enjoy. We often find that we spend twenty-four hours a day (at least!) keeping other people happy—so many enthusiasts turn to Classic because they can get everything they want from our comprehensive range of high-fidelity equipment.

Send for our 16-page catalogue (U.K. 6d.; Special export edition 1/-; airmail extra).

# **CLASSIC ELECTRICAL**

COMPANY LIMITED

THE HI-FI SPECIALISTS

352-364 LOWER ADDISCOMBE ROAD, CROYDON, SURREY

Telephone: ADDiscombe 6061

# FOR H.F. COMMUNICATION - - -

Six Channels at less cost than ever before



The Labgear Model E.5103 6-Channel H.F. Converter Unit is designed to be coupled to any normal single channel receiver. The combination provides reception on up to six preselectable channels in the frequency range 2.5-25 Mc/s. Each channel is crystal controlled and the standard of performance is usually better than that of the main receiver to which the Converter is connected.

FOR FURTHER DETAILS PLEASE WRITE TO :—

## *Labgear (Cambridge) Limited*

WILLOW PLACE,  
CAMBRIDGE, ENG.

Tel: 2494-5  
Grams: Labgear, Cambridge

## *Cellular Polythene*

**75 ohm. T.V. DOWNLEAD CABLE**  
Nominal Attenuation at 50M/cs: 2.5dB/100 ft.

P.V.C Sheath . . . . .

Plain Copper Wire Braid . . . . .

Cellular Polythene Insulated to 0.129" Diameter . . . . .

1/.029" Annealed Copper Conductor . . . . .

## *A Glover Product*



**W.T. GLOVER & CO. LTD.**

MEMBERS OF THE C.M.A.

TRAFFORD PARK MANCHESTER 17

TRAFFORD PARK 2141



**Specialists in  
Plastic Extrusion**



THE  
*Concertone*



for new

★ perfection ★

and

★ fidelity ★

in

**TAPE RECORDERS**



**48 GNS.**  
COMPLETE

TRADE  
ENQUIRIES  
INVITED

MAGNETIC RECORDER

Meticulously recording every *tonal facet* with *complete mastery*, the "Concertone" tape recorder will give you the *ultimate listening pleasure* that comes from superb music *faultlessly* recorded and reproduced.

The "Concertone" will re-create, in the home, the *true image of the original performance*. Whether it be Solo Violin, or Oboe, or a Full Organ with its demanding power and range, the "Concertone" with its *wide frequency response*, and *extended dynamic range*, will satisfy the *connoisseur* of fine music.

Simple, absolutely reliable, rugged, compact, lightweight, and easily portable, the "Concertone" will, wherever there are sounds to be recorded, *serve faithfully*, earning, justly, *unqualified praise* for its *faultless performance*.

Manufactured by the company in its own precision machine shop, the tape mechanism employs three motors and a special design servomatic brake. The brake not only locks the spools *securely* during transit but, of greater importance, it is *completely free from fade*, being *self-compensating* for wear. Unique is the provision of a *mechanical interlock* which prevents faulty operation.

All Export enquiries to:—  
BARNETT SHIPPING CO.  
25 MONUMENT ST.,  
LONDON, E.C.3

Entirely Manufactured by  
**FISHER ELECTRONICS COMPANY LTD.**

ASK YOUR DEALER FOR  
A LEAFLET. IN CASE OF  
DIFFICULTY WRITE  
DIRECT (s.a.e. please).



# Hi Fi HIGH FIDELITY AMPLIFIER

The PF91 amplifier, with the PF91A remote control unit, is a versatile and practical combination for those who demand realism in sound reproduction from record players, tape recorders, microphones or radio tuners.

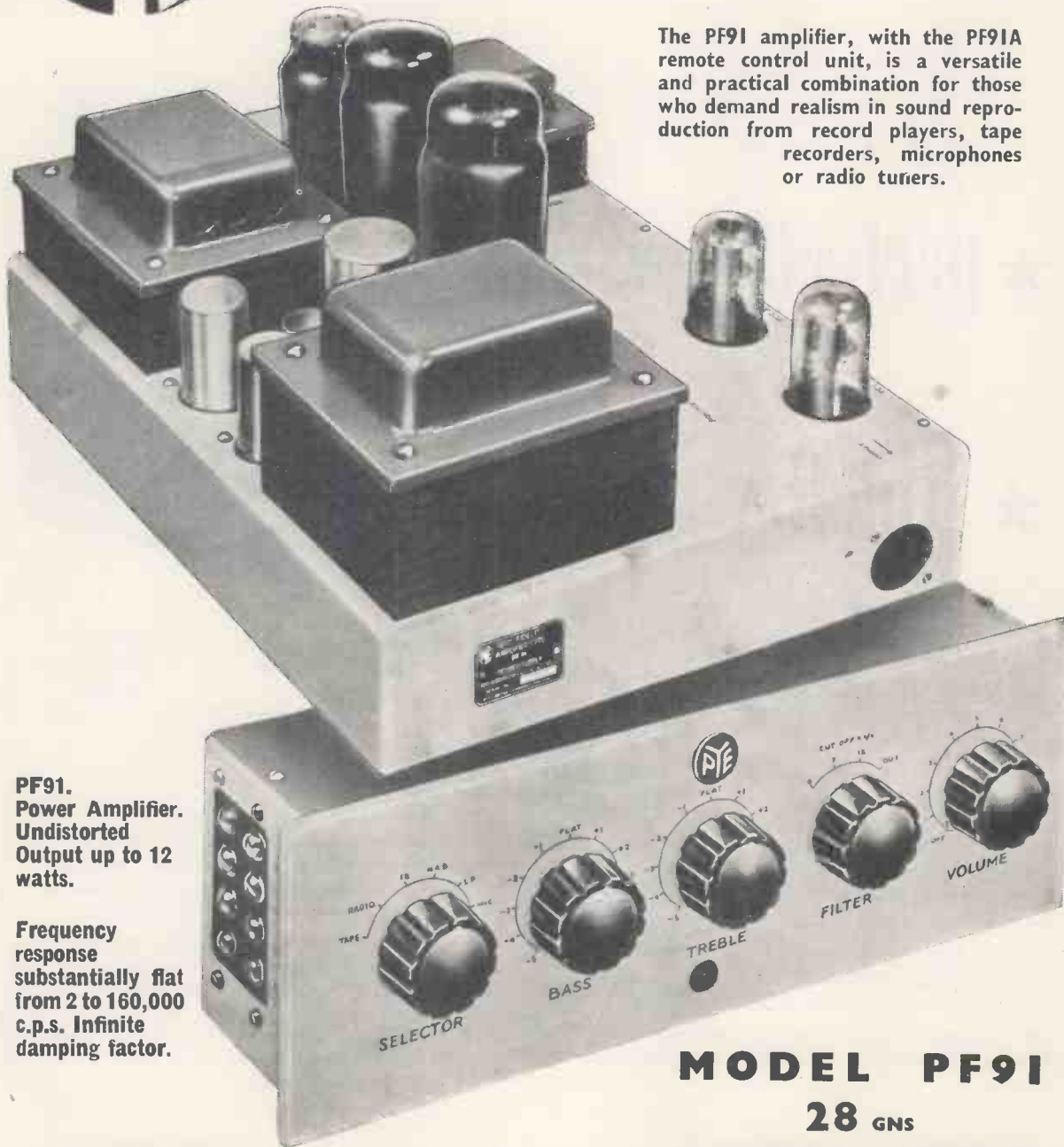

**PF91.**  
Power Amplifier.  
Undistorted  
Output up to 12  
watts.

Frequency  
response  
substantially flat  
from 2 to 160,000  
c.p.s. Infinite  
damping factor.

Demonstrations of the PF91 can be arranged through Pye Hi-Fi agents. Please write for a fully illustrated booklet to Pye Limited, Box 49, Cambridge.

**MODEL PF91**  
28 GNS  
**MODEL PF91A**  
12 GNS



# SHAKING OUT the facts!

## ... the story of a PROTOTYPE CAR RADIO

A new product—a car radio! How to be sure—absolutely certain—that its laboratory performance would always be duplicated on the road? Would vibration mar its performance, or shorten its life? Goodmans Vibration Generators, which accurately simulate vibratory forces of variable frequency and amplitude, find the answers—in the prototype stage! Recently a wise radio manufacturer sought Goodmans advice and a series of pre-production tests were carried out to vibrate the equipment from 10 c/s. to 500 c/s. at various amplitudes. The results, some of which are enumerated on the right, enabled positive design and constructional modification to be made, ensuring perfect, long-life peak performance of every production model.

*Just one example of the service rendered to Industry by Goodmans Vibration Generators.*

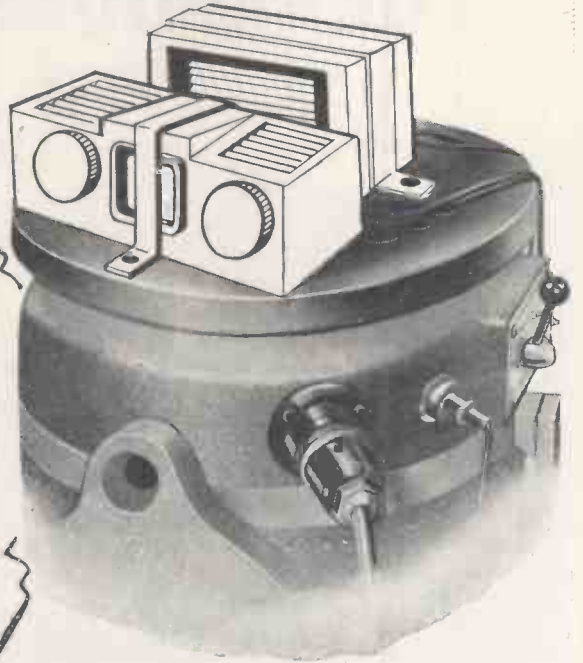

at

75 c/s

Pronounced vibration mode in main chassis, bending of base and movement of components.

150 c/s

Spurious noises from loudspeaker, microphony in amplifier, and instability in output components.

220 c/s

Tuner cover in resonance, setting up audio radiations.

310 c/s

Phase-splitter Valve and Screening Can vibrating, causing peaking at this frequency with consequent audio distortion.

375 c/s

Vibration mode evident, smaller "between-wiring" components and connecting leads flapping freely.

~10 c/s

Protecting cover of power pack in resonance, generating objectionable sound energy.

Now ANY PRODUCTION MODEL IS READY FOR THE WORST THAT THE ROAD CAN OFFER

Thanks to VIBRATION INVESTIGATION

with

**GOODMANS**

Vibration Generators

*If you have a vibration problem, whether it is fatigue testing, torsional vibration testing, flexure testing or structural investigation—consult Goodmans first—you may save many, many pounds on research and production costs. The Goodmans range of Vibrators extends from a model developing ± 300 lb. to a midget with a force output of approximately ± 2lb.*

Full details on request to Vibration Dept. W.

GOODMANS INDUSTRIES LTD., AXIOM WORKS, WEMBLEY, MIDD.

Telephone: WEMbley 1200 (8 lines)

# And NOW—a range of 'CERAMICAPS' for your

## LAB Storage Unit!



The LAB Continuous Storage Unit is widely acknowledged as the most efficient and convenient method of storing and selecting resistors. Now its usefulness is still further extended with the introduction of LAB pak'd 'Ceramicaps'.

With the LAB Unit, research and experimental laboratories and small production groups have to hand immediately, a complete range of resistors and 'Ceramicaps', easily selected with card index simplicity from some 700 sorted and carded components. Empty cards are merely replaced with full ones from stock.

The LAB unit is supplied FREE with initial purchase to your specification. Standard assortments available. Each LAB Unit can be used to store one type of component exclusively, or quantities of the complete range of resistors and 'Ceramicaps'. Full details and illustrated list will be sent on application.

## THE LAB CONTINUOUS STORAGE UNIT

| RESISTORS                         |        |                          |            |                       |             |
|-----------------------------------|--------|--------------------------|------------|-----------------------|-------------|
| Ref.                              | Type   | Loading                  | Max. Volts | Range                 | Dimensions  |
| T                                 | ½ watt | ½ watt                   | 250        | 10 ohms to 10 megohms | ¾" x ½"     |
| R                                 | ½ watt | 1 watt                   | 500        | 10 ohms to 10 megohms | ¾" x ¾"     |
| Tolerance available ±20%, 10%, 5% |        |                          |            |                       |             |
| HIGH STABILITY RESISTORS          |        |                          |            |                       |             |
| HS3                               | ½ watt | ½ watt                   | 750        | 1 ohm to 500 megohms  | 1.1" x 0.1" |
| Tolerance available ±5%, 2%, 1%   |        |                          |            |                       |             |
| WIREWOUND RESISTORS               |        |                          |            |                       |             |
| 5 ohms to 100K ohms — 5-10 watts  |        |                          |            |                       |             |
| 'CERAMICAPS'                      |        |                          |            |                       |             |
| Tubulars 3 - 470 pf               |        | Tolerances ±2%, 10% Hi-K |            |                       |             |

The Lab Continuous Storage Units are available from your normal source of supply, but more detailed information can be obtained from

- ★ Continuous Storage for Resistors and 'Ceramicaps'
- ★ Values separately carded
- ★ Finger-tip Selection

**THE RADIO RESISTOR COMPANY LTD**  
50, ABBEY GARDENS · LONDON · N.W.8 · Telephone: Maida Vale 5522

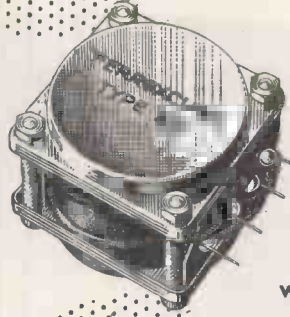

## High Q inductance coils

wound on Ferroxcube cores

DESIGNERS of compact and efficient tuned circuits and wave filters are making ever-increasing use of Mullard high Q inductance coils.

Based on Ferroxcube, the world's most advanced magnetic core material, these coils combine small size with an inductance of up to 30 henries over a wide frequency range. Furthermore, their convenient shape and self screening properties facilitate either individual mounting or stacking.

Full details of these and other high grade components now available from Mullard will be gladly supplied on request.

### TYPICAL Q VALUES

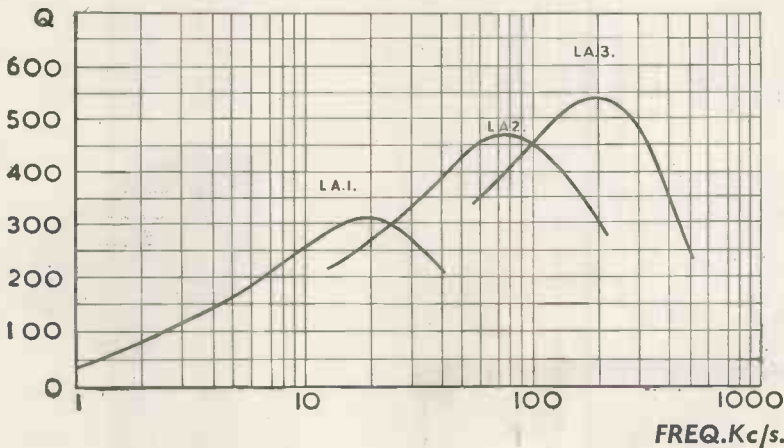

### Special Features

- Small size
- Low hysteresis loss factor
- High value of inductance
- Low self capacitance
- Controllable air gap facilitating inductance adjustment
- Self screening
- Controlled temperature coefficient
- Operation over a wide frequency range
- Easily mounted

# Mullard



'Ticonal' permanent magnets,  
'Magnadur' ceramic magnets,  
Ferroxcube magnetic cores.



**RECMF  
EXHIBITION  
STAND  
NO: 28**

Pre-recorded tapes can now be replayed  
on the proved

**TRUVOX**

**TAPE DECK NEW MODEL MK. III/TR2U**  
Incorporates BSS sense of tracking.

Price Still Remains at  
**22 GNS.**



Manufactured in Gt. Britain by

**TRUVOX LTD**

Sales Office: 15 Lyon Road, Harrow, Middx. (Harrow 9282)

Tech & Service Depts.: 328 The Broadway, Station Rd., Harrow, Middx.  
(Harrow 4455)



The popular TRUVOX  
Radio Jacks can now be  
used with Grundig and  
other Continental Tape  
Recorders for listening to  
and recording Broadcast  
Programmes.

Model TA7 (with Con-  
tinental Plug).

Model TA3 (BSS Model)  
£2/10/- + 18/4 P.T.



The Light Programme can  
now be received and re-  
corded with the new SENIOR  
RADIO JACK which adds  
the 1500 m. wavelength to  
the two Medium Wave  
stations.  
Model TA.8 (BSS Plug).  
Model TA.9 (Metric Plug),  
for Grundig or Continental  
Recorders.

£3/9/6 + £1/5/5 P.T.

# AND A FOURTH ONE



The new Truvox Corner Diffuson Speaker for Hi-Fidelity reproduction, particularly of the pre-recorded tapes played back on Tape Recorders. Increases the pleasure of listening, at the same time a beautiful addition to any home.

12 watts, 10,000 lines, 5 or 15 ohms.  
Cabinet only (Patts. Apd. for) £26 8 6  
Special Speaker to match £3 0 0  
Purchase Tax on Speaker £1 0 6

Manufactured in Gt. Britain by  
**TRUVOX LTD**  
Sales Office: 15 Lyon Road,  
Harrow, Middx.  
(Harrow 9282.)



## ANNOUNCING THE 'SECUNDUS' FOR SUB MINIATURE WORK

by  
**ADCOLA**  
PRODUCTS LIMITED  
(Regd. Trade Mark)

$\frac{1}{8}$ "  
BIT

Illustrated  
List No. 70  
(Actual Size)

### SPECIAL FEATURES

1. Traditional British quality.
2. Designed temperatures.
3. Weight 2 oz. (excluding flex)
4. Length 8 in.
5. 18 watts.
6. Practical temperature for high class solder jointing.

Supplied in all  
voltage ranges

Models  
to  
cover all fields  
of the  
Radio, TV. and  
Electronic Industry.

For all Soldering  
Instruments  
and  
Allied equipment,

WRITE TO:—

**ADCOLA**  
PRODUCTS LIMITED  
(Regd. Trade Mark)

Head Office and Sales

**GAUDEN RD.  
CLAPHAM HIGH ST.  
LONDON S.W.4** Telephone  
MACAULAY 4272



# REAL HIGH FIDELITY at modest cost . . .

•Manufacturer-to-Consumer policy saves you at least one-third cost!

We are now specialising in the supply of units for making up high-fidelity Radio and Record-reproducing Equipments for use in the Home, small Halls, Schools and Gramophone Societies and single items for replacing in existing equipments and radiograms. Our Chief Engineer, who is operating a Technical

Guidance Service, is available daily, including Saturdays, from 10 a.m. to 6 p.m., or will deal with enquiries by return of post. Our new Illustrated Catalogue and Supplement will be a great boon to those desiring high quality equipment for modest expenditure. Send two 2½d. stamps for your copy now. It may well save you pounds.

Treble Baffle Optional Extra

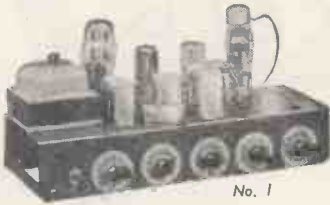

No. 1

**No. 1 "SYMPHONY" AMPLIFIER** is a 3-channel 5-watt Gram/Radio Amplifier with astonishingly flexible tone control. You can lift the treble, the bass, or—and here is the unique feature—the middle frequencies to suit your own ear characteristics and the record or radio programme being heard. It is thus possible to arrange the frequency-response of the amplifier to a curve equal and opposite to the resultant curve of the other items in the chain so that what finally registers in the brain is as per original. This flexibility of control is far more important than mere nominal linear response of the amplifier, as the pick-up, speaker, etc., are not linear. Independent Scratch-Cut is also fitted and special negative-feedback circuit employed. The Amplifier can accommodate a wide variety of records from old 78's to new L.P.'s. Input is for all types of pick-up of 0.1 v. output or more and there is full provision (and power) for Radio Tuner. It is available to match 2/3 or 15 ohms speakers. Price: 10 gns. (carriage 5/-). Fitted in portable Steel Cabinet, 35/- extra.

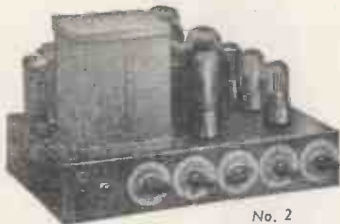

No. 2

**No. 2 "SYMPHONY" AMPLIFIER** as No. 1 but with 10-watt Push-pull triode output and triodes throughout. Woden mains and output transformers and choke. Full provision and power for Tuner. Output tapped 3, 7.5 and 15 ohms. Competes with the most expensive amplifiers on the market yet costs only 15 gns. (carriage 5/-). Fitted in portable Steel Cabinet 2 gns. extra.



**"SYMPHONY" AMPLIFIERS with REMOTE CONTROL.** Both the above model Amplifiers are available with all controls on a separate Control Panel with up to 4 feet flexible cable which simply plugs into the amplifier. Enables the Amplifier proper to be sat in the bottom of a cabinet whilst the controls are mounted conveniently higher up. Extra cost 2 gns.

**"STUDIO SYMPHONY" AMPLIFIERS, Models 1 and 2,** new models specially designed to get the maximum out of the revolutionary new Collaro Studio pick-ups and heads type "P" or Transcription. Specification as per our Standard Symphony models but with high-gain, low-noise, built-in Pre-amplifier stage with separate switched correctors for Std. and L.P. Third position on switch provides input matching for Acos and similar output pick-ups. These remarkable new models thus provide all the facilities and matching of our Standard Symphony Amplifiers PLUS the specialised Collaro matchings. Send for copy of "The Gramophone" review of these instruments. Price: No. 1, 12 gns; No. 2, 17 gns. Carriage 5/-.

**CURRENT GARRARD PRODUCTS AVAILABLE FOR IMMEDIATE DELIVERY FROM STOCK AT PRESENT.**

**MODEL TA** 3-speed unit, but with plug-in turnover head Type G.C.2, £10/16/-, or with Acos HGP 33 or 37 heads, £10/14/-, or with two separate high fidelity Acos HGP35 heads, £12/17/- . Unit less heads, £8/11/- . post 2/6. Heads, 42/3 each, post 1/-.

**MODEL TB** as above, but with long pickup arm. Less heads, £8/11/-, post 2/6.

Heads to fit this unit: Decca XMS, 5/6, Decca Crystal, 33/-, Garrard Standard Magnetic, 28/-, miniature magnetic low impedance, 28/-, miniature magnetic high impedance, 38/- . Post on heads 1/- . Unit can be supplied with any combination of above heads and is carefully adjusted for stylus pressure on despatch.

**MODEL RC80M**, less heads, £15/5/-, with new turnover head, £17/9/6, with two separate Acos HGP35 heads, £19/9/-, carriage 5/-.

**COLLARO PICKUPS AND HEADS.** Studio Pickup Arm, 13/10. Studio Pickup head type "O" or "P," £3/0/9. Pickup complete £3/14/7. Studio Transcription Pickup Arm with Studio "P" head, £4/15/9. Ditto with Transcription head, £5/2/5.

**TRANSCRIPTION MOTORS IN STOCK.**

**NEW CONNOISSEUR** variable speed on all 3 speeds £25/15/5.

**GARRARD Model 301** £25/3/6.

Cabinets available to house either of the above motors together with pick-up, price £3/7/6. Carriage 5/-.

## SNIP NO. 1

**GARRARD LATEST MODEL RC80M AUTO-CHANGER.** Fitted with full-length Pick-up Arm to take 3-pin plug-in heads, manufactured end of Oct. 1954. PRICE LESS HEADS, £15/5/-, carriage paid. These extraordinarily versatile units can be supplied fitted with the following combinations of Pickup Heads at the following prices:

With two Decca XMS ferr Magnetic Heads, £20/15/-.

With two Decca Crystal Heads, £18/10/-.

With Decca Crystal for L.P. and Garrard Miniature Mag. for Std. Takes miniature fibre or steel needles. £18/13/-.

With adaptor and two Acos HGP39-1 Heads, £20/5/-.

With adaptor and one Acos HGP39-1 Head for L.P. and Garrard Miniature Mag. High Impedance for Std. Takes miniature fibre or steel needles. £19/17/-.

The above combinations of heads are matched for output and the stylus pressure is carefully adjusted before despatch. Carriage paid.

Above mounted in Portable Cabinet 90/- extra IMMEDIATE DELIVERY from STOCK *Guaranteed*.

## SNIP NO. 2

Very latest Model "MONARCH" 3 speed **AUTO-CHANGER** fitted with latest ACOS HGP37 turnover Pickup Head for Std. and L.P. Plays 12in., 10in., and 7in. records mixed in any order. Capacity 10 records. Operates on 100/125 and 200/250 v. A.C. 50 c/s. Unit plate measures 12½in. x 10½in. Height above plate required 5½in.; depth below required 2½in. PRICE COMPLETE £13/10/- . Carriage 5/- . IMMEDIATE DELIVERY. Leaflet 2½d. Above mounted in Portable Cabinet, 16 gns., plus carriage 7/6.

## "SYMPHONY" BASS REFLEX CABINET KITS.

30in. high, consist of fully-cut ¾in. thick, heavy, inert, non-resonant patent acoustic board, deflector plate, felt, all screws, etc., and full instructions. 8in. speaker model, 85/-; 10in. speaker model, 97/6; 12in. speaker model, £5/7/6. The design is the final result of extensive research in our own laboratory and is your safeguard of optimum acoustic results. Carriage 7/6. Ready built, 10/6 extra.

## HIRE PURCHASE FACILITIES

NOW AVAILABLE on orders of £15 or over.

Send one-third deposit with order, balance over 6 or 12 monthly instalments. State which required.

## NORTHERN RADIO SERVICES

11, KINGS COLLEGE RD., ADELAIDE RD.

LONDON, N.W.3. Phone: PRImrose 8314

Tubes: Swiss Cottage and Chalk Farm.

Buses: 2, 13, 31, 113, 187.



**"SYMPHONY" BASS REFLEX CABINETS**, fully finished in figured walnut, oak or mahogany to match our Console Amplifier Cabinet, enabling the housing of a whole equipment in a two piece suite; cost: 10in. speaker model, £11/10/-; 10in., £11; 8in., £10/10/- . Carriage according to area. The 10in. model is ideal for the WB HF 1012 (see "The Gramophone" review March).



**CONSOLE AMPLIFIER CABINETS** (above), 33in. high, lift-up lid with piano hinge, take Tape Deck, Gram Unit or Auto-changer, Amplifier, Pre-Amplifier, and Radio Feeder Unit, finished medium walnut veneer. De Luxe version, price 10 gns. Oak or Mahogany veneers 10/- extra. Special finishes to order. Carriage according to area, we will quote.

# Northern Radio Services (CONTD.)

## "SYMPHONY" RADIO FEEDER UNITS



**NO. 1 "SYMPHONY" TUNER.** A T.R.F. model designed for the quality reception of local stations. Quality is adequate for amplifiers of the highest fidelity class. Infinite impedance detection. Controls: gain, wave-change and radio/gram switch. Illuminated engraved glass dial. Latest miniature valves. Overall dimensions: 9in. wide x 6in. deep x 6in. high. Power required: 6.3 v. at 1 amp. and 250/500 v. at 16 m/a. Price £7-7-0. Carr. & pkg. 5/-.

**NO. 2 "SYMPHONY" SUPERHET TUNER.** Three wave-bands, advanced circuit, very newest valve types, floodlit glass dial with bronze escutcheon provided. Suitable for use with the best amplifiers. Overall dimensions: 12in. wide x 8 1/2in. high x 7in. deep. Controls: on/off/gain, radio/gram, wave-change and tuning. Dial cut-out: 8in. x 4 1/2in. reading horizontally or vertically (state which required). Tuner can be readily mounted at any angle. Requires 6.3 v. at 1.5 amp. and 250/300 v. at 20 m/a. Price £11-11-0. Carr. & pkg. 5/-.

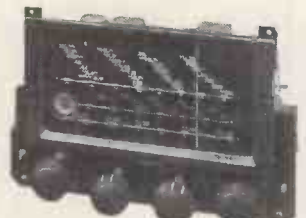

**NO. 2VS "SYMPHONY" SUPERHET TUNER.** As No. 2 but incorporating on the wave-change switch an extra position for radio, thus making two radio positions. One is the standard one with 9 kc. separation and the extra one providing virtually T.R.F. band-width and quality on local stations. Price £13-13-0. Carr. & pkg. 5/-.

All above tuners are made to plug in to any of our "Symphony" Amplifiers in a matter of seconds by means of the octal plug fitted at the end of a flexible multi-cable. They are ideal for providing in conjunction with our "Symphony" Amplifiers, the same high quality on radio as is obtained from these amplifiers on gramophone, but they are equally suitable for use with other high fidelity amplifiers. And where the output circuit requires modification to match a given amplifier this can be carried out free of charge. Either of the two Superhet models can be fitted with a magic eye tuning indicator for £2-2-0 extra. Furthermore, they can be fitted with a pre-amplifying stage to match the Decca Magnetic Pickups or the Collaro Studio type "P" pickup head for use with amplifiers which would not otherwise have enough gain for these comparatively low output pickup heads. In these cases, two separate correction circuits—one for standard and one for LP as recommended by the pickup manufacturers—are incorporated in the radio/gram switch. Please send for our catalogue giving further details.

## TAPE DECKS AND AMPLIFIERS

**TRUVOX TAPE DECK MARK III.** TR2/U. Latest version to take pre-recorded tapes. Price 22 gns. Illustrated leaflet 2 1/2d.  
**TAPE AMPLIFIER TYPE C,** expressly designed by Truvox to work perfectly with their Deck, 3 valves plus rectifier and Magic Eye level indicator. Price 16 gns.

## NEW MODEL PORTABLE RECORD PLAYERS

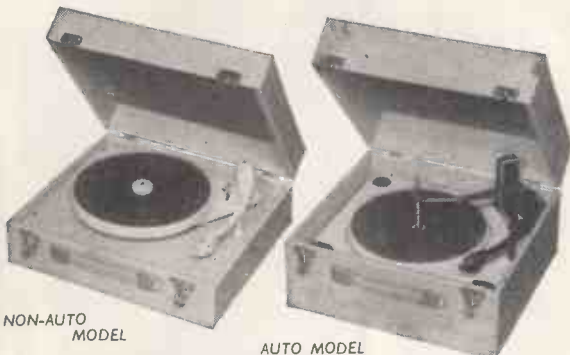

We are pleased to announce the entry on to the market of two "Symphony" Record Players designed to represent the greatest value in this line ever offered. Model No. 1 contains the Collaro 3-speed single record playing unit AC3/554 and model No. 2 contains the Collaro Autochanger RC54. They are available with either Type "O" insert, "P" insert or transcription insert. Prices (in attractive rexine case), No. 1 £10-19-6, No. 2 £14-19-6. Carr. 7/6. Transcription insert 6/9 extra. Fully illustrated leaflets on the units 2 1/2d.

**GOODMANS CORNER CABINETS** (right) for the AXIOM 150 Mark 2 manufactured by us to Messrs. Goodmans' specification and approved by Messrs. Goodmans. Height, 44in. Price: complete kit in plain board with lin. thick felt, 8 gns. Price: ready built, 10 gns. Finished in figured walnut, 16 gns. Other veneers to order. Carriage extra according to area.



# BE SURE OF SUCCESS IN RECEIVING F.M. PROGRAMMES BY BUILDING THE "MAXI-Q" F.M. FEEDER UNIT.

Full constructional details, Point to Point wiring diagram and alignment instructions are given in our Technical Bulletin DTB.8, price 1/6. The guaranteed components described below have been acclaimed by thousands as the finest obtainable.

**F.M. SCALE AND POINTER MECHANISM SHORTLY AVAILABLE.** Price 9/-  
**RATIO DISCRIMINATOR TRANSFORMER 10.7 Mc/s. Ref. RDT.1.**

A 10.7 mc/s. transformer for use in ratio discriminator type circuits. Can size 1 1/2in. square x 2 1/2in. high. Secondary winding of bifilar construction. Iron dust core tuning, polystyrene former and silver mica condensers. Price 12/6 each.

**PHASE DISCRIMINATOR TRANSFORMER 10.7 mc/s. Ref. PDT.1.**

A miniature 10.7 mc/s. transformer for use in frequency modulation detector circuits where the limiter/Foster-Seeley type of circuit is employed. Designed for carrier deviation of ±75 kc/s. Qk = 1.5. Wound on black Bakelite former, complete with iron dust slugs and two 6 B.A. threaded fixing holes on .532in. centres. Screening can 1 1/2in. x 1 3/16in. square. Price 9/- each.

**I.F. TRANSFORMER IFT.11/10.7.**  
 A miniature I.F. Transformer of nominal frequency 10.7 Mc/s. The transformer is primarily intended for the I.F. stages of frequency modulation receivers and converters. The Q of each winding is 90 and the coupling critical. Construction and dimensions as PDT.1. Price 6/- each.

**I.F. TRANSFORMER IFT.11/10.7/L.**  
 As IFT.11/10.7 but with secondary tap for limiter input circuits. Price 6/- each.

**GENERAL CATALOGUE** covering technical information on full range of components, 1/- post free. Obtainable from all reputable stockists or in case of difficulty direct from works.

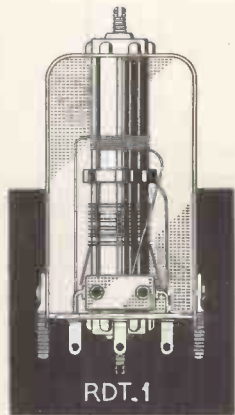
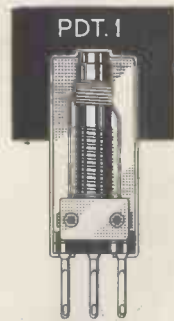

## DENCO (CLACTON) LTD. 357/9 Old Road, Clacton-on-Sea, Essex

**STOP PRESS:** "Osram" "912" and "Mullard" "5-10" Amplifier Chassis and Bronze finished Front Panel. Price 21/- each. The "Practical Wireless" "Fury Four" uses the "Max-Q" Yellow (3/11) and Green Chassis Mounting Coils (4/9) (please state frequency range when ordering). Also available are the "Fury Four" Chassis and Paxolin Front Panel, 19/6. Long and Medium Wave T.R.F. Coils wound on Polystyrene Formers, 9/- per pair.



*A family of famous microphones*  
made by **Ronette**

RONETTE Microphones, world-famous for quality, uniformity and finish, are manufactured in a variety of models.

Experience, precision and skilled workmanship stand behind each RONETTE Microphone.

For technical details, catalogues etc. please contact:

*Sole distributors for Gt. Britain*

**TRIANON ELECTRIC Ltd. LONDON NW10**

95, Cobbold Rd., Willesden

Telephone Willesden 2116



## NEW ARCOLECTRIC SIGNAL LAMPS

### For Low Voltage or Mains

Illustrated are a few signal lamps taken from our wide range. The insulation of every Arcoelectric signal lamp will resist a flash test of 1,500 volts A.C.

The S.L.90 illustrated here is a typical Arcoelectric low voltage signal lampholder. It is designed to accept popular M.E.S. bulbs. The bulb is accessible from front or rear of panel. The domed plastic lens surrounded by a polished chrome bezel gives a most attractive panel appearance. This holder can be fixed in a single  $\frac{3}{4}$ " hole.

The mains voltage signal lamp S.L.88/N is supplied complete with an M.E.S. neon tube and a suitable series resistance.

Write for Catalogue No. 128

**ARCOLECTRIC**  
SWITCHES LTD



S.L.88/N

S.L.90

S.L.86

S.L.82

S.L.92

CENTRAL AVENUE, WEST MOLESEY, SURREY. TELEPHONE: MOLESEY 4336 (3 LINES)





# Component Bridge

THE WAYNE KERR MODEL B.121

A MODERATELY PRICED self-contained instrument, capable of a wide range of accurate measurements.

In addition to giving direct readings of resistance, capacitance, and inductance, it will measure the impedance between any pair of terminals in a three-terminal network, and it can also be used for in situ measurements of component values.

Two individually calibrated dials give simultaneous readings of parallel combinations of resistive and reactive components, with independent scale multiplying of R and C values. The mains supply constitutes the source, and a selective amplifier with sensitive "magic eye" is used for null indication.

## Specification

**RESISTANCE RANGE:** 3 ohms to 1,000 megohms, using six ranges and 3 multipliers of 0.1, 1 and 10.

**CAPACITANCE RANGE:** 1.0 pF to 1,000  $\mu$ F, using six ranges and 3 multipliers of 0.1, 1 and 10.

**INDUCTANCE RANGE:** 100 mH to 10,000 H in five ranges.

**ACCURACY:** 2% on all ranges over the major part of the scale. If higher accuracy is required, the instrument can be supplied hand-calibrated.

**POWER SUPPLY:** 110/115 V. or 200/250 V. at 50 c/s — 10 W. approx.

**DIMENSIONS:** 17 $\frac{1}{2}$ "  $\times$  10 $\frac{1}{2}$ "  $\times$  10" high.

**WEIGHT:** 15 lb. approximately. **PRICE** £60 NETT Immediate Delivery





# Home Constructors

## MAKE A SOUND JOB OF IT WITH . . . HUNTS CAPACITORS



### APPROVED CAPACITOR KIT FOR THE OSRAM 912 HI-FI Amplifier

| Ref. | Capacitance     | Volts D.C. Wkg. | List No. | List Price s. d.  |
|------|-----------------|-----------------|----------|-------------------|
| C 1  | 0.005 $\mu$ F   | 1000            | B 402    | 2 0               |
| C 2  | 25 $\mu$ F      | 25              | JD 52T   | 2 6               |
| C 3  | 0.1 $\mu$ F     | 350             | B 406    | 2 3               |
| C 4  | 0.05 $\mu$ F    | 500             | B 405    | 2 3               |
| C 5  | 8 + 16 $\mu$ F  | 450             | JE 561   | 7 6               |
| C 6  | 470pF $\pm$ 5%  | 350             | L 433    | 1 6               |
| C 7  | 1000pF $\pm$ 5% | 350             | L 435    | 1 9               |
| C 8  | 2000pF $\pm$ 5% | 350             | L 435    | 2 4 $\frac{1}{2}$ |
| C 9  | 0.02 $\mu$ F    | 750             | B 404    | 2 1 $\frac{1}{2}$ |
| C 10 | 22pF $\pm$ 5%   | 350             | L 430    | 1 6               |
| C 11 | 220pF $\pm$ 5%  | 350             | L 433    | 1 6               |
| C 12 | 470pF $\pm$ 5%  | 350             | L 433    | 1 6               |
| C 13 | 25 $\mu$ F      | 25              | JD 52T   | 2 6               |
| C 14 | 0.1 $\mu$ F     | 150             | B 500    | 2 0               |
| C 15 | 2 $\mu$ F       | 150             | B 504    | 5 6               |
| C 16 | 0.01 $\mu$ F    | 350             | B 810    | 1 6               |
| C 17 | 0.05 $\mu$ F    | 500             | B 405    | 2 3               |
| C 18 | 0.05 $\mu$ F    | 500             | B 405    | 2 3               |
| C 19 | 50 $\mu$ F      | 25              | JD 53T   | 2 9               |
| C 20 | 50 $\mu$ F      | 25              | JD 53T   | 2 9               |
| C 21 | 0.001 $\mu$ F   | 600             | B 847    | 1 3               |
| C 22 | 0.001 $\mu$ F   | 600             | B 847    | 1 3               |
| C 23 | 8 + 16 $\mu$ F  | 450             | JE 561   | 7 6               |

2 Horizontal Mounting clips H I

Special price for complete kit

**£2.15.0**

### APPROVED CAPACITOR KIT FOR THE MULLARD 5 VALVE 10 watt circuit

| Ref.   | Capacitance      | Volts D.C. Wkg. | List No. | List Price s. d.  |
|--------|------------------|-----------------|----------|-------------------|
| C1/2   | 50 + 50 $\mu$ F  | 350             | KB 418   | 12 6              |
| C 3    | 8 $\mu$ F        | 450             | JF 553TS | 3 6               |
| C 4    | 8 $\mu$ F        | 450             | JF 553TS | 3 6               |
| C 5    | 100 $\mu$ F      | 12              | JF 28T   | 3 9               |
| C 6    | 0.02 $\mu$ F     | 600             | A 61     | 1 1 $\frac{1}{2}$ |
| C 7    | 0.1 $\mu$ F      | 600             | A 65     | 1 6               |
| C 8    | 0.1 $\mu$ F      | 600             | A 65     | 1 6               |
| C 9    | 0.1 $\mu$ F      | 600             | A 65     | 1 6               |
| C 10   | 100 $\mu$ F      | 25              | JF 54T   | 3 9               |
| C 11   | 100 $\mu$ F      | 25              | JF 54T   | 3 9               |
| * C 12 | 180pF $\pm$ 5%   | 350             | L 431    | 1 6               |
| C 13   | 0.001 $\mu$ F    | 600             | B 822    | 1 3               |
| C 14   | 33pF $\pm$ 10%   | 350             | L 430    | 1 4 $\frac{1}{2}$ |
| C 15   | 680pF $\pm$ 10%  | 350             | L 435    | 1 7 $\frac{1}{2}$ |
| C 16   | 270pF $\pm$ 10%  | 350             | L 433    | 1 4 $\frac{1}{2}$ |
| C 17   | 3300pF $\pm$ 10% | 350             | L 435    | 3 6               |

Mounting clip for C 1/2

Special price for complete kit

**£2. 5. 0**

\* The capacitance at this stage is determined by the impedance of the Loud Speaker.

3.75 ohms requires 180pF  $\pm$  5%  
 7 ohms requires 120pF  $\pm$  5%  
 15 ohms requires 82pF  $\pm$  5% } 1/6 each

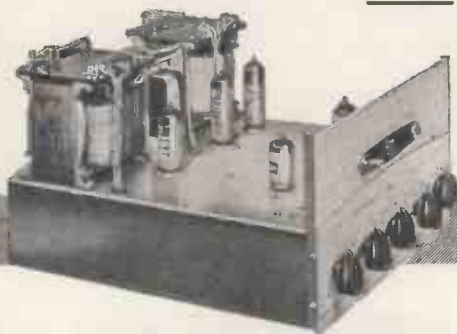

**A. H. HUNT (Capacitors) LTD.**  
**WANDSWORTH, LONDON, S.W.18**

Telephone: **BAT**tersea 1083/7

And in Canada: **HUNT CAPACITORS (Canada) LTD. AJAX ONTARIO**



**NEW!**

# EXPERIMENTAL KITS in Radio, T.V. etc.

## LEARN THE PRACTICAL WAY

Specially prepared sets of radio parts with which we teach you, in your own home, the working of fundamental electronic circuits and bring you easily to the point when you can construct and service radio sets. Whether you are a student for an examination; starting a new hobby; intent upon a career in industry; or running your own business—these Practical Courses are intended for YOU—and may be yours at very moderate cost.

### EASY TERMS FROM 15/- A MONTH

With these outfits, which you receive upon enrolment, you are instructed how to build basic Electronic Circuits (Amplifiers, Oscillators, Power Units, etc.) leading to complete Radio and Television Receiver Testing and Servicing.



### 1 BEGINNER'S RADIO OUTFITS

— For carrying out basic practical work in Radio and Electronics, from first principles and leading to the design and building of simple Receivers.

**ALL EQUIPMENT SUPPLIED  
IMMEDIATELY AND REMAINS  
YOUR PROPERTY**

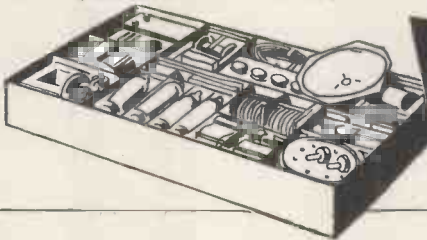

### 2

### ADVANCED RADIO OUTFITS

— With this equipment, you are instructed in the design, construction, testing and servicing of complete modern TRS. Superhet Radio Receivers.

**TELEVISION** Outfit No. 3 —  
With this equipment you are instructed in the design, construction, servicing and testing of a modern high-quality 15" Television Receiver.

### 3

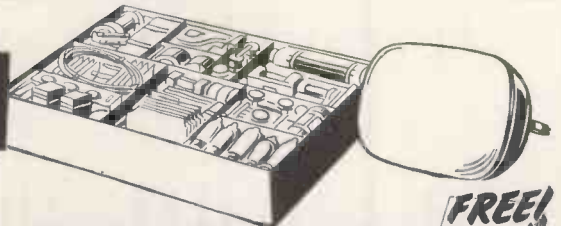

**OTHER COURSES WITH EQUIPMENT INCLUDE:**

**MECHANICS • ELECTRICITY  
CHEMISTRY • PHOTOGRAPHY  
CARPENTRY**

**ALSO DRAUGHTSMANSHIP • COMMERCIAL ART  
AMATEUR S.W. RADIO • LANGUAGES • ETC.**

**POST THIS COUPON TODAY**

Please send me your FREE book on Practical Courses.

Subjects of interest.....

To: E.M.I. INSTITUTES, Dept. 127x, Grove Park Road, London, W.4.

NAME .....

ADDRESS .....



**E.M.I. INSTITUTES** The only Postal College which is part of a world-wide Industrial Organisation

There's a  
big future in  
printed circuits  
and dip-soldering—  
consult **ENTHOVEN**  
who can provide  
everything necessary  
to ensure perfect results

ENTHOVEN SOLDERS LIMITED

Enthoven House, 89 Upper Thames Street

London, E.C.4

MANsion House 4533

*New* **MARCONI**  
**Vacuum Tube**  
**Voltmeter**



**TYPE TF 1041**  
**FREQUENCY RANGE**  
**20 c/s to 700 Mc/s**  
**AND D.C.**

This together with other new designs for 1955, may be inspected on stand no. 103, 19th to 21st April, at the R.M.C.M.F. Exhibition and on stand no. 89, 25th to 28th, April, at the Physical Society Exhibition.

# MARCONI INSTRUMENTS

SIGNAL GENERATORS • BRIDGES • VALVE VOLTMETERS • Q METERS • WAVEMETERS  
FREQUENCY STANDARDS • WAVE ANALYSERS • BEAT FREQUENCY OSCILLATORS

**MARCONI INSTRUMENTS LTD • ST. ALBANS • HERTS • Telephone: ST. ALBANS 6160/9**

30 Albion Street, Kingston-upon-Hull. Phone: Hull Central 16144. 19 The Parade, Leamington Spa. Phone: 1408

*Managing Agents in Export:*

**MARCONI'S WIRELESS TELEGRAPH CO. LTD • MARCONI HOUSE • STRAND • LONDON, W.C.2**

# GOODSELL



## T.W. 100 Tape Amplifier (below)

For use with Wearite "A" or "B" deck. Separate circuit for immediate playback when used with "B" deck. Meter monitoring facilities. With PFA pre-amplifier **£45** complete.



## Type PFA Pre-amplifiers (above)

The latest PFA unit is built especially for use with our range of Williamson Amplifiers. Separate bass and treble control in equaliser section. Low noise—high gain, 5 mv. input, 6 valves. Price **£20.**

★ Demonstrations of all these units at B.K. Partners Ltd., 229 Regent St., London, W.1, and Classic Electric Co, Ltd., Croydon.

## GOODSELL LTD.

40 Gardner Street · Brighton 1 · Sussex  
Tel. : Brighton 26735

## OMNI-DIRECTIONAL

# 3-Speaker System

W15/CS SUPER 8/CS SUPER 5

*Treble Units Facing Upwards Crossover Frequencies 800 and 5,000 c/s*

The bass speaker is the W15/CS with a fundamental resonance below 30 C/S; the middle speaker is the Super 8/CS; and the third speaker is the Super 5 with response well maintained to 16,000 C/S. The crossover unit is a ½ section type, with crossover frequencies of 800 and 5,000 C/S. A volume Control is now fitted to the middle and top speakers which also face upwards to avoid undue directional effects.

All seats for 21st May have been sold, but standing room tickets at 1s. 0d. each may be still available from Wharfedale Wireless Works.

Cash and S.A.E. with order.

# Wharfedale

WIRELESS WORKS LTD.

BRADFORD ROAD · IDLE · BRADFORD · YORKS

Phone: Idle 1235/6 (2 lines). Grams: Wharfedel, Idle, Bradford.



### PRICES (TAX FREE)

|                              |            |           |          |
|------------------------------|------------|-----------|----------|
| W15/CS sand-filled Enclosure | £47        | 0         | 0        |
| Treble Assembly .....        | £18        | 0         | 0        |
| HS/CR3 Crossover with V.C.'s | £8         | 10        | 0        |
|                              | <u>£73</u> | <u>10</u> | <u>0</u> |

2 Sand-filled Back Panels (40in. x 24in.) to complete the enclosure, where a suitable corner is not available, can be supplied at £12 per pair.

# Valves for Industry

## R.F. Heating

*The increasing use of R.F. Heating in industry has shown the need for units to provide outputs between 10 and 50 kW*

To meet this demand, the English Electric Valve have developed two new valves for R.F. generators and upwards. These new products are not modifications for communications, but are designed expressly for the less favourable conditions imposed by factory rugged and will withstand severe overloads; they first cost and have a long service life. Both types in air-cooled or water-cooled versions and a suitable valves for use in conjunction with them is also available.



Company of 10 kW of valves used operation under use. They are are low in are available range of rectifying



### Valves for Industry

is the title of a new publication giving full details of these valves, which is available on request.

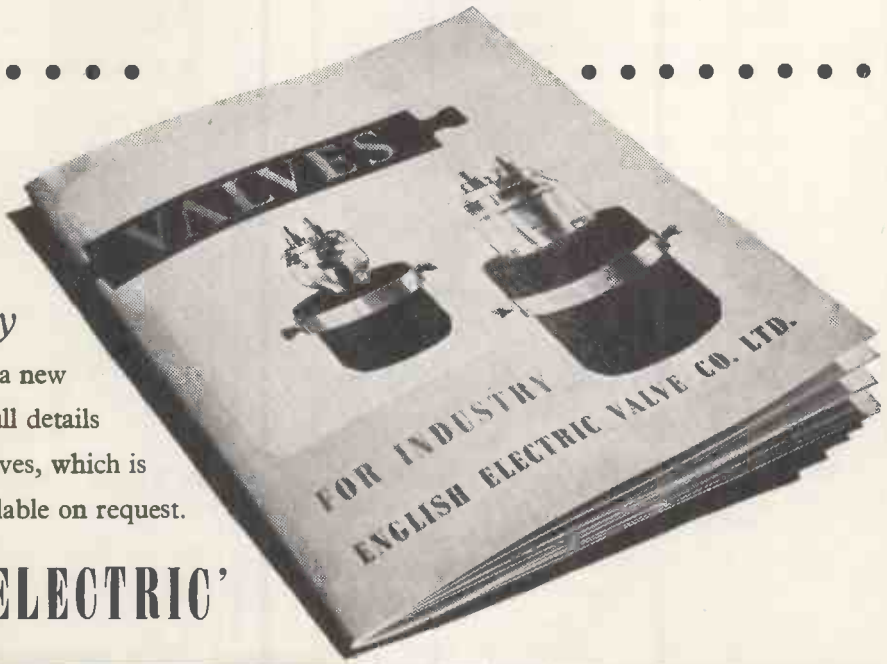

## 'ENGLISH ELECTRIC'

**ENGLISH ELECTRIC VALVE CO. LTD.** Waterhouse Lane, Chelmsford Telephone: Chelmsford 3491



## HARTLEY-TURNER SOUND EQUIPMENT

### THE HARTLEY 215 LOUDSPEAKER

The 215 Speaker is designed to cover the entire audio frequency range as a single unit. Employing a mechanical crossover and special coil assembly the response of the 215 extends from 20 c/s to 20 Kc/s.

The very free suspension enables the lower frequencies to be reproduced without distortion.

The power handling capacity is 10 Watts.

The 215 speaker when used in conjunction with the Hartley-Turner True Bass Baffle provides the best means of obtaining distortion free reproduction.

The prices are:—

Hartley-Turner 215 Loudspeaker at £14 10s plus £4 14s 3d purchase tax.

Hartley-Turner True Bass Baffle at £8.

*Illustrated literature sent free and post free on request to:—*

**H. A. HARTLEY CO. LTD.**  
**152, HAMMERSMITH ROAD,**  
**HAMMERSMITH, LONDON, W.6.**

Telephone: RIVerside 7387

*Special Note for Overseas Dealers:*

*If you require supplies of any items of Communication Equipment and are not already served, our Purchasing and Export Departments can help you. Let us know your requirements.*

for

## SELENIUM RECTIFIERS

consult



WHETHER the need is for a single unit or a supply running into thousands . . . if it's a Selenium Rectifier that must fulfil critical requirements and maintain its characteristics over long periods . . . the answer is to be found with Electrix.

- Electrix Rectifiers are characterized by their cool running and consistent long-life conformity to stated specification.
- Manufacturers, Traders and Electronic Engineers, send us your specific requirements.
- Your needs may possibly be met from "standard" types, or
- "To specification" models can be quickly prepared.
- Quotations by return . . . and deliveries a matter of days only.
- We welcome export enquiries.

Here are some typical "standard" full-wave types each

|                                     |            |      |
|-------------------------------------|------------|------|
| Output 12/15 Volts D.C. 1 Ampere.   | List Price | 9/-  |
| Output 12/15 Volts D.C. 2.5 Ampere. | ..         | 13/6 |
| Output 12/15 Volts D.C. 4 Ampere.   | ..         | 22/6 |
| Output 12/15 Volts D.C. 6 Ampere.   | ..         | 35/- |

New range H.T. Rectifiers ( $\frac{1}{2}$  Wave)

| Max. A.C. Input | Max. D.C. Current | List Price |
|-----------------|-------------------|------------|
| 125 Volts       | 80 mA             | 4/3        |
| 250 Volts       | 50 mA             | 8/-        |
| 250 Volts       | 300 mA            | 18/-       |

Trade Supplied

- We use only freshly manufactured selenium plates and components, no ex-W.D. materials whatsoever

**HOUSEHOLD ELECTRIX LTD**  
47-49 HIGH ST., KINGSTON-ON-THAMES

Telephone: KINGston 4585





## COSSOR Model 1322

Model 1322 — used in conjunction with a cathode ray oscillograph — provides equipment for the display, measurement and correct adjustment of RF and IF response curves of television receivers. This entirely new instrument comprises a swept oscillator covering the Television BANDS I and III (5-75 Mc/s. and 155-255 Mc/s.) and a frequency marker oscillator so that precise calibration of the oscillograph display may be made; accuracy of the frequency of the marker pips being verified by reference to an internal crystal. The

## Telecheck and Marker Generator for Bands I and III

alignment oscillator is set to the video carrier to which the receiver is tuned and the sweep (either 1 Mc/s. or 10 Mc/s.) is automatically derived from the time base voltage of the display oscillograph. The response of the "strip" under test to the frequency band applied is then presented on the screen of the cathode ray tube. The RF output of Model 1322 is available at 75 ohms and is adjustable from a maximum of 40 millivolts to a minimum of 10 microvolts through a coarse and fine attenuator.

## TELECHECK CONVERTER FOR BAND III

## Model 1321

This adaptor provides owners of Model 1320 "Telecheck" with an extension of the frequency range of the original instrument into the BAND III television channel. Thus, alignment procedures adopted for BAND I RF/IF "strips" are available also for BAND III receivers. A selection of the desired BAND is made by means of a switch. Pattern generator facilities for picture time base linearity checks have been retained. Model 1321 Adaptor is designed for permanent attachment to the standard "Telecheck" providing a neat, light and compact unit. Mounting is effected by four screws and the inter-connecting wiring is carried in a single insulating sleeve.

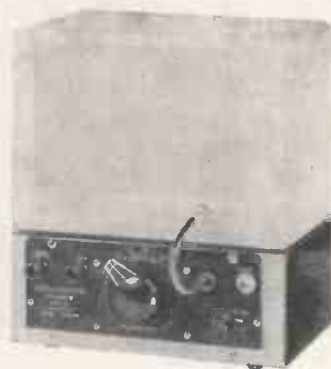

# COSSOR ELECTRONIC INSTRUMENTS

Write for illustrated leaflets about both these instruments :

COSSOR INSTRUMENTS LIMITED (Dept. 1) Highbury Grove · LONDON · N.5

Telephone: CANonbury 1234 (33 lines)

Telegram: Cossor, Norphone, London

Cables: Cossor, London

CL.60  
N.5



## GARDNERS RADIO

There are 399 Standard types  
of 'SOMERFORD' Transformers  
and Chokes IN STOCK . . . . .



GARDNERS RADIO LTD., SOMERFORD, CHRISTCHURCH, Hants. Tel. 1024

# NEW!

and NOW available . . .

## FERROVOICE PLASTIC TAPE

*Incorporating all the latest developments in tape production*

PRE-STRETCHED PVC  
BROWN OXIDE  
HIGH OUTPUT  
LOW BACKGROUND NOISE  
EASE OF ERASURE  
HIGH TENSILE STRENGTH  
NON-CURLING

The **QUALITY** tape at  
a competitive price . . .

**32/6 per 1200 ft reel**

On the well-known universal Ferrovoice Spool

600 ft 19/6

300 ft 12/6

The popular FERROVOICE PAPER TAPE is still available

### MAGNETIC COATINGS LIMITED

38 GROSVENOR GARDENS LONDON SW1 Telephone: SLOANE 9129

WORKS & LABORATORY: 25 DASHWOOD TRADING ESTATE  
LARCH ROAD · LONDON · SW12 BALHAM 5579

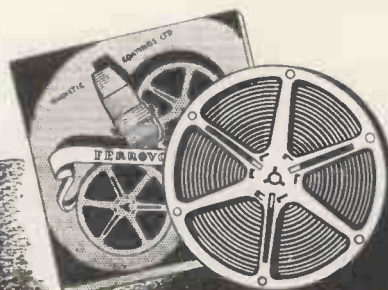

## The case for 'Castanet'...

The problems of obtaining satisfactory time constants and at the same time keeping component bulk down to a minimum are all too familiar. These polarised miniature electrolytic capacitors —CASTANET by name—go all the way in removing what has for a long time been a thorn in the side of designers. A mere 22 mm by 6 mm, with a capacity of 50 microfarads and a D.C. leakage of less than one microamp at 70V., CASTANET capacitors are capable of operating over a temperature range of—60° C. to + 150° C. After shelf storage, without volts, at 70° C. for several thousand hours, the capacity, power factor and D.C. leakage current values show no significant change.



## The place for 'Castanet'...

The determination of the place for CASTANET is simple. It is anywhere where space is at a premium and essential characteristics demand stability of performance coupled with low leakage current over a very wide temperature range. The units are normally provided with a 4 BA stud and anode tag. A silicone rubber grommet is available by means of which the units can be mounted on a chassis and connected in series or parallel, providing a range of working voltages and capacities. Time constants of the order of one hour can be obtained making the units ideal for very long period discharge circuitry, in addition to the more conventional applications.

**Plessey**

**'Castanet'**

REGD. TRADE MARK

# Tantalum Electrolytic Capacitors

Manufacturers are invited to write for Plessey Publication No. 659/1 which contains comprehensive details of the product.

'Castanet' Electrolytic Capacitors are produced by the Chemical & Metallurgical Division of The Plessey Co. Ltd., Wood Burcote Way, Towcester, Northants.



where  
small size  
and  
performance  
count



**VENNER**  
**ACCUMULATORS**

The Venner Lightweight Silver-Zinc Accumulator is ideal in every application where minimum size and weight are essential. It is particularly suitable for radio and "walkie-talkie" equipment.

Write for full particulars and catalogue *WV*.

**VENNER ACCUMULATORS LTD.,**  
KINGSTON-BY-PASS, NEW MALDEN, SURREY.

Phone: MALden 2442.

Associated Companies Venner Limited — Venner Electronics Ltd.

# WHY ENGINEERS SPECIFY EGEN potentiometers —

Egen Potentiometers are based on long experience of requirements of television and electronic equipment manufacturers. In design, dependability, accuracy and freedom from wear they are *outstanding*, but, above all, they are completely **NOISELESS**.



**DUAL POTENTIOMETERS** with concentric operating spindles. The new Egen Dual Potentiometers incorporate all these outstanding design features — multiple contact rotors, smooth easy movement, thorough screening between sections, plus a convenient soldering tag for earthing screened connections on each metal case. Switch and Potentiometer soldering tags are of high-grade brass heavily silver plated for easy soldering; they are positively located and withstand soldering heat and bending without loss of rigidity. Control spindles can be supplied to suit customers' requirements.

**PRE-SET POTENTIOMETERS.** Completely enclosed in high-grade phenolic mouldings. Solder tags heavily silver plated for quick soldering. Fully insulated spindles with integral control knobs. Tapped for 2-hole 6 B.A. fixing on  $\frac{1}{4}$ " centres. Type 126, wire-wound. Type 127, carbon.



**STANDARD CARBON POTENTIOMETERS.** Made by an entirely new method ensuring a highly stable resistance element, which is also very durable. Silent and smooth in operation, these controls offer both mechanical and electrical reliability. Soldering tags are heavily silver plated to resist oxidation, and the mains switch has an efficient quick make-and-break action.



**PRE-SET RESISTOR.** This has a wire-wound resistance element, traversed by a nickel-silver slider. Adjustment is effected by a worm drive spindle fitted with a knurled and slotted knob. This component is smooth and noiseless in action and is designed to meet the many and varied requirements of the Electronic Industry. Egen pre-set resistors can be supplied in multi-bank assemblies to suit individual requirements. There are also twin-track models, and types with an electrically divided slider, giving adjustment on two resistors with one operation.

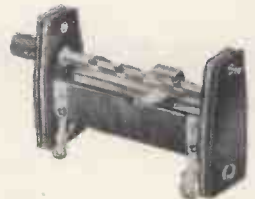

**EGEN ELECTRIC LTD.** Charfleet Industrial Estate, Canvey Island, Essex • Phone: Canvey Island 691/2



An important new achievement

a lightweight mobile transmitter/receiver 68U



has been added to B.C.C. range of communications equipment

68U designed and built with the same precision and care



as a scientific instrument,

has several new features

**TYPE 68U.**

**VHF TRANSMITTER RECEIVER**



which make 68U really outstanding in its class

B.C.C. sets the standard

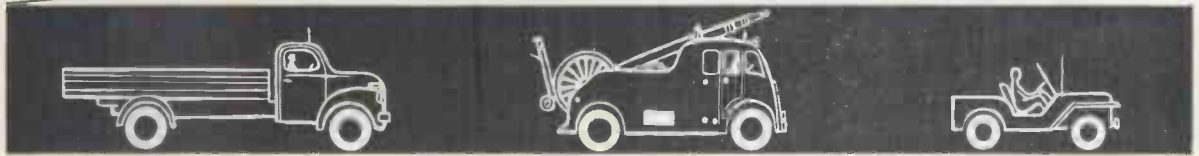

**BRITISH COMMUNICATIONS CORPORATION LIMITED**  
 Second Way, Exhibition Grounds, Wembley, Middlesex  
 Telephone : Wembley 1212

**BK**

SPECIALISED LOUDSPEAKER ENCLOSURES

**H.C.12****Corner Horn Assembly**

*Designed and executed for those  
who appreciate near  
perfection in Sound Reproduction.*

★ H.P. TERMS AVAILABLE

This and other fine loudspeaker systems are demonstrated daily at our Regent Street Show-rooms on audio amplifiers by LEAK, GOODSSELL, ACOUSTICAL, ROGERS, and ARMSTRONG.

*Send for illustrated brochure.*

**B. K. PARTNERS LTD.**

229 Regent St., London, W.1. (Entrance Hanover St.)

'Phone: REG 7363

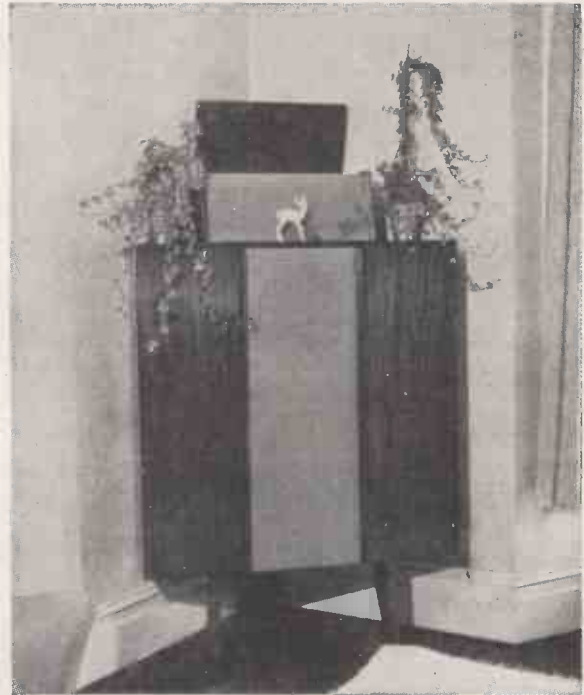
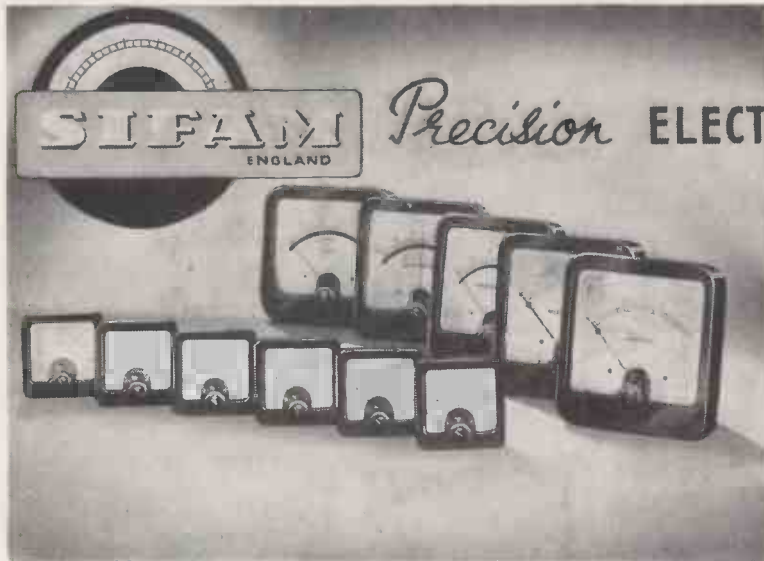
**FOR THE LABORATORY and PRODUCTION LINE**

SIFAM Electrical Instruments fully meet the high standards of accuracy and reliability demanded by modern industrial techniques, production control, laboratory testing, etc.

*Write for illustrated catalogue detailing the wide SIFAM range.*

**SIFAM ELECTRICAL INSTRUMENT CO. LTD.**

LEIGH COURT · TORQUAY

Telephone: TORQUAY 4547-8

**Precision ELECTRICAL INSTRUMENTS**

In addition to our well-known standard ranges of 2in. to 4½in. square and round panel-mounting instruments, the following are a few examples of special types which we have developed to meet industrial requirements:—

- Audible Braille Multi-range milliammeters.
- Contact instruments.
- Semi log scaled instruments.
- VU indicators and decibel meters.
- Modulation meters with special ballistics.
- Temperature measuring equipment.
- Airborne instruments of special design.
- 6in. and 8in. portables for precision and industrial use.

See our exhibits  
on Stand

**27**

Block 'C'

**BRITISH  
INSTRUMENT  
INDUSTRIES  
EXHIBITION**



EARLS  
COURT  
LONDON

June 28 - July 9 1955

# WOLSEY

## "QUICK-FIX" AERIALS for BAND I, BAND III and F.M.

**Peak Performance types for Everywhere**

**"WALL-WAND"**  
 Unobtrusive In-door Aerial. Does not clash with colour schemes. Rigid upper element, flexible lower element. Neat metal Junction box.

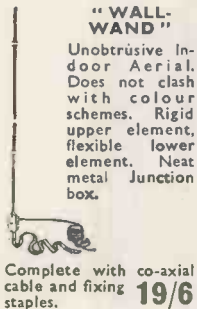

Complete with co-axial cable and fixing staples. **19/6**

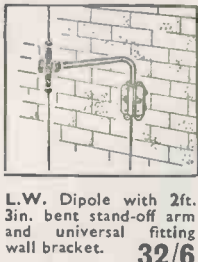

**L.W.** Dipole with 2ft. 3in. bent stand-off arm and universal fitting wall bracket. **32/6**

**LW/VA.** As above, with 4ft. 6in. almost vertical arm. **39/6**

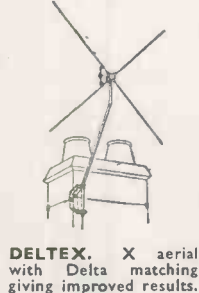

**DELTEX.** X aerial with Delta matching giving improved results. **77/6**

**DXL.** With 6ft. stand-off arm and chimney lashing **77/6**  
**DXW.** With 4ft. 6in. arm and wall bracket. **65/-**



**HL.** "H" aerial with 4ft. 6in. cranked arm and chimney lashing. **82/6**

**HM/CA.** With 9ft. x 1 1/2in. medium Dural mast and chimney lashing. **£5.17.6**

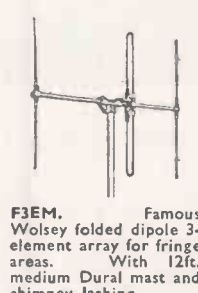

**F3EM.** Famous Wolsey folded dipole 3-element array for fringe areas. With 12ft. medium Dural mast and chimney lashing.

Channels 1, 2, 3 **£12.12.6**  
 4 and 5 **£12.2.6**  
 Aerial only available. Price on request.

### F. M. AERIALS

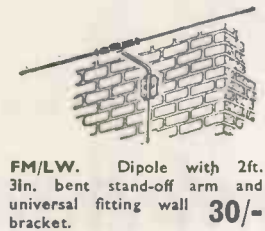

**FM/LW.** Dipole with 2ft. 3in. bent stand-off arm and universal fitting wall bracket. **30/-**

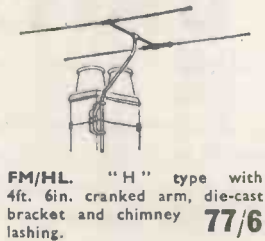

**FM/HL.** "H" type with 4ft. 6in. cranked arm, die-cast bracket and chimney lashing. **77/6**

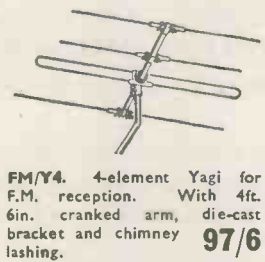

**FM/Y4.** 4-element Yagi for F.M. reception. With 4ft. 6in. cranked arm, die-cast bracket and chimney lashing. **97/6**

### BAND III AERIALS

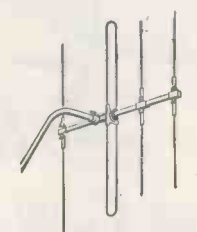

**Y4.** 4-element Yagi for districts not fully covered in primary service area. With 4ft. 6in. cranked arm, die-cast bracket and chimney lashing. For use with 70-80 ohms co-axial cable only. **77/6**

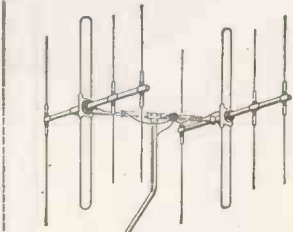

**BA/Y4.** Broadside Array for Band III fringe areas. Two Y4 aeriels connected via matching lines and splitter box. Complete with cranked arm, die-cast bracket and chimney lashing. For use with 70-80 ohms co-axial cable only. **£7.15.0**

### The WOLSEY CROSS-OVER UNIT (WITH PRINTED CIRCUIT)

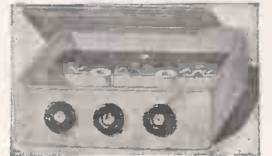

*Patent Pending*  
 For linking separate Band I and Band III aeriels (both 70-80 ohms) to receiver via one down-lead.  
**1957.** Wall or wainscot mounting. **15/-**  
**1957A.** For mast mounting only. **17/6**

### The WOLSEY "TWIN-BAND" COMBINED BANDS I AND III AERIAL

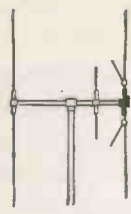

*Patent Pending*  
 Designed to receive Band I and Band III transmissions within their primary service areas on one aerial. One downlead only. No cross-over unit required. For use with 70-80 ohms co-axial cable only. Complete with 4ft. 6in. cranked arm, die-cast bracket and chimney lashing. **92/6**

- ★ All Band I types available for all Channels, vertical or horizontal polarisation.
- ★ All types PRE-ASSEMBLED for speedy installation.
- ★ Wolsey's unique SQUARE FITTING ensures self alignment plus rigidity.
- ★ All Junction Boxes completely waterproof and positively locked to cross-arm.

**WOLSEY TELEVISION LTD., 43-45 KNIGHT'S HILL, WEST NORWOOD, S.E.27.**  
 GIPSY Hill 2207 (4 lines).      Telegrams: Kwikflx, Westnor, London.      Established 1934.

# THE ADVERTISEMENT

## WE DIDN'T WRITE OURSELVES

*The leading experts and users all over the world wrote it for us!*



**F. J. CAMM**  
Editor of 'Practical Wireless' and 'Practical Television'



**JOHN GILBERT**  
of Northern Polytechnic and of B.B.C. Inventors' Club



**P. WILSON**  
Technical Editor, 'The Gramophone'



**H. J. BARTON-CHAPPLE**  
Wh. Sch., B. Sc. (Hons.), A.C.G.I., D.I.C., M.I.E.E., Hon. M. Brit. I.R.E.



**L. ORMOND SPARKES**  
Radio Consultant and Designer



Prov. Patent  
10037/53

CAMBRIC  
CONE

# Stentorian HI-FI UNITS

Every claim we have made for these remarkable units has been substantiated by experts and users—they have produced the largest volume of unsolicited testimony ever known in the history of loudspeaker manufacture.

From every part of the world we are told that the quality of reproduction is unrivalled except at many times the price—that these units have enabled everyone to enjoy High Fidelity at realistic cost. We are truly grateful for this amazing response.

Points to note: patented Cambric Cone, high flux density Alcomax magnet, die-cast chassis, Universal impedance speech coil (at 3, 7.5 and 15 ohms) on 8, 9 and 10 inch models. Prices from 37/6 to £9.15.6 (tax paid).

Ready-to-assemble Base Reflex Console Cabinet for 10" or 12" unit £10.10.0.  
Corner Console Cabinet for 8" unit £5.10.0.

Write for descriptive leaflets, or ask your usual dealer to demonstrate. Alternatively, these and other Stentorian speakers may be heard at our London Office (109 Kingsway, W.C.2) any Saturday from 9 a.m. to noon.



WHITELEY ELECTRICAL RADIO CO. LTD  
MANSFIELD NOTTS





## 60 Watt H.F. FIXED STATION

This completely new Pye equipment has been specifically designed for point-to-point communication and will fulfil equally well a ground-to-air role in air traffic control systems.

Push button control brings any one of four preselected channels into immediate operation; this facility is also available when the equipment is installed for remote unattended operation. The 60 watt Fixed Station Transmitter offers R/T, C/W, or M.C.W. operation with 'break-in' facilities on telegraphy.

The equipment is suitable for unattended operation in the tropics.



**Telecommunications**

CAMBRIDGE

ENGLAND



|  |   |   |  |
|--|---|---|--|
| <p>Pye (New Zealand) Ltd.<br/>Auckland C.I., New Zealand</p> <p>Pye Radio &amp; Television (Pty.) Ltd.<br/>Johannesburg<br/>South Africa</p> | <p>Pye Canada Ltd.<br/>Ajax, Canada</p> <p>Pye Limited<br/>Plaza de Necaxa 7<br/>Mexico 5</p> | <p>Pye-Electronic Pty., Ltd.<br/>Melbourne, Australia</p> <p>Pye Limited<br/>Tucuman 829<br/>Buenos Aires</p> | <p>Pye (Ireland) Ltd.<br/>Dublin, Eire</p> <p>Pye Corporation of America<br/>5th Avenue Building<br/>200, 5th Avenue, New York</p> |
| <p><b>PYE LIMITED . . . CAMBRIDGE . . . ENGLAND</b></p>  |   |   |  |

Developed for use in very high voltage-low current circuits, these rectifiers give approx. 600 volts output for each inch of length. The highly insulated tubular construction and the end tags for soldering enable them to be wired directly into circuit, whilst, providing adequate insulation is present, there is no limit to the number that may be connected in series. Below are tabulated some of the many types available in this range of:

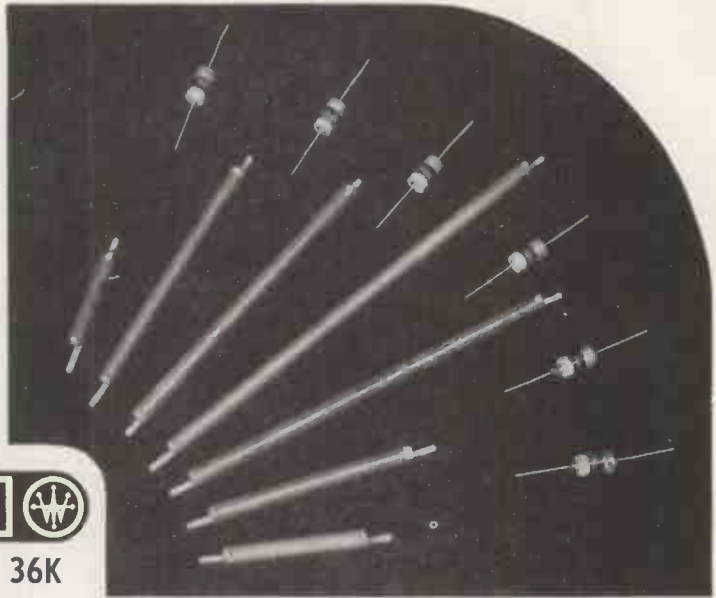

# WESTALITE

## RECTIFIERS TYPE 36EHT & 36K

| TYPE No. | PEAK INVERSE VOLTAGE | R.M.S. INPUT VOLTAGE | OUTPUT VOLTAGE |      | PEAK PULSE INPUT VOLTAGE | TYPICAL OUTPUT VOLTAGE AT 100 $\mu$ A |
|----------|----------------------|----------------------|----------------|------|--------------------------|---------------------------------------|
|          |                      |                      | 100 $\mu$ A    | 2 mA |                          |                                       |
| 36K1     | 85                   | 27                   | 35             | 30   | -                        | -                                     |
| 36K6     | 510                  | 162                  | 210            | 185  | -                        | -                                     |
| 36K14    | 1190                 | 378                  | 490            | 440  | -                        | -                                     |
| 36EHT25  | 2125                 | 675                  | 875            | 820  | 1810                     | 1640                                  |
| 36EHT70  | 5950                 | 1890                 | 2450           | 2320 | 5080                     | 4580                                  |
| 36EHT100 | 8500                 | 2700                 | 3500           | 3250 | 7250                     | 6550                                  |
| 36EHT130 | 11050                | 3520                 | 4550           | 4300 | 9420                     | 8500                                  |
| 36EHT240 | 20400                | 6480                 | 8400           | 7900 | 17400                    | 15700                                 |

For further information on EHT rectifiers, write for Data Sheet No. 60 to: Dept. W.W.4.

**WESTINGHOUSE  
BRAKE & SIGNAL CO. LTD.**

82 York Way, King's Cross, London, N.1

Telephone: TERminus 6432

## for world wide reception

The Viscount Table Radiogram is a long range nine valve superhet with Collaro 3-speed Autochanger. Six electrically band-spread ranges in the 13, 16, 19-20, 25, 31 and 41 metre bands, M.S.W. and M.W. or M.W. and L.W., A.C. operation, push-pull output. Twin speakers. Large glass dial. 12½ in. scale length each band. Separate bass and treble controls. Tuning indicator.

Reports reach the factory daily as to the excellence of its performance in all parts of the world.

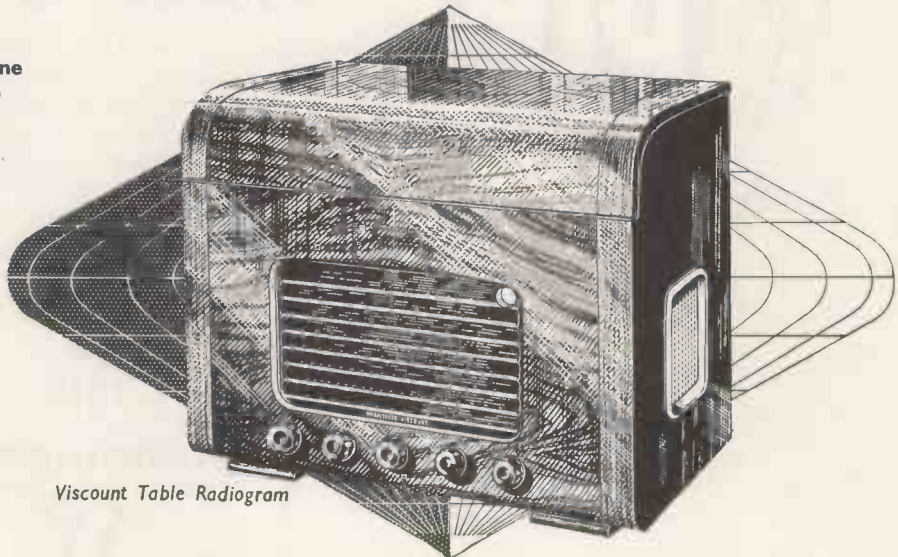

Viscount Table Radiogram

# the AMBASSADOR Viscount

Full details on request.

AMBASSADOR RADIO AND TELEVISION

PRINCESS WORKS

BRIGHOUSE



Instrument Type

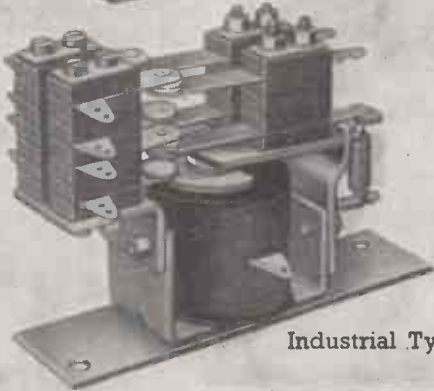

Industrial Type



Miniature Moving-Coil Type

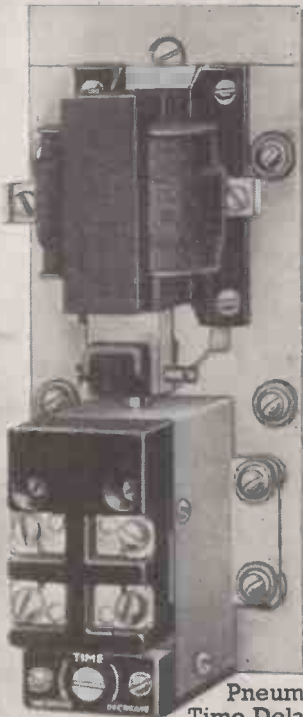

Pneumatic Time-Delay Type

Also manufacturers of:- Cartridge Thermostats, Adjustable Contact Thermometers, Magnetic Amplifiers, Low-Inertia Integrating Motors.

**ELECTRO METHODS LTD**  
**OF STEVENAGE**

**—the first name for precision RELAYS**

Comprehensive technical data of our extensive range of standard relays will be forwarded on request

**Most types now available for PROMPT DELIVERY**

**ELECTRO METHODS LTD. (Division WR), CAXTON WAY, STEVENAGE, HERTS  
PHONE: STEVENAGE 780**

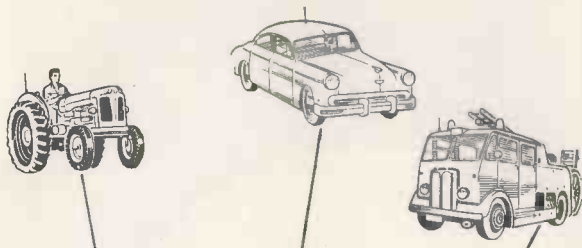

# RADIO TELEPHONE SYSTEMS

The Hudson range of highly efficient and economically operated two-way communication systems comprises equipment applicable to various requirements in all countries.

Consult  
**Hudson**  
OF LONDON

-----LIST OF MODELS-----

- AM/250/M ... 5 watt Vehicle Station, 60 to 100 Mc/s.
- AM/150/M ... 5 watt Vehicle Station, 100 to 185 Mc/s.  
Single or up to 5 channels.
- AM/250/F ... 6 watt Fixed Station, 60 to 100 Mc/s.
- AM/150/F ... 6 watt Fixed Station, 100 to 185 Mc/s.  
Single or up to 10 channels.
- FM.102 ..... 10 watt FM Vehicle Station, 60 to 185 Mc/s.  
Single or up to 4 channels via remote control.
- FM.101 ..... 10 watt FM Fixed Station, 60 to 185 Mc/s.  
Single or up to 10 channels.
- HED.113 ... 50 watt AM or FM Fixed Station, 60 to 185 Mc/s.  
Up to 4 channels via remote control.

Supplied to the G.P.O. and Home Office.

**HUDSON ELECTRONIC DEVICES, LTD.**

APPACH ROAD, LONDON, S.W.2

Telephone: TULse Hill 4861  
Cables: HUDELECT, LONDON

# "WEYRAD" COIL PACKS AND I.F. TRANSFORMERS

## FOR HIGH PERFORMANCE THE B.30 SERIES

These packs have been developed to provide an answer to the problem of reliable operation on overcrowded broadcast bands. The use of an R.F. stage results in much improved sensitivity and selectivity



### UP TO 4 WAVE BANDS — GRAM. SWITCHING

Fully tropicalised, iron-cored coils wound on moulded bakelite formers. Ceramic based, compression-type trimmers. Close tolerance, silvered mica padders.

**B30/G — TUNING CAPACITY 483-532 pF.**  
**B31/G — " " 354-399 pF.**  
Coverage 12.5-550 m. in 4 bands.

**B32/G — TUNING CAPACITY 483-532 pF.**  
**B33/G — " " 354-399 pF.**  
Coverage 12.5-37, 33-100, 190-550 & 800-2,000 m.

**B34/G — TUNING CAPACITY 483-532 pF.**  
**B35/G — " " 354-399 pF.**  
Coverage 16-50, 190-550, & 800-2,000 m.

PRICES: B30-33 93/9 + 30/6 P.T.  
B34-35 84/5 + 27/5 P.T.

### FOR USE WITH THESE I.F. TRANSFORMERS

**WEYRAD  
TYPES  
P.3, P.4,  
P.5 or P.6.**

Operating at  
465-470 Kc/S.



A very wide choice of I.F. stage arrangements is possible. The types listed cover transformers of the highest possible electrical and mechanical quality, low cost versions for manufacturers and special types providing variable selectivity characteristics.

|                     |           |
|---------------------|-----------|
| P.3.A & P.3.B. .... | 9/10 each |
| P.4 .....           | 7/6 each  |
| P.5 .....           | 8/6 each  |
| P.5.A .....         | 10/- each |

**WEYMOUTH RADIO MFG. CO., LTD.**  
CRESCENT STREET, WEYMOUTH, DORSET

# JUST RELEASED!



## NEW TAYLOR VALVE TESTER Model 45c

A Comprehensive valve tester which may be used to measure the mutual conductance of most types of British, American and Continental receiving valves. Measures for over 4,000 different valves.

### TESTING FACILITIES

**Mutual Conductance.** Two ranges: 0-3 to m A/V and 0-15 m A/V.

**Cathode Leakage.** Tests for Heater/Cathode insulation up to 10 megohms, with heater hot.

**Emission.** Rectifiers and Diodes may be tested for emission.

**Inter Electrode Shorts.** Short circuits between electrodes are shown on the meter.

**Heater Continuity.** Meter Indicates continuity of heater or filament.

**Gas Tests.** Press button "gas" tests shows abnormal positive or negative grid current.

T.V. tube adaptor to check most tubes can be supplied separately.

**Price £27-10-0      Prompt delivery**

AVAILABLE ON ADVANTAGEOUS H.P. TERMS.

## Taylor Signal Generator

For Television 240 Mc/s.

### Model 67A

The Colpitt's oscillator circuit used on all ranges gives good frequency stability and good waveform over the wide frequency range.

Frequency range: 100 Kc/s-240 Mc/s in six bands. Covers Band III.

Total scale length: 48in.

Accuracy  $\pm 1\%$ .

Modulation: 400 cycles, 30% depth.

Output impedance: 75 ohms.

Direct A.F. output provided.

Attenuation: Coarse—5 steps of  $-20$ dB. Fine—Variable to  $-20$ dB approx. (rather more on the lower frequency ranges). Output impedance 75 ohms. Automatic cut-out against mains overload.

**Cash Price £22-0-0      Prompt Delivery**

AVAILABLE ON ADVANTAGEOUS H.P. TERMS.



MONTROSE AVENUE, SLOUGH BUCKS.

● Separate leaflets giving full technical details available. All other Taylor Instruments available on H.P. Write for catalogue and details of H.P. terms.

**ELECTRICAL INSTRUMENTS LTD.**

Telephone: Slough 21381. Cables: Taylins, Slough.



We will gladly send you our catalogue and full information on request

VITAVOX LIMITED, Westmoreland Road, London, N. W. 9. Telephone: COLindale 8671

# Connoisseur VARIABLE 3-SPEED GRAMOPHONE MOTOR



## CONNOISSEUR Super Lightweight 3-head Pick-up with Sapphire Stylus

Prices: Complete Pickup with one head (either Standard 78 r.p.m. or Microgroove 33 $\frac{1}{2}$  or 45 r.p.m.) £4 10s. 0d. + P.T. £1 12s. 1d. Total £6 2s. 1d. Each additional head £2 10s. 0d. + P.T. 17s. 10d. Total £3 7s. 10d. Replacement Armature 10s. 3d. + P.T. 3s. 8d. Total 13s. 11d.

Fitted with Diamond Stylus, complete Pickup with one head £7 12s. 9d. + P.T. £2 14s. 5d. Total £10 7s. 2d. Each additional head £5 12s. 9d. + P.T. £2 0s. 2d. Total £7 12s. 11d. Replacement Armature £? 13s. 0d. + P.T. £1 6s. 0d. Total £4 19s. 0d.

We present an entirely new three-speed unit operating at 33 $\frac{1}{2}$ , 45 and 78 r.p.m. The full 12" turntable is lathe-turned and manufactured of non-ferrous material. The main spindle is precision ground and lapped to mirror finish and runs in phosphor bronze bearings. The synchronous motor is dynamically balanced and resiliently mounted, making it virtually vibrationless, with low noise level and low hum induction.

The speed change is arranged mechanically and gives a 2% variation on all speeds, the synchronous motor running at constant speed at all settings. No braking action is employed to obtain speed change.

It is suitable for playing standard transcription and micro-groove recordings. Input voltages 200/250 v. A.C. 50 cycles or, as specified to order for 200/250 v. A.C. 60 cycles, or 110 v. A.C. 50 or 60 cycles. Mounted on  $\frac{1}{2}$ " die-cast board 15 $\frac{1}{2}$ " x 13 $\frac{1}{2}$ " with 3 $\frac{1}{2}$ " clearance distance below motor-board. Speed selector turret is fitted at left rear of motor-board. On-off switch at left front; also releases pressure on the rubber drive assembly. All motorboards are drilled to take Connoisseur Standard and Super Lightweight Pickups unless otherwise ordered. When used with these pickups mounted in position, 3 $\frac{1}{2}$ " clearance above motorboard is recommended.

Price: £19 + P.T. £6 15s. 5d. Total £25 15s. 5d.

**A. R. SUGDEN & CO. (Engineers) LTD.**  
WELL GREEN LANE : BRIGHOUSE : YORKSHIRE  
Phone: Halifax 69169. Grams: Connoisseur, Brighouse

OVERSEAS AGENTS: S. Africa: W. L. Proctor (Pty.) Ltd., 63 Strand Street, Cape Town. Australia: J. H. Magrath & Co. Pty. Ltd., 208 Little Lonsdale Street, Melbourne. Canada: The Astral Electric Co. Ltd., 44 Danforth Road, Toronto 13, Ontario. New Zealand: Turnbull & Jones Ltd., Head Office, 12/14 Courtenay Place, Wellington. Hong Kong: The Radio People Ltd., 31 Nathan Road, Hong Kong. Malaya: (Main Distributors) Eastland Trading Co., 1 Prince Street, Singapore. U.S.A.: (Main Distributors) Danby Radio Corporation, 2042 Chestnut Street, Philadelphia, 3, Pa. Audio Supply Laboratories, Nickels Arcade Buildings, Ann Arbor, Michigan.

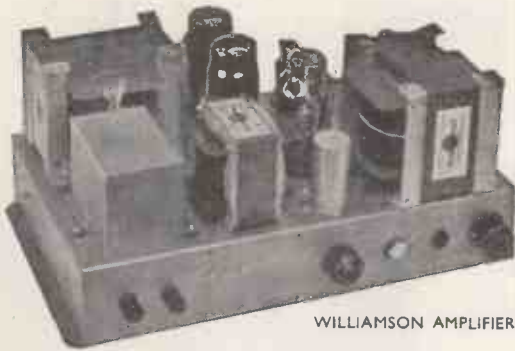

WILLIAMSON AMPLIFIER



P.A.I. PRE-AMP

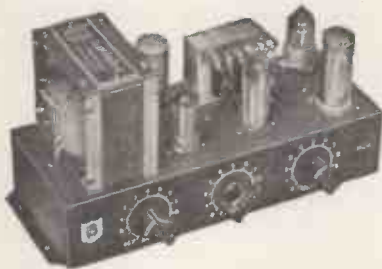

**SPEAKERS**

|                          |          |
|--------------------------|----------|
| G.E.C. Metal Cone        | £8 15 0  |
| WHARFEDALE Super 5 CS/AL | £6 13 3  |
| "    Bronze 8 AL         | £3 10 8  |
| "    Super 8             | £5 13 3  |
| "    Super 8 CS          | £6 6 7   |
| "    Super 8 CS/AL       | £6 13 3  |
| "    Golden 10           | £7 13 3  |
| "    Golden CSB          | £8 6 7   |
| "    W.12                | £9 5 0   |
| "    W.12 CS             | £9 15 0  |
| "    Super 12 CS/AL      | £17 10 0 |
| "    W.15                | £17 0 0  |
| "    W.15 CS             | £17 10 0 |
| GOODMANS Axiom 101       | £6 12 1  |
| "    "    102            | £9 18 2  |
| "    "    150 Mk. II     | £10 5 6  |
| "    "    22 Mk. II      | £14 14 0 |
| "    Audiom 60           | £8 12 6  |
| "    "    70             | £13 15 0 |
| "    "    80             | £22 10 0 |
| "    "    90             | £28 0 0  |
| W.B. HF.810              | £3 5 6   |
| "    HF.1012             | £3 17 6  |

**AMPLIFIERS**

**OSRAM 912**

This renowned amplifier complete—with drilled chassis—front panel, Brand new B.V.A. Valves. All transformers approved by G.E.C. Everything included.  
Partridge Kit £22/6/3. Wired and Tested £4 extra.  
Haddon Kit £21/19/3. Tele-Radio Kit £18/18/6.

**WILLIAMSON**

This amplifier justly celebrated all over the world. Absolutely complete with all parts.  
Partridge Kit £22/1/- . Wired and Tested £26/15/6.

**P.A.I. PRE-AMP FOR WILLIAMSON AMPLIFIER**

The P.A.I. pre-amp. especially designed by us—for use with the Williamson. Up to a standard—Down to a special price.  
Kit £6/16/6. Wired and Tested £8/18/6.

**MULLARD 5-10**

This clever new amplifier is offered complete to last nut and bolt. Brand new B.V.A. Valves. First quality components throughout.  
Kit Price £12/10/-.

**LEAK**

TL.10 £17/17/- . Point 1 Pre-Amp. £10/10/- .  
Vari-Slope Mk. II £16/16/- . TL 12 £28/7/- . TL.25 £34/7/- .

**UNITELEX MG4**

Designed to meet the need for a low-cost but flexible medium-power, general purpose amplifier, £8/18/6.

**QUAD**

Quad II £22/10/- . Quad II Control Unit £19/10/- .

**PICK-UPS**

|  |          |
|--|----------|
| ACOS GP.20 Arm                                       | £1 6 1   |
| ACOS HGP39 Head Std. & L.P.                          | £2 2 3   |
| COLLARO Standard Magnetic P.U.                       | £1 17 0  |
| COLLARO Studio O or P. Pick Up                       | £3 14 8  |
| COLLARO Transcription Arm Studio "P" Pick up.        | £4 15 9  |
| COLLARO Transcription Arm Studio (Super) PX          | £5 2 5   |
| B.J. Arm   | £2 19 11 |
| DECCA XMS Heads Std. or L.P.                         | £2 14 8  |
| DECCA XMS P.U. with 2 heads                          | £6 9 5   |
| CONNOISSEUR P.U. with 2 Heads                        | £9 5 6   |
| CONNOISSEUR Transformer                              | 13 0     |
| CONNOISSEUR P.U. Heads. Diamond Stylus. Std. or L.P. | £7 8 11  |
| LEAK Dynamic P.U. with Diamond Stylus                | £11 9 6  |
| LEAK Dynamic Extra Head                              | £7 15 3  |
| Mu-Metal Transformer                                 | £1 15 0  |

**GRAM MOTORS**

|  |          |
|--|----------|
| COLLARO 3/554 3 Speed Motor and Pick up                  | £8 18 4  |
| COLLARO 2000 3 Speed Transcription Motor                 | £13 9 6  |
| COLLARO 2010 3 Speed Transcription Motor and "P" Pick up | £18 4 9  |
| GARRARD 301 3 Speed Transcription Motor                  | £25 3 6  |
| GARRARD RC.80M 3 Speed Autochanger with 45 R.P.M. Post.  | £18 12 9 |
| CONNOISSEUR 3 Speed Transcription Motor. (Latest Model)  | £25 15 5 |

**OCTAGONAL SPEAKER CABINET**

Designed for the G.E.C. Metal Cone Speaker.  
Price £12 10 0

**R.J. SPEAKER CABINET**

The sensational new miniature speaker Cabinet by Wharfedale.  
Price £9 10 0

**TUNER UNITS**

|                                    |         |
|------------------------------------|---------|
| CHAPMAN S4. Four Stage Feeder Unit | £16 0 0 |
| Ditto. S5. Five Stage Feeder Unit  | £21 6 8 |
| F.M.81 V.H.F. FM Feeder Unit       | £21 0 0 |

Postage and Packing extra.



**TELE-RADIO (1943) LTD**

189 EDGWARE ROAD, LONDON, W.2.

Phone: PAD 4455/6

Shop hours: Monday-Saturday, 9 a.m. to 6 p.m. Thursday 9 a.m. to 1 p.m.

# Tape recorders the world over use 'SCOTCH BOY'

THE NAME THAT PUT QUALITY ON TAPE

Leading Recording Companies, and home and professional recordists everywhere, choose 'SCOTCH BOY' MAGNETIC RECORDING TAPE. More reels of this tape are sold than any other recording tape in the world.

'SCOTCH BOY' is supplied on 7" easy-to-thread styrene plastic reels, holding 1200' of absolutely splice-free tape. The tape is also available on 600' and 2400' reels.

'SCOTCH BOY' has an output variation, within each 1200' reel, at 1000 c/s, of less than plus or minus  $\frac{1}{2}$ db., and less than plus or minus  $\frac{1}{2}$ db. from reel to reel.

'SCOTCH BOY' SPLICING TAPE—

The new 'SCOTCH BOY' Splicing Tape No. 41 is the ideal material for all editing and tape repairs.



## 'SCOTCH BOY'

REGD TRADE MARK

### MAGNETIC RECORDING TAPE

ANOTHER **3M** COMPANY PRODUCT

MINNESOTA MINING AND  
MANUFACTURING CO. LTD.

Arden Road, Adderley Park, Birmingham 8.  
167 Strand, London W.C.2.  
90 Mitchell Street, Glasgow C.1.  
16 Mosley Street, Manchester 2.

# RADIO EXPORT

# TUBES ONLY



1,000 types  
of Receiving and  
Transmitting Radio  
Tubes available ex stock.

HALL ELECTRIC LTD  
Haltron House, 49-55 Lisson Grove,  
London, N.W.1.

Tel.: Ambassador 1041 (5 lines) Cables: Hallelectric, London



# MODERN ELECTRICS LTD.

164 Charing Cross Road, London, W.C.2.

Tel.: TEMple Bar 7587.

Cables: Modcharex, London.

Export enquiries welcomed.

Immediate delivery from stock.

Prompt attention to post orders.

**TAPE RECORDERS**

|                 |          |
|-----------------|----------|
| GRUNDIG TK12    | £73 10 0 |
| GRUNDIG TK819   | £99 15 0 |
| GRUNDIG TK9     | £68 5 0  |
| FERROGRAPH 2A/N | £79 16 0 |
| VORTEXION 2A    | £84 0 0  |
| VORTEXION 2B    | £99 0 0  |
| SUPER EDITOR    | £57 15 0 |
| PLAYTIME        | £31 4 6  |
| ACE (Battery)   | £52 0 0  |

**RECORDING TAPES**

|                         |         |
|-------------------------|---------|
| GRUNDIG L.G.S. 1,200ft. | £2 0 0  |
| 850ft.                  | £1 14 0 |
| 600ft.                  | £1 5 0  |

**FERROVOICE**

|                          |         |
|--------------------------|---------|
| 1,200ft.                 | £1 2 6  |
| Spare Spools             | 4 6     |
| E.M.I. type 88, 1,200ft. | £1 15 0 |
| E.M.I. type 88, 600ft.   | £1 1 0  |

**GEVAERT**

|          |         |
|----------|---------|
| 1,200ft. | £1 15 0 |
|----------|---------|

**SCOTCH BOY**

|                       |         |
|-----------------------|---------|
| 1,200ft.              | £1 15 0 |
| 600ft.                | £1 1 0  |
| Spare Spools 1,200ft. | 4 3     |
| Spare Spools 600ft.   | 3 6     |

**FERROGRAPH**

|              |        |
|--------------|--------|
| 1,200ft.     | £2 5 0 |
| 1,750ft.     | £3 3 0 |
| 8½in. Spools | 9 6    |

**AGFA**

|                     |         |
|---------------------|---------|
| 1,200ft.            | £1 17 6 |
| 600ft.              | £1 2 6  |
| Lead on tape 150ft. | 8 0     |

**RECORD REPRODUCING EQUIPMENT**

**COLLARO TRANSCRIPTION**

|            |         |
|------------|---------|
| Model 2000 | £13 9 6 |
| Model 2010 | £18 6 6 |

**GARRARD UNITS**

|                            |          |
|----------------------------|----------|
| RC80M AC                   | £17 9 6  |
| RC80M AC/DC                | £26 3 5  |
| 301 Transcrip              | £25 3 6  |
| Type TA/AC                 | £10 16 0 |
| Type TA/B w th Decca heads | £14 0 11 |

**CONNOISSEUR**

|                  |          |
|------------------|----------|
| Variable 3 speed | £25 15 5 |
|------------------|----------|

**SPEAKERS**

**W.B. STENTORIAN**

|   |         |
|---|---------|
| HF.610                                  | £2 10 6 |
| HF.810                                  | £3 0 6  |
| HF.912                                  | £3 9 6  |
| HF.1012 tapped coil, 3, 7.5 or 15 ohms. | £3 17 6 |

**GOODMANS**

|                  |         |
|------------------|---------|
| Axiom 150 Mk. II | £10 5 6 |
| Axiom 102        | £9 18 2 |
| Axiom 101        | £6 12 1 |

**WHARFEDALE**

|                     |          |
|---------------------|----------|
| W15 CS.             | £17 10 0 |
| Super 12 CS/AL      | £17 10 0 |
| W12 CS.             | £9 15 0  |
| Golden 10 CSB       | £8 6 7   |
| Super 5 and 8 CS/AL | £6 13 3  |
| Bronze 10in.        | £4 12 9  |
| Bronze 8in.         | £3 4 0   |
| W.B. Crossover Unit | £1 10 0  |
| W.B. Tweeter Unit   | £4 4 0   |

**TEST EQUIPMENT**

**AVO**

|                                       |          |
|---------------------------------------|----------|
| Model 8                               | £23 10 0 |
| Model 7 (latest)                      | £19 10 0 |
| Unimino Mk. II                        | £10 10 0 |
| Electronic Meter                      | £40 0 0  |
| Wide Band Sig/Gen                     | £30 0 0  |
| Valve Characteristic Meter (new type) | £60 0 0  |
| D.C. MInor                            | £5 5 0   |
| 10kV Multiplier for Model 8           | £3 5 0   |
| Carrying Cases for Models 7, 8 and 40 | £3 0 0   |

**ADVANCE**

|               |          |
|---------------|----------|
| H.1 (Sig/Gen) | £25 0 0  |
| E.2 (Sig/Gen) | £28 0 0  |
| P.I           | £19 19 0 |

**COSSOR**

|                       |          |
|-----------------------|----------|
| Oscilloscope 1035     | £120 0 0 |
| Oscilloscope 1052     | £104 0 0 |
| Volt: Calibrator 1433 | £18 5 0  |

**TAYLOR**

All new Taylor Test Gear in stock.

**PICK-UPS**

|              |        |
|--------------|--------|
| ACOS Hi G 20 | £3 8 4 |
|--------------|--------|

**DECCA**

|                 |         |
|-----------------|---------|
| X.M.S. Magnetic | £6 9 5  |
| W12             | £12 0 0 |

**CONNOISSEUR**

|                |         |
|----------------|---------|
| Super L/weight | £9 9 11 |
| Spare Heads    | £3 7 10 |

**COLLARO STUDIO**

|             |         |
|-------------|---------|
| Type O or P | £3 14 8 |
|-------------|---------|

**LEAK**

|                             |          |
|-----------------------------|----------|
| 2 Heads with Diamond Stylus | £20 19 9 |
|-----------------------------|----------|

**MICROPHONES**

**ACOS**

|                       |          |
|-----------------------|----------|
| Mic 22 (Crystal)      | £4 4 0   |
| Mic inserts for above | £1 0 0   |
| Mic 16 (Crystal)      | £12 12 0 |
| Mic 35-1 (Crystal)    | £1 5 0   |

**LUSTRAPHONE**

|               |         |
|---------------|---------|
| M/C High Imp. | £5 15 6 |
|---------------|---------|

**RESLO**

|                |        |
|----------------|--------|
| URA Ribbon     | £7 5 0 |
| RVA Ribbon     | £9 0 0 |
| VMC (low imp.) | £6 0 0 |

**FILM INDUSTRIES**

|        |         |
|--------|---------|
| Ribbon | £10 0 0 |
|--------|---------|

**MICROPHONE STANDS**

|                     |         |
|---------------------|---------|
| Floor, 3 extensions | £3 12 6 |
| Table Stand         | £1 5 0  |

**LEAK AMPLIFIERS**

|                |         |
|----------------|---------|
| TL-10 complete | £28 7 0 |
| Point 1, TL-12 | £28 7 0 |
| Point 2, TL-25 | £34 7 0 |

**QUAD, Mk. II**

|  |         |
|--|---------|
|  | £42 0 0 |
|--|---------|

**OLON, New Instrument Iron 200-250 v. 25 w.**

|  |      |
|--|------|
|  | 19 8 |
|--|------|

**ALL GARRARD, CONNOISSEUR, DECCA and COLLARO HEADS, SAPPHIRE and DIAMOND STYLII for the above HEADS NOW AVAILABLE**

## Quality Equipment Designers Ltd. 75 GRAND PARADE, HARRINGAY LONDON, N.4. Phone: STA. 3712

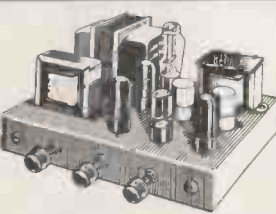

**Complete Kit £10-7-6**

PLUS 3/- Pkg., Carr. & Ins.  
For operation on A.C. mains 200/250 v. This amplifier can be supplied ready built and tested at £11/12/6 plus 4/- postage and packing.

### REPRODUCTION AT ITS VERY BEST

This High Fidelity 8-10 watt amplifier has been designed for use with Gram or Radio. Valve line up:—6SL7, 6BN7, 2 6V6's (matched) output 5Z4. Negative feedback, tone control using separate Bass and Treble. Output transformer tapped for 3 or 15 ohm speakers. Feeder unit input socket provided. Chassis dimensions 12 x 8 x 2½. Circuit diagram with wiring instructions, priced stock list, etc., 1/- (all parts may be purchased separately).



### THE NEW LOOK T.R.F. RECEIVER

Build this superb radio at a total cost of only **£5-15-0**

**Complete Set of Components**  
plus 2/6 Pkg. and Carr.

coverage is 180/550 metres on Medium wave, and 800/2,000 metres on Long wave. The Walnut cabinet is the latest design and is outstanding in appearance. Assembly instructions 1/- (post free), include point-to-point wiring, chassis layout, etc. Also stock list of priced components (which may be purchased separately). This receiver may be purchased completely built and ready for use at total cost of £6/15/- plus 3/6 Pkg. and Carr. All components are guaranteed for one year. Valves 3 months.

This is a 3 valve T.R.F. plus Metal Rectifiers; with a valve line up as follows:—6K7 (HF); 6J7 (DET); 6V6 (OUTPUT). Wave band boards, Tape Decks, Cabinet drawers, etc. LENGTH 13in.—RUNNER EXTENDS 9in. **10/-** post FREE

**4-WATT QUALITY AMPLIFIER** for use with Gram or Radio. Valve line up:—6SL7, 6V6 output, 5Z4. Separate Bass and Treble Controls. Suitable for Mag or Crystal pick-ups. Speaker imp. 3 ohms. Mains voltage 200/250 v. A.C.

**COMPLETE KIT £4/15/-** or Ready Built, tested at **£5/5/-** plus 2/6 postage and pkg. Full wiring instructions, theoretical circuit, priced stock list, etc., 1/-. **FREE TECHNICAL ADVICE GIVEN TO ALL OUR CUSTOMERS.**

**MAINS NOISE SUPPRESSOR UNIT**  
A simple and effective method of cutting out all mains noises. The Kit consists of 2 specially designed chokes together with 3 condensers. The unit can be assembled in existing receivers or separately if so desired.

**4/11 COMPLETE WITH CIRCUIT DIAGRAM**  
Plus 6d. post, etc.

**F.M. FEEDER UNIT**  
To Denco specification. Valve line up:—6AM6, 12A8S, EB91, 2-6AB6's. Complete kit, £6/7/6 (or supplied less valves). Point to point diagram and complete instructions, 1/6.

### ALUMINIUM CHASSIS WITH REINFORCED CORNERS

|             |      |             |      |
|-------------|------|-------------|------|
| 6 x 4 x 2½  | 4/9  | 8 x 6 x 2½  | 6/9  |
| 10 x 7 x 2½ | 7/6  | 12 x 8 x 2½ | 9/9  |
| 14 x 8 x 2½ | 10/9 | 16 x 9 x 2½ | 13/6 |
| 12 x 3 x 2  | 6/-  | 14 x 3 x 2  | 6/6  |
| 12 x 5 x 2  | 7/-  | 16 x 6 x 2  | 10/- |

Add 1/- to whichever size required for post/pkg.

**BALL BEARING SLIDERS**  
**BRAND NEW AT A THIRD BELOW NORMAL PRICE.** Specially designed to give smooth silent movement with complete rigidity in any position. Cadmium plated steel captive ball carriage with brass spring. These sliders are suitable for extending Radiogram Motor Boards, Tape Decks, Cabinet drawers, etc. LENGTH 13in.—RUNNER EXTENDS 9in. **10/-** post FREE

**RADIO-GRAM CHASSIS**  
Using a 3 waveband coil pack covering L.M.S. wavebands. Valve line up: 6K6, 6K7, 6Q7, 6V6, 5Z4 Rec. Illuminated 3 colour Dial, size 10in. x 4½in., overall chassis dimensions: 7in. x 13½in. x 7in. Four front controls: tone; on/off volume; w/change; tuner. For operation on A.C. mains only. 200/250 v. Fully guaranteed 12 months. £10/17/6, plus 5/- post and pkg.

**TERMS OF BUSINESS:—**Cash with order or C.O.D. All orders for small items totalling over £2 post free unless otherwise stated.  
**ALL ITEMS LISTED ABOVE CAN BE SEEN AND HEARD WORKING IN OUR SHOWROOM.**  
Shoppers wishing to visit our premises **ALIGHT AT HARRINGAY ARENA. OPEN 9 a.m.-6 p.m. MON.-SAT. (EARLY CLOSING WED.)**

# Bullers CERAMICS FOR INDUSTRY

High quality material and dimensional precision are attributes of Bullers die-pressed products. Prompt delivery at competitive prices.

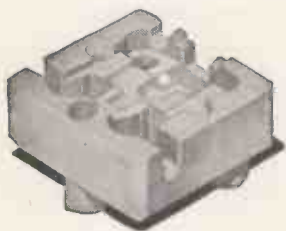
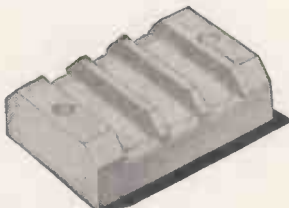
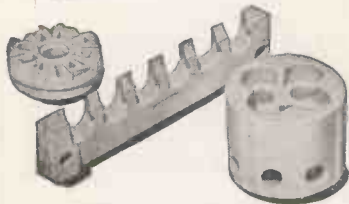

We specialise in the manufacture of

**PORCELAIN**  
for general insulation

**FREQUELEX**  
for high-frequency insulation

**REFRACTORIES**  
for high temperature insulation

**PERMALEX & TEMPLEX**  
for capacitors

## BULLERS LIMITED

MILTON · STOKE-ON-TRENT · STAFFS

Phone: Stoke-on-Trent 21381 (5 lines) · Telegrams & Cables: Bullers, Stoke-on-Trent  
Ironworks: TIPTON, STAFFS London Office: 6 LAURENCE POUNTNEY HILL, E.C.4  
Phone: Tipton 1691 Phone: MANsion House 9971

B.108

# A SOUND TIE UP



A.I.D. APPROVED

**"WILLESDEN" TRANSFORMERS**  
*for all*  
**ELECTRONIC & TELECOMMUNICATION REQUIREMENTS**

WILLESDEN TRANSFORMER CO. LTD., 2a, FRITHVILLE GARDENS, SHEPHERDS BUSH, LONDON, W.12. Telephone: SHE 5819, 2714.



## *You are there...*

It is odd that the merits of a system for re-creating the sounds  
of waves which are far from square can best be judged by  
how the system responds to waves which are square.

We don't claim to make reproducers which will produce  
mathematically precise square pressure waves but we do make  
loudspeakers which are unusually free from major vices.

**BA**

---

LOUD-SPEAKER MANUFACTURERS TO THE RADIO INDUSTRY SINCE 1930  
REPRODUCERS AND AMPLIFIERS LIMITED . WOLVERHAMPTON . ENGLAND



Miss Carole Carr using the L.F.V.59.

Telephone: PRImrose 8844/6.

Telegrams: LUSTRAPHON, NORWEST, LONDON.

Cables: LUSTRAPHON, LONDON.

## The new LUSTRAPHONE 'FULL VISION'

MODEL L.F.V.59 *Personal* MICROPHONE

THE MODEL L.F.V.59 is the *acme* of dynamic microphones for highest quality *personal* presentation in television, recording, broadcasting and public-address. Its beautiful styling and high performance, plus extremely smooth frequency response and non directional polar patterns, make this handsome full vision microphone the finest obtainable.

MODEL L.F.V.59 can be used anywhere—indoors or outdoors—in your hand—mounted on a floor or table stand—with 'Stayput' flexible tube to tilt microphone to desired positions. There is no need to shield the microphone when used in the open air, it is already protected from wind noise effects. Its design enables MODEL L.F.V.59 to be used under all conditions—in all temperatures and it is unaffected by rapid climatic changes.

for

television

recording

broadcasting

public-address

LUSTRAPHONE the foremost name in MICROPHONES

Literature gladly sent on request.

## LUSTRAPHONE LTD.

ST. GEORGES WORKS, REGENTS PARK ROAD, LONDON, N.W.1.

# McMURDO VOLTAGE SELECTORS

Two types of voltage selector panels for mains voltage adjustment. Both types have three-pin plugs which connect pairs of contacts to one common contact for the simultaneous adjustment of two transformers or circuits in parallel.

### 4-WAY

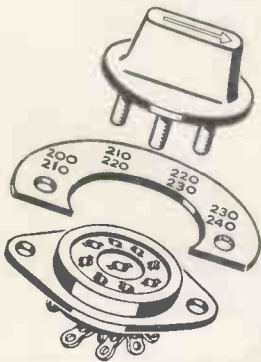

BVS/4 Moulded in P.F. Escutcheon is Black SRBP Sheet with "standard" voltage range engraving as follows:—

200 210 220 230

210 220 230 240

Non-standard marking is available to special order.

### 6-WAY

XVS/6 Moulded in Nylon P.F.

No "standard" marking. Engraved according to requirements. Please specify required marking on order.

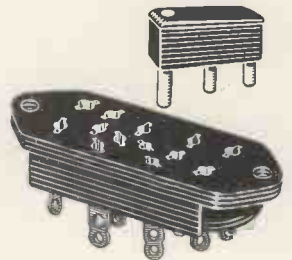

## THE McMURDO INSTRUMENT COMPANY LTD.

Victoria Works, Ashted, Surrey. Tel: Ashted (Surrey) 3401

# We're Marching On...

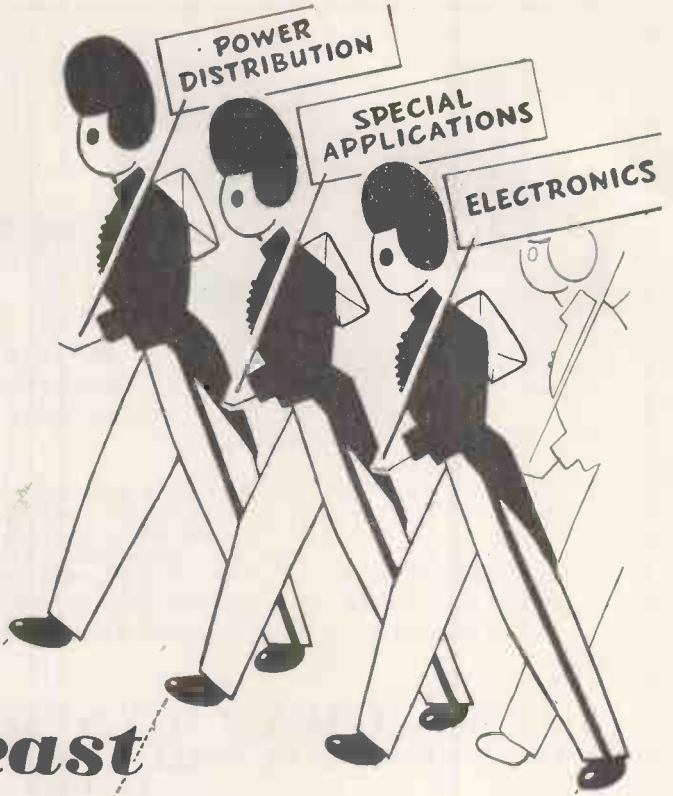

## ...three abreast

To keep abreast of the constantly growing demand in new fields for Gresham Transformers the Company's functions have been reorganised into three divisions—Power Distribution, Special Applications and Electronics. Each Division is manned by specialist liaison engineers and designers, and all the technical and manufacturing resources of the Gresham organisation are available to each Division.

### POWER DISTRIBUTION DIVISION

The transformers produced by this Division range from 5 to 1500 kVA and are installed in Power Stations, Sub-stations and Rural Areas. The range includes the well-known LOFEL (low iron loss) transformers of 5, 15 and 25 kVA rating.

### SPECIAL APPLICATIONS DIVISION

This Division designs and builds transformers for electric furnaces, motor body welding plant, high-frequency heating units, H.F. and V.H.F. transmitter rectifier supply, H.T. laboratory equipment, etc. Mobile sub-stations are supplied to the National Coal Board for mining use.

### ELECTRONICS DIVISION

The transformers and chokes used in telecommunications, radar, electronics and instrumentation are designed and made to stringent specifications. The types which have been granted Joint Services Approval are a feature of this Division.

*The knowledge and experience of the GRESHAM Specialists are as close to you as your telephone — ring FELtham 2271 (7 lines)*

HANWORTH **GRESHAM** MIDDLESEX  
TRANSFORMERS LTD

**BRITAIN'S LARGEST INDEPENDENT TRANSFORMER MAKERS**

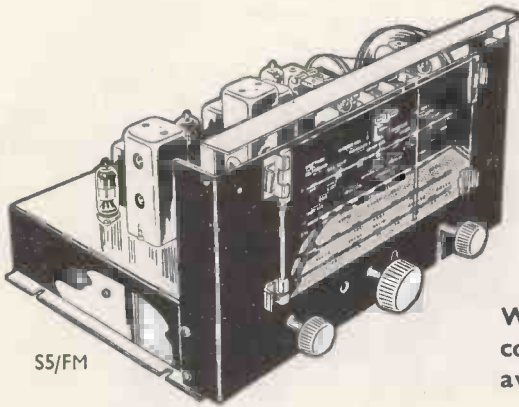

S5/FM

An illustrated leaflet on this and other models is available on request to:—

# THE TUNER

of the

## FUTURE with a FUTURE

We are pleased to introduce the first comprehensive AM/FM Tuner to be made available in this country.

The V.H.F. Frequency Modulation channel uses an R.F., F.C., 2 I.F. and Ratio Detector with A.V.C. based on the stable drift free circuitry already well known in the FM81. The Amplitude Modulation channel using an R.F. amplifier, Delayed amplified A.V.C. and variable selectivity on Short, Medium, and Long Wavebands ensures that the S5/FM will give the best possible fidelity on all its ranges.

A Cathode Ray tuning indicator is fitted and operates on all channels.

**C. T. CHAPMAN (Reproducers) LTD.**  
 RILEY WORKS, RILEY STREET, CHELSEA, S.W.10.

FLAXman 4577/8

Export Enquiries Invited.

## Simon is Sound

When you listen to a Simon Portable you're hearing sound Recording at its lively best. Ask your dealer for a demonstration. Try its simple controls. Hear its faultless reproduction of speech and music—remember that for P.A. or record reproduction you can use the high fidelity amplifier independently of the recorder.

SIZE:..... 18in. x 15in. x 10in.

LOUDSPEAKER:..... 6 $\frac{1}{2}$ in. built-in Monitor.

POWER SUPPLY:..... 200/250 v. 50 cycles A.C.

INPUT CHANNELS:..... High impedance for microphone;  
 low or high impedance for radio

POWER CONSUMPTION:..... 100 watts approx

RESPONSE:..... 50-12,000 c.p.s.  $\pm$  3db



**PORTABLE TAPE RECORDER 79 GNS**  
 MODEL SP/1

H.P. FACILITIES WITH PLEASURE

Ask for illustrated literature  
 and Information Sheet TI/6.

**SIMON SOUND SERVICE LTD.** (Dept. W.),  
 48-50 GEORGE ST., LONDON, W.1. Phone: WELbeck 2371 (5 lines)

- ★ Monomaster Finger-tip control
- ★ 2-stage capstan
- ★ Three motor drive
- ★ 10 watts push-pul. output
- ★ Simple loading

- ★ Fast rewind and wind-on

Servo self-energising brakes provide very rapid stop from full speed



*The full range  
of the World's finest  
record playing equipment  
is exhibited on stand*

**64**

*at the*  
**R.E.C.M.F. EXHIBITION**

**Garrard**  
**record playing units**

THE GARRARD ENGINEERING & MANUFACTURING CO. LTD.



# OSCILLOSCOPE MODEL 2300

This Model meets the need for a compact and robust instrument in which nothing has been sacrificed in order to achieve true portability. It has many of the facilities required in the laboratory as well as ruggedness demanded in the field. Note these features:

- Cathode Ray Tube diameter  $2\frac{3}{4}$  in.
- Square Wave Response adequate for Television synchronising wave-forms.
- Direct-coupled X and Y Amplifiers.
- Hard-valve Time Base-range 7 c.p.s. to 50 Kc/s.
- Deflection Sensitivity 50 mV. R.M.S./cm.
- Trace Expansion control from zero to 15in.
- Frequency Response D.C. to 3 Mc/s.
- Weight:  $6\frac{1}{4}$  lbs. Size:  $7\frac{1}{4}$  x  $4\frac{3}{4}$  x 7 $\frac{1}{4}$  in.



Full details of this and other instruments on application to:

**INDUSTRIAL ELECTRONICS** MAGNET WORKS  
DERBY ROAD, EAST SHEEN, LONDON, S.W. 14. Phone: PRO 8211

## Industry is Solving Valve Testing Problems

WITH THE

**Mullard** HIGH SPEED VALVE TESTER



Industries which deal extensively with radio and other electronic equipment are finding the Mullard High Speed Electronic Valve Tester ideal for routine checks. This instrument provides the quickest method of checking large quantities of valves, and can be operated if necessary by non-technical personnel after only a few minutes' instruction.

Write for full details and a copy of the folder "High Speed Testing in Industry" to Department E.V.D. at the address below.

# Mullard



MULLARD LTD., CENTURY HOUSE, SHAFTESBURY AVENUE, W.C. 2



**NEW**  
*and*  
**SUPERB...**

THE *Goldring*  
**VARIABLE RELUCTANCE**  
**CARTRIDGE** N° 500

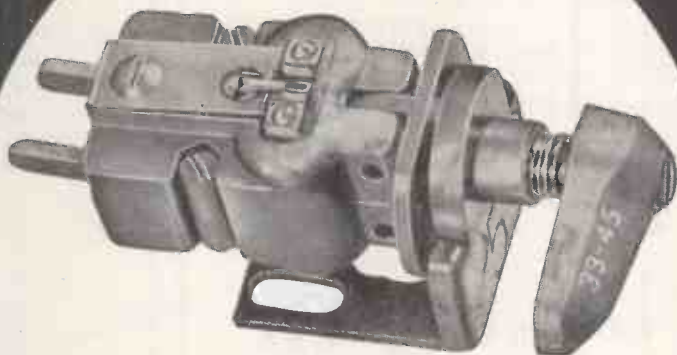

See Technical Report  
January 1955 of the Gramophone  
\*Service note now Available

*Magnificent in  
performance . . . it meets every  
challenge of the most  
discriminating ear*

**THE GOLDRING MANUFACTURING CO. (GT. BRITAIN) LTD.**  
49-51A, DE BEAUVOIR ROAD, LONDON, N.1 Telephone: *CLIssold 3434*

# ACCLAIMED... BRITAIN'S FINEST AUDIO REPRODUCER



Type T.P.I. £96 as illustrated. Finished walnut or light oak. Ex works.

- ★ Built as a musical instrument, sounds like a musical instrument.
- ★ Entirely new development in electrical-mechanical-acoustical system.
- ★ The most efficient reproducer of audio frequencies in the world with a single drive unit/compound horn housing.
- ★ Now used by Television, Broadcasting and Recording Studios throughout the World, as standard monitor.

LOWTHER  
F.M. TUNER

Tunable over V.H.F. Band II. Quality reception guaranteed from Wrotham and other sites when ready.



Price £22  
Plus purchase tax £7.6.4

### LOWTHER MOVING COIL PICK-UPS

- Fitted with diamond stylus. Std. or L.P. .... £9/10/- (plus £3/3/3 P. Tax)
- Fitted with sapphire stylus. 33½ and 45 r.p.m. or 78 r.p.m. .... £5/10/- (plus £1/16/7 P. Tax)

THE LOWTHER MANUFACTURING COMPANY, LOWTHER HOUSE, ST. MARKS RD., BROMLEY, KENT, ENGLAND  
Tel.: RAVensbourne 5225

## TELC ON N E C T O R S

**co-axial plugs and sockets**

These connectors enable identical cables to be joined together, or flexible cables to be joined to their lead-sheathed counterparts. They are fully waterproofed and suitable for use up to 3,000 Mc/s. The flange may be fitted to either half for passing cables through panels.

Illustrated is the 53/29M Plug and 53S/29M socket, for use with PT29M cable; also the 53C panel-mounting socket for terminating cable runs and the 53S protective cap for excluding dust and moisture.

*All types are readily available in various sizes and combinations.*



## TELCON RF

THE TELEGRAPH CONSTRUCTION & MAINTENANCE CO. LTD  
Head Office: 22 Old Broad Street, London, E.C.2.  
Tel: LONDON Wall 7104  
All enquiries to: Telcon Works, Greenwich, S.E.10.  
Tel: GREenwich 3291



**cables**



# ANNOUNCE

## The release of the Oak 12K switch type television tuner

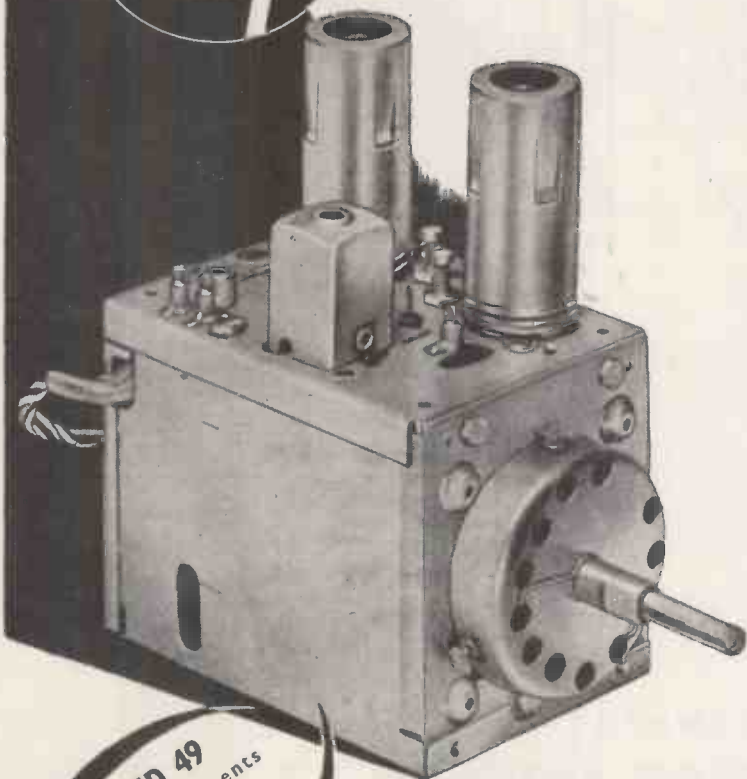

**STAND 49**

Radio Components  
Exhibition  
Grosvenor House  
19th-21st April

**S**PECIFICALLY designed for the British market, and based on the well-proved NSF-OAK rotary switch principles, this switch-type cascade amplifier television tuner reflects, once again, the consistently high quality for which all NSF-OAK products are

renowned. Two models are now in production, the 12K13 and the 12K14 (with provision for U.H.F. reception), both of which cover all 13 channels in Bands I and III.

Manufacturers can obtain full particulars on application.

*Sole licensees of Oak Manufacturing Company, Chicago*

**NSF LIMITED · KEIGHLEY · YORKS**

London Office: 9 Stratford Place, W.1 Phone: Mayfair 4234



# ORYX

MINIATURE  
SOLDERING  
INSTRUMENTS

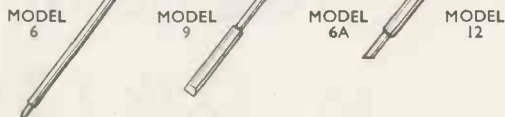

AS LONG  
AS THIN  
AS LIGHT  
AS A PENCIL

Heats up in 30 seconds.

Robust construction, no ceramics or mica to break or flake.

Greatest efficiency, elements situated under bits.

Heat-capacity ample for use on production lines.

Sole Distributors

**ANTEX** 3, TOWER HILL,  
LONDON, E.C.3.

Phone: ROYal 4439. Grams: (Overseas) "Antexlim London"

SUPPLIERS TO H.M. & FOREIGN GOVERNMENTS, LEADING ELECTRONIC, HEARING AID, INSTRUMENT, RADAR, RADIO, T.V. & ELECTRO MEDICAL MANUFACTURERS, HOSPITALS & UNIVERSITIES THROUGHOUT THE WORLD

| Model | Consumption | Voltage         | Bit Diameter   | Weight   | Length | Price | Spare Bits |
|-------|-------------|-----------------|----------------|----------|--------|-------|------------|
| 12    | 12 watts    | 6, 12, 24 or 50 | 3/16" (4.8 mm) | 0.5 oz   | 6 1/4" | 25/-  | 2/-        |
| 11*   | 10 watts    | 6 only          | 5/32" (4 mm)   | 0.5 oz.  | 6"     | 35/-  | 7/6        |
| 9     | 8.3 watts   | 6, 12 & 24      | 5/32" (4 mm)   | 0.25 oz. | 6"     | 25/-  | 1/8        |
| 6A    | 6 watts     | 6 only          | 3/32" (2.4 mm) | 0.25 oz. | 6"     | 25/-  | 1/8        |
| 6     | 6 watts     | 6 only          | 1/16" (1.6 mm) | 0.25 oz. | 6"     | 25/-  | fixed bit  |

\* Model 11—Special High Temperature Model.

## AIR-DAMPED ANTI-VIBRATION MOUNTS

of exceptional performance:  
FOR THE PROTECTION OF AIRBORNE EQUIPMENT



- Superior vibration isolation.
- Improved shock absorption.
- Low permanent set and drift.
- Operation over wide temperature range.
- Minimum side sway.
- Wide load range with uniform performance.

Air-damped BARRYMOUNTS have been specially developed to provide assured protection for sensitive equipment against shock and vibration. An outstanding feature is their remarkably uniform performance over the full range of rated load variation. Over 1,000,000 BARRYMOUNTS go into use every year for the protection of every type of air-borne equipment, from the lightest and most delicate instruments and electronic devices to apparatus up to 140 lbs. weight. There are also BARRYMOUNTS available for specialised vehicle-borne and ship-borne equipment applications.

Air-damped BARRYMOUNTS are supplied in a wide range of sizes for Rated Loads of from 0.1 to 35 lbs.

MINIATURIZED BARRYMOUNTS ARE USED IN THE BRISTOL "BRITANNIA"

Made in England under licence from the Barry Corporation of U.S.A.

Write for technical bulletins.

**CEMENTATION (MUFFELITE) LTD.,**

39 VICTORIA ST., LONDON, S.W.1 (Abbey 5726)

# BARRYMOUNTS



# JUNCTION TRANSISTORS

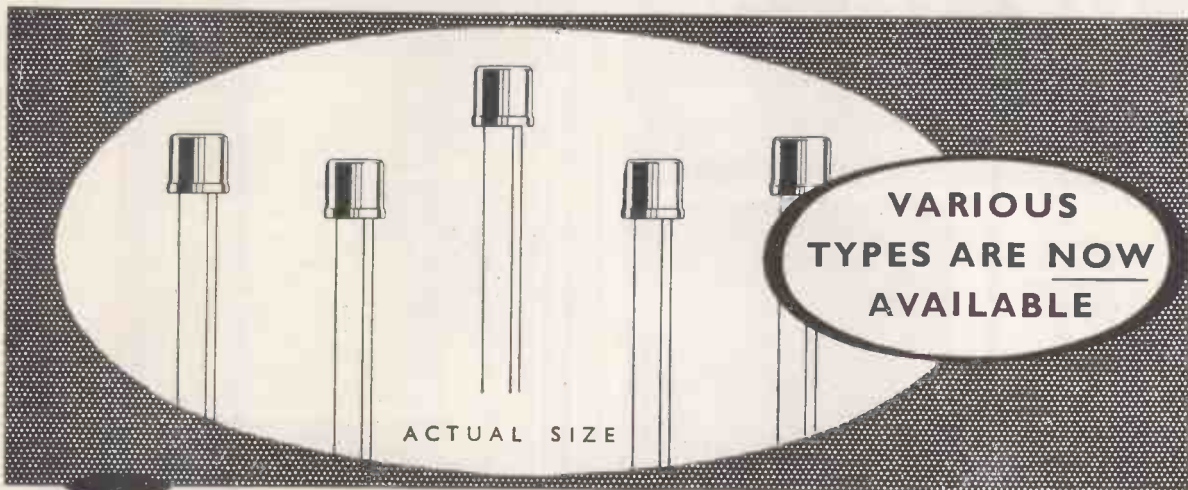

## INDUSTRIAL ELECTRONICS LTD.

EXNING ROAD, NEWMARKET

Technical enquiries to PYE LIMITED · CAMBRIDGE · Tel: 3434

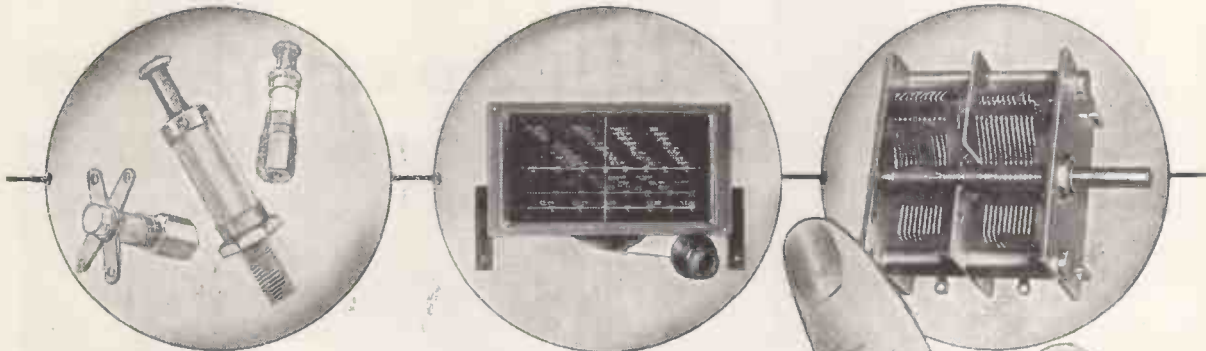

**You can count on these . . .  
 . . . for a reliable performance**

**STAND-OFF INSULATORS.** Working voltage 1,500/5,000. Very high insulating resistance. Ceramic non-tracking. Silicone treated to repel moisture (ideal for tropics). Tag or spill end. We have a full range to cover most needs.

**S.L.8 SPIN WHEEL DRIVE.** A precision slide rule drive complete with 3 band glass scale. The spin wheel drive gives perfect control through ratio 24:1. Fitted with constant velocity coupling, eliminating strain on condenser and providing mechanical and electrical isolation from vibration and noise.

**M.G. GANG CONDENSER.** Available as 1, 2 or 3 gang, 490 p.F. nominal capacity, matched and standardised to close limits. Cadmium plated steel frame. Aluminium Vanes. Low loss non-hygroscopic insulation. Length excluding spindle: 1 gang—1 1/4 in. to 3 gang—3 1/4 in. Price 1 gang, 9/3. 2 gang, 14/-. 3 gang, 18/3.

Write for full details of the complete range of precision-built components for Radio and Television industry.

**JACKSON BROS. (London) LTD.,** KINGSWAY · WADDON · SURREY  
 Telephone: CROYdon 2754-5. Telegrams: WALFILCO, SOUPHONE, LONDON.

# MULTITONE

## SPECIALIZE

in equipment for the DEAF  
and for PHYSIOTHERAPY

### THE ADAPHONE RADIO AND TELEVISION ATTACHMENT

enables the deaf to hear the programmes without disturbance to others.



### A WIDE RANGE OF HEARING AIDS

including the latest 4-stage ALL-TRANSISTOR instrument with Automatic Volume Compression.



### EARPHONES, PILLOWPHONES, MICROPHONES AND CONTROL BOXES

for Hospital Radio, Churches and other group installations.

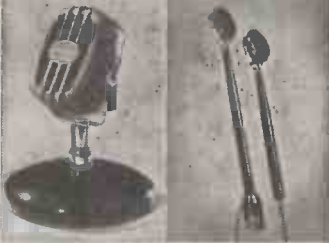

### GROUP HEARING AIDS

for Schools for the deaf.



### ELECTRO-MEDICAL APPARATUS

The Multitone Portable Short-Wave Unit as shown here and a wide range of therapeutic and diagnostic instruments.

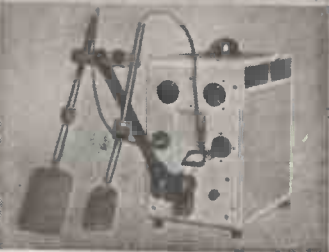

Inquiries should be addressed to

**MULTITONE ELECTRIC CO. LTD.**

223-227 St. John Street, London, E.C.1.

PIONEERS IN SOUND AMPLIFICATION

## M. R. SUPPLIES Ltd.

For high quality materials at the most attractive prices. Rapid delivery from the diligent and enthusiastic service. All prices nett.

**DECADE RESISTANCE BOXES.** Total resistance 210 ohms in 10 ohm steps on two radial arms. Fitted m/coil galvo. In first-class condition in teak portable case 16in. x 7 1/2in. x 8 1/2in. (cases soiled on outside). A few at 65/- (des. 2/8).

**DUAL ELECTROMAGNETIC COUNTERS.** Operational 20/24 v. D.C. (or 50 v. A.C.) and fitted with manual re-set. Each contains two separately energized counters each counting up to 9999 (speed up to 1,000 operations per minute). In cylindrical housing 3 1/2in. dia. by 5 1/2in. deep, suitable for panel mount. Brand new, each in moisture-proof pack. 37/6 (des. 2/-).

**EXTRACTOR FANS.** 200/250 v. A.C. (induction motor—no interference). With mounting frame and back grille, ready for easy mount. 5in. impeller (12,000 c. ft./hr.), 25/5/-, with 10in. impeller (15,000 c. ft./hr.), 25/12/6 (des., either, 2/8).

**MICROAMMETERS** (first-class makers) 0/50 microamps, 1st grade m/coil in projection housing 3 1/2in. dia. by 4 1/2in. prof., 52/6 (des. 1/6).

### MOTORS AND GEARED MOTOR UNITS

Immediate delivery from the largest stockists in London.  
**ONE-HALF H.P. MOTORS**, brand new, capacitor/induction. 230 v. 50 c. 1 ph. ball bearings, 1,425 r.p.m., reversible, shaft 1/2in. dia. by 2 1/2in. prof. Very special limited offer, 27/5/- (des., U.K., 7/6).

**GEARED MOTORS**, 220/240 v. 50 c. 1 ph., capacitor/induction, by best makers, continuously rated. Final shaft 300 r.p.m. (10lb./in. final torque) and motor shaft 1,440 r.p.m. brought out for use. Overall length 7 1/2in. Leads brought out for reversing. Splendid opportunity, 24/10/- (des. 2/6).

**GEARED MOTORS.** Large choice of brand new units, off the shelf! All with leads brought out for reversing, all continuous rated.—Series wound, 220/240 v. A.C./D.C. final speed 100 or 50 r.p.m., overall length 9 1/2in., either 25/17/6 (des. 2/6). Final speed 10 or 1 r.p.m., overall length 8 1/2in., either 23/18/6 (des. 2/6). Capacitor/Induction, 100 r.p.m., 46 r.p.m., 33 r.p.m. and 17 r.p.m., with capacitor, 28/17/6 (des. 2/6). Also Cap./Ind. High duty models, 60 r.p.m. (35lb./in.), overall length 8 1/2in., 210/18/6, also same model 20 r.p.m., same price. Also 10 r.p.m. and 1 r.p.m. (80 lb./in.), overall length 10 1/2in., either 214/10/- (des. 5/-). And many others. Please send us your FEP Geared Motor enquiries. We are supplying many of the large industrial firms.

**CAPACITOR/INDUCTION MOTORS** (Croydon), 220/240 v. 50 c. 1 ph. rated 1/40th H.P., 1,400 r.p.m., fitted 1 1/2in. pulley, in original cartons, with correct capacitor, 55/- (des. 2/6). Also series wound, 1/20th H.P., 220/240 v. A.C./D.C., 4,000 r.p.m., ideal for cine projectors, stirrers, sewing machines, etc., 23/15/- (des. 2/-).

**SEWING MACHINE MOTOR OUTRITS** (Complete). Really high quality job at about half usual price. 200/250 v. A.C./D.C., including motor, foot control, needle light, belt, etc., with instructions for easy installation on any machine, 28/15/- (des. 2/6).

**SMALL GEAR BOXES.** Double worm gear, 300/1 reduction, in die-cast housing 2 1/2in. x 2 1/2in. x 2 1/2in. Final shaft 1/2in. dia. by 1 1/2in. prof. Ball bearings, transmission up to 1/10th H.P., 45/- (des. 1/6).

**SYNCHRONOUS ELECTRIC CLOCK MOVEMENTS.** (Again in stock!) 200/250 v. 50 c., with spindles for hours, minutes and central seconds hands, in plastic dust cover 3 1/2in. dia., 2 1/2in. deep, with dex, ready for use, 27/6 (des. 1/-). Set of three hands, in good style, for 5/7in. dial, 2/-.

We are stockists of Philips Variable Transformers, Stuart Electric Pumps, G.E.C. Metal Cone Speakers.

**M. R. SUPPLIES, Ltd., 68 New Oxford St., London, W.C.1.**

Telephone: MUSeum 2958

## BROOKES Crystals

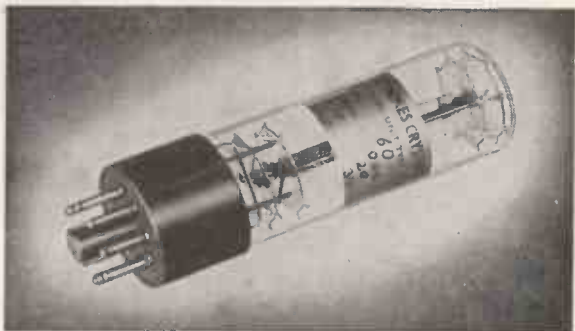

### mean DEPENDABLE frequency control

Illustrated above is a Type OB Crystal Unit with a frequency range of 50-110 kc/s Frequency Tolerance ± .005% of nominal at 20°C.

ALL Brookes Crystals are made to exacting standards and close tolerances. They are available with a variety of bases and in a wide range of frequencies. There is a Brookes Crystal to suit your purpose—let us have your enquiry now.



## Brookes Crystals Ltd.

Suppliers to Ministry of Supply, Home Office, B.B.C., etc.  
181/3 TRAFALGAR ROAD, LONDON, S.E.10  
Phone: GREENwich 1828 Grams: Xtals, Green, London

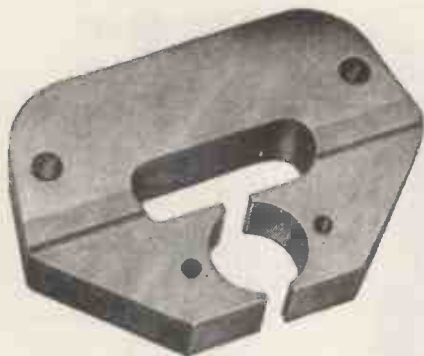

# MUREX 'SINCOMAX' PERMANENT MAGNETS are used in all TAYLOR ELECTRICAL INSTRUMENTS

Yet another example of the use of Murex 'Sincomax' Magnets where the need is for high flux density and magnetic stability. In this application, as in many others, Murex Sintered Magnets continue to give accurate and reliable service.



Photographs by courtesy of Taylor Electrical Instruments Ltd. of model 88a Multirange Measuring Meter, 20,000 o.p.v. D.C., 2,000 o.p.v. A.C., and model 77a Multirange Universal Test Meter, 20,000 o.p.v. D.C., 5,000 o.p.v. A.C.

**MUREX LIMITED** (Powder Metallurgy Division)  
**RAINHAM • ESSEX • Rainham, Essex 3322**  
 LONDON SALES OFFICE: CENTRAL HOUSE,  
 UPPER WOBURN PLACE, W.C.1 EUSon 8265

## RD JUNIOR

### AMPLIFIER AND CONTROL UNIT

Designed solely as the nucleus for domestic high fidelity installations, the RD JUNIOR has, since its introduction only some four months ago, already gained an enviable reputation both in this country and abroad. Representing the finest value in contemporary high fidelity equipment it combines precise workmanship with a flexibility of control and standard of performance never before attained in this price class.

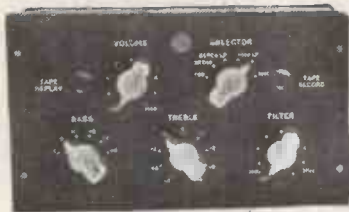

**RECORD NEWS. DEC. '54 :-**  
 "... the 'RD JUNIOR' is something out of the ordinary. Everything about it is right, from appearance and performance to price."

#### MAIN FEATURES

- ★ Power Output 8-10 watts ("UL" Class "A" p.p. EL84s)
- ★ Distortion .12% at 8 watts
- ★ Frequency Response  $\pm .25$  DB 20-30,000 cps
- ★ 20 DB NFB
- ★ Hum and Noise—80DB below 8 watts
- ★ O.P.T. employs C-core lamination material
- ★ Simplified speaker matching
- ★ Ample Spare Power (40m/A H.T.)
- ★ Four accurate playback characteristics
- ★ Two RADIO Inputs
- ★ Simplified pick-up matching
- ★ High Input Sensitivity
- ★ INDEPENDENT VARIABLE LOW PASS FILTER
- ★ Switched Bass and Variable Treble Controls
- ★ Tape Record and Replay Jacks
- ★ Choice of Panel Colours—BLACK, IVORY, BRONZE, or RED
- ★ TWO-YEAR GUARANTEE:

PRICE COMPLETE

**£25**

Recommended Accessories:—RD JUNIOR CORNER HORN, fitted either Goodmans AXIOM 102 or Wharfedale SUPER 8 AL; Collaro STUDIO "P" pick-up.

12-page Illustrated Booklet post free on request.

# ROGERS DEVELOPMENTS Co.

Trade and Export enquiries invited.  
 "RODEVCO HOUSE," 116, Blackheath Road,  
 Greenwich, London, S.E.10. TIDeway 1723.

an open  
*Invitation*  
to all manufacturers

*of*

**Photo Flash Equipment**

**Deaf Aids**

**Private Telephone  
Installations**

**Amplifiers**

**D.C. Power Units**

**Spot Welding Equipment**

**Test Gear**

**Magnetisation Equipment**

You are invited to regard the **TECHNICIANS** at DALY as a part of your own technical staff. Non-standard components are invariably a source of worry, therefore the Electrical Industry find the DALY "made-to-measure" service for individual requirements specially helpful and a great time-saver.

For **URGENT** problems a telephone request will bring us post haste to your factory for consultation without obligation—and you will find our readiness to help both valuable and economic.

*DALY ELECTROLYTICS for ELECTRONICS and COMMUNICATIONS . . . MOTOR START . . . RADIO and T.V. . . are in great demand throughout the world; send for appropriate pamphlet.*

# DALY

## ELECTROLYTIC CAPACITORS

CONDENSER SPECIALISTS FOR OVER 20 YEARS

**DALY (CONDENSERS) LTD., WEST LODGE WORKS,  
THE GREEN, EALING, LONDON, W.5**

Phone: EALING 3127-8-9. Cables: DALYCON, LONDON

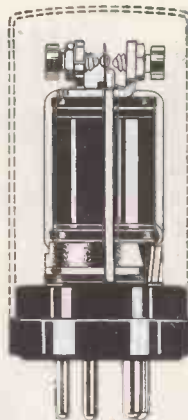

Actual Size

## Announcing the new Manning-Carr P.53C Miniature Polarised Relay

Now in dust-proof heavy gauge anodised aluminium can and miniature 5- or 9-pin base for plugging in, thus protecting the relay and obviating wiring.

(Original version still available.)

**BOTH TYPES FITTED WITH PLATINUM POINTS IF SPECIFIED**

**DATA**—A Sensitivity of 25 milli-watts and capable of handling mains voltage on the contacts with alternating currents up to 0.25 amps. Being polarised it has the advantage that the Armature contact can be biased to lock in either direction by suitable adjustment of the contact screws which provides a useful facility where pulse operation is required. Speed of operation is also high and the Relay will follow A.C. frequency of 50 c.p.s. Resistance up to 7,000 ohms which is acceptable for Anode circuits. Alternatives to specification if required. Sole Concessionaires.

**POST OFFICE TYPES 3,000 AND 600 RELAYS**

to specification. Tropicalising, impregnating and Services jungle finish if required. Delivery 3-4 weeks.

Manufacturers to H.M. Govt. Depts. and leading contractors

**L. E. SIMMONDS LTD.**  
5, BYRON ROAD, HARROW, MIDDX.

Telephone: Harrow 2524-0315.

## AUTOMATIC COIL WINDING MACHINE

Type A1/1. (25-50 S.W.G.) Type A1/X. (19-46 S.W.G.)

This machine is the most modern on the market and it possesses many exclusive refinements including:

- Dustproof construction throughout.
- Provision for winding up to four coils simultaneously.
- Micrometer traverse setting.
- Wire Gauge Indicator engraved with various wire gauges to which the machine can quickly be set.
- All steel parts are either cadmium or chromium plated.
- Instantaneous re-set counter reading up to 100,000 Turns.
- Entirely new Wire Tensioning Stand to hold two reels of wire.

*We will be pleased to send you an illustrated leaflet giving a full technical specification on request.*

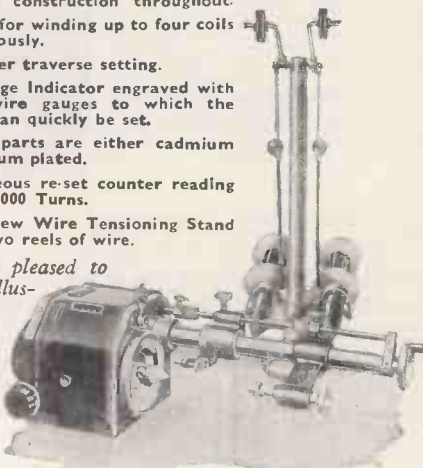

**KOLECTRIC LTD**

**73 UXBRIDGE ROAD, EALING, LONDON, W.5**

Ealing 8322



# A new wide range L.F. Valve Voltmeter

TYPE GM. 6017

For measurement of voltage in the acoustic and ultra-sonic field

## FEATURES

- 1 0-10M/V to 0-300V in 10 ranges
- 2 Frequency range 2 c/s-200 kc/s
- 3 3 internal calibrating voltages available
- 4 Can be used as separate wide band amplifier
- 5 Fully stabilized mains unit

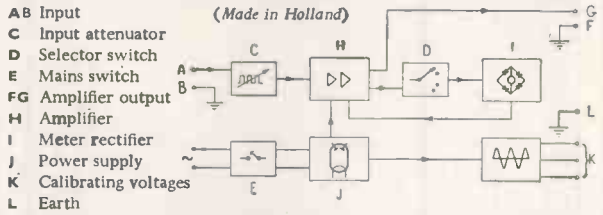
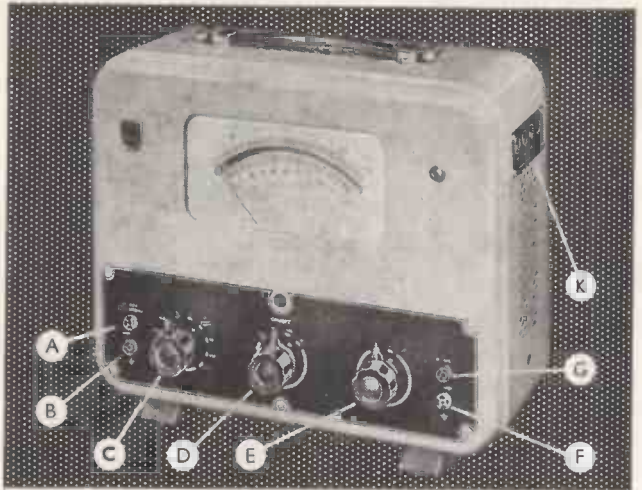

For full technical specifications please write to:—

 **PHILIPS ELECTRICAL LIMITED**

INDUSTRIAL PRODUCTS DIVISION · CENTURY HOUSE · SHAFTESBURY AVENUE · LONDON · WC2 (PM10079)

## THE I.A.L. BEACON MONITOR RECEIVER

The value of navigational aids—dependent on accurate and continuous operation—can only be assured by constant checking. IAL Beacon Monitor Receivers (which fully conform to ICAO standards) provide automatic monitoring of high- and low-power MF beacons. The constant watch they keep is a vital link in the navigational chain—their vigilance providing maximum homing safety.

*International Aeradio provides the following services to aviation: Installation, operation and maintenance of telecommunications, radio and radar aids to navigation; airport management; air traffic control and Aeradio training schools; briefing; Aeradio and navigation consultants; systems planning; Aeradio engineering layouts; flight guides; trunk route manuals; maps, charts and other navigational needs.*



## INTERNATIONAL AERADIO LIMITED

40 PARK STREET, LONDON, W.1.

Telephone: HYDE PARK 5024

Cables: INTAERIO, LONDON

# PREMIER RADIO CO.

B. H. MORISS & CO. (RADIO) LTD. EST. 40 YRS.

(Dept. W.W.) 207 EDGWARE RD., LONDON, W.2. Tel.: AMBassador 4033 & PADdington 3271

MAY BE  
BUILT FOR  
**£30.0.0**  
Including all valves  
(plus cost of CRT)

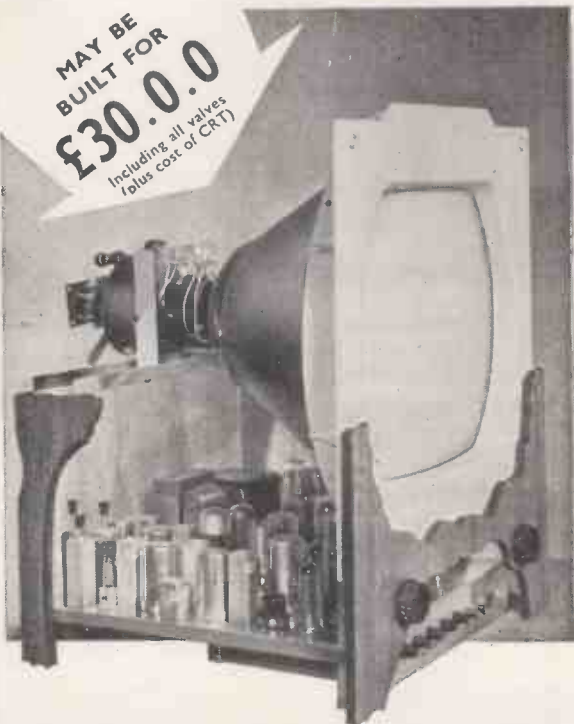

THE COMPLETE TELEVISOR IS SAFE TO HANDLE, BEING COMPLETELY ISOLATED FROM THE MAINS BY A DOUBLE WOUND MAINS TRANSFORMER. ALL PRESET CONTROLS CAN BE ADJUSTED FROM THE FRONT, MAKING SETTING UP VERY SIMPLE.

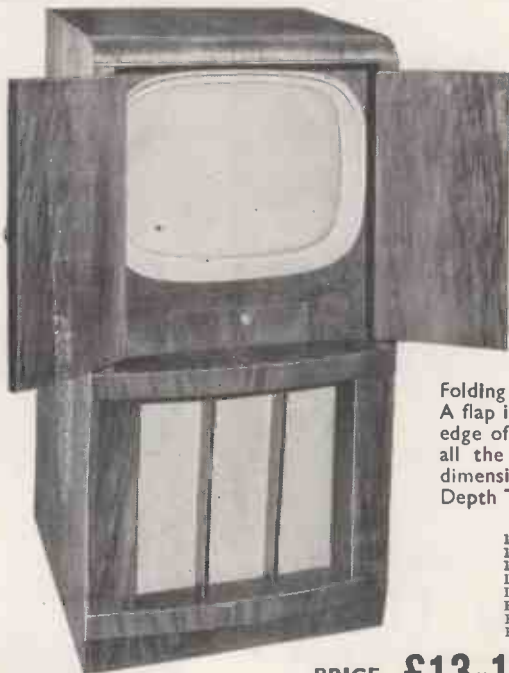

## The NEW PREMIER TELEVISOR

SUITABLE FOR USE WITH THE ENGLISH ELECTRIC CATHODE RAY TUBE T901 OR ANY POPULAR WIDE ANGLE TUBE

Brief Technical Details are as follows:

20 valves (plus tube) Superhet Receiver, tunable from 40-68 Mc/s without coil or core changing. Wide Angle scanning Flyback EHT giving 14 kV. Duomag Focalliser, permanent magnet focusing with simple picture centring adjustments, suitable for any wide angle Tube, may also be used with a 12in. Tube with very minor modifications.

**VISION CIRCUIT.** Common RF Amplifier, single valve frequency changer, two IF stages, Video Detector and Noise Limiter followed by special type of Video Output Valve. ALL COILS PRE-TUNED ASSURING ACCURATE ALIGNMENT AND EXCELLENT BANDWIDTH.

**SOUND CIRCUIT.** Coupling from anode of frequency changer, two IF stages, Double Diode Triode detector and first LF Amplifier, Diode Noise Limiter and Beam type Output Valve, feeding a 10in. Speaker. ALL COILS PRE-TUNED.

**TIME BASES.** 2 valve sync. Separator, giving very firm lock and excellent interlace.

**LINE TIME BASE.** Blocking Oscillator using a pentode driving a high efficiency output stage comprising Ferroxcube Cored Output Transformer with Booster Diode.

**FRAME TIME BASE.** Blocking Oscillator driving a Beam Output Valve coupled through a Transformer to the high efficiency FERROXCUBE Cored Scanning Coils.

**POWER PACK.** Double wound Mains Transformer supplying all L.T. and H.T. using two full-wave Rectifiers.

The Televisor may be constructed in 5 easy stages: (1) Vision, (2) Time Base, (3) Sound, (4) Power Pack, (5) Final Assembly. Each stage is fully covered in the Instruction Book, which includes layout, circuit diagrams and point-to-point wiring instructions.

The Instruction Book also includes full details for converting existing Premier Magnetic Televisors for use with modern wide angle tubes. All components are individually priced.

Instruction book 3/6, Post Free.

## PREMIER TELEVISOR CONSOLE CABINETS For 14", 16" and 17" Televisors

A handsome Walnut Cabinet that will be a fitting housing for a first-class Televisor.

Folding doors are fitted to cover the Cathode Ray Tube when not in use. A flap is provided which gives access to the preset controls on the front edge of the Chassis. A baffle board suitable for a 10in. Loudspeaker and all the necessary Tube and Chassis bearers are included. The overall dimensions of the Cabinets are the same: Height 38½in. Width 19in. Depth Top 19in. Depth Bottom 21in.

### TUBE ESCUTCHEONS

|   |                        |
|---|------------------------|
| 17in. White Moulded .....                                   | 21/- (pkg. & post 1/6) |
| 17in. Bronze Moulded, complete with Protective Glass .....  | 48/- (pkg. & post 2/6) |
| 14in. Black Moulded .....                                   | 7/8 (pkg. & post 1/-)  |
| Dark Screen Filter suitable for 14in. Tube .....            | 21/- (pkg. & post 1/6) |
| Dark Screen Filter suitable for 16in. and 17in. Tubes ..... | 25/- (pkg. & post 1/6) |
| Polyethylene Mask for E.E.T.901 .....                       | 43/4 (pkg. & post 2/6) |
| Rubber Ring (anti-Corona) for E.E.T.901 .....               | 6/8                    |
| Polystyrene Shroud for E.E.T.901 .....                      | 6/2                    |

PRICE **£13-10-0** PLUS 21/- PKG. & CAR. H.P. TERMS: DEPOSIT **£3.7.6** & 12 MONTHLY PAYMENTS OF 18/9

TERMS OF BUSINESS: Cash with order or C.O.D. over £1. Please add 1/- for Post Orders under 10/-, 1/6 under 40/-, unless otherwise stated.

# PREMIER RADIO COMPANY

Limited supplies of C.R. TUBES

**VCR517C**

6 1/2 in. picture. This tube is a replacement for the VCR97 and VCR517. Guaranteed full size picture. Price 35/- plus 2/6 pkg., carr., ins.

**VCR516**

9 in. blue picture. Heater volts 4 anode 4 kV. In manufacturer's original carton. £1/19/6, plus 5/- pkg., carr., ins.



ALL BRAND NEW

**CABINETS—PORTABLE**

**Model PC/1**

Brown Rexine covered

Overall dimensions 15/11

15 in. x 13 in. x 5 in.

Clearance under lid when closed 2 1/2 in.

**Model P2/C**

Grey Lizard Rexine covered

Overall dimensions 45/-

15 in. x 13 in. x 6 in.

Clearance under lid when closed 3 in.

**Model PC/3**

Rexine type covering in various colors

Overall dimensions 69/6

16 in. x 14 in. x 10 in.

Clearance under lid when closed 6 1/2 in.

All the above Cabinets are supplied with Panel, Carrying Handle and Clips.



Packing and Postage 2/6.

**UNITELEX 5-watt Amplifier Type MG4/MG4A**

For Gramophone and Microphone operation, enclosed in metal case, output suitable for 15 and 3 ohms Speakers, switched input 2VA miniature Valves, separate treble and bass tone controls, for A.C. mains 200/250 v. Price, enclosed in metal case, £9/19/6. Price, less metal case, £8/18/6. Packing and Postage 7/6.

SPECIAL OFFER!

**CONSOLE TV CABINET**

Ex-Baird at £10.10.0

Send for copies of photographs.

**RECTIFIERS**

| E.H.T. Penoid Type S.T.C. |          |         |      |
|---------------------------|----------|---------|------|
| Type K3/25                | 650 v.   | 1 mA.   | 4/7  |
| " K3/40                   | 3.2 kV.  | 1 mA.   | 6/-  |
| " K3/45                   | 3.6 kV.  | 1 mA.   | 8/2  |
| " K3/50                   | 4 kV.    | 1 mA.   | 8/8  |
| " K3/100                  | 8 kV.    | 3 mA.   | 14/8 |
| " NS/160                  | 12 kV.   | 1 mA.   | 21/6 |
| " K3/180                  | 14.4 kV. | 1 mA.   | 24/6 |
| H.T. Type S.T.C.          |          |         |      |
| Type RM1                  | 125 v.   | 60 mA.  | 4/-  |
| " RM2                     | 125 v.   | 120 mA. | 4/6  |
| " RM3                     | 125 v.   | 125 mA. | 5/6  |
| " RM4                     | 250 v.   | 250 mA. | 18/- |
| L.T. Type Full Wave       |          |         |      |
| 6 v. 1 amp.               |          |         | 4/-  |
| 12 v. 1 amp.              |          |         | 8/-  |
| 12 v. 2 amp.              |          |         | 10/9 |
| 12 v. 4 amp.              |          |         | 15/- |

**BATTERY CHARGERS**

200-250 v. A.C. Will charge 2 v. 6 v. and 12 v. Car Battery at 1 amp. Housed in strong metal casing. Finished in Green Hammered enamel. Size 6 in. long, 3 1/2 in. wide, 3 1/2 in. high. Guaranteed 12 mths. The above unit is manufactured by PREMIER and does not contain Ex - Govt. components. Plus 2/6 P. and P. **39/6**



**BATTERY CHARGER KITS**

All incorporate metal rectifiers. Transformers are suitable for 200-250 v. A.C. cycle mains. Cat. No.

2002 Charge 6 volt accumulator at 1 amp. Resistance, supplied to charge 2 volt Accumulator ..... **13/6**  
 2004 Charges 2, 6 and 12 v. accumulators at 1 amp. **19/11**

**ALUMINIUM CHASSIS 18 s.w.g.**

Substantially made from Bright Aluminium with four sides:

|                         |     |                         |      |
|-------------------------|-----|-------------------------|------|
| 7 x 5 1/2 in. ....      | 4/- | 10 x 9 x 3 in. ....     | 7/-  |
| 7 x 3 1/2 x 2 in. ....  | 3/9 | 12 x 10 x 3 in. ....    | 7/9  |
| 9 1/2 x 4 1/2 in. ....  | 4/3 | 14 x 10 x 3 in. ....    | 7/11 |
| 10 x 8 x 2 1/2 in. .... | 5/6 | 16 x 10 x 3 in. ....    | 8/5  |
| 12 x 9 x 2 1/2 in. .... | 7/- | 16 x 8 x 2 1/2 in. .... | 8/-  |
| 14 x 9 x 2 1/2 in. .... | 7/6 |                         |      |

**ALUMINIUM PANELS 18 s.w.g.**

|                    |     |                    |      |
|--------------------|-----|--------------------|------|
| 7 x 6 in. ....     | 1/3 | 7 x 4 in. ....     | 1/-  |
| 9 1/2 x 6 in. .... | 1/8 | 9 1/2 x 4 in. .... | 1/5  |
| 10 x 9 in. ....    | 2/8 | 10 x 7 in. ....    | 1/11 |
| 12 x 9 in. ....    | 2/8 | 12 x 7 in. ....    | 2/5  |
| 14 x 9 in. ....    | 3/2 | 14 x 7 in. ....    | 2/11 |
| 16 x 9 in. ....    | 3/8 | 16 x 7 in. ....    | 3/5  |
| 20 x 9 in. ....    | 4/8 | 20 x 7 in. ....    | 4/5  |
| 22 x 9 in. ....    | 5/2 | 22 x 7 in. ....    | 4/11 |

**STOP PRESS**

First release of the Famous COMMUNICATION RECEIVER TYPE RA-1B manufactured by the BENDIX RADIO CORP. OF AMERICA, valve line-up 6K7, R.F. Amp., 6L7 1st det., 6K7 Osc., 6K7 1st IF. Amp., 6K7 2nd IF. Amp., 6K7 CW. Osc., 6B7 2nd det., AVC and 1st Audio. 6K6 Audio output. Frequency coverage 0.15 to 1.5 Mcs. (2,000-200 metres) in three bands. 1.8 to 15.0 Mcs. (166-20 metres) in three bands. The frequency coverage on each band is approximately 2/1 giving EXCELLENT BAND SPREAD TUNING. Power requirements are 1.5 amps. at 12 volts and approximately 70 mA. at 225 volts. WRITE FOR FULL DETAILS.

**GRAMPHONE PRE-AMPLIFIER**

Power requirements 200-250 v., 2 mA., and 6.3 v. .3 mA., this may be taken off existing radio. All the components to build the above unit, 22/6, plus 1/6 pkg. and postage.

*Famous Manufacturer's Surplus of*

**ANTI - INTERFERENCE AERIALS**

offered at a fraction of original cost. The aerial is designed for reception of long, medium and short waves, with any ordinary or communications receiver, having an input impedance greater than 1,000 ohms long/medium waves and 150 ohms short waves. The installation discriminates against locally generated electrical interference, especially on the short wavebands. The equipment enables the installation of an 8.3 Mc/s flatly-tuned dipole which operates as a "T" aerial on medium and long waves. The aerial and receiver transformers are intended to be interconnected with a 70 ohms co-axial cable.

**COMPONENT PARTS**

Aluminium Aerial Transformer Assembly. Comprising one each: Aluminium transformer, Transformer clip rubber sucker, 1/2 in. x 1/2 in. brass screw, 4AB x 1/2 in. brass bolt, 4BA nut. Receiver Transformer. Complete with insulators, clips, etc.; porcelain insulators, 2 each, 60ft. insulated aerial wire, 60ft. screened co-axial down lead. Installation instruction leaflet included. LESS CO-AXIAL CABLE & AERIAL WIRE, 15/-, plus 1/6 pkg. and carr. COMPLETE, 35/-, plus 1/6 pkg. and carr.

★ **QUALITY CRYSTAL PICK-UP ROTHERMEL TYPE U48 26/-** Plus 1/6 Pkg. and Carr.

## The New "PREMIER PORTABLE" TAPE RECORDER

USING THE NEW LANE 2-SPEED TAPE UNIT MARK 6  
**COMPLETE 39 GNS CASH**

Packing & Carriage 1 gn.

(Including Reel of Scotch Boy Tape and Microphone)

H.P. Terms: Deposit £10.4.9 and 12 monthly payments of £2.16.11,

or Complete Kit Including All Parts, Valves, Speaker Cabinet, Tape Unit, Reel of Scotch Boy Tape, Rewind Spool and Microphone at **£37.4.0** plus pkg. & carr. 15/-.

H.P. Terms: Deposit £9.6.0 and 12 monthly payments of £2.10.0.

**SPECIFICATION**

- ★ TWO SPEEDS 7 1/2 in. AND 3 1/2 in.
- ★ 7-VALVE HIGH QUALITY AMPLIFIER.
- ★ THREE SPECIALLY DESIGN-ED RECORDING MOTORS.
- ★ INDEPENDENT TREBLE AND BASS CONTROLS.
- ★ 1,200ft. TAPE REELS PROVIDING PLAYING TIMES OF 1 HR. AND 2 HRS.
- ★ MAGIC EYE RECORD LEVEL INDICATOR.
- ★ DROP-IN TAPE LOADING.
- ★ AMPLIFIER MAY BE USED FOR RECORD REPRODUCTION OF HIGH QUALITY.
- ★ EASY FORWARD OR REWIND WITHOUT REMOVING TAPE.
- ★ COMPARTMENT FOR HOUSING MICROPHONE.
- ★ ONE KNOB DECK OPERATION.
- ★ SPECIALLY DESIGNED MICROPHONE BY A LEADING MANUFACTURER.

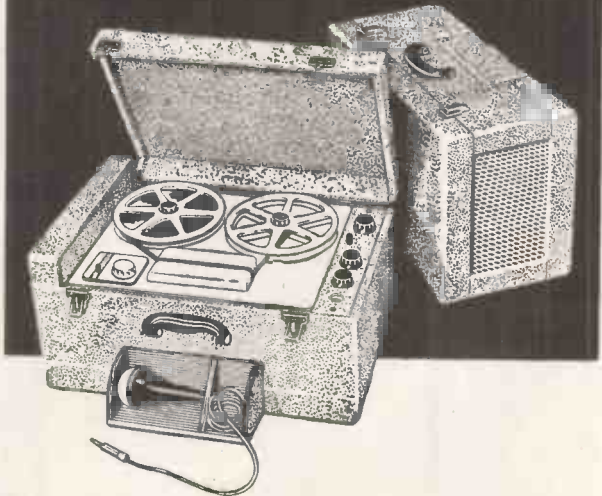

**SEPARATE UNITS CAN BE SUPPLIED AS LISTED BELOW:—**

- Amplifier (built, wired and tested with Speaker). £14/15/-, plus postage and carriage 7/6.
- Hire purchase terms, Deposit £3/13/9 and 12 monthly payments of £1/0/6.
- Amplifier Kit (including Speaker). £11/- plus packing and carriage 5/-.
- Hire purchase terms, Deposit £2/15/- and 9 monthly payments of £1/0/7.
- New Lane 2-speed Tape Unit Mark 6, £18/10/- plus packing and carriage 7/6.
- Hire purchase terms, Deposit £4/12/6 and 12 monthly payments of £1/5/9.
- Portable Cabinet (rexine covered). £4/19/6, plus postage and carriage 5/-.
- Microphone, £2/15/-, plus postage and carriage 1/-.
- Reel Scotch Boy Tape MC2-111 (1,200ft.), £1/15/-, plus packing and carriage 1/-.
- Instruction Booklet, 2/6. Post free.



# PREMIER RADIO COMPANY

## 1155 RECEIVER UNIT

### NEW CONDITION

In original cases complete with 10 valves. Frequency range 18.5 Mc/s. 75 Kc/s. in 5 wave-bands. £11/19/8. Plus 10/8 packing and carriage.  
Hire Purchase Terms: £2/10/11 Deposit and 10 monthly payments of £1.



## POWER SUPPLY UNIT WITH OUTPUT STAGE FOR ABOVE



Jones plugs for connecting the Power Pack to the Receiver are included. The 6V6 output stage complete with Output Transformer and 6in. speaker is built into the unit. Price £25/5/-, plus 9/- packing and carriage. The two above Units together on Hire Purchase Terms: £4/6/2 Deposit and 12 monthly payments of £1/3/11 plus 15/6 pkg. and carriage.

**PUSH-PULL OUTPUT TRANSFORMERS.** 2 x 6V6 into 2/3 ohms, 5/6, post free.

**T.1154. BRAND NEW COMPLETE WITH VALVES.** £3/19/6, post and carriage 7/6.

**METER RECTIFIERS.** Miniature type with leads 1.5 mA., 6/9, post paid.

**AMPLIFIER TYPE A1134A.** Battery operated 2 valves, type VR.21 and VR.35, 9/11, postage and carriage 1/6.

**SLIDER RESISTANCE.** Geared adjustments, 7.5 ohms, 4 a., 12/8, postage and carriage 1/6.

**HEAVY DUTY POWER RESISTANCE.** 17.5 ohms, 8 a., with adjustable tapping 19in. long, 2in. diameter, 10/-, postage and carriage 2/-.

**HEAVY DUTY L.T. TRANSFORMER.** Primary tapped 180-230 volts, 60 cycles. Secondaries 4.2 v. 10 a. 4.2 v. 10 a., 25/-, postage and carriage 2/6.

**ROTOR RESISTANCE.** Wire wound heavy duty 14 k. ohms, 7/6, postage and carriage 1/-.

**VACUUM PUMPS.** For model makers, etc. Ex-B.A.F. Type B3-Mk. III, £2/6, postage and carriage 2/-.

## E.A.R. MULLARD 5-10 AMPLIFIER



PRICE  
**£18.18.0**

Plus postage and packing 7/6.

This Amplifier is based on the Mullard design and incorporates a change-over switch for standard, L.F. records and radio. Plug-in filter supplied, alternative types available. The switched input is fed in on 2 Co-axial Sockets, output is available for 3 to 15 ohms Speakers. Power supply for Pre-amplifier or Radio Unit provided by the Amplifier, H.T. 300 volts 40 mA. and 6.3 volts 2 amps. H.F. Terms are available, Deposit £4/14/6 and 12 monthly payments of £1/6/3.

### SELECTION OF H.P. ITEMS

**GARRARD 301 TRANSCRIPTION UNIT.** Cash Price £25/3/8. Deposit £8/6/-, 12 monthly payments £1/15/- Post and packing 7/6.

**CONNOISSEUR TRANSCRIPTION UNIT.** Cash price £25/15/5. Deposit £8/7/-, 12 monthly payments £1/16/- Post and packing 7/6.

**LEAK TL.10 AMPLIFIER AND PREAMPLIFIER.** Cash price £28/7/-, Deposit £7/2/-, 12 monthly payments £1/19/6. Post and packing 7/6.

**LEAK DYNAMIC PICKUP WITH DIAMOND STYLI.** (A) Cash price £11/9/6, Deposit £2/17/6, 9 monthly payments £1/1/4 (B) With extra head. Cash price £19/5/3. Deposit £4/16/9, 12 monthly payments £1/6/4. Mu Metal Transformer £1/15/- Post and packing 8/-.

**TRUVOX TYPE C AMPLIFIER.** Cash price £16/16/-, Deposit £4/2/-, 12 monthly payments £1/3/8. Post and packing 7/6.

**TRUVOX MK. III DECK.** Cash price £23/2/-, Deposit £5/17/-, 12 monthly payments £1/12/- Post and packing 7/6.

**ELFEO TUNER UNIT MODEL RF/720.** Cash price £15/15/-, Deposit £3/18/9, 12 monthly payments £1/1/11. Post and packing 5/-.

**REGENTONE HANDY GRAM.** Cash price £21. Deposit £5/2/-, 12 monthly payments £1/9/6. Post and packing 7/6.

## RADIOGRAM CHASSIS

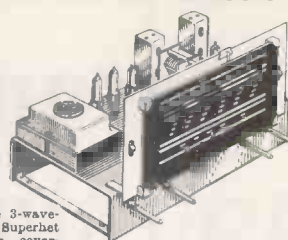

5 Valve 3-wave-band Superhet Receiver covering short, medium and long waves. Using the latest miniature all glass valves, overall chassis size 13in. x 7in. high x 6in. deep, dial aperture 10in. x 4in. **BRAND NEW, READY FOR USE AND GUARANTEED.** Packing and postage 10/-.  
**£10-5-0**  
Or on Hire Purchase Terms, deposit £2/11/3 and 8 monthly payments of £1/1/9.

**CABINET** available for above Chassis in figured walnut lined with white asbestos, size 3ft. wide, 2ft. 8in. high 3ft. 5in. deep, £15/15/-.  
Or on Hire Purchase Terms, deposit £3/18/9 and 12 monthly payments of £1/1/11.  
Packing and Carriage extra.

## GARRARD S5 UNIT

Garrard rim drive 78 r.p.m. complete with magnetic pickup and turntable.  
**£4-19-6**  
Postage and packing 2/6.

## FREQUENCY MODULATION

All components for the Denco F.M. Unit, less Valves.  
Packing and postage 1/6.  
**£4-16-1**

## COMPONENTS AVAILABLE FOR THE MULLARD AND OSRAM DESIGNS.

### Consistency of Performance

# Just one of a bunch . . .

We test our precision resistors on a sampling basis. Here's the performance of one little fellow, taken at random from a batch and loaded at its full rated power for close on 1,000 hours. You'll see from the chart how it stood up to the treatment: a total excursion of 0.036 per cent. and an absolute change of only 0.01 per cent.



## . . . and they're all much alike!

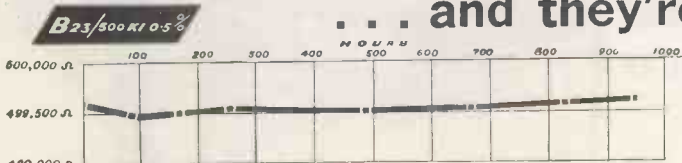

Even our miniature precision resistors are guaranteed a standard tolerance of 0.1 per cent.

Welwyn Precision Wirewound Resistors for

- Long term stability
- Freedom from noise
- Fine performance in tropical conditions



Products include:

- Toroidally Wound Power Potentiometers.
- Pancilmatic High Stability Carbon Resistors.
- Vitreous Enamelled Wirewound Resistors.
- Carbon Composition and Wirewound Potentiometers.
- Insulated High Stability Carbon Resistors.
- High Voltage Composition Resistors.

# Rigorous inspection

*ensures  
faultless  
performance*



*One of a line of testing booths where the final electronic test is carried out.*

Continual, exacting inspection is an important routine at the B.S.R. factories. Throughout the entire production cycle, each Monarch Autochanger is submitted to the most stringent tests for quality, accuracy and performance. Here, the inspector's word is final.

Tests carried out by independent authorities further prove the high standard attained by B.S.R. inspectors. In one such test recently, over 90 years' normal usage was condensed into a few weeks.

The Monarch performed faultlessly throughout the entire period! This exhaustive testing and re-testing is the buyer's finest safeguard, and his guarantee of a lifetime's trouble-free, superlative performance from the Monarch Automatic Record Changer. B.S.R. are today the world's largest manufacturers of autochangers and players outside the U.S.A.

## MONARCH

AUTOMATIC RECORD CHANGER



BIRMINGHAM SOUND REPRODUCERS LTD., MONARCH WORKS, OLD HILL, STAFFS

# Wireless World

RADIO, ELECTRONICS, TELEVISION

*Managing Editor:*

HUGH S. POCOCK, M.I.E.E

*Editor:*

H. F. SMITH

APRIL 1955

## ***In This Issue***

|   |     |
|---|-----|
| Editorial Comment .. .. .   | 151 |
| Tape Selector Mechanism. <i>By J. R. Price and R. A. Frewer</i> ..                      | 152 |
| Tubeless Television? .. .. .  | 153 |
| Alternative London Television .. .. .   | 154 |
| World of Wireless .. .. .   | 155 |
| Components Show .. .. .   | 158 |
| Design for an F.M. Tuner. <i>By S. W. Amos and G. C. Johnstone</i> .. .. .              | 159 |
| Short-wave Conditions .. .. .   | 163 |
| D.C. Stability of Transistor Circuits. <i>By Francis Oakes</i> ..                       | 164 |
| Waveguides as Microwave Links .. .. .   | 168 |
| Propagation on Bands I and III. <i>By F. R. W. Strafford and I. A. Davidson</i> .. .. . | 171 |
| Interference Suppression. <i>By R. Davidson</i> .. .. .                                 | 173 |
| Letters to the Editor .. .. .   | 176 |
| Testing Precision Oscillators. <i>By M. P. Johnson</i> .. .. .                          | 179 |
| Phase-to-Amplitude Modulation. <i>By Bryant D. Virmani</i> ..                           | 183 |
| Geophysical Research. <i>By R. L. Smith-Rose</i> .. .. .                                | 188 |
| Distortion. <i>By "Cathode Ray"</i> .. .. .   | 191 |
| Output Transformer Design. <i>By R. F. Gilson</i> .. .. .                               | 195 |
| Books Received .. .. .  | 196 |
| April Meetings .. .. .  | 197 |
| Random Radiations. <i>By "Diallist"</i> .. .. .   | 198 |
| Unbiased. <i>By "Free Grid"</i> .. .. .   | 200 |

VOLUME 61 NO. 4

PRICE: TWO SHILLINGS

FORTY-FIFTH YEAR  
OF PUBLICATION

**PUBLISHED MONTHLY** (4th Tuesday of preceding month) by ILIFFE & SONS LTD., Dorset House, Stamford Street, London, S.E.1. Telephone: Waterloo 3333 (60 lines). Telegrams: "Ethaworld, Sedist, London." Annual Subscription: Home and Overseas, £1 7s. 0d. U.S.A. \$4.50. Canada \$4.00. BRANCH OFFICES: Birmingham: King Edward House, New Street, 2. Coventry: 8-10, Corporation Street. Glasgow: 26B, Renfield Street, C.2. Manchester: 260, Deansgate, 3.



# VALVES, TUBES & CIRCUITS

## 28. A NEW 25W AUDIO OUTPUT PENTODE

The EL34 is an indirectly-heated octal-based output pentode which is now being added to the Mullard range of audio valves. It has a rated anode dissipation of 25W and the high mutual conductance of 11mA/V. This valve covers all applications requiring powers between 11W (single valve) and 100W (push-pull), and is equally suitable for high quality domestic amplifiers and public address equipment. It has a comparatively small diameter for a 25W output pentode: the straight-sided envelope rises directly from a foot less than 38mm in diameter. The maximum overall length is 113mm and the maximum seated height 98mm.

Two triode-connected EL34's operated in push-pull for a domestic amplifier give an output of either 14W at less than 1% total harmonic distortion with a line voltage of 430V, or 16W at 3% distortion with a line voltage of 400V. For public address equipment two EL34's may be operated in pentode push-pull, again using cathode bias, and with a line voltage of 375V the available output is 35W at 5% total harmonic distortion. For even higher powers fixed bias may be used with anode voltages of up to 800V; the power output when the anode voltage is 800V is 100W at 5% distortion.

A single EL34 operated in Class A gives an output of 11W at 10% distortion with a line voltage of 265V.

A special technique has been devised to enable the EL34 to operate at high anode voltages whilst retaining a single-ended octal-based construction. The valve envelope is made completely of glass, with a conventional pressed glass foot, and clamped into a metal ring which holds together the glass and the plastic material of the octal base. The stiff wire leads projecting from the glass envelope line up exactly with the pinning in the octal base; during manufacture these leads are passed straight inside the octal pins, without crossing over outside the bulb, and so the risk of flash-over is very much reduced. For high voltage operation the valvholder of course must also be able to withstand the high tension.

Such a small valve as the EL34, dissipating a large amount of power at the anode and screen grid as heat, needs reasonable ventilation. It should be mounted vertically, and the air should be able to circulate freely. The distance between two EL34's should be at least 40mm, and the distance from the cabinet and other components at least 30mm. Wirewound resistors, mains transformer, and rectifier should not be in the immediate vicinity.



### Abridged Data

#### HEATER

|                |     |   |
|----------------|-----|---|
| V <sub>h</sub> | 6.3 | V |
| I <sub>h</sub> | 1.5 | A |

#### TYPICAL OPERATING CONDITIONS

##### Single valve

|                          |       |      |
|--------------------------|-------|------|
| V <sub>b</sub>           | 265   | V    |
| V <sub>a</sub>           | 250   | V    |
| V <sub>g2</sub>          | 265   | V    |
| V <sub>g3</sub>          | 0     | V    |
| V <sub>g1</sub>          | -13.5 | V    |
| I <sub>a</sub>           | 100   | mA   |
| I <sub>g2</sub>          | 14.9  | mA   |
| g <sub>m</sub>           | 11    | mA/V |
| r <sub>a</sub>           | 15    | kΩ   |
| μ <sub>g1-g2</sub>       | 11    |      |
| R <sub>a</sub>           | 2     | kΩ   |
| V <sub>in</sub> (r.m.s.) | 8.7   | V    |
| P <sub>out</sub>         | 11    | W    |
| D <sub>tot</sub>         | 10    | %    |

##### Pentode Push-Pull

|                                | Self Bias | Fixed Bias |    |
|--------------------------------|-----------|------------|----|
| V <sub>b(a)</sub>              | 375       | 800        | V  |
| V <sub>b(g2)</sub>             | 375       | 400        | V  |
| R <sub>g2</sub> (common)       | 470       | 750        | Ω  |
| I <sub>a(o)</sub>              | 2 x 75    | 2 x 25     | mA |
| I <sub>a</sub> (max. sig.)     | 2 x 95    | 2 x 91     | mA |
| I <sub>g2(o)</sub>             | 2 x 11.5  | 2 x 3      | mA |
| I <sub>g2</sub> (max. sig.)    | 2 x 22.5  | 2 x 19     | mA |
| V <sub>g1</sub>                | -22.5     | -39        | V  |
| R <sub>k</sub>                 | 130       | —          | Ω  |
| R <sub>a-a</sub>               | 3.4       | 11         | kΩ |
| V <sub>in</sub> (g-g) (r.m.s.) | 42        | 47         | V  |
| P <sub>out</sub>               | 35        | 100        | W  |
| D <sub>tot</sub>               | 5         | 5          | %  |

##### Triode Push-Pull (Self Bias)

|                                |        |        |    |
|--------------------------------|--------|--------|----|
| V <sub>b</sub>                 | 400    | 430    | V  |
| R <sub>k</sub> (common)        | 220    | 250    | Ω  |
| I <sub>a(o)</sub>              | 2 x 65 | 2 x 64 | mA |
| I <sub>a</sub> (max. sig.)     | 2 x 71 | 2 x 67 | mA |
| V <sub>g1</sub>                | -29    | -32    | V  |
| R <sub>a-a</sub>               | 5      | 10     | kΩ |
| V <sub>in</sub> (g-g) (r.m.s.) | 44     | 48     | V  |
| P <sub>out</sub>               | 16     | 14     | W  |
| D <sub>tot</sub>               | 3      | <1     | %  |

#### LIMITING VALUES

|                      |     |    |
|----------------------|-----|----|
| V <sub>a</sub> max.  | 800 | V  |
| p <sub>a</sub> max.  | 25  | W  |
| V <sub>g2</sub> max. | 425 | V  |
| p <sub>g2</sub> max. | 8   | W  |
| I <sub>k</sub> max.  | 150 | mA |

#### BASE

| Pin:— | 1  | 2 | 3 | 4  | 5  | 6  | 7 | 8 |
|-------|----|---|---|----|----|----|---|---|
|       | g3 | h | a | g2 | g1 | NC | h | k |



Reprints of this advertisement and additional information may be obtained free of charge from

MULLARD LTD., Technical Service Department, Century House, Shaftesbury Avenue, London, W.C.2



# Bigger and Better Pictures

WITH

# BRIMAR

## TELETUBES-VALVES METAL RECTIFIERS

*Shortly available*

### The BRIMAR 21 inch TELETUBE C21HM

C21HM—Rectangular Wide Deflection Teletube with Aluminized Screen and external Conductive Coating and operates at 16 kV. This tube is fitted with an improved tetrode gun assembly giving excellent overall focus and minimum astigmatism.

*Brimar have developed powerful valves suitable for use with existing or future types with larger screen areas.*

6CD6G, 50CD6G (A.C./D.C.)—Line Output Valves with a peak current of  $\frac{1}{2}$  amp. and plenty of power in hand for wide angle scanning.

6U4GT Efficiency Diode—The high working peak heater to cathode potential renders a separate highly insulated heater supply unnecessary.

R19 E.H.T. Rectifier—A replacement for the American 1X2A but with higher Ratings.

RM5 H.T. Rectifier—A worthy successor to the RM4 with a rating of 300 mA. This rectifier has a reserve of power and should be used initially in equipment so that additional valves may be added if required without redesigning the power supply stages.

### VALVES FOR THE BAND III CONVERTOR

(for 6 volt operation)

★ ECC84—Consists of two separate high slope triode units designed for use as a VHF cascode amplifier.

★ ECF82—Is a triode pentode frequency changer featuring a high slope triode and a high slope pentode with a high input impedance.

6BW7—The 6BW7 is recommended in areas where extra sensitivity is required. It has a slope of 9.3 mA/V with anode and screen voltages of 180 v.

★ The PCC84 and PCF82 and .3 amp equivalents of these types and are suitable for equipments where series connected valves are used.

*Standard Telephones and Cables Limited*

**FOOTSCRAY, SIDCUP, KENT** Footscray 3333

**acos**

**For  
tape  
and  
disc  
recording,  
P.A.  
and  
amateur  
radio.**

# quality crystal microphones

*at reasonable prices*

A crystal hand or desk omni-directional microphone for the high quality public address and tape recording field, incorporating a specially designed acoustic filter giving a response flat from 30 to 7,000 c/s.

RETAIL PRICE: £2-10-0d.

**MIC 33**

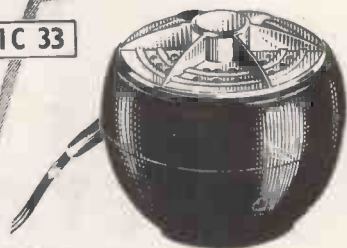

**MIC 36**



A handsome omni-directional instrument of high sensitivity and a substantially flat response from 30 to 7,000 c/s. Alternative models, with or without switch, are available with suitable adaptors for floor or table stands or for hand use.

RETAIL PRICE: £3 - 3 - 0d. without switch or £3 - 8 - 0d. with switch.

**MIC 35**

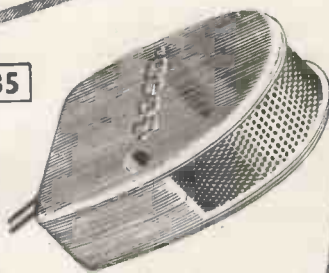

A general purpose hand microphone of robust construction with substantially flat response from 50 to 5,000 c/s. Suitable for recording apparatus. Public Address equipment etc.

RETAIL PRICE £1 - 5 - 0d.

*... always well ahead*

*ACOS devices are protected by patents, patent applications and registered designs in Great Britain and abroad.*

**STAND No. 79**

R.E.C.M.F. EXHIBITION

April 19th—21st.

## "BELLING-LEE" NOTES

### EARLY CONVERSION TO BAND III

We always look upon readers of the "Wireless World" as a collection of individuals to whom all their friends turn for advice on anything concerning radio or television.

If you haven't given the matter much thought, we would like to remind you of the importance of having new aerials or adaptors, or where necessary, converters ordered and fitted as early as possible. If everybody leaves this matter till the commencement of the band III programme, there will not be the manpower available to carry out the work. The conversion of most receivers other than thirteen channel sets, will mean their return to the dealers, who must not be expected to do them all at once. A tremendous number of viewers who now receive a good picture on an indoor aerial will require a band III aerial on the roof, although, because of their small physical size, it will often be possible to fix up to a six element array in the loft. In a favourable location, such an aerial might have a range of 7-10 miles or over. An aerial of this type would cost £2.7.6. Where it is necessary to erect an outdoor aerial, on a wall or lashed to a chimney, most viewers have the work carried out by their dealer, who often places the work to contract with a firm of specialised aerial riggers. If you want a "Belling-Lee" aerial, it is important to insist upon having one erected. Most people are satisfied if they see a reasonable picture on their set and many sets are not seen at their best because of indifferent aerials.

The average price of erecting a T.V. aerial is between £2.10.0 and £3.0.0, therefore if there is any doubt as to which aerial will be required, remember that the difference in price between a better aerial and one not so good or so sensitive, is less than the cost of an installation firm coming and raising ladders a second time.

"Belling-Lee" Adaptors are available to convert a band I aerial to a combined band I/band III; from 4/6d. for a "Lafrod" to £1.16.0 to convert and band I dipole to a combined aerial for band III reception up to 20 miles.

All these aerials are guaranteed and insured for three years, and have been proved on a local transmitter.

Advertisement of  
BELLING & LEE LTD.  
Great Cambridge Rd., Enfield, Middx.  
Written 18th February, 1955

## TWIN NEON INDICATOR LID

*gives visual signal  
of fuse failure*

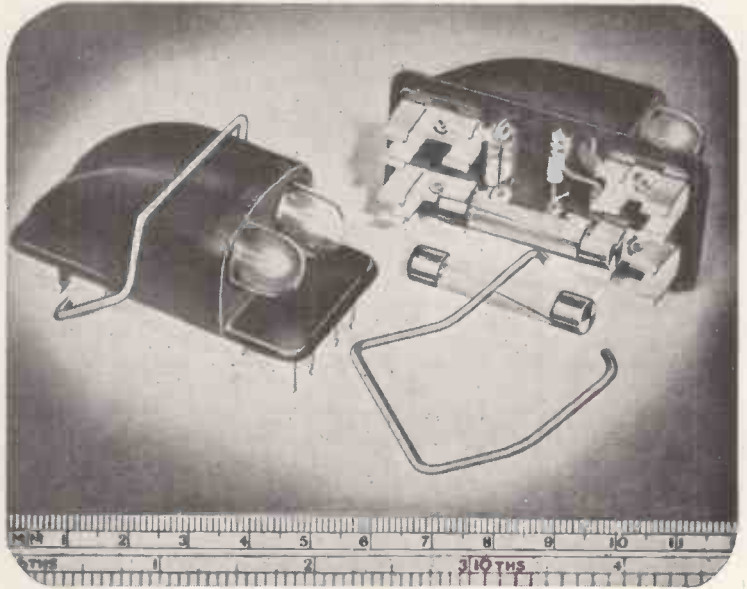

This is fitted with two bayonet cap neon lamps with their associated resistor network, and is intended to carry a pair of  $1\frac{1}{2}$  in. x  $\frac{1}{2}$  in. fuses of the standard glass or H.R.C. types.

The lamps are designed to go out on a fuse failure; it has been said that it would be more convenient if the lamps were to light, but engineers designing critical and important equipment will not countenance such an arrangement where there would be no indication in the event of a lamp failure, whereas now the worst that can happen is for an apparent "fuse failure" signal when no such failure has occurred.

The lid is designed to be a direct replacement for the lid of our standard twin safety fuseholder, thus providing neon indication without any modification to existing circuit wiring. A replacement safety clip ensures non-reversibility.

Complete boxes with or without back connections can also be supplied if desired under List Nos. L.730 or L.731.

The unit is suitable for Relay Control equipment or any similar gear having a number of fused mains or H.T. circuits, and saves the cost of separate indicator lamps with their attendant wiring and additional space requirements.

The neons will glow satisfactorily over a voltage range of 180/250 V. a.c. (r.m.s.) and 220/250 V. d.c.

L.732 PRICE 16/3

**BELLING & LEE LTD**  
GREAT CAMBRIDGE ROAD, ENFIELD, MIDDX., ENGLAND

# PICK-UP DESIGN FOR HIGH FIDELITY RECORD REPRODUCTION

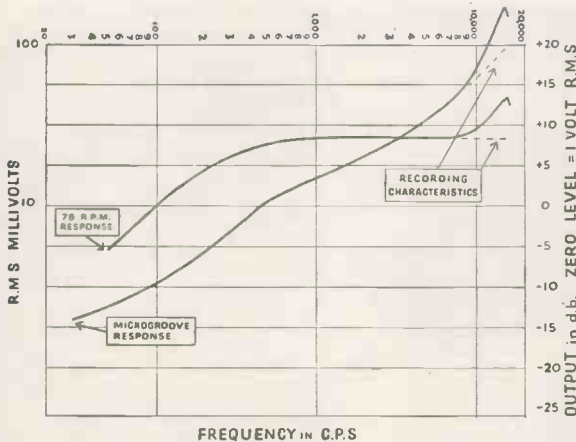

*Frequency Response Curves of type 18 pick-up for 78 r.p.m. and Microgroove Records.*

The increasingly high standard of present day recordings call for continuing developments in pick-up design. Long established principles still hold good, but design requirements are now much more exacting and require the application of precision engineering techniques. In the light of present knowledge the requirements for a high fidelity pick-up are:

- (1) The frequency response should extend smoothly over the entire audible recorded range (30 c.p.s. to 15,000 c.p.s.).
- (2) Distortion should be kept below the audibly detectable minimum. In this respect intermodulation measurements are probably the most significant, since they have the particular advantage that they are a direct measurement of the most objectionable form of distortion from the final listening point of view.

Possible causes of distortion in a pick-up which must be avoided are:

- (i) Non-linearity arising either mechanically or electrically.
  - (ii) Undamped mechanical resonances outside the audible range, which can produce audible cross-modulation effects.
  - (iii) Sensitivity to pinch-effect.
  - (iv) Distortion of record material due to excessive mechanical impedance.
- (3) Record wear must be kept to a negligible minimum. The movement of the pick-up must be highly compliant both vertically and horizontally and the playing weight must not cause distortion of the record material but must be sufficient to ensure continuous contact between stylus

and groove walls at the maximum recordable modulation level.

- (4) Long stylus life is necessary to avoid damage to records by rapidly worn styli and frequent changing of styli.
- (5) The design must be stable to ensure maintenance of the performance specification both in production and in prolonged use.
- (6) Sensitivity must be as high as possible consistent with the above in order to obtain the high signal/noise ratio for the complete reproducing equipment necessary for the wide dynamic range of modern recordings.

The above requirements are incorporated in the design of the type 18 pick-up used on "His Master's Voice" Model 3001. For performance consistency and freedom from mechanical resonances in the required frequency range, a magnetic system was chosen. Exhaustive experiments on the moving iron types of movement showed that provided that the reluctance of the return magnetic path is kept high and the signal flux in the armature is kept small compared with the saturation flux, then this type of movement possesses as linear a transfer characteristic as a corresponding moving coil design. The moving iron type was, therefore, chosen for its higher sensitivity and greater simplicity.

A cantilever stylus mounting with vertical axis of rotation has been used, since this effectively decouples the pick-up head from the stylus for vertical pinch effect movements and permits the use of a higher armature mass for a given effective inertia at the stylus point, thus reducing the signal flux density.

The material used for the suspension of the moving system in the pick-up was chosen for its stability and high mechanical resistance, stiffness ratio in order to ensure reliable and effective damping of the mechanical resonances outside the required frequency range.

For the long playing head a highly polished diamond stylus held to precise dimensional tolerances has been incorporated, since this is the only material which possesses sufficiently good wearing properties for extreme high fidelity reproduction of microgroove records. A sapphire stylus is used on the 78 r.p.m. head, since the larger tip radius used for these recordings together with the extremely high compliance of the pick-up movement result in adequately long life.

The features mentioned above and others combine to make the type 18 pick-up a reliable means of obtaining the full recorded quality from present day recordings and the best possible quality from old recordings.

## "HIS MASTER'S VOICE"

THE GRAMOPHONE COMPANY LIMITED

HAYES · MIDDLESEX



# Life line of communication . . .

World wide radio-communication began with Marconi's Transatlantic messages in 1901. Since then Marconi research and development have been behind every major advance in technique. Marconi equipment today, operating at all frequencies, covers a very wide field of both long and short range radio-telegraph and radio-telephone requirements. Marconi VHF multi-channel equipment can provide for as many as 48 telephone channels and is largely superseding land-line or cable routes on grounds of efficiency, economy, ease of installation and maintenance.

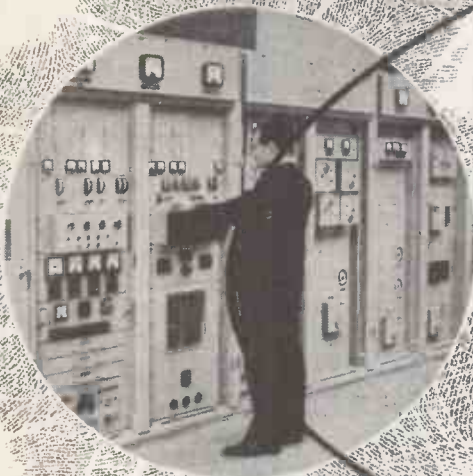

COMPLETE RADIO/TELEPHONE  
AND RADIO/TELEGRAPH  
SYSTEMS AND EQUIPMENT

# MARCONI

COMPLETE COMMUNICATION SYSTEMS

*Surveyed, Planned, Installed, Maintained*

MARCONI'S WIRELESS TELEGRAPH COMPANY LIMITED · CHELMSFORD · ESSEX

*Standard*  
 magnetic alloys  
 for component designs  
 of maximum efficiency

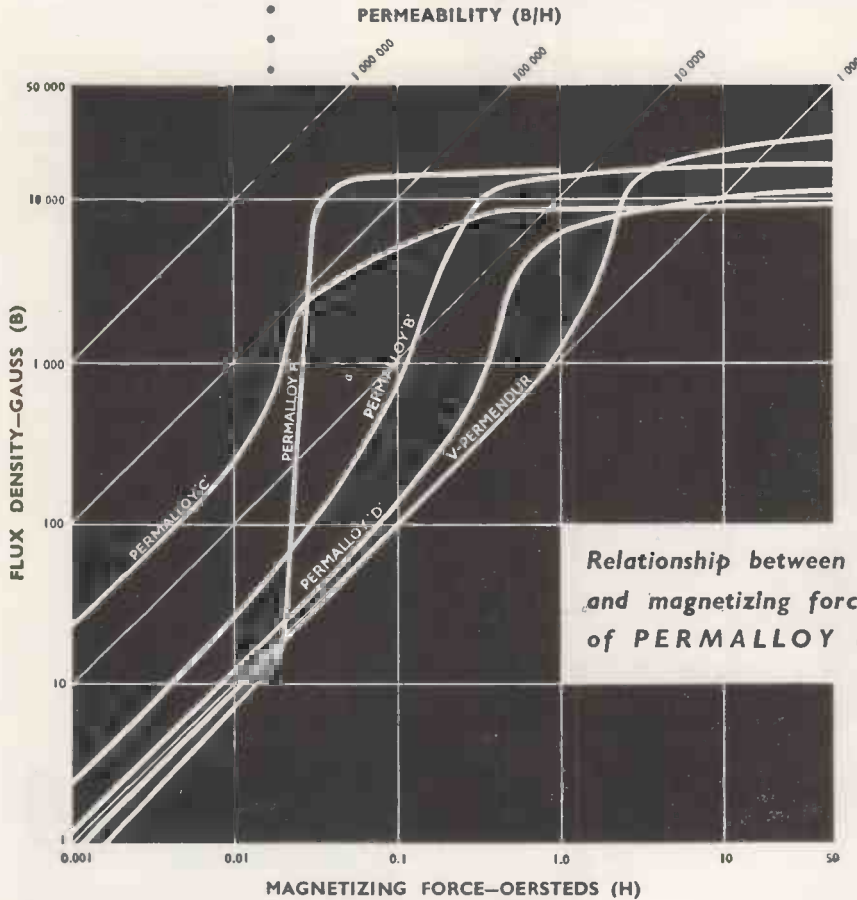

Relationship between flux density, permeability and magnetizing force for the various grades of PERMALLOY and V-PERMENDUR.

Please ask for further particulars.

**H**IGH quality and consistency, backed by first-class service, are important features in this range of *Standard* magnetic alloys. As large-scale users of Permalloys in communication, electronics and other fields, *Standard* enjoy the unique advantage of observing these alloys under normal working conditions, a factor which has played an important part in their development.



*Standard Telephones and Cables Limited*

Registered Office: Connaught House, Aldwych, W.C.2

TELEPHONE LINE DIVISION: North Woolwich, London, E.16



**Why Ediswan Clix P.T.F.E. Valveholders are widely used in B.B.C. Television equipment**



Large quantities of Ediswan Clix P.T.F.E. Valveholders are used in B.B.C. Television equipment. Only the combination of the finest insulation—P.T.F.E., the most efficient contact material—Beryllium copper—and Ediswan Clix design and manufacture can match the requirements of efficiency and reliability in this and all other

stringent valveholder applications. Ediswan Clix P.T.F.E. Valveholders are fully type approved for Services Grade 1, Class 1 conditions. Full details of these valveholders and other components in the Ediswan range are given in catalogue CR. 1681. Manufacturers and Development Groups may have a copy on request.

**EDISWAN**

**CLIX**

**RADIO, TELEVISION & ELECTRONIC COMPONENTS**

THE EDISON SWAN ELECTRIC COMPANY LIMITED, *Member of the A.E.I. Group of Companies*

155 Charing Cross Road, London, W.C.2 and Branches. Telephone: Gerrard 8660. Telegrams: Ediswan, Westcent, London

CR3 Radio Components Sales Office: 21 Bruton Street, London, W.1. Telephone: Mayfair 5543

# EMI ELECTRONIC INSTRUMENTS

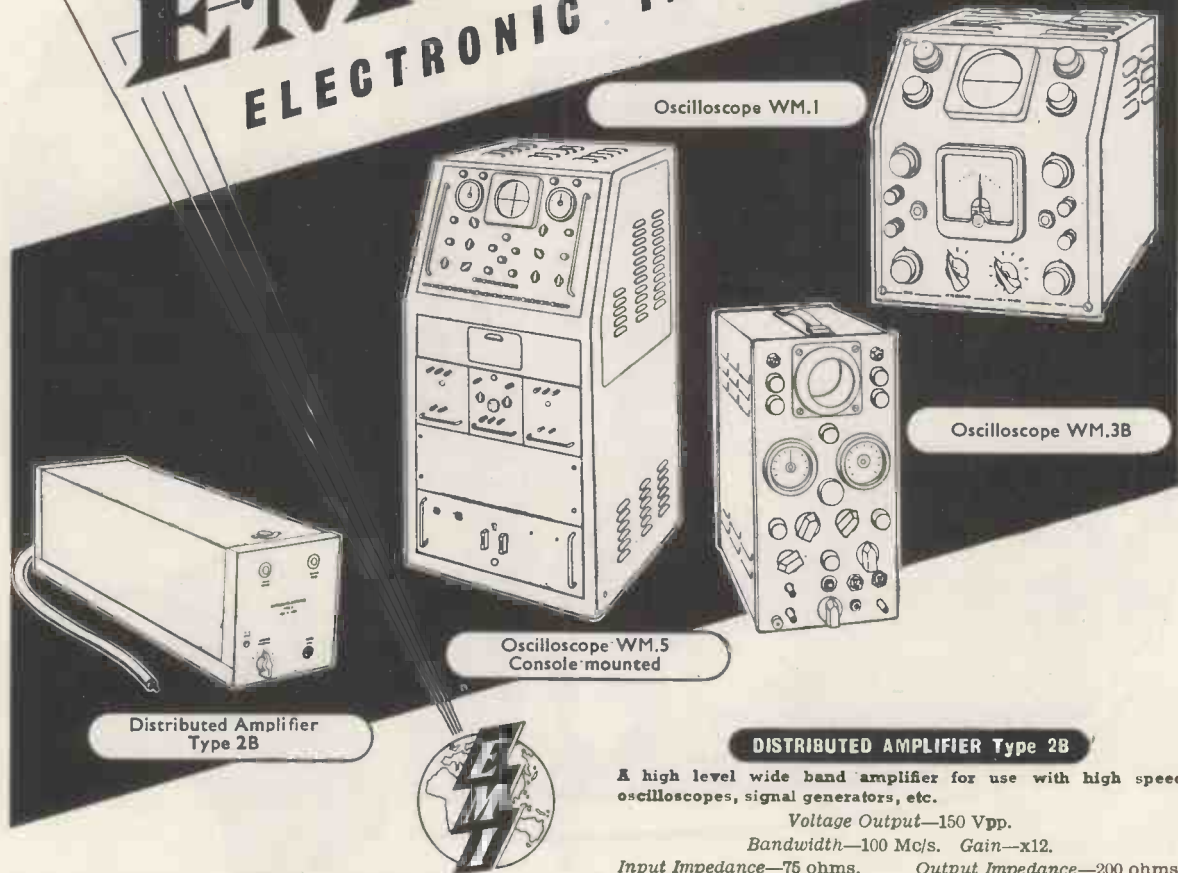

Distributed Amplifier Type 2B

Oscilloscope WM.5 Console mounted

Oscilloscope WM.1

Oscilloscope WM.3B

### OSCILLOSCOPE Type WM.5

**A new multi-purpose precision measuring oscilloscope.**  
**NEW FEATURES:** (a) The console model accommodates up to 6 plug-in sub units. This allows the basic oscilloscope to be adapted for a wide range of requirements; i.e. additional gain at high and low bandwidth, signal delay, comparison signals, T.V. picture and line selection, high voltage inputs, monitoring high impedance sources, etc.

- (b) Continuously variable EHT—10KV.
- (c) 25 Mc/s bandwidth 'Y' Amplifiers.
- (d) D.C. or A.C. coupled 'X' and 'Y' Amplifiers.
- (e) Linear pre-sweep. A visual delaying sweep.

**Time Range**—10 milli-micro-seconds to 0.1 sec. } Measurements by instantaneous metering system. No calibration markers required.  
**Voltage Range**—10 mV to 500 V. AC/DC.

**Photo Sweep**—Single sweep for photo recording of transients, subsequent few sweeps before blackout of the tube give reference trace which can be pre-set to any D.C. voltage between 0 & ± 500V.

The above instruments and other E.M.I. electronic equipment can be seen at the Exhibition of Scientific Instruments and Apparatus, Stand 88, New Horticultural Hall, Westminster, 25-28th April, 1955.

### DISTRIBUTED AMPLIFIER Type 2B

**A high level wide band amplifier for use with high speed oscilloscopes, signal generators, etc.**

**Voltage Output**—150 Vpp.  
**Bandwidth**—100 Mc/s. **Gain**—x12.  
**Input Impedance**—75 ohms. **Output Impedance**—200 ohms.

### OSCILLOSCOPE Type WM.3B

**A compact, general-purpose portable oscilloscope with facilities for making rapid precision measurements of time and voltage.**

**EHT**—0.8—1.2KV. **Bandwidth**—D.C.—4.5 Mc/s.  
**Volts Range**—10mV-500V. AC/DC. } Measurements by instantaneous metering system. No calibration markers required.  
**Time Range**—0.5 micro-seconds. }  
 —40 milli-seconds.  
**Max. writing speed**—0.5 micro-second/cm.

### OSCILLOSCOPE Type WM.1

**An inexpensive general-purpose miniature measuring oscilloscope.**

**EHT**—800V. **Bandwidth**—1 Mc/s.—3 Mc/s.  
**Volts Range**±0.5-500 volts. AC/DC. } Measurements by instantaneous metering system. No calibration markers required.  
**Sweep Range**—200 milli-seconds-10 micro-seconds (uncalibrated).  
**Sensitivity**—1 cm/Volt.  
**Max. sweep speed**—2 micro-seconds/cm.

## E.M.I. ELECTRONICS LTD

Head Office: HAYES, MIDDLESEX, ENGLAND.

Telephone: SOUTHALL 2468 Extensions-655 & 857



# TRAIN FOR THE FUTURE with E.M.I.

## FULL-TIME COURSES PLANNED TO MEET MODERN INDUSTRIAL REQUIREMENTS

Industry must have more personnel trained in radar, television and the industrial applications of electronics. This demand grows greater day by day, as more industries introduce electronic processes to improve efficiency. This vast new field presents opportunities and a challenge to



*Carrying out the first tests on transmission equipment built in E.M.I. Factories.*



*Students at work in one of the E.M.I. institutes laboratories.*

ambitious young people, to those who are willing to work for a worth-while future.

Train now and train well with E.M.I. Institutes, the college which is part of one of the world's greatest electronic organisations concerned with the research and latest developments in the application of electronics.

Our Attendance Courses are therefore planned and conducted with an intimate knowledge of present and future requirements.

**4-YEAR COURSE : ELECTRONIC ENGINEERING**—intended for outstanding Science sixth-formers who are capable of training into future team leaders in scientific applications. Final qualifications are B.Sc. and City and Guilds Full Technological Certificate in Telecommunication Engineering. At least 18 E.M.I. Scholarships are offered for the 1955 Course which commences October 4th.

**3-YEAR COURSE : TELECOMMUNICATIONS**—Entrance standard (G.C.E. ordinary level or its equivalent). This Course is designed to train assistant Development Engineers. Final qualification is the City and Guilds Full Technological Certificate. This Course provides opportunities for practical attachment in E.M.I. Laboratories and Workshops. Next course commences 14th September 1955.

**1-YEAR COURSE : Full-time day Course in the Principles and Practice of Radio and Television**, mainly designed for the training of Radio and Television Servicing Engineers. Next course commences 19th April 1955.

Write for our free Brochure giving full details of the above courses.

**E.M.I. INSTITUTES LTD.**, Dept. 16, 10 Pembridge Square, London, W.2.

Telephone : Bayswater 5131/2.

Associated with "His Master's Voice", Marconiphone, Columbia, etc.





*a New*

## STABILISED POWER SUPPLY UNIT FOR PHOTO-MULTIPLIERS

Ediswan now have available a new stabilised power supply unit which has been specially designed to feed Photo-Multipliers. It is particularly suitable as a supply unit for Ediswan Mazda Photo-Multipliers type 27.M1, 27.M2 and 27.M3.

### BRIEF SPECIFICATION — R.1184

| INPUT  | OUTPUT  | STABILITY   | OUTPUT RESISTANCE         | RIPPLE                 |
|--|---|---|---------------------------|------------------------|
| 200–250 v., 40–100 c.p.s.  | High stability low ripple D.C. supply variable between 300 and 1,100 volts. Max. current 2 mA. Pos. or neg. may be earthed. | A 10% change in mains input voltage results in a change of less than 0.1% between 1,100 volts and 600 volts output. | Approximately 1,500 ohms. | Less than 0.01% R.M.S. |
| MOUNTING The Unit is suitable for standard rack mounting or for bench use. Bench Stands are available. |   |   |                           |                        |



PRICE — £48

*Further information is available on request*

# EDISWAN

RADIO DIVISION · THE EDISON SWAN ELECTRIC COMPANY LIMITED  
155 Charing Cross Road, London, W.C.2. Telephone: Gerrard 8660. Telegrams: Ediswan, Westcent, London  
Member of the A.E.I. Group of Companies

# VORTEXION

# HIGH QUALITY TAPE RECORDER

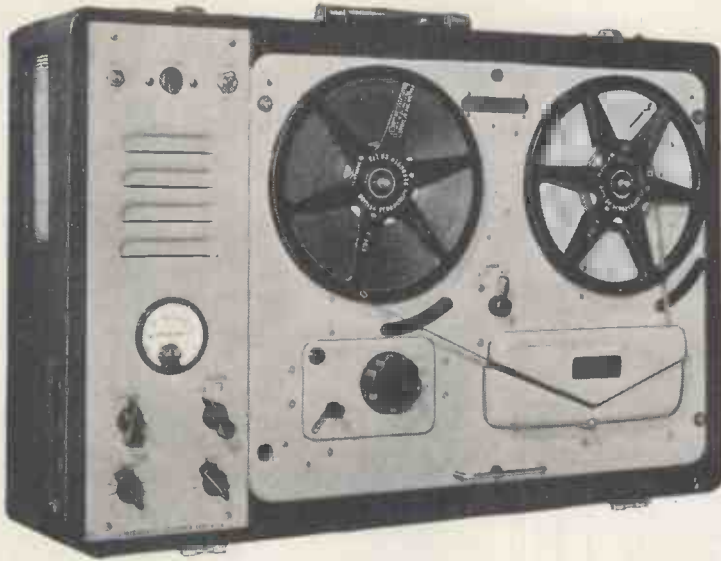

The amplifier, speaker and case, with detachable lid, measures 8½ in. x 22½ in. x 15½ in. and weighs 30 lb.

**PRICE, complete with WEARITE TAPE DECK** ..... £84 0 0

- ★ The play back amplifier may be used as a microphone or gramophone amplifier separately or whilst recording is being made.
- ★ The unit may be left running on record or play back, even with 1,750ft. reels, with the lid closed.

★ The total hum and noise at 7½ inches per second 50-12,000 c.p.s. unweighted is better than 50 dbs.

★ The meter fitted for reading signal level will also read bias voltage to enable a level response to be obtained under all circumstances. A control is provided for bias adjustment to compensate low mains or ageing valves.

★ A lower bias lifts the treble response and increases distortion. A high bias attenuates the treble and reduces distortion. The normal setting is inscribed for each instrument.

★ The distortion of the recording amplifier under recording conditions is too low to be accurately measured and is negligible.

★ A heavy mu-metal shielded microphone transformer is built in for 15-30 ohms balanced and screened line, and requires only 7 micro-volts approximately to fully load. This is equivalent to 20ft. from a ribbon microphone and the cable may be extended 440 yds. without appreciable loss.

★ The .5 megohm input is fully loaded by 18 millivolts and is suitable for crystal P.U.'s, microphone or radio inputs.

★ A power plug is provided for a radio feeder unit, etc. Variable bass and treble controls are fitted for control of the play back signal.

★ The power output is 3.5 watts heavily damped by negative feedback and an oval internal speaker is built in for monitoring purposes.

**POWER SUPPLY UNIT** to work from 12 volt Battery with an output of 230 v., 120 watts, 50 cycles within 1%. Suppressed for use with Tape Recorder. **PRICE £18 0 0.**

## TYPE C.P.20A AMPLIFIER

For A.C. Mains and 12 volt working giving 15 watts output, has switch change-over from A.C. to D.C. and "Stand-by" positions. Consumes only 5½ amperes from 12 volt battery. Fitted with mu-metal shielded microphone transformer for 15 ohm microphone, provision for crystal or moving iron pick-up with tone control for bass and top. Outputs for 7.5 and 15 ohms. Complete in steel case with valves. **PRICE £30 16 0.**



*Manufactured by*

**VORTEXION LIMITED, 257-263, The Broadway, Wimbledon, London, S.W.19**

Telephones: LIBerty 2814 and 6242-3

Telegrams: "Vortexion, Wimble. London"

# The Cultured Voice of Quality



## SOUND SALES PHASE INVERTER SPEAKER

For its size, this is one of the most attractive loudspeaker combinations I have yet come across . . . "the standard of reproduction obtainable must be heard to be believed." That extra half octave above about 12 kc/s and the corresponding one below about 30 c/s usually cost an awful lot of money. The range here is audible from below 30 up to above 13,000 c/s!

TECHNICAL REPORT by P. WILSON, M.A.,  
of "THE GRAMOPHONE"

Price **£14.10.0**  
complete with cabinet

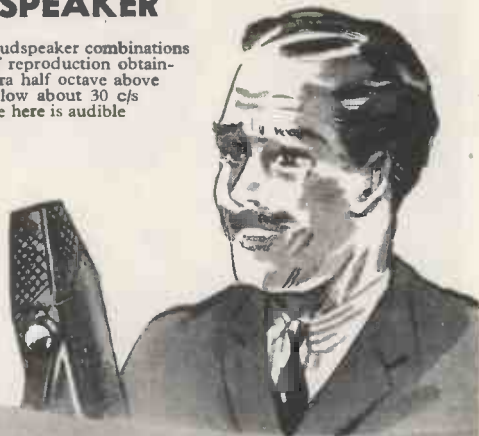

OBTAINABLE FROM ALL LEADING STOCKISTS **SOUND SALES LIMITED**  
WEST STREET, FARNHAM, SURREY Tel.: FARNHAM 6461/2/3 Manufacturers of Electronic Equipment Established since 1931

Extract from one of many letters received:—"It is unbelievable that a speaker at this price can be so very good. A friend of mine who heard it remarked that the clarity was amazing. I am now really hearing my records for the very first time."—J. A. Pearson, Doncaster.



Type O-120

# Two NEW



# 'Scopes!

## MAY WE SEND YOU PARTICULARS?



Type O-100

Portable, Lightweight, High-sensitivity Audio 'scope. 4mV/cm. r.m.s. (max.). Push-pull Plate deflection. External terminal connections to "X" Amplifier and C.R.T. available. 3c/s to 25Kc/s.

Servo and General Purpose 'scope. 7mV/cm. r.m.s. (max.). Direct coupled, symmetrical "X" and "Y" Amplifiers. Triggered Time Base. Time and Voltage calibration. D.C. to 4Mc/s.

# Furzehill Laboratories Ltd.

57, CLARENDON ROAD · WATFORD · HERTS.

Cables: FURZLAB, LONDON.

Tel.: Gadebrook 4686/7



# In the U.S.A.

and all over the world  
you will find



EQUIPMENT

This advertisement, prepared by our American Agents, is appearing in current U.S.A. technical publications and is reproduced here for the interest of our friends in this country.

**Leonard Carduner** (President, British Industries Corp., New York): Mr. Leak, please tell our readers what the "Point One" amplifier combination does in a high fidelity music system.

**H. J. Leak:** As you know, Mr. Carduner, the amplifier is actually the "heart" of the system. Your record player, radio tuner, or tape recorder feeds electrical impulses into the pre-amplifier and amplifier. These, in turn, strengthen the signals and feed them into a speaker.

It is difficult to strengthen a signal without distortion. "Point One" means that the Leak reproduces voice and instruments with insignificant harmonic distortion of 0.1% at 8 watts! This gives the illusion of the actual "presence" of the performer.

**L.C.:** In demonstrating the "Point One" amplifier at Audio Fairs, the most impressive thing we do is to turn the amplifier on its side, show people the terminal board "custom" construction used in American scientific instruments, almost never in radios.

**H.J.L.:** We had a practical reason for this . . . because every terminal connection is easily accessible. It keeps servicing costs down . . .

**L.C.:** Yes, and many have praised the control panel of the "Point One" pre-amplifier, because it offers every sensible adjustment to match the new hi-fi records . . . and full 25 db bass and treble range.

**H.J.L.:** In fact, the "Point One" has more adjustments than the Leak amplifiers supplied to the B.B.C., but no superfluous settings to add unnecessary cost.

**L.C.:** Well, you have one very important exclusive feature. Plug-in jacks on the Leak front panel make it easy to give any tape recorder the full benefit of the Leak circuit, in recording and playback! People with portable tape recorders, who put them away when not in use, can connect them instantly. Practical features like this make the "Point One" most enjoyable to use.

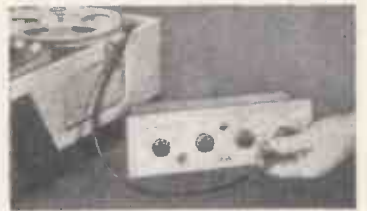
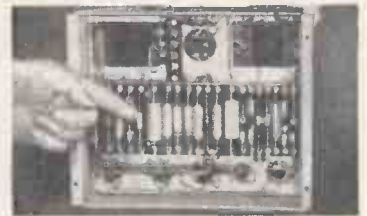

**T.L.10 & POINT ONE 27 GUINEAS COMPLETE, in Great Britain.**  
AMPLIFIER                      PRE-AMPLIFIER                      *Price made possible only by world-wide sales.*

Write for illustrated literature *W*.

**H. J. LEAK & CO. LTD., BRUNEL ROAD, WESTWAY FACTORY ESTATE, ACTON, W.3**  
'Phone: SHEpherds Bush 117314                      Telegrams: Sinusoidal, Ealux, London                      Cables: Sinusoidal, London

## SPECIAL PAGE FOR INDUSTRIAL USER

### R. F. HEATER CONSTRUCTORS KIT

All the parts including metal chassis for building a 250/500 watt R.F. Heater for dielectric or induction heating is available as a kit complete with theoretical diagram and practical notes—price for the complete kit of parts is £40 plus carriage at cost.

#### RADAR TRANSFORMER

For pulse work at 4 kV., this is Ministry style No. 224261 Type 2. Oil filled and fitted with two valve holders and ceramic insulators. It contains a pulse transformer, a choke and a filament transformer, all of which are designed to operate on 4 kV., 25/- each.

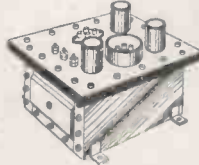

#### HIGH POWER TRANSFORMERS

For R.F. Heaters, transmitters, etc., etc. These are open wound type for maximum cooling and have the normal 200-250 primary fully screened.  
 Type 5F4. 1,000 v. at 1 amp., e.g. .5 K.V.A. Price £8/10/-, carriage and packing 5/-  
 Type 5F7. 1,500 v. at 1 amp., e.g. 1.5 K.V.A. Price £15, carriage and packing 7/6.  
 Type 5M1. 1000-0-1000 v. at 1.5 amps., e.g. 1.5 KVA. Price £12/10/-, carriage and packing 7/6.  
 Type 5M2. 1000-0-1000 v. at 500 ma. and 4 v. at 4 a. Price £7/10/-, carriage and packing 4/6.  
 Type 5M3. 375-0-375 v. at 250 ma. and 4 v. at 4 a. Price 37/6, carriage and packing 3/6.

#### AUTOMATIC MOTOR STARTER

For remote control of D.C. motor between 1 and 3 kw., adjustment for 100 v. or 230 v. Unused and in first-class condition, complete with metal and wired glass cover. Price £10, carriage 5/-.

#### POWER FILAMENT TRANSFORMERS

Type 5M4. 4 v. at 4 a. 2-0-2 v. at 10 a. Price 13/6, carriage and packing 3/6.  
 Type 5M5. 3.15-0-3.15 at 10 a. 4-0-4 at 10 a. 4-0-4 at 2 a. 4 at 4 a. 2.5-0-2.5 at 3 a. Price £27/6, plus carriage and packing 3/6.  
 Type 5M6. 34 v. at 2 a. tapped 32 v., 30 v. and 25 v., for relays, etc., £2/6, plus 3/6 carriage and packing.

**POWER CHOKES.** Open wound type and feet with clamps.  
 Type 5M7 30 Henry at 500 ma., 35/-  
 Type 5M8 20 Henry at 500 ma., 32/6.  
 Type 5M9 15 Henry at 500 ma., 27/6.  
 Type 5M10 10 Henry at 500 ma., 22/6.  
 Type 5M11 25 Henry at 250 ma., 13/6.  
 Type 5M12 3 Henry at 10 amps., 13/6.  
 Type 5M13 200 Henry at 5 ma., 15/-.

#### POWER FOR TR1154/55

We can offer brand-new, and unused, the two rectifier units for mains operating the transmitter TR1154 and its associated receiver B1156. Both rectifier units are completely enclosed in metal cases and operate directly from normal 60 cycle A.C. mains. Price £17/10/- the pair, carriage and packing £2 extra.

#### TRANSMITTER 1131

This is a high powered transmitter for operating over the same frequency range as the Receiver 1132, i.e., 70-130 megacycles. It is a very bulky transmitter and probably contains around £200 worth of equipment. As far as we know these have never been used but of course have been in store for a long time and therefore they will need attention before being put into operation. We offer these less valves £37/10/-. Buyer collects. We also have a quantity already stripped so if you are needing spares for this transmitter please get in touch with us now.

#### R1132

We have a small quantity of these receivers still available less valves. Their condition unfortunately is not good but they appear to be repairable, and of course, contain a multitude of spare parts. At 30/- each they represent a real bargain. If not collecting, please include 5/- for packing and carriage.

#### RECEIVER TRANSMITTER 38

This is the British equivalent of the walkie-talkie. It operates on the frequency range 7.4-9 meg. It has many novelty applications in the home and can eventually be turned into a useful little portable receiver. Complete and with valves, unused but not guaranteed, price 37/6, post 2/6 extra.

#### STABILAVOLT

This is a valve designed and constructed to facilitate the taking off of several voltages, each of which will be stabilized. These are brand new and unused. Price 10/6 each, post 1/- extra.

#### POTTED MAINS TRANSFORMERS

These are of really superior construction fitted in cast metal cases and compound filled. Terminals come to ebonite baseboard. All are upright mounting and have 220/230 normal 50 cycle mains input and fully screened primary.  
 Type 5P1. 265-0-265 at 300 m.a.; 6.3 v. at 7 amp.; 4.4 v. at 2.5 amp.; Price 35/- plus 3/6 carriage.  
 Type 5P2. 365-0-365 at 150 m.a.; 4 v. at 3.5 a.; 6.3 v. at 4.2 a. Price 32/6, carriage and packing 3/6.  
 Type 5P3. 1540 v. 2 v. at 2 a.; 4 v. at 1 a.; This is an ideal transformer for televisions and scopes using V.O.R. 97, etc. Price 25/-, carriage 2/6.

#### POTTED CHOKES

These chokes are in similar type cases and therefore match the above transformers.  
 Type 5F4. 5 H. at 300 m.a. Price 10/-, carriage and packing 2/6.  
 Type 5F5. 10 H. at 150 m.a. Price 12/6, post and packing 2/6.

#### RELAYS P.O. 3000 TYPE

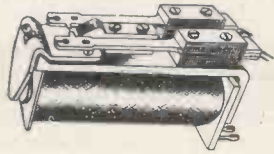

Ref. 5A1. 2000 ohm, slow close coil plat. contacts, one break, two make. Price 12/6 each.  
 Ref. 5A2. 2000 ohm. standard coil, plat. contacts, change over make before break, two make, 1 break. Price 15/-.  
 Ref. 5A3. 200 ohm. standard coil, plat. contacts, two make. Price 7/6 each.  
 Ref. 5A4. 10 ohm. standard coil, one pair plat. contacts, also mounted but not operated by the relay, are thermal change-over contacts, make before break. Price 8/6 each.

#### RACKS AND RACK EQUIPMENT

Standard 6ft. rack, heavy gauge channel construction, tapped holes and standard 19in. centres. Price £4/15/- plus carriage. Ditto, but enclosed with sheet metal sides (vented) and with door, fitted handle and locking bars. Price £5/15/-.  
 Ref. 5A8. Safety switch, cuts off mains directly door is opened. Price 8/6.

#### MOUNTING PLATES FOR ABOVE RACKS

Fitted with slide supports to hold chassis. Chassis will be included if requested but this will already have several holes punched and drilled.  
 Ref. 5A5. 14in. front plate with chassis supports. Price 17/6.  
 Ref. 5A6. 12in. front plate with chassis supports. Price 13/6.  
 Ref. 5A7. 10 1/2in. front plate with chassis supports but cut out for meters and other items. Price 8/6.

#### AUTO TRANSFORMERS

For working American equipment of our main etc., etc. Input tapped 200-240 v. Output 115 v. In addition to those listed below, we have special this month 150/200 watt totally enclosed in metal box with input and output leads. Price 47/6, plus 2/- post and packing. Totally enclosed and screened.

|                    | Price    | Carr. |
|--------------------|----------|-------|
| 50 watt            | £1/2/6   | 1/6   |
| 100 watt           | £1/16/-  | 1/6   |
| 150 watt           | £3/-     | 2/-   |
| 250 watt           | £4/10/-  | 2/6   |
| 500 watt           | £5/10/-  | 2/6   |
| Unscreened.        |          |       |
| 1 KVA (3,000 w.)   | £6/10/-  | 5/-   |
| 1.5 KVA (1,500 w.) | £7/17/6  | 5/-   |
| 2 KVA (2,000 w.)   | £10/17/6 | 7/6   |
| 3 KVA (3,000 w.)   | £12/7/6  | 10/-  |
| 5 KVA (5,000 w.)   | £18/5/-  | 12/6  |

#### SLIDER RESISTORS

Heavy Duty Type.  
 Size 7in. x 1/4in. 11 ohms 4.5 amp., 22/-; Size 9in. x 1/4in. 1.2 ohms 15 amp., 15/-; Size 13 1/2in. x 1/4in. 3 ohms 10 amp., 15/-; 1 ohm 25 amp., 15/-.



#### AMERICAN FORCES UNITS I-122A and TR-24A

These provide a means for rotating an aerial (or other medium) to any desired azimuth. The operation is briefly as follows:—

1. Dial on control panel is turned to desired azimuth.
2. The Selsyn in the indicator generates a voltage which after being amplified causes the driving motor to rotate the tower.
3. As the tower rotates towards the null position the voltage applied to the drive motor decreases and is removed before the tower stops. If the tower stops before correct position voltage is again automatically applied. If the tower rotates beyond the correct position, the reverse relay operates and causes the tower to move backwards, until it stops at the null point where it remains at rest.

#### PROTECTION DEVICES

1. Circuit breaker prevents voltage being applied before valve 7 has warmed up.
2. Circuit breaker prevents the drive motor from over-loading.

#### SELSYN MOTORS

Both receiver and transmitter selsyns are three phase rotor induction motors. The operation is briefly as follows:—  
 Stators of transmitter are connected to corresponding stators of receiver. Note the rotor of one is connected to single phase supply. A voltage would appear on the rotor terminals of the other. This voltage will be of the same frequency as the voltage applied but its value will depend upon the relative angular positions of the rotors of the two selsyns.

#### DRIVING MOTOR

This is a two phase squirrel cage induction motor geared to the antenna mast. In order to operate the motor from a single phase source a condenser is connected in series with one of the phase winding. Direction of rotation is reversed by switching the condenser from one phase to the other by means of reversing relay.

#### IMPEDANCE AMPLIFIER

When the two selsyns have an angular displacement a voltage is generated in the receiving selsyn. This is amplified by two independent amplifiers. THE IMPEDANCE AMPLIFIER controls the magnitude of an impedance connected in series with the antenna motor and consequently controls the motor. THE CONTROL IMPEDANCE consists of the anode circuit of Valve 7, matched to the motor by means of Transformer 102. When Valve 7 has negative bias the anode circuit has high impedance. When conducting, however, the impedance falls to just a few ohms. The effect of which will vary the voltage to the motor and thus control its speed of rotation.

#### THE RELAY AMPLIFIER

The output of the selsyn receiver is also applied to the relay amplifier, through transformers so that it is either in phase with or 180° out of phase with the amplifier voltage depending upon which side of the present position the antenna rests. The relay controls the direction of rotation of the motor.

#### POWER SUPPLIES

The equipment is fitted with power components for 117 volts 60 c.p.s. but will operate off our Mains if supply is connected through a slip-down transformer of 1 K.W. rating. Price £55 the two units, or separately I-122A £25, TR-24A £35, carriage extra at cost.

#### MAGNETRONS

Precision make for RADAR type Nos. CV-156 and OV-64. Unused, guaranteed. Any not functioning correctly will be replaced. Price £2/10/- Post and insurance 10/-.

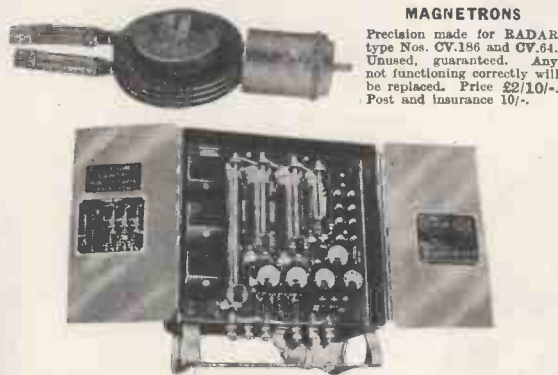

#### CHARGING SWITCHBOARD

Feed this Switchboard through a Mains Transformer and Rectifier giving 24 volt D.C. up to 50 amps, and you have an excellent multi-circuit charger for simultaneously charging several batteries at different currents. This is an ex-Government switchboard rated at 550 watts 18 volts fitted into steel cases with doors. It contains three reverse current relays, one voltmeter, one main ammeter, two secondary ammeters and three variable resistors for controlling circuits. These are brand new, in original cases. Price £4/10/-, carriage 10/-.  
 We can supply a 12 volt, 50 amp. Mains Transformer at £4/5/-, plus 5/- carriage.

#### IMPORTANT NOTICE.

The equipment described on this page is not available at our normal retail shops—it can be seen at our special sales department address as below. Order and enquiries should also be addressed as below:—

**E.P.E. LTD., SPECIAL SALES DEPT., BOURNE HOUSE, GROVE ROAD, EASTBOURNE, SUSSEX.**



**THE TWIN 20**

This is a complete fluorescent lighting fitting. It has built-in ballast and starters—stove enamelled white and ready to work. It is an ideal unit for the kitchen, over the work-bench, and in similar locations. It uses two 20-watt lamps. Price, complete less tubes, 29/6, or with two tubes, 39/6. Post and insurance, 2/6. Extra 20-watt tubes 7/6 each.

**ALL MAINS THREE**

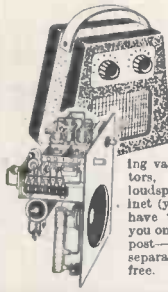

A handy mid-gig A.C./D.C. 3-valve mains receiver giving powerful reception over long and medium waves. All component parts, including valves, coils, resistors, etc., but not loudspeaker and cabinet (you may already have these) will cost you only 19/6 plus 1/6 post—data available separately 2/- post free.



**NOBLEMAN GRAM**

A 70 Gn. RADIOGRAM direct from makers for only 40 Gns. Or £4 deposit. A beautiful piece of furniture yet a most up-to-date radiogram—figured walnut lined syncamore—radio raised to comfortable level—compartment for records—5-valve A.C. mains superhet, covers long, medium and short waves—all latest refinements, negative feed-back tone control, etc.—large multi-coloured edglet dial—latest "HI G" three-speed auto-changer with the famous pick-up—plays all types of records perfectly. Free Delivery in London Area. Elsewhere £2.

**ELPREQ TAPE RECORDER**



This instrument combines the Mk. IIIU Truvox Tape Deck and the Cleveland Wide Band Amplifier with a special high flux speaker and forms one of the finest tape recorder combinations available to-day. It will, of course, play pre-recorded tapes as well as make its own recordings of radio, music, meetings, telephone conversations, letters, etc., etc. The price, complete with reel of tape and ready to operate, is

**39 Gns.**

Carriage and insurance 12/6. Hire Purchase terms if required.

**DID YOU GET YOUR £1 BACK?**

3-speed record player with pick-up using the famous Acos "HI G" turnover crystal—motor also by very famous maker—speed selection is by Bakelite knob. All on unit board ready for installation. A wonderful bargain at £6/10/- plus 5/- carriage—Hire Purchase 15/- deposit.

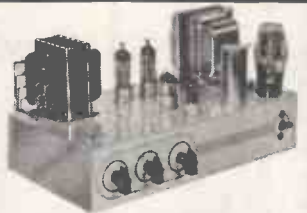

**MULLARD AMPLIFIER "510"**

A High Quality Amplifier designed by Mullard engineers. Robust high fidelity, with a power output exceeding 10 watts and a harmonic distortion less than .4% at 10 watts. Its frequency response is extremely wide and level being almost flat from 10 to 20,000 C.P.S.—three controls are provided and the whole unit is very suitable for use with the Collaro Studio and most other good pick-ups. The price of the unit completely made up and ready to work is £12/10/- or 25/- deposit, plus 10/- carriage and insurance. Alternatively, if you wish to make up the unit yourself we shall be glad to supply the components separately. Send for the Mullard amplifier shopping list.

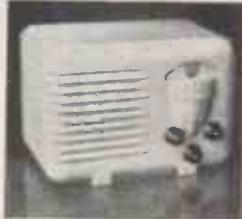

**MINIATURE PORTABLE T.V.**

Uses standard conventional circuitry employing a total of 13 valves and 2 crystal diodes. The Cathode-ray tube used is a 2 1/2 in. Service type VCR139A. The layout is extremely clean, straightforward and professional. The wiring, whilst naturally being a little more intricate due to miniaturisation, is nevertheless completely accessible. The total cost comes to £16-£17. Its size will be approximately 9 1/2 x 8 x 6 in. Full construction data, layout, diagrams, templates, etc., running into some 50 sheets, is available, price 5/- post free.



**CABINETS FOR ALL**

We confidently believe we carry the best stock of cabinets in London. The one illustrated is The Bureau, a really beautiful cabinet elegantly veneered in walnut and finely polished. The control board is revealed when the front is dropped. Both radio board and motor board are left uncut to suit your own equipment. Price is 16 guineas, carriage 12/6. We have many other types in stock. Pay us a visit, or send for Cabinet List.



**THE CONTEMPORARY**

In the modern trend is this very stylish contemporary console. Veneered in oak with contrasting mouldings, and is ideal for use with modern furniture or with other contemporary fittings or furnishings. The radio and motor board is uncut and its size, 30 x 15 1/2 in., provides ample room for all equipment. Price £8.15/-, carriage, etc., 12/6.



**MINI-MAINS FOUR**

Uses a 4-valve circuit with high-efficiency coils—covers long and medium wave bands and fits into the neat white or brown Bakelite cabinet—limited quantity only. All the parts, including cabinet, valves, in fact, everything, £3/19/6 plus 2/- post. Constructional data free with the parts or available separately 1/6.



**P.V.C. HEATER WIRE**

This has a resistance of 16 ohms per ft. It is wound on non-hygroscopic insulation and covered over with P.V.O. shrunk sleeving. Quite suitable for use underground or under water. Ideal also for twisting around pipes to stop freezing or to pre-heat liquid. Price 1/- per yard.

**YOURS FOR £1 ONLY**

**COMMUNICATIONS RECEIVER R1155**



This set, as most will know, is considered to be one of the finest communications receivers available to-day. The frequency range is 75 kc/s to 18 Mc/s. It is complete with 10 valves and is fitted in a black metal case. Made for the R.A.F., so obviously a robust receiver which will give years of service. Slightly used but

completely overhauled and guaranteed in perfect working order. PRICES Grade 2 £7/19/6, Grade 1 £9/19/6, or new and unused £11/19/6. Or will be sent against deposit of £1. If you cannot call to collect please include an additional 10/- to cover cost of transit case and carriage. This partly returnable to you if and when you return the transit case.

**MAINS POWER PACK FOR R1155**

With Pentode output stage. Plugs into socket on receiver so no internal modifications are required. Price £5/10/- complete with speaker ready to work, carriage 3/6. If bought with receiver, deposit is 11/-.



**BARGAIN FOR CONSTRUCTORS**

Modern style cabinet in contrasting veneers, with metal chassis, three knobs, coloured scale, and pointer. Price 29/6, post, etc., 2/- All other components to build 2-waveband superhet. Price £5. Data, 1/6 (free with components).



**GRAMOPHONE AUTO-CHANGER**

The latest model by very famous manufacturers. 3 speed, mixes 10in. and 12in., with crystal turn-over pick-up, brand new and perfect in original cartons. Price £11/10/-, Carr., etc., 12/6.

**E. P. E. LTD. (SEE OVER)**

**BEST SELECTION OF RADIO CHASSIS IN LONDON**

**THE "WINDSOR 5"**

This is a 5-valve A.C. superhet covering the usual long, medium and short wavebands. It has a particularly fine clear dial with an extra long pointer travel. The latest type local valves are used and the chassis is complete and ready to operate. Chassis size 15in. x 6in. x 6in. Price £9/10/6 complete with 8in. speaker. Carriage and insurance 10/- H.P. terms if required.

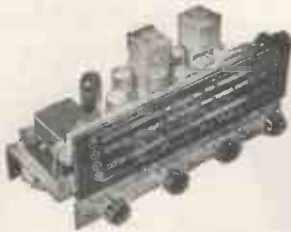

**TABLE RADIO CABINET**

Due to a special purchase, we are able to offer this very fine cabinet, size approx. 15½ x 14 x 6½in. Walnut veneered and satin finished, 37/6 carriage and packing 3/6. Note.—This cabinet is the correct one for the Windsor chassis above with 6½in. speaker.



**SUPERHET RADIO BY BEETHOVEN**

**NOW AVAILABLE FOR LONG, MEDIUM and SHORT WAVES**

Extremely well built on chassis size approx. 9½ x 7½ x 8½ using only first-class components, fully aligned and tested, 110-240 volt A.C. mains operation. Large clear edge-lit dial. Three wave bands covering Long, Medium and Short waves. Complete with five Mullard valves, frequency changer, double diode triode, pentode output and full wave rectifier. Complete with Rola loud-speaker ready to operate. Special cash-with-order price this month, £3/17/6, carriage and insurance 7/6. Hire purchase terms £3 deposit, balance over 12 months.

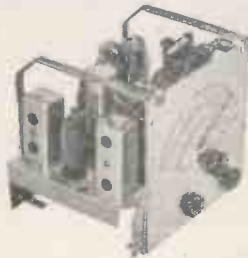

**SAVE £1**

Really beautiful walnut veneered and polished cabinet for only 39/6 if purchased at the same time as the Beethoven 5 valve superhet chassis (illustrated) above. Bought separately the price of the cabinet is 59/6. H.P. deposit on cabinet and chassis is 32/- only.

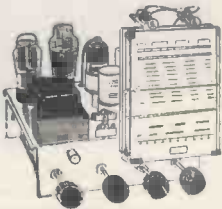

**THE EXPORT 5**

**3-WAVE BAND 5 VALVE SUPERHET CHASSIS**

Brand new, tested and ready for immediate operation, full vision scale size 6in. x 8in. covering the long wave 900-2,000 metres, medium wave 185-550 metres, and short wave 16-50 metres. Complete with valves and covered by our six months' guarantee. First-class parts. Parmeko mains, transformer

Eric resistors, Hunts condensers, etc. Special points include: (1) Flywheel tuning. (2) Dust core I.F.'s. (3) Sockets for extension speaker and pick-up. (4) 4-watts output. Price £9/10/-, carriage, packing and insurance 7/6 extra.

**10/- SECURES THIS BARGAIN**

The set, a product of one of our famous manufacturers, has H.F. stage, tuning indicator, and all modern refinements, covers 5 wavebands including a short wave to 11 metres. Offered less valves, power-pack, scale and drive, otherwise complete and unused, price £5. or 10/- deposit, balance over 12 months, carriage 7/6 (uses octal range valves).



**THE CLEVELAND "ORGANTONE"**

The Cleveland "ORGANTONE" is a 5-valve 3-wave band superhet covering long, medium and short wave. Built to a very stringent specification. Osram miniature valves are employed and low loss iron cored coils account for an excellent signal to noise ratio. Full A.V.C. is applied to both frequency changer and I.F. stages, and particular care has been taken to ensure freedom from frequency drift.

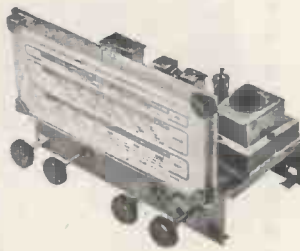

The output stage utilises variable negative feedback for tone control, and, but for standard pentode correction, no cut in the ordinary sense is applied. A gram. position is provided and reproduction of records is particularly good. An amply proportioned power transformer with a primary tapped for 110-280 volts gives complete isolation from the mains. Chassis size is 12in. x 7in. x 7in.—Scale size is 10½in. x 4½in. This receiver has been tested in particularly difficult areas and its stability and noise rejection have produced exceptional results. Price £11/10/- or £1/5/- deposit—carriage, etc., 7/6. A circuit diagram and photograph available price 2/- post free.

**ANOTHER CLEVELAND CHASSIS—"THE TREMEMDO"**

The first Cleveland chassis was good, but this one is really superb. It has a 7-valve circuit with 6 watts output, fitted with independent bass and treble controls. It is really an efficient R.F. circuit coupled to a high-fidelity amplifier. The chassis size is the same as the Organtone, namely 12 x 7 x 7 with the 10½ x 4½ multi-coloured scale, and it is built to the same exacting specification as the Organtone. Price £14/10/-, carriage and packing, 7/6. H.P. terms if required.

**DULCI RADIO CHASSIS**

Complete range of these famous receivers now available at all our branches—cash or Hire Purchase—demonstrations gladly given.

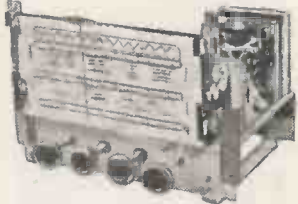

3-wave (L. M. & S.) 5-valve £12/12/- Ref. B3.

Pushpull 6-valve 3-wave £15/15/- Ref. B3PP

All available on H.P.—deposit 10 per cent, balance over 12 months.

|   | £  | s. | d. | Ref.    |
|---|----|----|----|---------|
| Pushpull with B.F. stage 3-wave 7-valve     | 18 | 18 | 0  | B3PF/BF |
| 6-wave L.M. and 4 short waves (band spread) | 15 | 15 | 0  | B6      |
| 6-wave with pushpull                        | 18 | 18 | 0  | B6PF    |
| 6-wave with pushpull and H.F. stage         | 23 | 2  | 0  | B6PFRF  |

**THE ARMSTRONG F.C. 48**

Among high class radio chassis, the name Armstrong is probably the most famous, and their new model FC48 certainly lives up to tradition. Of course, only the best of everything has been used and extreme attention has been paid to the fitting up—it is virtually a 10 valve circuit, for among its eight valves two double triodes are employed. Special features of this chassis are (a) 8-watts output in a pushpull circuit with ample negative feed-back to ensure the highest fidelity; (b) provision for using F.M., e.g., power brought out to sockets and indicator on dial; (c) independent bass and treble controls with visual indication of setting; (d) four wave-bands covering 16-51, 50-120, 190-550, and 1,000-2,000 metres. The size of this chassis is 12½in. x 9in. x 9½in. Price £23/18/-, plus 7/6 carriage and insurance.



**THE LATEST DULCI**

This is the Model F3PP. Developed especially to meet the increasing demand for high fidelity equipment. Particularly suitable for replacement in a radiogram. This is a 7-valve 3-wave band superhet with pushpull output, incorporating separate bass and treble controls thereby ensuring a maximum control of fidelity, volume and tone. Wave band coverage 16-50, 190-550, 900-2,000 metres. Valve line X79, 6BA6, ECC83, GZ30, and two 6AQ5. This chassis is suitable for use on A.C. mains from 100-110 v. and 200-250 v. Price 17 guineas or £2 deposit, carriage and insurance 7/6.

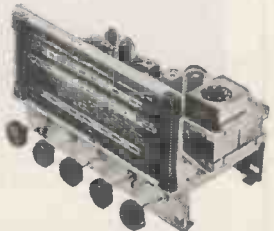



# THIS MONTH'S NEW OFFERS

## Hi-Fi EQUIPMENT

We carry good stocks of the latest equipment and except for very busy periods we can usually give demonstrations. To name a few items of stock which we carry and recommend.

### SPEAKERS

The latest W.B. cantrix cone speaker units all in die cast frames with universal impedance speech coils 3 ohm., 7.5 ohm., and 15 ohm.

|                            |         |
|----------------------------|---------|
| Model H.F. 812 8in. ....   | £3 5 6  |
| Model H.F. 912 9in. ....   | £3 9 6  |
| Model H.F. 1012 10in. .... | £3 17 6 |

Also in die cast frames but with 3 ohm. or 15 ohm. speech coils.

|                            |         |
|----------------------------|---------|
| Model H.F. 510 5in. ....   | £1 19 6 |
| Model H.F. 610 6in. ....   | £2 12 6 |
| Model H.F. 1214 12in. .... | £9 15 6 |

We also carry a range of G.E.C. Wharfedale and Goodmans Hi-Fi speakers.

### PICKUPS

ACOS HI-G HEADS for use with Garrard or Collaro plug-in units in brown or ivory £2/- each.

THE B.J. ARM, new type to give correct tracking over the whole recording. Extra lightweight, suitable for Decca, Garrard and Chancery heads £2/19/6.

ACOS EP20 HI-G with the new HI-G plug-in heads, all designed to obtain the nearest to perfect reproduction—pressure only 8 grammes. Complete with either head £3/7/6; extra head £2/2/-.

THE NEW LEAK TL-10 AMPLIFIER WITH "POINT-ONE" PRE-AMP. In the amplifier world the name Leak probably stands highest. It is symbolic of precision sound engineering. The TL-10 has an output of 10 watts and with its pre-amplifier will operate from any good pickup. A continuously variable input attenuator in the pre-amp permits the use of crystal, moving iron or moving coil pick-up. Provision is made for tape recording and play-back as an exclusive feature. Easy accessible jacks being provided on the front panel for speedy hook-up. The complete amplifier with pre-amp. £28/7/-, or TL-10 amplifier only 17 gns. or "Point-One" amp. only 10 gns.

## ELECTROLYTIC CONDENSERS

Recent manufacture. Not Gov. surplus.

### SINGLE SMOOTHING TYPES.

|                        |      |
|------------------------|------|
| 8 m.f.a. 150 v. ....   | 1/6  |
| 8 m.f.a. 450 v. ....   | 1/11 |
| 8 m.f.a. 500 v. ....   | 2/6  |
| 16 m.f.a. 350 v. ....  | 2/3  |
| 16 m.f.a. 450 v. ....  | 2/9  |
| 16 m.f.a. 500 v. ....  | 3/9  |
| 32 m.f.a. 350 v. ....  | 2/11 |
| 32 m.f.a. 450 v. ....  | 4/9  |
| 32 m.f.a. 500 v. ....  | 5/9  |
| 64 m.f.a. 350 v. ....  | 3/9  |
| 64 m.f.a. 450 v. ....  | 5/9  |
| 100 m.f.a. 350 v. .... | 4/-  |
| 100 m.f.a. 450 v. .... | 4/9  |
| 150 m.f.a. 350 v. .... | 4/9  |

### MULTIPLE TYPES

|                           |      |
|---------------------------|------|
| 8-8 m.f.a. 450 v. ....    | 3/11 |
| 8-8 m.f.a. 500 v. ....    | 4/6  |
| 16-8 m.f.a. 450 v. ....   | 3 11 |
| 16-8 m.f.a. 500 v. ....   | 5/-  |
| 16-16 m.f.a. 450 v. ....  | 4/11 |
| 16-32 m.f.a. 350 v. ....  | 4/9  |
| 32-32 m.f.a. 350 v. ....  | 4/9  |
| 32-32 m.f.a. 275 v. ....  | 5/6  |
| 50 m.f.a. 25 v. ....      | 5/6  |
| 250-50 m.f.a. 350 v. .... | 9/6  |

### BIAS TYPES

|                      |     |
|----------------------|-----|
| 25 m.f.a. 24 v. .... | 1/- |
| 50 m.f.a. 12 v. .... | 1/- |
| 50 m.f.a. 50 v. .... | 2/- |

## THE CLEVELAND OCTAVIAN

In this instrument is combined the exceptional qualities of the G.E.C. metal cone loud-speaker in its ideal cabinet (the Octagonal illustrated below) and a most modern 3-valve amplifier. This combination will give a realism of musical reproduction not easily obtained even at twice or three times its price and is definitely the reproducer for bringing out the full frequency now available in long playing microgroove recordings. If you can please come to one of our branches and hear this fine instrument—failing this, then take our word that it is really good and send an order today. Price 27 guineas or £4/10/- deposit, balance over 12 months. Amplifier available separately at £10/10/-.



## OCTAGONAL SPEAKER CABINET

Conforming exactly to the designer's specification—for G.E.C. metal cone speaker—price £12/10/- or 37/6 deposit, carriage and insurance 6/- extra. G.E.C. metal cone (extra octave) speaker £8/15/-.

## A NEW APPROACH

to an almost universal problem....

An electronic computer to indicate foot-candle results is the subject of our latest publication. The computer uses 3-valves and information is fed into 12 ratio arms. The result "home," "draw" or "away" is indicated on a centre zero-meter, suitably scaled. The information to be fed into the ratio arms can be derived from the operator's own pet methods, or alternatively the data freely available in newspapers and

popular magazines can be used. The circuit is quite an interesting one but is not at all difficult to construct or operate. When complete the unit is entirely self-contained and mains operated. The price of all components needed, excluding metal and chassis, is £3/10/-, plus 2/6 post. Our Publication "A New Approach" is given free with orders, alternatively will be supplied separately at 7/6. post free.

## BENDIX RA-1B COMMUNICATIONS RECEIVER

Originally intended for the American Forces this fine receiver. (A small quantity of which has been released by the Ministry of Supply) is available to you if you act promptly Designed to receive C.W. or R.T. it uses probably the finest Vernier tuning and band spreading arrangement possible, it covers the following bands:—

|        |         |          |                         |
|--------|---------|----------|-------------------------|
| Band 1 | 15 to   | .315 mc. | } i.e. 20 to 200 metres |
| Band 2 | .315 to | .680 mc. |                         |
| Band 3 | .680 to | 1.5 mc.  |                         |
| Band 4 | .18 to  | 3.7 mc.  |                         |
| Band 5 | 3.7 to  | 7.5 mc.  |                         |
| Band 6 | 7.5 to  | 15.0 mc. |                         |

The sensitivity is 4 micro volts for full output. It uses 8 valves and operates from batteries (12 or 24 volt) or from the mains through a power pack. It has built in output stage with a jack socket for phones. Controls, all of which are brought to the front panel, include: aerial switch, aerial compensating condenser, main tuning condenser, band selector, C.W. switch, power on/off switch, and volume control. Very compactly built in crackle finished case, these sets are brand new having never been used and in perfect working order—special price this month is £14/10/- each or 45/- deposit, balance over 12 months—carriage and insurance 10/- . Order now to avoid disappointment. Circuit diagram and component data given free with sets, or available separately price 2/6, post free.

## A PRESENT FOR WIFE OR MOTHER

Probably the most thrilling part of dressmaking is the cutting out operation. Any dressmaker then will be pleased to receive a pair of electric (mains operated) scissors. The scissors illustrated not only prevent the fatigue of cutting out, but also permit more control as they have only to be guided. These Swiss made scissors will cut all materials but not fingers they are in fact 100% safe even for young children to use. Price is 66/6 post free.



## MADE-UP—READY TO WORK

The astonishing "Occasional 55"—two valves T.R.F.—completely assembled and ready to switch on—complete with all valves and 5in. speaker—Covers both medium and long wave bands and uses dust cored coils in a unique modern circuit which gives almost superb performance. Price £6/5/-, plus 3/6 post—Bakelite or wooden cabinet available price 16/6, post 2/6.



## FRICITION DRIVE MOTOR



Operates from standard 50 cycle mains—a thoroughly good job with dozens of applications—limited quantity only—17/6 each, post and packing 1/6.

## SPECIAL BATTERY VALVES

All .45 v. heaters. 1T4, 1B5, 155, 3A4 offered as a set 30/- the four.

## THIS MONTH'S SNIP

Mains transformer and choke by Haines Radio Ltd, Standard 50 cycle input with 10 volts tapplings. Secondary: 500-0-500 volt at 500 milliamps and 6.3 volt at 6 amps., also choke to match 10 Henry's at 500 milliamps. Limited quantity only at 45/- the pair. Carriage and packing 6/- extra.

## P.M. SPEAKERS

All by best makers. Rola, Elac, Plessey, Truvox, etc.

|                 |
|-----------------|
| 5in. p.m. 19/6  |
| 6in. p.m. 17/6  |
| 8in. p.m. 19/6  |
| 10in. p.m. 25/- |
| 12in. p.m. 35/- |

## COMPONENT BARGAINS

(all new and unused)

ELAC FOCUS MAGNET. Type No. R26-7D. Price 12/6, plus 9d. post.

OUTPUT TRANSFORMERS. Standard pentode matching, ordinary 2/6, push pull centre tapped, 3/6.

COILS suitable for F.M. and T.V. with dust cores and fixing lugs. 12 assorted 5/6.

I.F. TRANSFORMERS. Medium small size exceptional high Q potted construction, tuning over 450-470 K.C.'s. 5/6 per pair.

2-GANG TUNING CONDENSER. Midget .0005, 5/6.

HALF MEG. POTS. With switch 1/9, less switch 1/3, double pole switch, 2/- (all short spindle but room for knob)

1 MEG. POTS. Less switch 1/3, short spindle, preset, 1/-

CERAMIC CONDENSERS. 1,000 pf. and 800 pf., 3/6 doz.

TRIMMERS. 3-30 pf standard compression type. 4/- doz.

# ELECTRONIC PRECISION EQUIPMENT LTD.

249, Kilburn High Road.  
Kilburn.  
(Now Open)

42-46, Windmill Hill, Ruislip,  
Middlesex.  
Phone: RUISLIP 5780  
Half-day Wednesday.

152-153, Fleet Street, E.C.4.  
Phone: CENTRAL 2833  
Half-day Saturday.

29, Stroud Green Road, Finsbury  
Park, N.4.  
Phone: ARCHWAY 1049  
Half-day Thursday.

Post orders should be marked "Dept. 2" and addressed to our Ruislip dept.

# HIGH VACUUM EQUIPMENT

VITAL TO THE  
ELECTRONIC ENGINEER

A simple optical system for Television Projection.

- (A) Front aluminized mirror.
- (B) Cathode Ray Tube.
- (C) Schmidt correction plate.
- (D) Focusing and deflection coil.

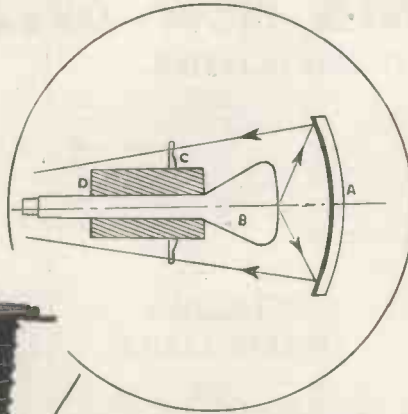

- "SPEEDIVAC" Rotary Pumps with safety non-return valves. A complete range of models covering many vacuum ranges and pumping speeds. Also a range of vapour traps, valves and connections, available.
- "SPEEDIVAC" HIGH SPEED MINIATURE VAPOUR PUMPS. A complete range of oil and mercury models with integral booster jets and baffle valves available. A special Booster range for high speeds in the industrial range also available.
- FAST "HARD" PUMPING SYSTEMS. Ranging from simple bench units to large automatic systems.

- CATHODE RAY TUBE ALUMINIZING PLANT. A specially designed, self-contained unit with unique neck and stem gripper device for the aluminizing of fluorescent screens.
- ALUMINIZING PLANT. For front surface mirrors photo-sensitive mosaics, H.F. crystal electrodes, filters and many other electronic devices.
- HIGH VACUUM MEASURING INSTRUMENTS. For every type of system with single or multi-point direct indication or permanent recording facilities.

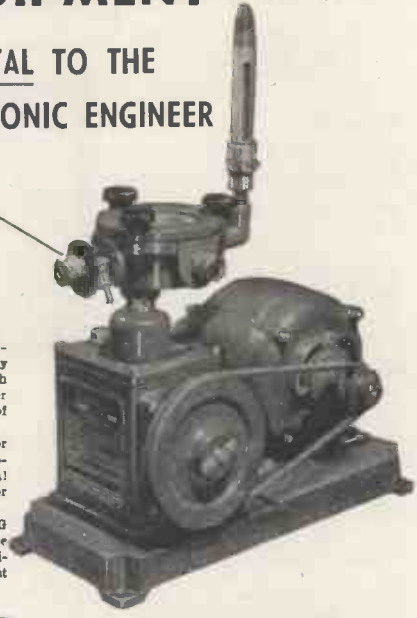

## W. EDWARDS

CO. (LONDON) LTD

MANOR ROYAL · CRAWLEY · SUSSEX  
CRAWLEY 1500 (0114) EDCHIVAC CRAWLEY



BRANCHES: GLASGOW & TORONTO. AGENTS THROUGHOUT THE WORLD

## brandenburg



high voltage engineering

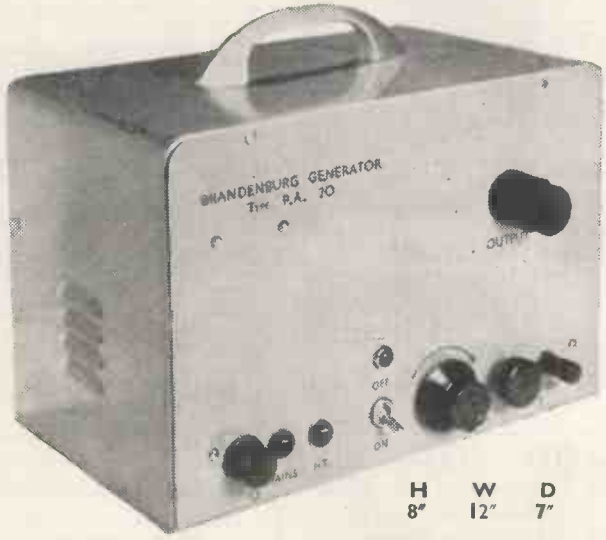

20,000 volts stabilized  
—for only £29-15-0

The Brandenburg PA20 high voltage generator provides a supply variable from either 17 kV. to 20 kV. or 14 kV. to 17 kV., with a regulation of 1% against mains variation of 5% and load variation of zero to 200  $\mu$ A. Fitted with EHT output current measuring jack for use with moving coil instrument to facilitate breakdown testing, CRT testing, experimental X-ray tube investigation and many other applications, with or without ancillary equipment.

Guaranteed 12 months

Teleonics | communications | Ltd.  
196 Dawes Road, London, S.W.6. Fulham 1534

# LINE OUTPUT TRANSFORMER

## TYPE L.O. 352

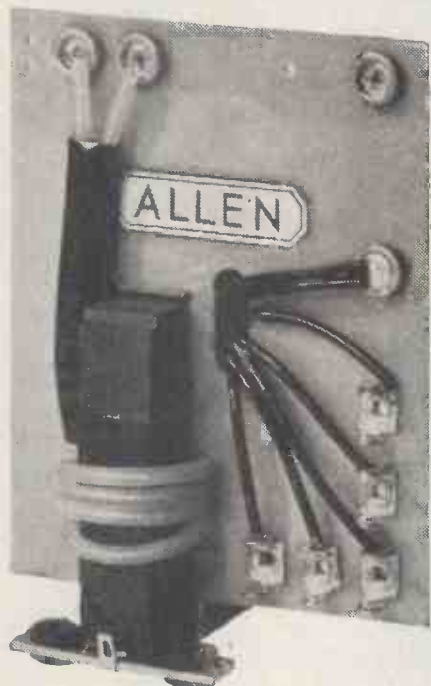

"L.O. 352" IS THE TYPE NUMBER OF AN ENTIRELY NEW ALLEN LINE OUTPUT AUTO-TRANSFORMER NOW AVAILABLE.

Note the following "Star" features:

- ★ E.H.T.: 14 to 18 KV.
- ★ E.H.T. Regulation: Better than 5 M.
- ★ Audible Whistle: Negligible.
- ★ Application: Self-running, Square-wave or Sawtooth driven.
- ★ Associated Valves: PL81, PY81.
- ★ Associated Yoke: Allen Type DC605/C.
- ★ H.T. Rail: 190 volts for 14KV.
- ★ Core Material: Mullard Ferroxcube (earthed).
- ★ Scanning Angle: 72 degrees.
- ★ Suitable C.R.T.s: Any "wide-angle" tube, from 14 to 2lin.

Manufacturers are invited to write for further details and prices. Home-Constructors: Please send S.A.E. for recommended circuit diagram and details.

## ALLEN COMPONENTS LTD.

(Specialists In high-grade television components)

197, LOWER RICHMOND ROAD, RICHMOND, SURREY



## EASY to SEE EASY to HANDLE

The NEW

## EDDYSTONE "840A"

Receiver with Full

Communications Specification

Long clear scales and Positive calibrations—34 Feet of Bandsread per range.

Operates from AC or DC mains. 100/110 and 200/250 volts. Uses 7 Valves (excluding rectifier) in a high performance circuit, with internal loudspeaker.

PRICE

★ ★ ★ ★ **£49** ★ ★ ★ ★

OR ON WEBB'S EXTENDED PAYMENT SCHEME

Deposit £9/16/- and 12 payments of £3/11/11.  
Or 18 payments of £2/10/1.

Ask Webb's for descriptive brochure, post free.

A FULL RANGE OF EDDYSTONE APPARATUS ALWAYS AVAILABLE AT

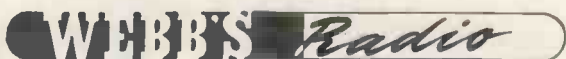

14 SOHO STREET, OXFORD STREET, LONDON, W.1

Tel: GERard 2089. Shop Hours: 9 a.m.—5.30 p.m. Sats. 9 a.m.—1 a.m.

# RELAYS

P.O. TYPES  
TO YOUR  
SPECIFICATION

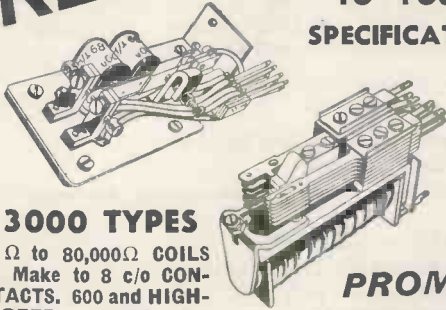

## 3000 TYPES

1Ω to 80,000Ω COILS  
1 Make to 8 c/o CON-  
TACTS. 600 and HIGH-  
SPEED TYPES also  
Supplied.

PROMPT  
DELIVERY

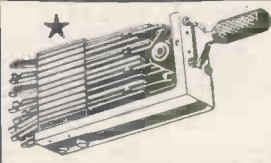

LARGE  
STOCKS  
OF  
KEYSWITCHES

## THE KEYSWITCH CO.

ALL POST OFFICE EQUIPMENT

★ Please note change of address ★

126 KENSAL ROAD, LONDON, W.10

Telephone: LAD. 0666.

## THE NEW

# BJ

Plug-in

## CRYSTAL HEAD



Protected by World  
patent applications

BJ ARM PRICE 44/11 plus 15/- Tax.

BJ HEAD Microgroove and Standard 32/6  
plus 10/5 Tax.

ASK YOUR DEALER FOR DETAILS

MAGNUM PRODUCTS MANUFACTURED BY

## BURNE-JONES & Co. Ltd.

309-317, BOROUGH HIGH ST., LONDON, S.E.1.

## VARIACS for S-M-O-O-T-H Voltage Control



The "VARIAC"† is the original, continuously adjustable auto-transformer... the ideal control for varying the a-c voltage applied to any electrical, electronic, radar or communications equipment. Voltages from Zero to 17% above line are obtained by a 320-degree rotation of the shaft, which is equipped with a direct-reading dial, calibrated accurately. "VARIAC" offers many real advantages over any other type of a-c control: compared with the losses of resistive controls they save their initial cost within about one year. They are available in various sizes from 170 VA up to 25 Kilowatts. 3-gang assemblies are also available for 3-phase working. Prices vary from £7.10.0. upwards.

Write for our Catalogue—Technical Manual V-549, which gives all possible information, to:

## CLAUDE LYONS LTD.

Head Office and Works, 76 Oldhall Street, Liverpool 3, Lancs.  
Southern Factory: Valley Works, Ware Road, Hoddesdon, Herts.

† Registered Trade Mark.

## HANNEY of BATH offers:—

OSRAM 618 Eric resistor-pot, kit with ceramite tube resistors, very highly recommended, 29/8; Lab resistor kit, 32/4; T.C.C. condensers, 55/-; PARTRIDGE Components, with loose lead terminations, Mains trans., 44/-; Smoothing Choke, 29/6; Output trans., 76/9. Price includes Partridge carriage/packing charge. Printed panel, 14/6. W.B. chassis, 28/6. DENCO 16 S.W.G. All-Chassis with beautiful Bronze Front Panel, 21/- (Printed.) S.A.E. List.

MULLARD 5 VALVE 10 WATT AMPLIFIER. T.C.C. Condensers, 45/-; Eric resistor-pot kit, 37/6; Elstone Mains trans., 36/-; Elstone Output trans., 45/- (both types); Denco chassis, 14/6; Printed bronze panel 14in. x 6in., 6/6. Small parts as per our list. Matched valves available for both the above designs.

WILLIAMSON AMPLIFIER. Woden potted components. Output trans. WOT.25 (1.7Ω), 130/-; PTM 14 a. mains trans., 87/6; PCF.12 150 mA. choke, 44/-; PCF.22 30 H. 20 mA. choke, 30/-; PIM 23 (mains trans. for pre-amp.), 47/6. Resistor (R&K and Condenser kits (CK) available, R&K, main amplifier, 29/6; R&K figs. 13 and 27, 12/6; R&K fig. 15, 28/9; R&K fig. 19, 36/-; R&K fig. 29, 29/3; CK fig. 13, 15/-; CK fig. 15, 47/-; CK fig. 19, 54/6; CK fig. 27, 19/-; CK fig. 29, 54/6. 12 1% silver mica's (fig. 19), 15/-; 7% 7/-; Elstone output trans., 50/-; mains trans., 57/6; 1 OH 150 mA. choke, 20/-; 30 H. 20 mA. choke, 10/-.

FREQUENCY MODULATION. For Wrotham high fidelity transmissions. DENCO technical bulletin giving circuit and point to point wiring diagram for building an F.M. Feeder unit, 1/8, post free. We have all components available. Priced parts list on application.

COLPACKS. DENCO, CP 4/L and CP 4/M, 33/4; CP 3/370 pf. and CP 3/500 pf., 42/8. OSMOR "Q" HO, 48/-; LM, 40/-; Batt., 50/-; TEF, 40/-; HF stage for HO pack, 20/-; ETA 4-station pack, 43/8. We stock COILS by Weymouth, Osamor, Wearite, Denco, Teleton and R.E.F.

WIDE ANGLE COMPONENTS. ALLEN. Teleking Chassis, 50/-; Collects (TK and Super-Visor), 44/8; LO.308, 40/-; FO.305, 21/-; DC.306, 38/6; FC302, 31/-; GL.18 and 18, 7/6 each; SC.312, 21/-; AT.310, 30/-; OF.117, 9/-; ET.314, 15/-; DENCO Chassis Magnaview, 37/6; Chassis, Super-Visor, 51/6; Collects Magnaview, 41/2; WA/DCAL, 43/-; WA/FOAL, 31/-; WA/LOI and WOL, 7/6 each; WA/FMA1, 21/-; WA/LOT1, 42/-; WA/FBT1, 18/-.

Send 6d. stamps for our General List of components for Viewmaster, Soundmaster, Williamson Amplifier, Teleking, Magnaview (Brimar and English Electric large screen TV), Super-Visor, Mullard Universal, Close tolerance Silver Micas, etc., etc. Please add 1/- postage to orders under £2.

## L. F. HANNEY

77 LOWER BRISTOL ROAD, BATH

Tel.: 3811

**PROOPS** BROS. LTD.

*The Walk-around Shop*

**SPECIAL OFFER!**

**BENDIX COMMUNICATIONS RECEIVER  
TYPE RA-10DB**

A superb 8 valve 4 band receiver covering 150-400 kc/s., 400-1100 kc/s., 2-5 Mc/s., and 5-10 Mc/s. Valve line up 6SK7 R/F, 6K8 F/C, Two 6SK7 IF Amplifiers, 6R7 Second Det. AVC and AF Amplifier, 6C5 BFO, 6K6 OP, 6H6 Sig. limiter diode.

**SENSITIVITY**

4 mV. signal, gives 50 mW. audio at 4-1 signal/noise ratio.

**SELECTIVITY**

At 5 Mc/s. is 39 kc/s. at 1,000 times down.  
At 150 kc/s, bandwidth is only 22 kc/s.

**IMAGE RATIO**

Minimum image ratio is better than 1500-1 on 5-10 Mc/s Band and 10,000-1 on 150-400 kc/s.

IF Frequency 1,630 Mc/s. Audio output 500 mW. (easily increased to 2 W.). In addition to normal tuning, two locked crystal channels are provided for the two HF bands. Crystals are not included. Band switching is electrical by motor-driven selector switch, and tuning is by remote control cable (not supplied or available at the moment). Conversion to manual control is extremely simple. Provision is made for D/F loop or normal antenna. Power supply 28 V. d.c. 2 A. to internal motor generator. If desired this can easily be changed to a similar generator with either 6 or 12 V. input. Alternatively the generator may be removed and the space utilised for a converter. A circuit for a.c. mains conversion is available.

As a **BOAT, TRUCK, CARAVAN** or **CAR RECEIVER** it is **UNEQUALLED** in value; converted to a.c. operation for fixed station, it equals receivers selling for over five times the price we ask.

Full technical details, servicing data and circuit are supplied with every receiver.

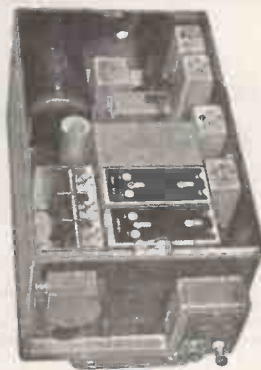

IN NEW CONDITION

PRICE

**£5.10.0**

Packing and Carriage, 10/-



**BRIDGE MEGGERS.** 250 V. Made by Evershed & Vignoles, with integral Decade Box. 1Ω-1 M. In leather case 12in. x 9in. x 8in. In perfect order

**£10**

plus 7/6 carriage.

NOTE: Orders and Enquiries to Dept. 'W' please.

**TRANSMITTER/RECEIVER.** New Zealand type ZC1 Mk. II. (8-W. input.) Frequency coverage: 2-4 and 4-8 Mc/s. Receiver line up: 6U7G tuned RF amplifier. 6K8G amplifier F.C. 6U7G IF amplifier. 6Q7G Det. and Audio amplifier. 6U7G Output. 6U7G BFO. Transmitter line up: is P.A., Driver, M.O. amplifier, Pre/amplifier (osc.) utilising two 6V6G and three 6U7G. I.F. frequency is 465 kc/s. Power supply, a 12-volt Vibrator Pack is incorporated in the set. (Basily converted to mains.) Size 22in. x 10in. x 10in. A really first-class Trans/Receiver. Price £6/19/6, plus 10/- carr.

IN NEW CONDITION

Moving Coil Headphones No. 7 ... 7/6 pair  
Moving Coil Microphones No. 7 ... 7/6 pair  
Morse Key with lead and plug ... 7/6

For use with the above Trans/Receiver.

**FLUX METER TYPE WY 0023.** Range 500-1,000, 1,000-2,000, 2,000-4,000 gauss. Complete with probe. In polished wooden carrying case 12in. x 6in. x 9in. Brand NEW, £5, post paid.

**MAINS MOTORS.** 220-250 volts a.c./d.c. Spindle 3/8in. extending 1in., # Pulley with V groove at 3/8 x 3/8. Overall length 8 1/2in., dia. 3 1/2in. Base plate 4in. square, 4 hole fixing. 12/6, plus carriage 2/6.

**AERIAL COUPLING UNIT TYPE ZA0032** Containing Thermo Couple H.F. Ammeter Scale 0-350 mA. Variometer with black bakelite dial calibrated 0-360. Unit housed in metal case 5 1/2in. x 7in. x 5 1/2in., 4/-, plus 2/- postage.

**AIRCRAFT LANDING LAMPS.** 9in. dia. polished aluminium reflector with inverted holder. Frame fitting can be adapted to take normal mains holder. Suitable for floodlighting, stage-lighting, photographic work, etc., 7/6, postage 2/-.

**PULLIN 24-VOLT D.C. MOTORS.** 0.4 A. Size 2in. x 2in. x 2 1/2in. 3/8in. spindle extending 3/4in. 4-pole laminated field. Brushes at 90°. External connections to field and armature. Will run on a.c., 6/6, plus 1/6 postage.

**ELECTRIC TURN AND SLIP INDICATOR.** A d.c. operated Gyro 24 volts. RAF ref. 6A/2872. Manufactured by R. B. Pullin Ltd. In perfect working order, 16/- post paid.

OPEN ALL DAY SATURDAY. Shops Hours 9 a.m.—6 p.m.

**PROOPS** BROS. LTD. *The Walk-around Shop*

52 TOTTENHAM COURT ROAD . LONDON . W.1

Telephone: LANgham 0141

# HUNTON will cut your press tool costs for PROTOTYPE and PRE-PRODUCTION RUNS!

THE UNIVERSAL BOLSTER OUTFIT USING STANDARDISED PUNCHES AND DIES FOR SHEET METAL PIERCING AND BLANKING ON FLY PRESSES

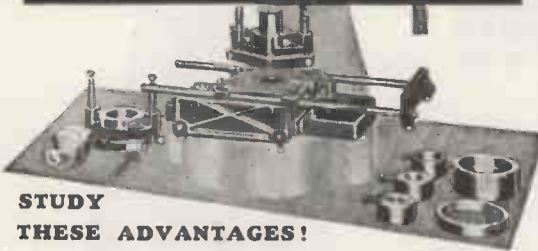

## STUDY THESE ADVANTAGES!

- Specialised range of Chassis Piercing and Forming Tools for the Radio and Electronics Industries.
- To get you started—standardised Punches and Dies  $\frac{1}{16}$  in. to  $\frac{3}{16}$  in. dia. in 1/32 in. sizes from stock.
- At short notice, standardised Tools for square, oblong, and other shapes.
- Adjustable Ganges for exact location of work. Automatic and Positive Stripping of material from Punch.

If in London and Home Counties, ask for a practical demonstration in your own works. Alternatively, write for illustrated price list to:

**HUNTON LIMITED, PHENIX WORKS,**  
114-116, EUSTON ROAD, LONDON, N.W.1.  
Tel.: EUSton 1477 (3 lines). Grams: Untonexh, London.

# SAMSON'S SURPLUS STORES

**SPECIAL OFFER A.M. H.T. TRANSFORMERS.** Pri. 200-240 v. Sec. 525-0-525 v. 150 mA. 5 v. 3 a. 6.3 v. 1.5 a. 55 v. 50 mA. £2/6/6, P.P. 2/6.

**BRAND NEW METERS BY FAMOUS MAKERS.** 4in. Round flush M1 Ammeters. 0-40 amps. 500 c/s. 37/6, P.P. 2/-. 3 1/2in. round flush MO 0-400 mA., 30/-. P.P. 2/-. 2 1/2in. round flush MO 0-500 mA., 15/-. P.P. 1/6.

**LIGHTWEIGHT UNSPILLABLE P. & G. 2-VOLT 7 AH. AT 10 HR. RATE ACCUMULATORS.** Size 4 1/2in. x 3 1/2in. x 1 1/2in., 15/-. P.P. 1/-.  
EKIDE 10 volt 5 Ah. Glass accumulators, size 7in. x 2 1/2in. x 5in. suitable for H.T. unit construction and models, etc. 7/6, P.P. 1/6. **MINIATURE ACCUMULATORS** made by Willard Co. 36 volt 0.2 Ah. Note size and weight. 3 1/2in. x 1 1/2in. x 1 1/2in., weight 5 1/2 oz., 5/-. P.P. 6d., or set of three 36 v. and one 6 v. same size but weight 4 1/2 oz. in sealed metal container, £1, P.P. 1/3. Easily filled with hypodermic syringe.

**EX-ARMY MEDICAL HYPODERMIC SYRINGES.** Brand new. 1 c.c. with needle, 4/6, P.P. 6d. 10 c.c., with needle, 7/6, P.P. 6d. Extra needles, tin of 6, 2/-. P.P. 6d.

**AMERICAN 8 VOLT 90 AH. 15 PLATE CAR BATTERIES.** Size 9in. x 9in. x 7 1/2in. Brand new in maker's cases, £2/19/6, carr. 7/6.

**PRICHETT AND GOLD STORAGE BATTERIES.** 12 volt 75 Ah. Built in teak cases. Brand new, £4/15/-. carr. 7/6.

**AMERICAN AIRCRAFT BATTERIES.** 24 volt 11 Ah., by Willard. Size 8in. x 7 1/2in. x 7 1/2in., 50/-. carr. 7/6.

**AMERICAN C.B. TUBES.** 5 CPL Brand new, 29/6, carr. 2/6. CRT Type NC13 7in., packed in crates, 35/-. carr. 4/-. R.F. UNITS, Type 24, 20-30 Mc/s., complete with valves, brand new, 15/-. P.P. 2/-.  
**INSTRUMENTS, ADMIRALTY INTEGRATORS, TYPE A 591.** Incorporating very fine Galvo movement, coil 40 ohms. Centre zero to F.S.D. 1 microamp. Small mirror one metre radius. A very useful laboratory instrument, 65/-. carr. 2/6.

**METRO-VICKERS MASTER VOLTMETERS.** 0-20 volts A.C. 50 cy. M.1.6 in. mirrored scale, 25/-. P.P. 1/6. A.M. 2 1/2in. panel mounting 500-0-500 microameters, blank scale, brand new, 25/-. P.P. 1/-.  
Howard Butler 0-150 volts D.C. MC. Built in 8in. square Bakelite case, 29/6, P.P. 1/6.

**HEAVY DUTY A.M. L.T. TRANSFORMERS.** Pri. 440 v. Sec. 220 v., in steps of 25 v. conservatively rated at 2.2 kW., weight approx. 90 lb. Half the above secondary can be obtained from 220 v. input, £9/10/-. plus carr. Pri. 230 v. Sec. 50 v. 20 amps., completely enclosed, £8/10/-. plus carr. Pri. 230 v. Sec. 13, 13.5, 14, 15 v., very conservatively rated at 60 amps., £8/5/-. plus carr. Pri. 115 v. Sec. 17 v. 15 amps. and 2.2 v. 18 amps., 35/-. carr. 4/-. Pri. 230 v. Sec. 8.2 C.T., very conservatively rated at 10 amps., 25/-. carr. 2/6. Pri. 200-250 v. Sec. 115 v. 5.7 amps., £5/15/-. carr. 5/-.  
**A.M. H.T. TRANSFORMERS.** Pri. 230 v. Sec. 1,500 v. 1.6 kVA. 65/-. carr. 7/6.  
**1154 TX H.T. TRANSFORMERS.** Pri. 200-250 v. Sec. 1250-1800 v. 350 mA., 35/-. carr. 4/-.  
**ADMIRALTY SOUND POWERED HAND SETS,** no batteries required, 17/6. P.P. 1/6.

169/171 Edgware Road,  
London, W.2. Tel: PAD 7851

125 Tottenham Court Road, W.1.  
Tel.: EUS 4982

All orders and enquiries to our Edgware Road branch, please. This is open all day Saturday.



# METERS

LARGE AND VARIED STOCKS AVAILABLE FOR IMMEDIATE DELIVERY

EXAMPLES FROM OUR RANGE OF 2 1/2" FLUSH PATTERN MOVING COIL INSTRUMENTS (as illustrated)

- AMPERES D.C. 0-1, 2, 3, 5, 10, 15, 20, 25, 30, 50.
- MILLIAMPS. 0-1, 1-0-1, 0-5, 10, 15, 20, 25, 30, 50, 100, 250, 500.
- MICROAMPS. 0-50, 100, 200, 250, 400, 500, 750, 50-0-50, 100-0-100, 250-0-250, 500-0-500.
- MILLIVOLTS. 0-10, 25, 50, 75, 100, 500.
- VOLTS D.C. 0-1, 5, 10, 15, 25, 50, 100, 250, 500, 750, 1,000.
- VOLTS A.C. 0-5, 10, 15, 25, 50, 100, 250, 500, 750, 1,000.

We can supply meters with NON-STANDARD CURRENT and VOLTAGE RANGES to any specification. DELIVERY 7-14 days. MOVING IRON, THERMO & ELECTROSTATIC INSTRUMENTS ALSO AVAILABLE.

**ANDERS ELECTRONICS LTD.**  
91, HAMPSTEAD ROAD, LONDON, N.W.1.  
Telephone: EUSton 1539  
Supplied to Government Departments, B.B.C.,  
Leading Manufacturers & Research Laboratories

# ASK ARTHURS FIRST

- ★ NEW VALVES Send your enquiries for all Radio and Electro. goods, especially those in short supply.
- We have probably the largest variety of valves in the country. Let us know your requirements.
- AVO METERS IN STOCK**
- Avo Model 7 ..... £19 10 0
  - Avo Model 8 ..... £23 10 0
  - Signal Generator, Mains and Battery Models ..... £30 0 0
  - Electronic Test Meter ..... £40 0 0
  - Valve Characteristics Meter ..... £60 0 0

Also full range TAYLOR METERS. List on request.

## VALVE MANUALS

- Mullard ..... 5 0
  - Osram ..... 5 0
  - Brimar No. 5 ..... 5 0
  - Mazda, Part 2 ..... 2 0
  - Mullard Valve Replacement Guide ..... 2 6
  - Art and Science in Sound Reproduction by F. H. Brittain, D.F.H. ... 2 6
- Postage 6d. each extra.

- Leak TL/10 Amplifier and "Point One" Preamplifier complete ..... £28 7 0
- Chapman Tuning Units ..... £17 6 8
- Leak Tuning Unit ..... £35 6 3
- Grundig Tape Recorder ..... £68 5 0
- Grundig Microphone ... £6 6 0

Recording Tapes: All makes in stock.

Terms: C.O.D. or Cash with order. Goods offered subject to being unsold and to price alteration.

*Arthur's*  
EST. 1919

PROPS: ARTHUR GRAY, LTD.  
GRAY HOUSE, 150-152 CHARING CROSS ROAD, LONDON, W.C.2  
TEMPLE Bar 5833/4 and 4765. Cables: TELEGRAY, LONDON

### C.R.T. ISOLATION TRANSFORMERS

Designed to cover practically every demand for Transformers for Cathode Ray Tubes having Heater/Cathode short circuit or for C.R. Tubes with falling emission. Type A. Low leakage windings. Ratio 1-1.25 giving 25% boost on Secondary.

- 2 volt ..... 10/6 each With Tag
  - 4 volt ..... 10/6 each Panel and
  - 6 volt ..... 10/6 each Solder Tags
  - 10.8 volt ..... 10/6 each
  - 13.3 volt ..... 10/6 each
- Type B. Mains Input 220/240 volts. Multi Output 2.2-4.5-7.3-10 and 13 volts. Input has two taps which increase output volts by 25% and 50% respectively. This transformer is suitable for most Cathode Ray Tubes. The MOST VERSATILE Low Capacity C.R. Transformer with Universal Output. With Tag Panel and Solder Tags. 21/- each.
- Type C. A most useful low capacity wound transformer for use with 2 volt Tubes with falling emission. Input 230/240 volts. Output 2.2-2.4-2.1-3 volts at 2 amps. With Tag Panel and Solder Tags 17/6 each. All Isolation Transformers are individually boxed, labelled and clearly marked with relevant data.

### Volume Controls

Midget type. Long spindles. Guaranteed 1 year. All values 10,000 ohms to 2 Meg-ohms. No Sw. S.P.S.w. D.P.S.w. 3/- 4/- 4/6

### 80 ohm COAX

Semi-air spaced Polythene Insulated. 1/4 in. diameter. Stranded core. 9d. yd. Losses cut 50%. STANDARD 1/4 in. diam. Coax. GRADE 8d. yd. "A"

BALANCED TWIN FEEDER per yd. 6d. TWIN SCREENED COAXIAL FEEDER 1/- yd. 80 ohms 5 OHM COAXIAL CABLE, 8d. per yd. 1/4 in. dia. TRIMMERS, Ceramic, 30, 50, 70 pf., 9d. 100 pf., 150 pf., 1/3; 250 pf., 1/6; 600 pf., 1/9.

RESISTORS—All values: 10 ohms to 10 meg., 1/2 w., 4d.; 1 w., 6d.; 1.5 w., 8d.; 2 w., 1/-; High stability, 1/2 w., 1% 2/6. Preferred values 10 ohms to 10 Meg.

WIRE-WOUND RESISTORS—Best Makes Miniature Ceramic Type—5 w., 15 ohms to 4 K., 1/9; 10 w., 20 ohms to 6 K., 2/3; 15 w., 30 ohms to 10 K., 2/9; 5 w., Vitreous, 12 K. to 25 K., 3/6.

WIRE-WOUND POTS, 3 WATT LAB. COLVERN, ETC. Pre-Set Min. T.V. Type Standard Size Pots, 24in. Knurled Slotted Knob. Spindle High Grade. All Values 100 ohms to 30 K. 3/- ea. 50 K., 4/-. Ditto Carbon Track 50 K. W/W EXT. SPEAKER CONTROL 10/6, 3/6.

O/P TRANSFORMERS.—Heavy Duty 70 mA., 4/6. Ditto tapped primary, 4/9. Multiratio, QPP, push pull 6/6. Tapped small pentode, 3/9.

L.F. CHOKES, 15/10 H. 60/85 mA., 5/-; 25/20 H. 100/120 mA., 11/6; 20/15 H. 120/150 mA., 12/6. MAINS TRANS. 350-0-350, 30 mA., 6.3 v., 4 s., 2 a., ditto 250-0-250, 21/-; AMPLIFIER TRANS. 250-0-250 v., 50 mA., 6.3 v., 2 a., 17/6. HEATER TRANS. 6.3 v. 1 1/2 a., 7/6; 6.3 v. 3 a., 10/6.

ELECTRODYNAMIC MIKE INSERT.—U.S.A. make, precision engineered. Size only 1/4 in. diam. by 1/4 in. Bargain Price 3/9. Matching Trans. 3/9.

SPEAKER PRET.—Expanded anodised metal, 14in. by 9in., 3/6. EXT. L.S.—Switched Socket, on-off and parallel switching, complete with plug, 2/6.

COPPER PLATED AERIAL RODS. 1/4 in. x 12in. push fitting, 2/6 down, 3/6 p. 9d. MAINS LEAD—8 rds. Twin Twisted Maroon Flex. 1/- 2 yd. Non-kink Appliance Leads. Bargain 1/3.

TYANA.—Midget Soldering Iron. 200/220 v. or 230/250 v. 14/11. TYANA TRIPLE THREE.—Complete with detachable bench stand, 19/6. 200/220 v. or 230/250 v.

NEW SLOW MIDGET IRON.—25 w., 19/6. IDEAL FOR RADIO CONSTRUCTORS. 200/220 v. or 230/250 v.

MIKE TRANS.—Ratio 80:1, 3/9 ea., new and boxed. V/OLDERS.—Fax. Int. Oct. 6d.; EF50, EA50, 6d.; B12A CRT, 1/3. Moulded: Int. Oct. 6d.; B76, 9d.; with screening can, 1/6; B8A, B9G, B9A, 1/-; VOE97, 2/6. Ceramic: EF50, B76, 1/-; Faxolin ENG. and AMER. 8/- and 8-9in., etc., 1/-.

Nuts, Bolts and Washers, 12 of ea. 1-1/2 packets, 2 or 6 BA TAG STRIPS.—2- or 3-way, 2d.; 4- or 5-way, 3d.; 6-way, 4d.; 9- or 10-way, 6d. etc.

TOGGLE SWITCHES EK-GOVT.—"On-Off" 9d. Erinic M-core solder 50/40, 16 g. or 18 g., 5/6; 1 lb., 4d. yd. T.C. wire, 18 to 22 a.w.g., 2/-; 1/2 lb. F.V.C. Connecting wire, 8 colours. Single or Stranded, 2d. yd. 2 K. 5 w. H.D. w/w Pots, 4/6, 10 K., 25 K., Colvern w/w Pot. 1in spindle, 3/6.

SCREENED GRID CAPS L. Oct. or Masda, 8d. ea. BULGIN HIGH VOLTAGE VALVE CAPS, 1 Oct., 1/-.

FUSES.—1/4 in. all values 60 mA., 10 to 10 A., 6d. ALADDIN FORMERS and cores, 1/4 in., 8d.; 1/4 in. 10d.

SLOW MOTION DRIVES.—Epileyette ratio 4:1, 2/3. INT. OCTAL CABLE PLUG (8-pin), with cover, 1/3.

200-250 Volt SELECTOR SOCKET (2in. x 1in.) with Plug 1/-. PILOT LAMPS.—6.3 v. 3 a., 8d.

MAINS DROPPERS. 3in. x 1/4 in. Adj. Sliders, 3 amp. 750 ohms, 4/3, 2 amp., 1,000 ohms, 4/3.

LINE CORD.—3 amp., 60 ohms per foot, 2 amp., 100 ohms per foot, 2 way, 1/6 a yard; 3-way, 1/8 a yard.

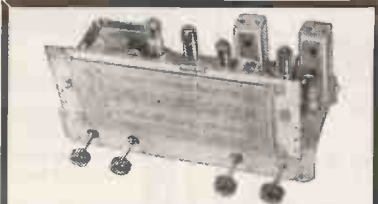

**ALL WAVE RADIOGRAM CHASSIS**

THREE WAVEBANDS LATEST FIVE VALVES  
S.W. 16 m.—60 m. ECH 42, EP41  
M.W. 200 m.—550 m. EBO 41, EL 41, EZ40  
L.W. 800 m.—2,000 m. Brand New and Guaranteed, with 10in. P.M. Speaker, A.C. 200/250 v. Four position Wavechange Switch. Short-Medium-Long-Gran. Slow Motion Tuning. Speaker and Pick-up connections. High Q iron-dust cored coils, 465 Kc/L.F. Latest circuit technique delayed. A.V.C. and Negative feedback. Output 4.3 watts. 3 v.o.c. output transformer on chassis. Chassis size 13 1/2 x 5 1/2 x 2 1/4 in. Glass Dial—10in. x 4 1/4 in., horizontal or vertical type available, lit by 2 Pilot Lamps. Colour Black Station names, L.W. Green, M.W. Red, S.W. White. Four Knobs supplied. Walnut or Ivory to choice, aligned and calibrated. Chassis isolated from mains. PRICE £10/15/-, Carriage and Insurance, 4/6. (Without 10in. Speaker, £9/15/-, Carr. & Ins., 4/6.) A.C.-D.C. 10/- extra.

### RECOMMENDED FOR ABOVE CHASSIS

**Plessey Multi Speed Changer**

PRICE Carriage Paid £9. 19. 6

GREAT REDUCTION

Brand New Plessey 3-speed Autochanger Mixer Unit for 7, 10 and 12in. Records. Twin Hi-Fi Xtal Head with Dipoint sapphire stylus. Plays 4,000 records sprung mounting, Superb Quality. Bargain.

This Changer will play—  
8 mixed 78 r.p.m. 10" and 12" records.  
8 45 r.p.m. 7" records.  
10 33 1/2 r.p.m. 7" records.  
10 33 1/2 r.p.m. mixed 10" & 12" records



**\* MIXER TYPE MECHANISM**

**\* DUAL POINT TURNOVER HEAD**

T.V. PRE-AMP.—Channel 1. Easily modified for other Channels or Converter use. Midget Chassis, 4 1/2 x 2 1/2 x 1 1/2. Complete with EF42 valve, coaxial lead and plug. Ready for use. Brand new Mfrs. Surplus. Listed £3/15/-. Special Clearance Price, £2/- Buy Yours Now.

EXCLUSIVE

**RECORDING TAPE**

1,200 ft. on standard fitting 7" reels. Brand new boxed famous G.E.C. make. High tensile strength, sensitivity and coercivity.

THE PRICE ONLY 17/6 REEL Post free

Covered by our usual money back guarantee.

PYE Aerial Plug and Socket, 1/6 pr.

5in. RADIO SCREWDRIVERS.—Sheffield made blade 2 1/2 in. x 1/4 in. Ins. handle 5,000 v. 4 1/4 d. each.

CONDENSERS.—New Stock .001 mfd. 6 kv. T.C.C. 5/6. Ditto, 12.5 kv., 9/6; 2 pf. to 500 pf. Mica, 6d.; .001 Mica or Tub. 500 v., .01 Sprague 500 v., .02 500 v., 1 mfd. 350 v. Micamould Tub., 9d.; Hunta Moidseal 500 v., .005, .01 mfd., 9d.; .05 mfd. and 1 mfd., 1/-, .25 mfd. 1/6; 1 mfd., 600 v., 1/3; Tubular, 5 mfd. 500 v., 1/9.

SILVER MICA CONDENSERS.—10%.

5 pf. to 500 pf., 1/-, 500 pf. to 3,000 pf., 1/3.

DITTO 1% (ex. stock)

1.5 pf. to 500 pf., 1/9. 515 pf. to 1,000 pf., 2/-.  
ELECTROLYTICS ALL TYPES NEW STOCK.

|                   |     |                          |      |
|-------------------|-----|--------------------------|------|
| Tubular Wire Ends |     |                          |      |
| 8+16/500 v.       | 5/6 | 50/25 v.                 | 1/9  |
| 16+16/500 v.      | 6/6 | 60/50 v.                 | 2/-  |
| 12/75 v.          | 2/- | Can Ties, Clips, 3d. ea. | 4/6  |
| 4/350 v.          | 2/3 | 32+32/350 v.             | 4/6  |
| 4/500 v.          | 1/6 | 32+32/275 v.             | 4/6  |
| 8/450 v.          | 2/- | 16/450 v.                | 3/6  |
| 8/500 v.          | 2/3 | 32/350 v.                | 4/6  |
| 8/500 v.          | 2/9 | 60/350 v.                | 4/6  |
| 10/500 v.         | 2/6 | 200/350 v.               | 5/6  |
| 16/600 v.         | 4/6 | 8+16/450 v.              | 5/6  |
| 8+8/400 v.        | 4/6 | 8+16/600 v.              | 5/6  |
| 32/350 v.         | 4/6 | 16+16/450 v.             | 5/6  |
| 32/600 v.         | 5/6 | 16+16/500 v.             | 6/6  |
| 32+32/350 v.      | 5/6 | 32+32/450 v.             | 6/6  |
| 32+32/500 v.      | 7/6 | 80+100/350 v.            | 11/6 |
| 25/25 v.          | 1/6 | 100+200/275 v.           | 12/6 |

SPECIALS. Can Types. 500 mfd. 12 v., 3/-; 1,000 mfd. +1,000 mfd., 6 v., 6/6; 1,500 mfd. 6 v., 4/6; 1 mfd. 1.5 kv. A.C.C. 3/6.

SENTERCEL RECTIFIERS. E.H.T. TYPE FLY-BACK VOLTAGES. K3/25 2 kv., 4/3; K3/40 3.2 kv., 6/-; K3/45, 3.6 kv., 6/6; K3/50 4 kv., 7/3; K3/100 8 kv., 12/6; K3/180 14 kv., 18/-; MAINS TYPE.—RM1, 125 v., 60 mA 4/5; RM2, 100 mA, 4/9; RM3, 120 mA, 5/9; RM4 250 v. 2/5, 1/6.

TV. AERIALS. Aerialite, all channels in stock. Indoor loft type Inv. T., 13/6.

KNOB, GOLD ENGRAVED.—Walnut or Ivory, 1 1/4 in. diam., 1/6 each. "Focus," "Contrast," "Brilliance," "Brilliance—On-Off," "On-Off," "Volume," "Vol.-On-Off," "Tone," "Tuning," "Treble," "Bass," "Wavechange," "Radio-Gran," "S., M., L., Gram," "Record-Play," "Brightness." Ditto not engraved, 1/- each. Size "B" 1in. engraved, 1/2, plain 8d.

FOINTER KNOB.—Brown with white marking line, small 9d., large 1/-.  
COILS — "P" type, 2/6 each. Midget "Q" Type ad. duct core, 3/6 each. All ranges in stock.  
REACTION COND.—0001, .0003, .0005 mfd., 3/6 ea.

BANKRUPT STOCK

PEN TORCHES.—Drydex, chromium plated with vest pocket clip. Complete. Brand new with battery and bulb. Listed 3/4. Our Price 2/6.

HANDLELITE.—Drydex, pocket or handbag flashlight. Complete. Battery and bulb. Listed 3/6. Our Price 2/6.

ALUMINIUM CHASSIS.—18 s.w.g. Plain, undrilled, folded 4 sides and riveted corners; lattice fixing holes. Strong and soundly constructed with 2 1/4 in. sides. 7in. x 4in., 4/6; 11in. x 7in., 6/9; 13in. x 9in., 8/6; 14in. x 11in., 10/6; and 18 x 18in. x 3in., 16/6.

FULL WAVE BRIDGE SELENIUM RECTIFIERS.—6 or 12 v. 1 1/2 amp., 8/9; 2 a., 11/3; 4 a., 17/6. Ditto. F.W. only 6 v., 1 a. (9 v. 0-9 v. A.C.), 5/6.

AGID HYDROMETER.—New ex-Govt. Unbreakable. Fitted in metal case, 7in. x 1 1/4 in., dia., 4/8.

H. F. MIDGET CHOKES.—14 M.H., 2/6 each.

BRIMISTORS.—CZ1 for 3 a. heater chassis, 3/6. CZ2 for 16 a., or 2 a., 2/6. CZ3, 1/6.

COPPER ENAMEL WIRE.—1/4 lb to 20 s.w.g., 2/-; 22 to 28 s.w.g., 2/6; 30 to 40 s.w.g., 3/6.

SWITCH CLEANER Fluid, squirt spot, 3/9 tin.

TWIN GAN TUNING CONDENSERS.—.0005 mfd. midget with trimmers, 5/6; 375 pf. midget less trimmers, 6/6; .0005 Standard size with trimmers and feet, 9/-; less trimmers, 8/-; ditto, 2/6.

SLEEVING.—Various colours, 1 2 mm., 2d.; 3, 4 mm., 3d.; 5, 6 mm., 5d. yd.

LOUDSPEAKERS P.M. 3 OHM. 3in. Plessey, 12/6. 5in. 16/6. 6in., 17/6. 7in. Elliptical 18/6. 8in. B. & A., 19/6. 10in.-E. & A., 25/- 6 1/2 in. Goodmans with trans., 21/-.

CRYSTAL DIODE.—Very Sensitive. G.P.O., 3/6.

H.E. PHONES.—(Hi-grade Amer.), 16/6 pr.  
S. G. BROWN'S, 4,000 ohms, 15/6 pr.

**VCR97 £2**

TESTED FULL PICTURE

P. & P. 2/-

**I. F. TRANSFORMERS**

WEARITE TYPE 500. 465 Kc/s., adjustable 450-470 Kc/s., size 3 1/2 x 1 1/2 x 1 1/2. Q value 110. BRAND NEW.

HALF PRICE. 10/6 PAIR

**CHANGE OF NAME SAME ADDRESS** We have no connection with any other firm. Please address all correspondence correctly as below.

**RADIO COMPONENT SPECIALISTS**

307 WHITEHORSE RD., WEST CROYDON  
OPEN ALL DAY SATURDAY.  
P. & P., 6d. £1 orders post free. C.O.D. Service 1/6. Lists free.

\*Phone THO 1665, after 6 p.m. 4198. Buses 133 or 68 pass door. 48-hour postal service.

**RHEOSTATS.** 12 v. 1A. 2/6. 12 v. 5A. 10/6.  
**NEW EX-W.D. MORSE KEYS.** In enclosed Bakelite Case, 4/6.  
**NEW FREQUENCY CRYSTALS.** 9100 kc. 10/6. 4250 kc. 6/6.  
 Also Type FT243 from 5675-8650 kc. in 25 kc. intervals. Send for list. Prices from 8/6-10/6.  
**PLESSEY T.V. PRE-AMPLIFIER.** London band. Valve 6F13. Complete, 25/6.  
**NEW VR65, SP61 VALVES, 5/6, 4 for £1.**  
**CYLDON 5-CHANNEL PRE-TUNER.** Gives 26 D.B. gain. Fit one of these to your T.V. for better pictures. I.F. Output 9.5-14 Mc/s., 15.5-22 Mc/s. With valves EF80, ECC81, 52/6. Less valves, 15/-.  
**MAINS TRANSFORMERS.** Input 200/240 v. Output 350-0-350 or 250-0-250 volt 80 mA., and 4 and 6.3 v. 4 a. and 4 and 5 v. 2 a. Price 21/6. Input 200/240 v. Output tapped 3, 4, 5, 6, 8, 9, 10, 12, 15, 18, 20, 24, 30 volts, 2 amp., 21/6. Output 17-11-5 volts 5 amp., 22/6. Output 17-11-5 volts 1½ amp., 16/6. 6.3 v. 2½ a., 8/6. All with one year's guarantee.  
**D.P.D.T. RELAYS.** Operate at 200/300 volts D.C. 8/6. We can supply any type of voltage and contacts at varying prices.  
**NEW SELENIUM RECTIFIERS.** F.W. 12/6 volts 3 amps., 14/6; 4 amp., 22/6; 6 amp., 30/-; 1 amp., 8/6; 12 v. 100 mA., 3/-; 24 v. 2 amp., 30/-; H.W., 250 v. 100 mA., 9/-; 250 v. 275 mA., 17/6; 250 v. 60 mA., 6/6.  
**GERMANIUM or SILICON CRYSTAL DIODES,** 3/9.  
**M/C MICROPHONES** with matched Trans., 15/6.  
**FL5 FILTER UNITS,** 8/6. Same as FL8 but less switch.  
**TRII½ TRANSMITTER SECTION.** New and complete but less valves. 4.6-6.8 Mc/s. Easily converted, 15/-. With valves TTI1, EL32, EF50, £2.  
**L.R. ARMY HEADPHONES,** 9/6.  
**TIME DELAY RELAYS.** We specialise in units giving varying time constants. Please send us your requirements or problems.  
**FISHING ROD AERIALS.** Set 3—12ft., 7/6. RUBBER BASES, 3/6.  
**P.O. FEEDER COUNTERS** 0-9999, 24/50 volts D.C., 15/6.  
**0-5 AMP. METERS,** 2½ in. sq., 11/-.  
**POCKET VOLTMETER,** 2 in. M/C., 0-20-200, 11/6.  
**U.H.F. AERIALS.** Complete with base, 180-200 Mc/s, 6/6.  
**NEW BROWNS M/C HEADPHONES.** With earpads and 6ft. lead and plug, list price £5/5-. Our price 18/6.  
**VCR97 TUBES.** Brand new, in original crates, picture tested, 45/-.  
**SPECIAL OFFER—SELENIUM RECTIFIERS,** 12 v. 16 amp., full wave, 50/-.  
 All Carriage Paid in the U.K. from Debt. W.W.  
**WE HAVE A LARGE QUANTITY OF CARBON PILES, 6, 12 AND 24 VOLT IN NEW CONDITION, BRITISH AND AMERICAN, OPEN TO OFFER.**  
**THE RADIO AND ELECTRICAL MART**  
 253B PORTOBELLO ROAD, LONDON, W.11.  
 Phone: PARK 6026

INSIST ON HIFI

for Precision Oscillators

Type H0/500 } 20-20,000  
 Type H0/50 } cycles  
 Type H0/500A } 20-40,000  
 Type H0/50A } cycles



- Type H0/50 giving 0.66 watts output
- Type H0/500 giving 5 watts output
- ★ Scale Calibration Accuracy of 1%.
- ★ Supplied in 2 Standard Frequency Ranges.
- ★ Output Voltmeter Fitted.
- ★ Built-in Attenuator.
- ★ High and Low Impedance Output.

Look for the Registered Trade Mark.

HiFi Ltd. DERRY ST., BRIERLEY HILL, STAFFS. Telephone: Brierley Hill 7604

USE A **3** IN ONE  
*Screwmaster*

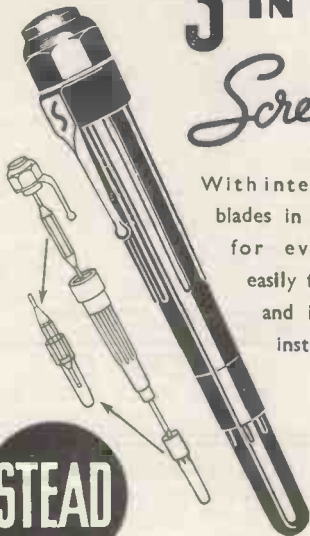

With interchangeable blades in 3 sizes. Ideal for every job, it easily fits the pocket and is ready in an instant.

**STEAD**

FROM SUPPLIERS EVERYWHERE

Manufactured by  
**J. STEAD & CO. LTD., SHEFFIELD, 2**

**MAGNETIC RELAYS**

Built to specification

**TYPES 3000 and 600**

**HIGH SPEED, also A.C. 6-400 volts**

**KEY SWITCHES. SEVERAL TYPES IN STOCK**

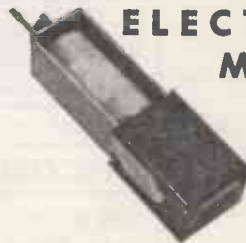

**ELECTRO-MAGNETIC COUNTER**



MAJOR TYPE 6 x 1½ x 1½ ins. for all D.C. voltages. Tested and guaranteed. 17/6, Post and Packing, 9d.

**JACK DAVIS (RELAYS) LTD.**

36 PERCY STREET · LONDON · W.1  
 MUSEUM 7960 LANGHAM 4821



# COME TO SOLARTRON

## for Oscilloscopes

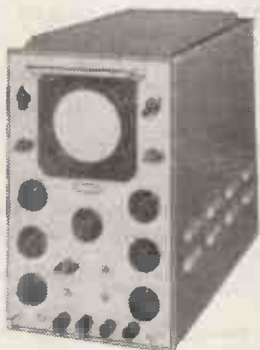

**OSCILLOSCOPE MODEL CD. 513**

Bandwidth : DC—11 Mc/s.  
Sensitivity : 1mV-10 volts per centimetre.  
Display : P.D.A. tube giving the same increased brilliancy of trace as Model CD. 568, together with illuminated graticule.

Time Base  
Speed Range :  $\cdot 1 \mu$  seconds per centimetre to  $\cdot 1$  sec./cm. with provision of  $\times \cdot 5$ ,  $\times 2$  or  $\times 5$  diameters balanced expansion.

Identical "X" and "Y" DC amplifiers and optional pulse bright-up.



**OSCILLOSCOPE MODEL CD. 568**

Bandwidth : DC—6 Mc/s.  
Meter Indication : Visual check of Input voltage to "Y" amplifier in  $\delta$  ranges up to 500 volts.  
Input Impedance : 1.6 Megohms shunted by approximately 45 pF.  
Display : P.D.A. tube giving up to 3 times greater brilliancy factor than previous models.  
Internal Sine Wave  
Calibration : 1 Mc, 100 Kc/s and 10 Kc/s, Frequency Accuracy 1%  
Sensitivity : 40 mm/v—DC to 750 Kc/s.

## and associated test equipment



**SQUARE WAVE GENERATOR MODEL GO. 511**

Square Wave  
Frequencies : 1 Mc, 100 Kc/s, 10 Kc/s, 50 c/s.  
Frequency  
Accuracy :  $\pm 2\%$  on all ranges excepting 50 c/s.  
Pulse Rise  
and Fall Times : 1 Mc 40 m $\mu$  seconds up, 25 m $\mu$  seconds down.  
100 Kc/s 200 m $\mu$  seconds up, 150 m $\mu$  seconds down.  
10 Kc/s 1  $\mu$  second up, 1  $\mu$  second down.  
Load Impedance : HF ranges—75 ohms.  
50 c/s—not less than 2,000 ohms.  
Output Voltage : 75 ohm output : 10 volts fixed.  
2,000 ohm output : 0-18 volts variable.

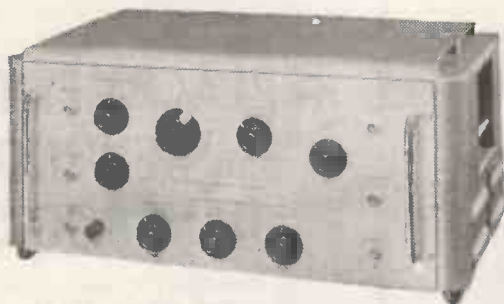

**PULSE GENERATOR MODEL OPS. 100C**

Pulse Width : Continuously variable 1-250  $\mu$  secs.  
Pulse Output : 1-70 volts in ten volt steps positive. 10 volts negative.  
Pulse Shape : Rise time 0.1  $\mu$  sec.  
Pulse Delay : Continuously variable 2  $\mu$  secs.—4,000  $\mu$  secs.  
Repetition Rates : 1-50,000 for square wave trigger.  
100-50,000 for sine wave trigger.  
Internal Trigger : 50 c/s-10 Kc/s in 8 steps.  
Sync. Output : 2 $\mu$ Sec. 10V. negative pulse.

Visit the Physical Society  
Exhibition and see us on

**STAND No 46**

**SOLARTRON ELECTRONIC GROUP LTD.**

RELIABILITY—COSTS  
UNDER OUR 12 MONTHS'  
GUARANTEE HAVE NEVER  
EXCEEDED 0.2% OF SALES

Queen's Road, Thames Ditton, Surrey.  
Telephone: Emberbrook 5611.  
Cables: Solartron, Thames Ditton.

Train to be a-

# RADIO & TV ENGINEER

ready to meet F.M., V.H.F. and Colour Television developments.

Now is the time to learn the theoretical and practical principles and so ensure your future in this rapidly expanding field of Electronics.

**ONE-YEAR COURSE IN MODERN RADIO & TV TECHNIQUES**  
A full-time day course in the Principles and Practice of Radio and Television.

Next course commences on the 19th April 1955.

**THREE-YEAR COURSE IN TELECOMMUNICATION ENGINEERING**  
(including opportunity for nine months' practical attachment in E.M.I. Laboratories and workshops).

Next course commences on the 29th August 1955.

## E.M.I. INSTITUTES

Dept. 127Z, 10 Pembridge Square, London, W.2.  
Telephone: Bayswater 5131/2.

The College associated with a world-wide electronics industry, including 'His Master's Voice', Marconi, Columbia, etc.

## direct TV REPLACEMENT and REWIND HANDBOOK



Containing 36 pages of important data on TV Transformers and Components, our 1955 Handbook will be invaluable to every Television Engineer and Dealer. The only comprehensive price list of TV Components issued in this country.

**1/-** (including postage)

SOME OF THE USEFUL INFORMATION IT CONTAINS

An exclusive article on Line Output Transformers; sections detailing modifications, particulars of our rewinding service, miscellaneous components, rectifiers, resistances, etc., service aids and test equipment.

## direct TV REPLACEMENTS

134/136 LEWISHAM WAY · NEW CROSS · S.E.14 TIDeway 3696-2330

## Z & I AERO SERVICES LTD.,

OVERHAULED AND GUARANTEED TEST EQUIPMENT

### SIGNAL GENERATORS

|  |          |
|--|----------|
| Marconi TF-144G, 85 kc-25 Mc, rebuilt as new...        | £90 0 0  |
| Marconi TF-390G, 4-100 Mc or 16-150 Mc.....            | £25 0 0  |
| Marconi TF-785B, FM-AM, 0.4-60 Mc .....                | £45 0 0  |
| Type 59, FM-AM, 96-160 Mc.....                         | £45 0 0  |
| G.E.C. Type BW-232, 500-1,000Mc.....                   | £120 0 0 |
| Boonton Corporation U.S.A. "Q" Meter Type 100-A, ..... | £75 0 0  |
| Marconi "Q" Meter Type TF-329C.....                    | £75 0 0  |
| Portable Oscilloscope, TS-34/AP, range up to 1 Mc      | £70 0 0  |

### AIRCRAFT AND RADIO EQUIPMENT & ACCESSORIES

#### Brand New and Boxed Inverters MG-153F

Input: 24 Volts, 52 Amps, D.C.  
Output: 26 Volts, 250VA, 400cps., 1-phase.  
115 Volts, 750VA, 400cps., 3-phase.

Price each..... £15 0 0

All types of Receiver Headgear, High or Low Impedance

Headsets HS-38, comprising two earpieces, low impedance, ANB-H-1, Cord, and Plug PL-354..... 12 6

Please write for complete Stock Lists

## Z & I AERO SERVICES LTD.,

19, Buckingham St., London, W.C.2

Telephone: TRAlgar 2371/2

We are interested in purchasing American and British Aircraft, Radio and TEST Equipment

## SOLDERING with a PRIMAX



**70/-**  
Post free

with the sensational new **UNBREAKABLE CASE**

NEW MODEL can now be used ALMOST CONTINUOUSLY without overheating. Weighs only 24 oz. Loop for hanging now provided.

The ideal tool for any RADIO - TV - TELEPHONE mechanic or amateur.

Available in 110, 200/220, 220/250 v. for A.C. only. 50/60 Cycles (60 w.).

### BALANCED GRIP SOLDERING GUN

Specially designed for soldering on hard-to-reach jobs.

★ **INSTANT HEATING**  
—Ready for soldering in 6 seconds.

★ **EXCLUSIVE ALLOY TIP**—lasts indefinitely under normal use and care.

★ **One year's guarantee.**

Sole Distributors: — **S. KEMPNER LTD.**  
29 Paddington St. (off Baker St.), London, W.1.  
Phone: HUNter 0755



# HIGH GRADE INSTRUMENTS for radio and electronic engineers

2½ in. scale moving coil A.C. rectifier meter. Square flush mounting. Type S25.



3½ in. moving iron AC/DC meter. Round flush. Type S35.

"Fulscale" meter 4 in. dia. scale moving coil having 270° arc with a 9 in. scale length.



Moving coil Microammeter 5 in. scale. Flush mounting rectangular case. Type S50.



High torque moving coil portable meter. Precision grade to BS.89.

## METERS



Multi purpose test set for simultaneous measurement of current voltage.



Ohmmeter for the rapid and direct measurement of very low values of resistance. Model RM.155.



Universal multi range test set for electrical and radio engineers.

## TEST SETS

*These represent just a few of our wide range of high quality instruments which are used by the electrical and electronic industries. May we supply you with our comprehensive catalogue.*



Breakdown Tester for measuring the breakdown voltage of electrical components and insulating materials. Model RM.215.



Universal Impedance Bridge covering a wide range of values for the measurement of resistance inductance and capacity. Model UB.202.



# BRITISH PHYSICAL LABORATORIES

Radlett, HERTS

Tel: RADLETT 5674-5-6





**EDDYSTONE COMMUNICATION RECEIVERS**

Now available on attractive Hire Purchase Terms.

| Model      | Cash Price | Deposit  | Monthly |
|------------|------------|----------|---------|
| 740 .....  | £42 15 0   | £8 11 0  | £3 2 10 |
| 840A ..... | £49 0 0    | £9 0 0   | £3 13 4 |
| 750 .....  | £68 0 0    | £13 12 0 | £5 0 0  |
| 680 .....  | £106 0 0   | £21 4 0  | £7 15 6 |

Instalments are for 12 months.

The model illustrated is the new 840A. All models are for A.C. operation except the 840A which is A.C./D.C. 110/250 v. making it especially suitable for universal use. Descriptive literature of all models gladly forwarded.

Latest Eddystone Component Catalogue 1/-.  
*The*  
**Eddystone**  
*Specialists*



**SERVICES LTD.,**

55 COUNTY ROAD, LIVERPOOL, 4  
 Telephone: AINTREE 1445 ESTAB. 1935  
 Branch Address: MARKET CROSS, ORMSKIRK

The target for 1955  
**HANNOVER**  
 the greatest market  
 of the German  
**ELECTRICAL  
 INDUSTRIES**  
 for  
 Investors and  
 Consumers Goods  
 Only at the  
**German Industries  
 Fair, Hannover  
 24 April to 3 May, 1955**

Information and Prospectus obtainable from :  
 Schenkers Ltd., 27 Chancery Lane, London, W.C.2  
 Tel. Chancery 6612, Fernschreiber: London 2-2625  
 and  
 Zentralverband der Elektrotechnischen Industrie,  
 Frankfurt/M., Am Hauptbahnhof 12



**STL**

*Hermetically  
 sealed  
 transformers  
 for  
 tropical  
 conditions*

**STL TRANSFORMERS**

incorporate sound design and are manufactured to the highest standards called for in the electronic and communication fields. Consult us for your next transformer requirements.

**STEWART TRANSFORMERS Ltd.**

75 KILBURN LANE, LONDON, W.10 · LADbroke 2296/7

**WEIR**

Instruments manufactured in Moving Coil and rectifier types to B.S. 89-1954.

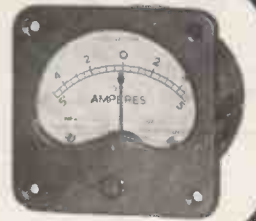

**SMALL PANEL INSTRUMENTS**



2in., 2½in. and 3½in. enclosed in cases of black moulded insulating material and provided with scales printed in black on matt white enamelled metal dials.

Available as Ammeters, Voltmeters, Milliammeters and Microammeters.

MANUFACTURED BY

**WEIR ELECTRICAL INSTRUMENTS CO. LTD.**

BRADFORD-ON-AVON

WILTSHIRE

TELEPHONE 2378

# IT'S A Sound JOB!



## unitelex "prima" TAPE RECORDER

Features of the new "prima" include use of the Truvox Mk. IIIU Tape Deck, which tracks the pre-recorded tapes now on issue; improved frequency response from 60c to 11.5 kc; matching for 15 ohm or 3 ohm external speakers; headphone monitor output. As before, amplifier can be used for direct playthrough; independent bass and treble controls are incorporated; valves are latest B.V.A. miniature types; magic eye is incorporated. Supplied complete with filtercell microphone and 1,200ft. Tape.

RETAIL  
**57 GNS.**



Also available with matching cover and base plate under Type No. MG4A  
Retail price **9½ GNS.**



TYPE MG4A

## unitelex M.G.4 amplifier

A low-cost general purpose amplifier of outstanding performance and distinguished appearance. Output is 5 watts, with matching for 15 ohm and 3 ohm speakers. Input is switched for pickup (90 mV) or microphone (30 mV). In gramophone condition, distortion is 0.8% for 3 watts output at 1 kc, and frequency range is 40/30,000 cycles  $\pm 3$  db, 20 db of negative feedback being employed. B.V.A. valves used throughout.

RETAIL  
**8½ GNS.**



# unitelex

(london) ltd.

2/4 PAGNELL ST., LONDON, S.E.14  
Tel.: TIDeway 5842



Estd.

1925

EASY

TERMS

**LEAK** QUALITY  
EQUIPMENT  
*for the Connoisseur*

The amazing New  
"TL/10" AMPLIFIER and  
"POINT ONE" PRE-AMPLIFIER



This 10-watt amplifier maintains, in every respect, the world-renowned LEAK reputation for precision engineering, fine appearance, and fastidious wiring. The Pre-amplifier will operate from any well-known pick-up, whether crystal, moving iron or moving coil. Provision is made for Tape Recorder and Play back and, as an exclusive feature, readily accessible jacks are provided on the front panel for instantaneous use.

SENT FOR  
**60/-**  
DEPOSIT

See maker's advt. p. 103 for full technical specification.

The total Cash Price for these Two Units is £23.7.0. Our **NEW EASY TERMS** are £3 Deposit with order and 14 monthly instalments of 40/- (carriage and crate free).

If you require **FINEST QUALITY REPRODUCTION** together with **WORKMANSHIP** of the **HIGHEST ORDER** your choice must be



THE VERY LATEST  
**LEAK DYNAMIC PICK-UP**  
complete with two detachable diamond heads and transformer is now available from stock. Cash price £20.19.9, or sent for £3 deposit and 10 monthly Payments of 40/- Post paid.

**The L.R. SUPPLY COMPANY LTD.**  
**BALCOMBE** Telephone: Balcombe 254 **SUSSEX**

**LEEVERS RICH**

**HEAVY DUTY  
MAGNETIC TAPE RECORDER**  
for Industrial and Professional Use

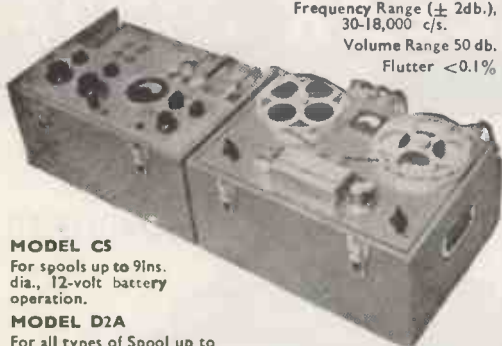

Frequency Range ( $\pm 2$ db.),  
30-18,000 c/s.  
Volume Range 50 db.  
Flutter <0.1%

**MODEL C5**

For spools up to 9ins. dia., 12-volt battery operation.

**MODEL D2A**

For all types of Spool up to 11½ins. dia. A.C. operation

**MODEL D2B**

For all types of Spool up to 11½ins. dia., 12-volt battery operation

Prices from £365 complete

All of these models may also be supplied with

**SYNCRPULSE (prov. pat.) INTERLOCK SYSTEM**

**LEEVERS-RICH EQUIPMENT Ltd.**

Please note new address :

78, Hampstead Rd., London, N.W.1. EUSton 1481

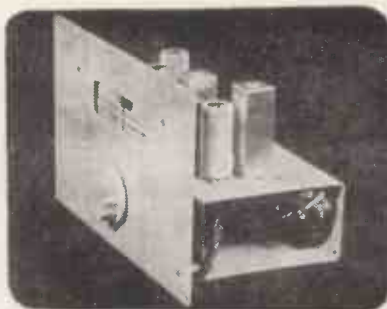

**F·M  
TUNERS**

Basic Model "A" is thoroughly proven in sensitivity, stability and reliability. Early deliveries are being maintained. These are in use from Bognor to Ely.

Closely to the Amos & Johnstone design. Additions include a modern hammer finish frontplate, "3-D" scale, and latest magic eye.

The kit version uses the same new miniature VHF type components. Fully worked chassis is stove enamelled, and wound tested coils are included, it is complete with valves, even nuts and bolts.

F.M. with really sensitive Medium Wave reception is possible with the CB4 double superhet. Incorporates variable de-emphasis, variable matching, ferramic rod aerial, mains power supply. Single or push-pull output can be added. A "hand-built" BEL product.

|  |          |
|--|----------|
| Model "A" .....                            | £11 17 6 |
| "A" kit .....                              | £7 5 0   |
| "A" tuning scale, magic eye...             | £2 0 0   |
| Standard power unit.....                   | £3 0 0   |
| Aerials 5- and .....                       | £1 10 0  |
| CB4, less output stage, mains driven ..... | £21 0 0  |
| "B" local station receiver.....            | £9 0 0   |

**MULLARD 5-10 AMPLIFIER**

|   |          |
|---|----------|
| Complete parts kit including valves.....                                | £12 10 0 |
| Built and Tested .....  | £14 10 0 |
| Scaled down to 11in. x 6in. plan. Hammer finish symmetrical frontplate. |          |

See these and Transistor Receiver at **MARBOROUGH YARD, MARLBOROUGH ROAD, N.19.** 25 mins. West End, 8 mins. Archway Station. Evening dems. arranged.

**BEL SOUND PRODUCTS CO. ARC. 5078**



Manufacturers of  
**POST OFFICE  
TYPE  
MAGNETIC RELAYS**  
3,000 and 600

Contractors to:  
**H.M. GOVERNMENT AND  
LEADING  
MANUFACTURERS**  
COILS up to 80,000Ω.  
CONTACTS up to 8 amps.  
INSULATION up to 5 kv.



Specialists in Tropicalisation and Inter Services Jungle Finish

Conforming to A.I.D. and C.I.E.M.E. standards

**PROTOTYPE Relays** made to specification.

**POST OFFICE TYPE KEYS** supplied to specification.

Speedy Deliveries—  
Enquiries Invited

**A. D. S. RELAYS LTD.** Dept. W.W.  
12, STORE STREET, LONDON, W.C.1.  
Tel.: MUSeum 2453

**MOTEK**

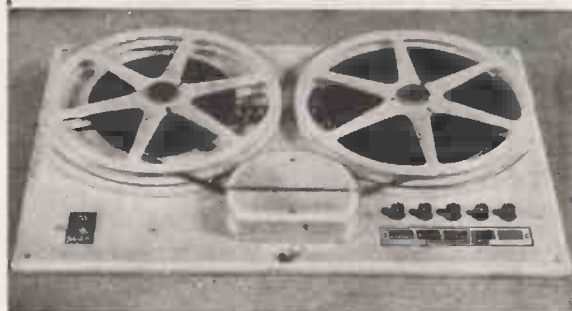

**TWO SPEED—SIMPLE PUSH BUTTON CONTROL**

**THE NEW K6 UNIT**

List Price **19 GNS.**

SEE AND HEAR IT AT  
YOUR LOCAL DEALER

**MODERN TECHNIQUES**

138-144 Petherton Road, London, N.5

Tel.: Canonbury 5896

# Make the most of F.M. with *Armstrong* Equipment

Specialists in High Quality Reproduction for over 20 years



### THE A.10 AMPLIFIER

Output: 10-12 watts.  
Distortion: 0.1% total harmonic at 8 watts.  
Frequency Response: within 1 db 15-30,000 cps.  
Input: 250 millivolts for 10 watts output.

### CONTROLS

1. Input—4 position.
2. Equaliser—4 position.
3. Filter—6 position with built-in "rumble" filter.
4. Treble Lift and cut giving  $\pm 15$
5. Bass f db—continuously variable

### THE F.M. 56 TUNER

Coverage: 85-95 mc/s.  
Image Rejection: 26 db.  
I.F. Rejection: 60 db.  
Output: 3 volts r.m.s.

Circuit: a low noise triode. R.F. stage is coupled to a high stability frequency changer. This is followed by two I.F. stages and a triple diode triode ratio detector and A.F. stage.

Valves: The latest type Mullard. ECC85, EF 85, EABC 80, EM 34.

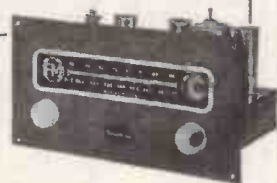

- Permeability tuning.
- Freedom from drift.
- Automatic limiting
- Magic eye tuning
- A.F. attenuator.
- 3 position H.T. supply socket.

AMPLIFIER £19.15.0  
CONTROL UNIT £9.15.0

*Demonstrations at your local High Fidelity specialists, or at our showrooms in Holloway. Special High Fidelity demonstrations each Thursday evening from 7 p.m.*

We consider that these two units used in conjunction, will (with the co-operation of the B.B.C.) give you the last word in quality reception. The control panels of both are the same size ( $9\frac{3}{4} \times 5\frac{1}{2}$ ) and finished in Florentine bronze; and will look well together in your cabinet. An A.M. Tuner to match will be available shortly.

PRICE £21.0.0

*All our models are sold under full and unconditional money-back guarantee of satisfaction. Prices include Purchase Tax. Hire Purchase facilities are available.*

**ARMSTRONG WIRELESS & TELEVISION CO. LTD., WARLTERS RD., LONDON, N.7 Telephone: NORTH 3213**

# RELAYS

**AMERICAN  
RELAYS  
FOR  
OFFSHORE  
CONTRACTS**

We are already tooled to manufacture many types of these relays, and through our association with the Guardian Electric Manufacturing Company of Chicago, we have access to full information on other types.

**ENQUIRIES  
ARE INVITED**

PHONE: NEWMARKET 3181-2-3

TELEGRAMS: MAGNETIC NEWMARKET



**MAGNETIC DEVICES LTD**  
EXNING ROAD, NEWMARKET

**BC610 TRANSMITTERS** with speech amplifier, aerial tuning unit, etc. Brand new.

**RCA TRANSMITTERS, Type ET-4336.** Complete with original speech amplifier, crystal multiplier and VFO units. Unused and re-conditioned. Can be supplied with very large quantity of spares.

**RCA TRANSMITTERS, Type ET-4332** modified by R.A.F. for use on crystal or master oscillator. Complete with speech amplifier.

**MULTI CHANNEL TRANSMITTER T-4/FRC,** with modulators MD-1/FRC, 2 Mc/s to 18 Mc/s. Each channel 400 w. output.

**W.S. No. 19 & 22.** Both complete with installation kit. Tropicalised. New.

**MAGNETO 10 LINE U.C. TELEPHONE SWITCH-BOARDS** (complete). And 40 Line F and F.

**MARCONI SIGNAL GENERATORS Type T.F. 144G.** As new, checked.

**A.R.88D's, A.R.77's, S27's, HRO, BC.312, BC.342, R.109** and others.

**METAL RECTIFIERS Type 1B, D.C.** output 10 amps at 22 v. input 220/250 v., 50 c/s.

All above items in excellent working condition  
Working demonstration upon request.

**SPARES** A large selection available for SCR399 (BC610), ET4336, SCR610, EEB Telephones, and Teleprinters type 7B.

**TX VALVES** 805, 807, 813, 861, 66A, 100TH, 250TH, and many others.

Large stock of Tx condensers, crystals and other components.

# P.C.A. RADIO

New Address, Offices and Works

**BEAVER LANE, HAMMERSMITH, LONDON, W.6**  
Telephone: RIV 8006/7

## STANLEY PRESENT A NEW STANDARD OF EXCELLENCE IN THE HIGH FIDELITY FIELD.

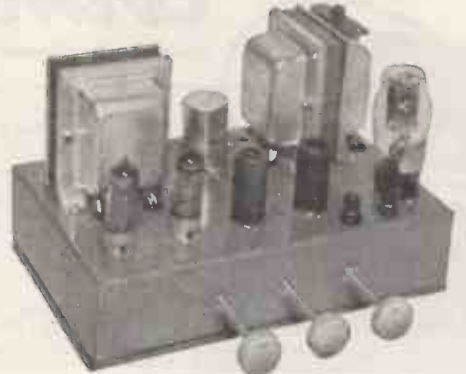

MODEL H.F. 125

BRIEF SPECIFICATION:

Response 10-20,000 Cycles within 2db, Hum and Noise -74db, total Distortion 0.4%, Output 12 Watts.

**18 GNS.**

Send for brochure.

**STANLEY SOUND & VISION PRODUCTS LTD.**  
Stanley Works, Lower Street, Haslemere, Surrey  
Phone: 1426

## MIDLAND INSTRUMENT CO.

**POWER SUPPLY UNITS No. 5,** complete except for the 6-v. accumulator, consists of the 6-v. 5-amp. hand generator, with cut-out, 6-v. input vibrator pack, provides all L.T. and H.T. outputs for the 18 and 38 sets, spare Mallory vibrator, bakelite accumulator box, etc., in metal back carrying case, complete with belt and shoulder webbing, new in sealed cartons, 40/-, carriage 6/-; Scot. 7/8; N.I. 10/-.

**ELECTROLYTIC CONDENSERS, 32-mfd. 450-v. D.C.,** by Zenith, Micamold, etc., new and guaranteed, cartons of 12 condensers, 10/-, post paid.

**PROJECTION UNITS,** consists of an optical mount, fitted with a bloomed f/2.2 Achromatic lens, 3 1/4 in. focal length, at one end, also a convex/concave ground glass at the other, attached to an enclosed lamphouse, fitted with a 24-v. 16-watt lamp, and polished reflector, fraction of original cost, 10/-, post 1/-.

**SELSYN TRANSMITTERS (Magalips), 3in. type, pure synchro x-y-1-2-3,** suitable as master or slave, 50-v. 50-cycle single phase A.C. operated. When two or more of these are wired up, the rotation by hand (or other means) of one, will result in a 100 per cent. follow in the others, both clockwise or anti-clockwise, supplied brand new with test report, in tropicalised sealed cartons. Value, £8 each, our price 25/-, post 2/-, 2 for 50/-, post paid with wiring diagram.

**TELEPHONE SETS,** consists of 2 combined receivers and microphones, connected by 20ft. twin flexible, provides perfect 2-way communication (up to 1 mile with extra flex), self-generated, no battery required, complete ready for use, new, boxed, 12/6, post 1/-.

**"NELCO" ROTARY TRANSFORMERS (matched),** brand new latest manufacture, receiver type, 6in. long, 2 1/2 in. dia., input 6-v., output 170-v. at 60-m/A., 15/-, post 1/6, ditto transmitter type, 7 1/2 in. long, 2 1/2 in. dia., input 6-v., output 350-v. at 170-m/A., 20/-, post 1/10.

**G.E.C. POWER UNITS,** intended for 100-watt R.F. amplifiers, input A.C. 200/220/240-v. plus 10-v. 45/120-c.p.s., output 550-v. at 300-m/A. D.C., and 6.3-v. r.m.s., consists of eight U52 rectifiers, separate heater and H.T. transformers, 2 Dubilier nitrogel 8-mfd. 1,200-v. capacitors, 2 heavy smoothing chokes, resistors, fuses, switches, etc., etc., for 19in. rack mounting, weight 104lb., new and unused, £7/10/-, carriage and crate, 15/-; Scot. 20/- extra.

**WIRE STRIPPERS,** strips the insulation from flexes and cables up to 1/4 in. dia., micrometer adjustment, brand new boxed, usual toolshop price 15/-, our price 3/6, post 6d., 3 for 10/-, post paid.

**ARROW SWITCHES, 250-v. 25-amp. rotary 4-position, 3-heat and off, series parallel,** panel mounting, complete with pointer knob, brand new, 2/6, post 1/3, ditto smaller Diamond H., 250-v. 15-amp., 2/6, post 9d.

**YENNER 24-VOLT TIME DELAY SWITCHES,** consists of high-grade clockwork motor with external press wind, 2 electro-magnets, 8-pole cam-operated contacts, in smart metal cases fitted 4-way terminal block, new boxed, 7/6, post 1/-.

**G.E.C. MINIATURE RELAYS, 40-ohm., 4-pole changeover platinum contacts,** brand new boxed, 8/-, post 6d., 90/- doz., post paid.

**ELECTRO-MAGNETIC COUNTERS, G.P.O. subscribers pattern, 3-ohm. coil, 0-9999** repeating, size 4 1/4 x 1 1/2 x 1 1/2 in., 5/-, post 1/-.

**ELECTRIC BELLS, 12-v. D.C., single dome 3in. dia., 1 1/2 in. high, very superior,** worth 20/-, our price, brand new boxed, 3/6, post 9d.

Many other bargains; send 3d. with S.A.E. for current lists.

**MIDLAND INSTRUMENT CO., MOORPOOL CIRCLE, BIRMINGHAM, 17**  
Tel.: HAR 1308

## TUNERS

for BAND III  
COMMERCIAL TELEVISION



Specially developed for incorporating into new T.V. receivers, or for tuning standard receivers for reception of Band III. Price £6.

ABOUT 2 1/2 MILLION T.V. SETS WILL PROBABLY BE TUNED FOR BAND III RECEPTION. MAKE SURE THAT YOU ARE UP TO DATE. WRITE TO US TODAY FOR FULLEST DETAILS



New Chapel Rd., High St., Feltham, Middx. Phone: Feltham 4242





**SELENIUM RECTIFIERS**

| L.T. Types               |      | H.T. Type H.W.            |       |
|--------------------------|------|---------------------------|-------|
| 2/8 v. 1/2 a.h.w....     | 1/9  | 120 v. 40 mA.....         | 3/11  |
| 6/12 v. 1/2 a.h.w.       | 2/9  | 250 v. 50 mA.....         | 5/11  |
| <b>F.W. Bridge Types</b> |      | 250 v. 80 mA.....         | 7/9   |
| 6/12 v. 1 a.....         | 4/11 | 250 v. 150 mA.....        | 9/9   |
| 6/12 v. 1.5 a....        | 7/9  | RM4 250 v. 250 mA.....    | 11/9  |
| 6/12 v. 2 a.....         | 9/9  | 300 v. 275 mA.....        | 12/11 |
| 6/12 v. 3 a.....         | 12/9 | <b>F.W. (Bridge Type)</b> |       |
|                          |      | 250 v. 80 mA.....         | 11/9  |

**CO-AXIAL CABLE.** 75 ohms 1/4 in., 7d yard. Twin screened feeder, 9d yd.

**SILVER MICA CONDENSERS.** 5, 10, 15, 20, 25, 30, 35, 50, 100, 120, 150, 180, 200, 230, 300, 330, 400, 470, 500, 1,000 pfd. (.001μF), .002 mfd. (2,000 pfd.). All at 5d. each, 3/9 dozen one type.

**DIAL BULBS, M.E.S.,** 8 v. 0.15 a., 6/9 doz.; 6.5 v. 0.15 a., 6/9 doz.; 4.5 v. 0.3 a., 6/9 doz.

**ELECTROLYTICS** (Current production) NOT ex Govt.

| Tubular Types     |      | Can Types          |      |
|-------------------|------|--------------------|------|
| 8μF 450 v....     | 1/9  | 16 mfd. 350 v....  | 1/11 |
| 8 mfd. 500 v....  | 2/6  | 16μF 450 v....     | 2/9  |
| 16μF 350 v....    | 2/3  | 24μF 350 v....     | 2/11 |
| 16μF 450 v....    | 2/9  | 32μF 350 v....     | 2/11 |
| 16μF 500 v....    | 3/9  | 32 mfd. 450 v....  | 4/9  |
| 32μF 350 v....    | 3/9  | 64 mfd. 450 v....  | 4/9  |
| 32 mfd. 500 v.... | 5/9  | 100 mfd. 450 v.... | 4/9  |
| 8-16μF 500 v....  | 4/11 | 8-8μF 450 v....    | 3/11 |
| 25μF 25 v....     | 1/3  | 8-8 mfd. 500 v.... | 4/9  |
| 50μF 12 v....     | 1/3  | 8-16μF 450 v....   | 2/11 |
| 50μF 50 v....     | 2/3  | 16-16μF 450 v....  | 4/11 |
| 100 mfd. 12 v.... | 1/9  | 16-32μF 350 v....  | 4/9  |
| 100 mfd. 25 v.... | 2/3  | 8 mfd. 450 v....   | 2/3  |
| <b>Can Types</b>  |      | 8 mfd. 500 v....   | 2/9  |
| 8 mfd. 350 v....  | 1/3  | 32-32μF 450 v....  | 5/11 |
| 8 mfd. 450 v....  | 2/3  |                    |      |
| 8 mfd. 500 v....  | 2/9  |                    |      |

**VOLUME CONTROLS** with long spindles, all values, less switch, 2/9; with S.P. switch, 3/9.

**WIRE WOUND POTS:** 20 ohms, 500 ohms, 5K, 20K, 50K, 100K (medium length spindles), 2/9, 220 ohms, 2K, 10K, 20K, Preset type, 1/9 each.

**AMMETERS.** Moving coil. G.E.C. 0-5 amps., 2in. scale, 11/9.

**EX-GOVT. E.H.T. SMOOTHING CONDENSERS**

|   |     |
|---|-----|
| 25 mfd., 4,000 v. Blocks.....   | 4/9 |
| 5 mfd., 2,500 v. Blocks.....  | 3/9 |
| 5 mfd., 3,500 v. Cans.....  | 3/3 |
| 1 mfd. plus 1 mfd. 8,000 v., large blocks (common negative isolated)..... | 9/6 |
| 1.5 mfd., 4,000 v. Blocks.....  | 5/9 |

**EX-GOVT. ACCUMULATORS** with non-spill vents. Unused and guaranteed. 2 v. 16 A.H., 5/9 each.

**EX-GOVT. BLOCK PAPER CONDENSERS**

|                    |     |   |      |
|--------------------|-----|---|------|
| 2 mfd. 800 v.....  | 1/9 | 8-8 mfd. 450 v....                      | 5/9  |
| 4 mfd. 500 v.....  | 2/9 | 8 mfd. 500 v.....                       | 5/9  |
| 4 mfd. 1,000 v.... | 4/3 | 8-8 mfd. 500 v....                      | 6/11 |
| 4 mfd. 1,500 v.... | 4/9 | 15 mfd. 500 v....                       | 7/9  |
| 4 mfd. 2,000 v.... | 6/9 | 4 mfd. 400 v. plus 2 mfd. 250 v., 1/11. |      |

**EX-GOVT. BLOCK ELECTROLYTICS.** Small size, 2,000 mfd. 12 v. for L.T. smoothing, 1/11 ea.

**M.E. SPEAKERS.** All 2-3 ohms, 8in. R.A. field, 600 ohms, 11/9. 10in. R.A. field, 1,500 ohms, 23/9. 10in. R.A. field, 1,000 ohms, 23/9.

**SPECIAL OFFER.** Mains Trans. 200-250 v. 50 c/s. Primary Secs. 250-0-250 v. 200 mA, 6.3 v. 4 a. 5 v. 3 a., 8/11

**GOODMANS 3 1/2 in. P.M. SPEAKER** (ex equip.), with battery pentode trans., 12/9.

**HEAVY DUTY BATTERY CHARGER** For normal 200/250 v. A.C. mains input. To charge 12 v. battery. Variable charge rate of up to 10 amps. Fitted Meter and Fuses. Guaranteed 12 months. Carr. 7/6. 28/19/6.

**HEAVY DUTY BATTERY CHARGER KIT** For normal 200/250 v. A.C. mains. Comprises mains transformer, 2 F.W. Metal Rectifiers, 2 variable resistors, 4 insulated terminals, 2 meters, 4 fuses and circuit. Total output 18 amps. Separate outputs for 6 v. and 12 v. Will make Ideal Charger for Garages. Carriage 15/-. 28/19/6.

**DRYDEX HANDLAMPS.** suitable for garage lights, etc. (Normal price 2/6). Limited number. Brand new boxed, fitted with bulb, 19/6.

**R.S.C. TRANSFORMERS**

**FULLY GUARANTEED, INTERLEAVED AND IMPREGNATED**

**MAINS TRANSFORMERS**

Primaries 200-230-250 v. 50 c/s.

**FULLY SHROUDED UPRIGHT MOUNTING**

|  |      |
|--|------|
| 250-0-250 v. 60 mA, 6.3 v. 2 a., 5 v. 2 a., Midget type, 2 1/2-3 1/2 in.                                   | 17/6 |
| 350-0-350 v. 70 mA, 6.3 v. 2 a. 5 v. 2 a. ...  | 19/9 |
| 250-0-250 v. 100 mA., 6.3 v.-4 v., 4 a., c.t., 0-4-5 v. 3 a.   | 26/9 |
| 250-0-250 v. 100 mA., 6.3 v. 4 a., 5 v. 3 a....  | 23/9 |
| 250-0-250 v. 100 mA., 6.3 v. 6 a., 5 v. 3 a., for R1355 conversion   | 31/- |
| 300-0-300 v. 100 mA., 6.3 v. 4 a., 5 v. 3 a....  | 23/9 |
| 300-0-300 v. 100 mA., 6.3 v.-4 v. 4 a., c.t., 0-4-5 v. 3 a.  | 26/9 |
| 350-0-350 v. 100 mA., 6.3 v. 4 a., 5 v. 3 a.   | 23/9 |
| 350-0-350 v. 100 mA., 6.3 v.-4 v., 4 a. ct., 0-4-5 v. 3 a.   | 26/9 |
| 350-0-350 v. 150 mA., 6.3 v. 4 a., 5 v. 3 a.   | 33/9 |
| 350-0-350 v. 150 mA., 6.3 v. 4 a., 5 v. 2 a., 5 v. 3 a.  | 33/9 |
| 425-0-425 v. 200 mA., 6.3 v. 4 a., c.t., 6.3 v. 4 a., c.t., 5 v. 3 a., suitable Williamson Amplifier, etc. | 49/9 |
| 450-0-450 v. 250 mA., 6.3 v. 6 a., 6.3 v. 6 a., 5 v. 3 a.  | 69/6 |

**TOP SHROUDED DROP THROUGH TYPE**

|   |       |
|---|-------|
| 250-0-250 v. 70 mA., 6.3 v. 2.5 a.                          | 13/9  |
| 260-0-260 v. 70 mA., 6.3 v. 2 a., 5 v. 2 a. ...             | 16/9  |
| 350-0-350 v. 80 mA., 6.3 v. 2 a., 5 v. 2 a. ...             | 18/9  |
| 250-0-250 v. 100 mA., 6.3 v. 4 a., 5 v. 3 a.                | 22/9  |
| 300-0-300 v. 100 mA., 6.3 v.-4 v. 4 a., c.t., 0-4-5 v. 3 a. | 23/9  |
| 350-0-350 v. 100 mA., 6.3 v. 4 a., c.t., 5 v. 3 a.          | 22/9  |
| 350-0-350 v. 100 mA., 6.3 v.-4 v. 4 a. c.t., 0-4-5 v. 3 a.  | 23/9  |
| 350-0-350 v. 150 mA., 6.3 v. 2 a., 6.3 v. 2 a., 5 v. 3 a.   | 29/11 |
| 350-0-350 v. 150 mA., 6.3 v. 4 a., 5 v. 3 a.                | 29/9  |

**E.H.T. TRANSFORMERS.** 2,500 v. 5 mA., 2-0-2 v. 1.1 a., 2-0-2 v. 1.1 a., for VCR97, VCR517 ..... 36/6

**FILAMENT TRANSFORMERS**

|                              |      |
|------------------------------|------|
| Primaries 200-250 v. 50 c/s. |      |
| 6.3 v. 1.5 a. ....           | 5/9  |
| 0-4-6.3 v. 2 a.....          | 7/9  |
| 6.3 v. 3 a. ....             | 8/11 |
| 6.3 v. 6a.....               | 17/6 |
| 12 v. 1 a. ....              | 7/9  |
| 0-2-4-5-6.3 v. 4a....        | 16/9 |
| 12 v. 3 a. or 24 v.          |      |
| 6.3 v. 2 a. ....             | 7/6  |
| 1.5 a. ....                  | 17/6 |

**CHARGER TRANSFORMERS**

All with 200-230-250 v. 50 c/s. Primaries: 0-0-15 v. 1 1/2 a., 11/9; 0-9-15 v. 3 a., 16/9; 0-0-15 v. 5 a., 19/9; 0-9-15 v. 6 a., 22/9;

**ELIMINATOR TRANSFORMERS**

|  |      |
|--|------|
| Primaries 200-250 v. 50 c/s. 120 v. 40 mA. | 7/11 |
| 120 v. 40 mA., 5-0-5 v. 1 a.               | 14/9 |

**OUTPUT TRANSFORMERS**

|  |      |
|--|------|
| Midget Battery Pentode 661 for 3S4, etc.   | 3/6  |
| Small Pentode, 5,000 Ω to 3Ω.....  | 3/9  |
| Standard Pentode, 5,000 Ω to 3Ω.....   | 4/9  |
| Standard Pentode, 8,000 Ω to 3Ω.....   | 4/9  |
| Battery Pentode, 10,000 ohms to 3 ohms...  | 4/9  |
| Multi-ratio 40 mA. 30:1, 45:1, 60:1, 90:1, Class B Push-Pull.....                    | 5/6  |
| Push-Pull 8 Watts 6V6 to 3 ohms.....   | 8/9  |
| Push-Pull 10-12 Watts 6V6 to 3Ω to 15Ω.....  | 8/9  |
| Push-Pull 10-12 Watts to match 6V6 to 3-5-8 or 15Ω.....                              | 16/9 |
| Push-Pull 20 Watts high quality sectionally wound, 6L6, KT86, etc., to 3 or 15Ω..... | 47/9 |

**SMOOTHING CHOKES**

|                                       |      |
|---------------------------------------|------|
| 250 mA., 3 H., 50 ohms.....           | 11/9 |
| 150 mA., 7-10 H. 250 ohms.....        | 11/9 |
| 100 mA., 10 H. 200 ohms.....          | 8/9  |
| 80 mA., 10 H. 350 ohms.....           | 5/6  |
| 60 mA., 10 H. 400 ohms.....           | 4/11 |
| 50 mA., 40 H. 1,000 ohms. Potted..... | 10/9 |
| 20 mA., 30 H., 1,000 ohms.....        | 4/9  |

**THE SKY CHIEF/2 T.R.F. RECEIVER**



A design of a 3-valve 200-250 v. A.C. Mains receiver with selenium rectifier. For inclusion in either of cabinets illustrated above. It employs valves 6K7, SP61, 6F6G, and is specially designed for simplicity in wiring. Sensitivity and quality is well up to standard. Point-to-point wiring diagrams, instructions, and parts list, 2/6. This receiver can be built for a maximum of 24/19/6 including cabinet. Available in brown or cream bakelite, or veneered walnut.

**P.M. SPEAKERS.** All 2-3 ohms. 6 1/2 in. Plessey, 16/9. 8in. Plessey, 16/9. 10in. R.A., 26/9. 10in. Plessey, 18/6. 10in. Rola with Trans., 29/6.

**R.S.C. BATTERY CHARGER KITS.**

For mains input 200-250 v. 50 c/s. To charge 6 v. accumulator at 2 amps., 25/9. To charge 6 v. or 12 v. battery at 2 a., 31/6. To charge 6 v. or 12 v. battery at 4 a., 49/9.

ABOVE KITS CONSIST OF BLACK CRACKLE LOUVRED STEEL CASE, MAINS TRANSFORMER, FULL WAVE METAL RECTIFIER, FUSES, FUSE-HOLDERS AND CIRCUIT.

Any type assembled and tested for 6/9 extra.

**R.S.C. 6 v. or 12 v. BATTERY CHARGER**

For normal A.C. mains input 200-230-250 v., 50 c/s. Selector panel for 6 v. or 12 v. charging. Variable charge rate of up to 4 AMPS. Fused, and with 5 amp meter. Well ventilated metal case with attractive crackle finish. Guaranteed for 12 months, 69/6. Carr. 2/6.

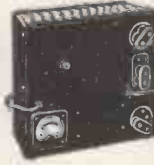

**EX-GOVT. MAINS TRANSFORMERS**

|                                  |      |
|----------------------------------|------|
| All 230 v. 50 c/s. input         |      |
| 8.8 v. 4 a. ....                 | 9/9  |
| 48 v. 1 a. ....                  | 9/9  |
| 0-11-22 v. 30 a. ....            | 72/6 |
| 16-18-20 v. 35 a. ....           | 79/6 |
| 7.7 v. C.T. 7 amps. 4 times..... | 25/9 |
| 460 v. 200 mA., 6.3 v. 5 a. .... | 27/9 |
| 278-0-278 v. 100 mA. ....        | 8/9  |

|   |      |
|---|------|
| 300-0-300 v. 150 mA., 610-0-610 v. 150 mA., 1,220 v. 350 mA.  | 29/9 |
| 400 v. C.T. 150 mA. 4 v. 6 a., 6.3 v. 6 a., 6.3 v. 0-6 a., 4 v. 6 a., 4 v. 3 a., 4 v. 3 a., 5 v. 2 a. | 22/9 |

**EX-GOVT. AUTO TRANSFORMERS**

|  |         |
|--|---------|
| 15-10-5-0-195-215-235 v. 500 watts.....                                | 27/9    |
| Double wound 10-0-200-240 v. to 10-0-275-295-315 v. 1,000 watts.....   | 69/6    |
| 0-230 v. in steps of 11 volts from 57.5 v. KVA (21 amps).....          | 28/15/- |
| Double wound 0-110-240 v. to 0-130-140-150-160-170 v. 1,500 watts..... | 69/6    |

Carriage on any of above 6/- extra.

**EX-GOVT. SMOOTHING CHOKES**

|   |       |
|---|-------|
| 250 mA., 10 H. 50 ohms.....               | 14/9  |
| 250 mA. 10 H. 100 ohms.....               | 14/9  |
| 250 mA. 3 H. 50 ohms.....                 | 8/9   |
| 150 mA. 10 H. 50 ohms.....                | 10/11 |
| 100 mA. 10 H. 100 ohms, Tropicalised..... | 6/9   |
| 100 mA. 5 H. 100 ohms, Tropicalised.....  | 3/11  |
| 50 mA. 50 H. 1,000 ohms. Potted.....      | 8/11  |
| 90/100 mA. 10 H. 100 ohms. Potted.....    | 8/9   |
| 50 mA. 5-10 H. ....                       | 2/9   |
| L.T. type 1 amp. ....                     | 2/9   |

**CHASSIS**

|   |      |   |       |
|---|------|---|-------|
| 18 s.w.g. undrilled aluminium amplifier type (4-sided). |      | 16 s.w.g. aluminium receiver type.          |       |
| 14in. x 9in. x 2 1/2 in.                                | 6/11 | 12in. x 8in. x 2 1/2 in.                    | 5/3   |
| 14in. x 10in. x 3in.                                    | 7/11 | 16in. x 8in. x 2 1/2 in.                    | 7/6   |
| 16in. x 10in. x 3in.                                    | 8/3  | 20in. x 8in. x 2 1/2 in.                    | 8/11  |
| 18 s.w.g. aluminium receiver type.                      |      | 18 s.w.g. aluminium amplifier type 4-sided. |       |
| 6in. x 3 1/2 in. x 1 1/2 in.                            | 1/11 | 12in. x 8in. x 2 1/2 in.                    | 7/11  |
| 7 1/2 in. x 4 1/2 in. x 2in.                            | 2/9  | 16in. x 8in. x 2 1/2 in.                    | 10/11 |
| 10in. x 6 1/2 in. x 2in.                                | 3/3  | 20in. x 8in. x 2 1/2 in.                    | 13/6  |
| 11in. x 6in. x 2 1/2 in.                                | 3/11 | 14in. x 1 in. x 3in.                        | 13/6  |

# R.S.C. HIGH FIDELITY 25 watt AMPLIFIER A 4

A NEW DESIGN FOR 1955 HIGH GAIN "PUSH PULL OUTPUT." BUILT-IN PRE-AMP. TONE CONTROL STAGES. INCLUDES 7 valves, sectionally wound output transformer, block paper reservoir condenser, and reliable small components. AN INPUT OF ONLY 20 millivolts IS REQUIRED FOR FULL OUTPUT. THIS MEANS THAT ANY TYPE OF MICROPHONE OR PICK-UP IS SUITABLE. Two separate inputs controlled by separate volume controls allow simultaneous use of "Mike" and Gram., or Tape and Radio, etc., etc. Individual controls for Bass and Treble "lift" and "cut." Six negative feedback loops giving total of 24 D.B. Frequency response  $\pm 3$  D.B. 30-20,000 c/s. H.P. Terms now available on request. Cover as illustrated if required. price 17/6 extra.

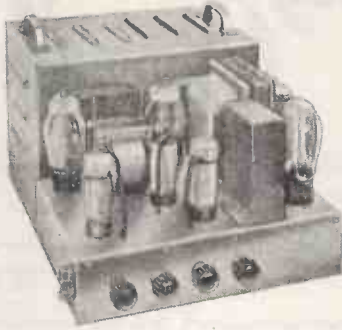

Hum level 66 D.B. down. Certified total harmonic distortion of only 0.35% measured at 10 watts. Comparable with the very best designs. SUITABLE FOR SMALL HOMES OR LARGE HALLS, CLUBS, GARDEN PARTIES, DANCE HALLS, etc., etc. For ELECTRONIC ORGAN OR GUITAR. For STANDARD OR LONG PLAYING RECORDS. Size 12 x 10 x 9 in. For mains A.C. 200-250 v. 50 c/s. Power consumption 175 watts. Outputs for 3 and 15 ohms speakers. The kit is complete in every detail. Chassis is fully punched. Easy to follow point-to-point wiring diagrams, are supplied. EXTRA HIGH SENSITIVITY, HIGHEST QUALITY for Assembled ready for use 50/- extra. **9 Gns.** plus carr. 7/6.

**W.B. "STENTORIAN"** High fidelity P.M. Speaker, HF1012, 10 watts, 15 ohm (or 3 ohm) speech coil. Where a really good quality speaker at a low price is required we highly recommend this unit with an amazing performance. £3/17/6.

**MICROPHONES.** Crystal, hand or Desk type, good quality Acos, 50/-. Stand type with base and adjustable stand, £6/19/6. Both suitable for use with our amplifiers.

**PLESSEY 3-SPEED MIXER AUTOCHANGERS** with high impedance magnetic pick-up with duo point alloy stylus for long playing or standard records. (Will play 2,000 records before replacement stylus required). Brand new, cartoned, guaranteed. Limited stocks at only 10 gns. plus 5/- carr.

**H.M.V. LONG PLAYING RECORD TURNTABLE COMPLETE WITH CRYSTAL PICK-UP (SAPHIRE STYLUS).** Speed 33 1/3 r.p.m. BRAND NEW, CARTONED. Only £3/19/6 (approx. half price). Carr. 5/- (For 200-250 v. A.C. Mains).

## R.S.C. 4-5 WATT HIGH GAIN AMPLIFIER TYPE A5



A highly sensitive 4-valve quality amplifier for the home, small club, etc. Only 50 millivolts input is required for full output so that it is suitable for use with the latest high-fidelity pick-up heads, in addition to all other types of pick-ups and practically all mikes. Separate Bass and Treble controls are provided. These give full long playing record equalisation. Hum level is negligible being 71 D.B. down. 15 D.B. of negative feedback is used. H.T. of 300 v. 25 mA. and L.T. of 6.3 v. 1.5 a. is available for the supply of a Radio Feeder Unit, or Tape Deck pre-amplifier. For A.C. mains input of 200-230-250 v. 50 c/s. Chassis is not alive. Kit is complete in every detail and includes fully punched chassis (with baseplate), with green crackle finish, and point-to-point wiring diagrams and instructions. Exceptional value at only £4/15/-, or assembled ready for use 25/- extra, plus 3/6 carr.

## A PUSH PULL 3-4 WATT HIGH-GAIN AMPLIFIER FOR £3/7/6

For mains input 200-250 v. 50 c/s. Complete kit of parts including point-to-point wiring diagrams and instructions. Amplifier can be used with any type of feeder unit or pick-up. This is not A.C./D.C. with "live" chassis but A.C. only with 400-0-400 v. Trans. Output is for 2-3 ohm speaker. (We can supply a very suitable 10in. unit by Rois at 27/9.) The amplifier can be supplied ready for use for £5/- extra. Full descriptive leaflet, 6d.

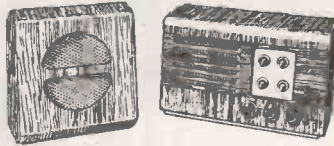

**R.S.C. MASTER INTERCOMM. UNIT**, with provision for up to 4 "Listen-Talk Back Units" individually switched. A high gain amplifier enables speech and other sounds emanating from the rooms containing remote control units to be heard at the master control. The unit is in kit form and point-to-point wiring diagrams are supplied. A walnut veneered wood or Brown Bakelite cabinet is included. Mains input is 200-250 v. 50 c/s. H.T. line 300 v. CHAS818 IS NOT "ALIVE." Ideal for use as "Baby Alarm." Sound amplification 4 watts. Price only £5/19/6. "Listen-Talk Back Unit" in bakelite or walnut veneered cabinet, can be supplied at 35/- each. Full descriptive leaflet 9d. The Master Unit can be supplied assembled and tested for 30/- extra.

## PERSONAL SET BATTERY SUPERSEDER KIT.



All parts for an "All Dry" Battery Eliminator. Complete with case. For 4 valve receivers requiring 90 v. 10 mA. and 1.4 v. 250 mA. Fully smoothed. Outputs from normal. 200-250 v. 50 c/s mains. Price with circuit, 35/9. Or ready for use, 42/6. Size of units 8 1/2-4 1/2 in.

**BATTERY SET CONVERTER KIT.** All parts for converting any type of battery receiver to all mains. A.C. 200-250 v. 50 c/s. Kit will supply fully smoothed H.T. of 120 v. 60 v. or 90 v. as up to 40 mA., and fully smoothed L.T. of 2 v. at 0.4 a. to 1 a. Price complete with circuit and instructions only 48/9. Supplied ready for use for 8/9 extra.

**H.T. ELIMINATOR AND TRICKLE CHARGER KIT** with case, Mains input 200-250 v. Output 120 v. 40 mA., and 2 v. 1 a. Price with circuit, 29/6. Or in working order, 37/8.

## R.S.C. A3 10 WATT "PUSH PULL" HIGH FIDELITY AMPLIFIER.

With Self Contained Pre-amplifier and Tone Control.

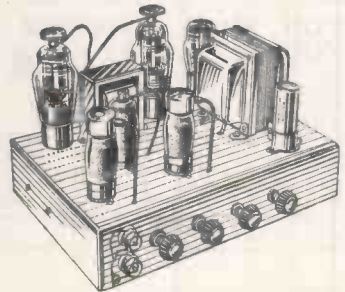

This amplifier, whilst having sufficient output to fill a small hall, is the ideal amplifier for the quality enthusiast who knows that though the average listening level is less than one watt it is necessary, for the very highest quality, to have an output of at least ten times this figure in order to obtain completely distortionless reproduction of sudden loud sounds. The layout of the components has been planned to give the very maximum of performance with the minimum of constructional effort. Large safety factors in every component A.C. and H.T. fuses, punched chassis with baseplate, screened input plugs, valves, and with easy-to-follow point-to-point wiring diagrams. The only things necessary to build this superb instrument are a soldering iron, screw-driver and pliers, everything else is supplied down to the last nut and bolt. Two independent inputs are provided with two associated independent volume controls so that programmes can be mixed together if desired, such as microphone announcements superimposed on a musical programme, or two independently controlled microphones, or even just gramophone/radio, fading over from one to the other. Variable bass lift and cut with variable treble lift and cut tone controls are fitted, giving full long playing record equalisation for uncorrected pick-ups. They are also provided so that the user can alter the total value to suit his personal taste and surroundings. Because of the large negative feedback employed the output transformer can be so designed that it provides all the specified power even with large variations of loudspeaker impedance. Terminals are provided for 3 ohm and 15 ohm loudspeakers. H.T. and L.T. available for the supply of a Radio Feeder Unit. Six Negative Feedback Loops. 130 millivolts input only required for full output. Frequency response  $\pm 3$  DB 50-20,000 cycles. Negligible hum and distortion. For A.C. mains input 200/230/250 v. 50 c/s. COMPLETE KIT of Parts, 7 GNS. (carrriage 5/-). Supplied assembled and tested for 45/- extra. H.P. TERMS AVAILABLE ON ASSEMBLED UNITS.

## FOUR STAGE RADIO FEEDER UNIT.

Design of a HIGH FIDELITY, L. and M. wave T.R.F. Unit with self-contained heater supply and thorough H.T. decoupling. Only 250-400 v. 15-20 mA. H.T. required from main amplifier. Three valves and Low Distortion Germanium Diode Detector. Flat topped response characteristic. Loaded H.F. coils. Two variable Mu controlled H.F. stages, 3 gang condenser tuning. Cathode follower output stage. Switch position for Gram. and Gram. input and output sockets. Performance comparable with the best in Feeder Units. For A.C. mains 200-230-250 v. operation. Size 11-6-7 1/2 in. Illustration, full set of easy-to-follow wiring diagrams and instructions and individually priced parts list 2/6. This unit can be built for only £3/15/-, including Dial and Drive Knobs and every item required.

**Radio Supply Co. (LEEDS) LTD.**

32 THE GALLS. — LEEDS, 2.

Terms C.W.O. or C.O.D. No C.O.D. under £1. Postage 1/- extra under 10/-. 1/6 extra under £2, 1/11 extra under £3. Full Price list 6d. Trade List 5d. Open to Callers : 9 a.m. to 5-30 p.m. Saturdays until 1 p.m.

# Introducing The Stern's Tape Recorder

"Fidelity"

!! A NEW DESIGN OF OUTSTANDING QUALITY !!

- WILL PLAY THE NEW PRE-RECORDED TAPES
- WILL TAKE ALL STANDARD TAPES UP TO 1,200ft.

- WILL PROVIDE 2 HOURS PLAYING AT 3 $\frac{1}{2}$ in. or 1 hour at 7 $\frac{1}{2}$ in. per second.
- INCORPORATES AN ELLIPTICAL P.M. SPEAKER 8in. x 5in., with EXTENDED FREQUENCY RANGE.

● We will supply it COMPLETE & READY FOR USE or YOU CAN ASSEMBLE IT AT HOME.



We have long delayed producing a Tape Recorder until we were completely satisfied that not only could we supply it at a genuinely low price, but also it had to be completely dependable and in addition it had to provide absolute fidelity recordings. **!!THIS WE HAVE DONE!!** and we offer our "Fidelity" model with the utmost confidence and with the knowledge that its performance equals Recorders marketed at a far higher price. It incorporates the Tape Deck and Amplifier described below both of which are so arranged that the "home assembly" of the Recorder is quickly and easily achieved.



SEND S.A.E. FOR DESCRIPTIVE LEAFLET.

**YOU CAN ASSEMBLE IT YOURSELF FOR £40**

H.P. Terms are shown below. THE DECK AND AMPLIFIER ARE ASSEMBLED AND TESTED WHEN SUPPLIED.

The actual assembly of the Recorder is extremely simple and only involves a few connections. The Truvox Tape Deck and the Amplifier are supplied tested and ready for use, all that is required is to connect the two together (a connection chart is supplied) and secure them in the Attache Case.

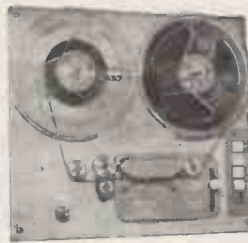

THE NEW TRUVOX MODEL TR7U TAPE DECK

THE NEW TRUVOX MODEL TR7U TAPE DECK. 3 Shaded-Pole motors. Drop-In Tape Loading. Push Button Control. Separate Push Button Brake. Fast forward and fast reverse. Silent drive eliminating Wow and Flutter. Half Track working and 2 speeds, 3 $\frac{1}{2}$ in. and 7 $\frac{1}{2}$ in. per sec. Positive Azimuth Adjustment. Overall size only 14 $\frac{1}{2}$ in. x 12 $\frac{1}{2}$ in.



ACOS CRYSTAL MICROPHONE MODEL MIC-33-1. A highly sensitive mike which accurately matches the input arrangement of the amplifier.

SCOTCH BOY MAGNETIC RECORDING TAPE. Supplied with a 1,200ft. reel of Scotch Boy plastic tape famous for its true brilliant quality. The Recorder will take all standard makes of tape.

**BRIEFLY:**

**MODEL TRIF QUALITY AMPLIFIER.** Expressly designed to correctly operate with the above Truvox Deck for recording and playback. Supplied complete with Elliptical Speaker and has level response from 60-10,000 c.p.s. Hum level 50 db down at 4 watts. Incorporates efficient tone control arrangement and MAGIC EYE LEVEL INDICATOR. Valve line-up: EF86, ECC83 EL84, 5Y3, EM34, provides 4 watts undistorted.

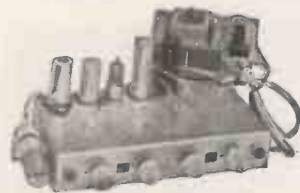

MODEL TRIF AMPLIFIER

THE ATTACHE CASE illustrated is attractively finished and covered with Rexin<sup>®</sup> and is only 18in. x 14in. x 8in. It has a concealed pocket to accommodate the Mike and Mains lead and also a pocket to carry a spare reel of tape.

GUARANTEED FOR 12 MONTHS (B.V.A. VALVES 90 DAYS)

## PRICE SUMMARY

EACH UNIT IS AVAILABLE SEPARATELY AS FOLLOWS:

|                                       | CASH PRICE | DEPOSIT | 12 monthly payments of |
|---------------------------------------|------------|---------|------------------------|
| (a) TRUVOX Mk. TR7U TAPE DECK         | £23 2 0    | £5 17 0 | £1 12 4                |
| (b) AMPLIFIER MODEL TRIF WITH SPEAKER | £14 14 0   | £4 16 6 | £1 0 5                 |
| (c) PORTABLE ATTACHE CASE             | £5 0 0     | —       | —                      |
| (d) ACOS CRYSTAL MIKE "33"            | £2 10 0    | —       | —                      |
| (e) REEL OF TAPE 1,200ft.             | £1 15 0    | —       | —                      |

Please include £1 when ordering (a), or (c) for packing charge, this whole amount will be refunded if case is returned to us intact.

WE WILL SUPPLY ALL FIVE UNITS LISTED ABOVE, i.e., THE COMPLETE BUT UNASSEMBLED RECORDER FOR £40/-/. H.P. Terms: Deposit £10 and 12 monthly payments of £2/15/10 or in two parts as follows:—

|  | CASH PRICE | DEPOSIT | 12 monthly payments of |
|--|------------|---------|------------------------|
| (a) TRUVOX Mk. TR7U TAPE DECK MODEL TRIF AMPLIFIER WITH SPEAKER, 1,200ft. REEL OF TAPE.. | £33 10 0   | £8 10 0 | £2 6 8                 |
| (b) ATTACHE CASE AS ILLUSTRATED..  | £6 10 0    | —       | —                      |

See note below re packing charge

NOTE: Please send 30/- to cover cost of packing, carriage and insurance. We will refund £1 if the packing case is returned to us intact.



**SUPPLIED COMPLETE AND READY FOR USE £50**

FOR USE ON A.C. MAINS  
H.P. Terms: Deposit £12 10 0 and 12 monthly payments of £3 10 0  
Including mike and 1,200ft. reel of tape.

# STERN RADIO LTD.

109 and 115 FLEET STREET, LONDON, E.C.4

Phone: CENTral 5812-3-4

# RECEIVER CHASSIS

# Modernise your old Radiogram

# RECORD PLAYERS

## COMPLETE RADIOGRAM EQUIPMENT—QUALITY AT LOW COST

### STERN'S DESIGN FOR HOME CONSTRUCTORS The "SUPER-SIX"

A compact and highly efficient superhet Radio-Radiogram chassis of outstanding quality.

### YOU CAN BUILD IT FOR £10/7/6

Including the OCTAL VALVE LINE-UP (£12/7/6 with the miniature valves)

Incorporating the new B.V.A. Miniature Valve Line up. This receiver is designed to the very latest specification and provision is made to incorporate either the standard Octal Valve Line-up or the new B.V.A. range of miniature valves. Great attention has been paid to the quality of the reproduction of both Radio reception and Record playings, and excellent clarity of speech and music is obtained.

- A few brief details.
- Covers 3 wavebands 18-50 metres, 190-550 and 800-2,000 metres.
  - Employs 6 valves having PUSH-PULL for 5-6 watts output.
  - Incorporates delayed A.V.C. on all wavebands and pre-selective feedback.
  - A 4 position Tone Control operation on both Radio and Gram.
  - Has independent mains supply socket for a Record Player.
  - Size of Assembled Chassis 12in. x 8in. x 8in. Dial aperture 8 1/2in. x 4 1/2in.
  - For operation on A.C. mains 200-250 volts 50 cycles.
- THE INSTRUCTION and ASSEMBLY MANUAL is available for 1/6. It contains very detailed practical drawings and circuit diagrams and a complete Component Price List.

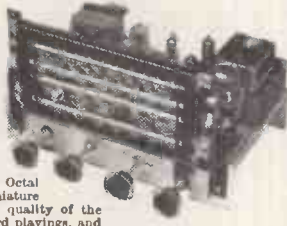

This 3-SPEED AUTOCHANGER is by a Famous Manufacturer and is offered for

**£11/10/0** (Plus 7/6 carr. & ins.) Normal Price £16/10/0

Hire Purchase Terms £2/17/6 Dep. and 12 months at 16/4.

● These units will autochange on all three speeds, 7in., 10in. and 12in.

● They play MIXED 7in. 10in. and 12in. records.

● They have separate sapphire for L.F. and 78 r.p.m., which are moved into position by a simple switch.

● Minimum baseboard size required 14in. x 12 1/2in., with height above 5 1/2in. and height below baseboard 2 1/2in. A bulk purchase enables us to offer these BRAND NEW UNITS at this exceptional price.



## WE HAVE THE LATEST 3-SPEED AUTOCHANGERS IN STOCK

SEND S.A.E. FOR DETAILS

WE CAN ALSO OFFER THE LATEST 3-SPEED NON-AUTOCHANGE UNIT

### THE NEW ARMSTRONG F.C. 48

A high quality replacement Radio or Radiogram Chassis having provision for an F.M. Feeder Unit.

PRICE ASSEMBLED and READY FOR USE **£23/18/0**

(Plus 7/6 Carr. and Ins.) H.P. Terms £5/18/- Deposit and

12 months at £1/13/9.

#### OUTSTANDING FEATURES INCLUDE :—

- 8 Valves including 2 double Triodes.
- 3 Watts output from push-pull tetrodes. Heavy negative feedback is used, resulting in negligible distortion and high damping factor.
- Provision for using F.M. adaptor to receive the present high quality transmissions from Wrotham and the new B.B.C. V.H.F. stations.
- An accessible socket at rear provides the power supply for this unit.
- Independent controls give BASS and TREBLE lift and cut with unique Thermometer visual indicator.
- Gram. position on wavechange switch.
- 4 Wavebands Coverage 16-51, 50-120, 190-550, 1,000-2,000 metres.
- Large four-colour illuminated dial.

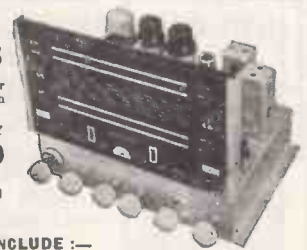

### !!!THE LATEST!!!

### RADIO-RADIOGRAM CHASSIS

Model F3PP. A 7-valve 3-waveband Superhet Chassis with Push-Pull Stage. This Chassis has been designed with particular regard to the quality of reproduction. It incorporates SEPARATE BASS and TREBLE CONTROLS thereby ensuring the utmost flexibility of Tone on both Radio and Gram.

Briefly:

● Waveband coverage 16-50, 190-550 and 800-2,000 metres.

● Valve line-up X79, 6BA6, 6AT6, ECC83, GZ80 and two 6AQ5's in push-pull for approx. 6 watts output.

● Negative Feedback and delayed A.V.C.

● Has independent mains supply socket for gram. connection.

● Overall size of Chassis 12in. x 8in. high x 7in. with dial size 11 1/2in. long x 4 1/2in.

For use on A.C. Mains 100/110 volts and 200/250 volts. Cash Price, tested and ready for use **£17/17/0** (plus 7/6 carr. and ins.)

H.P. Terms: Deposit £4/7/- and 12 monthly payments of £1/5/4.

### THREE COMPLETELY ASSEMBLED ALL-WAVE SUPERHET CHASSIS

- Model B.3. A 5-valve 3-waveband receiver.
- Model B.3.P.P. A 6-valve 3-waveband Receiver with PUSH-PULL OUTPUT.
- Model B.3.P.P./R.F. A 7-valve 3-waveband Receiver incorporating an R.F. stage with PUSH-PULL OUTPUT.

The three Receivers are for operation on A.C. mains 100/110 volts and 200/250 volts, and employ the very latest miniature valves. They were designed to the most modern specification, great attention having been given to the quality of reproduction which gives excellent clarity of speech and music on both gram. and radio, making them the ideal replacement chassis for that "old Radiogram," etc.

Brief specifications: Model B.3.—Valve line-up, 6BE6, 6BA6, 6AT6, 6BW6, 6X4—waveband coverage short 16-50, medium 187-550, long 900-2,000 metres. Controls: (1) volume with on/off; (2) tuning (flywheel type); (3) wavechange and gram; (4) Tone Control (operative on gram. and radio). Negative feedback is employed over the entire audio stages. Chassis size: 11x7 1/2 x 8 1/2in. high. Dial size 8 1/2 x 4 1/2in. Price complete and READY FOR USE, excluding speaker £12/12/- (carr. and ins. 7/6 extra). H.P. Terms £3/4/- deposit, 12 months at 17/8.

Model B.3.P.P. This model is the B.3 Receiver but incorporates two 6BW6 VALVES in PUSH-PULL, resulting in really excellent quality reproduction up to approximately 6 watts. Price £15/15/- (plus 7/6 carr. and ins.) or £3/18/- deposit, 12 months at £1/2/2. Model B.3.P.P./R.F. This model is similar in appearance and has same STAGE together with PUSH-PULL OUTPUT, employing a total of 7 valves with two type 6BW6 in Push-Pull. This makes for a really sensitive receiver with genuine quality reproduction. Price £18/18/- (plus 7/6 carr. and ins.) or £4/13/- deposit, 12 months at £1/6/9.

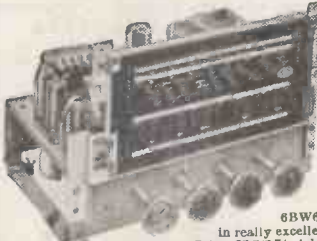

### AN OUTSTANDING OFFER

A BULK PURCHASE ENABLES US TO OFFER THIS "PUSH-PULL" 7 VALVE SUPERHET RECEIVER

For only **£12/19/6** (Carr.&ins. 7/6 extra.)

H.P.—£3/4/6 Dep. 12 mths. at 18/4.

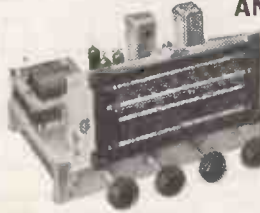

These receivers Models AW3-7 are made by a well-known set of manufacturers and incorporate the latest Oram Valve Line-up of X79—W77—DH77—H77—U78 and two N78's in Push-Pull for approx. 7 watts output. They cover 3 wavebands 16-50 volts. A Gram. position is on the Wavechange switch. They make an excellent replacement Radiogram Chassis having a P.U. connection on the chassis. Extension speaker connection is also provided. Overall size of chassis: 12in. long x 7 1/2in. x 6 1/2in. high, dial aperture 8 1/2in. x 4 1/2in. (Dist Escutcheon available for 4/9).

THESE RECEIVERS ARE BRAND NEW AND FULLY GUARANTEED.

### SPECIAL REDUCTIONS FOR COMPLETE EQUIPMENT

SUMMARY—Select a RECEIVER CHASSIS and we will supply it TOGETHER WITH THE ABOVE 3-SPEED CHANGER AND AN 8-inch or 10-inch P.M. SPEAKER as follows:—

|                           | THE £11/10/- AUTOCHANGER WITH A SPEAKER AND:— |         |                |
|---------------------------|---|---------|----------------|
|                           | Cash Price                                    | Deposit | Monthly        |
| (a) With Model B3 chassis | £24 15 0                                      | £6 4 0  | 12 of £1 14 10 |
| (b) " " B3PP              | £28 0 0                                       | £7 0 0  | 12 of £1 18 5  |
| (c) " " B3PP/R.F.         | £31 2 0                                       | £7 15 0 | 12 of £2 3 9   |
| (d) " " Armstrong F.C.48  | £36 4 0                                       | £9 1 0  | 12 of £2 10 11 |
| (e) " " AW3-7             | £25 5 0                                       | £6 7 0  | 12 of £1 15 6  |
| (f) " " F3PP              | £30 2 0                                       | £7 10 0 | 12 of £2 2 0   |

An additional charge of 10/- is made in each case to cover Carriage and Insurance.

**STERN RADIO LTD.**  
109 and 115 FLEET ST., LONDON, E.C.4.  
Phone: CENTral 5812/3/4

# "Hi-Fi" EQUIPMENT and KITS TO SUIT ANY BUDGET

## TWO COMPLETE "Hi-Fi" AMPLIFIER KITS

### "STERNS" HIGH QUALITY 8-10 WATT AMPLIFIER



Having a front panel which is very attractively finished in deep gold, and on which the controls are clearly identified. The ideal amplifier for general home use and for small halls, etc.

Price of COMPLETE KIT including Valves and Drilled Chassis, etc. (Plus 2/6 Carr. & Ins.) **£7/10/-**

We will supply it Completely Built for **£9/10/-** (Plus 5/- Carr. & Ins.)

Designed for high quality reproduction up to an output level of 10 watts, having 6V6s in Push-Pull and incorporating negative feedback. It is suitable for use with all types of Pick-ups and most types of microphones and the output transformer provides for use of 3 and 15 ohm speakers.

#### BRIEF FEATURES

- Valve line up 6Z5, 6SN7, 5Z4, with 6V6s in push pull.
- The undistorted output level of up to 10 watts is produced from an input of 25 volts.
- First class reproduction of Radio (where a Tuning Unit is used) and Record Playing.
- Separate Bass Boost and Treble Controls providing an excellent range of frequency control.
- Very satisfactory results are obtained with an average type of high impedance Moving Coil or Crystal Microphone, a clear speech level of approx. 5 watts output being obtained.
- Power supplies (HT and LT) are available for a Tuning Unit.
- For operation on A.C. Mains 200-250 volts 50 cycles.

THE ASSEMBLY MANUAL is available for 1/- and includes detailed layouts and component Price List.

### "STERNS" 12 Watt "HIGH FIDELITY" Pull-Pull AMPLIFIER

A very high quality Unit attractively finished in deep gold with each control clearly identified on the front panel. Comprising a Main Amplifier Chassis and a Remote Control Pre-Amplifier-Tone Control Unit. The remote control unit measures only 9in.x4in.x2½in. and contains four controls, being: Bass, Treble-Volume and a Radio, Gram, Microphone Switch control. It incorporates its own feedback circuit on the Base Channel. Loop negative feedback is employed on the Main Amplifier which has a valve line up of 6J5-6N7-5U4 with two 6X2's in push-pull and 6J5 and 6SN7 are used in the remote control unit.

THE COMPLETE KIT IS AVAILABLE FOR **£14/-** (Carr. & Ins. 6/- extra.) THE COMPLETE UNIT ASSEMBLED AND READY FOR USE **£17/-** (H.P. Terms **£4/5/-** Deposit, 12 Months at **£1/3/11**.) (Carr. & Ins. 7/6 extra.)

The measured frequency range of the amplifier with this unit shows an excellent response from 14,000 cycles down to 20 cycles, the bass and treble controls allowing independent control of gain at both ends of the frequency range from zero to a gain of 50. It can be seen, therefore, that ample correction is provided to suit any type of pick-up with any type of recording. Input voltage for maximum output is 70 mV and 6.3 volts at 2 amps, and 30 mA. H.T. is provided for tuning unit, etc. This Amplifier compares well with the Williamson and similar designs at a fraction of their cost. The complete set of assembly instructions is available for 2/-.

## SPECIAL PRICE REDUCTIONS FOR COMPLETE EQUIPMENT

SELECT A TUNING UNIT and AMPLIFIER or TUNING UNIT, AMPLIFIER and RECORD PLAYER (and a SPEAKER if required) and we will supply at a REDUCED PRICE. H.P. TERMS ALSO QUOTED.

## WE CAN SUPPLY... COMPLETE KIT or ASSEMBLED CHASSIS FOR THE OSRAM 912 AMPLIFIER. Designed by General Electric Co.



A modern high quality 12 watt Amplifier for the HOME CONSTRUCTOR, having a Valve line-up of U709, B309, Z729 and two N709's in Push Pull. The Assembly instructions include five "easy stage-by-stage" diagrams and are available for 3/6.

Price of COM- **£21/4/-** (Plus 7/6 Carr. and Ins.)  
WE WILL SUPPLY THE COMPLETELY ASSEMBLED **£25/-** (Plus 7/6 Carr. & Ins.)  
AMPLIFIER for **£26/5/-** Deposit and 12 months at **£1/15/2**.

H.P. Terms: **£6/5/-** Deposit and 12 months at **£1/15/2**.

## WE HAVE IN STOCK... THE DENCO F.M. FEEDER UNIT

Consisting of a 5 valve Superhet design incorporating R.F. (6AM6) and F/C (12AH9) Stages followed by Two I.F.s. (6BA6's) and Ratio Discriminator 6AL5, the coverage provided being 88-100 Mc/s.

THE COMPLETE KIT including VALVES and DRILLED CHASSIS is available for **£6/13/6**

It is suitable for use with any type of High Fidelity Amplifier. (Plus 4/- Carr. & Ins.) The descriptive manual, including circuit and Component Layout, etc., is available for 1/6.

THE COMPLETELY ASSEMBLED CHASSIS, **£8/17/6** (Plus 6/- Carr. & Ins.) ready for use, aligned and tuned EACH PRICE INCLUDES TWO I.F. STAGES.

## THE DENCO M.T.O.I. MODULATED TEST OSCILLATOR

**£3/15/0**

(Plus 2/- Carr. and Ins.)

Has Frequency range continuously variable from 170-475 Kc/s. and 550-1,600 Kc/s. Battery operated and thereby completely self-contained.

## BRAND NEW C.R.T. MASKS

Latest aspect ratio for 12in. "Round" tubes, finished Ivory (plus 1/- postage) **12/6**

## "STERNS" MODEL CP3G 3 WAVEBAND SUPERHET TUNING UNIT

A highly sensitive tuning unit providing for excellent reception of stations on the short wavebands (16-50 metres) medium waveband (200-550 metres) and the long waveband (800-2,000 metres).

- We can supply this tuner to correctly operate with each of the amplifiers.
- Valve line-up—6K8G (Frequency Changer), 68K7g (I.F. Amplifier), 6Q7g (Detector, AVC and 1st A.F. Amplifier), and 5Z4g (rectifier).
  - A gramophone position is incorporated with the wavechange switch and the 6Q7g valve becomes the 1st A.F. Amplifier for the gramophone pick-up.
  - Volume control and tone control operative in both radio and gramophone positions of the wavechange switch.
  - This unit is precisely similar in appearance to the AN/FM unit illustrated, but the overall chassis dimensions are 12in. x 8½in. x 8½in. including the full vision dial. Size 8½in. x 4½in.
  - For A.C. Mains only, power supply required—H.T. 250 volts 30 mA., L.T. 6.3 volts 1½ amp.
- Price, completely assembled and including built-in power supply **£20/10/-**. H.P. Terms. Deposit **£2/12/6**. 12 months of 15/-.
- Price completely assembled excluding power supply **£9**. Carriage and insurance 7/6 extra.

## The NEW "LEAK" TL/10 AMPLIFIER and "Point One" PRE-AMPLIFIER

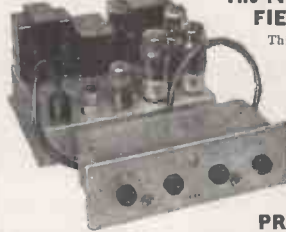

This Amplifier has a maximum output of 10 watts and maintains in every respect the world renowned LEAK reputation for precision engineering; fine appearance and fastidious wiring. The Pre-Amplifier will operate from any make or type of pick-up. A continuously variable input attenuator at the rear of the Pre-amp. permits the instantaneous use of crystal, moving iron and moving coil pickups. H.T. and L.T. supplies are available for a Radio Tuning Unit. An input attenuator is fitted. S.A.E. for descriptive leaflet.

#### PRICES:

- (a) The COMPLETE AMPLIFIER WITH PRE-AMPLIFIER, **£28/7/-**, or **£7/2/-** Deposit and 12 months at **£2**.
- (b) The TL/10 MAIN AMPLIFIER ONLY: **£17/17/-**, or **£4/7/-** Deposit and 12 months at **£1/5/4**.
- (c) The "POINT ONE" PRE-AMPLIFIER ONLY: **£10/10/-**, or **£2/12/6** Deposit and 12 months at **15/-**.

## ANOTHER GENUINE BARGAIN! A PORTABLE PLAYING DESK CONTAINING

THE NEW COLLARO MODEL R.C. 54  
3 SPEED AUTOCHANGER for only **£13/5/-**  
(plus 10/- carriage and insurance)

H.P. TERMS. Deposit **£3/5/-** followed by 12 monthly payments of 18/7.

THE COLLARO MODEL R.C. 54 is the latest "mixer" 3-speed unit and incorporates the famous Studio "O" Crystal Pick Up. It is supplied accommodated in a Portable Carrying Case covered in grey rexine.

## WILLIAMSON AMPLIFIERS BY GOODSSELL

These Amplifiers hardly need enlarging upon. It being sufficient to say that they have now become the accepted standard for quality reproduction by which all others are judged. Two Models are available:

**MODEL G.W.18.** Built completely to specification and giving 15 watts output. Price **£33/15/-** (Plus 7/6 Carriage and Insurance). H.P. Terms, Deposit **£3/9/-** and 12 months at **£2/7/5**.

**MODEL G.W.12.** Uses slightly lower H.T. voltage to produce 10-12 watts output but otherwise built completely to specification. Price **£27/10/-** (Plus 7/6 Carriage and Insurance). H.P. Terms Deposit **£6/17/6** and 12 months at **£1/18/8**.

**THE MODEL P.F.A. TONE CONTROL UNIT**  
This Control Unit has established a reputation for its excellent quality of reproduction, and ability to give adequate gain for any type of pick-up.

Price **£20/-** (Plus 7/6 Carriage and Insurance). H.P. Terms. Deposit **£5** and 12 months at **£1/8/2**.

WE HAVE THEM IN STOCK and WILL BE PLEASED TO DEMONSTRATE

or send S.A.E. for illustrated and descriptive leaflet.

When submitting orders, please include postage and packing

# STERN RADIO LTD.



**CONSTRUCTORS SAY**  
**"IT'S STILL THE BEST MAINS or BATTERY PORTABLE SET"**

A Midget 4-valve Superhet Portable covering medium and long wavebands. Designed to operate on A.C. mains 200/240 volts or by an Aldry "battery". The set is designed so the main section can be supplied as a separate unit, and can be added at any time. The set supplied as an "Aldry" battery Superhet can be accommodated in the attache case illustrated (size 9 1/2 in. x 4 1/2 in. x 7 in.). This is attractively finished in lizard, maroon, dark green or blue resin. As a combined Mains/Battery Superhet Portable a polished cabinet is available to accommodate both Mains Unit and Batteries. Circuit incorporates delayed

A.V.C. and pre-selective Audio Feedback. The set is complete in every detail and includes ready-wound frame aerials, fully aligned I.F. transformer, and drilled chassis, etc. Overall size of assembled chassis 8 in. x 4 in. x 2 1/2 in. This receiver, as illustrated, can be completely built for £8/10/3 (plus Mains Unit if required). Send 1/5 for the fully descriptive Assembly Book which includes Practical Layouts and complete Price List of Components. Portable Case available separately, 3/7/6.



**THE "MINI TWO-THREE"**

An "Aldry" Battery Portable of midget size, 6 1/2 in. x 4 1/2 in. x 3 1/2 in. designed to cover medium waveband 190-559 metres, with use of short trailer aerial.

The simple design of this Receiver is so arranged that either a 3-valve set or a 2-valve (afterwards easily converted to the 3-valve) can be made.

Consists of a T.R.F. circuit using a regenerative detector with I.F. stage and a high gain output pentode. Valve line up IT4-IT4-DL94.

The 2-valve set can be completely built for £4/3/6 (less case) and the 3-valve for £5/3/6 (less case). Each price includes valves, speaker, and drilled chassis.

Send 2/- for the assembly instructions; they include simple and complete practical component layouts and diagrams.

**!! CONSTRUCTORS !!**  
**A NEW SUPERHET TRANSPORTABLE THE "SUPER THREE"**

Designed for local station reception without the use of an external aerial. This design provides for a 3-valve (plus Metal Rectifier) Superhet Receiver incorporating a Frame Aerial for "room to room" use, provision is also made for a short external aerial, if required, for the reception of Continental Stations.

Briefly the features are as follows:-

- For use on A.C. Mains 200-250 volts.
- This set includes a Mains Transformer and Chassis is NOT live to mains (as many other sets of this type are) and consequently the Receiver can safely be used in the Kitchen, etc.
- Valve line up 6K5-4J7-KT61, plus Metal Rectifier.
- The I.F. Transformer is supplied "pre-aligned" and thereby ensures extreme simplicity of Tuning—in fact, more simple than most T.R.F. Receivers.
- Compact and easy to build simple "point to point" practical diagrams are supplied with a completely drilled chassis.

The complete Receiver Chassis can be built to cover the Medium Waveband only for **£6 - 6 - 6**  
 Or to cover both Long and Medium Waves for **£6 - 16 - 3**  
 The attractive Polished Wood Cabinet 11 1/2 inches wide, 8 1/2 inches high and 6 inches deep illustrated above is **£1 - 1 - 0**  
 THE CONSTRUCTOR'S MANUAL is available for 1/-, this shows the component prices, which are all available for separate purchase.



**"PERSONAL SET" BATTERY ELIMINATOR**

A complete Kit of parts to build a Midget "Aldry" Battery Eliminator, giving approx. 69 volts at 10 m/a. and 1.4 volts at 250 m/a.

This eliminator is for use on A.C. mains and is suitable for any 4-valve Superhet Receiver, requiring H.F. and L.T. voltage as above, or approx. to 69 volts.

The Kit is quite easily and quickly assembled and is housed in a light-aluminium case size 4 1/2 in. x 1 1/2 in. x 3 1/2 in. Price of complete Kit with easy-to-follow assembly instructions, 42/6. In addition we can offer a similar COMPLETE KIT to provide approx. 90 volts at 10 m/a and 1.4 volts at 250 m/a. Size of assembled unit 7 in. x 2 1/2 in. x 1 1/2 in. Price 47/6.



**A COMPLETE "CAR RADIO" FOR THE HOME CONSTRUCTOR**

1 1/2 in. x 4 1/2 in. x 3 1/2 in.

A design of a complete 5-VALVE SUPERHET RECEIVER employing an R.F. Stage, and incorporating a separate VIBRATOR PACK size 4 1/2 x 6 1/2 in. for use on 6 or 12 volt D.C. supplies.

We can supply all components to build this complete Receiver and Vibrator Pack including a Metal Case, Valves, Drilled Chassis and 5 in. P.M. Speaker for £13/9/6. (Carr. and Ins. 5/6 extra.) Or the Receiver Components for £8/19/6 and the Vibrator Components for £3/10/-. This is NOT an EX-GOVT. Receiver, it is a new design employing new Components. Send 2/8 for the complete set of ASSEMBLY INSTRUCTIONS, CIRCUITS and PRACTICAL LAYOUTS, including a complete individual Component Price List.



**A BULK PURCHASE ENABLES THIS SPECIAL PRICE REDUCTION**

OF THE FAMOUS

**SHAFESBURY PORTABLE AMPLIFIER**

Suitable for home use and small Halls. Has matched inputs for both Record Players and Microphone. Also provides for the "mixing" and "fading" of both Gram. and speech as requested.



**COMPRISING**

- A 4-Valve High Gain Amplifier for use on A.C. or D.C. mains 200-250 volts with 5 watts output. Incorporating independent Volume Controls for Mike and Gram., either of which can be faded at will, a variable Tone Control and independent input sockets for Mike and Gram.
- A Transverse Carbon microphone which obtains its polarizing current from the amplifier—no batteries are necessary.
- An 8 in. Goodmans P.M. Speaker with the "Ticonal" magnet for first-class reproduction.

**THE COMPLETE EQUIPMENT is all contained in the PORTABLE CARRYING CASE £18'0'0**

Having been reduced from £30/9/-, HIRE PURCHASE TERMS. DEPOSIT £4/10/- and 12 monthly payments of £1/5/4. Light in weight. Easy to CARRY. GENUINELY PORTABLE. An illustrated leaflet containing free data is available on receipt of S.A.E.

**BATTERY CHARGER KITS**

All kits are for A.C. Mains 200-250 volts. They comprise a Metal Rectifier and Transformer, tapped for 6 or 12 volt charging, and a tapped Resistor, with Selector Switch, to enable the charging rate to be varied. A M/cool meter 4 amp. max., 13/6 extra.

- For 6 or 12 volt batteries at max. 1 amp. .... £1/17/6
  - For 6 or 12 volt batteries at max. 2 1/2 amp. .... £2/5/3
  - For 6 or 12 volt batteries at max. 4 amp. .... £3/2/8
- An easily followed Wiring Diagram is included with each kit.

**SPEAKER BARGAINS**

|                               |         |
|-------------------------------|---------|
| PLESSEY 10in. 3 ohm V/cool    | £15/0   |
| GOODMANS, 10in. 3 ohm V/cool  | £11/3/6 |
| TRUVOX, 12in. 3 ohm V/cool    | £2/7/6  |
| ROLA, 12in. 3 ohm V/cool      | £3/19/6 |
| BAKERS, 12in. 15 ohm V/cool   | £4/19/6 |
| GOODMANS, 12in. 15 ohm V/cool | £5/19/6 |

(Carriage and Ins. 1/6 extra)

**THE NEW W.B. "STENTORIAN" HI F SPEAKERS ARE IN STOCK**

|                    |         |
|--------------------|---------|
| Model H.F. 6-inch  | £2/10/6 |
| Model H.F. 8-inch  | £3/0/6  |
| Model H.F. 9-inch  | £3/7/0  |
| Model H.F. 10-inch | £3/13/6 |

These speakers are of the very latest design and provide quality reproduction for the lower-price range, 3 or 15 ohm models are available.

**A COMPLETELY ASSEMBLED 4 VALVE T.R.F. CHASSIS**

Including a 5 in. P.M. SPEAKER and VALVES

**£6'9'6**

(Plus 7/6 carr. and Ins.)

This receiver is of the very latest design and is for use on A.C. or D.C. Mains. It covers both Long and Medium Wavebands, and includes the modern BVA miniature valves. The line up being 12BA6-12AT6-12AG-35W4. It incorporates Permeability Tuned Coils, thus ensuring excellent selectivity and sensitivity.

The overall size of the complete chassis including speaker is 10 1/2 in. x 4 1/2 in. x 6 1/2 in. An attractive Cabinet size 11 1/2 in. x 6 1/2 in. x 6 1/2 in. is available for 16/6 (plus 2/6 carriage and insura. col.)



**109 and 115 FLEET ST.**

**LONDON, E.C.4. Phone: CENTRAL 5812-3-4**

# CLYNE RADIO LTD.

## 18, TOTTENHAM COURT ROAD, LONDON, W.1

MUSEum 5929/0095.

All goods specially selected for quality and value. Prompt Service—Money-back guarantee—I will pay you to visit our new rebuilt shop premises. Situated 60 yds. only from Tottenham Court Road Tube! (Genuine).

### VERY LATEST 3-SPEED AUTO-CHANGER BY FAMOUS MANUFACTURER

Further limited quantity-mixer, turn-over crystal head. Cream finish. Our price £11/10/- only, plus 3/6 p. & p., or 50/- deposit plus p. & p., and 12 monthly payments of 16/9.

### COLLARO 80/54 PLAYER!

Just released. Fawn leatherette covered portable case, incorporating very latest Collaro 3 speed mixer-changer. Cream finish. Lightweight turn-over crystal pluck-up head. Only £13/19/6 cash, plus 5/- p. & p. Complete, or, 69/6 deposit plus p. & p., and 12 monthly payments of 19/8.

**RECALL** A well-made cabinet in medium coloured walnut veneer. Size 29 1/4 x 14 1/2 x 9 1/2 in. Unique motor-board measures 2 1/2 x 13 1/2 in. Record or tape storage aperture alongside motor-board measures 3 1/2 in. wide x 12 in. deep. Price £9/19/6 plus 10/- p. & p. H. P. terms available.

We have in stock the identical cabinet to this above illustrated, but slightly larger. Measurements: 29 1/2 in. high x 3 1/2 in. x 14 1/2 in. Uncut motor-board measures 2 1/2 x 14 1/2 in. Aperture 5 1/2 x 12 in. deep. Price £10/17/6. **R1155A RECEIVERS** guaranteed serviceable in original packing cases. £7/19/6. Fully assembled Power Pack and output stage, to plug straight into R1155 for A.C. 200/250 volts at 79/6. We have a few brand new R1155A at £11/10/6, also in original packing cases—Deduct 10/- if purchasing either receiver together with power pack. Plus 10/- packing and carriage. **R1124 RECEIVER UNIT.** Coverage 30-40 Mc/s. Including 6 valves—3 type 9D2. 1 each, 8D2, 15D2 and 4D1—8ix valve-screening cans, 24 ceramic trimmers, 6 ceramic valve holders, resistors, condensers, I.F.T.'s coils, etc. In very good condition, a bargain at 16/6 each only, plus 3/6 packing and postage.

**RECEIVER TYPE 25/73.** (The receiver section of TR1196.) Supplied complete with full data for conversion to 3-wave-superhet receiver. Unit in complete with 6 valves 2-EP39, 2-EP36, PK39 and EBC33, also standard I.F.T.'s 465 Kc/s. Price 27/6 plus 3/6 p. & p.

**TR1196 TRANSMITTER PORTION.** We can also supply the transmitter portion of the above receiver incorporating valves, EL32, EP50, CV50L. Type 800 relay, transformer, coils, switches, etc. Limited quantity at 12/6 only, plus 2/6 p. & p. **24 VOLT ROTARY CONVERTER.** Input 24 v. D.C. Output 200/250 v. A.C. 100 watts. Complete in black steel box 18 1/2 in. x 11 1/2 in. x 8 1/2 in. Weight approx. 30lb. Completely smoothed incorporates Sodium Lamp transformer. Brand new, 92/6.

## LAST FEW ONLY! EX-NEW ZEALAND ARMY TRANSMITTER/RECEIVERS.

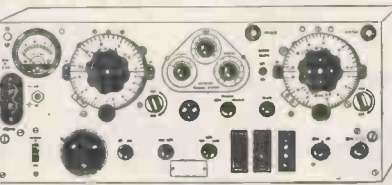

**TYPE ZC1 MK. I.**—Built into substantial steel cabinet mounted on easily removable resilient mountings. The instrument is fully tropicalised. We regret we have sold out Mk. II version previously advertised!! We have few only left. Mk. I general specification 'as for Mk. II, but single waveband only; with frequency coverage 2-6.5 Mc/s. Front panel layout very slightly different to Mk. II illustration. Transmitter output up to 2 watts depending on type of aerial used, gives ranges up to 35 miles on Morse and 30 miles speech, in average country. Considerably greater ranges may be obtained by the use of horizontal aerials. H.T. is supplied by a built-in vibrator pack, requiring 12 volt input. Valve line-up, 2-6V6GT, 7-6U7G, 6K8G and 6Q7GT, 465 Kc/s. I.F.T.'s. Set weighs 58lb. Measurements 22 1/2 x 10 1/2 in. x 10 in. These units are new condition, and price is £5/19/6 only, plus 10/- packing and carriage. This price includes fully illustrated 20-page instruction booklet including full circuit diagrams, suggested aerials, fault-finding, etc. An unrepeatable bargain!!

coverage 2-6.5 Mc/s. Front panel layout very slightly different to Mk. II illustration. Transmitter output up to 2 watts depending on type of aerial used, gives ranges up to 35 miles on Morse and 30 miles speech, in average country. Considerably greater ranges may be obtained by the use of horizontal aerials. H.T. is supplied by a built-in vibrator pack, requiring 12 volt input. Valve line-up, 2-6V6GT, 7-6U7G, 6K8G and 6Q7GT, 465 Kc/s. I.F.T.'s. Set weighs 58lb. Measurements 22 1/2 x 10 1/2 in. x 10 in. These units are new condition, and price is £5/19/6 only, plus 10/- packing and carriage. This price includes fully illustrated 20-page instruction booklet including full circuit diagrams, suggested aerials, fault-finding, etc. An unrepeatable bargain!!

### REMOTE CONTROL UNITS.

These units originally intended for use with the above transmitter/receiver, when inter-connected can be used as ordinary telephones or for practice Morse-working one-to-one. Complete in handsome steel case, can be operated by ordinary torch battery. Has built-in Morse key and buzzer unit. Price for each is 15/-. Suitable headphones can be supplied at 7/6 plus 5/- for carbon hand microphone. The whole plus 2/6 p. & p. Each unit includes full operating instructions—and is brand new.

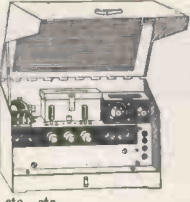

**OTHER ACCESSORIES AVAILABLE.** Moving Coil Microphones for transmitter 7/6 each, 100 yd. drum twin cable with plugs both ends, 10/-, 70 yd. drum twin, 7/-, etc., etc.

| F.S.D.       | Size           | Type   | METERS Fitting    | Price |
|--------------|----------------|--------|-------------------|-------|
| 50 microamp  | D.C. 2 1/2 in. | M.O.   | R.F.              | 50/-  |
| 100 microamp | D.C. 2 1/2 in. | M.O.   | F.R.              | 45/-  |
| 500 microamp | D.C. 2 1/2 in. | M.O.   | R.F.              | 13/6  |
| 1 mA.        | D.C. 2 1/2 in. | M.O.   | F.R.              | 18/6  |
| 1 mA.        | D.C. 2 1/2 in. | M.O.   | F.R.              | 22/6  |
| 1 mA.        | D.C. 2 1/2 in. | M.C.   | Desk Type         | 27/6  |
| 5 mA.        | D.C. 2 1/2 in. | M.C.   | F. Sq.            | 7/6   |
| 10 mA.       | D.C. 2 1/2 in. | M.C.   | R.F.              | 8/-   |
| 10 mA.       | D.C. 2 1/2 in. | M.C.   | F. Sq.            | 10/-  |
| 50 mA.       | D.C. 2 1/2 in. | M.C.   | F. Sq.            | 8/6   |
| 150 mA.      | D.C. 2 1/2 in. | M.C.   | F. Sq.            | 7/6   |
| 200 mA.      | D.C. 2 1/2 in. | M.O.   | R.F.              | 10/-  |
| 1 amp.       | R.F. 2 1/2 in. | Thermo | R.F.              | 10/-  |
| 3 amp.       | R.F. 2 1/2 in. | Thermo | F. Sq.            | 6/-   |
| 5 amp.       | D.C. 2 1/2 in. | M.O.   | F. Sq.            | 13/6  |
| 6 amp.       | R.F. 2 1/2 in. | M.O.   | Thermo F.R.       | 7/6   |
| 20 amp.      | D.C. 2 1/2 in. | —      | E.P. (with shunt) | 10/6  |
| 25 amp.      | D.C. 2 1/2 in. | M.I.   | F.R.              | 8/6   |
| 30 amp.      | D.C. 2 1/2 in. | M.I.   | F.B.              | 17/6  |
| 15 volt      | A.C. 2 1/2 in. | M.C.   | F. Sq.            | 12/6  |
| 20 volt      | D.C. 2 1/2 in. | M.C.   | F. Sq.            | 7/6   |
| 15-15 volt   | D.C. 2 1/2 in. | M.C.   | F.R.              | 17/6  |
| 150 volt     | D.C. 2 1/2 in. | M.C.   | F.R.              | 15/-  |

R.F. = Round projection. M.C. = Moving Coil. Thermo = Thermo-couple. F. Sq. = Flush square. F.R. = Flush Round. M.I. = Moving Iron.

**EX-W.D. CATHODE RAY TUBES.** Guaranteed full picture. VCB97 at 40/-. VOR570 at 35/-. Also VOR31A—ideal for oscilloscope 2 1/2 in. screen at 55/-. We also have VCB97 with slight out-off, very suitable for oscilloscope, testing purposes, etc., at 15/- only. All these tubes are brand new, in original packing, and tested before despatch. Please add 2/6 packing and carriage for any of the above tubes.

**AMERICAN INDICATOR UNIT TYPE BC929A.** Brand new incorporating 3in. tube 3BP1 with mu-metal shield, 2-6SN7GT, 2-6HG0T, 6X5G, 2X2, 8046G, 9 potentiometers 24 v. aerial switch motor, transformer, and a host of small components. The whole unit which measures only 8 1/2 in. x 8 1/2 in. x 1 1/2 in. is brand new, enclosed in black crackle box, and can be supplied at 65/-, plus 5/- p. & p.

**BRAND NEW C.B. TUBES.**—By leading manufacturer. 14KP4A. Latest type 14in. rectangular 6.3 v. heater. 12-14 Kv. in original sealed cartons. Limited quantity only at £13/19/6. Plus 15/- packing, carriage and insurance.

**TRIPLETT RECTANGULAR METER.** 4in. scale. Knife-edge needle. Basic movement 0-100 microamps. At present graduated for multi-range meter. Brand new in sealed cartons, 90/-, plus 2/- p. & p.

### STOP PRESS!!!

2 1/2 in. ROUND FLUSH MOUNTING METER by WESTON, blank scale ready for re-engraving, FSD 650 microamps, brand new, 27/6 only.

**HIRE PURCHASE**  
We are pleased to announce advantageous hire purchase facilities on any single item over £5. Ask for details, mentioning what you are interested in. We regret we cannot extend this facility to kits.

- 32 SET POWER UNIT No. 4MK1 ZA10478.—Complete with 4 metal resistors each 250 v. 60 mA. 2-12 v. 4 pin Mallory Vibrators, transformers, condensers, resistors, signal 1 amp. indicator, etc., etc., in good condition. Complete in metal box size 10 1/2 in. x 6 1/2 in. x 8 in. Weight 19lb. 27/6, plus 5/- p. & p.
- L.T. RECTIFIERS TYPE R.K. A newly manufactured range guaranteed 12 months. 6 or 12 v. 1 a. F.W. bridge type ... 7/6  
6 or 12 v. 1.5 a. F.W. bridge type ... 9/6  
6 or 12 v. 2 a. F.W. bridge type ... 11/3  
6 or 12 v. 2.5 a. ... 12/6  
6 or 12 v. 4 a. F.W. bridge type ... 15/-
- CHARGER TRANSFORMERS. Input 230 v. 8/12 v. 1 a. ... 9/9  
2 6/12 v. 2 a. ... 14/6  
2 6/12 v. 4 a. ... 17/6
- ROTHEMEL. DA1 Crystal Microphone Inserts. Brand new, 7/6 each, plus 9d. p. & p. We also have a limited number of Bonetto Type ZA crystal microphone inserts at 23/6.
- METER SPECIAL. We have a limited quantity of aircraft electrical thermometers Brand new, by Weston. 2in. moving coil meter, dash square fitting. These meters have a luminous scale graduated 0-100 degrees centigrade, but the full scale deflection is approximately 150 microamps! Price 12/6 each only, plus 1/- p. & p.
- VIBRATOR PACK. Brand new, by Mallory. 12 volt input, 150 v. 40 mA. output. Complete with synchronous vibrator, 27/6.
- DECCO LIGHTNING PIGTAILS. Complete with either standard or L.F. Crystal Cartridge inserts. Complete with Rest and Tracking instructions, 32/6 plus 1/6 p. & p. Also their very latest type, as above, but with turn-over head 47/6 only! Plus 1/6 p. & p.
- 8-VOLT VIBRATOR PACK. Ex-W.D. 6-volt input, output 140 v. 30 mA. Fully smoothed and rectified, incorporating Wearite 6 volt 4 pin vibrator type N8B6. Unit size only 6 1/2 in. x 6 in. x 2 1/2 in. Price 15/- plus 1/6 p. & p. New condition. SPECIAL OFFER—RE-SETTING VALVES. These are brand new originally boxed, and guaranteed O.K. Type 813, 80/- per pair. Type 866A, 17/- per pair, both post free. Also type 29C1 at 20/-. 12E1 at 40/-.
- VALVES. We have a very comprehensive stock of surplus valves at competitive prices. A stamp will bring Valve Price List.
- SPECIAL OFFER—METERS. Taken from equipment, but guaranteed perfect. 2in. round, 0-50 amp. 2in. round, 0-40 amp. 2in. round 0-50 volt, 3/9 ea., or 3 for 10/6. 2 1/2 in. round panel-mounting 0-500 mA., 5/-.

All the above plus P. & P. please!  
**R.F. UNITS.** All new condition and complete. Case size 9 1/2 in. x 7 1/2 in. x 5 in.  
Type 24—29-30 Mc/s. 15/-, Switched Tuning. Type 25—40-50 Mc/s. 19/6. Switched Tuning. Type 27—45-86 Mc/s. 45/-. Variable Tuning. Type 28—60-65 Mc/s. Variable Tuning 35/-. We have a limited supply of R.F. units in addition and complete, but tuning dial damaged. Price only 30/- each. All these units Post Free.  
**AVR20—R.O.A. COMMUNICATION RECEIVER.** Absolutely brand new in sealed box, containing all circuit, and fully illustrated instruction booklet. Designed for reception of either speech or Morse. A three-position switch provides either standard variable condenser tuning (calibrated dial) or crystal "lock-in" on either of two frequencies. These two frequencies are determined by the crystals used. For 6 or 12-volt supply. Valve line-up: 6B7, 6K8, 6P7 and 6B8, Superhet, 2.3-6.7 Mc/s. Size only 6 1/2 in. x 7 1/2 in. x 5 1/2 in. Weight only 6 1/2 lb. Price only 59/6. Plus 2/6 p. & p.

**AMERICAN CONTROL UNIT C58/AFT1.** Box measures only 5 1/2 in. x 3 1/2 in. x 2 in. Incorporating 2in. round 0-1 mA. meter 200 ohm. pot. 2 toggle switches, indicator lamp, etc. Price 22/6, post free.

**HEADPHONES.** Brand new, ex-Govt., by S. G. Brown. Type CLR. Low resistance, 12/6 per pair. Type CHR high resistance, 12/6 per pair. We can also supply very special brand new American ex-Govt. lightweight high resistance phones by Trimm at 45/- per pair.

**4 VOLTALYTES** 9 volt 60 amp. ACCUMULATORS MULTI-PLATE Type in celluloid containers. Size 3in. x 3in. x 4 1/2 in. high at 9/6 each plus 2/- p. & p. Or 3 for 23/6, post free.

**No. 38 TRANSMITTER / RECEIVER WALKIE-TALKIE.** Range approx. 5 miles. Coverage 7.4-9 Mc/s. The set only, complete with valves at 30/-, in very good condition. **RECORD PLAYER CABINETS.** Specially made to house any type of single record unit. Finish in dove-grey leatherette. Baseboard measures 14 1/2 in. x 12 1/2 in. Clearance above and below board 3in. 45/- plus 3/- p. & p.

Please add postage under £1. C.O.D. or Cash with order. C.O.D. charge extra—open 9 a.m.-6 p.m. Monday to Friday. Sorry but we close at 1.0 p.m. on Saturday.



**OUR NEW "POPULAR" AMPLIFIER, A.C.**

Maine 2/3 ohms. 4 watts output. Suitable for either crystal or magnetic pick-up. Valve line-up, 6V6GT, 6SL7GT, 5Y3GT. Provision for radio feeder unit. Volume and tone controls. Built in chassis. Finished steel box, with chrome carrying handle. Attractive bakelite engraved front panel. Box measures 9 1/2 in. x 7 1/2 in. x 6 1/2 in. Price only £8/12/6 carriage paid. Ready for use.

We have in stock the very latest "Elipco" Feeder Unit type RF720. Superhet for L., M., Short and Trawler Bands. Very attractive illuminated black and gold dial for immediate use with any amplifier. 15 gas. tax paid.

**HIRE PURCHASE**

We are pleased to announce advantageous hire purchase facilities on any single item over £5. Ask for details, mentioning what you are interested in. We regret we cannot extend this facility to kits.

**LATEST 3-SPEED AUTO-CHANGER**, long arm model complete with C. and D. high density heads. Limited quantity at £17/10/- plus 5/- p. & p. H.P. terms available.

**THE R.C. 3/4 WATT AMPLIFIER KIT**—Just released! Compare the advantages! Treble, bass, AND middle tone controls! For crystal or magnetic pick-up! A.C. Mains. 200/250 v. Valve line-up, 6V6GT, 6X5GT, 6X5GT. Negative feedback. Built on Stove enamelled steel chassis, measuring only 8 in. x 4 in. x 1 1/2 in. Four engraved cream knobs are included in the price of the complete Kit with all necessary practical and theoretical diagrams, at £4/5/- only, plus 2/6 packing and post, or Instruction Book, fully illustrated, for 1/-, post free! This amplifier can be supplied assembled, tested, and ready for use at £5/5/- plus p. & p. Hearing is believing!



**SUPER-QUALITY 6-VALVE RADIOGRAM CHASSIS.**

Very limited quantity by Britain's leading quality manufacturers, 3 waveband, superhet, valve line-up, 6V6G, E240, ECH42, L63, EP41 and EB041. Combined pick-up amplifier and A.F. amplifier on Radio and Gram. Employs a special circuit for gramophone pre-amplification. Large glass dial horizontal tuning measuring 1 1/2 in. x 3 1/2 in. Chassis measurement: 14 1/2 x 9 in. x 8 in. This is a superior chassis designed to sell originally in a Radiogram costing £75. Our price is £12/10/6 only, tax paid, plus 5/- packing and carriage. We will gladly demonstrate this chassis or any other working item from our stocks, to personal callers!

**ARMSTRONG F.C.48.** Their very latest high quality replacement chassis having provision for F.M. feeder unit, 3 valves, four wavebands. Independent bass and treble with unique thermometer visual indicator. Ready for use £23/12/- plus 5/- p. & p. or £5/12/- deposit and 12 monthly payments at 33/8.



Carrying cases in black leatherette finish. An extremely well-made case with chrome locks and corner pieces for extra strength. This cabinet will house any 12in. Hi-Fi speaker, but can be put to a number of uses. Front panel and lid are removable, and the cabinet is packed in a strong cardboard container for carrying purposes. Size: 18 1/2 in. x 10 1/2 in. x 16 1/2 in. 55/- plus 5/- post and packing.

**F.M.!! (Frequency Modulation)**

We are pleased to announce our complete Kit for the "Denco" F.M. Feeder Unit.

This unit provides an A.F. output suitable for feeding into the audio section of a standard broadcast receiver where triode/pentode output are available. Within an average of 30 miles from a V.H.F. transmitter one I.F. stage should be adequate, but our complete Kit supplied includes all components and valves for an extra I.F. stage if necessary, or if the unit is used at greater distance. Full Constructional details, theoretical circuit and point-to-point wiring diagram can be supplied for 1/6 post free, or the complete Kit right down to the last nut and bolt, at only £8/7/6, plus 2/6 packing and postage. This unit can be supplied if desired ready assembled, aligned and tested, at £9/10/- plus 2/6 packing and postage.

If required we shall be pleased to align this unit for constructors not possessing the necessary equipment, for a charge of 7/6. N.B.—Valve line-up is 6AM6, 12AH8, 2-6BA6 and 6AL5. Chassis measures only 8 1/2 x 5 1/2 x 1 1/2 in. Demonstrations at 18, Tottenham Court Road!



**THE "SUPERIOR" FOUR KIT.** Our new four-valve receiver. A.C. mains. 200/250 v. M. and Long waves. As with our very successful "Economy Four" all required components are supplied. Valve line-up: 2 68G7, 6X5GT and 6V6GT. Chassis ready drilled. Cabinet size, 10 1/2 in. x 10 in. wide. Maximum depth at base 5 1/2 in. tapering to 3 1/2 in. at top. Sloping front. Very attractively finished in light walnut and peach. Each component brand new and tested prior to packing. Complete instruction booklet with practical and theoretical diagrams is provided. Booklet available at 1/6, post free. Our price for complete kit, £5/9/6 1/11! Please add 2/6 packing and carriage. If preferred, we can supply Cabinet Assembly only, comprising Cabinet and bracket wavechange switch, dial, pointer, drum pulleys, drive spindle, drive spring and knobs, at 45/-, plus 2/6 packing and carriage. N.B.—Our kits are even supplied with sufficient solder for the job.



**THE R.O. GRAM REPLACEMENT CHASSIS KIT**

To meet the very great demand for this type of receiver, we have produced this unit. For Long, Medium, and Short Waves. Valve line-up: 6K8 Frequency changer, 6K7, I.F. Amplifier, 6Q7 1st Audio, Detector and A.F.C. 6V6 Output, 6X3 Full-wave rectifier. For A.C. mains 200/250 volts. 4 watts output. Excellent quality. High sensitivity. Provision for gram. Attractive illuminated black, red, green and gold dial for horizontal tuning. Four controls are: Tuning, L/M/S/Gram, Vol/on/off, Tone (variable). Chassis size: 13 1/2 in. x 6 1/2 in. x 2 1/2 in. Dial size: 10 in. x 4 1/2 in. Assembly is simplified by the use of a 3-waveband coil pack, and pre-aligned 465 Kc/s. I.F. transformers—high-grade drop-through half-shrouded Main Transformer, with voltage adjuster panel. This chassis can easily be assembled in one evening. Illustrated pamphlet with full assembly instructions, practical and theoretical wiring diagrams and itemised price list.

1/6, post free. The main items for this receiver can be supplied separately, as under. Drilled chassis, complete valve-holders, A/E panel, P/U panel, tuning condenser and ready-assembled dial and drive at 39/6. 3 waveband coil pack with gram position, 39/6, tax paid. Pair of 465 Kc/s. I.F. Transformers, 9/6 pair. Half shrouded drop through Main Transformer, 22/6. The total cost of ALL items purchased separately is nearly £10, but we shall be pleased to supply all the required components right down to the last nut and bolt, at a special inclusive price of £5/8/-, plus 2/6 packing and postage. A set of four small brown and cream engraved knobs to suit is available at 1/2 each knob. This chassis is a professional job in every respect and can be seen and heard at our premises. This chassis can also be supplied, ready assembled, in very limited quantities at £9/19/6, plus 5/- carriage and packing.

**THE "ECONOMY FOUR" T.R.F. KIT**

A three valve plus metal rectifier receiver. A.C. mains 200/250 v. Medium and Long waves. We can supply all required components right down to the last nut and bolt. Valve line-up, 6K7, 6J7, and 6V6, Chassis ready drilled—Cabinet size 12 in. long by 6 in. high by 6 in. deep—Choice of Ivory or Brown Bakelite, or wooden, walnut finish cabinet. Complete instruction booklet with practical and theoretical diagram. Each component brand new and tested prior to packing. Our price £5/10/- complete—Remember this set is being demonstrated at our shop premises! We proudly claim that our fully illustrated instruction booklet is the most comprehensive available for this type of receiver—Booklet available at 1/6 post free. This is allowed if kit is purchased later—Please, 2/6 packing and carriage for complete kit.

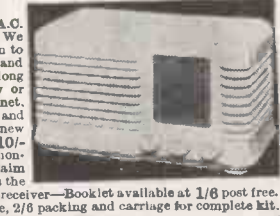

**DULCI RADIO/RADIOGRAM CHASSIS**

This very popular range of superior chassis can be supplied from stock. We will gladly demonstrate any to personal callers. All incorporate latest type valves 6BE6, 6BA6, etc. Flywheel tuning, negative feedback over entire audio section. Engraved knobs—3 tone position for Radio and Gram. All are built on chassis size 1 1/2 in. x 7 in. x 8 1/2 in. high. All A.C. 100/110 and 200/250 v.—Dial size 8 1/2 in. x 4 1/2 in. for horizontal tuning. Attractive appearance.

- Model B.3, Long, Medium, Short Waves (5 valves). Cash Price £12/12/- H.P. Terms £3/4/- deposit and 12 months at 17/8.
  - Model B.3 Plus Push Pull Stage. (6 valves). Cash Price £15/15/- H.P. Terms, £3/19/- deposit, 12 months at £12/2.
  - Model B.3 Double Feature Push Pull and R.F. Stage (7 valves). Cash Price £18/18/- H.P. Terms, £4/13/- deposit, 12 months at £18/9.
  - Model B.6 (Medium, Long and Four Short Wavebands, hand-operated). Cash Price £15/15/- H.P. Terms, £3/19/- deposit, 12 months at £12/2.
  - Model B.6, Plus Push Pull Stage (6 valves). Cash Price £18/18/- H.P. Terms £4/13/- deposit, 12 months at £18/9.
  - Model B.6, Double Feature Push Pull Plus R.F. Stage (7 valves). Cash Price £22/22/- H.P. Terms £5/15/6 deposit, 12 months at £12/12/6.
- All chassis fully guaranteed 12 months. Please include 7/6 packing, carriage and insurance. Illustrated leaflet available. Suitable speakers available. Ask for speaker list.

**THE R.O. RAMBLER ALL-DRY PORTABLE KIT**

Full assembly details with practical and theoretical diagrams can be supplied at 1/6 post free. This is a truly professional 4-valve superhet—all dry—for medium and long waves. A cream plastic top panel, with dial engraved in red and green, adds to the very imposing appearance of this model which is housed in an attractive cream and grey leatherette covered attache-case type cabinet; measuring only 9 in. x 7 in. x 6 1/2 in. Weight less batteries, 4 1/2 lbs. with batteries 6 1/2 lbs. This set really has everything! Built-in frame aerial, high quality, extremely sensitive, and very adequate volume from the 6in. speaker. Valve line-up: 3V4, 1B5, 1B5, 1T4. Also the required components, exactly as specified, including cabinet, can be supplied from stock at the special inclusive price of £7/7/- plus 2/6 p. & p. (less batteries). Uses Ever-Ready 90 v. H.T. type B120 at 9/3. Also L.T. 1.5 v. A.D.35 at 1/4.



**RAMBLER MAINS UNIT I**—At last we are able to offer our special mains units kit for using our popular all-dry "Rambler" on A.C. Mains. Complete kit, which when assembled fits snugly into battery compartment, can be supplied at 47/6, plus 1/6 packing and postage. Price includes all required components, and full assembly instructions. N.B.—This unit is completely self contained in a metal box measuring 7 in. x 2 1/2 in. x 1 1/2 in. and is ideally suitable for ANY all-dry battery portable requiring 90 v. H.T. and 1.5 v. L.T.

**THE R.E.P. SINGLE-VALVE BATTERY RECEIVER KIT.** One-valve all-dry battery receiver for headphones, easily built in one evening. All required components including headphones, can be supplied at inclusive cost of 42/- plus 2/- p. & p. Operated by Ever-Ready B114 type battery available at 7/9. Full assembly details available separately at 9d. plus 3d. post.

**THE NEW R.C. HIGH-FIDELITY AMPLIFIER.** P.P. 6V6 output. Freq. 25-18,000 cps—60 db at 6 1/2 watts. Treble boost and cut—Bass boost—L.P. correction. Provision for Feeder Unit Max. UNDISTORTED OUTPUT 8 1/2 watts. Price 14 gns. plus 7/6. NOW AVAILABLE—Kit of Parts, complete with fully illustrated instructions £11/19/6, plus 5/- carriage. Illustrated booklet available separately at 1/6. Attractive metal cover, now available, with built-in carrying handle 19/6.

**STUPENDOUS HALF-PRICE OFFER!** DECCA SINGLE SPEED RECORD PLAYER! DECCA DESES 53A. Easily converted to either Standard or I.F. Price with one crystal cartridge of either type, £4/19/6; or with both cartridges, £5/19/6. Plus 5/- p. & p. We have in stock at our usual competitive prices, ALL the required components for Gram and Mullard amplifiers. Available ex-stock. The LEAK TL10 Amplifier complete. 27 guineas, or H.P. terms available.

We also have in stock—Connors 3-speed motors, pick-ups, Pick-ups and heads by Garrard, Decca, Coltaro, Accos, Chancery, etc., etc., at current prices.

**AMPLIFIER BARGAIN. "THE EMPRESS"** Super quality push-pull 4 valve 4 watt amplifier. Ideal for record or radio tuner reproduction. Measures only 7 1/2 in. x 7 1/2 in. x 3 1/2 in. Valve line-up EL42, EL42, EZ41, EC83, for use with one or two 3-ohm speakers. Price £7/7/- plus 3/- p. & p.

**CLYNE RADIO LTD.**  
  
 18, Tottenham Court Road,  
 London, W.1.

# ALPHA

|               |               |                |               |
|---------------|---------------|----------------|---------------|
| 6G6G ... 6/6  | 807 ..... 8/- | VR137 ... 5/-  | 956 ..... 3/6 |
| 9004 ... 6/3  | 5Z3 ..... 8/6 | VR55 ... 7/3   | 9003 ... 6/3  |
| VR136 ... 7/- | 955 ..... 4/- | 6SA7 ... 9/-   | 2X2 ... 5/6   |
| VR66 ... 3/9  | TT11 ... 6/6  | ATP4 ... 6/9   | VR65 ... 3/9  |
| VUI20A 3/6    | VR116 ... 4/- | VU111 ... 3/6  | 6S57 ... 8/-  |
| 9002 ... 6/3  | VR56 ... 7/-  | VT75A ... 7/6  | 9001 ... 6/3  |
| VR53 ... 7/6  | 954 ..... 2/- | 1A5GT ... 7/6  | VR56A ... 3/6 |
| VR91 ... 6/-  |               | 6S77 ..... 8/- |               |

## OFFER THESE SPECIAL PURPOSE VALVES

**MAINS FLEX.** Plastic Twin flat 3d. yd.

**BAKELITE CASED HAND MICROPHONES,** switch in handle complete with lead, 7/6 each.

**GOLDTONE BUZZERS** in bakelite case, 2/6 each.

**PENTODE OUTPUT TRANSFORMERS,** 2/9 each.

**HIGH TO LOW RESISTANCE HEADPHONE** matching units (insert in lead), 3/6 each.

**COLVERN WIRE WOUND PONTIOMETERS,** 10KΩ, 20KΩ, 2/6 each.

**BLACK 1 mm. SLEEVING,** 1/- doz. yds

**BLACK 4 mm. SLEEVING,** 4d. yd.

**WEARITE 501-502 IF TRANSFORMER,** 10/- pair.

**PHILIPS ROUND CAN IF TRANSFORMERS,** 470 Kc/s, 8/- pair.

**EX-GOVERNMENT PRE-AMPLIFIER,** uses EF50, 6/6 each.

**20-WAY JUNCTION BOXES,** 1/4 each

**BELLING LEE 7-PIN PLUG AND SOCKET,** 1/6 each.

**TWIN FUSE HOLDERS** panel or base-board mounting, state type required (suitable for 1½in. fuses), 1/9 each.

**AMPLIFIER OR CHARGER CASE.** Brown crackle cabinet with removable chassis and bakelite front panel. Size 9½in. width x 7½in. height x 6½in. depth, 8/6 each.

**HEAVY DUTY OUTPUT TRANSFORMER.** Suitable for PX4 or 6L6 valves in push-pull, 12/- each.



**LOUDSPEAKER CABINETS**

This attractive walnut finished cabinet is available for 6½in. or 8in. speaker units. Metal speaker fret, complete with back and rubber feet.  
6½in. type: Measures 8½in. x 8½in. x 4½in. at base. Price 16/6 each.  
8in. type: Measures 10½in. x 10½in. x 5in. at base. Price 20/6 each.

**CHOKE.** Wavox choke, max. current 100 mA D.C. Resistance 125 ohms, 6/- each.

**MICROPHONE STAND.** Folding microphone floor stand, adjustable, 25/- each.

**DEFIANT EXTENSION SPEAKERS.** Extension loudspeaker in attractive pale green cabinet. Volume control fitted, 6½in. speaker unit, 42/- each.

**TABLE MICROPHONE.** Lustraphone type moving coil microphone on table stand. Complete with lead and Jack plug, 24/10/- each.

**NUTS AND BOLTS.** Box of nuts, bolts and washers 4BA countersunk and round head, over 100 items, 1/- box.

**WESTINGHOUSE 1 mA Rectifier wire ends,** 9d. each.

**PERSPEX IMPLOSION GUARDS,** incorporating brown acetone and grey filter drilled ready to fit to cabinet. 12in. type 11/-; 16in. type 12/6.

**EX-MINISTRY BAKELITE DOUBLE POLE TOGGLE SWITCH.** Single hole fixing, 1/6 each.

**6 Volt VIBRATOR PACK** complete with 4-pin Vibrator, 14/6 each.

**ELAC type 1T6 Ion Traps,** 2/9 each.

**GOOD QUALITY, maroon cotton covered** 2 amp. 3 core line cord, 1/9 each.

**TCC type (CE37FE) 100 mfd. 450 V.,** 4/- each.

**MAINS TRANSFORMER.** Input 200/250 v., output 225-0-225 V. 20 mA/6.3 v. 3 a., 11/- each.



### COMPARE THE PRICE THE "EKE" QUALITY 3 WATT AMPLIFIER



This is a complete unit, not a kit of parts.

For use with Hi-Fi Pick-up.

- 3 valves; 6B8, 6V6, 6X5.
- Tone and volume controls.
- Input and output sockets.
- A.C. mains fully isolated.
- Negative feedback.

Price 79/6. P. & P. 2/6.

## CONDENSERS

The following is a selection of our stocks of manufacturers' surplus condensers, all by well-known makers.

### ALUMINIUM CAN TYPES, GLIP FIXING

|                              |          |
|------------------------------|----------|
| 8 x 8 mfd. 450 v. ....       | 4/- ea.  |
| 8 x 18 mfd. 450 v. ....      | 4/- ea.  |
| 8 x 24 mfd. 350 v. ....      | 3/- ea.  |
| 8 x 32 mfd. 475 v. ....      | 3/9 ea.  |
| 12 x 4 mfd. 450 v. ....      | 2/- ea.  |
| 16 mfd. 450 v. ....          | 3/- ea.  |
| 16 x 8 mfd. 350 v. ....      | 4/- ea.  |
| 16 x 16 mfd. 350 v. ....     | 3/3 ea.  |
| 16 x 16 x 8 mfd. 350 v. .... | 3/6 ea.  |
| 20 x 20 mfd. 500 v. ....     | 4/9 ea.  |
| 24 mfd. 450 v. ....          | 2/9 ea.  |
| 24 x 16 mfd. 350 v. ....     | 3/6 ea.  |
| 32 mfd. 450 v. ....          | 3/- ea.  |
| 32 x 8 mfd. 350 v. ....      | 3/3 ea.  |
| 32 x 16 mfd. 350 v. ....     | 4/9 ea.  |
| 32 x 32 mfd. 450 v. ....     | 6/11 ea. |
| 32 x 32 x 8 mfd. 350 v. .... | 5/6 ea.  |
| 25 v. ....                   | 5/9 ea.  |
| 60 mfd. 450 v. ....          | 2/9 ea.  |
| 64 mfd. 350 v. ....          | 2/- ea.  |

### B.R. RANGE

|                                |         |
|--------------------------------|---------|
| B.R. 850, 8 mfd. 500 v. ....   | 2/9 ea. |
| B.R. 1650, 16 mfd. 500 v. .... | 3/3 ea. |
| B.R. 2950, 20 mfd. 500 v. .... | 3/9 ea. |
| 8 x 8 mfd. 500 v. ....         | 4/- ea. |
| B.R. 501 50 mfd. 12 v. ....    | 1/9 ea. |
| 16 x 16 mfd. 600 v. ....       | 5/- ea. |
| 16 x 8 mfd. 500 v. ....        | 4/9 ea. |

### MIDGET METAL TYPES

|                          |         |
|--------------------------|---------|
| 2 mfd. 350 v. ....       | 1/9 ea. |
| 8 mfd. 350 v. ....       | 1/3 ea. |
| 8 x 8 mfd. 350 v. ....   | 3/- ea. |
| 8 x 8 mfd. 450 v. ....   | 4/- ea. |
| 16 mfd. 350 v. ....      | 2/9 ea. |
| 16 x 8 mfd. 450 v. ....  | 4/6 ea. |
| 16 x 16 mfd. 450 v. .... | 4/9 ea. |
| 16 x 24 mfd. 350 v. .... | 2/9 ea. |
| 24 mfd. 350 v. ....      | 2/9 ea. |
| 32 mfd. 350 v. ....      | 1/9 ea. |
| 32 x 32 mfd. 350 v. .... | 4/9 ea. |
| 25 mfd. 12 v. ....       | 1/9 ea. |

### WIRE ENDED TYPES

|                                 |          |
|---------------------------------|----------|
| 8 mfd. 450 v. cardboard covered | 1/11 ea. |
| 30 mfd. 450 v. ....             | 3/9 ea.  |

### BIAS CONDENSERS

|                       |         |
|-----------------------|---------|
| Tag ended metal types |         |
| 12 mfd. 50 v. ....    | 1/- ea. |
| 25 mfd. 25 v. ....    | 1/3 ea. |
| 50 mfd. 12 v. ....    | 1/- ea. |
| 100 mfd. 50 v. ....   | 2/6 ea. |
| 100 mfd. 12 v. ....   | 1/9 ea. |
| 100 mfd. 25 v. ....   | 1/9 ea. |

### WIRE ENDED TYPES CARD-BOARD COVERED

|                    |         |
|--------------------|---------|
| 25 mfd. 25 v. .... | 1/9 ea. |
| 50 mfd. 12 v. .... | 1/9 ea. |
| 50 mfd. 50 v. .... | 2/9 ea. |

## SILICONE COATED WIRE-WOUND RESISTORS

Tolerance plus or minus 10%. Each resistor clearly marked with resistance value and wattage. Available in the following values: 25, 50, 68, 100, 150, 200, 250, 350, 500, 680, 1,000, 1,500, 2,000, 2,500, 3,500, 5,000, 6,800, 10,000 ohms.

|         |         |
|---------|---------|
| 5 watt  | 1/- ea. |
| 10 watt | 1/3 ea. |
| 15 watt | 1/9 ea. |

### VOLUME CONTROLS

|                  |      |      |      |
|------------------|------|------|------|
| WIRE WOUND TYPES |      |      |      |
| 5Ω               | 2KΩ  | 15KΩ | 30KΩ |
| 200Ω             | 5KΩ  | 20KΩ | 50KΩ |
| 1KΩ              | 10KΩ | 25KΩ | 500Ω |
| All 2/6 each.    |      |      |      |

### SUPPRESSORS

|   |                   |
|---|-------------------|
| Metal Case Mains Suppressor inserted in Mains Lead will cut out that interference | 2/6 ea.           |
| Plug Suppressor. Terminal Screw Fitting   | Post 1/1- 1/2 ea. |

## THE COMPACT TELEVISION AERIAL BY ANTIFERRE LTD.

Supplied complete with universal mounting and backplate in neutral brown finish. Overall length 5ft. 6in. Packed in carton 3ft. 4in. long. Complete with full instructions. Cat. No. CD4. Original price 50/- Our price 12/6 each.

## CONDENSERS MOULDED MICA

.0001, .0002, .0003, .0004, .0008, .00027, .0005, .001, .002, .003, .003, .01, 50 PF. 20 PF.

All 4½d. each.



## LOUDSPEAKER UNITS

|  |      |
|--|------|
| 5in. Rola with output transformer          | 16/6 |
| 6½in. Rola Standard Type                   | 17/6 |
| 6½in. Truvox wafer speaker                 | 17/6 |
| 8in. Plessey                               | 20/6 |
| 8in. Plessey                               | 20/6 |
| 6 x 4 Elliptical                           | 21/6 |
| 8½in. Mains energised 600 field            | 17/6 |
| 8in. Mains energised 1,000 and 2,000 field | 21/6 |



## SPRAGUE CONDENSERS

.05 mfd. 500 v.; .01 mfd. 1,000 v.; .1 mfd. 350 v.; .02 mfd. 750 v. All 9/- doz.

### CHASSIS

Aluminium Undrilled with Reinforced Corners. Available in the following sizes:

|                      |          |
|----------------------|----------|
| 6in. x 4in. x 2½in.  | 4/6 ea.  |
| 8in. x 6in. x 2½in.  | 6/3 ea.  |
| 10in. x 7in. x 2½in. | 7/8 ea.  |
| 12in. x 8in. x 2½in. | 8/6 ea.  |
| 14in. x 8in. x 2½in. | 9/6 ea.  |
| 16in. x 9in. x 2½in. | 12/- ea. |

All are four sided—ideal for radio receivers—amplifiers—powerpacks, etc.

## CRYSTAL DIODES

Plastic case, wire ends, 2 for 2/1.

## IRON ELEMENTS

Standard adaptable type 230 v., 450 v.  
Morphy-Richards replacement  
H.M.V. replacement type

|  |         |
|--|---------|
| Standard adaptable type 230 v., 450 v. | 1/8 ea. |
| Morphy-Richards replacement            | 3/9 ea. |
| H.M.V. replacement type                | 3/- ea. |

## DOUBLE TRIMMERS

250/250 pf.; 100/100; 100/50. All 6d. each.

## MAINS TRANSFORMERS

**3-WAY MOUNTING TYPE**

**MT1**  
Primary: 200-220-240 v.  
Secondaries: 275-0-275 v., 80 mA. 0-6.3 v. 4 amp. 0-5 v. 2 amp. Both tapped at 4 v. 17/6 ea.

**MT2**  
Primary: 200-220-240 v.  
Secondaries: 350-0-350 v., 80 mA. 0-6.3 v. 4 amp. 0-5 v. 2 amp. Both tapped at 4 v. 17/6 ea.

**MT3**  
Primary: 200-220-240 v.  
Secondary: 30 v. 2 amps.  
Taps at 3 v., 4 v., 5 v., 6 v., 8 v., 9 v., 10 v., 12 v., 15 v., 18 v., 20 v., 24 v. 17/6 ea.

## IF TRANSFORMERS

Radiocraft I.F.S. 465 Kc/s. with compression trimmers, solid construction, a real quality job. Size: 3½in. x 1½in. 100/127 Kc/s. 12/- pr. Philips Round Type, 470 Kc/s. 8/- pr. Wearite Type 501A and 502, 465 Kc/s. 10/- pr. Surplus Type 465 Kc/s. 6/9 pr.

**TERMS:** Cash with order or C.O.D. Postage and Packing charges extra, as follows: Orders value 10/- add 9d.; 20/- add 1/-; 40/- add 1/6; £5 add 2/- unless otherwise stated. Minimum C.O.D. fee and postage 2/3.

## MAIL ORDER ONLY

# ALPHA RADIO SUPPLY CO.

5/6 VINCES CHAMBERS, VICTORIA SQUARE, LEEDS 1.

WHEN ORDERING PLEASE QUOTE "DEPT. W.W."

**RADIO · TELEVISION · HI-FI · ELECTRONICS · RECORDERS**



**RECORDING TAPE**

1,200ft. reels, kraft base on Cyldon metal spools. Each, 12/11. Post 1/- extra. Every make and type of Recording Tape stocked. Scotch Boy, E.M.I., Ferrovoice, Grundig, Ferragraph, Puretone, Gaverit and Agfa, etc.

**"SENTERCEL" SELENIUM RECTIFIERS**

|                  |      |
|------------------|------|
| K3/10, 250 v.    | 2/6  |
| K8/40, 3.2 kV.   | 6/-  |
| K3/45, 3.6 kV.   | 8/2  |
| K3/50, 4.0 kV.   | 8/8  |
| K3/100, 8.0 kV.  | 14/8 |
| K3/160, 12.8 kV. | 21/6 |
| K3/200, 16 kV.   | 26/- |

**"SENTERCEL" METAL RECTIFIERS**

|                      |      |
|----------------------|------|
| RM1, 125 v., 60 mA.  | 3/10 |
| RM2, 125 v., 100 mA. | 4/3  |
| RM3, 125 v., 125 mA. | 5/-  |
| RM4, 250 v., 250 mA. | 16/- |

**MAINS TRANSFORMERS**

Special for MT1155, etc. Drop-through chassis mounting, half shrouded. 275-0-275 v., 110 mA. 6.3 v. 4 amps., 5 v. 3 amps. LASKY'S PRICE, each 29/6.

**COLLARO 3-SPEED AUTO-CHANGERS**  
With dual purpose crystal P.U. Limited quantity only. LASKY'S PRICE £9/19/6. Carriage 2/6. Large range of other makes, Garrard, Plessey, B.S.R.

**COLLARO 3-SPEED RECORD PLAYERS**

Complete with P.U. and orthodynamic switched head. P.U. transformer also included. Limited quantity only. £6/19/6. As above, with "Studio" turn-over Crystal Pick Up (O or P), £8/18/4. Post, either type, 3/6.

**TAYLOR JUNIOR TEST METERS**

Type 120A. 0-1,000 v. in 5 ranges A.C. and D.C., 0-500 M/A. with extension up to 10 amps, and two resistance ranges. These Meters have been used but thoroughly tested and in perfect working order. LASKY'S PRICE 79/6. Carr. & Ins. 5/-.

**P.M. LOUDSPEAKERS**

2½in., 16/-, 5in., 18/6, 6½in., 16/6, 3in., 12/6, 8in., 18/6, 10in., 19/11.

**HI-FI SPEAKERS**

Full range of leading makes. Wharfedale, Stentorian, Goodmans, G.E.C., Bakers, etc.

**FILAMENT TRANSFORMERS**

|                    |      |
|--------------------|------|
| 6.3 v., 1.5 amps.  | 5/11 |
| 6.3 v., 1.75 amps. | 6/11 |
| 6.3 v., 3 amps.    | 9/6  |
| 2 v., 2 amps.      | 6/11 |

**THE NEW "LANE" TAPE TABLE MK.VI IN STOCK**

Two speed, 7½in. and 3½in./sec. Three high-grade motors. Record, playback, fast forward and fast rewind (under 1 minute). Takes standard reels up to 1,200ft. capacity. Separate record and crase heads.

PRICE **£18.10**  
Carr. 3/6. Available on H.P. Terms.

**HIRE PURCHASE**

terms on certain items. Please give details of your requirements.



**CONVERT YOUR "VIEW MASTER" TO 14, 16 or 18 inch SCREEN**

Wide Angle Conversion Kit using only W/B components as specified. The Kit consisting of line trans., frame trans., scanning coils, width and linearity controls, focus magnet, ion trap, tube base, 1-K3/100, 1-K3/40, metal rectifiers, 1-6CD6, 1-6U4GT, 3 resistors, 9 condensers. COMPLETE PARCEL including valves and data book **£7.19.6** Post and packing 3/6 extra. 16in. C.R. Tube available at £12.19.6 See next page. "View Master" Wide Angle Conversion Booklet, 3/6, post free.

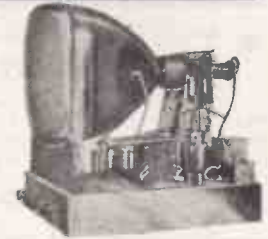

**INEXPENSIVE RADIO YOU CAN BUILD**

ALL COMPONENTS AND CABINETS AVAILABLE SEPARATELY THIS TRF 3-VALVE RECEIVER CAN BE BUILT FOR **£5.10.0** (Carr. & Pkg. 2/6 extra)

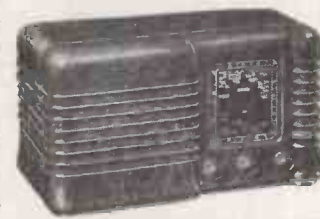

Latest type circuit for 200/250 A.C. Mains, medium and long wave. Uses 6K7G, 6J7, 6V6, and Metal Rectifiers. Handsome Plastic Cabinet, 12 x 6½ x 5½in. deep, Walnut or Ivory finish. If preferred a Wood Cabinet is available (see illus. below). FULL DATA, wiring and circuit diagrams and price list of components, 1/- post free. CABINET only, plastic or wood 17/6. Carr. & Pkg. 2/6 extra.

**THIS 4-VALVE, 3-WAVE SUPERHET CAN BE BUILT FOR £7.19.6** (Carr. & Pkg. 2/6 extra)

Very efficient Superhet Circuit for 200/250 A.C. Mains, long, medium and short wavebands. Uses 6K8 freq. changer, 6K7 I.F. amp., 6Q7 det., A.V.C., AF-amp., and 6V6 output valves. Wood Cabinet, Walnut veneer, size 12 x 6½ x 5½in. deep, or Plastic Cabinet as illus. above. FULL DATA, wiring and circuit diagrams and price list of components, 1/- post free. CABINET only, plastic or wood, 17/6. Carr. & Pkg. 2/6 extra.

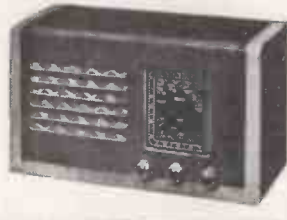

**THE "HARROW" BAFFLE RADIO CAN BE BUILT FOR LESS THAN £5.10.0** (Carr. & Pkg. 2/6 extra)



200/250 A.C. Mains, medium and long wave, using 2-6K7, 6V6 and 5Z4 valves. Note the attractive Baffle design Cabinet, outside dim. 17½ x 11½ x 5in. deep, finished satin mahogany veneer. Easy to build and gives fine performance. CIRCUIT DIAGRAM and price list of components, 1/- post free. CABINET only, 32/6. Carr. & Pkg. 2/- extra.

**LASKY'S T.V. CONSTRUCTORS' PARCELS**

**No. 1 WIDE ANGLE PARCEL.** Containing ferroxcube line E.H.T. transformer, ferroxcube scanning coils, frame output transformer, p.m. focus unit, frame blocking osc. transformer, 14-, 16- or 17-inch mask and glass, width and linearity controls. Also the following valves: 6U4gt, 6CD6, 6AL5, 2-6AM5 (N78). 3-12AU7. Full circuit. LASKY'S PRICE COMPLETE £8/15/11 Carriage 3/6 extra.

**No. 2 WIDE ANGLE PARCEL.** As No. 1 parcel but less valves. LASKY'S PRICE £8/11 Carriage 2/6 extra.

**No. 3 PARCEL.** All brand new components by Igranic. Comprises E.H.T. flyback line transformer, 7-10 Kv. with ferroxcube core and rectifier heater winding; scanning coils; frame output transformer; Elac focus unit with vernier adjuster, U.25 E.H.T. rectifier, 12in. mask and glass. LASKY'S PRICE COMPLETE 79/6 Carriage 3/6 extra.



**TRANSCRIPTION MOTORS**

Garrard, Collaro, Connoisseur, in stock.

**EVERY TYPE OF PICK UP**

We stock Pick Ups, P.U. Heads and Stylus by Garrard, Acos, Decca, Chancery, Collaro, B.S.R., etc.

**AMPLIFIERS**

One of the best stocks in London. Leak, Rodgers, Unitelex, Trix, etc.

**SPECIAL PURCHASE OF TABLE RADIOGRAM CABINETS**

Solidly made of half-inch laminated wood finished beautiful Walnut veneer. Panel (3in. x 16in.) for dial and controls baffle for 8in. speaker, gold finish metal grille, fully hinged lid. Overall size 18in. deep, 18in. wide, 13in. high. Slightly soiled, **£4.19.6** Perfect **£5.19.6** Carr. 7/6 extra. Cabinet complete with Collaro 3-speed Autochange and dual purpose crystal pick-up. Brand new, £14/19/6. Carriage 12/6 extra.

**MORE MONEY-SAVING LASKY BARGAINS ON NEXT PAGE**

# LASKY'S RADIO

## ★ ANOTHER BIG BARGAIN RADIOGRAM CHASSIS

5-valve superhet, 3 wavebands—long, medium, short. Latest type miniature valves, gram. switch, ext. speaker socket. Large full vision dial. Size 12x7x8in.

**LASKY'S PRICE £10.5.0**

Packing and Insurance 10/- extra.

SAVE POUNDS! ORDER BY POST IF YOU CANNOT CALL

## BUILD THE "TELE-KING"

### 5 Channel 16 or 17 inch SUPERHET RECEIVER

This famous and well tried home constructor set can now be built for £29/10/-. Tube and cabinet extra.

EVERY COMPONENT CAN BE SUPPLIED SEPARATELY.

Full constructional data, wiring diagrams and circuits.

**PRICE 6/- POST FREE**

WRITE NOW FOR OUR NEW "TELE-KING" PRICE LIST. WE CAN SAVE YOU MONEY.

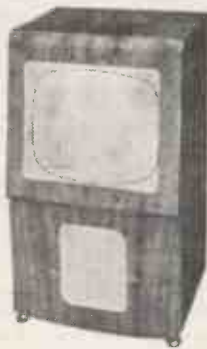

### MAINS TRANSFORMERS

All 200-250 v. 50 c.p.s. primary. Finest quality, fully guaranteed.

MBA/3. 350-0-350 v. 80 mA. 6.3 v. 4 a., 5 v. 2 a. Both filaments tapped at 4 volts. An ideal replacement trans. 18/-.

MBA/6. 325-0-325 v. 100 mA. 6.3 v. 3 a., 5 v. 2 a. With mains tapping board. Price 22/6.

MBA/7. 250-0-250 v. 80 mA. 6.3 v. 3 a., 5 v. 2 a. Both filaments tapped at 4 volts. 18/-.

MBA/8. SPECIAL OFFER. Drop through type. 235-0-235 v. 60 mA. 6.3 v. 3 a. 12/6.

MBA/9. 400-0-400 v. 60 mA. 6.3 v. 1 a., 4 v. 2.5 a. Price 12/6.

AT/3. Auto transformer. 0-10-120, 200-230-240 volts 100 watts. Price 17/6.

## HOUSE YOUR TV MAGNIFICENTLY IN ONE OF THESE SUPERB CABINETS!

### THE DE LUXE

Complete with mask, glass, castors, shelf, bearers, C.R.T. neck end protector, back, speaker fret and baffle board. Finished in beautiful figured medium, light or dark walnut veneer, with high polish. Suitable for most home constructor TV receivers, including the "Viewmaster", "Practical Television", "Tele-King", "Magnavision", "Wireless World," etc. Can be supplied with cut-out for 14in., 16in. and 17in. C.R. tubes at no extra cost.

An allowance of 4/6 will be made if the mask is not required. Inside Dimensions: Depth 16in.; width 17in.; height 28in. Overall height 32in. and width 18in.

WHY NOT CONVERT YOUR TABLE RECEIVER TO A CONSOLE MODEL? Adaptor frames for fitting 9in. or 10in. C.R. tubes available if required.

**LASKY'S PRICE £8/10/-**  
Carriage 12/6 extra.



H.P. Terms. Dep. £2/17/- plus carriage. Balance plus charges spread over 12 mths.

### THE ROTHESAY

The last word in outstanding contemporary design. Absolutely rigid construction throughout with the finest laminated woods, veneered in walnut, polished light, medium or dark shade. Fitted with gold anodised speaker grille. The C.R.T. aperture frame is detachable, supplied to suit any size tube to order. Full length doors if required can be supplied with the cabinet. Veneered both sides, polished to match the cabinet, and mounted with full length piano hinges.

NOTE THESE GENEROUS SIZES. Outside dim. 34in. high, 21in. wide, 21in. deep. Inside dim. 18in. wide, 19in. deep. Size of top 22in. x 21in. Thickness 1in.

**LASKY'S PRICE £9/19/6**  
Carriage 15/- extra.

H.P. Terms. Deposit £3/10/- plus carriage charge. Balance plus charges spread over 12 months.



The Rothesay cabinet with doors. Price £14/9/6.

### MANUFACTURERS' SURPLUS

- WIDE ANGLE 38 mm.**  
Line E.H.T. trans., ferro-cube core. 9-16 kv. . . . 25/-  
Scanning Coils, low imp. line and frame . . . . . 25/-  
Frame Output Transformer Scanning Coils low imp. line and frame . . . . . 17/6  
Frame blocking, osc. transformer . . . . . 4/6  
Line Blocking osc. transformer, caslam cored . . . 4/6  
Focus Magnets Ferroxdure P.M. Focus Magnets. Iron Cored . . . . . 19/6  
Duomag Focalisers . . . . . 29/6  
300 mA. Smoothing chokes 15/-  
Electromagnetic focus coil, with combined scan coils 25/-

### TV COMPONENT BARGAINS

- STANDARD 35 mm.**  
Line Output Transformers No. E.H.T. 12/6 Line Output Transformers 6-9 kv. E.H.T. and 6.3 v. winding. Ferro cube. . . . 19/6  
Scanning Coils. Low imp. line and frame . . . . . 12/6  
Scanning Coils. Low imp. line and frame, by Igranic 14/6  
Line blocking oscillator transformer . . . . . 4/6  
Frame blocking oscillator transformer . . . . . 4/6  
Frame output transformer . . 7/6  
Focus Magnets:  
Without Vernier . . . . . 12/6  
With Vernier . . . . . 17/6  
Focus Coils. Electromagnetic 200 mA. Smoothing chokes 10/6

### "TELETRON" SUPER INDUCTOR COILS

Ferrite Rod Aerials, wound on high permeability Ferroxcube Rod, 5/16in. diam. 4in., medium wave . . . . . 8/9  
8in., med. and long wave. . . 12/9  
Full range of all types in stock.

### ION TRAPS. All types, 3/-

### ★ THE MULLARD 10/12 AMPLIFIER KIT

All components, chassis and valves in stock. Available separately. **THE BOOK, 2/6**, post free.

### ★ THE OSRAM 912 AMPLIFIER KIT

All components in stock. Chassis, Partridge trans., chokes, W/B., etc. Available separately. **THE BOOK, 3/6**, post free.

### Super Bargain in Speaker Cabinets



**SPECIAL PURCHASE**  
Attractive design finished in figured walnut veneer. Size 12½ x 8 x 4½in. Will take 6in. speaker.  
**LASKY'S PRICE 17/11**  
Post and packing 2/6.



### ★ SPECIAL PURCHASE OF 16" C.R. TUBES

Famous make offered at nearly Half-Price. Metal cone, .3 amp. heater, e.h.t. required 10-14 Kv.

**LASKY'S PRICE £12.19.6**

Carr. & Ins. 22/6 ex. 16in. FILTER MASK ESCUTCHEON to suit above C.R.T. 15/- Post extra.

### ELECTROLYTIC CONDENSERS ALL BRAND NEW

- |                                |      |
|--------------------------------|------|
| 8 mfd. 450 v.w. . . . .        | 1/9  |
| 16 mfd. 350 v.w. . . . .       | 2/6  |
| 16 mfd. 500 v.w. . . . .       | 3/6  |
| 20 mfd. 500 v.w. . . . .       | 3/6  |
| 30 mfd. 450 v.w. . . . .       | 3/3  |
| 60 mfd. 350 v.w. . . . .       | 3/11 |
| 64 mfd. 450 v.w. . . . .       | 3/11 |
| 150 mfd. 350 v.w. . . . .      | 3/6  |
| 400 mfd. 150 v.w. . . . .      | 2/6  |
| 8 + 8 mfd. 450 v.w. . . . .    | 3/6  |
| 8 + 16 mfd. 450 v.w. . . . .   | 4/3  |
| 12 + 12 mfd. 350 v.w. . . . .  | 2/6  |
| 16 + 16 mfd. 350 v.w. . . . .  | 3/6  |
| 16 + 16 mfd. 450 v.w. . . . .  | 4/6  |
| 20 + 20 mfd. 257 v.w. . . . .  | 2/-  |
| 60 + 100 mfd. 350 v.w. . . . . | 7/6  |
| 32 + 32 mfd. 450 v.w. . . . .  | 5/11 |
- Many other single and multiple condensers.

### HIGH VOLTAGE E.H.T. CONDENSERS

- |                              |      |
|------------------------------|------|
| .1 + .1 mfd. 3.5 Kv. . . . . | 5/11 |
| .1 mfd. 7 Kv. . . . .        | 15/- |
| .001 mfd. 12.5 Kv. . . . .   | 7/6  |
| .001 mfd. 15 Kv. . . . .     | 10/- |
| .0005 mfd. 10 Kv. . . . .    | 3/6  |
| .0005 mfd. 15 Kv. . . . .    | 6/6  |
| .04 mfd. 12.5 Kv. . . . .    | 5/-  |

### C.R.T. MASKS

PLASTIC. Brand New. 14in., 6/6 16in. and 17in. 9/6  
RUBBER, 12in., including fitted armour plate glass.  
Black . . . . 8/6 Cream . . . . 11/6  
Post Extra.

### PERSPEX IMPLOSION GUARDS

Incorporating escutcheon & filter. 12in. . . . . 7/6 16in. . . . 12/6  
12 in. de Luxe . . . . 10/6

### C.R.T. Neck Protectors 2/6.

### SPECIAL TV CONDENSERS

- |                                 |      |
|---------------------------------|------|
| 64 mfd. 450 v.w. . . . .        | 3/11 |
| 100 mfd. 450 v.w. . . . .       | 4/11 |
| 32 + 100 mfd., 450 v.w. . . . . | 7/6  |
| 100 + 200 mfd. 350 v.w. . . . . | 5/11 |

### DENCO F.M. FEEDER UNIT

All components and valves in stock. Uses 6AM6, 12AH8, EB91, and two 6AB6. **THE COMPLETE PARCEL £6/7/6**. Post extra. All components available separately.

**VALVES & C.R. TUBES.** Over 25,000 in stock. Mullard, Brimar, Osram, G.E.C., Ferranti, etc.  
**METROSILS.** 10 Kv. 5/-

MORE MONEY-SAVING LASKY BARGAINS ON NEXT PAGE

EVERYTHING FOR HOME CONSTRUCTOR & SERVICEMAN

COMPLETE 5-VALVE RADIO CHASSIS

Completely wired and ready for use with the addition of a speaker and output transformer. Two controls: Volume and Station switch. Valves used: 10C1, 10F9 or UF41, 10LD11 or UBC41, 10P14, U404 or UY41.

LASKY'S PRICE, less 69/6 valves, Post 3/6.  
Complete with valves, £5/19/6.

- ★ I.F. 465 kc/s.
- ★ A.V.C.
- ★ 4 watts output.
- ★ 3 Station Pre Set.
- ★ Frame aerial.
- ★ Fully aligned.
- ★ Chassis size only 10in. x 5½ in. Max. height 5½in.

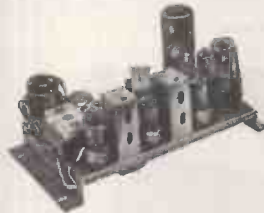

LASKY'S LATEST SUPER SCOOP!  
THE "SOUND MASTER" TAPE DECK KIT

LIMITED QUANTITY ONLY

ORIGINAL LIST PRICE £13.13.0

LASKY'S PRICE £6.15.0 Plus 5/- P. & P.

The only real high-fidelity Tape Recorder for the home constructor. Built from precision-machined parts and standard radio components. Easily wired and assembled without previous experience.

Lasky's now offer the Complete Kit of Brenell components to make this super-quality Deck, including full data, circuit diagrams and stage-by-stage details, for only £6/15/-, plus 5/- post.

Remember, a Deck of this quality deserves the finest motors and heads:—

The Set of three Collaro "Wearite" Heads. Red Seal, £4/4/- pair. Gold Seal, £7/7/- pair.

The cost of building the "Sound Master" Deck complete with motors, heads, switches and sundries is £17/17/-.

If you require the Amplifier and Speaker we can supply all the specified components, chassis, etc., at competitive prices. Cabinet, as illustrated, also available.

When completed this Tape Recorder is comparable with models costing £100 or more.

Data Book, 30 pages, containing full wiring diagrams and stage-by-stage construction details, 6/6 post free. (Credited in full if Deck Kit purchased.)



ARMOUR PLATE GLASS

|                          |      |
|--------------------------|------|
| 16in. (17½ × 15½ × ½in.) | 7/11 |
| 15in. (16½ × 13 × ½in.)  | 6/11 |
| 12in. (13 × 10½ × ½in.)  | 4/-  |
| 9in. (9 × 8 × ½in.)      | 3/-  |

TRIPLEX DARK SCREEN FILTERS

|                  |     |
|------------------|-----|
| 14 × 12½ × ½in.  | 7/6 |
| 15½ × 13½ × ½in. | 9/6 |

Postage and packing 5/- per piece extra. (This charge is necessary owing to extra packing required.)

BRIMISTORS.

|                |                |
|----------------|----------------|
| CZ.1 1/6 each. | CZ.3 6d. each. |
|----------------|----------------|

OUTPUT TRANSFORMERS

|                               |       |
|-------------------------------|-------|
| Midget Pentode                | 3/6   |
| Miniature Personal, 3S4, etc. | 3/6   |
| Standard Pentode              | 3/11  |
| Push-pull, 6V6                | 9/6   |
| Multi Ratio, P.P.             | 12/6  |
| Heavy Duty P.P.               | 14/11 |

MINIATURE TUNING CONDENSERS

3-gang, ½in. spindle, size 3 × 1½ × 1½in., less trimmers, 10/6.  
Post 1/- extra.

BRANDENBURG E.H.T. UNITS

|                          |                  |
|--------------------------|------------------|
| 13-16 kV., £9/9/-;       | 6-9 kV., £6/6/-; |
| 6-9 kV. Osc. Coil, 39/-. | Post free.       |

SALE OF REMAINDER OF OUR 12" "VIEW MASTER" STOCK

Mostly half price or less. Write for list. Examples:—  
Sets of Coils (Wearite). List 30/- NOW 5/9.  
Chassis and Power Pack, sound/vision. List 18/6. NOW 5/-.  
L9 Boost Chokes. List 5/9. NOW 1/6.  
Date Book (List 7/6), 2/6 post free.

CRYSTAL DIODES

Glass type, wire ends. Each 1/6 Higher grades, 12 assorted for 30/-, post free.

AERIAL ROD SECTIONS

Steel, heavily copper plated. 12in. long, ½in. diameter. Any number may be fitted together. 2/6 per doz. Post free.

SPECIAL TRANSFORMER

Secondary tapped as follows: 3, 4, 5, 6, 8, 9, 10, 12, 15, 18, 20, 24 and 30 volts at 2 amps. PRICE 17/6.

3-WATT MIDGET AC/DC AMPLIFIERS

PUSH PULL VERY HIGH GAIN. 4 valves: 2 U41 in push pull, 1 UCH42 and 1 UF42. Input voltage 100/110 AC/DC. Very easily converted to 230 volts. Supplied with circuit diagram and full details. Size—9 × 4 × 4 inches. Uses 2 metal rectifiers, 1 each RM2 and RM3. Ideal for ships record players, tape recorders, home record players, baby alarms, etc., etc. Supplied complete fully assembled and wired, with 4 valves. LASKY'S PRICE, 65/-, carriage free.



CO-AXIAL CABLE

|                            |     |
|----------------------------|-----|
| 75-80 ohms impedance.      |     |
| Single Core, per yard ..   | 8d. |
| Twin Core .....            | 1/- |
| Twin Balanced Feeder ..... | 6d. |

CHOKES

|         |      |          |      |
|---------|------|----------|------|
| 40 m/a. | 3/3  | 120 m/a. | 7/3  |
| 60 m/a. | 3/11 | 200 m/a. | 12/6 |
| 80 m/a. | 4/11 | 250 m/a. | 14/- |

DULCI RADIO CHASSIS

Full range stocked. 6 types to choose from.

ALUMINIUM CHASSIS. 18 S.W.G., un-

drilled, with 4 sides, reinforced corners. Depth 2½in.  
6 × 4in., 4/- 12 × 8in., 7/- 16 × 10in., 8/3  
8 × 6in., 5/- 14 × 9in., 7/6 12 × 3in., 4/9  
10 × 7in., 6/- 16 × 9in., 8/- 12 × 6in., 6/6  
Post 1/- per chassis extra.

METAL RECTIFIERS

|               |      |
|---------------|------|
| 6 or 12 v.    |      |
| F.W. Bridge   |      |
| 2 amp. ....   | 11/3 |
| 4 amp. ....   | 15/- |
| 6 amp. ....   | 23/6 |
| 1 amp. ....   | 6/6  |
| 10 amp. ....  | 32/6 |
| ½ amp., 6 v.  | 2/6  |
| ½ amp., 12 v. | 3/11 |
| 3 amp., 12 v. | 12/6 |

R.1155 RECEIVERS

Now available on H.P. terms

5 Frequency ranges: 18.5-7.0 Mc/s; 7.5-3.0 Mc/s; 1,500-600 kc/s; 500-200 kc/s; 200-75 kc/s. Supplied in maker's original wood transit case.

LASKY'S PRICE, brand new .. £11/19/6  
Secondhand, Grade 1 .. £9/19/6  
Secondhand, Grade 2 .. £7/19/6

Carriage 17/6 extra, including 10/- returnable on packing case.

ASSEMBLED POWER PACK/OUTPUT STAGE FOR R.1155 RECEIVER.

For use on 200-250 v. A.C. Complete with 2 valves. In metal case, size 12 × 7 × 5½in. 79/6. Carriage 5/- extra.

POWER PACK as above, fitted with 6½in. P.M. Speaker, £5/5/-. Carriage 5/- extra.



POSTAGE & PKG. CHARGES (unless otherwise stated)  
Orders value £1, 1/- extra.  
Orders value £5, 2/- extra.  
Orders value £10, 3/6 extra.  
Over £10 carriage free.  
All goods fully insured in transit.

TWO ADDRESSES FOR PERSONAL CALLERS

Open all day Saturday. Early closing: Thursday.

370 HARROW ROAD, PADDINGTON, W.9.

42 TOTTENHAM COURT ROAD, W.1.

(Opposite Paddington Hospital)  
CUNningham 1979/7214.

Between T.C.R. and Gooch St. Stns.  
MUSEum 2605.

ALL MAIL ORDERS TO HARROW ROAD PLEASE



LASKY'S (HARROW ED.) LTD.

# 4 reasons why... IT PAYS TO SOLDER with

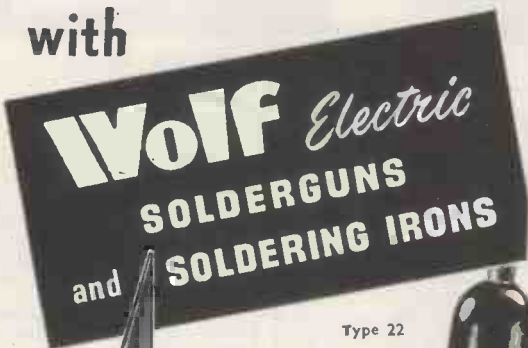

Alternative Types



Type 81

- RAPID CONSTANT HEAT
- ABSOLUTE DEPENDABILITY
- SOLID CONSTRUCTION
- PERFECT BALANCE

Type 22



Alternative Types



Type 32



Type 42

### TRIGGER FEED SOLDERGUN



Type No. 51 is designed specially for all assembly operations. Solder is fed automatically with trigger-action and two reels are supplied—one 15 ft. acid-cored and one 15 ft. resin-cored.

Unbeatable from every point of view, well able to withstand hard workshop treatment and ideal for continuous use. Features include rapid constant localised heat—solid sturdy construction—low current consumption—perfect balance—absolute dependability. A type and bit for every purpose from fine instrument to heavy industrial work.

Each tool includes 5 feet tough rubber 3-core cable.

Obtainable from all leading tool merchants and factors.  
Fully descriptive Brochure free on request.

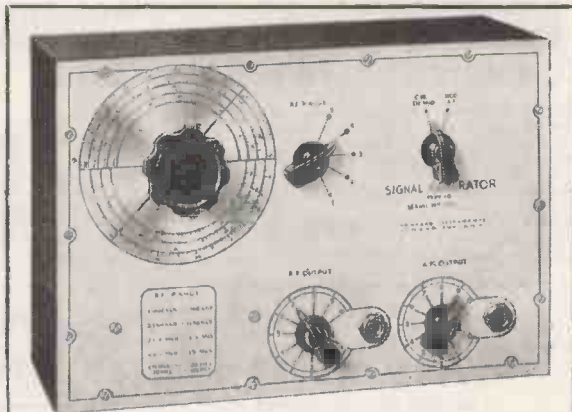

SIGNAL GENERATOR TYPE 10. 100 Kc/s-100 Mc/s

Price £7.10.0 (Postage and packing 3/6 extra)  
 ● 100 Kc/s to 100 Mc/s ● Modulated or unmodulated carrier ● Direct calibration ● Adjustable 400c. p.s. AF signal ● Stable RF oscillator ● Large, easily read scale ● AC mains operation.

PATTERN GENERATOR TYPE 4

Price £8.0.0 (Postage and packing 3/6 extra)  
 ● Coverage 40-70 Mc/s ● AC mains operation ● Provides vertical and horizontal bars for time base testing and setting up.  
 Obtainable only direct from the manufacturers. Send for full technical details or call at address below.

Easy Payment Terms available on all our instruments

**HOMELAB INSTRUMENTS LTD.,**  
 615-617, HIGH ROAD, LEYTON, LONDON, E.10  
 Telephone: LEY 5651

## WIRE

ALL GAUGES FROM 48 to 18. E. ESC. EDC. ESS. EDS. SS.SC.DS. ALSO, LITZ. AND RESISTANCE.

AT BELOW MANUFACTURERS PRICES  
 SHELF SOILED BUT GUARANTEED 100%. EXAMPLE.  
 NICKEL CHROME RES. .050 x .0035. 2.93 ohms per ft. 15/- per 1 lb. reel. C.W.O.

SEND S.A.E. FOR LIST.

**RADIO MAILING LTD.** 164, KING STREET, LONDON, W.6.

## THE VESPA TAPE DECK

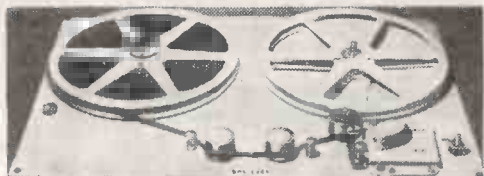

2 speed 3½in. and 7½in. Twin Track.  
 Model 521 Compact Deck, 7½in. x 11in., 5in. reels, kit. £7/10/-.  
 Model 721 Standard Deck, 10½in. x 11in., 7in. reels, kit. £8/10/-.  
 Easy to assemble. precision machined parts, latest high fidelity heads, first class motors, full assembly instructions.  
 Either model fully built and tested 27/6 extra.

Send stamp for full details.  
**E.W.A., 266 WARBRECK DRIVE, BLACKPOOL**

**MONEY BACK GUARANTEE**  
**GOODS OF QUALITY**  
**PROMPT DESPATCH**

# BARTON'S (Radio)

MAIL ORDER, WORKS & DESPATCH DEPT. : 44, TOTTENHAM STREET, LONDON, W.1.  
OFFICE : 34, MONTPELIER RISE, LONDON, N.W.11. Tel. : MEAdway 1736.

**TERMS OF BUSINESS:** Cash with order (or C.O.D. Post Items only); all orders for small items totalling over £2 post free unless otherwise stated.

Tel.: LANgham 1151  
Open 9 a.m. to 6 p.m. Daily, Saturdays 1 p.m.

## BUILD YOUR OWN RADIO ! 4 MODELS TO CHOOSE FROM

We can supply all the parts (including valves, 5in. moving coil speaker, cabinet, chassis and everything down to the last nut and bolt) to enable YOU to build a professional-looking radio. The chassis is punched and drilled ready to mount the components. There is a choice of any of three attractive cabinets 12in. long, 5in. wide by 6in. high, as follows:



**MODEL 1 T.R.F. RECEIVER**  
This is a 3-valve plus metal rectifier T.R.F. receiver with a valve line-up as follows: 6K7 (HF), 6J7 (Det.) and 8V6 (Output). The dial is illuminated. Coverage is for the Medium and Long Wave Bands. Model 1—200/250 volts A.C. Mains operation. Model 3—200/250 volts A.C./D.C. Mains operation. **£5.10.0**



### MODEL 2 SUPERHET RECEIVER

This is a powerful midget 4-valve plus metal rectifier Superhet Receiver with a valve line-up as follows: 6K9, 6K7, 6Q7, 6V6. The dial is illuminated and coverage is for the Short Wave bands between 16-50 metres, the Medium Wave bands between 190-450 metres, and the Long Wave bands between 1,000-2,000 metres. Operates on 200/250 volts A.C. mains. **£7.19.6**

### 4 WATT AMPLIFIER KIT

This is a 3-valve 3-stage Amplifier for use with Gramophone, Microphone or Radio. Valve line-up is as follows: 6SL7, 6V6, 5Z4. Negative feed-back. Tone control. Voltage adjustment panel incorporated. 4 watts output. For operation on A.C. Mains 200/250 volts. The complete Kit, which includes every item down to the last nut and bolt, drilled and punched chassis, and comprehensive point-to-point wiring circuit diagram

## THE NEW T.R.F. ... MODEL 1 PLUS ... THE RECEIVER WITH THE SENSATIONAL PERFORMANCE !!

This is a completely new design 4-VALVE 2-Waveband T.R.F. Receiver, incorporating the latest type MINIATURE HIGH GAIN VALVES, and the most modern design HIGH "Q" IRON CORED COILS, ensuring greatly increased sensitivity and selectivity over the whole of the Medium Waveband, and providing outstanding performance on the Long Waveband. 4 valves—6BJ6 R.F. Amplifier. 6BH5 Anode Bend Det. 6AQ5 Output. 6X4 Rectifier. For operation on 200/250 volts A.C. Mains. All the parts to build this Receiver can be supplied at Plus 2/6 Packing, Carriage and Insurance. **£6.19.6**

ALL COMPONENTS SUPPLIED ARE GUARANTEED FOR 12 MONTHS

Can also be supplied ready built at **£8/5/-** plus 3/6 p. & c.  
INSTRUCTION BOOKLET and PRICED PARTS LIST for any of the above receivers available separately at 1/-. This money will be refunded if circuit diagram is returned as new within 7 days.

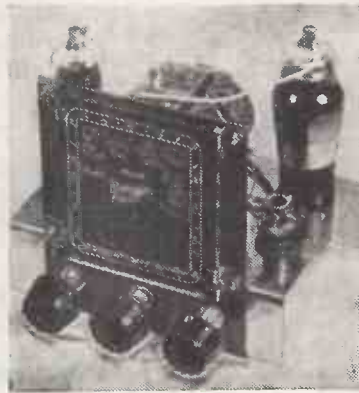

**£4.5.0**

Plus 2/6 Packing, Carriage and Insurance.

The Output Transformer supplied is for use with a loud-speaker of 3 ohms impedance, and we would suggest that the output of the completed amplifier justifies the use of one of the latest W.B. H.F. speakers which can be supplied as follows: 8in., 60/8; 9in., 67/-; 10in., 73/6. All plus 2/6 pkg., carr., ins. Circuit Diagram and Parts List available separately at 1/-.

### RADIO TUNER UNIT

A new T.R.F. Tuner Unit designed for High Quality Local Station Reception, at Low Cost. Incorporates 2 Valves—6K7 and 6J7. Volume, Tuning and Wavechange Controls. Medium and Long Wave coverage. Dimensions: L. 6in., H. 5 1/2in., D. 4 1/2in. Power Requirements: 6.3 volts at 0.6 amps. 250-300 volts 15 mA. (This supply is already available in the above illustrated Amplifier.) All the parts to build this Tuner Unit can be supplied at **£2.15.0**

Plus 2/6 Packing and Carriage. Complete with easy-to-follow Circuit diagram and Parts List. Circuit Diagram and Parts List available separately at 1/-.

# CITY SALE & EXCHANGE LTD

The High Fidelity Specialists

## NEW HIGH FIDELITY EQUIPMENT

|   |            |   |          |
|---|------------|---|----------|
| Tannoy amplifier and control unit .....             | £65 0 0    | Salex 12in. reflex cabinet.....                                 | £11 0 0  |
| R.D. Senior amplifier and control unit .....        | £43 0 0    | Garrard 301B transcription motor .....                          | £25 3 6  |
| Pye PF.91 amplifier and control unit .....          | £42 0 0    | Connoisseur 3-speed variable motor .....                        | £25 15 5 |
| Acoustical Quad II amplifier and control unit ..... | £42 0 0    | Collaro 2010 transcription motor with studio pick-up ...        | £18 4 9  |
| Leak TL/10 and Point one preamplifier .....         | 27 gns.    | Collaro 2000 motor .....  | £13 9 6  |
| R.D. Junior amplifier and preamplifier .....        | £25 0 0    | Garrard RC.80M 3-speed interchange, turnover Xtal pick-up ..... | £17 9 6  |
| Trinetee amplifier and preamplifier .....           | £16 10 0   | Collaro RC54 3-speed interchange, turnover Xtal pick-up ..      | £13 6 4  |
| R.D. Minor amplifier .....                          | £12 17 6   | Garrard TA 3-speed motor with pick-up.....                      | £10 16 0 |
| Unitec amplifier .....                              | 9 1/2 gns. | Collaro 3-speed with turnover studio pick-up .....              | £8 18 11 |
| Lowther CM.3 corner speaker .....                   | £93 0 0    | Chapman FM81 V.H.F. tuner .....                                 | £21 0 0  |
| Wharfedale treble assembly .....                    | £73 10 0   | Sound Sales FM tuner.....                                       | £20 18 2 |
| Lowther PW1/PM2 corner horn .....                   | £70 0 0    | Sound Sales medium/long AM tuner .....                          | £17 4 0  |
| Tannoy dual concentric corner speaker .....         | 46 gns.    | Chapman FM82 V.H.F. pre-set tuner .....                         | £24 0 0  |
| R.D. Junior corner horn cabinet.....                | £18 17 6   | Chapman S6 all wave tuner .....                                 | £30 0 0  |
| R.D. 12in. reflex cabinet .....                     | £18 17 6   | Chapman S4 all wave AM tuner .....                              | £16 0 0  |
| Octagonal cabinet for A.E.C. speaker .....          | £16 0 0    | Truvon 2 station radio jack.....                                | £3 8 11  |
| Salex reflex cabinet for 2 or 3 8in. speakers ..... | £18 0 0    | Truvon 3 station radio jack.....                                | £4 0 0   |
| Salex sand-filled corner baffle .....               | £11 0 0    |   |          |

Mail Orders executed promptly, also long playing records by return—no post charges.

Part Exchange is our speciality

Demonstrations daily of all high fidelity equipment

93-94 FLEET STREET, LONDON, E.C.4

Phone: CENTral 9391/2

## BUILD THIS RADIO FOR 49/6

Build this high quality portable radio in 45 mins. Exceptionally sensitive, twin-triode circuit using unique assembly system. Can be built by anyone. Size only 6 1/2 in. x 5 in. x 3 in. in handsome black crackle steel case, with beautiful black and gold dial panel (stations printed!). Covers all Medium and Long waves. Uses only one self-contained standard dry battery—running costs less than 1d. for 4hrs. Luminous on/off switch. Ideal for Bedroom, Garden, Holidays, Christmas Present etc. Many unsolicited testimonials:—Mr. J.N., of Oxted, writes: "Yesterday evening between 10 p.m. and 10.30 p.m. I counted 32 separate stations! I am very pleased with the set, which is well worth the money." Mr. W.J.B., of Acton, writes: "Radio received today, I was surprised and very pleased with the performance. For such a small set reception is very clear. The tone is perfect and the stations just roll in." Mr. G.F.F., of Ipswich, writes: "I think it is a wonderful station getter, with lovely tone and ample volume on all. Its performance is almost unbelievable, and it gives me stations I've never been able to get on my large radio." These testimonials and many others can be seen any time at address below. Send today, Cheque or CWO for 22/- (includes 2/6 packing and post), for Case, Handle, Dial Panel, Plans, Parts List, etc., or 49/6 (post free) for complete kit of parts. C.O.D. 1/6 extra. Overseas orders and enquiries welcomed.



**BRIGHTON RADIO CO. (Dept. W11), 69 Preston Street, Brighton, 1.**

### SEND THIS COUPON NOW!

To Brighton Radio Co., 69 Preston Street, Brighton, 1, Sussex. I enclose cheque/POs/Cash/M.O. (mark which) for 22/- (or 49/6 for Full Kit). Please send to:—

NAME ..... [C.O.D. 1/6 extra]  
 ADDRESS .....

Please print in block letters.

- T/V TECHNOLOGY
- RADIO ENGINEERING
- ELECTRONICS
- RADIO SERVICING

There's a big future in T/V and Radio. Act now! Increase your knowledge. Back up experience with a sound theoretical background: I.C.S. offer courses of instruction in—

T/V TECHNOLOGY ● ADVANCED SHORT-WAVE RADIO ● RADIO ENGINEERING ● RADIO SERVICE ENGINEERING ● RADAR ● BASIC ELECTRONICS. FREQUENCY MODULATION.

I.C.S. will also coach you for the following examinations:— B.I.R.E.; P.M.G. Certificate for Wireless Operators; Radio Servicing Certificate (R.T.E.B.); C. & G. Telecommunications, etc., etc.

**DON'T DELAY—SEND COUPON TODAY** for free descriptive booklet, stating which subject or examination interests you. Fees include all books needed. Examination students coached until successful.

Reduced terms for H.M. Forces.  
 Dept. 223D, I.C.S., 71 Kingsway, W.C.2.

**INTERNATIONAL CORRESPONDENCE SCHOOLS.**  
 Dept. 223D, International Buildings, Kingsway, London, W.C.2.

Please send Booklet on subject.....

Name..... Age.....  
 (Block letters, please)

Address.....



## Transformers Transformers Transformers

### QUALITY-RELIABILITY

For the Mullard Amplifier.  
 For the Osram 912 Amplifier.  
 For the Williamson Amplifier.  
**C. R. Tube Isolation Transformers.**  
 Instrument Transformers,  
 and all popular types.

FROM

## Ellison Transformers LIMITED

62, BRIDGE ST. NORTHAMPTON  
 AND ALL LEADING COMPONENT DEALERS

## INSULATING SLEEVINGS...

P.V.C. AND  
 POLYTHENE  
 SLEEVINGS  
 INSULATED  
 WIRES AND  
 FLEXIBLES

An aircraft's performance... your car's reliability... tonight's Television and Radio's sound may depend upon efficient electrical insulation.

A.I.D. Approved

**PLASTICABLE LIMITED**  
 HAWLEY LANE, FARNBOROUGH, HANTS

Phone: Farnborough, Hants 85

## A. C. SOLENOID TYPE SB.

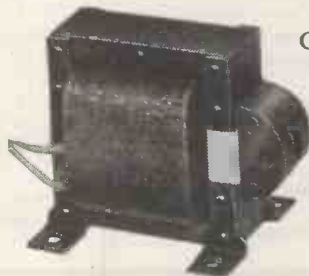

Continuous 2.3/8 lb. at 1'  
 Instantaneous to 16 lb.

100% PRODUCTION  
 INSPECTION

Smaller Sizes Available.  
 Also Transformers to  
 6KVA 3 Phase

**R. A. WEBBER LTD.**  
 18 FOREST ROAD, KINGSWOOD, BRISTOL. PHONE 74065.



# for unfailing activity

**S.E.C.**  
 SUB-MINIATURE  
 QUARTZ  
 CRYSTAL  
 UNITS



Type BA, frequency change not exceeding 0.01% from 0°C to +70°C  
 Type DA, frequency change not exceeding 0.01% from -30°C to +45°C  
 Type EA, frequency change not exceeding 0.002% from +65°C to +80°C

For further details please apply to:-

**SALFORD ELECTRICAL INSTRUMENTS LTD**  
 PEEL WORKS • SILK STREET • SALFORD 3 • LANCS  
 A Subsidiary of THE GENERAL ELECTRIC CO. LTD. OF ENGLAND

**Q.C. 500**  
 Frequency range  
 10,000 Kc/s to 16,000 Kc/s.

## THE NEW GRUNDIG TK12 is perfectly attuned to the New V.H.F. . . . .



**F**OR the new V.H.F. broadcasts you need the new Grundig TK12 Two-speed Tape Recorder. Those owners of the TK12 who tune in to Wrotham, 91.4 and 93.8 mc/s, will be thrilled with its possibilities for high-fidelity recording. The same satisfaction will be enjoyed when the proposed eight additional high-power transmitting stations start operating throughout the country, in Band II (88-95 mc/s), on wavelengths of approximately 3 meters.

Similar in size to the popular Grundig TK9, the TK12 has 2 speeds: 7½ ins./sec. with frequency range of 50 to 12,000 c.p.s. and 3½ ins./sec with frequency range of 50 to 9,000 c.p.s. It is in the middle price group and within the range, in every sense of the word, of all wireless fans and experimentalists.

**GRUNDIG (Gt. Britain) LTD., (Dept. W.W.)**  
 39/41 New Oxford Street, London, W.C.1  
 (Electronics Division, Gas Purification and Chemical Co. Ltd.)

### SPECIAL FEATURES

*Two Speeds. Track Buttons identify which Track has been used. Magic Eye tuning for sound modulation if illuminated time running Indicator.*

**GRUNDIG**

**TK12**

- PRICE 70 GNS. (less microphone).
- Ribbon Microphone GRM 1Z 12½ gns.
- Dynamic Microphone GDM 5Z 6½ gns.

## Repeats All It Hears

Be careful what you do in front of a Celsonic tape recorder. Remember it is not merely an imitator. It is a repeating machine that reproduces all it hears with exactitude.

It may be a single voice or a massed choir, a solo instrument or a full orchestra, sound effects for a film or the lisping voice of a child receiving speech therapy.

The Celsonic recorder covers nothing up with 'tone,' 'resonance,' 'boomp' or any other inherent noise. It gives you the naked truth, from 50 to 14,000 cps.

That is why, time after time, it is placed first for absolute fidelity when compared with other machines. It will record 3,250ft. of tape at one session and give an hour and twenty-five minutes play-back without break at  $7\frac{1}{2}$  in. per second.

The "Celsonic" has two other outstanding advantages. Firstly, a superimposing device is part of its standard equipment. This device makes it possible to record words over music. This is of particular interest to cine enthusiasts who wish to add commentary and suitable music to their films.

Secondly, the "Celsonic" can be supplied with a synchronising unit which permits the conversion of silent films to "talkies." This unit marries the speed of the tape to that of the film and makes it possible to synchronise the dialogue with the movements of the speaker's lips.

The Celsonic has everything needed by the professional recordist at a price the amateur can afford.

Write for descriptive leaflet to Excel Sound Services Ltd., Celsonic Works, Garfield Avenue, Bradford, 8.

*For*

**SPRINGS  
SPECIALITIES  
WIRE WORK  
METAL PRESS WORK**

*Consult*

**HEATH SPRING & NOTION  
COMPANY LIMITED**  
BIRCHFIELD ROAD, HEADLESS CROSS  
REDDITCH

Telephone : Redditch · 861 · 862

## WE PAY TOP PRICES

FOR  
AMERICAN SURPLUS  
ELECTRONIC EQUIPMENT  
LOOK AT THESE EXAMPLES

For equipment in good condition

|                                  |      |
|----------------------------------|------|
| Receiver R54/APR4 complete ..... | £200 |
| Test Sets, TS13 .....            | £100 |
| Frequency Meter TS175/U .....    | £80  |
| Frequency Meter BC221 .....      | £20  |
| Receiver BC348R .....            | £25  |

We pay similar remarkable prices for many other U.S.A. units not listed above. We particularly require American test equipment. If you have anything to offer, telephone Central 7834, transfer charge.

**TO HAMS WHO CONVERTED BC348, BC342, BC312**  
Post to us the dynamotors and power units which you removed  
We pay top prices for these items i.e., DM28, DM21, RA20.

### TO OVERSEAS BUYERS

We have the largest stock in Europe of American Government surplus electronic equipment and we would be pleased to quote by return of post against your enquiries. The following are a few examples only of the equipment which we can supply from stock.

BC221 Frequency Meter.

BC348 Receiver.

SCR522 Transmitter/Receiver.

ET4336 Transmitter.

SCR720C Search Radar complete, also separate units and spare parts.

Please write for our list.

Deal with the firm that has been established for twenty-five years.

## ALTHAM RADIO CO.

JERSEY HOUSE, JERSEY STREET

MANCHESTER 4

Telephone : Central 7834/5/6

JUST OUT!!!

OUR 1955

FULLY ILLUSTRATED  
CATALOGUE

**6d**

POST FREE

**BERRY'S**  
(SHORT WAVE) LTD.

25, HIGH HOLBORN, LONDON, W.C.1

Tel. : HOLborn 6231

POLYTHENE

## H. F. EQUIPMENT

(AMBYTHENE BRAND)

COIL FORMERS

CHOKES

STAND-OFFS

FEED-THROUGHS

Send for particulars and Samples

### AMPLEX APPLIANCES (KENT) LTD.

19 DARTMOUTH ROAD, HAYES, BROMLEY, KENT

(RAVensbourne 5531)

All export enquiries to

ANTEX LTD., 3 TOWER HILL, LONDON, E.C.3

# SUPERIOR RADIO SUPPLIES

(WWA), 37 HILLSIDE, STONEBRIDGE, LONDON, N.W.10.

Tel: ELGar 3344

IMPROVED PERFORMANCE

*Reduced Price!*

*The New*

## SUPERIOR THREE

T.R.F. BUILDING COST £6-17-6, Plus P.P.

- ★ SIMPLE TO CONSTRUCT
- ★ ALL NEW COMPONENTS
- ★ WALNUT VENEERED CABINET
- ★ CABINET SIZE: 10" w. x 10½" h. x 5" d.



Our new Three-valve T.R.F. Receiver, suitable for A.C. mains 200/250 volts. M. and L. waves. Improved selectivity due to use of high quality iron-dust cored coils. Latest type contact cooled H.T. rectifier. A 7in. x 4in. elliptical speaker ensures ample volume and quality. Valve line-up: 6SG7, 6SG7, 6V6, chassis drilled ready for mounting components, which can all be purchased separately. Send 1/6 for "Superior Three" price list and construction booklet.

**PERSONAL SHOPPERS WELCOME**

A REALLY  
OUTSTANDING  
PORTABLE!

*The*

## SUPEREX 55 ATTACHE

BUILDING COST £7-15-0  
Plus P.P.

- ★ 4 valve superhet L.M. wave.
- ★ 7in. x 4in. elliptical speaker.
- ★ Latest miniature valves.
- ★ Very attractive cabinet.
- ★ A.B.C. Construction booklet.

**TERMS:** Cash with order  
or C.O.D. Extra charge  
for C.O.D. U.K. and N.  
Ireland only.



This is a first-class receiver which we guarantee will give the very best of reception in all parts of the country. No trouble has been spared to ensure simplicity of construction, combined with equality in appearance and performance to any commercial models. All parts available separately. Send 1/6 for "Superex 55" construction booklet.

Shop open 9 a.m. to 6 p.m. Monday  
to Saturday. 1 p.m. Thursday.

## NOT A TRACE OF DISTORTION

Trace A shows the waveform of a normal Hartley oscillator. Looks harmless enough, doesn't it? But now examine:

Trace B which is the same waveform but taken through the filter C. Harmonics of a high order are clearly visible and it is these which cause the trouble.

Trace D shows the HATFIELD oscillator waveform. Perfect! And note the greater amplitude over A. Remember that wattage is proportional to the square of the voltage.

Trace E shows the HATFIELD oscillator waveform taken under the same conditions as B, and using the same time-base (Cossor D.B. scope).

**ABSOLUTELY NO FAKING OF ANY KIND.**

Last month we claimed "Less than 1 per cent. distortion," we now claim "Less than 0.4 of 1 per cent. distortion," and ask you to send for copy of National Physical Laboratory report confirming this.

Are you COMPLETELY satisfied with your recordings? Bad waveform in an oscillator can cause DISTORTION due to intermodulation, NOISY BACKGROUND due to D.C. component in an asymmetrical waveform and INTERFERENCE with radio due to HARMONICS beating with incoming signal.

The new HATFIELD oscillator is GUARANTEED to give at least 4 watts output with less than 1 per cent. distortion, and high stability, using only one valve (6V6 or similar). 45 Kc/s to 50 Kc/s. Suitable for high impedance heads. Motek, Lane, Truvox, etc.

Every coil is tested for amplitude AND waveform.

**COIL**, complete with circuit, 10/6 post free. Patent app. for.

### BIAS REJECTOR COILS

Even a small amount of bias frequency getting into the amplifier can cause a lot of trouble, and nearly all tape recorders need a rejector coil to prevent this.

**COIL**, complete with instructions, 5/6 post paid.

### MOTEK TAPE DECKS

The famous K6 deck; twin track, two speed, with push buttons and electronic braking; is a beautifully finished job at only £19/19/- Post free. Or £3 down and 12 monthly payments of £1/10/-.

### TAPE AMPLIFIERS

The HATFIELD amplifier is complete with oscillator as above, and magic eye, less speaker, at £12/15/-.

### COMPLETE RECORDERS

The HERGA recorder incorporates ALL the above items together with a first-class crystal mike and one reel of SCOTCH BOY tape in an attractive two-tone portable cabinet, absolutely complete at 39 gns. Or £5 down and 12 monthly payments of £3/3/4.

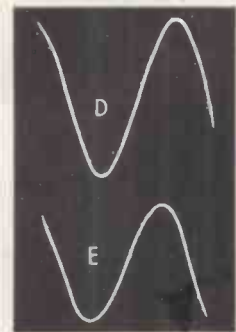
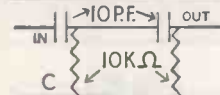
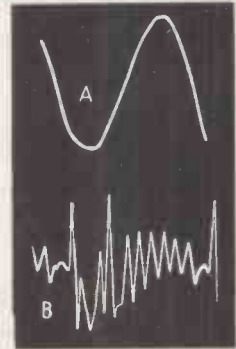

**HATFIELD RADIO**  
78 STROUD GREEN RD., LONDON, N.4



**HIGH QUALITY  
TAPE RECORDING EQUIPMENT**

**THE MODEL 5D TAPE DESK** (to take 10 $\frac{1}{2}$ in. NAB Reels)  
 Programme Time: 62 minutes at 7 $\frac{1}{2}$  i.p.s.  
 124 minutes at 3 $\frac{1}{2}$  i.p.s.

Panel size: 20in. x 14 $\frac{1}{2}$ in.  
 Two speeds, 3 $\frac{1}{2}$  and 7 $\frac{1}{2}$  i.p.s. Double track heads. Push button control. Fast wind and rewind. Three heavy duty motors. Three separately shielded heads. Complete with NAB reel adaptors.

**PRICE:** (fitted with 6RP heads) £50/-

**ALSO AVAILABLE**

**MODEL 5C TAPE DESK** (to take 9in. Reels)

Programme Time: 55 minutes at 7 $\frac{1}{2}$  i.p.s.

110 minutes at 3 $\frac{1}{2}$  i.p.s.

**PRICE:** (fitted with 6RP heads)  
 Large Panel (20in. x 14 $\frac{1}{2}$ in.) £47/10/-  
 Small Panel (13 $\frac{1}{2}$ in. x 15 $\frac{1}{2}$ in.) £45/10/-

**MODEL 5B TAPE DESK** (to take 9in. Reels)

Programme Time: 31 minutes at 7 $\frac{1}{2}$  i.p.s.

62 minutes at 3 $\frac{1}{2}$  i.p.s.

**PRICE:** (fitted with 6RP heads)  
 Panel size (13 $\frac{1}{2}$ in. x 15 $\frac{1}{2}$ in.) £42/-

**PORTABLE RECORDERS**

In rexine covered case, fitted with model 5B tape desk, type D2 C.J.R. amplifier with monitoring. Provision for external loud-speaker.

**PRICE:** £117/- (without microphone)

High fidelity sound heads. Type SRP (Record/Play) £3/5/-, Type 6RP (super fidelity), £3/15/-, Type 5E (Erase), £3/5/-, Mumetal Screening cans, 8/6. Amplifiers, microphones. All types and sizes of magnetic tape.

Trade supplied.

Send for lists.

**BRADMATIC LIMITED**

STATION ROAD · ASTON · BIRMINGHAM 6

Telephone: East 2881-2

Grams: Bradmatic, Birmingham

**INSTRUMENT CASES**

Sizes up to 17" x 10" x 9".

Send for list 32.

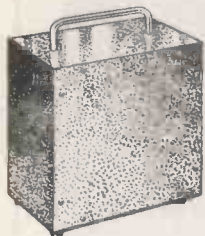

**CHASSIS**

Steel, cadmium plated and passivated.

Sizes from 6" x 6" up to 19 $\frac{1}{2}$ " x 10".

Send for list 42.

**SUTTON GOLDFIELD ELECTRICAL ENGINEERS**

Clifton Street, Sutton Goldfield. Phone SUT. 5666

ALWAYS "FIT"



**CASTORS**

THE WORLD'S BEST

**CONTRACTING  
TUBE  
ADAPTOR**



For  $\frac{7}{8}$ ", 1", 1 $\frac{1}{8}$ ", 1 $\frac{1}{2}$ " tubes, Quickgrip Adaptors are fitted by hand as no tools are required. 2", 2 $\frac{1}{2}$ ", 3", and 4" wheels may be used.

Ask for Brochure and pages 8, 25, 57.

Numerous other types of head fittings available

Engineers, Patentees and Sole Manufacturers

**AUTOSSET (PRODUCTION) LTD.**

DEPT. "H," STOUR STREET, BIRMINGHAM, 18

Est. over 35 years.

EDG. 1143 (3 lines).

Please mention "Wireless World"

**TRANSFORMERS**

**COILS  
CHOKES**

LARGE OR SMALL QUANTITIES

TRADE ENQUIRIES WELCOMED

SPECIALISTS IN

**FINE WIRE WINDINGS**

MINIATURE TRANSFORMERS, PICK-UP, CLOCK AND INSTRUMENT COILS, ETC. VACUUM IMPREGNATION TO APPROVED STANDARDS

**ELECTRO-WINDS LTD.**

CONTRACTORS TO G.P.O., M.O.S., L.E.B., ETC.

123-5-7 PARCHMORE ROAD, THORNTON HEATH, SURREY LIVINGSTONE 2261

EST. 1933

**hallicrafters**

**McELROY**

**TELEGRAPHIC EQUIPMENT**

Sole Concessionaire U.K.:

**McELROY ADAMS MFG. GROUP LTD.**

Phone: FUL 1138/9

**COMMUNICATION**

**RECEIVERS and**

**TRANSMITTERS and**

**RAYTHEON**

**MARINE RADIO DEVICES**

*Again becoming available*

328 LILLIE ROAD, LONDON, S.W.6

Cables: Hallicraft, London

**All UNIVERSAL ELECTRONICS equipment guaranteed in perfect condition**

**RECEIVERS**

All receivers are in good working order and condition unless stated. Hallicrafters Portable, mains or battery receiver, as new, £50. SX28, 550 kc/s.-42 Mc/s., £45. SX24, 550-42 Mc/s., £28. S20R, 550-42 Mc/s., £25. S20, £20. S29, A.C./D.C. portable battery 550-32 Mc/s., £25. S38 A.C./D.C. 110-250 v. 550-30 Mc/s., £20. Also in stock S27, 30 Mc/s.-150 Mc/s., S27CA, 150-230 Mc/s., HT11 A Marine 12 v. radiotelephones. HRO receivers junior and senior types with all coils and power supplies from £27, complete. National NC44, NR100, NC81X, NC200, National NC173, 550-32 Mc/s., as NEW, £65. Marconi CR100. 60 kc/s.-30 Mc/s. reconditioned, £32. RME 69, £35. Eddystone receivers: Types 640, 1.2-30 Mc/s., £22/10/-; 740, 550 kc/s.-32 Mc/s., £35; 750, £48; 680, £65; 670, £35; 504, £25. Hammarlund Super Pro, £45. RCA receivers, AR88D and LF from £55. Set of three dials for model D, £1/10/-. Many other makes in stock.

**MANUALS**

For RECEIVERS AR88D-LF, AR77E, R107, Marconi CR100, S20R, SX24, SX28, B2, TX/RX, HROs, etc., photostatic copies ..... per copy **£1 7 6**

**BRITISH TEST EQUIPMENT**

AVO model 7, as NEW, £15. Avo 40, £12/10/-. Taylor TV wobblulator, 260A, as NEW, £27. AVO Roller panel Valve tester, £10. Evershed Wee Meggers, 500 v., £12/10/-. Bridge types in stock. Marconi Signal Generators. TF144G. TF390G. TF517. Cossor Double Beam Scopes, from £35. Many other instruments in stock.

**SERVICE AND REALIGNMENT**  
of all British and U.S.A. types  
**COMMUNICATIONS RECEIVERS**  
to makers' specifications **AT LOW COST**

BENDIX BC221 Frequency Meters 125 kc/s.-20 Mc/s. available from stock.

**U.S.A. MICROWAVE TEST GEAR**

No technical manuals for sale. Please write for prices.

Spectrum analyser TSX-4SE. 3CM. TS3. S band power frequency meter TS10. APNI Test set. TS13. AP. X band signal generator. TS14. S band signal generator. TS34. Radar Syncroscope. TS36. X band power meter TS62. X band echo box. TS69. 300-100 Mc/s. frequency meter. TS127 300-700 Mc/s. frequency meter. TS226. 300-1,000 Mc/s. power meter. BC221. Frequency meter (Bendix). BC1277. S band signal generator. TS45/AP. 3 cm. signal generator. 1-222A. 8-15 Mc/s. 150-230 Mc/s. signal generator. IE-19 signal generator. TS89. Pulse voltage divider. TS47. 40-500 Mc/s. signal generator. TS174. (V.H.F. version of BC221) 20-250 Mc/s. TS175. 80-1,000 Mc/s.  
**GENERAL RADIO 804B.** 30-300 Mc/s. signal generator. £70.  
All laboratory equipment may be inspected by appointment.

**Lavoie  
Frequency Meter  
TYPE TS127U**

The TS127U is a compact self-contained battery powered precision frequency meter which has a continuous frequency coverage of 375-725 Mc/s. Individually calibrated with an accuracy of  $\pm 1$  Mc/s.



*EACH MONTH we will be illustrating and fully describing British and U.S.A. LABORATORY INSTRUMENTS which we have in stock. Cut out and file the data for future reference.*

**22 LISLE STREET, LEICESTER SQ., LONDON, W.C.2.**

Shop hours, 9.30 a.m. to 6 p.m.

**OPEN ALL DAY SATURDAY.**

Thursday 9.30 a.m. to 1 p.m.

Write, Call or Telephone  
GERrard 4447 and 8410 (Day)  
MEAdway 3145 (Night)

# Essential books for technicians

Published for  
"Wireless World"

Obtainable from booksellers or direct from :—  
**Iliffe & Sons Limited**  
Dorset House, Stamford St., London, S.E.1

**INTRODUCTION TO VALVES**

By R. W. Hallows, M.A. (CANTAB.), M.I.E.E., and H. K. Milward, B.Sc. (LOND.), A.M.I.E.E. Describes the principles, construction, characteristics and uses of most types of radio valves. The approach is simple and as far as possible non-mathematical.

8s. 6d. net. By post 8s. 10d.

**ADVANCED THEORY OF WAVEGUIDES**

By L. Lewin. Sets out the various methods that have been found successful in treating the types of problems arising in waveguide work. The author has selected a number of copies as representative of the field in which the micro-wave engineer is at present engaged.

30s. net. By post 30s. 7d.

**LAPLACE TRANSFORMS FOR ELECTRICAL ENGINEERS**

By B. J. Starkey, DIPL. ING., A.M.I.E.E. A presentation of the theory of the Laplace transformation in which a physical vocabulary rather than a purely mathematical one is used as far as possible. The work provides a thorough treatment of the subject in a language which will be familiar to engineers.

30s. net. By post 30s. 8d.

**SHORT-WAVE RADIO AND THE IONOSPHERE**

By T. W. Bennington, Engineering Division, B.B.C. Long-distance communication by means of short waves is dependent on the state of the ionosphere, which changes during the day and at different seasons of the year. This book explains simply the reasons for these changes and shows how they influence the choice of wavelength for signalling between different points on the earth's surface.

2nd Edition. 10s. 6d. net. By post 10s. 10d.

## LABORATORY TUBE ANALYSER U-61 B

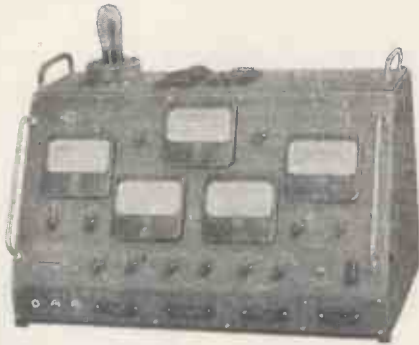

**TECHNICAL CHARACTERISTICS:** Filament volts: 19 values from 1.1 to 117 v. Anode volts: variable from 0 to 300 v. max. current 100 m/a. Auxiliary Grid volts: Two identical sources. Variable from 0 to 300 v. max. current 15 m/a. Control Grid volts: Variable from 0 to 50 v. Power supply stabilisation: less than  $\pm 1\%$  variation of all sources for  $\pm 10\%$  power supply variation. Power supply: 110-130-220-250 v. 50-60 c/s. Tubes used: 3 x 5Y3 GB, 2 x 6V6, 2 x 6L6, 3 x 6AU6, 2 x OB2. Dimensions: 24 x 13½ x 15½ in. (610 x 340 x 400 mm.). Weight: 66lb. (30 kg.).

## V.H.F. SIGNAL GENERATOR 936



**PRINCIPAL CHARACTERISTICS:** Frequency coverage: 8 to 230 mc/s. in 6 ranges all on fundamentals. Output voltage: Adjustable from 1  $\mu$ V to 0.25 v. Modulation: internal amplitude modulation 1 kc/s switched to 10%, 30% or unmodulated. Output: by 75 ohms matched coaxial cable. Power supply: 110 to 250 v., 50 c/s. Tubes used: 1 x EC81-1 x 6AQ5-1 x 6X4. Net weight: 50lb. 10oz.

# METRIX

**Compagnie Générale de Métrologie**  
Chemin de la Croix-Rouge  
**ANNECY FRANCE**

Manufacturers of :

**A.F. — H.F. — V.H.F. SIGNAL GENERATORS**  
**MULTIMETERS IMPEDANCE BRIDGES**  
**T.V. — SWEEP GENERATORS**

WORLD-WIDE REFERENCES

U.K Agent :

**The Solartron Electronic Group Ltd.**  
**THAMES DITTON SURREY**

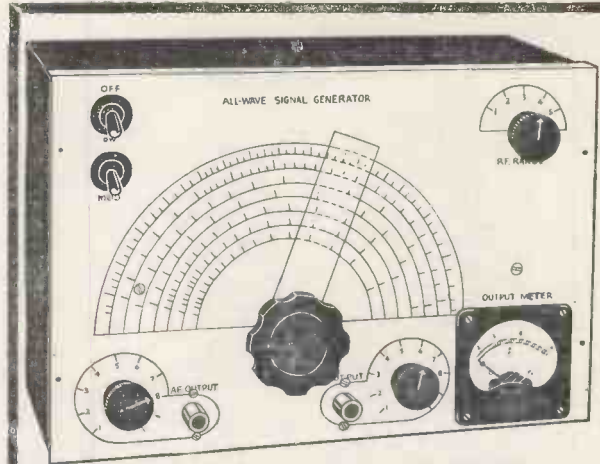

### COMPLETELY BUILT SIGNAL GENERATOR

Coverage 120 Kc/s-320 Kc/s., 300 Kc/s-900 Kc/s., 900 Kc/s.-2.75 Mc/s., 2.75 Mc/s.-8.5 Mc/s., 8 Mc/s.-28 Mc/s., 16 Mc/s.-56 Mc/s., 24 Mc/s.-84 Mc/s. Metal case 10 x 6½ x 4½ in. Size of scale 6½ x 3½ in., 2 valves and rectifier. A.C. mains 230-250 v. Internal modulation of 400 c.p.s. to a depth of 30 per cent., modulated or unmodulated, R.F. output continuously variable 100 milli volts. C.W. and mod. switch, variable A.F. output and moving coil output meter. Black crackle finished case and white panel. Accuracy plus or minus 2%. £4/19/6 or 34/- deposit and 3 monthly payments 25/- P. & P. 4/- extra.

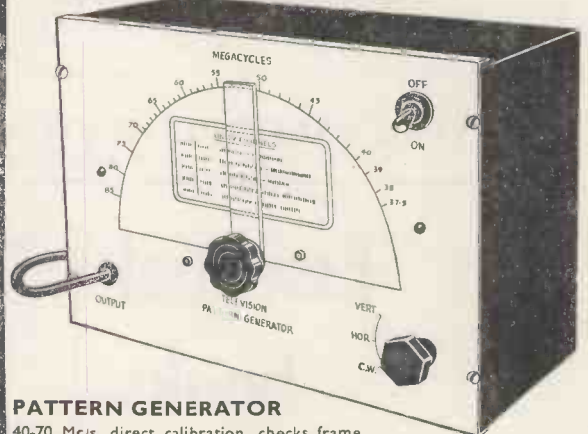

### PATTERN GENERATOR

40-70 Mc/s. direct calibration, checks frame and line time base, frequency and linearity, vision channel alignment, sound channel and sound rejection circuits and vision channel band width. Silver plated coils, black crackle finished case 10 x 6½ x 4½ in. and white front panel. A.C. mains 200/250 volts. This instrument will align any T.V. receiver, accuracy plus or minus 1%. Cash price £3/19/6 or 29/- deposit and 3 monthly payments of £1. P. & P. 4/- extra.

### EXPORT & TRADE ENQUIRIES INVITED

(N.B. Post and packing charges stated apply to British Isles only.)

★ Both generators guaranteed for 12 months ★

#### USED TELEVISION TUBES WITH HEATER CATHODE SHORT.

#### GUARANTEED FOR THREE MONTHS.

6 volt heater, duodecal base: all with bent gun construction.  
12in. .... £3/17/6. Post & Packing 7/6 extra.  
9in. .... £1/17/6. Post & Packing 7/6 extra.  
Maximum E.H.T. 10 Kv.

Any of the above complete with line and E.H.T. Trans., Ferrocart core, line and width control scan coils and frame. Output Transformer, 35/- extra.

#### SPECIAL NOTE: NO GOODS SENT WHERE CUSTOMS DECLARATION IS APPLICABLE

Terms of Business: Cash with order. Despatch of goods within 3 days from receipt of order. Where post and packing charge is not stated please add 1/6 up to 10/-, 2/- up to £1, and 2/6 up to £2. All enquiries S.A.E., lists 5d. each.

**MAINS TRANSFORMERS**

Primary, 200-250 v. P. & P. 2/-  
300-0-300, 100 mA., 6 v. 3 amp.,  
5 v. 2 amp., 22/6.

Drop thro' 350-0-350 v. 70 mA., 6 v.  
2.5 amp., 5 v. 2 amp., 14/6.

Drop thro' 250-0-250 v. 80 mA., 6 v.  
3 amp., 5 v. 2 amp., 14/6.

280-0-280, drop through, 80 mA.  
6 v. 3 amp., 5 v. 2 amp., 14/6.

250-0-250 80 mA., 6 v. 4 amp., 14/-.

Drop thro' 270-0-270, 80 mA., 6 v.  
3 amp., 4 v. 1.5 amp., 13/6.

Drop thro' 270-0-270, 60 mA., 6 v.  
3 amp., 11/6.

250 v. 350 mA., 6.3 v. 4 a., twice 2 v.  
2 a., 19/6.

Auto-Trans. Onpnt 200/250 H.T. 500 v.  
250 mA., 6 v. 4 a., twice, 2 v. 2 a., 19/6.  
250-0-250, 60 mA., 6.3 v. 1.5 a.  
0-5-6.3 v. 1.5 a., 10/6.

Auto Trans. Input 200/250. H.T.  
200 v. 350 mA. Separate L.T. 6.3 v.  
7 a., 6.3 v. 11 amp., 5 v. 3 amp., 25/-  
P. & P. 3/-.

Heater Transformer. Pri. 230/250 v.  
6 v. 1 1/2 amp., 6/-; 2 v. 2 1/2 amp., 5/-  
Pri. 200/250. Secondary 9 v. 3.5 amp.  
6.3 v. 3 amp., 12/6.

Pri 200 v. Sec. 500-0-500 and 500-0-500  
250 mA. both windings. 4 v. 3 amp.,  
4 v. 3 amp., 39/6. P. & P. 5/-.

Mains Transformer, fully impregnated,  
input 210, 220, 230 and 240. Sec.  
600-0-600, 275 mA., and 200 v. at  
30 mA., complete with separate heater  
transformer. Input 210, 220, 230, 240.  
Sec. 6.3 v. 2 amp. three times, 0, 4,  
6.3 v. at 3 amp. and 5 v. 3 amp., 4/-  
P. & P. 5/-.

Mains Transformer, fully impregnated.  
Input 210, 220, 230 and 240. Sec. 350-0-350  
100 mA., with separate heater trans-  
former. Pri. 210, 220, 230, 240. Sec.  
6.3 v. 2 amp., 6.3 v. 3 amp., 4 v. 6 amp.  
and 5 v. 2 amp., 30/- P. & P. 3/-.

**MAINS TRANSFORMERS, chassis**  
mounting, feet and voltage panel.  
Primaries 200/250.

300-0-350 75 mA. 6.3 v. 3 a. tap 4 v.  
6.3 v. 1 a., 13/6.

500-0-500 125 mA. 4 v. C.T. 4 a., 4 v.  
C.T. 4 a., 4 v. C.T. 2.5 a., 27/6.

500-0-500 250 mA. 4 v. C.T. 5 a., 4 v.  
C.T. 5 a., 4 v. C.T. 4 a., 39/6.

9in. T.V. Cabinet, front in contrasting  
walnut veneers, size 18 1/2 in. long, 11 1/2 in.  
high, by 12 1/2 in. wide. Complete with  
two pieces expanded aluminium in gold  
12 x 9 in. and 5 in. speaker baffle and  
chassis, 20/-, post paid.

6in. M.E. Speaker, 1,000 ohm. field.  
15/-.

R. & A. T.V. energised 6 1/2 in. speaker,  
with O.P. trans., field coil, 175 ohms  
9/6. P. & P. 2/6.

R. & A. 6 1/2 in. M.E. speaker, with O.P.  
trans., field 440 ohms, 10/6. P. & P. 2/6.

Volume Controls. Long spindle less  
switch, 50K, 500K, 1 meg., 2/6 each.  
P. & P. 3d. each.

Volume Controls. Long spindle and  
switch, 1, 1/2 and 2 meg., 4/- each.  
10K and 50K, 3/6 each. 1/2 and 1 meg.,  
long spindle double pole switch, miniature,  
5/- P. & P. 3d. each.

Trimmers, 5-40 pf., 5d. 13-110, 10-250,  
10-450 pf., 10d.

Twin-Gang, .0005 Tuning Condenser, 5/-  
With trimmers, 7/6.

Twin Gang, .0005, with feet, size  
3 1/2 x 3 1/2 in., 6/6.

3-gang .0005, with feet, size 4 1/2 x 3  
1/2 in., 7/6.

T.V. Coils, moulded former, iron-cored  
wound for re-winding purposes only.  
All-can 1 1/2 x 1 1/2 in., 1/- each. 2 iron-core  
All-can 2 1/2 x 1 1/2 in., 1/6 each.

Used Metal Rectifier, 250 v. 150 mA.,  
6/6.

Metal Rectifier, 230 v. 45 mA., 6/-  
Metal Rectifier, RM2, 125 v. 100 mA.,  
3/6.



6 1/2 in. deep, 4 1/2 in. high, 9 in. blank-scale. Width including scale-override 1 1/4 in. Four stages  
permeability tuned. Complete with 3 valves. Post and Pkg. 3/-, 22/19/6.

**T.V. CONVERTER** for the new commercial stations complete with 2 valves. Frequency—can  
be set to any channel within the 188-198 Mc/s. band. I.F.—will work into any existing T.V.  
receiver designed to work between 42-68 Mc/s. Sensitivity—10 Mu/v. with any normal T.V.  
set. Input—arranged for 300 ohm feeder. 80 ohm feeder can be used with slight reduction in  
R.F. gain. Circuit EF80 as local oscillator, ECC81 as R.F. amplifier and mixer. The gain of  
the first stage, R.F. AMPLIFIER 10 db. Required power supply of 200 v. D.C. at 25 mA. 6.3 v.  
A.C. at 0.6 amp. Input filter ensuring complete freedom from unwanted signals. 2 simple  
adjustments only. 22/10/- P. & P. 2/6.

USED 12in. TUBE, aluminumized, heater cathode-short, 10KV max. 2 v. heater complete with  
line and E.H.T. transformer 9 KV with ferrocart core, line and width control, EY51 rec. winding  
form O.P. scan coils and 12in. Perspex escutcheon. 26/17/6. P. & P. 7/6.

As above but with 12in. non-aluminumized tube 8KV max. 25/17/6. P. & P. 7/6.

**GENERAL PURPOSE 3-IN-1 MAINS TRANSFORMER.** Input 200/250. Sec. 250 v. 350 mA.  
6.3 v. 4 amp. twice, 2 v. 2 amp., 500 v. 350 mA., 6.3 v. 4 amp. twice, 2 v. 2 amp. Auto-trans-  
former, 110, 250 v., 250 watt, 19/6. P. & P. 3/6.

**HIGH-IMPEDANCE PLASTIC RECORDING TAPE,** by famous manufacturer. 600ft. on  
aluminium spool, 8/-. 1,200ft. on aluminium spool, 17/6, post paid.

**PLASTIC CABINET,** as illustrated, 11 1/2 x 6 1/2 x 5 1/2 in. In Walnut, Cream and Green, also  
in polished Walnut complete with T.R.F. chassis, 2 waveband scale, station names,  
new wave-band, back-plate, drum, pointer,  
spring, drive spindle, 3 knobs and back.  
22/6. P. & P. 3/6.

**AS ABOVE,** with superb chassis, 23/6.  
P. & P. 3/6.

Used metal rectifier, 230 v. 50 mA. 3/6.  
Gang with trimmers, 6/6; M. & L. T.R.F.  
coils, 5/-; 3 obsolete ex-Govt. valves  
3 v/b and circuit, 4/6; heater trans., 6/-;  
volume control with switch, 3/6; wave-  
change switch, 2/-; 32 x 32 mfd., 4/-; bias  
condenser, 1/-; resistor kit, 2/-; condenser  
kit, 4/-.

Cyclon 5 channel T.V. Tuner, uses EF80 and 12AT7 less valves, 12/6, post paid.  
Radiogram Chassis, 5 valve A.C./D.C. 3 v. wave-band superb 195-255 v. 10-40, 200-550 and  
1,000-2,000 metres, I.F. 470 Kc. size of chassis 13 x 6 1/2 x 2 1/2 in. size of scale 7 1/2 x 3 1/2 in. Valve  
line-up 10C1, 10F9, 10D11, U404 and 10P14. Twin mains filter input, 2 dial lights and 8in.  
P.M., 28/17/6. P. & P. 3/6.

**CR100 Coil packs in first-class condition less oscillator section, complete  
with 4-gang tuning condenser, 19/6. P. & P. 3/6.**

**CR100 465 Kc. I.F.s., types 3, 4 and 5 and F.B.O., new condition, 7/6 each.  
465 Kc. Xtal for CR100, 12/6.**

**4-gang tuning condenser for CR100, 9/6.**

**CONSTRUCTOR'S PARCEL,** medium and long wave A.O. mains 230/250 2-valve plus meta-  
rectifier, comprising chassis 12 1/2 x 4 1/2 x 1 1/2 in., 2 wave-band scale, tuning condenser, wave-  
change switch, volume control, heater trans., metal rectifier, 2 valves and v/holders, smoothing  
and bias condensers, resistors and small condensers, and medium and long wave coil. Litz  
wound, 22/6. P. & P. 2/6 extra. Circuit and point-to-point, 1/3.

**CONSTRUCTOR'S 2 PARCEL**  
comprising chassis 12 1/2 x 8 x  
2 1/2 in., cad. plated, 18 gauge,  
v/b, I.F. and trans. cut-outs,  
back-plate, 2 supporting brack-  
ets, 3 wave-band scale, new  
wavelength stations names.  
Size of scale 11 1/2 x 4 1/2 in.  
drive, sp., drum, 2 pulleys,  
pointer, 3 bulb holders, 5  
pax. I.O. v/b., 4 knobs and  
pair of 465 I.F.s., twin gang,  
16 x 16 mfd. 350 wkg. mains  
trans. 250-0-250 60 mA., 6.3 v.  
2 amp., 5 v. 2 amp. and 6 1/2 in.  
M.E. speaker with O.P. trans.  
39/6. P. & P. 3/6.

**Battery charger, input 230/250 v. output 6 and 12 volt 1 amp. Block  
c-ackle finished case size 10 x 6 x 4 in. Incorporating metal rectifier,  
main on-off switch, and output switch, 21/- P. & P. 3/-.**

**OUTPUT TRANSFORMERS.** Standard type 5,000 ohms imp., 4/9; 42-1 with extra feed-back  
windings, 4/3. Miniature 42-1, 3/3. Multi-ratio 3,500, 7,000 and 14,000, 5/6. 10-watt push-  
pull, 4/6 matching, 7/-, 90-1 300 ohm coil, 6/6.

**FUSE-BACK CONNECTING WIRE.** Box, yds., 1/6. Post paid.

**STANDARD WAVE-CHANGE SWITCHES** 4-note 3-way, 1/9; 5-pole, 3-way, 1/9; 3-pole, 3-way  
1/9; 3-pole 3-way, 3/8; Miniature type, long spindle 3-pole 4-way, 4-pole 3-way and 4-pole  
2-way, 2/6 each. 2-pole 11-way twin wafer 5/-; 1-pole 12-way single wafer 5/- P. & P. 3d.

**POTATO AND VEGETABLE PEELER**  
By famous manufacturer. To suit models A200 and A700. Capacity 4 1/2 lbs., complete with  
water pump. All aluminium construction, white stove-enamelled finish. Originally intended  
for adaptation on an electric food-mixer, can be easily converted for hand operation. 39/6.  
P. & P. 3/-.

**Mains Droppers.** 0.3 amps., 460 ohms.,  
tapped 280 and 410, 1/6; 0.2 amp., 717  
ohms, tapped at 100 ohms, vitreous, 1/6;  
0.3 amps. 950 ohms, tapped 700 and 925,  
2/6; 0.2 amp., 1,000 ohms, vitreous, tapped  
2/6; vitreous, 0.3 amp., 700 tapped 680,  
640, 600, 3/6. P. & P. on each 3d.

T.V. Width Controls, 3/6.

**PERSONAL SHOPPERS ONLY.** 9in.  
Enlarger, 17/6; 13in., 27/6.

Germanium Crystal Diode, 1/6. post paid.

Used 9in. Tube with ion burn, 17/6, post  
paid.

Line O.P. Transformer in aluminium cas.  
mounted in rubber, 12/6.

**PERMEABILITY**

**TUNED T.V. UNIT**  
Input 300 ohm bal-  
anced line, coverage  
54 Mc/s-89 Mc/s and  
174 Mc/s-217 Mc/s.  
Vision I.F.—45 Mc/s.,  
sound 40.5 Mc/s. Uses  
6AK5 RF valve, 6AK5  
as mixer, and 6C4  
oscillator. Provision  
for auto-gain control.  
Dimensions 9in. wide,  
12in. high.

Crystal Set, medium and long wave. in  
plastic cabinet, 16/-.

Headphones, per pair, 8/-.

Speaker Matching Unit on aluminium  
chassis, 3-15 ohms reversible, 12/6.

Line and E.H.T. Transformer, 14 Kv.,  
using ferrocart core, complete with line  
and width control, and corona shields  
U37 rectifier winding, 35/-.

Line and E.H.T. Transformer, 9 Kv.,  
using ferrocart core, complete with  
built-in line and width control. Mounted  
on small all-chassis. Overall size  
4 1/2 x 1 1/2 in. EV61 rec. winding, 27/6.

Scan coils, low line low impedance  
frame coil, complete with frame transformer,  
to match above, 27/6. P. & P. 2/-.

Line and E.H.T. Transformer, 9 Kv.  
ferrocart core, EY51, heater winding,  
complete with scan coils and frame  
output transformer, and line and width  
control. 22/6. P. & P. 3/-.

As above, but complete with line and  
frame blocking transformers, 5 Henry  
250 mA. choke, 100 mfd. and 150 mfd.  
250 wkg. 380 mA. A.C. ripple. 22/19/6.  
P. & P. 3/-.

Valve Holders, moulded octal Mazda  
and loctal, 7d. each. Paxolite, octal  
Mazda and loctal, 4d. each. Moulded  
B7G, B8A and B9A, 7d. each. B7G  
moulded and B9A with screening can  
1/6 each.

32 mfd., 350 wkg. .... 2/-  
16 x 24, 350 wkg. .... 4/-  
4 in. dia., 200 wkg. .... 1/3  
40 x 40, 400 wkg. .... 3/6  
10 x 16 mfd., 500 wkg. .... 4/6  
10 x 16 mfd., 500 wkg. .... 4/6  
16 x 16 mfd., 450 wkg. .... 3/9  
32 x 32 mfd., 350 wkg. .... 4/-  
32 x 32 mfd., 350 wkg., and  
25 mfd., 25 wkg. .... 6/6  
25 mfd., 25 wkg. .... 11d.  
250 mfd., 15 v. wkg. .... 3/6  
16 mfd., 500 wkg., wire ends .... 3/3  
8 mfd., 500 v. wkg., wire ends .... 2/6  
8 mfd., 350 v. wkg., tag ends .... 1/6  
50 mfd., 25 v. wkg., wire ends .... 1/9  
100 mfd., 350 wkg. .... 4/-  
100 mfd., 450 v. wkg., 280 mA.  
A.C. ripple .... 3/11  
150 mfd., 350 v. wkg., 280 mA.  
A.C. ripple .... 4/6  
100+200 mfd., 350 wkg. .... 9/6  
16 x 16 mfd., 350 wkg. .... 3/3  
60 mfd., 180 wkg. .... 1/9  
65 mfd., 220 wkg. .... 1/6  
8 mfd., 150 wkg. .... 1/6  
60+100 mfd., 280 wkg. .... 7/6  
50 mfd., 12 wkg. .... 11d.  
32 x 32 mfd. min. 275 wkg. .... 4/-  
50 mfd., 50 wkg. .... 1/9

Miniature wire ends moulded, 100 pi.,  
500 pf., and .001, each 7d.

T.V. Filter, in lightly tinted Perspex,  
size 13 1/2 x 11 x 3 1/2 in., 4/6.

Combined 12in. mask and escutcheon,  
in lightly tinted Perspex. New aspect  
edged in brown. Fits on front of  
cabinet, 12/6. As above for 15in. tube,  
17/6.

Frame Oscillator Blocking Trans., 4/6.  
Line Osc. Blocking Trans., 4/6.

Tube Mounting Bracket, size 9 1/2 x 4 1/2 in.  
12in. tube clamps, 2/-.

**CHOKES:**  
2-20 Hen. 150 mA., 15/- P. & P. 3/-  
6 Hen. 275 mA., 15/- P. & P. 3/-  
100 Hen., 40 mA., 15/- P. & P. 3/-  
2 Henry 150 mA., 3/6; 250 mA. 10 henry,  
10/6; 5 Henry 250 mA., 60 ohms,  
8/6.

P.M. Focus Unit for any 9 or 12in. tube  
except Mazda 12in. with Vernier  
adjustment, 15/-

P.M. Focus Unit for Mazda 12in., less  
Vernier adjustment, 15/-

Wide Angle P.M. Focus Units. Vernier  
adj. state tube, 25/-

Energised Focus Coil, low resistance  
mounting bracket, 17/6.

Ion Traps for Mullard or English Elect. c  
tubes, 5/-, post paid.

Standard 465 Kc. iron-cored I.F.s.,  
4 x 1 1/2 x 1 1/2 in., per pr., 7/8. Weirite  
standard, iron-cored, 465 Kc. I.F.s.,  
3 x 1 1/2 x 1 1/2 in., per pr., 9/6.

Iron-Cored 465 Kc. Whistle Filter, 2/6.  
465 Kc. MIDGET I.F.s., 3/120 size  
1 1/2 in. dia. wide, 1 1/2 in. deep by very  
famous manufacturer. Pre-aligned  
adjustable iron-tust cores, per pair,  
12/6.

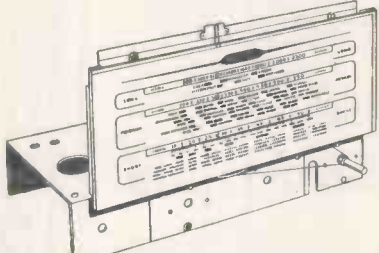

**RADIO & T.V. COMPONENTS (Acton) LTD.**  
(Late D. COHEN)  
**23 HIGH STREET (Uxbridge Road) ACTON, W.3.** Telephone: ACOrn 5901  
Hours of Business: Saturday 9-5 p.m. Wednesday 9-1 p.m. Other days 9-4.30 p.m.

# Completely New & Unique Battery/Spring driven

## MINIATURE RECORDER A.C.E. "CONSORT"

SIZE : 6½" x 7" x 12". NO LARGER THAN A TELEPHONE !

Provides foolproof "quality" recording anywhere WITHOUT MAINS POWER.



- MANY "ALL MAINS" FEATURES INCLUDE :
- ★ 2 TRACKS
  - ★ AUTOMATIC ERASE
  - ★ 3 SPEEDS
  - ★ POWER REWIND
  - ★ MONITORING CIRCUIT
  - ★ 5in. SPEAKER
- (Full Trade and Export Terms.)

**£52**

With Tape, Batteries and Microphone

CALL FOR DEMONSTRATION OR SEND FOR ILLUSTRATED BROCHURE  
**ASSOCIATED GINE EQUIPMENTS LTD.**

353, BEXLEY ROAD, ERITH, KENT. Phone : ERTH 2543

# ELECTRICAL INTERFERENCE ?

IF YOUR RADIO RECEPTION IS MARRED BY NOISE, FIT AN

## EDDYSTONE MAINS FILTER



Cat. No. 732. Specially designed for use with receivers covering short and medium wavelengths, this well screened Filter Unit is most effective in suppressing mains borne electrical interference. Finished ripple brown and supplied complete with flexible lead and socket. £2/15/-.

For address of nearest stockist, please write.

# STRATTON & CO. LTD.

ALVECHURCH ROAD, BIRMINGHAM, 31



## S.G. Brown

**SINGLE HEADSET with BOOM MICROPHONE for :—**

TELEPHONE OPERATORS  
CONFERENCE INTERPRETERS  
BROADCASTING TECHNICIANS

Designed with fully adjustable single earpiece and microphone. Leaves both hands free. Enables operators to listen and speak, independently.

Earpad and Microphone housings moulded from dermatitis-proof rubber. Designed to withstand very heavy wear. (Available with two earpieces if desired.)

Telephone: Watford 7241

**S.G. Brown, Ltd.**

SHAKESPEARE STREET, WATFORD, HERTS.

(3)



## TELEPHONE EQUIPMENT

Brand new and boxed American Desk telephones with built in ringer complete with handsets as shown. 59/6.

Ditto :— of English manufacture, complete with distributor boards. 49/6 each.

Telephone Secrecy Equipment :— Army No. GAC-YBO2700. Complete frequency scrambler units for secret telephone conversations which cannot be tapped or overheard, for operation from 230 v. A.C. or 12 volt D.C. Offered in brand new condition at a fraction of their original cost. £5 each. Limited number only available.

**G. W. SMITH & CO. (RADIO) LTD.**  
3-34, LISLE STREET, LONDON, W.C.2

Telephone ; Gerrard 8204/9155.



# G.W. SMITH & CO (RADIO) LIMITED

Phone: GERRARD 8204/9155  
3-34, LISLE ST., LONDON, W.C.2.

TRADE ENQUIRIES  
INVITED

FOR ALL RADIO BARGAINS

WE PURCHASE ALL TYPES OF  
RECEIVERS AND TEST GEAR

## R.1155 COMMUNICATION RECEIVERS

Individually aerial tested. BRAND NEW



in original transit cases, £11/19/6 each. BRAND NEW but shop soiled, £9/19/6 each. USED MODELS but in perfect working order, £7/19/6 each. A combined power pack and audio output stage for A.C. mains, can be supplied with a receiver for an extra cost of 79/6 each.

**METERS.** All brand new and boxed. 25-; 0-10 mA., 2½ in. round, F/M, M/coil, 10/-; 0-100 mA., 2½ in. round, F/M., M/coil, 9/6; 0-150 mA., 2 in. square, F/M., M/coil, 7/6; 0-200 mA., 2 in. square, F/M., M/coil, 7/6; 0-200 mA., 2½ in. round, F/M., M/coil, 9/6; 0-20 volts, 2 in. square, F/M., M/coil, 7/6.

**AMMETERS.** 0-1 amp., 2½ in. projecting, R.F., 7/6; 0-5 amp., 2½ in. round, F/M., R.F., 7/6; 20/20 amp., 2 in. round, F/M., M/l., 6/6; 0/30 amp., 2 in. square, F/M., M/coil, 7/6.

**A.C. VOLTMETERS 50 CYCLE.** 0-15 volts, 2½ in. round, F/M., M/l., 8/6; 0-20 volts, 2½ in. round, F/M., M/l., 10/-; 0-300 volts, 2½ in. round, F/M., M/l., 25/-; 0-300 volts, Sin. projecting, M/l., 50/-.

**TELEPHONE TYPE "F."** Complete with hand generator, buzzer and hand set. A pair of these units may be used as a complete telephone system over any distance. Price 45/- each.

**MAINS TRANSFORMERS.** All 230 volt 50 cycle input. 250 x 250 volt 150mA., 4 volt 3 amp., 9/6; 500 x 500 volt, 170 mA., 4 volt C.T., 4 amp., 3,000 volt insulation, 22/6 each; 670 x 670 volt 200 mA., 6.3 volts 4 amp., 5 volts 3 amp., 49/6 each; 1,500 volts 330 mA., 52/6; 2,000 volt 5 mA., 15/6; 4 volt 14 amp., 6.3 volt 1½ amp., 10/6; 6.3 volts 1½ amp., 5/9; 6.3 volts 3 amp., 9/6 each.

**MIDGET REVERSIBLE MOTORS.** For operation on 4, 6, 12 or 24 volt D.C. Size 2 in. x 1½ in., spindle length ½ in. x ½ in. Ideal for model Boats and Locos., 10/6 each.

**CHROMIUM PLATED TELESCOPIC AERIALS.** Min. length 12 in. extends to 48 in. Ideal for car radios, etc., 7/3 each.

**HEADPHONES.** Brand new, Canadian "Northern Electric," finest ever produced, Res. 100 ohms, complete with P.O. Jack Plug, 10/6 pair.

**P.O. UNISELECTOR SWITCHES.** 4 bank, double wipers, 25 position, 32/6; ditto, 8 bank, 45/-.

**TELEPHONE HANDSETS.** Ex-American, standard P.O. type, 12/6 each.



**H.R.O. 6 VOLT VIBRATOR POWER SUPPLY UNITS.** Output 165 volts 80 mA., 6.3 volts 3 amp. 6 x 5 rectifier, choke and condenser smoothed, cabinet size 7 in. x 7 in. x 6 in. Supplied brand new, 29/6 each.

**SPECIAL OFFER PACKARD BELL AMPLIFIERS.** These brand new American amplifiers are complete with a 6SL7 and 28D7 valves, condensers, resistors, relay and pot and 8-way midjet plug and socket, 12/6 each with circuit.

**AMERICAN POWER RHEOSTATS.** 8 ohm, 3.3 amp., 8/6 each; 8 ohm, 2.5 amp., 7/6 each; 60 ohm, 1.3 amp., 7/6 each; 90 ohm, 0.74 amp., 7/6 each; 200 ohm, 0.3 amp., 5/6 each. Ideal for train, model or charging control.

**BENDIX RECEIVERS TYPE RA-1B.** 8 valve receiver covering 150 K/c/s-16 Mc/s. on 6 wavebands. 1 R.F. and 2 I.F. stages, and B.F.O., Power requirements 250 volts D.C. and 12 volts D.C. This receiver is an American equivalent to the R.1155 and covering the top band. Supplied brand new and aerial tested, £11/19/6 each.

**P.40 POWER PACKS.** Input 200-250 volts A.C. Output 175 volts 60 mA., 12 volts 2.5 amp. Fully smoothed, 5Z4 rectifier, 32/6 each.

**MUIRHEAD PRECISION BUILT KEY SWITCHES** with heavy contacts. 8 pole, 2 way, brand new, 4/6 each.



**PYE 45 MEG. I.F. STRIPS.** Complete television I.F. strip with 6 EF50 valves. Size 1¼ in. x 3½ in. x 3½ in., finest strip ever produced, 69/6 each complete. Brand new.

**RELAYS.** Polarised, twin 600 ohm coils, 8/6 each. We stock all types of relays, 600 and 3,000 types, heavy and light contacts including platinum, send us your enquiries, we are the cheapest in the trade.

**HOURLY RECORDERS.** A time recorder for operation on 200-250 volts A.C., range from 1/10-10,000 hours on five separate scales. Supplied brand new, 39/6 each.

**MULTIWAY TOGGLE SWITCH BOXES.** Fitted with 16 toggle type switches. Ideal for train or model control. Brand new and boxed, 4/- each.

**100 MICROAMP METERS.** A 2½ in. flush mounting meter, scaled 0-1500 yards, first grade instruments, brand new and boxed, 42/6 each.

**METER SWITCHES.** Standard Yaxley type, 8 bank, single pole, 9, 11 or 12 way, 7/6 each. **SOUND POWERED MICROPHONES AND RECEIVERS.** No batteries required. Just connect wires to speak or listen, 3/6 each.

**ADMIRALTY POWER PACK TYPE F.H.B.** 200-250 volt A.C. input. Output 2,500 volts 10 mA., stabilised 350 volts 200 mA., stabilised 110 volts negative 200 mA., 6.3 volts 10 amp., also containing a complete 6V6 audio output stage and 6 in. p.m. loud-speaker, £5/10/- each.

**P.O. KEY SWITCHES.** Double pole change-over. Complete with knob, brand new, 2/9 each.

**BATTERY CHARGERS.** 200-250 volts A.C. input, 24 volts 10 amps. output, perfect working condition, fine and coarse controls, £12/10/- each.



**CONSTRUCT A QUALITY AMPLIFIER.** This amplifier is designed to give quality reproductions of records at a price to suit any pocket, supplied complete to the last nut and bolt with an attractive cream cabinet and easy to build point to point diagrams. Push-pull 6V6 output stage giving 8 watts output. Output matched to 3 ohms or 15 ohms, tone and volume controls. For operation on 200/250 volts A.C. Complete valve line-up, 6SN7, 6V6, 6V6, 5Z4. Complete kit, £5/10/-. This amplifier can be supplied ready built and tested, £6/10/-. Circuit only, 2/6.

**S.111B POWER PACK.** 200/250 volt input. Output 300 v.c.t.s 200 mA., 12 volts 3 amp., choke and condenser smoothed, 5U4G rectifier, 62/6 each.

**TEST SETS TYPE 109.** Brand new, fitted with 2 in. 0/5 mA., M/C meter, also 0/40 volt 2 in. M/C. meter, with mains plugs and leads, and many other useful parts, 12/6 each.

**METER RECTIFIERS.** Full wave 2 mA., S.T.C. brand new, 5/6 each.

**TEST SET TYPE 74A.** The ideal basis for an oscilloscope. These units contain a VCRI39 3 in. CRT., 11 other valves and complete A.C. mains power pack for the scope. Paper condensers throughout. Supplied, tube tested, £4/19/6 each.

**CERAMIC SWITCHES.** 3 pole 4 way, 4 bank, 10/6 each; 4 pole 3 way 3 bank, 6/6 each; 7 pole 2 way, 3 bank, 5/6 each.

**APPARATUS TELEGRAPH TWO TONE MK. II.** Complete with all valves and send receive relays, £7/10/- each.

**EX-W.D. POWER PACKS.** 230 volts A.C. input. Output 150 volts 60 mA., 6.3 volts 1½ amps. Fully smoothed, 29/6 each.

**TYPE 4 WAVEMETERS.** Cavity tuned absorption wavemeter covering 200 Mc/s-220 Mc/s., brand new and boxed, supplied with VU39, 5P61, EA50 and CV51 magic eye tuner, 29/6 each. Less valves, 10/6 each.

**TEST SET TYPE 28.** Complete with 50 microamp 2½ in. meter, housed in instrument case with many other useful components, supplied with leads and wooden transit case, 65/- each.

**TRANSMITTING VALVES.** We have a large selection, 829b, 250TH, TX3-200, TX4-400, PZ1-75, MZ2-200, etc., send us your enquiries.

**LORAN INDICATOR APN4.** Supplied brand new with 5CP1 CRT., 14 valves, Type 6SN7, 8 of 6H6, 3 of 6SL7, 1 of 6SJ7, 100 K/c/s. Crystal, and 1,000's of other components, £6/19/6 each.

**A.C. or D.C. TEST METER.** 300 volt moving iron 3½ in. meter housed in wooden case complete with test leads, 39/6 each.



**EX-A.M. SWITCH BOXES.** Fitted with 3 independent 5 amp. switches, size 3½ x 2 in. x 2 in. Ideal for models, cars, boats, etc., 1/9 ea.

**HOURS OF BUSINESS:** 9 a.m. to 6 p.m. Thursday 1 p.m. Open all day Saturday. PLEASE PRINT YOUR NAME AND ADDRESS CLEARLY ALSO INCLUDE POSTAGE OR CARRIAGE ON ALL ITEMS.

Great Britain's Valve Mail-Order House

SALE

2000

VALVES



FROM 2/-

|       |      |        |      |
|-------|------|--------|------|
| 0Z4   | 6/-  | 884    | 21/- |
| 01A   | 3/-  | 954    | 5/6  |
| 1A4   | 5/-  | 955    | 4/-  |
| 1B4   | 5/-  | 937    | 10/- |
| 1HG   | 3/-  | 11726  | 7/-  |
| 1LN5  | 7/-  | 1299A  | 4/-  |
| 2A6   | 2/-  | 1625   | 9/6  |
| 2A7   | 3/-  | DD207  | 4/-  |
| 6A7   | 11/- | EF6    | 17/6 |
| 6AG7  | 19/- | HLL320 | 5/-  |
| 6E3   | 11/- | P2     | 3/-  |
| 6SF5  | 14/- | P215   | 2/-  |
| 12A   | 2/-  | 31     | 2/-  |
| 12SF5 | 6/-  | ARP3   | 7/-  |
| 12SPA | 5/-  | ARP4   | 5/6  |
| 32    | 3/-  | ARP12  | 3/6  |
| 34    | 3/-  | CV1124 | 5/-  |
| 48    | 4/-  | VR18   | 5/-  |
| 50Y6  | 8/-  | VR65   | 5/-  |
| 71A   | 2/-  |        |      |

Post gd.

STOP PRESS

|       |       |           |      |
|-------|-------|-----------|------|
| 5T4   | 12/10 | 14A7/12B7 |      |
| 6A3   | 9/-   | 14B6      | 15/- |
| 6N7   | 10/8  | 14B6      | 10/- |
| 6X4   | 10/-  | 24        | 17/6 |
| 7B8   | 10/-  | 39/44     | 10/6 |
| 7C7   | 9/-   | 46        | 10/6 |
| 7V7   | 10/-  | 58        | 10/6 |
| 10D1  | 5/-   | 84/824    | 9/6  |
| 11D5  | 11/7  | 886A      | 5/-  |
| 12SC7 | 9/-   | 1904      | 10/- |

Post gd.

One Year's Guarantee

|         |       |        |       |
|---------|-------|--------|-------|
| IB5     | 16/5  | ECC40  | 22/1  |
| IB4     | 14/6  | ECC81  | 22/1  |
| IB5     | 16/5  | ECC82  | 22/1  |
| IT4     | 14/6  | ECC83  | 22/1  |
| 384     | 14/6  | ECC91  | 31/6  |
| 3V4     | 14/6  | EOH3   | 22/8  |
| 1A7GT   | 18/11 | EOH35  | 20/2  |
| IC5GT   | 14/6  | EOH42  | 20/2  |
| 1HG7    | 14/6  | ECH31  | 20/2  |
| IN5GT   | 14/6  | ECL80  | 23/4  |
| 3A4     | 18/11 | EP9    | 19/6  |
| 3A5     | 31/6  | EP37A  | 22/1  |
| 5Y3GT   | 13/3  | EP39   | 16/5  |
| 6A4     | 15/1  | EP40   | 22/1  |
| 6AL5    | 11/4  | EP41   | 16/5  |
| 6AQ5    | 16/5  | EP42   | 22/1  |
| 6AT6    | 15/1  | EP50   | 22/1  |
| 6AU6    | 22/1  | EP80   | 22/1  |
| 6BA6    | 16/5  | EP91   | 22/1  |
| 6BE6    | 20/2  | EP93   | 16/5  |
| 8A6     | 31/6  | EK32   | 22/8  |
| 6SA7GT  | 20/2  | EK90   | 20/2  |
| 6SK7GT  | 16/5  | EL3N   | 20/2  |
| 6SQ7GT  | 15/1  | EL33   | 16/5  |
| 6V6GT   | 16/5  | EL37   | 22/1  |
| 6X4     | 13/3  | EL38   | 25/2  |
| 6X5GT   | 13/3  | EL41   | 16/5  |
| 12AT7   | 4/-   | EL42   | 18/5  |
| 12AU7   | 22/1  | EL84   | 18/5  |
| 12AX7   | 22/1  | EL90   | 16/5  |
| 12BA7GT |       | EM1    | 16/5  |
|         |       | EM4    | 16/5  |
|         |       | EM34   | 19/5  |
|         |       | EY51   | 25/2  |
|         |       | EZ35   | 13/3  |
|         |       | EZ40   | 13/3  |
|         |       | EZ41   | 13/3  |
|         |       | EZ60   | 13/3  |
|         |       | EZ90   | 13/3  |
|         |       | 60L6GT | 16/5  |
|         |       | 80     | 13/3  |
|         |       | AZ1    | 13/3  |
|         |       | AZ31   | 13/3  |
|         |       | AZ60   | 13/3  |
|         |       | CLB1   | 22/1  |
|         |       | CL4    | 20/2  |
|         |       | CY1    | 30/3  |
|         |       | EAS0   | 11/4  |
|         |       | EAB0   | 9/5   |
|         |       | EAF42  | 17/8  |
|         |       | EBB30  | 15/1  |
|         |       | EB41   | 11/4  |
|         |       | EB91   | 11/4  |
|         |       | EBC33  | 15/1  |
|         |       | EBC41  | 15/1  |
|         |       | EBF60  | 18/11 |
|         |       | E3L1   | 22/1  |
|         |       | E3L21  | 20/2  |

DEMOBBED VALVES MANUAL

2/6

Giving equivalents of British and American Service and Cross Reference of Commercial Types with an Appendix of B.V.A. Equivalents and Comprehensive Price List. We have still some Valves left at very old Budget Rates (33%) which are actually sold at the old price. (1951 rate).

PIFCO



All-in-one Radiometer A.C./D.C. Tests everything in Radio. Complete with Test prods.

29/6. Post 1/6.

Chassis Cutters with Keys



The easiest and quickest way of cutting holes in sheet metal. The cutter consists of three parts: A die, a punch and an Allen screw. The operation is quite simple. Prices incl. key: 1in. 12/4; 1 1/4in. 13/4; 1 1/2in. 13/4; 1 3/4in. 14in. and 1 1/2in. 16/- each; 1 1/2in. 19/9; 2 1/2in. 31/9; 2 1/2in. 36/9; 1in. square, 24/3. Post 1/-.

UNIQUE SERVICE



SERVICE SHEETS

The one you require enclosed if available in a dozen assortment of our best choice. 10/6.

RADIO BULLS VALVES

246 HIGH ST. HARLESDEN NN10

TUBES VCR 97 20/-

Post 2/6.

12" Type 511

Electrostatic, same base as VCR 97 £4-10-0 Carr. 4/6.

9" TUBE CRT 516 Magnetic 4 v. heater, 4 to 5 kv. E.H.T. Int. Octal Base. BARGAIN Carr. and Crate, 4/6. 29/6

TAYLOR METERS on EASY TERMS Ask for Catalogue

B.T.H. GERMANIUM CRYSTAL DIODE. Complete with Blue-2/- print and operating instructions.

ROD ANTENNAS. 1ft. sections interlocking and extending, copper plated steel. BARGAIN. 2/6 Dozen

7/6 REDUCED FROM 21/- 7/6 Pre-heated Electric Soldering Irons. 24 v. 36 Watts. Press button switch fitted. Corrosion-free Bit. Specially designed for fine work. Limited quantity.

EX-GOVT. LIGHTWEIGHT HEADPHONES Brand new. In original boxes. Complete, a pair. 7/6

COMPONENTS FOR OSRAM 912 AMPLIFIER

|                                 |         |
|---------------------------------|---------|
| T.C.C. Condensers               | £2 15 0 |
| W.B. Mains Transformers         | £3 18 8 |
| W.B. Output Transformer         | £1 12 0 |
| W.B. Smoothing Choke            | £1 18 0 |
| W.B. Chassis                    | £1 14 9 |
| Bulgin Knobs L.370 (5), each    | 1 6     |
| Bulgin Switch S.300             | 6 0     |
| Bulgin Signal Lamps             | 2 8     |
| Bulgin Plug and Sockets P.73    | 4 6     |
| Bulgin Plug and Sockets P.437   | 6 6     |
| Bulgin Tag Panel C.114-1        | 4 0     |
| Bulgin Tag Strip T.17 (2), each | 5       |
| Lab. Resistors and Pots         | £1 12 6 |
| Dial Plate                      | 14 6    |
| A.B. Switches (2), pair.        | 14 0    |
| Book                            | 3 6     |

Deposit and Monthly 10/- A.C. ELECTRIC



PAINT SPRAYER

Just plug in and spray. Easier than a brush and twice as fast. Post 2/- Ceiling Adaptor Free. Cash 75/-

Electric PAINT STRIPPER



Outdates blow-lamp. It's a unique foolproof electric tool. Easier and faster. Clean and safe. Old paint goes like magic. Cost 1d. per hour. A.C./D.C. Complete. Guaranteed one year. Tax Free 39/6 Post Free.

A new book of great interest to all concerned with Sound Broadcasting

STUDIO ENGINEERING FOR SOUND BROADCASTING

By Members of BBC Engineering Division: General Editor J. W. Godfrey

Compiled for the training of B.B.C. staff in the principles underlying operational procedures at studio centres, this book will be valuable to broadcasting staffs throughout the world on both the engineering and non-engineering sides. Although the information mainly relates to B.B.C. equipment and procedures, most of the text has a very general application in audio-frequency engineering. Each of the six authors is a specialist with long experience in his field, and the technical level throughout is practical rather than academic.



Published for "Wireless World"

Obtainable from booksellers or direct from:

Iliffe & Sons Limited, Dorset House, Stamford Street, London, S.E.1

Contents

- Development of the Broadcasting Chain
- Transmission Quantities
- Acoustics and Microphone Placing
- Amplifier Equipment
- Broadcast Programme Sources
- The Control Room
- Programme Circuits on Post Office Lines
- Monitoring
- The B.B.C. Communication System

Get your copy NOW

8 1/2" x 5 1/2" 208 pp. Illustrated

25s. net.

By Post 25s. 6d.

# "MUST HAVE" BARGAINS!

**CONSTANT VOLTAGE TRANSFORMERS.** Manufactured by SOLA of CHICAGO, U.S.A. Primary 90-125 v. or 190-250 v. Secondary 115 v. precisely at 2 KVA. Can be adjusted for 50 or 60 cycles operation. Primary and secondary are completely isolated, and for 230 v. output two can be used in series. Fully guaranteed. ONLY £21 each, or £40 per pair.

**RF UNITS TYPE 26 and 27.** For use with the R.1355 or any receiver with a 6.3 v. supply. These are the variable tuning units which use 2 valves EF54 and 1 of EC52. Type 26 covers 65-50 Mc/s (5-6 metres) and Type 27 covers 85-65 Mc/s (3.5-5.0 metres). Complete with valves, and BRAND NEW IN MAKER'S CARTONS. ONLY 29/6 each.

**"PYE" 45 MC/S I.F. STRIP.** Ready-made for London Vision Channel, this 5-stage strip contains 6 valves EF50 and 1 EA50. Supplied with circuit and details of very slight mods. required. BRAND NEW, ONLY 69/6 or less valves 50/-.

**VACUUM PUMPS.** For Handymen and Model Makers. Ex-R.A.F. Type B3. BRAND NEW IN MAKER'S CARTONS. ONLY 22/6 (post 2/-)

**TRANSFORMERS.** Manufactured to our specification and fully guaranteed. Upright mounting, fully shrouded, normal primaries.

425 v.-0-425 v. 250 mA., 6.3 v. 4 a., 6.3 v. 4 a., 5 v. 3 a., 65/-  
 350 v.-0-350 v. 160 mA., 6.3 v. 6 a., 6.3 v. 3 a., 5 v. 3 a., 47/6.  
 350 v.-0-350 v. 150 mA., 6.3 v. 5 a., 0-4-5 v. 3 a., 37/6.  
 250 v.-0-250 v. 100 mA., 6.3 v. 6 a., 5 v. 3 a., 37/6.  
 250 v.-0-250 v. 60 mA., 6.3 v. 3 a., 5 v. 2 a., 21/-.

Please add 2/- per transformer postage.

**TRANSFORMERS, FILAMENT.** 6.3 v. 2 a., 7/6 (postage 1/-), 6.3 v. 3 a., 10/6.

**TRANSFORMERS, EHT.** Upright mounting.

EHT for VCR97 Tube 2,500 v. 5 mA. 2 v.-0-2 v. 1.1 a., 2 v.-0-2 v. 2 a., 42/6.  
 EHT 5,500 v. 5 mA., 2 v. 1 a., 79/6.  
 EHT 7,000 v. 5 mA., 2 v. 1 a., 89/6.  
 EHT 7,000 v. 5 mA., 4 v. 1 a., 89/6.  
 Please add 2/- per transformer postage.

**TRANSFORMERS, EX-W.D. AND ADMIRALTY,** built to more than 50 per cent. safety factor with normal A.C. mains primaries. Brand New and unused. 330-0-330 v. 100 mA. 4 v. 3 a., 22/6.

L.T. 6.3 v. 7.7 amp., 4.2 v. 2.5 amp. 4 v. 1 amp., 19/6.

Please add 2/6 per transformer postage.

**UNREPEATABLE OFFER.** Manufacturer's surplus EHT Transformer giving 2,000 volts RMS (approx. 2,800 v D.C.) Suitable for VCR 97 or similar tubes. Ideal as an insurance against breakdown of EHT supplies in equipment of this nature, at ONLY 15/- (post 2/-).

## COMMUNICATIONS RECEIVER R.1155

The famous ex-Bomber Command Receiver known the world over to be supreme in its class. Covers 5 wave ranges: 18.5-7.5 Mc/s., 7.5-3.0 Mc/s., 1,500-600 kc/s., 500-200 kc/s., 200-75 kc/s., and is easily and simply adapted for normal mains use, full details being supplied. Aerial tested before despatch. BRAND NEW AND UNUSED IN MAKER'S TRANSIT CASES, ONLY £11/19/6.

BRAND NEW BUT SHOP-SOILED, also tested working before despatch, £9/19/6 (carriage 10/6).

**A.C. MAINS POWER PACK OUTPUT STAGE,** in black metal case, enabling the receiver to be operated immediately, by just plugging in, without any modification. Can be supplied as follows, WITH built-in 6in. P.M. Speaker, £5/5/-. LESS speaker, £4/10/- (carriage 3/6).

DEDUCT 10/- IF PURCHASING RECEIVER AND POWER PACK TOGETHER.

Send S.A.E. for illustrated leaflet, or 1/3 for 14 page booklet, which gives technical information, circuits, etc., and is supplied free with each receiver.

## MODULATOR TYPE 67

Contains fully smoothed normal A.C. Mains Power Pack, transformer being 345 v.-0-345 v. at 200 mA., 6.3 v. 5 a., 6.3 v. 250 mA., 5 v. 2 a., 6 valves SP61, 3 of EA50, 2 of EB34, and 1 of 5Z4. BRAND NEW IN MAKER'S CASES. ONLY 47/6 (carriage 7/6)

## METERS

| F.S.D.        | SIZE AND TYPE                      | PRICE |
|---------------|------------------------------------|-------|
| 5 milliamp.   | D.C. 2in. Flush square             | 7/6   |
| 100 "         | D.C. 2½in. Flush circular          | 12/6  |
| 150 "         | D.C. 2in. Flush square             | 7/6   |
| 500 "         | thermo 2in. Flush square           | 5/-   |
| 500 "         | thermo 2in. Proj. circular         | 5/-   |
| 20 amps.      | D.C. 2in. Proj. circular           | 7/6   |
| 40 amps.      | D.C. 2in. Proj. circular           | 7/6   |
| 30-0-30 amps. | D.C. Car type moving iron          | 5/-   |
| 15 volts      | A.C. 2½in. Flush, circ., mov. iron | 8/6   |

All meters Brand New in Maker's Cartons.

## 100 MICROAMPS METERS

2½in. circular flush mounting. Widely calibrated scale of 15 divisions marked "yards" which can be rewritten to suit requirements. These movements are almost unobtainable today and being BRAND NEW IN MAKER'S CARTONS are a snip at ONLY 42/6.

## HOUR METERS

For checking running time of equipment up to 9,999 hours. Operates from normal 50 cycles mains. BRAND NEW IN MAKER'S CARTONS. ONLY 39/6.

## MODEL MAKERS MOTOR

Reversible poles. Only 2in. long and 1½in. diameter, with ½in. long spindle. Will operate on 4, 6, 12 or 24 volts D.C. ONLY 10/6.

## 12 v. AMERICAN DYNAMOTORS

Output 255 v. 60 mA. Ideal for car radio or running electric shaver from car battery. ONLY 22/6.

## HEAVY DUTY TRANSFORMER

Normal Primaries. Has 3 separate windings of 5 v.-0-5 v. at 5 amps., and by using combinations will give various voltages at high current. Ex Admiralty and extremely robust. BRAND NEW. ONLY 39/6.

**SPECIAL OFFER. Ex-Admiralty L.T. TRANSFORMER.** Normal mains input, output 4 v. 20 amps. C.T. New and unused, these have become damaged, but are still usable, the damage being confined to broken fixing lugs, and/or broken bakelite terminal panels. Formerly sold at 30/-, now offered at 17/6 (post, etc., 2/6).

**POCKET VOLTMETERS.** Not Ex-Govt. Read 0-15 v. and 0-300 v. A.C. or D.C. BRAND NEW AND UNUSED. ONLY 18/6.

**SUNDRIES.** Warning light assemblies, Red, Green or Clear, 2/- ea. Miniature plugs and sockets, 3-way 7d. pair, 4-way 9d. pair, 5-way 10d. pair. Jack plugs, 2/- each. ½in. coil formers with slug 10d., ½in. 8d. Valveholders I.O. & M.O. Amphenoil, 6d. ea., B3G (diode) 6d., B9G ceramic 10d., Brit. 5-pin Ceramic 1/-, Co-axial plugs and sockets, Pye 6d. ea., Belling, plug 1/3, socket 1/4, coupler for joining cable 2/- (post 3d. per item).

**POTENTIOMETERS,** less switch, long spindle, 1K, 3K, 5K, 10K, 20K, 25K, 100K, 250K, 500K, 2M, 2/9 ea., short spindle 50K, 75K, 1M, 2/9 ea. WITH switch long spindle, 1K, 2K, 2.5K, 10K, 15K, 20K, 25K, 50K, 75K, 250K, 500K, 2M, 3/9 ea. (post 3d.).

**SPRAGUE** .1 mfd. 600 v. metal tubulars, 10d. ea., 9/6 dozen (add post).

**SILVER MICAS AND MICAS.** 2pf, 5pf, 10pf, 11.5pf, 15pf, 20pf, 25pf, 40pf, 47pf, 50pf, 75pf, 80pf, 100pf, 115pf, 160pf, 300pf, 430pf, 440pf, 1050pf, 2300pf, .0001 mfd., .00016 mfd., .0002 mfd., .00025 mfd., .001 mfd., .002 mfd., .005 mfd., 5d. each, or 3/6 per dozen 1 type.

**INTERNATIONAL OCTAL PLUG** Fits into I.O valveholder, 2/- (post 3d.).

**GANGED POTENTIOMETERS.** Double 50K and double 1 meg., 7/6 each.

**CERAMIC 2-WAY 3-BANK SWITCHES,** 7/6 each.

24 v. **BLOWER MOTORS.** Only 12/6.

**CRYSTALS.** British Standard 2-pin 500 kc/s. 15/-. Miniature 200 kc/s and 465 kc/s. 10/- each.

**SPEAKERS.** P.M., 6½in. ess trans., 19/6; 8in., less trans., 19/6; 10in. with trans., 27/6 (postage 2/- ea.).

**CHOKES.** 10H 60 mA., 4/-, 5H 200 mA., 7/6, 20H 120 mA., 10/6 (post 1/- ea.).

**MU-METAL SCREEN FOR VCR97 TUBE,** etc., ONLY 8/6.

**CABLE.** CLEARANCE OFFER of 23/36 twin polythene. Weatherproof, and suitable for outdoor use, 39/6 per 100 yard coil (carriage, etc., 3/6). S.A.E. for sample, trade enquiries invited.

Cash with order please, and print name and address clearly

# U.E.I. CORPORATION

Radio Corner, 138, Gray's Inn Road, London, W.C.1. Phone: TERMINUS 7937

(Open until 1 p.m. Saturdays. We are 2 mins. from High Holborn (Chancery Lane Station) and 5 mins. by bus from King's Cross)

# GEE Radio RADIO LTD.

## SCR-720 RADAR EQUIPMENT EX-U.S.A. CONSISTING OF THE FOLLOWING ITEMS:

RADIO MODULATOR B.C. 1142A. RADIO FREQUENCY UNIT B.C. 1091AM. CONTROL BOX B.C.1150V. RECTIFIER RA-88-A. RECTIFIER RA-90-A AND POWER EQUIPMENT P.E. 158B.

ALL THE ABOVE ITEMS WHICH ARE ALL NEW AND SOUND FORM THE MAJOR PART OF THE COMPLETE SCR-720 SET AND CAN BE SOLD AT A FRACTION OF THE ORIGINAL COST. LIMITED QUANTITY AVAILABLE ONLY. PLEASE WRITE FOR FURTHER DETAILS, ETC.

**50 WATT AMPLIFIER EX-GOVT.** With 4-KT66s in paralld push-pull. Standard 200-250 v. mains input. A.C. Output impedance 600 ohms line. High imp., gram. and microphone input. Bass boost control fitted. This excellent quality amplifier is housed in a strong metal case and is ready for use. Our price £25, carriage paid.

**ELECTRIC LIGHT SLOT METERS.** 200-250 v. at 5-10 amps. 1/- in slot at 6d. per unit, by Measurement Ltd. All bakelite case, in very good condition. 50/-, p.p. 2/6.

**TELEPHONE L/SPEAKER No. 2 (By Vitavox).** Semi-re-entrant all-metal. H/Duty 6in. P.M. 15 ohms 5/Coil., with 600 ohm built-in line transformer. Housed in a strong wooden case. £1/5/-, carriage 5/-.

**WESTON BATTERY OSCILLATOR, MODEL E.692 TYPE 2.** New and unused. Coverage 100 kc/s-26 Mc/s. Audio output approx. 400 c/s. Available complete with instruction booklet at the ridiculously low price of only £5/19/6, p.p. 4/6 extra.

**VITAVOX PRESSURE UNITS.** Heavy duty, P.M. 20 watts. Brand new. £4/9/6, carriage 5/-.

**TRUVOX 12in. 3 OHMS P.M. SPEAKERS.** Brand new and boxed, 39/6 post paid.

**ROTARY CONVERTERS.** 12 v. D.C. input, 230 v. A.C. 50 cycles output at 100 watts. Brand new. £4/17/6. Ditto 24 v., same price, carriage 7/6.

**INDICATOR UNIT TYPE 302.** Containing VCR97 with screen and base, 4-VR91s (EF50), 3-VR65s, 3-VR54s, diode, 1 at 2.5 kv., etc. Bargain value at £2/19/6, carriage 5/- extra.

**AN/APA-1 CATHODE RAY INDICATOR AMPLIFIER UNIT.** Complete, comprising 3BP1 C.R.T., 7-6SN&gts, 1-6H6, 1-6G6, 1-2X2, 1-6X5, valves. Bargain value, £4/19/6, plus 10/- carriage.

**RA-88 RECTIFIER UNIT (PART OF SCR.720) EQUIPMENT.** Containing the following valve line-up: 3-6L6 metal valves, 3-5T4 metal valves, 2-6SL&gts, 2-VR150/30s, etc., etc. Bargain value at £4/19/6, carriage 5/-.

**A.C./D.C. SUPPLY UNIT (S.T.C. Selenium rectifier).** Complete with mains isolation transformer, fixed and housed in strong metal cabinet. 250 v. A.C. at 200-220 v. D.C. at 3-4amps. Ready to use for £8/10/- only, carriage 10/-.

**R.1155 COMMUNICATION RECEIVERS.** Individually tested and despatched in good working order. Cases slightly soiled. £8/19/6. Brand new, £10/19/6.

**RECEIVER TYPE 109.** In good condition. Freq. range 1.8-3.9 mc/s and 3.9-8.5 mc/s continuous. Designed to operate on 6 v. battery. Limited quantity only, £4/7/6, plus 10/- carriage.

**No. 38 WALKIE-TALKIE TRANS-RECEIVER.** In good condition (less external accessories). 30/-, p.p. 2/6.

**TRANSMITTER-RECEIVER No. 19.** Complete with all valves. Soiled but good. Bargain value at £6, carriage 10/-.

**CATHODE RAY TUBES.** Type 3BP1, 3in. new and unused with base and screen, 42/6, p.p. 2/-; Type VCR138 (ECR35), 3 1/2in. with screen and base, in new and unused condition, 42/6, p.p. 2/-; Type VCR97, 6in., ex-equip., in good order, 20/-, p.p. 3/6. VCR131, lin. C.R.T. new and in perfect condition. Miniscope replacement tube, etc., 35/-, p.p. 1/-; Type CV1526, 2 1/2in., 4 v. filament, 3,000 v. anode. Complete with base and mu-metal screen, 20/-, p.p. 2/6.

**PHOTO ELECTRIC MULTIPLIER CELLS. TYPE 931A, £2/10/-, p.p. 1/-.** Also 931A complete on chassis with multiplier network and 2-832 valveholders, etc., £3/10/-, p.p. 2/-

**PAINTON PLUGS AND SOCKETS (MIN. JONES).** All types available below list price. Please let us quote you.

**HIGH VOLTAGE TRANSMITTING CONDENSERS.** Hank pot type (25 pf. 8 kv.), (40 pf. 9.6 kv.), (500 pf. 15 kv.), (600 pf. 9.6 kv.), (750 pf. 15 kv.). Any type, 3/6 each, p.p. 1/-; Also in stock, glass vacuum condensers, 50 pf. 32 kv. 25/-, p.p. 1/-.

**L.M.S. SMALL COIL PACK.** Size 2 1/2in. x 2 1/2in. x 1 1/2in. Very good quality, with circuit diagram. 19/6 each only. Every one guaranteed.

**CERAMIC WAVE-CHANGE SWITCH (WEARITE).** One-pole 12 position 2 bank. 7/6, p.p. 1/-.

**813 CERAMIC VALVE HOLDERS.** 9/6 each, p.p. 6d. Also 4-pin large "Jumbo" ceramic valve holders, 6/6 each, p.p. 6d.

**POWER UNITS.** Type 3, made for use with the R.1132A, this is a standard rack mounting job to match the receiver and is for 200/250 v. 50 cycle mains with output of 250 v. D.C., 100 mA, at 6.3 v. 4 amps., £3/15/-, carriage 5/-; Power unit for Wireless No. 11, 12 v. D.C. input, 230 v. D.C. output at 30 mA, fully smoothed, 19/6, 2/6 p.p. Power unit ex-No. 19 Trans-Receiver, 12 v. D.C. input, 275 v. D.C. output at 100 mA, fully smoothed, 19/6, p.p. 4/-; Power unit No. 4 MK 1, ex-No. 22 set. 12 v. D.C. input, 300 v. H.T. output at 100 mA. (Metal rectifier and vibrator) fully smoothed, etc., in strong metal case. 35/-, p.p. 3/6.

**TELESCOPIC AERIALS.** Min. length 12in., max. length 48in., suitable for car radio aerials. 8/6 each, p.p. 9d.

**CAR RADIO TRANSFORMERS.** 12 v. ex-Philco, 300 v. H.T. at 90 mA. Brand new and unused. Only 12/6, p.p. 2/-; 12 v. Oak vibrators 4-pin U.X. base, new and unused, 7/6 each, p.p. 9d.

**HALF MILE OF TWIN DON "8" TELEPHONE WIRE.** Brand new, on wooden drums, £2/12/6, per drum, carriage 10/- extra, England only.

**MANY OTHER LINES IN STOCK. YOUR ENQUIRIES INVITED. TRADE SUPPLIED.**

**15 LITTLE NEWPORT ST., LONDON, W.C.2.**

GERrard 6794/1453.

# RADIO TRADERS LTD.

23 WARDOUR ST., LONDON, W.1. (Coventry Street end)  
Phone No. GERrard 3977/8 Grams: "Radiotrade"

## PAXOLIN SHEET

18in. x 4 1/2in. x 1/8in. .... 1/- each 10in. x 10in. x 1/8in. .... 1/6 each  
18in. x 10in. x 3/8in. .... 1/6 each 20in. x 10in. x 1/8in. .... 3/- each

## BLOCK PAPER CONDENSERS.

4 Mid., 400v., 3/6 each. Many other types in stock. Your enquiries invited.

## CONDENSERS

|   | Per doz. |
|---|----------|
| 16 Mid., 375 v., 2/- each.....          | 21/-     |
| 16 x 16 Mid., 350 v., 2/6 each .....    | 27/-     |
| 16 x 24 Mid., 350 v., 2/6 each .....    | 27/-     |
| 16 x 32 Mid., 275 v., 1/6 each .....    | 15/-     |
| 20 x 20 Mid., 275 v., 2/6 each .....    | 27/-     |
| 24 Mid., 350 v., 1/6 each.....          | 15/-     |
| 24 Mid., 450 v., 2/3 each .....         | 24/-     |
| 32 x 8 x 8 Mid., 275 v., 1/9 each ..... | 18/-     |
| 50 Mid., 12 v., 1/- each .....          | 10/6     |
| 100 Mid., 6v., 10d. each .....          | 9/-      |

Condenser Clips for above Tubular Condensers 3/6  
Large Assortment Tubular Condensers 6/-

**MIDGET MICA CONDENSERS:** .0001, .0002, .0003, .0004, .0005, 5/-  
200 Assorted Moulded Micas. Popular Values £2 10 0  
200 Assorted Silver Micas. Popular Values £2 10 0  
200 Assorted Carbon Resistors: 1/4 and 1 watt. Good selection £1 10 0

## SPECIAL OFFER

**0.1, 12,000 volts D.C. test Mansbridge Condensers, Price 5/6**  
Height 6in. Width 3 1/2in. Depth 2 1/2in. Flxing centres 4in. + postage 1/-

Special prices for quantity.

**CARBON RESISTORS:** 1/4 watt 2/6; 1/2 w. 3/-; 1 w. 4/-; 2 w. 6/- per doz.

**HIGH STABILITY RESISTORS:**

Tolerance: 1% 2% 5%  
1/4 watt 1/- 9d. 6d. each  
1/2 watt 1/3 1/- 9d. each  
1 watt 1/9 1/6 1/3 each  
8-40 MEG 2 watt 2/6 each

C.O.D. preferred for resistor orders as we cannot guarantee to stock all values.

**PYE PLUGS AND SOCKETS** 1/6 pair

**WW AND VITREOUS RESISTORS.** 5 watt, 1/6; 10 watt, 2/6; 15 watt, 3/-; 20/30 watt, 3/6 each

**WW V/CONTROLS.** COLVERN and B-NSF. 5K PRESET and other values, 2-3 watt, 2/- each. 10K Isolated Spindle..... 2/-

500 ohms, 1K, 20K, 25K, 50K, with spindle ..... 2/6

**V/CONTROLS WITH SWITCH:** most values, B-NSF 2/6

**V/CONTROLS:** Less Switch, Preset and Spindle. MOST VALUES 1/9

**METERS** 0-300 mA 2 1/2" Flush Mounting..... 8/6 each  
0-500 mA 2 1/2" Flush Mounting..... 10/6 each

**TWIN MIDGET GANGS,** .0005, with trimmers, PERSPEX COVER 6/9

**4-WAY PUSH BUTTON UNITS,** 2/6 each 20/- doz.

**PUSH BUTTON KNOBS** 3/- "

**TAG STRIPS:** 3-way 2/- doz.; 4-way 2/6 doz.; 5-way 3/- doz.; 7-way 4/- doz.; 28-way 12/- doz.

**POINTER KNOBS.** Small black, with line, 1/4in. hole 7/6 "

**WANDER PLUGS.** Red and Black 2/- "

**PHILIPS TRIMMER TOOLS** 1/- each

**BELLING & LEE. P/M FUSE HOLDERS.** Type L356 2/6

**WEARITE COILS:** Types PA4, PO4, PA5, PO5, 1/3 each 12/- doz.

**VALVE HOLDERS:** Moulded. B9A, 7/6; B7G, 6/-; EF50, Pax., 6/-; EF50, Ceramic, 9/- per doz.; ENGLISH OCTAL, 3/- per doz. SCREEN CANS for B9A, B7G, 6/- doz.

**PAXOLIN** - B7G, MAZDA 4-pin UX 3/- "

Valveholders fitted with lower screens to accommodate cans, 1/6 per doz. extra.

**BELLING & LEE PLUGS AND SOCKETS.** Ex-Govt. BRAND NEW. 5-pin, 1/6; 7-pin, 1/9; 10-pin..... 2/6 pair

**BULGIN.** P74, Plug and Socket, 2/6; P200, Plug and Socket, 2/-; Rotary Switches, S.255, 2/-; Dolly Switches, S.267, 2/-; Standard Switches, Ex-Govt. On-off ..... 1/6 each

**POST OFFICE LAMP JACKS,** No. 10, 1/- each 9/- doz.

Lamp Covers for same 3/- "

**WESTINGHOUSE KHI HALF WAVE RECTIFIER.** Rating 3.6 v., at 10 mA, 3/6 each; 36/- per doz.

**OUTPUT TRANSFORMERS.** Multi Ratio, 5/-; Pentode or Power 4/- each

**VALVE SCREEN CANS** for Standard Valves, 1/- each 10/6 doz.

**DRUM DRIVES,** 4pin. 1/- each

**WESTECTORS.** WX6, WX12, W1, W12, W4, 1/- each 9/- doz.

**ARCOLETRIC (Whitney Lamp),** Red, green, clear, 1/6 each 15/- "

**SIGNAL LAMP HOLDERS P/M,** complete with adjusting lamp holders, 1/9 each 18/- "

**AIR SPACE TRIMMERS.** Preset and spindle types, 5PL, 10PF, 15PF, 20PF, 25PF, 50PF, 75PF, 15/-; 100PF Preset, 1/6 each 15/- "

**JONES PLUG AND SOCKETS.** 4-pin, 2/6; 6-pin, 3/-; 8-pin, 3/6; 10-pin, 4/-; 12-pin ..... 6/- pair

**NUTS,** 8BA, 3/-; 6BA, 2/6; 4BA, 3/-; 2BA ..... 4/- gross

**SOLDER TAGS,** 2/6 gross. **SHAKEPROOF WASHERS** 2/- "

**WASHERS,** 2, 4 and 6BA ..... 1/- "

**SHAKEPROOF SOLDER TAGS,** 4BA and 6BA, 2/-; 2BA... 2/9 "

**CASH WITH ORDER OR C.O.D. ALL ORDERS DEPT. W.1**

**ALL ORDERS FOR LESS THAN £2 ADD POSTAGE**

We invite your enquiries for items not listed.

Trade Counter open 9 to 6 Monday to Friday.

Callers Welcomed.

WHOLESALE, MANUFACTURERS' AND EXPORT ENQUIRIES INVITED



5 Harrow Road, Paddington, W.2

PADddington 1008/9 and 0401

OPEN MONDAY to Sat. 9-6. THURS. 1 o'clock.

SEND STAMPS FOR NEW 1955 28-PAGE CATALOGUE

**RADIO-GRAM CHASSIS**

3 Wave-band Superhet. Med., long and short.

5 Latest Type MULLARD Valves.

4 Position Switching Gram., med., long and short.

Provision for Extension Speaker. A.C. Mains. 110/250 volts.

Chassis 1 1/2 in. x 7 in. x 2 1/2 in. Scale Bin. Square. Or Chassis 1 3/4 in. x 6 1/2 in. x 2 1/2 in. Dial 10 in. x 5 1/2 in. PRICE £10/5/-.

BRAND NEW AND GUARANTEED. CARR. PACKING AND INS. 10/-.

**G.E.C. RECORDING TAPE**

600ft. Reels ..... 10/-

**EF50 (VR91A)**

The selected EF50, Red Sylvania, original boxes 10/- each, 90/- for ten.

**PYE 45 Mc/s. STRIP TYPE 3583 UNITS**

Size 1 1/2 in. x 8 in. x 2 in. Complete with 45 Mc/s. Pye Strip, 12 valves 10 EF50, EB34 and EA50, volume controls, and hosts of Resistors and Condensers. Sound and vision can be incorporated on this chassis with minimum space. New condition. Modification data supplied. Price £5. Carriage paid.



(CASE REMOVED FOR ILLUSTRATION)

**TRANSMITTER/RECEIVER "38" WALKIE TALKIE SETS**

We have purchased large quantity of the above "38" Sets, and can now offer same complete in case with 5 valves 4-VP23 and ATP4, Throat Microphone, Headphones, Junction Box and Collapsible Aerial in absolutely new condition and guaranteed Air Tested. Freq. range 7.4 to 9 Mc/s. Range approx. 5 miles. Voltage 150 v. and 3 v. L.T.

59/6 CARR. 5/-.

**CRYSTALS**

|                               |      |
|-------------------------------|------|
| 200 kc/s, 2 pin, U.S.A.....   | 10/- |
| 465 kc/s, 2 pin, U.S.A.....   | 10/- |
| 500 kc/s, 2-pin, British..... | 15/- |

Holders for U.S.A. Types 1/6.

**PHILIPS COMMUNICATION RECEIVER P.C.R.3.**  
Brand New. In original cartons. Valves. Frequency 12/560 metres. Less power unit. Can be adapted for mains at cost of 35/-. £10/10/- Carr. 7/6.

**"426" CONTROL UNIT**  
Containing 4 EF50, 2 SP61, 2 EA50, 1 EB34, 2-single-gang .0005 tuning condensers. W/W volume/controls switches, condensers and resistors. Size 12 in. x 9 in. x 5 in. New condition. 35/-, carr. 3/-.

**T.V. PRE-AMPLIFIER FOR LONDON AND BIRMINGHAM.** Complete with 6AM16. Ready to plug into your set, 27/6. P.P. 2/6.

**CRYSTAL MICROPHONE INSERTS**

8/6 POST FREE  8/6 POST FREE

Ideal for tape recording and amplifiers. No matching transformer required.

**"R.F. 26" F.M. CONVERTOR UNIT— 88/100 Mc/s.**

We can now offer this self-contained Unit comprising 6 Valves—2-8BA6, EB91, VR137, EF54, EF54. Two I.F. stages and separate local oscillator, also Mullerhead graduated vernier drive assuring easy tuning.

**COMPONENTS OFFERED TO COMPLETE F.M. UNIT**

- New RP26 Unit with 3 valves VR137, EF54, EF54, £11/15/-.
- Complete set of all components for conversion including 2 8BA6 and EB91, tuning condenser, I.F.T.'s Osc. and coils. Resistors and fixed condensers, plus wire and tag strips, 24/12/6.
- Instruction Book with technical circuit and complete lay-out diagrams, 2/-.
- Voltage required 250 v. 50 mA. 6.3 2 amps.
- Special offer of all above items and RP26, including circuit, £28/5/-, postage 3/-.

**ALL ITEMS SOLD SEPARATELY**

- Charge for alignment when completed ..... 7 6
- Assembled, aligned and ready for use ..... £8 10 0



Call for demonstration.

**MORSE PRACTICE KIT**

Complete with buzzer, morse tapper and battery compartment on baseboard, 6/-, post paid.

**RCA 931A PHOTO-ELECTRIC CELL AND MULTIPLIER.** For facsimile transmission, flying spot telecine transmission and research involving low light-levels. 9-stage multiplier. Brand new and guaranteed, only £2/10/-. Special 11-pin base 2/- Data sheets supplied.

**TUNING CONDENSERS**

|  |     |
|--|-----|
| .0005 Midget 2 1/2 x 1 1/2 in. ....                | 5/- |
| .0005 Midget 2 1/2 x 1 1/2 in., with trimmers..... | 6/6 |
| .0005 Standard Size, with trimmers.....            | 7/6 |
| .0005 with 4-way push-button assembly.....         | 7/6 |

**NEON INDICATOR LAMP**

Siemens type V1132. Diameter 1 1/2 in. Striking volts 80 v. S.P.B.C. 2/6 post free.

**INDICATOR UNIT TYPE 182A**

Unit contains VCR517 Cathode Ray 6in. tube, complete with Mu-metal screen, 3 EF60, 4 8P61, and 1 6U4G valves, 9 wire-wound volume controls and quantity of resistors and condensers. Suitable either for basis of television (full picture guaranteed) or Oscilloscope. Offered BRAND NEW (loss relay) in original packing cases at 67/6. Plus 7/6 carr. "Radio-Constructor" scope circuit included.

**R.F. UNITS**

|                        |      |
|------------------------|------|
| R.F.24 20/30 Mc/s..... | 15/- |
| R.F.25 40/50 Mc/s..... | 19/6 |
| R.F.26 50/65 Mc/s..... | 35/- |
| R.F.27 60/80 Mc/s..... | 35/- |

Brand new, carr. free.

**U.S.A. PACKARD-BELL PRE-AMPLIFIER**



Complete with 6SL7GT-28D7GT, relay, plugs, condensers, etc. Instruction booklet. Brand new 12/6, p.p. 2/-.

**CATHODE RAY TUBES**

|  |         |
|--|---------|
| VCR139A. 2 1/2 in. O/B Tube. Brand new in original cartons (carr. free).....                   | £1 15 0 |
| VCR97. Guaranteed full T/V picture (carr. 2/-).....  | £2 0 0  |
| VCR517C. Guaranteed full T/V picture..   | £1 15 0 |
| MU-METAL SCREENS for VCR97 or 517. P.P. 1/6.....   | 10 0    |
| 6in. ENLARGER for VCR97 or 517. P.P. 1/6.....  | 17 6    |
| VCR97. Brand new and crated—slight cut-off—Ideal for 'scopes. Limited quantity. Carr. 2/-..... | 15 0    |

**PHOTO CELLS G.S.18.** Brand new, 25/-

PLEASE ADD POSTAGE. ARTICLES UP TO 10/-, 1/-, £1, 1/6, £2, 2/-.

# MAINS TRANSFORMERS

FULLY INTERLEAVED  
SCREENED AND IMPREGNATED. ALL GUARANTEED

ALL PRIMARIES ARE 200/250 v. Half Shrouded.

|  |      |
|--|------|
| HSM63 (Midget). Output 250-0-250 v. 60 m/a., 6.3 v. at 3 amps., 5 v. at 2 amps. .... | 16/3 |
| HS63. Output 250-0-250 v. 60 m/a., 6.3 v. at 3 amps., 5 v. at 2 amps. ....           | 16/6 |
| HS40. Windings as above. 4 v. at 4 amps., 4 v. at 2 amps. ....                       | 16/6 |
| Output.  |      |
| HS2. 250-0-250 v. 80 m/a. ....   | 19/- |
| HS3. 350-0-350 v. 80 m/a., 19/-.   | 19/- |
| HS30. 300-0-300 v. 80 m/a. ....  | 19/- |
| HS2X. 250-0-250 v. 100 m/a., 21/-.   | 21/- |
| HS75. 275-0-275 v. 100 m/a. ....   | 21/- |
| HS30X. 300-0-300 v. 100 m/a., 21/-.  | 21/- |
| HS3X. 350-0-350 v. 100 m/a. ....   | 21/- |

**Fully Shrouded**

|   |      |
|---|------|
| FSM63 (Midget). Output 250-0-250 v. 60 m/a., 6.3 v. at 3 amps., 5 v. 2 amps. ....   | 16/9 |
| Output  |      |
| FS2. 250-0-250 v. 80 m/a. ....  | 21/- |
| FS30. 300-0-300 v. 80 m/a., 21/-.   | 21/- |
| FS3. 350-0-350 v. 80 m/a. ....  | 21/- |
| FS2X. 250-0-250 v. 100 m/a., 23/-.  | 23/- |
| FS75. 275-0-275 v. 100 m/a. ....  | 23/- |
| FS30X. 300-0-300 v. 100 m/a., 23/-.   | 23/- |
| FS3X. 350-0-350 v. 100 m/a. ....  | 23/- |
| All the above have 6.3 4-0 v. at 4 amps., 5-4-0 v. at 2 amps.   |      |
| FS43. Output 425-0-425 v. 200 m/a., 6.3 v. 4 amps., C.T. 6.3 v. 4 amps., C.T. 5 v. 3 amps. Fully shrouded .....               | 47/6 |
| FS50. Output 450-0-450 v. 250 m/a., 6.3 v. 2 amps., C.T. 6.3 v. 4 amps., C.T. 5 v. 3 amps. Fully shrouded .....               | 67/6 |
| FS5X. Output 350-0-350 v. 250 m/a., 6.3 v. 6 amps., 4 v. 8 amps., 4 v. 3 amps., 0-2-6.3 v. 2 amps. Fully shrouded .....       | 65/- |
| FS160X. Output 350-0-350 v. 160 m/a., 6.3 v. 6 amps., 6.3 v. 3 amps., 5 v. 3 amps. Fully shrouded .....                       | 44/- |
| FS43X. Output 425-0-425 v. 250 m/a., 6.3 v. 6 amps., 6.3 v. 6 amps., 5 v. 3 amps. Fully shrouded .....                        | 63/6 |
| HS6. Output 250-0-250 v. 100 m/a., 6.3 v. 6 amps., C.T. 5 v. 3 amps. For receiver R1355. Half shrouded .....                  | 26/6 |
| HS150. Output 350-0-350 v. 150 m/a., 6.3 v. 3 amps., C.T. 5 v. 3 amps. Half shrouded .....                                    | 27/9 |
| F36. Output 250-0-250 v. 100 m/a., 6.3 v. 6 amps., C.T. 5 v. 3 amps. Fully shrouded .....                                     | 29/6 |
| FS120. Output 350-0-350 v. 120 m/a., 6.3 v. 2 amps., C.T. 6.3 v. 2 amps., C.T. 5 v. 3 amps. Fully shrouded .....              | 29/9 |
| FS256. Output 250-0-250 v. 80 m/a., 6.3 v. at 6 amps., 5 v. at 3 amps. Fully shrouded .....                                   | 28/6 |
| PR1/1. Output 230 v. at 30 m/a., 6.3 v. at 1.5/2 amps. ....   | 21/- |
| FS150. 350-0-350 v. 150 m/a., 6.3 v. 4 amps., 5 v. 3 amps. ....   | 31/6 |
| FS150X. Output 350-0-350 v. at 150 m/a., 6.3 v. at 2 amps., C.T. 6.3 v. at 2 amps., C.T. 5 v. at 3 amps. Fully shrouded ..... | 31/6 |

The above have inputs of 200/250 v.

**OUTPUT TRANSFORMERS**

|  |      |
|--|------|
| MIDGET OP. 5,000Ω to 3Ω .....                                      | 3/9  |
| 8,000Ω to 3Ω .....   | 3/9  |
| OP10. 10/15 watts output. 20 ratios on Full and Half Primary ..... | 17/9 |
| OP30. 30 watts output. 20 ratios on Full and Half Primary .....    | 25/9 |
| Williamson's O.P. Transformer to Author's specification... £4/13/6 |      |
| Chokes for Williamson's Amplifier, 30 H. at 20 m/a. ....           | 16/6 |
| 10 H. at 150 m/a. ....   | 32/- |

**FILAMENT TRANSFORMERS**

All 200/250 v. Input.

|   |      |
|---|------|
| F3. 6.3 v. @ 3 amps. ....   | 9/6  |
| F4. 4 v. @ 2 amps., 7/6.  | 7/6  |
| F6. 6.3 v. @ 0.3 amps., 5/6.  | 5/6  |
| F12X. 12 v. @ 1 amp. ....   | 8/-  |
| FU6. 0-2.4-5-6.3 v. @ 2 amps., 10/-.  | 10/- |
| F12. 12.6 v. tapped 6.3 v. @ 3 amps. ....   | 16/6 |
| F24. 24 v. tapped 12 v. @ 3 amps. ....  | 23/6 |
| F29. 0-2.4-5-6.3 v. @ 4 amps., 18/9.  | 18/9 |
| FU12. 0-4-6.3 v. @ 3 amps. ....   | 17/6 |
| FU24. 0-12-24 v. @ 1 amp. ....  | 17/6 |
| F5. 6.3 v. @ 10 amps. or 5 v. @ 10 amps., or 12.6 v. @ 5 amps., or 10 v. @ 5 amps. ....   | 34/- |
| F6/4. Four windings at 6.3 v. tapped 5 v. @ 5 amps. each, giving by suitable series and parallel connections up to 6.3 v. @ 20 amps. .... | 51/6 |

Quotations, etc. stamped addressed envelope, please.

C.W.O. (add 1/6 in £ for carriage).

Export enquiries invited.

**H. ASHWORTH (Dept. W.W.),**  
676, Gt. Horton Road, Bradford 7, Yorks.

## G2AK This Month's Bargains G2AK

**T.V. POWER TRANS.** By Parmeko. Pri. 200/250 v. EHT 6 kV (RMS) 350/350 v. 250 m.A., 6.3 v. 6 a., 4 v. 3 a., 4 v. for EHT Rec Wired to Holder. Beautiful job. £4/10/-, carr. paid. FEW ONLY.

**METERS:** 2 1/2 in. Scale Flush Mounting. 0-10 m.A. Ditto 0-30 m.A., ditto 0-100 m.A., 12/6 each. 2 in. Scale Square Flush Mounting 0-50 m.A., ditto 0-150 m.A., ditto 0-3 Amp. Thermo., ditto 0-20 v. d.c., ditto 20/0/20 Amp. d.c., 7/6 each. 2 1/2 in. Scale Projecting Type 0-15 Amp. Thermo. 7/6. 2 in. Scale Round Flush 0-1/2 Amp. R.F., ditto 0-350 m.A. Thermo. 7/6.

**SPECIAL VALVE OFFER:** TZ40, 35/-; 6L6G, 10/6; 5R4GY, 12/6; 829/3E29, 60/-; 100TH, 90/-; 866A, 17/6, or 30/- per pair; 807, 10/- each, or 17/6 per pair; 931A, 45/-; 813, 80/-.

**CONDENSERS:** 802F 600 v. Trop. 750 v. normal condensers. New ex-W.D. stock, 5/6, p. & p. 1/6.

**H. S. KEYING RELAYS (Siemens):** 1700 x 1700 coils, 12/6.

**SPECIAL OFFER, AR88 SPARES.** Cabinets, complete with base, feet and side strips, £4/15/- each. Pkg. and Carr. 5/-.

Set of 14 valves for "D" or "LF" model receivers, £5/10/-.

Panel escutcheons, 22/6 each. "D" type I.F.S., 12/6 each. Good selection of Spare Coils available for "D" Model, 7/6 each. Output Transformers for "D" or "LF", 37/6 each.

**HEADPHONES:** L.R. Type CLR No. 3, 9/6, DLR No. 2, 13/6, H.R. Type CHR Mk. 2, 17/6, DHR 5b (very sensitive), 18/6, p. & p. 1/-.

**COPPER WIRE.** 14G H.D. 140ft. 15/-, 70ft. 7/6, postage and packing, 2/-.

**STREAMLINED BUG KEYS.** By famous manufacturer. List over £4. Our price 45/-.

**AIR SPACED COAXIAL CABLE,** 150 ohm (normal price 3/11 per ft.), 20 yd. coils only. £1 per coil, post free.

**NEW MULLARD QUALITY AMPLIFIER** chassis, and all specified parts available from stock.

Carriage paid on all orders over £1 except where stated. Please include small amount for orders under £1.

Please print your name and address. All Mail Orders to—

**CHAS. H. YOUNG, G2AK**  
Dept. 'W' 102 HOLLOWAY HEAD, BIRMINGHAM 1  
Phone: MIDLAND 3254  
All callers to 110 DALE END, BIRMINGHAM 4  
Phone: CENTRAL 1635

## THE UNITED KINGDOM ATOMIC ENERGY AUTHORITY

has vacancies for the following skilled craftsmen to serve as Research and Experimental Mechanics at Windscale Works, Sellafield, Cumberland.

- ★ **INSTRUMENT MECHANICS**  
for interesting work in connection with electronics and precision instruments.
- ★ **MAINTENANCE FITTERS**
- ★ **MAINTENANCE ELECTRICIANS**

All applicants must have served a recognised apprenticeship as appropriate.

Rates of pay, for a 44 hours 5 day week, 165/7d. on entry, with early assessment for merit pay, and opportunities for advancement to 191/7d., with a maximum of 207/7d. for a specialised few in the case of Instrument Mechanics. Successful married applicants will be considered for housing within a reasonable period of appointment, and Hostel accommodation is available for single men.

For application forms, or further details, apply to  
The Senior Labour Manager,  
UNITED KINGDOM ATOMIC ENERGY AUTHORITY,  
Windscale Works, Sellafield, Cumberland.

# Best Buy at Britain's

**HEAVY DUTY L.T. TRANSFORMERS.** Standard tapped primary. Type A, 30 v. 35 amp. or Type B, 50 v. 16 amp. Size 6in. x 6 1/2in. x 8 1/2in. high. Weight 24 lb. BRAND NEW, not ex-Govt. Suitable for soil heating, rectifiers, chargers, etc., special offer, 55/- each plus 5/- carriage.

**EX-ADMIRALTY.** Primary 230 v. 50 c/s. Secondary 0-0.5 v., 0-0.5 v., and 0-0.5 v., all at 5 amps, each winding. This means, in effect, that you can have 5, 10, 15, 20, 25, 30 v. at 5 amps. or other possible combinations. Size 4 1/2in. x 4 1/2in. x 6 1/2in. high. Weight 12lb. BRAND NEW. A very useful transformer at only 39/6.

**EX-ADMIRALTY.** Primary 230 v. 50 c/s. Secondary 620-550-375-0-375-550-620 v. (620 v. at 200 mA., 550 v. at 250 mA.). Two rectifier windings at 5 v. 3 amps, each. Total rating 278 vA. Upright mtg. weight 24lb. BRAND NEW, 42/6.

**E.H.T. TRANSFORMERS.** For VCR97, etc. Mains input. Output 2,500 v., 4 v. 2 a. and 2-0-2 v. at 2 a. Fully guaranteed at 35/- plus 2/- postage. SPECIAL SURPLUS SNIFF. 230 v. 50 c/s. input. 2 kV. R.M.S. output (2.5 kv. when rectified). Size 2 1/2in. x 2 1/2in. x 3 1/2in. high. Upright mtg. ONLY 15/- plus 2/- postage.

**EX-MANUFACTURERS SURPLUS.** Drop through type. Pri. 200-250 v. 50 c/s. Secondary 310-0-310 v. 70 mA., 6.3 v. at 3 a., 4 v. at 2 a. Can be used with either 4 or 6.3 volt rectifier. Only 9/6 plus 1/6 postage. A similar type, 325-0-325 v. 100 mA., 6.3 v. 4 a., 4 v. 2 a., supplied to callers only, 12/6 each.

**METAL RECTIFIERS.** Heavy duty, funnel cooled, 2 units required for bridge. Size 12in. x 12in. x 4 1/2in. Input 36 v. R.M.S. Output 50 amps., 27/10/- per pair, plus 6/- carriage. BRAND NEW ex-Govt. RM4, 250 volts, 250 mA., only 12/6 each. Selenium, 300 volts, 100 mA. Brand new, ex-W.D., 6/9 each. 12 v. 1 amp. Full wave bridge, 7/6 each.

**E.M.I. OUTPUT METER.** Desk type incorporating a 2 1/2 in. 1 mA. meter together with instrument rectifier, etc. 2 ranges 0-500 milli-watts and 0-5 watts and decibel scale. Brand new in original manufacturers' boxes with instructions. Price 35/-, post 1/6.

**METER BARGAINS, ALL BRAND NEW.**  
 15 v. (50~) mov. iron 2 1/2in. pnl. meg. .... 8/6  
 3,500 volts moving coil 3 1/2in. projection .... 10/-  
 150 milli-amp. 2 1/2in. sq. pnl. mtg. .... 7/6  
 20 amp. moving coil 2 1/2in. dia. .... 7/6  
 1 mA. 2 1/2in. barrel flush pnl. mtg. .... 25/6  
 1 milli-amp. 2 1/2in. barrel desk type .... 25/-  
 100 micro-amps. barrel pnl. mtg. scaled 0-1,500  
 in 15 clear divisions. Only .... 42/6  
 500 mA. Thermo Couple 2 1/2in. sq. pnl. mtg. .... 5/-

**METER RECTIFIERS.** 1 mA. Salford Instruments, 8/6. 5 mA. Salford Instruments, 8/6. 2 mA., S.T.C. as used in E.M.I. Output Meter, 5/6. All are full wave bridge and brand new.

**METAL RECTIFIERS.** R.M.4 250 volts 250 mA. Only 12/6. Selenium 300 volts 100 mA. Brand new, ex-W.D., 6/9 each.

**COMMUNICATIONS RECEIVER R.1155.** World-wide reception is ensured by the R.F. and 2 I.F. stages. Five wavebands, 2 L.W., M.W. and 2 S.W. Magic-eye, large dial and vernier make tuning simple. Contained in attractive black crackled cabinet, its handsome appearance does justice to its superb performance. Supplied with FREE BOOKLET giving circuit data and details of the power pack required for A.C. mains operation. Fully aerial-tested before despatch. Gladly demonstrated to callers. BRAND NEW. "MINT" condition, in ORIGINAL MAKER'S TRANSIT CASES, 211/19/6. Shop soiled models, as new, 29/19/6. A few only used models, 27/19/6. 6/10/6 carriage on each. Send S.A.E. for full details of power packs and receivers, or 1/3 for booklet.

**A.C. MAINS POWER PACKS AND OUTPUT STAGE.** Enable the R.1155 to be used to operate speaker from 200/250 volts A.C. without ANY MODIFICATION WHATSOEVER. All our power packs have heavy duty transformers, are complete with leads and Jones plugs and are guaranteed for 6 months. Type A. In smart black metal case, size 8 1/2in. x 4 1/2in. x 6 1/2in. less speaker, price 24/10/- plus 3/6 carriage. Type B. With built in 5in. speaker in black metal case size 13 1/2in. x 5 1/2in. x 7 1/2in. Price 25/5/- plus 3/6 carriage. Type C. With an 8in. speaker in specially designed beautiful black crackle cabinet speaker to match receiver, size 11 1/2in. x 10 1/2in. x 6 1/2in. A de Luxe job. Price 26/10/- plus 3/6 carriage. NOTE: 10% REDUCTION WHEN PURCHASING ANY OF THE ABOVE POWER PACKS WITH RECEIVER.

**COMMAND RECEIVERS.** BC455. Covers 6-9 Mc/s (33-50 Metres), 12K8, 12K8, 12K8K, 12K8K, 12K8K, 12A6. Brand new. Black crackled. 69/6 plus 2/6 post.

**45 Mc/s PYE STRIPS.** Vision unit for London frequency. Complete with 6 EF50 and EA50. Circuit provided. Brand new. 23/10/- each.

**VALVE VOLTMETERS.** Ex-R.A.F. Operates from standard A.C. mains, stabilised H.T. supply. Three ranges: 50/200/500 volts D.C. Meter employed 2 1/2in. 1 mA. F.S.D. Contained in handsome wooden instrument case size 14in. x 8 1/2in. x 9in. Complete with all valves and tested prior to despatch. In brand new condition and a real bargain at only 79/6 plus 5/6 carriage.

**U.H.F. SIGNAL GENERATORS BY R.C.A. TYPE 710A.** Covers 370 to 560 Mc/s. Large directly calibrated dial. Carrier level and 400 c/s. modulation monitored by large 200 micro-amp. meter. Precision piston attenuator. For A.C. mains operation 117 volts 50/60 c/s. Complete with instruction manual. BRAND NEW. 235.

**TEST SET TYPE 87.** Ex-R.A.F. corresponds to TF796. Incorporates a signal generator covering 150 to 300 Mc/s. Also pulse generator. Operates from standard A.C. mains. Contained in handsome grey instrument case size 23 in. x 10in. x 8 1/2in. Basis of the audio signal generator described in "W.W." Aug./Sept. 1949. Complete with all valves and in brand new condition. Price 24/19/6.

**HOUR-METERS.** Indicate the time any given A.C. mains operated apparatus has been in use. Ideal for life testing, process timing, etc. BRAND NEW and BOXED. 39/6 each.

**MODULATOR TYPE 67.** This unit is a pulse modulator with pulse width of 1, 2 and 5 microseconds. The pulse amplitude is also variable. It is a particularly useful instrument as it contains a heavy duty power pack suitable for 230 volt 50 cps. mains supply. The mains transformer outputs are 6.3 volts twice, 5 volts for the rectifier and the H.T. winding is 345-0-345 volts. Also included are 5 SP61, one VR116, 2 EB34, and 3 EA50. Size of case 18 x 9 x 7 inches. These units are brand new in original packing cases. Price 67/6 plus 7/6 carriage.

**VALVE BARGAINS**  
 New and in original boxes. 6AG6, VR53 (EF39), VR66 (EF39), 6K7G, 6C5Met., 6SH7-Met., VT301 (TT11), all at 6/6. RK34, E1148, 954, X22, VU120A, all at 2/6. Replacement bargain EL50, 5/-.  
 New, ex units 6AK5, VR91 (EF50), Sylvania, VT52 (EL32), 807, 7/6. VR63 (SP61), 3/6. VT301 (TT11), 3/6. CV6, VR78. VR92 (EA50), 1/6 each, 15/- dozen.

**RACKS.** 6ft. "U" channel P.O. type for 19in. panels. Heavy angle. Price 79/6, plus carriage at cost.

**H.R. HEADPHONES.** Consists of two high resistance earpieces with adjustable metal headbands. Price, less cord 6/6.

**POWER UNIT TYPE 285.** A.C. mains input 230 v. 50 cps. Outputs E.H.T. 2 kV. @ 5 mA., H.T. 450 volts @ 200 mA., L.T. 6.3 v. @ 17 amps., fully smoothed, 2 chokes, paper condensers, etc., complete with valves 5U4G, VU 120 and EF 50. This was the ground power unit for the "Gee" equipment and should be very useful for T.V., etc. A REAL BARGAIN AT ONLY 69/6.

**INDICATOR UNIT TYPE 95.** Exactly the same as the 62 indicator unit but is 50 cycle version. Double decker chassis, containing loads of components, 16 SP61, 2 EB34, 4 EA50, etc., etc. Brand new condition (less VOR97). Only 45/- plus 7/6 carriage.

**INDICATOR TYPE 182A**  
 Indicator contains 3 EF50, 1 5U4G, 4 SP61 and a 6 1/2in. C.R.T. Type VCR 317, complete with Mu Metal screen, 9 wire wound pots, with large assortment of resistors and condensers. Can be converted to Oscilloscope (as described in "Radio Constructor"). Circuit supplies Tubes have no "Cut-off" and can be demonstrated to callers. BRAND NEW (less relays). In original transit case, 67/6 plus 7/6 carriage.

**HEAVY DUTY POTENTIOMETERS.** Wire-wound on porcelain former, 2 1/2in. diam. 20 W. 1,200 ohms, 6/6 each. Covert-type wire-wound 5,000 ohms, 2 1/2in. diam. 7/6 each.

**X-TALS**  
 465 kc/s S.T.C. 1 1/2in. pins suitable for crystal, gates. IP checking, etc. Brand new, boxed, 10/- each. 200 kc/s American G.E.C. 1 1/2in. pins suitable for crystal calibrators, etc. Brand new, boxed, 10/- each. 100 kc/s 1 1/2in. pin spacing. British, ex new units, 15/- each.

**TRANSFORMER BARGAINS.** Brand new ex-manufacturer's surplus drop through. Primary 200/250 volts 50 cps. Secondary 310-0-310 v. 70 mA., 6.3 v. @ 3a., 4 v. @ 2 a. Can be used with either 4 v. or 6.3 v. rectifier. Only 9/6 plus 1/6 post. A similar type transformer, 325-0-325 100 mA., 6.3 v. 4 a., 4 v. 2 a. can be supplied to callers only at 12/6. Filament transformer, standard tapped primary, 12 v. 1 1/2 a. and 5 v. 1 1/2 a. secondary. Only 7/6.

**E.H.T. TRANSFORMER.** For VCR97, etc. Mains input, output, 2,500 volts, 4 volts at 2 amps. and 2-0-2 volts at 2 amps. Fully guaranteed at 35/- plus 2/- postage.

**CABLE.** Heavy duty twin polythene weatherproof, suitable for extension mains lead, etc. SPECIAL CLEARANCE OFFER, 39/6 per 100 yd. coil, plus 3/6 carriage. S.A.E. for sample.

**BARGAINS, BARGAINS, BARGAINS. HUGE STOCKS OF COMPONENTS, RECEIVERS, VALVES, AT SPECIAL REDUCED PRICES FOR CALLERS.**

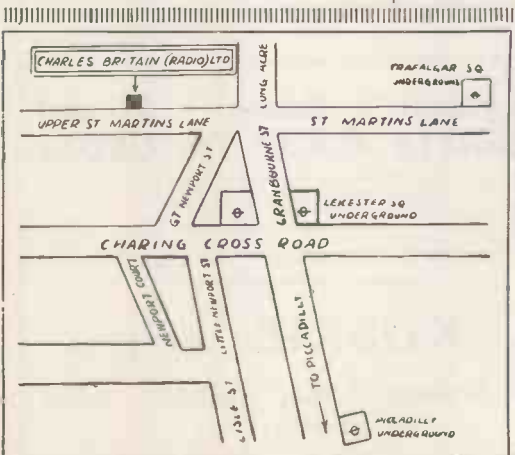

**BLOCK CONDENSERS.** 8 mfd. 600 v. D.C. wkq. at 71° C. size 4 x 2 x 4 1/2in. high. Very suitable for all good quality amplifiers, etc. Brand new. Price 5/- each.

**HEAVY DUTY SLIDING RESISTORS.** 250 watts rated to carry 25 amps., resistance 0.4 ohms, suitable for physics labors, charging board, etc. Laboratory type with worm drive, on metal stand, size 9 1/2in. x 4in. x 6in. high. Price 7/6 each. BRAND NEW.

## CHARLES BRITAIN (Radio) Ltd.

11 UPPER SAINT MARTIN'S LANE LONDON, W.C.2. TEMple Bar 0545

One Minute from Leicester Sq. Station (up Cranbourn St.) Shop Hours: 9-6 p.m. (9-1 p.m. Thursday) Open all day Saturday

THE  
**BRITISH NATIONAL  
RADIO SCHOOL**

ESTD. 1940

NOW IN OUR FIFTEENTH YEAR  
AND STILL

**NO B.N.R.S. STUDENT  
HAS EVER FAILED**

to pass his examination(s) after completing  
our appropriate study course.

**Our Secret ?**

*Sincerity, Long Experience, Family  
Ownership, Pride of Service and a  
genuine attempt to mould the "Course"  
to the student.*

A.M.Brit.I.R.E. and CITY and GUILDS Radio and  
Telecommunications Exams., etc., etc.

PRINCIPAL, M.I.E.E., M.Brit.I.R.E.  
**BRITISH NATIONAL RADIO SCHOOL**  
2, CANYNGE ROAD, CLIFTON, BRISTOL, 8  
Tel. BRISTOL 34755

ELECTRONIC ENGINEERS are required by The ENGLISH ELEC-  
TRIC CO., LTD., to work initially at LUTON and later at STEVENAGE  
as follows:—

**SENIOR ENGINEER**—with experience of production engineering  
of prototype electronic equipment, having a working knowl-  
edge of Electronic Circuitry.

**SENIOR ENGINEER**—to lead a group of engineers in the develop-  
ment of specialised electronic test gear.

**SENIOR ENGINEER**—for work on general circuit development  
of electronics with a sound fundamental knowledge and the  
ability to apply it.

**SENIOR INSTRUMENTATION ENGINEERS**—with a degree or  
H.N.C. and experience of the design of transducers for elec-  
tronic or bridge measuring systems.

**SENIOR ENGINEER**—to lead a group concerned with develop-  
ment and field trials of ground radar. Previous experience  
essential.

**SENIOR RADAR AND ELECTRONIC ENGINEERS**—for field and  
flight experiments of radar equipment. Degree or H.N.C.  
standard preferred but applicants without these standards  
but with a wide experience of this type of work will be con-  
sidered.

**SENIOR ENGINEER**—for missile telemetry installation planning.  
Applicants must be familiar with existing telemetry systems  
and measuring techniques. Suitable to a man with trials ex-  
perience.

**JUNIOR ENGINEERS AND LABORATORY ASSISTANTS** are  
required to assist in the above work. Vacancies also exist  
for Junior Staff with experience or an interest in micro-wave  
techniques.

Housing assistance may be given in some cases.

All of the above posts are permanent, progressive and pensionable  
after qualifying period; attractive salaries are offered to the success-  
ful applicants. Applications to Dept. C.P.S., 336/7, Strand, W.C.2,  
quoting Ref. S.A.38E.

**SPECIAL OPPORTUNITY:—**

- 250-WATT AM BROADCAST TRANSMITTERS  
Type BR5—Short Waves  
Type BRM—Medium Waves

Features: Small size—low power consumption—high fidelity—  
low distortion.

Price: Complete stations from £397 for all orders placed  
during the month of March.

Quick delivery—write for full technical details

● COMMUNICATIONS TRANSMITTERS

By leading American manufacturers (R.C.A., Hallicrafters,  
Techrad and Westinghouse). 5 types available for immediate  
delivery: 250 w., 400 w., 1 kW., 2½ kW. and 5 kW.  
Full technical details will be gladly sent on request.

- We can supply a full range of spares for:  
R.C.A. TRANSMITTERS ET-4331, 4332, 4336 and AVT-22

● TEST EQUIPMENT—A large range of laboratory test  
equipment of American manufacture (including BC-221)

● RADAR EQUIPMENT (Airborne, Ground and Naval).  
Our Radar Dept. will welcome your specific enquiries.

**BRITISH SAROZAL LIMITED**

ELECTRONIC WORKS

1-3 Marylebone Passage, Margaret St., London, W.1.

Cables: Sarozal, London. Telephone: LANGham 9351 (3 lines)

A.I.D. and A.R.B. approved

**FERRANTI LIMITED, EDINBURGH**

—FLIGHT TRIALS DIVISION—  
APPLICATIONS ARE INVITED FOR

**ELECTRONIC ENGINEER** for interesting work in their Flight  
Trials division. The engineer will be engaged on trials to evaluate  
the technical and operational performance of fire control and  
navigational systems, air and ground. The qualifications required  
are to degree or equivalent standard with a minimum of three  
years' experience. Ref. No. 59/EE/TID.

**RADAR MAINTENANCE ENGINEER** who will be responsible  
for a small outstation. Duties will involve limited travelling in the  
U.K. Ref. No. 59/RME/TID.

Ex Radar Officers and Senior N.C.O.s are invited to apply for  
either or both vacancies. The appointments are pensionable and  
offer excellent prospects and working conditions in or attached to  
our new laboratories.

Apply for an application form, quoting appropriate reference  
number to the

**PERSONNEL OFFICER,**  
Ferranti Limited, Ferry Road, Edinburgh, 5.

**Television • Radio • Record  
CABINETS MADE TO ORDER**

**ANY SIZE OR FINISH**

CALL OR SEND DRAWINGS FOR QUOTATION

**B. KOSKIE (DEPT. E.)**

**72-76 Leather Lane, Holborn, E.C.1**

Phone: CHAncery 6791/2



# Wireless World Classified Advertisements

Rate 7/- for 2 lines or less and 3/6 for every additional line or part thereof, average lines 6 words. Box Numbers 2 words plus 1/- (address replies: Box 000 of "Wireless World" Dorset House, Stamford St., London, S.E.1.) Trade discount details available on application. Press Day: May 1955 issue, Tuesday, March 29th. No responsibility accepted for errors.

## WARNING

Readers are warned that Government surplus components and valves which may be offered for sale through our displayed or classified columns carry no manufacturers' guarantee. Many of these items will have been designed for special purposes making them unsuitable for civilian use, or may have deteriorated as a result of the conditions under which they have been stored. We cannot undertake to deal with any complaints regarding any such items purchased.

**NEW RECEIVERS AND AMPLIFIERS**  
C.J.B. ELECTRICAL & ELECTRONIC DEVELOPMENT, Ltd., Bickford Rd., Witton, Birmingham, 6, Tel. East 0822, SPECIALIZE in the manufacture of High Fidelity Sound Reproducing equipment, including:

WILLIAMSON Amplifiers, Tone Control Stages with variable Steep Cut Filters, Cross-over Units, High Fidelity Portable Tape Recording equipments ideally suitable for replaying the new EMI pre-recorded tapes, Professional Recording Amplifiers, Microphone Mixing Units, etc. Send for details and leaflets. [0105]

LANCASTER Hi-Fidelity for all audio requirements; full range of equipment stocked and demonstrated.—The North's Reproduction Specialists, 29, Lancaster Ave., Manchester, 4, Deansgate 2503. [0066]

**RECEIVERS, AMPLIFIERS—SURPLUS AND SECONDHAND**  
BC348L for sale in Dublin, first-class working order, power pack built in, output valve wired for L.S.—Box 2042. [4304]

R1155, new condition with p.pack and L.S. in separate cabinet; £8.—18, Cambourne Ave., Edmonton, N.9. [4317]

**HRO** Senior available, exchange for tape recorder.—22, Wellington Rd., Oxton, Birkenhead. [4318]

FOR sale, C.R.100 communications receiver, complete with 3 ohm speaker; £23, or offer; view East London.—Box 1765 [4257]

HBC348R, CR100, etc.—Requirements please to R. T. & I Service, 254, Grove Green Rd., London, E.11. Ley. 4986 [0053]

F units, new in original cartons, types R 26-27/6, 25-11/6, 24-10/0, post 2/6.—E.W.S. Co., 69, Church Rd., Moseley, Birmingham. [4365]

FOR sale, Williamson amplifier with Goodsell PP2F preamplifier and spare set of matched KT66 output valves; £25/10.—Ring Moseley 6208 evenings, 8-10 p.m. [4297]

LEAK T.12 amplifier Varislope tuner pick-up, in special oak cabinet, Connoisseur motor, boxed Wharfedale, 3-speaker corner assembly; cost nearly £200 recently, offers.—Box 1809. [4265]

PORTABLE P.A. eqt., 20-watt 6L6 amp., feedback, 3W. superhet feeder, 33/78 player, M/C mic., floor stand, speaker, etc., perfect; £20.—Wide, 12, Wentworth Close, N.3. Finchley, 7393. [4333]

**WIRELESS WORLD 2 R.F.** 3-valve quality tuner, M.W. and L.W., unused, ideal for use with all high fidelity amplifiers; £6/10.—Including valves, limited number; bargain.—Box 0892. [4035]

ENTHUSIAST has surplus equipment for disposal.—Dynamatron Regency "Ether Conqueror"; Leak TL/12 amplifier with Vari-slope and V.S. tuner; Armstrong EXP 125/C chassis; AC/DC preset receiver; Hartley 125 loudspeaker in baffle, etc.—Box 2172. [4342]

**RECEIVERS, AMPLIFIERS—SURPLUS AND SECONDHAND WANTED**  
WANTED, second-hand Eddystone 680X receiver and 14in Ecko television.—Box 1766. [4258]

**LOUDSPEAKERS—SURPLUS AND SECONDHAND**  
SENSATIONAL offer.

15IN P.M. loudspeaker units, by leading Hi-fi manufacturers, 30 watt handling capacity, high flux, rugged construction, reconditioned as new; £5 each or offers for quantities.

FRAMES and magnets for above, 2in voice coil; £3 each or offers for quantities.

MAGNAPHONE, 356, Norwood Rd., S.E.27, Tel. Gipsy Hill 5394. [4099]

TANNOY 5 watt speakers, pressure unit, horn, transformer, brackets; £4 complete; carriage forward, good condition.—Box 2138. [4351]

**LOUDSPEAKERS WANTED**  
WANTED, Harp 250 complete with baffle, must be perfect.—Tonge, 6, Bryan Rd., Blackpool, Lancs. [4305]

**TRANSMITTING EQUIPMENT**  
AVAILABLE: ET4332B, BC375 with T.U.S. T1131, TR1430, TR1464, W.S.32.—E.W.S. Co., 69, Church Rd., Moseley, Birmingham. [4366]

# 100 STANDARD TYPES

The Partridge Range of Transformers is such that there is a type to fulfil almost every replacement need. Each is covered by a 12 months' guarantee.

The range includes Power Transformers, single or multiphase, up to 100 kVA; all grades of audio frequency transformers; "C" core transformers, etc.



## TRANSFORMERS for Special Circuits

Many of the prominent amplifier circuits, including those published by the G.E.C. and Mullard, Technical Departments, employ Partridge Transformers. Two examples are the Osram 912 High Quality Gramophone Amplifier, where Partridge Transformers and chokes were used in the prototype, and the Mullard 510 High Quality Amplifier which employs a Partridge Type PPO.

Write for illustrated brochure giving full details of the Partridge components s.p.cified for the Osram 912 and Mullard 510 amplifiers.



# PARTRIDGE TRANSFORMERS LTD. TOLWORTH SURREY

Phone: ELMbridge 6737/8

**NEW TEST EQUIPMENT**  
TV signal intensity meter (S.I.M.) for aerial checks and installation, etc.—Send for full details Radio-Aids, Ltd., 29, Market St., Watford, Tel. Watford 5988. [4345]

**TEST EQUIPMENT—SURPLUS AND SECONDHAND**  
SIGNAL generators, oscilloscopes, output meters, valve voltmeters, frequency meters, multi-range meters in stock; your enquiries are invited.—Requirements to R.T. & I. Service, 254, Grove Green Rd., London, E.11. Ley. 4986. [0056]

**TEST EQUIPMENT WANTED**  
WANTED, signal strength measurement set covering Band I (TV), preferably with meter, surplus or in good s/h condition; cheap. R. C. Davies, Electricity House, Townyn, Merionethshire. [4352]

**NEW DYNAMOS, MOTORS, ETC.**  
WARD rotary converters for radio, television amplifiers, etc. ALSO, rotary transformers, alternators, DC generators, etc. SPECIAL offer.—Revolving armature alternators, 2 pole, ball bearing, 3,000 r.p.m., with direct coupled 24-30v exciter and voltage control components; output 230v, 50 cycles, 3.25 k.v.a., 8 power factor; price with Vee rope pulley, £42 each, nett, ex-works. WARD, 75, South St., Bishops Stortford, Herts. Tel. 1694. [0039]

FOR Sale—50 British Thomson-Houston shaded pole type motors No. 1304, these motors are brand new and were built to British Standard 170, incorporate oiled for life bearings in their construction, suitable for horizontal or vertical mounting; price £1/16.—Write: Belark Tool & Stamping Co., Ltd., 33 Sussex Place, W.2. Ead. 0477. [4362]

**SPECIAL television rotary converters**, guaranteed interference free, fitted radio and television filters, wt. 60lb, d.c. input 12v 200va, out, 24v, 32v, 110v, 230v, d.o., to 230v out, 250va £28/10 del, also converters for radio-gam and general use, inputs, outputs and price as above; the above also supplied without smoothing, £25 del, immediate despatch; trade supplied.

At a purchaser's home 60 mls. S.W. of Sutton Coldfield a 24v. TELEVISION converter was tested on Ecko television 12in. tube, stated consumption 135 watts d.c. current from battery only 9/4, amps, picture and sound were perfect and completely free of interference or flutter.

THE above is the latest product of British manufacture, and is guaranteed for one year. J.A.P. No. 2A 1.2hp petrol engine, air-cooled, 4-stroke, starting rope, tools; £17/10 delivered. T. W. PEARCE, 66, Great Percy St., W.C.1 (near Angel). [0013]

**DYNAMOS, MOTORS, ETC.—SURPLUS AND SECONDHAND**  
ROTARY converter for TV, by Electro Dynamic Construction, d.c. volts 100/110, a.c. 220/240, a.c. amps 1.08, condition as new; £15.—Weston Estate Office, Shipston-on-Stour. [4188]

**NEW GRAMOPHONE AND SOUND EQUIPMENT**  
T.V.R. amplifiers for Truvox, Lane Decks, etc.: 5 watt £14, 10 watt 19gns. F.M. tuners, Denco £8, ready built. U/L 14 watt amps, with pre-amp, £24. HARDING ELECTRONICS, 120a, Mora Rd., London, N.W.2. [0032]

**EROGA RECORDING SERVICES** (regd. 1949), Ferrograph Tape Recorders, for dependent, tape microphones, speakers, etc., from stock, tape to disc transcription service, especially L.P. microgroove.—31, Peel St., Eccles, Manchester, Tel. Eccles 1624. Director, Thurlow Smith, A.R.M.C.M. [0122]

**CINE-VOX** disc recording equipments, type C7J for high-quality recordings from existing microphone equipment; price from 28gns; also available as a complete channel inclusive of mic., amplifier and playback equipment, at 70gns; type C7, for highest quality professional requirements—recorder mechanism at 48gns, or complete channel at 110gns; demonstrations arranged in London. PLEASE write for details to K.T.S., Ltd., Coplow, Park Rd., Braunton, N. Devon. Tel. Braunton 224. Callers by appointment only. [0209]

**TAPE** recorders for sale, exchange, or hire in Greater London, good quality tape recorders wanted for cash, all types of repairs, mechanical and electronic, carried out by specialists, all accessories available, we deal exclusively in magnetic recording equipment. THE MAGNEGRAPH RECORDING Co., Ltd., 1, Hanway Place, London, W.1. Tel. Langham 2156. [5396]

**GRAMOPHONE AND SOUND EQUIPMENT—SURPLUS AND SECONDHAND**  
EMITAPE £ 3M used once only (I need foils), 1,200ft 16/-—Crampins, Grimsby. [4315]

L.H.P. Exchange Mart for used quality equipment; send s.a.e. for lists.—31, Lancaster Ave., Manchester, 4. [0067]

GRUNDIG 700L 2-speed recorder with mike G and remote control, as new, hardly used; best offer over £40.—Cryer, Princes Way, Fleetwood. [4350]

E.M.I. disc recorder 2300, complete with microphone, spare cutters, blanks, etc., as new, cost £245; £150 o.n.o.—11, Streattham Vale, S.W.16. Follards 3568. [4314]

JUST PUBLISHED!

THE RADIO AMATEUR'S HANDBOOK—1955

By 'A.R.R.L.'

30/- Postage 1s.

Television Antennas by Donald A. Nelson. 16s. 0d. Postage 6d.

Mullard 5 Valve 10 Watt High Quality Amplifier Circuit. 2s. 6d. Postage 3d.

Radio Engineers' Servicing Manual edited by E. Molloy. 42s. 0d. Postage 1/-.

Radio Laboratory Handbook by M. G. Scroggie. 25s. 0d. Postage 8d.

The Oscilloscope at Work by A. Haas and R. W. Hallows. 15s. 0d. Postage 6d.

Foundations of Wireless by M. G. Scroggie. 12s. 6d. Postage 8d.

Radio and Television Engineers' Reference Book edited by E. Molloy. 70s. 0d. Postage Free.

Servo-Mechanisms by John C. West. 25s. 0d. Postage 6d.

World Radio Handbook for Listeners edited by O. Lund Johansen. 9s. 6d. Postage 4d.

Radio Valve Data compiled by "Wireless World." 3s. 6d. Postage 3d.

THE MODERN BOOK CO.,

19-23 PRAED ST., LONDON, W.2 (Dept. W.4)

Britain's Largest Stockists of British and American Technical Books

Please write or call for our catalogue.

\*Phone: PADdington 4185. Open 6 days from 9-6 p.m.

SURPLUS

AERIAL MASTS. American Yagi 5 element array AS-46/APG. 30ft. one piece 4in. dia. hollow wood masts. 36ft. 3 section 2in. dia. tubular steel masts. 45ft. 9 section 1 1/2 in. dia. American steel masts MS-44. 50ft. Bendix plywood masts MF-7A. 70ft. American plywood masts. 200 mc/s. Birdcage "H" array. 20ft. American tripod base aluminium masts AS/TPX. 9ft. one piece American police whips. 18ft. BC-610 6 section whips. DIRECTION FINDERS. SCR-206, SCR-291, SCR-503, DFG-20, DFG-24, etc. TELEPHONE AND TELEGRAPH APPARATUS. 1 + 1 terminals and bypass filters; 1 + 3 terminals; 1 + 4 terminals and repeaters; S and SX, S and DX, filters; power bays; repeaters; V.F. ringers; perforators; Wheatstone equipment; teleprinters; undulators; switchboards; rectifiers; EE-65, TG-10, etc., etc. AUDIO EQUIPMENT. R.C.A. squadron announcers (12-25 watt speakers). R.C.A. 25 watt high power speakers. Portable mezophones PA-4. CONTROL UNITS. RM-6, 7, 12, 13, 21, 25, 29, 42. AMERICAN TRANSMITTING TRANSFORMERS AND CHOKES. A large variety by Amertran, Kenyon, R.C.A., Thordason, etc., etc. TRIPLE DIVERSITY RECEIVERS. 1.5 to 30 mc/s. Self contained on rack with all refinements. Full details available. 100 WATT BROADCASTING TRANSMITTERS by Woden. Self contained in 4ft. 6in. cabinet £22/10/- with valves, RACKS, de luxe, 19 inches wide channel iron sides, 3 x 2, 3ft. 6in., 40/-; carr. 10/-.

Many other items too numerous to mention. Send your requirements. Lists available. All packing and shipping facilities.

P. HARRIS

ORGANFORD DORSET

Telephone: Lychett Minster 212.

NEW COMPONENTS

TRANSISTORS and associated parts, types up to 50 Mc/s. outputs of avg. speech power.—Bel. Marlborough Yard, N.19. Arc. 5078.

SOUNDMASTER tape recorder, full constructional details, circuits, component list; 6/6 post free.—Franklin & Hall, 371, Havant Rd., Farlington, Portsmouth.

FREE 54-page illustrated catalogue short-wave, transmitting, television and broadcast components.—Southern Radio, Redlynch, Salisbury, Wilt.

FOR Sale—1,500 Friedland transformers, Type N.S., varnish impregnated under vacuum and wax dipped, passed K.110 test and will withstand 20-30° C without deterioration, primary voltage 230 A.C. 25-60 cycles, secondary no load voltage 2v, full load 1.5v at 1 amp; price 3/- each.—Write: Belark Tool & Stamping Co., Ltd., 33, Sussex Place, W.2. Pad. 0477.

COMPONENTS—SURPLUS AND SECONDHAND

SUPREME RADIO, 746B, Romford Rd., Manor Park, London, E.12.

RE. 11, 1260 Est. 19 years.

1355 RADIO and television component part bargains at the right price.

ELECTROLYTIC cond., 8mfd 450v working, sieved tubular w/end, our price 1/11 ea.; 35mfd 350v tag end, aluminium can, small 4/9 ea., 16+8mfd 450v, all. can or sieved w/end, 4/9 ea.

4MFD 150v Dubilier Drylytic w/e card, cond., 10d ea.

METAL-PACK 0.1mfd 350v condensers, 8d ea. or 1/6 doz.

SARGENT 0.1mfd 350v w/end cond., 6d ea. or 5/6 ea.

INT/OCTAL v/holders, Amphinol type, 6d ea. or 5/6 doz.

E.F.50 valves, Red Sylvania, 10/6 ea.

ALL parts in stock for "Denco" F.M. unit; this will be the future radio.

DENCO F.M. Technical Bulletin "DTB8" for guiding F.M. feeder unit, 1/6.

CO-AXIAL cable, 800cm. brown or black, 8/- doz. yds.

STEEL chassis, ready punched for a/net layout, 14in X 6in X 3in, 2/6 ea.

HEATER trans., 0-250v sec 6.3v at 1.5amp; bargain price, 5/9 ea.

TAPPED heater trans., 0-210v-230v-250v, sec. 0-2V, 4v-6.3v at 1.5amp, really a bargain at 4/8 ea.

SMALL type vol/controls, 1meg or 1/2meg with 1/spindle and S/P switch, 2/6 ea.

POPULAR mains trans. buy; shrouded upright mounting with base connections, 290-0-290v, 60m/a, 6.3v 1.5amp and 4v 2amp. with screen, primary tapped on vol/panel, 0-200v, 220v, 240v size, H.3 1/2 in w 3 1/2 in, D2 1/2 in, our price 12/6 and 1/- pack/post.

HUNDREDS of other bargain lines in stock and our price is right. Your enquiries welcomed.

TERMS: C.w.o., no c.o.d. SEND 9d extra for postage orders under £5. 2/4d s.a.e. all enquiries and list [0021

RADIO CLEARANCE, Ltd., 27, Tottenham Court Rd., London, W.1. Tel. Museum 9188.

ELECTROLYTICS, capacity, voltage, size, type of mounting, price post paid: 400, 6v, 1x2in, lug, 1/9; 250+250, 6v, 1x2in, lug, 2/-, 40, 150v, 1x2, clip, 2/6; 20+20, 275v, 1x2, lug, 3/3; 16+32, 275v, 1/2, lug, 3/3. 16+16, 275v, 1x2, clip, 3/5; 100, 275, 350v, 1 1/2 x 3, clip, 3/6; 52+12, 350v, 1 1/2 x 2, clip, 4/7; 16+16+16, 350v, 1 1/2 x 2, clip, 4/9; 16, 350v, 3/4 x 2, lug, 1/9; 10, 450v, 3/4 x 2, lug, 1/6; 16, 450v, 7/8 x 2, tag, 2/9; 20, 450v, 1x2, 2/3; 32, 450v/525v, 1 1/2 x 2, clip, 3/9; 15+15, 450v+20mf 25v, 1 1/2 x 3, lug, 4/6; 200, 6v, 3/4 x 1 1/2, clip, 1/6; 100, 12v, 3/4 x 1 1/2, clip, 1/9; 8, 450v, 1x2, clip, 2/-; 50, 12v, 3/4 x 1 1/2, tag, 1/6; 150, 25v, 3/4 x 1 1/2, clip, 2/-; 250, 12v, 3/4 x 1 1/2, wire, 2/3; 40+40, 275v, 1 1/2 x 2, clip, 3/3; 24+24+16, 350/425v, 1 1/2 x 2, clip, 4/9; 4, 150v, 3/4 x 1 1/2, clip, 1/1; 500, 12v, 1 1/2 x 3, clip, 3/8; 350v, 3/4 x 2, clip, 1/9. 32+32, 350/425v, 1 1/2 x 2, clip, 5/-; 8+16, 450x525v, 1x2, clip, 4/-; 2, 450/525v, 3/4 x 1 1/2, tag, 1/6; 8, 450v, 3/4 x 2, clip, 1/9; 64+120, 275v, 1 1/2 x 4 1/2, clip, 5/6; 1,000+1,000, 6v, 1x3in, lug, 3/3; all all cans, some with sleeves, all voltages, WKG, surge where marked, new stock guaranteed.

UNIVERSAL amplifiers, 8-valve 20watt A.C./D.C., black crackle chassis, and black and chrome cover, overall size 15 1/2 in X 7 1/2 in X 7 1/2 in. First-class components (Partridge G.E.T. and driver, Gardiner choke, A.E.E. Mu-Meta input trans. for mike). Valves, 2XEF37, 4XCL33. 2XUR3C. Switched input for high of low imp., top cut and bass cut switches, V.C. mains switch, mains plug and socket, 220-250v, isolated chassis, 15Ω output. Wired and tested, ready for use, with valves, brand new. £10/19/6, carr. paid

5Ma meters, moving coil, bakelite case, 2in square, flush mounting, new, boxed; 7/- post paid.

MAINS trans., 250-0-250v, 80ma 6.3v, 2.5A, 6.3v, 0.6A, Pri. 0-210-230-250v 12/- post paid.

TELEVISION chassis, cadmium plated, steel, size 14x13x2 1/2 in, complete with 13 valve holders (9-B9A Fax, 1-B9A Cer, 2-B7G Cer, 1-1st, Oct, amph.), 20 various tag strips, cut away for metal rect., line trans., etc.; 9/11 each, post paid.

FRONT and rear tube mounts to fit above chassis, 3/- post paid.

P.M. focus rings, wide angle, tetrode tube, fully adjustable, 12/-, post paid.

RADIO CLEARANCE, Ltd., 27, Tottenham Court Rd., London, W.1. Tel. Museum 9188 10015

SOUTHERN RADIO SUPPLY, Ltd., 11, Little Newport Street, London, W.C.2. See our displayed advertisement, page 163. [0016

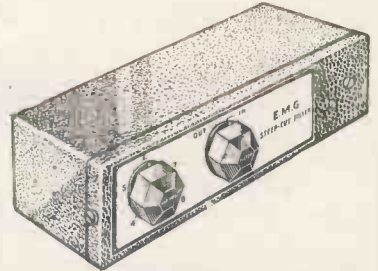

E.M.G. INFINITELY VARIABLE STEEP-CUTTING FILTER

No other filter combines all the advantages of this model which are, briefly, to cut response above any desired level between 4,000 and 8,000 c.p.s. at an average steepness of 30 db per octave, easy fixing (connects between 15 ohm speaker and amplifier output), robust construction, no distortion or appreciable loss of volume and cannot introduce hum. Recommended for reducing surface noise on '78' records, cutting 'edge' on some L.P. records, and eliminating high pitched interference on radio.

Price £4/10/- Leaflet on request Trade Enquiries Invited.

E. M. G. HANDMADE GRAMOPHONES LTD. 6, Newman St. London W.1. Museum 9971

THE INSTRUMENT MODEL

Specially designed for soldering operations in the compact assemblies used in present day radio, television and electronic industries. Weight 3 1/2 oz. excluding flexible. Length 9 in. 25 Watts—200/220 volts, LIST No. 624 220/240 volts, LIST No. 625

19/8d



HENLEY SOLON ELECTRIC SOLDERING IRONS

W. T. HENLEY'S TELEGRAPH WORKS CO. LTD. 51/53, Hatton Garden, London, E.C.1

**ENSURE  
THE BEST  
RESULTS**

*from your*  
**ULTRA - LINEAR  
AMPLIFIER**



with  
the



**SAVAGE**  
OUTPUT  
**TRANSFORMER**  
3S95

The Savage Massicore output transformer type 3S95 is designed to the same standard as the 3C67A, which so many enthusiastic friends incorporated in the Williamson circuit. The specification is as follows:—

- ★ Primary D.C. resistance 100Ω + 100Ω Inductance taken at 5 v. 50~ 80 hys minimum.
- Primary impedance 7,000Ω tapped at 43% symmetrically about the centre tap.
- Leakage reactance tested at 1 v. 800~.
- Whole primary to secondary: 8 m/Hys.
- Half primary to secondary: 4 m/Hys.
- Half primary to the other half primary: 8 m/Hys.
- Secondary impedances: 0.45Ω, 1.8Ω, 4Ω, 7Ω, 11Ω, 16Ω, 22Ω, and 30Ω.



**NURSTEED ROAD,  
DEVIZES : WILTS.**  
Telephone : DEVIZES 932.

**CLEARANCE offer.**—400 Chiltern Circuit Breakers, 7/6 each (15. 30 and 50 amp), samples 10/6.—B.D.C., 591, Green Lanes, London, N.8. [4321]

**WANTED, EXCHANGE ETC.**  
WANTED, receivers A.P.R.4 also T.N.16. 17. 18, 19, etc., and any radio test gear.  
LESLIE DIXON & Co., 214, Queenstown Rd., Battersea, S.W.8. Macaulay 2159. [0176]

**WANTED, signa. generator** TF517F/1.—K. R. Hooge, 29, Street Lane, Leeds, S. [4266]

**WANTED, tuning units** TN17, TN18, TN19 for R54/APR4; £50 each offered.—Box 4963. [0261]

**WANTED, Aerial tuning units** B.C. 939a.—P.C.A. Radio, Beavor Lane, Hammersmith, W.6. [0080]

**WANTED, HRO coils, Rxs, etc.** A.R.88s, BS348s, S27s, etc.—Details to R.T. & I. Service, 254, Grove Green Rd., London, E.11. Ley. 4986. [0163]

**WANTED, set manufacturers' or ex-Govern-** ment radio equipment, large or small quantities of valves, electrolytics, speakers, meters, also components.  
LOWE BROS., 9a, Diana Place, Euston Rd., N.W.1. Eus. 1636/7. [2703]

**WANTED, Cardioid microphone, S.T. & T.** Type 4033-A, good condition, with suspension mounting if available.—Replies: W. N. Larmour, 73, May St., Belfast. [4360]

**WANTED, BC 610, Hallicrafters, ET 4356** transmitters, AR 89 Ds and LPs, receivers and spare parts for above, also BC 221 frequency meters; best prices.—P.C.A. Radio, Beavor Lane, Hammersmith, W.6. [0079]

**WANTED, signal generators types** TF146, TF390C, TF762A, frequency meters BC221, TS174, TS175, also receivers types AR88 etc., APR4 or similar.—Send price and details to Hatfield Instruments, Ltd., 175, Uxbridge Rd., Hanwell, W.7. Tel. Ealing 0779/9257. [0037]

**ALL U.S.A. V.H.F. test and communication** equipment: TS174, TS175, TS47, BC 221, freq. meters; receivers 1294, 1359, Hallicrafters S 27, S 27CA, U.S.A.; APR4 and tuning units TN16, 17, 18 and 19, RCA AR88D-LF, Hallicrafters SX28; valves 707A-707B, 2K28, 2K39, 2K33, 2K41; highest offers given, by return.—Ger. 8410 and 4447, Universal Electronics, 22, Lisle St., Leicester Sq., London, W.C.2. [0229]

**VALVES WANTED**  
ALL types of valves required for cash; state quantity and condition.—Radio Facilities, Ltd., 38, Chalcot Rd., N.W.1. Primrose 9090. [4073]

**VALVES** purchased for cash, large or small quantities, why not make a parcel of your unwanted new valves and send us full details with your price required in your first letter.—Walton's Wireless Stores, 48, Stafford St., Wolverhampton [0061]

**LEWIS RADIO** have the best selection and finest finish.—See page 167. [0224]

**WALNUT** radiogram and television cabinets, soundly constructed; stamp for details.—R. Shaw, 69, Fairlop Rd., Leytonstone, E.11. [4330]

**METERS WANTED**  
WE urgently require meters of all types, meter components test equipment, etc.: any quantity, large or small; prompt cash.  
ANDERS ELECTRONICS, Ltd., 61, Hampstead Rd., London, N.W.1. Euston 1639. [3738]

**REPAIRS AND SERVICE**  
Mains transformers rewound, new transformers to any specifications.  
MOTOR rewinds and complete overhauls; first-class workmanship; fully guaranteed.  
F.M. ELECTRIC Co., Ltd., Pottery Bldgs., Warsler Gate, Nottingham, Est. 1917, Tel. 47898.

**LOUDSPEAKERS** repaired promptly.—Model Loudspeaker Service, Bullingdon Rd., Oxford. [4141]

**MAINS** transformers, E.H.T.s, chokes, field etc., promptly and efficiently rewound or manufactured to any specification.  
LADBROKE REWIND SERVICE, LTD., 820a, Harrow Rd., London, N.W.10 [0222]

**VAC.,** drill armatures rewound, 15/- each, fully guaranteed; special prices for quantities.—K.R., 6 Mitchells Cres., Penydarren, Merthyr Tydfil [4269]

**SERVICE** sheets for hire or sale, over 2,000 models, radio and television, list 1/-; same enquiries.—W. Gilbert, 24, Frithville Gardens, London, W.12. Tel. She. 3052. [4296]

**TRANSFORMER** rewind service, mains, E.H.T. transformers and chokes, prompt delivery, range of replacement types ex-stock or manufactured to your specifications.  
METROPOLITAN RADIO SERVICE Co., 75, Kilburn Lane, London, W.10 Ladbroke 2296

**NOTICE** that Melton Electronics, Ltd., 337 N. Ashley Rd., Parkstone, Poole, Dorset, manufacture transformers, chokes, line and frame outputs, R.F. and E.H.T. coils, and a complete range of "C" core types.

**YOUR** enquiries for rewinding all Commercial Types will receive immediate attention. [4303]

**REWINDS** and conversions to mains and output trans, pick-ups, fields, clock coils, etc., from 4/6. P.P. equipment a speciality; all work guaranteed.—N.L. Rewinds, 173, High Rd., Willesden Green, N.W.10, Tel. Wordsworth 7791. [4364]

**ELECTRICAL** test instruments repaired and recalibrated, makes, ammeters, voltmeters, multi-range test meters; meters supplied or converted to any range.—Electrical Instrument Repair Service, 329, Kilburn Lane, W.9. Ladbroke 4168. [4016]

**24-HOUR** service, 6 months' guarantee, any transformer, rewind, mains outputs, and i.f.s., etc.; all types of new trans, etc., supplied to specification; business heading or service card for trade prices.—Majestic Winding Co., 180, Windham Rd., Bournemouth. [4268]

**Armstrong**

Specialists for over 20 years in the manufacture of

**HIGHEST QUALITY CHASSIS**

Hand made by Craftsmen



Price  
**£23.18.0.**  
(inc. tax.)

**F.C.48 RADIOGRAM CHASSIS**  
with provision for F.M. Tuner.

- 8 VALVES including 2 double triodes.
- 8 WATTS output from push-pull tetrodes.
- NEGATIVE FEED BACK—20 dB, resulting in negligible distortion and high damping factor.
- BASS and TREBLE controls independent and continuously variable. LIFT as well as cut. Unique Thermometer Visual Indicator ensures positive setting of these controls.
- MAGIC EYE Tuning Indicator.
- 4 WAVE BANDS: 16-50, 49-120, 190-550, 900-2000 metres.
- Large 4 colour illuminated dial.
- Overall size 12 1/2 in. x 9 in. x 9 1/2 in. high.

**T.V.5 14" and  
17" CONSOLE  
TELEVISION**



Giving the true black and white picture.

The same high standard of design and manufacture, for which our radio chassis have been renowned for many years, has been maintained in the T.V.5 range. Aluminised rectangular Cathode Ray tubes are used, which together with tinted filters, pin point focussing, full bandwidth and accurate interlacing, ensures BRILLIANT DAYLIGHT VIEWING.

The cabinet is finished in beautiful walnut veneer and makes an elegant addition to any well furnished room. Silent running castors are fitted for easy movement.

The Prices (including Purchase Tax) are:—  
17in. CONSOLE ..... £32 19 0  
14in. CONSOLE ..... £72 9 0

The chassis may be purchased separately as follows:  
17in. CHASSIS ..... £64 15 11  
14in. CHASSIS ..... £54 0 3

\* Provision is made for a tuner which will enable you to receive alternative programmes as soon as it becomes possible to receive them in your area.

**ARMSTRONG WIRELESS & TELEVISION CO. LTD.**  
WALTERS ROAD, HOLLOWAY, LONDON, N.4

—Telephone: NORTH 3213/4—

### "AUTOMAT" HOME CHARGERS AND KITS

**SELENIUM L.T. RECTIFIERS.**  
S.T.C., Westallie, G.E.C. etc., 40 m.a. to 10amps  
All new goods with full guarantee.

**FOOLPROOF CHARGER KITS.** Genuinely trouble free and ultra reliable. As sold for 12 v. through "W.W." with full data sheet and instructions. No. 1 Kit. (As illus.). Westallie 3 amp. rectifier, 65 watt tapped, impregnated trans., ballast bulb, for 2 v. 6 v. 12 v. charger, all rectifier troubles eliminated, 46/-, P.P. 1/10. Handsome steel case, really punched, louvred, enamelled, 12/6. No. 1A Kit. 3 a. rectifier, 65 watt trans., ballast, res., ammeter for 2 v., 6 v., 12 v. 3 a., 52/6, p.p. 1/10, No. 2 Kit. 12 v. 2 amp. rect., 45 watt trans., ballast/indicator bulb for 2 v., 6 v., 12 v. charger, 38/6. Case 12/6, p.p. 1/10. W.I. 81b. with case. Minor Kit 6 v. 2 amp., 32/-, p.p. 1/10, case 12/6 extra. Senior Model, for 6 v./12 v. at 4 to 5 amp., 12 v. 5 amp. S.T.C. rect., 85 watt trans., ballast bulb, 64/-, p.p. 2/-. Slider Kit, 120 watts trans., 14 v. 6 amp., large finned type rect., alder res., high grade ammeter, wt. 17lb., for 6 v./12 v. charger, 24/13/-, carr. 4/-. Ditto, 3 a., to 4 a., 67/-, p.p. 2/4.

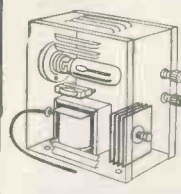

**"AUTOMAT" SELF REGULATING CHARGERS.** "Export" model for 6 v./12 v. 5 amps, using S.T.C. selenium rectifier, damp-proof, ultra reliable, wt. 18lb., for 218/245 v. A.C., 25/5/-, carr. 4/8 extra. Gtd. 12 months. Also our well known 12 v. 3 amp. charger with protective ballast and glow indicator, 69/6, ditto 6 v. 3 amp./12 v. 2 amp., 69/6, ditto, 6 v./12 v. 2 a., 59/6, surplus 1/10, wt. 8lb.

**SELENIUM RECTIFIERS.** new stock not postage with full data sheet, 6 v. 1 a., 4/-, 2 a., 7/6, 4 a., 15/-, 12 v. 0.5 a., 5/- 1 a., 7/6 2 a., 9/6 all p.p. 6d. 12 v./14 v. 3 a. to 3.4 a., 15/6 5 a., 27/-, Large finned 5 a., 32/-, p.p. 10d. 24 v. 50 mA., 2/9, 24 v. 0.3 a., 9/-, 1.5 a., 15/-, 3 a., 27/-, 5 a., 42/-, 8 a., 62/-, all p.p. 10d. 50 v. 1 a., 24/-, 2 a., 47/-, 230 v. 1 a., 97/-, p.p. 1/6. E.T. rectifiers, 120 v. 80 mA. R.M.2, 3/4, 135 v. 30 mA. elim. 5/6, 250 v. 60 mA., 7/-, 250 v. 100 mA. bridge, 14/6, all p.p. 6d. Many other L.T. and H.T. types in stock.

**"RENEWBAT" BATTERY DESULPHATER AND CONDITIONER.** Car size, 3/6, p.p. 6d.

### CHAMPION PRODUCTS

43 Uplanes Way, LONDON, N.21. Phone LAB. 4457.

### CABINETS

We specialise in making **HIGH CLASS** cabinets to individual specification, particularly in high fidelity field.

Competitive Prices.

**ALAN GRANSTON (Cabinet Makers),**  
20, Lorrimore Bldgs., Olney Road, Waltham,  
Phone: RODney 2349. LONDON, S.E.17.

### FOUR STAR HIGH-FIDELITY PROGRAMME

**A.M. and F.M. UNITS** by leading makers, prices from **£14/14/-.**

**AMPLIFIERS** by Leak Quad, Sound Sales, Rogers, Pamphonic, from **£20.**

**AUDIO FURNITURE** to house all types of equipment. Send S.A.E. for details.

**TRANSCRIPTION MOTORS** by Garrard, Collaro, Connoisseur, Jason.

### HOLLEY'S RADIO

285, CAMBERWELL ROAD, LONDON, S.E.5  
Phone: RODney 4988  
Hours 9.30 to 6 p.m. 1 o'clock Thurs.  
Open all day Saturdays

**D.C. BOULTON** for repairs to any loud-speaker; specialists on heavy and P.A. types; cone assemblies, field coils, repair accessories, pressure units, microphones; transformers rewound and to specification; motor rewinds.—Lumby St., Manchester Rd., Bradford. Tel. 22858. [0171

**ARMATURE** rewinding service to the trade, vacuums, drills, grinders, hood dryers, dental motors, vacuum cleaner armatures replaced from stock; 24 hours' service; every job guaranteed; we also specialise in complete overhauls and rebuilds of vacuum cleaners; all vacuum cleaner parts, hoses, bearings, fans, brushes for any make in stock.—Regam Electric, 95, Park Lane, Leeds, 1. [0028

**PAINTS, CELLULOSE, ETC.** spraying handbook, 3/6 post free, cellulose and synthetic paints and all spraying requisites supplied; catalogues free.—Leonard Brooks, 53, Harold Wood, Romford. [0207

**WORK WANTED**  
**A.L.D.-APPROVED** contractors seek model-room or short run work; comprehensive test gear and machine capacity.

**SOUND PRODUCTS** Co., Marlborough Yard, London Archway, N.19. Arc. 5078.

**CAN W?** help? Your development or production; assembly and wiring service at your disposal.—R.A.E. Mig. Co., 135a, Kentish Town Rd., N.1. [0219

**CAPACITY** available for small plastic moulds and stamping tools; highest limits, clean work, reasonable prices; speciality: hearing aids and electronic components.—Toolmaker, 23b, St. Stephens Ave., London, W.12. Appointment by phone She. 7069. [0084

**CAPACITY AVAILABLE**  
**VACUUM** impregnation capacity available. Haddells Solventless to RGS214 Specification.—Enquiries to, Avis & Baggs, Ltd., Gosbrook Rd., Caversham, Reading. Tel. 71763.

**MISCELLANEOUS**  
**FLUORESCENT** 4ft balton: 39/6, less tube.—(Dept. W.W.) B.D.C., 591, Green Lanes, London, N.8. [0277

**METALWORK**, all types cabinets, chassis racks, etc., to your own specification; capacity available for small milling and capstan work up to 1in bar. [0219

**WIRE PRODUCTS**, Ltd., (G4B1), Chapman St., Loughborough. [0208

**COPPER** winding wires, most gauges, leading manufacturers, enamelled, synthetic and textile covered; keen prices; immediate delivery. [4173

**YOUR** own tape recording transferred to disc.—Write, call or phone Queensway Private Recording Studios, 123, Queensway, W.2. Tel. Bay. 4992. Studio recordings, tape recording service. [4341

**BUILD** your own TV and learn about its operation, maintenance and servicing; qualified engineer-tutor available whilst you are learning and building.—Free brochure from E.M.I. Institutes, Dept. WW.58, London, W.4. (Associated with H.M.V.) [0180

**COPPER** wires enamelled, tinned, Litz, cotton silk covered, all gauges; B.A. screws, nuts, washers, soldering tags, eyelets, ebonite and laminated bakelite panels, tubes, coil formers; Tuinol rod, headphones, flexes, etc.; latest radio publications, full range available; list, S.A. Trade supplied.—Post Radio Supplies, 35 Bourne Gardens, London, E.4. [0138

**NOTICES**  
**BRITISH SOUND RECORDING ASSOCIATION.** Details of membership, open to the professional sound recording engineer and all others interested in recording, high quality reproduction and other branches of engineering, together with details of the London lecture programme and the Manchester, Portsmouth and Cardiff Centres, may be obtained from the Hon. Membership Secretary, H. J. Houlgate, A.M.I.E.E., 12, Strongbow, Eltham, S.E.9. [0031

**PUBLIC ANNOUNCEMENTS**  
**CITY OF PLYMOUTH EDUCATION COMMITTEE.**  
**PLYMOUTH** and Devonport Technical College, Tavistock Rd., Plymouth.  
**RADIO Officers Course.**  
A FULL-TIME course for radio operators leading to the P.M.G. second-class certificate will commence at the above college on April 18, 1955.

**APPLICANTS** who have reached a good standard of education in general subjects including Mathematics and English may be admitted direct to the course; other applicants must pass an entrance test.

**ALL** applicants must be physically sound and **ENQUIRERS** should be addressed to The Principal to reach him not later than March 31, 1955.

**ANDREW SCOTLAND,** Director of Education.

**PATENTS**  
The proprietor of British Patent No. 567462, entitled "Electronic Tube" offers same for licence or otherwise to ensure practical working in Great Britain.—Enquiries to Singer, Stern & Carberg, 14, E. Jackson St., Chicago 4, Illinois, U.S.A. [4356

**SITUATIONS VACANT**  
The engagement of persons answering these advertisements must be made through the local office of the Ministry of Labour and National Service, etc. If the applicant is a man aged 18-64 or a woman aged 18-59 inclusive, unless he or she or the employer is excepted from the provisions of The Notification of Vacancies Order, 1952.

**RADIO** and/or television engineer required for bench and on repairs, driver; references, age, experience, salary expected. Field's Radio, Ltd., 52, Hall Gate, Doncaster.

## OPPORTUNITIES IN RADIO



Get this FREE Book!

**'ENGINEERING OPPORTUNITIES'** reveals how you can become technically qualified at home for a highly paid key-appointment in the vast Radio and Television Industry. In 144 pages of intensely interesting matter, it includes full details of our up-to-the-minute home study courses in all branches of **TELEVISION and RADIO, A.M. Brit. I. R. E., City & Guilds, Special Television, Servicing, Sound Film Projection, Short Wave, High Frequency and General Wireless Courses.**

We definitely Guarantee

### "NO PASS—NO FEE"

If you're earning less than £15 a week this enlightening book is for you. Write for your copy today. It will be sent FREE and without obligation.

**BRITISH INSTITUTE OF ENGINEERING TECHNOLOGY**  
388 COLLEGE HOUSE,  
29-31, WRIGHT'S LANE,  
LONDON, W.8.



### BRASS, COPPER, DURAL, ALUMINIUM, BRONZE

**ROD, BAR, SHEET, TUBE, STRIP, WIRE**  
3,000 STANDARD STOCK SIZES

No Quantity too Small List on application  
**H. ROLLET & Co., Ltd.**  
6 Chesham Place, S.W.1. SLOane 3463  
ALSO AT LIVERPOOL, BIRMINGHAM,  
MANCHESTER, LEEDS

### LYONS RADIO Ltd.

**SIGNAL GENERATORS TYPE TF3800.** A.C. mains operated by Marconi Instruments Ltd., designed to produce an E.F. output covered by 4 turret switched ranges of 4-8, 8-16, 16-32 and 50-100 Mc/s., either unmodulated or modulated at 400 cps. to a depth of 30% by an internal A.F. Osc. or can be modulated by an external source. The Manufacturers have made a series of interchangeable coils to enable the frequency range of these instruments to be extended to cover from 3 to 150 Mc/s. The E.F. output of the oscillator is monitored by a diode and a microammeter arranged as a valve voltmeter. The output is taken to a continuously variable attenuator. Condition is as new and in working order with spare valves, handbook and calibration charts and in transit case. PRICE £25, carriage and insurance 25/-.

**TRANSMITTER/RECEIVERS TYPE 58.** Canadian made, man carried T/R's, frequency range 6-9 Mc/s. continuously variable. Range approx. 5 miles. Valves 2-1299A's, 1-1R5, 3-185's, 2-1T's. Front panel contains all controls together with 2 1/2in. dia. m.c. meter and range switch for checking operating voltage and current drain. Microphone, Headphones, 3 Aerials (Wire, Rod and Telescopic types) are all included together with instructions. Weight of complete set (less batteries) approx. 12 lb. In good condition and working order, sold externally, clean internally. PRICE £25/19/6, carriage 4/6.

**METERS.** Moving coil types, flush panel mtg. 3 1/2in. dia. 0/100 mA, 15/-; 0/2 mA., 19/6. Postage 1/-.

3 GOLDHAWK ROAD, (Dept. M.W.),  
SHEPHERD'S BUSH, LONDON, W.12  
Telephone: Shepherd's Bush 1729

# DUODE

# 12<sup>A</sup> <sup>B</sup> <sup>C</sup>

## MASTERS OF NATURAL SOUND



**INSIST on hearing one  
of these Units**

### DUODE 12A

A full 12-inch unit with the famous dual drive built-in-crossover, feed back and individual care which have made the Barker and Duode names so world known for NATURAL sound. Fitted with a magnet system giving about 12,000 gauss. List price £10. Full value—no tax.

### DUODE 12B

The same cone and drive assembly with a better magnet giving about 15,000 gauss and similar performance to that of the standard Duode of the past two years. List price £14. Full value—no tax.

### DUODE 12C

A very special unit, similar to the well-known 150 but now fitted with a cloth outer suspension and selected cone. Its bass range extends well down to 25 cps., almost sub-sonic, and the extreme top, to over 16,000 cps.—almost ultra-sonic. The large magnet gives about 17,000 gauss, which, with the Duode built-in damping, holds all transients and the bass register in the firmest grip. Definition throughout the entire range is superb. We believe the Duode 12C is the finest high quality Sound Unit available at any price to-day. List price £20. Full value—no tax.

Any recognised music or radio dealer can, if he wishes, buy Duode Units from us for his stock and demonstration. If yours will not do this for you, we will help by offering you the facility of trying a Duode at home, under very fair and reasonable conditions.

Write for details to-day.

**Barker Sound Reproducers**  
3 Newman Yd., London, W.1

### RADAR and electronic

ENGINEERS are invited to apply for a number of posts as area maintenance engineer with a leading originator in the radar field: the positions are of senior status, and call for men of considerable experience in micro-wave equipment to work without supervision: successful candidates will be given specialized training in the company's works, and then based in various parts of the country: a salary and allowances commensurate with qualifications and responsibility will be paid, and a car will be provided: a pension scheme is in operation.—Applicants should write, giving full details, to Box 38 N2098, A.K. ADVG., 212a, Shaftesbury Ave., London, W.G.2. 14069

### ELECTRONICS research.

ENTHUSIASTIC physics or engineering graduates required for interesting research on electronic circuits and devices in research laboratory situated in pleasant rural surroundings near Reading.

EVERY encouragement for visiting other laboratories, conferences, etc., and for publication of original work.

EXCELLENT opportunities for advancement within the laboratory and the vast engineering industrial group it serves.

APPLY in writing to Personnel Officer, Research Laboratory, Associated Electrical Industries, Ltd., Aldermaston Court, Aldermaston, Berks. 14225

### SALES Liaison Engineer.

A VACANCY exists for a keen engineer (age 20 to 30) to join expanding division dealing with commercial electronic instrument and equipment sales. Duties include technical liaison with design team, production unit and customers, also preparation of technical literature. Salary commensurate with ability, experience and qualifications.

APPLY to the Personnel Dept., (FS) E.M.I. Factories, Ltd., Blyth Rd., Hayes, Middx.

### ULTRA ELECTRIC, Ltd.,

WESTERN Ave., Acton, London, W.3.

RADIO & television development engineers.

(a) APPLICATIONS are invited from senior development engineers with experience and academic qualifications for important work on new development projects.

THE posts are permanent and pensionable and offer scope for the right men to work in ideal conditions in modern, well-equipped laboratories.

PLEASE write in strict confidence to the Personnel Manager for an interview appointment.

(b) JUNIOR engineers (aged 21/25) are also required, and applicants for these posts should have some technical training and preferably previous experience. Please write as above.

### ULTRA ELECTRIC, Ltd.,

WESTERN Ave., Acton, London, W.3.

ELECTRONIC development engineers are required in all grades for work on: (a) sub-miniaturisation of VHF, radio and audio circuitry; (b) transistor applications; (c) VHF communication; (d) pulse techniques; (e) radar and radio navigation.

APPLICATIONS are invited from:—

(a) SENIOR development engineers with degree or equivalent qualifications, and more than five years' experience in one or more of the above fields.

(b) JUNIOR engineers with degree or HNC with or without experience for work in the above fields.

(c) TEST equipment development engineers with experience of design of test equipment to meet production requirements.

THE posts are permanent and pensionable, and offer scope for the right men to work in ideal conditions, in modern, well-equipped laboratories.

PLEASE write, in strict confidence, to the Personnel Manager for an interview appointment.

TRINITY HOUSE, London.

RADIO Maintenance Assistants Wanted.

RADIO Maintenance Assistants are required to maintain radio and radar equipment in shore stations and ships.

CANDIDATES must possess a knowledge of the fundamental principles of radio and radar and must have had practical experience in the maintenance and use of such equipment. They should be medically fit and of British nationality.

SOME of the appointments are permanent and pensionable subject to one year's probation. Salary scales £565 rising to £695 (minimum linked to age 26) or £452/10 rising to £610 (minimum linked to age 25), depending on qualifications and experience.

APPLICATIONS to be made in writing to the Secretary, Trinity House, London, E.C.3, not later than 18th April, 1955, stating age, present occupation, qualifications, experience and enclosing copies of testimonials. 14369

### ELECTRONICS and physics.

ASSISTANTS required for laboratory work of wide interest in electronics or physics research. EXCELLENT opportunities for further education and advancement.

ENTHUSIASM major requirement.

LABORATORY in pleasant rural surroundings near Reading.

APPLY in writing with full particulars of any previous experience and training to Personnel Officer, Research Laboratory, Associated Electrical Industries, Ltd., Aldermaston Court, Aldermaston, Berks. 14224

## DEPENDABLE RADIO SUPPLIES

12a TOTTENHAM STREET, W.1  
TEL.: LANGHAM 7391/7392  
1 minute Goudge St. Station

Wireless Sets No. 19, Supply Units No. 1, Mark III, Ref. No. ZA 15208, complete with two rotary transformers.



Price £5/5/-, post and packing extra. Cases, chassis, spares and motors can be supplied separately.

### ROTARY TRANSFORMERS



H.T.31

Input 11.5 v.  
Output 250 v.  
at 125 m/a.

H.T.32

Input 11.5 v.  
Output 490 v.  
at 65 m/a.

H.T.31 55/-, Postage 2/- H.T.32 30/-, Postage 2/-.  
Can be supplied for tropical use at a small extra cost.

American Johnson variable condensers. (Brand New.)  
Cap. 1008 uF Test 2500 v. Gap .06. Price 17/6 each. Post 1/6.

## LOUD HAILERS

Made by Tannoy  
and Truvox.

22/6 each. 3/- P.P.  
40/- for 2. 5/- P.P.

(BRAND NEW)  
Impedance 15 Ω.  
Handling Capacity  
8-10 watts.



Large stocks of American aircraft fuses, switches, transmitter and radio components. Including spares for AR88Ds and AR77s.



Heavy Duty Sliding Resistors, 250 watts to carry 25 amps. Resistance 0.4 ohms. Suitable for charging board, etc. Size 9 x 4 x 6 in. high. Brand new. Price 10/6. Post 2/-.

Quantities and Export. Inquiries invited. Callers also welcome.

Open Monday to Friday 9.30—5.30

TERMS—CASH WITH ORDER  
DEPENDABLE — ALWAYS DEPENDABLE

# Fidelia

**HAND BUILT  
QUALITY  
UNITS**



MAJOR  
10 VALVE  
RADIOGRAM  
CHASSIS £32/8

There is no magic in the Fidelia: it is just engineered throughout to give fine results and carefully hand built. The design has always been in advance of current practice and this is exemplified in the arrangements available for F.M. reception. We can provide for the reception of these high quality transmissions on all Fidelia models, whenever made, at modest cost. There is no obsolescence with Fidelia, the design is right, the price is right too.

Fidelia Standard 7 valve model. . . . . £21 12 0  
Fidelia de Luxe 9 valve model with triode push-pull output stage . . . . . £25 5 0  
Fidelia F.M. Tuner . . . . . £13 10 0  
Fidelia 10 watt Amplifier and tone control unit . . . . . £27 10 0

Full details on request. **ALL MODELS** have triode output stages, Variable Selectivity, Separate Bass and Treble Controls, Cathode follower detector, 20-20,000 cycle audio response.



**ELECTRO  
Acoustic  
DEVELOPMENTS**

2 AMHURST ROAD,  
TELScombe CLIFFS,  
Nr Brighton,  
SUSSEX

Tel: Penchance 3156

**R**ADIO and television engineers.

FIRST-CLASS openings for an experienced car radio engineer, television engineers and senior design draughtsmen will shortly become available with a firm of repute in the London area; engineers able to undertake immediately development work on broadcast radio and television apparatus would be offered an attractive salary; the successful candidates will be eligible for company superannuation and insurance schemes.—Please reply, giving full details of experience, to Box 2167. 14537  
NEW ZEALAND Air Department.

**A**PPLICATIONS are invited from male communicators for employment in the Civil Aviation Administration of the Air Department in New Zealand; age preferably 21 to 35 years; applicants should possess Morse operating speed of 20-25 w.p.m., ability to touch-type and should be fit for tropical service; initial salary in accordance with qualifications and experience up to £N2705 p.a., advancement on merit is possible to £N2785 p.a. with prospects of higher positions.

**F**URTHER information, conditions of service and application forms may be obtained on request from:  
THE High Commissioner for New Zealand, 415 Strand, London, W.C.2, quoting reference number 3/47/47 and mentioning this paper; completed applications in duplicate accompanied by copies only of two recent testimonials (also in duplicate), to be lodged not later than 31 March, 1955. 14276

**R**ADIO officers required by the  
**EAST AFRICA HIGH COMMISSION  
DIRECTORATE OF CIVIL AVIATION** for one tour of 30 to 48 months in the first instance with prospect of permanency; salary scale (including inducement pay and present 10 per cent temporary allowance) £772 rising to £1,122 a year, commencing salary according to experience, good prospect of promotion to grade of radio superintendent (salary scale including inducement pay and present 10 per cent allowance rising to £1,280 a year); gratuity of 13½ per cent of total basic salary drawn during contract for those not taken on permanent establishment, free passages, liberal leave on full salary; outfit allowance £50; candidates must be capable of operating at 25 w.p.m. and should preferably hold M.C.A. 1st class certificate in radio telegraphy, knowledge of touch typing for teleprinter, the operation of modern radio or radar aids, or experience in radio maintenance would be an advantage.—Write to the Crown Agents, 4, Millbank, London, S.W.1 stating age, name in block letters, full qualifications and experience and quote M2C/30606/WF. 14301

**E**NGINEERS required to work on  
(A) Printed Circuitry.  
(B) Transistor Applications.  
APPLICANTS, who are assured of interesting and progressive work, should have had at least three years' experience on development of radio or television equipment. Please send full details to Personnel Manager,  
VIDOR-BURNEDEPT, Ltd., Erith, N. Kent. 14240

**A. H. HUNT (CAPACITORS), Ltd.**  
REQUIRE engineers for design and development of PAPER mica and ceramic capacitors. APPLICANTS should have previous capacitor experience, or training in electrical engineering at least to intermediate B.Sc. standard.—Apply Personnel Manager, A. H. Hunt (Capacitors), Ltd., Bendon Valley Garratt Lane, Wands-worth S.W.18 14057  
**E**LECTRONICS development engineer.

**R**APIDLY expanding company located near Aylesbury, offers outstanding opportunity to a development engineer with a wide experience of electronics design; applicants must have a sound knowledge of communications/pulse techniques; be qualified by degree or equivalent and experience of aerial design would be an advantage; the post offers great scope for future advancement to a man with a good background of industrial or establishment experience; full details of age, experience, qualifications and salary expected to—Airtel, Ltd., Aylesbury and Thame Airtel, Haddenham Bucks. 10096  
**N**ORTHAMPTON POLYTECHNIC, E.C.1.

**D**EPARTMENT of Electrical Engineering, REQUIRE, Laboratory Technician. Post offers experience, training and education in all aspects of electrical engineering, with high current or power specialization; part-time day education for degree or H.N.C.; 5 weeks paid holiday annually; salary: age 16, £3/13/6 to £401 p.a. at approximate age 26, plus supplement for certain qualifications; post superannuable.

**A**PPLICATIONS to Head of Department.  
**T**ELECOMMUNICATIONS (Line Transmission) Engineer required by large organisation in the North-West to train for position in Technical Publicity Department.  
APPLICANTS should be aged between 25-30 years, and should have a good educational background with the ability to write clear concise English; a sound knowledge of modern telecommunications techniques, including coaxial and other multi-channel carrier telephone and telegraph systems, essential.  
THE position is on the established staff of the Company, with contributory Pension Fund, and usual staff conditions and amenities.—Please write to Box No. 458, Dorian Advertising, Ltd., 18-20, Regent Street, London, S.W.1, giving details of age, qualifications and experience.



The **ELBAR** two-speed portable **TAPE RECORDER**. Speeds 7½ and 3½ (switched). Size 15½ x 12 x 7in., incl. lid. Elegantly finished two-tone Rexine covered cabinet. Weight 26 lb. No tape lacing. Efficient self-aligning brakes and interlocking switching makes it simple to operate and eliminates any possibility of accidental erasing, tape spilling and tearing. It is built to British and U.S.A. standards and will faithfully reproduce speech and music.

Price **45 Gns.** incl. Microphone.  
Fully guaranteed.

H.P. Terms or HIRE facilities available for details, write to or visit  
**Jackson Radio**  
163, Edgware Rd., London, W.2.  
Paddington 0537.

**WORLD'S FINEST**

# ARKAY KITS

**RADIOS PHONOGRAPHS TV  
TEST EQUIPMENT HI-FI**

Write for **FREE Brochure**

**Radio Kits, Inc. • 120 CEDAR STREET  
NEW YORK 6, NEW YORK • U.S.A.**

**CABLE CHEAPER IN SMALL COILS**

No coil under 25 yds. unless requested. All prices per a 100-yd. lot. Less supplied, add 5%.

|               |       |       |      |       |
|---------------|-------|-------|------|-------|
| Twin Flat     | 1/044 | 3/029 | W/E  | W/E   |
| Rubber        | 42/-  | 53/-  | 63/- | 109/- |
| Plastic       | 38/-  | 52/-  | 61/- | 107/- |
| Single V.I.R. | 18/-  | 23/-  | —    | 38/-  |

**EARTH WIRE 7/029** tinned copper, 3/6 a 100-ft. lot. Send for lists of other cables, flexes, wiring accessories, and surplus switch and fuse gear. (We buy surplus electrical items, send details.) Add part carriage to small orders please.  
**BRITISH DISTRIBUTING (Desk W), 591 Green Lanes, London, N.8.**

Introducing the:—

## TYANA TRIPLE THREE



Reg. Design,  
No. 867834

**MAKE SOLDERING A PLEASURE  
SMALL SOLDERING IRON**

Complete with detachable BENCH STAND **19/6**

The smallest high-power soldering iron. Length only 8½in.; adjustable long bit dia. 3/16; mains voltages 100/110, 200/220, 230/250.

### The "STANDARD" Popular Soldering Iron



now reduced to **14/11**

Replacement Elements and Bits for both types always available.

**KENROY LIMITED**  
152/297 UPPER ST., ISLINGTON,  
LONDON, N.1.  
Telephone: Canonbury 4905-4663

## WEST END RADIO

**EDISON ALKALINE BATTERIES.** 3.6 v. 37 amp. units in wood crate, new 59/6. Carr. 5/-. Dims.: 6in. x 7in. x 10in. U.S.A. manufacture.

**CANADIAN MARCONI NO. 9 RECEIVER.** 2 channels 1.9-5 Mc/s. Crystal Freq. check. B.F.O. 10 valves. Brand new 95/-. P. & P. 15/-.  
**EIMAC Vacuum conds.** 50 MMF. 20 KV. 25/-, P. & P. 1/-.

**SAVAGE AUTO TRANS.** Inputs: 110 v., 130 v., 200-250 v. Switch controlled. Outputs: 110 v. and 230 v. at 3 KVA. Normal 1.2 KVA. Tropical dims.: 8in. x 8in. x 13in. in handsome steel case. Brand new. Our price £8/15/-, Carr. free.

TRADE TERMS FOR QUANTITIES

**SWITCH PANELS** with 16 Toggles, new 4/6. P. & P. 1/6.

**R.109 RECEIVERS** with Vib. Pack and Speaker, 6 volt operation, 79/6. Carr. free. 6 and 12 v. 4 amp. **CAR BATTERY CHARGERS.** Complete with meter 79/6. 2½ amp., 59/6. P. & P. 2/6.

1,000 Bargains for callers!

**WEST END RADIO LTD.**  
14, LISLE STREET, LEICESTER  
SQUARE, LONDON, W.C.2.  
Phone: GER 7341 OPEN ALL DAY SATURDAY

**B**ENSON'S  
**B**BETTER  
**B**ARGAINS

**BRAND NEW. ORIGINAL CARTONS.**  
**R.F. UNITS. TYPES 26 or 27, 27/6; 24, 15/-**  
(Postage 2/6.)

**High Stability, Close-tolerance Resistors, best makes;** mainly 1 and 1 watt (a few 1/2), from 10Ω to 5.1MΩ in pref. values: 7000 available, 1/- each (quotations for quantities). Ordinary resistors, our selection, 12/6 per 100. **DYNAMOTORS, solenoid coils, D.C.** (approx. 250 v. 80 mA., at 6 v.), 8/6. 12 v. input; 250 v. 60 mA. and 6.3 v. outputs, P.M. field, 8/6. **Filters for these, 2/6. I.F.T.S., new, canned 10/13** Me/s., 1/6. **POWER UNIT 285.** 230 v. 60 c. input. Outputs D.C. 2 kV. 5 mA., 350 v. 150 mA. A.C. 6.3 v. 15 a., 3 valves. New 75/-, carr. paid Island. **TRANSFORMERS, new, std. mains input: 800 v. H.I.W., 6.3 v. 3 a., 4 v. 2 a., 10/6; 230 v. to 6.3 v. 5 a. and 10 a., 17/6; 2 kV. 5 mA., 2 v. 2 a., 20/-; 350-0-350 v. 150 mA., 5 v. 3 a., 25/-; 55 v. 30 mA. (twice), 6.3 v. 3.2 a., 9/-; 220-0-220 v. 33 mA., 7.1 v. 8 a., 8.4 v. 10 a., 5 v. 3 a. each C.T., 15/6; 7.0-0-7.40 v. 165 mA., 470-0-470 v. 220 mA., 4 v. 8 a. C.T. (twice), 30/- (carr. 5/-). 350-0-350 v. 120 mA., 6.3 v. 4 a., 4 v. 2 a., 16/- (Post 2/- each). **METAL RECS.** 600 v. 30 mA., 6/- H.W. 400 v. 1 a. 22/6. 240 v. 250 mA., 10/-, 270 v. 80 mA., 6/-, FW 24v. 2 a., 12/6. **MOTORS,** tiny 24 v. driving aerial switch, 5/6. Co-ax. Aerial c/o relays 12/24 v. or manual, 7/6. R1155, coilpacks, new, 12/6, used, 9/6; twin-knob drives, 7/6; I.F. FILTERS, 2/6; Condensers, tubular, 3 x 1 mfd., 1/8. **RX 78,** two-band S.W. Tuner, I.F. 560 kc/s., with 100 kc/s crystal, less valves, 22/6. Close tolerance caps, 2 to 5%, 1800, 2700, 3300, 3900, 4110, 4700, 5600, 5965, 6700, 8200 pfs. 6d. each. Tiny 10, 15, 39 pfs. 10% S.M. 4d. each. 50 pf. Tz variables, 3/6 Dipole Insulators, perspex, flat, for 1/2 rods, 5/6.**

**METERS—BRAND NEW—BOXED**

| FSD        | Scale | Size      | Type      | Fit.    | Price   |      |
|------------|-------|-----------|-----------|---------|---------|------|
| 100.0-100  | μA    | 1 1/2 in. | MC        | Pr. Rd. | 15/-    |      |
| 500        | μA    | 2v. AC    | 3 1/2 in. | MC      | Pr. Rd. | 20/- |
| 2mA        |       |           | 2 in.     | MC      | Pr. Rd. | 10/6 |
| 5mA        |       |           | 2 in.     | MC      | Pr. Rd. | 7/-  |
| 10mA       | Lines |           | 2 in.     | MC      | Pr. Rd. | 5/6  |
| 60mA       |       |           | 3 1/2 in. | MC      | Pr. Rd. | 7/-  |
| 100mA      |       |           | 4 1/2 in. | MC      | Pr. Rd. | 20/- |
| 200mA      | 200A  |           | 3 1/2 in. | MC      | Pr. Rd. | 7/-  |
| 250mA      | 50A   |           | 2 in.     | MC      | Pr. Rd. | 6/-  |
| 30mA       |       |           | 2 in.     | MC      | Pr. Rd. | 6/-  |
| 40 & 120mA |       |           | 2 in.     | MC      | Pr. Rd. | 8/6  |
| 100mA      | 300mA |           | 2 in.     | MC      | Pr. Rd. | 5/6  |

List and enquiries. S.A.E. please! Terms: Cash with order. Postage extra. Immediate despatch.

Callers and Post  
W. A. BENSON (WV)  
308 Rathbone Rd.,  
Liverpool 13.  
STO 1804

Callers & Post  
S T P E R A D I O  
(W)happell, Ltd., 118  
Whitechapel, Liver-  
pool L. ROY 1130.

**RADIO—RADIOGRAM CHASSIS**

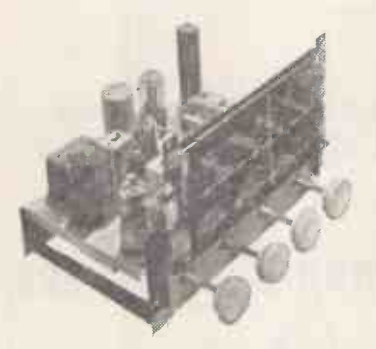

Superhet 5-valve S.M.L. wave chassis of advanced design, with station name multi-coloured edge-lit dial, 9in. x 4 1/2in. negative feedback, 4 watts output, chassis size 1 1/2in. x 7in. x 2 1/2in. supplied for horizontal or vertical mounting, 200-250 volts, A.C./D.C. mains. Model U5/3, or for A.C. mains, Model AC5/3, £12/12/-, plus 7/6 P. and P. and insurance. Escutcheon 4/6 extra.

**TUNER UNITS.** Superhet S.M.L. wave, complete with plugs and leads, chassis size 1 1/2in. x 6 1/2in. x 8in. high, multi-coloured edge-lit dial, £10/10/-, plus 7/6 P. and P. and insurance. T.R.F. Unit, medium wave, illuminated dial, H.F. stage, with infinite impedance detector and cathode follower, £6/15/-, plus 5/- P.P.

**POWER PACK** for A.C. mains output 250 volts 60 mA. fully smoothed, with L.T. 6.3 volts 3 amps., A.C., 24/10/-, plus 5/- P.P.

**AMPLIFIERS.** 3 valves, negative feedback, 4 watts output, £8/15/-.

Illustrated details from

**O. GREENLICK LTD.,**  
14, HILLSIDE RD., TOTTENHAM,  
LONDON, N.15  
Tel.: STAmford Hill 2991

UNITED Kingdom Atomic Energy Authority.

A specification writer for AIRBORNE service electronic equipment is required at the ATOMIC Weapons Research Establishment, Aldermaston, Berks.

THE successful applicant will be in charge of a small group of specification writers.

APPLICANTS should have served a recognized engineering apprenticeship or have had equivalent training and experience in electrical or electronic engineering; experience in testing prototype and/or initial production electronic equipment and in specification writing is desirable.

THE post is in the technical class and the salary scale is £830 rising to £1,015; the successful candidate will be required to join the Authority's superannuation scheme and contribute 6% of his salary.

HOUSING accommodation will be available within a reasonable period for married officers who live outside the radius of the establishment's transport facilities.

IT may be necessary for a short period of outstation duty to be served at Fort Halstead, Kent. Application form from Senior Recruitment Officer, A.W.R.E., Aldermaston, Berks. quoting reference 302/WGE/45. [4327]

**E.M.I. ENGINEERING DEVELOPMENT, Ltd.**

**COMPUTER Engineers.**

APPLICATIONS are invited from senior and junior electronic engineers with experience in the design of digital computers to take part in a large-scale development programme for commercial accounting systems. The posts carry good starting salaries and outstanding opportunities.

VACANCIES also exist for asst. programmers. APPLICANTS should write in confidence, with full details to Personnel Dept. (ED/226). E.M.I. Eng. Dev., Ltd., Hayes, Middlesex. [4309]

**AUTOMATIC TELEPHONE & ELECTRIC Co., Ltd.**

**LIVERPOOL 7.**

**COMMUNICATION engineers and DRAUGHTSMEN.**

THE expanding programme of the Transmission Department offers vacancies in both senior and junior categories for line transmission laboratory engineers, and apparatus design engineers, and also for draughtsmen with experience in telecommunications or light current engineering.

SPECIALIST experience in any branch of line transmission engineering is desirable for some of the posts.

POSITIONS offered are on the company staff with contributory pension fund and usual staff conditions.

APPLICANTS should write to Personnel Manager, Automatic Telephone & Electric Co., Ltd., Strowger Works, Edge Lane, Liverpool, 17, giving full details of age, qualifications and experience. [4243]

**AUTOMATIC TELEPHONE & ELECTRIC Co., Ltd.**

**SCHOOL of Electronics,**

**STROWGER Works, Liverpool, 7.**

APPLICATIONS are invited for the post of full-time lecturer in the School of Electronics; candidates must hold a degree in electrical engineering which includes the subjects electronics and telecommunications.

APPLICANTS should have had both teaching and industrial experience, and a knowledge of electronic switching techniques would be an advantage.

FURTHER details and application forms may be obtained from the Personnel Manager, Automatic Telephone & Electric Co., Ltd., Strowger Works, Edge Lane, Liverpool, 7. [4244]

**METHODS development section of Pvc.**

Limited has

VACANCIES for senior and junior television circuitry engineers and mechanical development engineers to work on printed circuit and other new system developments; this is work in a new and expanding field and offers almost unlimited scope for engineers with drive and initiative; salaries dependent on qualifications and experience.—Apply to Chief Television Engineer, Pvc. Ltd., Cambridge. [5994]

**APPARATUS development engineers** required for design of electro-magnetic devices.

PREVIOUS experience in the manufacture or design of relays, contractors or switchgear is desirable.

GOOD salary, pension scheme and excellent working conditions.

APPLY in writing in first instance TO: Personnel Manager, Thorn Electrical Industries, Ltd., Gt. Cambridge Rd., Enfield, Middx. [4299]

**MULLARD, Ltd.** has a vacancy in the telecommunications and industrial valve division for an engineer to take charge of the technical office; in the first instance he will be required, after initial establishment, to handle technical data, technical callers, phone calls and correspondence; other important functions and responsibilities are available to be assumed in due time and the post offers good scope for employment of the full capabilities of a clear thinking, conscientious engineer who prides himself on factual correctness; an assistant to the engineer-in-charge is also required, and applications are therefore invited from the standard of technical assistant up to that of graduate engineer; the salaries to be paid will be appropriate to the age, experience and qualifications of the successful applicants.

—Write giving full details to the Personnel Officer, Century House, Shaftesbury Avenue, London, W.C.2, giving reference M.L.I. [4234]

**LONDON CENTRAL RADIO STORES**

**Moving Coil Inserts** suitable for Mikés or Loudspeakers. Size 1 1/2 in. diameter. 2/6.

**A.C./D.C. Motor** 110-220 v., about 150 revs. Size approx. 4in. by 3in. diameter, with control. 50/-, carriage paid.

**High Resistance Single Ear-phones,** 1,000 ohms. 3/6.

**Wire Wound Potentiometers,** 8 or 10,000 ohms. 2/-.

**New 12 Volt 16 Amp. Accumulator** in metal case. 27/6.

**VCR97 Tubes.** 23/6.

**12 Volt Vibrators,** 4-pin American base. 7/6.

**New Cyldon Condensers,** variable transmitter, single gang, .0005. 3/6.

**Motor Meter Movement,** 220 volt A.C. for models, etc. 7/6.

**10 Line Portable Telephone Switchboards** with plugs, counterweights, etc., in metal cabinets. £7-10-0.

**Large Aldis Signalling Lamps,** trigger movement, approx. 7 1/2 in. diameter, in wood transit cases. 70/-.

**Small Neon Lamps, B. C.,** 120 volts, lots of 3. 5/-.

**Aldis Signalling Lamps,** trigger movement, 5 1/2 in. diameter. 32/6.

**Metal Rectifiers,** 160 volts 60 mA, size about 4in. 4/6.

**CV1526 2 1/2 in. Tubes,** 3 to 4 volt heater, anode 1300. 22/6.

**Electro Magnetic Counters.** Counting to 9,999. Operating volt 25-50 D.C. Perfect condition. 7/6.

**100-Volt Safety Bridge Megger.** Weight 25lb. Size, 14 1/2 x 7 x 6in. In perfect working order, £3/10/-.

**6in. Goodmans P.M. Speakers,** 3 ohm impedance. In perfect condition, 10/6.

**Trans-Receiver Type 18. Mk. 3.** H.T. 120 volt. L.T. 3 volt. Frequency 6-9 mcs. Complete in case with aerials, etc. Less mike and phones. £3/15/-.

**4-Valve (Used) Superhet Utility Receivers.** Fully reconditioned. Medium wave-band only. 6 1/2 in. P.M. speaker. Complete in pinewood cabinet. Size 13 1/2 x 12 x 6 1/2. 200-250 A.C. mains. £3/18/6.

**FREE CARRIAGE · FREE PACKING**

No more to pay

**23 LISLE ST., LONDON, W.C.2**  
(GER. 2969)  
Closed Thursday 1 p.m. Open all day Saturday

**Solder with**  
**LITE SOL**  
 REGD. TRADE MARK

**THE LIGHTWEIGHT CHAMPION**  
 NOW AVAILABLE WITH THE REMARKABLE NEW  
**PERMABIT**  
 REGD. TRADE MARK

The soldering bit which lasts indefinitely, does not become pitted or lose its face and requires no re-shaping, filing or maintenance. Fixed bit models and replaceable bits available in all sizes. All voltages supplied from 6/7 v. to 230/50 v. (State voltage when ordering.) Many leading manufacturers have already "switched" to these instruments.

Details of full range now comprising 20 models in folder No. S.P. 5 sent on request.

Sole Manufacturers and Distributors:  
**LIGHT SOLDERING DEVELOPMENTS LTD.,**  
 106, GEORGE STREET, CROYDON, SURREY.  
 Tel. CR0ydon 8589

### A NEW TAPE PRE-AMPLIFIER

Designed to professional standards for 3 HEAD DECKS.

- ★ Completely separate recording and replay channels with direct/replay monitor comparison switching.
- ★ Correct pre- and post-equalisation to C.C.I.R. standards.
- ★ Peak-programme metering.
- ★ Good bias and erase supply.
- ★ Designed primarily for WEARITE TYPE 2B TAPE DECK—perfectly suitable for all good 3 head tape decks.

Write to:

**ARIEL SOUND**  
 57, LANCASTER MEWS, LONDON, W.2  
 Telephone: PADdington 5092.

### WAFER SWITCHES TO SPECIFICATION

One or more type "H" switches having any desired contact arrangement or wafer spacing made from parts supplied by A.B. Metal Products Ltd.

Most types despatched within 48 hours.

Send for Price List of 82 "standard" arrangements and switch design chart

Orders and enquiries by post only:  
**SPECIALIST SWITCHES**  
 24 CRANBOURN STREET,  
 LONDON, W.C.2

SENIOR TV engineers required; must drive; salary from £650 p.a.—Apply E. Coyne, 120, Ladbroke Grove, W.10, Bay, 1947.

JUNIOR electrical engineer required by a large Company engaged in the telecommunication industry situated in S.E. London district.

THE position offered is for experimental work in connection with the editing of polarised relays for special applications.

H.N.C. is desirable but not essential. Applicants who are studying for such a qualification would be considered.

PENSION and staff bonus scheme after qualifying period.

WRITE giving full details of education and experience and salary required to Box 3R, P5278, A.K. Advcs., 212a, Shaftesbury Ave., London, W.C.2. [4263]

TELECOMMUNICATIONS (Radio Transmission) Engineer required by large organisation in the North-West to train for position in Technical Publicity Department.

APPLICANTS should be aged between 25-30 years, and should have a good general education, background with the ability to write clear concise English; a sound knowledge of modern telecommunications techniques, including V.H.F. and U.H.F. multi-channel systems and frequency-shift signalling practices.

THE position is on the established staff of the Company, with contributory Pension Fund, and usual staff conditions and amenities.—Please write to Box No. 434, Dorland Advertising, Ltd., 13-20, Regent Street, London, S.W.1, giving details of age, qualifications and experience.

MECHANICAL design engineer; young man with flair, own bright ideas, for aerial manufacturers South London; progressive salary.—Write full details Box 1866. [4270]

ELECTRONIC Engineers required by The General Electric Co., Ltd., Brown's Lane, Allesley, Coventry, in the development of Laboratories for work on the following items:—

- (a) Development of Pulse Circuitry Techniques for Guided Weapons.
- (b) Microwave Development.
- (c) General Radar Circuit Development.
- (d) Trials Team in connection with Guided Weapons.
- (e) Servo-mechanisms.
- (f) Test Equipment.
- (g) Magnetic Amplifiers.
- (h) Power Units including Electronic Stabilizers and Rectifier Systems.
- (i) Application and Circuit Theory of Transistors.
- (j) Design of R.F. Modulators.
- (k) Investigation into Valve Parameters.
- (l) Design of Valve Test Apparatus associated with (k) above.

APPLICANTS, preferably with a degree or an equivalent qualification should have had at least 2 years' experience in the development and engineering of Service equipment as well as experience in one of the above departments stating age, qualifications and experience to—The Personnel Manager, Ref. RG. [4131]

TELEVISION engineers able to drive required by leading and progressive dealers; good salary conditions and prospects.—Singer's, 350, Edgware Road, W.2, Pad. 7915. [4213]

REPRESENTATIVES with extensive wholesale contacts wanted for nationally known tape recorder manufacturer; many territories available.—Write to Box 2125. [4326]

TECHNICAL executives required for expanding retail and mail order concern; permanency, excellent salary with prospects.—Write to Box 2121. [4325]

U.T.M., Ltd., 79a, Parkhurst Rd., N.7, require 2 first-class TV service engineers, 5-day week and good starting salary—telephone for interview appointment North 3842. [4355]

RADIO engineer wanted, London; good practical knowledge of disc and tape recording essential; interesting position; permanency; Box 2230. [4357]

EXPERIENCED TV service engineer; old-established firm; good salary; small flat available.—Full particulars to W. J. Elliott, Ltd., Chequer St., St. Albans, Herts. [4340]

Air Ministry invite applications from men for 186 posts as civilian instructor, grade III, in the trades of air radio fitter, ground radar fitter, air and ground wireless fitter, instrument fitter and electrical fitter.

POSTS in provinces; appointments temporary but there are good prospects of their becoming pensionable; training followed by practical experience in the trade and the ability to teach are essential; pay £535 at 26 rising to £665.—Apply to Air Ministry, S.5(g) (C.I.V.3), Cornwall House, Waterloo Rd., London, S.E.1.

TEST/CALIBRATION engineers for high quality scientific and electronic instruments, with good basic knowledge electronics; at least 2 years' experience testing/calibrating audio-frequency apparatus; full details.

L.M.K. MANUFACTURING Co., Ltd., Harlequin Ave., Great West Rd., Brentford, Middx.

AN expanding instrument firm pioneering new developments in the field of radiation physics has vacancies on its research staff for Electronic Engineers or Physicists with an electronic background.

APPLICANTS should have a sound theoretical training and considerable practical experience. The posts would be of particular interest to those who wish to obtain experience in new fields of electronic technology.

THE laboratory is pleasantly situated in Surrey and a Pension Scheme exists.—Box 0635. [3969]

RADIO service mechanics required by Smiths (Radiomobile), Ltd., for many parts of the country.—Write details of experience and qualifications to Personnel Officer, Goodwood Works, North Circular Rd., London, N.W.2. [0342]

### This UNIQUE BENDER



#### Quickly and Accurately Forms

Angles, Channels, Sections, Boxes, Lids, Trays, Tanks, Chassis Brackets, Clamps, Clips, Shrouds, Chemical, Electronic and Electro Medical apparatus. Used by leading Radio Manufacturers. Invaluable to Servicing Engineers, Hospitals, Universities and Research Workers.

For 6 page Folder write to:—



### A. A. TOOLS (W)

197a Whiteacre Rd., Ashton-u-Lyne

Every genuine A.A. tool bears this mark.



### BASS REFLEX CABINETS

Walnut, Mahogany or Oak, 30" high, with gold anodised expanded metal grille.

12" Speaker Model £10. 0.0  
 10" " " £9.10.0  
 8" " " £9. 0.0

Carr. paid

**GOODMANS & G.E.C.**  
 Full range of cabinets for these speakers.

You can see your cabinet being made in our cabinet-making workshop.

Cabinets made to order.

Armstrong Chassis and Amplifiers.

The Leak TL/10 Amplifier.

LOUDSPEAKERS.

Open till 5.30 Saturdays

### A. DAVIES & Co. (Cabinet Makers)

3 Parkhill Place, off Parkhill Road, London, N.W.3. GULLIVER 5775.

### ODDIE FASTENERS

Pat. 507249

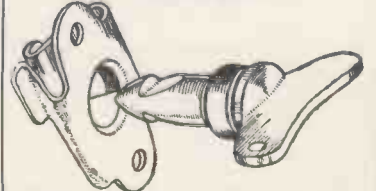

THIS FASTENER WITH ENDLESS APPLICATIONS—SIMPLE—POSITIVE SELF-LOCKING. MADE IN A VARIETY OF TYPES AND SIZES.

SPECIAL FASTENERS TO SUIT CUSTOMERS' REQUIREMENTS.

WIDELY USED IN THE RADIO INDUSTRY.

Illustrated brochure and other information will be gladly sent on request.

DEPT "W.W."

**Oddie, Bradbury & Cull Ltd., Southampton**

Tel.: 55883 Cables: Fasteners, Southampton



# SOUTHERN RADIO'S WIRELESS BARGAINS

**TRANSCEIVERS.** Type "38" Mark II (Walkie-Talkie). With 5 valves and ready for use. Metal carrying case, 30/- per set.

**THROAT MICROPHONES,** with long lead and plug, 4/6.

**JUNCTION BOX, 2/6. HEADPHONES** 15/6 per pair. **AERIALS, 2/6.** ALL OF THESE ITEMS ARE FOR USE WITH THE "38" Walkie-Talkie.

**TRANSCEIVERS.** Type "18" Mark III. Comprising Superhet Receiver and Transmitter. Two units contained in metal carrying case. Complete with 6 valves, £4/10/- per complete set.

**RECEIVERS.** Type "109." Built-in speaker. 8 Valves with VIBRATOR PACK for 6 volts. Contained in metal case. Perfect, £5 each.

**TELESONIC** 4-valve Battery Portable. Complete with Hivac valves in metal carrying case. Simply converted to Personal Portable, £2 per set including Conversion Sheet.

**BOMBIGHT COMPUTERS.** BRAND NEW ex-R.A.F. Contains gyro, motors, rev. counters, gear wheels, etc., etc. Ideal for model makers, experimenters, etc., £3/5/- each, plus 10/- carr.

**LUBBRA HOLE CUTTERS.** Adjustable £2 to 3/1in. For metal, wood, plastic, etc., 6/6.

**RESISTANCES.** 100 Assorted, all useful values, etc. Wire end, 12/6 per 100.

**CONDENSERS.** 100 Assorted. Mica, Metal, Tub, etc., 15/- per 100.

**PLASTIC CASES.** 14in. by 10 1/2in. Transparent. Ideal for maps display, etc., 5/6.

**STAR IDENTIFIERS.** Type 1 A-N. Covers both Hemispheres, in case, 5/6.

**CONTACTOR TIME SWITCHES.** In sound-proof case, 2 impulses per second. Thermostatic control. Clockwork movement, 11/6 each.

**REMOTE CONTRACTORS** for use with above, 7/6 each.

**MORSE PRACTICE (WITH BUZZER) SET.** Mounted, 6/9. Full List of Radio Books, 2/4.

**METERS,** 12 Instruments. May need adjustment or with broken cases, 35/- for 12.

*Postage and carriage extra.*

**SOUTHERN RADIO SUPPLY LTD.**  
11 LITTLE NEWPORT STREET  
LONDON, W.C.2 Gerrard 6653

## Excellence in design..

Specialists in Sub miniature Telecommunication Components

### STAND OFF INSULATOR

For 1500 volt working  
Overall height 1.1"  
Over chassis .86"  
Silver plated spill .35"  
6BA hexagon stud chromium plated.

These are reproduced (approx.) actual size

### MINITRIMMER

Standard maximum capacities up to 13pF. Voltage 500 DC. Base 3/4" square with fixing centres for 10 BA 1/4" apart.



Details from—

# OXLEY

**DEVELOPMENTS CO. LTD.**  
**ULVERSTON, NORTH LANC'S**  
Tel: ULVERSTON 3306

**ASSISTANT to the Chief Engineer** required on the established instrument company in the Home Counties, now pioneering new developments in the field of electronic technology.

WHILE academic qualifications are not essential, applicants should have a sound theoretical training and considerable **PRACTICAL** experience. The salary will be according to experience—£1,200 per annum is envisaged. There is a pension scheme.—Box 1540. [4195]

**ENGLISH ELECTRIC Co., Ltd.**, wish to extend their present laboratory facilities for study of the effect of environmental conditions on guided weapons and their components. Applications are therefore invited from **SENIOR and Junior Engineers** to direct and carry out this work. A wide variety of electrical, mechanical and physical testing is under consideration, and although previous experience of guided weapons is desirable, it is by no means essential; the possession of an engineering or Physics Degree, H.N.C., or similar qualification, coupled with some experience in designing and handling ingenious electrical and mechanical test contrivances would form a satisfactory qualification. Focusing assistance can be given if required. Please write, stating age, experience and qualifications, to Dept. C.P.S., 336-7, Strand, W.C.2, quoting Ref. 1000F. [4116]

**ELLIOTT BROS. (LONDON), Ltd.** have vacancies for senior and junior electronic engineers in their expanding activities in the fields of industrial control, measurements and instrumentation.

**SENIOR Engineers** with good academic background and experience in this or similar fields. There is one vacancy for a Chief Engineer to take charge of a Division and several vacancies for leaders of development teams. Ref. E.T.1

**JUNIOR Engineers** with University degree and 2-3 years' practical experience to work under the guidance of seniors in development teams. Ref.: E.T.2.

**LABORATORY Assistants** with B.N.C. or equivalent and with interest to further their education and expand and train as development engineers. Ref.: E.T.3.

**APPLICATIONS** for the above positions with full details of age, qualifications and experience and quoting the appropriate reference number, to Personnel Officer, Century Works, Lewisham, S.E.13.

**A. G. ALLEN & Co., Ltd.** have a permanent position for fully experienced television/radio service engineer with good references; able to drive.—3-4, Bridge Rd., Wembley Park, Arn. 2261. [4337]

**MINISTRY OF SUPPLY** requires radio/radar technicians in Buckinghamshire to help equipment investigations and installation design of pulse and C.W. navigational aid systems and long distance and mobile radio installations.

**QUALIFICATIONS:** British of British parents, recognised engineering apprenticeship or equivalent in radio industry, experience with installations of type specified, H.N.C. or O.N.C. or appropriate City and Guilds or equivalent qualification desirable; salary, three grades within £555 (aged 26)—£945 according to age and qualifications; not established but opportunities to compete for establishment may arise. Application forms from M.L.N.S., Technical/Scientific Register (K), 26, King Street, London, S.W.1, quoting D60/5A. Closing date April 9, 1955. [4295]

**DESIGNER/Draftsman** required for Compression, Transfer and Injection Moulding Firm, Cheshire district; only fully competent men need apply.—Write, stating age, experience and salary required, to Box 1759. [4253]

**TELEVISION engineers** required for busy and well-established workshop; must be fully experienced; permanent position; excellent staff amenities.—Apply Personnel Controller, Bentalls of Kingston-on-Thames, Surrey. [4259]

**AIRCRAFT electrical design** draughtsman required, excellent opportunities for advancement.—Apply Personnel Department, Vickers-Armstrongs, Ltd., Hursley Park, nr. Winchester. [4176]

**COMPETENT radio and/or TV serviceman** required; old-established firm; good conditions and prospects; permanent; call or write fully; expenses paid for interview by arrangement.—Nicklins, Square, Barnstaple.

**TECHNICAL assistant** with knowledge of telecommunications or electronics required by London firm of chartered patent agents; 5-day week.—Apply in writing stating age, experience and salary required Box 2210.

**THE Edison Swan Electric Company, Ltd.**, have vacancies in their Special Products Development Laboratory for Engineers for development work on a wide range of electronic instruments and apparatus for Medical, Industrial and Government use.

PLEASE write, stating experience, age and salary required, to 155, Charing Cross Road, London, W.C.2, reference SF/LAB. [1038]

**EXPERIENCED radio testers and inspectors** required for production of communication and radio apparatus, also instrument makers, wiremen and assemblers, for factory test apparatus.—Apply Personnel Manager, E. K. Cole, Ltd., Ecco Works, Malmesbury, Wilts. [1038]

**RADIO technicians** required by International Aeradio, Ltd. for overseas service; permanent and pensionable positions, inclusive salary from £894 per annum to £1,373 per annum, tax free, according to marital status; free accommodation; kit allowance; free air fares; generous U.K. leave.—Qualified candidates to whom replies only will be sent please write quoting RT to Personnel Officer, 40, Park St., W 1. [10262]

# TRANSFORMERS FOR THE ELECTRICAL ENGINEER

## R. F. GILSON LTD

11a ST. GEORGE'S ROAD, WIMBLEDON, S.W.19

Phone: WIMbledon 5695

Specialists in the design and manufacture of small transformers for power and audio frequencies.

### FROM OUR RANGE

Miniaturised mains transformers oriented grain laminations. 200-240 v. 50~ PRI 275-0-275 v. 90 mA 6.3 v. 3 a. Size 3 1/2in. x 2 1/2in. x 2 1/2in. LIST PRICE £2/9/6. FULLY TROPICAL TO RCS 214.

**5KVA** semi-portable Outdoor type for low voltage portable tools. Details and prices on application. As supplied to Electricity Authority.

### THE OSRAM 912 AMPLIFIER

The Gilson output transformer, Ref. WO 710, has been tested by G.E.C. and found to have an excellent performance.

### THE MULLARD 5-10 AMPLIFIER

Extract from Mullard letter: "We have much pleasure in informing you that the two sample transformers—Ref. Nos. WO 696A and 696B—for the Mullard 5 valve 10 watt amplifier which you exhibited to us for approval have been tested in our laboratory and have been found to meet all the specifications laid down."

**LIST PRICE £2.7.6**  
Or less panel, tags on coil £2.3.6

### MAINS TRANSFORMERS FOR THE 912 and 5-10 AMPLIFIERS

205-225-240 volts 50 c/s. 300-0-300 v. 150 mA 5 v. 2 at 6.3 v. 1 a., 6.3 v. 5 a. Ref. WO 695. List price £3/-, or less panel, tags on coil, £2/15/-.

Contractors to Admiralty, etc., A.I.D. Approved

**EUREKA & CONSTANTAN  
RESISTANCE WIRES**

Prices per ounce

| SWG | Enam. | DASC. | SWG | Enam. | DASC. |
|-----|-------|-------|-----|-------|-------|
| 16  | 1/6   | 1/6   | 28  | 2/1   | 2/6   |
| 17  | 1/6   | 1/6   | 29  | 2/2   | 2/6   |
| 18  | 1/6   | 1/6   | 30  | 2/2   | 2/6   |
| 19  | 1/6   | 1/6   | 31  | 2/3   | 2/8   |
| 20  | 1/6   | 1/6   | 32  | 2/3   | 2/9   |
| 21  | 1/6   | 1/6   | 33  | 2/4   | 3/-   |
| 22  | 1/6   | 1/8   | 34  | 2/6   | 3/-   |
| 23  | 1/6   | 1/10  | 35  | 2/8   | 3/3   |
| 24  | 1/8   | 2/-   | 36  | 2/9   | 3/6   |
| 25  | 1/10  | 2/2   | 37  | 3/-   | 3/9   |
| 26  | 2/-   | 2/4   | 38  | 3/3   | 4/3   |
| 27  | 2/-   | 2/4   | 40  | 3/6   | 4/9   |

Wires to 50 swg available

**COPPER INSTRUMENT WIRE  
ENAMELED, TINNED, LITZ,  
COTTON AND SILK COVERED.**

All gauges available.  
B.A. SCREWS, NUTS, WASHERS,  
soldering tags, eyelets and rivets.  
EBONITE AND BAKELITE PANELS,  
TUFNOL ROD, PAXOLIN TYPE COIL  
FORMERS AND TUBES.  
ALL DIAMETERS.  
SEND STAMP FOR LIST. TRADE SUPPLIED.

**POST RADIO SUPPLIES**  
33 Bourne Gardens, London, E.4

**YOUR METER DAMAGED?**



Leading Electrical Instrument Repairers to the Industry

Contractors to the Ministry of Supply and General Post Office  
Repairs by skilled craftsmen of all makes and types of  
Voltmeters, Ammeters, Microammeters, Multirange Test  
meters, Electrical Thermometers, Recording Instruments,  
etc. Quick deliveries—for speedy estimate send defective  
instruments by registered post—

**L. GLASER & CO.**  
Electrical Instrument Repairers  
96-100 ALDERSGATE STREET, E.C.1  
(Tel. : MONarch 6822)

**F.M. FRINGE AREA TUNER**

Five valves including two I.F. stages and a limiter. Attractive appearance with slide rule type of scale. Frequency drift negligible. Sensitivity better than 10µv for good limiting. Useful range 60-100 miles or more depending on location. As conditions are variable at these frequencies, this unit is available on approval against cash, and may be returned in one week. Trade enquiries for this service welcomed.  
**PRICE £19/16/3 INCLUSIVE.**

**STANDARD TUNER (up to 60 miles) PRICE £15/17/-.**

**PARTS AVAILABLE SEPARATELY TO BUILD AN F.M. TUNER**

ENQUIRIES INVITED FOR OUR VARIABLE SPEED GRAMOPHONE MOTORS

**THE JASON MOTOR CO.**  
328 Cricklewood Lane, London, N.W.2. SPE 7050

**CHIEF** maintenance engineer required to direct a team working on development equipment associated with trials programmes on radar projects, and to work in association with development groups and services representatives.

APPLICANT should preferably have had considerable experience of radar equipment and possess a degree, higher national certificate or equivalent qualification.

RESIDENCE in the Midlands is desirable but not essential and applicant must be prepared to travel occasionally.

REPLY stating age and experience to the Personnel Manager, The General Electric Co., Ltd., Brown's Lane, Allesley, Coventry. [4328

**(1) PHYSICISTS** and Electronic Engineers are required for the Chemical and Metallurgical Division of the Plessey Co. Ltd. Attractive posts are available for junior and senior: grades in new, well-equipped and expanding Physics and Electronics Laboratories. APPLICANTS should be interested in the development and application of semi-conductors, dielectric, piezoelectric or magnetic materials.

POSITIONS are permanent and pensionable and offer considerable scope for creative work; salaries will be generous and commensurate with qualifications and experience. Write in confidence to the Technical Manager, The Plessey Co. Ltd., Towcester, Northants

**(2) THE Chemical and Metallurgical Division** of the Plessey Co., Ltd., is engaged in the development of interesting new products for the electronics, radio and TV industries. PHYSICISTS and Electronic Engineers are required for development, applications and instrumentation work on semi-conductors, ferroelectric and ferromagnetic materials.

ATTRACTIVE posts are available for junior and senior grades in new, well equipped and expanding Physics and Electronics Laboratories. POSITIONS are permanent and pensionable and offer considerable scope for advancement. Salaries will be generous and commensurate with qualifications and experience.

WRITE in confidence to the Technical Manager, The Plessey Co., Ltd., Towcester, Northants.

**(3) THE Plessey Company, Ltd.**—Vacancies exist in new, well-equipped and expanding laboratories of the Chemical and Metallurgical Division for junior and senior Physicists and Electronic Engineers with progressive ideas; experience in any of the following fields an advantage:

- Magnetic measurements.
- Acoustics.
- Piezoelectricity.
- Design of electronic apparatus.
- Radio interference suppression.
- Design of electromagnetic devices.

POSITIONS are permanent and pensionable and offer considerable scope for advancement; salaries will be generous and commensurate with qualifications and experience.—Write in confidence to the Technical Manager, The Plessey Co., Ltd., Towcester, Northants.

**JUNIOR** radio mechanic required; preference given to applicant who has completed National Service; the position is permanent, has good prospects; pension scheme available.—Write details to the Service Manager, Ray Powell, Ltd., Eastern Ave., Ilford, Essex. [4339

**WRIGHT & WAIRE, Ltd.**—Vacancies occur at Simonside Works, South Shields, Co. Durham, for senior and junior radio and electronic engineers, also those with magnetic recording experience; apply giving details of experience. [4223

**BERRY'S (SHORT WAVE), Ltd.**, have vacancies for Sales Assistants with good general radio knowledge. Interesting work. permanency.—Write giving details of experience, age and salary required to 25, High Holborn, London, W.C.1. [4084

**ELECTRICAL SERVICE (EDGWARE), Ltd.**, 95, Edgware Rd., W.2 require urgently a senior T/V and radio service engineer; able to take complete charge of service dept. clean licence, good refs., congenial, top salary.—Psd. 2342. [4264

**TRANSFORMER** and filter design engineer required to take charge of design and manufacture; qualifications and experience essential.—Apply to Personnel Manager, Pye Telecommunications, Ltd., Ditton Works, Cambridge. [4287

**MICHAEL RADIO, Ltd.**, Slough, Bucks. have vacancies from time to time for electronic engineers to be engaged on Government projects; those wishing to be considered are invited to write fully to the Chief Engineer, Equipment Division. [0198

**ELECTRONIC** engineer with wide experience in on video amplifiers reqd. for interesting work in small development dept. degree or similar qualification an advantage; outer West London; salary £700-£800 per annum; pension scheme.—Write full details to Box 1677.

**SENIOR** electronic inspectors required for special work in the radar field; men with good academic background and sound experience are invited to apply for these progressive posts.—Apply immediately, preferably in person, to the Personnel Officer, Decca Radar, Ltd., Shannon Corner New Malden. [4063

**BRITISH INSULATED CABLES** and **CABLES, Ltd.**, have a vacancy with their telecommunications laboratory at Kirkby for an honours graduate in physics or electrical engineering to take charge of a small but growing team engaged on the design of accessories for audio carrier and V.H.F. cables and the development of pneumatic protection for underground cables.—Applications, quoting reference P/58/54, should be submitted to The Staff Officer, B.I.C.O., Ltd., Prescot, Lancs. [4285

**QUARTZ CRYSTAL UNITS**



Type B7



The type B7 unit is mounted in the standard B7G valve envelope and is hermetically sealed and fully evacuated.

Available for the frequency ranges from 100 kc/s. to 500 kc/s. and from 8 Mc/s. to 16 Mc/s. Gold electrodes applied by cathodic sputtering give permanence of calibration. Normal adjustment accuracy 0.01% Max. adjustment accuracy 0.003%.

Early delivery can be given of some frequencies, and we will be pleased to quote for your specific requirements.

**THE QUARTZ CRYSTAL Co. Ltd.**  
63-71 Kingston Road,  
NEW MALDEN, SURREY

Telephone: MALDEN 0334 Cables, etc. QUARTZCO NEWMALDEN

**MORSE CODE Training**



**COURSES FOR BEGINNERS and OPERATORS**, also a **SPECIAL COURSE** for passing the G.P.O. Morse Test for securing an **AMATEUR'S TRANSMITTING LICENCE.**

Send for the Candler **BOOK OF FACTS.**  
It gives details of all Courses.

Fees are reasonable.  
Terms: Cash or Monthly Payments.

**THE CANDLER SYSTEM CO.**  
(55W) 52b ABINGDON ROAD, LONDON, W.8  
Candler System Co., Denver, Colorado, U.S.A.

**Rowridge & Norwich**



**CONVERTOR TYPE 26.** For conversion from channel 3 to channel 1, complete with self contained power supply unit and totally enclosed in a handsome well finished steel case. Price complete, £11/17/-.  
Also available in chassis form less HT supply but including mains operated heater supply for inclusion in receivers. Price complete, £8.  
**CONVERTOR TYPE AC/4.** For weak signal areas. Price complete, £15/15/-.  
(Leaflets on request.)

**SPENCER - WEST,**  
Quay Works, Gt. Yarmouth.  
Telephone: 3009.  
Grams: Spencer-West, Gt. Yarmouth.

COMPLETE RADIO/RADIOGRAM CHASSIS  
NEW AND FULLY GUARANTEED

**DIRECT FROM THE  
MANUFACTURER**

NEW MODELS

A/C 200/250 volts  
3 wavebands  
HIGH QUALITY  
REPRODUCTION

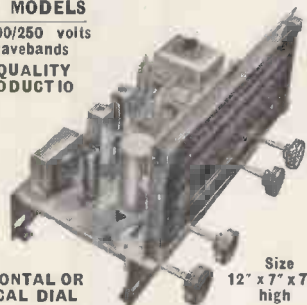

HORIZONTAL OR  
VERTICAL DIAL

Size  
12" x 7" x 7 1/2"  
high

BUILT FOR THE CONNOISSEUR OF  
QUALITY MUSIC REPRODUCTION

MODEL F3 5 valves, 4 watt output - £13.18.3  
Wide range tone control ...

MODEL F3 PUSH-PULL, 7 valves, 6 watt  
output. Separate bass and treble  
tone controls..... £17.17.9

Latest type components and B.V.A. miniature  
valves built on steel chassis. Plug-in connections  
for pick-up, speaker, Gram motor. Gram switching  
on wavechange switch. Negative feedback  
applied from output transformer secondary.

Full particulars from:

**THE DULCI CO. LTD.**  
97 VILLIERS ROAD, LONDON, N.W.2.  
Telephone: WILLESDEN 7778.

**A. T. & E. (BRIDGNORTH), Ltd.**, Bridgnorth, Shropshire, radio and telecommunication equipment manufacturers, require experienced technical writer to compile operational and technical sales literature for V.H.F. radio links, mobile transmitting and receiving equipment and electronic test gear. **PERMANENT** and progressive position with pension scheme, sports and canteen facilities and assistance with housing accommodation if required.

APPLY to Secretary giving age, qualifications, previous experience and approximate salary required. [4267]

**TRANSFORMER** Designer required for development projects involving audio-frequency power transformers, pulse transformers, oil-filled units, etc.—Apply stating age, qualifications and experience to The Personnel Manager (Ref. R.G.), The General Electric Co., Ltd., Brown's Lane, Allesley, Coventry. [4260]

**SENIOR** Television Development Engineer with administrative experience required; capable of carrying out development projects with minimum supervision up to production stage, Kingston area; write giving full personal details stating salary required—Chief Engineer, Box 1582. [4208]

**RADIO** testers and mechanical inspectors required (male); must have experience on service equipment and used to working to Government specifications; high rates of pay to first-class men; excellent conditions in modern factory in the West London area; write fullest details to—Box 1631. [4229]

**TELEVISION** field and bench service engineers required immediately for modern service department of leading radio retailers in East London; high rates of pay per week or according to ability; permanent position.—Apply for interview to Leytonia Radio, Ltd., Tel. Leytonstone 1396. [4271]

**LABORATORY** Assistant required for test and calibration of wireless, radar, electronic instruments; excellent conditions; capable of setting up basic calibration and experimental equipment; 5-day week.—Write or tel. Atkins Laboratories, Gowan Avenue, Fulham, Remov 5931. [4320]

**DEVELOPMENT** Engineer required for work on transistor oscillators. Previous experience need not include transistor applications but a fundamental knowledge of time base circuits is desirable.—Applications to, Personnel Manager, Ferguson Radio Corp., Ltd., Gt. Cambridge Rd., Enfield. [4239]

**ELECTRONIC** Engineer required by West E. London company; technical knowledge and practical experience of servo-mechanisms, temperature control, weighing, counting and magnetic amplifiers is desirable. Applicants giving age, experience and qualifications, to Box 1762. [4256]

**RADIO** and television service engineer required for expanding company in Slough area; excellent prospects for rapid advancement for man of proven ability; write, with full details of experience and stating salary required, to—Teleonic Radio, Ltd., 1, Station Approach, Slough. [4290]

**ELECTRONIC** Engineer required for position in an expanding laboratory engaged on the development of electronic equipment including control gear, servomechanisms and special-purpose tape recorders. Applicants should state qualifications, experience and salary required.—Write full details to Box 2057. [4239]

**ELECTRONIC** Engineers and Physicists reqd. for rapidly expanding research Dept. Candidates should have experience of electronic instrument development. Experience in pulse circuits or ultrasonics desirable but not essential. B.Sc. or H.N.C. standard.—Write full particulars to Glass Developments, Ltd., Brixton, S.W.2. [4237]

**ENGINEERS** required for development work on television equipment used in connection with film making. Applicants, who must have had television experience, will be paid a salary in the range £500-£1,000 according to qualifications and experience.—Apply, Chief Engineer, High-Definition Films, Ltd., 98, Highbury New Park, London, N.5. [4236]

**ENGINEERS** (Radio Valves) are required for all grades of work on development, production and pre-production. Minimum qualifications H.N.C. or B.Sc. for Senior positions—O.N.C. or Inter for Junior, some experience necessary for senior appointments.—TA/6, Personnel Dept., M.O. Valve Co., Brook Green, Hammersmith. [4261]

**ELECTRONIC** engineers required for work on the application of radio valves for future development; work calls for vision and imagination combined with circuit experience; O.N.C. or Inter minimum qualification; weekly or monthly staff vacancies available according to experience.—Quote EE/1, Personnel Dept., M.O. Valve Co., Brook Green, Hammersmith. [4262]

**THE TELEGRAPH** CONDENSER Co., Ltd., require radio and TV engineer with laboratory experience for work in connection with printed circuits, H.N.C. standard for Super-education and experience, age and salary required to Personnel Manager, T.C.C., Ltd., North Acton, W.3. [4311]

**RADIO** (Meteorological) Mechanics required by Meteorological Office; qualifications: basic knowledge of radio and radar and experience in maintenance/operation of radar equipment, including oscilloscopes; successful applicants serve in United Kingdom and overseas; commencing London salary £467/10 s plus 25% or over, rising to £565, subject to deductions for each year below age 25. Provincial salary £20 to £30 lower; overtime, night duty allowance, etc.—Apply at any Employment Exchange, quoting Borough 831. [4117]

**RELAYS TYPE 3000**

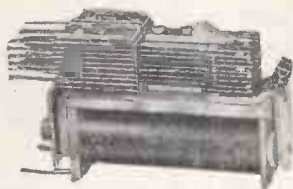

BUILT TO YOUR SPECIFICATION—EARLY DELIVERY—QUOTATION BY RETURN—PLEASE STATE RESISTANCE OF COIL REQUIRED AND CONTACT BUILD UP.

**MICROPHONE.** A most attractive professional mike for studio use, etc., with a beautiful friction slide, adjustable heavy floor stand, complete with 12ft. screened cable £8/6/-, Post 2/6.

**MICROAMMETERS**

250 F.S.D. 3 1/4 in. FLUSH MODEL 537 Specially scaled for test meters. Knife edge 55/- pointers, magnetic shield. Brand new VENTAXIA EXTRACTION FANS. 230-250 volts, 50 cycles. Bakelite cased, 6in. blades, silent running, 90/-, Post 2/6.

**BLOWER MOTORS.** Dual voltage 12-24 volts. Recommended for car cooling or heating, 25/-, Post 2/-.

**RECEIVER RI155**

BRAND NEW. AERIAL TESTED IN maker's original frame case. Now is the chance to get one from the best delivery we have had from the Ministry. Car. 19/6, £11-19-6 Send S.A.E. for further details or 1/3 for publication giving circuit diagrams, etc. Others available from £9/10/- according to condition.

45 Mc/s P.YE IF STRIP. These vision units are brand new and complete with 6 E.P50 valves and EA50. Our price only 65/-, Post 2/6.

**RACKS P.O. STANDARD** for 19in. panels. Steel channel sides, correctly drilled. Heavy angle base. Height, 4ft. 10in. or 6ft., or 7ft. 2in.

**AIR COMPRESSORS.** 60 lb./sq. in. Ex-R.A.F. Size 9in. x 5in. Splined shaft 1 1/4 in. x 1/4 in., 37/6, Post 2/6.

**VACUUM PUMPS or Rotary Blowers.** Ex-R.A.F. Brand new, 7 cu. ft. per min. 10 lb. per sq. in. at 1,200 r.p.m. Ideal for a brazing torch, etc. Size 6in. x 4in., shaft 2 x 1/4 in.; 22/6 each. Post 2/-.

**AERIAL BODS.** 12in. long, 1in. diameter. Any number of sections can be fitted together, 2/6 dozen. 6/- for 3 dozen. Post 1/-.

**SLOW MOTION DIALS.** 6in. Scaled 0-100, reduction 200 to 1 or direct, ideal for wavemeters, signal generators etc. Our price, while they last, 5/6 each. Post 1/-.

**TERRY ANGLEPOISE LAMPS.** Complete with flex and S.B.C. holder, shade, etc. Will stay put in any position, wall or machine fixing, 35/-, Post 2/6.

**VOLTMETERS.** 0/300 v. A.C. 50 cy. 5in. projection-type moving iron, 60/-.

**VOLTMETERS.** 0/300 2in. flush D.C. moving coil, 10/6; 0/40, 10/6. Post 1/4.

**AMMETERS.** 2in. Flush 0/20, 10/6 each. 20-0-20, 12/6 ea. Moving Coil D.C.

**MOVING COIL METER** with 1 m.a. movement, 2 1/2 in. flush, rectifier type scaled 0/100 volts A.C., resistance, 100 k. ohms. A very useful basic meter, 30/-.

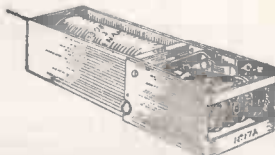

**ELECTRO MAGNETIC COUNTERS.** Post Office type 11A, counting up to 9,999, 2 to 6 volts D.C., 3 ohm coil, 12/6 each. Post 1/-, Many other types in stock. Lists sent with order or send S.A.E.

**HEADPHONES. HIGH RESISTANCE.** 4,000 ohms. Type OBE. New. 12/6 pair. Post 1/6.

**CONDENSERS. PAPER BLOCK TYPE**  
5mfd. 1,000 volt 2/6 | 8mfd. 500 volt .. 7/6  
4mfd. 350 volt .. 4/8 | 8mfd. 750 volt .. 10/6  
4mfd. 2,000 volt 7/8 | 10mfd., 350 volt .. 10/6

**CONDENSERS.** Nitrogol 1 Mfd. 5,000 Vt., 17/6; 3.5 Mfd. 400 Vt. A.C., 7/6; 4 Mfd. 800 Vt., 10/6; Visconol 0.02 Mfd. 12.5 kV., 12/6. Post 1/-.

**R.F. UNITS TYPE 28.** 50/65 Mc/s. Variable tuning, complete with valves, 35/-, Post 2/6.

**ROTARY CONVERTERS.** Input 12 volts D.C. output 230 volts A.C. 50 cycles, 100 watt, 92/6 each. Also available with 24 volt input, car. 7/6.

**LISTS AVAILABLE.** Motors, Meters, Telephones, Rectifiers, Relays, Potentiometers, Resistances. All types including High Stability Carbon and Wire-wound. Send S.A.E.

**L. WILKINSON**

(CROYDON) LTD. DEPT. W.W.W.  
19, LANSDOWNE ROAD, CROYDON

Phone CRO 0839 Telegrams: "WILCO" CROYDON

**20**  
CIRCUITS  
for 2/6 only  
NEW 1955 EDITION

- Enlarged again! Our Super-Handbook, "The Home Constructor" (76 pages) now incorporates—
- ★ 20 CIRCUITS—Superhets, T.R.F. Equipment, etc.
- ★ SUPERHETS—Full constructional details, supra-simplified layout and building a variety of superhets.
- ★ COIL PACK—Full constructional details for building a superhet coil pack.
- ★ CAR RADIO—Full constructional details.
- ★ BATTERY CHARGER—Details for building a CHEAP charger.
- ★ RADIO GEN—Pages of information, Resistance Colour Code, Formulae, and "know-how."
- ★ RADIO CONTROL—General information and list.
- ★ RADIOGRAM Constructors list.
- ★ CATALOGUE—Profusely illustrated price list of components covering a wider range than ever before.
- ★ WOLF CUB—Home Constructor equipment details.

YOU CAN'T GET BETTER VALUE!  
IT'S TOPS!  
"The most helpful book in the Trade."  
SEND 2/6 FOR YOUR COPY TODAY  
**SUPACOILS** (DEPT. W.4)  
21, Markhouse Road, London, E.17

# Smith's

of  
EDGWARE ROAD

Component Specialists since Broadcasting Started. Invite all those interested in **ELECTRONIC COMPONENTS** (both Regular and Surplus) to send for their latest Price-lists.

**H. L. SMITH & CO. LTD.**  
287/289 EDGWARE ROAD, LONDON, W.2  
Telephone: Paddington 5891

Hours 9 till 6 (Thursday 1 o'clock)

Near Edgware Rd. Stations, Metropolitan & Bakerloo

## SPECIAL OFFER G.E.C. & B.T.H. GERMANIUM CRYSTAL DIODES

1/- each. Postage 2½d.

Diagrams and three Crystal Set Circuits Free.

A large purchase of these fully GUARANTEED diodes from the MANUFACTURERS enables us to make this attractive offer.

**POST RADIO SUPPLIES**  
33 Bourne Gardens, London, E.4

## This Month's Offers

**PRECISION TEMPERATURE CONTROL OVENS** for quartz crystals. 230 volts 50 cycles. Will give stability with suitable crystals of better than two parts in one million. Fitted precision thermostat and thermometer. Temp. adjustable 40/60 degrees cent.

**FREQUENCY METERS.** 6in. Ironclad S/bd. type, 40/60 cycles 230 volts, moving needle pattern. £15.

**VARIABLE WIRE WOUND RESISTANCE.** Geared movement, to carry up to 5 amps. All wound to specification. Send us your enquiries.

**LIGHTING PLANTS.** D.C. Lighting Plants 360 watts 12/18 volts with S/bd. and Tand. £20. 1260 watts with fuel tank, £35. Switchboards £10 extra. Write for list, or send us your specification.

**NIFE BATTERIES.** 1.2 volt 45 amp. hour, new surplus, Nife Batteries, 30/- each. Post 2/-. Or supplied 10 cells in wood crate for 12 volts 45 a.h., £12/10/-. Carr. 10/-.

**ELECTRO-MAGNETIC COUNTERS,** to 9999, 6 volt d.c. coil, genuine G.P.O. surplus stock in perfect condition, 5/-, post 1/-.

**Leslie Dixon & Co.**

Dept. A, 214 Queenstown Road, London, S.W.8

Telephone: MACaulay 2159

**ELECTRONIC** Engineers are wanted in large Midland engineering plant, the positions are progressive and interesting requiring qualified and experienced electronic engineers, senior and junior for rapidly expanding laboratory engaged upon measurement and control problems; state age, qualifications, and experience fully in confidence to—Box 1742. [4250]

**A** LIGHT engineering company in West London has vacancies for engineers and physicists in their magnetic recorder design laboratory; preference will be given to applicants experienced in this work and who are capable of accepting responsibility; salary will be according to age and experience.—Write, giving age and fullest details of experience, to Box 2169.

**ENGINEERS,** 25-30, required for electronic and mechanical work by The Plessey Co. Ltd., at Ilford; good prospects of promotion, interesting work, and a pension scheme await suitably qualified graduates or holders of H.N.C.—Apply with full details of past experience to The Plessey Co., Ltd., Vicarage Lane, Ilford. [4358]

**TEST** gear design engineers and maintenance engineers required with practical experience of this class of work, based on sound knowledge of electronic principles; these vacancies are permanent and progressive; a company pension scheme in operation; London area.—Please write, in confidence, giving full details of qualifications to Box 2119. [4255]

**ELECTRO-MECHANICAL** inspectors are required by a large and expanding company. Practical experience and sound knowledge of radio component manufacture is necessary. A good salary is offered to suitable applicants who should, in the first instance, state their qualifications and experience, to Box 1094, quoting E.M.1. [4097]

**ASSISTANT** foreman inspector required for an engineering company situated in the eastern suburbs of London; applicants should preferably have a sound basic knowledge of capacity bridges and test gear as applicable to gang condensers; a good salary will be paid to the selected applicant.—Please reply, giving full details of experience to Box 2120. [4324]

**APPLICATIONS** are invited from young physicists possessing honours degree for work on the development of transistors. Post-graduate work on semi-conductors and solid state physics would be an added qualification. Laboratories in ideal country surroundings. Applications to Personnel Manager, Standard Telephones and Cables, Ltd., Thimble Street, [4255]

**SKILLED** radio mechanics and assemblers (male) required; experienced on service equipment preferred but not essential; excellent conditions in modern factory, with good wages for the right type; ex-R.E.M.E. and R.A.F. personnel will also be favourably considered; Acton district; write fullest details to—Box 1630. [4228]

**TEST** gear design engineers and maintenance engineers required with practical experience of this class of work based on sound knowledge of electronic principles; these vacancies are permanent and progressive; a company pension scheme in operation, London area.—Please write in confidence, giving full details of qualifications to Box 1962. [4294]

**TWO** graduate physicists or electrical engineers with an interest in electronic engineering are required for the development of equipment for the measurement of the properties of semi-conductor materials and devices; previous experience in the design and construction of electronic equipment is desirable for one of the vacancies.—Box 1971. [4286]

**PHILIPS** Balham Works, Ltd., 45, Nightingale Lane, S.W.12, requires Graduate in Electrical Engineering or Physics, preferably with experience in electronics, for development of nucleonic instruments. Permanent appointment with excellent prospects.—Applications should be addressed to the Personnel Officer at the above address. [4254]

**ELECTRONIC** Engineer required to test nucleonic instruments. Previous experience of this type of work is not necessary but a thorough knowledge of electronic theory and practical experience in fault finding is essential; 40hr 5-day week; salary range £400-£600 according to qualifications.—General Radiological Ltd., 18, New Cavendish St., London, W.1. [4319]

**ASSISTANT** engineers required for radio communication development work; good prospects for men with H.N.C. and up to 5 years' industrial experience commensurate salary according to age and experience; apply in writing stating age, experience, etc., to—Siemens Brothers & Co. Ltd., Telecom Group, 744-6, Woolwich, London, S.E.18.

**ELECTRONIC** Engineer required by London firm to take charge of measurements laboratory and test gear design; experience of measurement of capacitors or telecommunication cables is essential; position involves direct responsibility to management and will suit engineer aged 25 to 32 who wishes to take up senior position.—Write details of qualifications, experience and present salary, Box 1760. [4255]

**ELECTRICAL/Electronic Engineer**—Vickers-Armstrongs, Ltd., Supermarine Works, require for employment at their experimental airfield, graduate with research and development experience in electronic or electro-mechanical devices and/or recording equipment for interesting work on ground and airborne measuring apparatus; the right man for this post will be keen to suggest and assess new techniques and to design, construct, suitably and workmanlike equipment; permanent pensionable post with good prospects for suitable engineer.—Apply Personnel Department, Hursley Park, Nr. Winchester. [4210]

## NEW BOOKS

### ON RADIO & TELEVISION

|  |      |
|--|------|
| Transistors and Crystal Diodes, by B. R. Bettridge .....                   | 5/3  |
| Sound Reproduction, by G. A. Briggs  | 18/6 |
| Loudspeakers, by G. A. Briggs  | 8/-  |
| The Oscilloscope at Work, by A. Haas and R. W. Hallows .....               | 15/6 |
| Radio and T.V. Engineers' Reference Book, by E. Molloy .....               | 70/- |
| Practical T.V. Aerial Manual for Bands I and III, by E. Laidlaw .....      | 4/9  |
| Radio Valve Data, 4th ed., by "Wireless World" .....                       | 3/10 |
| Simple Electronic Musical Instruments for the Constructor, by Alan Douglas | 5/3  |
| Fundamentals of Transistor, by L. Krugman .....                            | 22/- |
| T.V. Servicing Manual, by Bradley .....                                    | 4/9  |
| Radio Control of Model Ships and Aircraft, by F. C. Judd .....             | 9/-  |

ALL POST FREE. Write for New List of ENGLISH AND AMERICAN BOOKS AND PERIODICALS

## UNIVERSAL BOOK CO.

12 LITTLE NEWPORT STREET,  
LONDON, W.C.2 (Adjoining Lisle St.)

## THE OSRAM NINE-ONE-TWO

AMPLIFIER INSTRUCTION BOOK

and

HIGHEST QUALITY COMPONENTS

Available from

## COVENTRY RADIO

189, DUNSTABLE ROAD, LUTON.

Phone: 2677.

Price 3/6, plus 3d. postage

also

Our 1954-5 Component Catalogue at 1/-



The  
MINNETTE

46  
Gns.

with mic.  
and tape  
(carr. 7/6)

Specification includes 2 speeds 2 tracks, press-button control, 5 v. plus magic eye, 'phone monitoring, remote stop-start.

Model 44, ten watt replay, price 60 gns. Hi-fi eight valves with Truvox deck.

Write for fully descriptive literature and H.P. Terms from £5 deposit.

NOTE: MODERN RECORDERS are in short supply. We ask your indulgence if you cannot obtain "on the dot"—more and more people are asking for them—place your order early, either direct or with your local dealer.

**MODERN SOUND EQUIPMENTS**

16 Pattison Road, London, S.E.18

WOO 0387

# CABINETS

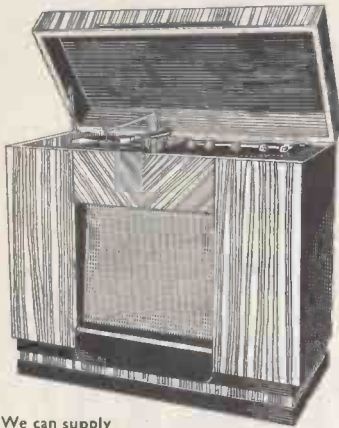

We can supply any Cabinet to YOUR OWN SPECIFICATION. The one illustrated can be obtained in Walnut, Oak or Mahogany for £19/15/0 or as a COMPLETE RADIOGRAM incorporating:

- 5 Valve Superhet Auto-changer and 10in. Speaker for ... £48/17/4
- 8 Valve Armstrong F.C.48 Auto-changer and 10in. Speaker for ... £62/14/4
- 10 Valve Armstrong R.F.41 Auto-changer and 10in. Speaker for ... £70/16/0
- 14 Valve Armstrong 125/C Auto-changer and 10in. Speaker for ... £88/6/4

(H.P. terms can be arranged)

Send 1/- for complete Catalogue of Cabinets, Chassis, Autochangers and Speakers (refunded on receipt of order).

**LEWIS RADIO CO.**  
120, GREEN LANES, PALMERS GREEN, LONDON, N.13. 80 Wes Park 6064

# COMMUNICATIONS EQUIPMENT



**60-WATT RADIOTELEPHONE**  
1.5-12 mc/s. for A.C. mains or 12 and 24 volt D.C. This non-radiating type communication receiver has 8 valves and BFO. Suitable for Land or Marine use. With 7 crystals or available with precision VFO and 5 crystals. Price £225 complete, ex works.

**HALLICRAFTER RADIOTELEPHONES**  
25 watt R/T 24 volt 1-12 mc/s. with 7 crystals, £150.

Press-button Crystal Controlled R/T equipment in stock for mobile or marine use. RECEIVERS AR88, AR77, S27, etc.

Full details upon request  
Export Enquiries Invited

**SOUTHERN MARINE RADIO CO.**  
353a Ballards Lane, London, N.12. Hillside 7951

**ENGINEER** required for expanding West London company; degree or equivalent with sound knowledge of electronics required; experience with production and application of miniaturised precision electro-magnetic relays or similar equipment essential; this position is an executive one and only those with ability to organise and supervise development and production will be considered.—Box 1539. [4138]

**RADIO** engineer for Bulawayo, Southern Rhodesia; design and development engineer with at least five years' experience on domestic radio; salary £1,200 per annum, with free air passage to Rhodesia.—Application should be made to Advertiser, 31, Burlington Ave., Kew Gardens, Surrey, with copy to P.O. Box 206, Bulawayo, Southern Rhodesia. Successful applicant will be interviewed in London. [4076]

**INSTRUMENT** maker at Norwood Technical College, Knight's Hill, S.E.27, with experience in radio and electronics duties include maintenance and construction of electronic test gear, laboratory and experimental apparatus; rate, 176/-, rising annually to maximum of 195/- 44-hour week.—Application forms with further particulars obtainable from the Secretary, returnable within 14 days (195) [4522]

**SENIOR** engineer required to be in charge of factory test equipment section, to be responsible for design and maintenance of radio and television test facilities; also junior radio engineer for work associated with production development of radio and television receivers. Telephone or write for appointment: Chief Engineer, Philco (Overseas) Ltd., Romford Rd., Chigwell, Essex, Hainault 4151. [4226]

**CHEMISTRY** and electronics; a scientist or engineer with good qualifications in one of these fields and a strong interest in the other is required to write for appointment: Chief Engineer, Philco (Overseas) Ltd., Romford Rd., Chigwell, Essex, Hainault 4151. [4226]

**RESEARCH** engineer required to be in charge of factory test equipment section, to be responsible for design and maintenance of radio and television test facilities; also junior radio engineer for work associated with production development of radio and television receivers. Telephone or write for appointment: Chief Engineer, Philco (Overseas) Ltd., Romford Rd., Chigwell, Essex, Hainault 4151. [4226]

**LABORATORY** Technician required for the Electrical Engineering Department for work in the electronics field; appointment according to age and experience, in the scale £315X£15-£450 plus London Weighting (max. £30). The successful applicant must join the contributory pension scheme.—Application, giving age and full details of experience, to the Secretary, King's College, Strand, W.C.2. [4316]

**DRAUGHTSMEN**, experienced in broadcast radio and television, are offered exceptional opportunities with a firm of repute in the London area; experience in production drawing of mechanical design would be an asset for a very attractive starting salary.—Applications, which will be treated in strict confidence, should give full details of experience and should be addressed to Box 2166. [4336]

**DEVELOPMENT** Engineer required for work on transistor amplifiers. Previous experience need not include transistor applications but applicant should be conversant with general radio engineering practice, in particular with negative feedback technique, class B amplification and design of detector circuits.—Applications to Personnel Manager, Ferguson Radio Corp., Ltd., Great Cambridge Rd., Enfield. [4275]

**ANALOGUE** computers and instrument servomechanisms; vacancy for an electronic development engineer with experience in the above fields for work on interesting and varied projects; candidates should be of degree standard in physics or engineering, with some years' industrial experience; good prospects with progressive firm in Surrey area; write giving full details of experience and salary required; ref. S.P.D.2.—Box 1878. [4275]

**INSTRUMENT** maker required with experience in electronic wiring, capable of constructing chassis and interpreting wiring diagrams; wages 176/- rising in 3 years to 195/- per week, less superannuation and statutory deductions.—Apply by letter giving details of age, training and experience to the Head of the Electrical Engineering Dept., Battersea Polytechnic, London, S.W.11, as soon as possible. [4348]

**ELECTRICAL** foreman, with wide production experience of small and medium electrical control gear manufacture, test and installation, required by manufacturers of materials handling vehicles in pleasant country district, 1 hour London; good prospects of advancement, housing assistance; car, ten and social facilities.—Please write, giving details of age, past experience, present salary, salary required, married/single, to Box 1972. [4284]

**MINISTRY OF TRANSPORT AND CIVIL AVIATION**—Radio Technicians (men only) required at aerodromes and radio stations in various parts of U.K. Special training courses for keen technicians with basic qualifications. Interesting work providing and maintaining aeronautical telecommunications and electronic navigational aids. Prospects of permanent pensionable posts and advancement. Rates of pay (London) from £342/10 at age 19, to £467/10 at 25, rising (subject to qualifying test) to £565. Rates slightly lower in provinces. Shift and night duty allowances from 1/- to 5/- according to conditions. Candidates aged 19 or over with practical experience in maintenance of radio or radar equipment should apply to any Employment Exchange, quoting Westminster 6627. [4289]

# GALPIN'S

ELECTRICAL STORES

408, HIGH STREET, LEWISHAM, S.E.13  
Tel: Lee Green 0309. Nr. Lewisham Hospital

TERMS: CASH WITH ORDER. NO C.O.D.

All goods sent on 7 days' approval against cash.

EARLY CLOSING DAY THURSDAY.

**EX-NAVAL ROTARY CONVERTORS**, 110 v. D.C. input 230 volts A.C. 50 cy., 1 ph. 250 watts, output. Weight approx. 110 lb. £12/10/- C/F.  
**ELECTRIC LIGHT CHECK METERS**, useful for subletting, garages, etc., all for 200/250 volts A.C. mains, 5 amp. load, 19/- each; 10 amps., 22/6; 20 amps., 27/- 25 amps., 32/6.

**1,000 WATT AUTO WOUND VOLTAGE CHANGER TRANSFORMER** tapped 0/110/200/230/250 volts. £5/15/- each, carriage 4/6. 1,500 watt ditto, £7/15/-, carriage 7/6. 350 watt 55/-, 500 watt 75/-, 200 watt 45/-.

**MOVING COIL SWITCHBOARD VOLTMETERS**, 6in. scale 0 to 75 volts 30/- each; ditto 0 to 200 volts 35/- each; ditto 0 to 40 volts 27/6 each.

**CHARGING KITS CONSISTING OF RECTIFIER AND TRANSFORMER** for charging 6 or 12 volt batteries at 2 amps. (input 200/250 volts 32/6 each; ditto for 4 amps., 46/6 each.

**EX-R.A.F. DYNAMOTORS** 24 28 volts D.C. input, 1,200 volts, 17 milliamps 1/2 hour rating, 11/6 each.

**EX-RADAR MAINS TRANSFORMERS**. Input 230 volts. Output 4 or 5 kilo volts at 30 min., also 3 L.T. windings 4 v. 2 a., 6.3 v. 2 a., 2 v. 2 a., these transformers are capable of a larger output than stated and are immersed in oil. £3/15/- each, carriage 5/-.

**MAINS TRANSFORMERS (NEW)**, input 200/250 volts in steps of 10 volts, output 350/0/350 volts, 180 m/amps., 4 volts 4 amps., 5 volts 3 amps., 6.3 volts 4 amps., 45/- each, post 1/6; another 350/0/350 volts 180 m/amps., 6.3 volts 8 amps., 0/4/5 volts 4 amps., 45/- each, post 1/6; another 500/0/500 volts 150 amps., 4 volts 4 amps., C.T., 6.3 volts 4 amps., C.T., 5 volts 3 amps., 47/6 each, post 1/6; another 425/0/425 volts 160 m/amps., 6.3 volts 4 amps., C.T., twice 5 volts 3 amps., 47/6 each, post 1/6.

**MAINS TRANSFORMERS**, 200-250 volts input, output 400/0/400 volts, 280 m/amps., 6.3 v. 8 a., 2 v. 3 a., 5 v. 3 a., 4 v. 2 a., 4 v. 2 a., the last two heaters insulated at 8,000 volts, 85/- each; another 200/300 volts input, output tapped 0, 9, 18 volts at 4 amps., 25/- each, post 1/6.

**EX-U.S.A. ROTARY CONVERTORS**, 12 volts D.C. input, outputs 500 volts 50 mA. 275 v. 100 mA. Complete with smoothing 22/6 each, carriage 2/6. As new.

**HEAVY DUTY SPOT WELDER TRANSFORMERS**, input 200/250 volts. OUTPUT a combination of 2, 4, 6, 8, 10, 12 volts at 120/150 amps. New £6/15/- each, carriage 6/-.

**LIGHT ARC WELDING TRANSFORMERS**, 200/250 volts input, output 40/60 volts, 30/40 amps., £7/5/- each.

**MEDIUM SPOT WELDING TRANSFORMERS**, input 200/250 volts, OUTPUT a combination of 2, 4, 6, 8, 10, 12 volts at 50/70 amps. New £5/2/6, C/paid.

**HEAVY DUTY L.T. OUTPUT TRANSFORMERS**, 200/250 volts input, output a combination of 6, 12, 18 and 24 volts at 30 amps. £4/2/6 each, C/paid.

Another input as above, output 0, 6, 12, 18, 24 volts at 12 amps., 55/- each, post 2/-.

Another input as above, output 0, 6, 12, 18, 24 volts, 6/8 amps., 46/6 each.

**HEAVY DUTY L.T. TRANSFORMERS** suitable for rectifiers, soil heating, etc. Input 200/250 volts. Output a combination of 6, 12, 18, 24, 30, 36 volts at 15 amps., 67/6 each, post 2/6.

Another input and output as above but at 6 amps., 47/6, post 2/-.

Another input and output as above but at 4 amps., 36/6 each.

**CONVERTORS**, 400 watts output, 24 volts D.C. input 50 volts 50 cycles 1 phase output. Complete with step up transformer from 50 volts to 230 volts at 400 watts, £12/10/- each C/F. Ditto 200 watts £9/10/- each C/F., fully guaranteed.

**ROTARY CONVERTORS**, 230 volts D.C. input 230 volts A.C. output. 50 cycles 1 phase at 250 watts. £15 each C/F.

**EX-RADAR IMPULSE TRANSFORMERS** 2 Mu-Metal transformer in oil, output believed to be 15 k.v. at 3 kW. R.F., only 7/6 each.

**ROTARY CONVERTORS** 24 volts D.C., input 50 or 110 volts 500 cycles 1 phase, output at 300 watts, £7/10/- each, C/forward.

**D.C. MOTORS** 230 volts 0.3 h.p. large 3,000 r.p.m. long shaft, £3/5/- each.

Clients in Eire, please allow at least double the carriage stated to allow for Customs clearance charges.

# ENGINEERS!

Whatever your age or experience, you must read "ENGINEERING OPPORTUNITIES." Full details of the easiest way to pass A.M.I.Mech.E., A.M.I.D.E.C. & G. (Electrical, etc.), General Cert., etc., on

**144 PAGES**  
**Free!**



terms and details of Courses in all branches of Engineering—Mechanical, Electrical, Civil, Auto, Aero, Radio, etc., Building, etc. If you're earning less than £15 a week, tell us what interests you and write for your copy of "ENGINEERING OPPORTUNITIES" today—FREE

## B.I.E.T.

387 College Lane, 29-31, Wright's Lane, London, W.8.

BRITISH INSTITUTE OF ENGINEERING TECHNOLOGY

THE

# CHAFFEY CABINET COMPANY

63a, CHELTENHAM RD., LONDON, S.E.15  
TEL: NEW CROSS 4766

**TANNOY**  
SOUND EQUIPMENT

Tells you what's going on clearly

WEST NORWOOD · S.E.27  
Telephone: GIPsy Hill 1131 (7 lines)

### CROYDON TRANSFORMERS

#### C.B.T. ISOLATION TRANSFORMERS

Type A: Ratio 1-1.25 giving a 25% boost on Secondary. 2 volt 7/6; 4 volt 7/6; 6.3 volt 7/6; 10.8 volt 7/6; 13.3 volt 7/6. Low leakage windings.  
Type B: Mains input 200/250 volts. Multi output, 0-24-4.3-7.3-10 and 13 volts. Input has two taps which increase output volts by 25% and 50%, 16/- each. Low leakage windings.  
Type C: For use with 2 volt Tubes with falling emission. Input 200/250 volts. Output 2-24-24-24-3 volts at 2 amps, 12/6 each. Low leakage windings.  
Please add postage 1/-.  
—2, Pawsons Rd., W. Croydon, THO 1665—

### PRECISION RESISTORS

Wirewound to 1% accuracy, any value between 1 and 1,000 ohms, 2/6d.  
Set of twelve Resistance Box Standards to cover 1 to 1,110 ohms in 1 ohm steps, accuracy 1%, wirewound, 27/- per set.  
R. MASSEY, 25, DOMINION AVE., LEEDS, 7



## Leads the world in TAPE RECORDING

For details of the world's most advanced Tape Units and Tape Recorders contact

### VERDIK SALES LTD.

8, RUPERT COURT, WARDOUR ST., LONDON, W.1  
Gerrard 8266

TELEVISION aerial riggers with ability to install all types of aerial from indoor to fringe models and capable of setting up receivers required by large and well-known department store organisation. Greater London area. Must be able to drive. Overalls supplied. Canteen. Non-contributory pension scheme. Liberal holidays. Age 21-40. Salary £9 to £10 per week. Please telephone Chamberlain, North 3294. [4094

FIRST-CLASS openings for experienced radio and television engineers will shortly become available with a firm of repute in the London area; engineers able to undertake immediately development work on broadcast radio and television apparatus would be offered an attractive salary; the successful candidates will be eligible for company superannuation and insurance schemes.—Please reply, giving full details of experience, to Box 2165. [4355

SENIOR and junior development engineers required for responsible work in radio and television development laboratories; applicants for senior position should be able to undertake development work with minimum supervision; excellent conditions and salary available for applicants who are accepted.—Apply in first case to Personnel Manager (Dept. R.D.), McMichael Radio, Ltd., Wexham Rd., Slough, Bucks. [3580

ELECTRONIC engineer required for the expanding electronic section of a prominent food organization in N.W. London to construct and maintain factory electronic installations and to assist in the development of new equipment; applicants should possess initiative and be below 35 years of age; salary according to age and experience; pension scheme, 5-day week.—Write Box W.W.908, c/o 191, Gresham House, E.C.2. [4329

PROJECT engineers are required to take charge of microwave electronic and mechanical developments in connection with guided wave and other applications in a company near London; candidates should be graduates or hold H.N.C. and be between the ages of 30 and 40; salaries range from £1,000 upwards according to age and experience; pension scheme in operation.—Full particulars of experience should be addressed in confidence to Box 2233. [4359

ELECTRICAL component manufacturers in N.W. London require keen and energetic man (30-35 years) to supervise small service department; applicants must be able to conduct correspondence, control manual and clerical staff and possess electrical engineering background; no Saturdays, superannuation scheme.—Write, stating age, full details of experience and salary required, to Box 3M, No. 5635, A.K. Ave., 21/2a, Sheppesbury Ave., London, W.10. [4359

ELECTRONIC Test Engineers are required by a leading Midlands manufacturing company for the maintenance of test equipment, alignment, testing and fault-finding on domestic radio and television receivers, and the testing of radio and other electronic and electronic devices. Ex-Service technicians or men with similar experience are particularly suitable.—Apply giving details of career to date, to the Personnel Manager (Ref. GLB), Box 1515. [4359

SENIOR and junior design draughtsmen required for interesting work in connection with electronic equipment, commercial radio and television and/or light electro-mechanical engineering; London area; the positions vacant offer ample scope and opportunity for future advancement to men of good ability; salary will be paid to the selected candidates; all recognised staff privileges available.—Please reply giving full details of experience to Box 1927. [4261

NEW ZEALAND calling British ex-Service men and ex-Service women; the Royal New Zealand Air Force has a limited number of vacancies in the ground trades for ex-Service men between 21 and 40 years and for ex-Service women between 21 and 40 years; commencing pay up to £16 per week; free passages to New Zealand and excellent conditions of service.—Write for full information to Dept. W.W., R.N.Z.A.F. H.Q., Adelphi Building, John Adam St., London, W.C.2. [4367

TOP-GRADE television service engineers with first-rate practical experience of a wide range of makes required for large and well-known department store organisation. Able to drive, and must have real ability to diagnose faults and effect repairs quickly. Greater London area. Commencing salary £600 to £750 p.a. according to qualifications. Non-contributory pension scheme. Liberal holidays.—Only really first-grade men please apply to Museum 6886, ext. 201 or 202. [4093

TECHNICAL assistants required in radar development laboratory; preferably with Higher National Certificate or equivalent qualifications, also experience in electrical testing or construction of test equipment, or service experience on ground radar equipment; excellent working conditions; opportunities exist for upgrading; write stating age and experience to the Personnel Manager (Ref. R.G.), The General Electric Co., Ltd., Brown's Lane, Allesley, Coventry. [4148

DIVISIONAL sales and contracts manager required for expanding medium-sized electronics company; applicants should be capable forthwith of inflating and negotiating development and manufacturing contracts in the electronic field and also at a later date establishing a sales organization for a commercial product, good opportunity for a man with initiative; prepared for hard work, and capable of earning £2,000 per annum; salary will include basic payment and commission by arrangement.—Applications invited in confidence to Ref. S.P.D.3, Box 1879. [4274



**3-VALVE QUALITY AMPLIFIERS**  
3-4 wt. 16 S.W.G. al. chass.; neg. fdbk.; vol. and tone controls; A.C. 200-250 v.; voltage panel; 2-Ω spkr socket; new comp. and PLAYING TESTED; B7z 6j; x 5 x 4jin., £4/2/6.  
INT. OCT. 9 x 6 x 4jin., £3/19/6.  
Carr. 2/6 either model and state type P.U. E.K.E., 47, Arksey Lane, Bentley, Doncaster.

# TELECRAFT

## TV AERIALS

ARE CHEAPER AND BETTER

Send for Lists

TELECRAFT LTD.

Quadrant Works, Wortley Rd. West Croydon, Surrey.

THORnton Heath 1191-2-3

Purchase or hire your  
**'VORTEXION TAPE RECORDER'**  
& ASSOC. EQUIPMENT FROM  
**GRIFFITHS HANSEN (Recordings) LTD.**  
32/33 GOSFIELD ST., LONDON, W.1.  
MUSEum 0642/2771.

# MALVYN ENGINEERING WORKS

Precision Engineers

Manufacturers of: Chassis, Small Pressings, Machined Components, Wiring and Mechanical Assemblies, to specification.

Single and Production Quantities. Enquiries Invited

100 PARK ROAD, WARE, HERTS.

Telephone: Ware 465

# RADIO & TELEVISION COMPONENTS

WE OPERATE A PROMPT & EFFICIENT MAIL ORDER SERVICE

"VIEW MASTER" & "TELE-KING" specialists

Easy terms available. Stamp (only) for lists

**JAMES H. MARTIN & CO.,**  
FINSTHWAITE, NEWBY BRIDGE,  
ULVERSTON, LANS.

# TELETRON SUPER INDUCTOR COILS

## FERRITE ROD AERIALS.



Dual wave 12/9. MW. 8/9.  
Wound on high permeability Ferroxcube Rod.

Selective crystal diode coil. Type HAX, 3/-, HAXL for L.W. 3/6. Dual wave TRF coils (as illustrated), matched pairs, 7/-, I.F.T.'s. Transistor coils, etc., etc.

Stamp for circuits and data

THE TELETRON CO. LTD.

266, Nightingale Road, London, N.9.

HOW. 2527

Trade enquiries to sole distributor. **SAM MOZER**  
95, Kendal Avenue, N.18. Edm. 7707

**NEW G.E.C., S.T.C. AND "WESTALITE" SELENIUM RECTIFIERS.**  
Largest L.T. range in Great Britain.  
Latest Current Products. NOT Surplus.

**CURRENT PRICE LIST**

**DEDUCT 15% FROM S.T. & C. PRICES.**  
S.T. & C. E.H.T. K3/15, 4/5; K3/45, 8/2; K3/50, 8/8; K3/100, 14/8; all post 4d. extra.

**BRIDGE CONNECTED FULL WAVE.**  
17 v. 1.2 a., 16/4; 1.6 a., 26/-; 2.5 a., 29/-; 3 a., 30/-; 4 a., 34/6; 5 a., 37/6; all post 6d.

33 v. 0.7 a., 24/3; 1 a., 28/-; 1.5 a., 45/-; 2 a., 51/-; 3 a., 52/-; 4 a., 62/-; 5 a., 67/-; all post 1/-.

54 v., 1 a., 38/6; 1.5 a., 62/-; 2 a., 69/-; 3 a., 70/-; 5 a., 93/-; 7.2 v. 1 a., 49/-; 1.5 a., 78/-; 2 a., 81/-; 3 a., 92/-; 5 a., 122/-; 100 v. 1 a., 70/-; 1.5 a., 112/-; 2 a., 128/-; 5 a., 174/-; all post 1/4.

**BRIDGE CONNECTED HEAVY DUTY 7pin. SQUARE COOLING FINNS.** 17 v. 6 a., 49/6; 10 a., 56/-; post 1/10.

**BRIDGE CONNECTED HEAVY DUTY Funnel Cooled, also**  
7pin. SQUARE COOLING FINNS. Revised price, same both types. 17 v. 12 a., 102/-; 20 a., 118/-; 30 a., 164/-; 50 a., 112/15/-; 33 v. 6 a., 91/-; 10 a., 104/-; 12 a., 168/-; 20 a., 188/-; 54 v. 6 a., 120/-; 10 a., 142/-; 7.2 v. 6 a., 154/-; 10 a., 178/-; 100 v. 6 a., 11/-; 10 a., 112/15/-; all post 2/-.

**"WESTALITE" (BRIDGE), 12-15 v. D.C.,** 1.2 a., 15/10; 2.5 a., 27/8; 5 a., 31/9; 10 a., 54/6; 20 a., 99/6; 30 a., 144/10; 50 a., 257/-; 24 v. 1.2 a., 15/10; 2.5 a., 27/8; 5 a., 51/-; 10 a., 92/7; 20 a., 176/2; 36 v. 1.2 a., 27/8; 2.5 a., 51/-; 5 a., 69/10; 10 a., 130/9; E.H.T. RECTS., 14D, 134, 22/-; 36 E.H.T. 60, 31/10, all post extra.

Wholesale and Retail  
Special Price for Export and Quantity.

**T. W. PEARCE**

66 GREAT PERCY STREET, LONDON, W.C.1  
Off Pentonville Rd. Between King's Cross and Angel

**SENIOR design draughtsmen** required by a large engineering company due to expansion of company's services and commercial business; applicants should have a comprehensive knowledge of mass production of radio, television and electronic equipment; salary up to £700 per annum; monthly status; the vacancies are of a permanent and progressive nature; company superannuation and life assurance schemes in operation.—Please reply, giving details of experience, to Box 1926. [4280]

**SENIOR coilwinding planning engineer** required, experienced in the planning of radio and television coils; the selected candidate will have the drive and initiative necessary to deal rapidly with the day-to-day electrical and mechanical problems on the shop floor; East London area; this vacancy, for which a good salary will be paid, presents ample scope and opportunity to a man of first-class ability.—Please reply, giving full details of experience, to Box 1717. [4247]

**THE PLESSEY CO., LTD.**, of Ilford, offers attractive permanent positions to draughtsmen, due to expansion of our electronic division; applicants should be experienced in development and design for production of high-grade communications equipment to service requirements; good salary and staff conditions; company superannuation and insurance scheme in operation.—Applications, which will be treated in confidence, should be addressed to The Plessey Co., Ltd., Vicarage Lane, Ilford, Essex.

**AMBASSADOR** have vacancies for engineers in their Development Department due to an expanding production programme. The work entails the design of general radio and television circuitry, and production test gear; previous experience is desirable but not essential. H.N.C. or similar qualifications will count. The positions will carry staff status.—Apply by letter in first instance to Chief Engineer, Ambassador Radio and Television, Ltd., Princess Works, Brighouse, Yorkshire.

**DRUGHTSMAN** required for detailing mechanical and electrical assemblies. Must be capable of reading electronic circuits. Applicants with any previous experience on such metal models. High power amplifier units, induction heaters or radio and television layouts should write, stating age and full details of previous experience and technical training. Housing facilities available near factory area.

The Edison Swan Electric Co., Ltd. Eastern Industrial Area, Harlow New Town, Essex.

**CANADA** needs electronic engineers. Measurement Engineering, Ltd., with expanding business in electronic instrument field, offer generous salary, excellent prospects, to keen man capable of starting and taking charge of sections to handle magnetic amplifier design. Applicants must be Phys. or Eng. graduates with several years industrial experience, including two years on magnetic amplifiers. The location is Ontario, within easy reach of Chalk River and Ottawa. Interviews London (England).—Box 2059 [4313]

**THE GENERAL ELECTRIC Co., Ltd., Brown's Lane, Allesley, Coventry,** requires mechanical development engineers, designer draughtsmen and draughtsmen, preferably with experience of radar-type equipments for guns, on guided weapons and like projects; also required, senior and junior electronic development engineers, particularly in the field of microwave and pulse applications; salary according to age, qualifications and experience.—Apply by letter, stating age and experience, to the Personnel Manager, Ref. R.G. [0259]

**A VACANCY** exists for an electronic instrument development engineer in the Telecommunications Laboratory of British Insulated Callenders' Cables, Ltd., at Kirkby, near Liverpool. Candidates should hold a degree in physics or engineering and have previous experience in the design and development of electronic instruments. Some experience of servo-mechanisms would be an advantage.—Apply by letter, stating age, qualifications, P/49/54, should be addressed to: The Staff Officer, B.I.C.C., Ltd., Prescott, Lancs. [4344]

**WORKS** or maintenance engineers required for factory in Sunderland; must have had experience in installation and operation of factory services, including heating, ventilation, water, gas and electricity supply; maintenance of machine tools and appliances used for light mass production work, and drawing office experience in mechanical design; ability to control office and works staff is necessary; salary £750/£900 per annum.—Apply Personnel Superintendent, The Edison Swan Electric Co., Ltd., Cosmos Works, Brimsdown, Enfield, Middlesex.

**ELECTRONIC** engineers, young engineers, possessing initiative and a desire for responsibility and technical training up to degree standard (Physics or Electrical Engineering), are required to assist in the development and testing of Guided Weapon Control Systems; some experience of the design and development of analogue computers desirable but not essential; good salary and bonus; Pension Scheme.—Apply, quoting ref. WW/58, to the Assistant Manager, The Fairey Aviation Co., Ltd., Weapon Division, Heston Aerodrome, Hounslow, Middx. [4293]

**THE TELEGRAPH CONDENSER Co., Ltd.** invite applications from engineers fully experienced in radio and television design to assist Chief Development Engineer in development of printed circuits. Qualifications at least to A.M.I.E.E. standard. This position offers scope for the right man who must be capable of initiating and following projects to finality, including contact with customers. Superannuation scheme.—Write giving full details of qualifications and experience, age and salary requirements, to Personnel Manager, T.C.C., Ltd., North Acton, W.3. [4312]

**Bargains from SHERMAN'S**

Car. Paid—Money-Back Guarantee!  
**PICADOR PUP**

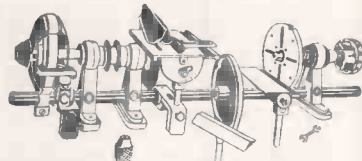

The most versatile tool ever offered to the public. Wood-turning lathe, rise and fall and fully tilting circular saw, hooded grindstone with drill sharpening attachment, sanding and drilling attachments, all accessories as illustrated. Complete **£6.15.0**

3" 4-jaw chuck independent reversible jaws for above, £3.0.0 Send 2jd FOR LEAFLET. **COMPUTOR**

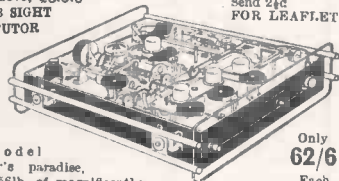

A model maker's paradise. Only **62/6** Each over 56lb. of magnificently made gears, driving shafts, bearings, miniature motor, repeater motor, gyroscopes, etc. All supplied in a strong wooden transit case 24in. x 22in. x 11in. high which itself is ideal as a tool box.

**AIR POSITION INDICATOR**

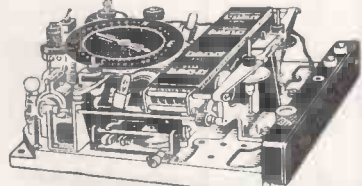

Containing a wealth of gears, drives and shafts, 3 infinitely variable gears, lampholders, repeater motors, Vee-drum counters. Been used by many Universities as a basis of a calculating machine. **£2.7.6**

**ALL-STEEL TOOL BOX**

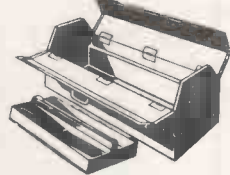

Complete with removable inner tray. Fitted with strong hasp, staple and carrying handles. Size 1, 14in. x 8in. x 8in. **25/-** Size 2, 17in. x 8in. x 8in. **30/-** Size 3, 24in. x 8in. x 8in. **36/6**

**MODEL MAKER'S MOTOR**

Extremely powerful and robustly designed motor measuring only 3in. x 1 1/2in. x 1 1/2in. Built-in variable resistance and centrifugal governor. 12 v. d.c. will operate on A.C. Unrepeatable **15/-** at



**ALL-PURPOSE STEEL SPINDLE**

15in. long. Complete with 1in. capacity 3-jaw chuck, 4-speed pulley. Ideal for circular saw, grinder, polisher, drill, etc. **37/6**

4-step Pulley. To match above spindle, 1 1/8" each. S.A.E. for list of pulleys, V-Belts, etc.

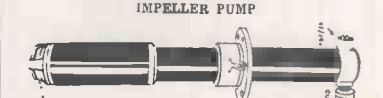

Approx. 20in. long by 2in. diam. 2 amp. at 24 v. d.c. will work on 12 v. at 4 amp. d.c. Ideal for bilge pumps or for transferring fuel or water to header tanks. Pump is self-cooled by liquid passing through it. Brand new and boxed. Each **39/6**

Send 3d. for New Catalogue  
TERMS—CASH WITH ORDER. C.O.D. 1/- EXTRA.  
Phone Orders Accepted. (Dept. W13)

**SHERMAN'S KILBURN COMPANY**

359, SILBURN HIGH ROAD, N.W.6.  
479 HARROW ROAD, LONDON, E.10. LADbroke 1718.  
HIGH STREET, HARLESDEN, N.W.10.

**EASY PAYMENTS ON 'SOUNDMASTER' COMPONENTS**

W.B.201 Amplifier chassis, grommets, valve holders, etc., 35/- cash or 4/4 deposit and 8 monthly payments of 4/4.

W.B.202. POWER UNIT CHASSIS and Accessories, 31/6 cash or 3/11 deposit and 8 x 3/11.

W.B.204. MAINS TRANSFORMER, 67/6 cash or 8/3 deposit and 8 x 8/3.

"COLLARO" MOTORS. Set of 3. 25/15/- cash or 14/2 deposit and 8 x 14/2.

BRENNEK COMPONENTS, 219/13/- cash or 33/5 deposit and 8 x 33/5.

BULGIN COMPONENTS, 23/10/- cash or 8/6 deposit and 8 x 8/6.

LAB COMPONENTS, 48/8 cash or 6/- deposit and 8 x 6/-.

T.O.G. COMPONENTS, 24/3/- cash or 10/3 deposit and 8 x 10/3.

WEARITE COMPONENTS. Red Seal Heads, 27 cash or 17/1 and 8 x 17/1.

WEARITE COMPONENTS. Gold Seal Heads, 210/3/- cash or 24/10 deposit and 8 x 24/10.

LUSTRAPHONE MIKE. Specified C51Z, 25/15/6 cash or 14/3 deposit and 8 x 14/3.

TRUYOX TAPE DECK, 223/2/- cash or 56/6 deposit and 8 x 56/6.

RADIO JACK (Standard) 23/8/4 cash or 8/4 and 8 x 8/4.

RADIO JACK (Senior) 24/14/11 cash or 11/8 and 8 x 11/8.

LANE TAPE TABLE, Mark VI, 2-speed, 218/10/- cash or 45/3 deposit and 8 x 45/3.

GRUNDIG ACCESSORIES. Let us know your requirements, we will be pleased to quote you.

Send your Remittance to Desk 141,

**LAFCO COMPOUNDS LTD.**

3, CORBETTS PASSAGE, ROTHERHITHE  
NEW ROAD, BERMONDSEY, S.E.16

BERmondsey 4341 (Ext. 1)



**TRANSFORMERS**  
of all types up to 25 KVA for Single or Three Phase operation, Phase Conversion, etc.

**MAINS**  
Output, and Special Purpose Transformers for Radio Equipment; Chokes, etc.

**COILS**  
for Contactors, E.M. Brakes, Air Valves, etc., and Coil WINDINGS for all purposes.

**SOLENOIDS**  
for A.C. and D.C. Operation.

**W. F. PARSONAGE & Co., Ltd.**  
INDUCTA WORKS · Park Rd · Bloxwich · Walsall  
Telephone: BLOX 66464

THE  
**Cape 25**  
AUDIO AMPLIFIER for the acoustics laboratory or with a CAPE FOUR STAGE PREAMPLIFIER forming a high fidelity reproducer which sets a new standard of performance.

AMPLIFIER £25. PREAMPLIFIERS from £10.

*Illustrated leaflets upon request.*

CAPE ELECTROPHONICS LTD.  
43-45, Shirley High Street, Southampton.  
Telephone: Southampton 74251.

**LOCKWOOD**  
makers of  
**Fine Cabinets**  
and woodwork of every description for the Radio and allied trades

**LOCKWOOD & COMPANY**  
Lowland Rd., Harrow, Middlesex. Byron 3704

**BATTERY CHARGERS**  
For the Motorist

BRIGHTON TERRACE, LONDON, S.W.9  
\*Phone BR11ton 4961 (3 lines)

ESASCO ELECTRICAL (Holdings) LTD.

Vitavox Public Address Multicellular Horns S/hand complete with new 15 Ohm Pressure Unit, £12. 10. 0. Secondhand 8" Speakers in Cabinet 5 Ohm, 21/- New Fluorescent Quick Start Ballast Units to operate 2 40w. Tubes, state voltage, 19/6 each. 100 yds. coils, Twin Elastic Cable, 50/- coil.

Please add postage.

**HAROLD MORRIS LTD.**  
423 Green Lanes, London, N.4. MOU. 2054.

**WEBB'S HAVE IN STOCK THE NEW ROGERS "RD JUNIOR" AMPLIFIER**

Unapproachable value, this 1955 design rivals amplifiers costing double the price. **£25 OR DEPOSIT £5.0.0 and 12 MONTHS AT £1.16.8.—OR—18 MONTHS AT £1.5.7.**

**WEBB'S RADIO,**  
14, SOHO ST., OXFORD ST., LONDON, W.1  
SHOP HOURS:  
9 a.m.—5.30 p.m. SATS. 9 a.m.—1 p.m.

**EDISON SWAN ELECTRIC Co., Ltd.**, have a vacancy for an engineer to take charge of their Special Products' Development Laboratory; candidates should have an engineering degree or its equivalent, and should have experience in developing electronic equipment ready for factory production.—Please write full particulars, including age and salary required, to 1056, Charing Cross Rd., London, W.C.2. Reference K. S. P.

**PRODUCTION** planning engineer required for factory in Enfield; should have had experience preferably but not essentially in electronic valve production; must be able to break down programmes into component part requirements and raw materials and organise supplies; also must be able to assess plant capacities and organise loading in economic quantities; knowledge of rate fixing and incentive schemes essential; salary £900/£1,000 per annum. Apply Personnel Superintendent, The Edison Swan Electric Co., Ltd., Cosmos Works, Brimsdown, Enfield, Middlesex. [4279]

**MINISTRY OF SUPPLY** require technical authors of chesses, Farnborough and Malvern to prepare instructional handbooks on theoretical and practical aspects (including servicing) of airborne and ground equipments for radio control, communication and navigation including radar. Qualifications: British or British parents, recognised engineering apprenticeship or equivalent; possession of O.N.C. or equivalent desirable. Salary, within £660-£791 according to age and location of post.—Further particulars and application form from A.E.101, London Appointment Office, Ministry of Labour & National Service, 1-6, Tavistock Square, W.C.1. [4245]

**A VACANCY** exists for a senior electronic engineer to take complete charge of a field project abroad for a period of 18 to 24 months. Work will include design and construction of radio transmitting/receiving equipment, mast erection, ancillary R/T gear, etc., and liaison duties with users. Candidates, preferably single, must be medically fit and should possess one of the following qualifications—Graduate Membership of appropriate professional institute, H.N.C. Final Cert. of Five Years' Course C. & G., Higher School Cert. with maths. or science as principal subject. Very good prospect permanency for the right man. Salary in accordance with experience and qualifications.—Box 2058. [4510]

**VACANCIES** exist on the staff of J. Lyons & Co., Ltd., for engineers to be trained in systems maintenance and fault-finding on electronic computers for commercial clerical work; candidates should have sound electronic engineering knowledge up to H.N.C. standard; experience of television or radar pulse circuiting would be a definite advantage; applications will be considered from men not usually engaged on electronic work provided they can show satisfactory evidence of technical knowledge; the organisation is expanding and there are excellent prospects of advancement for able engineers; further vacancies will arise over the next 6-14 months and men serving with the forces should make enquiries as soon as their release date is known.—Apply Control Office, Cadby Hall, W.14. [4302]

**VENEZUELA:** A company in Venezuela representing well-known British manufacturers of radar and electronic equipment has requested its principal to recruit a man of experience with the object of forming an electronic section of the company in Venezuela. The man required must have the necessary technical qualifications and experience in radar and electronic equipment both for marine and air use and in defence applications. Technical sales experience is an advantage, a single man able to speak Spanish is preferred; the salary for the initial contract period of one-year will be in the region of 3,500 to 5,000 Bolivian months (equivalent of approximately £400 per month).—Please write full details qualifications, experience and all relevant information to Ref: RS Box 2050. [4298]

**MURPHY RADIO Ltd.**, have vacancies in the Electronics Division Laboratories for qualified engineers to design and develop the following: (1) V.H.F. and U.H.F. communications equipment; (2) airborne and ground radar equipment; (3) computing devices and servo systems; (4) nucleonic equipment and measuring instruments; (5) transistors and associated circuitry; the salary range is £600-£1,000 per annum depending upon experience; further posts are available to engineers of H.N.C. standard or equivalent having less experience, the salary range being £450 to £650 per annum; these vacancies are at Welwyn Garden City but one or two vacancies of a similar nature are available at the Ruislip works.—Applications, giving age, full details of qualifications, experience and salary required, should be forwarded to Personnel Department, Murphy Radio, Ltd., Welwyn Garden City. [3991]

**B.E.C.** requires engineering staff (British, minimum age 20) for operations and maintenance duties at transmitter, studio, recording and television centres; must be willing to serve anywhere in U.K. and have completed or been exempted from National Service; experience in radio engineering desirable; essential qualifications include university degree, Higher National Certificate or equivalent in electrical engineering, or success in examination for C. & C. Final Certificate in Telecommunications or Full Technological Certificate or Graduateship of I.R.E. or Graduateship with maths. of Brit. I.R.E. promotion prospects; starting salary £556 rising by 5 annual increments to £755.—Requests for application forms (enclosing addressing envelope and quoting ref. EX.25 W.W.) should reach Engineering Establishment Officer, Broadcasting House, London, W.1, within 7 days. [4353]

**THE EDISON SWAN ELECTRIC CO. LTD.,**  
Cosmos Works, Brimsdown, Enfield, Middlesex, has vacancies in its Research and Development Departments for:  
1. Development Engineers for work on design and development of thermionic valves.  
2. Technical Assistants for work in connection with design and development of thermionic valves.  
3. Mechanical Engineers interested in the problems of mass production associated with thermionic valves.  
These vacancies are the result of a rapid expansion in the Company's activities. The positions are progressive and carry the advantages of a Pension Scheme.  
Applicants for vacancies (1) should have an Engineering or Physics degree, but applications from candidates with H.N.C. or equivalent will be considered.  
Applicants for vacancies (2) and (3) should have Ordinary N.C. or H.N.C. or Inter B.Sc. or equivalent.  
The starting salary will be in accordance with the qualifications, experience and age of the applicants.  
Applications should be in writing and will be treated with the strictest confidence. Apply to the Personnel Superintendent.

**A.R.I. 5206 (STR 16/17) EQUIPMENTS**  
150-505 Kc/s C.W., 14 watts.  
2.4-13 Mc/s C.W., 25 watts.  
MCW. R/T, 6 watts.  
Built in 100 Kc/s X-tal calibrator.  
Complete T/R installations or separate units.  
Send your enquiries to:  
**AVIONICS LIMITED**  
Croydon Airport, Surrey. Tel. Croydon 5791, 4383, 7744.  
Grams: Aeradio Croydon.

THE "Dust Bug"  
**AUTOMATIC GRAMOPHONE RECORD CLEANER**  
PATENT APPLIED FOR  
From **CECIL E. WATTS**  
Consultant and Engineer (Sound Recording and Reproduction)  
Oakleigh Grange, High Cross, nr. Uckfield, Sussex.  
Or your local dealer.  
Price 18/6, plus 6/2 purchase tax

**—THE POLLOCK M.C. PICKUP—**  
Response 10 c.s. to 20 Kc/s. H.F. resonance 25 Kc/s., L.P. 20 Kc/s. Kit of parts to make pickup complete, including 100:1 transformer and sapphire stylus, 001 or .0025in., and full building instructions £4. 8s. 6d. Parts sold separately, prices: head and stylus 38/6; separator min. thorns 31/-; arm/pivot 26/-; transformer 26/-; all prices post free. S.a.e. for details to:—  
**G. BLUNDELL, 7 Sunnyside House, Child's Hill, London, N.W.2.**

**'Radiospares' Quality Parts**

**THE SERVICE ENGINEER'S FIRST CHOICE**



## THE EDISON SWAN ELECTRIC CO. LTD.,

Cosmos Works, Brimsdown, Enfield, Middlesex, has vacancies in its Research and Development Laboratories for:

1. Circuit Development and Application Engineers for Colour Television investigations.
2. Circuit Development and Application Engineers for Black and White Television development work.
3. Engineers for development work on Television and F.M. Amplifier problems. Previous experience in V.H.F. or F.M. required.
4. Cathode Ray Tube Development Engineers for development work on colour and black and white tubes. Previous experience on cathode ray tube development or design required.
5. Application Engineers for work in connection with Customer problems on Television, Radio and F.M.
6. Engineer for design of test equipment for Colour, Black and White Television and allied development work.
7. Engineers for Circuit development and Application work on Transmitters.

The above applicants should have a good Engineering or Physics degree or equivalent, but vacancies also exist for candidates with H.N.C. or equivalent qualifications.

The vacancies are a result of a large expansion in the Company's activities. Good salaries will be paid to suitable applicants and the positions are progressive and carry the advantage of a Pension Scheme.

The starting salary will depend on the qualifications, experience and age of the applicants.

Applications in writing, which will be treated with the strictest confidence, should be sent to the Personnel Superintendent.

## MULLARD LIMITED (Valve Division)

require several Junior Engineers, preferably aged 20-25 and of Higher National Certificate or equivalent standard, as Assistants in their Technical Service Department to deal with data and Publications in one of the following capacities:—

- (i) Preparing published data on Valves, Tubes and Transistors.
- (ii) Answering technical correspondence and enquiries from Home Constructors and Service Engineers.
- (iii) Editing laboratory reports and preparing technical articles for publication.

These positions offer an excellent opportunity to obtain a general grounding in all applications of Valves and similar devices prior to specialisation in a particular field. Good prospects of advancement for persons of ability. Write, stating age and giving full details of education, training and previous experience to Personnel Officer,

**MULLARD LIMITED**  
Century House,  
Shaftesbury Avenue, W.C.2.

**MULLARD RESEARCH LABORATORIES** have vacancies for several technical assistants to be trained, at full salary, as microwave valve engineers; successful candidates will be engaged upon the design, construction and electrical measurement of valves in the research and development stages.

The positions are permanent, progressive and carry attractive salaries and benefits, without National Service liabilities, should have scientific qualifications of, or equivalent to G.C.E. (advanced level), O.N.C., H.N.C.; however these requirements might be waived if the applicant has experience in a suitable technical field; salaries are based on qualifications, experience and age, and are in keeping with present-day levels; general prospects within the organisation are excellent.—Apply Personnel Manager, Mullard Research Laboratories, Cross Oak Lane, Salfords, Near Redhill, Surrey.

**THE GENERAL ELECTRIC COMPANY, Stanmore Laboratories:** Guided Weapon Trials Group have a number of vacancies for technical staff to be filled during the next few months; they call for a good general understanding of the theory and functioning of radar or similar equipment, and academic qualifications, preferably of degree or equivalent standard; the work will involve association with aircraft operations and opportunities for flying may be available.—Apply in writing to the Staff Manager, The Grove, Stanmore Common, Middlesex, or telephone to Bushey Heath 2441, Ext. 22. [4300]

**A**n Electronic Engineer is required for work in the research laboratory of a progressive East Midlands firm in the design and development of electronic measuring instruments and of circuits for automatic control systems, etc.; the post should prove most attractive to a man aged 25/30, who has obtained a good degree and has had some experience in servo systems, electronic motor control and/or magnetic amplifiers; a salary up to £700 depending on qualifications is offered; please apply, quoting Ref. 106/EE, stating age, experience, etc., to—Box 21, F. 5491, A.K. Adv., 212a, Shaftesbury Ave., London, W.C.2. [4249]

**DESIGNER** Draughtsman required for design and development of test gear to meet production demands of thermionic valves and cathode ray tubes. Applicants should have good mechanical knowledge with previous experience in mechanical and electrical interlocks, component layouts for power supply units up to 50 kv 50 cycles and R.F. or induction heaters. Housing facilities available near factory area.—Write, stating age and full details of previous experience and technical training, to: The Edison Swan Electric Co., Ltd., Eastern Industrial Area, Harlow, New Town, Essex. [4346]

**SITUATIONS WANTED**  
**R**ESearch, development supervisor Ph.D. Physical Chemistry; metal film resistors, electronic components; U.S. citizen, 36, desires location in Great Britain.—Box 1613. [4222]

**R**ADIO officer, M.N., 12 years at sea and sick of the sight of it, desires position television service, trainee. City and Guilds Intermediate plus.—Box 1918. [4275]

**R**ADIO Officer, M.N., recent first-class certificate, radar maintenance certificate; some 10 years' experience marine radio, desires to be considered for teaching post P.M.G. marine radio courses.—J Kidd, 47, Southcoote Lane, Reading. [4252]

**TECHNICAL TRAINING**  
**L**EARN it as you do it—we provide practical equipment combined with instruction in radio, television, electricity, mechanics, chemistry, photography, etc.—Write for full details to E.M.I. Institutes, Dept. WW.47, London, W.4. [0001]

**CITY and Guilds (Electrical, etc.) on "No Pass—No Fee" terms over 95% successes.**—For full details of modern courses in all branches of Electrical Technology send for our 144-page handbook, free and post free. B.I.E.T. (Dept. 388A), 29, Wright's Lane, London, W.8. [0117]

**TUITION**  
**N**OTHING succeeds like success! What we have done a thousand times we can do again for you—see the B.N.F.S. advt. page 154. [0172]  
**WIRELESS** operating; attendance and postal courses.—Stamp for reply to Manager, The Wireless School, Minor Gods, London, N.7.  
**S**EE the world as a Radio Officer. Short training period—low fees. Scholarships, etc., available. Boarding and day students. Send 2d stamp for prospectus.—Wireless College, Colwyn Bay. [0018]

**A.M.I.Mech.E., A.M.Brit.I.R.E.E., City and Guilds etc.** on "No Pass—No Fee" terms; over 95% successes.—For details of Exams and courses in all branches of Engineering, Building, etc., write for 144-page Handbook—Free: B.I.E.T. (Dept. 387B), 29, Wright's Lane, London, W.8. [0118]

**FREE!**—Brochure giving details of Home Study Training in Radio, Television, and all branches of electronics; courses for the hobby enthusiast or for those aiming at the A.M.Brit.I.R.E.E., City and Guilds, R.T.E.B., and other professional examinations; train with the College operated by Britain's largest electronics organisation; moderate fees.—Write to E.M.I. Institutes, Dept. WW.2/2, London, W.4. [0088]

**T**he available home study courses in every phase of radio and television engineering, specialising in the practical training of apprentices in the retail trade; enrolments limited, fees moderate.—The Syllabus of Instructional Text may be obtained post free from the Secretary, I.P.R.E., Fairfield House, 20, Fairfield Rd., Crouch End, London, N.8. [0088]

**MONEY BACK GUARANTEE DUKE & CO**  
621 ROMFORD ROAD, LONDON. E.12  
CWO or COD - TEL: GRA 6677

**SPEAKERS.** 12/9. 8in. P.M. std., 3-5 ohms, or with O.P. trans., 14/6. Used, tested, guaranteed. Post 1/9.

**SPEAKERS.** 4/9. 8in., M.E. field 1K, 1½K or 2K ohms. With O.P. trans., 6/9. Used, tested, guaranteed. Post 1/9.

**R.F. UNIT 24.** 12/6. New and packed. Tuning 20-30 mc/s., including 3 valves, Post 2/-.

**I.F. TRANSFORMERS.** 2/6 pair. 465 kc/s. Unrepeatable offer. Post 6d.

**V.H.F. 1124 RECEIVER.** 17/6 with 6 valves. X.V.D. new condition, 6 channel switching. Receives T.V. sound, police, fire and amateurs. 30.5 to 40 mc/s. I.F. 7 mc/s. Post 2/6. Drawings and Conversion data free with each set.

**2 GANG CONDENSERS.** 2/9, standard size .0005. Store soiled, tested. Also 3 gang at 2/9. Post 6d.

**O.P. TRANSFORMERS.** 1/9. Salvage. All tested. Post 6d. (std. 3-5 ohms). 1%-1 meg. resistors, 2/9. IRC U.S.A. Post 3d.

**MAINS TRANSFORMERS.** 9/9. 350-0-350 v., two heater windings, 6 volt and 5 volt. Post 2/-.

### AMPLIFIERS

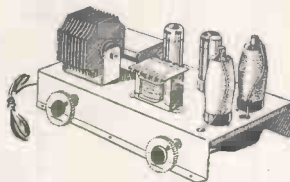

**AMPLIFIERS.** 57/6. 4 watts output A.C. Also 77/6. Universal push pull, 7 watt output. Post 2/6.

**AMPLIFIERS.** 97/6. 5 valve, 10 watts with pre-amp. stage, 3 controls. Post 3/6.

**T.V. TUBES AND CHASSIS.** Overwhelming orders make further orders at present unacceptable.

**H.T. BATTERIES.** 96 volt. 4/9. Made from our 12 volt batteries at 9d. each or 8, 4/9. Post

**MORSE KEY TAPPERS.** 1/- Post 3d.

**LIFE JACKET LAMPS.** 9c. Complete with lead and clip. U2 batt. and bulb to fit, 9d. Post 5d.

**MIXED CONDENSERS.** New. 5/- per 100. Not tested or guar., but good makes. Post 1/-.

**FULL-TIME** courses for P.M.G. Certs., C.G.L.I. Telecommunications, Radar Maintenance Cert. and B.Sc. (Eng.): prospectus free.—Technical College, Hull. 10111

**WIRELESS** telegraphy.—Merchant Navy offers to youths 16 upwards after qualification, lucrative positions as radio officers—Apply British School of Telegraphy, 179, Clapham Rd., S.W.9 (Est. 1906). Recognised by Ministry of Education, moderate fees, modern equipment, day and evening tuition; also postal courses in theory of wireless telegraphy for P.M.G. Certs. and Amateur Transmitting Licence. 10124

**T/V & Radio—A.M. Brit. I.R.E., City & Guilds, R.T.E.B. Cert., etc.** on "No Pass—No Fee" terms; over 95% successes.—Details of Exams. and Home Training Courses in all branches of Radio and T/V, write for 144-page Handbook—Free. B.I.E.T. (Dept. 387A), 29 Wright's Lane, London, W.8. 10116

**BOOKS, INSTRUCTIONS, ETC.**  
**SALE, "Wireless World," "Practical Wireless," 1937-40.**—Lambert, 347, Gertrude Rd., Norwich. [4248]  
**"W.W.," June, 1946, to July, 1954, complete;** also Practical Wireless and Radio Constructor; offers.—Box 2173. [4343]

**OFFERS "Wireless World's"** over 200 copies, 1937 onwards, incomplete series lot only, buyer pays carriage. N.I.—Box 2137. [4332]  
**I.P.R.E. technical publications, 5,500 Alignment Peaks for Suprathetodynes, 5/9, post free, data for constructing TV aerial strength meter, 7/6; sample copy "The Practical Radio Engineer,"** quarterly publication of the Institute 2/-; membership and examination data, 1/-.—Sec., I.P.R.E., 20, Fairfield Rd., London, N.8.

**BOOKS WANTED**  
**WANTED** for binding, in good condition, "Wireless World," volume LV4, April, 1949.—Box 2211. [4351]

**H.P. Terms if desired**

**AMPLIFIERS · TUNER UNITS · LOUDSPEAKERS**  
**GRAM MOTORS · CABINETS**

**LANCASTER HI-FIDELITY**  
 Acoustical Equipment Co., 27/29/31 Lancaster Ave., Fennel St., **MANCHESTER, 4**  
 DE A 2503.

**Fiji Electronic Agencies, P.O. Box, No. 8, Nadi, Fiji.**  
 Invite offers from Manufacturers and Export Houses in the U.K. and the continent for all classes of RADIO RECEIVERS—robust dry battery; 6 volt operated; 110/240 A.C.; A.C./D.C.; and 6/12 volt Car Radios with M.W.; M.S.W.; and Shortwaves; **PUBLIC ADDRESS SYSTEMS, PICKUPS, MICROPHONES, RECORD CHANGERS, SOUND RECORDING instruments, CINE EQUIPMENTS, ELECTRICAL AND LIGHTING ACCESSORIES, BATTERIES, RADIO COMPONENTS, METERS, AERIALS, LOUDSPEAKERS ETC.**

**PRECISION SHEET METALWORK**

We specialise in manufacturing of Chassis in all metals, large or small quantities to your own specifications.

**V. W. BEAMISH**  
 Shardeloes Garage, Shardeloes Rd., New Cross London, S.E.14.  
 Telephone: TIDway 4795



**BELCLERE**  
 MINIATURE  
 INPUT, OUTPUT  
 AND INTERSTAGE  
**TRANSFORMERS**

We specialise in the manufacture of coupling transformers to customers' requirements. An illustrated brochure describing the range of transformers we manufacture will gladly be sent on request.

Illustrated above is a standard input transformer type "E" size 1in. x 3/4in. x 3/4in. overall, available with varnish dip finish, encapsulated block form, or in mu-metal screening can

Quick delivery—low prices—maximum efficiency.

**JOHN BELL & CROYDEN, 117 HIGH STREET, OXFORD,**  
 Telephone: 47072. Cables: Belclere, Oxford

**CABINETS!!**

Many and varied types (Table and Console) and Console Tape Recorder Types.

**The "Empress" DE LUXE CONSOLE CABINET**

Beautifully styled, elegantly veneered in medium full grain walnut, highly polished finish. Interior finished in light polished sycamore. Ample storage space. Designed to our own specification, it will accommodate the largest tape desk on the market. It has many applications, good quality amplifier, etc. O.A. dimensions 3ft. x 1ft. 6 1/2in. x 2ft. 10in. high with lid closed.



Send for our cabinet list which gives details of this and many other types.



Send for our current monthly bulletin of Replacement Radio/Radiogram chassis, Tape Recording equipment, etc.

Trade Only Supplied

**V.E.S. WHOLESALE SERVICES Ltd**  
 Dept (W.W.), 11, Gunnersbury Lane, Acton, W.3. Tel.: ACOrrn 5027

**Australia Calls**

**TELECOMMUNICATION ENGINEERS**

**REVISED SALARY** Grade 1 Engineer—£890 to £1310  
 SCALE: (in £A) Group Engineer—£1394 to £1564

**AUSTRALIA** is developing rapidly and urgently needs professionally qualified electrical, mechanical and civil engineers to assist in the expansion and maintenance of its national telephone, telegraph, radio and television services.

**QUALIFICATIONS:** Engineers academically qualified for Membership of main Institutions of Engineers.

**STARTING SALARIES:** According to qualifications and experience. Graduates £932 to £1,058.

**CONDITIONS OF APPOINTMENT:** Permanent appointment to the Postmaster-General's Department. Free passages for appointee and dependants. Initial accommodation provided. In approved circumstances, special settling-in allowances. Full salary from date of embarkation. Superannuation, annual and sick leave conditions. Good opportunity for advancement.

**FOR FURTHER DETAILS:** Engineers qualified or about to qualify, enquire from the Australian Post Office Representative, Australia House, Strand, London, W.C.2.

FOR RAPID ERASURE USE THE HARVEY ELECTRONICS LIMITED

**BULK ERASER**

FOR 1/2" MAGNETIC TAPE. IDEAL FOR QUICK CLEANING OF ALL 1/2" STANDARD TAPE, ENABLING EACH RECORDING TO COMMENCE WITH ABSOLUTELY CLEAN TAPE. SUITABLE FOR GRUNDIG STENORETTE SPOOLS

LIST PRICE £7.10.0

Send for pamphlet and full details from:—

**HARVEY ELECTRONICS LTD.**  
 273, FARNBOROUGH ROAD, FARNBOROUGH, HANTS.  
 Tel.: Farnborough 1120  
 LONDON OFFICE:—  
 59, Union Street, S.E.1. Phone: FOP. 4587



**H. WHITAKER G3SJ.,**  
 10, YORKSHIRE STREET, BURNLEY  
 Phone: BURNLEY 4924

Manufacturers of precision Quartz Crystals in a wide variety of bases covering the complete range 40 Kc. to 18 Mc. in fundamental frequencies. All are made to extremely fine tolerances, and frequency adjustment can be given up to .005%. Plated electrodes of gold, silver or aluminium with wired in spot welded contacts are available. Quotations can be given for any type of cut or mode of oscillation including a complete range for filter circuits with zero temperature co-efficient over a sensibly wide temperature range. Our new works is equipped with up-to-the-minute production technique methods, X-ray orientation ensuring accuracy of all cuts. Artificial aging by etching and plating by evaporation under vacuum ensure long term stability of the final calibration. Early delivery can be given of most types. Our regrind service is still available and in some cases we are prepared to quote for lowering the frequency of your existing crystals.

**SPECIAL OFFER:**

200 kc. DT cut, zero temperature co-efficient over the range—30° centigrade to +53° centigrade. Frequency adjustment .005% or better. Mode: Face shear. Silver-plated electrodes, wire mounted. Basing 1/16in. pin spaced. Other bases: to order, £1 each.

# A MAST PROBLEM?

# WRITE TO Sky masts

BEADON GARAGE · BEADON ROAD · LONDON W.6 Telephone: RIVerside 1124 & 7878



## DECCA RECORD PLAYERS

Standard or L.P.  
List Price £12/1/6

**OUR PRICE**  
**6 GNS.**

Packing, carriage, insurance, etc., 10/6

Decca 78 r.p.m. variable speed record players, fitted centre drive Garrard motors, frr plug-in heads, sapphire styli, Rexine case. List price £12/18/6. Our price £8/19/8. Packing, carriage, insurance, etc., 10/6.

Send stamp for bargain list of record players.

**RONALD WILSON & CO.**  
12, BRIDGE ST., WORCESTER

**NEW!**

## "FROM THE ELECTRON TO THE SUPERHET"

700 pages. 733 illus. and diagrams.

A simplified radio course consisting of 42 lessons each dealing with a specific subject specially based on radio service practice.

PRICE **55/-** POSTAGE 1/6.

**MODERN BOOK CO.**  
19-23 Praed Street, London, W.2



## METER REPAIR SERVICE



ALL TYPES and MAKES  
Single and Multi-Range  
METERS SUPPLIED FROM STOCK OR  
CONVERTED TO ANY RANGE

Phone for immediate service

### THE ELECTRICAL INSTRUMENT REPAIR SERVICE

329 Kilburn Lane, London, W.9

Tel.: LADbroke 4168

## OUR NEW GOVERNMENT SURPLUS CATALOGUE No. 12

containing over 400 items price 1/6d. post free. 2/6d. overseas seamount.

**ARTHUR T. SALLIS (W.W.)**  
93 NORTH ROAD, BRIGHTON, SUSSEX.  
Tel.: BRIGHTON 25806

*Chassis, Cases* and all metal fittings made to specification for the Radio and Electronic Industry.

**STAR METAL PLATE WORKS**  
74 CHURCH Rd., BARNES, S.W.13  
Tel.: RIV 6673/4

## AUTOMATIC (TIME) SWITCHES

New and reconditioned 15 day clockwork and electric switches  
from **35/-**

Send S.A.E. for illustrated details to:—  
**DONOHUE (TIMERS) GEORGE STREET NORTH SHIELDS, NORTHUMBERLAND**

## PARKER'S SHEET METAL FOLDING MACHINE



Heavy Vice Model. Capacity 18 gauge M.S. x 2ft. wide. Loose Attachments for Radio Chassis Making Weight 22 lb. Price 50/-. Attachments 1/6 per ft. Carriage 4/- with attachments 5/6. Also Parker's Square Type Drill Vice. Machined table 7in. x 6in. x 1in. Jaws of Bright Steel. Admits stock of 4in. Complete with stand. Heavily constructed. Wt. 13 1/2 lb. Price 37/6. Carriage 2/6

Machines guaranteed. Send for details.

**A. B. PARKER** WHEATCROFT WORKS, WELLINGTON STREET, BATLEY, YORKSHIRE. Tel.: Batley 426

## THE WORLD'S GREATEST BOOKSHOP

# FOYLES

★ ★ FOR BOOKS ★ ★

All new Books available on day of publication. Secondhand and rare Books on every subject. Stock of over three million volumes.

Foyles have depts. for Gramophone Records, Handicraft Materials, Stationery, Music, Magazine Subscriptions, Foreign Stamps.

119-125 CHARING CROSS ROAD, LONDON, W.C.2

Gerrard 5660 (16 lines) ★ Open 9-6 (Thurs. 9-7)

Nearest Station: Tottenham Court Road

## The NEW ACRU CELLOPHANE SEALING IRON

Gives the right heat in the right spot and makes perfect joints. Suitable for most plastics.



Ask for leaflet

**THE ACRU ELECTRIC TOOL MFG. CO.,**  
CHAPEL STREET, LEVENSHULME, MANCHESTER, 19.

Tel.: Rusholme 4613

## INDEX TO ADVERTISERS

|   | PAGE               |  | PAGE                 |  | PAGE               |
|---|--------------------|--|----------------------|--|--------------------|
| A.A. Tools  | 162                | Fisher Electronics Co., Ltd.                   | 33                   | Painton & Co., Ltd.                            | 26                 |
| Acoustical Mfg. Co., Ltd.                                   | 4                  | Foyle, W. & G., Ltd.                           | 173                  | Parker, A. B.                                  | 173                |
| Acru Electric Tool Mfg. Co., Ltd., The                      | 173                | Furzehill Laboratories, Ltd.                   | 102                  | Parsonage, W. F., & Co., Ltd.                  | 170                |
| Adcola Products, Ltd.                                       | 59                 |  |                      | Partridge Transformers, Ltd.                   | 155                |
| A.D.S. Relays, Ltd.   | 120                |  |                      | P.G.A. Radio                                   | 122                |
| Advance Components, Ltd.                                    | 2                  |  |                      | Pearce, T. W.                                  | 169                |
| Airmec, Ltd.  | 6                  | Galpins  | 167                  | Phillips Electrical, Ltd.                      | 83                 |
| Allen Components, Ltd.                                      | 119                | Gardners Radio, Ltd.                           | 52                   | Plasticable, Ltd.                              | 138                |
| Alpha Radio Supply Co., The                                 | 152                | Garrard Engineering & Mfg. Co., Ltd.           | 73                   | Plessey Co., Ltd., The                         | 53                 |
| Altham Radio Co.  | 140                | Gee Bros., Radio, Ltd.                         | 150                  | Post Radio Supplies                            | 164, 166           |
| Ambassador Radio & Television                               | 60                 | General Electric Co., Ltd.                     | 30                   | Power Controls, Ltd.                           | 25                 |
| Amplex Appliances (Kent), Ltd.                              | 140                | Gilson, R. F.                                  | 163                  | Premier Radio Co.                              | 84, 85, 86, 87     |
| Anders Electronics, Ltd.                                    | 112                | Glaser, L., & Co.                              | 164                  | Proops Bros., Ltd.                             | 111                |
| Antex   | 78                 | Glover, W. T., & Co., Ltd.                     | 32                   | Pye, Ltd.                                      | 34, 59, 79         |
| Antiference, Ltd.   | 15                 | Goldring Manufacturing (Gt. Britain), Ltd.     | 75                   |  |                    |
| Appointments Vacant   | 152, 154, 171      | Goodmans Industries, Ltd.                      | 15, 35               |  |                    |
| Arcoelectric Switches, Ltd.                                 | 42                 | Goodsell, Ltd.                                 | 48                   | Quality Equipment Designers, Ltd.              | 67                 |
| Ariel Sound   | 162                | Gramophone Co., Ltd., The                      | 94                   | Quartz Crystal Co., Ltd.                       | 164                |
| Armstrong Wireless & Television Co., Ltd.                   | 121, 157           | Gray, Arthur, Ltd.                             | 112                  |  |                    |
| Ashworth, H.  | 152                | Greenlick, O.                                  | 161                  |  |                    |
| Associated Cine Equipments, Ltd.                            | 146                | Gresham Transformers, Ltd.                     | 113                  | Radio & Electrical Mart, The                   | 114                |
| Australian Post Office                                      | 172                | Griffiths Hansen (Recordings), Ltd.            | 168                  | Radio Component Specialists                    | 113                |
| Automatic Coil Winder & Electrical Equipment Co., Ltd., The | 1                  | Grundig (Gt. Britain), Ltd.                    | 139                  | Radio Corporation of America                   | 23                 |
| Automatic Telephone & Electrical Co., Ltd.                  | 27                 |  |                      | Radio Kits, Inc.                               | 160                |
| Auloust (Production), Ltd.                                  | 142                | Hall Electric, Ltd.                            | 66                   | Radio Resistor Co., Ltd., The                  | 36                 |
| Avionics, Ltd.  | 170                | Hanney, L. F.                                  | 110                  | Radio Servicing Co.                            | 124, 125           |
|   |                    | Harris, P.                                     | 156                  | Radio Supply Co.                               | 150                |
| Barker Natural Reproducers                                  | 159                | Hartley, H. A., Co., Ltd.                      | 50                   | Radio Traders, Ltd.                            | 170                |
| Barton's (Radio)  | 157                | Harvey Electronics, Ltd.                       | 172                  | Radiospares, Ltd.                              | 69                 |
| Beamish, W.   | 172                | Hatfield Radio                                 | 141                  | Reproducers & Amplifiers, Ltd.                 | 81                 |
| Bel Sound Products, Ltd.                                    | 120                | Heath Spring & Notion Co., Ltd.                | 140                  | Rogers Development Co.                         | 158                |
| Bell, John, & Croyden                                       | 172                | Henry's, W. T., Telegraph Works Co., Ltd.      | 156                  |  |                    |
| Belling & Lee, Ltd.   | 93                 | Henry's, W. T., Telegraph Works Co., Ltd.      | 151                  | Salford Electrical Instruments, Ltd.           | 139                |
| Benson, W. A.   | 161                | Hif Ltd.                                       | 114                  | Sallis, A. T.                                  | 173                |
| Berry's (Short Wave), Ltd.                                  | 140                | Holley's Radio                                 | 158                  | Samsons Surplus Stores                         | 112                |
| Bird, Sydney S., & Sons, Ltd.                               | 22                 | Homelab Instruments, Ltd.                      | 136                  | Savage Transformers, Ltd.                      | 157                |
| Birmingham Sound Reproducers, Ltd.                          | 88                 | Household Electrix, Ltd.                       | 50                   | Sherman's Supply Co., Ltd.                     | 169                |
| B. K. Partners, Ltd.  | 56                 | H.P. Radio Services, Ltd.                      | 118                  | Sifam Electrical Instruments Co., Ltd.         | 56                 |
| Blundell, G.  | 170                | Hudson Electron Devices, Ltd.                  | 62                   | Simmonds, L. E., Ltd.                          | 82                 |
| Bradmatic, Ltd.   | 142                | Hunt, A. H. (Capacitors), Ltd.                 | 44                   | Simon Sound Service                            | 72                 |
| Brighton Radio Co.  | 138                | Hunton, Ltd.                                   | 112                  | Sky-masts                                      | 173                |
| Britain Chas. (Radio), Ltd.                                 | 153                |  |                      | Smith, G. W. (Radio), Ltd.                     | 146, 147           |
| British Communications Corp., Ltd.                          | 55                 | Iliffe Books                                   | 145, 148             | Smith, G. W. & Co., Ltd.                       | 81                 |
| British Distributing Co.                                    | 160                | Industrial Electronics                         | 74                   | Solartron Electronic Group, Ltd.               | 115                |
| British Institute of Engineering Technology                 | 158, 168           | International Aeradio, Ltd.                    | 83                   | Sound Sales, Ltd.                              | 102                |
| British Insulated Callender's Cables, Ltd.                  | Cover 11           | International Correspondence Schools           | 138                  | Southern Marine Radio Co.                      | 167                |
| British National Radio School                               | 154                |  |                      | Southern Radio Supply, Ltd.                    | 163                |
| British Physical Laboratories                               | 117                | Jackson Bros. (London), Ltd.                   | 79                   | Specialist Switches                            | 162                |
| British Plastics Exhibition                                 | 9                  | Jackson Radio                                  | 160                  | Spencer-West                                   | 164                |
| British Sarazol, Ltd.                                       | 154                | Jason Motor & Electronic Co.                   | 164                  | Standard Telephones & Cables, Ltd.             | 28, 91, 96         |
| Brookes Crystal, Ltd.                                       | 80                 |  |                      | Stanley Sound & Vision Products, Ltd.          | 122                |
| Brown, S. G., Ltd.  | 146                | Kempner, S.                                    | 116                  | Star Metal Plate Works                         | 173                |
| Bulgina, A. F., & Co., Ltd.                                 | Edit. 199          | Kenroy, Ltd.                                   | 160                  | Stead, J. & Co., Ltd.                          | 114                |
| Bull, J., & Sons  | 148                | Keyswitch Co., The                             | 110                  | Steatite & Porcelain Products, Ltd.            | 14                 |
| Bullers, Ltd.   | 68                 | Kolectric, Ltd.                                | 82                   | Stern Radio, Ltd.                              | 126, 127, 128, 129 |
| Burne-Jones & Co., Ltd.                                     | 118                | Koskie, B.                                     | 154                  | Stewart Transformers, Ltd.                     | 118                |
|   |                    |  |                      | Stratton & Co., Ltd.                           | 146                |
| Candler System Co.  | 164                | Labgear (Cambridge), Ltd.                      | 32                   | Suflex, Ltd.                                   | 64                 |
| Cape Electronics, Ltd.                                      | 170                | Laico Compounds, Ltd.                          | 169                  | Surden, A. R., & Co. (Engineers), Ltd.         | 165                |
| Cathodeon Crystals, Ltd.                                    | 17                 | Lancaster Hi-Fidelity Acoustical Equipment Co. | 172                  | Superior Radio Supplies                        | 141                |
| Cementation (Muffelite), Ltd.                               | 168                | Lasky's Radio                                  | 133, 134, 135        | Sutton Coldfield Electrical Engineers          | 142                |
| Chaffey Condenser Co.                                       | 158                | Leak, H. J., & Co., Ltd.                       | 103                  | Tannoy Products, Ltd.                          | 163                |
| Champion Products   | 158                | Leavers-Rich Equipment, Ltd.                   | 167                  | Taylor Electrical Instruments, Ltd.            | 63                 |
| Chapman, C. T. (Reproducers), Ltd.                          | 144                | Lewis Radio Co.                                | 137                  | Telegraph Condenser Co., Ltd.                  | Cover 11           |
| Cie Generale de Metrologie                                  | 18                 | Light Soldering Developments, Ltd.             | 162                  | Telegraph Construction & Maintenance Co., Ltd. | 77                 |
| Cinema Television, Ltd.                                     | 187                | Lockwood & Co.                                 | 161                  | Teleonics, Ltd.                                | 108                |
| City Sale & Exchanges, Ltd.                                 | 31                 | London Central Radio Stores                    | 170                  | Tele-Radio (G13), Ltd.                         | 85                 |
| Classic Electrical Co., Ltd.                                | 130, 131           | Lowther Mfg. Co.                               | 78                   | Telectron Co., Ltd.                            | 167                |
| Clyne Radio, Ltd.   | 144                | L. R. Supply Co., Ltd.                         | 100                  | Trixon Electric, Ltd.                          | 42                 |
| Cohen, D.   | 144                | Lustraphone, Ltd.                              | 70                   | Trion Electrical Co., Ltd.                     | Edit. 197          |
| Cosmocord, Ltd.   | 92                 | Lyons, Claude, Ltd.                            | 110                  | Truvox, Ltd.                                   | 38, 39             |
| Cossor, A., Ltd.  | 160                |  |                      | United Kingdom Atomic Energy Authority, The    | 152                |
| Covey Radio   | 166                | Magnetic Coatings, Ltd.                        | 52                   | Unitelex (London), Ltd.                        | 108                |
| Cranston, Alan  | 158                | Magnetic Devices, Ltd.                         | 16, 129              | Universal Book Co.                             | 166                |
|   |                    | Mail Order Supply Co.                          | 29                   | Universal Electrical Instruments Corp., Ltd.   | 149                |
| Daly (Condensers), Ltd.                                     | 82                 | Malvyn Eng. Co.                                | 168                  | Universal Electronics                          | 143                |
| Davies, A., & Co.   | 162                | Marconi Instruments, Ltd.                      | 47                   |  |                    |
| Davis, Jack (Relays), Ltd.                                  | 114                | Marconi's Wireless Telegraph Co., Ltd.         | 95                   | Valradio, Ltd.                                 | 122                |
| Denco (Clacton), Ltd.                                       | 41                 | Martin, J. H.                                  | 168                  | Vanner Accumulators, Ltd.                      | 54                 |
| Dependable Radio Supplies                                   | 159                | Masssey, R.                                    | 168                  | Verdik Sales, Ltd.                             | 168                |
| Direct T.V. Replacements                                    | 116                | McElroy, Adams Mfg. Group, Ltd.                | 142                  | V.S. Wholesale Services, Ltd.                  | 172                |
| Dixon, L., & Co.  | 166                | McMurdo Instruments Co., Ltd.                  | 70                   | Vitavox, Ltd.                                  | 84                 |
| Donohoe's (Timers)  | 173                | Midland Instrument Co.                         | 122                  | Vortexion, Ltd.                                | 101                |
| Dubilier Condenser Co. (1925), Ltd.                         | 171                | Minnesota Mining & Manufacturing Co., Ltd.     | 66                   |  |                    |
| Duke & Co. (Condensers), Ltd.                               | 165                | Modern Book Co., Ltd.                          | 156, 173             | Watts, Cecil E.                                | 170                |
| Dulci Co., Ltd., The  | 165                | Modern Electronics, Ltd.                       | 67                   | Wayne Kerr Laboratories, Ltd., The             | 43                 |
|   |                    | Modern Sound Equipments                        | 166                  | Webber, R. A., Ltd.                            | 138                |
| Easco Electrical, Ltd.                                      | 170                | Modern Techniques                              | 120                  | Webb's Radio                                   | 119, 170           |
| Edison Swan Electric Co., Ltd.                              | 24, 97, 100        | Morley Transformers                            | 168                  | Weir Electrical Co.                            | 118                |
| Edwards, W.   | 54                 | Morris, H.                                     | 80                   | Weyl Electrical Laboratories, Ltd.             | 87                 |
| Egen Electric, Ltd.   | 169                | M.R. Supplies, Ltd.                            | 170                  | West End Radio, Ltd.                           | 160                |
| E.K.E.  | 123                | Mulard, Ltd.                                   | 3, 7, 20, 57, 74, 93 | Westinghouse Brake & Signal Co., Ltd.          | 60                 |
| Electric Audio Reproducers                                  | 173                | Multicoore Solders, Ltd.                       | 54                   | Weymouth Radio Mfg. Co., Ltd., The             | 62                 |
| Electrical Instrument Repair Service, The                   | 19                 | Murex, Ltd.                                    | 81                   | Wharfedale Wireless Works                      | 48                 |
| Electro-Acoustic Developments                               | 61                 |  |                      | Whitaker, H.                                   | 172                |
| Electro-Acoustic Industries, Ltd.                           | 142                | Northern Radio Services                        | 40, 41               | Whiteley Electrical Radio Co., Ltd.            | 59                 |
| Electro-Methods, Ltd.                                       | 107                |  |                      | Wilkinson, L.                                  | 165                |
| Electro-Winds, Ltd.   | 138                | Oddie, Bradbury & Cull, Ltd.                   | 162                  | Willesden Transformer Co., Ltd.                | 68                 |
| Electronic Precision Equipment                              | 104, 105, 106, 107 | Osmer Radio Products, Ltd.                     | 20                   | Wilson, Ronald                                 | 173                |
| Ellison Transformers, Ltd.                                  | 138                | Oxley Developments Co., Ltd.                   | 163                  | Wolf Electric Tools, Ltd.                      | 136                |
| E.M.G. Handmade Gramophones                                 | 156                |  |                      | Wolsey Television, Ltd.                        | 57                 |
| E.M.I. Factories, Ltd.                                      | 98                 |  |                      | Wright & Weaire, Ltd.                          | 5                  |
| E.M.I. Institutes   | 8, 45, 99, 116     |  |                      |  |                    |
| English Electric Valve Co., Ltd.                            | 49                 |  |                      | Young, C. H.                                   | 152                |
| Enthoven Solders, Ltd.                                      | 46                 |  |                      |  |                    |
| E.W.A.  | 136                |  |                      | Z. & I. Aero Services, Ltd.                    | 116                |
| Excel Sound Services, Ltd.                                  | 140                |  |                      |  |                    |

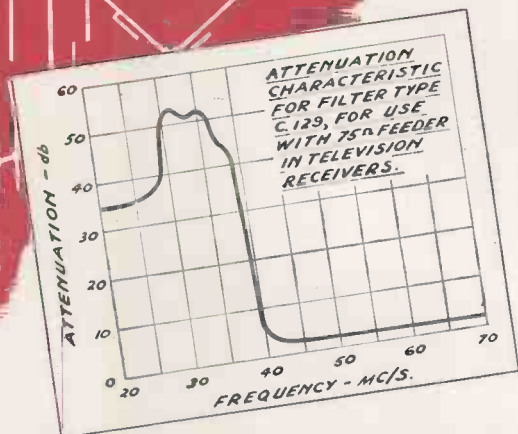
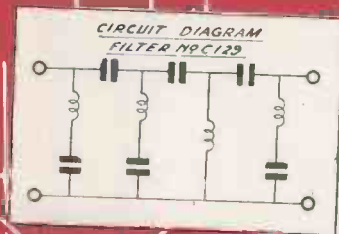
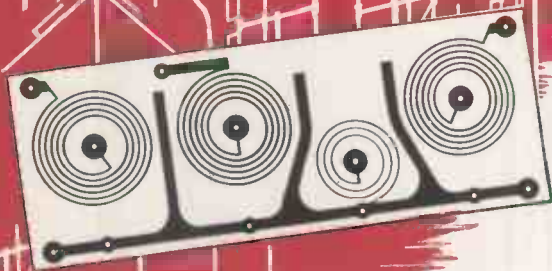
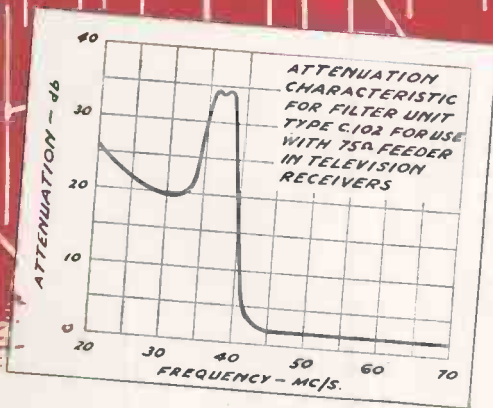
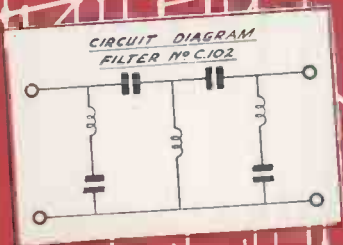
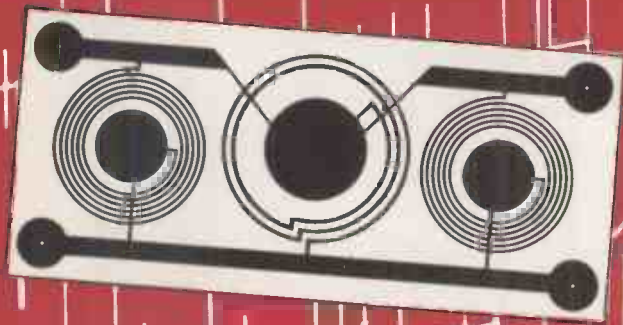

# PRINTED CIRCUITS

by



## T.V. FILTERS

With Band III transmissions commencing soon, it is becoming common practice for designers to incorporate a high-pass filter in series with the aerial feeder to the Receiver. These filters are designed to give maximum attenuation (see curves) at around 34 to 37 mc/s. This is correct for 35 mc/s I.F. amplifiers, which are becoming standard for Band I and Band III receivers. By this means, interference in the form of 'patterning' is eliminated.

**T.C.C. Engineers**—with their wide experience in the development of Printed Circuits—have now produced a range of Filters low in cost, compact in size, uniform in performance and above all, completely stable. It is one more ingenious T.C.C. application of a technique destined to play a great part in the advancement of Electronics.

*Engineers and Manufacturers interested in the various applications of Printed Circuits in the electronic industry are invited to register their names to receive our Technical Bulletins as issued. They should also apply for details of services available.*

**THE TELEGRAPH CONDENSER CO. LTD.**

SPECIAL PRODUCTS DIVISION · North Acton · London W3 · Tel: ACORN 0061



## SEE WHAT WE'RE SAYING IN THE R.E.C.M.F. EXHIBITION CATALOGUE . . .

*The World's Leading Manufacturers*  
OF TELEVISION, RADIO, TELEPHONE AND ELECTRONIC EQUIPMENT PREFER

# Ersin Multicore

—THE WORLD'S FINEST CORED SOLDER



THE 7 LB. REEL  
FOR FACTORY USE  
Prices on application

For over 16 years Ersin Multicore Solder has been the choice of manufacturers all over the world. Its 5 entirely separate cores of flux prevent breaks in the flux stream; there are no wasted lengths of solder without flux and the risk of making dry joints through insufficient flux is eliminated. Savings can often be made when using Ersin Multicore 5-core Solder as an alloy of lower tin content can often be used with complete efficiency.

#### ALLOYS AND GAUGES

Ersin Multicore Solder is supplied in all the usual Tin/Lead Alloys: 60/40, 50/50, 45/55, 40/60, 30/70, 20/80. Other alloys are supplied to special order. Standard gauges are as follows: 10, 12, 13, 14, 16, 18, 19, 20, 22, 24, 26, 28, 30, 32, and 34 s.w.g.

#### FLUXES

The A.I.D. approved type 362 flux, or even faster type 366 is incorporated in Ersin Multicore 5-core Solder. The following types of flux are also available: N flux containing Pentacol; 3E flux, the original Ersin Flux formulation which has been supplied for more than 16 years; R2 and R3 fluxes, Halide and Chloride free for modern production soldering processes calling for this type; L flux, suitable for high-speed machines and particularly lamp production; 2L flux which is the same as L type but with only 2.2% flux content.

#### SPECIAL HIGH AND LOW MELTING POINT SOLDERS

Ersin Multicore is available in the following special alloys, all containing 5-cores of Ersin Flux.

Type T.L.C. Melting Point 145° C.  
Type L.M.P. Melting Point 179° C. Avoids 'pick-up' of silver when soldering ceramics.  
P.T. Melting Point 232° C. When lead-free solder is required.  
COMSOL. Melting Point 296° C. Extra high melting point soft solder with or without cores of flux.

#### Bib WIRE STRIPPER AND CUTTER



This handy tool strips insulation without nicking the wire, cuts wires cleanly and splits plastic extruded twin flex. Adjustable to most wire thicknesses by the turn of a screw. 3/6 each (subject).

#### LIQUID AND JELLY FLUX

Ersin Flux is supplied in liquid form for dipping purposes when it is not possible to use cored solder. A high viscosity red jelly is now also available for processes where a flux with greater properties of adherence is required. Ersin Jelly Flux is M.O.S. approved for specific soldering purposes.

#### SOLID SOLDER WIRE

Multicore Precision-made Solid Wire is supplied to special order in all gauges, for the comparatively few soldering processes where cored solder is unsuitable.

#### PRINTED CIRCUITS

A complete soldering process has been developed by the Multicore Laboratories, including a protective coating which has been specially formulated for the tags of components to be solder dipped. Ask for Special Information Folder Ref. PCL101.

#### Bib RECORDING TAPE SPLICER

18/6 EACH  
(Subject)

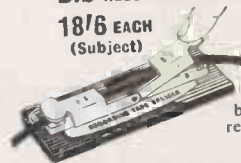

This Splicer, which incorporates many new detail refinements, enables recording tape to be jointed easily and accurately so that no breaks or "clicks" in the recording are discernible.

#### SIZE 1 CARTON 5/- (SUBJECT)

| Cat. Ref. No. | Alloy Tin/Lead | S.W.G. | App L'gth per carton |
|---------------|----------------|--------|----------------------|
| C 16014       | 60/40          | 14     | 21 feet              |
| C 16018       | 60/40          | 18     | 55 feet              |
| C 14013       | 40/60          | 13     | 19 feet              |
| C 14016       | 40/60          | 16     | 38 feet              |



We shall be pleased to see you on Stand 69 at the R.E.C.M.F. Exhibition to answer questions about the Multicore range or show you the latest additions. If you are unable to do so, but would like up-to-date information, please get in touch with our Technical Service Department, who are at your service to help in solving any soldering problems.

MULTICORE SOLDERS LTD., MULTICORE WORKS, HEMEL HEMPSTEAD, HERTS · (BOXMOOR 3636)

#### LATEST NEWS

Recent Multicore developments include the introduction of SAVBIT alloy which increases the life of soldering bits approximately 10 times.