

Wireless World

RADIO AND ELECTRONICS

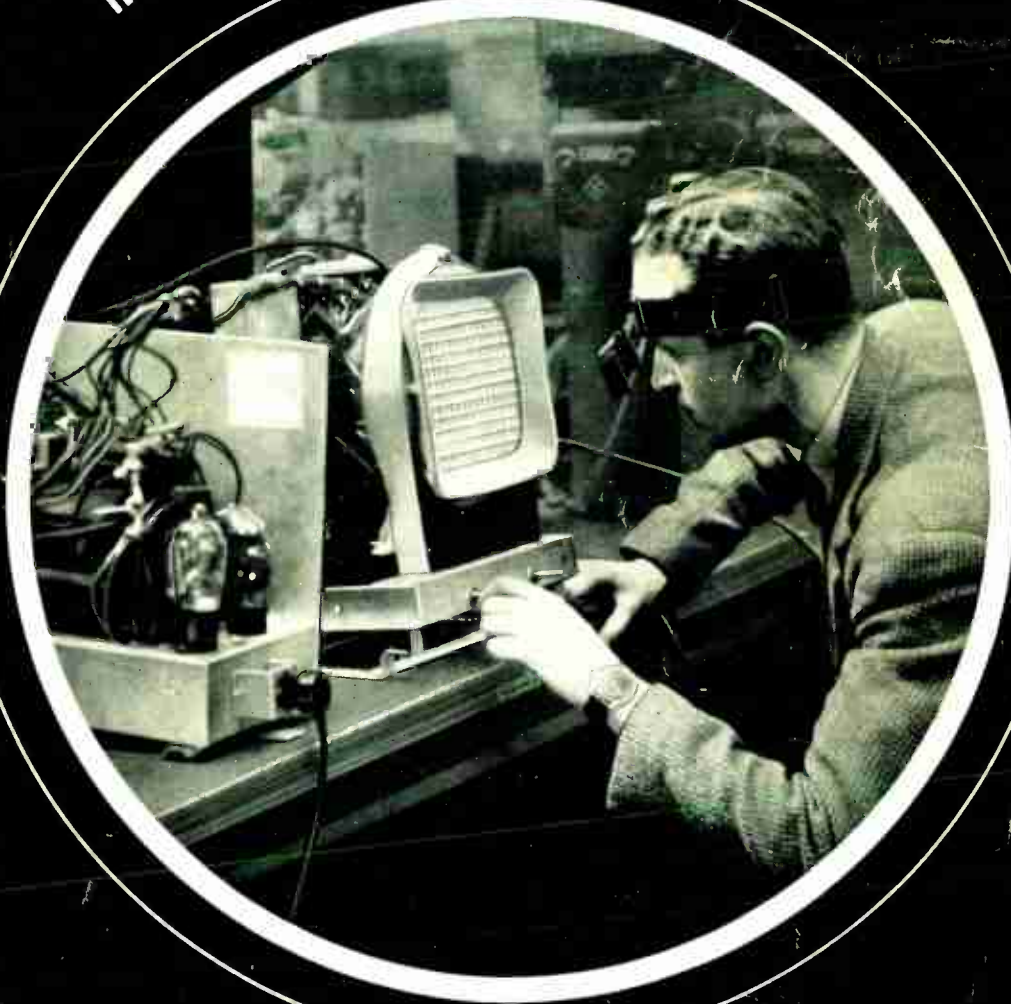

AUG. 1949

2/-

Vol. LV. No. 8

IN THIS
ISSUE :

THE "WILLIAMSON" AMPLIFIER

B I C C



All Wave
ANTI-INTERFERENCE AERIAL

THERE'S A NAME BEHIND IT!

WHAT IT DOES It has been specially designed to alleviate interference caused by radiation from electrically-operated transport, vehicle ignition systems, electrical appliances using commutator motors, lighting systems, etc. A high signal level is obtained and this ensures better listening on all broadcast wavelengths, giving maximum choice of programmes against a quiet background.

WHAT IT IS A 60-ft. polythene-protected dipole complete with insulators and matching transformer, 80-ft. coaxial screened downlead with polythene plug moulded to each end, and a receiver transformer. All the necessary components for the Aerial are included in the complete kit.

Write for Publication No. 221S giving further information.

Obtainable only from recognised dealers. **£6.18.0**



All Wave —————
ANTI-INTERFERENCE AERIAL

**BRITISH INSULATED CALLENDER'S CABLES LIMITED
 NORFOLK HOUSE, NORFOLK STREET, LONDON, W.C.2**



PRICE
£35

This instrument, which is an up-to-date example of current instrument practice, has been developed to meet the growing demand for an instrument of laboratory sensitivity built in a robust and portable form, for use in conjunction with electronic and other apparatus where it is imperative that the instrument should present a negligible loading factor upon the circuit under test.

The instrument consists basically of a balanced bridge voltmeter. It incorporates many unique features and a wide set of ranges so that in operation it is as simple to use as a normal multi-range testmeter.

The instrument gives 49 ranges of readings as follows:—

- D.C. VOLTS: 2.5mV. to 10,000V.
(Input Resistance 111.1 megohms).
- D.C. CURRENT: 0.25 μ A. to 1 Amp.
(150mV. drop on all ranges).
- A.C. VOLTS: 0.1V. to 2,500 V. R.M.S. up to 1 Mc/s. With external diode probe 0.1V. to 250V.
up to 200 Mc s.
- A.C. OUTPUT POWER: 5mW. to 5 watts in 6 different load resistances from 5 to 5,000 ohms.
- DECIBELS: -10db. to +20db.
- CAPACITANCE: .0001 μ F. to 50 μ F.
- RESISTANCE: 0.2 ohms to 10 megohms.
- INSULATION: 0.1 megohm to 1,000 megohms.

The thermionic circuit gives delicate galvanometer sensitivity to a robust moving coil movement. It is almost impossible to damage by overload. The instrument is quickly set up for any of the various tests to be undertaken, a single circuit selector switch automatically removing from the circuit any voltages and controls which are not required for the test in question.

Fully descriptive pamphlet
available on application.

Sole Proprietors and Manufacturers:

The AUTOMATIC COIL WINDER & ELECTRICAL EQUIPMENT CO. LTD.
WINDER HOUSE • DOUGLAS STREET • LONDON • S.W.1 Telephone: VICTORIA 3404/9

E.T.M.3

A

WEBB'S Radio Map & Globe

NEW EDITIONS

Webb's Radio Map of the World

INDISPENSABLE FOR THE RADIO "SHACK"

Shows the true directivity of any place in the world and gives amateur radio international prefixes, also indicates the time of the day for the world. Originally printed in 1936, many thousands of radio men have proved its use time and time again.

ENTIRELY NEW PRINTING with revised and up-to-date Call Signs prefixes, coded to country and time-zones, combined with improved printing in multi-colours.

This Map is drawn on an azimuthal projection and looks strange to those accustomed to Mercator's projection, but, giving directivity and Great Circle distances, it performs many functions for radio men that the original map cannot do. Printed on the margin is an index to Call Signs and full explanation of use of time-zones and "Great Circle" projection.

Printed in full colours on heavy white paper, size 40" x 30", price 4/6, plus 6d postage.

(Also on heavy linen rollers, price 11/6, plus 9d. postage).

Webb's Radio Globe

An improved and enlarged version of our famous pre-war globe brought right up to date with new continental boundaries and Amateur Radio Prefixes. The enlarged diameter (13½") greatly increases map area, and a

compass fitted in the base makes correct orientation simple. Invaluable for quick location of unfamiliar calls and a handsome adjunct to receiver or transmitter.

Price 47/6 to callers.
50/- by rail.



EDDYSTONE "640" Communications Receiver

Limited supplies available at Webb's Radio. Unparalleled value at £27 10. 0. Send for details of extended payment scheme.

WEBB'S RADIO

14, SOHO STREET, OXFORD STREET, LONDON, W.1
Telephone: GERard 2089.

Note our Shop Hours: 9 a.m. to 5.30 p.m. Sat. 9 a.m. to 1 p.m.

The Connoisseur



PICK-UP

Obtainable from all good dealers
Price 54/- plus purchase tax.
Transformer if required 13/-.
Special head for fitting to
Garrard Auto-changers.

R.C. 60, 65, 70, 42/- plus
purchase tax.

Long playing needles 20 for 2/-,
plus tax.

The Connoisseur pick-up is a super sensitive instrument, scientifically developed for the benefit of music lovers who insist on Natural reproduction.

If you are scientifically-minded you will know how good it is when we say that every pick-up is hand tested to show within + or - 2 db's of our published response curve, which is substantially flat from 50-9,000 cps.

If you have a musician's ear you will know how good it is immediately you hear it bring the first few notes from a record in their original purity.

Made by A. R. SUGDEN & Co. (Engineers) Ltd., Well Green Lane, Brighouse, Yorks

* Perfect Reproduction ?

* PROBLEMS REFERRED TO IN PREVIOUS NOTES

- Spatial Distribution of Sound
- Echoes in the Listening Room
- Limitations of Single Channel
- Limitations of the Human Ear
- Distortions and Faults caused by Apparatus
- The Radio Link
- Frequency Response
- Non-linearity
- The Signal Rectifier

THE A.V.C. RECTIFIER

In our last article we dealt with the trials of the signal rectifier. They are indeed severe if anything less than reasonable harmonic distortion is aimed at.

The rectifier used for producing A.V.C. can also produce bad distortion unless care and money are spent. Suppose that this diode is fed from the primary of the last intermediate frequency transformer, as is commonly the case. Suppose also for the moment that the action of the A.V.C. is undelayed. The effect of the diode on the tuned circuit can be represented by a damping resistance which remains sensibly constant provided that the diode conducts at every positive carrier frequency peak. But unless the AC/DC load ratio of this diode is high, the diode will cease to conduct during periods of minimum carrier in the troughs of the modulation cycle. Precisely the same criterion holds here as for the signal rectifier.

As soon as the A.V.C. diode ceases to conduct, the damping on the tuned circuit is reduced so that the amplitude of the modulated carrier increases, thus distorting the modulation envelope. If for the sake of good A.V.C. the action of the diode is delayed by an applied negative voltage, the case becomes even worse for it is easy to see that the diode will certainly cease to conduct as soon as the carrier falls below the delay voltage. For example, if the carrier input is 10V. peak and the delay voltage is also 10V. then for all percentage modulations the diode will conduct during the positive half of the modulation cycle but will be an open circuit for the negative half. For a signal of twice this value, distortion will only occur for modulation depths greater than 50%. It is simple to combine the effects of delay and AC/DC load ratio by saying that the highest percentage modulation which will not produce distortion is the product of the AC/DC load ratio and the delay/carrier level ratio.

This extremely severe limitation can be mitigated by one route and virtually overcome by another. It can be mitigated by arranging that the delay action required for good A.V.C. is obtained, not by back-biasing the A.V.C. diode itself, but by delaying the effect of its negative output on the controlled stages until the desired carrier level has been reached. This is only a mitigation since it still leaves the trouble with the delay/carrier ratio.

The complete cure is to use a signal amplifying valve from whose output the A.V.C. signal is derived. This avoids the envelope distortions which then occur in the A.V.C. chain.

In cases where the delay voltage is greater than the signal voltage, the change of signal level of the A.V.C. diode feed is greater than the change of signal level of the A.V.C. diode feed. Unf...

***murphy radio
limited***

WELWYN GARDEN CITY · HERTS

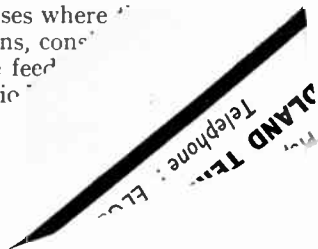

★ All three models are identical except in size.

A wonderful reception!

Since the new Stentorians were introduced a few months ago many thousands have been sold. This wonderful reception is due to their outstanding value, quality and appearance plus the unique remote control feature on Beaufort and Bristol models. Each Speaker incorporates a die-cast unit fitted with Alcomax magnet; volume control; handsomely finished in polished walnut veneer.

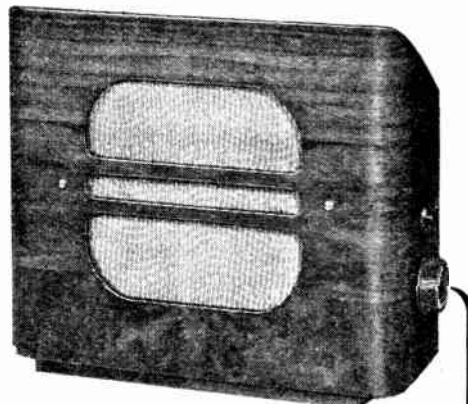

Stentorian BAFFLE SPEAKERS

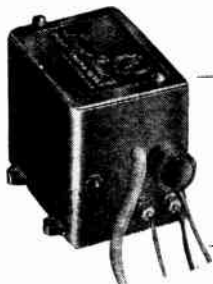

One 'Long Arm' Remote Control operates any number of Stentorian speakers (Remote control models) and enables any make of set to be switched on or off from any room in the house.

Price 35/- No Purchase Tax.

★ 'LONG ARM' REMOTE CONTROL

Beaufort £3. 7. 6. (with transformer £3.15.0).
 Bristol £2.13.6. " " £2.19.6.
 Bedford £1.19.6. " " £2. 5. 6.

Ask your dealer to demonstrate today.
 Literature on Stentorian Speakers & 'Long Arm' free on request.



WHITELEY ELECTRICAL RADIO CO., LTD · MANSFIELD · NOTTS.

VICTORIA "SPECIALS"

A very keen interest is taken by the technical staff at Victoria Instruments in the design and development of special-purpose instruments. This willingness to undertake the "teasers" does not surprise those who already buy Victoria products. Users of electronic measuring instruments should avail themselves of this service, and take a leaf from the book of some of the largest firms in the electronic industry.

PORTABLE TEST SETS

Robust moving iron instruments. Suitable for the Electrical Contractor or Automobile Electrical Engineer.

Size: 3½" x 3½" x 2½" overall
 complete with carrying strap

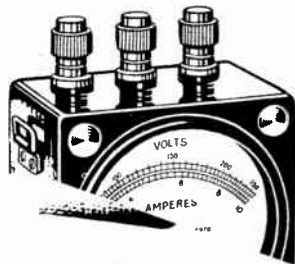

These combined instruments are made in many standard ranges. Combination examples:

- 260V A.C. or D.C.
- 15A A.C. or D.C.
- 25V A.C. or D.C.
- 25A A.C. or D.C.

Other Combinations to order

VICTORIA INSTRUMENTS

Distributors: V.I.C. (Bournemouth) Ltd.

100, WHITELEY ROAD · LONDON · N.W.10

Phone 7871/2

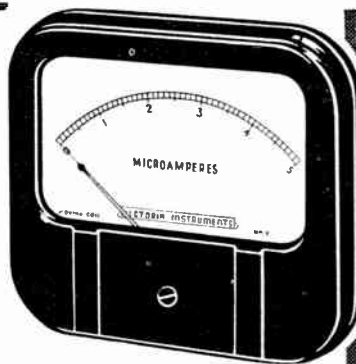

SQUARE FLANGE METERS

4" Large Open Scale. Mirror Scale can be supplied if required.

RANGES:

- A.C. from 1V-10kV
- 25uA-100 Amps.
- D.C. From 5mV-10kV
- 5uA-5000 Amps.



NOTICE

"POINT ONE" is the Trade Mark of H. J. Leak & Co., Ltd. It was originally applied to the first power amplifiers having a total distortion as low as point one of one per cent, when in June, 1945, H. J. Leak, M. Brit. I.R.E., revolutionised the performance standards for audio amplifiers by designing the original "POINT ONE" series.

**NEW
LEAK
"POINT ONE"
AMPLIFIERS**

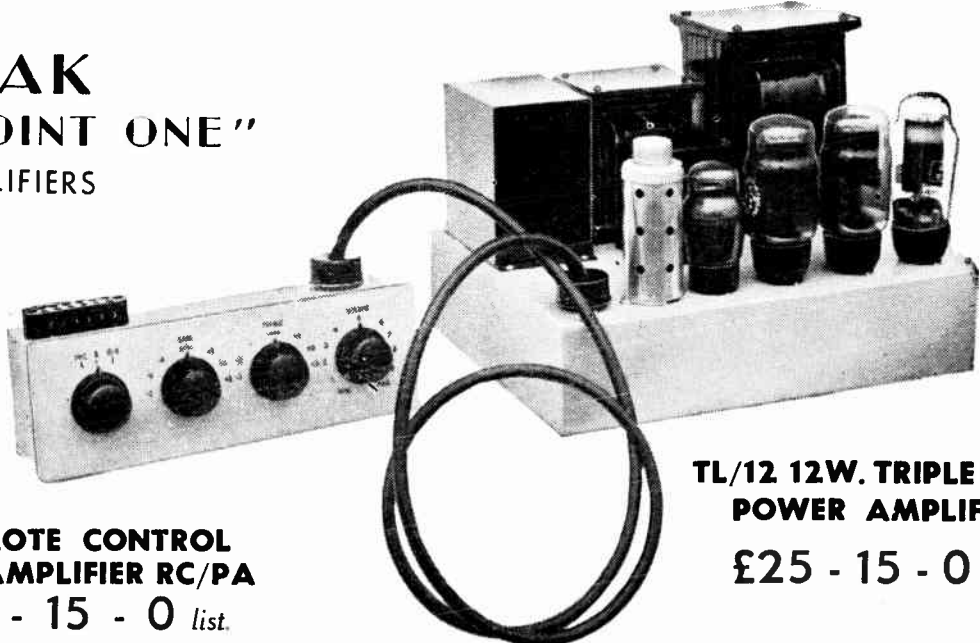

**TL/12 12W. TRIPLE LOOP
POWER AMPLIFIER**

£25 - 15 - 0 list.

**REMOTE CONTROL
PRE-AMPLIFIER RC/PA
£6 - 15 - 0 list.**

An original feedback tone-control circuit which will become a standard.

No resonant circuits employed.

- Distortion: Less than 0.05%.
 - Switching for Pick-up, Microphone and Radio, with automatic alteration of tone-control characteristics.
 - High sensitivities. Will operate from any moving-coil, moving iron or crystal P.-U.; from any moving-coil microphone; from any radio unit.
 - Controls: Input Selector; Bass Gain and Loss; Treble Gain and Loss; Volume.
- Output Impedance: 0-30,000Ω at 20 kc.p.s.

The unit will mount on motor-board through a cut-out of 10½ in. × 3½ in., or it can be bolted to the power amplifier, when, with a top cover, the whole assembly becomes portable.

For use only with LEAK amplifiers.

Used with the RC/PA pre-amplifier and the best complementary equipment the TL/12 power amplifier gives to the music-lover a quality of reproduction unsurpassed by any equipment at the moment. The amplifier can be housed in the base of a cabinet and the small pre-

DO YOU KNOW what these
PHASE MARGIN 20 ± 10°

They are of vital importance, for the "goodness" of the absence of this information, however impressive, is the only organisation advertising these figures ("Wireless World" May 1949).

If you would like to know more about a-

A Leak triple loop feedback circuit, the main loop giving 26 db. feedback over 3 stages and the output transformer.

- Push-pull triode output stage. 400 V. on anodes.
- No H.T. electrolytic smoothing or decoupling condensers.
- Impregnated transformers; tropically finished components.
- H.T. and L.T. supplies for pre-amp. and radio units.
- Distortion: at 1,000 c/s and 10 W. output, 0.1%; at 60 c/s and 10 W. output, 0.19%; at 40 c/s and 10 W. output 0.21%.
- Hum and Noise: -80 db. on 10 W.
- Frequency response: ±0.1 db., 20 c/s-20 kc/s.
- Sensitivity: 160 mV.
- Damping Factor: 20. Input impedance: 1 MΩ
- Output impedances: 2Ω; 7-9 Ω; 15-20 Ω; 28-36 Ω.

25 W. model available at £27.10.0.

The TL/12 power amplifier gives to the music-lover a quality of reproduction unsurpassed by any equipment at the moment. The amplifier can be housed in the base of a cabinet and the small pre-amplifier can be bolted to the power amplifier, when, with a top cover, the whole assembly becomes portable.

made in

3. London.

EAST YORKS.

ABOYNE

H

BRUN

Phone: SHEpher-

KOLECTRIC AUTOMATIC COIL WINDING MACHINE

Type A1/1



This machine is precision built and it embodies all the latest improvements in coil winding technique. It is suitable for winding coils up to 5" (127m/m) diameter and 7½" (190.5m/m) long. Minimum length of coil 7/32" (5.6m/m).

Among the many features to be found on the Type A1/1 machine are the following :—

- A clear Wire Gauge Indicator is fitted with a glass window and calibrated in mils, or millimetres, as desired. The machine can be quickly set to wind any required wire gauge .020" (.508m/m and .001" (.0254m/m).
- For setting purposes, micrometer adjustments are provided on the trip rod. These enable the machine to be set to the required width of coil to fine limits. The wire feed carriage automatically reverses its direction of travel when the trip rod operates.
- The railstock is fully adjustable along its bed and the centre is spring loaded to enable rapid change of the coil former

Please write to us for illustrated leaflets A1/1, A1/2 and RT/1, which contain a full technical specification on the machine and reel stand.

GR **KOLECTRIC**

Wireless World August, 1949
INDUSTRY IS CATCHING UP WITH SCIENCE



Mullard STROBOSCOPE

Type GM.5500

An industrial and laboratory unit for the visual examination of mechanical parts, liquids or gases under working conditions.



Special Features

Maximum light flux 20 million lumens • Flash duration 3 to 10 microseconds • Light intensity variable over seven switched positions • Flash frequency adjustable between 0.5 to 250 per second • Built-in frequency meter gives direct reading of flash frequency over whole range • Connectors and a switched system for external synchronisation • Removable lamp unit • Built-in mains filter • Simple to operate Completely mobile.

Write for full information to:—



Mullard
Electronic Products Ltd.,

ELECTRONIC EQUIPMENT DIVISION
WORKS • ABOYNE ROAD • S.W.17.

Now available, the new
Ferranti
 Television tube

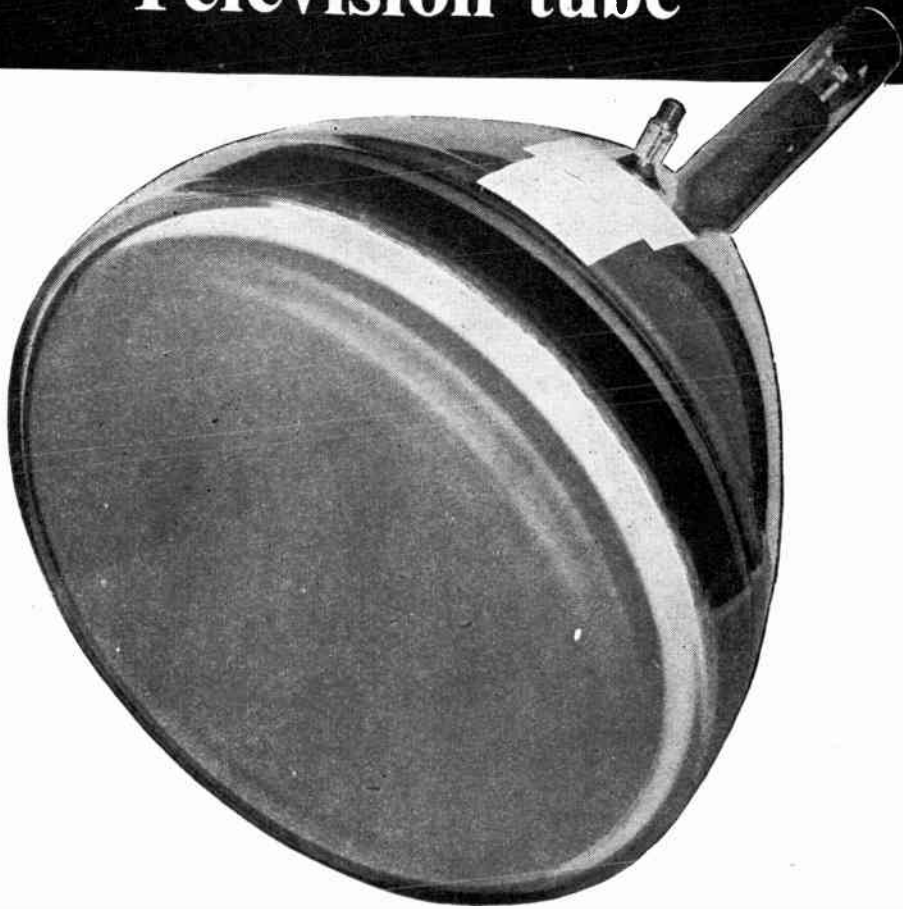

Our new T 12/46 12" Television Tube (above) upholds the Ferranti tradition of reliability in radio engineering. The screen is specially flat, and gives a bright, pleasantly coloured image.

Improved design ensures long life and complete elimination of ion spots, while the electron gun assembly produces a finely-focused spot for clear



Ferranti

FERRANTI LTD. MOSCOW

STREET,
 LONDON WC2



INTRODUCING THE R22/12, 20-WATT, 12" P.M. LOUDSPEAKER

**MORE POWER—STILL
GREATER EFFICIENCY—**
the ultimate development of the famous T2
Available with two types of Cones:—
CONE TYPE "1205"
Fundamental Resonance 75 c.p.s.
(Designed for PUBLIC ADDRESS)
CONE TYPE "1206"
Fundamental Resonance 55 c.p.s.
(Designed for BASS REPRODUCTION)
Write for descriptive leaflet D.8.



GOODMANS
R22 **20-WATT** **12" P.M.**
Loudspeaker **17,500 GAUSS**

FULLY DUSTPROOF

GOODMANS INDUSTRIES LTD. Lancelot Rd., Wembley, Middx.
Telephone: WEMbley 1200 (8 lines). Telegrams: Goodaxiom, Wembley

let "Mighty Midget"
Boost Your Sales

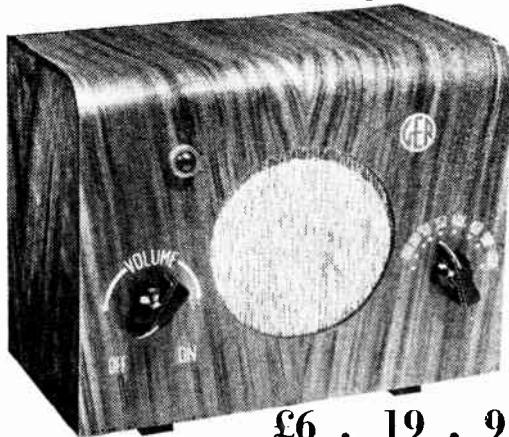

£6 . 19 . 9
INC. P.T.

- 3 valve, plus rectifier, midget radio receiver; 200-250 volts A.C. or D.C.
- Cabinet: Fully seasoned wood, finished in polished walnut
- Valves: Latest British Octal and Ballast Type
- Coils: High "Q" iron cored on "low-loss" formers
- Wave-range: 200-550 metres
- Chassis: Steel, plated for reliability & long life
- Loudspeaker: 5" dia. "Monobolt" construction, to which is fed 3 watts of Audio Power
- Guarantee: 12 months
- Apart from Mains, the only connection is an aerial supplied with the set

Volume, Tone and Sensitivity are remarkable from a Radio measuring 8½" x 7" x 4½". The advertising campaign now getting into its stride, will be increased in volume and tempo, as space becomes available

GENERAL SONIC INDUSTRIES

(Formerly General Electrical Radio)

BATH STREET, LONDON E.C.1

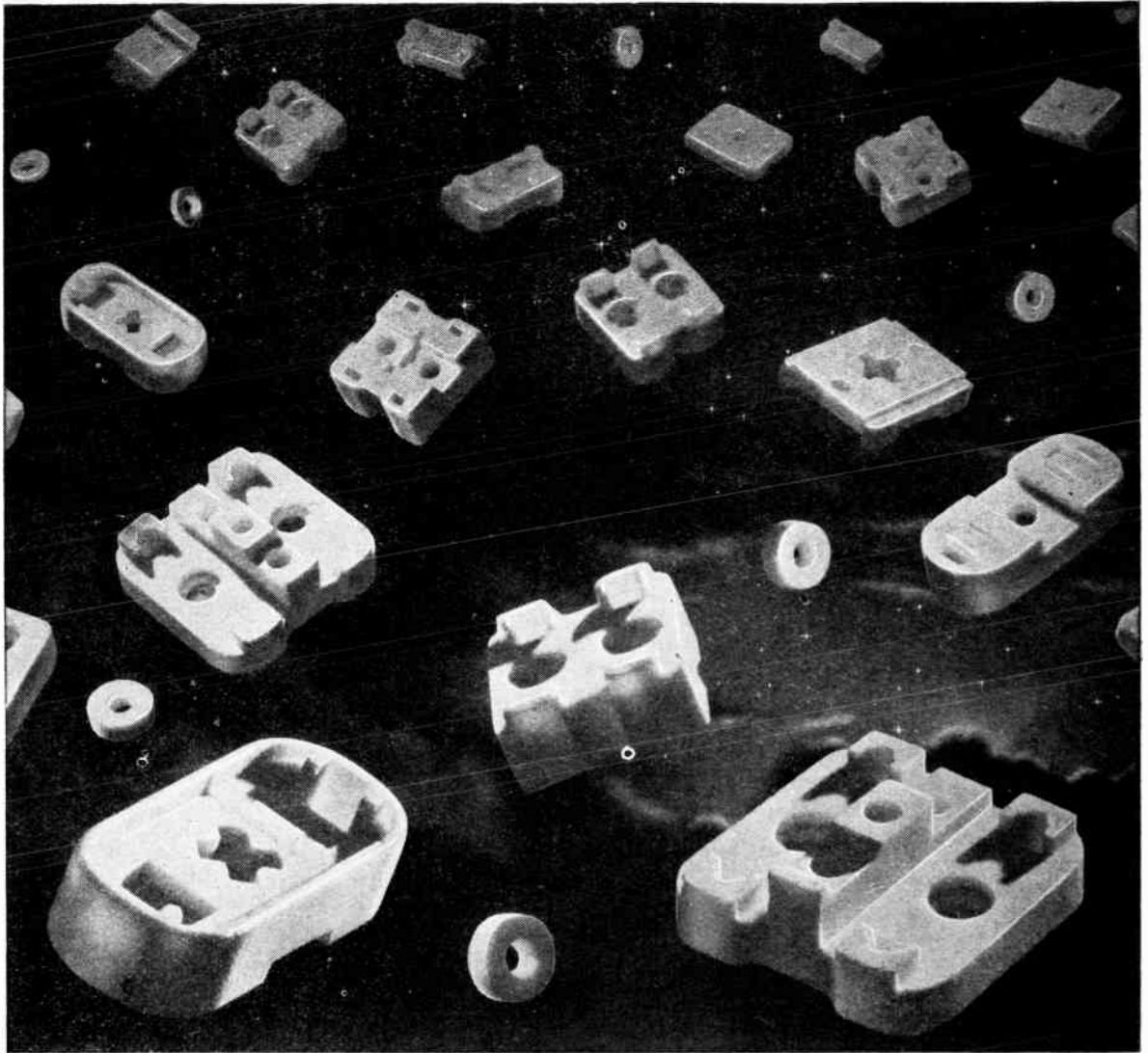

CERAMICS

FOR TRIMMER CONDENSERS
and all radio components
FREQUENTITE-FARADEx-TEMPRADEx

STEATITE & PORCELAIN PRODUCTS LTD.

Stourport on Severn, Worcester. Telephone: Stourport 111. Telegrams: Steatint, Stourport



S.P. 51



introduce the
**Leak Proof
Battery!**

**A REVOLUTIONARY DEVELOPMENT
EXCLUSIVE TO ALPHA**

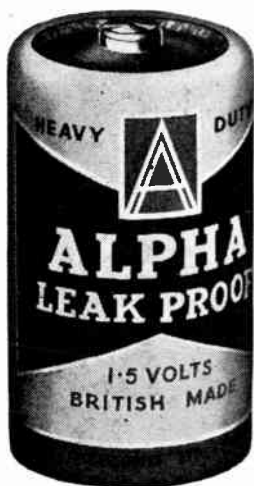

- Sealed in Steel ★
- Cannot deteriorate when idle
- Stands up to rough handling and years of storage
- Unaffected by extremes of temperature

Here is a new type of battery ; the cell is completely sealed in an insulated steel jacket. Only Alpha have this exclusive development which prevents leakage, allows storage for years without loss of power, and will not corrode in the torch-case. Next time you buy a battery insist on Alpha—and get the power you pay for. The Alpha Leak-proof Battery (1.5 volts) is made in the standard size and is available from local dealers.

★ Covered by British Patent No. 531237

Retail Price 6d.

**ALPHA ACCESSORIES LTD., SALES OFFICE, GRAMOPHONE BLDGS.,
BLYTH ROAD, HAYES, MIDDLESEX. Telephone Southall 2468.**

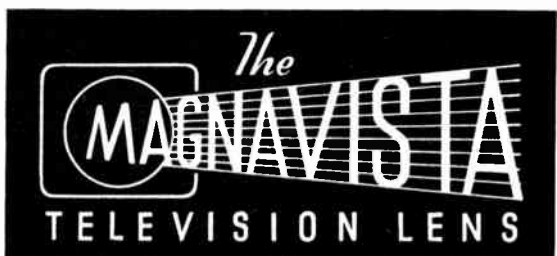

**TAKING
A WIDE
VIEW**

It is astonishing how perfectly an image enlarged by a Magnavista Lens can be seen in comfort from almost any angle. You don't have to sit dead in front of the receiver. You don't have to peer closely into the screen. That is because a Magnavista Television Lens is optically correct and constructed in accordance with specifications arrived at in consultation with eminent independent authorities on lens computation. It gives HIGH MAGNIFICATION plus absolute clarity and a wide angle of view. The Magnavista Television Lens is not just another refinement but an important contribution to the pleasure of televiewing—one which no connoisseur of television can be content to ignore.

PRICES

Type	£	s.	d.
A.7, 6in.	3	3	0
A.1, 2, 4, 5, 8 and 9, 9in.	4	14	6
D.1, C.1, 10in. and 12in.	5	5	0
D.1, 15in.	5	15	6
A.3 (Universal), 9in.	6	16	6
B.2 (Universal), 10in.	7	7	0

*MAGNAVISTA Magnification
is Television Perfection*

METRO PEX LTD

38, Gt. Portland St., London, W.1
(Phone : Museum 9024-5)

'CINTEL'

METAL DETECTION EQUIPMENT

provides an additional safeguard for the quality of the product and eliminates the risk of fire and damage to machinery by tramp metal.

Typical installations of the 'CINTEL' INDUSTRIAL ELECTRONIC METAL DETECTOR



Chocolate Coated Biscuits

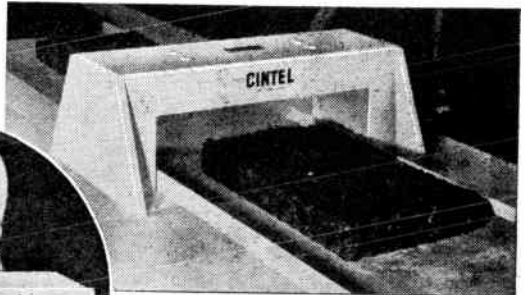

Dried Fruits

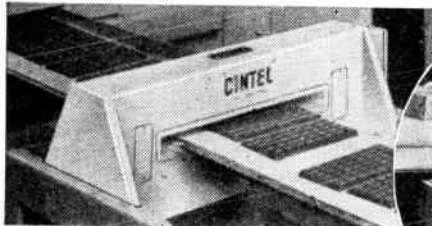

Chocolate Bars

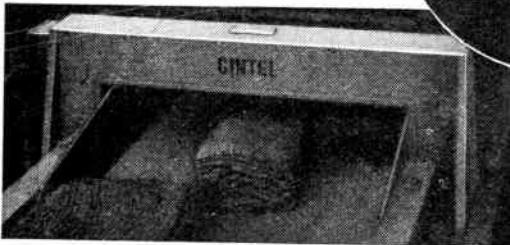

Raw Rubber



Toilet Requisites

Packaged Confectionery

Applications in other industries including Plastics, Tobacco, Textiles, Insulating materials, Limestone, Sugar cane crushing, etc.



Registered Trade Mark

The 'Cintel' Industrial Electronic Metal Detector has been specially designed to provide permanent inspection facilities with the minimum of attention. Fully automatic in operation, the equipment removes the risk of error that may be present with visual inspection and detects both ferrous and non-ferrous metal inclusions.

CINEMA TELEVISION

WORSLEY BRIDGE ROAD

Telephone: H17

RAY



Installations

Large and small Multi-Unit Rack Assemblies for all types of installations.

The illustration shows a typical 2 channel Radio System with automatic microphone switching.

 **ACOUSTICAL**
MANUFACTURING COMPANY LIMITED

HUNTINGDON • Telephone: HUNTINGDON 361

MYCALEX

(REGD. TRADE MARK)

THE INSULATOR

May solve your Insulation Problems
with the following

UNIQUE COMBINATION OF PROPERTIES

- HIGH DIELECTRIC STRENGTH
- LOW-LOSS FACTOR
- HEAT RESISTING
- MANUFACTURED TO CLOSE TOLERANCES
- NON-TRACKING
- RESISTANT TO FUNGUS GROWTH
- WILL NOT SHRINK OR WARP
- LOW EXPANSION CO-EFFICIENT

MACHINED TO CUSTOMER'S REQUIREMENTS OR AVAILABLE
IN SHEETS, RODS AND MOULDINGS

Also makers of INGRAM MYCALEX Capacitors utilising MYCALEX
as a dielectric with plates moulded in, to form a sealed unit

Phone: CIRENCESTER 400 or send enquiries to

ASHCROFT LTD • ASHCROFT ROAD • CIRENCESTER GLOS

PREMIER RADIO COMPANY

MORRIS & CO. (RADIO) LTD

207, EDGWARE RD., W.2 Phone: AMBassador 4033
AND AT 152-153, FLEET STREET, E.C.4 Phone: CENtral 2833

ALL POST ORDERS to 167, LOWER CLAPTON ROAD, LONDON, E.5. 'Phone: AMHerst 4723.

Terms of Business: Cash with order or C.O.D. over £1. Send 2d. Stamp for list.

EDGWARE ROAD IS OPEN UNTIL 6 p.m. ON SATURDAYS

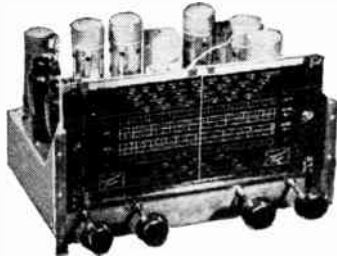

A NEW A.C. ALL-WAVE SUPERHET RECEIVER. 7 Valves (plus metal Rectifiers) for 200-250 volts; 40/60 cycle A.C. mains. 4 wavebands, 13.6-22, 51-200, 200-550 and 900-2,100 metres. Pick-up input. Uses 6K7, 6K8, 6K7, 6B8, 6J7 and 2-6V6 in push-pull, giving an output of 10 watts. Specially designed O.P. Transformer to match 6V6's to 3 and 15 ohm Speakers. Negative feedback is applied over 3 stages giving a high fidelity output. Completely wired and tested. **£15 17/8.** Our Universal model is still available at **£15** full; or **£13/8/-** in kit form. All prices include Purchase Tax.

WESTINGHOUSE J50 E.H.T. RECTIFIERS. Output 400 volts 2 mA. Any number can be used in series. Price 3/6 each; 6 for 18/-.

E.H.T. TRANSFORMERS. For 200-230 v. 50 c. input half wave. For use with valve or metal rectifier. Used in a voltage doubling circuit, these will give slightly over double the half-wave output. We can supply suitable rectifiers.

E.H.T.1. Output 800 v. 17 6
 E.H.T.2. Output 1,000 v. and 2-0-2 v. 2 a. 25 -
 E.H.T.3. Output 2,000 v. and 2-0-2 v. 2 a. 35 -

TELEVISION MAGNIFYING LENS. Suit any 5in., 6in., or 7in. tube. Increase picture size considerably. 25/-

MASKS for VCR97 tubes, 3/6 each.

C.R. TUBES. VCR97, 6in. diameter, green screen, 4 v. 1 a. Heater, 2,500 v. max. H.T. Complete with socket, in maker's original cartons, 35/-.

C.R. TUBES. E.M.1.4/1 Cathode Ray Tubes, 3 1/2 in. diameter, green screen, short persistence, 4 v. 1-3 a. Heater, 800 v. H.T. Complete with socket, 17/6 each.

MULLARD MW 18-2 Magnetic Tubes, 7in. 2 v., 5 kV. Max. H.T., 79/6.

METER KIT

A FERRANTI 500 MICROAMP M.C. METER, with separate High Stability, High Accuracy, Resistors to measure, 15, 60, 150 and 600 volts D.C. Scale length 1 1/2 in., diameter 2 1/2 in. 10/- the complete kit.

SECTIONAL WHIP AERIAL. Seven sections which plug into each other making an aerial 14ft. long. Thinnest section 1in. diam., thickest section 1in. diam. Weather proof enamel. 3/6 each complete.

INSULATED BASE for above, 2/6 each.

LOUDSPEAKERS BY FAMOUS MAKER

5in. P.M. 2-3 ohms 10 11
 6in. " 2-3 " 16/8
 8in. " 2-3 " 17/6
 10in. " 2-3 " 23/6
 12in. " 15 " 35/-
 10in. Energised, 2,000 ohm field 25/-
 8in. Energised, 2,000 ohm field with O.P. Trans. 15/-

OUR NEW ENLARGED CATALOGUE IS NOW READY
 Please send stamps for copy

GOVERNMENT SURPLUS MAINS TRANSFORMERS.

All are for use on 230 volt 50 cycle Mains.
 Type
 33 38 v. 2 a. Tapped at 32, 34, 36 v. 15 -
 42 500-0-500 v. 170 mA. 4 v. 4 a. 25 -
 44 10 v. 5 a., 10 v. 5 a., 10 v. 5 a. 35 -
 51 350-0-350 v. 60 mA 6.3 v. 1 a., 6.3 v. 3-5 a. 12/6
 53 250-0-250 v. 60 mA, 5 v. 2 a., 6.3 v. 2-3 a. 15 -
 54 275-0-275 v. 60 mA, 5 v. 2 a., 6.3 v. 2-3 a. 15 -
 55 250-0-250 v. 100 mA, 5 v. 2 a., 6.3 v. 3-5 a. 17/6



SUPER MOVING COIL MIKE AND STAND. We have purchased the entire stock of a famous Manufacturer of P.A. Equipment at a very low price, and are offering a £5 5/- Super Moving Coil Mike, with a chromium plated folding stand to match. The list price of the stand was £3 3/-.

WE OFFER THE PAIR AT 79/6. LESS THAN HALF THE USUAL PRICE.

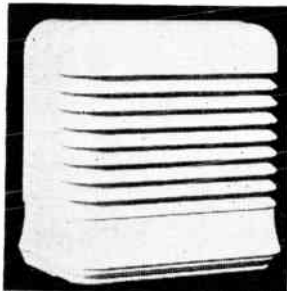

A NEW PREMIER PRODUCTION

A 3in. Moving Coil PM Loudspeaker in an attractive plastic cabinet. Fitted with Volume Control. A fine extension speaker for 30/-.

"ELECTRONIC ENGINEERING" TELEVISOR

"Allen" TV Television Components have now been approved or the "Electronic Engineering" Televisor, and delivery can be made from stock.



Focus Coil's type 210, 35/- each



Scanning Yokes, type 201, 35/- each.



Line Output Transformers, type 203, 35/- each.

Premier Mains Transformers for the "Electronic Engineering" Televisor. Exact specification, £9/6 each

We can supply all the specified components for this famous Televisor. Get our quotation.



NEW PRICES

PREMIER MIDGET RADIO RECEIVER. Due to greatly increased production we are now able to offer this receiver at a greatly reduced price. The Receiver is housed in an attractive Bakelite case, 12in. long x 5in. wide x 6in. high. The valve line-up is 6K7, 6J7, 6V6 and a Selenium Rectifier in the A.C. model; and 6K7, 6J7, 25A6 and Selenium Rectifier in the A.C./D.C. model. Both are for use on 200 to 250 volt mains. The dial is illuminated, and the receiver presents a very attractive appearance. Coverage is for the medium and long wavebands. PRICE **£6 15/-**.

Complete kit of parts with diagrams **£6/6/-** inc. Purchase Tax

PREMIER MIDGET SUPERHET RECEIVER. This powerful Midget Superhet Receiver is designed to cover the short-wave bands between 16 and 50 metres and the medium wavebands between 200 and 557 metres. Two models are produced, one for 200-250 volt A.C. mains and the other for 200-250 volts A.C. or D.C. mains. Both are supplied in the same plastic cabinet as the TRF Receiver. The A.C. valve line-up is 6K8, 6K7, 6J7, 6V6 and a selenium rectifier. The A.C./D.C. line-up is the same, with the exception of the output valve, which is a 25A6. The dial is illuminated, making a very attractive receiver. PRICE: **£8 19/6.** Complete kit of parts with diagrams, **£8/8/-** inc. Purchase Tax.

PLASTIC CABINETS, as illustrated above. In Brown, 17/6. In Ivory, 22/6.

METERS. All meters are by the best makers and are contained in bakelite cases. Prices are about one-quarter the original cost.

Range	Ext. Diam.	Fitting	Type	Price
40 v.	2 1/2 in.	Flush	M.C. D.C.	5/9
21 a.	2 1/2 in.	Flush	Thermo H.F.	5/-
20 a.	2 1/2 in.	Flush	M.C. D.C.	7/6
40 a.	2 1/2 in.	Flush	M.C. D.C.	7/6
25 a.	3 1/2 in.	Flush	M.C. D.C.	7/6
25 a.	3 1/2 in.	Proj.	M.C. D.C.	7/6
25 a.	3 1/2 in.	Flush	M.I. D.C.	2/11
500 ua.	2 1/2 in.	Flush	M.C. D.C.	7/6
5 m/a.	2 1/2 in.	Flush	M.C. D.C.	5/-
1 m/a.	3 1/2 in.	Flush	M.C. D.C.	15/11
500 ua.	3 1/2 in.	Flush	M.C. D.C.	19/6
15 v.	2 1/2 in.	Flush	M.C. D.C.	5/9
20 v.	3 1/2 in.	Flush	M.I./A.C.D.C.	7/6
150 m/a.	2 1/2 in.	Flush	M.C. D.C.	6/-
5,000 v.	4 1/2 in.	Flush	Electrostatic	50/-
1 m/a.	2 1/2 in.	Flush	M.C. D.C.	8/6
50 m/a.	2 1/2 in.	Flush	M.C. D.C.	8/6
30 m/a.	3 1/2 in.	Flush	M.C. D.C.	10/6

TELEPHONE KITS

Build yourself a 2-Station Telephone. 2 Complete Units as illustrated.

Uses Balanced Armature Units. No Batteries needed. 10/- Set of 2 Units. With diagrams.





Here are sets
to delight the expert

★ WITH 2 YEARS' FREE ALL-IN SERVICE IN THE HOME ★

Apply any test you wish to these Sobell 5-valve superhet table receivers. You will find that every component is superbly engineered. Check the circuits, the signal rectification, the I.F. selectivity, the audio sensitivity — and any other points you like. They'll all satisfy your critical judgment.

We'll say nothing about the obvious — the pleasing cabinets, the simple controls, the easy-to-read 3 wave band tuning dials, the special gramophone pick-up sockets with automatic switches, the provision for external loudspeakers — because these are "musts" in sets designed to the highest standards.

The two models illustrated are 519P and 519W respectively, working on 200-250 volts A.C. only. There's a Sobell dealer in your district — he'll be glad to arrange a thorough demonstration.

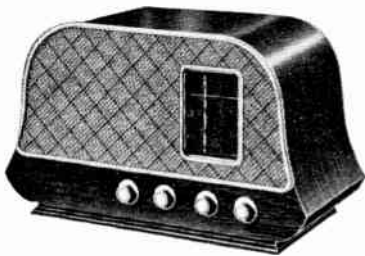

SOBELL
RADIO
AND TELEVISION

Advt. of Sobell Industries Limited, Langley Park, Nr. Slough, Bucks.

*Phone: Slough 22201/5

BAFFLETTE Trade Mark
EXTENSION SPEAKERS

- ★ Better Reproduction
- ★ Attractive Appearance
- ★ Sound Value for money



by

Richard Allan

FROM 49/6

AT GOOD SHOPS EVERYWHERE

Made and Guaranteed by

RICHARD ALLAN LIMITED
BAFFLETTE HOUSE, BATLEY YORKS

"You're CERTAIN to get it at ARTHURS!"

★ **VALVES**: We have probably the largest Stock of valves in the Country. Send your enquiries. We will reply by return.

AVO METERS IN STOCK

Avo Model 7	£19 10 0
Avo Model 7, high resistance	£19 10 0
Valve Tester	£16 10 0
Test bridge.....	£11 0 0
Avo Minor, AC/DC model.....	£8 10 0
Electronic Test Meter	£35 0 0
Signal Generator	£25 0 0

TAYLORS METERS. List on request.

DECCA PICK-UPS	£6 14 6
DECCA HEAD for Garrard	£4 11 0
Adaptors	3 8

DENCO COILS & COMPONENTS in stock.

London's Oldest Leading Radio Dealers.
All types stocked

Arthur's
EST. 1919

PROPS: ARTHUR GRAY, LTD.

Terms C.O.D. or cash with order

Our Only Address: **Gray House, 150, Charing Cross Rd., London, W.C.2** TEmple Bar 5833/4

ELECTRICAL, TELEVISION & RADIO ENGINEERS.

DUBILIER

CONDENSER CO (1925) LTD



DUBILIER Capacitors are available for every requirement in all industries where capacitors are used.

Years of concentrated and highly specialised experience, maintained by continuous research and development, the use of special purpose plant of our own design allied to production based upon a well balanced economy, are some of the reasons why our capacitors go in an ever increasing stream to the Markets of the World.

Catalogues of these outstanding examples of modern capacitor engineering are available if you will indicate the types of capacitors in which you are interested.

DUBILIER CONDENSER CO. (1925) LTD., DUCON WORKS, VICTORIA ROAD, NORTH ACTON, W.3
 *Phone: Acorn 2241 (5 lines). *Grams: Hivoltcon, Phone London. Cables: Hivoltcon, London. Marconi International Code

D30A

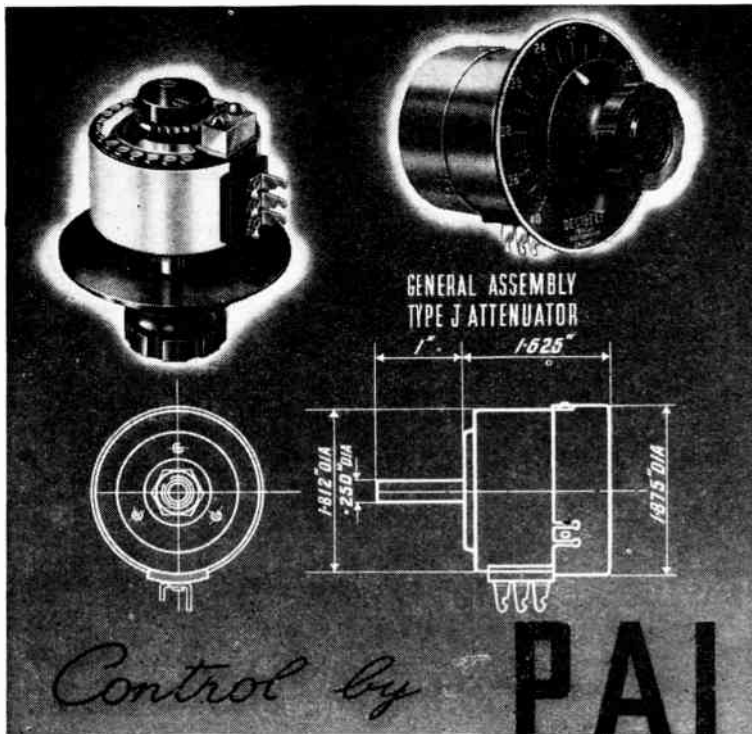

DESIGN INFORMATION

If you have a design problem involving audio Attenuators or Faders, consult Painton. Our engineers will be pleased to assist in selecting suitable units for specific requirements.

Long experience in building top class instruments for many of the foremost authorities is your assurance: you cannot do better than consult a specialist.

We invite you to send us your enquiries.

ILLUSTRATION

Ladder Attenuator, 20 steps, 40 db, 600 ohms; accuracy 0.1 db to 40 Kc/s.

Agents in Denmark:
Janko Kondensatorfabrik A.S.
Holbergsgade 15, Copenhagen.

PAINTON & CO LTD
KINGSTHORPE NORTHAMPTON

Control by

PAINTON

NEW

The following are now available:—

BOOKS:

“**Sound Reproduction**” by G. A. Briggs. 8/- post free
A leaflet detailing the full contents of this outstanding new book will be forwarded on request.

“**Frequency Modulation**” by K. R. Sturley, Ph.D., M.I.E.E. 2/9 post free
(An “**Electronic Engineering**” Technical Monograph)

A full list of all the books and leaflets available on high fidelity and allied subjects will be forwarded on receipt of a 2½d. stamp.

LOUDSPEAKER CABINETS:

The RD Junior Corner Cabinet. For use with the Wharfedale W10/CS.

A compact and attractive design giving good bass response down to 35 cps.

A full description and art photograph of this cabinet will be forwarded on request.

GRAMOPHONE FEEDER UNITS:

Two new models suitable for use in conjunction with the Williamson amplifier are now ready.

Model RD3 £10 10 0 Model RD4 £6 10 0

Full descriptions of these units will be forwarded on request.

DRAWINGS:

Complete set of drawings for the Williamson amplifier, including layout diagram, circuit diagram and component list 7/6 post free.

ROGERS DEVELOPMENTS Co.,

106. HEATH STREET, HAMPSTEAD, LONDON, N.W.3.
HAMPSTEAD 6931

from the range of  instruments

The **CONSTAC**
Constant Voltage Transformer

A versatile transformer which provides a fully stabilised 6.3v. heater supply in addition to a variety of stabilised H.T. outputs. Originally designed for use in E.I.L. instruments, the CONSTAC* is now available to manufacturers of high grade equipment.

*Made under licence by
The Banner Electric Co., Ltd.

Input: 160 to 260 v., 50 c/s.
L.T. Output: 6.3 v., 2 A.
H.T. Output: 350 v., 25 mA
or 700 v., 15 mA or 15 v.,
15 mA and 170 v., 25 mA.



TYPE A

ELECTRONIC INSTRUMENTS LTD
17 PARADISE ROAD · RICHMOND · SURREY



They speak for themselves . . .

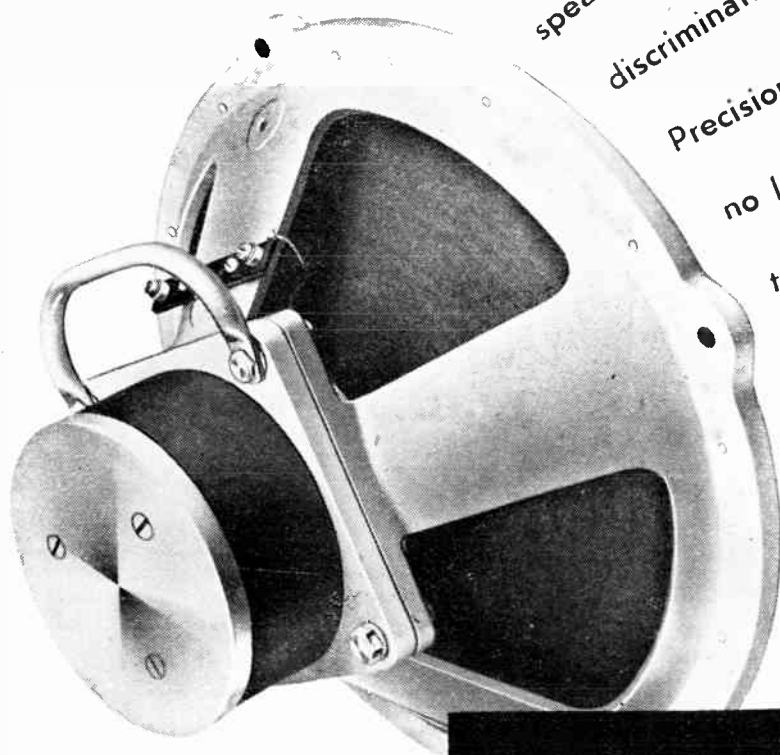

fidelity of response

speaks for itself to the discriminating ear.

Precision manufacture is no less eloquent to the

trained engineer. These

qualities make

TRUVOX speakers famous

The SS10A 12-inch Heavy Duty Speaker, illustrated, offering a frequency response from 55 to 11,000 c.p.s. and handling 10 watts is a typical example of TRUVOX workmanship.

TRUVOX

TRUVOX ENGINEERING CO. LTD · EXHIBITION GDS · WEMBLEY · ENGLAND

Furzehill at your fingertips

VIBRATION ANALYSIS
INDUSTRIAL RESEARCH
ELECTRO-MEDICAL
ELECTRONICS
NUCLEAR PHYSICS
RADIO & TELEVISION

D.C.
Oscilloscope 1684D/2

AN EXAMPLE from the Furzehill range of fine instruments is this high-grade oscilloscope for industrial, radio and television applications. Both axes have identical d.c. coupled high sensitivity amplifiers with symmetrical inputs and a level frequency characteristic from zero to 3 M/cs. Particularly valuable features are the instantaneous action of the shift controls, expansion of the time base scan from $\frac{1}{4}$ to 5 screen diameters, negligible phase shift in the amplifiers and automatic amplitude-limited synchronisation.

For full details of this, and other instruments in the Furzehill range, write for our new illustrated catalogue.

Furzehill

FURZEHILL LABORATORIES LIMITED
BOREHAM WOOD . HERTS . Tel. EL3tree 1137

WESTERN GATEWAY HEADQUARTERS
For Radio and Television Equipment

MOTORS AND GENERATORS. 24 v. D.C. input. 250 v., 50 mA, output. Choke and condenser smoothing, enclosed in metal cabinet. 4in. x 6 $\frac{1}{2}$ in. x 8 $\frac{1}{2}$ in., 7/6 each, 1/3 post. 23 v. D.C. input. 200 v. 50 mA, smoothed with choke and condensers, VS110A Voltage stabilizer. Also 13 v. at 1.8A LT. Cast aluminium chassis and cabinet. 5in. x 7in. x 10 $\frac{1}{2}$ in., 12/6 each, 1/6 carriage. 27 v. A.C./D.C. input. Shunt motor. 1/135 h.p. 5,000 r.p.m., size 2 $\frac{1}{2}$ in. x 1 $\frac{1}{2}$ in. $\frac{1}{2}$ in. driving spindle, 10/6 each, 1/- post. 24 v. A.C./D.C. input. Motor driven fan, size 4in. x 2 $\frac{1}{2}$ in., 10/6 each, 1/- post.

VALVES. CV57, 75 watt Tetrode, similar to 813, working conditions supplied with each valve, complete with base, 5/6 each. VU508/U23, Half wave 1,000 v. Rectifier, 7/6 each. VU120, Half wave 5,000 v., VU111, Half wave 5,000 v. Rectifiers, 7/6 each. 807 and 6V6 Valves, 6/6 each. VR65 and VR65A, 2/6 each.

CONDENSERS. .01, .02, .04, 5,000 Kv. working, 4/6 each.

VARIACS. Ferranti and General Radio. 0-270 v., 2Kva, £7/10/- each, mounted in cast iron case, with direct visual control.

RADIO INTERFERENCE MAINS SUPPRESSORS. Neat aluminium case, two wires in and out, 7/6 each, postage 9d.

EIMAC & JENNINGS. High voltage vacuum condensers. 100 pf., 7/6 each.

BC610 EXCITER TUNING UNITS. Brand New. TU 61, 1.5-2.0 Mc/s., 8/6 each. TU 62, 1.01-1.5 Mc/s. 6/6 each, plus 1/3 postage.

TANK COILS. BC 610 Top Band, 5-pin on ceramic strip, swinging link, made by Barker & Williamson, 7/6 each, 1/- postage.

CHANGE OVER RELAYS. 6-pole 2-way, as used in the 1154 transmitter, operates on 6/9 v., will switch complete transmitter and receiver station, including aerials, 7/6 each.

VIBRATOR UNITS. 12 v. input. Output, 120/150 v., 50/30 mA., including G.B. and L.T. For battery valves. U.S. made by Jefferson-Travers to A.M. spec., 19/6 each, plus postage.

TELEVISION LEAD-IN CABLE. 80 ohms twin co-ax. cable. Any length cut. New. 9d. per yard, postage 1/- per 10 yds.

5-PIN PLUG AND SOCKETS. Centre locating key, excellent insulation, with plated connecting pins, 2/- pair, 20/- per dozen pair.

5-WAY RUBBER INSULATED CABLE. Cotton covered for use with the above connectors, 9d. per yard.

10-PIN PLUG AND SOCKETS. With centre locating key and 6ft. of connecting cable. Plug fitted both ends. Complete with sockets. Brand new. 5/- per set.

We guarantee satisfaction with all our equipment. Write to us for all your requirements.

CABOT RADIO CO. LTD. 28 BEDMINSTER PARADE,
BRISTOL, 3

Phone: 64314. Open Saturdays 9 a.m. to 5.30 p.m.

M.R. SUPPLIES Ltd.

The diligent and enthusiastic service for supply of Electro-Technical Material of the highest quality at attractive prices. Latest list with each despatch. All prices net.

GREAT OPPORTUNITY—SYNCHRONOUS ELECTRIC CLOCKS for simple assembly.

(1) The Movement, 200/250v. 50 c. Spludles for hours, minutes and seconds hands. Centre-screwed bush mount (1 hole). Mounted in plastic dust cover, dia. 3 $\frac{1}{2}$ in., depth 2in. Silent and reliable, 35/-.

(2) Set of three chromium hands in good style, suit 5/8in. zone, 2/-.

(3) Attractively designed mounted mantle dials in translucent perspex, blue, green, yellow, pink and cream (please give second choice) with fretted figure zone and domed glass, height 4 $\frac{1}{2}$ in., to suit movement and hands, 22/6. Or the threethems, making a £6-0 clock for 57/6 (despatch 1/9). This offer is limited by the number of dials available. Any item sold separately.

M COIL SPEAKER/MICROPHONE UNITS (Goodman), 3 $\frac{1}{2}$ in., with high-flux alni magnet, 16-ohms coil, perfect as extension speaker or microphone and right for intercom., 9/6. Also 5in. Plessey M coil, 3-ohms coil, with Transformer, 12/6.

PUBLIC ADDRESS SPEAKERS, P.M. in/coll Pressure Type Units, 15-ohms coil, with multi-match line transformer in weatherproof housing, 10 watts, complete with 30in. all-metal horn, flare 20in. square (reconditioned, perfect), £5/5/0, cart. paid.

TRIPODS, for P.A. Speakers, all steel, sturdy construction, best type, extending to 12ft., and suitable for any P.A. speakers, 55/- each (despatch, England only. 5/- Ireland and Scotland 8/6).

ELECTRIC WATER PUMPS (Stuart). Delivery from stock. Operation 220 250 v. A.C./D.C., soundly constructed on non-ferrous metals with patented features for exposure and long life. No. 10, 120 g.p.h., £5/15/- (des. 2/-). No.11, 300 g.p.h., £7 (des. 2/-). No. 12, 600 g.p.h., £8/10/- (des. pass. train, 3/6). Instructions and guarantee with each. Also ex-A.M. Immersion Self-priming Pumps, approx. 18in. long and 2in. dia. A precision motor within the tube drives impeller and delivers up to 300 g.p.h. Operation 12/24 v. A.C./D.C. 20/6. Or with transformer enabling pump to be used on 200/240 v. A.C. mains, 47/6 complete (des. 2/-).

FRACATIONAL MAINS MOTORS, 200/250 v. A.C. Brand new shaded pole. Running torque 400 gram/cm. 100% starting torque, 1-200 r.p.m. Silent in operation. Shaft 1in. long by 1in. Frame 3 $\frac{1}{2}$ in. by 3 $\frac{1}{2}$ in., ventilated-enclosed, 32/6 (des. 1/-).

"NIFE" CAPLAMPS, with 2-cell "Nife" nickel-alkali long-life battery (re-chargable at 3 amps) 8in. by 3 $\frac{1}{2}$ in. by 1 $\frac{1}{2}$ in., with weatherproof lamp fitted standard 2-filament bulb, 2ft. lead and headgear. Ideal for inspection or portable lamp. Initially charged, ready for use, 25/- (des. 1/6). These are despatched in original Govt. wrappings.

MINIATURE RELAYS. Note the very small dimensions, 1 $\frac{1}{2}$ in. by 1in., type 107/274. Coil 65-ohms, switching 2 single-pole C.O., (paired contacts, platinum) 7/6 each. (These are relisted 30/- each, and are brand new).

HIGH DUTY RECTIFIER UNITS, several models available including the following: Input 400/450 v. 50 c. 3 ph., output at 122 deg. F., 36 volts 50 amps. Metal rectified, contained in steel housing approx. 19in. by 20in. by 21in. (weight approx. 2 cwt.), £21 each. Also a few for input of 200/250 v. 50 c. 1 ph., same price. These must be collected.

ROTHERMEL PIEZO-CRYSTAL HEADPHONES, Type "A" the best for sensitivity, response and comfort, £3/10/0 pair, brand new, for 32/6.

OPERATION COUNTERS (Mechanical) up to 99,999, with rocking-arm action. In housing 1 $\frac{1}{2}$ in. by 2in. by 1in., 7/6.

Please include sufficient for packing/despatch.

List TCP/649 (Pumps, Transformers, Electric Clocks).

List R/449 Sliding Resistances and Dimmers. Please send stamp.

M. R. SUPPLIES Ltd., 68, New Oxford Street, London, W.C.1

Telephone: MUSEUM 2958

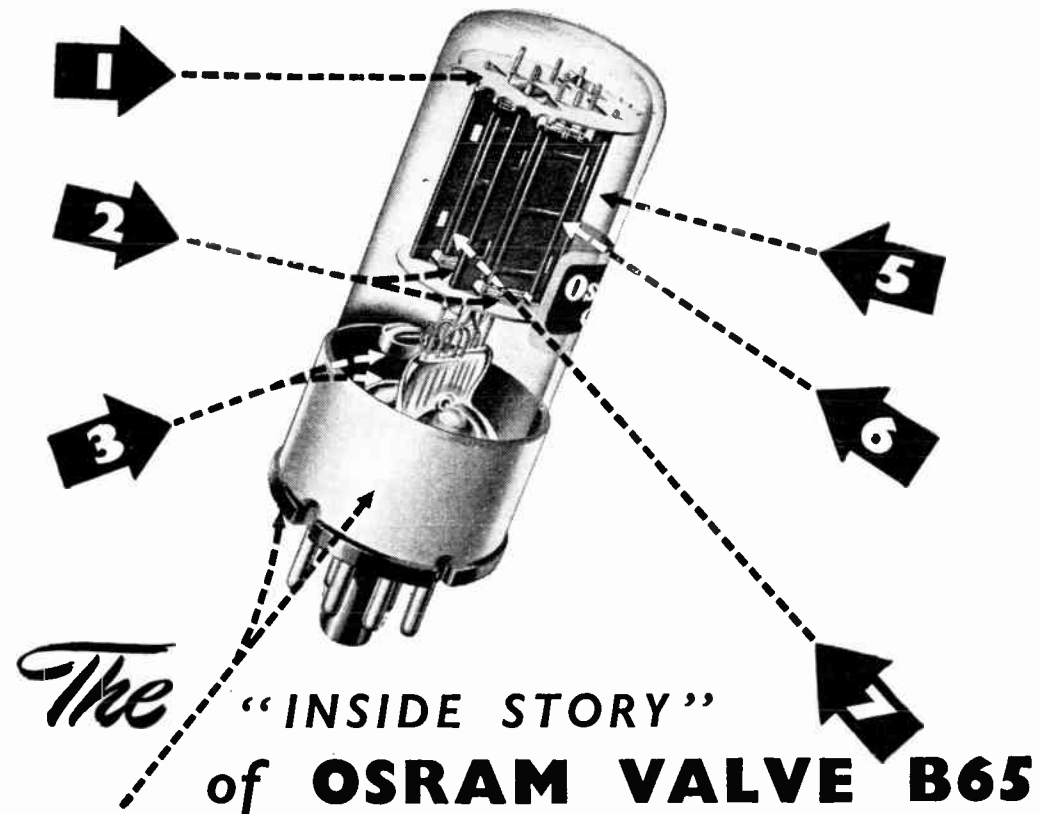

This is a double triode designed for use in push-pull, parallel or cascade circuits. The valve is octal based, compact in design, and apart from the common 6.3 volt. 0.6 amp. heater, the two sections are entirely independent.

1 MICA SPACER—anchors the various electrodes in accurately locked positions. It is sprayed with magnesia to provide high surface insulation.

2 CONTROL GRIDS—Molybdenum wire wound onto copper rod supports.

3 GETTER CUP & PATCH. The metal barium, contained in the cup is deposited in a silvery film on the inside wall of the bulb. It maintains a high vacuum condition during the life of the valve.

4 TWO PART BASE ensures reliable fixture of base to bulb.

5 ANODES are carbonised externally to enhance heat radiation.

6 ANODE RIBBING. Designed to impart additional mechanical strength to anode assembly.

7 EYELETS for easy assembly of anode plates. Reducing spot welding to a minimum.

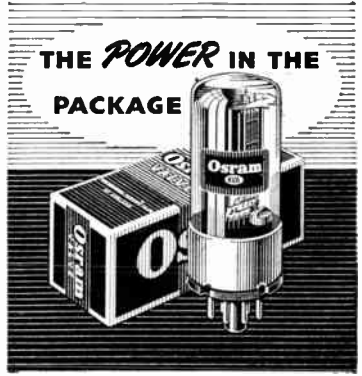

Osram
PHOTO CELLS

G.E.C.
CATHODE RAY TUBES

Osram
VALVES

THE GENERAL ELECTRIC CO., LTD., MAGNET HOUSE, KINGSWAY, W.C.2.



Spire
Regd.
SPEED NUTS

The SNU type is self-retaining, pushed into position by thumb pressure. Expensive riveting, welding or clinching operations are eliminated. If the minute gap between assembled parts is not desirable for certain applications, the SNJ type ensures a close seal.

Spire Speed Nuts cut assembly time to a minimum; they're so easy and quick to fix, even in really difficult blind assemblies and awkward locations. They will not "clog" with paint or enamel. They eliminate a retapping operation. And once home, Spire Speed Nuts lock tight as long as they're wanted (regardless of any number of bolt removals) their unique double-spring action sees to that. If you're worrying right now over a fastening problem, why not send for more news of Spire—fastest thing in fastenings.

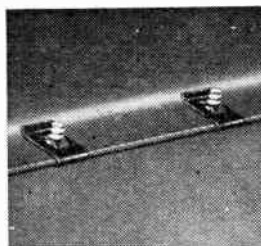

**THAT'S
FIXED
THAT**

Enquiries to:

Simmonds Aeroaccessories Ltd., Byron House, 7-8-9, St. James's Street, London, S.W.1 Head Office and Works: Treforest, Glamorgan

14

LAMINATIONS

FOR

All Radio and Electrical Uses.

In Silicon, Dynamo, Intermediate and Transformer Qualities.

Permalloy, Mumetal, Radiometal.

Screens for all Electrical Uses.

Transformer Shrouds for 35 and 74 Lams.

General Precision Engineers.

Heat Treatment.

Sheradising to the Trade.

Electrical Sound & Television Patents Ltd.

12 Pembroke Street, London, N.1. — TERminus 4355
2/4 Manor Way, Boreham Wood, Herts. — ELSTREE 2138
We shall be closed until Tuesday morning, the 2nd August 1949.



Inductance Meter

TYPE M148-2

This instrument has been designed to provide simple and direct reading measurement of inductance values between 0.05 microhenry and 100 millihenrys. A stable variable-frequency oscillator is

used to resonate the unknown inductance with a fixed standard capacitor. Provision is made for the measurement of Q at resonance frequency. Price £38.50.

Wayne Kerr

WAYNE KERR LABORATORIES LIMITED, NEW MALDEN, SURREY

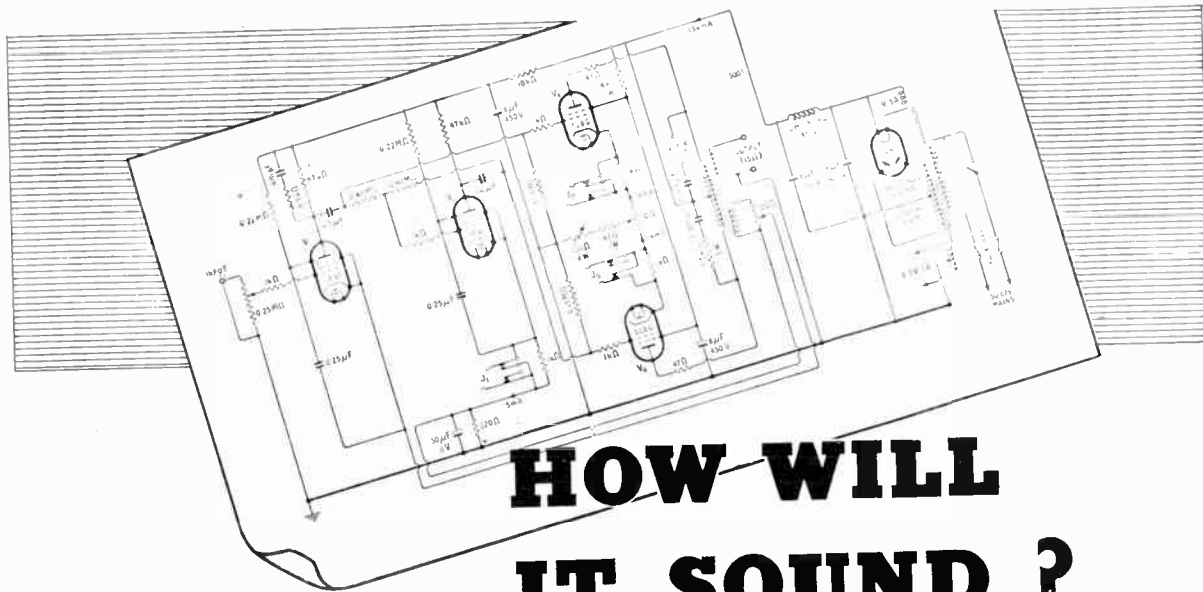

HOW WILL IT SOUND ?

It may look O.K. on the blueprint, but the only thing that really matters is—how does it sound? Time and money are often spent by enthusiasts who

neglect the essential feature of all sound equipment—a high quality, reliable speaker—best of all, a VITAVOX. Consult us on your sound problems and remember—

IT WILL SOUND BETTER THROUGH

VITAVOX LOUDSPEAKERS



Console Reproducer
Model KC. 10 £21.

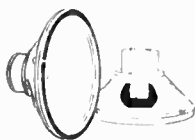

12" Cone Loudspeaker
Model K.12/10. £7.

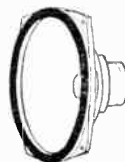

15" Cone Loudspeaker
Model K.15/40. £18.

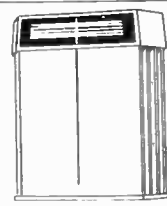

Klipschorn Reproducer
£135.

Fulllest information gladly sent on request

VITAVOX LIMITED

WESTMORELAND ROAD - LONDON - N.W.9 - ENGLAND
 Telephone: COLindale 8671/3 Telegrams: Vitavox, Hyde, London Cables: Vitavox, London

Precision with a Pedigree

FREQUENCY MEASURING EQUIPMENT

Type TME 1

Years ago, the frequency measuring equipments made by Marconi's were for their own use — because nowhere else could sufficiently accurate instruments be obtained. The present equipment therefore, Type TME 1, boasts a long and distinguished pedigree and, like its predecessors, is precision-built to an exacting specification. Anywhere in the world it can be rapidly installed and its rated stability of 1 part in 10^6 maintained indefinitely. In price too, it commends itself as the ideal laboratory standard. Please ask for further details. Type TME 1 Frequency Measuring Equipment is available for early delivery.

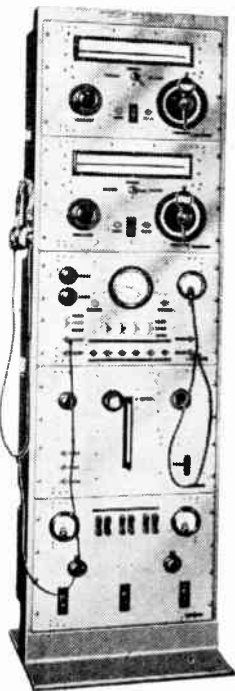

Marconi Instruments Ltd

ST. ALBANS, HERTS. Telephone: St. Albans 6161/5

Northern Office: 30 Albion Street, Hull. Western Office: 10 Portview Road, Avonmouth. Southern Office & Showrooms: 109 Eaton Square, London, S.W.1. Midland Office: 19 The Parade, Leamington Spa.

LEARN MORE



Write for
FREE BOOKLET

containing full details of POSTAL and ATTENDANCE courses covering such subjects as Television • Elementary and Advanced Radio, Theory and Practice • Radio for the Amateur Licence • Intermediate and Higher Mathematics • Electronics in Industry, Etc.

Write to Dept. 16

E.M.I. INSTITUTES

43, GROVE PARK ROAD, LONDON, W.4. Chiswick 4417/8

Associated with
"H.M.V."
MARCONIPHONE
COLUMBIA
ETC.

E.134A

• CONSTANT VOLTAGE • POWER SUPPLY UNITS

NEW SERIES 101

Our new Laboratory Power Supplies, Series 101, are based on our well-known Model 101-A, but incorporate a number of improvements and refinements.



DETAILS ON REQUEST.

ALL-POWER TRANSFORMERS LTD.

8a, GLADSTONE ROAD, WIMBLEDON, S.W.19

Tel.: LIBerty 3303.

HIGH FREQUENCY AERIAL FEEDERS

for Television, F.M., Transmission and Anti-Static Systems

Ediswan offer for quick delivery a useful range of radio frequency cables. The types available meet general requirements of set design and area signal strength. Scientific construction, controlled by rigorous tests, is responsible for the accurate characteristics and long service given by Ediswan radio frequency cables.

Nominal Characteristic Impedance, Type and Code Ref.	Attenuation db/100 ft. at 50 Mc/s.	Conductor size, inch	Construction	Dimensions Overall, inch
50 Ohm Coaxial (50/CS/60)	6.0	7/.0076	POLYTHENE DIELECTRIC, COPPER WIRE BRAID, P.V.C. SHEATH	.165
70 Ohm Coaxial (70/CS/40)	4.0	7/.0076		.230
75 Ohm Coaxial (Low attenuation) (75/CS/10)	1.0	1/.048		.300
70 Ohm Coaxial (Low Attenuation) (70/CS/12)	1.2	1/.056		.450
70 Ohm Balanced Screened Twin (70/TS/60)	6.0	7/.010		.250
75 Ohm Unscreened Twin (75/TU/45)	4.5	7/.012	POLYTHENE DIELECTRIC	.19 x .10
150 Ohm Unscreened Twin (150/TU/21)	2.1	7/.012		.17 x .09
300 Ohm Unscreened Twin (300/TU/10)	1.0	7/.012		.44 x .10
300 Ohm Unscreened Three Core (300/VK/10)	1.0	7/.012		.44 x .10

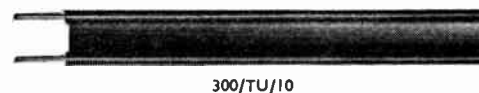
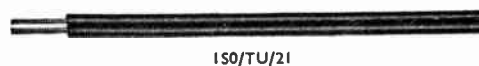
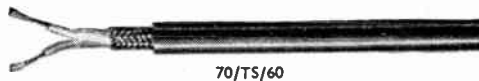
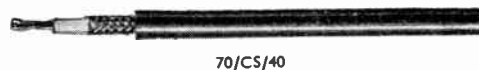

EDISWAN Radio Cables

THE EDISON SWAN ELECTRIC CO., LTD., 155 Charing Cross Road, London, W.C.2



THE COMPLETE SERVICE FOR SOUND RECORDING AND REPRODUCTION

- ★ Mobile, static and specialised recording units
- ★ Recording amplifiers, speakers, microphones, etc.
- ★ Sapphire cutting and reproducing stylii
- ★ Blank recording discs from 5in. to 17in. Single and Double-sided
- ★ Groove locating and cueing devices
- ★ A comprehensive range of accessories to meet every requirement of the sound recording engineer
- ★★ A development of special interest to users of sapphire and delicate pick-ups—THE SIMTROL. This is a controlled micro-movement easily fitted for use with any type of pick-up
- ★★★ OUR CDR49A RECORDER UNIT complete and self-contained measuring only 22in. x 14in. x 13½in., incorporating 8-valve amplifier, recorder unit, light-weight pick-up, speaker and microphone and with many exclusive features, is now ready for early delivery.

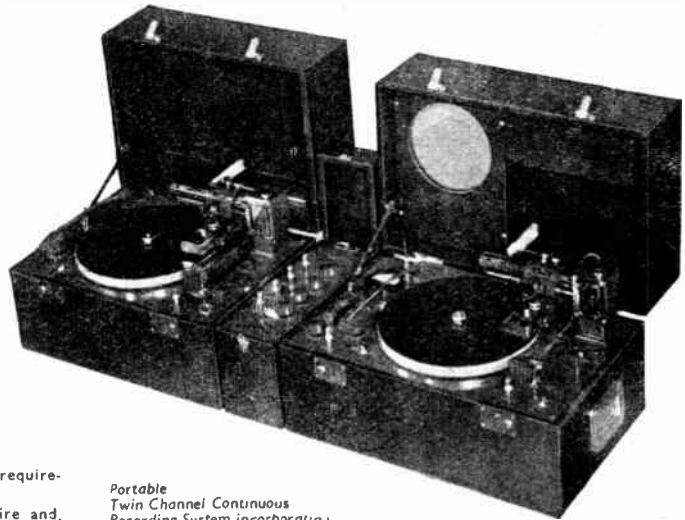

Portable Twin Channel Continuous Recording System incorporating CDR49A Recorder Amplifier DR49A Recorder and EM49A Electronic 4 Channel Mixer

OUR WELL-EQUIPPED WORKSHOPS ARE AVAILABLE FOR THE DEVELOPMENT OF EQUIPMENT TO MEET SPECIAL NEEDS.

SIMON SOUND SERVICE, Recorder House, 48/50, George St., Portman Square, London, W.1.

CABLES: Simsale, London.

TELEGRAMS: Simsale, vves Jo, London.

TELEPHONE: Welbeck 2371 (4 lines)

The RIMINGTON JEWEL

will bring new life to

GRAMOPHONE REPRODUCTION



Straight for Crystal pick-up only.



Lightweight for new miniature pick-up.



Trailer type for Heavier pick-up.

- ★ Reproduces the maximum recorded frequency range.
- ★ Wear on records is negligible, the jewel is scientifically designed to follow the groove of the record lightly and smoothly.
- ★ Preserves the higher frequencies delicately imprinted in the record, so easily destroyed, and reproduces them!
- ★ Jewel well set and angle correct.
- ★ Contained in plastic box well packed and mounted.
- ★ LIFE. It is not possible to state categorically the life of a jewel point, but in the interest of quality it is advisable to replace the jewel after 1000 playings—it is a matter of personal discretion.
- ★ The Rimington Jewel has had exhaustive tests by Messrs. W. R. Prior Ltd., microscope manufacturers, of Bishops Cleeve, who have stated that the needles are free from blemish and perfect in detail.
- ★ The Rimington Jewel needle reveals new beauties in your records which you have heretofore unsuspected.

PRICE—Most reasonable. The Rimington Jewel is the finest sapphire on the market and it retails at only 9/9.

Order your Rimington Jewel NOW and revolutionise your gramophone reproduction.

TRADE ENQUIRIES INVITED

RIMINGTONS

RIMINGTON, VAN WYCK LTD., 42-43 Cranbourn St., London, W.C.2
Gerrard 1171

RIMINGTON, VAN WYCK (Mail Order) LTD., 28a Devonshire St., Marylebone, London, W.1 Welbeck 4695

TRANSIENTS ARE TRANSIENT from BARKER'S 148a SPEAKER

One of the delights of listening to the 148a is the amazingly clean, NATURAL, transient reproduction. It is an ever recurrent joy to hear staccato passages, plucked strings, cymbals, the triangle, the whole tracery of complex orchestration rendered without blur, without false colouration, each note, each instrument characteristic, true to its origin.

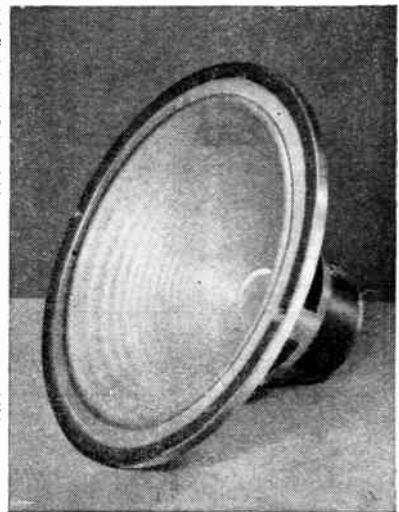

With good equipment before it and a good transmission or record the 148a is superb. And it is economical, for its extended frequency range renders one unit adequate for any domestic high quality installation;

base to shake the floor if needed and extreme top to catch the most delicate breath of violin string. A single 148a, properly mounted, will give results otherwise unobtainable at several times its cost.

Practically all specialists in really high quality gear have the 148a always in stock: Brierley, E.M.G., Goodsell, Lowther, Rogers, Vallance & Davison, Webbs Radio and many good music dealers like Largs of Dundee, Storeys of Chichester. If your own dealer hasn't one, write direct to:

BCM/AADU, LONDON, W.C.1

UNIVERSITY RADIO, LIMITED

Offer Guaranteed Used Equipment at Attractive Prices

Brierley Ribbon Pick-up, with Transformer and Pre-amplifier. As new	£12 10 0	Ward Rotary Converter. 24v. D.C., 230 A.C. 50 cycles, 300 watts. With filter unit Perfect	£8 10 0	R.S. Amplifiers with valves. AC/DC, 10-watts. M/C Mike and 'Gram inputs. Perfect condition	£8 10 0
Decca FFRR High Impedance, Lightweight Pick-up. As new	£4 5 0	B.T.H. $\frac{1}{2}$ h.p. Motors, 230/250. Single phase, 50 cycles, 1,425 revs. As new	£4 10 0	R.C.A. 50-watt Amplifiers, with 10 valves (4 6L6's parallel Push-Pull). 110-250 volts AC, 50 cycles. Output impedances; 2, 5, 7 $\frac{1}{2}$, 15, 500 ohms. As new	£10 10 0
Decca Heads (Garrard fitting), as new	£2 12 6	E.D.C. Rotary Convertors, 200-250 volts D.C., to 230 A.C. Single phase, 50 cycles, 120 watts. Cabinet and filter unit. Others in stock. As new	£13 10 0	Southern Sound Studios 16 mm. Silent-to-Sound Conversion Equipment. Including Amplifier, Valves, Soundhead, Photocell, etc. Complete. Condition as new	£18 10 0
Lexington Senior Pick-ups, with Transformer and Pre-amplifier. As new	£6 17 6	Vortexion Super 50-watt Amplifier, with valves. Latest model. As new	£17 10 0	Vortexion 15-watt Amplifier, with valves. AC 200-250 volts. 50 cycles. M/C Mike and 'Gram inputs. Output; 2 $\frac{1}{2}$, 5, 7 $\frac{1}{2}$ and 15 ohms. As new	£12 0 0
R.I. Lightweight Pick-up. As new	£3 15 0	Pam 25-watt Amplifier, with 2 Pam speakers and 'Gram Unit. As new. With M/C Mike input	£32 10 0	Grampian Amplifier Chassis, 12 volt DC and 200-250 volt AC, 25-watts. With valves—2 KT66's P.P. Output; 2 $\frac{1}{2}$, 5, 7 $\frac{1}{2}$ and 15 ohms. With M/C Mike and 'Gram inputs. As new	£11 10 0
Rothermel Senior Crystal Pick-up. As new	£1 15 0	Phillip's PCR-1, complete with valves and Power-pack. As new	£14 0 0	Collaro Portable Record-Player. Latest model. As new	£8 10 0
E.M.I. Lightweight Pick-up. As new	£2 15 0	Several Radiogram Cabinets. Brand new. Beautiful jobs	£20 0 0	Romac Record-Player, in portable steel case. As new	£9 0 0
Lexington Head (Garrard fitting). As new	£2 15 0	Avo Valve-Testers, roller panels, with charts. As new	£11 0 0	Pam Record-Player, in portable steel case. As new	£9 0 0
AR88's Model D. As new	£37 10 0	Avo Oscillators As new. All wave. 1948	£10 0 0	Columbia Latest Model Portable Record-Player, in polished wood case, with lightweight Pick-up. As new	£8 10 0
Dynatron 10-valve Console, 2 Triodes, P-P. Twin chassis. Latest model. Floor-model cabinet. Cost £97/10/- As new. Cur price	£47 10 0	Taylor Windsors. As new	£12 10 0	Decca Latest Model Portable Record-Player. As new	£8 10 0
Voigt Amplifier (pre-war) and Radio Unit in 3ft. Rack. Metered and with valves. In perfect condition and working-order	£15 0 0	Taylor Valve-Testers 45A, with charts, as new	£12 10 0	Garrard AC/DC Record-Player, in grey steel portable case. As new	£9 0 0
S-27 Hallicrafters. As new. A.C. 220-250 volt	£30 0 0	Taylor Valve-Tester and Test-Meter Combined. 47AP. As new	£17 10 0	Rothermel Crystal Mikes, model BR52. (Golf-ball). Sound Cell type. As new	£5 0 0
National H.R.O. Senior. 5 coils, 30 meg. to 430 kc's, (cont.) 200-250 A.C. with Power Pack. In perfect condition	£27 10 0	Taylor AC DC Test-Meter, 20,000 O.P.V. Model 85A. As new	£11 0 0	R.S.A. Ribbon Mike. As new	£7 10 0
BC348, with Power-Pack. 200-250 A.C. In perfect condition	£12 10 0	Taylor AC/DC Test-Meter. Model 83C. As new	£10 10 0	G.E.C. Ribbon Mike. As new	£6 10 0
Eddystone 504. As new	£32 10 0	Weston AC/DC Test-Meter. Model E772. As new	£10 0 0	R.C.A. Ribbon Mike, on table stand. As new	£6 10 0
Eddystone 640, with speaker. As new	£22 0 0	Weston Test-Meter, 20,000 O.P.V. In portable case. As new, AC/DC	£14 0 0	Meico M/C Mike. As new	£3 0 0
Avo 7's, in perfect condition and working-order	£10 10 0	Mullard Oscilloscope. Model G.M. AC mains 200-250 volts. Case soiled, but in perfect working-order	£25 0 0	Lustraphone M/C Mike. As new	£3 0 0
Avo 7's, as new	£13 0 0	Taylor Oscilloscope. As new	£18 10 0	B.S.R. M.C. Mike. As new	£3 10 0
Avo Capacity and Resistance Bridge. As new	£7 10 0	Cossor Oscilloscope, ex-W.D. Model II, AC 200-250 volts, 50 cycles, 2 $\frac{1}{2}$ in. Tube, with Circuit Diagram. As new	£12 10 0	Portable Chrome Mike Stands. As new	£1 10 0
Taylor Cap. and Res. Bridge. As new	£8 0 0	Cossor Double-Beam Oscilloscope. Model 3339. As new	£27 10 0	Evershed's Megger Ohmmeters, high and low ranges, with leather cases. As new	£3 10 0
Hunt's Capacity and Res. Bridge. Model C.R.B. As new	£11 0 0	Others in stock from £25. Price varies according to external condition only. All are internally perfect.		M.S.S. Disc Recording Unit, complete less Amplifier. As new	£37 10 0
G.E.C. Miniscope with Wobbulator Unit, leads, adaptors etc. Latest model. As new	£21 0 0	B.S.R. Amplifiers, model P.A.20, in portable steel cases. Mike and 'Gram inputs. 200-250 volts AC, 50 cycles. As new	£17 10 0	Technifon Tracking-gear and Cutting-head. As new	£13 10 0
Flux-Meters, M.I.M. Marrion U.S.A. 3 only. Brand new. Each	£15 0 0	Shaftesbury Portable Amplifier, AC/DC. With 2 speakers, M/C Mike, stand etc., 15-watts. As new	£18 10 0	Heavy-duty Recording Motor and Turntable, 200-250 volts AC. 50 cycle. As new	£9 0 0
BC221F's. Brand new	£12 0 0	R.S.A. Amplifier, AC/DC, 25 watt, complete with Ribbon Mike and stand. Output impedance 7 $\frac{1}{2}$ and 15 ohms. 2 Mike and 'Gram inputs. As new	£22 0 0	Recording Turntable. As new	£2 10 0
Complete Recording-Unit—Motor and Turntable, tracking-gear and cutting-head, on Unit-plate, less Amplifier. A.C. 200-250v. As new	£16 10 0				
Taylor Capacity and Inductance Adaptor, 313c. As new	£2 17 6				
S.T.C. Ball and Biscuit Mikes. 4021A. As new	£7 10 0				

Hundreds of other items too numerous to list at Bargain Prices. Please state requirements. No Lists, and no C.O.D., Cash or Cheque with order. All items listed are Carriage Paid. We take your used equipment in part exchange for new goods.

22 LISLE STREET, LEICESTER SQUARE, LONDON, W.C.2

Phone GERrard 4447 and 8582.

Hours 9 to 6.

Thursdays 9 to 1.

THE NEW *Aerialite* TELEVISION AERIAL

D.P.O. MODEL 50. The best Aerial on the market at the lowest price. Available in 2 types—"London" and "Midlands" and made up for three different styles of mounting as illustrated. Features: Low-Loss Insulator—Waterproof Plug Assembly—Accessibility—Easy Erection—Strength—Broad Bandwidth—Rigidity. 47/6.
(Prov. Patent 26255/48).

COAXIAL CABLES. Manufactured under strict Laboratory conditions and to Government Specification where possible. Send for list of the full range of AERIALITE R/F Cables and Feeders.

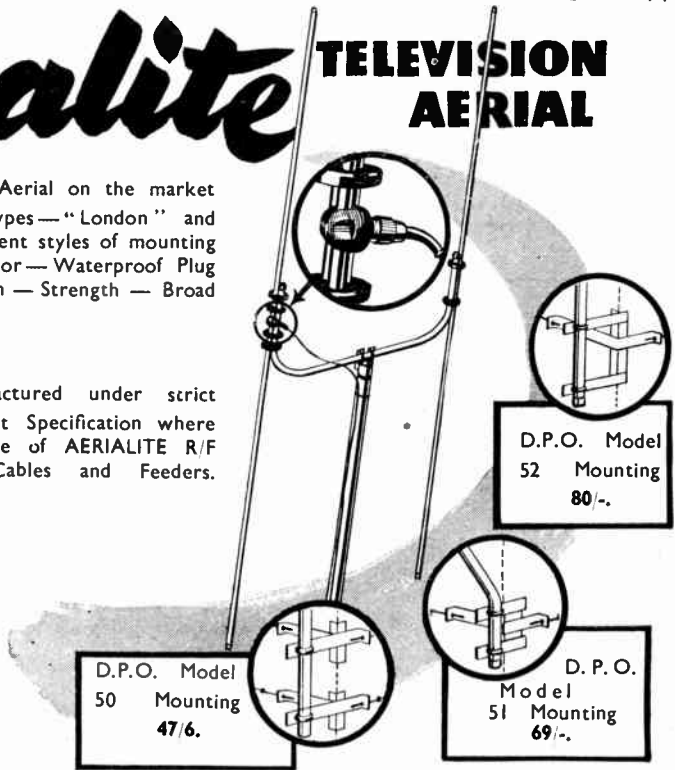
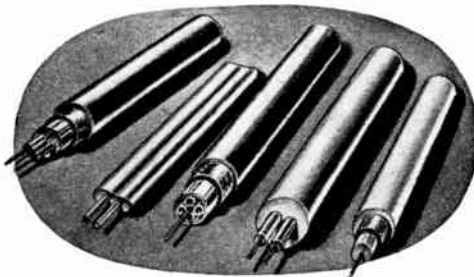

D.P.O. Model 50 Mounting 47/6.

D.P.O. Model 52 Mounting 80/-.

D.P.O. Model 51 Mounting 69/-.

AERIALITE LTD., CASTLE WORKS, STALYBRIDGE, CHESHIRE

BAKERS 'Selhurst' RADIO

PIONEERS OF MOVING COIL SPEAKERS SINCE 1925

NEW 1949 MODELS
HIGH FIDELITY SPEAKERS

The standard 12" P.A. model 12.C.

The World Famous 12" triple cone 12.B.

The Cinema Model 18" "Duplex" C.T.



Write for illustrated list of —SPEAKERS, TUNERS and AMPLIFIERS.

BAKERS 'SELHURST' RADIO
25, Dingwall Road, Croydon
Telephone: CROYdon 2271/2

SPECIAL OFFERS

They certainly are, and wonderful value too

HIGH VOLTAGE OIL FILLED CONDENSERS. 4 mfd. 2,000 v. wkg. 15/-. 4 mfd. 1,500 v. wkg., 12/6. 4 mfd. 1,000 v. wkg., 10/-. 2 mfd. 1,000 v. wkg., 5/-. 4 mfd. 600 v. wkg., 5/-. 2 mfd. 500 v. wkg., 7/6.

FIXED CONDENSERS. .002 mfd. 1,000 v., screened, 9d. .01 ditto, 9d. .1 mfd. 1,000 v., rectangular metal cased, 9d. .001 5,000 v. Test High Voltage Mica, 2/- .002 1,250 v. Test ditto, 1/-.

AERIALS. R.A.F. Dipole, 27in. (approx. 21S mc/s.) with 3ft. Co-ax. and Pye plug. Built-in matching transformer. Ideal for making into any frequency dipole or television aerial. Price 5/-.

R.A.F. FILTER UNITS. Comprising plated steel box 4in. x 3 1/2in. x 6 1/2in. with eight separate compartments (the whole assembly detachable). 12 VHF Chokes, 3 Silver Mica 7 pF. Condensers, 4-pin Plug and Socket. A most useful assembly. Price 9d., packing and postage 9d.

MICROPHONES. Brand new American single button carbon breast assembly. Ribbed aluminium diaphragm, bakelite case, complete with 3 position switch. Speech quality equal to moving coil type, 8/6. Moving Coil Microphone and Headphone Assembly. Microphone has "press to talk" switch. Genuine Alni magnets. Approx. impedance of each unit 48 ohms. Price 12/6. Hand Microphone only, 5/6. Moving Coil Assembly in bakelite case, with 3in. grille, 3/11. Special Throat Microphones, ex-R.A.F. Comprising two midgeet microphones and strap. Price 3/6 complete.

TYPE 26 U.H.F. CONVERTER. Needs no modification, covers 50-60 mc/s. Can be used with any superhet covering 7.5 mc/s (40 metres). Supply required 6.3 v. 1 amp. hrs. 250-300 v. 30 m/a H.T. 3 stages, R.F., Mixer, Osc., all tuned. All parts and chassis silver plated. Muirhead S.M. Drive. Connections external. Ideal for 5 metre band or Birmingham Television. Price 35/-, postage 1/4.

Numerous other bargains are now available. Send 3d. in stamps for No. 8 Special Offers List and Raymart new illustrated catalogue.

RADIOMART 48 HOLLOWAY HEAD
BIRMINGHAM, 1
Tel.: Midland 3254

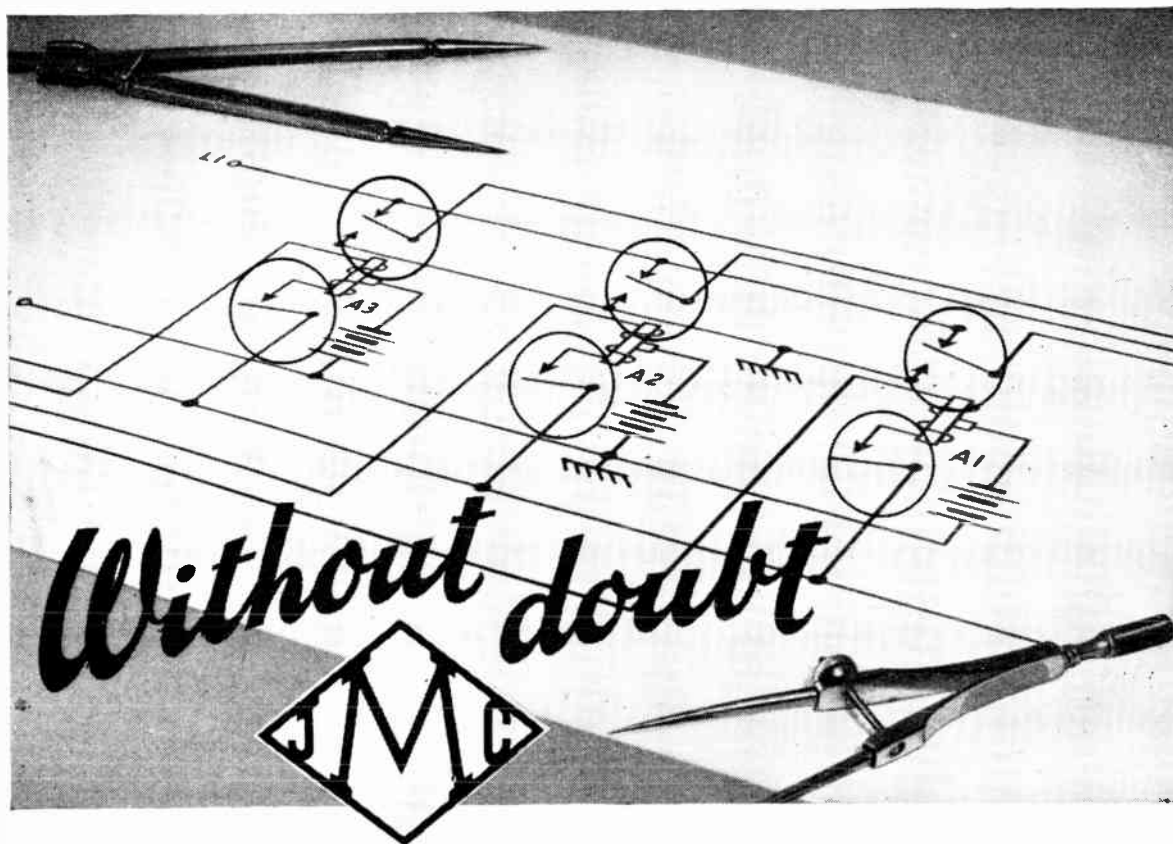

RELAY CONTACTS & SPRINGS

You will be in no doubt of the basic excellence of your design. It is the result of many hours of detailed planning and experimental work, and you will have left nothing to chance. The operation of the equipment when it leaves your hands will be faultless. But—will it continue to be so?

Shortening of useful life due to mechanical or electrical wear of contacts, fluctuations in circuit characteristics through surface tarnishing—these are ever-present possibilities when the contacts you have fitted are not suited to their work.

If you have experienced such problems, or others more subtle, remember that we maintain at your command a range of contact materials we know to be without equal and an advisory service always ready to assist you impartially in obtaining the maximum working life from your equipment.

Specialised Products of

Johnson 
MALLORY Matthey

JOHNSON, MATTHEY & CO., LIMITED, HATTON GARDEN, LONDON E.C.1.

CONTROLLING MALLORY METALLURGICAL PRODUCTS LTD.

"SOUND REPRODUCTION"

by **G. A. Briggs**

7'6

Bound Full Rexine. About 144 pages
120 Illustrations (70 original) Fine Art Paper
8/- POST FREE

7'6

CONTENTS

PART I.

Size and Shape of Cabinets. Density and Vibration. Frequency Range. Analysis of Sound. 15 inch Speakers. The Ear. Delayed Resonances. Free-field Sound Rooms. Reproduction in Schools. Inter-modulation. Dynamic Range and Tone Quality.

In view of the demand for the book "LOUDSPEAKERS" it is expected that the first Edition of 10,000 copies of "SOUND REPRODUCTION" will be quickly sold out. Order early to avoid disappointment. Many radio dealers can accept orders.

Published by:

WHARFEDALE WIRELESS WORKS

BRADFORD ROAD • IDLE • BRADFORD • YORKS

Telephone : Idle 461

Telegrams : Wharfedel, Idle, Bradford

PART II.

Recording Systems. Disc Recording. Recording Characteristics. Direct Recording. B.B.C. Recording. Needles and Grooves. Distortion and Tracking Error. Surface and Motor Noise. Pick-ups. Signal to Noise Ratio. Microgroove Recording. Electronic Sound.

"LOUDSPEAKERS"

The Why and How of Good Reproduction

by **G. A. Briggs**

88 pages
36 Illustrations

5/- per copy

(5/3 post free)

Third Edition
now ready

Read this book before
"SOUND REPRODUCTION"
to be published in July.

Economy!

DIODE FILTER CAPACITOR

100pF 100pF

SRC

Our diode filter capacitor $2 \times 100 \text{ pF} \pm 20\%$ has been designed for economy. Its cost compares favourably with that of two capacitors. It saves space and it saves time on the assembly line. Manufacturers are invited to ask for samples and prices.

STABILITY RADIO COMPONENTS LTD

14, NORMAN'S BUILDINGS
CENTRAL STREET, LONDON, E.C.1

Telephone: CLerkenwell 5977/8

CHARLES AMPLIFIERS

FOR THE
UTMOST
REALISM FROM
RECORDS AND
RADIO



The CONCERTO Amplifier

... acclaimed by music lovers for its exceptionally high fidelity, this magnificent amplifier covers all normal requirements for home or concert hall. Distortion level below 0.5 per cent. Two channels of bass boost ensure unusually smooth balance and depth. Designed for any type of pick-up. Radio input socket provided. Two year guarantee. Price £27.10.0. Heavy perforated steel cover with bottom plate and rubber feet. 37s. 6d. extra. Delivery by passenger train, Carriage Paid. 10s. deposit (returnable) for crate.

DEFERRED TERMS NOW AVAILABLE

Charles
AMPLIFIERS
LTD

1m PALACE GATE, KENSINGTON, LONDON, W.8
Telephone: WEstern 3350

Our equipment can also be seen and heard at
UNIVERSITY RECORDING CO. 16 BURLEIGH PLACE, CAMBRIDGE
Telephone: CAMBRIDGE 54947

'LIVING MUSIC'

... our fully illustrated 16pp catalogue showing complete range of amplifiers and tuning units. Write for your copy today, enclosing 5d. in stamps.

VALVES**For
SPECIAL
PURPOSES**

27 M 1 Photo-Multiplier

This High Vacuum Photo-Cell has a high response in the visible region and is capable of multiplying very small currents produced under weak illumination by more than *one million times* when operated at 100 volts per stage. Of great sensitivity, low noise level, low dark current, freedom from distortion and small size, this cell lends itself ideally for application in such fields as :—

- 1 Spectrography.
- 2 Film scanning and facsimile Transmission
- 3 Astronomical Measurements.
- 4 Alpha Particle Counting.

Equivalent to American Tube 931A.

PRICE £15 . 0 . 0

TYPICAL OPERATION.

Overall Voltage	1000 v.
Sensitivity	10A/lumen
Spectral Range	3300—6500 Å

*The sensitivity is on the basis of a lamp colour temperature of 2700°K and a light area of 4mm x 20mm.

DIMENSIONS.

Max. Overall Length (mm)	94.0
„ Bulb Diameter (mm)	28.5
„ Base Diameter (mm)	33.4
Light Centre from Seat (mm)	49.2 ± 2.4

BASE. Special 11 pin Low Leakage Sub Magnal (Holder supplied with valve).

The 27M2 is similar to the 27M1 except that it has a wider tolerance on the anode dark current necessitating a lower anode supply voltage of 900 volts and a consequent reduction in overall magnification to 250,000.

PRICE £12 . 0 . 0



EDISWAN

MAZDA

RADIO VALVES AND CATHODE RAY TUBES

THE EDISON SWAN ELECTRIC CO. LTD., 155 Charing Cross Road, London, W.C.2

FREE GIFT OFFER

Largest Stocks
best selections

CLYDESDALE

and Bargains in Ex-Service Radios and Electronic Equipment

NEW

UNUSED

Units of the 5CR-522 (TR5043) for experiments on 2 metres T.V. and Radio Telephone wavebands. **BC-624-A Receiver Unit Chassis.**

Frequency 100-156 Mc/s with 11 valves :
3/125G7's.
12C8.
12J5.
12AH7.
12H6.
3/9003's.
9002.

Complete chassis (less Xtals) with 3/12 Mc/s. I.F.T.'s Relay, etc., designed for operation on pre-determined Xtal frequencies, but easily altered for continuous tuning. Power requirements (external) H.T. 300 v. D.C. 75 mA., L.T. 24 v. D.C. 3A. Dimensions 15½ x 7½ x 6in. Circuit supplied.

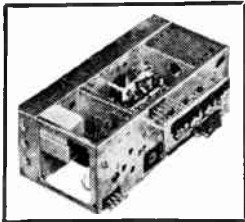
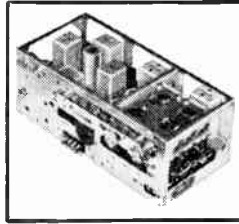

CLYDESDALE'S PRICE ONLY 37/6 CARRIAGE PAID.

Plus Free Gift of **BC-625-A Transmitter Chassis**, partly stripped, but containing many useful parts. R.F. section in good order. No valves, modulation trans. or Xtal switch. Dimensions as Recvr. Circuit supplied.

All goods advertised or in our list can be ordered from any of our branches in England, and Northern Ireland, or direct from:—

CLYDESDALE SUPPLY CO. LTD. • 2 BRIDGE STREET GLASGOW - G.5.

Send now for new Illustrated List. Please print Name and Address. Phone: SOUTH 2706, 9

For those 144 Mc's. experiments. Brand New, Rack mtg. V.H.F. R/T Receiver Units.

R1481 Frequency 65-86 Mc/s.
R1132 Frequency 100-124 Mc/s.

Each a 10-valve (plus stabilizer) superhet. Enclosed chassis 19 x 10½ x 1 1/2 in., finish (R1481 dark grey) (R1132 light grey). Circuit supplied, all units tested and guaranteed working before despatch.

CLYDESDALE'S PRICE ONLY £4.19.6 CARRIAGE PAID
either

POWER UNIT TYPE 3.

For the R1481 or 1132, input 0-200-210-220-240-250 v., complete with Voltmeter 0/300 v. H.T. Meter 0/150 mA, 5Z4 rectifier fully smoothed. Output 200 v. 40 mA, 63 v. 3a, 4 v. 1.5 a. Rack mounting chassis, size 19 x 7 x 1 1/2 in. Finish dark grey.

CLYDESDALE'S PRICE ONLY £4.10.0 CARRIAGE PAID

SPECIAL OFFER

Receiver and Power Unit.

CLYDESDALE'S PRICE ONLY £8.9.6 CARRIAGE PAID
both units

G.L.P.

PORTABLE PUBLIC ADDRESS EQUIPMENT IN TRAVEL CASES WITH SPEAKERS, ETC.

Ten New Designs in Production

Foundation casework of heavy plyboard, expertly covered serviceable leathercloth, with chromium locks, corner protectors, drop flat handles.

C/12, 12/15 watt amplifier. A.C. For Mic. and Gram. Attache case pattern. 12 x 10 x 6ins. 16 gns.

C/126, as above, dual AC/6 volt D.C. 20 gns.

CS/12, 12/15 watt A.C. with 10in. L.S. 18 gns.

CS/126, as above, dual AC/6 volt D.C. 25 gns.

CG/12, 12/15 watt amplifier, AC Mic and Gram. With var. speed playing desk. 21 gns.

Separate speakers in cases to match are available. Where speaker is combined in the equipment, that part of the case detaches for distant location. This new range provides for portability and completeness, facilities for carrying all accessories. Full details on this latest range, see List CE.

THE SOUND MAGNET

Deliveries soon commencing.

Have you considered recording on TAPE ?

The phenomenal success of our tape recorders bring orders from every corner of the world. Long programme time, twin tracks, three speeds. Two models, £35 and £47/10/-. Write for SM Data Sheets.

GENERAL LAMINATION PRODUCTS LTD.

294 BROADWAY, BEXLEYHEATH, KENT.

Why you should use ...



- 1 Maximum "Wetting" Capacity.
- 2 Accelerated Fluidity.
- 3 Moderate soldering bit temperatures.
- 4 Mechanical bonding and perfect Electrical conductivity ensured.
- 5 Minimum amount of solder used per joint.
- 6 Residue sets hard, is non-corrosive, and of high dielectric strength.
- 7 No harmful fume deposits.
- 8 Continuous, unvarying core.
- 9 Even distribution of activator in core.
- 10 Approved by Air Ministry and General Post Office.

Supplied in a wide range of Gauges and Alloys on 1 lb and 7 lb reels, works coils, or as required. Prices on application.

Sole Manufacturers:

H. J. Enthoven & Sons, Ltd.

89, UPPER THAMES STREET, LONDON, E.C.4.
Phone: MANsion House 4533. Works: Rotherhithe, Croydon, Derbyshire.

in communications...



WILCOX SERVES THE GOVERNMENTS OF THE WORLD

Wherever airplanes fly—wherever lives depend on reliable communications—you'll find WILCOX radio transmitting and receiving equipment. From the Scandinavian countries to New Zealand...from Portugal to Pakistan, the governments of the world select WILCOX because of its *proven* performance under all extremes of climate, temperature, and humidity.

As with many governments, WILCOX is being used by the United States government in the basic communication systems for the Air Force, Signal Corps, and the Civil Aeronautics Authority.

The governments of the world have spanned the globe with WILCOX communications. From the Berlin Airlift to the Orient...WILCOX equipments carry the messages that help keep freedom a vital force in the turbulent affairs of the world.

WRITE TODAY... for complete information on all types of point-to-point, air-borne, ground station, or shore-to-ship communications equipment.



WILCOX ELECTRIC COMPANY

KANSAS CITY

MISSOURI

COULPHONE RADIO PRODUCTS

MAINS TRANSFORMERS 16/6 POST PAID



COULPHONE COIL PACKS. Medium, long and short wave. Built on 16 S.W.G. Aluminium chassis. Totally enclosed. One hole fixing. Aligned ready for connection into receiver. I.F. 465 kc/s.

MODEL A. For use with 2 gang tuning condenser. 6K8G or any triode hexode frequency changer. **£1 19/6.**

MODEL AE. For use with 3 gang tuning condenser. R.F. Stage for 6K7G and 6K5G. Nine iron dust cored coils. **£3 17/6.**

COULPHONE 20-WATT HIGH FIDELITY AMPLIFIER. Built to famous Williamson circuit but with push-pull 807's for higher power output. Linear response from 20-20,000 c.p.s. Power supply for feeder unit or tone control unit brought out to octal socket. 6.3 v. 4A and 250 v. 40 mA. **£22 10/-.**

EX GOVT. SURPLUS. COULPHONE offer the best bargains. Over 200 items in our illustrated catalogue. If interested please send extra 2d. stamp—it will save you 2s.

ROTHERMEL "TORPEDO" "MUKEL" List. Price. £18/15/-. My price **£3 18/6.** Post paid.

Terms: C.W.O. or C.O.D.

Coulphone Mains Transformers are made to the highest electrical standards and are fully guaranteed. We supply them to the Ministry of Supply Atomic Research Stations, so they will no doubt meet your requirements. Special quotations for quantities and types to order.

Standard Replacement Types. Drop-through chassis type with top shroud. Impregnated and interleaved screened Primaries tapped for 200/250/250 volts.

- (a) 250-0-250 v. 60 mA. 4/6.3 v. 3 A. 5 v. 2 A. 16/6
- (b) 250-0-250 v. 60 mA. 4 v. 4 A. 4 v. 4 A. 16/6
- (c) 250-0-250 v. 80 mA. 0/4/6.3 v. 4 A. C.T. 0/4/5 v. 2 A. 19/0
- (d) 300-0-300 v. 80 mA. 0/4/6.3 v. 4 A. C.T. 0/4/5 v. 2 A. 19/0
- (e) 350-0-350 v. 80 mA. 0/4/6.3 v. 4 A. C.T. 0/4/5 v. 2 A. 19/0
- (f) 250-0-250 v. 100 mA. 0/4/6.3 v. 4 A. C.T. 0/4/5 v. 2 A. 22/0
- (g) 300-0-300 v. 100 mA. 0/4/6.3 v. 4 A. C.T. 0/4/5 v. 2 A. 22/0
- (h) 350-0-350 v. 100 mA. 0/4/6.3 v. 4 A. C.T. 0/4/5 v. 2 A. 22/0
- (i) 350-0-350 v. 150 mA. 0/4/6.3 v. 6 A. C.T. 0/4/5 v. 3 A. 30/0
- (j) 425-0-425 v. 180 mA. 6.3 v. 4 A. C.T. 6.3 v. 4 A. C.T. 5 v. 3 A. 44/6
- (k) 425-0-425 v. 180 mA. 4 v. 8 A. C.T. 4 v. 4 A. C.T. 4 v. 4 A. 44/6
- (l) 425-0-425 v. 180 mA. 6.3 v. 4 A. C.T. 4 v. 2 A. C.T. 4 v. 2 A. C.T. 5 v. 3 A. 47/0

Types (a) (b) (c) (d) (e) (f) (g) (h) (k) illustrated on left. Types (i) (j) (l) upright shrouded type.

WILLIAMSON OUTPUT TRANSFORMER

A superb job exactly to author's specification. Upright mounting **£3 12/6**

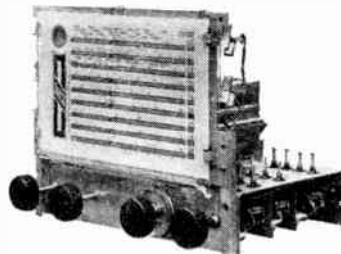

FEEDER UNITS

MODEL B DE LUXE (illustrated above). High gain R.F. stage operative on all nine wavebands. 45/145 M., 190/550 M., 900/2000 M. Plus six range of Bandspread 13.5-14.8, 16-17.4, 19-20.5, 24.2-26.30-32, 41-43.5 metres. Large colour printed glass dial, 10in. x 6in. aperture. Horizontal drive. Wave-range indicator and magic eye. Switched pick-up sockets. Volume and Tone Controls. Completely aligned ready for connection to audio amplifier. Price less valves **£18/7/6.**

Valves required. EF50, 6K4G, 6K7G, 6Q7G, 6U7. Price for set of five valves, **£3/11/5.**

MODEL A. A first class feeder unit with R.F. stage operative on all wavebands, 16/50, 190/550, 900/2000 metres. Switched pick-up sockets. Volume control. Glass dial Sin. x Sin. in colours. Completely aligned ready for connection to audio amplifier. Price less valves, **£10/8/6.**

Valves required. 6K7G, 6K9G, 6K7G, 6Q7G. Price for set of four valves, **£2 11/3.**

A.F. AMPLIFIER POWER UNIT. Specially designed for use with above units. Employs 6V6G output (4 watts) and 5Z4G rectifier.

Price less valves **£4/10/-.** Two valves if required, **£1/13/10.**

NEW GOODS ONLY

COULPHONE RADIO 53 BURSCOUGH ST. ORMSKIRK, LANCS.

"The Return of Post Mail Order Service"

Tel.: Ormskirk 987



BROWN—E.R.D. 13 inch Portable Disc Recorder
An important S. G. Brown product

Brown-E.R.D.

DISC RECORDER

Incorporating the latest advances in Sound-on-Disc Recording

Write for interesting brochures presenting full technical details of this latest development in Sound-on-Disc recording. Also 17 inch models for the Professional user.

S. G. BROWN LTD., Shakespeare St., WATFORD

Established in Electro Acoustics and high precision Engineering for over 40 years. Manufacturer of the world-famous "BROWN" Gyro Compass.

Telephone: Watford 7241

High Fidelity Reproduction.



TYPE "K."

The S. G. Brown Type "K" Moving Coil headphones, with the following outstanding characteristics, supply that High Fidelity Reproduction demanded for DX work, monitoring and laboratory purposes, etc.

CHARACTERISTICS.

D.C. RESISTANCE, 47 Ohms.

IMPEDANCE 52 Ohms at 1,000 c.p.s.

SENSITIVITY, 1.2 x 10⁻¹² Watts at 1kc. = .0002 Dyne/cm²

Descriptive Literature on request

PRICE **£5.5.0** PER PAIR

Your Local Dealer can supply

For details of other S. G. Brown Headphones (prices from 30/- to 77/6) write for illustrated Brochure "W.W."

HEADPHONES WHICH UPHOLD BRITISH PRESTIGE

Telephone: Watford 7241

S.G. Brown, Ltd.

SHAKESPEARE STREET, WATFORD, HERTS.

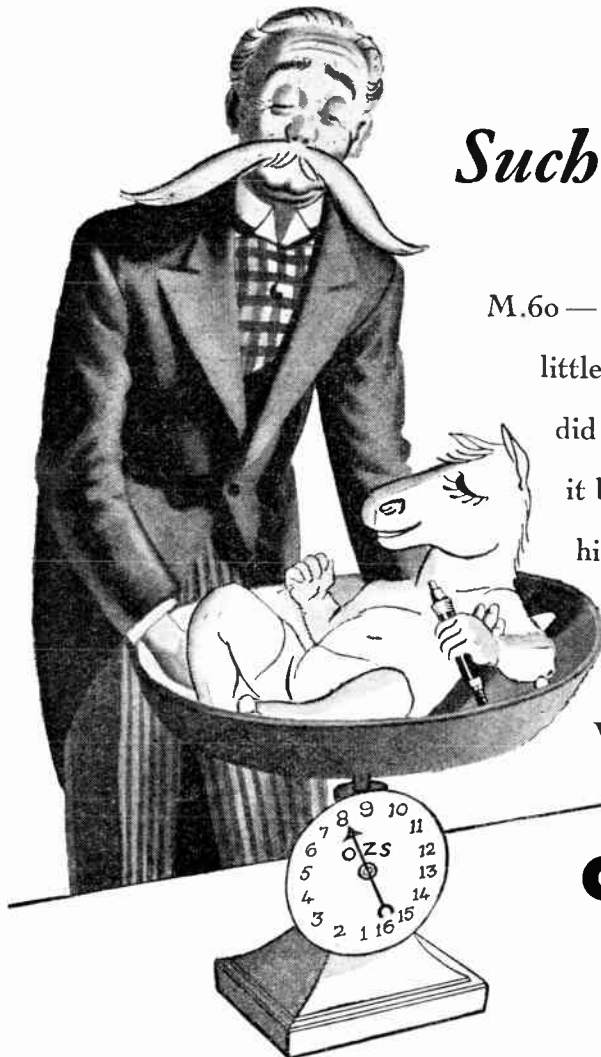

Such a lovely Baby

M.60 — we call him, the quietest, best behaved little darling of a baby screwdriver you ever did see. And quick! Well you won't believe it but he revolves at 14,000 r.p.m. Bad for him? Not a bit, dearie, the little sweet stays as cool as a cucumber. Never tires, never complains. Like to hold him? Well so you shall, dearie! Just send us a postcard to say you're interested.

Call up the little teeny-weeny horse

THE DESOUTTER MINIATURE SCREWDRIVER weighs 8 ounces. Size: $5\frac{1}{2}$ " long by $\frac{7}{8}$ " diameter. Capacity: Screws, No. 3 to 10 BA, and equivalent nuts. Operation: The air is automatically switched on when the tool is applied to the head of the screw and pressed on to the work. The tool can quickly be reversed by turning the ring switch fitted in the head of the tool. The impact clutch of new design gives perfect torque selection when used with pressure regulator on the air line.

Write for literature giving much more information.

DESOUTTER

Specialists in Lightweight Pneumatic and Electric Portable Tools.

DESOUTTER BROS. LTD., THE HYDE, HENDON, LONDON, N.W.9.

TELEPHONE: COLINDALE 6346-7-8-9.

TELEGRAMS: DESPNUCO, HYDE, LONDON.
CRC 200



NEWS FROM HUNTS!

FOR ENGINEERS who want HEAVY DUTY CAPACITORS for high voltage, high frequency and similar equipment.

HUNT-INGRAM CAPACITORS

(Mycalex Product)

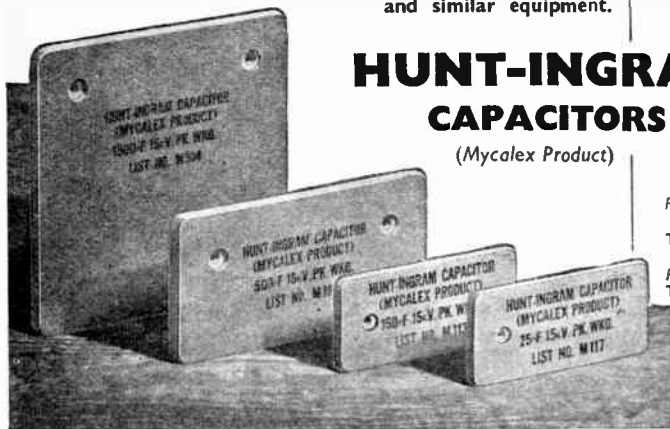

Here is a new development of importance to all users of speciality capacitors. HUNT-INGRAM CAPACITORS, previously marketed as "Ingram-Mycalex"—are now available with the pooled marketing and technical resources of the two companies behind them.

For heavy duty work and limited space, Hunt-Ingram Capacitors offer great advantages and show savings in costs where they can be applied. Available in standard units or made to order for special requirements, both mechanically and electrically, in a wide variety of shapes.

For Blocking and Bypass in High Frequency Heating and Radio Transmission; High Altitude Airborne Equipment; Delay Networks in Pulse Circuits; Voltage Dividers; Stabilising Units, etc.

TYPICAL STANDARD UNITS

Full load: 70 kVA at 500 KC to 10 MC per sec. Peak Wkg. 10kV.

Type	Cap.	Overall Dim.	Approx. Weight
Type M1A	10,000 pF	6½" x 13" x 1½"	7lb. 3 oz.
	5,000 pF	6½" x 13" x 3/8"	5lb. 14 oz.

Type	Cap.	Overall Dim.	Approx. Weight
Type M4A	150 pF	2" x 4½" x 8"	5 oz.

Full list and details on application.

A. H. HUNT LIMITED

Wandsworth, London, S.W.18. Tel.: BATtersea 3131
ESTABLISHED 1901

A NEW B.P.L. INSTRUMENT



THE VOLTASCOPE—A combined valve-voltmeter and oscilloscope. VALVE-VOLTMETER—Infinite Input Resistance for D.C. ranges 0 to 300 volts. A.C. ranges 0 to 150 volts in 5 ranges. 3½ inch scale meter. OSCILLOSCOPE—3 inch screen tube provided with balanced amplifiers for Y and X plates giving a 5 times trace expansion. Maximum sensitivity 150mV/cm. Response from D.C. to 100 kcs.

Limited quantity available for early delivery.

BRITISH PHYSICAL LABORATORIES

HOUSEBOAT WORKS, RADLETT, HERTS.

Tel: Radlett 5674-5-6

TELE-RADIO (1943) LTD.

177, EDGWARE ROAD, LONDON, W.2.

AMB. 5393. PADD. 6116. PAD.5606.

High Fidelity Williamson Amplifier	£26 10 0
Pre-amplifier Tone Control Unit, for above amplifier	£6 10 0
Rogers Development Junior Amplifier—frequency response flat within plus or minus .5 db from 20-20,000 cps. Output 8-10 watts	£19 10 0
Partridge Mains Transformer, for Williamson amplifier	£2 17 0
Partridge Chokes, for above amplifier, 25 H. 60 mA. and 13 H. 200 mA., 16/- and	£1 11 0
Partridge Williamson Output Transformer, as specified "W.W." of '47	£5 0 0
Punched Chassis, for "Williamson Amplifier"	£1 17 6
Matched Valves, in pairs, KT66, per pair ...	£1 16 6
Matched Valves, in pairs, 6L6, per pair	£1 16 6
Matched Valves, in pairs, PX4, per pair	£1 13 0
Matched Valves, in pairs, PX25, per pair ...	£2 14 4
Gram Record Changers, "Collaro"	£14 6 8
Gram Record Changers, "Garrard" Hi Fi Head	£20 10 0
Gram Record Changers, "Plessey"	£18 10 0
Paper Condenser, 4 mfd. 1,000 v. size, 5½ x 4 x 1½ in., 2/9 each or 3 for	7 0
Two Gang Tuning Condenser, 500 mmfd.	5 6
Electrolytic Condenser, 16 x 16 x 350 v., 4/9 each or five for	£1 1 0

When ordering please include sufficient for postage and packing.

Increased Production means **LOWER PRICES . . .**

THE COLLARO "DE LUXE" MICROGRAM
NOW 14 GNS. PLUS P.T.

As the happy result of increased production, the Collaro "De Luxe" Microgram is now reduced from £19.19.0 plus P.T. to £14.14.0 plus P.T.—the world's finest portable electric gramophone at even better value than ever!

Judge this wonderful offer for yourself . . . SEE and HEAR the Microgram at your Dealer's Showroom today.

MORE GOOD NEWS! . . . Watch these spaces for the next Collaro advertisement announcing the new Gramophone Units . . . and a new low-priced Record Changer!



The **COLLARO**
 "DE LUXE"
Microgram
Portable Electric Gramophone

The "De Luxe" Microgram with 6½" Speaker, Automatic Stop & Crystal Pickup. A.C. Mains.

NEW PRICE

£14 . 14 . 0

Plus Purchase Tax £6.7.5

Trade Details and Illustrated Literature from:—

COLLARO LTD., RIPPLE WORKS, BY-PASS ROAD, BARKING, ESSEX (Telephone RIPPLEWAY 3333)

LONDON CENTRAL RADIO STORES

R.A.F. 6-VALVE SUPERHET RECEIVING UNIT No. 25

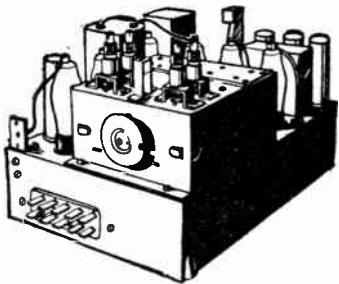

Easily adapted for short-wave reception for home use. Contains two EF36, two EF39, one EK32, one EBC33 valves, condensers, resistances, etc. Free circuit diagram, 9in. x 19in., showing all components, supplied with each set. Diagram free with set.

Price 25/- carr. paid

You will find many attractive bargains detailed in our June and July advertisements.

When in Town call and examine our vast range of Government Surplus Equipment.

23, LISLE ST. (GERrard 2969) LONDON, W.C.2

Closed Thurs. 1 p.m. Open all day Sat. and weekdays 9 a.m.—8 p.m.

LAWRENCES

NEW AMERICAN GROUND STATION MASTS. 30ft. telescopic, dia. 5in. Adjustable self supporting tripod base. Fabricated wood construction, enormous strength. 2 masts in fitted transit case 18ft. x 4ft. x 4ft. Cost manufacturer £92. Astonishing value at £12 complete.

NEW V.H.F. RECEIVERS B0824A, part of SCR522 installation. Ten valves, including 3 9C03, 1 9C02. Suitable for operation on 144 mc/s. see "S.W. Mag." Sept. 1948. Complete, excepting crystals, 45/-.

NEW AIRCRAFT CINE CAMERAS. Type G45. To take 16mm. film. Anastigmat lens f/3.5 5 cm. Operate from 12 v. D.C. supply. Complete with Film Magazine in sealed maker's cartons, 50/-. Suitable 16 mm. Panchromatic Film 2/- spool.

NEW METAL STORAGE BINS. Ideal for storage of small parts, etc. Nine sliding drawers. Overall size 10in. x 6in. x 5in., 15/-.

CAVITY MAGNETRONS TYPE RK725A. Freq.: 0345-0405 mc/s. Heater 0.3 v. 1A. Anode 12kV. Peak power output 50,000 watts. Complete with 5400 gauss Magnet Assembly, 50/-.

SPECIAL CARLTON POWER TRANSFORMERS, for BC348, BC453 etc. Primary 230 v. Secondaries: 220-0-220 v. 80mA; 26 v. 1A. 5 v. 2A. Finest quality, 30/-.

AIRCRAFT INSTRUMENTS. We have in stock an enormous variety of precision instruments, including compasses, gauges for pressure, vacuum, fluid measure, velocity, etc. Send stamp for illustrated list.

ANTENNA TUNING UNITS TYPE B0306A. Originally part of TX BC375. Variometer type. Ceramic switch. Slow motion dial. Instrument case, 11/-.

NEW R.C.A. RADIO DIRECTION FINDING EQUIPMENTS TYPE DZ1. A complete installation, comprising Receiver, Streamlined D.F. Loop with control, 24 v. Power Unit, connecting cables, etc. Freq. 15-70 kc/s. 100-1500kc/s. Suitable for Marine or Aviation employment. With comprehensive handbook. £18.

RECEIVERS TYPE R0F1. 13 valves. Tuning dial. Suitable for TV. conversion. Freq.: 136-170mc/s. I.F. 19.7-22.4mc/s. With circuits, 37/6.

NEW AMERICAN ASTRO-COMPASSES MK2. Can be used as a theodolite. Fitted with sight, spirit levels, vernier adjustment. In case, 17/6.

CARLTON MEDIUM WAVE CONVERSION COILS, for Receivers BC458, BC454, BC455. Provide excellent broadcast reception. With instructions. State type required. 10/6; BC453 Plug-on A.C. Power Packs, complete 45/-.

NEW CAMERA CONTROL UNITS TYPE 35. A precision instrument. Supplied with full instructions for conversion to a most efficient Dark Room or Enlarger Timing Unit. In makers case, 25/-.

NEW AMERICAN STAR IDENTIFICATION INSTRUMENTS. An accurate navigational instrument, complete with charts for all latitudes, in North and Southern hemispheres. In leather cases, 3/-.

A 2d. stamp brings you our latest list describing countless bargains. Terms C.W.O. All prices include carriage.

LAWRENCES, 61, BYROM ST., LIVERPOOL. 3. Central 4430.

Special Waxes FOR THE

ELECTRICAL INDUSTRIES

Manufacturers of electrical and radio materials and components are invited to investigate

OKERIN

WAXES AND DI-JELLS

for insulating, waterproofing, impregnating, sealing and finishing condensers, cables, transformers, batteries, resistances, etc.

For technical data and samples please telephone TEMPLE BAR 5927

Sales Department

ASTOR BOISSELIER & LAWRENCE LTD

NORFOLK HOUSE · NORFOLK STREET · STRAND · W.C.2

Works and Laboratories: West Drayton Middlesex

CO-AX AIR-SPACED ARTICULATED R.F. CABLES



BASICALLY BETTER.

IMMEDIATE DELIVERIES FOR HOME & EXPORT

LOW ATTEN. TYPES	IMPED. OHMS	ATTEN. dB/100ft at 100 Mc/s	LOADING KVA	O.D.
A.1	74	1.7	0.11	0.36
A.2	74	1.3	0.24	0.44
A.34	73	0.6	1.5	0.85

HIGH POWER FLEXIBLE

FOR RADIO FREQUENCIES

LOW CAPAC. TYPES	CAPAC. pF/ft	IMPED. OHMS	ATTEN. dB/100ft at 100 Mc/s	O.D.
C.1	7.5	150	2.5	0.36
P.C.1	10.2	132	3.1	0.36
C.11	6.3	173	3.2	0.36
C.2	6.3	171	2.15	0.44
C.22	5.5	184	2.8	0.44
C.3	5.4	197	1.9	0.64
C.33	4.8	220	2.4	0.64
C.44	4.1	252	2.1	1.03

PHOTOCELL CABLE

FOR VIDEO AND SPECIAL APPLICATIONS

VERY LOW CAPACITANCE CABLES

Write for data sheets to the originators of air-spaced R.F. Cables.

TRANSRADIO LTD. 138A CROMWELL ROAD LONDON, S.W.7. CONTRACTORS TO H.M. GOVERNMENT.

The **Soundmirror** "Magic Ribbon"
offers all these Advantages

Using reels of magnetised paper—or "Magic Ribbon"—the "Soundmirror" will record and reproduce with perfect fidelity THE SPOKEN WORD; MUSIC, from a violin concerto to a full orchestra; SOUND EFFECTS of all kinds. It gives life-like tonal quality (without scratch or extraneous noises) of any desired volume equal to the best radio receivers.

Perfectly designed for simplicity of operation—you can't go wrong—one single finger tip control provides for play—record—rewind or fast forward requirements. The "Soundmirror" Recorder is a complete electronic unit—contains speaker, amplifier, microphone and is equipped with jacks for easy hook-up to radio, public address and other electronic audio systems.

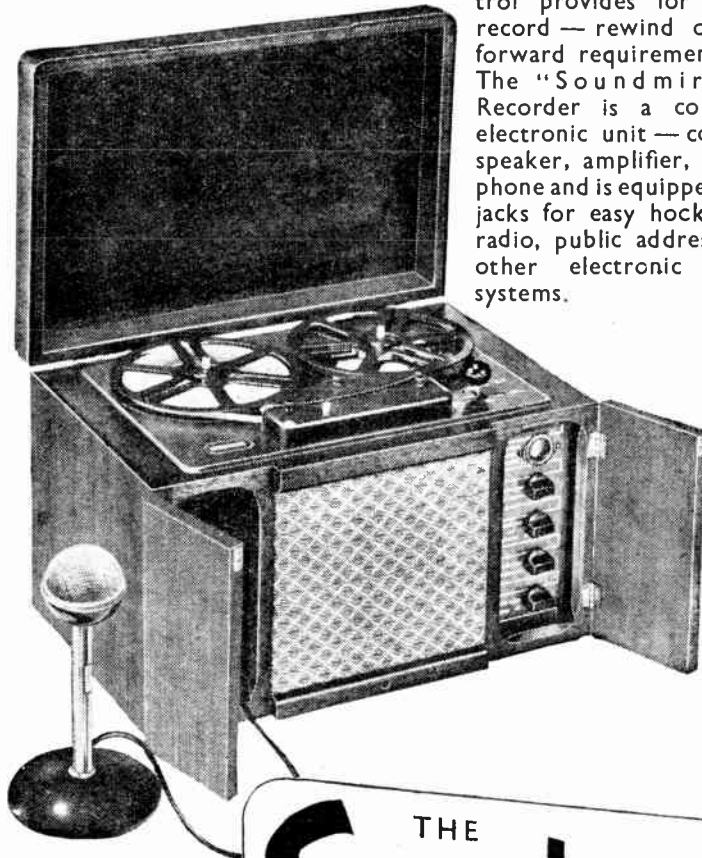

THE
Soundmirror
MAGNETIC TAPE RECORDER



"Soundmirror" gives a full unbroken half-hour's recording on every reel of "Magic Ribbon."



"Soundmirror" "Magic Ribbon" can be erased and used an indefinite number of times. Erasure is accomplished automatically whenever a new recording is made.



"Soundmirror" "Magic Ribbon" can be cut and spliced—short recordings joined together—unwanted parts removed. The unwanted portions can be erased and used again.



"Soundmirror" "Magic Ribbon" is easy to handle—it does not become coiled or tangled. Easy to handle—easy to thread—easy to store.

Made in England
Protected by British & Foreign
Patents & Patents Pending

THERMIONIC PRODUCTS LTD. LEADERS IN THE FIELD OF MAGNETIC RECORDING

Head Office: Morris House, Jermyn Street, Haymarket, London, S.W.1

Telephone: Whitehall 6422 (5 lines)

MODERN SERVICING METHOD

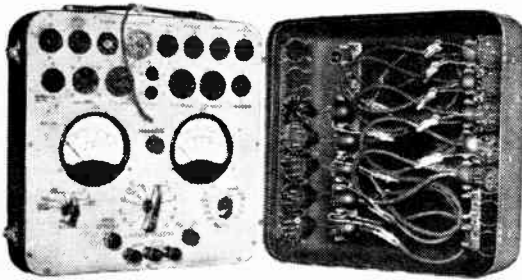

The "L.S.L." Servicing Method is a combined fault analyser and circuit tester; simultaneously capable of indicating all voltage, current and resistance on each valve electrode without removing the chassis from the cabinet. Readings can be taken whilst the set is under actual operating conditions. The "L.S.L." Analyser is a combination o. multi-range instrument and valve tester.

PRICE: £18. 18. 0 Subject.

THE "LSL" PORTABLE ANALYSER

★ Saves time and trouble. ★ Greatly increases Profit in the Service Department. ★ Is portable, can be used on the bench or in the home ★ Is simple to operate.

Send for further particulars from the sole distributors:

Kerry's
(GREAT BRITAIN) Limited

WARTON ROAD, STRATFORD, LONDON, E.15,
Telephone: Maryland 4611 AND BRANCHES
Export Address: 23-26 St. DUNSTONS HILL, E.C.3

CELESTION

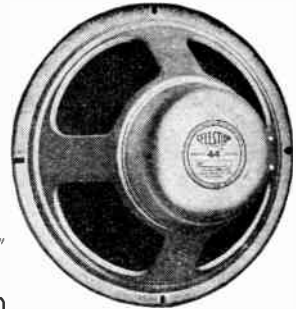

MODEL P44

- Overall Diameter 12- $\frac{3}{8}$ "
- Voice Coil Impedance ohms 3.0
- Magnet Pole Diameter 1 $\frac{1}{2}$ "
- Flux Density (Gauss) 10,000
- Total Gap Flux (Maxwells) 60,000
- Peak Power Capacity 10W

The General Public should please order through their Local Dealers.

Manufacturers are invited to write for details of the full range of Celestion speakers.

CELESTION LTD. SUMMER ROAD, THAMES DITTON, SURREY

Telephone: EMBERBROOK 3402-5

New WOLSEY INDOOR T.V. AERIAL

THE BEST YET

FULLY ADJUSTABLE

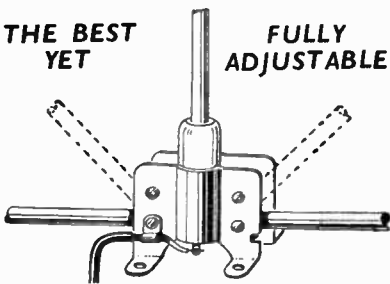

Wolsey present their new "ALL-WAYS" Indoor T.V. Aerial, for use where an outdoor aerial is difficult and where signal strength is adequate. A special feature is a polythene A.V.C. insulator giving improved results over normal indoor aerials.

Elements are easily adjusted for use as T.V., Inverted V.L. or Vertical D.pole. Best used in loft or attic but can be fitted in passage or room. Packed flat in carton, with all extra bolts, nuts, etc. for various positions. 25/-

Address of your nearest Stockist on request.

Eight types of Wolsey Outdoor T.V. Aerials for London and Birmingham. Send for Brochure.

WOLSEY TELEVISION LTD.,
75, GRESHAM RD., BRIXTON, LONDON, S.W.9
Phone: BRixton 6651/2 Established 1934

"Cyldon"
Type No. IP
MICA-DIELECTRIC
TRIMMER
CAPACITORS
SYDNEY S. BIRD & Sons, Ltd.
CAMBRIDGE ARTERIAL RD., ENFIELD, MIDDLESEX
Phone: Enfield 2071-2 "Grams: "Capacity, Enfield"

Varley
REGD. TRADE MARK

Products of
Quality & Reliability

MAINS TRANSFORMERS
A. F. TRANSFORMERS
THERMAL DELAY SWITCHES
SMOOTHING CHOKES
POWER RESISTANCES

Made by
OLIVER PELL CONTROL LTD

Telephone: WOOLWICH 1422-1426
CAMBRIDGE RDW. WOLWICH S.E.18

MAGNETIC T.V. PARTS

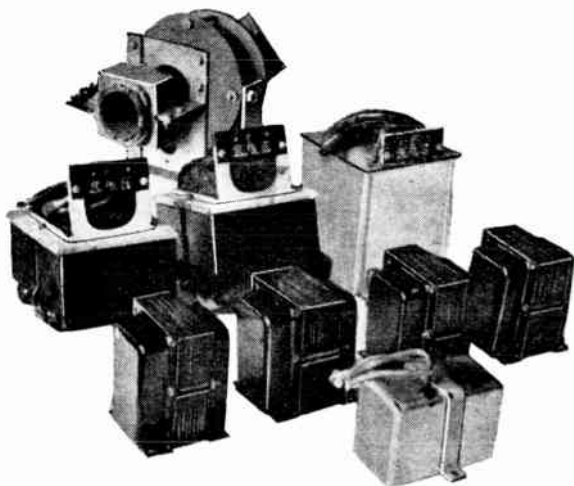

We have available, at very much below the standard prices, all the essential parts for making a magnetic type Televisor or for converting your 6in. green picture into a white picture. Actually these parts were made by a famous company for a smaller Television manufacturer, who unfortunately was under-capitalized, and could not make a success of his business. This is the reason why the parts are so cheap, for they are definitely superior to most that are on offer to-day.

The three main parts are: (a) The tube assembly which consists of a frame on which are mounted the focus coil and the line and frame deflection coils. This is suitable for a 9, 10 or 12in. magnetic Cathode Ray Tube. (b) The H.T. Transformer to give 4 kV and (c) the very efficient line output transformer. The price for this set of three parts is **£3 10s. 0d.**, and we will forward without extra charge the circuit diagram of the Televisor which was originally designed around these parts. The interesting feature about this Televisor is that it uses mostly easily obtained H.F. pentodes. We will supply the circuit data separately at 2/6 per copy, and we will allow you to deduct this from the cost of the kit if you buy within 2 weeks. Of course you don't have to stick to the circuit as supplied; any conventional circuit will do equally well.

If you are starting from scratch, the other parts for the original circuit are available as per the above illustration, and at similar keen prices:

- Fully shrouded chokes 9 henry 120 mA—2 required. Price 7/6 each.
- Fully shrouded chokes 17 henry 80 mA—2 required. Price 8/6 each.
- Mains Transformer—350-0-350 at 120 mA, 4 v. at 10 amp., 4 v. at 2 amp.—1 required. Price 17/6.
- Mains Transformer—400-0-400 at 80 mA, 4 v. at 6 amp., 4 v. at 2 amp., 2 v. at 2 amp.—1 required. Price 15/-.

We will supply any of the above parts separately at prices as shown or you can have the complete outfit of the nine parts as illustrated for **£6 10s. 0d.**, carriage paid.

THE ITEMS BELOW ARE OF SPECIAL INTEREST TO CONSTRUCTORS OF TELEVISORS USING ELECTROSTATIC TUBES (VCR97, etc.).

"50 PITFALLS FOR TELEVISION CONSTRUCTORS." If you are having difficulty in getting a perfect picture, then this publication may solve your problem. The price is only 2/6 post free.

WHITE PLASTIC MASK. Designed to fit a 6in. electrostatic tube, VCR97, etc. This will give a professional look to your home-built Televisor. If yours is a bigger than usual picture, the size of the opening can be enlarged to suit your own needs. The price is 7/6 post free.

MAGNIFYING LENS. De Luxe type. The lens which is really designed to give optical perfection. First class quality and workmanship throughout. Guaranteed against any discoloration of the special oil content. Price 39/6, postage, packing and insurance 6/-.

AERIALS. Indoor type—for fitting in loft. Very simple in installation. Full instructions and fixing clips, etc., supplied with every one. Order "8NAPPY AERIAL KIT", price 15/-.

VCR97 CATHODE RAY TUBES. Brand new in original cartons. Price 35/-, carriage and insurance paid. Buy a spare now while they are still available at this silly price.

PRE-AMPLIFIER FOR TELEVISION. Complete conversion details for using RF26 or RF27 ex-R.A.F. units, 2/3 post free. Brand new RF26 units, 35/- post free. Nothing else needed. Suitable for sound or vision.

H.T. CONDENSERS. .1 mfd. 2,500 v., 2/6; .02 mfd. 8 kV can type at 3/9; .1 mfd. 4 kV at 2/9; .02 mfd. 5,000 v. at 1/6; .1 mfd. 5 kV, 3/9.

Send cash with order or request C.O.D.
Orders over £2 are post free—we are open
until 5 p.m. Sats. List available on request
—it helps us if you can quote our Bin No.

PRECISION EQUIPMENT

AUGUST SALE OF RADIO SPARES

Bin No.

- 01 **MAINS TRANSFORMER "WODEN"** potted, fully shrouded and impregnated. Fitted primary screen. 300-0-300 at 150-200 mA., 6.3 v. at 10 amp., 5 v. at 3 amp. Primary tapping to give adjustments at 10 v. spacings between 190-250 v 50 C.P.S., 27/6.
- 02 **MIDGET** 465 kc/s I.F. Transformers. High Q iron dust cored, made by "PLESSEY." 7/6 per pair.
- 04 **CLIX** 15 amp. switch plugs, 10/- each.
- 05 **SCREWS**, tin. 4B.A. cheese-head cadmium plated, 1/9 per gross.
- 06 **TUNING CONDENSER**, 2-gang .0005 standard size. Made by "PLESSEY," and undoubtedly a very good job, 3/6 each.
- 07 **P.M. SPEAKER**, 10in. "ROLA." New and perfect, 24/6.
- 08 **SMOOTHING CONDENSER**, E.H.T. .1 mfd. 4 kV., these are recent manufacture by "T.C.C.", but casing is slightly soiled, 3/- each.
- 011 **TOGGLE SWITCH**, metal special dolly with a V cut out, as fitted in receiver where the wave-change knob also cuts off mains, 10d. each.
- 012 **DIAL PAN** flywheel tuning—separate band-spread drive, and pointer cut out, and clip for magic eye, and complete with pointer and drive cord already fitted, 8/6 each. Few only.
- PF2 **MAINS TRANSFORMER "PARMEKO,"** half-shrouded drop through chassis type, 350-0-350 at 80 mA., 6.3 v. at 4 amps., 5 v. at 2 amps. Primary tapped for 200-240 v. Fitted primary screen and impregnated. New and perfect, 16/6 each.
- PF3 **MAINS TRANSFORMER**, 260-0-260 at 70 mA., 6.3 v. at 3 amps., 5 v. at 2 amps., otherwise as PF2 above, 13/9 each.
- PF4 **MAINS TRANSFORMER**, 260-0-260 at 60-TL mA., 4 v. at 4 amp., 4 v. at 2 amp., otherwise as PF2 above, 13/9 each.
- B86 **P.V.C. INSULATED COPPER CONNECTING WIRE**—really fine for chassis wiring or as throw-out aerials, etc., 250 yd. coil, £1.

ELECTROLYTIC CONDENSERS. (Only new stock from best manufacturers)

2 mfd. 450 v.	1/-	8 mfd. 350 v.	1/6
4 mfd. 450 v.	1/3	16 mfd. 350 v.	1/11
8 mfd. 450 v.	1/11	32 mfd. 350 v.	1/11
16 mfd. 450 v.	2/8	25 x 25 mfd. 200 v.	3/11
8 x 16 mfd. 450 v.	3/4	8 mfd. 150 v.	1/3
16 x 16 mfd. 450 v.	3/4	25 mfd. 25 v.	1/-
16 x 8 24 mfd.	4/9	25 mfd. 50 v.	1/6
8 mfd. 500 v. BR.850	2/6	50 mfd. 12 v.	10d.
16 mfd. 500 v. BR.1650	3/6	10 mfd. 25 v.	10d.

- PC10 **BROWN KNOBS, SET OF THREE**, 1-1/2in. and 2-1/2in. diameter, 1/4 the set
- PD9 **TRACKER CONDENSERS**, 400-500 p.f., 6d. each.
- PI3 **TRIMMER CYLINDRONS** postage-stamp compression type 50 p.f. ceramic, extremely nice job, 4d. each.
- PD2 **TOGGLE SWITCH** meta "BULGIN," S.P.S.T., 1/3 each.
- PE8 **PANEL METER**, 2in. flush mounting, moving coil 0-500 micro-amps., 8/6 each.
- PE9 **METER**, 0-1 milliamp., 2in. flush, in bakelite case, made for M.O.S., but quite standard, 8/6 each.
- PE10 **AMPHENOL INTERNATIONAL** octal valve holder, 6d. each.
- PF6 **MIDGET TUNING CONDENSERS**, 2-gang .0005, fitted with trimmers, and complete with perspex dust cover. These condensers made by "PLESSEY" are of the type used for tuning personnel receivers, 6/6, plus 8d. postage.
- PF7 **4-GANG TUNING CONDENSERS**, .0005 each section—fitted trimmers—ceramic insulation. These are complete in a very useful chassis, and are fitted with a drive. Government Surplus equipment but new and perfect. 2/9, plus 1/3 postage case of 6 units, 17/6, carriage paid.
- B87 **6in. ENERGOISED SPEAKER**—"PLESSEY," 2,000 ohm field, complete with pentode matching U.P.T., 17/6.
- PF11 **3in. P.M. SPEAKER "ROLA,"** less output transformer, 8/9.
- PF13 **5in. P.M. SPEAKER "ROLA,"** fitted standard O.P. transformer, 11/3.
- B88 **12in. P.M. SPEAKER "TRUVOX,"** 42/6.
- PB11 **SYSTOFLEX SLEEVING**, 1 mm. assorted colours, 1/9 per dozen.
- PB10 **DROPPER** for 1.2 amp. valves, vitreous enamel covered, with taps mark 220, 240 1/6 each.
- PD4 **CROCODILE CLIPS**, small instrument type, very well made by "BULGIN," 3/6 per doz.

ELECTRON HOUSE (2) Windmill Hill, RUISLIP MANOR, MIDD.



SOUND AMPLIFYING EQUIPMENT

for every purpose

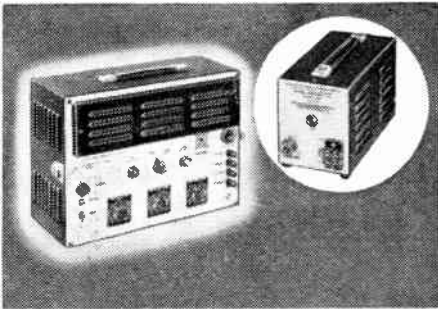

AMPLIFIER P.A. 20 B CONVERTER L.T.20. ★

This portable 20 watt amplifier is for the discriminating public address engineer. An attractive appearance and unique construction with an unbeatable performance give this instrument a hallmark of distinction usually associated with B.S.R. products. Suitable for A.C. mains or 12 volt battery in conjunction with Converter Unit Type L.T.20. Inputs for Ribbon and Moving Coil Microphones. Mic. and gram. mixing; high and low impedance outputs. Output level indicator. Supply socket for Radio Feeder Unit RF.1. Peak output 25 watts.

Price £36. 10. 0.

Converter Type L.T.20 £12. 10. 0.

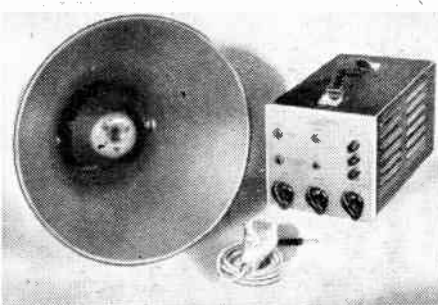

M.A. 15 MOBILE OUTFIT. ★

A mobile P.A. outfit comprising:

- (a) 15 watt amplifier for either 6 volt or 12 volt D.C. operation.
- (b) High quality hand microphone.
- (c) Co-axial re-entrant horn speaker.

An ideal set for elections and campaigns.

Price £42. 0. 0. Complete

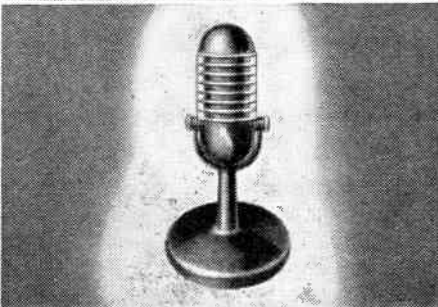

RIBBON MICROPHONE R.B.M.1. ★

A beautifully styled high fidelity ribbon microphone for Sound Recording and Public Address work. Finished in silver grey wrinkle with matt silver relief. Special interval anti-vibration suspension and built-in 600 ohm line transformer. Sensitivity 0.13 millivolt/dyne/cm² open circuit. P.A. 20.B. Amplifier is provided with suitable input for this microphone.

Price £10. 10. 0.

Other Products: High Power Sound Systems, Disk Recording Apparatus, Gramophone Motors, "Telemaster" Intercomm Sets, Shaded pole motors, Beat Frequency Oscillators.

BIRMINGHAM SOUND REPRODUCERS LIMITED

Claremont Works, Old Hill, Staffs.

'Phone Cradley Heath 6212/3

Wireless World

RADIO AND ELECTRONICS

AUGUST
1919

39th YEAR OF PUBLICATION

Proprietors: ILIFFE & SONS LTD.
Managing Editor: HUGH S. POCOCK, M.I.E.E.
Editor: H. F. SMITH

Editorial, Advertising and Publishing Offices:
DORSET HOUSE, STAMFORD STREET,
LONDON, S.E.1.

Telephone: Waterlooo 3333 (60 lines).
Telegrams: "Ethaworld, Sedist, London."

PUBLISHED MONTHLY

Price: 2/-

(Publication day: last Thursday of preceding month)

Subscription Rate: 26/- per annum. Home and Abroad

Branch Offices:

Birmingham: King Edward House, New Street, 2.
Coventry: 8-10, Corporation Street.
Glasgow: 26B, Renfield Street, C.2.
Manchester: 260, Deansgate, 3.

In This Issue

OUR COVER: Testing Television Sets (See Page 316)

EDITORIAL COMMENT	281
HIGH-QUALITY AMPLIFIER: NEW VERSION By D. T. N. Williamson	282
SHARED TELEVISION AERIALS	287
TEST REPORT: PHILIPS MODEL 681A	289
TELEVISION MOVING IMAGES By R. W. Hallows	291
AUDIO SIGNAL GENERATOR By M. G. Scroggie	294
ELECTRONIC CIRCUITRY By J. McG. Sowerby	298
WORLD OF WIRELESS	301
TELEVISION RECORDING By D. A. Smith	305
MILLER EFFECT By "Cathode Ray"	307
BIRMINGHAM TELEVISION RECEPTION	312
UNBIASED By "Free Grid"	314
LETTERS TO THE EDITOR	315
SHORT-WAVE CONDITIONS	317
RANDOM RADIATIONS By "Diallist"	318
RECENT INVENTIONS	320



"Stratosil" fully sealed vibrators are supplied in synchronous, non-synchronous and split-reed synchronous types. Being available in both shunt and series drive (the latter being made under "OAK" patents) they offer a replacement service for the majority of American-pattern vibrators as well as covering fully the needs of the designer of new equipments.

See **RADIOLYMPIA** Stand 63 Grand Hall

WEARITE VIBRATORS

set the standard for efficiency

A data book, complete with replacement guide and transformer design information is now ready and will be gladly sent to you at 6d. post free. Please use the coupon.

POST THE COUPON NOW

Wright & Weaire, Ltd., 138 Sloane Street, London, S.W.1, England
Please send me VIBRATOR DATA BOOK for which I enclose 6d.
Name and Address

WW 849

Wright and Weaire Limited

138, SLOANE ST. · LONDON · S.W.1 TEL SLOANE 22145 FACTORY: SOUTH SHIELDS, CO. DURHAM

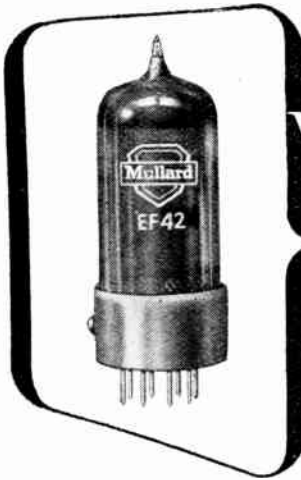

Valves and their applications

A Linear Time-base Generator for an Oscillograph using the EF42

The design of a broad band Amplifier for an Oscillograph has already been discussed in previous articles*, and a linear time base waveform generator may be found useful in complet-

ing the design of a general purpose oscillograph using EF42 valves.

The time-base generator is designed to operate with an ECR35 Cathode ray tube operating at 1.2 KV. overall accelerating voltage. The total signal required under these conditions will be 350 volts (peak to peak) or 175 volts per valve from two EF42's in push-pull, when the X plates are used. Allowing for 25% over-deflection this output voltage must be increased to 420 volts (peak to peak).

To obtain this large output from two EF42 valves a 300 V. H.T. Line is found desirable, although the circuit described may still be made to oversweep the C.R. tube with only 250V. H.T. Some non-linearity is to be expected when operating at this high output level, but this may be considerably reduced by the use of negative feedback. A resistive feedback network from the anodes of the output valves proves effective in providing the required degree of linearity.

Figure 2 shows a linear sawtooth generator providing the input to the pair of EF42 valves. The sawtooth voltage waveform is generated at a lower voltage level (approx. 25 volts peak to peak); the pair of EF42 output valves serves to

amplify and paraphase the output from the sawtooth generator.

The d.c. connection to the deflector plates prevents drifting of the trace with variation of the time base amplitude.

The circuit of the sawtooth generator is shown in figure 1. This is a circuit of the self-running 'Miller' integrator type; it differs from the 'transitron' in the omission of the coupling capacitor between the screen and the suppressor grids. The 'switching' or 'flyback' is provided by accumulated charge on the suppressor grid and is thus independent of the time constants in the screen grid circuit.

The 'Miller' capacitor C_1 is switched to provide coarse increments in the variation of the time-base velocity, the fine control being provided by a d.c. potential (V_1) derived from a potentiometer (R_1). The amplitude of the waveform will remain constant, with constant H.T. to the waveform generator, but the output may be preset to any desired value by the adjustment of the network arm R_5 .

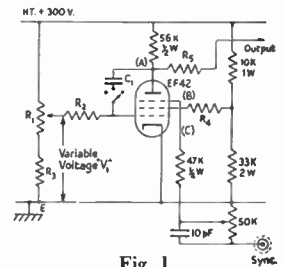

Fig. 1

* See "Wireless World" January and April 1949.



Reprints of this report from the Mullard Laboratories, together with additional circuit notes and details of the power supply may be obtained free of charge from the address below.

**MULLARD ELECTRONIC PRODUCTS LTD.,
TECHNICAL PUBLICATIONS DEPARTMENT,
CENTURY HOUSE, SHAFTESBURY AVE., W.C.2**

(MVM98)

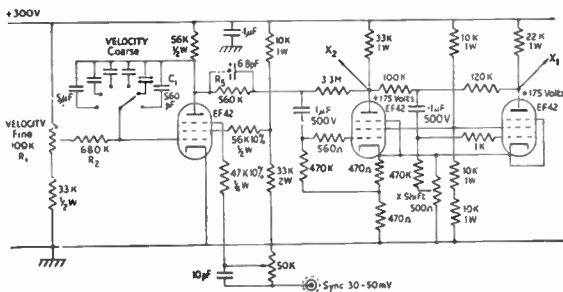

Fig. 2

Wireless World

VOL. LV. NO. 8

AUGUST 1949

RADIO AND ELECTRONICS

Comments of the Month

BROADCASTING FOR EXPORT

FOR a long time there has been growing dissatisfaction over the low field strength provided by the broadcasting service in certain areas of the country, notably the South Coast. Last month a reader made what seems to be an eminently practical suggestion: that the Kingston station, near Brighton, should be used, at such times as it is not carrying out its normal function of distributing the Third programme, for reinforcing the Home and Light programmes over an area that is notoriously badly served.

Many readers now protest that this suggestion, though useful, offers merely a palliative. It is pointed out that the supplementary service would not be available at night-time, when, during the summer, atmospheric conditions are most likely to spoil reception of the long-wave station. The real cause of the trouble, it is contended, is that the B.B.C. is using two of its medium-wave channels exclusively for broadcasting to Europe, and not for the internal service. Here it should perhaps be added that one of the channels in question is "borrowed" and is not one of those officially allocated to this country under the Lucerne Plan. But, as a reader whose letter is printed elsewhere in this issue points out, the avowed intention of the B.B.C. is to use two of the medium-wave channels given to Great Britain under the Copenhagen Plan, including one of our three exclusive (non-shared) frequencies for the European Service. Thus it would seem that medium-wave broadcasting for export is to become a semi-permanent activity.

The general idea is, of course, one with which we have become uncomfortably familiar of late years: the exporting of something we need ourselves. The parallel is not quite perfect, and in any case, most of the issues raised cannot be commented upon here. It is permissible, however, to say that our correspondent is probably right in assuming the frequencies given to us at Copenhagen were for home consumption: it seems unlikely that the delegates of

all the countries represented there agreed on our having extra channels, over and above our domestic requirements, for propagating our ideas abroad. And it also seems to follow that, at future conferences, we shall find it difficult to sustain claims for the number of channels enjoyed at present if it can be shown we evidently can do without some of them for home consumption.

One conclusion is clear. If the Government decides that medium-wave channels that are in fact necessary for a good home service are to be permanently used for other purposes, it is more than ever desirable that the development of a supplementary e.h.f. service should proceed at all speed. As to whether a.m. or f.m. will be used for the service will presumably depend on the results of the B.B.C.'s forthcoming full-scale tests.

TELEVISION PICTURE QUALITY

AN article elsewhere in this issue will serve to draw attention to the fact, of which there is growing recognition, that definition as expressed in the number of scanning lines is not the only quality that goes to make a satisfactory television picture. One of the novel views put forward is that, so far as reproduction of moving objects is concerned, it might be better to reduce the number of lines and increase the number of frames. This and other suggestions of the author, though ingenious, call for experimental verification before they can be accepted.

In view of our editorial comments last month on the relative merits of British and American television standards, we were particularly interested in our contributor's suggestion that the U.S. practice of using 60 frames per second (as opposed to our 50) might give less distortion of rapidly moving images. If he is proved to be right, we may have to modify our statement, though we stick to our original contention that the 60-per-second rate was chosen to fit in with the standard American supply frequency.

HIGH-QUALITY AMPLIFIER:

Since the "Williamson" amplifier, as it has come to be called, was first described in our issues of April and May, 1947, it has aroused world-wide interest. In the *Australian Radiotronics* (Nov.-Dec., 1947) it was described as "by far the best we have ever tested. . . . It not only gives extraordinary linearity and lack of harmonic and intermodulation distortion, but is comparatively simple. . . ." The present article repeats the original design data, with slight modifications, and deals at length with special precautions to be taken

SINCE the publication in the April and May, 1947, issues of this journal of an amplifier design suitable for high-quality reproduction of sound, correspondence has revealed that a more complete explanation of

mand exists for a pre-amplifier unit to enable the amplifier to be used in conjunction with gramophone pickups and microphones of low output. In the present article it is proposed to deal with the amplifier, and in a subsequent

necessity for frequent reference to the May, 1947, issue, the circuit of the amplifier and the list of component values are printed again. These differ in minor detail from the originals. In the circuit previously printed a potentiometer was provided in the penultimate stage to enable the signal to be balanced. Due to the use of common unbypassed cathode resistors for the push-pull stages, the amplifier is largely self-balancing to signal, and it is permissible to dispense with this adjustment. Accordingly, revised values and tolerances are shown for resistors R_5 , R_7 , R_{11} and R_{13} . A transitional phase-shift network consisting of R_{26} and C_{10} ,

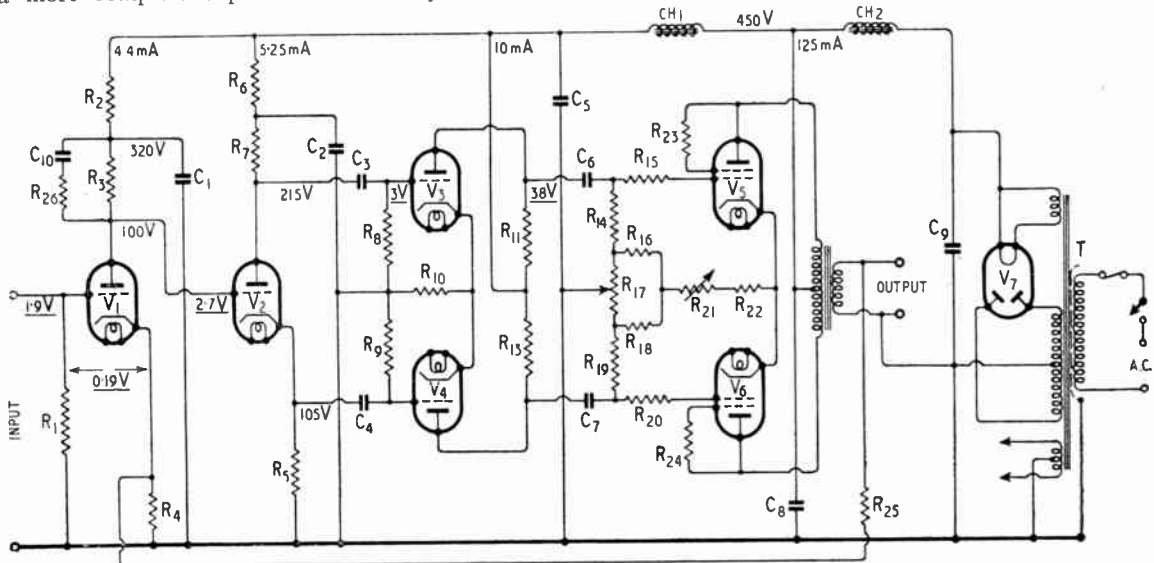

Fig. 1. Circuit diagram of complete amplifier. Voltages underlined are peak signal voltages at 15 watts output.

R_1	1M Ω	$\frac{1}{4}$ watt $\pm 20\%$
R_2	33,000 Ω	1 watt $\pm 20\%$
R_3	47,000 Ω	1 watt $\pm 20\%$
R_4	470 Ω	$\frac{1}{4}$ watt $\pm 10\%$
R_5, R_7	22,000 Ω	1 watt $\pm 5\%$
	(or matched)	
R_6	22,000 Ω	1 watt $\pm 20\%$
R_8, R_9	0.47M Ω	$\frac{1}{4}$ watt $\pm 20\%$
R_{10}	390 Ω	$\frac{1}{4}$ watt $\pm 10\%$
R_{11}, R_{13}	47,000 Ω	2 watt $\pm 5\%$
	(or matched)	

R_{14}, R_{19}	0.1M Ω	$\frac{1}{4}$ watt $\pm 10\%$
R_{15}, R_{20}	1,000 Ω	$\frac{1}{4}$ watt $\pm 20\%$
R_{16}, R_{18}	100 Ω	1 watt $\pm 20\%$
R_{17}, R_{21}	100 Ω	2 watt wirewound variable

R_{22}	150 Ω	3 watt $\pm 20\%$
R_{26}	1,200 $\sqrt{\text{speech coil impedance}}$	$\frac{1}{4}$ watt (see table)
R_{26}	4,700 Ω	$\frac{1}{4}$ watt $\pm 20\%$
C_1, C_2, C_5, C_8	8 μ F	500V wkg.
C_3, C_4	0.05 μ F	350V wkg.

C_6, C_7	0.25 μ F	350V wkg.
C_9	8 μ F	600V wkg.
C_{10}	200pF	350V wkg.
CH ₁	30H	at 20mA
CH ₂	10H	at 150mA
T	Power transformer	
Secondary	425-0-425V	150 mA, 5V, 3A, 6.3V 4A, centre-tapped
V_1, V_2	2 \times L63 or 6J5, 68N7 or B65	
V_3, V_4	do.	do.
V_5, V_6	KT66	V_7 Cossor 53KU, 5V4

some of the features of the design, with the addition of some information about construction, would be of interest. The correspondence also shows that considerable de-

article to present the design of auxiliary equipment to form a domestic sound-reproducing installation.

Circuit Diagram. To avoid the

which was previously recommended as a temporary measure, has been added as a permanent feature to increase the margin of stability at high frequencies. This

New Version

Design Data : Modifications : Further Notes

By **D. T. N. WILLIAMSON** (*Ferranti Research Laboratories*)

will be discussed later when the stability of the amplifier is considered.

Finally, an indirectly - heated rectifier has been substituted as this prevents a damaging voltage surge when the amplifier is switched on. No suitable type was available when the circuit was originally published. A list of alternative valve types is also shown.

Amplitude and Phase/frequency Response. A curve showing the transmission and loop gain of the amplifier at frequencies between 1 c/s and 1 Mc/s is shown in Fig. 2. Although only the section between 10 c/s and 20,000 c/s is useful for sound reproduction, the curves outside this range are included as they may be of interest to those who may wish to use the amplifier for other purposes. They may also serve to emphasize that, in a feedback amplifier, the response must be carefully controlled at frequencies very remote from the useful range if stability is to be achieved.

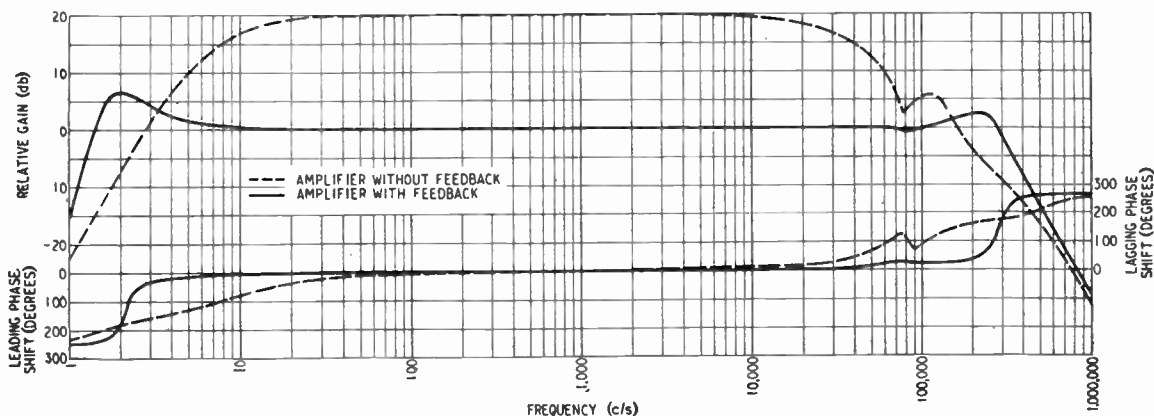

Fig. 2. °Loop gain and phase-shift characteristics of the amplifier.

General Constructional Data. The layout of the amplifier is not critical, provided that a few simple precautions are observed.

Many different arrangements have been used satisfactorily to suit differing circumstances. An excellent plan is to construct the power supply and the amplifier on separate chassis, as this gives greater flexibility in accommodating the equipment in a cabinet.

The following

Fig. 3. Suggested layout of principal components of combined amplifier and power pack.

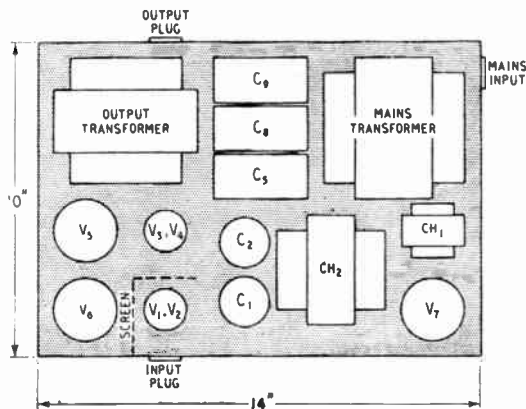

- precautions should be observed: —
1. The output transformer core should be positioned at right angles to the cores of the mains transformer and the main smoothing choke.
 2. The output transformer and loudspeaker leads should be kept

able gain at low radio frequencies, and care is necessary to avoid oscillation.

3. Signal wires, especially grid leads, should be kept as short as possible, and the stopper resistors associated with the output stage must be mounted on the valve-holder tags, and not on pump panels.

4. A bus-bar earth return formed by a piece of 12 or 14 s.w.g. tinned copper wire, connected to the chassis at the input end, is greatly to be preferred to

the use of the chassis as an earth return.

5. Electrolytic and paper capacitors should be kept away from sources of heat, such as the output and rectifier valves.

Figs. 3 and 4 show the positions of the major components in two

at a reasonable distance from the input leads, which should be screened. As the response curve shows, the amplifier has consider-

alternative layouts which have been used successfully.

Initial Adjustments. Before the amplifier is put into service

High-Quality Amplifier—

there are a few adjustments which require to be made. These concern the balancing of the standing currents in the output stage, and (with the original circuit) balancing of the signal currents in the push-pull stages.

Accurate balance of the standing currents in the output stage is essential, as the low-frequency characteristics of the output trans-

put voltage about half maximum.

(d) Adjust R_{12} for minimum output in the detector.

The Output Transformer. As stated previously, the output transformer is the most critical component in the amplifier and satisfactory performance will not be obtained with a component differing substantially from the specification. The effect of de-

it is considerably larger than the transformers which are usually fitted to 15-watt amplifiers. The fact that the peak flux density of 7,250 gauss for maximum output at 20c/s lies on the upper safe limit for low distortion is sufficient comment on current practice.

Some confusion arose regarding the method of connection of the transformer secondary windings to match loads of various impedances, whilst utilizing all the secondary sections. The correct primary load impedance is 10,000 Ω and as the turns ratio in the original design is 76:1 the impedance of each secondary section is 10,000 Ω /76² or 1.7 Ω . When secondary sections are connected in parallel, the turns ratio, and hence the impedance ratio, remains unchanged. If now two secondary sections, or sets of paralleled sections, are connected in series the turns ratio is halved, and the secondary impedance, being proportional to the square of the turns ratio, becomes 1.7 \times 2² = 6.8 Ω . Similarly if three sections are connected in series the impedance becomes 1.7 \times 3² = 15.3 Ω . Thus the available secondary impedances, keeping a 10,000 Ω primary load impedance, are 1.7, 6.8, 15.3, 27, 42.5, 61, 83 and 109 Ω . The connections to obtain these values are shown in the table.

Should it be necessary, in an emergency, to match loads of other impedances to the amplifier, it is permissible to reduce the primary load impedance to 6,000 Ω giving another series of secondary impedances, namely 1, 4, 9, 16, 25, 36, 49 and 64 Ω . Under these conditions the power output will be increased slightly and the distortion will be doubled. The value of the feedback resistor R_{22} must remain unaltered, as the turns ratio is unchanged. The values of R_{22} are given in the table.

Winding data for an output transformer to match loads in the region of 3.5 Ω are given in the Appendix and the connections and other data are included in the lower section of the table.

The two outer layers of the output transformer primary should normally be connected together to form the centre tap, the inner sections of the winding being taken to the valve anodes. This gives

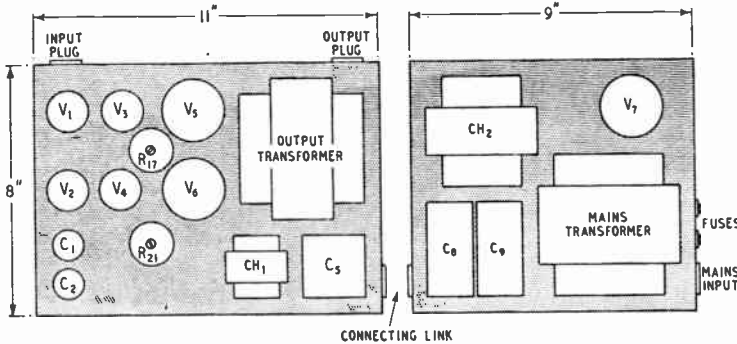

Fig. 4. Layout when using separate power pack.

former deteriorate rapidly with d.c. magnetization. The procedure to be adopted for static and signal balancing is as follows:—

Static Balancing.

(a) Connect a suitable milliammeter in the lead to the centre tap of the output transformer primary.

(b) Set the total current to 125 mA by means of R_{21} .

(c) Connect a moving-coil voltmeter (0-10 V approx.) across the whole of the output transformer primary and adjust R_{17} until the reading is zero, indicating balance. Random fluctuations of this instrument may be noticed. These are due to mains and valve fluctuations and should be disregarded.

Signal Balancing.

(a) Connect the low-impedance winding of a small output transformer in the lead to the centre tap of the output transformer. Connect a detector (headphones or a cathode-ray oscillograph if available) to the other winding, earthing one side for safety.

(b) Connect a resistive load in place of the loudspeaker.

(c) Apply a signal at a frequency of about 400c/s to the amplifier input to give an out-

creasing the primary inductance will be to produce instability at low frequencies, which can be cured only by altering the time constants of the other coupling circuits, or by decreasing the amount of feedback. At high frequencies the situation is more complex, as there are more variables. The leakage inductance, the self-capacitance of the windings, the capacitance between windings and the distribution of these parameters determine the transmission of the component at high frequencies, and great variations are possible.

In the output transformer specified, the only parameter which is likely to vary appreciably is the inductance of the primary at low signal levels, due to the use of core material with a low initial permeability, or to careless assembly of the core. The high-frequency characteristics are not dependent on the core material to a substantial degree. They are dependent only on the geometry of construction, and to some extent upon the dielectric properties of the insulants used, and are therefore reproducible with a high degree of accuracy.

Comments are frequently expressed about the size of the output transformer. It is true that

the minimum external electric field.

Stability with Negative Feedback.—Much has been written about the stability of amplifiers under conditions of negative feedback, and the criteria for stability are now widely appreciated. The article by "Cathode Ray" in the May, 1949, issue, states the matter simply and with characteristic clarity.

Continuous oscillation will occur in a feedback amplifier if the loop gain—that is the transmission of the amplifier and the feedback network—is greater than unity at any point where the phase shift of the amplifier has reached 180°. It is also possible for an amplifier to be unstable in the absence of continuous oscillation if these conditions should occur in a transient manner at a critical signal level. This latter condition is particularly likely to occur in badly designed amplifiers with iron-cored components, where the inductance and, therefore, the time constant







than those of the fixed coupling circuits, an increase in its value due to a high signal level may be sufficient to render the system unstable. In order to avoid this condition the fixed time constants must be made much longer than that of the variable stage. This condition would lead to undesirably large interstage couplings if good low frequency response were required. Alternatively, the variable time constant must be chosen in relation to the fixed time constants, such that its minimum value is sufficiently longer than the fixed values to produce stability. An increase in its value then serves only to increase the stability margin. This method is used in the amplifier under discussion.

To ensure a wide margin of stability, whilst at the same time preserving the high loop gain necessary to reduce the effect of transformer distortion at frequencies of the order of 10-20 c/s, would require a transformer with

to the lowest practicable value.

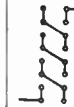
When the amplifier is reproduced, the "spread" in tolerance of components will normally be such that changes in characteristics due to departure from the nominal value of one component will be balanced by opposite changes produced by departure in another component, and the amplifier as a whole is likely to have characteristics close to the average. Individual amplifiers may, however, have characteristics which differ substantially from the average, due to an upward or downward trend in the changes produced by component deviations. If the trend is in a direction such that the loop gain is reduced, no instability will result, the only effect being a slight degrading of the performance. If, on the other hand, the loop gain is increased by an amount greater than the margin of stability, oscillation will occur. It should be emphasized that this will happen only very

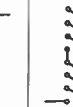
OUTPUT TRANSFORMERS. TABLE OF CONNECTIONS.

		No. of secondary groups of sections in series	1	2	3	4	5	6	7	8
		Connections								
Original Output Transformer	Correct secondary impedance (ohms)		1.7	6.8	15.3	27	42.5	61	83	109
	Minimum secondary impedance permissible (ohms)		1	4	9	16	25	36	49	64
10,000/1.7Ω	Feedback resistor R ₂₅ (ohms)		1,500	3,300	4,700	6,800	8,200	10,000	11,000	12,000
	Turns ratio		76	38	25.4	19	15.2	12.6	10.8	9.5
Alternative Output Transformer (See Appendix) 10,000/3.6Ω	Correct secondary impedance (ohms)		3.6	14.4	32.5	57.5	90	130	176	230
	Feedback resistor R ₂₅ (ohms)		2,200	4,700	6,800	9,000	11,500	13,500	16,000	18,000
	Turns ratio		52.5	26.25	17.5	13	10.5	8.75	7.5	6.5

controlling the phase and amplitude characteristics of one or more stages may increase by as much as a factor of five between zero and maximum signal levels. If this variable time constant is shorter

a very large initial primary inductance. This would necessarily be expensive, and a compromise must be drawn between the three factors. Because of this, the margin of stability must be kept

rarely, and when it does the remedy is obviously to reduce the loop gain to its correct value.

To assist the unfortunate few who experience instability, the following procedure is recom-

High-Quality Amplifier—

mended. If oscillation should occur at a low frequency (about 2 c/s) the first step should be to disconnect the feedback resistor R_{25} . If the oscillation continues the decoupling circuits should be checked and any faulty components replaced. The amplifier should also be examined to ensure that it is operating correctly balanced in push-pull, and not in an unbalanced manner due to the failure of some component.

Primary Inductance

Assuming that the amplifier is, or has been rendered, stable with the feedback disconnected, the next step should be to check the phase and amplitude characteristics at low frequencies. It is not practicable to make direct measurements of these characteristics without very special equipment, as inspection of Fig. 2 will show that the interesting region lies below 10 c/s. It is therefore necessary to arrive at the desired result by indirect means, namely by measurement of the component parameters which determine the characteristics. The parameter which is most likely to show a large deviation from specification is the initial primary inductance of the output transformer, since the quality of the core material is not easy to control accurately, and careless assembly of the core may cause considerable variations in its permeability.

The initial primary inductance should be checked by connecting the primary winding across the 5-V, 50-c/s rectifier heater winding of the mains transformer and measuring the current in it. The secondary windings should be open circuit. The current, which can just be read on the 10 mA a.c. range of a Model 7 Avometer, should be 150 μ A or lower. The component should be rejected if the current exceeds 200 μ A.

If the output transformer is satisfactory the values of the other components should be checked, particular attention being paid to the coupling components. Should the time constants of the couplings, that is their RC product, be higher than the nominal values by more than 20 per cent, the resistors should be adjusted to give the correct value.

The trouble will probably have

revealed itself by this time, but, if upon reconnecting R_{25} the oscillation is still present, it is very likely to be due to the use of valves with mutual conductances higher than average, and it is legitimate to increase the value of R_{25} to reduce the loop gain. If instruments are available, the loop gain may be measured by disconnecting R_{25} from the cathode of V_1 and reconnecting it via a $470 \Omega \pm 10$ per cent resistor to chassis. The voltage gain, measured from the input grid to the junction of R_{25} and the 470Ω resistor, should be 10 at frequencies between 30 c/s and 10 kc/s. Care must be taken not to overload the amplifier when this measurement is being made.

The adjustment of the loop gain to its correct value at medium frequencies should render the amplifier stable at high frequencies. It is unlikely that the phase characteristic at high frequencies of individual amplifiers will deviate appreciably from normal unless the layout is very poor or the transformer is not to specification.

Capacitive Loads

The amplifier is absolutely stable at high frequencies with a resistive or inductive load, but it is possible for oscillation to occur when the load impedance is capacitive at very high frequencies, for example, when a long cable is used to connect the amplifier and loudspeaker. To avoid this possibility, and to give an increased margin of stability, a transitional phase-shift network consisting of R_{26} and C_{10} in conjunction with the output resistance of V_1 , has been included in the circuit. This has the effect of reducing the loop gain at frequencies from 20 kc/s upwards without affecting the phase shift in the critical region.

The use of a phase advance network consisting of a capacitor shunting R_{25} has been advocated as a means of stabilizing this amplifier. The effect of such a network is to increase the loop gain at high frequencies, at the same time reducing the amount of phase lag. It is sometimes possible by this means to steer the phase curve away from the 180° point as the loop gain is passing through unity, thus increasing the margin of stability.

The connection of a capacitor across R_{25} , however, will not stabilize this amplifier if it has been constructed to specification, although it may produce improvement if oscillation is due to some large departure from specification, such as the use of an output transformer with completely different high-frequency characteristics. The writer has no information about this.

The use of separate RC bias impedances for the output valves has also been suggested. This procedure is not endorsed by the writer, as there are numerous disadvantages in its use and no redeeming features whatsoever. If the time constant of the bias network is made sufficiently long to ensure that the low-frequency performance of the amplifier is unimpaired, the phase shift of the bias network will have its maximum at or near the lower critical frequency and may provoke oscillation. If, on the other hand, it is made sufficiently short to avoid this, the ability of the amplifier to handle low frequencies will be impaired. The use of separate bias impedances destroys the self-balancing properties of the amplifier, and if two dissimilar valves are used in the output stage "motor boating" is likely, due to the presence of signal in the h.t. line. The performance of the output transformer may be seriously affected by the out-of-balance current caused by valves whose anode currents lie within the manufacturer's tolerance limits. Finally, there can be little justification of this modification on economic grounds, as the costs are roughly similar. Indeed, if the question of replacement due to failure is considered, the common bias arrangement shows a definite saving.

It is to be hoped that these remarks on stability will not have the effect of frightening those who already possess amplifiers of this type or are contemplating acquiring them. Their purpose is to help the occasional "outer limit" case where instability is experienced, but if they serve to impress upon the reader that negative feedback amplifiers are designed as an integral unit, and that any modifications, however insignificant they may appear, may seriously affect the performance or

stability, a useful purpose will have been accomplished. Such modifications should be attempted only by those who are confident that they know what they are doing, and who have access to measuring equipment to verify results.

APPENDIX

Output Transformer with 3.6-ohm Secondaries

Winding Data

Core: 1½in. stack of 28A Super Silcor laminations. (M. & E.A.)
The winding consists of two identical interleaved coils each 1½in. wide on paxolin formers 1½in. × 1½in. inside dimensions. On each former is wound :

5 primary sections, each consisting of 440 turns (5 layers, 88 turns per layer) of 30 s.w.g. enamelled copper wire interleaved with 2 mil. paper.

alternating with 4 secondary sections, each consisting of 84 turns (2 layers, 42 turns per layer) of 22 s.w.g. enamelled copper wire interleaved with 2 mil. paper.

Each section is insulated from its neighbours by 3 layers of 5 mil. Empire tape. All connections are brought out on one side of the winding, but the primary sections may be connected in series when winding, two primary connections only per bobbin being brought out. Windings to be assembled on core with one bobbin reversed, and with insulating cheeks and a centre spacer.

circuit is to connect two receivers to one aerial. Then $n = 2$ and $R = Z_0/3 = 24 \Omega$ if $Z_0 = 72 \Omega$ as is usual. Each receiver input is 6 db below the aerial output. The resistors can be the ordinary small composition type and in this instance it would be convenient to use for each two 47- Ω components in parallel, since this would permit the use of standard-value components.

The matching unit can be connected at any convenient point. Where it is desired to operate several receivers simultaneously in the same room, as in a demonstration showroom, the unit would obviously be fitted where the aerial feeder enters the room and short lengths of feeder run from it to each set. On the other hand, a pair of semi-detached houses might decide to share an out-door aerial. It might then be desirable to fit the matching unit fairly close to the aerial and run separate long feeders from it into the separate houses. In this case the unit must be carefully weather-proofed.

The unit can equally well go

SHARED TELEVISION AERIALS

Methods of Feeding Several Receivers

IT is not always realized that it is a simple matter to operate more than one television receiver from a single aerial. There is, of course, a loss of signal, for in the ideal case the signal power provided by the aerial is divided equally among the receivers connected to it. The loss is rarely a serious one, however, except in areas of low field strength

The most obvious way of connecting several sets to a common aerial is by means of a transformer, for then there is no loss in the network, apart from some unavoidable transformer loss. This is shown in Fig. 1 and if each receiver is designed for a feeder impedance Z_0 and the aerial feeder impedance is also Z_0 the trans-

turns ratio of $1 : N = 1 : \sqrt{1/n}$. Ignoring transformer losses, the input to each individual receiver is $10 \log n$ db below the aerial output.

Where only a few sets

are used it is much simpler to use a resistance matching network, but it is rather less efficient. The arrangement is shown in Fig. 2. It can be seen by inspection that for proper matching it is necessary to have

$$Z_0 = R + \frac{Z_0 + R}{n}$$

whence

$$R = Z_0 \frac{n - 1}{n + 1}$$

The aerial current divides equally among the receivers, there-

fore the input power to each is $20 \log n$ db below the aerial output. The power lost in the resistors is as much as that fed to the receivers.

The commonest use of this

Fig. 2. Here a resistance network is used for matching several receivers to an aerial.

in the middle of a cable run. Thus, two flats on different floors might share an aerial, and the obvious place for the unit is at the entry point of the cable into the upper of the two.

Since the loss of signal for two sets is 6 db the scheme may be inapplicable in fringe areas. There is, however, the possibility that if two neighbours combine they could for the cost of two separate aerials erect one more elaborate and lofty structure which would provide an increase of more than 6 db in signal. However, the transformer matching system

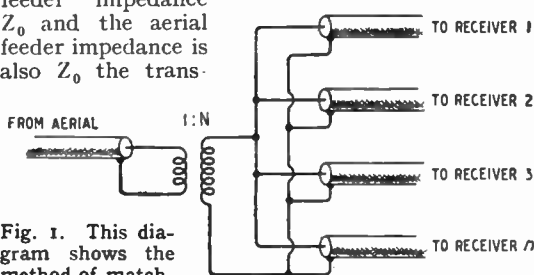
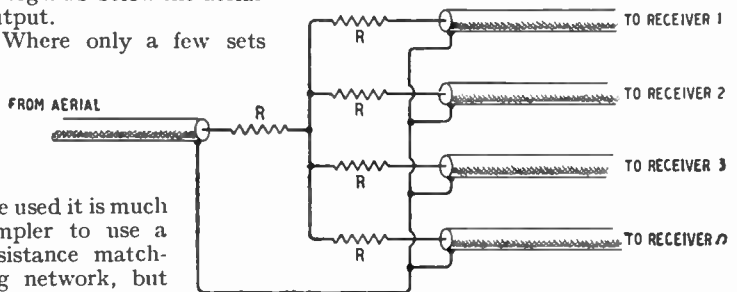

Fig. 1. This diagram shows the method of matching a feeder to several receivers by a transformer.

former must have an impedance ratio $Z_0 : Z_0/n$ where n is the number of receivers. This is a

Shared Television Aerials—

is likely to be more satisfactory under this condition.

For two receivers the unit has the form shown in Fig. 3 (a). An alternative form which is exactly equivalent is shown in Fig. 3 (b). By the star-delta transformation

since it is obviously inapplicable to coaxial feeders. One resistor R_1 is still needed. The aerial feeder is properly matched without it and as it is connected to points of equal potential there is no current in it and no power loss in it. It is needed to retain proper

vides a 1,000-c/s modulating tone for calling the shore station. A simple code will be used to distinguish between stations operating in the same channel.

The coast stations are assembled in the standard 19in wide racks and give about 50 watts r.f. output. Unit construction is adopted for ease of maintenance and a complete unit, transmitter, receiver or power supply, can be quickly replaced if a failure occurs.

Under development is a further set intended for installation on board ships. It will give about 10 watts r.f. output and provide a considerably greater range than the lightweight portables. It will be

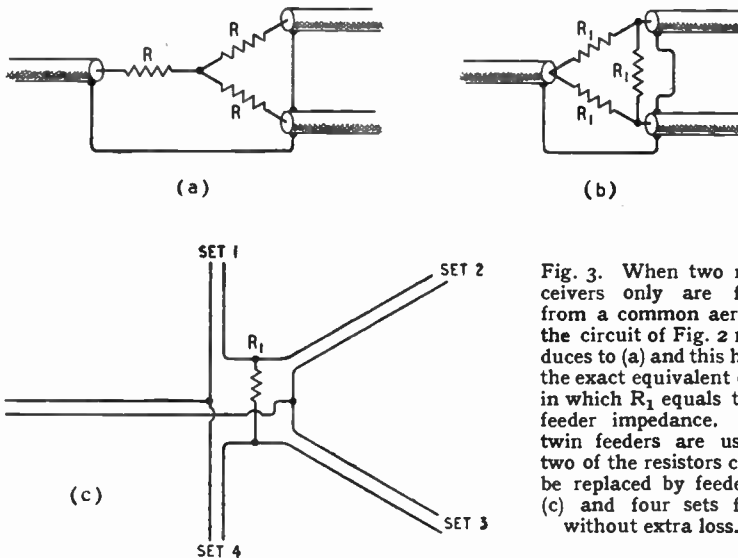

Fig. 3. When two receivers only are fed from a common aerial the circuit of Fig. 2 reduces to (a) and this has the exact equivalent (b) in which R_1 equals the feeder impedance. If twin feeders are used two of the resistors can be replaced by feeders (c) and four sets fed without extra loss.

theorem $R_1 = 3R = Z_0$. Therefore, the resistor and the feeder impedances are the same. Hence, two of the resistors could be replaced by feeders and so four sets could be operated without any loss.

This scheme is sketched in Fig. 3 (c) for twin-wire lines,

matching looking in from the receiver feeders.

It should be noted that none of the receiver feeders is balanced to earth in this arrangement, but the aerial feeder is. Such a unit should, therefore, be used only when but short connections to the receivers are needed.

HARBOUR RADIO

Supplementary Aid to Radar Navigation

A v.h.f. radio telephone system is being installed by the Mersey Docks and Harbour Board in order to provide direct communication between the port radar station* or docks and the pilots on board ships entering or leaving the river.

Initially 150 portable sets and 10 fixed shore stations will be employed. The portable sets are battery operated, weigh just under 20lb and are designed to provide a working range of up to 25 nautical miles.

Twelve radio channels have been allocated to this service, six for the portable sets in the band 158.6 to 159.1 Mc/s and six for the land

stations covering 163.6 to 164.1 Mc/s.

The portable sets are crystal controlled and any channel can be selected merely by turning a switch. A 5-Mc/s i.f. is used and as this is arranged to be the difference between the transmitting and receiving frequencies of each set the same crystals can be used for both the transmitter and the receiver. A 4-volt accumulator powers the set and the r.f. output to the aerial is 0.25 W, amplitude modulation being employed.

An important feature of the set is its simplicity of operation. There are three controls only, a channel selector, combined on-off and send-receive switch and a ringing key. The last mentioned is a novelty for this type of equipment and it pro-

Portable v.h.f. radio telephone used by pilots of the Mersey Docks and Harbour Board for ship - to - shore communication.



flexible enough in design to cover the United Kingdom harbour requirements as well as general radio-telephone communications between ships and from ship to shore in foreign harbours.

The equipment is designed by British Telecommunication Research and made by the Radiogramophone Development Co.

"High-Quality Audio Amplifiers"

THIS 20-page booklet containing reprints of five *Wireless World* articles on amplifier design is now available from our Publisher, price 2s 6d (postage 2d). The circuits included are "W.W. Quality Amplifiers," "A.C./D.C. Quality Amplifier," Jeffrey's "Push-Pull Phase-Splitter," Baxandall's "High-Quality Amplifier Design" and Woodville's "Economical 50-watt Amplifier."

* See "Harbour Radar," *Wireless World*, September, 1948, pp. 317-320.

TEST REPORT

PHILIPS MODEL 681A

Double Frequency Changing on Short Waves

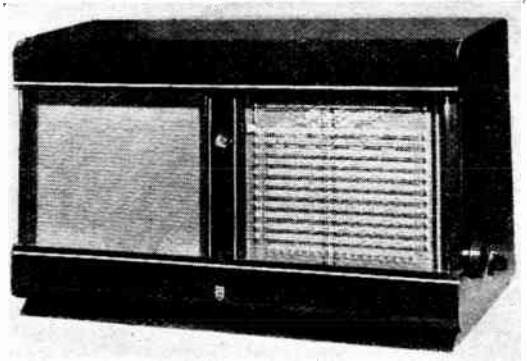

UNUSUAL care has been taken in the design of this table model receiver to provide ease and stability of tuning on short waves. In addition to the usual medium- and long-wave ranges and two short-wave ranges covering 11 to 110 metres, which are covered by the basic superheterodyne circuit consisting of r.f. amplifier, frequency changer, i.f. amplifier, detector and a.f. stages, there are eight selected short-wave broadcast bands of about 0.5 Mc/s which are each expanded to the full width of the 7-inch horizontal tuning scale. A double superheterodyne principle has been applied to the bandspread circuits in such a manner that the local oscillator on each band works at a single fixed frequency and is therefore easier to stabilize.

On the bandspread ranges the section of the main ganged tuning condenser associated with the input to the r.f. stage is discon-

FEATURES
 Waveranges:
 Normal Tuning:
 11.1—34.2 m.
 34.2—110.5 m.
 192—560 m.
 900—2,000 m.
 Bandspread; 11, 13, 16, 19, 25, 31, 41 and 49 m. bands.
 Power Output; 8.9 watts.
 Mains Supply; 100-250 V., 50-100 c/s.
 Consumption; 85 watts at 220 V.
 Price (including tax) £48 8s 9d.

of the auxiliary frequency changer. The r.f. stage is fixed-tuned to a point in the middle of the band and will accept, without appreciable attenuation, signals up to 250 kc/s on either side of the centre frequency. The oscillator section of the first frequency changer is also fixed-tuned to a frequency 3 Mc/s higher than the centre point of the r.f. tuned circuits. Other signals in the band produce a spectrum of frequencies, centred on 3 Mc/s, and this first intermediate band is

signals follow the same course as on other wave ranges.

Fig. 1 shows the circuit arrangement of the two frequency changers on the bandspread ranges. The filter circuit in series with the primary of the first i.f. transformer is included for whistle suppression. Fig. 2 shows the progress of the signal through the receiver on the bandspread ranges.

As the first oscillator is higher in frequency than the signals, the calibration of the scales on the bandspread ranges is opposite to that on the normally tuned broadcast ranges. Wavelength decreases as the pointer moves from left to right, instead of increasing as on the long-, medium- and general-coverage short-wave bands.

The i.f. amplifier, detector and

Fig. 1. Circuit arrangement (without switching) of frequency changers on the bandspread ranges.

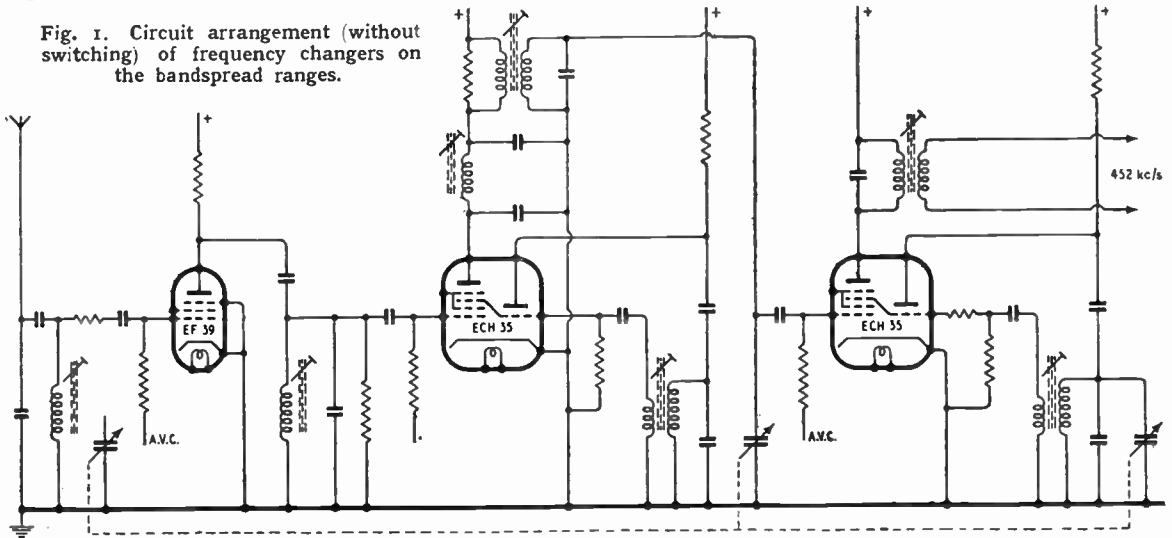

nected, and the second section tuning the intervalve coupling is transferred to a first intermediate-frequency transformer in the anode circuit of the mixer section

explored by the tuned secondary circuit connected to the grid of the second frequency changer. Here the conversion is made to the main i.f. of 452 kc/s and the

a.v.c. stages follow standard practice and a cathode-ray tuning indicator, controlled by the a.v.c. bias, is included.

A centre-tapped auto-trans-

Philips Model 681A

former couples the triode a.f. amplifier to the push-pull pentode output valves, and Fig. 3 gives the circuit arrangement of the stage. To balance out hum in the push-pull circuits R_1C_1 is introduced to offset RC. Feedback is applied from the secondary of the output transformer to one side of the phase-inverting circuit.

Tone control is effected by feedback through a capacitance from the anode to the grid of the first a.f. stage. A potential divider, which includes the tone control resistance, is connected across the phase-splitting inductance, and values are chosen so that the point X is at the same a.f. potential as the grid of the valve. When the slider is at this end of the control there is no feedback, and maximum high-note response is obtained.

Performance.— On the bandspread ranges the set handles like an ordinary broadcast receiver on medium waves—except that there are more stations to choose from and there is less overlapping. Each station can be tuned in to the mid-point of its bandwidth as easily as the local station, and if the ear does not give this point clearly, it can be found quite accurately by observing the cathode-ray tuning indicator with its two-stage sensitivity.

The set is remarkably free from self-generated whistles on all wavebands and the sensitivity and selectivity enable any station above background noise to be well received. On the bandspread

ranges the scales are accurately calibrated in both metres and megacycles and a check at several points showed that the gradua-

tion of the set and a large proportion of the top area of the chassis is occupied by them. The main tuning condenser is rubber-

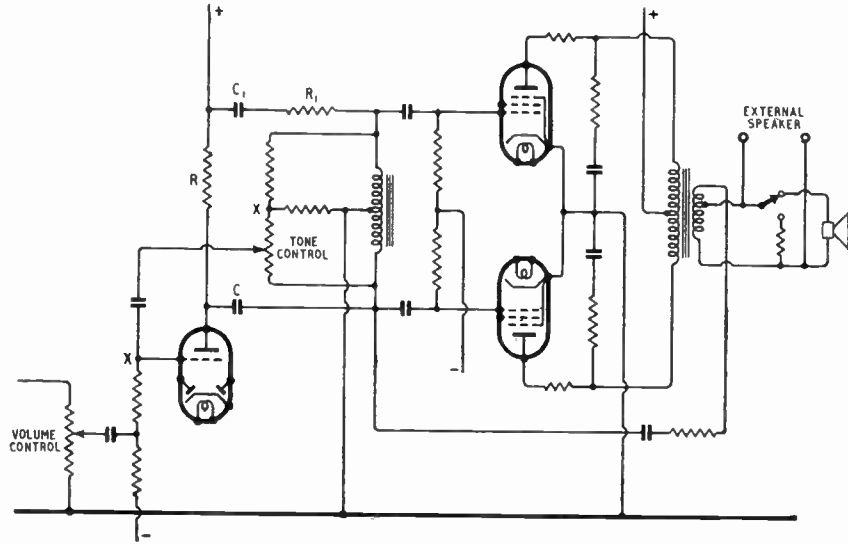

Fig. 3. Output stage and its associated circuits.

tions could be relied upon to find a wanted station.

Frequency stability was also very good and no warming-up drift could be detected. Station settings can be logged with accuracy by means of an auxiliary 180-degree scale.

The 8-inch loudspeaker gives good quality, and volume much above the average for a table model.

Mechanical Features.— The rather complicated wave-range switching is accomplished on three spindles, ganged together by a rack and pinion mechanism. It is positive in action and not unduly heavy to operate.

All trimmers are accessible from

mounted, but we did not find any evidence of microphony even when the condenser body was clamped for transit.

From every point of view the Type 681A can be classed as a high-quality receiver and it is particularly well fitted for serious short-wave listening.

The makers are Philips Electrical, Century House, Shaftesbury Avenue, London, W.C.2.

PUBLICATION DATE

In future *Wireless World* will be published on the last Thursday of the month preceding the date of publication instead of on the 26th as in the past.

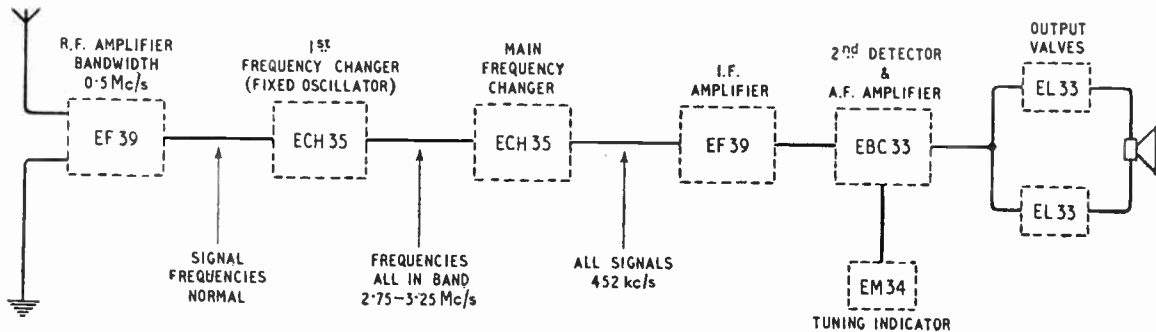

Fig. 2. Block diagram showing progress of signal on bandspread ranges

1R5

1S4

1T4

3S4

1S5

1L4

3V4

A POPULAR range of Brimar Battery Miniatures suitable for all Battery Receivers built since the war.

Reception Tested for reliability, Brimar Miniature Valves are manufactured to a specification to entirely eliminate microphony.

BRIMAR

MINIATURE VALVES



STANDARD TELEPHONES AND CABLES LIMITED, FOOTSCRAY, SIDCUP, KENT.

CRYSTAL PICK-UP PREJUDICES

—their Rhyme and Reason . . .

PREJUDICES are frequently unreasonable, often enough they are formed not from experience but from hearsay. The reputation of Crystal pick-ups has suffered in this way, yet every day and any day there are many thousands of Crystal pick-ups giving delight to gramophone enthusiasts, particularly those who are "sound purists." Then why this prejudice in other quarters? Let us be frank. *Under certain circumstances* Crystal pick-ups have in the past possessed some failings, but, let us hasten to add, failings small enough to be discounted by the user who sought the finest yet obtainable in sound reproduction.

Now, when Radiolympia is about to show us the great strides that ACOS research has made in utilising the amazing characteristics of the piezo-electric principle, it is opportune to review the reasons for the prejudices which persist from the pre-ACOS era.

The fallacy of their fragility

First, there is the belief that the Crystal pick-ups must necessarily be fragile and easily damaged. True, certain early types were easily fractured because assembly methods were as yet unperfected. But the Cosmocord laboratories produced an unbreakable crystal assembly which ensures that NO crystal in an ACOS pick-up can be broken, even by so drastic a measure as tapping the needle with a hammer—an extreme of violence which would never be approached in ordinary usage.

Humidity deterioration effects defeated

A second persistent prejudice against Crystal pick-ups is that the crystal element—Rochelle-Salt—is susceptible to deterioration when subjected to the higher degrees of humidity. Since this failing is an inherent characteristic of Rochelle-Salt, counter measures had necessarily to be those of *protection*. ACOS research was indeed set a formidable problem, the solution of which was particularly elusive, for in

this country the humidity count is much higher than, say, in the United States, where Crystal pick-ups are in almost universal use. Nevertheless the problem was solved by long and intensive research in the Cosmocord laboratories. Now an assembly has been designed which positively counteracts any danger of deterioration from humidity. In this assembly the crystal is mounted in a gel-like substance which provides a complete water-vapour barrier, rendering the cartridge absolutely non-hygroscopic.

Equaliser Circuits now past history

Another criticism is that the Crystal pick-up requires the fitting of an equaliser before satisfactory reproduction can be obtained from the ordinary commercial "constant velocity" records. In passing it should be mentioned that this condition is not confined to Crystal pick-ups only. The criticism is then that in order to attain the best from a crystal pick-up it is necessary to spend time and money on fitting additional components. The connoisseur of sound reproduction has con-

sidered this effort well justified by the results, knowing that a crystal pick-up alone is capable of giving him the high quality he demands.

Now, however, even the critical requirements of the connoisseur can be met without recourse to an equaliser circuit for again ACOS research has solved the problem in providing a crystal pick-up which, without additional components, can be connected direct to any domestic radio set or amplifier.

An invitation to the critics

Thus all past criticisms have been met, and any lingering prejudices shown to be without reason. And in confirmation there is to be inspected *and heard* at the Cosmocord Stand No. 7 and Demonstration Room No. D.10 the latest product from the Cosmocord Research laboratories—a Crystal pick-up of revolutionary design which, apart from providing a new and higher standard of performance, is also a thing of beauty. This pick-up will be available through the Trade after Radiolympia.

See and hear the new

ACOS G.P.20 MICRO-CELL PICK-UP at RADIOLYMPIA

STAND NO. 7. DEMONSTRATION ROOM D. 10.

- Has output 5 to 20 times greater than that of any comparable magnetic type.
- No equaliser components required. Can be connected direct to any domestic radio or amplifier.
- Has unbreakable Crystal element.
- Is unaffected by conditions of extreme humidity.
- No needle talk.
- Record wear virtually eliminated.
- Has provision for interchangeable clip-on head for long playing records. One instrument for ALL records.



COSMOCORD LIMITED • ENFIELD • MIDDLESEX

TELEVISION MOVING IMAGES

By

R. W. HALLOWS,

M.A., M.I.E.E.

Further Thoughts on Definition

IN the pages of *Wireless World** and elsewhere there has been much discussion of late concerning the many problems involved in television definition. The writers of the articles (I feel that I may be permitted to criticise, since I was one of them) like the participants in most verbal discussions and the authors of many textbooks, advance arguments that are perfectly sound, so long as one rather important proviso is made. That proviso is, perhaps, something more than rather important; for it is to the effect that in television transmission and reception we are mainly concerned with still images, such as test patterns. All of the generally accepted rules and equations are of unquestionable correctness when applied to still images; they enable one to calculate to a nicety the modulation bandwidth needed to deal properly with fixed vertical straight lines of any width and spacing, or the number of scanning lines necessary to televise fixed horizontal straight lines of any width or spacing.

Movement the Keynote

The contingency that they do not cover is that the lines in question should be moving. And movement is surely the keynote of television. The cinematograph could never have obtained its present popularity as a means of entertainment had it not been able to outdo its forerunner, the magic lantern, by projecting moving scenes on to the screen. Years ago the B.B.C. and the Vienna broadcasting station ran for some time transmissions of still pictures, which would be received in anyone's home by means of comparatively inexpensive apparatus fed by the output of an ordinary receiver. The pictures themselves were

excellent—as still pictures. It took about four minutes to receive one of them and those who came to one's home to witness the new miracle of broadcasting were lost in wonder and admiration: but, apart from their novelty-appeal (which soon wore off, as I can testify from personal experience, even with the most dyed-in-the-wool wireless enthusiasts) these transmissions had no genuine entertainment value. It was not until J. L. Baird showed that moving images could be transmitted and received by radio that broadcast pictures stood any real chance of providing worth-while entertainment in the home.

When we come to consider the moving image, as opposed to the still, test-pattern, new factors are involved; and these modify considerably the accepted ideas of definition in television.

Let us take as the basis of the argument a runner, human or equine, moving at such a velocity that his image would cross the screen of a television receiver in one second. I am not for one moment suggesting that the transit of the subject of a television broadcast from one side to the other of the viewing screen would ever occur in practice in this space of time. An important part of the technique of the operator of a television camera is to ensure that no such thing happens: by swinging his camera he keeps his principal subject at or near the centre of the screen at all times.

The reason for this is that the viewer instinctively keeps his eyes glued to the most arresting figure in the scene shown on his screen. So long as he can do this without moving his eyes, all is well; but if the figure is allowed by the camera operator to move rapidly across the screen and the eyes of the viewer follow its move-

ment, interlacing is at once destroyed and "interline flicker" is very much in evidence. This would not happen if the movement of the eyes was absolutely parallel with the scanning lines; but there is nearly always some vertical component in the passage of a figure across the screen.

Yet, no matter how great the skill of the cameraman parts of any rapidly moving image must have velocities such that, if they did move right across the viewing screen, they would do so in one second or less. Think, for example, of the legs and feet of a dancer or a runner, of the hands of an actor making a gesture, or of the whole outline of a figure which makes some brief, rapid movement too quickly for the camera to be swung so as to follow it. Things of that kind are constantly happening in every television transmission; it is in fact, to the continual occurrence of numbers of such movements that the television image owes its animation.

The Moving "Figure"

It is simplest to think of our object as a single vertical straight line, moving from left to right across the screen with a velocity that would accomplish one complete traverse in one second. This straight line we will call the "figure" for the word "line" is needed for other purposes. During the first odd-numbered 405-line interlaced scan one small element of the figure is depicted on the screen. This is a straight line equal in length to $1/377$ th of the height of the whole screen image, since 377 is the number of active lines. The next element is put in 99 μ sec later (99 μ sec is the total duration of a line, including initial and final blacks and line sync pulse) by the

*Television Standards, *Wireless World*, October, 1948; Television Goodness Factor, *ibid* March, 1949.

Televising Moving Images—

following odd-numbered line. In that time the figure has travelled a distance equal to 0.000099 of the whole width of the screen: the second element appearing on the viewing screen is therefore displaced by this distance from one before. As odd-numbered line follows odd-numbered line the displacement of the elements is cumulative. If we were watching a 10×8 -in image the displacement of the final odd-numbered element of a figure extending to the whole height of the screen would be $0.000099 \times 188.5 \times 10 = \text{approx. } 0.19\text{in.}$

The result is illustrated diagrammatically and in much exaggerated form in Fig. 1 (b). It must be emphasized that in the ordinary way the eye of the viewer is not actually conscious of any leaning of a moving figure. Still, the inclination is there and it must to some extent affect the reproduction of the image. It will be seen that the original vertical line of Fig. 1 (a) has become a slope built up of displaced vertical elements with gaps between them. Were the figure stationary, these gaps would be filled by the even-numbered scans. As the figure is moving at the velocity under discussion the even-numbered elements do not fill the gaps. Since there are

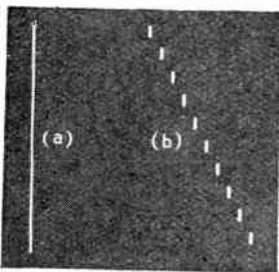

Fig. 1. Showing in much exaggerated form the elements "painted" by the odd-numbered lines in the reproduction of a moving vertical line.

50 frames per second, each including frame sync pulses as well as active lines, every even-numbered element is displaced by $1/50\text{th}$ of the screen-width, or $1/5\text{th}$ in. on a 10-in screen from its corresponding gap. This is illustrated, again with considerable exaggeration, in Fig. 2 (a). Fig.

2 (b) shows how the original clear, single, vertical line is reproduced as two slopes, each composed of spaced and displaced vertical elements. Besides the distortion introduced by the slope, there must be some haziness due (1) to the gaps between the elements and (2) to the fact that the elements are vertical whilst the line built up by them is not.

Several interesting facts emerge from these considerations. The first is that it becomes doubtful whether in the case of a moving image, we are entirely justified in regarding each even-numbered scan as complementing and, so to speak, belonging to the preceding odd-numbered scan, the two together forming one image complete in itself. An even-numbered frame would "belong" unquestionably to the preceding and not to the following odd frame, if there were a short blackout between an odd frame and the even frame following it and then a much longer blackout

after the even frame to mark the completion of the image. As it is, the sync pulse blackouts are identical in duration in both cases.

Consider the four consecutive frames seen in Fig. 3. Can it be held that A and B or C and D are always linked together to form images and that in some way the eye combines them rather than B and C? Is it not nearer the truth to regard A, B, C and D each as separate skeleton images, from the merging of which the eye receives a reasonably good general impression of a moving object rather than a clear-cut picture?

In any event it is plain that no increase in the number of scanning lines can make any improvement in the distortion due to the sloping reproduction of an image moving across the screen. This slope, or "distortion angle" becomes less as

the number of frames per second is increased. From this it becomes apparent that the use of a larger number of frames is likely to provide a better moving image and that the 60 frames per second used in the U.S.A. may, after all, mean something more than a mere waste of good bandwidth.

A second small shock comes when we think about those gaps between the elements in each frame of a moving image. More lines must lead to smaller gaps and, therefore, to a clearer picture drawn by each frame. A figure in vertical movement is, again, likely to be better reproduced by the use of a larger number of scanning lines. In fact, by taking

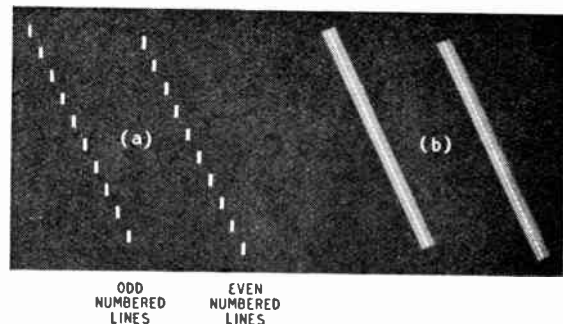

Fig. 2. The reproduction—again much exaggerated—of a single moving vertical line by two consecutive frames.

an extreme case and imagining the lines reduced to a very small number it is not difficult to picture a narrow horizontal figure in rapid upward or downward movement which is barely touched by any scanning line—or even not touched at all.

What it comes to is that calculations of balanced definition cannot be based entirely on the transmission and reception of still images. The moving image, which is what we want to televise, brings many new complications into the problem. Since we live on the surface of the ground the movements that we and our fellows most often make, and those which are, therefore, the most important to television, are in the horizontal sense. To attain genuine high-fidelity reproduction of these on the c.r.t. screen it is probably necessary to increase the number of frames to more than

50 per second. I have given some reasons why interlaced scanning cannot be looked to to furnish the answers we had hoped.

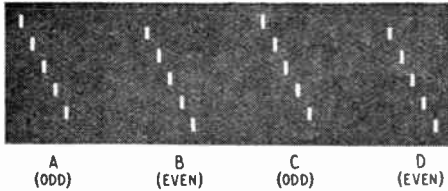

Fig. 3. Four consecutive frames reproducing a moving vertical straight line. Does A always interlace with B and C with D?

For what it is worth, my view is that research on high definition television should not take 1,000-line scanning as its goal. Rather, it should be directed first and foremost towards developing methods of producing wide-band transmitting and receiving gear

at reasonable cost. Once that has been accomplished, the next objective should be to discover how to make the best use of the bandwidth of, say, 20 Mc/s thus made available. It goes almost without saying that single-side-band methods of both transmission and reception will be used, which means that a modulation-frequency range of some 18-19 Mc/s will be possible.

The most important problem will then be to discover how best to use the frequencies available. Experiment will show what the eye will and will not accept. For moving images it appears to be important to strike the most suitable balance not so much between horizontal and vertical definition as between the number of images per second, and the number of scanning lines. My feeling is that we should

plump for sequential scanning. Where the best balance lies between image-frequency and number of lines only experiment can decide. It may be that it will be found with 50 images per second and some 700 lines. The ciné film to-day uses the equivalent of 72 images per second; there are actually 24 pictures projected each second, but two blackouts occur whilst each is on the screen and a third between it and the next picture. It may, then, be that the high-definition television of a few years hence will find that the best balance is obtained by combining an image-frequency of 75 per second with a small number of scanning lines.

But—and it is a big but—all that depends upon the discovery of a means of producing wide-band gear, and particularly receiving apparatus, at a cost considerably lower than that ruling at present.

MARINE SOUND EQUIPMENT

IN order to facilitate the demonstration of marine sound amplification systems, Ardenne Acoustic Laboratories have equipped a large caravan with the various types of apparatus produced for use on merchant ships. The unit is entirely self-contained and carries its own power supplies so that demonstrations can be given anywhere.

The towing vehicle is a complementary part of the unit, since it carries a special dynamo for battery charging. It also has a pair of weather-proof loudspeakers and a loud hailer on the roof.

Inside the caravan is a comprehensive display of Ardenne marine sound apparatus. One interesting item is the "Sonomarine" system giving radio, gramophone and speech facilities in all parts of the ship. It operates from the ship's mains of from 100 to 250 volts a.c. or d.c. It has three microphone input circuits, and these can be arranged in order of importance. Thus the captain would be given highest priority and, no matter what is being relayed, switching on his microphone immediately silences everything else. Every loudspeaker in the ship comes on at full volume even if it had been turned down or even turned off. An announcement from any microphone interrupts radio or gramophone in the same way.

Another piece of equipment we had demonstrated to us was the

"Talk-Back Hailer," a combined communication system having three sub-stations and a loud hailer. This is battery operated, 12 or 24 volts, and has a 4-valve amplifier, resistance-capacitance coupled throughout, with a small motor generator for h.t. supply.

At the sub-station the loudspeaker serves also as a microphone, and the sensitivity is such that replies from a considerable distance can be made if extraneous noises are not overriding. It has marked directional properties and this can usually be taken advantage of in mounting it. At a demonstration in the open and

with some traffic noise to contend with replies from distances up to about 20 feet were perfectly audible.

Among the other apparatus in the caravan is a "Master Communicator" which is a multiple system feeding up to 10 remote stations, all with "talk-back" and calling facilities. The loudspeaker is in all cases used as a microphone for replies. There are examples of the various styles of loudspeaker available for cabin or deck use, microphones and a small emergency communication set for point-to-point working, which does not use valve amplification.

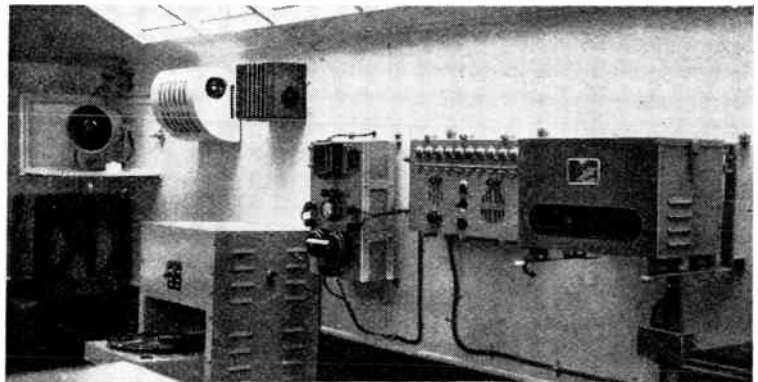

Part of the marine sound equipment inside the Ardenne mobile demonstration unit. Shown are the "Master Communicator," a loudspeaker mounted on a quadrant which swings outside when required and cabin-type loudspeakers.

AUDIO SIGNAL GENERATOR

Basic 20-20,000-c/s Oscillator with Optional Refinements

By M. G. SCROGGIE, B.Sc., M.I.E.E.

DETAILS of this instrument are offered in the hope that they may be of interest to readers who want to construct an oscillator covering the audio band. Some of the features are unusual and have been found very convenient for general laboratory work. In case a glance at the full circuit diagram (Fig. 1) and the control panel suggests that it would be better to look elsewhere for something simpler, it should be understood that most of the apparatus shown consists of optional "extras."

General Description.—The nucleus is a 2-valve resistance-capacitance oscillator (V1 and

harmonic distortion, is about 40 mW (20V peak across 5 kΩ) and is held constant by a thermistor within 0.2 db or less over the whole frequency range of 20 to 20,000 c/s, covered in three decade ranges.

The usefulness of the instrument, especially for measurements on amplifiers, filters, etc., is much increased by adding the attenuators, covering 0 to 105 db continuously by means of a 0.5 db potentiometer in front of the output stage and two switched attenuators following it, one giving four 5 db steps and the other four 20 db steps.

V6 and V7 comprise another

the effects of all stray capacitances from bridge arms to earth to be practically eliminated.

An incidental advantage of having the two output stages is that their signal currents cancel one another out in the anode supply circuit.

If steep-fronted square waves are available, apparatus under test can be much more searchingly examined than with sine waves alone, and many transient effects are shown up that would otherwise go unrevealed. So the next refinement is a squarer section (V3 and V4), brought in as desired by a Sine/Square change-over switch. The complete absence of signal transformers anywhere in the instrument, and the use of simple

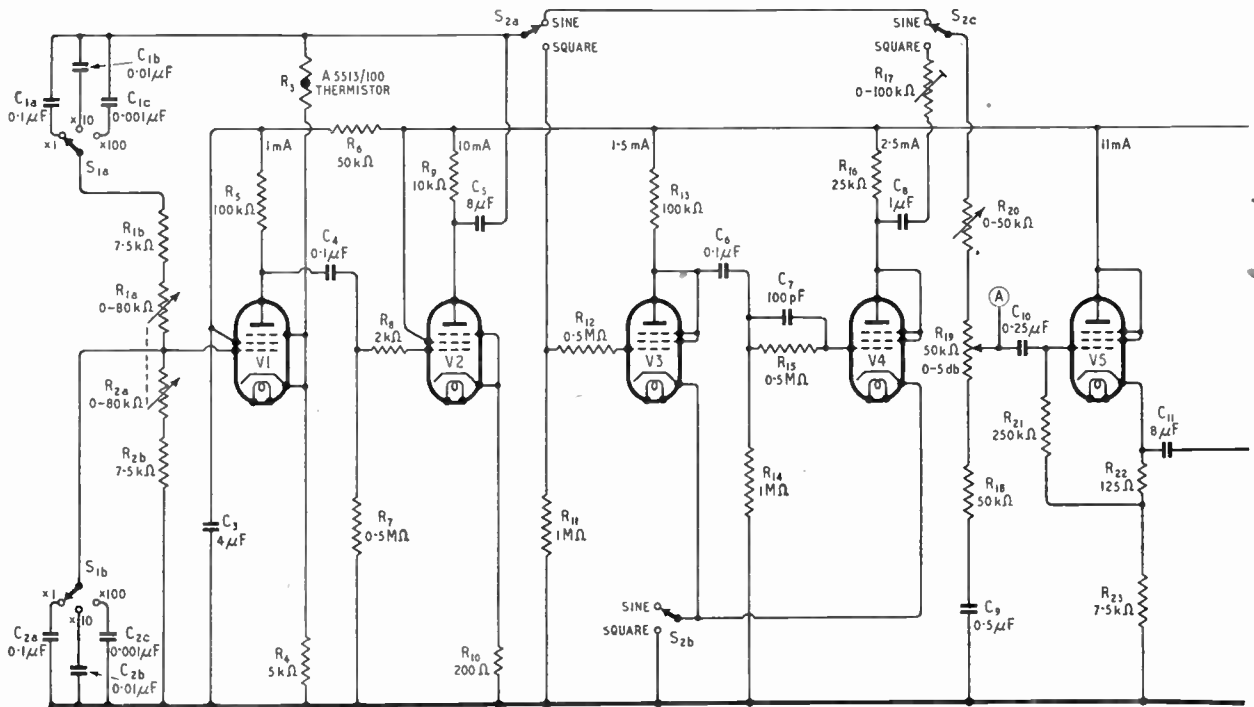

Fig. 1. Complete circuit diagram, with component values and approximate current readings

V2 in Fig. 1), which with one of the cathode-follower output stages (V5) would make a self-sufficient audio source. This circuit is shown by itself as Fig. 2.

The output, for less than 1%

refinement—a phase inverter and second output stage. For many purposes it is useful to have an output balanced to earth. In bridge work this feature is equivalent to a Wagner earth and enables

low-frequency compensation, assist in the preservation of good flat tops down to 20 c/s and wavefronts of only a few microseconds duration.

Lastly there is V8, a valve

voltmeter, with a switch to connect it to various points in the signal generator and also to an external terminal so that the voltmeter can be used independently. A simple device renders the calibration unaffected by the worst fluctuations in anode voltage.

A further provision that might be useful would be a switch to change the grid of V₁ over to an external terminal, so that the instrument could be used as an amplifier, squarer, phase splitter, etc., for external signals.

The particular generator shown was adapted from a war surplus Test Set Type 87. In this way the whole of the chassis, mains power unit, all nine valves, much of their wiring, and many of the controls and components, were ready-made. The front panel was fairly easily removable for drilling holes to take the extra controls. The r.f. oscillator (the original set was a 150-300 Mc/s generator) was in a small section at one end and came away bodily to make room for the frequency-determining network.

Design Considerations — Oscillator.—The beat-frequency type

the ability to sweep over the whole band in one turn of the frequency control—is counterbalanced by

frequency controls described in *Wireless World* by K. C. Johnson (March 1948) and B. J. Solley

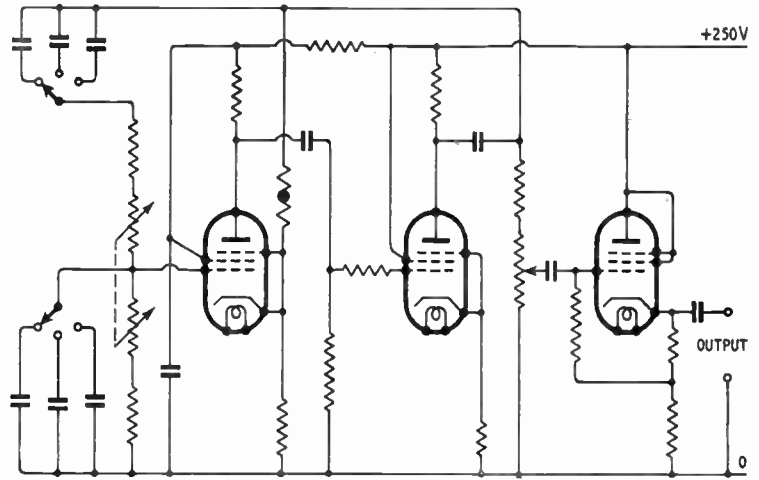
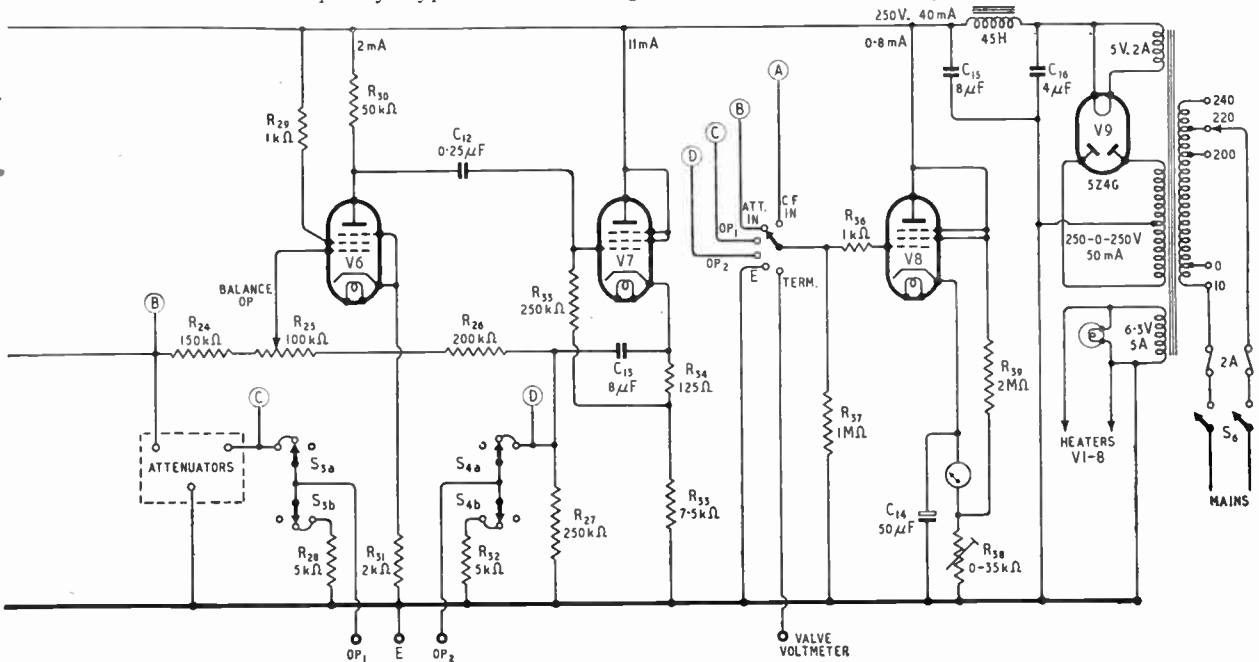

Fig. 2. Circuit diagram of the essential parts, consisting of bridge-controlled, amplitude-stabilized RC oscillator with cathode-follower output stage. Component values are as in Fig. 1.

the cramping of the frequency scale.

Before deciding on the conventional series-and-shunt or "Wien bridge" network, con-

(Sept. 1947). The latter was attractive not so much because the frequency is controlled by one potentiometer (after all, they are easily ganged) but because the



of oscillator was quickly ruled out because of the great difficulty of achieving stable frequency and pure waveform at the lowest frequency. Its one advantage—

siderable thought was given to possible alternatives. Twin-T networks were rejected as undesirably complicated. On the other hand there were the single-component

switching can be arranged so that three decades of frequency can be covered without a break, in three successive sweeps (up-down-up) of the control, and because a

Audio Signal Generator—

logarithmic scale is given by a linear potentiometer. But unfortunately the attenuation varies so widely with frequency setting that no automatic amplitude control could be found that would keep amplitude and waveform closely constant.

The theory of the Wien bridge oscillator is well known, but a recapitulation may be helpful. Neglecting R_3 and R_4 in Fig. 3, the two arms C_1R_1 and C_2R_2 form a potential divider such that the output (across C_2R_2) is in phase with the input (across the whole) at only one frequency, namely:

$$f = \frac{1}{2\pi\sqrt{R_1R_2C_1C_2}} \dots (1)$$

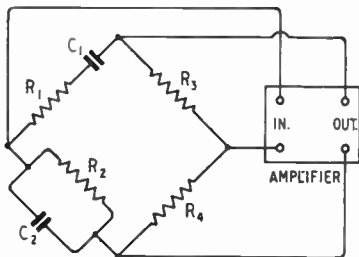

Fig. 3. Functional diagram of bridge-controlled RC oscillator.

When, as is usual, $R_1 = R_2$ ($=R$) and $C_1 = C_2$ ($=C$), this frequency is inversely proportional to R and C , and the output voltage is one third of the input (attenuation $9\frac{1}{2}$ db). If, therefore, this output is fed back to the input through an amplifier having $9\frac{1}{2}$ db gain and zero phase shift, continuous oscillation will be maintained at frequency f .

Any phase shift in the amplifier necessitates a corresponding phase shift in the RC network and consequently a departure from the frequency as given by equation (1). To minimize amplifier phase shift, and so stabilize the frequency of the oscillator, negative feedback is usually introduced, by feeding the input in opposite polarity with a proportion of the output, tapped off by the potential divider R_3R_4 . The gain of the amplifier must of course be correspondingly increased.

Another way of looking at the circuit is to consider it as a bridge, which would be balanced if $R_3 = 2R_4$, because both "detector" points would then be at the same

potential. In other words the attenuation of the network would be infinitely large. By lowering the tapping of R_3R_4 the attenuation is reduced, until the loop gain of the amplifier is sufficient to cause oscillation.

If the gain of the amplifier itself is made very much larger than $9\frac{1}{2}$ db the necessary shift in the R_3R_4 tapping is small, so that the $R_3:R_4$ ratio becomes extremely effective as an oscillation control. By choosing for R_3 an element whose resistance decreases with amplitude of oscillation (or R_4 with opposite characteristics), the amplitude is automatically limited other than by overloading of the amplifier and consequent distortion.

Using a bridge circuit, one inevitably encounters the difficulty that either both the input or both the output terminals must be at signal potential. There is the further difficulty in this case that for good a.a.c. (automatic amplitude control) the control element should not have to carry d.c. as well as the signal a.c. In some designs, R_3 and R_4 have been made respectively the anode and cathode resistors in the output stage: but since they must necessarily be fairly low in resistance, the exclusion of d.c. from the control element without bypassing most of the signal a.c. and introducing phase shift at

the lowest frequencies is an awkward requirement. In the present design the alternative has been

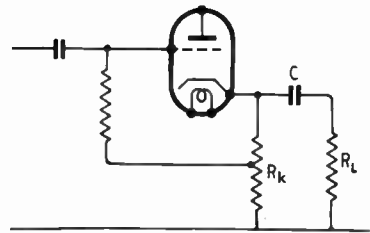

Fig. 5. Schematic circuit of output stage.

chosen, so that R_3 in Fig. 3 is the thermistor R_3 in Fig. 1, and R_4 is the cathode resistor of the input valve V1. The signal current in R_4 via V1 is small compared with that from V2 via R_3 .

Fig. 4 shows the characteristics of the thermistor, Standard Telephones Type A5513/100. This device is many times more effective than the special lamps that are usually specified for a.a.c., and at one stroke completely banished all the "hunting" (or amplitude bounce) troubles that had been experienced with lamp or rectifier methods of a.a.c. It occupies negligible space (approx. 1 in long by $\frac{1}{4}$ in dia.), and is cheaper than special lamps: and it is obtainable in higher resistances, more suitable for valve circuits. It is appreciably sensitive to ambient temperature, but long-term amplitude stability is relatively unimportant. At the output of V2, short-term amplitude variations are imperceptible, most of the 0.2 db drop at 20,000 c/s being due to the coupling to V5.

The amplifier is conventional, but care must be taken to minimize low-frequency phase shift by making the coupling capacitances adequate in relation to the coupled circuits. Parasitic oscillation is possible with some layouts, and in the preliminary trials 100 pF had to be used across R_7 .

Turning to the frequency control there was the question of capacitance versus resistance variation. Most designers favour capacitance as the continuously-variable element, for the sake of smoothness of control. But even if two 4-gang capacitors are coupled together

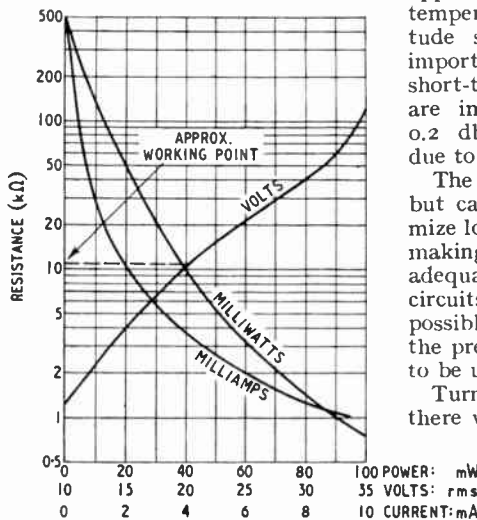

Fig. 4. Characteristics of Standard Telephones thermistor Type A5513/100 (R_3 in Fig. 1).

the associated resistance has to run into megohms to get down to 20 c/s, and the whole system has to be carefully screened to exclude hum. All this, especially the coupled drive, is a considerable mechanical problem, and the result is inevitably bulky. The writer, disliking both mechanical problems and high-impedance circuits, eventually settled on variable resistance.

Incidentally, one advantage of resistance over capacitance control is that the scale is spread over about 300° instead of being confined to 180°.

For convenience, the capacitances were made 0.1, 0.01, and 0.001 μF , so for ranges of 20-200, 200-2,000, and 2,000-20,000 c/s

The three decade logarithmic frequency ranges together correspond with the graph paper usually used for frequency characteristics.

Suitable ganged potentiometers can be obtained from Reliance Manufacturing Co., Sutherland Road, London, E.17, or Colvern, Mawneys Road, Romford. Values over 50 k Ω are not available with semi-log windings in the smaller sizes, and the larger ones, which are also desirable for precise frequency control, are several times more expensive—in the region of £2 per gang. If a slightly lower standard of setting is acceptable, the ordinary 3-watt type can be substituted, with resistance values multiplied by $\frac{5}{3}$ and capaci-

ties multiplied by 1.5. The minimum phase shift and distortion, was chosen as the buffer stage between the oscillator and output terminals.

To exclude d.c. from the load, the arrangement shown in Fig. 5 was adopted, in which R_L , the load resistance, is separated from R_k , the valve feed resistance, by a capacitance large enough to have negligible impedance compared with R_L at the lowest frequency. The optimum values of R_L and R_k for maximum undistorted power in R_L do not seem to be given in the literature of the subject; but according to the writer's calculations, confirmed by experiment, they are equal to r_a and $\sqrt{2}r_a$ respectively, where r_a is the nearest linear approximation to the I_a/V_a curve of the valve at the grid bias where grid current starts. In the present

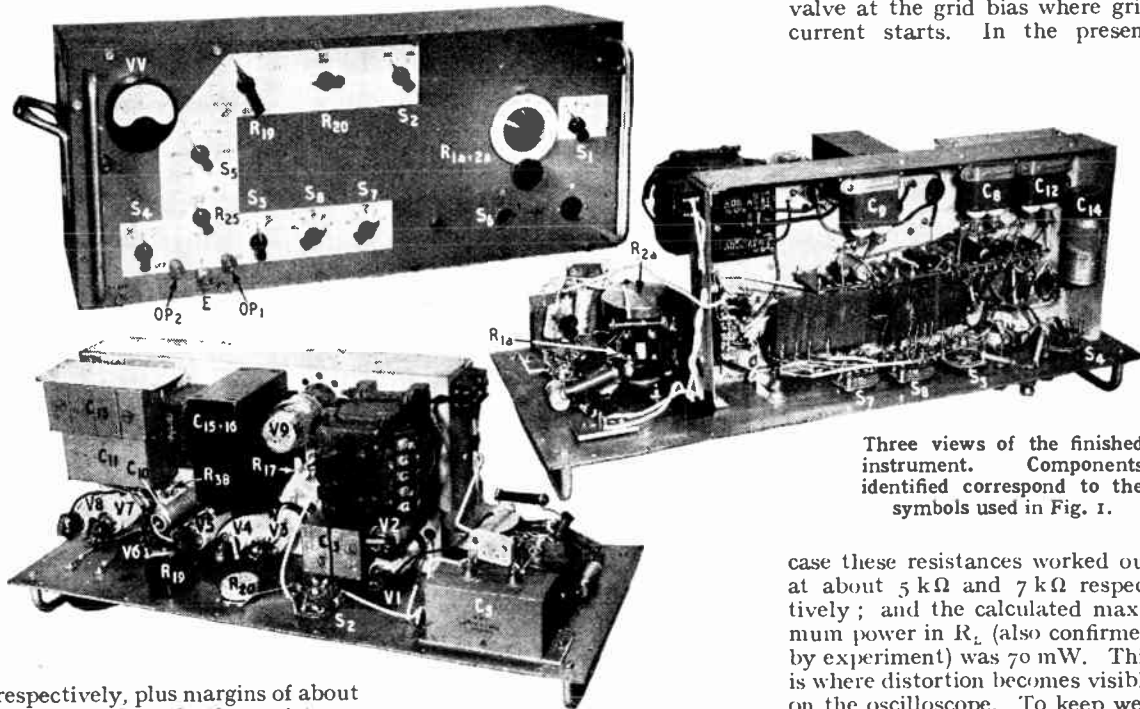

Three views of the finished instrument. Components identified correspond to the symbols used in Fig. 1.

respectively, plus margins of about 8% at each end, the resistance range worked out at 7.5 k Ω fixed and 80 k Ω variable. The graph of resistance against angular setting to give a logarithmic scale of frequency was found to be almost identical with the commercial potentiometer characteristic known as semi-log. If the frequency control is to be of the type in which a pointer moves over a fixed scale, then in order to have a scale with frequency increasing clockwise an "inverse semi-log" potentiometer is necessary.

tances by $\frac{5}{3}$. One must then look out for a tendency to overload V_2 at the high-frequency end of each range, as the impedance of the RC chain goes down to 10 k Ω .

Output Stage.—Preservation of waveform was considered more important than high power; one can always obtain the latter with a separate power amplifier, but waveform once lost cannot readily be restored. So a cathode follower with its high input impedance, low output impedance and mini-

case these resistances worked out at about 5 k Ω and 7 k Ω respectively; and the calculated maximum power in R_L (also confirmed by experiment) was 70 mW. This is where distortion becomes visible on the oscilloscope. To keep well away from this overload point the normal output was rated as 40 mW (20V peak across 5 k Ω). If desired, it would be quite easy to raise this to 50 mW in order to agree with a widely adopted standard, either by a slight increase in anode voltage or by accepting a lower but still very good purity of waveform.

About 50% greater undistorted voltage is available on open circuit.

(To be concluded.)

ELECTRONIC CIRCUITRY

Selections from a Designer's Notebook

By J. McG. SOWERBY

(Cinema Television Ltd.)

LAST month ring counters were discussed, and it was shown how a counter of any division ratio consisting of the product of numbers not exceeding seven could be arranged. This month we shall discuss how a counter of any scaling factor may be designed starting with an appropriate chain of scale-of-two counters.¹

Electronic Counters (Concluded)

If we start with three scales of two in cascade, we shall have a total scaling factor of eight; and there will be eight possible different combinations of conducting (or non-conducting) valves in the three stages. We may give each of these combinations (or states) a letter, thus A, B, C, D, E, F, G, H, A, B, and the states will follow one another in the order given. Now if a scaling factor of seven is required, then we must arrange matters so that one of the states is missed—say A

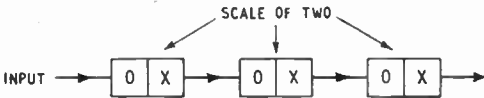

Fig. 1. Scale of eight in state A.

—so that the sequence of states becomes: B, C, D, E, F, G, H, (A), B, C, and the state which is missed is shown in brackets. Similarly to obtain a scaling factor of six the required sequence is C, D, E, F, G, H (A, B), C, D, and for five D, E, F, G, H, (A, B, C), D, E

If S is the number of states resulting naturally from a chain of a scale-of-two counters, S may have values of 2, 4, 8, 16, 32, 64, 128 If N is the required scaling factor then (S-N) states must be missed. To obtain a scaling factor of N=23 for example, one begins with a chain of scales-of-two having a natural scaling factor in excess of 23, by as small

a margin as possible—and in this case S=32. Then (S-N)=(32-23)=9 states must be missed. For illustration of the method we shall confine ourselves to S=8, as this is a sufficiently large number to indicate the principles involved, and in addition by arranging for three states to be missed a value of N=5 is obtained.² This is particularly valuable as a scale of five in association with another scale of two forms a scale of 10, or counter decade.

Fig. 2. Block diagrams, modified scale of eight.

As we have already discussed a scale of two, interest is now centred on the means whereby particular states in a chain of scales of two can be arranged to be missed. Let us first therefore draw up a table showing what combinations of conducting and non-conducting valves correspond to the eight possible states in the chain of three scales of two schematically in Figure 1. This shows three rectangles each of which is divided into two, so that each square corresponds to one valve in a scale of two. We may begin with all the left-hand valves conducting—indicated by (O) and all the right-hand ones non-conducting—indicated by (X). In drawing up the table we may confine our attention to the left-hand valves only, and indicate whether each one is conducting (O), or not (X). Thus:

TABLE.

		Three Scales of 2.											
		A	B	C	D	E	F	G	H	A	B	C	
L.H.	1st Scale of 2 ...	O	X	O	X	O	X	O	X	O	X	O	
L.H.	2nd Scale of 2 ...	O	O	X	X	O	O	X	X	O	O	X	
L.H.	3rd Scale of 2 ...	O	O	O	O	X	X	X	X	O	O	O	

There are eight possible states —A to H inclusive— after which the sequence repeats. On closer inspection we see that in the last scale of two (the third in this case) (X) changes into (O) only at one point in the sequence; in changing from states H to A, in fact.

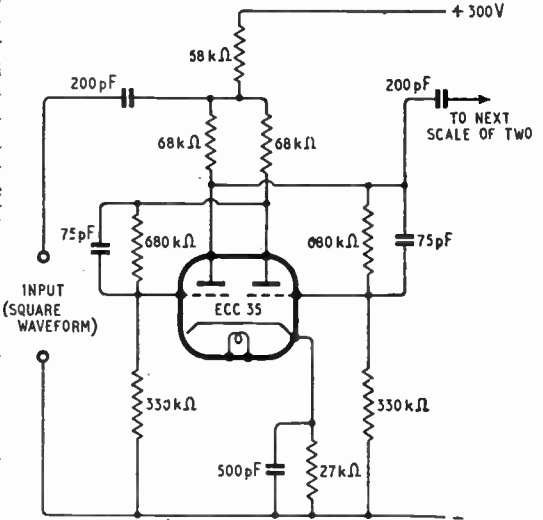

This is not true of any of the other scales of two, and means simply that one pulse of a particular polarity can be obtained from the last scale of two once at the completion of each sequence of eight states.

Now suppose that we wish to have a scaling factor of seven so that, as already noted, state A is to be missed; when the circuit falls into state A it must be automatically altered to B. States A and B differ only in the condition of the first scale of two, so that to alter A to B the first scale of two must be reversed. This reversal may be carried out by injecting the pulse (derived from the last scale of two in changing from H to A) into the first scale of two in

² I. E. Grosdorff, R.C.A. Review, Sept., 1946.

¹ Blume, R. J., Electronics, Feb., 1948.

such an asymmetrical manner as to make the left-hand valve non-conducting. If this is done we obtain the block diagram of Figure 2 (a).

Again if a scaling factor of six is required, two states—A and B—must be missed. As H changes into A a pulse is derived from the last scale of two, and this is used to change state A automatically into state C. Now A and C differ only in the condition of the second scale of two into which the feedback pulse must be introduced asymmetrically as shown in Figure 2 (b). As the first scale of two remains unaltered in this arrangement it follows—as might have been expected—that the scale of six is built up of the first scale of two and a scale of three formed by the last two scales of two when the feedback has been added. Thus in arranging a scale of six we have also derived a scale of three.

Similarly if a scale of five is required, three states—A, B, and C—must be missed, and to convert A into D both first and second scales of two required to be reversed. The pulse from the last scale of two is then fed asymmetrically into both the previous scales of two as shown in Figure

If we take the reduction of scaling factor a step further to obtain

pulse and this technique is of value in flexible circuits of variable scaling factor. A delayed feedback pulse is required when N is equal to or less than $S/2$. In circuits of fixed scaling factor, the difficulty need never arise, as if $N \leq S/2$ one or more scales of two can simply be removed from the circuit.

A scale of five circuit incorporating the feedback described is shown in Figure 3, and here

Fig. 4. Practical scale of two for low frequencies.

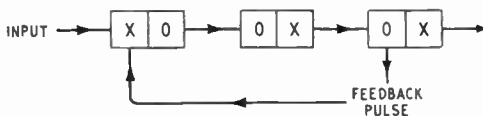

(a) SCALE OF SEVEN IN STATE F

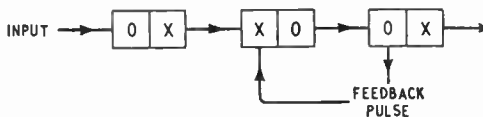

(b) SCALE OF SIX IN STATE C

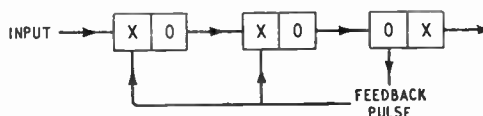

(c) SCALE OF FIVE IN STATE D

a scale of four a difficulty arises, as we shall then require states A, B, C and D to be missed, so that the sequence is E, F, G, H, E, F This requires that the third scale of two shall be reversed and since this reversal is caused by a pulse derived from the same scale of two, direct feedback of the pulse cannot be used, as the

each double triode and its associated components forms a scale of two. The feedback is applied asymmetrically at the grids of the first and second scales of two from one anode of the last scale of two.

For those readers who may wish for some initial guidance in experimental work, Figure 4 shows a practical scale of two, capable

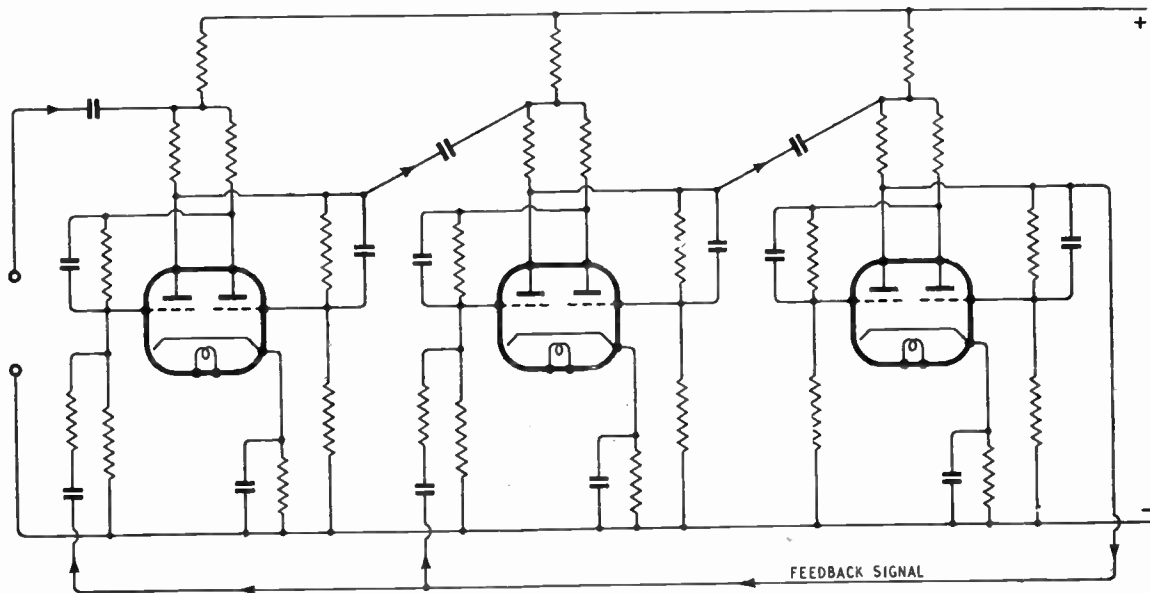

Fig. 3. Schematic circuit of scale of five.

2 (c). By prefacing this scale of five with another scale of two a counter decade is obtained.

pulse will then neatly cancel itself out. The difficulty can be overcome by delaying the feedback

of being cascaded without buffers, which is designed to operate at frequencies not exceeding 10 kc/s.

Electronic Circuitry—

In wiring care must be taken to keep stray capacitances to as low a value as possible, and it is desirable to wire the anode-grid coupling components directly across the valveholder. Matched pairs of resistances should be used where

Fig. 5. Circuit arrangement for frequency measurement.

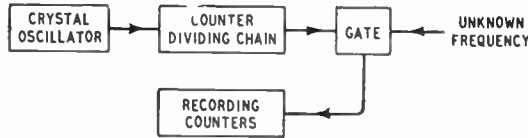

symmetry is desirable—i.e., in the anode loads and the cross-coupling networks. High stability resistors should be used for maximum reliability.

Having designed a counter of a particular scaling factor, one state is then allotted the figure nought, and then subsequent states are allotted numbers 1, 2, 3, 4 up to the scaling factor. It is usually convenient to be able to reset the circuit to nought, and this may be done by arranging for the valves to be forced into the state corresponding to nought either by applying a positive bias to those grids of valves required to be conducting, or by applying negative bias to those required to be cut-off. The bias may be applied on the depression of a push-button switch.

It is often desirable that the state existing in the circuit at any instant shall be indicated. The simplest and most usual way of arranging this is to associate a miniature neon indicating lamp with each scale of two to show which valve is conducting. Alternative methods of indication using milliammeters and cathode ray tubes are sometimes used.

The applications of counters

are many and various. One which may be of interest to readers is shown in Figure 5. This represents an arrangement for the accurate measurement of frequency. The reference standard is a crystal oscillator which is frequency

divided by a counter chain to produce pulses at 1 c/s. These are fed into an electronic gate which remains in its "open" condition for exactly one second. During that second the recording counters

are allowed to count individual cycles of the unknown frequency, so that at the conclusion of the second the unknown frequency is displayed on the indicators associated with the recording counters. The gate may be designed so that having once remained "open" for one second and closed again, it remains closed until reset manually. By this means the unknown frequency can be sampled for one second and the result displayed until reset manually. The method is limited to frequencies not exceeding the maximum repetition rate of the recording counters (about 1 Mc/s with present techniques), but within these limitations the method is extremely rapid and convenient.

MANUFACTURERS' LITERATURE

CATALOGUE of aluminium and aluminium-alloy wire from the Aluminium Wire & Cable Co., Ltd., 10, Buckingham Place, London, W.1.

Illustrated leaflets describing the Baird a.c./d.c. portable television receiver and the Scophony-Baird magnetic tape sound recorder for use with sub-standard film projectors, from Scophony-Baird, Ltd., Lancelot Road, Wembley.

Information leaflets (Nos. 1 to 4) dealing with neon test prod, appliance switches, fuses and plug-in ignition interference suppressors from A. F. Bulgin, Bye Pass Road, Barking, Essex.

Leaflet describing the Model 8903 record player unit, from the Marconiphone Co., Hayes, Middlesex.

Comprehensive catalogue of "Somerset" chokes and transformers, from Gardner's Radio, Somerset, Christchurch, Hants.

Catalogue of television receivers for 1949-50 season from the General Electric Co., Magnet House, Kingsway, London, W.C.2.

Leaflet describing the Axiom 22, twin diaphragm, 20-watt loudspeaker and H6, 30-watt output transformer, from Goodmans Industries, Lancelot Road, Wembley.

Catalogue and price list of electrical meters from Taylor Electrical Instruments, 419-424, Montrose Avenue, Slough, Bucks.

The following new illustrated lists have been received from Marconi's Wireless Telegraph Co., Chelmsford: SL14/2, d.f. equipment; SL17/3, 500W transmitters; SP5, v.h.f. communication equipment; SP14, television equipment; D19, type U19 valve; SP7/3, transmitting and power rectifying valves; SP8/3, receiving and rectifying valves.

"Television Aerials," a booklet on choice of types and methods of installation, from Philips Electrical, Century House, Shaftesbury Avenue, London, W.C.2. Also leaflets describing Philips 25-W and 50-W amplifiers; type 9816T 6-W horn loudspeaker; and "Voxinobile" p.a. equipment.

Brochure dealing with fabricated plate electrolytic capacitors made by the Plessey Co., Components Division, Ilford, Essex.

Catalogue V-549 of "Variac" auto-transformers from Claude Lyons, 180, Tottenham Court Road, London, W.1.

Illustrated leaflet describing "Telrad" high-quality radio-gramophone, from Telrad Electronics, 70, Church Road, Upper Norwood, London, S.E.19.

Specification and technical details of Model RA101 schools broadcasting equipment, from Trix Electrical Co., 1-5, Marble Place, Tottenham Court Road, London, W.1.

List of d.c.-a.c. vibratory converters from Valradio, Ltd., 57, Fortess Road, Kentish Town, London, N.W.3.

Catalogue, with long technical introduction, entitled "Electrical Standards for Research and Industry" from H. W. Sullivan, Ltd., Lee Street, Peckham, London, S.E.15. For limited circulation only.

Catalogue of electrical, radio and television components from Mullard Electronic Products, Century House, Shaftesbury Avenue, London, W.C.2.

Leaflet describing "Eta" Series 111 permeability-trimmed i.f. transformers from Electro Technical Assemblies, 109, West Hill, St. Leonards-on-Sea.

"Report, 1948-49": financial report and illustrated record of achievements of the company for the year from Pye, Ltd., Cambridge.

MORE COPIES OF "WIRELESS WORLD"

As already announced, the Government's decision to increase the allowance of paper for technical periodicals makes it possible to print more copies of *Wireless World*. Starting with this issue there should be enough for all anticipated requirements. But the number of copies will still be limited, and so it will be necessary for an order to be placed with a newsagent.

THE "BELLING-LEE" PAGE

Providing technical information, service and advice in relation to our products and the suppression of electrical interference

Lightning Protection

At this time of year we constantly receive anxious enquiries as to the risk involved in having a television dipole* or "Skyrod" **2 aerial on the roof. We have not the slightest hesitation in stating that the chances of trouble are negligible.

Any "Belling-Lee" aerial, or radio or television receiver connected thereto is insured for the sum of £100 against damage by lightning. This applies in the event of there being no collateral insurance or after existing cover has been exhausted. This operates for one year after the date of purchase by the ultimate user no matter where purchased or by whom installed. If insurance companies considered aerials a risk, they would not be slow in calling for increased premiums.

We have been making and installing television aerials since the advent of television and of the total of all makes installed a very high proportion are of "Belling-Lee" manufacture, but we have no record of a single claim of damage by lightning, and we do not suggest that other makes of aerials are more likely to be struck. As things are at present we feel quite safe in suggesting that there must be more dwellings without aerials struck by lightning than vice-versa, but only because there are a greater number of such dwellings.

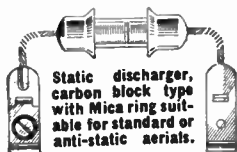

Static discharger, carbon block type with mica ring suitable for standard or anti-static aerials.
Manufactured by BELLING & LEE Ltd.
List No. L.350 selling at 9/6d.

Now Let Us Deal With Television Aerials*

It is almost impossible to envisage conditions which would set up an excessive potential difference between the two elements of a television

dipole, and consequently we need only concern ourselves with voltages which may develop between the dipole elements and earth. In some cases, where an unbalanced feeder is employed, one dipole element is connected to the earth, via the receiver, and there is no reason why the earthy conductor of the feeder should not be independently connected to a safety earth outside the building. This, however, would not really afford any advantage, since the unearthed element, which is usually the upper one, requires some other form of protection.

Obviously, any method of protection must take the form of a path to earth which only becomes operative when the potential of the conductor to be protected rises above a certain value. This points to some form of spark-gap. In a television aerial a built up charge would spark across the dipole insulator, and it is only necessary to earth the cross-arm

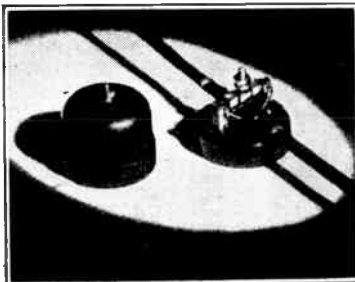

Another type of static discharger specially designed for use with Television aerials and "Belling-Lee" Twin-Feeder **3. List No. L376. Price 7/6d.

of the aerial in order to implement this form of protection. In theory, this method should be of greater value than a spark-gap placed in the feeder at, say, the point of entry into the house, since in such an arrangement the heavy discharge currents would have to flow through the conductors of the feeder, and might thus cause them to fuse. Smaller charges would leak to earth harmlessly in the cable.

In a normal installation we do not earth a crossarm or metal pole directly, because it all puts up the

Will those in coastal towns, fishing ports, yachting centres etc., bear in mind that "Belling-Lee" are specialising in suppression on board ship. We have done such work on ships of all sizes from the "Queen" class to trawlers, drifters and yachts.

cost of an already relatively expensive installation, and we do not consider the risk warrants even the extra few shillings. Instead we insure them all for £100. But, as mentioned above, where it is necessary to calm down an over anxious user, or in order to comply with a particularly fussy specification, the crossarm and/or metal pole may be earthed independently, with a copper conductor going to solid earth by the most direct route, and not round corners, nor entering the building.

If this conductor is as heavy as some authorities would like, its cost will be many times that of the most expensive television aerial installation.

- *1. "Viewrod" (Regd. trade mark) television aerial "H" type for chimney mounting L502/L London, £6/6/-. L652/LM Midland, £6/5/-. Simple dipole for chimney mounting L501/L London, £3/12/6. L647/L Midland, £3/5/-. "Veerod" (Regn. applied for) Inverted "V" television aerial chimney mounting L606 London, £4/10/-. L635 Midland, £4/2/6.
- *2. "Skyrod" (Regd. trade mark) 18 foot vertical aerials L638 collector, chimney mounting, £4/4/-. L638/K plus "Eliminoise" equipment, £10/-/-. L638/C collector mast mounting, £3/-/-. L638/CK plus "Eliminoise" equipment £8/15/-.
- *3. Balanced twin feeder. L336 un-screened 7½d. per yard. L1221 screened 1/9d. per yard.

BELLING & LEE LTD
CAMBRIDGE ARTERIAL RD. INFIELD, MIDD. ENGLAND

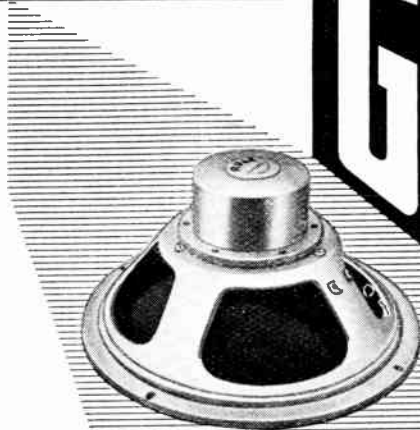
ROLA**G12**

Maximum sensitivity with uniform frequency response from a more compact speaker, appreciably reduced in weight—that is what Rola technicians have achieved with the new G.12. Special features include dust-proof suspension completely protecting coil and magnet gap and the powerful Alcomax II magnet. Write for details and also for particulars of Rola 3" and 4" P.M. models, dust-proofed and equipped with Alcomax II magnets.

**best
of the
BIG
speakers**

BRITISH ROLA LTD. · FERRY WORKS · SUMMER ROAD · THAMES DITTON · SURREY
Telephone : EMBERBROOK 3402 (5 lines)

"THE DX PLUS ONE FEEDER UNITS AND THE DX PLUS SEVEN QUALITY CHASSIS"

by the Specialists for Feeder Units and Chassis since 1934

Sound Sales Limited

PRICE
£15
plus P.T.

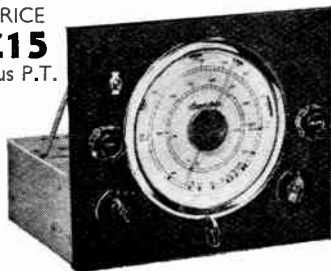

Remember that the products of SOUND SALES LTD., are guaranteed for 12 months, in accordance with the guarantee issued.

PRICE
£25
plus P.T.

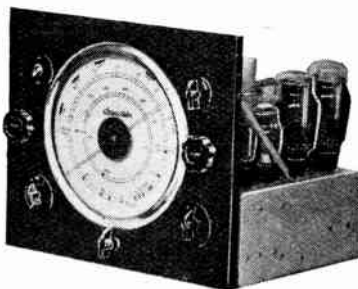

Like the Phase Inverter Speaker, flattered by imitation, the Feeder Units and Chassis by Sound Sales Ltd., can usually be found as the Heart of most Quality Equipment.

Unique features include, the latest dial of no less than 8½ in. diameter, and tandem coupled variable selectivity, etc.

Particulars and Demonstrations from our London Office at

57 ST. MARTIN'S LANE, LONDON, W.C.2. TEMple Bar 4284

Works : West Street, Farnham, Surrey. Farnham 6461-2-3

WORLD OF WIRELESS

B.B.C. Inquiry ♦ Television Progress ♦ U.S. Citizens' Radio ♦ New B.B.C. Station

Broadcasting Committee

THE committee set up by the Government to consider the constitution, control, finance, etc., of the broadcasting service in this country has been officially called the Broadcasting Committee, 1949.

The first meeting of the committee was held on June 24th under its new chairman, Lord Beveridge. It has been officially stated that the committee will be glad to receive representations from organizations and individuals on matters falling within its terms of reference. These should be sent to the Secretary, Broadcasting Committee, G.P.O. Headquarters, London, E.C.1, not later than October 1st.

Midland Television

TEST transmissions from a mobile transmitter set up in three centres within the area to be served by the Sutton Coldfield station, are to be radiated for the next two months in order to give dealers an opportunity of testing receivers.

The transmitter will operate for two or three weeks from a site in Birmingham and will then go on to

Wolverhampton and Coventry. A still image will be transmitted on the vision frequency to be used by Sutton Coldfield (61.75 Mc/s) with a power of about 1 kW. The transmissions should have a range of a little more than five miles. One of the B.B.C. O.B. transmitters with a "fire escape" aerial will be used for these tests, which will begin about the middle of August and continue until just before the Sutton Coldfield station opens—probably in November.

Third Television Station

ALTHOUGH official confirmation has not yet been given to the rumour that the B.B.C.'s third television station will be at Holme Moss, near Huddersfield, it is known that it is the chosen site so far as the B.B.C. is concerned.

Tests were carried out by B.B.C. engineers some months ago at a number of sites in the north-east, and the final choice was Holme Moss. Approval has, however, still to be received from various Government departments.

Some idea of the anticipated service area to be provided by the



NORTH - EAST TELEVISION—
All the towns shown on this map are expected to come within the service area of the proposed television transmitter at Holme Moss.

station can be gained from our sketch map. Holme Moss, which is 1,750 feet above sea level, is on the borders of Cheshire and Yorkshire. With the introduction of this third transmitter it is anticipated that the country's potential television audience will be about ten million.

Communication Networks

THE problems arising in communication networks which utilize more than one method of transmission are most acute at those places where the different methods join up. Radio-telephone terminal units produced by the Marconi Company, in collaboration with Siemens Brothers, have been designed to minimize the special problems of linking radio and land-line transmissions. They ensure stability of signal and provide facilities for controlling the signal level, for discriminating against line and radio noises and for rendering conversation unintelligible to unauthorized listeners.

Twenty-two of these units, which embody the most recent circuit designs and practice of the G.P.O., have been ordered by Cable and Wireless. They can be remotely controlled and a number of terminals can be handled simultaneously from a central control.

Citizens' Radio

REGULATIONS were recently introduced by the F.C.C. for the licensing of citizens' radio stations as an established service. They have, up to now, been operating as experimental transmitters.

Under the new rules, any American citizen of 18 years of age or over may obtain a five-year licence to operate a station in the

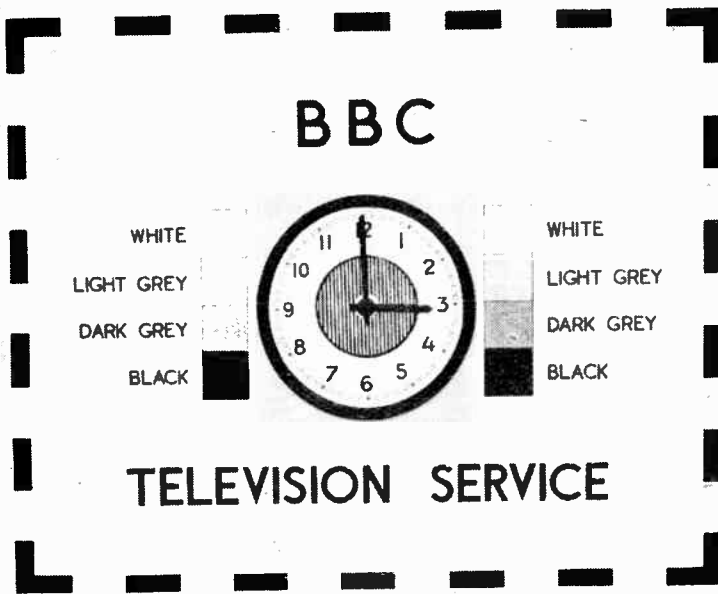

TELEVISION TUNING SIGNAL—This visual tuning signal is now being radiated by the B.B.C. prior to each programme. The monotone tuning note has been replaced by a specially composed tune.

World of Wireless—

460 to 470 Mc/s band. Two types of station, with powers of 10 and 50 watts, are authorized. Operation is limited to 'phone unless the licensee also holds a telegraphy licence.

The operation of "citizens' radio" differs from our "business radio" in that in this country one of the stations must be mobile. Moreover, there does not appear to be any provision to limit its use to purely business concerns—it is for "Sam Citizen."

East Anglian Transmitter

THE new B.B.C. station at Postwick Grange, near Norwich, which was opened last month, has an interesting aerial system. Two 126ft tubular steel mast radiators, spaced 240 feet apart, which is $\frac{1}{4}\lambda$ at the operating frequency of 1.013 kc/s, are used. The easterly mast is energized, the power being conveyed to it over a 6-wire feeder, whilst the other mast, which is not energized, acts as a parasitic reflector. Each mast is insulated from the ground and is connected to its nearby tuning house.

Between the mast heads are stretched two parallel wires, the end sections of which act as capacity tops and increase slightly the electrical lengths of the masts.

The present power of the new transmitter is 5 kW. Under the Copenhagen Plan it is permitted to use 20 kW.

European Broadcasting

ACCORDING to the latest survey of the International Broadcasting Organization, 195 frequencies between 150 and 1,600 kc/s were occupied by broadcasting stations at the beginning of this year. Some of these frequencies are used by as many as seven countries.

A chart published in the O.I.R. Bulletin shows that there were at that date 331 utilizations—that is, the use of a frequency by a country whether for one station, synchronized network or a number of low-power transmitters. The total is 10 less than that recorded six months earlier. The number of actual stations operating in this band is said to be approximately 426.

Colonial Broadcasting

ONE million pounds has been earmarked for the development of Colonial broadcasting services from the funds provided under the Colonial Development and Welfare Act. This was stated in the House of Commons in response to a question on the extension of the broadcasting systems in the Colonies.

It was further stated that a complete survey of the broadcasting needs of the four West African Colonies has just been completed; a wire rediffusion service designed to serve 10,000 homes has been opened in Hong Kong and that a detailed broadcasting system for Cyprus has also been prepared. The Northern Rhodesian Government is installing a higher-powered transmitter, and some thousands of cheap receivers, specially designed by a British manufacturer, were being made available to African listeners.

Slow Morse

THE latest schedule of slow morse transmissions radiated regularly by members of the R.S.G.B. and organized by C. H. L. Edwards (G8TL) is given below. The times are B.S.T.

Sundays	
09.50 1840 kc/s	G6NA (Guildford).
20.30 1802 kc/s	G2D1J (Derby).
Mondays	
13.00 1870 kc/s	G3AXN (Southend-on-Sea).
20.00 1900 kc/s	G2AJU (Stutton, Ipswich).
20.00 1820 kc/s	G3BHS (Eastleigh, Hants).
20.00 1800 kc/s	G2DJS (Bradford).
20.00 1750 kc/s	G3DSR (Derby).
21.00 1900 kc/s	G2BLN (Bournemouth).
21.00 1850 kc/s	G8VR (London, S.E.2).
Tuesdays	
13.00 1870 kc/s	G3AXN (Southend-on-Sea).
22.00 1896 kc/s	G8TL (Hford).
22.30 1896 kc/s	G4GA (Chingford).
22.30 1820 kc/s	G6JB (Salcombe, Devon).
23.00 1820 kc/s	G34AN (Kirkcaldy).
Wednesdays	
20.00 3625 kc/s	PAOAA (Hilversum, Holland).
20.00 1783 kc/s	G3AFD (Southampton).
22.00 1800 kc/s	G3DLC (Grays).
22.00 1840 kc/s	G6NA (Guildford).
Thursdays	
13.00 1870 kc/s	G3AXN (Southend-on-Sea).
22.00 1873 kc/s	G2BCX (South Woodford).
22.30 1873 kc/s	G3ARU (South Woodford).
22.30 1803 kc/s	G30B (Manchester).
Fridays	
13.00 1870 kc/s	G3AXN (Southend-on-Sea).
19.00 1900 kc/s	G3BLN (Bournemouth).
20.00 1900 kc/s	G2AJU (Stutton, Ipswich).
20.00 1820 kc/s	G3BHS (Eastleigh, Hants).
20.00 1860 kc/s	G3AKW (Wirral).
20.30 1868 kc/s	G8LZ (Gravesend).
22.30 1820 kc/s	G6JB (Salcombe, Devon).
23.00 1820 kc/s	G34AN (Kirkcaldy).
Saturdays	
23.00 1800 kc/s	G3CHY (Ashton-u-Lyne).

OBITUARY

It is with regret that we record the death of C. B. De Soto, technical editor of the *Proceedings of the I.R.E.* and former editor of *OST*, at the age of 37. He was for sixteen years on the headquarters staff of the American Radio Relay League prior to accepting the editorship of the *Proc.I.R.E.* in 1945.

We also record with regret the sudden death of J. A. Corbett, the secretary of the Guild of Radio Service Engineers. He has been associated with the Guild from its earliest days.

René Mesny, professor at l'Ecole Supérieure d'Electricité of France,

who died on June 8th, was one of the pioneers of French radio, having been a close collaborator with General Ferrié. He was a specialist in direction-finding and author of many published works on fundamental research.

PERSONALITIES

Professor E. B. Moullin, M.A., Sc.D., professor of electrical engineering at Cambridge University, has been elected president of the I.E.E. for the ensuing year. He was chairman of the Radio Section for 1939-1940. Professor Moullin was lecturer at Cambridge from 1920 to 1929, during which time he established the electrical laboratory. His researches include work on radio-frequency measurements, dielectric losses and background noise in radio receivers.

Professor Willis Jackson, D.Sc., D.Phil., who has been head of the Electrical Engineering Department of the Imperial College of Science since 1946, has been elected a member of the I.E.E. Council. For eight years prior to going to the Imperial College he occupied the chair of electro-technics at Manchester University. He is a member of the Ministry of Supply Advisory Council on Scientific Research and Technical Development and of the B.B.C. Scientific Advisory Committee.

J. A. Saxton, Ph.D., B.Sc., A.R.C.S., who is in the Radio Division of the N.P.L., has been elected to the I.E.E. Council. Prior to going to the N.P.L. in 1938 Dr. Saxton was on the staff of the Physics Department at the Imperial College of Science. During the war he was Radio Liaison Officer at the British Commonwealth Scientific Office in Washington. His researches include investigations into the propagation of v.h.f. and the dielectric properties of liquids at microwaves.

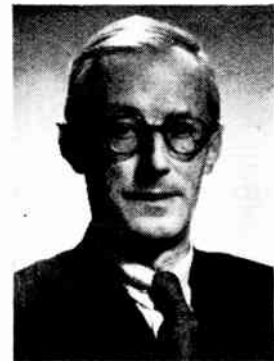

PROF. E. B. MOULLIN, new I.E.E. President.

Sir George Nelson, chairman of the Marconi Group of Companies, has been elected a member of the I.E.E. Council.

Dr. E. C. Bullard, M.A., F.R.S., Professor of Physics in Toronto University, has been appointed director of the National Physical Laboratory in succession to Sir Charles Darwin,

K.B.E., Sc. D., F.R.S. During the war Prof. Bullard was concerned with the degaussing of ships against the magnetic mine and with measures to combat the acoustic mine. From 1944 to 1945 he was Assistant Director of Naval Operations at the Admiralty. He went to Toronto in 1948.

H. G. Whiting, who has been appointed engineer-in-charge of the Sutton Coldfield television station, joined the B.B.C. in 1932. He was for a short time at the Chelmsford experimental Empire station (G5SW) and then went



H. G. WHITING, Midland Television E.-in-C.

to the Daventry short-wave station. When the B.B.C. television service started in 1936 he transferred to Alexandra Palace. After serving at one of the overseas transmitters during the war he returned to A.P. as senior service maintenance engineer (studios). Before joining the B.B.C. he was with Western Electric (now S.T.C.) from 1921.

E. M. Deloraine, a director and vice-chairman of Standard Telecommunication Laboratories—the research organization of Standard Telephones and Cables—at Enfield, has received the degree of Doctor of Engineering from the University of Paris. He joined the London staff of Western Electric (now S.T.C.) in 1921 and became European technical director of the company in 1933.

W. J. Gray has retired from the post of assistant general manager of the Canadian Marconi Company which he joined in 1906. Prior to going to Canada he was six years with the G.P.O. and two years with the Marconi International Marine Communication Co. He was officer-in-charge at the Cape Race station in April 1912 and handled the messages from the sinking *Titanic*.

Dr. V. K. Zworykin, vice-president and technical consultant of the Radio Corporation of America, has been awarded the Lamme Medal by the American I.E.E. for his work on fundamental television and electronic apparatus.

Oswald F. Mingay editor and publisher of the Australian journal *Radio Electrical Weekly*, who was organizing secretary of the World Radio Conven-

tion, Sydney, 1938, is now in this country. Mr. Mingay, who is studying technical developments in all branches of radio, is on a 12-months' tour of Europe and America.

D. A. Lyons, managing director of the Trix Electrical Co., is examining the latest trends and production techniques in the American radio industry during a six-week's visit.

A. J. E. Hoyten has been appointed manager of the Bristol branch of the Edison Swan Electric Company at 47 Colston Street. He has been with the company since 1929 and has been in charge of the radio division's maintenance sales at the company's head office since the war. **G. W. Natrass** has been appointed manager of the Newcastle branch and **A. H. Sutton** manager of the Manchester branch.

IN BRIEF

11,873,950 broadcast receiving licences, including 140,850 for television sets, were current in Great Britain and Northern Ireland at the end of May. The month's increases were 43,350 "sound" licences and 7,600 for television.

I.E.E. Radio Section.—No nominations other than those made by the Section Committee having been received to fill the vacancies occurring on the committee on September 30th, the following were duly elected:—chairman, R. T. B. Wynn, assistant chief engineer, B.B.C.; vice-chairman, Dr. D. C. Espley, G.E.C. Research Laboratories; A. W. Cole, Marconi's; Dr. H. G. Hopkins, D.S.I.R.; Dr. J. S. McPetrie, S.R.D.E.; Dr. R. A. Smith, T.R.E.; and H. Stanesby, P.O. Research Station.

I.E.E. Students.—The new vice-chairman of the committee of the I.E.E. London Students' Section is I. J. Shelley, of the B.B.C.



OSWALD F. MINGAY
(See Personalities).

Record Processing.—For the guidance of those who may wish to have pressings made from direct disc recordings, the Association of Professional Recording Studios has issued a pamphlet setting out the requirements of a good recording from the point of view of those who will have to process the

record and make the stamper. The author is E. B. Pinniger, F.C.S., and the title is "Recording Discs for Processing." Copies are available to non-members of the association and may be obtained from R. Cussins of Cussins and Light, Kings Square, York. The price, including postage, is 3d.

Business Radio.—Some of the concerns to which Marconi's have recently supplied or demonstrated "business radio" equipment include the Brighton Waterworks Department and the Grimsby Fishing Fleet. At Brighton 10-watt transmitter-receivers have been installed in the waterworks service and maintenance vans. The master transmitter is located at the reservoir and is remotely controlled over a G.P.O. line from the engineer's office two miles away. Marconi "Seaphone" v.h.f. gear was recently installed in a tug at Grimsby for passing on information regarding the requirements of the incoming trawlers to the pier-head and for receiving berthing instructions.

Tyre Tests.—A decrease of 6 db in background noise was registered during tests at Fort Dunlop recently when using a receiver on a car fitted with special conducting rubber tyres.

"Superheterodyne Television Unit."—It is regretted that there has been some delay in issuing the reprint of the articles published in the February and March issues giving details of a long-range unit for the reception of Alexandra Palace. This is now available from our Publisher, price 2s 6d, postage 2d. The modifications necessary to make this unit suitable for the reception of the Birmingham transmissions are described elsewhere in this issue.

More Hospital Television.—Two Marconi Image Orthicon television cameras with associated equipment were installed at University College Hospital, London, for this year's International Gynaecological Congress. Delegates were thus able to watch operations in progress without having to crowd into the small gallery. The 625-line apparatus worked on a closed circuit; viewing was by special Cintel receivers with 20-inch tubes.

Pye v.h.f. radio-telephony equipment has been ordered by the Ministry of Civil Aviation for the fire service at eighteen civil aerodromes. The equipment for each aerodrome comprises five sets—two master transmitter-receivers and three mobile sets. The sets operate in the 118 to 132-Mc/s aeronautical band and have an output of 12 watts. Each radio-equipped fire appliance has a loud hailer which is fed from the a.f. section of the receiver.

Irish Radio Exhibition, which has not been held for eleven years, is being revived this autumn. It will be held in the Mausion House, Dublin, from September 19th to 24th. The organizing secretary is J. J. McCann, of 67, Grafton Street, Dublin.

Now You Know!—"A radio engineer is a person who passes as an exacting expert on the basis of being able to procreate with prolific fortitude infinite series of incomprehensible formulae calculated with micrometric precision from vague assumptions based on debatable figures taken from inconclu-

World of Wireless—

sive experiments carried out with instruments of problematical accuracy by a person of dubious reliability and questionable mentality." Quoted in the *Journal of the Engineering Society of University College, London.*

G.R.S.E.—It is understood that consequent upon the death of J. A. Corbett, the secretary of the Guild of Radio Service Engineers, R. F. Howard is temporarily acting as secretary. Correspondence should continue to be sent to 37, York Road, Holland-on-Sea, Essex.

Amateurs' Choice.—The result of an analysis of the relative interests of members of a west-country amateur radio society in the various branches of radio makes interesting reading. Model control gear came first in order of preference, valves second, communications gear third, and high-fidelity equipment fourth.

Colonial Communications.—Cable and Wireless provided the equipment and operators for the "Round the Colonies by Cable" exhibition which has been held for the past six weeks in the *Daily Express* building in Fleet Street. Visitors were able to hand in written questions for certain Colonial stations, from which replies were received within a few minutes. Despite the title wireless was used for some of the routes.

Aiding Motorists.—In order to increase the operational range of the v.h.f. radio-telephone equipment installed at the H.Q. of the Automobile Association for communication with its breakdown vans, a 60ft tower has been erected on the roof of the building. Both the fixed and mobile stations, which were supplied by Marconi's, are crystal controlled and have an output of 10 watts.

Institute of Physics.—An increase of 187 in the membership of the Institute is recorded in the annual report. The total at the end of the year, including 818 students, was 3,455.

Metals and Alloys.—Although not directly concerned with radio, some readers may be glad to learn of the publication of a fifth edition of "Metals and Alloys," a 214-page book listing some 4,600 compositions. It is issued by the Louis Cassier Co., and distributed by our Publisher, price 15s.

Engineers' Guild now has a Western branch—the sixth—with headquarters in Cardiff.

FROM ABROAD

Denmark has ordered a new 100-kW medium-wave broadcast transmitter from Marconi's. The transmitter, which is expected to be operating by the end of next year, will be erected at Skive, Western Denmark.

U.S. Television Stations.—According to an F.C.C. analysis of the applications for licences for television transmitters over 31 per cent (which represents 128 stations) have been made by newspaper proprietors. The next highest in the list are broadcasting companies, 16 per cent (66 stations), and cinemas and theatres, 6 per cent (27 stations).

Navigational Aids.—Ten radio-beacon transmitters operating in the 200 to 415-kc/s band have been ordered by the Indian Air Force from Marconi's. The output of the WB8 transmitter, which is enclosed in a cabinet measuring 6ft by 5ft by 2ft 6in, is 2.5 kW on c.w. and 3.4 kW on m.c.w. Two 150ft masts are used to support a 4-wire 300ft top "T" aerial.



SYMBOLIC of British Radio. The Alexandra Palace television and f.m. aeriels are incorporated in the design of the Radiolympia poster.

Indian Amateurs have formed the Amateur Radio Club of India—for transmitters, and the Short-wave League of India—for non-transmitters. Headquarters are at Mhow, Central India, and the address of the QSL bureau is Post Office Box 6666, Bombay. A monthly journal, *QRZ*, is being issued jointly by these organizations for their members. Two transmitters have been installed at the headquarters with the call signs, VU2ARCI and VU2SWL; they operate in the 7, 14 and 28-Mc/s bands.

Popularizing F.M.—The suggestion is made by our New York contemporary, *Tele-Tech*, that American television receivers should cover the 88 to 108-Mc/s f.m. band. This would increase the potential audience for the service provided by the 750 or more f.m. stations.

INDUSTRIAL NEWS

Redifon, Ltd., is the new name adopted by Redifusion, Ltd., of Broomhill Road, Wandsworth, London, S.W.18. The change has been made to avoid confusion—the name Redifon having been the trade name of the company for some time, whilst the name Redifusion has been applied to the system of wire broadcasting operated by the Broadcast Relay group of companies.

New Trademark.—The Truvox Engineering Co. advises us that they have registered the trade name "Wafer" in respect of electro-acoustic and electro-mechanical transducer units for the recording or reproduction of sound.

Celestion.—An announcement from the Board of Celestion, Ltd., states that the company is going into liquidation preparatory to the business being sold.

Philco (Great Britain), Ltd., has vacated its premises at Greenford, Middlesex. All correspondence should be sent to 92, New Cavendish Street, London, S.W.1.

Steatite & Porcelain Products have transferred their London office to Victoria Station House, 191 Victoria Street, London, S.W.1. (Tel.: Victoria 7715.)

Ekco have closed their service depot at 14 Redcross Street, Bristol. Correspondence should now be sent to 1, Brook Street, Birmingham, 3.

CLUB NEWS

Birmingham.—At the meeting of the Slade Radio Society on August 19th the chief engineer of Radiovision, Ltd., will describe and demonstrate the "Commander" receiver. Members of the society are to visit the B.B.C. short-wave station at Daventry on August 21st. An inter-club direction-finding test is being organized by the society on September 18th. Clubs who wish to take part can obtain full particulars from the secretary. Meetings are held on alternate Fridays at 7.45 in the Parochial Hall, Slade Road, Erdington. Sec.: C. N. Smart, 110, Woolmore Road, Erdington, Birmingham, 23.

Carlisle.—Meetings of the Carlisle Amateur Radio Society are being held only once a month during the summer. The H.Q. is Richmond Hall, Y.M.C.A., Fisher Street, Carlisle. Although present members are all transmitters, the club intends to extend its activities to cater for beginners and those interested in short-wave reception. Sec.: J. Ostle, G2DYV, 2, Outgang, Aspatria, Cumberland.

Derby.—"Radio Interference" is the subject of a talk to be given by C. E. Woolley, of the G.P.O. Engineering Department, to members of the Derby and District Amateur Radio Society on August 17th at 7.30 in the lecture theatre, Derby School of Arts, Green Lane. Sec.: F. C. Ward, G2CVV, 5, Uplands Avenue, Littleover, Derby.

Edinburgh Amateur Radio Club has been formed, and regular weekly meetings are being held. Details of the club, which has a membership of 25, are obtainable from David A. E. Samson, 56, Elm Row, Edinburgh.

Southend.—A d.f. contest between the Romford and Southend societies is being held on August 28th. A philanthropic work undertaken by members of the Southend Radio Society is the provision of free receiver maintenance service for the local blind people. Sec.: J. H. Barrance, M.B.E., 49, Swanage Road, Southend-on-Sea, Essex.

TELEVISION RECORDING

Simplified System

By D. A. SMITH, (B.B.C. Television Service)

A BRIEF description of the system developed by B.B.C. engineers for making high-quality recordings of television programmes for subsequent transmission was published last year.* More recently a need has been felt at Alexandra Palace for a rather simpler and more economical system of television recording, intended primarily to enable producers to study their pro-

Three successive pictures from the film recorder are shown here; the sound track is on the left.

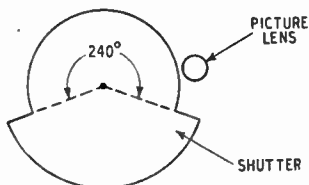
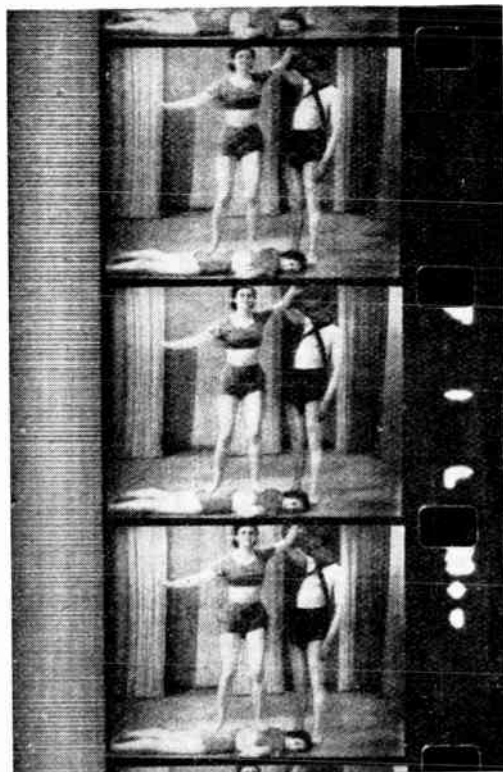

Fig. 1. The arrangement of the revolving shutter which permits an exposure during two consecutive frames and closes the lens during the third, is sketched here.

ductions after transmission and hold post-mortems on them. To meet this need, a system using standard 16-mm film, perforated on one edge and running at 16-2/3 frames per second, has now been developed and is being tried out at Alexandra Palace.

To record all the information on an interlaced television picture, one must be able to photograph consecutive frames; i.e., one odd-line scan and one even-line scan. The method now about to be described photographs two consecutive television frames, and misses the third frame, then photographs the fourth and fifth frames, and misses the sixth frame, and so on. To achieve this the film must remain stationary in the camera gate for at least twice as long as it takes to

move downwards to the next frame. The ratio of the period during which the film is being pulled down to that during which it is stationary is called the pull-down ratio, and it will be seen from the foregoing that this ratio must be 1:2 or greater. The pull-down ratio of most cameras is 1:1, but that of projectors is usually 1:3, which is quite suitable. It was, therefore, decided to modify a standard projector and use it as a camera, running in synchronism with the television transmission. This was achieved by driving the projector with a 3-phase motor running at 1,500 revolutions per minute and connected to the

the motor, so that the projector runs at 16-2/3 frames per second; i.e., a gear-down ratio of 3:2.

A projector was converted by fitting a shutter with an aperture or opening of 240° (Fig. 1) on to the projector-shutter shaft, the shaft having been extended so that the shutter revolves just in front of the lens. (Fig. 2.) In a period of one second fifty television frames are displayed and 16-2/3 film frames pass through

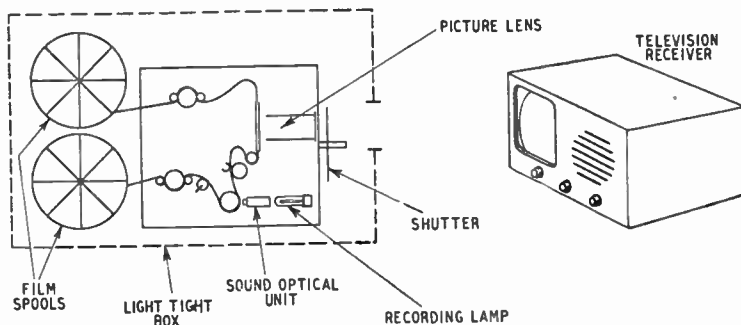

Fig. 2. Layout of the recording equipment.

main electricity supply, to which the television transmission is locked. The projector mechanism is suitably geared down from

the camera. The shutter opening of 240° allows two consecutive television frames to be photographed on one film frame, after

* B.B.C. Quarterly, Vol. III, No. 1, April 1948.

Television Recording

which the shutter closes during the third television frame and the film is moved down to its next position. The shutter next opens

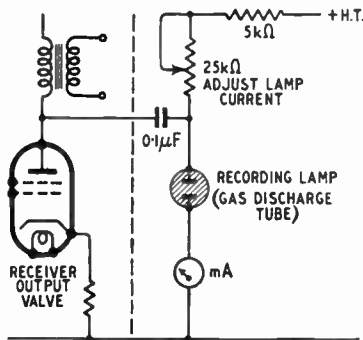

Fig. 3. Method of feeding the recording lamp for the sound signal.

while the fourth and fifth television frames are displayed and closes during the sixth frame and the film is again moved down. Thus two out of every three television frames are photographed. When the film has been processed and is projected on a standard projector having a three-bladed shutter and running at silent speed (i.e., 16 frames per second), very little flicker is apparent, and reasonably good reproduction of the television programme is obtained.

The sound system of the projector was modified to enable the sound component of the programme to be recorded on the film. This modification consists of replacing the exciter lamp with a gas-discharge recording lamp (Fig. 2), and reducing the width of the slit in the sound optical unit to less than $1/4,000$ inch, in order to permit frequencies up to 5,000 c/s to be recorded. The recording lamp is connected to the sound output valve of the receiver as Fig. 3.

With panchromatic film, it is essential that all sources of light should be shielded from the film. For this reason the entire projector is housed in a light-tight box. (Fig. 2). Using Kodak Super X panchromatic film, with a lens aperture of $f/1.9$, an excellent exposure can be obtained with an ordinary television receiver adjusted for normal viewing. Experiments have also

been made using Kodak Positive film (a film very sensitive to blue light, but insensitive to red light) and a receiver modified to give a negative image of rather greater brightness than usual. In this way a very good film negative can be obtained in a positive sense. There are many advantages in using positive film—a sharper picture can be reproduced because the grain size in the emulsion is very much smaller, and the frequency range of the sound track can be extended up to some 6,000 or 7,000 c/s. If the apparatus is set up in a dark room, and the light from the television receiver is screened from the projector and film spools, the projector need not be encased in a light-tight box, and a red safe light can be used while filming, which eases the operators' lot by enabling him to watch the progress of the film through the projector.

The silent speed of most 16-mm projectors is about 16 frames per second, and good television recordings can be made by increasing the

shutter aperture to an angle that is dependent on the film speed. The formula for calculating this angle is:—

$$\text{shutter aperture} = \frac{\text{film frame speed}}{\text{television frame frequency}} \times 360 \times 2 \text{ degrees}$$

Thus for a projector running at 16 frames per second in conjunction with the B.B.C. television service:—

$$\text{shutter aperture} = \frac{16}{50} \times 360 \times 2 = 231 \text{ degrees.}$$

Using Super X panchromatic reversal film, a transmission lasting one hour can be filmed at a cost of about £25. If positive release film is used the cost is only about £10 for an hour's programme.

This description has been confined to a system using 16-mm film, but the same system is equally applicable to 35-mm or 9.5-mm film. On 35-mm film, of course, a picture of rather better quality can be obtained, but the cost is much greater.

TELEVISION AERIAL TESTER

DESIGNED to measure the signal voltage appearing at the end of the aerial feeder, this instrument consists of a battery-operated 7-valve superheterodyne tunable over the range of 40-50 Mc/s. The

output is fed to a meter which is calibrated in microvolts. A three-range attenuator is included in the i.f. amplifier and the full range of $100 \mu\text{V}$ to 100 mV is thus obtained in three steps. A loudspeaker is included so that an audible signal can be obtained.

The instrument measures $9\frac{1}{2}$ in by $5\frac{1}{2}$ in by 13 in and weighs 18 lb including batteries. It was designed for Rediffusion Ltd. by British Communications Corp., Ltd., of Gordon Avenue, Stanmore, Middlesex, to which firm any enquiries should be addressed.



Rediffusion television aerial tester.

RUBY NEEDLES

GRAMOPHONE needles of the straight-shank, trailer and miniature type with ruby tips are being marketed by Brooks & Bohm, 90, Victoria Street, London, S.W.1. Ruby is a variety of corundum and belongs to the same group as sapphire, of which there are white and blue types, depending on the nature of the colouring impurity. Corundum has a hardness of 9 on the Mohs scale (diamond is 10) and there are slight variations according to the method of production. The makers claim that their ruby is superior to sapphire and will have a longer life.

The retail price is 7s 6d each.

Vortexion

SUPER FIFTY WATT

This **AMPLIFIER** has a response of 30 c/s. to 25,000 c/s. within $\frac{1}{2}$ db, under 2 per cent distortion at 40 watts and 1 per cent at 15 watts, including noise and distortion of pre-amplifier and microphone transformer. Electronic mixing for microphone and gramophone of either high or low impedance with top and bass controls. Output for 15/250 ohms with generous voice coil feedback to minimise speaker distortion. New style easy access steel case gives recessed controls, making transport safe and easy. Exceedingly well ventilated for long life. Amplifier complete in steel case, with built-in 15 ohm mu-metal shielded microphone transformer, tropical finish.

As illustrated. Price **36½ Gns.**



CP20A. 15 WATT AMPLIFIER

for 12 volt battery and A.C. Mains operation. This improved version has switch change-over from A.C. to D.C. and "stand by" positions and only consumes $5\frac{1}{2}$ amperes from 12 volt battery. Fitted mu-metal shielded microphone transformer for 15 ohm microphone, and provision for crystal or moving iron pick-up with tone control for bass and top and outputs for 7.5 and 15 ohms. Complete in steel case with valves.

As illustrated. Price **£28 0 0.**

30 WATT RECORD REPRODUCER

This amplifier has been produced for extremely high quality gramophone or microphone quality in large halls or in the open. An output power of 30 watts is obtainable at under 1% distortion after the output transformer which is arranged for 4, 7½, or 15 ohm output. The most noticeable point is the absence of background noise or hum.

Very generous feedback is employed to help out any distortion developed by the speaker and the large damping factor ensures good transient response. The usual response of 30 to 25,000 cycles plus or minus $\frac{1}{2}$ db is given, and recording compensation of 5 db per octave lift below 300 cycles is obtainable on the gramophone input by means of a switch. A carefully balanced treble control is arranged to correct top lift on some recordings as well as to reduce scratch on old records without noticeable effect on frequencies below 3,500 to 4,000 cycles. The input is intended for the high fidelity type of pick-up and is fully loaded by an input of .2 volts on 100,000 ohm or $\frac{1}{4}$ meg. ohm as required. The microphone stage requires an input of .3 millivolts on 15 ohm balanced line through the wide response mumetal shielded microphone transformer. An octal socket is fitted at the rear of the chassis to provide power for feeder units, etc., 6.3 volts at 2 amps and 350 volts at 30 milliamps is available.

Complete in well ventilated steel case. Price **30½ Gns.**

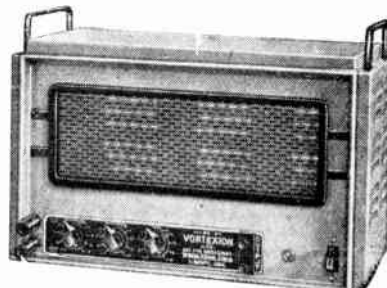

EXPORT

Enquiries from Overseas will receive prompt attention. Continental Buyers are invited to get into touch with our Belgian Agents:

Ms. Constant J. Bisman,
129 Avenue de la Reine,
Bruxelles
Téléh. 16.10.31.

FOUR WAY ELECTRONIC MIXER

This unit has 4 built-in, balanced and screened microphone transformers, normally of 15-30 ohms impedance. It has 5 valves and selenium rectifier supplied by its own built-in screened power pack: consumption 20 watts.

Suitable for recording and dubbing, or large P.A. Installations since it will drive up to six of our 50 watt amplifiers, whose base dimensions it matches. The standard model has an output impedance of 20,000 ohms or less, and any impedance can be supplied to order. Price in case with valves, etc., **£24.**

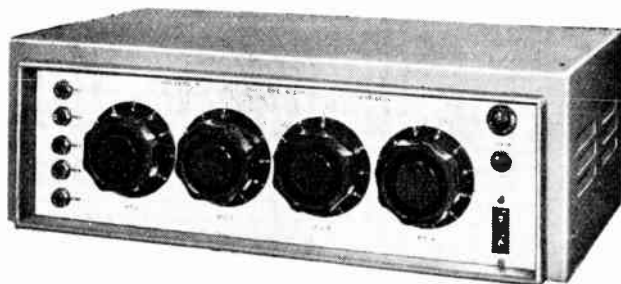

VORTEXION LIMITED, 257-261 THE BROADWAY, WIMBLEDON, LONDON, S.W.19
Telephones: LIB 2814 and 6242-3

Telegrams: "Vortexion, Wimble, London"



G.E.C.

QUARTZ CRYSTAL UNITS

FOR STABLE FREQUENCY GENERATION

FEATURES

Low temperature co-efficient — less than 2 in 10° per °C
 Patented nodal suspension. Mounted in vacuum; performance independent of climatic conditions. Exceptionally high Q value.
 High stability. Small size, 3" x 5/8" overall excluding pins. Fits standard miniature deaf aid valve socket.

FOR FREQUENCY SUB-STANDARDS

Type JCF/200, 100 KC/S. Available from stock adjusted to 0.01%. Higher accuracies supplied to special order.

The type JCF/200 unit illustrated is representative of the wide range of vacuum type unit available for low and medium frequencies.

PRICE
£2 - 15 - 0

SALFORD ELECTRICAL INSTRUMENTS LTD.
 PEEL WORKS, SALFORD 3, LANCS. Telephone BLAckfriars 6688 (6 lines). Telegrams & Cables SPARKLESS Manchester
 Proprietors THE GENERAL ELECTRIC CO., LTD., OF ENGLAND

* S.R.E. for all purposes

Philips have supplied through traders and others throughout the world S.R.E. for almost every conceivable application. While specialized equipment is produced whenever necessary, a very wide range of standard apparatus units minimizes the need for this, and simplifies installation and maintenance.

As it can be shown to be much better engineering practice to use one large amplifier instead of a lot of little ones to feed one load, the standard range includes three large rack amplifiers.

Features include triode valves throughout, four push-pull stages, no electrolytics, and three separate anode supplies.

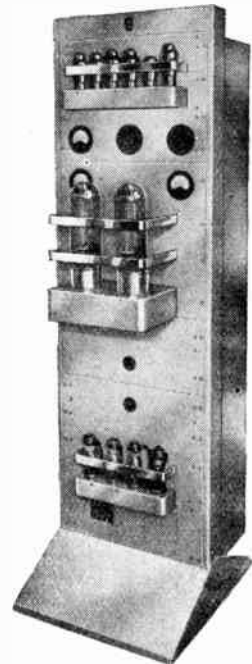

- 250 watt**List Price **£255**
- 500** "List Price **£325**
- 1,000** "List Price **£425**

S.R.E. available through the trade on hire purchase or rental terms.

* What expression should be used to refer generally to amplifiers, and related apparatus? "Public Address?" This hardly applies to gear that may well be used in private for purposes other than addressing. "Sound Equipment?" This can also mean tomtoms, or brewery apparatus in sound condition! We have adopted the Navy's term "S.R.E." or "Sound Reproducing Equipment", as in our submission there is no other so accurate or so generally applicable.



PHILIPS ELECTRICAL LIMITED

Amplifier Dept., Century House, Shaftesbury Avenue, London, W.C.2. (A482)

MILLER EFFECT

Step-by-Step Resolution of Some of Its Paradoxes

By "CATHODE RAY"

ONE of the stickiest patches in valve circuit theory seems to be Miller effect with reactive load. Why should an inductive anode circuit look like a negative resistance when viewed from the grid? Even those who are prepared to accept a mathematical proof of this curious fact generally find its action difficult to visualize.

Several readers have asked me to make this clearer for them; and in case there are some who are not too happy even with a simple resistive load I propose to start right from the beginning, taking the thing by easy stages. The difficulty arises from trying to think of the whole problem at one go.

Very well, then.

In discussing circuits one often talks about parts of them "looking like" something else. This sort of statement may sound rather casual and unscientific to the uninitiated, but actually it has quite a precise meaning. Fig. 1 (a) shows a celebrated example. One may say that at resonance the circuit LCR looks to the generator (E) like a resistance R, as shown in Fig. 1(b).

C are usually much greater than that across R. What it does mean is that so far as the magnitude and phase of the generator current is concerned there is no difference between (a) and (b). If LCR were

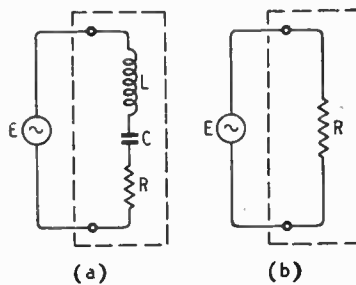

Fig. 1. The generator here (and in other diagrams) represents any source of voltage, E. So long as its frequency is equal to the resonant frequency of the circuit LCR(a), it makes no difference so far as the generator is concerned if L and C are removed, leaving only R(b).

shut up in a box provided with terminals, one would be unable to tell by any external measurements of the current and voltage that the box contained L and C as well as R.

altered, so that the circuit is no longer at resonance, it no longer looks anything like Fig. 1(b). At any particular frequency, however, another equivalent could be calculated, which would include only resistance and inductance or capacitance.

Forgive me if all that is painfully familiar, but it is important to be quite clear from the start about the trick of using circuit equivalents. We shall be doing it steadily from now on.

Imagine another of these mysterious sealed boxes with terminals, and that you are provided with as many batteries and a.c. generators and meters as you like, and have been asked to find out what circuit there is inside. And suppose that whatever you connect to the terminals you can detect no trace of current, either continuous or transient. You will probably report that the terminals are open-circuited. And you might easily be right. On the other hand you might be wrong. Because for all you know there may be a small but extremely

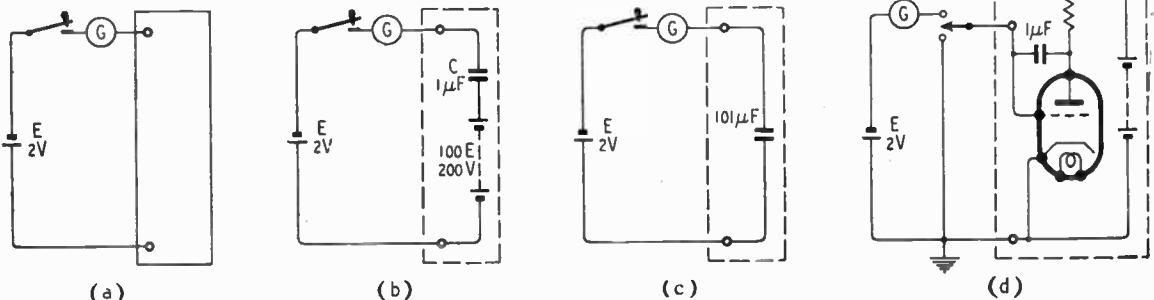

Fig. 2. If by any means an internal voltage is introduced which is always 100 times the applied voltage E(b), it makes the capacitance seem to be 101 times larger than it really is (c). One way in which this internal voltage can be introduced is by means of amplification (d).

That is not, of course, intended to mean that LCR is the same thing as R; obviously it is not, because the voltages across L and

Such statements usually have conditional clauses; in this case, "at resonance." Directly the frequency of the generator is

efficient demon inside the box, always connecting a low-resistance battery or generator exactly equal and opposite in voltage to any you

Miller Effect—

connect. If so, although the resistance between the terminals would be low, to you it would "look like" an infinitely high resistance.

I hope you haven't thrown this line of argument aside with contempt as vain superstition, unworthy of *Wireless World*—even of "Free Grid"—for it is just another of these convenient and quite legitimate equivalents. The precise mechanism by which the internal voltage was kept so exactly equal to whatever you might have chosen to apply externally was unimportant, and it was less fatiguing to invoke a demon than to think out some more humdrum electronic device, which by its sheer ingenuity might have distracted attention from the main conclusion, viz., that the presence in a circuit of a voltage proportional in some way to the applied voltage may make the circuit impedance behave exactly like some quite different impedance.

Suppose now that the box contains a real capacitor, as bought from a reputable firm, and guaranteed $1\mu\text{F}$ (within the usual tolerances). You want to make quite sure, however; and as you have a 2-volt cell and a ballistic galvanometer (an instrument for measuring quantity of electricity by the amplitude of the transient deflection), and can recall the textbook formula $C=Q/E$, you connect them up as shown in Fig. 2(a). In the ordinary way of things the galvanometer would indicate a charge of 2 microcoulombs, and knowing the voltage

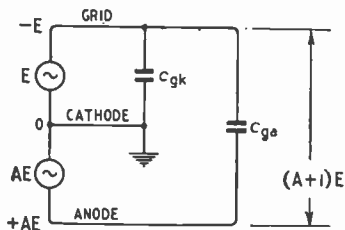

Fig. 3. In this diagram, the input and output voltages of an amplifying valve are represented by the generators giving voltages E and AE respectively, showing clearly how the current through c_{ga} (the grid-to-anode capacitance) may be much larger than it would be if only E were acting, and hence how the capacitance seems to E to be larger.

was 2 you would deduce that the capacitance in the box was in fact $1\mu\text{F}$. But unfortunately the demon has crept in again (b), and has misleadingly inserted a 200-volt battery in such a way as to augment your 2 volts. The charge is therefore actually 202 microcoulombs. When you and the galvo have recovered from your surprise, your version of the incident (seeing that you don't believe in demons) is that the box contained $202/2 = 101\mu\text{F}$, as shown in Fig. 2(c).

If, perhaps, you are more experienced and wary you may suspect that someone has been playing a trick on you by charging up the capacitor when you weren't looking, hoping you would touch both terminals at once. So you short the terminals to discharge it and then try again; perhaps

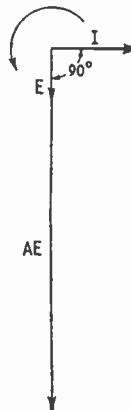

Fig. 4. Reckoning the voltages E and AE in Fig. 3 from the grid instead of the cathode, they are in phase, as shown in this vector diagram, which also shows the current through c_{ga} leading by 90° .

with the battery reversed. But the demon is too quick for you and he first removes and then reverses his battery. So, still half sceptically, you label the box " $101\mu\text{F}$."

Although the box actually contains only $1\mu\text{F}$ it "looks like" $101\mu\text{F}$, and is in every way equivalent to it.

If you still object to the introduction of supernatural agencies, I will withdraw my demon and Fig. 2(b), and substitute (d). Here is a valve giving a voltage amplification (A) of 100. So when you apply, say, -2V, the anode (to which the other terminal of the $1\mu\text{F}$ capacitor is connected) goes +200V relative to what it was before, just as if the demon were still at work. The total voltage to which the capacitor charges is therefore 202V, and the galvo, if it is still functioning, flicks up to 202 microcoulombs. But the only charging voltage you know about is your 2V, so again you calculate the capacitance to be $101\mu\text{F}$.

This discrepancy between the actual and apparent capacitance arises from the fact that by looking at it from outside the box, ignoring what is going on inside, you are accounting for the charging current by the small charging voltage you apply, whereas the actual charging voltage set in motion by it is (A+1) times as large.

Further experiments would soon show up the limitations of this apparent $101\mu\text{F}$ capacitor; applying a large negative voltage would cause about 99% of its capacitance to disappear, and a positive voltage would (apparently) make it leak. And tests with a.c. would be complicated by the very long time constant—the valve is not so efficient as the demon, because it brings in considerable resistance. But leaving this resistance out of account, and breaking open the box to see what it actually contains, we should now have no difficulty in writing down a formula for the effective or apparent capacitance (C_e) between the terminals:

$$C_e = c_{ga} (A + 1)$$

where c_{ga} is the capacitance between grid and anode and A is the voltage amplification. (There is of course always the grid-to-cathode capacitance of the valve, c_{gk} in the usual nomenclature, to add in; but I shall not bother to mention it every time).

To reduce the time-constant complication to relative insignificance, and at the same time to arrive at a more typical case of Miller effect, we next remove the $1\mu\text{F}$, leaving the interelectrode c_{ga} , which would be only a few pF. But the same principle holds good regardless of the actual amount; the input capacitance of the valve is still (A+1) times as great (plus, of course, c_{gk} , which is charged only by the input voltage, so is not amplified). To take some actual figures from the *Wireless World Valve Data book*, a certain triode with a g_m of 2mA/V has $\mu = 68$ and $r_a = 34\text{k}\Omega$. If these characteristics hold good with a coupling resistance of $50\text{k}\Omega$, the voltage amplification A is $(68 \times 50)/(50 + 34) = 40.5$. c_{ga} is given as 2.5pF and c_{gk} as 3pF ; so the effective input capacitance, C_e , is $3 + (41.5 \times 2.5) = 104\text{pF}$. Substituting a comparable pentode, $g_m = 1.8$, $\mu = 2160$, $r_a = 1.2\text{M}\Omega$; A would be 87.

For this valve c_{au} and c_{gk} are 0.002 and 4pF respectively, so $C_e = 4 + (88 \times 0.002) = 4.18\text{pF}$. Rather a difference! In practice

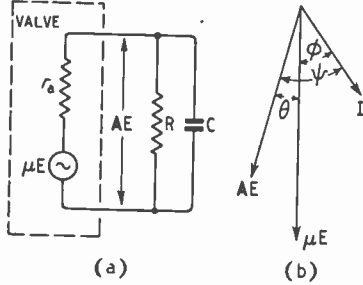

Fig. 5. If the resistance coupling (R) is shunted by capacitance (C) the equivalent anode circuit is as at (a), and the vector diagram as at (b)

any external stray capacitance between anode and grid would have to be added to c_{ga} , and C_e in both cases would be rather larger, especially with the pentode.

Another way of representing the situation is as in Fig. 3, in which the output voltage of the valve, AE, is shown as if it were being produced by a generator synchronized with the source of E. It is negative relative to E if both are reckoned from cathode; but if they are reckoned from grid (which, being one terminal of c_{ga} , is more convenient) they are in phase. This is represented in the vector diagram, Fig. 4. (If the frequency were high enough, the reactance of c_{ga} and c_{ak} would offer an appreciable bypass to the anode load resistance, and would throw the output voltage out of phase; but we are assuming that the frequency is not so high, or else that the effect of capacitance on the anode load impedance is neutralized by inductance). The voltage at the grid has an entirely capacitive load, so its current vector must be 90° leading (I in Fig. 4, remembering that the diagram conventionally rotates anti-clockwise).

Well, that is the particular case of Miller effect in which the output voltage of the valve is exactly opposite to the input (relative to cathode or earth) and exactly in phase with it (relative to grid)—the case in which the anode load is purely resistive, whether it consists actually of a coupling

resistor, or only looks like one, being actually a parallel-resonant circuit. Most people can follow it quite easily because the input and output voltages are in line with one another and so add up across the grid-to-anode capacitance by simple arithmetic. It is when the anode load is reactive that the trouble starts. But it will be all right if we tackle it bit by bit.

A reactive anode load may consist of a tuned coupling such as an i.f. transformer at some off-tune frequency, or an audio transformer at very low or very high frequencies, or even the resistance shown in Fig. 2(d) at very high frequencies, when the effect of stray capacitance across it is appreciable. Let us take the last case first, and examine it with the help of the "valve equivalent generator," Fig. 5(a).

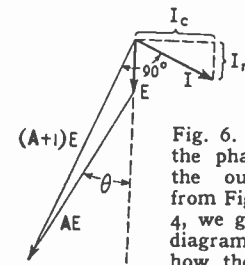

Fig. 6. Transferring the phase lag (θ) of the output voltage from Fig. 5(b) to Fig. 4, we get this vector diagram, showing how the effect of C in Fig. 5(a) is to bring the current through c_{ga} partly into phase with E.

Here the valve is represented by a generator giving a voltage μ times the input voltage E, (reckoned from grid) in series with its own internal anode resistance r_a . R shunted by C forms its load.

As the whole circuit (r_aRC) is partly capacitive, the current will lead the generator voltage by some angle which we will call ϕ , depending on the proportions of capacitive reactance to resistance. This is shown in the vector diagram, Fig. 5(b).

If the load (RC) had been purely capacitive, this current would have led the voltage across the capacitance by 90° , so the voltage across the load would have had to be drawn 90° behind the I vector. But in practice there must be a conducting path, R, for the d.c., so the load cannot be wholly capacitive. But at least it will be relatively more

capacitive than the whole circuit r_aRC , and so the phase angle between its current and voltage will be greater than ϕ . Let us call it ψ , and draw in the output voltage vector AE, in the diagram. The black letter A is to show that it is a vector quantity.

What we have discovered from Fig. 5 is that the effect of a capacitive reactance in the load is to make the output voltage lag behind the internally generated voltage, μE , which is in phase with the input voltage reckoned from the grid, E. It is a matter of ordinary a.c. calculation to determine the actual angle of lag, and the magnitude of A, from any given circuit data.

We now know that with a capacitive load the output generator AE in Fig. 3 is synchronized with E at a different phase angle, so that the current through c_{ga} will also shift its phase from what is appropriate to a pure capacitance fed from E, and will "look" to E like something different. It is easier to see what by constructing a revised vector diagram in place of Fig. 4. We know from Fig. 5(b) that AE must be replaced by AE, lagging by an angle $(\psi - \phi)$, which we can rename θ . So we can draw the diagram, as Fig. 6. The total voltage across c_{ga} is, of course, the sum of the input and output voltages, $E(A + 1)$. And, as c_{ga} is a pure capacitance, the current through it (I) leads its voltage by 90° . When this current vector is added in Fig. 6 we can see what we have been trying to find all the time—that when the anode load becomes capaci-

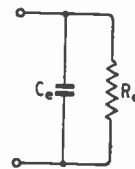

Fig. 7. Effective input circuit of a valve when its anode load is partly capacitive, as shown in Figs. 5 and 6.

tive the current vector I tends to pull into phase with E. In other words, to the input voltage the valve looks like a mixture of capacitance and resistance. So far as input current is concerned, the valve could be replaced by the circuit shown in Fig. 7, in which the component of current still at right angles to E (I_c in Fig. 6) is accounted for by the

Miller Effect—

path C_e , and the new component in phase with E (I_r) is accounted for by R_e .

The interesting thing is that the grid circuit now appears to conduct, even although true conduction may be entirely prevented by grid bias. The more capacitive the anode circuit, the more conductive is the grid circuit. Generally this is even more undesirable than a high input capacitance, because capacitance can be tuned out, whereas the conductance damps any tuned circuit supplying signal voltage to the grid. Hence the preference for screen-grid valves, in which c_{ga} is very small.

Before going on, it might be as well to take a final look at Fig. 3 and visualize the generator AE shifting in phase so that the current through c_{ga} is no longer 90° in front of E, and therefore no longer what E would expect from a true and pure capacitance.

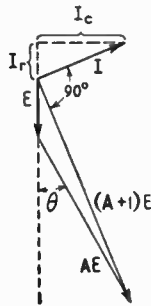

Fig. 8. Vector diagram corresponding to Fig. 6, but with the load inductive instead of capacitive. The component of current in phase with E is negative, indicating a negative input conductance.

E, of course, knows nothing about the demoniacal **A** in the box, and can only suppose that the strangely inflated c_{ga} has developed a leak.

It should not be too difficult, with the help of Fig. 6, to arrive at the actual formulae for the values of C_e and R_e in Fig. 7—the equivalent input circuit. Taking C_e first, the component of **AE** in phase with E is $AE \cos \theta$. So the capacitive part of the current through c_{ga} is $(I + A \cos \theta)$ times as large as it would be if E were the only e.m.f. acting; and therefore :

$C_e = c_{ga} (I + A \cos \theta) \dots (1)$
 plus, of course, c_{gk} . The component of **AE** at right angles to E is $AE \sin \theta$; so the resistive component of current through c_{ga} is this voltage divided by the impedance of c_{ga} , and is therefore

$AE \sin \theta \omega c_{ga}$. The input conductance, I/R_e , is this current divided by the input voltage E; so we have :

$$I/R_e = -A \sin \theta \omega c_{ga} \dots (2)$$

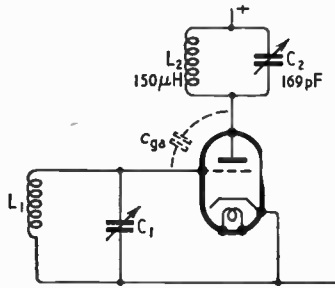

Fig. 9. If L_2C_2 is tuned to exactly the same frequency as L_1C_1 , at which it is equivalent to a pure resistance, why should it not amplify stably?

I have expressed it in the form of a conductance, rather than the resistance R_e , because it is the conductance that is responsible for the disturbing effects.

The negative sign comes in this way: with a capacitive load, θ is a lagging angle, as already explained; lag is conventionally denoted by a negative sign; the sine of a negative angle between 0 and 90° is negative, but the corresponding component of current, as can be seen from Fig. 6, is in phase with E and therefore implies a positive resistance or conductance. So a second negative sign is necessary to neutralize the one brought in by θ .

You will see the importance of this sign if you go through the whole argument relating to Figs. 5 and 6 again, substituting an inductance for C in Fig.

Fig. 10. These curves show the circuit L_2C_2 in Fig. 9 becomes highly inductive at a frequency only very slightly lower than the resonant frequency.

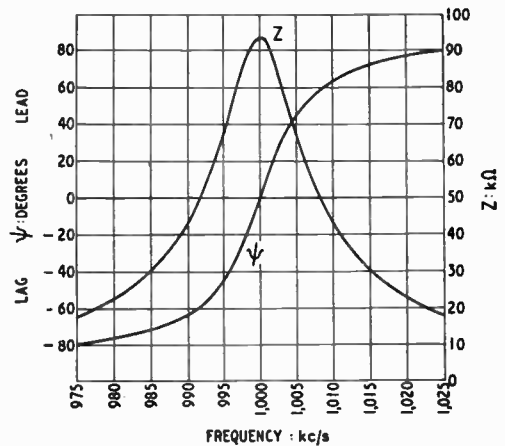

5(a). I needn't write it all out in full, because it should be quite clear that θ will be a leading angle, so that the vector diagram corresponding to Fig. 6 will be something like Fig. 8, in which the hori-

zontal component of I leads E by 90° , indicating input capacitance, as before, but the vertical component is in opposition to E, indicating negative resistance or conductance. This agrees with the formula again, because θ is now positive. The only change in Fig. 7 is that R_e is negative. So if C_e is tuned by an inductance connected across the input to the valve, and $-R_e$ is sufficient to neutralize the positive resistance of the coil and other losses, it will oscillate.

There is one other thing that is commonly misunderstood—the application of the above result to the tuned-grid, tuned-anode circuit (Fig. 9). Every experimenter knows that this is a very reliable oscillator, in spite of needing no back-coupling other than the accidental one via the anode-to-grid capacitance (c_{ga}) of the valve. And that for this reason it is useless as a r.f. amplifier, unless most of c_{ga} is abolished by means of the screening provided in a tetrode or pentode. Yet one might suppose that it would be a simple matter to obtain stable amplification even with a triode, by tuning both L_1C_1 and L_2C_2 to the frequency to be amplified. Then at that frequency L_2C_2 would be equivalent to a resistance and the only thing fed back to the input would be capacitance, which could easily be allowed for

in adjusting C_1 . Or by detuning L_2C_2 slightly, making it slightly inductive, enough negative resistance could be fed back to compensate for the losses of a cheap L_1C_1 and sharpen up the tuning.

It all sounds very plausible. But try it, and I shall be surprised if you find it works out like that.

The snag can be explained by referring to Fig. 10, which shows the impedance and phase angle of a typical tuned circuit ($Q = 100$) adjusted to resonate at 1,000 kc/s. At that frequency the impedance is about $94k\Omega$ and the phase angle is zero, so if the circuit is used as L_2C_2 in Fig. 9 it is equi-

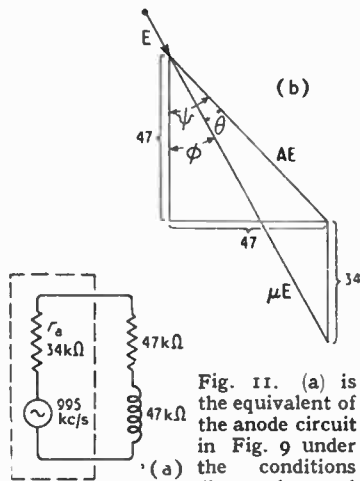

Fig. 11. (a) is the equivalent of the anode circuit in Fig. 9 under the conditions discussed; and (b) the vector diagram.

valent to a $94k\Omega$ resistance coupling. If the triode has the same characteristics as the one we used earlier as an example, the fed-back capacitance would be $2.5 \left(\frac{68 \times 94}{94 + 34} + 1 \right) = 2.5 (50 + 1) = 127 \text{ pF}$. Assuming that C_1 is adjusted to allow for this, why shouldn't we get a perfectly good 50-fold r.f. voltage amplification at 1,000 kc/s?

The answer is to consider what is happening at, say, 995 kc/s. Here the impedance is $67k\Omega$ and the phase angle is -45° . Being a lag, this indicates inductive reactance, amounting to $47k\Omega$, in series with a resistance which is also $47k\Omega$. So we have the equivalent circuit shown in Fig. 11(a). The current is in phase with the voltage across the resistances, and at right angles to the voltage across the inductive reactance. Drawing vectors proportional to the resistances and reactance, to represent the voltages across them, we get Fig. 11(b). The angle between current and output voltage, which as we have

already noted is 45° , is marked ψ , as in Fig. 5 (b); and the angle between the current and internal generator voltage (ϕ), as measured from the diagram, is just over 30° . So the angle θ between output and input voltage is the difference, approximately $+15^\circ$. The magnitude of A can also be derived from the diagram; it is 48.

Inserting these values in equations (1) and (2) we get:

$$C_e = 119 \text{ pF}$$

$$R_e = -5100\Omega.$$

A negative resistance as low as this is a very powerful provoker of oscillation—it is capable of causing oscillation in any circuit (resonant at 995 kc/s) which has a dynamic resistance of $5.1k\Omega$ or more. Assuming circuit L_1C_1 is the same as L_2C_2 , it has a dynamic resistance of $94k\Omega$ at 1,000 kc/s and almost as much (shunted by an inductive reactance) at 995 kc/s. 995 kc/s is only 0.5% less than 1,000 kc/s, yet this slight mistuning transfers nearly 20 times as much negative conductance into the input circuit as is needed for oscillation. Since $\sin \theta$ is nearly proportional to θ for small angles, we can guess that the conditions for oscillation would be fulfilled at a frequency something like 0.03% less than 1,000 kc/s.

Calculating the actual frequency of oscillation is rather more complicated a business; but this simple approach may be sufficient to show that the stability of the Fig. 9 circuit is a fallacy—as of course we all know by experience.

If the anode circuit is tuned to a frequency higher than that of the grid, then of course it will be an inductive load, liable to cause oscillation if the circuit values permit. On the other hand if the anode circuit is tuned to a lower frequency, possibly by adding inductance, it will be a capacitive load, tending to damp out oscillations. If this paradox of making a circuit less inductive by adding inductance sounds puzzling, think it out with the help of Fig. 10. Suppose both L_1C_1 and L_2C_2 are tuned to 1020 kc/s. To make L_2C_2 fit Fig. 10 it is necessary to tune it to a lower frequency (1000 kc/s) by increasing L_2 or C_2 or both. Suppose it is done by increasing L_2 . Then Fig. 10 shows that at 1020 kc/s (the input frequency)

New
TRIX
Quality
SOUND EQUIPMENT

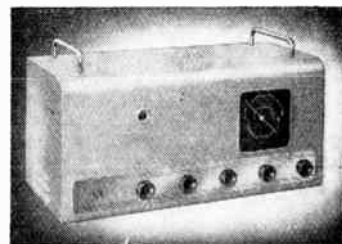

Model RA101
-for SCHOOL
BROADCASTING
and small installations in Hotels, Clubs, Factories, etc.

Approved by the School Broadcasting Council for U.K.

This new model has been designed to meet the demands of Educational authorities and other users for broadcasting installations giving high quality reproduction.

The complete unit is mounted in a well finished grey metal case, with chromium handles. It incorporates the radio receiver unit, superhet type, covering three wavebands, together with amplifier unit giving fully 12 watts undistorted output. Individual tone control circuits for Bass and Treble boost are incorporated. In order to ensure correct tuning, the radio unit is fitted with a Magic Eye tuning indicator, making a total of 9 valves.

Inputs are also provided for the addition of a gramophone turntable unit or a microphone, and adequate gain is provided for this purpose. The output circuit is high impedance, allowing a number of external speakers to be attached on long lines, without loss of power.

Send for full details of this and other Trix Quality Sound Equipment

THE TRIX ELECTRICAL CO. LTD.
1-5 Maple Place, Tottenham Court Road, London, W.1. Phone: MUSeum 5817.
Grams & Cables: "Trixdia, Wesdo, London."

AMPLIFIERS · MICROPHONES · LOUDSPEAKERS

Miller Effect—

its current has a leading phase angle, so is a capacitive load.

If this is still not perfectly convincing, imagine that the anode load consists of an a.f. transformer shunted by a r.f. bypass capacitor. As a tuned circuit, this would

resonate far below 1000 kc/s. The inductance is very high indeed. So high, in fact, that it can be regarded as a complete barrier to r.f. currents in comparison with the capacitive bypass. To them the circuit is capacitive.

The paradox arises, as I

explained a few months ago,* out of the relationship between impedance and admittance. The greater the inductive impedance the greater by comparison is the capacitive admittance.

* "Admittance," Jan., 1949.

BIRMINGHAM TELEVISION RECEPTION

Modifying the "Wireless World" Superheterodyne Unit

WHEN describing the Superheterodyne Television Unit for the *Wireless World* Television Receiver it was said that the changes needed to make it suitable for the reception of the Birmingham station would be described later. It was expected that the changes would be to three coils only.

As the Birmingham station is not yet in operation it is obviously impossible to test the modified receiver on the actual television reception, but signal-generator tests indicate that it should behave correctly. As single-side-band transmission will be used, there is always the possibility that some further minor changes might be needed, but this is considered unlikely.

The alterations needed to the Superheterodyne Unit are confined

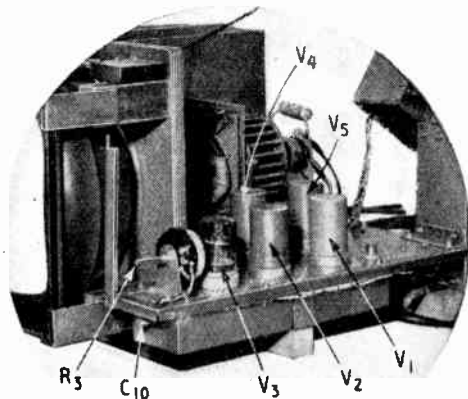

to the three coils T_1 , T_2 , and L_1 of the original circuit diagram and to one minor circuit alteration. The coil formers are unchanged

T_1 should have 10 turns for the winding 1-2 and $1\frac{1}{2}$ turns for 3-4, instead of the $12 + 1\frac{1}{2}$ turns used for Alexandra Palace. T_2 should have one winding of 6 turns instead of the double winding of 9 turns. The turns are spaced out

oscillator coil L_1 has 8 turns of No. 20 enamelled wire close wound instead of the original 15 turns.

The circuit change consists of the use of a tuned-anode coupling for T_2 instead of a double-wound

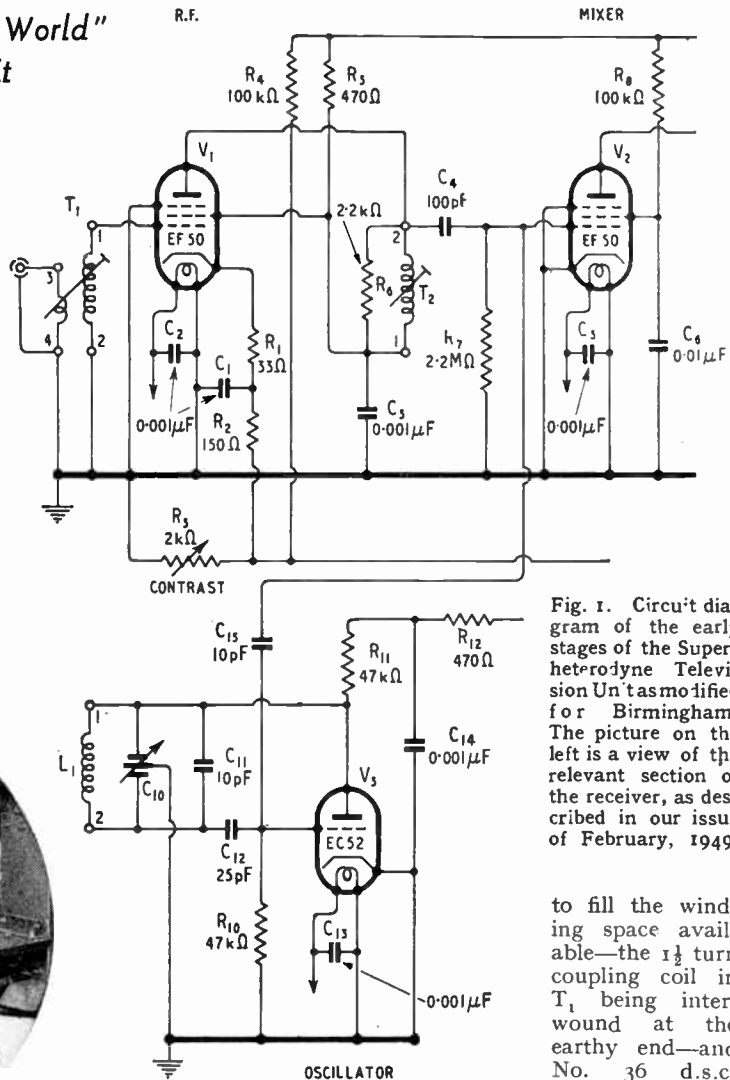

Fig. 1. Circuit diagram of the early stages of the Superheterodyne Television Unit as modified for Birmingham. The picture on the left is a view of the relevant section of the receiver, as described in our issue of February, 1949.

to fill the winding space available—the $1\frac{1}{2}$ turn coupling coil in T_1 being interwound at the earthy end—and No. 36 d.s.c. wire is used. The

transformer. The latter is generally to be preferred, since it permits the complete isolation of the return leads to the cathodes of the two valves and so reduces chassis currents. In this instance, however, it was found to be unsatisfactory because it proved impracticable to secure sufficiently tight coupling between the two windings with so few turns in each. The tuned-anode form of intervalve coupling has been adopted, therefore, and is satisfactory in the single-stage amplifier used in this set.

The circuit of the early part of the unit has been re-drawn in Fig. 1 to show this modification. If it is compared with the original diagram, the change can be seen to be a very minor one.

Since the sound and vision carriers are at 58.25 and 61.75 Mc/s respectively the oscillator must operate at 48.75 Mc/s, while the

signal circuits should be tuned to 59 Mc/s and 61.5 Mc/s for T_2 and T_1 respectively.

The alignment procedure described in the original article is unchanged except for the frequencies to which the signal-generator must be set while adjusting the signal and oscillator circuits. Frequencies for adjustments in the i.f. amplifiers remain unaltered.

This original procedure should, therefore, be followed exactly, but wherever 41.5 Mc/s occurs in the description substitute 58.25 Mc/s. Similarly, for 44 Mc/s substitute 60.75 Mc/s and 61.75 Mc/s for 45 Mc/s. T_2 is to be adjusted with the signal-generator at 59 Mc/s instead of 45 Mc/s and T_1 with it at 61.5 Mc/s instead of 45 Mc/s.

Of course, the aerial must be modified for the higher frequency. The dipole length should be about 7ft 6in instead of 10ft 6in.

VERSATILE TEST SET

Taylor Circuit Analyser

WITH this instrument, aided only by signals from a broadcast station, it is possible to carry out a complete investigation of any fault in a broadcast or television receiver. The main unit contains a triode valve functioning as an a.f. amplifier, a loudspeaker, a magic eye indicator and switching for selecting various methods of test. Included is an a.c. mains supply unit, input and output sockets and an octal valveholder into which can be plugged a separate probe unit.

This probe is used for all r.f. tests and it functions as an aperiodic detector over a very large band of frequencies. Without any other aid an audible signal from the main unit was heard with the probe connected to the feeder from a television aerial in the heart of London.

When looking for a defect in a receiver the set can be tuned to the known position of the local broadcast station and the r.f. probe used to explore, stage by stage, from the aerial socket to the loudspeaker. Signals will be heard from the built-in loudspeaker up to the point in the set where the defect lies and it should then be a simple matter to isolate and locate the trouble.

Apart from fault tracing the analyser can be used to search for possible weaknesses in de-coupling components, for when exploring with the probe signals should be audible on one side of the by-pass capacitors but not on the other.

For most audio tests the signal is injected into the main unit via the input terminals, amplified and passed to either the loudspeaker or headphones as required.

The magic eye can also be used for audio tests but without amplification. Normally this indicator will be employed for d.c. tests and as it imposes no load on the circuit it is ideal for checking a.g.c. circuits.

This versatile test set is listed as the Model 20A Circuit Analyser and the price is £15 15s. The makers are Taylor Electrical Instruments, Ltd., 419-424, Montrose Avenue, Slough, Bucks.

Taylor Circuit Analyser
Model 20A.



M. WILSON LTD

"White Rose Radio"

TELEVISION CIRCUIT for HOME CONSTRUCTORS

Built on one chassis only, 9in. black and white magnetic tube.

EASY TO BUILD. RELIABLE, SAFE.

Two models. London or
Birmingham.

Full specification upon request.

Blue Prints. Two full-size practical, and theoretical, and priced list of parts. 10/6

A NEW HIGH FIDELITY TUNING UNIT

Brief specification.

One R.F. stage, F.C. with separate oscillator, 1 stage of I.F., using our new I.F. Transformers, iron cored, permeability tuned, with a "Q" of 155, feeding into second detector of the cathode follower type, using our new Audio filter unit.

Fitted with its own power pack and smoothing ready to attach to any good L.F. amplifier.

CONTROLS

Main tuning control, no band-spread required, sensitivity control working on the first R.F. valve. I.F. gain control with selectivity control incorporated. 6 wave-band switch. The chassis is built of 16 s.w.g aluminium, rigid corners Box type 6 wave-band coil unit, fitted with our latest iron cored high "Q" coils, completely screened. A.V.C. Magic eye tuning indicator. Measurements $9\frac{1}{2} \times 8\frac{1}{2} \times 11$ in. high.

We honestly believe this to be the finest tuning heart on sale, for sensitivity, selectivity, and the high fidelity obtained on the medium wave-band, due in measure to the cathode follower detector valve with its distortionless output, in conjunction with its filter system.

Price £25 including purchase tax.

Still giving satisfaction in five continents. Our well-tested, world renowned

CIRCUIT NO. 20

A 10-valve superheterodyne circuit with R.F. stage, six wave-bands, 5-2,000 metres, push-pull output for radio and gramophone. Full specification for those interested. Two full-size practical and one theoretical blue-prints, and priced list of parts. Price 7/6d. per set.

OUR SIX WAVE-BAND COIL UNIT

5-2,000 metres, completely wired up, as used on our No. 20 circuit, and 6 wave H.F. unit. Price wired up, calibrated to our 6 wave-band dial, and tested. £8 2 6. including purchase tax. Complete in every detail, in kit form, together with the necessary blue print.

Price **£5 10 0**

307, HIGH HOLBORN.
LONDON W.C.1. Phone HOLborn 4631

Unbiased

Oyez

MOST of us suffer to greater or lesser degree from one or more of the infirmities of age long before we approach the Psalmist's three score years and ten. It is then that we summon science and Mr. Bevan to our aid to equip us with dentures and deaf-aids, to say nothing of spectacles and wigs. Of these, the hearing-aid is undoubtedly the Cinderella and the only one with which I am concerned as it alone depends on a radio-begotten technique for its operation. Now this device has of recent years made great strides from a technical point of view, but from the all-important aesthetic one it shows little advance on the formidable-looking ear trumpet which our grandparents used to direct at us when conversationally inclined. This is in marked contrast to our aids to vision which are designed to enhance rather than impair such beauty as we possess.

In the case of hearing-aids, however, we still seem tied to an entangling wire leading from our ears to other parts of our person on which are concealed microphone, amplifier and batteries which spoil the "line" of our gent's summer suiting. Now in the case of our aids to vision all the apparatus is carried neatly in front of our eyes where, of course, it should be, and I can see no reason at all why all the apparatus of our auditory aids should not be housed on our ears.

It may seem a very tall order to endeavour to mount battery, amplifier and mike

Hearing-Aid of the Future.

on our ears, but actually it is nothing of the kind. In far-off Melanesia much bulkier articles are carried in the ear lobes as I briefly mentioned last month. I myself have seen such knick-knacks as pipes, matches and quarter-pound tins of tobacco carried in this manner. This is done by piercing the ear lobes, ear-ring fashion, in early youth and then enlarging the hole with a wooden plug and later a springy twig of wish-bone shape so that eventually a narrow strip of flesh hangs down.



Whatever men may say, women at least could have no objection to carrying hearing aids in this way for they already mutilate themselves to wear ear-rings and they might just as well carry something useful as well as ornamental. No doubt our manufacturers could easily develop amplifier and battery containers in cylindrical form with a groove round the periphery into which the strip of flesh could be stretched as I endeavour to show in my illustration. Parents might treat their children's ears in this fashion as a sort of insurance policy against the infirmities of old age; even if never required the ear-lobe carrier would be useful for holding the ever-increasing burden of documents which our bureaucrats require us to carry about with us.

I need hardly say that women with their craze for fashion could insist on an alteration in shape or colour every year and there would thus be an almost bottomless well of fresh trade to warm what Sir Stafford Cripps would probably call his *Cochleae Cardis*.

Womanproof

AS most of you who have visited Radiolympia in bygone years will know, technical information from some manufacturers' stands has always been, what in modern jargon is called, in short supply. In fact, I could go so far as to say that in the case of certain firms who ought to know better it is easier to obtain an intelligent answer from a Government Department than from their representatives at the exhibition. One particular manufacturer to whom I complained about this state of affairs frankly admitted it and told me that the reason was that statistics prepared by his sales research department showed that only a very small percentage of buyers cared a bishop's tut-tut about the technical details of a receiver.

He further told me that in most cases it was the woman or women of the household who had the final say in the choice of a new set. His research laboratories have therefore been bending all their energies during the past year toward the production of a set which was not only pleasing to the ladies but was in all respects womanproof. Special attention had, he said, been paid to the question of accurate tuning which was as much a stumbling block to

them as was noiseless gear changing to the motor manufacturer.

My informant considers that the fundamental mistake hitherto made by manufacturers was in marking their tuning scales in metres, kilocycles or station names. The two former meant just nothing to the average woman while the latter



Pleasing the Ladies.

meant very little more, and he soon realized that what was wanted was a scale marked with such things as "Mrs. Dale's Diary," and "Sentimental Slush." Unfortunately he had encountered difficulty with the B.B.C. who had refused to accept his suggestion to put all the slush on one wavelength instead of scattering it all over the scale.

Finally, he tells me, he has solved his problem by remembering a suggestion I made some years ago. It was, that the time had come for us to give up referring to dress materials by such foolish terms as "a delicate shade of blue" and adopt instead a precise scientific description of the myriad shades of colour in the visible spectrum by referring to their wavelength in Angstrom units. He intends to reverse my suggestion and deliberately pander to women's love of describing colours with their customary circumlocutory verbosity instead of the plain and precise A.U. for which I had pleaded. He proposes to sweep his tuning scales clear of all names and numbers and simply change it from violet to red by almost infinite gradations of shade. He will then issue a chart showing in descriptive colour terms exactly where a particular programme is to be found on the scale. Mrs. Dale, for instance, being simply labelled "Alice-blue" or some such nonsense. By this means he hopes to sweep the market at the forthcoming exhibition to such an extent that all other manufacturers will be sweeping the streets.

LETTERS TO THE EDITOR

Contrast Expansion Problems ♦ B.B.C. Television in Holland ♦ "Exporting" Broadcast Channels ♦ What is "Strobing"?

"Contrast Expansion"

THIS article in your June issue of *Wireless World* prompts me to draw attention to an important design parameter to which the author did not refer; viz., the frequency/gain characteristic of the auxiliary amplifier feeding the rectifier producing the gain-controlling voltage. It is, of course, a fundamental requirement of the contrast amplifier that the output should not include any component of the gain-controlling voltage waveform (as pointed out by the author when discussing Langford Smith's circuit). This requirement is most readily met by designing the auxiliary amplifier to have low gain at all frequencies below that whose period is at least several times that of the time constant for the increase in gain of the system. Assuming with the author that the optimum value of the latter is 20/25 milliseconds, the auxiliary amplifier should provide low gain at all frequencies below, say, 250 c/s. This condition is obtained by reducing C_6 in Fig. 5 from 0.1 μ F to 330 pF.

Besides improving the low frequency transient response this modification will ensure that the gain of the contrast amplifier is dependent more upon the apparent loudness of the signal than upon the energy level, which may be greatest in the bass frequencies. G. MITCHELL.

I HAVE read with interest the article by L. J. Wheeler in the June *Wireless World*, and should like to offer some comments on the section referring to the use of negative feedback.

Examination of Fig. 4 of the article shows that the feedback from anode to cathode is not negative. In order that it should be so, it would be necessary to introduce either a transformer or an extra amplifying stage to obtain a further 180° phase shift.

It was, therefore, surprising to find what at first sight appeared to be this circuit used in Fig. 5, and, according to the table of results, used successfully. However, Mr. Wheeler's reference to my device for avoiding current feedback in the first stage of my expander gave the necessary clue. As Mr. Wheeler arranges the circuit, not only is current feedback avoided, but also the voltage feedback from the anode

circuit. The output of V_1 is developed between its anode and the junction of R_{10} and R_{11} , no part of the alternating anode current passes through R_{10} , and V_{2a} is simply a variable shunt across these points. The gain of V_1 is substantially $g_m R_L$, where R_L is the effective anode load and includes the impedance of V_{2a} , which varies with its bias and so produces expansion. This explains, of course, why Mr. Wheeler found a pentode desirable as V_1 . The only effects of R_{10} are to introduce a very small amount of negative feedback in the screen circuit of V_1 , because C_2 is returned to earth and not to the low-potential end of R_1 , and to set up a hum voltage between control grid and cathode of V_1 from any residual ripple in the h.t. supply.

In order to check these conclusions, an amplifier was set up and consisted of V_1 and its associated components, using Mr. Wheeler's values, but with a variable resistance in place of V_{2a} , and with C_2 connected to avoid the secondary screen circuit feedback. The gain was measured with high and low values of "feedback" resistance and then the measurements were repeated with R_{10} short-circuited. For a given value of feedback resistance there was no difference in gain whether R_{10} was in circuit or shorted and, therefore, no difference in the ratio of gains for different values of "feedback" resistance. Thus R_{10} is not essential to the circuit, the analysis given above is justified, and Mr. Wheeler's claim that the circuit is an example of a "negative feedback" expander fails. Returning C_2 to earth produced no effect invalidating these conclusions.

Certain secondary comments seem pertinent. While it is true that a pentode, unlike a triode, will work satisfactorily with widely different values of anode load, it is still necessary that the a.c./d.c. ratio should be as high as possible, in order that harmonic distortion may be kept small. Admittedly, in Mr. Wheeler's circuit, the load ratio increases with the signal input to V_1 , but it is a consideration which may constitute a limiting factor in the application of the circuit.

Mr. Wheeler advocates, as I did, a standing bias on the variable impedance valve. He does this in order to avoid the small range over

THE ANTIFERRE D.5. THREE ELEMENT TELEVISION AERIAL

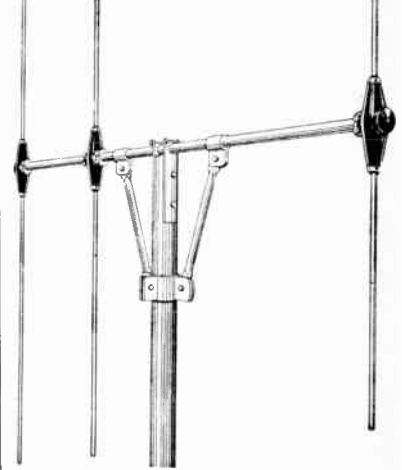

FOR LONG RANGE RECEPTION
All connections enclosed and sealed against corrosion

The D.5 Aerial is designed for Television reception at long range. In addition to the normal dipole and reflector rods, a third element—the Director—is mounted on the supporting arm and positioned between the dipole and the transmitting station. The addition of this director element results in extra gain of signal and much improved directional properties. The aerial may also be used in stronger signal areas where extra directivity is required to eliminate ghost images or to minimise interference.

The Antiferrence Junction Units (Prov. Pat.) provide ample support for the aerial rods and a high degree of insulation in all weathers. All electrical connections are completely weathertight, preventing any possible deterioration in performance. The adjustable mast cap enables any size mast to be used, but a minimum of 2½ in. diameter is recommended. Mast mounting brackets are available for either lashing to a chimney (LSG/2) or bolting to any flat surface (SMB/2). The signal gain of the D.5 Aerial compared with that of a standard dipole is approximately 7dB (2-1).

Cat. No. for London D5. LIST PRICE £6.

Cat. No. for B'ham D5/B. LIST PRICE £6.

ANTIFERRE
LIMITED
67 BRYANSTON ST., LONDON, W.1.

Letters to the Editor—

which gain changes slowly with increase of signal. He then arranges for a variable delay on the rectifier circuit so that the onset of expansion may be delayed until the signal reaches a certain level. I should have thought that this was throwing away on the swings what had been gained on the roundabouts.

Mr. Wheeler uses a full-wave circuit to obtain the control voltage, and this is an arrangement which is well worth while, as the a.f. ripple on the resultant d.c. is at twice the frequency of the fundamental and may, therefore, be reduced to the required extent by the use of a filter circuit of lower time constant than would be needed after a half-wave rectifier.

In conclusion, and in case Mr. Wheeler's references to my articles may revive interest in them, they appeared in the issues of your journal for September and October, 1945, and April, 1946, not in those quoted in your footnote.

J. G. WHITE.
Leatherhead, Surrey.

A. P. in Holland

AS regular reader of *Wireless World* I have pleasure in informing you that I nearly every night have good reception of the B.B.C. television in my home at Delft. As the distance is more than 330 kilometres I think that the results are not bad.

Perhaps some details of the receiver are worth publishing as I think long-distance reception is always interesting.

As synchronization splitter I use a ECC40. The frame time-base is a ECC40 as squegging oscillator and

cathode-follower and after that 2 EF40s as deflection push-pull amplifiers.

The line time-base has also a ECC40 as blocking oscillator and 2 EF40s in push-pull. The picture tube is a war-surplus VCR97.

For reception of the Philips experimental television transmitter at Eindhoven, Holland, which I receive with the same receiver I use a separate radio-frequency amplifier and oscillator (mixer). Also I have to change the detector for the negative modulation, and to turn the potentiometer knob of the blocking oscillator to get the right line frequency for Eindhoven.

J. TH. VAN REYSEN.
Delft, Holland.

Blocking Oscillators

I THINK W T Cocking overstates his case when he says that a blocking oscillator is now almost standard for television time base generation (*Wireless World*, June, 1949). Very many set-makers, both large and small, use thyratrons for this purpose.

The thyatron provides a very elegant method of time base generation which avoids the cost of a transformer and allows for synchronization with very small voltages.

K. S. PHILLIPS.
Edison Swan Electric Company,
London, W.C 2

B.B.C. Coverage

THE better B.B.C. service for the South Coast for which D. C. Smith pleads in your July issue could easily be provided under the Copenhagen Plan if the two medium-wave channels to be used

OUR COVER

TELEVISION TESTS—The operator, shown in the illustration on the front cover of this issue, is wearing a binocular magnifier lens for checking focus and interlacing on a Ferranti receiver. The test pattern is obtained from a picture generator. This visual check is made immediately after the set has been aligned and preparatory to its final test in its cabinet.

for political and propaganda broadcasts to Europe were applied to their proper use—distribution of broadcasting inside this country. I submit that these channels—incidentally they include one of our 3 exclusive frequencies—were not allocated to Great Britain for the purpose to which they are to be put.

Mr. Smith's suggestion for using the Kingston station for relaying the Home or Light Programme is good and apparently practicable, so far as it goes, but would provide only a palliative. A. ALFORD.
Worthing.

Calibrating a Wobbulator

I AM afraid Mr. Gibson (July issue) has been anticipated in his discovery as the American technical Press has for some months carried advertisements for "F.M. and T.V. sweep generators with built-in marker sig. gen."

Incidentally, I can't accept the term "strobing" for this use of a marker signal.

There is a faint analogy to an early radar system in the aspect of the trace, but the only "strobe" effect present is that which the system shares with all apparently stationary c.r.o. traces.

It would be interesting to know if there is an official definition.

It is not too easy to frame a really elegant one that includes the essentials of mechanical and electronic systems and those dependent on persistence of vision as well as "long-persistence screen" types.

Chester. R. C. WINDSOR.

Car Radio

ON technical grounds may I press for the abolition of the separate licence for a car radio?

This step would at once lead to a great increase in all-round efficiency due to the installation of the more efficient rod aerial in lieu of the less obtrusive running board type.

ROBERT C. BELL.
Ambleside.

**Books Published for "Wireless World"**

	Net Price	By post
RADIO VALVE DATA. Characteristics of 1,600 Receiving Valves	3/6	3/9
FOUNDATIONS OF WIRELESS. Fourth revised Edition, by M. G. Scroggie, B.Sc., M.I.E.E.	7/6	7/10
RADIO LABORATORY HANDBOOK. Fourth Edition, by M. G. Scroggie, B.Sc., M.I.E.E.	12/6	12 11
WIRELESS SERVICING MANUAL, by W. T. Cocking, M.I.E.E., Seventh Edition	10/6	10/10
TELEVISION RECEIVER CONSTRUCTION. A reprint of 10 articles from "Wireless World"	2/6	2/9
HIGH-QUALITY AUDIO AMPLIFIERS. Popular circuits reprinted from "Wireless World"	2/6	2 9
RADIO DATA CHARTS, by R. T. Beatty, M.A., B.E., D.Sc., Fourth Edition—revised by J. McG.Sowerby, B.A., Grad.I.E.E.	7/6	7/11
HANDBOOK OF TECHNICAL INSTRUCTION FOR WIRELESS TELEGRAPHISTS, by H. M. Dowsett, M.I.E.E., F.Inst.P., and L. E. Q. Walker, A.R.C.S., Eighth Edition	30/-	30/8
WIRELESS DIRECTION FINDING. By R. Keen, M.B.E., B.Eng. (Hons.), Fourth Edition	45/-	45/9

Obtainable from all leading booksellers or from

ILIFFE & SONS LTD., Dorset House, Stamford Street, London, S.E.1.

SHORT-WAVE CONDITIONS

June in Retrospect : Forecast for August

By T. W. BENNINGTON and L. J. PRECHNER (Engineering Division, B.B.C.)

DURING June, maximum usable frequencies for this latitude decreased considerably by day and increased at night in accordance with the normal seasonal trend. Consequently the difference between the day and night value of m.u.f.s was quite small. The month was less disturbed than May, ionosphere storms being observed on 1st, 4th, 8th, 12th, 16th, 19th, 26th and 30th. The period 5th to 6th, during which a severe magnetic storm was recorded, was exceptionally disturbed.

Working frequencies for the month were generally very low and long-distance communication on the 28-Mc/s band was seldom possible, except on a few southerly circuits. During the night no frequencies below 7 Mc/s were really necessary. The rate of incidence of Sporadic E was very high and, as forecast in this column, transmissions on frequencies as high as 60 Mc/s were occasionally received via this layer.

Two "Dellinger" fadeouts, neither of which was particularly severe, were recorded in June—on 16th and 17th. Sunspot activity in June was considerably greater than in May. Three large sunspot groups crossed the central meridian of the sun (on 5th, 16th and 28th), the disturbances associated with the first group being particularly intense.

Long-range tropospheric propagation was very prevalent, particularly in the second half of the month, probably owing to the long periods of anticyclonic weather conditions.

Forecast.—During August the working frequencies for long-distance transmission will tend to be a little higher than those for July during the day-time and a little lower by night, thus the working frequencies for long-distance transmission will probably still be relatively low by day and high by night. Communication on very high frequencies (like the 28-Mc/s band) is not likely to be very frequent. However, towards the end of the month they may begin to become more useful, particularly in the southerly directions. Over many circuits fairly high frequencies, such as 15 Mc/s, will remain regularly usable until midnight. During the night, frequencies lower than 11 Mc/s will seldom be required. For medium distances up to about 1,800 miles E and F₁ layers will control transmission.

Sporadic E is usually very pre-

valent in August, although rather less so than during July. Communication over distances up to 1,400 miles may be possible by way of this medium on frequencies greatly in excess of the m.u.f.s for the regular E and F layers, and frequencies as high as 60 Mc/s may be occasionally reached for a short time. Owing to the irregular behaviour of the Sporadic E it is impossible to predict when such communication may occur.

Below are given, in terms of the broadcast bands, the working frequencies which should be regularly usable during August for four long-distance circuits, running in different directions from this country. All times are G.M.T. In addition, a figure in parentheses is given for the use of those whose primary interest is the exploitation of certain frequency bands, and this indicates the highest frequency likely to be usable for about 25 per cent of the time during the month, for communication by way of the regular layers:—

Montreal :	0000	11Mc/s	(16Mc/s)
	0200	9 "	(13 ")
	0900	11 "	(16 ")
	1100	15 "	(20 ")
	2300	11 "	(16 ")
Buenos Aires :	0000	11Mc/s	(17Mc/s)
	1000	15 "	(21 ")
	1100	17 "	(24 ")
	1200	21 "	(28 ")
	2000	17 "	(23 ")
2200	15 "	(20 ")	
Capetown :	0000	15Mc/s	(20Mc/s)
	0200	11 "	(16 ")
	0600	17 "	(24 ")
	0800	21 "	(28 ")
	2000	17 "	(23 ")
	2200	15 "	(20 ")
Chungking :	0000	9Mc/s	(14Mc/s)
	0400	11 "	(16 ")
	0600	15 "	(20 ")
	1000	17 "	(23 ")
	1600	15 "	(19 ")
	1900	11 "	(15 ")
2300	9 "	(14 ")	

Ionospheric storms are not usually very prevalent during August, but at the time of writing it would appear that storms are more likely to occur during the periods 6th-7th, 21st-23rd and 25th-27th than on the other days of the month.

"**Trader Year Book.**"—The 1949 edition of this old-established annual, which was first published in 1925, is the usual mine of information for those seeking details of radio and electrical manufacturers' addresses, trade names, receiver specifications, valve base connections, etc. Prepared by our associated journal *The Wireless and Electrical Trader*, it is published by the Trader Publishing Co., price 10s 6d.

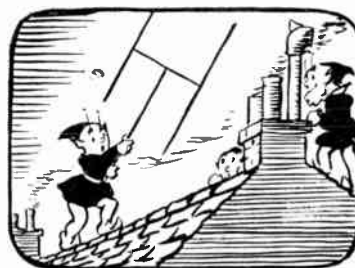

THE "FLUXITE QUINS" AT WORK

"Fixing with FLUXITE," cried EE,
 "Is the easiest job, I can see.
 But this part of the prank
 Is like walking the plank.
 Why they want 'em on roofs beats me!"

See that FLUXITE is always by you—in the house—garage—workshop—wherever speedy soldering is needed. Used for over 40 years in Government works and by leading engineers and manufacturers. Of all Ironmongers—in tins, 10d., 1/6 & 3/-.

TO CYCLISTS! Your wheels will NOT keep round and true unless the spokes are tied with fine wire at the crossings AND SOLDERED. This makes a much stronger wheel. It's simple—with FLUXITE—but IMPORTANT.

The FLUXITE GUN puts FLUXITE where you want it by a simple pressure. Price 2/6, or filled, 3/6.



ALL MECHANICS WILL HAVE

FLUXITE

IT SIMPLIFIES ALL SOLDERING

Write for Book on the ART OF "SOFT" SOLDERING and for Leaflets on CASE-HARDENING STEEL and TEMPERING TOOLS with FLUXITE Price, 1d. each.

FLUXITE LTD.

(Dept. W.W.), Bermondsey Street, S.E.1

RANDOM RADIATIONS

Cosines Without Tears

THE JULY NUMBER of the New York *Radio-Electronics* contains a useful tip for obtaining sine and cosine values—when you haven't a book of trig tables handy—of angles which are integral multiples of 10 degrees. All that you need do is to memorize the series of numbers 2, 4, 8, 10, 12, 14, 16, 17, 17. Not a difficult business for it means simply the even numbers up to sixteen, with six left out, and then a couple of seventeens. You will observe that the first six add up to 50 and the whole lot to 100. To find $\cos 10^\circ$ subtract the first number from 100; for $\cos 20^\circ$ subtract the sum of the first two; for $\cos 30^\circ$, the sum of the first three, and so on. Put a decimal point in front of the result and there you are. Thus:

For $\cos 10^\circ$, $100 - 2$ gives 0.98.

For $\cos 20^\circ$, $100 - (2 + 4)$ gives 0.94.

For $\cos 30^\circ$, $100 - (2 + 4 + 8)$ gives 0.86.

And so on to $\cos 80^\circ$, when $100 - (2 + 4 + 8 + 10 + 12 + 14 + 16 + 17)$ gives 0.17. Compare these values with those of a trig table and you'll find that their accuracy (better than $\pm 2\%$) is quite good enough for everyday electrical calculations. In point of fact it is amply sufficient for the bulk of one's normal work on a.c. problems. Sines of angles are found just as easily, since $\sin \phi = \cos (90^\circ - \phi)$. Thus, if you want $\sin 50^\circ$, all you have to do is to find $\cos (90^\circ - 50^\circ) = \cos 40^\circ$ in the way suggested: $100 - (2 + 4 + 8 + 10)$ gives 0.76.

Interpolation

The method may also be used with quite remarkable accuracy for finding the cosines and sines of angles which are not integral multiples of 10° . Suppose, for instance, that the wanted cosine is that of 56° . For $\cos 50^\circ$ we have $100 - (2 + 4 + 8 + 10 + 12)$ which gives 0.64. But for 56° we must also subtract $6/10$, or 0.6, of the next number in the series, 14. Hence we have $100 - (2 + 4 + 8 + 10 + 12 + 8)$, which gives 0.56—and that doesn't compare badly with the 0.559193 of a six-figure table. Or we might want to find $\sin 63^\circ$. $\sin 63^\circ = \cos 27^\circ$. Then we have $100 - (2 + 4 + [0.7 \times 8])$, which gives, to

By "DIALLIST"

two figures, 0.88. The six-figure tables show the value as 0.891007, so again we haven't done too badly. In practice any of these calculations can, of course, be made in one's head in far less time than it takes to describe the steps involved. To me, at any rate, the idea is quite new, though I fully expect to hear from some reader who is versed in the history of mathematics that it dates back to the time of Archimedes, or before. Can anybody suggest a method for obtaining tangents which is as easily memorized and as simple to use.

Rough on Rats

THE SAME JOURNAL quotes an apparently authenticated account of the successful use of magnetic wire recording to deal with a plague of rats! No, it wasn't on Pied-Piper-of-Hamelin lines; and yet, perhaps one part of the process was, in a way. A warehouse in Vancouver, British

Columbia, was infested by rats, which were doing a great deal of damage. The manager, owned a wire recorder and decided to see whether something could not be done with its aid. Rats, he knew, will set up speed records in their dash for the horizon if they hear the warning squeaks of their fellows. He caught two or three in a cage trap, placed a microphone near the contrivance and proceeded to prod and harry its occupants until they were squeaking with fright. Next, he played back his record over the p.a. system of the warehouse. The result, he declares, was a positive stampede. Rats of all ages and sizes emerged from every hole and made as fast as their legs would carry them for the great open spaces. The trouble was that unless the record was kept playing, which was more than human flesh and blood could stand, the rats came back. Another method was evolved and this is where the Pied Piper part of the business came in. It is well known to professional ratcatchers, or rodent officers as they are now officially called, that male rats respond instantly, though not with purely altruistic motives, to the squeaks of distress of female rats. The cries of a few trapped females were recorded and played back over the p.a. loudspeakers. This produced just the opposite of the previous breakaway. Male rats appeared from everywhere and converged on the loudspeakers so purposefully that they offered easy targets. I'm wondering whether a campaign on similar lines would help me to combat the legions of mice which this year have dug up and eaten vegetable seeds almost as fast as I have been able to sow them in my garden.

'Ware Strobing

GLANCING RECENTLY through a book written for amateur workshop enthusiasts, I was disturbed at finding an unqualified recommendation of fluorescent lighting for workshop use. The fluorescent lamp has no more ardent supporter than myself; I would not for anything be without the "daylight" example by the light of which I do most of my reading and writing of nights. But *not* in the amateur workshop,

COMMERCIAL ULTRASONIC GENERATOR

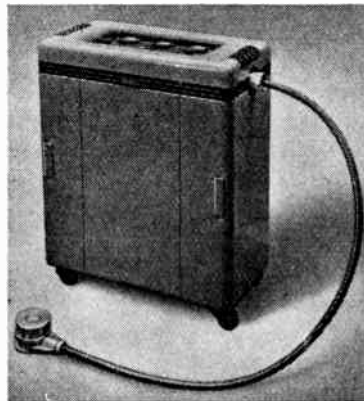

Capable of producing 1 kW of ultrasonic power at nominal frequencies of 0.25, 0.5, 1 and 2 Mc/s this generator is mounted on a trolley for ease of transport. The quartz crystal transducer is air-backed to give maximum radiation in a forward direction and is coupled to the oscillator by a coaxial cable. Silver electrodes, fired on both sides of the crystal, are used to establish the electric field. The makers are Mullard Electronic Products, Aboynce Road, London, S.W.17.

for there it may be a dangerous thing to use. The reason is that these lamps actually throw a flickering light, cutting out at each zero point of the a.c. mains voltage. The flickers are much too rapid (2f, or 100 per second in this country) to be perceptible to the eye. But in the workshop they can give rise to stroboscopic effects, which may make rapidly revolving or reciprocating machine tools appear to be motionless. In factories, where 3-phase a.c. is nearly always available, since the 3-phase induction motor is by far the most widely used of electrical turners of the wheels of industry, this snag is easily avoided. The usual practice is to mount fluorescent lamps in banks of three, each tube being connected to a different phase of the mains supply. The amateur, though, has seldom, if ever, more than a single phase at his command and he should, therefore, be duly on his guard against the risks which strobing may involve. If you don't believe me, take an ordinary hand-driven emery wheel, fix it to a table beneath a fluorescent light and gradually work up the revs, getting a friend to observe what happens. You can see something of the strobing effect if you watch an electric fan illuminated by a fluorescent lamp. Its blades never appear quite motionless since the induction motor which drives it has always some "slip" —it couldn't work if it hadn't. Its rate of revolution is, therefore, a little less than an integral sub-multiple of the frequency applied to both it and the lamp and perfect strobing cannot take place. Still, you will obtain, especially if your eyes are a little tired, the impression of rather indistinct blades moving slowly backwards, like the spokes of motor car wheels in old-time ciné films.

Treating 'em Rough

THE SPECIFICATION recently brought out by the Radio Industry Council for climatic and durability tests of radio and other electronic components makes interesting reading. I should emphasize, by the way, that the specification is the Council's own private product and has not yet reached the stage of being considered by the British Standards Institution. The tests outlined are of so exacting a nature that they should ensure a very high standard of performance

25 YEARS *Switch* EXPERIENCE

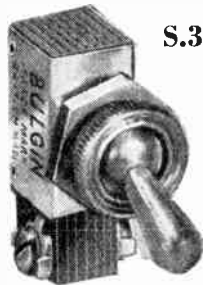

S.356

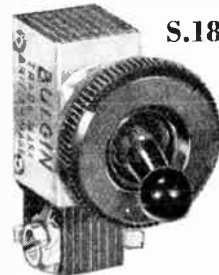



S.185

Types—







- SINGLE POLE
- DOUBLE POLE
- MAKE-BREAK
- CHANGE-OVER
- BIASED
- KEY-OPERATED
- PUSH-PULL
- TOGGLE
- ROTARY
- SEMI-ROTARY

FINISHES
AVAILABLE FOR ALL SWITCHES



DOLLIES—

		
PEAR	FORKED	BALL

RINGS & NUTS—

		
KNURLED	PLAIN	HALF-DOMED
		
PLASTIC	SLOTTED	BEVELLED

BUSHES—

		
SHORT	MEDIUM	LONG

● DOLLY AND RING FINISHES
AVAILABLE IN



25,000 OPERATIONS GUARANTEED!

MINIATURE

BULGIN

SWITCHES

A. F. Bulgin & Co. Ltd., Bye Pass Road, Barking, Essex.
Telephone: R1Ppleway 3474 (5 lines)

Random Radiations—

under the most adverse conditions by British-made components. Take the "salt-atmosphere test"—six hours in a closed cabinet with a spray (not directed straight at the component) atomizing a solution of sodium chloride, magnesium chloride, calcium chloride and potassium chloride; then 18 hours with the spray off and the cabinet open. Repeat the cycle three times. I'm particularly taken by the design of the special bumping machine. In fact I'm wondering whether, to judge from the condition of some of

the parcels I receive, the Post Office has not had a "super" model in use for some time! The R.I.C. bumping machine is a gem of fiendish ingenuity. The component under test is fixed to a wooden platform, hinged at one end to a support. Fifteen inches from the hinge a square spindle with tin faces turns at a speed of 120 revolutions a minute under the free end of the platform. If a component can stand up to the prescribed eight minutes of that, or $8 \times 4 \times 120 = 3,840$ hefty bumps, it should be able to smile at normal rough handling.

RECENT INVENTIONS

A Selection of the More Interesting Radio Developments

Short-wave Amplifiers

THE invention, which claims an early priority date, is based on the fact that effects associated with the presence of inductance in the supply leads to a short-wave amplifier can, within limits, be offset by providing

reactance such as a magnetron or similar valve of the space-charge or braking-field type. Such valves show an apparent capacitance particularly in the neighbourhood of their inherent resonance, which is highly sensitive, in the case of the magnetron, to small changes of anode potential.

In one arrangement, a waveguide terminating in a flared radiator is coupled through a coaxial line to a magnetron to which television signals are separately applied. The resulting changes in capacitance control the flow of waves towards the radiator to an extent that varies from the normal maximum to a complete cut-off.

A carrier wave of several hundred watts can be fully modulated in this way by signal energy of the order of one watt. Moreover, the method does not tend to damp or otherwise affect the frequency stability of the main generator.

Cie Generale de Telegraphie Sans Fil. Convention date (France), February 6th, 1945. No. 611931.

Indicators for Radio Navigation

RELATES to approach and blind-landing systems of the overlapping-beam type in which complementary signals are radiated in morse alternately in a given time cycle to produce an equi-signal zone marking out a desired course and having distinctive signals to port and starboard of it.

According to the invention, a visual indication of such signals is secured by feeding them to the grid of a rectifier tube, the anode of which is also coupled to a local oscillator, so that a pulsating output appears only during the intervals when both the grid and anode are positive with respect to the cathode. After amplification, this output is applied to a first pair of half-wave rectifiers, and then through a low-pass filter to an auto-transformer, which feeds a second pair of rectifiers controlling a zero-centre galvanometer. So long as the aircraft is "on course," the auto-transformer receives a direct

current only, so that the indicating needle remains at zero; but any deviation from course will deflect the needle either to port or starboard.

The Decca Record Co., Ltd., and W. J. O'Brien. Application date, April 15th, 1946. No. 610954

Receiver for F.M. Signals

THE anode of the limiter valve is connected to two parallel-resonant circuits, arranged in series relation, one being tuned to the carrier frequency, and the other to double that frequency. These are coupled to a pair of secondary circuits, similarly arranged and similarly tuned, and shunted across two oppositely-poled diode rectifiers.

The coupled network of resonant circuits acts as a phase-shifting device which, so long as no signal is present, produces an output wave that is symmetrical in form and so balances out across the rectifiers. Any departure from resonance, due to the appearance of a signal, will upset the normal quadrature phase relationship between the couplings, to an extent and in a sense which depends upon the original signal. The resulting output is a waveform of corresponding asymmetry, from which the signal is readily extracted by the diode rectifier.

Marconi's Wireless Telegraph Co., Ltd. (assignees of W. L. Carlson). Convention date (U.S.A.) May 22nd, 1945. No. 612448.

Television Safeguard

SO long as the electron stream is kept in rapid movement over the picture raster, under the influence of the line and frame scanning deflectors, there is no danger of damage to the fluorescent screen of the cathode-ray tube. But should one or other of the scanning generators fail, the sharply focused stream either becomes subject only to the comparatively slow-moving frame voltage, or else makes repeated traverses along the same scanning line. In both cases the sensitive coating of the screen is likely to be badly burnt.

According to the invention, the electron stream is automatically swept off the fluorescent screen should either of the scanning generators fail. While, say, the line-scan generator is in operation, the intermittent flow of its grid current serves to develop a negative potential. This is used to apply a cut-off bias to the grid of an auxiliary valve arranged in series with the frame deflecting coil. When the cut-off bias fails, the auxiliary valve at once releases sufficient current to sweep the focused stream completely off the screen. A second auxiliary valve similarly supervises the running of the frame-generator.

A. C. Cossor, Ltd.; A. H. A. Wynn and M. France. Application date, March 7th, 1946. No. 609830

The British abstracts published here are prepared with the permission of the Controller of H.M. Stationery Office, from specifications obtainable at the Patent Office, 25, Southampton Buildings, London, W.C.2, price 2 - each.

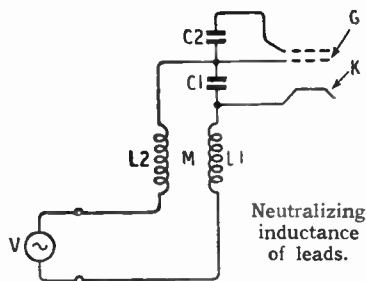

mutual coupling between certain of the leads.

In the diagram, the inductance L_1 of the supply wires to the cathode K is closely coupled at M to the inductance L_2 of the wire leading to the control grid G , the interelectrode capacities of the amplifier being represented at C_1 and C_2 . When an input signal is applied at V , the back e.m.f. developed through the coupling M reduces the value of the circulating current that would otherwise bypass the amplifier. The value of M must be at least half that of L_1 , which in turn should not exceed 0.04 microhenrys. Various devices are described for securing the necessary degree of close coupling between the supply leads.

Philips Lamps, Ltd. Convention date (Netherlands), September 14th, 1939. No. 612651.

Systems of Modulation

CENTIMETRE waves flowing through a waveguide are modulated in amplitude by varying the normal coefficient of transmission of the guide through the agency of a variable

PREMIER RADIO COMPANY

MORRIS & CO. (RADIO) LTD.

Introduce . .

THE TELEVISION KIT

YOU CAN BUILD FOR £17.17.0

This Receiver consists of 4 units :

The Sound Receiver, Vision Receiver, Time Base and Power Pack. As is usual in all Premier Kits, every single item down to the last bolt and nut is supplied. All chassis are punched and layout diagrams and theoretical circuits are included.

The cost of the Kits of Parts is as follows :

Vision Receiver with valves	£3 13 6
Sound Receiver with valves	£2 14 6
Time Base with valves	£2 7 6
Power Supply Unit with valves	£6 3 0

In Addition you will need :

VCR97 Cathode Ray Tube	£1 15 0
Set of Tube Fittings and Socket	7 0
6in. PM Moving Coil Speaker	16 6

The Instruction Book costs 2/6, but is credited if a Kit for the complete Televisor is Purchased.

Any of these Kits may be purchased separately ; in fact any single part can be supplied. A complete priced list of all parts will be found in the Instruction Book.

20 valves are used, the coils are all wound and every part is tested. All you need to build a complete Television Receiver is a screwdriver, a pair of pliers, a soldering iron and the ability to read a theoretical diagram.

Modification details for the Birmingham frequency will be available later.

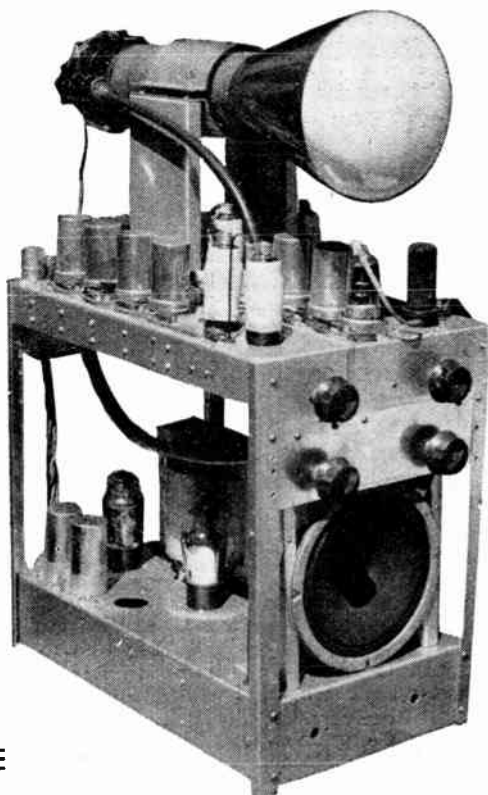

A GLANCE AT THE PRICES WILL SHOW THAT THIS IS THE GREATEST VALUE OFFER PREMIER HAVE EVER MADE

WORKING MODELS CAN BE SEEN DURING TRANSMITTING HOURS
AT OUR FLEET STREET AND EDGWARE ROAD BRANCHES.

BRANCHES AT

207, EDGWARE RD., W.2 Phone : AMBassador 4033
AND AT **152-153, FLEET STREET, E.C.4** Phone : CENTral 2833

All POST ORDERS to 167, LOWER CLAPTON ROAD, LONDON, E.5. *Phone : AMHerst 4723

Terms of Business : Cash with order or C.O.D. over £1. Send 2d. Stamp for list.

EDGWARE ROAD IS OPEN UNTIL 6 p.m. ON SATURDAYS

H.P. RADIO SERVICES LTD. OFFER

The following items representing unique value in Government Surplus Radio Equipment.

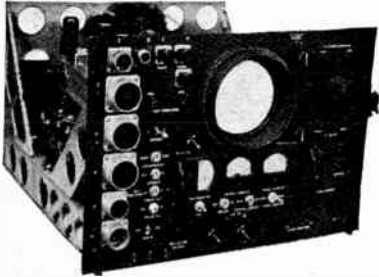

40 Valve Radar Receivers. Type R-31 APS-2E. A magnificent instrument. Absolutely brand new and unused in original manufacturer's packing cases. Fitted two Cathode Ray Tubes. One type 5FP7 5in. diameter Magnetic deflection and one 2API 2in. electrostatic. Valves fitted comprise 8 6L6G, 13 6SN7, 1 2X2, 2 6H6, 2 6X5, 8 6AC7, 3 VR105, etc. Has Blower motor cooling fan, 3 panel meters and a fabulous quantity of components. Input 115v. 400 c. Size 26 in. x19 in. x12 in. housed in a fine black crackle case. Original cost approx. £150 each. A few only available and offered subject to being unsold at 16 gns. each. Carriage 10/- extra. Available in British Isles only.

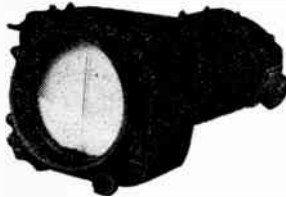

5FP7 Cathode Ray Tubes. Magnetic Deflection. Complete in Black Crackle Mu Metal Shroud fitted with deflector coils and Brilliance Control. A beautifully made unit. Easily worth 15 gns. by today's standards. Our price 3 gns. Carr 2/6. Guaranteed brand new and unused.

Antenna Units. Size 16in. x 8in. x 8in. Black Crackle Cabinet. Aerial Loading Variometer 3 pole 5 way Ceramic Switch. 4 porcelain lead-through insulators. Precision slow motion dial. 3 6000v. 80 mmf. block condensers. Brand New 10/- each. Carr. 2/6.



VCR97 Cathode Ray Tubes. (Equivalent to Mullard ECR60.) Brand New and Unused. As specified for "Inexpensive Television." Price 39/6. Carr. 2/6.

AR88. 13 Valve Communication Receivers. 230v. Immaculate condition. 5 only £40 each. Carr. paid.

1155 Receivers. Really beautiful condition. 10 valve Communication Receiver of outstanding efficiency. £9 each. Carr 5/-.

2-METRE ENTHUSIASTS !!! BC624 Receivers part of SCR522. Brand New. Easily converted to cover 2 metre band. 10 valves. 9003 1st R.F. 9003 Mixer. 12AH7 Crystal Osc. 9002 Harmonic Gen. 9003 Harmonic Amp. 12SG7 1st I.F. 12SG7 2nd I.F. 12SG7 3rd I.F. 12C8 2nd Det. A.V.C. 1st audio. 12J5 2nd audio. I.F. 12mcs. Power Required 300v at 60 ma & 12v 1.7 a. Conversion details supplied. Outstanding Value 39/6. Carr. & Packing 5/-.

H.P. RADIO SERVICES LTD.
Britain's Leading Radio Mail Order House
55 COUNTY RD., WALTON, LIVERPOOL, 4
Established 1935 Telephone: Aintree 1445
STAFF CALL SIGNS G3DLV, G3DGL

HOME STUDY backs radio experience with sound technical knowledge

MANY men who wished to link their radio experience with a sound technological background have received successful instruction by means of an ICS Course. Its value has been proved not only to amateurs but to men who already have a professional interest in radio and television engineering, including those taking qualifying examinations. It is invaluable, also, to students who wish to prepare themselves for a job in this field. Courses of instruction covering radio and, if necessary, television include the following:

**Complete Radio Engineering Radio Service Engineers
Radio Service and Sales Advanced Short-Wave Radio
Elementary Electronics, Radar and Radio
Television Technology**

And the following Radio Examinations:

**British Institution of Radio Engineers
P.M.G. Certificates for Wireless Operators
City and Guilds Telecommunications
Wireless Operators and Wireless Mechanics, R.A.F.**

Write today for our FREE "Radio" booklet which fully describes the above ICS Courses and the facilities for the complete study of Radio and/or Television technology. The ICS Advisory Department will also give free and impartial advice on need and means of instruction.

International CORRESPONDENCE SCHOOLS

Dept. WL.I., International Buildings, Kingsway, London, W.C.2

HIVAC
THE SCIENTIFIC
VALVE
BRITISH MADE

Pioneers & Specialists in Small Valves

LONDON H.V.C.
P.M.
NOV
1948
U.K. BRITAIN

Messrs. Hivac Ltd
Greenhill Crescent
Harrow-on-the-Hill,
Middx.

*THE address for:—
Electric Midgets-Miniatures*



53 Ranges with Rotary Switch Selection

This new and unique comprehensive Test Set has 53 ranges for measuring A.C. and D.C. current and voltage, resistance and insulation. It is completely self-contained, with internal batteries to provide power for the ohms ranges and self-contained power pack for insulation measurement at 500 v. Selection is carried out by two 20-position switches. A fully protective safety device is fitted and is operative for forward or reverse overload. The 150-division 6in. scale is uniformly divided and is fitted with an anti-parallax mirror. The set is enclosed in a handsome bakelite case and fully complies with B.S.S. No. 89 covering first-grade instruments.

Full details of the ranges covered and of the complete specification will gladly be supplied on request.

PRICE £65

SANGAMO WESTON LTD.

ENFIELD, MIDDX.

Tel. : Enfield 3434 (6 lines) and 1242 (4 lines)

201 St. Vincent Street, Glasgow - - - - - Tel. : Central 6208
 22 Booth Street, Manchester - - - - - Tel. : Central 7904
 Millburn House, Newcastle-upon-Tyne - - - - - Tel. : Newcastle 26867
 33 Princess Street, Wolverhampton - - - - - Tel. : Wolverhampton 21912



18, TOTTENHAM COURT ROAD,
 LONDON, W.1. MUS. 2453/4539.
 Hours. MON./FRI. 9-5.30. SAT. 9-1 p.m.

THE COMPONENT SPECIALISTS NOW OFFER TECHNICAL SERVICE

FOR TELEVISION & RADIO (Inc. "W.W." & "E.E." DESIGNS).
 A CALL, 'PHONE, OR STAMPED ADDRESSED ENVELOPE WILL
 BRING FREE EXPERT ADVICE ON YOUR PROBLEM.
 A SELECTION FROM OUR WIDE STOCK IS SHOWN BELOW

C.R. TUBES.	
Mazda CRM91, Standard 9in.	£11 6 10
Mazda CRM92, Long 9in.	£11 6 10
Mazda CRM121, Standard 12in.	£15 2 5
G.E.C. 660L, flat screen, 9in.	£11 6 10
Ferranti, flat screen, 12in.	£15 2 5
"W.W." TRF Telesivisor Coils, complete	£2 8 6
"W.W." Superhet Coils, complete	£2 12 6
BELSOL Polystyrene Cement.	
1 oz. bottle	11
3 oz. bottle	2 6
RECTIFIERS. U.S. 451U, GZ32, U14/20	18 3
ELSTONE MT9 Mains Transformer. 500-0-500 v. 250 mA., 6.3v. 6 a. C.T., 6.3 v. 3 a. C.T., 5 v. 3 a.	£3 7 6
CHOWS.	
5 Hy. 250 mA.	£1 5 9
10 Hy. 150 mA.	10 0
10 Hy. 80 mA.	13 0
200 Hy. 60 mA.	18 6
SCANCO EHT Transformers, new and improved type.	
5 kv. for 12in. CRT	£3 0 0
4 kv. for 9in. CRT	£2 8 0
Scanning coil line and frame	£1 5 6
Line Output Transformer	£1 5 6
Focus Coil Series Type 150 mA.	£1 7 0
Focus Coil Shunt Type 45 mA.	£1 10 0
MASKS.	
12in. Stone	£1 1 6
9in. Stone	11 3
12in. Black	18 0
9in. Black	9 6
TUBE MOUNTING STANDS. in wood, for 9in. or 12in. tubes	18 6

Fresh stock of can-type Electrolytics. All 500 v. B.I. Callenders. 8 mfd., 2/6 ; 8-8 mfd., 3/6 ; 32 mfd., 5/- ; 16 mfd., 3/3 ; 16-16 mfd., 5/6 ; 4 mfd., 2/-. DUBLIER. 16-24 mfd., 5/6 ; 4 mfd., 2/-. Coax. Cable. 1/4 in. dia., 80 ohm, per yd. 1 0 Coax. Cable. 1/2 in. dia., 80 ohm, per yd. 1 0 Twin Telecon Poly Feeder, 80 ohm, per yd. 6 2 Sleeving, 2 mm., all colours, per yd. 2 2 High Voltage Cable, 10 k.v. test, per yd. 1 0 Single Push-back, 22 S.W.G., all colours, per yd. 2 2 Waveform Generators, 34 + 65, less valves 7 6 Receiver Cabinets, brown bakelite (callers only), 17 x 12 x 7in. 12 6 10in. Travox Loudspeaker, 3 ohm coil 22 6 8in. E. & A. Loudspeaker, 3 ohm coil 17 6 5in. Goodmans, with 7k ohms transformer, 3 ohm 18 6 2 1/2in. Johnson & Phillips, less transformer, 3 ohm 12 6 2 1/2in. Celestion, less transformer, 3 ohm 18 6 14/26 PVC Wire, assorted colours, 100ft. coil 1 9 9/12 Canvas Covered, ideal for aerials, 100ft. coil 1 6 Jones Plug, 6-, 8-, 10-way, each 1 6 Jones Sockets, 6-, 8-, 10-way, each 6 6 Belling & Lee Plugs, 7- and 10-way, each 9 9 Belling & Lee Sockets, 7- and 10-way, each 9 9	
---	--

HEATER TRANSFORMERS (all new and guaranteed)

2 volt 2amp. Pri. 230 v. 50 cps. Size, 3 1/2 in. x 1 1/2 in. x 2 1/2 in.	9 6
4 volt O.T. 1.75 amp. Pri. 230 v. 50 cps. Size, 3 1/2 x 1 1/2 x 2 1/2 in.	10 6
4 volt 3 amp. Pri. 210/230/250 v. 50 cps. Size, 2 1/2 x 2 1/2 x 2 1/2 in.	18 6
6.3 volt 1.5 amp. Pri. 230 v. 50 cps. Size, 1 1/2 x 2 1/2 x 2 1/2 in.	9 9
6.3 volt 1.5 amp. Pri. 230 v. 50 cps. Size, 2 1/2 x 3 1/2 x 2 1/2 in.	15 0

(Postage 1/- extra)

ALL "W.W." TECHNICAL BOOKS AVAILABLE.

FULL POSTAL FACILITIES. PLEASE ADD POSTAGE.

TELEVISION AND GENERAL CATALOGUE, PRICE 6d.

STOCKISTS OF VALVES, BATTERIES AND TEST EQUIPMENT.

For all Electrical Tests

PIFCO

ALL-IN-ONE RADIOMETER



with internal battery and multi scale the PIFCO All-in-One Radiometer tests everything electrical, Radio and P.A. Equipments, Household appliances of all kinds. Car Lighting Systems, Bell and Teleprinter Circuits. May be used on AC or DC mains.

● **CIRCUIT TEST**

Tests for open or faulty circuits in all radio and electrical apparatus and domestic appliances. Equally for testing car lighting and starting circuits.

● **L.T. TEST**

0-6 volts AC or DC.
● **MILLIAMPERE TEST**
0/23 m.a. scale for testing total discharge from battery or testing single cell.

● **H.T. TEST**

0-240 volts. May be used direct on any mains, AC or DC

● **VALVE TEST**

Made by inserting valve in socket on front of meter.

Write for full details and Export terms. Overseas Agency enquiries invited.

PIFCO LTD., PIFCO HOUSE, WATLING STREET, MANCHESTER, 4
and at **PIFCO HOUSE, GT. EASTERN STREET, LONDON, E.C.2**

Speaking of Operations



Speaking of operations, a delicate but highly successful one has been carried out in striking the balance of correctly matched voice coil and curvilinear cone for our new 12" loud speaker. By carefully

suiting the weight of coil to cone we have reduced the peaks and secured a freedom from break-up, while the very high flux density of the large Alcomax magnet considerably increases the sensitivity, especially in the higher frequencies. All very worth while as you may see, or rather hear.

GRAMPIAN
12" SPEAKER
TYPE 3512/15

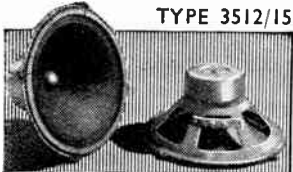

Overall diam. 12 3/4". Depth 6". Weight 7lb. 15 ozs. Voice Coil Impedance 15 ohms. Fundamental resonance 60 cycles. Flux density 14,000 lines per sq. cm. Frequency range 50-7,000 c.p.s. Fixing holes 4 holes 1/2" diam. spaced 90° on P.C.D. 12 1/4".

DELIVERY FROM STOCK
LIST PRICE £6-10-0

GRAMPIAN REPRODUCERS LTD
Hampton Road, Hanworth, Middx. Phone: Feltham 2657

G. W. SMITH & CO., (RADIO) LTD.

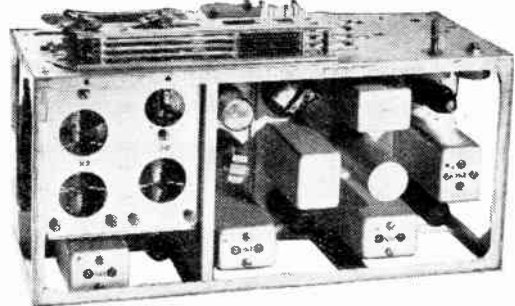

BC 624A BENDIX RECEIVERS **22/6** COMPLETE WITH VALVES
FREQUENCY COVERAGE 100-150 Mc/s

BC 522 TRANSMITTER CHASSIS
Less Mod. Trans. Chokes and Switching
4'6 EACH
Mod. Trans. and Chokes sold separate
4'6 PAIR

3 Lisle Street, London, W.C.2
Telephone Gerrard 8204

E.H.T.

FROM LINE
FLY BACK ●

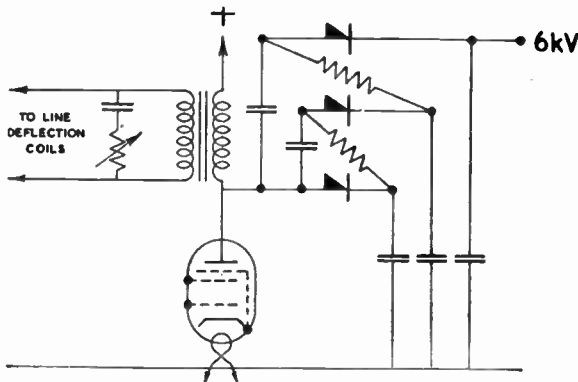

Tripler circuit using

WESTALITE

TYPE 36EHT35
RECTIFIERS

Peak pulse input approximately 2,500V.
Output approximately 6kV at 100
micro-amperes.

Simple . . . efficient . . . and reliable

Write for data sheet No. 60, to Dept. W.W.8

**WESTINGHOUSE BRAKE & SIGNAL
CO., LTD.**

82 YORK WAY, KING'S CROSS, LONDON, N.1



DIRECT RECORDING ON DISC

An Invitation

To all who seek the highest possible fidelity in sound reproduction, we extend a warm welcome to inspect and hear the M.S.S. equipment at

RADIOLYMPIA

STAND NO. 76

AND DEMONSTRATION ROOM D4

There is a range of models embracing types from simple Portable Recorders to complete Studio Recording Channels, and including a new Portable Studio Recording Equipment which sets entirely new standards of versatility and performance for portable recorders.

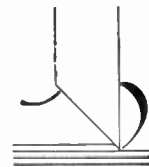

M · S · S · RECORDING COMPANY LTD
POYLE CLOSE · COLNBROOK · BUCKS · ENGLAND

Success through constant research—can we help you?

LOW LOSS CERAMICS

by

TAYLOR TUNNICLIFF

TAYLOR TUNNICLIFF (REFRACTORIES) LTD.,
Albion Works, Longton, Stoke-on-Trent, Staffs.
London Office: 125 High Holborn, W.C.1.

Phones: Stoke-on-Trent 5272 & Holborn 1951/2.

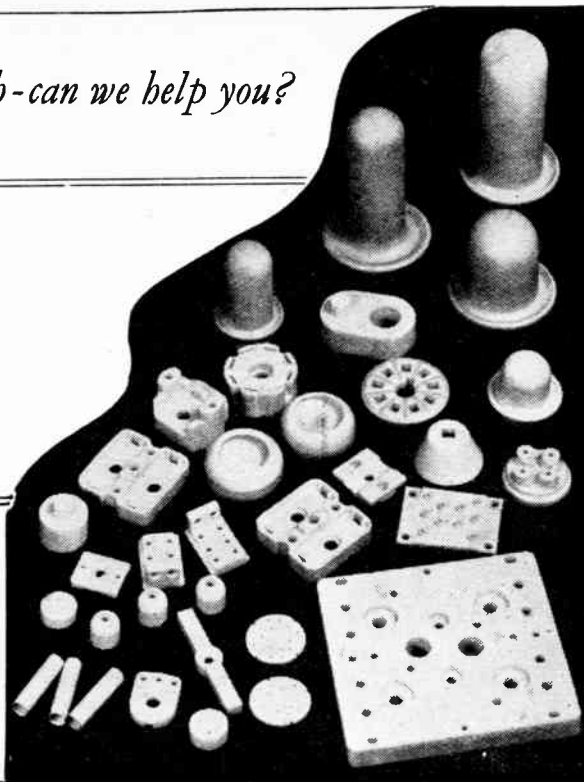

T.A.S./T.T.8

MAINS TRANSFORMERS SCREENED, FULLY INTERLEAVED AND IMPREGNATED.

H.S.63.	Input 200/250 v.	Output 250/0/250 v., 60 m/a., 6.3 v. 3 amps., 5 v. 2 amps.	15/6	} Half Shrouded.
H.S.40.	Windings as above.	4 v. 4 amps., 4 v. 2 amps.	15/6	
H.S.2.	Input 200/250 v.	Output 250/0/250 v. 80 m/a.	17/6	
H.S.30.	Input 200/250 v.	Output 300/0/300 v. 80 m/a.	17/6	
H.S.3.	Input 200/250 v.	Output 350/0/350 v. 80 m/a.	17/6	
H.S.2X.	Input 200/250 v.	Output 250/0/250 v. 100 m/a.	19/6	
H.S.30X.	Input 200/250 v.	Output 300/0/300 v. 100 m/a.	19/6	
H.S.3X.	Input 200/250 v.	Output 350/0/350 v. 100 m/a.	19/6	
F.S.2.	Input 200/250 v.	Output 250/0/250 v. 80 m/a.	19/6	
F.S.30.	Input 200/250 v.	Output 300/0/300 v. 80 m/a.	19/6	
F.S.3.	Input 200/250 v.	Output 350/0/350 v. 80 m/a.	19/6	} Fully Shrouded.
F.S.2X.	Input 200/250 v.	Output 250/0/250 v. 100 m/a.	21/6	
F.S.30X.	Input 200/250 v.	Output 300/0/300 v. 100 m/a.	21/6	
F.S.3X.	Input 200/250 v.	Output 350/0/350 v. 100 m/a.	21/6	
All above have 6.3-4.0 v. at 4 amps., 5-4.0 at 2 amps.				
F.S.43.	Input 200/250 v.	Output 425/0/425 v. 200 m/a., 6.3 v. 4 amps C.T., 6.3 v. 4 amps C.T. 5 v. 3 amps.	42/6	} Fully Shrouded.
F.S.35.	Input 200/250 v.	Output 350/0/350 v. 250 m/a., 6.3 v. 6 amps, 4 v. 8 amps., 0-2-6.3 v. 2 amps., 4 v. 3 amps.	98/6	
F.S.50.	Input 200/250 v.	Output 450/0/450 v. 250 m/a., 6.3 v. 2 amps. C.T., 6.3 v. 4 amps. C.T., 5 v. 3 amps.	77/6	} Framed Flying Leads.
F.30X.	Input 200/250 v.	Output 300/0/300 v. 80 m/a., 6.3 v. 7 amps., 5 v. 2 amps.	26/6	
E.H.T.2.	2,000 v. 5 m/a., 2-0-2 v. 2 amps, 4 v. 1.1 amps.		35/-	} Framed Flying Leads.
F.4.	Filament Transformer.	Input 200/250 v., 4v. 2 amps.	7/6	} Framed Flying Leads.
F.6.	Filament Transformer.	Input 200/250 v. 6.3 v. 2 amps.	7/6	
F.12.	Filament Transformer.	Input 200/250 v. 12.6 v. tapped at 6.3 v. 3 amps.	15/6	
F.24.	Filament Transformer.	Input 200/250 v. 24 v. tapped at 12 v. 3 amps.	21/6	

C.W.O. (add 1/- in £ for carriage), all orders over £2 carriage paid.

H. ASHWORTH (Dept. W.W.)
676, GREAT HORTON RD., BRADFORD, YORKS.

The T.G.2 Direct Disc Recording Traverse Gear

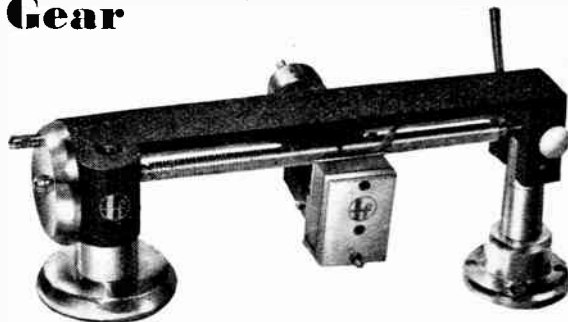

A precision built robust mechanism simple in operation producing first quality recording - - - £21 0 0
Recording Motor and Turntable - - - £14 0 0

Ideal for assembly into Light, Portable Equipment

A New Permanent Needle at the amazingly low price of - - - 5/- (Inc. P.T.)

We supply a well established and guaranteed reputable make of superior quality Sapphire Needle

- REGRIND SERVICE AVAILABLE
- Diamond Needles can be supplied
- Prompt attention given to enquiries for any quantity—large or small.
- Speedy delivery.

ELECTRO SOUND SUPPLIES CO.,
99, BELGRAVE ROAD, S.W.1.
PHONE: VIC. 8814



CONSISTENTLY *Accurate* PULLIN SERIES 100 TEST SET

SENSITIVITY 10,000 OHMS/VOLT

with
A.C./D.C. Voltage Multiplier
for 2,500 V. and 5,000 V.

Volts A.C. and D.C. Range :
10, 25, 100, 250, 500, 1,000.

Milliamps D.C. only :
2.5, 10, 25, 100, 500.

Ohms : 0-10,000 and 0-1 megohm.

A.C. Current Transformer
Range : 0.025, 0.01, 0.5, 1.0, 5.0,
25.0 Amps.



We can give early deliveries—
Address all enquiries to:

MEASURING INSTRUMENTS (PULLIN) LTD

ELECTRIN WORKS, WINCHESTER STREET, LONDON, W.3. Tel : ✈COrn 4651/3 & 4995

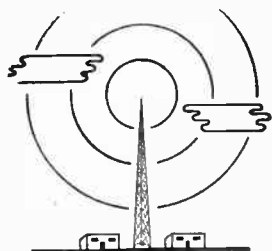

TELCON METALS

are used extensively for

RADIO & TELEVISION COMPONENTS

The value of MUMETAL for magnetic screening is well appreciated and shields for cathode ray tubes, transformers and other devices susceptible to stray magnetic fields are made in large quantities. Apart from producing a range of MUMETAL SCREENS for all normal applications, we undertake the manufacture of special screens, either in the form of DEEP DRAWN CANS for large quantity production, or hand fabricated assemblies for the shielding of apparatus of complicated shape. Whether the screening reduction is to be 10 dB, or 100dB, we can offer a solution, and the services of our technicians are always available. A list of standard sizes of screens will be sent on request. We also manufacture RADIOMETAL, RHOMETAL, H.C.R. ALLOY, TELCON BIMETAL, TELCON BRONZE (Beryllium - Copper), TELCUMAN and TELCOSEAL GLASS SEALING ALLOYS.

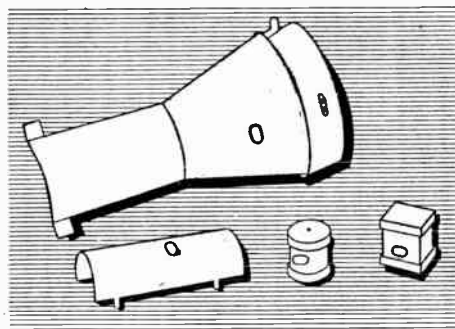

Meet us at Radiolympia Stand 30

Ask also for details of
TELCON
R. F. CABLES

THE TELEGRAPH CONSTRUCTION & MAINTENANCE CO. LTD

Head Office: 22 OLD BROAD ST., LONDON, E.C.2. Tel.: LONdon Wall 3141
Enquiries to: TELCON WORKS, GREENWICH, S.E.10. Tel.: GREenwich 3291



De
Luxe
&
Potted
Type



WHEN ORDERING TRANSFORMERS Specify

WODEN FOR RELIABILITY

TYPES AVAILABLE FOR:—

**TELEVISION EQUIPMENT,
QUALITY AMPLIFIERS,
TRANSMITTERS, ETC.**

Send for Illustrated Catalogue and Price List of full range.

WODEN TRANSFORMER CO LTD

MOXLEY ROAD · BILSTON · STAFFS

TEL: BILSTON 41959.

J.T.L.

Stars for Sale!

DELIVERY from
STOCK of the
LATEST
COLLARO
RADIOGRAM
UNITS

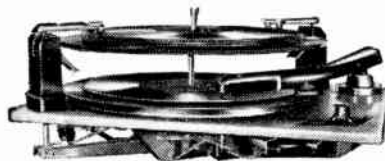

RC49. The lowest-priced automatic record changer. Plays 10in. or 12in mixed records. Crystal pick-up, 100/130 and 200/250 v. A.C.
Price only £14. 6. 8 inc. P.T.

RP49. Single record radiogram unit. 10in. turntable, auto stop. Magnetic pick-up. 100/130 and 200/250 v. A.C.
Real value at £5. 14. 8 inc. P.T.

QUALITY COMPONENTS FOR THE "W.W." SUPERHET TELEVISION RECEIVER

- Complete set of 20 coils for London or Birmingham .. 63/-
- Line O.P. transformer .. 70/-
- Blocking oscillator do. .. 15/-
- Mounted Scanning coil assembly with Line, Frame and shrouded focus coils .. 120/-
- 4uF 1,000 v. Paper condenser .. 7/6
- 32uF 500 v. Electrolytic B.I. .. 7/6
- Dubiller 1,500Ω 20-watt wire-wound resistor .. 4/-
- Single flex 135/012 per yd. .. 7/6
- Reliance T.W. wire-wound pots, 1K, 2K, 10K .. 5/7
- Reliance S.G. pots 100K, 150K and 2 meg Ω .. 6/10
- S.T.O. H4/200 H.V. rectifiers .. 28/-
- Dubiller .001/5,000 v. mica .. 5/-
- Dubiller .002/5,000 v. mica .. 6/-

Also B.T.H. crystal diodes, co-ax plugs, sockets and cable, small resistors and condensers, mains transformers and ohokes, valves and picture tubes.

ENAMEL WIRE

- 14, 16, 18, 20, 22, 4/- per lb., on maker's reels, 3 to 7 lbs. each. Small reels, ½ lb. 3/-; 1 lb. 6/-.
 - 24, 26, 28, 30, 5/- per lb., on maker's reels, 2 to 5 lbs. each. ½ lbs., 1/8; ¼ lb., 3/8; 1 lb., 7/-.
 - 32, 34, 36, 38, 6/- per lb., on maker's reels, 2 to 4 lbs. each. ½ lb., 2/-; ¼ lb., 4/-; 1 lb., 8/-.
 - 40, 7/- lb.; 42, 9/- lb.; on maker's reels, average ½ lb. to 1½ lb. each.
 - 44, 12/- lb.; 46, 18/- lb.; on maker's reels, average weights ½ lb. to 1 lb.
- "Maker's reels" are random weights as wound. Reels are extra 6d. to 2/6. Small reels are free of charge.

Frith RADIOCRAFT Ltd.
69-71 CHURCH GATE LEICESTER
G2CQZ G3BYI G2RI
PHONE 58927

FOR QUICK DELIVERY
AT
REASONABLE PRICES
OF
RADIO & ELECTRONIC PRODUCTS
(Wholesale Only)

Write or phone:—

S. Szymanski
(pronounced SHE-MAN-SKEE)

ELECTRONIC ENGINEER & STOCKIST
95 STRODES CRESCENT

Staines 3971

STAINES, MIDDLESEX

VALVES are our speciality—Probably the
Largest Actual Stockist in England

EXPORT ENQUIRIES WELCOMED

INTRICATE PARTS



BULLERS LOW LOSS CERAMICS

but not too
intricate
for
Bullers

Made in Three Principal Materials

FREQUELEX

An insulating material of Low Di-electric Loss, for Coil Formers, Aerial Insulators, Valve Holders, etc.

PERMALEX

A High Permittivity Material. For the construction of Condensers of the smallest possible dimensions.

TEMPLEX

A Condenser material of medium permittivity. For the construction of Condensers having a constant capacity at all temperatures.

BULLERS LTD., 6, Laurence Pountney Hill, London, E.C.4

Telegrams: "Bullers, Cannon, London"

Phone: Mansion House 9971 (3 lines)

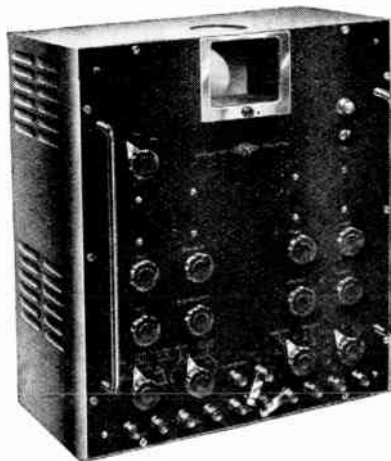

Tube: 4" electrostatic type with optically flat screen and provision for direct connection to deflecting plates.

Sensitivity: Maximum 15 mV/cm.

Shifts: Instantaneous and symmetrical.

Amplifiers: Balanced "Y" amplifier and additional auxiliary amplifier for

AN ADVANCED DESIGN IN OSCILLOSCOPES



● The new Airmec Oscilloscope has been designed to incorporate features found from practical experience to be advantageous. Some characteristics are indicated briefly below. Further details are given in pamphlet No. 19 available on request. The instrument has been designed to have minimum forward dimensions and is therefore suitable for bench or rack mounting on the standard P.O. centres. Racks are available if required.

"X" trace or independent use, e.g. beam modulation.

Frequency response: D.C. to 5 Mc/s flat within ± 2 db.

Time Base: 0.5 second to 1 microsecond with provision for single stroke.

Brilliance Control: Manual, and automatic compensation for photography of high speed traces. 4 kV. for extra brilliance.

Photography: Motor operated camera provided for mounting above oscillo-

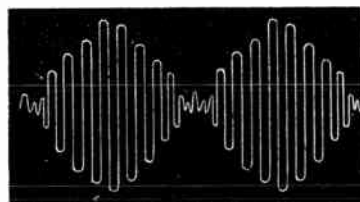

scope. Screen visible up to instant of exposure.

Controls: Switches and rotary controls are provided to minimise need for manipulation of external connections.

AIRMEC LABORATORIES LTD.

HIGH WYCOMBE • BUCKINGHAMSHIRE • ENGLAND • Tel. High Wycombe 2060 • Cables: Commlabs.
MANUFACTURERS OF ALL TYPES OF INDUSTRIAL ELECTRONIC EQUIPMENT & TEST GEAR

Metal work—by Ritherdon's

INSTRUMENT CASES
 AMPLIFIER RACKS
 RADIO AND TELEVISION CHASSIS
 FUSE BOXES
 BUSBAR CHAMBERS
 GENERAL SHEET METAL WORK, Etc.

RITHERDON & CO. LTD.
 LORNE STREET, DARWEN, LANC'S
 Phone Darwen 1026
 ESTABLISHED 1895

BRIERLEY PICKUPS

Ribbon, type JB/P/R/2

Microarmature, type JB/P/A/1

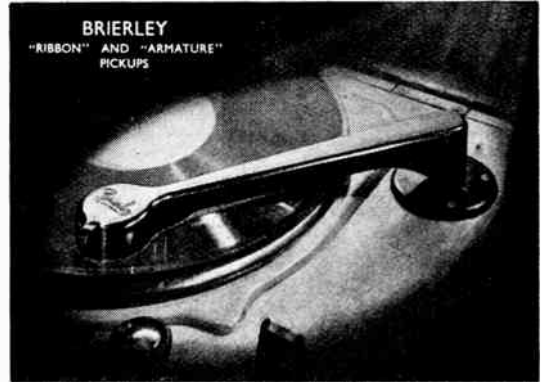

Brierley Pickups are individually hand-made and their performance is dependent on certain essential parts being so made; for this reason, production cannot be easily stepped up. It is regretted that there is still an average delay of about 2 months on home orders and supplies for the home market may indeed become unobtainable from time to time.

J. H. BRIERLEY (GRAMOPHONES & RECORDINGS) LTD.,
 46, TITHEBARN STREET, LIVERPOOL, 2.

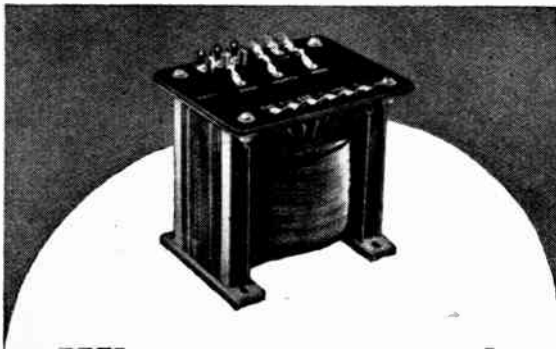

When an unusual Specification is required

We can give you the benefit of 20 years' experience in transformer construction and design. We do NOT mass produce. Every instrument is built to suit your most exacting individual specification.

Send your enquiries for the personal attention of our Mr. W. Bryan Savage.



SAVAGE TRANSFORMERS LTD. • NURSTEED ROAD, DEVIZES, WILTS.

Pushbutton?

Slider?

Rotary?

Band Selection?

Circuit Selection?

Tap Switching?

Whatever it is—the answer is always OAK! Equalised pressure, double contact clips and floating rotors are exclusive features embodied in all special or standard type OAK switches

WITHOUT QUESTION SPECIFY



BRITISH N.S.F. CO. LTD., Keighley, Yorks.

Sole Licensees of OAK Manufacturing Co., Chicago

You simply MUST make a WIRE RECORDER

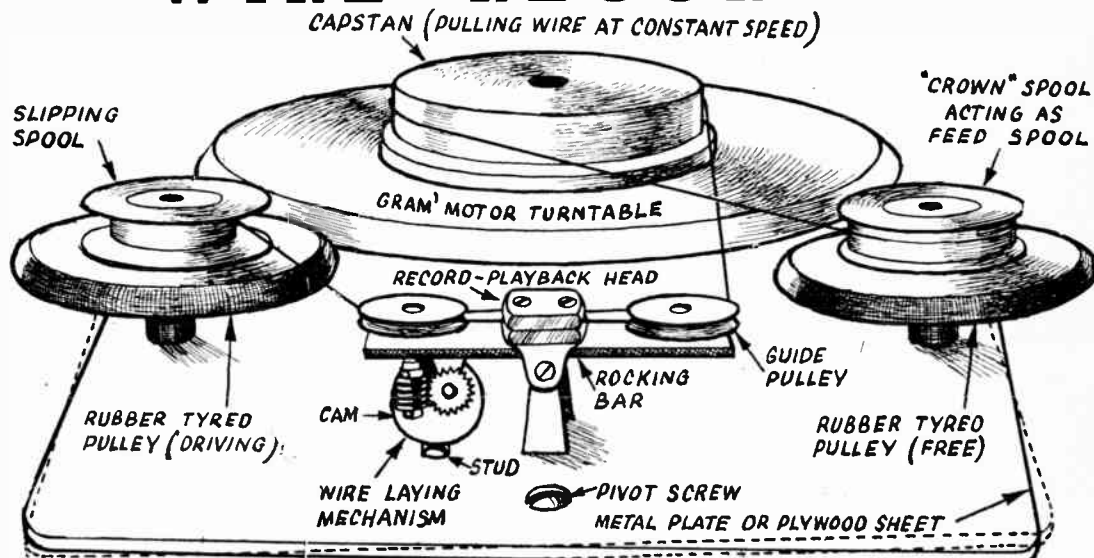

More thrilling than Radio—More gripping than Television. Complete constructional "Gen," 5/-.
All Components in stock. DEMONSTRATIONS BY APPOINTMENT.

PARK RADIO 676-8, Romford Road, London, E.12 Phone: ILFORD 2066

VIBRATORS FOR RELIABLE REPLACEMENTS

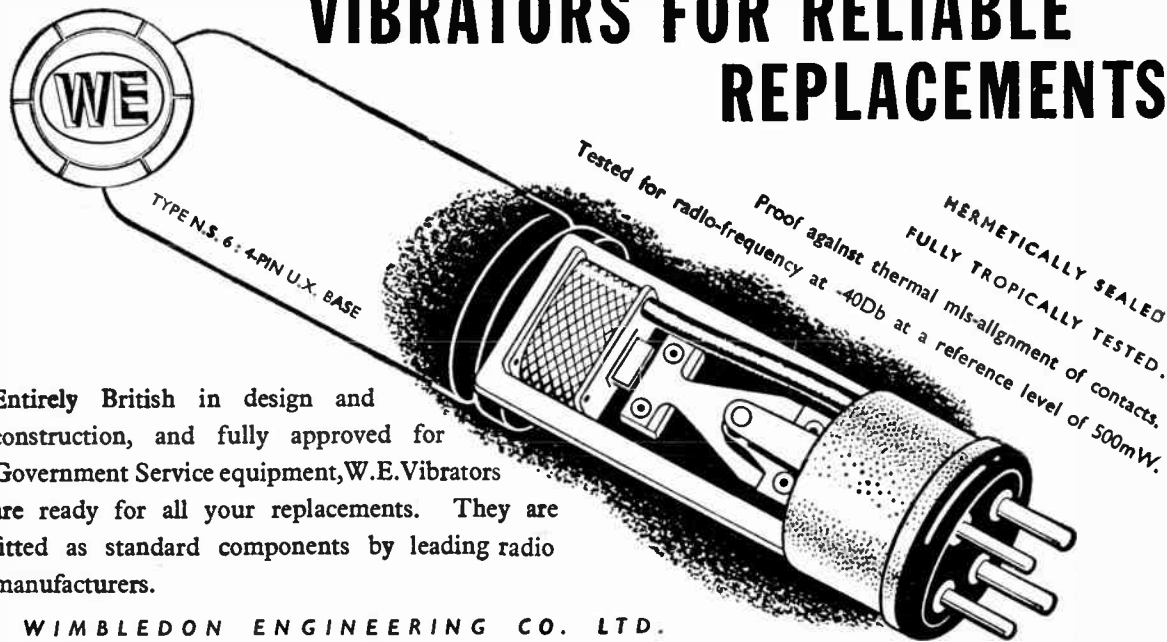

Entirely British in design and construction, and fully approved for Government Service equipment, W.E. Vibrators are ready for all your replacements. They are fitted as standard components by leading radio manufacturers.

WIMBLEDON ENGINEERING CO. LTD.
GARTH ROAD · LOWER MORDEN · SURREY · TELEPHONE: DERWENT 4814, 5010.

HERMETICALLY SEALED
FULLY TROPICALLY TESTED.
Proof against thermal mis-alignment of contacts.
Tested for radio-frequency at -40Db at a reference level of 500mW.

**THE NEW "75"
SIGNAL GENERATOR Model 1**



Frequency Range
110 to 50 Megacycles.
With calibrated extension covering London, & Midland Television frequencies, at over 60 Megacycles.

Modulation
400 C.p.s. sinusoidal.

Attenuator
5-step ladder, with fine control.

Output
Switched via single test-lead, RF. and AF. 1 volt Max.

External Radiation
Less than 1 micro-v.

For A.C. mains operation. Complete with Standard Dummy Aerial.



LIST 12 1/2 GNS. SUBJECT.

**EXCELLENT PERFORMANCE
ATTRACTIVE APPEARANCE
LOW PRICE
HIGH EFFICIENCY**

INQUIRIES INVITED:

SPHERE RADIO LIMITED
HEATH LANE, WEST BROMWICH, ENGLAND

MIDLAND INSTRUMENT CO.

For Govt. Surplus Stock, etc.

RADIO RECEIVERS, BC-624-A, includes 11 valves, 12SG7 (3), 9003 (3), 12AH7 (2), 9002, 6X8 and 12BE, condition new unused, 30/-, carriage 2/6. **MIDLAND TV., GE UNITS,** contains VCR-37 C.R. tube, also 7 valves, 6F50 (4), 6B34 (3), units complete, condition new unused, 65/-, carriage 5/-. **VCR-37 C.R. TUBES,** brand new in crates, 35/-, carriage 5/-. **AN/APA-1 INDICATOR UNITS,** consists of a 3BP1 G.B. tube in metal case, 11 valve amplifier, 68N7(GT (7), 6HG/GT, 606G, 6X5/GT, 2X2, control unit, etc., instructional booklet, will operate from A.C. mains using a 150-watt lamp in series, brand new in manufacturer's sealed cartons, 70/-, carriage 7/6. **MAINS TRANSFORMERS,** all 200/250 v. input, output 20 v. 3 amp., 10/-, post 11d., output 40 v. ct. 3-amp., 5/-, post 11d., output 70 v. 1 amp., 5/-, post 9d. **SANTON SWITCHES,** mains 20 amp. rotary 6 position, single pole 5-way and off, complete with pointer knob, brand new, 3/6, post 7d., 36/- doz. **THERMOSTATS,** superior make, variable setting dial marked 50 to 200 deg. Fah., handles 71 amp. at 440 v. A.C., cuts out at high temp. and in at low, new unused, fraction of to-day's list price, 12/6, post 9d. **MAINS MOTORS,** 200/250 v. A.C., fitted gear-box, final drive approx. 60 r.p.m., 15/-, post 1/2; motors only, fitted 3/16in. shaft 12/6, post 11d.; gearboxes only 65-1, straight spur type, 5/-, post 9d. **MOVING COIL headphones,** fitted moving coil microphone with switch, brand new boxed, 10/-, post 9d. **WALKIE TALKIE AERIALS,** copper, collapsible, 9-section, total 7ft., No. dia. tapers to 3/32in., brand new, 2/6, post 6d. **MAINS TRANSFORMERS,** input 230 v. 50 cycle, output 50 v. 11 amp., or with little alteration, 140v. at 51 amps., 25/-, carriage 5/-. **ELECTRIC PUMPS,** immovable self-priming centrifugal type, delivery 10 g.p.m., lift 25ft., suitable for water supply, garden fountains, bilge pumps, etc., 24 v. 5 amp. A.C./D.C., brand new in special containers, 25/-, post 1/4. **ELECTRIC MOTORS,** 12 v. 12 amp. A.C./D.C. 1/6 h.p., reversing, suitable for fitting to lawn mowers, hedge clippers, etc., brand new, 12/6, post 1/3. **IMMERSION HEATERS,** 230 v. 250 watt, fitted thermostat to cut out at 111 deg. Fah., 2in. dia. hole fitting, depth from flange 4 1/2in. ideal for aquariums, etc., new unused, 15/-, post 9d. **PRISMATIC BINOCULARS,** 8 x 25, complete in leather carrying case, used, otherwise in perfect order, satisfaction guaranteed, 27/10/-, post and regist. paid; ditto, showing double image, require correction, will make two perfect monoculars, 25, post paid. **DINGHY ANTENNA BOX KITES,** collapsible, size 36in. x 19in. x 19in., aluminum tube frame, a grand flyer, brand new, 12/6, post 9d. **MAGNETIC COMPASSES, TYPE P-8,** alcohol fluxgate, cardinal points and cross wires luminous, brand new in wood carrying cases, 10/-, post 1/-. **PERMANENT MAGNETS,** very powerful, overall size 9 1/2in. x 9 1/2in. x 1 1/2in., fitted keeper, brand new, in strong wood cases, 15/-, carriage 5/-. **P.V.C. COVERED 1/044 (18 a.w.g.) wire,** 100 yd. coils, red or black, brand new, clean, 5/-, post 1/-. **CRYSTAL VALVE RECTIFIERS,**sylvania 1N21 or B.T.H. CV-10, brand new stock, 3/6, post 3d. **BURGESS MICRO SWITCHES,** 4 different types, brand new, 5/-, post 9d.

Our greatly enlarged July lists are now available, send 2d. with s.a.e. for a copy. Our C.O.D. service is cancelled for the time being.

MOORPOOL CIRCLE, BIRMINGHAM, 17

Tel.: HARborne 1308 or 2654

TELEVISION COMPONENTS by well known manufacturer, complete tube mounting assembly, focus and deflection coils, line output trans., 4 heavy duty chokes, 5 kVA., E.H.T. trans., one each of the following, 350.0-350 v., 80 mills., 4 v. 10 amp., 4 v. 2 amp., 400.0-400 v., 80 mill., 4 v. 6 amp., 4 v. 2 amp., 2 v. 2 amp. Most of the valves used in this circuit are SP41. Kindly note: we do not supply valves. Complete with full circuits.....**£7/10/-.**

- 1/2 meg. volume con., long spindle with switch... **3/10**
- 1/2 MEG. POT WITH SWITCH LONG SPINDLE **3/3**
- 20K pot long spindle **1/9**
- 50K pot with switch long spindle **3/-**
- 1 meg. pot medium length spindle **1/9**
- 8 position press button unit, not surplus..... **2/4**
- 4 position press button unit, one pos. mains on/off **1/9**
- 8in. Mains Energised 2000 ohm field, output trans., 5000 ohm imp. **15/9**

Plus post, 1/-.
Set of four 1 1/2 dia. brown knobs, marked "Tuning, Volume, Wavechange and Tone," in gold lettering per set **2/-**

EXTENSION SPEAKER, in Walnut cabinet, Walnut louvres, volume control, R. & A. high fidelity 8in. speaker. Size of cabinet, 11in. high, 17in. long, 8in. deep, sloping to 6in. at top. Switch for cutting out speaker on back. **39/6,** plus 2/6 post and pack.

Write for lists.

D. COHEN

67 Raleigh Ave., Hayes, Middx.

E H T

2-6 KV Unit at
£3.15.0 retail
plus 5%
Complate.

RF EHT UNITS

SUITABLE FOR ALL

ELECTROSTATIC AND

ELECTROMAGNETIC

CATHODE RAY TUBES,

GEIGER COUNTERS,

INFRA RED IMAGE

CONVERTERS, Etc., Etc.

Units available to 25 KV. Trade supplied.

HAZLEHURST DESIGNS LTD.,

186, BROMPTON ROAD, KNIGHTSBRIDGE.

LONDON, S.W.3 KENsington 7793

MEET US AT
RADIOLYMPIA
SEPT 28 - OCT 8

Rate 6/- for 2 lines or less and 3/- for every additional line or part thereof, average lines 6 words. Box Numbers. 2 words plus 1/- Press Day: Sept. 1949 issue, first post, Thursday, Aug. 4th. No responsibility accepted for errors

WARNING

Readers are warned that Government surplus components which may be offered for sale through our columns carry no manufacturers' guarantee. Many of these components will have been designed for special purposes making them unsuitable for civilian use, or may have deteriorated as a result of the conditions under which they have been stored. We cannot undertake to deal with any complaints regarding any such components purchased.

NEW RECEIVERS AND AMPLIFIERS TUNING UNITS.

FULL range of Denco, Lowther and Eddystone goods available. 5 to 10 waveband gram chassis covering 3 to 60mc/s, 150 to 1,500kc/s, amplifiers for every use, television kits, radio kits, television £51, working at 150 miles range with good results; s.a.e. for leaflet of single items or illustrated 54-page catalogue price 9d., to Mason's (P.W.), Wivenhoe, nr. Colchester. [3594]

AEROTRON RADIO, Peel St., Chadderton, Lancs. SPECIALISTS in the manufacture of high quality radio and sound equipment; new models in development include the Model R.A.22 receiver/amplifier incorporating the following features, volume expansion, scratch filter, T.R.F. tuner with N.F.B. detector, output stage 2-PX25s in push pull, when finished this will be the finest and most ambitious amplifier on the market today; send us your name so that full details may be sent when available. TRADE enquiries welcomed. [3938] AGENTS required in all areas.

G. W. SMITH & Co. (RADIO), Ltd., offers the following sound and perfect 10-valve television chassis for long distance reception with 4mc/s bandwidth, complete with all valves and including complete modification sheet; 52/6. TELEVISION receivers, type R3084A, ex-W134, brand new in sealed boxes with 1 5Z4, 1 VU13, 1 VR137, 2 VR136, 7 EF50 valves, a very cheap and reliable television conversion unit; 72/6 each. TELEVISION units type 26, brand new and boxed, complete with valves, 30/-; ditto type 24, 12/6.

CHOKES, 5 Henry at 200ma, 3/6 each; 7 Henry at 250ma, 8/6 each; 7 Henry at 100ma, 6/-; 10 Henry at 400, 9/6; l.t. 5amp, 5/- each.

CONDENSERS variable 15pf single gang, 6d each; 15pf twin gang 1/-; 00016 variable, 6d each; 5pf with spindle, 9d each; 75pf ditto, 9d each; 2 gang 00035, 1/- each.

TELEVISION coil formers Polystyrene dust cores, 4/9 doz., wound 5/9 doz. (1 1/2 x 1 1/2).

SUPPLY PACKS, 6v input, 190v 80ma output, fully smoothed with 3 Ferranti chokes, 17/6 each; 12v vib. packs, 5/6 each.

ROTARY converters, 230v d.c.-230v a.c. at 250 watts, £10 each.

24 VOLT d.c. input, 230 a.c. output at 100watts, 55/- each.

METERS, 0-5ma 2in, 4.9 each; 0-20amp a.c., 7/6 each; 0-4amp 20mc, 2.9 each; 0-6amp thermo, 3/6 each; 0-20v d.c., 3/9 each.

CUTOFFS 12v, 3/6; stater relays, 12v, 3/6; mouse keys, ex-R.A.F., 1/- each; e.h.t. sleeving, 3d length.

G. W. SMITH & Co. (RADIO), Ltd., 3, Lisle St., London, W.C.2. Tel. Gerrard 8204. Open all day Saturday. [3975]

UNIVERSAL ELECTRONIC PRODUCTS, 36, Marylebone High St., London, W.1. Tel. Welbeck 4058.

SPECIALISTS in the design and manufacture of high fidelity reproducing equipment from 4-100 watts for domestic or industrial purposes. Our U.E.5 (6 watts) and U.E.7 (12watts) series amplifiers are designed especially for the connoisseur who requires the finest possible reproduction from recorded music; both amplifiers have a linear response over 30-20,000 cycles with a damping factor of 12, and incorporate pre-amplifier stage, together with independent control of bass and treble. Our policy is to produce an instrument which represents the highest standards in workmanship and performance and no expense has been spared to achieve this object.

A new addition to our range is the type U.E.3 (4watts) at £11.10. We also supply a range of tuning units, both t.r.f. and superhet, for use in conjunction with either our own or other makes of amplifiers. We should be pleased to quote you for the design and construction of a unit or replacement chassis to your exact requirements. Full details of our products will be forwarded on request, and we would welcome the opportunity to demonstrate our equipment at any time to suit your convenience. [3352]

VORTEXION amplifiers, 50 watt, and mixers, in stock.—Harmony House, 116, Cambridge Rd., Southport. [3788]

AMPLIFIERS, new 60watt heavy duty p.a. models, built for continuous rating and rack mounting, £40; early delivery, send for spec.—Broadcast & Acoustic Equipment Co., Ltd., Tombland, Norwich. [2905]



A new standard in
PUSH-PULL
OUTPUT PERFORMANCE

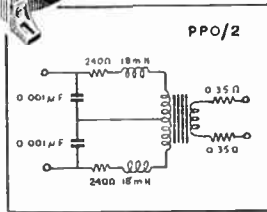
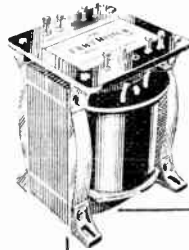

THE new "PPO" output transformers permit the reproduction of a full A.F. range with minimum distortion. Rating is 12w. for 0.5% harmonic distortion at 50 cycles. Six standard models are available, for accurate matching anode to anode loads of 4,000 ohms to 12,000 ohms. The secondary in each case is brought out in two sections for series or parallel connection to match a 15 ohm or 3.7 ohm load. These standard models are available from stock, other specifications can be wound to special order.

Full details are given in *Technical Data Sheet No. 1*, a copy of which will gladly be sent on request.

PARTRIDGE

TRANSFORMERS LTD

ROEBUCK ROAD, KINGSTON-BY-PASS
TOLWORTH SURREY

Telephone: ELMbridge 6737-8

TELEVISION pre-amplifiers with built in power pack, two stages R.F. amplifiers, B7G valves, totally enclosed and nicely finished, £5 complete. G. WERTHEIM, 3, Elmbridge Drive, Ruislip, Middx. [4002]

1949 bandspread feeder unit with R.F. stage, nine wavebands, 13.5-2,000 metres; 24d stamp for illustrated brochure.—Coulphone Radio Ormskirk Lancs. [2528]

R.A.F. model 1155, new, complete with valves, £8/10, plus carriage; converted models, power packs, quality amplifiers, speakers, auto changers and cabinets reduced prices; send for list.—Broadcast & Acoustic Equipment Co., Ltd., Tombland, Norwich. [2906]

CONNOISSEUR'S receiver—world-wide results on highly sensitive 10-valve communication receiver or, by change of switch, very high quality reception of local stations on non-superhet high fidelity receiver; basis rebuilt R1155 9-1.5mc metres; bass and treble controls (boost to cut), gram input, PX4 push pull output, an. all refinements.

FEEDER units as above, for use with external high quality amplifiers; write for details, or call for demonstration; R1155 specialists, receivers repaired and re-aligned, also modified as above, or to your requirements; R1155 circuit and valves 2/- post free.—R.T.S., Ltd., 5, Gladstone Rd., Wimbledon, S.W.19 Tel. Lib. 3303. [126f]

WE offer the new "Extended Range" 8-watt amplifier with revolutionary dual-tone control system, giving widest possible variation to suit all old and new recordings; built to independent standards this 6-valve amplifier, matched to 0.03v input, is now offered at £24 complete; hear it at its best with Tridem Corner speakers and the new Felicity TRF push-button unit. FELICITY GRAMOPHONE Co., 87a, Upper Richmond Rd., London, S.W.15. Putney 1665.

C.T.R. ELECTRICAL AND ELECTRONIC DEVELOPMENT Ltd., Hubert St., Birmingham, 6 (Aston Cross 2440), the Midlands; specialist manufacturers of high fidelity equipment for the "W.W. Williamson" and other quality amplifiers; also tone control stages, loud-speaker crossover units, distortionless contrast, amplifiers and radio feeders; see our illustrated advert, in alternate issues of this publication; send for full details and prices. [3503]

TELRAD ELECTRONICS, 70, Church Rd., Upper Norwood, London, S.E.19.—Specialists in the design and manufacture of electro-acoustical apparatus, announce a completely new range of high quality reproducing equipment, quality amplifiers with control units providing independent bass and treble control, giving widest possible variation to suit all recording; and the varying acoustic properties of one room with another; radio tuner units for use with the above or other makes of amplifiers; chassis units to suit all requirements, and to satisfy the discriminating ear; full details and demonstration on request, write, call or phone Livingston: 4879. [3969]

MIDCO high fidelity audio amplifiers for home and commercial use; AA/4.5 watt 6V6 amplifier tone and volume controls, £4/10; AA/10 super 10 watt amplifier with two mix/fade inputs, multi match output, 5 valves, tone control, £10; new PA/12 series portable amplifiers in carrying cases with chrome fittings, panel lamp, twin inputs for mix/fade, wide range NFB, multi match output, PA/12T record reproducer, high impedance input; independent bass and treble tone control, £14; PA/12M high gain microphone type, one high one low impedance input, tone control (top cut type), £14/10; detailed catalogue available; trade supplied. MAIL orders, 19, Newcomen Rd. Enquiries: 61a, Gt. Park St., Wellingborough. [3957]

R.T.M.C. (EALING), Ltd., pioneers of the Williamson amplifier and now recognised as the leading production of 1949, are again first with a 9-valve model which incorporates built in pre-amp, built to specification from finest components; there is definitely no other amplifier on the market to compare with it for quality and price, offered at £20/10 complete; also PX4 model (10 watt) (an entirely new production), £17/10, original 7-valve model, £25/10; standard model, £17/10; separate pre-amp if required, £6/10; also special offer of simplified Williamson 7-valve models at £20; all amplifiers are guaranteed to be of highest quality.—Full details from R.T.M.C. (Ealing), Ltd., Laurel House, 141, Little Ealing Lane, W.5. Eal. 6962. [3674]

RECEIVERS, AMPLIFIERS—SECOND-HAND

MURPHY Station Master rec., as new, 2-22 m/cs, in 7 bands and m.w.; £25.—Box 7255. [3824]

10 watt amplifier, with 9in speaker on baffle, and radio unit, faultless condition.—Box 7484. [3792]

SUPER pro £28; 2kva, 220-110 oil filled transformers, £3.—McGarroch, 29, Grant St., Elgin, Morayshire. [4004]

MURPHY A40 console, 15 valve all-wave, super job, as new.—Seward, 76, Naunton Cresc., Cheltenham. [3986]

TECHNICALITIES AND SUMMER BARGAINS

We are providing a technical data sheet service for our American customers as a supplement to "New Notes in Radio."

These sheets contain useful facts and figures on the matter of achieving real high-fidelity reproduction. Five sheets are ready and others will follow from time to time as we do more research work.

We have been told that these data sheets will also be useful to British high-fidelity enthusiasts and we are therefore happy to announce their availability to all who care to send us the modest subscription of 2/6. If you have "New Notes" you ought to have these supplementary sheets: if you have not yet read "New Notes in Radio" send 5/- for the book and the data sheet service. Catalogue sheets are free for the asking.

We have seven slightly shop-soiled 215 Speakers which we offer at £6 each, plus 5/- for postage and packing. They will perform exactly like a brand-new 215, and that is good enough for anyone. But there are only seven, so don't lose this one and only chance. We have also a few pre-war models at keen prices for personal shoppers only, and a few other odds and ends of surplus equipment.

Why not call and see what we have ?

H. A. HARTLEY CO. LTD.

152 HAMMERSMITH ROAD, LONDON, W.6.

R/V. 7387

THESE ARE IN STOCK

High-Quality Audio Amplifiers—Circulars reprinted from "Wireless World." 2s. 6d. Postage 2d.

Outline of Radio—covering the principles of Radio Television and Radar. By H. E. Penrose and Others. 21s. Postage 9d.

Radio Valve Data—compiled by the "Wireless World." 3s. 6d. Postage 3d.

The Radio Amateur's Handbook. By A.R.R.L. 15s. 6d. Postage 9d.

The Antenna Book 1949 edition. By A.R.R.L. 9s. 6d. Postage 6d.

Practical Electrical Wiring and Contracting. 9s. 6d. Postage 9d.

The Mathematics of Wireless. By Ralph Stranger. 7s. 6d. Postage 5d.

Radio, Television and Electrical Repairs—edit. by R. C. Norris. 10s. 6d. Postage 9d.

Radio Receivers and Transmitters, by S. W. Amos and F. W. Kellaway. 25s. Postage 9d.

Industrial Electronics and Control. By R. G. Kloeffler. 35s. Postage 1s.

Loudspeakers—The How and Why of Good Production. By G. A. Briggs. 5s. Postage 2d.

Handbook of Line Communication. Volume 1. (Royal Signals). 20s. Postage 1s.

Newnes Television Manual. By F. J. Camm. 7s. 6d. Postage 4d.

Electronic Musical Instruments. By S. K. Lever. 3s. 6d. Postage 2d.

We have the finest selection of British and American radio books. Complete list on application.

THE MODERN BOOK CO.

(Dept. W.8),

19-23, PRAED STREET, LONDON, W.2

ACOUSTICAL mains/battery 30 watt amplifier. M.B.31, perfect; £25 or near.—Graham Newbery, Axminster. [3948]

R107. Army's finest communication receivers, R 230v ac or 12v dc; £15 each.—Logan, West Alley, Hitchin, Herts. [3950]

COMMUNICATION receiver R.208, 10-60 m/cs; also R.1355 with R.F.26 unit, all in good order; £8 (London).—Box 7352. [3934]

HALLICRAFTERS S-20 receiver, 540 k/cs to 44 m/cs, excellent condition, with manual; £18.—142, Shirley Way, Shirley, Surrey. [3820]

A.R.88 Receiver, 540kc/s/32Mc/s, perfect order, Avo Universal, nearest £45.—Carter, 15, Tithelit Shaw Lane, Upper Warrlingham, Surrey. [4022]

60 watt heavy duty continuous rating, today's advertised price £40, our price £30, perfect.—Harmony House, 116, Cambridge Rd., Southport. [3789]

TELEVISION G.E.C. combined radio BT 7092, condition. £45; Murphy VIIA, £45; Murphy V136c, £48; all perfect.—R. W. Clitherow, 27, High St., Saffron Walden, Essex. [3790]

AMPLIFIERS, 50 watt, 24 at £8 each; speakers, horn type, 40-42in, compete with units, 100 at 30/- each.—Apply Monitor Radio & Communications, Stechford, B'ham, 9. [3816]

COMMUNICATION receiver, Phillips 7-valve allwave built-in speaker, separate matching power pack, perfect, as new, bargain; £15.—Romford 1887. 48, Woodlands Rd., Romford. [3800]

ACOUSTICAL 32 watt amplifier M32, perfect condition, £15 or offer; also K20 speaker in cabinet, M.C. microphone, etc.—Tel. Syd 4312 (evenings). 65, Sherborne Court, Anerley, S.E.20. [3939]

EDDYSTONE 640 receiver, complete with S-meter, speaker, and instruction manual, offers over £25; also C.D.P. disc recorder; buyer must collect the recorder.—Garner, 5, Bank Sq., Wilmslow, Cheshire. [3946]

EDDYSTONE model S.640 communications receiver, nearly new (30 hours operational time), complete with set of Brown's phones and Eddystone speaker; nearest offer to £25.—Fistral House, Westfield Rd., Bengoe, Hertford. [3817]

15 watt gram, amplifiers complete, rack mounting, twin chassis, heavy duty iron cored components; 2 PX 25 in pp with valves. £6/15; 25 valves, £4/10, plus carriage.—Broadcast & Acoustic Equipment Co., Ltd., Tombland Norwich. [2907]

TELEVISION.—Invicta Console T103 (London), 2 months' old, £60, perfect, buyer collects; also latest Senior RK P.M., £3/10; Sphere 75 sig generator, £9; Taylor Scope 30A, £18.—R. J. Newey, 23, Lea-House Rd., Langley, Birmingham. [3964]

FOR sale, Hallicrafter SX-28, Eddystone 598 with 9 coils, 2nd power Marconi BC312 or BC342 set HRO coils incl. handbread; first reasonable offers secure, all excellent condition and overhauled; Bills available (April, 1949).—Edwards, 12, Coledale Drive, Stanmore, Middx. [4019]

CR100 (B28), 11-valve communication receivers, covering 10-2,000 metres in 6 wavebands, 200/250v a.c. mains, Marconi equiv. of AR88, 2RF, 31P stages with Xtal gate, 3watt O.P., overhauled, aligned, remetalised cabinets, first rate condition; a large purchase enables us to offer these magnificent receivers (usually valued around £35) at the amazing price of 19gns. carr. forward; secure yours while they last; money back if not satisfied guarantee. **THE AMATEURS DEN**, 181, Lake Rd., Portsmouth. [3747]

NEW LOUSPEAKERS

THE Tridem 12D Corner cabinet with Barker unit is delighting all customers, price £30; also standard model 12B at £21.—Details from Felicity Gramophone Co., 87a, Upper Richmond Rd., S.W.15. [3802]

PUT the finishing touch to your HI FI equipment with the Gee Reproducer Unit, suitable any cone speaker; exquisite cabinet design and finish, size 40x36x13; details, stamp please.—Gee, 69, Fairlop Rd., E.11. [3963]

BROADCAST new model pm/12.12in die cast frames, Ticonal magnets, 15ohm, 12watts, detachable cones, 12,500 lines, standard £5/15; Hi-Fi twin cone £6/10.—Broadcast & Acoustic Equipment Co., Ltd., Tombland, Norwich. [2908]

LOUSSPEAKERS, SECOND-HAND UNUSUED manufacturers' surplus.—Rola 6½in P.M. speakers; 11/6 each, postage 7d.—McNell, 164, Streatham Rd., Mitcham. [3653]

VOIGT light-coil twin diaphragm unit, £15; also available O.P.T. for push-pull PX255, power pack, experimental H.C. horn; £25 the lot, or nearest offer secures; near North London.—Box 7519. (4005)

DYNAMOS, MOTORS, ETC.

ELECTRIC motors.—Our famous range of motors again available from stock; example, ½hp single-phase, 200-250v, 1,400 rpm, from £6/16/6; send for lists.—John Steel, Bingley, Yorks. Tel. 1066 (4 lines). [3968]

GOVT. SURPLUS, UNUSED

CONDENSERS

of all types . . .

We can offer, FOR IMMEDIATE DELIVERY from very generous stocks, a wide range of ultra-high quality fixed paper Condensers, from .001 μF to 8 μF. Also STOCKS of small, genuine MICA Condensers from .00001 (10 pf) to .01 μF (10,000 pf). Prices are exceedingly moderate.

Enquiries are invited for manufacturers' requirements, wholesale and export only for bulk quantities, and for scheduled deliveries over a period, as required.

Most condensers are now available for immediate delivery.

Please request our 4 page bulletin CONSEVEN 0114

CLAUDE LYONS LTD.

180 Tottenham Court Rd., London, W.1 and 76, Oldhall St., Liverpool 3, Lancs.

AMAZING BARGAIN

Ex. M.O.S.
NEW & UNUSED
ELECTRIC MOTORS

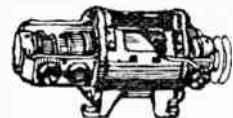

A.C. single phase, approx. one-sixth h.p., for 200/250 volts, 50 cycles. They're worth £'s. Dimension 1½in. long x 5½in. x 5in. Weight 16lb., shaft ½in. x 1in. Keyed ready for pulley. Vee Die Cast Pulley 3½in. O.dia. Supplied at 7/6 extra.

20/-
carr. paid.

Post Free.

MOVING COIL
HEAD & MICROPHONE SET (Brand new)

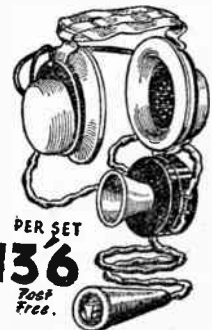

Made by the same famous maker, these units must have cost the Government many pounds.

Our Bargain Price

PER SET

13/6
Post Free.

Send stamped addressed envelope for illustrated list.

BARGAIN

WIRELESS INSTRUMENTS (LEEDS) LTD.
54-56, THE HEADROW, LEEDS 1.

Te. 2762.

BATTERY chargers, 4 models 2-6-12v. 1-2-4 amps D.C.; any mains voltage; also larger types special transformers, chokes, test gear, interior car heaters, etc.—The Banner Electric Co., Ltd., Hoddesdon, Herts. 12122

NEW Onan pet. generators, 12-15v, 600 watts (not 400) self-start, air-cooled, 4-stroke, volt reg. auto cut-out, ammeter, complete with tools, spares and instruction book, £25 plus carr.; new crated pet. or T.V.O. (paraffin) 600 watt, choice of J.A.P. or Villiers engine, 550 watt, 12-18v, air-cooled, side valve, 4-stroke (2hp), complete with control box, cut-out, m.c. meter, tool box, spares, instruction book and waterproof cover, a first-class heavy-duty job, £27/10, delivery free; Alco-Lyon 12-15v 360 watt, air-cooled 4-stroke, m.c. meter, cut-out, etc., used, from £10-£15, del. free; 14-32v 280 watt new shunt-wound dynamos, not ex-aircraft, £5, del. free; control boxes for these with cut-out, fuse, var. res. ammeter and conn. leads £2/10, p.f. or £7 the pair; note all pet. gens. and dynamos are tested individually on load by us before despatch; mains chargers, metal rects., H.D. 50v 50a 3cct control panel, 200-250/150 or 440/350 input, £20 plus carr.; 24v 26a with control panel, meters, fuses, rheos, 200/250/1n, £15, carr. free; another, 6-24v 12a m.c. meter, 200/250/1n, £10 plus carr. send P.C. for free lists and photographs of pet. gens., dynamos, etc.

T. W. PEARCE, 66, Gt. Percy St., London, W.C.1. See under Components for STC rects., etc. 13996

97/6, charging switchboards, 12v-32v, 500 and 1,260 watts, volts, amps, cut-outs, fuses, resistances etc., 4 tks. off's, superb unit in case or send £5 carriage paid; 75/- dynamos, 24 volts, 1,000 watts, 9inX7in, 3in spindle, or send 80/- carriage paid; 75/- 230v/150, 1/2hp electric motors, incorporating 1,260 cycle converter, or send 80/- carriage paid; 58/- mains transformer switchboards, 250v a.c. to 12v, 5 tks. off's, complete distribution panel, all switches, fuses, amps, etc., brand new, or send 60/- carriage paid; 55/-, electric motors, 12v and 24v, 1/2hp, 4inX4in, with 1/2in spindle for drive, beautiful job, or send 60/- carriage paid; 45/-, dynamo units, containing 12v, 24v, 130v and 300v d.c. dynamo or suitable as 6v, 12v or 24v motor, approx. 1/2hp, 11inX5in, with spindle to take small grindstone, mop, etc., also contain adjustable 24v cut-out automatic voltage control, smoothing condenser, resistances, and many other extremely useful fittings, beautifully made, or send 50/- carriage paid; 38/-, radio voltmeters, adjustment dial, 350-370 Mc/s, beautiful instrument in case, or send 40/- carriage paid; host other valuable equipment; lists free.—Benmott's, Summerley St., Earsfield, S.W.18, Wim. 3653, (1) yds S. Rly. Electric Line; 10 minutes Waterloo.)

TEST EQUIPMENT

TAYLOR 75A, as new, with manual; £9.—Radio Facilities, Eaton Socon, Hunts. 13935

FOR sale, very slightly used Hickock electronic volt ohm milliammeter, series A, model 202; best offer secures.—Box 7214. 13810

WESTON model E772 (type 4), analyser, in good condition; £11 carriage paid.—T. G. R. Dowsett, 48, Grove Rd., Eastbourne. 14015

SALE—Taylor signal generator model 65B, £11; also Avo valve tester model 45a, £15.—Michaelson, 77d, Companye Gdns., London, N.W.6. 14016

FERRANTI 7.5kva moving coil automatic voltage regulators, input 230v ±8% to -12%, 45-66 cps, output 230v ±1/2%, frequency compensated, new and unused, with handbook; offered at a fraction of cost price: (Herts). Box 7488. 13949

OSCILLOSCOPE and Wobulator complete £20; T.B. c/s 10 to 350,000 c/s X and Y plate amplifiers, easy to handle, has outstanding performance, fully guaranteed, with permanent with set of leads and booklet. "Oscilloscope technique" further details from the manufacturers.—Erskine Laboratories, Ltd., Scalby, Scarborough. 13456

METERS—0-7v, 2 1/2in, m/c, 9/6; 15v, 2 1/2in, m/c, 9/6; 150v 2in, m/c, 10/-; 300v, 2 1/2in, m/l, 13/6; 3,500v, 3 1/2in, m/c, 20/-; 6,000v, 3 1/2in, m/c, 57/6; 15,600v, 2in, m/c, double reading, 8/-; 100ma 2in, m/c, 7/6; 40/120ma, 2in, m/c, double reading, 8/6. Samp. 2in, T.C. 5/-; 4amp 2in T.C. in case with switch, 7/6; 20amp, 2 1/2in, m/l, 9/6. Meter movements, 2in size with magnet and case (500microamp), 2/6; Units containing two movements, 5/-, or with two 100microamp, 5/6. All meters post extra. Ex-R.A.P. 2valve (2volt) microphone amplifiers, as used in plane Intercom., in self-contained metal case, can be used to make up a deaf-aid outfit, intercommunication system, or with crystal set, complete with valves, 20/-, post 1/6; wooden box to hold amplifier, 2/-, extra; crystal sets, with permanent detector, 9/6, in oak case, 18/6; headphones, 5/6, 7/6, 10/-, and 12/6 pair; permanent detectors, 2/6; soldering irons, streamline, 50w, 9/-, standard 60w, 9/6; heavy duty, 150w, 12/6, all post extra; letters only; new illustrated list sent on request with 1d stamp and P.C. 13940

HIGHSTONE UTILITIES, 58, New Wanstead, London, E.11. 13540

Great Summer Sale!

ALL GOODS REDUCED IN PRICE TO CLEAR OWING TO EXPIRATION OF LEASE. COMPARE PRICES AND TAKE ADVANTAGE OF THIS SPECIAL OFFER.

Dynamos. D.C. Shunt Wound 12 volts 10 amps, 1,400 r.p.m. 25/-, 12 volts 10/15 amps, 600/1,000 r.p.m. for windmill work, shaft at both ends for prop. 40/-, 24 volt 30 amp, 2,500 r.p.m. 30/-, 12 volt 30 amp, 2,500 r.p.m. 25/-, 30 volts 5 amps, 1,500 r.p.m. 30/-.

Mo/or Blowers. Keith Blackman 24 volt D.C. 4 h.p. Motor with Blower, Sin. inlet and Sin outlet 55/-, carriage 5/-.

Variable Resistances. Wire wound slider type, laminated brush gear 3 ohms 10 amps, 12/6, 1.2 ohms 15 amps, 7/6, 6 ohms 6 amps, 15/-, Rotary type, Resistance Mats, radial stud switch and contact arm, 10 ohms 18 amps, 20/-, carriage 5/-, Pickin, 50 ohm 2 amp, 5/-, front glass broken.

Transmitters. Trench type in canvas covered wood boxes, 10-way rotary switch with laminated brush, litz wound variometer, coupling, valve holder mounted on ebonite panel, folding morse key, etc., 3/6, carriage 2/6.

Meters.

Ammeters. 2in. D.C. Moving Coil 0-20, 0-25, 0-40, with shunts, 4/6 each.

Central Zero 50-0-50 amps., 5/-

Milli-amps., 25-0-25, 4/-

Ammeters A.C., 2 1/2in, 0-35 amps, 7/6

Ammeter A.C., 4in, 1/2C 0-14 amps., 15/-

Micro Ammeters. Weston 5angamo, 2in, dia., 500 micro amps., D.C. M.C. 8/-

Milli-ammeters D.C. M.C. 0-1 flush panel, 2 1/2in, dia., 14/6

Voltmeters. 2in. D.C. Moving Coil, 0-20, 0-30, 4/- each. Voltmeters, 2 1/2in, Flush D.C. M.C. 100-0-100 volts, 5/6. Double Range, 2in. D.C. M.C. 0-15 volts 0-5ma., 4/-

Double Range, 3in. D.C.M.C. 25 volts and 150 volts, 18/6

Speakers. Chassis, Moving coil type, new, 5in, dia. 6/-, post 1/-. Moving coil sound units, 45 ohm for use as headphones, M.C. Mikes or miniature loud speakers, 4/6 each.

Transformers. Foster double wound, 100 watt 50 volts 2 amps. insulated terminal blocks, in new condition, input 230 volts 50 cy., 15/- each. B.T.H. Transformer 200/230/250 volts 50 cy. input, 2 volts 20 amps. and 75 volts 6 amps. with 15 taps output, 45/-.

House Meters. 230 volt D.C. 2 1/2 and 3 amp. in metal cases, 7/6 each. 5 amp., 10/-. Carriage 2/- extra.

Spark Coils. 6/12 volt D.C. input to give 1/2in. spark, with trembler and contacts, 5/- With helix fitted on outside of case, 7/- Postage 1/- Spark Gaps, 1/- each.

Rotoceptors. For E.H.T. at 50 cycles from 12 volts D.C., two sizes, 5,000 volts and 10,000 volts at 20 ma. for portable neon luminous tubes, or daylight colour matching lamps. Completely iron clad with small interrupter motor at top condenser and Transformer below, £3/10, carriage extra.

Telephone Constructors Parts for your own set-up. Ex-G.P.O. wall type, bracket milke, transformer, and condenser, magneto, bell in walnut case, 8in. x 6in. x 3 1/2in., fitted terminals and connections, switch hook and contacts, and magneto generator and single receiver, with wiring diagram, 30/- per pair.

A.C. Motors. We have a number of fractional h.p. 110 volt A.C. motors. Send for special leaflet "W.W." 1.

Lighting Plants. Villiers 550 watt sets, 2 h.p. engine direct coupled to 18 volt 30.5 amp. dynamo with switchboard in steel cabinet, £22/10/-, Pelaphone 500 watt water cooled 1 h.p. engine coupled to 50/70 volt 10 amp. dynamo, £35. ChoroHorse 300 watt single cylinder 4 stroke engine direct coupled to 12 volt dynamo with switchboard £17.

PARCELS. 10 lb. useful oddments for the junk box. All clean, dismantled from Government and other surplus apparatus, 7/6 post free. (For home buyers only.)

ELECTRADIX RADIOS

214 Queenstown Road, London, S.W.8

Telephone: MACaulay 2159

E.T.A. type A semi-automatic coil winding machine for coils up to 5in diameter and 5in long, with reset counter and double end drive for winding flat strips, 230v ac motor drive, complete with stock of insulating material, as new, cost, £28/15 net; £20 carriage paid.—Box 7491. 13965

VARIACS: Type 100 L, 230v in. 0-230v out, 8 amps, £12/10 each; type 200 CMH, 230v in, 0-270v 2amps out, £5/10 each; type 100 L-3G, 415v, 3 ph in, 0-415v 6kva out, £37/10, all in excellent condition. Please write: F. B. Crawshaw, 166, Pixmore Way, Letchworth, Herts. 13951

SELLING UP!—B.P.L. signal generator, just overhauled, £10; Avo valve tester, £8/10; Vortexion amplifier, AC20, with mike stake and modified for mains/batteries, £15; Goodmans 12in speakers in mahogany cabinets, £7/10; Meico trans. current mike with floor stand, £3/10; 2 Re-entrant horns, A.D.M. pattern, 20/- each; lot for £40 or offers.—Priest, 23, Bank St., St. Columb. 13787

TRANSMITTING EQUIPMENT

FRITH RADIOCRAFT, Ltd., offer:—

R.C.A. TRANSMITTERS, type ET4336, brand new in original cases; coverage 2 to 20mcs, 807 crystal osc driving pr 813s in parallel, band-switched final; input 250-350 watts; front panel has all tuning, meters, switches for tune/operate phone/cw, modulator indicator, chassis carries filament and bias supplies, keying re.ay, etc.; requires external HT power transformer and modulator; will run very comfortably at 150 watts with 1,000v and one 813, or up to maximum rating with 2,000v and pair of 813s; less valves, £12/10 c. net; lists giving "Dollar Bargains" are now available, free on request.

FRITH RADIOCRAFT, Ltd., Leicester. 13992

T1154 complete with valves and transit case; £5/10 including carriage.—Needham, 504, Tile Hill Lane, Coventry. 13932

HALLICRAFTER transmitters, type HT4E, complete to makers' latest specification, covering all amateur bands up to 30 mcs, with speech amplifier, connecting cables, etc.; immediate deliveries in quantity; also available, export only, British made Hallicrafter 5X42.—Hallicrafter United Kingdom Distributors, McEroy-Adams Manufacturing Group, Ltd., 2778 Greyhound Rd., London, W.6.

GRAMOPHONE AND SOUND EQUIPMENT

LOUDSPEAKER separator.

COMPLETE kit enables bass and treble to be divided correctly between two loudspeakers; this results in the elimination of modulation distortion, gives increased top and clearer bass response. The kit allows loudspeakers of different impedances to be used if necessary and gives control of amount of treble relative to bass; model A, 6 db per octave, £21/9/6; model B, 12 db per octave, £22/12/6; cross over 1,000 c/s. We will be pleased to recommend and supply suitable loudspeakers.

RADIO COMPONENTS, East St., Darlington. 13952

LEXINGTON £8 pick-ups (2); accept £3, unused.—62, South St., Cottingham. 13677

4021C S.T.C. spherical m.c. microphones, 39/6 each.—D. E. White, 95, Friern Rd., S.E.22. 13809

E.M.I. Type 12 (hyersensitive), 50/-; wanted, Telefunken toner-arm, suit 3001 pickup.—Box 7510. 13987

M.S.S. long-arm pick-up, removable head, sapphire, transformer and equaliser; £5/10.—Box 7485. 13795

BRIERLY ribbon pick-up, EB/PR.1, unused and boxed, cheap for quick sale; £7/10.—6, Maple Av., Beeston, Notts. 13944

RECORDING blank discs, 12in box of 15 discs, packed, carr. paid, 35/-.—G. Lawrence & Co., 3, Slater Place, Liverpool. 13981

INFINITE baffle corner deflectors, scientifically designed acoustic chambers for 8 to 15in speakers; lists.—Broadcast & Acoustic Equipment Co. Ltd., Tomband, Norwich. 12904

TAPE recording and erasing heads 5 or 15 ohms, 1in dia., 1in high, 30/- each; the G.D.P. recorder, £32; recording discs all sizes.—Morecambe Sound Service, 4-6, Green St., Morecambe. 13749

B.T.H. cinema loudspeakers, handle 20 watts, £5; Amperite ribbon microphones, £5; R.C.A. condenser mikes £3; 50watt Vortexion amp, £25; p.p. l.f. transformers, 10/-.—Ross, 58, St. John's Rd., Manchester, 16. 13701

RECORD player, modern mahogany console, 27inX16inX14in, connoiseur pick-up and transformer, Collaro universal motor, 8in Celestion speaker, storage for 50 discs, excellent condition; £11.—142, Shirley Way, Shirley, Surrey. 13821

RAYMAX offer mahogany playing desks fitted with the latest well-known rim drive unit, magnetic pick-up, auto-st. p. etc., £6/14/6 incl. p. tax; Collaro rim drive unit, PU auto-stop, etc., £5/10.—Raymax Elec. Co. Ltd., 126, Norwood Rd., London, S.E.24. 13207

SOUTHERN RADIO'S WIRELESS BARGAINS

INVERTORS TYPE 16AP. Input 28v. Output 115v. at 400 c.p.s. Black crackle finish. In maker's sealed crates with circuit diagram. 80/- carriage paid.

RECEIVERS R9SARC-5. Ideal for two metre converter. 100-156 meg. V.H.F. super-het. 10 valves. 717 (4), 128H7GT (3), 128L7GT (2), and 12A6GT (1) and 1/60th h.p. tuning motor. Complete with circuit. In maker's sealed cases. 60/- carriage paid.

BC 454 (3-6 mers) and BC 455 (6-8.1 mers) RECEIVERS. 6 valves. 128K7 (3), 128R7 (1), 12A7 (1), 12K8 (1). Ideal for converters, AG/DC receivers, and car radios. In maker's sealed cartons. Either set, 35/-, post 1/6.

DRIVE ADAPTOR AND KNOB FOR BC453/4/5. Gives slow motion drive from existing spindle. 2/6 each, post 3d.

CONTROL BOXES FOR BC453/4/5. Three slow motion dials and drives. Three 50,000 ohm volume controls and six rotary switches. In maker's sealed cartons. 12/6 each, post 1/-.

DRIVE CABLE FOR BC453/4/5, 14ft. long. Adaptors at both ends, 8/6 each, post 1/-.

R.A.F. BOMBSIGHT COMPUTERS, complete with gyro. motors Gearing. Blowers etc., etc. New £3. carriage paid.

TIME SWITCHES, 10-hour clockwork movement, in sound proof box, 11/6, post paid.

INDICATOR UNITS, BC929A. 7 valves. 2X2 (1), 6XSGT (1), 6H6 (2), 606 (1) and 68N7 (2) 2 1/2 in. dia. 3B1 tube and switching motor. In black and crackle case, 44/-, carriage 5/-.

RECEIVER UNIT TYPE 25 from TR 1196. 4.3-6.7 megs. 6 valve super-het. EF39 (2), EF33 (1), EF36 (2), EK32 (1). 2 x 460 kcs 1/1 coils. Suitable for conversion to AG/DC car radio, 25/-, post 2/6.

Southern Radio Supply Ltd.
46, LISLE STREET, LONDON W.C.2.

GERrard 6653

LIFE GETS TEDIOUS—DON'T IT!

Not if you possess a copy of the new, revised "Home CONSTRUCTOR'S HANDBOOK" (now in its fifth edition!). This justly famous 2/6 book is crammed full of many good things for the keen radio engineer, experimenter or beginner.

- Eight tested and guaranteed circuits, with full descriptions and parts.
- Feeder Units, Tuning Units and Sets.
- Quality Amplifier, etc.
- Servicing and Constructional Hints and Tips.
- Resistance Colour Code and Charts, etc.
- Simple Formulae, etc., etc.
- And many other interesting items.

We are proud to make the special offer once again of this useful book to "W.W." readers for 1/- ONLY. Send NOW for your copy.

Letters of praise continue to reach us daily regarding the new improved model 40 coil pack with CERAMIC switching for improved performance.

The price is still unchanged at 42/- inclusive or 47/- aligned and sealed for 465 kcs. I.F. These letters confirm our opinion that this unit has no equal anywhere even at double the price!

A stamp will bring full details of this and our other advertised units and components.

RODING LABORATORIES,
70 LOND AVENUE, ILFORD, ESSEX

COMPLETE service for rebuilding customers' radiograms, to modern standards; our advice free to those wishing to convert their own sets; we can supply amplifiers, auto-changers, R.F. units, etc.—Felicity Gramophone Co., 87a, Upper Richmond Rd., S.W.15. [3493]

PROFESSIONAL recording equipment, blank discs, amplifiers, microphones and magnetic tape recorders, gramophone motors with non-magnetic turntables; pressings produced from your own masters in any quantity; full trade terms available.—Sound Discs (Supplies), 37, Hoghton St., Southampton, Lancs. [3486]

COLLARO AC47 induction type motors, with 12in non-magnetic t.t. var. speed our price £5; Collaro new model AC49 motor-pickup-autostop gram. unit 10in t.t., £5/6/3; Collaro new RC49 mixed automatic record changer with hi-fi crystal pick-up, our price £14; all above for 110-230v ac; terms c.w.o. or c.o.d.; bargain list of amplifiers and t.r.f. and superhet tuners 2/6d.—N.R.S., 102, Parkhill Rd., London, N.W.3, Gulliver 1453. [3819]

MEMBERSHIP of the British Sound Recording Association ensures the professional and amateur recording engineer and quality reproduction enthusiast, of all the latest information in the form of monthly lectures, publications, demonstrations and the official journal, "Sound Recording," published quarterly; Vol. 3, Nos. 1, 2, 3, 4 available at 2/6 each.—Details of membership and application form from Membership Secretary, Harrie J. King, 48, Mount View Rd., N. Chingford, London, E.4. [2119]

WIRE recorders, ex-U.S. Navy. Western Electric design, providing approx 45 mins quality recording, complete with amplifiers and mikes; armour wire recorder with 12" speakers; 40watt and 600watt amplifiers, stamp for details. Also available: Indicator 198, with 3in short persistence CRT, 4 SP61s, 3 EA50s and hundreds of parts. 37/6; 19 set PU with 540v and 275v generator and 275v vibrator pack, 12 or 24v input, 19/6; portable telephones with bell, buzzer and key, P.O. type, handset, 27/6 each; American IFF sets with 13 (6.3v) valves and crammed with parts, 12v input, 25/-.—Radio Exchange Co., 9, Caudwell St., Bedford. [3958]

COMPONENTS—SECOND-HAND, SURPLUS SOUTHERN RADIOS' wireless bargains.

BENDIX Command receivers, B.C. 454/455, complete with 6 valves, brand new, 35/- plus 1/6; drive adaptor for Command receivers with knob, 2/9; control boxes for 453/454/455 Command receivers, 12/6 each, plus 1/-; drive cables for 453/454/455 Command receivers, 14ft with adaptors, 8/6, plus 1/-.

CAR radios, plus converted from Bendix Command receivers, complete, ready for use, with speaker, £6; carriage paid; R.A.F. bombsight computers, brand new, complete with motors, gearing, counters, bellows, gyro, etc., etc., 50/-, plus 5/-; contactor time switches, complete in soundproof boxes, thermostatic control, ideal for photographic and other uses, 10/- plus 1/6; Lufbra hole cutters, adjustable to 3 1/2 in, cuts plastic, metal, wood, etc., 5/-, plus 6d; crystal detectors, 2/6; mercury switches, 5/6; micro switches, 4/6; M.C.R. batteries, 6/6; Westectors, Wx6 and W12, 6/4 per doz; International Octal valve-holders, 6/- doz.; 4mfid electrolytic condensers, metal tubular, 450v, 1/6; transformers, 1:1, 2/-; Mainsbridge condensers, 1mfid, 2mfid, 1/-, 4mfid, 2/6; throat microphones, complete with plug and lead, 3/6; speaker throat microphones, units, 1/-; Lewcos inspection lamps with lead and plug, for any size screw-in bulb, 2/9; indicator lamps, red, green or white, 1/3; Delco hand generators, 6v at 4amps, brand new, 17/6; radio compass indicators with Selsyn motors, 3in 360 degree dial, 13/6; indicator units, 929a, 7 valves, with 2 1/2 in 3B1 C.R. tube, ideal for oscilloscope conversion, 45/-; full list of radio publications, 2/6d; thousands of other lines for callers.

SOUTHERN RADIO SUPPLY Ltd., 46, Lisle St., London, W.C. Gerrard 6653. [3956]

THE simplest s'het pack, type M1, M.L. waves, 22/6; thousands in use.

DOUGLAS COIL Co., Brinklow, Nr. Rugby. [3991]

WALTON'S WIRELESS STORES' offer this month is of special interest to all 2 meter enthusiasts. SCR.522 transmitter and receiver units, all are new, receiver is complete and includes 11 valves. 32/6; transmitter unit, partly dismantled by the Ministry, less valves, 8/6; modulation transformer and A.F. choke, 5/- the pair; special terms in lots of not less than 1 dozen to all radio societies; please write for details; we still have large stocks of 80 ohm co-ax complete with plugs each end, 9d per yard; 11ft television mast, in 2 sections, 12/6; 22ft in 4 sections, 22/6; and hundreds of other bargains; write today for our latest list; do not include extra for postage, all is free to any address in Great Britain.

WALTON'S WIRELESS STORES, 203, Staveley Rd., Wolverhampton. [3970]

MANUFACTURERS.—Enamel, copper wires, all gauges, laminations, all types, huge stocks radio components, s/m, m/m, p/t and block condensers, close tolerance and high stability resistors to 1%; all goods guaranteed.—L.E. Simmonds, 6a, Byron Rd., Harrow, Middx. Telephones, Underhill 0045, Harrow 0315. [2515]

ETA

TYPE J COILS



This FULL SIZE illustration shows the latest ETA triumph. A really midget range of adjustable dust core coils fitted with soldering tags and available in all types for all wavebands.

In spite of their small size, the use of high permeability dust cores gives high Q values and an ample range of inductance variation.

Fixing is by a single 4 BA nut.

Price 3/3 each all types.

Also available in this midget range are high Q IF filters with adjustable dust cores.

Price 3/9 each series or parallel types.

Manufacturers' and Trade Enquiries Invited.

ELECTRO TECHNICAL ASSEMBLIES
West Hill, St. Leonards-on-Sea, Sussex

RECORD

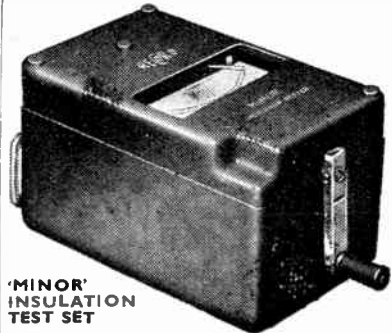

'MINOR' INSULATION TEST SET

Compact and inexpensive without sacrificing accuracy and reliability. Weighs only 3lbs. Height allows for full swing of generator handle. Ranges up to 20 megohms 500 volts.

CONTINUITY TESTER

This latest addition to the Record Ohmmeter range is enclosed in a moulded bakelite case of pleasing appearance. Equipped with self-contained dry battery. Specially designed test spikes and leads can be supplied also a "test and carry" case in which the instrument may be used without removal. Ranges:— 0/3—0/30 ohms, 0/30—0/300 ohms, 0/500—0/50,000 ohms, 0/1,000—0/200,000 ohms.

THE RECORD ELECTRICAL CO. LTD., Broadheath, Altrincham, Cheshire.
Tel.: Altrincham 3291/2/3, Grams. "Infusoln.", Altrincham LONDON: 28, Victoria St. W.1. Tel: Abbey 5148



BCA 931A PHOTO-ELECTRIC CELL AND MULTIPLIER. For facsimile transmission, flying spot telecine transmission and research involving low light-levels. 9-Stage multiplier. Brand new and guaranteed, only 30/- each.

TYPE BC 924A RECEIVERS. Absolutely brand new by BENDIX, etc. Valve line-up 12AH7, 12J5, 3 12BG7, 12C8, 3 9003, 9002, making 10 Valves in all. Frequency coverage 100-156 mc/a. Can be supplied at the absurdly low price of 25/- (plus 5/- carriage and packing).

E.H.T. TRANSFORMERS. Output 2,500 v., 5 m/a., 4 v., 1.1 amps., 2-0-2 v., 2 a. (for VCR97), 35/- only. Output 3,250 v., 5 m/a., 6.3 v., 1 a., 2-0-2 v., 2 a. (for 5C7P), 39 6. Output 4,000 v., 10 m/a., 2-0-2 v., 2 a., 48/-. Output 5,000 v., 10 m/a., 2-0-2 v., only 60/-. All input 200-250 v., and fully guaranteed.

OSMOR MIDGET "Q" COIL PACKS. Size 3 1/4 in. x 2 1/4 in. x 1 1/4 in. Amazing performance. Polystyrene formers with adjustable iron cores. One hole fixing, only five connections. Factory aligned, complete with full receiver circuits, and instructions. 8" Het for 465 kcs., 23/- only. L.M.S. also for TRF operation M. and L. W. 30/-.

Please note that separate H.F. Stare, for addition to the above Superhet Coil Pack, can now be supplied at 15/- only. Complete with all necessary easy-to-follow instructions.

MIDGET TWO-GANG .000375 mfd. with trimmers—Valves enclosed in "Persexp." Size only 2 1/4 in. x 1 1/4 in. Our price 6/6.

THE NEW DENCO TELEVISION KIT OF PARTS

★ Employs recently developed circuit and components including line fly-back EHT/output transformer unit, ready assembled. Vision section has 3 RF stages, Detector, Noise Limiter and Video Amplifier.

★ Suitable for use at all distances within the service area of the station.

★ The new miniature high slope B7G pentode valves are used in RF and video stages, etc. A total of 17 valves.

★ Circuit, layout and instructional data supplied with each kit.

★ All valves and CRT, Drilled Chassis, etc., are included (Loudspeaker and O.P. Transformer excluded).

The following units will be available for sale separately, each complete with Circuits, Layout and Instructional Data.

★ **DTK3 RF.** Outfit consisting of all components, valves and 9in. C.R.T., for vision and sound sections up to the detector stages, including drilled sub-chassis. Price—£14/15/-. Tax on Valves, etc., £3 16/7.

★ **DTK3/TB** A similar outfit for time base circuits including ready assembled fly-back EHT, video amp., sync. separator, deflector and focus assemblies and main chassis. Price—£15/5/-. (Tax on Valves, 19/8).

★ **DTK3/PS.** Complete Power supply outfit (excluding EHT which is part of line output circuit), consisting of all components and rectifier valve; output 310 v., 225 M.a. and 6.3 v., 7 a. (rect. heater winding also). Price—£8/7/8. Tax on Valve, 3/3.

An assembled demonstration model may be seen working at these premises, during transmitting hours.

VCR 87 C/R TUBES. Please note we are still able to supply these Ex-Govt. Tubes, brand new and guaranteed. Each tube is tested for Television suitability prior to despatch. Price 35/- each, plus 7/6 registered carriage and packing. Black rubber masks are in stock for these tubes, at 3/6 each.

8in. ENLARGING LENS. Owing to a large purchase of these items, we are now able to supply at 25/- only plus 1/6 carriage and packing. Send stamp for current component list. Probably the most comprehensive in the trade.

5, HARROW ROAD, LONDON, W.2
PADDINGTON 1008/9

TWO B.F.O.s output 2 watts at 5 or 5,000Ω impedance, range: 350-3,000 & 2,500-6,000 c.p.s.—Box 6873. [3702]

FRAME aeriels. M.L. chassis mounting, 9 1/4 in. x 5 1/4 in. 7/6; manufacturers' surplus midget L.F. chokes, 2/6.
HILLFIELDS MAIL RADIO. 8, Burnham Rd., Whitley, Coventry. [3990]

THE signal generator you need at the price you can afford; only £5/6; see our advt. in this issue for picture and full details.
HELY-MANN ELECTRONICS LABORATORIES. 116, Grove Rd., London, E.17. [3974]

LITTLEWOODS, North London's best selection of radio and television components; pay us a visit or post or phone your enquiries; no lists.
G. HENSON LITTLEWOOD & Co., 27, Ballard's Lane, Finchley, N.3. Fin. 3060. [3979]

POWER units, new ex-R.A.F. 200-250v 50 c.p.s. input; 350v 200ma smoothed output +6.3v 5a. 85/-; other items. s.a.e. list.—Box 7307. [3829]

MAGSLIPS and Selsyns, many types in stock. send for list.—Hopton Radio, 1, Hopton Parade, Streatham High Rd., S.W.16. Streatham 6165. [3721]

SELENIUM rectifiers, chargers, kits, D.C. packs. New goods with full guarantee. Add postage 7d up to 12/6, 1/3 above. Data supplied.

CHARGER kits—Standard charger kit. S.T.C. 12v 3amp selenium rectifier with 50-watt interleaved impregnated transformer, tapped sec. and baretter for 2v to 12v 3amp charger, no rectifier troubles with these kits, no rheostat or ammeter required, 39/6; ditto, but 2amp model, 36/-; ditto, 1amp, 29/6; also 6v 2amp rectifier, transformer, 32/-.

MEDIUM duty charger kit—12v-15v 4amp rectifier, 75-watt transformer, baretter for 2v to 12v charger 4amp, 55/-; specially manufactured steel cases with terminals, screws, grommets, for any of above, 17/6, not odd surplus junk.

HEAVY duty kits. 120-watt transformer, 4amp rectifier, slider rheostat and high grade ammeter for 6v, 12v charger, 75/-; ditto, but with 140-watt trans and 6amp rectifier, giant finned type, 87/6. Automot chargers, 6v, 12v, 1.5 to 2amp, 52/6; 6v 2amp, 12v 1amp, 47/-; 12v 3amp, 79/6; 12v 4amp, 90/-; guaranteed 12 months.

SELENIUM rectifiers, new, not surplus. Any L.T. rectifier up to 250 watts with transformer if required, 5 days del. Popular items: 12-15v 3amp, 15/6; 4amp, 21/-; 5amp, 25/-; giant 6amp finned type, 29/6; 10amp, 42/-; 12-15v 1amp, 7/6; 2v-6v 1amp, 5/-; 6v 10amp, 25/-; 6v 4amp, 15/-; 24v 2.5amp, 32/-; 3amp, 35/-; 4amp, 38/-; 6amp, 60/-.

Selenium small space H.T. rects for radio, 250v 60ma, 6/-; 110v 60ma, 6/-; 120v 20ma eliminator type, 6/-; ditto, with 25-watt transformer, 2v trickle charge rectifier, 25mfd condensers for eliminator, 29/-; 250v 100ma bridge rectifier, 12/6; 350v-0-350v 80ma for A.C. sets, 9/-; sliders, 1ohm 12amp, 16/-; 0-6amp ammeters, 12/6; crystal diodes, new, in capsules, 3/9; RoLa "8" 2 M. spkrs., less trans, 13/6; Lustraphone m/c mikes, 58/6.

CHAMPION. 43, Uplands Way, London, N.21. Tel. Lab 4457. [4011]

TELEVISION, all parts in stock for "EE" television: Haynes' scan and focus coils, line trans., model on view.—H. G. Radio, 1350, Stratford Rd., Birmingham, 28. [3931]

BRAND new guaranteed components: Mica condensers, 5pf, 10pf, 50pf, 100pf, 5, 6 doz; paper condensers, .1, .02, .01, .005, 350 volts, 5/6 doz; .001 midget 250 volt, 6/- doz. **CO-AXIAL** plugs and sockets, plated, 1/- pair or 10/6 doz pair; 1 meg vol controls, 2/6; Amphenol Ictal bases, 5/6 doz; B7G ceramic bases with bottom screen, 12/- doz; B7G paxolin bases, 5/6 doz; 6BA solder tags, 1/6 gross; Midget mains transformer, 200/250in., secondary 250v at 25ma, 6.3v at 2amps, 10/6 each.
G. WERTHEIM, 3, Elmbridge Drive, Ruislip Middx. [4003]

TELEVISION scanning coils, 30/-; frame output transformers, 17/6; line output transformers, 25/-; also mains transformers, chokes, etc.—The Banner Electric Co., Ltd., Hoddesdon.

TRANSFORMERS, 350-0-350, 120m/a, 4v 10a, 4v 2a, 400-0-400, 80m/a, 4v 6a, 4v 2a, 2v 2a, 19/- ea; 260-0-260, 70m/a, 6.3v 3a, 5v 2a, 16/- each.—Bell, 66, Vaughan St., Leicester. [3982]

H.T. transformers (new) for 6.3v vibrators, output 250-0-250v at 80m/a, 10/6 ea., one doz. lots 8/6 ea.; special terms for quantities.—Stewart Transformers, Ltd., 1021, Finchley Rd. N.W.11. [3620]

A NEW face and brain? No, we are not plastic surgeons, but we can offer a really attractive 3-wave 3-colour glass transformer, and the super-efficient Q Coilpack which has earned us so much praise from our customers. An invaluable pair, for the rejuvenation of an old set or the construction of a new one. The dial is unique, fitting anywhere, in any position! Price 22/6 complete. Send for full details of these, and other radio and television components, also our latest bargain list. (Trade enquiries invited.)—Osmer Radio Products, Ltd., Borough Hill, Croydon, Surrey. (Tel. Cro. 1220.) [3193]

ARMSTRONG
now
introduce

MODEL EXP. 83 TYPE 2
7-VALVE ALL WAVE RADIO CHASSIS
Complete with 10 in. Loudspeaker

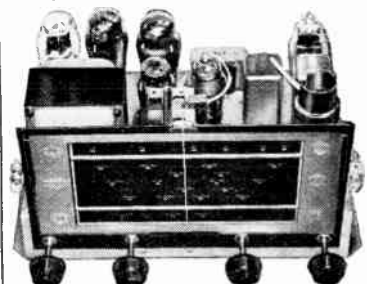

THIS MODEL IS AN IMPROVED VERSION OF OUR EXTREMELY POPULAR MODEL EXP. 83, WHICH HAS BEEN MODIFIED IN ORDER TO INCORPORATE SEVERAL ADDITIONAL REFINEMENTS. THE RESULT IS A CHASSIS OF PLEASING DESIGN AND HIGH PERFORMANCE, WHICH WE OFFER TO YOU FULLY CONFIDENT OF ITS OUTSTANDING VALUE.

- ALL-WAVE 7-VALVE CHASSIS
- 10 in. LOUDSPEAKER
- NEGATIVE FEEDBACK
- FLYWHEEL TUNING
- HORIZONTAL SCALE
- 8 WATTS PUSH-PULL OUTPUT

For 200/250 v. A.C. Price £15/8/8 plus tax

STAND Meet us at **RADIOLYMPIA** 92
Sept. 28-Oct. 8

Model UN183, TYPE 2 7-VALVE ALL-WAVE RADIO CHASSIS complete with 10 in. Loudspeaker. Negative feedback, Flywheel tuning, Horizontal scale, 5 watts push-pull output. For 200-250 v. D.C./A.C. mains.
Price £15/8/8 plus tax

Model RT103 TYPE 2 10-VALVE ALL-WAVE RADIO CHASSIS. R.F. stage, 2 I.F. stages, variable selectivity. 10 watts push-pull output. For 200-250 v. A.C. mains.
Price 19 gns. plus tax

Model EXP. 125 14-VALVE ALL-WAVE RADIO CHASSIS giving continuous waveband coverage from 11.9 m. upwards. Waveband expansion, R.F. Pre-amplifier. Two I.F. stages with variable selectivity. Electronic bass and treble lift controls. 15 watts push-pull output. For 200-250 v. A.C. mains.
Kindly write for illustrated catalogue Demonstrations at our Showrooms

ARMSTRONG WIRELESS & TELEVISION CO. LTD.
WALTERS ROAD, HOLLOWAY, LONDON, N.7
Phone: NORTH 3213

DEFLECTOR coil assembly, 22/-; focus coil, 25/-; for W.W. television receiver; instrument wires; s.a.e. list.—R. F. Shilton, 19, Clarendon Rd., Salisbury, Wilts. [3985]

FOR sale. Westinghouse charging unit. 200/250v 50 cycles input; 56v 10amp output (style RE 15, type H.8).—British School of Telegraphy, Ltd., 179, Clapham Rd., London, S.W.9. [3796]

48/⁶ only for the famous Model 30 tuning unit, consisting of 3-waveband Model 30 superhet. coil pack, pair I.F. transformers, 2-gang condensers and attractive dial (8in x 6in); each component individually selected pre-aligned, sealed and the whole matched together as a unit; the superhet you build with this unit needs no further adjustment! Full details of this and our other high quality products (coils, I.F.T.s, mains transformers, etc.) together with many circuits and constructional tips, contained in the "Home Constructor Handbook," price 1/-. Mail order office. SUPACOILS, 98, Greenway Ave., London, E.17.

TELEVISION—We are manufacturers of approved and tested components for "Wireless World" Televsion. see review Nov., 1948, issue, and can supply from stock. line and frame deflector coils, line output transformers, focus coils and shrouds, focus and deflection assemblies correct to designer's specification; complete sets of 21 coils, and filters can be supplied from stock for "Wireless World" superhet vision and sound units; television components of all types from stock at current prices.—For particulars please write or phone "Handy-parts," 226, 222, Merton Rd., Wimbledon Lab. 7461, near S. Wimbledon Tube Station

TELEVISION components, line output trans., 32/6; focus coils (35mm tubes), 32/6; deflector coils, 37/6; chassis units, sound, 18/9; vision, 22/6; 12in base, 17/6; periscope, 4/-; set of gantry, 9/-; rubber masks (cream), 9in tubes, 11/-, 12in 21/-; 9in tube mounting, 17/6; i.f. chokes, 5h 250ma, 14/6; 10H 100ma (ex-Govt.), 4/-; 10H 150ma, 18/-; 20H 60ma, 7/6; filament transformers, 6.3v 1.5amp, 4/6; 5amp, 9/-; output trans. (6.3v ratio), 4/6; periscope, 4/-; i.f. 14.4 16/- pr.; pots, W.W. 1k-25k, 2/- each; linecord, 7dft; condensers, 0.0005 twin gang, 7/3; 8x500, 3/9; 16x8x450v, 4/-; 25x25, 1/3, etc.; s.a.e. for lists; c.w.o./; please cover postage.—Ark, 4, Queen Sq., Brighton, Sussex. [3947]

RADIO UNLIMITED offer from their new address at Elm Rd., Walthamstow, London, E.17, the following outstanding bargains; selected goods in new condition: Brand new headphones, 60ohm bal./arm., 5/6; soiled m/coil phone/mic. sets, 5/9; m/coil hand microphone, 2/11; Tannoy hand mic., 5/6; ex-R.A.F. 1134 battery amplifier in transit case with valves, 17/6; precision clock device in cabinet, 6/9; morse trainer set, 3/6; twin maroon flex, 30/- 100yds; m/iron 0-25 ammeter flush mounting, 2/11; m/coil 0-20amp, 0-40amp, 0-50v, 3/6 each; test meter, range, w/b, 1 0-5v/amp and 0-20v meters, plus switches, var. resistance, etc., 12/6; heavy duty panel switches, 5amp, 7/- doz; 90ft aerial with lead and insulator, 3/6; 250ft, 6/6; 465 iron core i.f. ts, 7/- pair; hundreds of other lines; 1d stamp, list. [3959]

NEW S.T.C. selenium rectifiers; largest I.T. range from stock in Gt. Britain; all maker's latest products, not surplus; H4/200 for W.W. Televsion, 28/- pr.; H.W. rectis., 1/2 2a 6/11, 8/2 2a 9/6, 16/6, all p. 6d, 4a 18/-, 6a 22/-, p. 10d; 30v, 1a 12/-, 2a 14/-, 4a 21/-, 6a 36/6; 48v, 2a 21/-, 4a 35/-, 100v, 2a 34/6, 4a 65/-, p. 1/-; H.D. with 73in sq. cooling fins, 16v, 5a 21/6, 10a 24/6; 30v, 5a 35/-, 8a 38/6, 48v, 2.5a 26/-, 5a 48/-, 8a 50/-, all p. 1/-; full wave bridge-comm. rectis., 17v, 1.5a 12/1, 2a 15/6, 2.5a 20/6, 3a 21/6, 4a 25/-, 5a 27/-, all p.f.; 33v, 3/4 18/6, 1a 21/3 1.5a 28/6, 2a 29/6, 3a 35/-, 4a 42/-, 5a 43/6, all p. 10d; 54v, 1.5a 39/-, 2a 47/6, 4a 65/-, 72v, 2a 61/-, 100v, 1.5a 72/-, 135v, 4/4a 188/-, all p. 1/-; D.D. type, with 73in sq. cooling fins, 17v, 6a 34/1, 10a 43/8, 12a 72/-, 20a 80/-, 33v, 6a 64/-, 10a 71/-, 12a 124/-, 20a 140/-, 54v, 6a 90/-, 10a 100/-, 72v, 10a 130/-, 100v, 10a 190/-, all p. 1/4; industrial type, funnel cooled, 17v, 12a 76/-, 20a 87/-, 30a 122/-, 50a 188/-, 33v, 6a 90/-, 10a 80/-, 33v, 12a 124/-, 20a 144/-, 54v, 6a 92/-, 10a 108/-, 72v, 6a 114/-, 10a 136/-, 100v, 6a 160/-, 10a 192/-, all p. 1/6; recapacitors for valve-type chargers, Phillips 328 and 367 Tunxar 68504 68530, U600, etc. fitted in 5min. without alteration to wiring; tropically rated rectifiers from stock, rect. kits, rect. rheo. and trans., 33v 6a 150/- (incl. tap. switch); 16v, 10a 132/6; 17v, 6a 92/6, both with 11v tap, following with wax impregnated trans. and fused voltage indicator, for 2-6-12v taps, 16v 5a 70/-, 16v 4a 60/-, 2a 58/6, (vent. steel cases 7/6); trans. 200/250 input charging, 15v 10a 65/-, p. 1/4, 18v 6a 47/-, p. 1/4, 17v 5a 41/6, p. 1/-, 16v 4a 35/-, p. 1/-, 16v 2a 25/6, p. 10d; slider res., all values, 150 watt from 24/6 p. 1/-; ammeters, 1-6a M.I., 12/6, p. 6d, 0-14a M.C. 5in dia, 32/6, p. 7/4; specialised equipment supplied to laboratories, industrial users, research labs. and universities, standard or tropical use; terms; c.w.o. or pro-forma invoice; c.o.d. over £1. post goods only; wholesale and retail. T. W. PEARCE, 66, Gt. Percy St., London, W.C.1. Off. Pentonville Rd., between Kings Y. and Angel, Est. 17 yrs. See under "Dynamo" for larger charging equipment. [3995]

GALPINS

ELECTRICAL STORES

408 HIGH STREET, LEWISHAM, LONDON, S.E.13

Telephone: Lee Green 0309. Near Lewisham Hospital.

TERMS: CASH WITH ORDER. NO C.O.D.

THURSDAY EARLY CLOSING

SUMMER SALE—10 per cent. discount allowed off all prices for the month of August.

ELECTRIC LIGHT CHECK METERS (watt-hour type), all for 200/250 volt A.C. 50 cycles, all electrically guaranteed; 2 1/2 amp. load, 15/- each; 5 amp. load, 18/6 each; 10 amp., 21/-; 20 amp., 25/-; 30 amp., 30/-; 40 amp., 35/-; 50 amp., 42/6; 100 amp., 50/-. Carriage on all types 2/- extra.

LARGE TYPE RECTIFIERS. Output 50 volts 1 amp. D.C., input 70/75 volts A.C. Half wave type, 8/6 each, post 1/6. **TANNOY P.M. SPEAKERS** (Small Hailers), 4 ohm speech coil, complete in wooden case with output transformer, 15/- each, carriage 2/6.

EX-R.A.F. TYPE 18 CRYSTAL CALIBRATORS. These units contain 100 kc/s crystal two E.F.50 valves. Are complete less power supply. New ex surplus. A few only to clear, 35/- each.

MAINS TRANSFORMERS (ex-Govt. surplus). Input, 200/250 volts 50 cycles; output, 1100/0/1100 volts at 500 m/amps., 85/- each, carriage 7/6. Another 525/0/525 volts 150 m/amps. 6.3 v. 5 a., 5 v. 4 a., 30/- each, carriage 2/6. Another 3300 volts 20 mA, 1,000 v. 10 mA, 6.3 v. 4 a., three times 2 v. 2 a., these are a large transformer weighing 20 lbs., size 7in. x 6 1/2in. x 6in., 30/- each, carriage 3/6.

METERS, all ex-Govt. now boxed, all first-grade moving coil, 2in. scale, 0 to 20 volts, 6/6 each; 0 to 40 volts, 10/6 each; 0 to 10 amps., 15/- each; 2 1/2in. scale, 0 to 10 mA, 12/6 each; 350/0/350 millivolts, 12/6 each; another 3 reading type 0 to 50 and 150 volts, 0 to 15 amps., 17/6 each; another 0 to 4 amps. THERMO coupled, 2 1/2in. scale, 10/- each; another calibrated 50 cycles 0 to 20 volts, 12/6 each.

EX ADMIRALTY ROTARY CONVERTERS, 500 watts input, 100/110 volts D.C. Output, 230 volts A.C. 50 cycles 1 phase, weight 100 lb. approx. In new condition. £8/10/- each, carriage 10/-.

EX-GOVT. AS NEW, SPENCER TURBO COMPRESSORS complete with an A.C./D.C. Motor 230 volts at 10 amps. (2 h.p.), 10,000 r.p.m. continuous rating, maker's Black and Decker, a few only to clear, £12/10/- each, carriage 10/-.

EX-NAVAL ROTARY CONVERTERS, AS NEW, 110 volts input. 230 volts 50 cys. 1 ph. output at 500 watts, £9 each, carriage paid. Ditto 230 volts input, output as above, £12/10/- each, carriage paid, weight approx. 100 lb.

MAINS TRANSFORMERS, Auto type input 200/250 volts 50 cys. 1 ph. Output tapped 14 and 17 1/2 volts at 30 amps., 55/-. Ditto with 2 tappings of 4 volts at 20 amps., 25/- each, carriage 2/6. Another double wound 110 volts to 230 volts or vice versa at 4,000 watts, £10 each, carriage paid.

MAINS VARIABLE STUD SWITCHARM TYPE. Resistances 25 Studs, 50 ohms to carry 1.4 to 9 amps., 30/- each. 10 ohms to carry 9/14 amps., 32/6 each, many other types in stock. Please forward your enquiries.

EX-NAVAL NAVIGATION INSTRUMENT Containing F.H.P. 230 volt A.C./D.C. Motor, first grade 3 1/2in. scale ohm-meter, Standard Potentiometers 2, other Resistances both variable and fixed, also some very useful Gun-metal Gears (new), 65/- each, carriage 10/-.

EX-NAVAL TELEPHONE HAND-SETS, BAKELITE PATTERN (self-energised), no battery required, complete with wall bracket (new), 15/- per pair, post 1/6. Ditto complete with Buzzer ringing mounted in weatherproof box, 24 volt required for energising Buzzer only, complete with Hand-set, 15/- each, or 25/- per pair.

SHORT WAVE COUPLING AERIAL UNITS (Wavemeters), absorption type wound with 20 and 12 gauge silver-plated wire, 2 1/2 to 5 1/2 meters, 3/6 each. No 19 VARIOMETERS containing H.V. Condenser Instrument Rectifier, useful for parts, 3/6 each.

EX-R.A.F. R.F. UNITS, TYPE 101. Containing 5 valves EF50, Ea50, 5U4g, EB34, approx. 100 assorted Resistances and Condensers, also a 24-volt Universal miniature Motor, all mounted on silver-plated chassis (new), 37/6 each.

EX-R.A.F. I.F.F. UNITS CONTAINING 10 VALVES, EF50s, SP61s, EA50s, etc., power supply Motor generator 12 volts D.C. input, 450 volts, 50 mA output, and many other useful components as new, 32/6 each. Ditto with a 24-volt input generator. Valve sequence slightly different. Generator can easily be converted to run as a motor off A.C. mains, 30/- each.

EX-NAVAL CATHODE RAY INDICATOR POWER UNITS (new). Sold for component parts only, consisting of approx. 150 Resistances and Condensers of various values, H.V. Condensers, Chokes, all mounted on solid brass chassis, weight 90 lb., to clear 35/- each, carriage forward.

SYNCHRONOUS MOTORS 200/250 VOLTS, 50 cys. 1 ph., convertible as Clock Movement, 12/6 each. Resistances 350 ohms to carry .25 amps. (fixed) but can easily be fitted with a slider, 8/6 each.

MOTOR ALTERNATORS, ex-R.A.F., as new, 230 v. A.C. 50 cys. 1 ph. input. Output, 250 v. 625 cys. 1 ph. at 24 amps., 75/- each. Ditto, 1,725 cys. output, 85/-. Please note both these machines require a 2 v. 2 a. D.C. excitation at 4 amps.

MAINS TRANSFORMERS INPUT, 200/250 volts in steps of 10 volts output tapped 6, 12 and 24 volts at 25 amps., 65/- each, carriage 3/6. Another 230 volts input with 3, 4 volt windings at 5 amps., 25/- each. Another 200/250 volts input, output 6, 12 and 20 volts at 4 1/2 amps., 27/6 each, post 1/6.

EX-RADAR POWER UNITS, TYPE 225, containing 4 H.V. Rectifying Valves, 1 5U4g H.V. Condensers 8,000 V/Wk/g. Chokes, Relays, etc. (New, boxed, 35/- each, carriage 5/-) Ex-U.S.A. Hand-driven Generators complete with all smoothing, output 450 volts at 110 mA, also 2 L.T. tappings, 30/- each, carriage 3/6. Ditto, 162 volts at 60 mA, also 3 v. 2 a., 22/6 each, carriage 2/6.

PRE-PAYMENT I/- SLOT ELECTRIC LIGHT CHECK METERS, 200/250 volts, 50 cys. 1 ph., 2 1/2 amp. load, 30/- each, carriage 3/6; 5 amp. load, 35/-, carriage 3/6. 10 amp. load, 42/6 each, carriage 3/6.

EX-R.A.F. ROTARY CONVERTERS, 12 v., D.C., input 230 v. A.C. 50 cys. 1 phase at 100 w. output, 85/- each, carriage 3/6. Ditto 24 v. input, 65/- each, carriage 3/6.

MAINS TRANSFORMERS, all 200/250 v., 50 cys., 1 phase input, output 700/0/700 v. 70 mA, 4 v. 2 a., 12 v. 1 a., 30/- each. Another 525/525 v., 150 mA, 6.3 v. 5 a., 5 v. 3 a., 37/- each. Another 2,350 v. at 500 mA, 85/- each. Mains Smoothing Chokes, 10 Hy. 100 mA, 6/-; 150 mA, 8/6; 350 mA, 25/-; 5 Hy. 250 mA, 17/6.

EX-R.A.F. CRYSTAL MONITORS, type 2, complete in wooden carrying case, the frequency depending on crystal used, 5/- each. Short Wave Aerial Coupling Units (Wavemeters), 5/- each.

MAINS TRANSFORMERS (Auto Wound). Voltage Changers tapped 10, 20, 25, 90, 130, 150, 190, 210 and 230 v., all at 1,000 watts, a combination of 24 voltages can be obtained from this transformer, new ex-Government Stock, £5/10/- each, carriage 5/-. Mains Booster Transformer, tapped 0, 6, 10, 19, 175, 200, 220, 225, 240 and 250 v. at 1,500 watts (new, ex-Government), £5/5/- each, carriage 5/-. Another Auto Wound, tapped 0, 110, 150, 190, 210 and 230 v. at 1,500 watts, £6/10/- each, carriage 5/-. Ditto, 2,000 watts, £7/5/- each, carriage 5/-.

EX-R.A.F. MICROPHONE TESTERS (new). These consist of a Ferranti 0 to 450 mA. 2 1/2in. scale meter shunted to 1 mA incorporated Westinghouse Rectifier, the whole encased in polished teak case, calibrated at present 0 to 10 v., 25/- each.

MAINS TRANSFORMERS, input 200/250 v., 50 cycles, in steps of 10 v. Output 450/0/450 v. 250 mA, 4 v. 4 a., 5 v. 4 a., 6.3 v. 8 a., 6.3 v. 8 a., 6.3 v. 8 a., 6.3 v. 8 a., 60/-, Another 500/350/0/350 v. 250 mA, 6.3 v. 8 a., 0, 4, 5 v. 4 a. twice, 6.3 v. tapped at 2 v. 2 a., 67/6. Another 350/0/350 v., 300 mA, 4 v. 8 a., 4 v. 4 a., 6.3 v. 4 a., 6.3 v. tapped 2 v. 2 a., 57/6. Another 500/0/500 v., 300 mA, 6.3 v. 8 a., 6.3 v. 8 a., 6.3 v. 4 a., 4.4 a., 5 v. 4 a., 67/6.

AMC

TELEVISION

Manufactured to "Electronic Engineering" Televisor Specification.

LINE OUTPUT TRANSFORMERS

NEW Improved SET OF GANTRIES COMPLETE

FOCUS COILS

LINE AND FRAME SCANNING COIL ASSEMBLIES

All Steel CADMIUM PLATED POWER AND TIME BASE CHASSIS valve-holders, 3 point and single socket and all necessary cut-outs.

SOUND PANEL CHASSIS ASSEMBLY, fitted with screens, valve-holders, formers and dust cores.

VISION PANEL CHASSIS ASSEMBLY, fitted with screens, valve-holders, formers and dust cores.

9" C.R. TUBE SUPPORT for mounting on top of Gantry Assembly

9" CREAM MASKS.

5, SHAKESPEARE RD., FINCHLEY, N.3

Phone: FINchley 2188

It's a Pleasure to demonstrate the following:—

AMPLIFIERS

Leak "Point One"
Vortexion "Stereophonic"
Acoustical, Sound Sales.

SPEAKERS

Barker's 148a
Goodmans Axiom 22
Sound Sales Phase Inverter
Wharfedale 10 and 12 cs.

PICK-UPS

Decca, Brierley, Coil and Connoisseur, also Tone Control and Feeder Units.

Call and hear them at:—

HOLLEY'S RADIO STORES
285, CAMBERWELL RD., S.E.5

Phone: RODney 4983

G. A. RYALL, "Utopia," Mayfield Rd., Herne Bay, Kent; mail order only; postage or carriage extra; c.o.d. £1 or over; special list for the trade; U.S.A. tubular metal cased wire ended 0.1m.f. 350v, 6/- doz., 350v 5/6 doz., U.S.A. tubular metal cased wire ended 0.5m.f. 350 7/6 doz.; Mansbridge 1m.f. 500v wkg. 3-2/-; Mansbridge 4m.f. 400v wkg. 2/3 each; silver mica 10 p.f. 40p.f., 200p.f., 300p.f., 400 p.f., 500p.f. 3/6 doz.; mica 0.01m.f. 3-1/3; all condensers guaranteed; Amphenol type British 5-pin chassis valve holders, 3/6 doz.; international octal chassis valve holders, paxolin, 4/- doz.; bar type 3-gangs 5/-; bar type 4-gangs 5/-; resistors 1/2 watt and 1/4 watt assorted 100 ohms to 2 meg. level assortment 40-5/-; switches, SB, 2P 6w miniature 1/6, 3B 2P 6w five poles total 2/3 each; SB-9w 2/-, SB SP 6w 1/6, SB, SP, 4w 1/- 2B, 3P, 3w 2/-, SB, 2P, 4w 1/3; twelve-way group boards with 9-1w and 1/2w resistances, etc., 2/-, all new; twenty other types in stock; octal plugs, cap and chassis socket, 3-3/-, with tags 3-3/6; Paxolin panels 1/4in size 12x5, 12x12 7/6; meters 0-1ma, scale 0-10, 2 1/2, 3 1/2, 5, 10, 15, 30 and 45, 6/-; dials on request, first class instruments; metal boxes, black finish with quarter inch paxolin panel, fixing lugs and corner sockets, size 8 1/2 x 7 1/2 x 3 1/2 deep, 6/9 each new; 10,000 ohm bakelite cased volume controls medium spindle 1/6; metal cased minimum depth 1/4meg vols., short spindle 1/6 each; special list for trade. [3485]

TELEBOOSTER for long range T.V. Birmingham or London, R.F. 2L, 40-48 mc/s, variable tuned, input slug tuned output, 2 VR91 valves, 3 tuned stages, co axial linked, H.T. and L.T. from receiver chassis, £3/12/6; R.F.I.L., as above, 1 VR91 valve, 2 tuned stages, £2/12/6; R.F. 2B, 55-65 mc/s, R.F. 1B for Birmingham specifications and price above, please state type required; power units for boosters, £4; s.a.e. for leaflet.—Boscombe Radio, 595, Christchurch Rd., Boscombe, Bournemouth. Tel. Boscombe 1704.

RAYMAX television sound unit, complete kit, using 2, EF50, EB33, EL33. Chassis punched and main components mounted, price (less valves) £2/17/6, valves supplied at current prices; suitable chassis pack complete with mains transformer choke, 8-16mfd, valve-holder £1/14/6; Collaro rim drive unit, magnetic P.U. auto-stop, etc., £5/10 incl. p. tax; Inter. octal moulded V.H. 7/- doz; all types of components ex stock, including cabinets for TV and table radiograms; our console TV cabinet at £13/15 is worth "looking into." Good photographs of the above cabinets available at 6d (returnable); mahogany playing desks fitted with the latest well-known rim drive unit, magnetic P.U. auto-stop, etc., £6/14/6. We welcome enquiries for cabinets to your own specification. Stamp for lists.—Raymax Elec. Co., Ltd., 126, Norwood Rd., London, S.E.24. [3206]

MAINS transformers, fully interleaved and impregnated, standard screened primaries, 200-250v, upright type, Midget 2 1/4-13-2 1/2in, 250/0/250v 50ma, 6.3v 1.5a, 5v tapped 4v 2a, 16/9; fully shrouded 350/0/350v 100ma 6.3v tapped 4v 3a, 5v tapped 4v 2a, 21/6; 425/0/425v 200ma 6.3v tapped 4v 4a, 6.3v tapped 4v 6a, 5v tapped 4v 3a, 39/11; half-shrouded drop-through type 250/0/250v 60/70ma, 6.3v 3a, 5v 2a, 15/6; 350/0/350v 80ma, 6.3v, 5v 2a, 16/9; heater trans., 200-250v input, 6.63v 2a output, 7/6; multi ratio output trans., Class 5, 5/2; 5in pull, 5/- ea., 45/- doz.; selenium rectifiers, small size, 250v 65ma, 3/6, 250/500v 90ma, 4/9 ea., 12v 1 1/2a H.W. C.T., 1/6 ea., 12/- doz.; ex-Govt. block electrolytics, 32mfd 450v T.C.C., 1/9 ea., 18/- doz.; aluminium chassis, receiver type, untrilled, 10-5 1/2in, 3/-; 8-2 1/2, 3/9, 12-9 2 1/2in 4/3, 16-8 2 1/2in 5/6, 20-8 2 1/2in 6/9; Plessey 5in P.M. speakers with trans., 11/9; all new guaranteed goods; send 2 1/2d stamp for full list of bargains; special list for trade; c.w.o. or c.o.d. over £1; postage extra.
RADIO SUPPLY Co., 15, Queen Sq., Leeds, 2. [4008]

BENDIX transmitter chassis, comprising 62-95m/c coils, 832 bases, tuning condensers, resistances, etc., 4/6 each; 19 set power pack containing 2 rotary transformers, 12v input 250v 125ma., 12v 490v 60ma., 25/-; rotary converter, 12v input 230v 30ma. with smoothing, new in carrying case, 17/6; ex-U.S. reflector aerial, 5/6; 0.02mfd 2c condensers, 4/0; 0.02 5k, 1/6; 0.5, 350v, 3/6 each; dural telescopic aerials, 7ft, 3/6; mains transformers, 200-250v sec, 585v 80ma., 6.3v C.T. 4amps, 4v 4amps C.T., 18/6 each; h.t. rectifiers, 250v 60ma., 3/- each; 12v 5amp, 22/6; all types of i.t. transformers in stock, 12v 4amp, 24v 8amp, 6v 5amp, etc., new from 17/6 each; 1, 2, 4, 5kva auto transformers; E.H.T. rectifiers, 620v 3ma., 8/6 each; special offer of Taylor square meters, model 400, 0-1ma., incorporating 1ma. meter rectifier, 30/- each; Lorain indicator units, complete with all valves, 100k/c crystal and 5e.p.l. C.R. tube, 90/- each; Sherry 200ma. chokes, 3/- each; all types of transmitting valves at competitive prices; communication receivers available at reduced prices, A.R.88 1.l., H.R.O.s complete with 7 coils, A.R.77, several Hallcrafters, S.X.24, Champions, etc.; rack mounted 30watt amplifiers, new, less valves, complete with rack mounted power pack, 200-250v a.c., including 6ft 6in standard rack, 105/- each; P.X.25 P.P. output valves for these units at special prices.
SERVICE RADIO SPARES (Ter. 1734), 4, Lisie St., London, W.C.2. [3942]

THE BRITISH NATIONAL RADIO SCHOOL

ESTD. 1940

where nothing is too much trouble and the Student is Always Right! Where the half-truth catch phrase is unknown and

The GOLDEN RULE still runs.

Overseas Students Especially Welcome

INDIVIDUAL COACHING BY POST

in

RADIO, TELECOMMUNICATIONS, RADAR · PHYSICS · MATHS.

All examinations C. & G., I.E.E., Brit. I.R.E.

We can arrange for most examinations to be taken anywhere, aboard ship or furthestmost outpost. Free Booklet from

STUDIES DIRECTOR

BRITISH NATIONAL RADIO SCHOOL

66, ADDISCOMBE ROAD, CROYDON

Phone: Addiscombe 3341

RADIO EXCHANGE CO.

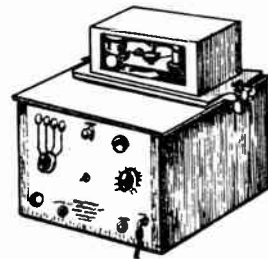

WIRERECORDERS. Of Western Electric design, these consist of an amplifier/recorder/playback/erase unit, with a detachable head and are ruggedly constructed from first-quality components.

The amplifier, with an output of approx. 3 watts, has provision for high impedance mike (built-in preamp) or for gramophone input; output is low impedance. The head contains wire approx. 40-45 mins. recording, incorporates automatic timing scales and switch, and is gear driven. Quality is absolutely first class.

They are designed for 115 v. input, but we supply a step-down transformer.

COMPLETE, with transformer and mike, £45.

ALSO AVAILABLE. 19 SET POWER UNITS, with 540 v. and 275 v. D.C. output from dynamotor, and 275 v. from vibrapack; 12 or 24 v. input, 18/6. DISPLAY UNIT 198, with 3in. short persistence tube, 42VR66's, 3 VR92's, etc., brand new, ONLY £22. TELEPHONES D Mk. V with bell, buzzer and key, and standard P.O. handset, 27/6.

Goods sold as used unless otherwise stated.

RADIO EXCHANGE CO.

9 Cauldwell St., BEDFORD, Phone 5568

You're SURE to get it at

STERN'S

ESTABLISHED 25 YEARS

Resistances. Special offer. Parcel containing 100 popular assorted values 1-watt type, 8/6 per 100, 1-watt type 11/6 per 100. (Trade enquiries invited.)

M/Coll Speakers. Well-known mfrs. surplus, all 2 1/2 ohms: 10in., 25/6; 8in., 17/- (16 ohm, 18/6); 6in., 13/6; 4in., 12/9 (with Transf., 18/6); 3in., 13/6. Engrished also available in all sizes. Truvox 12in. P.M. 2/5 ohms, 47/6.

STERN'S MIDGET BATTERY PORTABLE "PERSONAL" KIT

A complete KIT of PARTS to build a Midget 4 Valve All-Dry Battery "Personal" Set. Consists of Regenerative T.R.F. Circuit employing Flat Tuned Frame Aerial, with PENROD Iron Dust Core Coil, thereby ensuring maximum gain for Single Tuned Stage covering Medium Waveband. Valve Line-up: I.T.4 (R.F. Amp.), I.T.3. (Detector), I.S.5 (1st A.P.) and 284 (Output).

Includes 3in. Moving Coil Speaker and Chassis already drilled and shaped.

Consumption of only 7 ma ensures long battery life.

The Kit is designed for a cabinet, minimum size 6 1/2in. x 4 1/2in. x 3 1/2in.

Detailed Building Instr. and Circuit with practical layout included with each kit make the assembly very easy (supplied separately for 1/6).

Price for COMPLETE KIT £3 18s. 9d. (plus 16s. 7d. P.T.H.).

Suitable unpainted cabinet 6 1/2in. x 4 1/2in. x 3 1/2in., 11s. 9d. Ever Ready B.114 Battery, 9s. 7d.

Coils, T.R.F. Matched pair, M. & L., 6/9. Weymouth ditto, 8/6 pair. 8 Het. matched, 3M. & L., 8/9. 10/6 and 11/6 pair. All Wirecut "P" Coils, 3/- each, including R.F., B.F.O. and A.F.

I.F. Transf., 465 k/c. New well-known mfrs. surplus 2 1/2in. x 1 1/2in. Perm. Tuned, 9/- each, or size 2 1/2in. x 1 1/2in. capacity tuned, 13/9 pair.

Potentiometers. Centralab, 5K, 10K, 25K, 50K, 100K, 1/4, 1 and 2 Meg., less Switch, 3/6. With Switch, 6/-. Midget with Switch, 4/1 and 1 Meg., 6/-. Special 7 1/2 Meg., with Switch, 4/9.

Meter Rectifiers. Westinghouse, 0.5 ma. 4/9; 0-10 ma., 7/6; 0-1 ma., 10/6.

Selenium Rectifiers. H.T. h/wave: 250 v. 50 ma. 1/4; 300 v. 100 ma., 5/9; 250 v. 100 ma., 7/6; 250 v. 300 ma., 13/9; Bridge Rect.: 6 v. 1 1/2 amp., 6/9; 12 v. 1 1/2 amp., 12/6; 12 v. 3 amp., 21/-; 12 v. 5 amp., 25/-; 70 v. 1 1/2 a., 37/6. Also I.T. 2 1/2 volts at 1 amp., 3/6.

Stern's Midget Inter-Valve Transf. 4in. x 1 1/2in. x 1 1/2in. Ratio 3:1 (also Ratio 5:1), 4/6.

Charger Transf. Each has input 230 v., outputs 24 v. (tapped 15.8 and 4 v.), 3 amps., 24/6; 20 v. (tapped 15 and 9 v.), 3 amps., 23/6; 15 v. (tapped 9 v.) 3 amps., 16/9.

Filament Transf. Input 200-250 v., output 6.3 v., 11 amps., 8/6. Also output 4 v., 11 amps., 7/9.

Ex-Govt. T.M.C. Reed-type Headphones. 70 ohms, 1/6 each (3/6 pair with leads). Single earphones, 70 ohms, with adjustable Headband, 1/6. Midget Output Trans., 32-1, 1in. x 1 1/2in. x 1 1/2in., 3/-; P/Pull Intervalve 2.5-1 each half output Trf., 60-1, both 1 1/2in. x 1 1/2in., 3/- each. Multi-ratio Matching Transfs. 4 windings 2 C.T. over 10 ratios between 10 and 100-1, 2in. x 1 1/2in. x 1 1/2in., 3/9. 12 volt D.C. motor suitable for models, 11/6. Moving Coil Mike with R.F. switch, 2/6. M/Coll Headphone, 2/-. Carbon Hand Mike, with 8/4 switch, 2/11. 1 mfd. 5,000 volt Mainbridge, 6/9. 25 mfd. 2,000 v. Mainbridge, 1/6. Throat Mikes, 3/6. .5 mfd. 2 kv., 2/-. .25 mfd. 100 v., 1/-.
L.F. Chokes. Midget 10 Hvy. 250 ohm 40 ma., 3/6. Standard 15 Hvy. 250 ohm 60 ma., 6/9. 20 Hvy. 300 ohm 100 ma., 12/9; 5 Hvy. 50 ohm 250 ma., 18/6; 20 Hvy. 250 ohm 120 ma., 18/6.

Wireless World Midget A.C. Mains 2-valve Receiver. All components to build this set as specified in March Issue at total cost of £3.0.0. Reprint of detailed building instructions and circuit, 9d. extra.

Output Transf. Wharfedale Midget 30-60 or 90-1, 6/9. Elstone Multi (over 12 Ratios some C.T.), 6/7 watts, 7/6. Kingway Multi Ratio, all C.T. for P/Pull, suit PX.4, 6L6, etc., handle 13 watts, 24/9 (also available in 30 watt type, 30/-). Stern's Midget 1 1/2in. x 1 1/2in. x 1 1/2in. Ratios 90-1, 4/6 (also at 90-1, 4/6).

★ Send 21d. stamp for our New Comprehensive Stock List. When ordering please cover packing and postage.

STERN RADIO LTD.
 109 & 115, FLEET STREET, E.C.4.
 Telephone: CENtral 5814 and 2280.

RADIO CLEARANCE, Ltd., 27, Tottenham Court Rd., London, W.1. Tel. Museum 9188.

REC. R. 1481 covers 65-86 Mc/s., 10 valves (6.3v), (tuning meter, 6in S.M. dial, circuit diagram, etc. brand new in transit case £4/4) carr. paid; rec. R.U.19 6 valve straight rec. with 3 R.F. stages, using plug-in coils H.R.O. type, valves 3x78's, 2x77's, 1x1642, black crackle case 15x6x8in supplied complete with valves and 4 coll. packs covering 524-844, 1285-2155, 2960-4620, 3965-6265, 675-7780 Mc/s., £2/19/6; carr. paid; personal receivers B.C.728c, 7 valve rec. using 1.4v valves, with 4 push buttons covering 2-6 Mc/s. built in L/S. supplied brand new complete with valves (1T4, 1R5, etc.) 2 and 12v V.I.B. 2v acc.; telescopic A.E. instruction book, etc. £8/19/6; main trans., all PRI 200/250v., 50c/s, sec. 230-0-230v., 100mA, 5v 2A, 6.3v, 2A, C.T., PRI tapped 110v, 15/6; Sec. 275-0-275v., 120mA, 4v 2A, 4v 3A, 13/6; Sec. 460v, 200mA, 210v 15mA, 6.3v 5A, 14/6; auto trans., 200/250v-60W rating enclosed 18/-; special line auto. 230/250-110v., 100W, 9/6; smoothing chokes 5H, 120mA, 1400 3/3; 5H 200mA, 1000 4/11; 6H, 200mA, 1000 5/6; 5H, 250mA, 900 7/6; 15H, 200mA, 1500 (6 1/2x4 1/2x3 1/2in) 7/6; 20H, 300mA, 3500 (7 1/2x5 1/2x3 1/2in) 8/6; 20H, 1mA, 220 3/3; electrolytics, 8mf, 150v, 8/10v, 16/350v, 3/350v, card 1/6, can 1/11; 16/450v 2/3; 16/350v can 2/3; 16/500v can 2/9; 16-8 450v large can or d/ended 3/6; 8-32 450v can 4/-; 16-24+8 450v can 5/-; 8-3+8 450v can 4/-; 32/450 large 2/9; 32 standard, 16c makes 10/6, can 3/-; 40+100 350v 3/-; 32/350v card 2/3; 100mf 3v 3d; 100mf 6v 6d; 25/25v 1/4; 100/25v 1/8; 25/50v 1/3; 16/350 card 1/9; 24/350 can 2/-; 8-24 350v can 2/6; P.M. loudspeakers 5in less trans. 9/11; with trans. 4500 11/6; 6 1/2in less trans. 10/11; 10in less trans. 11/6; R.F. units: type 24 8/6; type 25 10/6; with valves, used, in good condition, post 1/6 extra please; marker beacon rec. B.C.357, 2 valves, (12C8, 125Q7) chassis 5x3x1 1/2in, with 1mA relay 8/6; output trans 200, 25/250/20, 2750/5, 500v/20, 1/-; 4500/20 7000/40, 3/6; standard, 16c makes 10/6, 350v heavy duty 7000 2/0 3/6; I.F. trans. 465 Kc/s small size, iron core 7/6 pr.; 2 gang conds., .0005 ceramic ins., 1in standard spindle 4/6; ceramic switches 2p., 3w. 1B 2/-; 3p., 3w. 1B 2/6; 3p., 3w. 2B 3/6; 4p., 3w. 4/6; switches small size 2p., 3w. 2p., 4w. 3/6, single bank 2/-; standard size 2p., 4w. 1B (additional wafer with shorting plate) 2/6; 4p., 3w. 2B 2/6; 2p., 4w. 3B 2/6; 1p., 10w. 2B 2/6; all have 3in spindles; resistors 100 assorted, 47 values ranging 180 1/4w -100K 2/9; 22 standard, 16c makes 10/6, post 1/6; ceramic trimmers 3/50pf, 3 on a bar 7/3; 1/15pf single 4d; 3/30pf air spaced concentric 6d; 3/25pf V.I.C. type 3d; air spaced variables 1 1/2in spindles 25pf, 50pf, straight, 50pf diff., ceramic bases 1/4, 35pf, butterfly 3/6; Eddy-stone .60pf double ended, 2 Mansbridge cond., condensers 4mf, 1000V, WKG 2 in a packet 6/9; selenium rectifiers 250v 40mA H.W. 3/6; 350v 60mA H.W. 4/6; 400v 120mA H.W. 5/6; 50v 4A double bridge 18/6; car radio vibrator packs with 12v 2.5A, P.M. rotary mounted on chassis 5 1/2x3 1/2x1 1/2in, output 250v 65mA, output brought out on oft screened lead 17/6; meters moving coil, metal case, 2in circular 0/500 microA 7/6; 0/15-600v rec. ext. res. 6/6; 0/20 or 0/40A with standard size bakelite case 2in square 0/1mA 7/6; 0/5mA 6/6; 0/50mA 8/6; 0/200mA 8/6; 0/15V 7/6; 0/200 1m, 5/6; 3.5d. 1mA desk type 15/-; control units with 2 2in meters 0/5mA, 0/40v rotary and toggle sw., 5 and 7 pin sockets 8/6; visual indicators type 1 crossover needle, with 2 separate 60microA movements 5/-, type 3 with 2 500microA movements and 100 ohm resistor, mounted on chassis as on R.F.26 etc., 3/11; ex-Admiralty patt. 1257, 1 1/2in engraved 0-100, fast/slow (50-1), panel mounting, fits 1/2in spin., 2/6; rotary power units type 104 12v D.C. input, outputs 250v 60mA, 6.5v 2.5A, P.M. rotary mounted on chassis with sup. 6/11; type 97, outputs as above, but 24v input 5/11; 10 valve receivers, R28/ARCS, cover 100-150 Mc/s. brand new with valves (inc. 4-717 A's) 42/6; modulator and mixer units W6332A, with 12 valves (1-5U4G, 2-6J5, 2-P61, 1-VR65, 1-VR54), 2 1/2in 0/50mA 3/6; 5H 200mA choke, large trans. (500 c/s) pots, res., conds., etc., in metal case with louveres 10 1/2x11 1/2x6 1/2in 21/-, carr. paid; Admiralty power units, input 24v D.C., output 230v 50 c/s. 75 watts, in grey case, 18 1/2x12 1/2in, with motor alt. auto on/off switch, 2 1/2in 0-250v meter, output control sw., Slydlock fuses, etc., these units will 50% overload comfortably, £3/5, carr. paid; rotary power units W2702 6v D.C. input, 190v 80mA output D.C. smoothed, with 3 chokes (inc. Ferranti 32), in metal case, 4 1/2x9 1/2x3 1/2in with on/off sw., rotary has wound field, 16/6 carr. paid; Wilcox Gay V.F.O. covers 2-10 Mc/s. with 0-10mA meter, supplied brand new in original carton, with 807 accessories (plugs, leads, etc.), and instruction book, £5 carr. paid; Wilcox Gay X-ray multipliers 2-7 Mc/s, brand new, with 807, plugs, leads, instruction book, etc. in original cartons 40/- carr. paid; superhet coils 1/4x1 1/2in formers M.W. HP, AE, osc., L.W. HF, AE, osc., 1/6 per coil; I.F. traps iron core, 465 Kc/s 1/9, set of 6 coils and trap 9/6; 7 or 10 pin plugs and sockets with keypad 1/6; 8 way Jones plugs and sockets with cover 1/6 pr.; V.C. carbon with sw. 2 1/2in spindle 5K, 25K, 50K, 100K, 250K, 500K, 4/-; 3 watt wire-wound no sw. 200 1/2, 400 1/2, 500 1/2, 1.5K, 2K, 2.5K, 5K, 10K, (Continued on next page)

GRAND NEWS

.. it's CHEAPER now

The demand for our Telesor Kit has exceeded all expectations due, no doubt, to the lucid nature of the instructions and easy to follow point-to-point wiring diagrams.

This demand has made it possible for us to purchase many of the components in bulk, resulting in considerable savings.

As is our usual policy we are extending this saving to our customers, and in consequence have pleasure in announcing the following price reductions.

KIT OF PARTS with 21 brand new valves, 6 1/2in. C.R.T., speaker, and complete down to the last nut and bolt is now reduced to **ONLY £16/19/6**. For those to whom price is a primary consideration we can supply the complete Kit as above; (the C.R.T. and valves are slightly used but guaranteed perfect), for **ONLY £15**. The carriage charge on either Kit is 10/-. Price of the comprehensive point-to-point wiring diagrams and 17 pages of data remains at 5/- post free, but will of course be refunded if a complete Kit is purchased. **FURTHER DETAILS AVAILABLE ON REQUEST.**

NOTE THESE STAR POINTS.

- ★ NO knowledge of television technique essential. Our point-to-point diagrams ensures success for the veriest tyro!
- ★ ALL parts brand new, unused and of the finest quality!
- ★ ALL parts may be purchased separately!
- ★ **ROCK-STEADY** picture is assured by the use of no less than 6 EF50 valves in the Time Base and Synch. Separator!
- ★ **UNIQUE "after sales" service.** Testing and alignment of Receivers after completion of assembly will be undertaken for a nominal sum!
- ★ **DEMONSTRATION** model may be seen working at our London premises during viewing hours!

SOME TOPICAL RELEASES.

Receiver Unit 257/3. Yet another bulk purchase enables us to offer these at 22/6 post free. This Unit is the receiver portion of the TR19E. Valve line-up; 2 EF39, 1 EK32, 1 EBC33, 2 EF36, and one pair of 460 Kc/s. I.F. Transformers, resistors and condensers. Rapidly converted to a fine medium-wave superhet, and for this purpose we supply circuits and modification data gratis. Many satisfied constructors will testify that the 257/3 is indeed an outstanding bargain.

Receiver Unit BC624. An eleven-valve American receiver, unused but slightly soiled, which employs valves of the 12 v., .15 amp. series. Included are 3 9000 and 1 9002. The receiver as supplied tunes between 100-156 Mc/s with 4 spot frequencies. It is necessary to modify the receiver for continuous tuning, as the local oscillator is crystal controlled and cannot be tuned. We are therefore supplying with each set circuit diagrams and full modification instructions for "Ham" use. The price of the Receiver is only 25/- carriage paid, and represents exceptional value.

Indicator Unit Type 97. Unused but slightly soiled. Valve line-up; 6 EF50, 3 EB34, 4 EA50, together with 12 pot./meters and hosts of 2 watt 1 watt and 1/2 watt resistors, and numerous high voltage condensers. The C.R.T. is a VCR517 and ideal for television use. ALL TUBES TESTED, PRIOR TO DESPATCH. **ONLY 59/6**, plus 7/6 carriage and packing. One of our most popular offers.

Best buy at Britain's

CHARLES BRITAIN (RADIO) LTD.

11, UPPER SAINT MARTIN'S LANE, LONDON, W.C.2

(3 minutes from Leicester Square Station)
 Telephone; TEM 0545.

Shop hours; 9 to 6 p.m. 9 to 1 p.m. Thursday
OPEN ALL DAY SATURDAY.

BESPOKE TRANSFORMERS OF DISTINCTION BUILT TO YOUR OWN REQUIREMENTS

Dealers & service engineers (R.T.R.A. definition) are invited to send ld. stamp for the latest "Monthly Bulletin."

A.W.F. Radio Products Ltd.
(DEPT. W)
Borough Mills, Bradford, Yorks.

TELEVISION CONSTRUCTORS!

E.E. Televisor Demonstrated Daily
MIDLAND CONSTRUCTORS ETC.
ARE INVITED TO SEND FOR OUR COMPLETE COMPONENT LIST AND TAKE ADVANTAGE OF OUR

PROMPT POSTAL SERVICE

J. T. FILMER MAYPOLE ESTATE,
BEXLEY, KENT.
Tel. Bexleyheath 7267

HILL & CHURCHILL LTD.

BOOKSELLERS

SWANAGE, DORSET

Available from stock

Standard Telephones and Cables— "Reference Data for Radio Engineers"	5/-
Scroggie—"Radio Laboratory Handbook"	12/6
A.R.R.L.—"Radio Amateur's Handbook," 1949	16/6
Smith—"Antenna Manual"	17/6
Nilson and Hornung—"Practical Radio Communication"	39/-
Rider—"Inside the Vacuum Tube"	30/-
Brainerd—"Ultra High Frequency Techniques"	28/-
Ramo and Whinny—"Fields and Waves in Modern Radio"	33/-
Schelkunoff—"Electro-Magnetic Waves"	42/-
Zworykin—"Electron Optics and the Electron Microscope"	60/-

Postage Extra.

CATALOGUE ON APPLICATION

(Continued from previous page)
20K. 25K. 2/-; twin w/w 2.5K/2.5K 2/6;
500/500! 2/6; 50K/50K 3/-; twin carbon 1m/1m
2/6; all telescopic aerials, 15in closed 7ft 6in
extended 3/6; rubber dinghies, large size (8 man)
17/6 carr. paid, to clear; receivers type 76,
150/505 Kc/s 3 valves ARTH2, VR53, VR92.
I.F. output 560 Kc/s, brand new in transit case
22/6 carr. paid.

RADIO CLEARANCE, Ltd., 27, Tottenham Court Rd., London, W.1. Tel. Museum 9188. [4009]

WANTED. EXCHANGE. ETC

AVO No. 6 winding machines wanted; details and price.—Box 6178. [3542]

FINE wires in large quantities only, must be new and perfect material.

L. E. SIMMONDS, 8a, Byron Rd., Harrow, Tel. Harrow 0315. [3661]

WANTED, Scott 1937 30-valve Philharmonic receiver, any condition, details.—Box 7191. [3808]

WANTED, six valves, American type 8020 high voltage vacuum rectifier.—Box 7483. [3791]

WANTED, console type 4, 5, 5A-D, 6, 6A, 7 and 7A, 10DB/785, 10DB/786.—Box 7520. [4012]

WANTED.—Surplus relays and push-button units, any condition large or small quantities; highest prices paid.—Box 6180. [3532]

WE pay top prices for used test equipment, all types.—University Radio, Ltd., 22, Lisle St., London, W.C.2. Tel. Ger. 4447 and Ger. 8582. [19992]

WANTED, all kinds of laboratory test equipment, standard signal generators, bridges, oscilloscopes, "Q" meters, etc.; send details to:—

OAK INSTRUMENTS, 86, Mill Lane, London, N.W.6. Tel. Hampstead 4219. [3977]

REQUIRED, V.H.F. sig. generator, 110 mc/s to 150 mc/s, mains 230-250, ex-Service preferred but must be very good.—Details and price to Box 7489. [3953]

CARRIER telephone and telegraph equipment of all types in any condition wanted; also teleprinter and teletypewriter apparatus.—Harris & Gillow, 93, Wardour St., W.1. [3036]

ST. DUNSTAN'S (for war-blinded Service men and women) requires a Webster wire recorder.—Details, please, to Chief Engineer, 8, Hinde St., W.1. (Tel. Welbeck 3762.) [4007]

WE buy for cash, new, used, radio, electrical equipment, all types; especially wanted, radios, radiograms, test equipment, motors, chargers, recording gear, etc.—If you want to sell at the maximum price call, write or 'phone to University Radio, Ltd., 22, Lisle St., Leicester Sq., W.C.2. Ger. 4447.

REPAIRS AND SERVICE

MAINS transformers rewound, new transformers to any specification.
MOTOR rewinds and complete overhauls; first-class workmanship, fully guaranteed.
F.M. ELECTRIC Co., Ltd., Potters Bldgs., Warser Gate Nottingham. Est. 1917. Tel. 3855.

LOUDSPEAKERS and transformers rewound, cones replaced, prompt service.—Dodds Radio Service, 131a, Hurst St., Oxford. [3650]

TRANSFORMER and choke rewinds, duplicate and to specification; prompt service.—F. Hadfield, Musard Place, Staveley, Chesterfield. [3984]

LOUDSPEAKER repairs, British, American, any make, moderate prices.—Sinclair Speakers, 12, Pembroke St., London, N.1. Terminus 4355. [3308]

MAIN and output transformers rewound to pattern or specification, return post service.—H. Pughe, Radio Rewind Service, Brithdir, Nr. Dolkelley N. Wales. [3243]

REWINDS and conversions to mains and output transformers, from 4/6; dp equipment a speciality.—N.L. Rewinds, 4, Brecknock Rd., N.7. Tel. Arnold 3390. [6283]

MAINS transformers rewound or constructed to any specification; prompt delivery.—Bede Transformer Co., Ltd., Bedesway, Bede Trading Estate, Jarrow. [3198]

AREWIND service which duplicates or modifies as required; transformers, loudspeakers, etc.; prompt returns.—Raidel Services, 49, Lr. Addiscombe Rd., Croydon. Cro. 6537.

ELECTRICAL measuring instruments of every make repaired and standardised.—The Electrical Instrument Repair Service, 329, Kilburn Lane, London W.9. Tel. Lad. 4168. [3715]

REPAIRS to moving coil speakers cones, coils fitted, field rewound or altered; speaker transformers, clock coils rewound; guaranteed satisfaction, prompt service, we do not rewind mains trans.—Closed Sat.
L.S. REPAIR SERVICE, 49, Trinity Rd., Upper Tooting London, S.W.17. Balham 2359.

TELERADIO.

Radiogram
Equipment

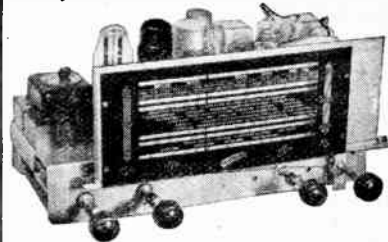

MODEL A70, 6 valve all-wave modern superhet chassis with tuning indicator, tone control and radiogram switch. The ideal replacement chassis. £14 14 0d. plus £3 3 3d. Purchase Tax.

MODEL 70 TU, As above but as 3 valve tuning unit feeding model 77 amplifier £8 0 0d. plus 34/10d. Purchase Tax.

MODEL 77, 4 valve push pull amplifier with 2 6V6 fed by phase inverter. Approx. 8 watts output £9 5 0d.

AVAILABLE AS KIT OF PARTS { Blueprints 4/-

Send for leaflet to:

THE TELERADIO CO.,
157, Fore St., Edmonton, N.18

TRANSFORMERS & COILS TO SPECIFICATION.

MANUFACTURED OR REWOUND

Filter Coils + 1% a Speciality.

JOHN FACTOR LTD.

9-11 EAST STREET, TORQUAY, DEVON.

'Phone: Torquay 2162

SERVICING for the WEST COUNTRY AMATEUR

COMMUNICATION RECEIVER REPAIRS

With good equipment and well qualified personnel we offer a first-class service for the repair and adjustment of communication receivers of every make.

No repairs too small, none too difficult, and our facilities for precision adjustment enable us to get the best from every set.

Estimates are given after examination and test, and receivers are carefully packed for return.

G. N. PILL & PARTNERS
49 COBOURG STREET, PLYMOUTH

Telephone : 2239

Here's your Chance . . .

14 VALVE COMMUNICATIONS RECEIVER
(Type AR1 5206). Three Equipments comprising a 14-valve crystal calibrated receiver covering a range of 2.4 to 13 Mc/s.

Specification: RF amplifier, mixer with separate L.O., crystal chock oscillator, limiter monitor, 2 stages I.F. (550 Kc/s), Detector, AVC, BFO, with AF amplifier (phones) and push-pull output for speaker. Approx. output 15 watts.

Aerial tuning unit supplied for use in front of the Receiver to improve signal strength. This unit provides correct impedance matching to the receiver over its frequency range, with any length of aerial in use.

Valve line-up: 4 EF39, 2 EF50, 1 EA50, 1 ECH35, 1 6J5G, 2 KT33C, 2 EF36, 1 EBC33. Complete with 100 Kc/s crystal and 24 v. input power supply.

A LUXURY JOB FOR ONLY £5 Add 15/- carr. and packing.

SCR 522 RECEIVERS

This famous receiver is a crystal controlled 4-channel superhet, covering the frequency range 100-156 Mc/s and is ideal for 144Mc/s.

Valve line-up: 9003 RF stage, 9003 mixer, 9002 oscillator, 9003 isolating amplifier 3 12SC7 I.F. stages, 12C8 2nd. Detector and 1st A.F., 12H6 noise limiter, 12AH7GT AVC, 12J5GT 2nd audio.

Ideal basic unit for TV conversion or, of course, for the 2-metre band.

Full modifications to 144 Mc/s described in Oct. 1948 issue of "Radio News."

Complete with 11 valves.
PRICE 32/6 TO Add 5/- for carriage and packing.
ONLY 32/6 TO CALLERS

TO CALLERS ONLY

The famous TU9B and TU26B Transmitter Tuning Units complete in outer case (17½ in. x 7½ in. x 8 in.) for only 7/6; or less outer case for 5/-.

R3084A RECEIVER

Incorporating 7 EF50, 2 EF54, 1 EC52, 1 VU39A, 1 HVR2, 1 EA50, plus 30 Mc/s. I.F. Strip.

Guaranteed absolutely brand new in maker's original packing case. This receiver is ideal for conversion to vision **65/-** Plus 10/- carr. and packing.

HIGH FREQUENCY ALTERNATORS

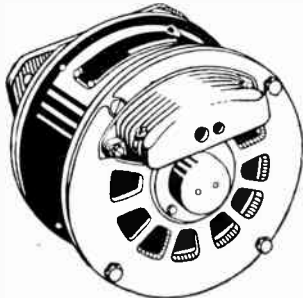

An engine-driven alternator. Output 80 v. 1200-2400 c/s. Rating 1200 watts. Excitation 24 v. D.C.
BRAND NEW 25/- Carr. and packing 5/-
Make use of that surplus equipment with 80 v. power packs!

M.O.S. NEWSLETTER A lively journal packed with good ideas, circuits etc., and news of the best in "surplus." Send 6d for specimen copy or 5/- for a year's subscription.

Terms: Cash with order

M.O.S

MAIL ORDER SUPPLY CO.

33 Tottenham Court Road, London, W.1.
Tele: MUSeum 6667-8-9

"SERVICE with a smile."—Repairers of all types of British and American receivers; coil rewinds; American valves, spares, line cord.—F.R.I. Ltd., 22, Howland St., W.1. Museum 5675. [1575]

RADIO MAINTENANCE SERVICE for guaranteed rewinds and repairs; armatures; F.H.P. motors, vac. units, portable tools, etc.; good deliveries.—139, Goldhurst Terrace, N.W.6. [9925] 6133.

"STURDY" rewinds, mains transformers, chokes, and fields, first-class work, prompt deliveries and satisfaction guaranteed.—Sturdy Electric Co., Ltd., Dipton, Newcastle-on-Tyne. [2430]

ACCURATE coil windings; tuning coils. I.F., I.F. and mains transformers rewound and wound to specifications; wave and progressive wave winding.—Rynford, Ltd., 17, Arwenack St., Falmouth. [2497]

SECOND-TO-NONE rewind service, reliable, neat, return of post service; your television requirements promptly executed, EHT, LHT and heater transformers; stamp for quotations.—R. E. F., 137a, Ashton Rd., Oldham. [3519]

24-HOUR SERVICE, 6 months' guarantee, any transformer, rewind, mains outputs, etc., supplied to specification; business heading or service card for trade prices.—Majestic Winding Co., 180 Windham Rd., Bournemouth.

L.T.P. rewind service, all rewinds are layer wound, vacuum impregnated, pressure tested at 2,000 volts and guaranteed for three months, 48-hour service.—Enquiries London Transformer Products, Ltd., L.T.P. Works, Cobhold Estate, N.W.10. Tel. Willesden 6486.

METROPOLITAN RADIO SERVICE for rewinds, mains and e.h.t. transformers, chokes and field coils; delivery 3-5 days; new transformers designed and manufactured singly or in quantities.—Metropolitan Radio Service Company, 1021, Finchley Rd., London, N.W.11.

REWINDS—Send your "burn outs" to be rewound; no technical data wanted; post transformer, etc., labelled with your name, address, and marked "for rewind"; our windings are double wound, interleaved and impregnated.—Southern Trade Services, Ltd., 297-299, High St., Croydon. Tel. 4870. [3110]

WORK WANTED

WE make wireless and radiogram cabinets for home and export; immediate deliveries.—Radac, Ltd., 26, Bronesbury Rd., London, N.W.6. Malda Vale 8792, also Terminus 7447/8. [8285]

RADIO mfrs. can undertake development and assembly of radio or electronic equipment; winding shop with vacuum impregnation plant; ample space and labour available.—Box 685.

CAPACITY open for assembling, wiring and testing, any type light electrical or mechanical apparatus; efficient, speedy and reasonable service on prototype or repetition work; personal supervision.—Box 7215. [3811]

FIRST-CLASS transformers and chokes manufactured stock lines available; also special manufacturers' components made to specifications; armatures and fields wound and motors assembled.—Avis & Bazys Ltd., 140-141, Friar St., Reading Berks. [2715]

EXPERIMENTAL and design work; for all types of radio and electronic apparatus designed or built to your specification. A.M., F.M., T.V., control and measuring instruments; write for quotation to—J. Mort, B.Sc., A.M.I.E.E., BCM/HIFIDEL, London, W.C.1.

DRAWING and tracing work for radio and electrical engineering; jig and tool and light engineering, photomirring; full sets of drawings undertaken to commercial or Ministry standards.—Drawing & Tracing Ltd., 456a, Ewell Rd., Tolworth, Surbiton, Elmbridge 7406.

MISCELLANEOUS

W.W. 1935-47, 1938-44, complete, some bound.—Offers Box 7380. [3943]

"Q.S.L.s." and "G.P.O." approved log books, samples free.—Atkinson Bros., printers, Elland. [3082]

AERIAL, unused, Belling-Lee six-guinea model; offers.—Pollitt, Hillside, Eskdale, Cumberland. [3793]

WALNUT radiogram and television cabinets, manf. samples, few only, stamp details.—Walters, 501, Hale End Rd., E.4. [3936]

EXCLUSIVE modern hand-made radiogram cabinet (empty).—Particulars from Cosgrove, 160, St. Helen's Avenue, Swansea. [3818]

80 Wireless Worlds, nearly consecutive to date, £3; 83 Electronic Engineering, £5; Avo all-wave oscillator, £10; Solar capacity bridge, £2/10; oscilloscope, £12; 500V Wee megger, £5.—Hill, 963a, Middleton Rd., Chadderton, Lancs. [3945]

AUGUST BARGAINS

from

U.E.I.

10in. P.M. SPEAKERS by Truvox less transformer. Brand new. ONLY 17/6 (postage 2/6).

2½in. CIRCULAR 0-1 M.A. METERS (with flange 3½in.) marked with 50 degree scale. Brand new. ONLY 15/- (postage, etc., 1/-).

AMPLIFIER SPEAKER CABINETS, of heavy timber, designed to take a 10in. speaker. Has compartment at rear for leads, etc., and leather carrying handle on top. Size 17in. x 17in. x 6in. Brand new. In cartons. ONLY 21/- (carriage 2/6).

EX-R.A.F. POWER UNITS, TYPE 10. Input 24 v., output 6 v., 150 v., and 300 v. Comprises type P Motor Generator, starting relay, HT and LT smoothing chokes, condensers, etc. All input and output connections from 10-way Jones plug. In black metal case, size 12½in. x 8in. x 5½in. Brand new. ONLY 15/- (carriage 3/6).

WAVEFORM GENERATORS, TYPE 34. Contains 6 valves SP61, 3 EF36, 1 EBL33, 2 EB34, 1 V872, and relays, transformers, condensers, resistors, etc. ONLY 22/6 (carriage 3/6).

TRANSMITTING "PARCEL" A beautiful piece of R.A.F. gear, containing two large .0002 mfd. transmitting variables, short wave coils, variable inductances, large knurled and bar knobs, etc., etc. Brand new. In maker's cartons. ONLY 10/- (carriage 3/6).

2-VALVE BATTERY AMPLIFIERS, used by the R.A.F. for intercomm. on aircraft. Makes an ideal pre-amp. stage for a gramophone, pick-up, etc. Complete with valves QP21 and 210LF. Operating voltages 2 v. LT and 120 v. HT. Brand new. In transit cases. ONLY 25/- (postage 2/6).

EXTENSION SPEAKERS. 5in. PM speaker in bakelite case. Cream or walnut. Fitted with volume control. ONLY 29/6 (postage 2/6).

E.H.T. CONDENSERS. 2,500 v. .01 mfd. & 1,500 v. .05 mfd. metal cased tubulars. 1/6 ea. (postage 3d.).

POCKET VOLTMETERS. Ex-Govt., 2-range 0-15 v. and 0-250 v. DC. Brand new. In cartons. ONLY 10/6 (postage 1/-).

TELEVISION CONSTRUCTORS should now be thinking of obtaining their gear. Don't wait for the long winter evenings when everything will be in demand and the bargains snapped up. Using Radar Gear you can construct a very cheap TV, and our 26-page data at 7/6 shows how it can be done. We can supply every item required, and if the two main Radar Units are purchased the data is supplied gratis, or it may be purchased and then credited if the units are bought within 14 days. Send for the Data NOW, and at least reserve your Radar Units before supplies "dry up."

C.W.O., PLEASE.

S.A.E. for lists.

U.E.I. CORP.

THE RADIO CORNER,

138, Gray's Inn Rd., London, W.C.1

(Phone: TERminus 7937).

Open until 1 p.m. Saturdays, we are two mins. from High Holborn, 5 mins. from King's Cross.

When QUALITY counts



... and price is the only limitation, the HOME LAB Signal Generator is the logical choice. For serious work at a modest outlay it offers a first rate design and a comprehensive specification.

- 100 kilocycles to 100 megacycles
- 30 per cent. modulation at 400 ~ or unmodulated carrier
- Provision for external modulation
- Two-stage constant impedance attenuator
- Output impedance 10 ohms
- Low external field
- Buffer stage
- Variable 400 ~ output voltage
- Accuracy of calibration ± 1 per cent.

PRICE £6:6:0 plus 3/- for packing.

AC and AC/DC models available. Send S.A.E., for free descriptive brochure and enclose P.O. for 2/6 if circuit diagram required.

TERMS OF BUSINESS: Cash with order only. Orders by post only until new showrooms open. HELY-MANN ELECTRONICS LABORATORIES, 116, Grove Road, London, E.17.

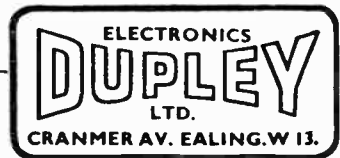

Transformer and Coil Manufacturers to the Trade
Telephone: EALING 5688

JOSEPH ENOCK LTD.

Manufacturers and suppliers of the Enock Diamond Pick-up, the Enock Amplifier and the Mordaunt Loud Speaker, all built to the exacting specification which has made the Enock Instrument the finest music reproducer in the world.

JOSEPH ENOCK LTD.,
273a HIGH ST., BRENTFORD,
ENGLAND.
EALING 8103

TRADE transfers, gold and black, four word—7 days' delivery; also decorative transfers; list free.—W. W. Axon, Jersey, C.I. [2160]

INSTRUMENT handles, chromium plated brass 4 1/4 in. fixing centres; 4/6 per pair, postage extra.—British Electronic Industries, 303-305, Burdett Rd., E.14. [3654]

MANUFACTURER has quantities of enamel-covered and rayon-covered copper wire in various sizes for disposal at considerably below market prices.—Box 7509. [3983]

RADIOGRAM, table radiogram and corner cabinets, prices from £4/15; trade enquiries invited.—Illustrated leaflets from Cabinetware, Summit Works, Heyes St., Blackburn. [3996]

ALUMINIUM chassis and panels, any size manufactured quickly; holes punched for valveholders, etc.; crackle and cellulose finishing.—E.A.D., 18, Broad Rd., Willingdon, Sussex.

NUTS, screws, washers, etc., large stock of useful sizes (4BA and similar) for disposal in small quantities to suit amateurs, low prices; P.C. for list.—J. M. McIntyre, Benson, Oxford. [3962]

EXPOSURE meter components, light cell 6/6, meter movement 7/10, moulded case 8/10; assembly instructions and conversion scale reproductions 3/6.—Surpluses, 78, Repton Rd., Bristol, 4. [3642]

RADIO supervisors and technicians should join their appropriate trade union, the Association of Supervisory Staffs, Executive and Technicians.—Write for free pamphlet to ASSET, 110, Park St., London, W.1. Tel. Mayfair 8541-2.

ENGRAVING.—Amateurs and trade requirements, panels, plates, metal and plastic, attention to urgent deliveries; one knob or repetition equally entertained.—Call or write Newman, 19a, Windmill Rd., Wandsworth, London, S.W.16. [3640]

FESTIVAL of Britain.—The Council of Industrial Design have opened a 1951 stock list to which they invite manufacturers to send photographs or drawings of their best products.—Address to Stock List, Council of Industrial Design, Tilbury House, Petty France, London, S.W.1. [3627]

FLUORESCENT lighting, special August offer, 80w control unit, choke, P.F. condensers, glow starter, suppressor, fully wired with two tube holders, tested 210-240v a.c., 42/6 only; buy your 5ft tube locally.—Malden Transformer Supplies, 200-202, Cambridge Rd., Norbiton, Surrey. [4001]

COPPER wires enamelled, tinned, Litz, cotton, silk covered, all gauges; BA screws, nuts, washers, soldering tags, eyelets; ebonite and laminated bakelite panels, tubes, coil formers; Tufrol rod; headphones, flexes, etc.; latest radio publications, full range available; list s.a.e.; trade supplied.—Post Radio Supplies, 33, Bourne Gardens, London, E.4. [1454]

ATTENTION.—Something new and original, perfect models of television or radiogram cabinets, veneered in walnut and french polished, ideal for miniature radios or novelty speakers, fitted with the latest gold anodised metal grill, accommodation up to six units; price 28/6 net; refund if not delighted.—Burmans, 64, Reigate Rd., Clapton, London, E.5. [3681]

SITUATIONS VACANT

Vacancies advertised are restricted to persons or employments excepted from the provisions of the Contract of Engagements Order, 1947.

UNION OF SOUTH AFRICA.

VACANCY-UNION OBSERVATORY, Johannesburg.

APPLICATIONS are invited for appointment on a three-year contractual basis to a post of assistant professional officer (physicist) on the establishment of the Un.on Observatory, Johannesburg.

QUALIFICATIONS: A university degree in electrical engineering (light currents) or a B.Sc. degree with physics as a major subject. The duties attaching to the post will include the maintenance of quartz crystal clocks and the development of electronic equipment in the observatory's time department. A thorough knowledge of radio physics is required.

THE salary scale applicable is £300×£25 to £600 p.a. plus a cost of living allowance which at present is £20 p.a. for married and £50 p.a. for single personnel. This allowance is subject to fluctuation from time to time.

APPLICATIONS must be made on the prescribed forms (Z.83 and P.S.C.8) which are obtainable from the Secretary, South Africa House, Trafalgar Square, London, W.C.2, to whom completed forms must be addressed so as to reach him not later than August 31st, 1949. [3802]

YOUNG Engineer-Salesman required for radio and television dept.; experience essential.—Apply Staff Manager, Bearmans, Ltd., Leytonstone, E.11. [3794]

SERVICE Engineer, preferably with experience in television, required by manufacturers.—Apply Service Manager, Masteradio, Ltd., 319, Euston Rd., N.W.1. [3797]

OPPORTUNITIES IN RADIO



Get this FREE Book! "ENGINEERING OPPORTUNITIES"

reveals how you can become technically-qualified at home for a highly-paid key-appointment in the vast Radio and Television Industry. In 176 pages of intensely interesting matter, it includes full details of our up-to-the-minute home study courses in all branches of TELEVISION and RADIO, A.M. Brit. I.R.E., A.M.I.E.E., City & Guilds, Special Television, Servicing, Sound Film Projection, Short Wave, High Frequency, and General Wireless Courses.

We definitely Guarantee "NO PASS—NO FEE"

If you're earning less than £10 a week, this enlightening book is for you. Write for your copy today. It will be sent FREE and without obligation.

BRITISH INSTITUTE OF ENGINEERING TECHNOLOGY
388b SHAKEPEARE HOUSE
17/19 STRATFORD PLACE, LONDON, W.1

THE Q5R9 HIGH PERFORMANCE AERIAL FOR BETTER TELEVISION.

Folded dipole, multielement design; executed in high duty alloy, provides wide bandwidth, high gain, low noise, and results in higher definition and longer range.

- ★ FD2. 2 Element 5 db gain, 7 lbs. weight.
- ★ FD3R. Triple reflector, for low interference.
- ★ FD3E. 3 Element long range, 7 1/2 db gain.

Also available for BIRMINGHAM frequency. EMDO LIMITED, AGE WORKS, STAINES.

RANSOM FOR RADIO VALVES

Just a selection from our Clearance Price List issued each month. List available.

SPEAKERS. P.M. 5in., 9/6; 6 1/2 in., 10/6; 8in., 14/6; 8in. with transformer, 17/-.

CONDENSERS. Cardboardpak 1 mfd. 350 v., 1/-; 2 mfd. 150 v., 6d.; 2 mfd. 350 v., 2/-; 20-20 mfd. 25 v., 1/6; 25 mfd. 50 v., 1/8; 50 mfd. 12 v., 6d.; 50 mfd. 50 v., 2/4. Aluminium Cans Standard Pak. 8 mfd. 450 v., 2/6; 8-8 mfd. 450 v., 3/4. Aluminium Case Midgetpak. 4 mfd. 450 v., 2/6; 16 mfd. 450 v., 2/3; 16-8 mfd. 450 v., 4/3; 8-8 mfd. 450 v., 3/8; 32 mfd. 350 v., 4/11. Miscellaneous. 1 mfd. 800 v., 7d.; .02 mfd. 750 v., 5d.; .02 mfd. 400 v., 3d.; .01 mfd. 1,000 v., 4d.; .001 mfd. 1,000 v., 4d.

YAXLEY TYPE SWITCHES. 2 way 4 pole, 2/4; 2 way 6 pole, 2/6; 3 way 3 pole 2 bank, 2/-; 3 way 3 pole 3 bank, 3/-; 4 way 3 pole, 3/-.

GARRARD AUTO-CHANGER A.C. TYPE RC55, plays 10in. and 12in. mixed records. £15/11/5.

EAR 'PHONES. 2,000 ohms, 7/9.

MIDGET RADIO CABINETS. 15/- each.

ENAMELLED WIRE. 4 oz. coils, 24 swg., 1/10; 26 swg., 2/-; 28 and 30 swg., 2/1; 32 and 34 swg., 2/6.

VALVES. Most types available 10,000 stocked, All new, at official B.O.T. prices. Valve list available.

34, BOND STREET, BRIGHTON.

GEE BROS. RADIO LTD.

FOR QUALITY COMPONENTS

TELEVISION 5KV E.H.T. transformer, complete tube mounting assembly with focus and deflection coils and line transformer (PEN46), all ex leading manufacturer, complete 65". Complete diagram for same, 4/6.

CONDENSER 1 mfd. 5 KWV, only 5/-.

WIRELESS SET CANADIAN 59 MARK I. Brand new, in sealed cartons. Complete with spares and descriptive booklet. This is a complete transmitter receiver with a range of from 6 to 9 mcs., 50 metres to 33.3 metres, and is continuously variable over this band. Complete £15.

MINIATURE LOUD SPEAKER, 2 1/2 in., 3 ohms. Ex personal receiver, 12/6.

MINIATURE 465 Kcs Iron-cored I.F.T.S., size 1 1/4 x 1 1/4, ex leading personal set manufacturers, 15/- pair.

EX-A.M. 16 pair line distribution boards, new and boxed, consisting of 42 standard two-way all-metal jack sockets, 22/6.

ROTARY CONVERTERS, 24 v DC Input, 230 v AC output, 100 watts, in perfect condition, 50/-.

ROTARY CONVERTERS, 24 v DC Input, 115 v. AC output, 10 amps, 800 cycles, complete with voltage current regulator. Brand new, in sealed cartons (ex Kellipsee Man. Co., U.S.A.). 55/-.

ELECTRIC LIGHT SLOT METERS, all bakelite case 230 v. AC, 10 + 20 amps, for 1d, 6d, 1/- slot. Re-conditioned. In perfect order, 55/-. Also check meters, 230 v. AC, 5 amps, 15/- 50 amp, ditto, 30/-.

TYPE 6C INDICATOR UNIT, ex-A.M., containing 3 1/2 in. electrostatic C.R. tube (VCR 135), 2 VR91, 2 EB34 valves, resistors, condensers, V-controls, etc., etc. Only 29/6.

EX-R.C.A. AMERICAN AERIAL VARIOMETERS on a large 2 1/2 in. porcelain former, brand new, in sealed cartons. Type No. 714847-501, 12/6.

HEAVY DUTY POTENTIOMETERS (WIRE WOUND). 25 watts open type on porcelain former 5K, 7/6. 15 watts totally screened 100K, 12/6. 15 watts, less screening, in 10K and 100K, 8/6.

THE JUBILEE SOLDERING IRON. 200-220 v., with swivel bit. Ideal for radio and instrument work. Only 9/11.

SANTON DP 30 amp. ROTARY SWITCH, with knob New and boxed, 7/6.

CAMERA CONTROL ELECTRICAL TYPE 35. 24 v. New and boxed. Ref. No. 14A. Price 35/-.

832 TRANSMITTING VALVES. New and boxed, 20/- each.

EXTENDABLE WHIP AERIALS. Comprising 7 sections, 2/- foot, each section 4/6. Mounting base for same, 2/6.

JUMBO V/HOLDERS. Large, 4-pin. New and boxed, 3/6.

CERAMIC INTERNATIONAL OCTAL V/HOLDERS, 1/- each.

CERAMIC B7G V/HOLDERS, 1/- each.

CONDENSERS, 600 P.F., 9-6 Kv. A.C. peak wkg., 5/-

CONDENSERS, 400 P.F., 10 Kv. A.C. peak wkg., 5/-

TEST SET, TYPE 86. Containing a 500 micro. ammeter, also neon R.F. valve housed in strong square metal case, 20/-.

ELECTRIC WATER PUMPS, 24v. AC DC. Delivering approx. 300 g.p.h. Size 1 1/2 in. x 2 1/2 in. Price 18/6.

TRANSFORMER, to operate same, 200-250 v. A.C. 21/- only.

Cash with order or C.O.D. Orders under £1. plus 1/- postage. 21d. stamp brings comprehensive catalogue.

GEE BROS. RADIO LTD.
15, Little Newport St.
LONDON, W.C.2

GER 8794

ELECTRICAL Branch, Royal Navy.

THE Admiralty announces an extension of the scheme for Short Service Commissions in the Electrical Branch of the Royal Navy to include all candidates who have had previous commissioned service in the R.N.V.R., the Army or the Royal Air Force on electrical and radio duties, and civilians who possess suitable qualifications. PERIOD of service will be five years on the Active List, to be followed by four years on the Emergency List. Officers who complete the full period of five years on the Active List will be eligible for a gratuity of £500, tax free, and, in certain conditions, pro rata for shorter periods.

AS in the previous scheme, R.N.V.R. officers will be entered in the substantive rank and with the same amount of seniority that they held at the time of their release.

FOR ex-Army and ex-Royal Air Force officers, seniority will be calculated as for former R.N.V.R. officers of relative rank.

EX-ROYAL Air Force and ex-Army candidates must be under the age of 35 on the date of entry. CIVILIAN candidates must be under 30 years of age and have obtained a degree or diploma from a recognised University in Electrical Engineering or Science, or be Graduate Members of the I.E.E. or Brit.I.R.E., or have passed such examinations as are recognised by the above-mentioned bodies as qualifications for Graduate Membership. They will be entered in the rank of Acting Sub-lieutenant (L), R.N., and promotion to the rank of Lieutenant (L), R.N., may be expected after a total of three years' service.

FOR further details application should be made to The Director of Naval Electrical Department, Admiralty, Queen Anne's Mansions, St. James' Park, London, S.W.1. [3988

NORTHERN POLYTECHNIC, Holloway, N.7.

THE Governing Body invite immediate applications for appointment as full-time Lecturer in Radio Engineering for the three-year full-time course in preparation for the Full Technological Certificate of the Institution of Electrical Engineers in Telecommunications Engineering Burnham Scale salary. Forms of application, together with full particulars, will be forwarded on receipt of a stamped addressed foolscap envelope.

R. H. CURRELL, Clerk. [4013

A LIGHT electrical engineering firm in the Midlands has vacancies in its research laboratories for work on:-

- (i) PHYSICAL chemistry.
 - (ii) ELECTRONICS engineering in all branches of the electronics field, viz.:-
 - (a) GAS discharge tubes.
 - (b) VALVE applications.
 - (c) CIRCUIT applications.
 - (d) ELECTRONIC instruments.
 - (iii) LOW frequency circuiting.
 - (iv) ELECTRO mechanical systems.
 - (v) SPEECH and audio frequency.
- APPLICANTS should preferably have an honours degree in Physics or Engineering and some experience although for some posts these qualifications are not essential.—Box M.388, Haddon's, Salisbury Sq., London, E.C.4. [4017

ELECTRONIC Engineer to control production of high-grade electronic equipment; technical qualifications to H.N.C. Standard. PRODUCTION experience of radar or electronic equipment essential.—Writing starting salary required to Box W5042, A.K. Advg., 212a, Shaftesbury Av., London, W.C.2. [3803

RADIO Mechanic with radar experience required for aircraft maintenance.—Apply C.F.1., No. 9 R.F.S., Eilers Rd., Doncaster. [3799

A QUALIFIED radio and television service engineer required.—Apply, Cyril Nicolls & Co., 28, Station Sq., Petts Wood, Kent. Orpington 2747.

ELECTRONICS engineer required by firm in South Wales for original design and development of control gear; state full particulars of experience, age and salary required, to Box 7508. [3980

RADIO and television service engineer required, must have first-class experience and clean driving licence, N.W. district, to take full charge of servicing dept.; good prospects for keen man.—Box 7143. [3806

DRAUGHTSMEN, senior and junior, for electronics, preferably with experience of reproduction work; Central London area; full particulars of age, experience and salary expected.—Box 7539. [4021

PILOT RADIO, Ltd., requires immediately fully experienced chargehands for radio and television assembly lines; five day week with good rates of pay. Apply or write to 31/37, Park Royal Rd., N.W.10. [3634

INTERESTING vacancies now exist for senior intermediate and junior draughtsmen in industrial electronic equipment with large well-known engineering company in their office near Victoria Station, London.—Please quote Ref. D6/59, and apply, giving full particulars, to Box 6780. [3645

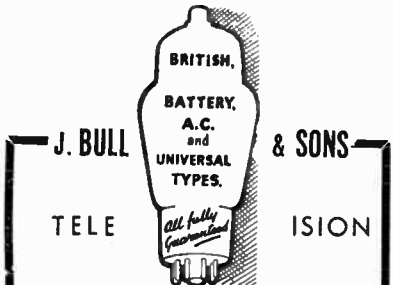

TELEVISION VALVES.—VR91 (EP50), boxed and P.T. paid, 7/6; VR92 (EA50), boxed and P.T. paid, 5/3; EBC33, 11/7; EF39, 12/10; EL33, 12/10; UCH42, UAF42, UL41, UY41, EF42, ECH42, EAF42, EB41, EL41, EL42, EZ40, E41, EC91, EA91, EOC91, EF91, EB91, EL91, EY91, and 101 more types. Order C.O.D. or remit cash with order. Lists sent.

TELEVISION COMPONENTS (To "Electronic Engineering" Specification). CHASSIS.—V.1. Vision Chassis, (td, 6 v/holders, screens, coil formers, etc., £12/6. 8.1. Sound chassis, (td, 3 v/holders, screens, coil formers, etc., 18/9. T.H.1 C. Tunc Chassis, Steel Cadmium Plated, 6 v/holders, 17/6. P1C Power Unit Chassis, Cadmium plated, (td, v/holders and sockets, £15/-. GANTRY, BRACKETS and Front Strip, Cadmium plated, 9/-. Deflector Coil Assembly, £11/0-. Line Output Transformer, £1 12/6. Focus Coil Assembly, £1 12/6. Cream coloured Rubber Television Mask, for 9in. tube, 7/4; 12in. tube, £1 1/6. Carrier for 9in. tube, 17/6. TRANSFORMERS.—5K6 EH Transformer, 5,000 v. A.C. with 2-4 v. tappings (for 12in. tube), £3 15/-. 4K6 EH Transformer, 4,000 v. A.C. with 2-4 v. tappings (for 9in. tube), £3 3/-. 2K/B EH Transformer, 1,750 v. A.C. with 2-4 v. tappings (for 6in. tube), £2 5/-. P112 Power Transformer 350-0-350 v. 250 m.a., 6.3 v. 6 amp.; 3 v. 8 amp.; 0-2-6 v. 2 amp.; 4 v. 3 amp., £4 10/0. EP46 VARLEY Power Transformer. Specification as P.T.I., £4 10/0-. W8903 VARLEY E.H.T. 1,000 v. A.C.—2 v. tapping, hermetically sealed vacuum filled, £8/7/6.

CHOKES.—DP2 VARLEY 5H, 250 m.a. 50 ohms, 18/6; DP2 VARLEY 5H, 250 m.a. 100 ohms, 17/-. Standard 10H—30 m.a. 100 ohms, 13/-. "ELECTRONIC ENGINEERING" HANDBOOKS, 2/6.

"ELECTRONIC ENGINEERING" WIRING DIAGRAMS, 3/6.

COILS.—Set of 8 permeability tuned coils and 9 RF chokes, for E/E Panels REF TELE/CC, 15/-. COIL FORMERS, with iron cores, Aladdin, per doz., 10/-.

WIRED CHASSIS.—V.2 Chassis and Components, wired and tested, £7 18/-. 8.2 Chassis and Components, wired and tested, £5 5/5; T.B.3 Chassis and Components, wired and tested (less line trans.), £8 14/2.

TELE-AERIALITE. FULL RANGE IN STOCK. In door Left Aerials, £1 15/-. DPM Dipole V/reflector mast fixing, £3 16/-. DRB Dipole w/reflector chimney lashing, £5 8/6. ALSO TVA1 Dipole, with wall bracket and arm, £1 5/-. TVB2 Dipole, with cast wall bracket and arm (de Luxe), £2 7/3; TVA3 Dipole, with chimney bracket lashing, £2; TVA5 Dipole, as above, with reflector, £3 2/2; TVA8 4 Element Hlgain Array, 3 reflectors and dipole, £4 10/0.

CO-AXIAL CABLE. Black, white or brown, 80 ohms, 1/- per yd.

TWIN SCREENED FEEDER.—Black or brown, 1/- per yd.

TWIN PARALLEL FEEDER. Polythene Aerialite Clear, 6d. per yd.

TWIN PARALLEL FEEDER.—Polythene black, 4d. per yd.

TELE-SCREEN ENLARGERS "NEW VUE" "NEW VUE" 6" A10 8" A11 10" B12 12" C14 15" D16 £3 10 0 £5 0 £5 5 0 £6 15 0 £8 0 0 Strap or Screen Fixing. Ask for Screen Guide.—A SCREEN FOR EVERY SET

VCR97 C/B Tube, Eastport, guaranteed brand new and tested for Television, 35/- + 7/6 carr. etc.; 6in. Enlarging Lens to fit, 25/- + 1/6 carr. D.C. AVO Minor, brand new condition, boxed, some shop-soiled, 55/-.

STOP PRESS.—SPORTS BINOCULARS, precision ground perfectly matched, pitch polished optical lenses, 17/6. Larger model 40/6, with lensard 42/9. TELESCOPES, 3x (4 sections) optically precision ground and polished lenses, 7/6. (Please mark Envelope W.W.)



We have been accused of being too modest about our products! Some of our customers have told us that the results obtained from our gear are very much better than they had expected from our advertisements. So perhaps we should make it known that we believe the equipment we produce to be every bit as good as, if not better in both performance and reliability than anything else on the market, and that as we have paid particular attention to simplicity of design and elimination of all unnecessary frills (of first importance in high fidelity equipment) we are able to market it at a most attractive price.

We believe that results speak for themselves, but should you wish to know more about our products a really comprehensive booklet, the IAN BAILEY BULLETIN No. 1 is being prepared and this will give performance figures, response curves, etc., of all our equipment, together with an exhaustive technical description of them and a discussion on the problems of high fidelity generally.

AMPLIFIERS, TONE CONTROL UNITS, TUNER UNITS WHISTLE FILTERS AND GRAMOPHONE EQUIPMENT, AND THE IAN BAILEY REPRODUCER SERIES II.

Incidentally we hope shortly to remove to more spacious premises in the Oxford area, but in the meantime all communications should be directed to:

ELMSLEIGH RADIO CO.

1102 London Rd., Leigh-on-Sea, Essex
Leigh-on-Sea 75168

HIGH FIDELITY REPRODUCTION

Our high fidelity equipment includes 2R.F. feeder, 8 gns., local station feeder, 5 gns., 6 watt amplifier 20-20,000 cycle response, 12 gns., 5 watt amplifier with tone control stage, £14 10s. Data sheets on request.

ELECTRO Acoustic DEVELOPMENTS
18 BROAD RD., WILLINGDON, SX.



CRYSTALS

FOR
**AIRCRAFT
MARINE
AND
AMATEUR
TRANSMITTERS**

ALL LOW TEMP. CO-EFF. CUTS.

BROOKES CRYSTALS LTD.

10, STOCKWELL ST., GREENWICH,
GRE. 1828. LONDON, S.E.10.

"ADCOLA" SOLDERING INSTRUMENTS

Reg. Trade Mark.



Designed for Wireless Assembly and Maintenance.

Working temperature reached in 1½ mins., consumption 25 watts, weight 2½ ozs. Supplied in voltage ranges from 6/7v. to 230/250v. ¼" diam. Copper Bit (standard model) 22/6. ½" diam. Copper Bit 25/-.

Replacement Unic Bit Elements available. British and Foreign patents.

Sole Manufacturers:

ADCOLA PRODUCTS LIMITED
Alliance House, Caxton Street, London, S.W.1
Write or Phone: WHI. 0030.

FERRANTI, Ltd. Moston Works, Manchester, have staff vacancies for engineers and scientists of all grades in connection with long-term development work on an important radio telecontrol project.

(i) Development Group Leaders. To take charge of large development groups. Qualifications include a good degree in physics or electrical engineering and extensive past experience in charge of development projects. Salary according to qualifications and experience in the range £1,200-£1,600 p.a.

(ii) Development Section Leaders. To take charge of sections in the above groups. Qualifications include a good degree in physics, or electrical engineering or its equivalent and previous experience in any of the following fields: Radar, radio communications, microwaves, servo control, electronic circuits, etc. Salary according to qualifications and experience in the range £750-£1,200 p.a.

(iii) Engineers and Scientists. Qualifications include a good degree in physics or electrical engineering or its equivalent and preferably some experience in the fields given in Section (ii). Salary according to age and experience in the range £400-£750 p.a.

(iv) Designers and Draughtsmen. Section leaders, draughtsmen and junior draughtsmen. Preferably with previous experience in the telecommunications or allied fields. Salaries based on A.S.E.D. rates, with allowances for special qualifications and experience.

THE company has a staff pension scheme and will give housing assistance in special cases. APPLICATIONS should be addressed to the Staff Manager, Ferranti, Ltd., Hollinwood, Lancs. [3646]

PILOT RADIO, Ltd. requires immediately experienced fitters and fitters for radio and television alignment; five day week with good rates of pay. Apply or write to 31/37, Park Royal Rd., N.W.10. [3635]

FARNHAM-FARNBORO' area. Chief of design required for small electronic devices, knowledge of printed-circuit technique and components associated with valve hearing aids essential; progressive position for man of experience. Write Box 7518. [3597]

SERVICE foreman required to take charge of well-known radio manufacturers' service dept., North Kent district; applicants must have good technical and organising ability.—First reply in writing, stating age, experience, and salary required, to Box 7225. [3815]

FOREMAN to take charge of transformer division of West Country manufacturers; experience of coil winding and assembly of transformers up to 50kva essential, and some previous executive experience desirable; give details of experience with dates to Box 6837. [3685]

PHYSICIST for work on radio and television circuitry required by large manufacturer in London area; applicants should preferably have degree in physics and experience in the above field; the position is a senior one, permanent and pension scheme is in operation.—Please reply to Box 7253. [3822]

DRAUGHTSMAN with experience in the layout and mechanical design of commercial radio and television receivers required by large company in the East London area.—Senior and junior draughtsmen with experience of this work are invited to submit full details of qualifications and experience to Box 7142. [3805]

ASSISTANT required in test laboratory in cable factory in S.E. London. Higher National Certificate standard of education expected; work involves testing of coaxial and multiple core cables at sonic and supersonic frequencies; some v.h.f. knowledge desirable; salary about £450.—Full particulars to Box 7222. [3812]

ELECTRICAL insulation varnishes.—Technologist, age 25-35, with experience in radar, radio or electrical equipment, required to specialise in insulating varnishes; will be trained for service and laboratory work based on London.—Please reply, stating age, technical qualification, and experience, to Box 7254, quoting T.V.T. [3823]

EXPERIENCED design engineer for miniature electronic equipment, such as hearing aids, VT fuses, with knowledge of modern practice, required for factory near Guildford; only those with at least five years' recent experience need apply; write, giving full details, age, etc.; application will be treated in confidence.—Box 7494. [3972]

EXPERIENCED circuit development engineers, preferable with degree in electrical engineering or physics and experience in development of radio, television and u.h.f. equipment, are required by large manufacturer in the East London area.—Kindly state full details, including age, experience, and salary required, to Box 7223. [3813]

RADIO engineer required for manufacturer's service department, North London district, education to School Certificate standard and adequate technical training essential.—Applicants should give full details of education, training, experience, age and salary required, to Box 337, c/o Era Publicity, Ltd., 7, Fitzroy Sq., London, W.1. [3937]

HIGH VOLTAGES ARE OUR BUSINESS

If you want the best in Transformers for Television, Photo-Flash, Neon Lighting, etc., why not consult us?

MILLETT & HOLDEN LTD.
BIRCHAM WORKS, BIRCHAM ROAD,
SOUTHEND-ON-SEA, ESSEX
Phone: Southend 68409

COPPER WIRE

ENAMELLED, SILK, D.C.C., etc., most sizes.

INSULATING MATERIALS. Empire cloth, leatheroid, paxolin, sleeving, etc.
MOTORS A.C. & D.C. up to 1 h.p. a speciality

Send S.A.E. for list to

STAN. HOLT,
349, HIGH ST. SMETHWICK, STAFFS.
Telephone: WOODGATE 3789

TELEVISION

Complete set of coils for The "Electronic Engineering" Telescor. Video and Heater Chokes Included. All Boxed and Marked. 13/- post free. (Cash with order).

The Holden Ferrule Co. Ltd.,
Quaker Street, London E.1.

VIBRATORPACK POWER SUPPLY UNITS

Famous British make. Steel case approx. 8½ins. long, 4½ins. wide, 5½ins. high. Input 6 volts. Output 250 volts 70 mA. (conservative rating). Non-sync. Vibrator, OZ4 Rectifier, massive power Transformer, elaborate smoothing and filtering circuit, both H.T. and L.T. filtered. Limited quantity available at 25/- each, post paid. Immediate despatch.

WIRELESS SUPPLIES UNLIMITED,
264-266, Old Christchurch Road,
BOURNEMOUTH, Hants.

HIGH "Q" IRON CORED COILS

of Unsurpassed Quality for Discerning Amateurs

AERIAL, H.F. OR OSCILLATOR, short, medium or long wave, size of former 1in. x 1in., 3/9 each.

INPUT FILTER, 465 Kc/s., parallel or series tuned, 3/9 each.

DUAL WAVE COILS, medium and long wave aerial and h.f., 9/6 pair.

I.F. TRANSFORMERS, standard, 465 Kc/s., permeability tuned, size 1½in. square x 3½in. high, 3/6 each.

All coils fitted with adjustable iron cores, and supplied with circuit diagram.

TERMS: Cash with order or C.O.D. on orders over £1. TRADE ENQUIRIES INVITED.

MONOCHORD RADIO
(Established 1929)
125, Mitcham Lane, Streatham, London, S.W.16.
Phone: Streatham 5495.

L-R-S FOR
PROMPT & EFFICIENT SERVICE
CASH OR EASY TERMS

ARMSTRONG ALL-WAVE CHASSIS

Various Models Available

GOODMAN'S "Axiom Twelve" Speaker Unit

Cash price £8 8 0

GOODMAN'S Standard 12" Speaker

Cash price £6 15 0

GOODSELL-WILLIAMSON HIGH FIDELITY AMPLIFIERS

A. C. BARKER'S New 148A Speaker
(See Advertisement p. 58)

COLLARO Radiogram Units—various models
AVO METERS—All models available.

PEERLESS RADIOGRAM CHASSIS

Specification of all the above on request.

When you purchase Radio Apparatus on L.R.S. Convenient Terms you deal directly with us from beginning to end, with no financial firm or other third party intervening. We shall be glad to quote for your requirements without obligation to purchase.

PERSONAL ATTENTION TO ALL ENQUIRIES

The LONDON RADIO SUPPLY CO.

Est. 1925

BALCOMBE, SUSSEX

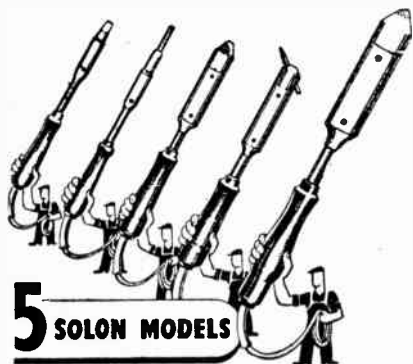

5 SOLON MODELS

SOLON electric soldering irons have proved their capacity for continuous service under the most exacting conditions. 5 models; 240 watt oval tapered bit; 125 watt oval tapered and round pencil bits and 65 watt oval tapered and round pencil bits. Each model complete with 6 feet of Henley 3-core flexible. Now available from stock. Write for folder Y.10.

HENLEY SOLON
ELECTRIC
SOLDERING IRONS

W. T. HENLEY'S TELEGRAPH WORKS CO. LTD.
61-63 Hatton Garden, London, E.C.1

SERVICE-REPAIR clerk for radio and sound equipment manufacturers near Guildford; able to organise service and installation crews; weekly routes, maintain vehicle records, deal with customers' service correspondence and 'phone calls, etc.; only those with previous experience in radio need apply; write full details, age, etc.—Box 7493. [3971]

VACANCIES occur for marine radar servicing engineers at home and abroad; applicants should have held at least senior N.C.O. radar mechanic rank during the war, and be capable of fault finding on their own; applicants must be prepared to travel as required; state whether single or married, age, home address, and all qualifications.—Box 7490. [3954]

RADIO-ELECTRONICS technician required by Boots Pure Drug Co., Ltd., Nottingham, for their plant laboratory with ability to construct, service and trace faults in industrial electronic equipment such as pH meters, d.c. and a.c. amplifiers and R.F. generators.—Applications, stating salary required, to Personnel Manager, Station St., Nottingham. [3671]

DESIGN draughtsman required for the design of electronic apparatus and light electro-mechanical mechanisms for instrumentation laboratory of a West London area engine manufacturer; previous experience in electrical, giving full details education, qualifications, experience, and salary required, to Box A.C.590, c/o Central News, 17, Moorgate, London, E.C.2. [3807]

MOTOR designer required to take charge of a F.H.P. electric motor design laboratory of a firm in the Home Counties, manufacturing industrial induction motors and domestic equipment; applicants should have an electrical degree or equivalent qualifications and works experience; salary £600 to £800 p.a. to commence.—Apply with details of age, education and experience to Box 7543. [4023]

OSCILLOGRAPH sales engineer required for increased sales of well established new type instrument, good technical knowledge essential, coupled with good appearance and personality; all areas of U.K. operating from London Head Office; reply, stating qualifications, experience and salary required; no commission; own car an asset.—Write Box W5222, A.K. Adv., 212A, Shaftesbury Ave., London, W.C.2. [4014]

REQUIRED by large manufacturer of communications equipment near London, an experienced designer of r.f. inductances and audio and power transformers, to take charge of development and production of prototype components of this type for high-grade communication equipment; engineers having experience of either r.f. or audio components will be considered.—Kindly state full details to Box 7224. [3814]

ENGINEER required for the development of electrical test equipment, large engineering company, West London area; Higher National Certificate (Electrical) essential; good practical training with preferably an engineering apprenticeship and a knowledge of electronic test equipment; good prospects for young man.—Write, giving age and details of experience, to Employment Officer, Hoover, Ltd., Perivale, Greenford, Middx. [3961]

BRITISH INSULATED CABLES' S CALLENDER'S Cables, Ltd., require a physicist for the development of sound recording media; candidates should be experienced in physical, electromagnetic and electroacoustic measurements and be capable of carrying out development work on own initiative; permanent position; salary according to age and qualifications.—Apply in writing to Staff Officer, B.I.C.C., Ltd., Prescott, Lancs. [3941]

REQUIRED, chief engineer (for mechanical design) by a firm in the London area specialising in radio, electrical appliances and allied products; responsibilities to include the complete control of the designs dept., production d.o., and model shop.—Applicants, who must be fully qualified draughtsmen-engineers and have had several years' experience in a similar position, should write in confidence, stating qualifications, experience, age, etc., to Box 7257. [3926]

SENIOR research engineers required by firm in London area; required on work on v.h.f. radio communication projects, and special electronic instruments; applicants should have good qualifications and industrial experience; extremely good positions offered to keen men with ideas and to develop equipment to the stage of production.—Write in confidence, stating age, full details of qualifications, experience, and salary required, to Chief Engineer, Box 7308. [3930]

TECHNICAL assistant (young) required in "The Wireless Trader" laboratory, to assist with and eventually take over preparation of radio servicing information; must be conversant with commercial radio and television practice, able to convert circuit diagrams to conform to a standard style, and explain technical matters clearly in writing; sound, technical knowledge essential; applications in writing only, stating age and salary required, should be addressed to the Technical Editor, "The Wireless Trader," Dorset House, Stamford St., London, S.E.1. [3976]



SPECIAL AUGUST CLEARANCE

RADAR RECEIVER TYPE 3034A. BRAND NEW AND UNUSED IN MAKER'S ORIGINAL WOOD TRANSIT CASE. Specifications: 14 brand new valves, 7 EF50, 2 VR136, 1 VR137. Dozens of useful components, including 80-volt A/C motor used for aerial switching, front panel tuning control, etc. With little modification this unit will make an ideal 2-metre receiver. Also suitable for television conversion. Totally enclosed in metal case, size 19in. x 8 1/2in. x 7 1/2in. Weight when packed, 40 lbs. We will exchange the 2 VR136's for 2 EF50's if so required.
LASKY'S PRICE 59/6. Carriage 5/- extra.

Television Constructors Buy Now and Save Money.
R.F. UNITS FOR USE WITH THE 1355 RECEIVER. BRAND NEW AND UNUSED, IN MAKER'S CARTONS. TYPE 25. Frequency range covers the sound and vision channel of Alexandra Palace without modification. Supplied complete with 3 new valves.
LASKY'S PRICE 19/6. Postage 1/6 extra.

TYPE 28. Frequency 65-50 Mc/s. This covers the new Sutton Colfield vision and sound channel without modification. Complete with valves, Muirhead slow motion drive and dial etc.
LASKY'S PRICE 32/6. Postage 1/6 extra.

TYPE 24. Frequency 30-26 Mc/s. Complete with valves, switch tuning, etc.
LASKY'S PRICE 15/-. Postage 1/6 extra.

TYPE 24 units as above only used. Price 8/6 each, postage 1/6 extra.
EX-A.M. RECEIVER, TYPE 1355. Containing 11 valves: 8 VR65, 1 5U4G, 1 VU120, 1 EA50. Incorporated in this unit is a 7.7 Mc/s I.F. strip. **THIS RECEIVER IS IDEAL FOR TELEVISION CONVERSION.**
LASKY'S PRICE 35/-. Carriage 5/- extra.

Full data book available, giving full details for converting the 1355 to television reception. Circuits, time base, etc., all are given. **PRICE ONLY 1/6** per copy.

SPECIAL MAINS TRANSFORMER FOR THE 1355 RECEIVER. (As specified in the Inexpensive Television data book No. 2.) Primary, 200/250 volts 50 c.p.s.; Secondary, 250.0-250 volts 80 mA; Filament windings, 6.3 volts 6 amps, 5 volts 2 amps.
LASKY'S PRICE 27/6. Postage 1/6 extra.

INDICATOR UNIT, Type 62. Contains 20 valves and a 6in. cathode ray tube type VCR97 (short persistence). Valve line up: 16 8P61, 2 EA50, 2 EB34. Dozens of other components, resistances, condensers, coils, crystal, 16 pot/meters, etc. Totally enclosed in metal cabinet, size 18in. x 9 1/2in. x 11in. Weight 40 lbs., enamelled black with coloured control knobs.
LASKY'S PRICE 59/6. Carriage 7/6 extra.

The type 62 indicator as above, but with brand new and unused VCR97.
LASKY'S PRICE 79/6. Carriage 7/6 extra.

BRAND NEW AND UNUSED, EX-GOVERNMENT CATHODE RAY TUBES. Type VCR97, 6in. short persistence. Each tube is fully guaranteed and is tested before despatch. Contained in specially sprung wood transit case. Characteristics: heater, 4 volts 1 amp; H.T., 2,500 volts maximum.
LASKY'S PRICE 35/-. Carriage 7/6 extra.

E.H.T. TRANSFORMER for the VCR97 CATHODE RAY TUBE. Specifications: Primary, 200/250 volts 50 c.p.s.; Secondary, 2,500 volts 4 mA; 4 volts 1.1 amp; 4 volts (C.T.) 1.5 amps.
LASKY'S PRICE 35/-. Post 1/6 extra.

WAVE FORM GENERATORS Type 34. Brand new in maker's cartons. Containing 6 brand new valves: 1 VR55, 3 VR56, 2 EB34. Hundreds of resistances, condensers, 2 relays, pot/meters, pye plugs, etc. Built on strong metal chassis, size 11 1/2in. wide x 10in. long, 7 1/2in. deep. Weight when packed 35 lbs.
LASKY'S PRICE 12/6. Carriage 3/6 extra.

The wave form generators as above, but with 7 8P61 valves, making 13 valves in all.
LASKY'S PRICE 25/-. Carriage 4/6 extra.

A 2jd. stamp and your name and address (block capitals, please) will bring you our monthly Bulletin of ex-Government bargains by return mail. Our keen prices will save you money.

LASKY'S RADIO

370 HARROW ROAD, PADDINGTON, LONDON, W.9.
(Opp. Paddington Hospital)

Telephone: CUNNINGHAM 1979.
Hours: Mon.-Sat., 9.30 a.m. to 6 p.m. Thurs. Half-day.

SUPACOILS

OFFER

Model 30 Coil Pack.—The 3-waveband superhet pack with adjustable iron cored coils and trimmers for absolute accuracy in padding and tracking. This pack is gaining more and more favour among experienced engineers and amateurs for its sound design, high quality workmanship and high sensitivity and selectivity. 21/- or 24/- fully aligned.

Model 40 Coil Pack.—Similar to the Model 30 but with RF stage. 42/- or 47/- fully aligned.

Model 30 Tuning Unit.—This is now one of the most popular units for easy and efficient superhet construction. It consists of a Model 30 coil pack, pair "MM" I.F. transformers, 2-gang condenser and attractive dial. Components are 48/6 aligned together as a unit in an actual receiver, and sealed. No further alignment is required.

Model 40 Tuning Unit.—Similar to above with provision for R.F. stage 76/9 FREE. A Free Copy of the enormously successful HOME CONSTRUCTOR'S HANDBOOK will be given to every purchaser. Or a copy can be obtained for 1/- from

SUPACOILS (Mail Order Office)
98, Greenway Avenue London, E.17

CHIEF Engineer required to take charge of design and development for company manufacturing electrical measuring instruments and industrial radio and electronic test equipment; excellent position and prospects for man with suitable experience.—Write giving full particulars of technical qualifications, experience and salary required to Box 7487. [3801]

A PPLICATIONS are invited for the post of radar engineer to specialise in marine installations; applicants should have either held a commission as Radar Officer during the war or been actively engaged on radar development in industry; the post calls for energy, willingness to travel, and ability to handle installations and repairs in a capable manner. W. H. SMITH & Co. Elec. Eng., Ltd., Praed Rd., Trafford Park, Manchester. [3955]

R EQUIRED, general works manager by a company engaged in the light electro-chemical engineering industry for a factory situated in the North of England; applicants must be first-class practical engineers, with wide administrative and organising experience, capable of taking full control of a mass production factory under direction of the Board, and only those who have held a position in a similar field, and who are fully qualified engineers, should apply; housing problem is not an insurmountable one.—Write in confidence, stating qualifications, experience, age, etc., to Box 7256. [3825]

E NGLISH ELECTRIC invite applications from mechanical and electrical draughtsmen for vacancies which exist on aircraft, gas turbines, steam turbines, water turbines, switchgear, transformers, a.c. and d.c. machines, electronic and telecommunication equipment; vacancies exist in various parts of the country; stable employment, good conditions; please state salary required, type of engineering equipment in which you are interested, and any preferences regarding location.—Apply, quoting Ref. D.O.62, to Central Personnel Services, English Electric Company, 24-30, Gillingham St., Westminster, London, S.W.1. [3933]

CHIEF Inspector required by the component division of the Plessey company; applicants must have predominantly electrical training, comprehensive knowledge of radio components and allied electrical equipment, and must have adequate technical knowledge; to a man between the age of 30 and 45 years, having the above experience and having controlled a large inspection staff the company offers a senior and permanent position with excellent prospects.—Written applications only, stating full details including age and salary required, should be made to the Personnel Manager, The Plessey Company Ltd., Ilford, Essex. [4018]

CHIEF radio engineer designer, manager production, draughtsmen, general manager, senior and junior draughtsmen, also women tracers, senior test engineer transmitters and receivers, development engineers for radio, radar, electronics, quartz Z crystals, speakers, magstrip uses; service engineers, P.A., radio, also television and radar (home and abroad); wiremen (skilled and semi-skilled); radar instruments, prototype radio, deaf aid; h.f. repairers; planning, production engineers, ratifiers, process chemists for electro-chemical process N. England; also other positions vacant.—Consult, Technical Employment Agency, 179, Clapham Rd., S.W.9 (Brixton 3487). [3966]

SITUATIONS WANTED
WORKS manager, 39, B.Sc. (Eng.), A.M.I.E.E., with experience in well-known companies covering the manufacture of both radio equipment and electrical components.—Box 7486. [3799]

TELECOMM. engineer, 27, extensive experience (P.O. and Army) O.N.C., 15 C. & G.s. finals in radio, transmission, telegraphy, Assoc. I.R.E. requires responsible experience, development and installations.—Box 7492. [3967]

BUSINESSES FOR SALE AND WANTED
RADIO, electrical, television sales service, prominent West-end location, living accommodation; complete with stock; £2,100.—Box 6833. [3673]

BUSINESS for sale owing to removal, in Croydon area; equipped for transformer rewinding, etc.; £250; machines and stock at value.—Tel. Lib. 7461. [4020]

RADIO, television and electrical business for sale, main thoroughfare in S.W.3, 18 years lease, whole house and shop, low rent, accommodation possible for buyer; price, £3,500, s.a.v.—Apply Box 7517. [3999]

OLD-ESTABLISHED and prosperous wireless training college for sale as a going concern; owner going abroad to retire.—Interested parties (principals only please) should write Glovers, 30, Bouverie St., E.C.4. [3973]

THE principal of an old-established wireless telegraphy school is retiring and will consider selling the business to a man of initiative; applicants for further information should possess the P.M.G. 1st or 2nd Class Certificate; other qualifications will be an advantage.—Write, Box 7506. [3828]

YOUR METER DAMAGED ?



Leading Electrical Instrument Repairers to the Industry.

Repairs by skilled craftsmen to all makes and types of Voltmeters, Ammeters, Microammeters, Multirange Test meters, Electrical Thermometers, Recording Instruments, Synchronous Clocks, etc. 14 days' Service—for speedy estimate send defective instrument by registered post to:

L. GLASER
SCIENTIFIC & ELECTRICAL INSTRUMENT REPAIRERS
341 CITY ROAD, E.C.1
Tel. Terminus 2489

"PERIMET" ELECTRODE
Soldering and Brazing Tool
Operates from 4 or 6 Volt Accumulator or Transformer

1 1/2 ft. Post free
MAINS TRANSFORMER, 3 Heats. 35s. Post free
HOLBOROW & CO.,
71, Weymouth Bay Avenue, Weymouth.

ELECTRONIC & ELECTRO-MECHANICAL EQUIPMENT
developed for Industrial applications.
Reasonable charges.

SPENCER-WEST
QUAY WORKS, Gt. YARMOUTH

RADIO UNLIMITED
OFFER
Exceptional bargains in radiogram equipment
A.E.P. Radiogram Chassis. A/C mains, 5 valve superhet. Large attractive dial in Red. Gold and Black. Volume, Tone, Gram switching, etc. Complete with 10in. P.M. speaker. Price, inc. tax, 12 Gns. Carriage paid.
Denco. 5 waveband chassis. 5 valve plus Magic eye. Complete with 10in. P.M. speaker. Price, inc. tax, 15 Gns., carriage paid.
ALSO
Single and Auto/change Gram motors, Amplifiers, Speakers, Valves, etc.
New catalogue now ready. 1d. stamp please.
Kindly note—We have moved from 16, Carnarvon Road, Leyton, to—
ELM ROAD, WALTHAMSTOW
LONDON, E.17.

PRECISION TEST EQUIPMENT
SIGNAL GENERATOR TYPE TF-144c. By Marconi Instruments. 80 Kcs to 25 Mcs. As new and guaranteed. £75
SIGNAL GENERATOR TYPE 52a. By Gossor. Frequency range 5 to 62 Mcs. Modulation either sine or pulse. Prov. for Ex. mod. R.F. output variable from 1uV. to 100mV. Complete with all accessories in transit case. New £28
SIGNAL GENERATOR TYPE I-222-A. Made for the U.S. navy. Two frequency ranges, 8-15 Mcs. and 150-230 Mcs. Provision is made for internal crystal calibration. R.F. output variable from 1uV. to 100 mV. As new £27
CRYSTAL OVENS. ADMIR. PATTERN 3190. For precision frequency control of quartz crystals. (See April advertisement). New £4/17/6.
Also "VARIACS," Attenuators etc. Send for lists. Carriage is extra on all the above.

PIKE BROS.
86 MILL LANE, LONDON, N.W.6
Telephone: HAMPSTEAD 4219

VOIGT PATENTS LTD.
15 SILVERDALE S.E.26
Town and Country PLANNING!

P.S. Mr. Voigt is slowly recovering his health. Re service, please await further announcement.

YOU SHOULD HAVE A NEW TAYLOR

We can supply the latest Taylor Test-Equipment, and take your used Equipment in part exchange. Balance by cash or hire purchase.
Write, phone or send your gear along for inspection and offer.

UNIVERSITY RADIO LTD.
22 LISLE ST. Tel. GERRARD 4447 & 3582

OUR 1949/50 R.49
RADIO and TELEVISION COMPONENT CATALOGUE
is NOW READY
Send 6d. in stamps for this super catalogue. Details of thousands of 1st Grade Branded Makes of components and resistor colour code, etc., send now
COVENTRY RADIO
DUNSTABLE ROAD, LUTON, BEDS.



PLANNING 1949-50

Have your equipment overhauled during the summer months in readiness for the **PROMS & WINTER SEASON**

or
Let us advise you on bringing your equipment up-to-date

Send for leaflets

"The Laboratory Production Unit"
THE LOWTHER MANUFACTURING CO.

Lowther House, St. Mark's Road,
Bromley, Kent

Rav. 5225

THE HEART OF A FIRST-CLASS RADIO-GRAM

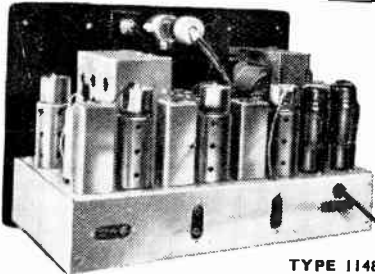

TYPE 1148
Radio-gram Chassis

Developed from the popular type 1047, this receiver will form the basis for a Radio-gram of unsurpassed performance, and at great saving in cost. Principal features include:
12 stage superhet circuit • 11 valves with magic eye indicator • 4 wavebands (11-2,000 metres)
• R.F. Amplifier • 2 I.F. stages • 4 stages AVC • 10 watts push-pull output • Separate treble and bass controls • Tropicalised components.
Other Peerless equipment of interest to the enthusiast includes: 10-valve Communications Receiver Type 1546 • R/F Feeder Unit (comprising R/F portion of Type 1148 Receiver) • A/F Unit and Power Pack Type 1. All details on request.

PEERLESS RADIO LIMITED
374 KENSINGTON HIGH STREET, LONDON W.14

Telephone: WEStern 1221

S. KENSINGTON.—Well established and flourishing retail radio and electrical contracting business for sale, in busy position close to S. Kensington Stn., double-fronted shop with office, spacious basement fitted with storage rack and work-bench, cloakroom, etc., lease 5 years with option of further 21 years; price, including stock, equipment, contracts, etc., at bargain price of £2,000 or near offer.—Apply, Stone, Martin & Jackson, 27, Thurloe St., S.W.7. Ken. 2137. 4669 and 9776. [4006]

BUSINESS OPPORTUNITIES

RADIO service partner wishes to dispose of his share in radio and electrical business, W. London.—Box 7507. [3978]

REPUTABLE electrical wholesale distributors and exporters well represented throughout the U.K. and overseas require additional attractive lines.—Write in confidence to Box 7366. [3940]

AGENTS WANTED

TECHNICAL sales representative for several sealed territories in the U.K. for the sale of public address and internal communicator equipment; only men with proved qualifications in this field need apply; car essential; salary, commission, expenses.—Box 7305. [3827]

TECHNICAL TRAINING

A.M.I.E.E. City and Guilds etc. on "No Pass—No Fee" terms; over 95% successes; for full details of modern courses in all branches of electrical technology send for our 112-page handbook, free and post free.—B.I.E.T. (Dept. 388A), 17, Stratford Place, London, W.1. [6270]

TUITION

THE British National Radio School OFFERS you a career. WRITE to-day for free booklet describing our wide range of training courses in radio, Radar, telecommunications, principles, mathematics, physics, and mechanics, correspondence and day classes for the new series of C. & G. examinations; we specialise in turning "operator" into "engineers," and for this purpose our "Four Year Plan" (leading to A.M.I.E.E. and A.M.Brit.I.R.E., with 9 C. & G. Certificates as interim rewards) unsurpassed; our "Guarantee has no strings attached."—Studies Director, B.Sc., A.M.I.E.E., M.Brit.I.R.E., 66, Addison Rd., Croydon, Surrey. [6811]

WIRELESS officer's attendance and postal courses.—Wireless Sch., Manor Gdns., N.7.

RADIO training—P.M.G. exams, and I.E.E. Diploma; prospectus free.—Technical College, Hull. [0611]

WIRELESS (sea and air) television, broadcasting, radar, etc., offer tremendous opportunities; students both sexes, age 14 upwards, trained for appointments in all branches of radio; low fees, boarders accepted; 2d stamp for pros.—Wireless College, Colwyn Bay. [3960]

A.M.I.Mech.E., A.M.I.E.E., City and Guilds, etc. on "No Pass—No Fee" terms, over 95% successes; for details of exams and courses in all branches of engineering, building, etc., write for 108-page handbook—free.—B.I.E.T. (Dept. 287B), 17, Stratford Place, London W.1.

TELEVISION postal course for radio trades Examination Board's diploma, also postal courses for P.M.G. 2nd and 1st class Certificates and Amateur Radio Transmitting licence.—Apply British School of Telegraphy Ltd., 179, Clapham Rd., London, S.W.3. (40 years' experience in coaching students in wireless telegraphy and allied subjects.) [2586]

RADIO ENGINEERING SCHOOL. Air Service Training, Hamble, Southampton, provides the best full-time training for responsible positions in industry or aviation; students coached for C. & G. Inter. and Final Certs. in radio- or tele-communications; Graduateship of Brit. I.R.E., M.C.A., radio engineer licence, and for air and marine radio officers' licences; full details from the Commandant. [2260]

EARN more. Write for free booklet showing how you can be trained for a variety of well-paid technical careers. Both postal and attendance courses are available covering such subjects as television, elementary and advanced radio theory and practice, mathematics, electronics in industry, etc.—Free booklet from E.M.I. Institutes, Dept. W.W., 43, Grove Park Rd., Chiswick, London, W.4. Tel. Chiswick 4417-8. [3993]

TELEVISION.—The Gothic Television School specialises solely in training in television. All tutors possess university degrees and/or corporate membership of professional institutions and are appointed individually to postal course students to ensure complete and thorough training; principals, M.B.E., B.Sc., M.Brit.I.R.E., education committee members, etc.; courses assume no previous television knowledge and provide guaranteed training for Brit. I.R.E. and R.T.E.B. examinations, numerous well known companies have adopted the school's basic television course as standard television training for their staffs; moderate fees.—Details from Gothic Television School, 13, North Ave., London, W.13. [3639]



*** Use Denco "MAXI Q" COILS** High "Q," with miniature size. There is one for all wavebands from 3.6 to 2,000 metres. Wound with Litz on Polystyrene. Formers with adjustable Iron Dust Cores—Aerial, H.F., or Oscillator types available, 465 K/C or 1.6 m.c. Prices—Chassis Mtg., 3/9 (with React., 4/9), or Pin Base type, fits Octal Valve Holder, 4/- (with React., 5/-).

THE NEW DENCO TELEVISION KIT OF PARTS

- * The Kit with a Name Behind it.
- * Acclaimed by Amateur Constructors for its simplicity in assembly and outstandingly clear picture definition.
- * Employs recently developed circuit and components including line fly-back EHT/output transformer unit, ready assembled. Vision section has 3 RF stages, Detector, Noise Limiter and Video Amplifier.
- * Suitable for use at all distances within the service area of the station.
- * The new miniature high slope B7G pentode valves are used in RF and video stages, etc. A total of 17 valves.
- * Circuit, layout and instructional data supplied with each Kit.
- * All valves and CRT, Drilled Chassis, etc., are included (Loudspeaker and O.P. Transformer excluded). Price complete, £36 (P. Tax £8/11/-).
- * A similar Kit to the above incorporating a 12in. C.R.T. is available at an additional cost of approx. £4/6/-.
- The following units will be available for sale separately, each complete with Circuits, Layout and Instructional Data:
 - * DTE3RF. Outfit consisting of all components, valves and 9in. C.R.T. for vision and sound sections up to the detector stages, including drilled sub-chassis. Price—£14/15/-. Tax on Valves, etc., £3/16/7.
 - * DTK3TE. A similar outfit for time base circuits including ready assembled fly-back EHT, video amp., sync. separator, deflector and focus assemblies and main chassis. Price—£15/5/-. (Tax on Valves, 19/9).
 - * DTK3FS. Complete Power supply outfit (excluding EHT which is part of line output circuit), consisting of all components and rectifier valve; output 310 v. 225 M/a. and 6.3 v. 7 a. (rect. heater winding also). Price—£6/7/6. Tax on Valve, 3/3.

COILS Matched pair Midget T.R.F. for Medium and Long Waves, 6/6.

Other available Denco Products are listed in a most comprehensive and detailed Catalogue. Price 9d.

EXPORT AND TRADE ENQUIRIES INVITED.

DENCO DISTRIBUTORS LTD.,
115, FLEET STREET, E.C.4.

Tele. CENTral 5814 and 2280.

MUMETAL and RADIOMETAL TRANSFORMERS and CHOKES

As Specialists with many years of experience we can design and supply practically any type of transformer or choke with a nickel-iron core for use on a band within the frequency range

1 c/s to 150 kc/s

Available for rapid delivery—Microphone Transformers, Input Transformers, Line Transformers, Pickup Transformers, Output Transformers, Rectifier Transformers, Vibrator Transformers, High Fidelity Transformers, Recorder Transformers, Midget Transformers, High Q Chokes, High Inductance Chokes, etc., with or without Mumetal Shields.

MAINS COMPONENTS ARE ALSO STOCKED.

SOWTER TRANSFORMERS
E. A SOWTER, 1-B HEAD STREET, COLCHESTER.

Phone: COLCHESTER 5469.



QUARTZ CRYSTAL UNITS

For—
**AIRCRAFT, MARINE AND
COMMERCIAL USE** are available in
the complete range from 35 kilo-
cycles to 15 megacycles.

Alternative mountings in standard
two-pin A.M. pattern 10X, International
octal, and miniature type FT243, can be
supplied for most frequencies.

Prices are fully competitive, and
we specialise in prompt deliveries for
urgent requirements.

WE WELCOME YOUR ENQUIRIES.
THE QUARTZ CRYSTAL Co., Ltd.
63-71 Kingston Road,
NEW MALDEN, SURREY
Telephone: MALden 0334

THE COIL PICK-UP

will give you real music when
you tire of the blare from the fair.

WILKINS & WRIGHT, LTD.,
Holyhead Road, Birmingham, 21.

B. T. S.

THE Radio firm of the South,
63 London Road, Brighton, 1, Sussex.
Phone: Brighton 1555

SPEAKERS BRAND NEW

Goodman's, Truvox, Rola (as available).
5 inch 13/-; 6 inch 14/-; 8 inch 16/-
including packing and postage.

EDDYSTONE RECEIVERS

Full range of components.
All C.O.D. orders promptly executed.
Send for Catalogue, 1/- post free.



Multiple Contact
Relay L.F.

RELAYS

for A.C. and D.C.
2 VA Coil consump-
tion from 2 to 600
volts and tested to
2,000 volts, Aerial
Change-over Relays,
Mercury Relays,
Measuring Relays and
Time Delay Relays.

Ask for leaflets
RE/JWW

LONDEX LTD.

Manufacturers of Relays
507 Anerley Road, London, S.E.20. 8YDenham 6258

THE Institute of Practical Radio Engineers
have available Home Study Courses in
every phase of radio and television engineer-
ing, specialising in the practical training of
apprentices in the retail trade; enrolments
limited, fees moderate.—The Syllabus of In-
structional Text may be obtained post free from
the Secretary, I.P.R.E., Fairfield House, 20,
Fairfield Rd., Crouch End, London, N.8. T1614

BOOKS INSTRUCTIONS, ETC.

"HOME Constructors' Handbook," the latest
edition of this famous handbook contain-
ing circuits, radio constructional and servicing
hints and complete catalogue, is now available at
only 1/-, mail order only.
SUPACOILS, 98, Greenway Ave., London, E.17.
[3779]

WEBB'S 1948 radio map of world, new multi-
colour printing, with up-to-date call signs
and fresh information on heavy art paper, 4/6,
post 6d; on linen on rollers, 11/6, post 9/-
Webb's Radio, 1-4, Soho St., W.1. Gerrard 2089.

MORSE CODE TRAINING



There are Candler
Morse Code Courses
for
**BEGINNERS AND
OPERATORS**

Send for this Free
"BOOK OF FACTS"

It gives full details con-
cerning all Courses.

THE CANDLER SYSTEM CO.
(Room 55W), 121 Kingsway, London, W.C.2
Candler System Co., Denver, Colorado, U.S.A.

TELEVISION RECEIVERS SCANNING and FOCUS COILS TIME BASE COMPONENTS 7KV. EHT. RF. UNITS and TRANSFORMERS



Publications post free
HAYNES RADIO LTD.
Queensway, Enfield.

LOCKWOOD

makers of

Fine Cabinets

and woodwork of every descrip-
tion for the Radio and allied trades

LOCKWOOD & COMPANY
Lowlands Road, Harrow, Middlesex. Byron 3704

POST RADIO SUPPLIES

OFFER EX STOCK

COPPER INSTRUMENT WIRE.
ENAMELLED, TINNED, LITZ,
COTTON AND SILK COVERED.
Most gauges available.

B.A. SCREWS, NUTS, WASHERS,
soldering tags, eyelets and rivets,
EBONITE AND BAKELITE PANELS,
TUFNOL ROD, PAXOLIN TYPE COIL
FORMERS AND TUBES, ALL DIAMETERS.

Latest Radio Publications.

Send stamped addressed envelope for com-
prehensive lists. Trade supplied.

POST RADIO SUPPLIES

33 Bourne Gardens, London E.4.
Phone: CLIssold 4688

GOODSELL LTD.,

40 Gardner Street, Brighton.

send for:—

Our Illustrated Brochure. Free on request
"Brimar Valve Manual 1949." 3/- post 3d.
"Loudspeakers" by G. A. Briggs 5/- post 3d.
"Partridge Manual" 5/- post 3d.

BRASS, COPPER, DURAL, ALUMINIUM, BRONZE

ROD, BAR, SHEET TUBE, STRIP WIRE.

3,000 STANDARD STOCK SIZES

No Quantity too Small List on application

London: **H. ROLLET & Co., Ltd.** Liverpool:
6, Chesbam Place, S.W.1. Kirkby Estate,
SLOane 3463 SIMONSWOOD 3271/3

A BIT OF SCREWY BUSINESS!

When you need screws, nuts, tags,
washers, rivets, etc., consult:—

HAROLD KING

"The Chestnuts," Crays Hill, Billericay, Essex

Send S.A.E. for lists

Large "PK" screws 4/6 per gross

RADIO BATTERY TESTER

Use "Quixo" method
of battery testing.

Reliable results. Guaranteed.

Send for interesting leaflet
K115 on battery testing.



RUNBAKEN • MANCHESTER

THE NORTHERN POLYTECHNIC HOLLOWAY ROAD, N.7.

Principal: T. J. DRAKELEY D.Sc., Ph. D.
F.R.I.C., F.I.R.I.

Department of Radio and Musical
Instrument Technology.

Head of Department:
S. A. Hurren, M.C., M.Brit.I.R.E.

Full-time Day Courses in

TELECOMMUNICATIONS ENGINEERING

in preparation for all
recognised qualifications in this subject.
Practical laboratory and workshop
experience provided.

Prospectus free on application to Secre-
tary. New term begins September 26th.

• Radiospares •
Quality Parts

THE
SERVICE ENGINEER'S
FIRST CHOICE

Technical Excellence

combines with beauty and soundness of DESIGN in the

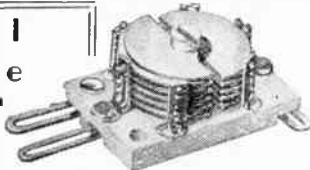

OXLEY
DIFFERENTIAL AIR DIELECTRIC TRIMMER

★ Width: 16.5 mm Length: 25 mm
Height:
1.5 to 8pF—8 mm
1.8 to 20pF—10.5 mm
2 to 26pF—11.5 mm
2 to 32pF—12.5 mm
Law: Straight line capacity
Power Factor: Less than .001
Insulation: Over 2,000 megohms
Voltage: 500 D.C.

OXLEY DEVELOPMENTS CO., LTD.,
ULVERSTON, N. LANCS. TEL. ULVERSTON 3304

KERSHAW'S KORNER KALLING SPECIAL!!!
M.O.S. LINES
TELESONIC RECEIVERS, brand new, complete with four 1.5 v. Hivac Midget valves ideal for making your own personal portable 32/6 each. Post paid.
INERT 1.5 v. CELL BATTERIES, long life, fill with plain water and have continuous use. Ideal for every purpose. 3 for 2/6. Post paid.
MAKE YOUR OWN CRYSTAL SET, with polished terminal box complete with volume control, resistance, etc. 1/6 each. Post paid.
S. KERSHAW
93/95 PERSHORE STREET, BIRMINGHAM, 5.

WILKINSON'S OF CROYDON
RADIO RECEIVERS BC824A. For 144 Mc. Convertible to 28-50-60 Mc. BRAND NEW, including 11 valves. Bargain Price, 39/6, Carr and Pkg. 5/-.
ELECTROLYTICS, 8 MPD 500 v. BR550, 3/- each, 34/- doz. NEW STOCK.
P.M. SPEAKERS, 8in., with transformer, in wall case, 21/-.
POWER UNIT, employing a 5Z4G and a high voltage rectifier SU2150A, together with a .1 mf condenser, 2.5 kV, and other components, 17/6 post free.
TELEVISION UNIT, 2HF stages, 1 detector and 1 video amplifier, complete with 4 valves, adjustable iron-cored coils, etc., brand new, only 45/-.
PLAN POSITION INDICATOR UNIT. Brand new 1 Ex-U.S. Navy. Employing 40 useful valves, 2 Cathode Ray tubes, power pack, motor blower, Milliammeters, etc. The following are the valves: 13 6SN7GT, 8 6AC7, 2 6L6, 6 6L6G, 3 VR150-30, 1 2X2, 3 5U4G, 2 6X5G, 2 6H6.
SPECIAL PRICE £16/10/-
SLOW MOTION DIAL. With Vernier 200-1 reduction. Front of panel mounting, 6in diam, calibration 0-100, 5/6 each.
MURHEAD SLOW MOTION DRIVES, ratio 50-1, 8/8 each.
ABKI SPARES KIT, including 32 Valves individually boxed, 18 6SH7, 6 6H6, 8 7193, also many useful relays, Resistors, Condensers, and a Dynamotor with extended Spindle which will work as a powerful motor on 200/250 A.C. mains without alteration. 145 items in all, brand new, properly packed, 70/- complete.
CRYSTAL MULTIPLIER UNIT, 2 to 6.67 Mc/s in 3-switch steps, 807 Oscillator and tuning control. Brand new with two 807 valves, instruction books, etc., 55/- each.
SENSITIVE METERS. Full scale 25 Microamps, 24in. dial, scaled 0-500, 57/8 each.
METAL RECTIFIERS, 60 M.A., 230 volts, 1/2 wave, 3/- each. List 4d.
L. WILKINSON, 204, Lower Addiscombe Road, CROYDON

REOSOUND
TRADE MARK
THIS IS
REOSOUND

CHASSIS: 10" x 6" x 2 1/2" 18G. Steel	6/3	16G. Aluminium	7/-
17" x 6" x 2 1/2" "	7/-	"	8/-
17" x 5" x 2 1/2" "	8/-	"	9/3
17" x 10" x 2 1/2" "	9/6	"	10/6
17" x 12" x 2 1/2" "	11/-	"	12/-

Other sizes to order.
TELEVISION CHASSIS: In Tinned Steel to order.
SMALL INSTRUMENT CASES: 18 Gauge Mild Steel Box with 16 Gauge Aluminium Front Panel secured by four screws. Finished in Black Wrinkle Enamel. 6" x 4" x 4", 8/6; 8" x 6" x 4", 10/6; 12" x 8" x 4", 12/6. Other sizes to order.
METAL CABINETS, RACK AND PANEL EQUIPMENT: Built to specification.
STANDARD FINISHES: Steel in Black and Grey Stoved Enamel. Aluminium Self-colour, Black and coloured Wrinkle Enamels to order.
CARRIAGE: Paid on Orders Over £2.
REOSOUND ENGINEERING & ELECTRICAL COMPANY,
"Reosound Works," COLESHILL ROAD, SUTTON GOLDFIELD.
Tel.: SUT. 4085. Grams: Reosound, SUTTON GOLDFIELD

THE "COMMANDER" DOUBLE SUPERHET COMMUNICATIONS RECEIVER FOR COMMERCIAL AND AMATEUR USERS
Brief Specification:
● COMPLETE COVERAGE 1.7 TO 31 Mc/s.
● SEPARATE ELECTRICAL BANDSPREAD.
● DIRECT READING FULL VISION DIAL.
● THREE SELECTIVITY POSITIONS.
● HIGHLY EFFICIENT NOISE LIMITER.
● ILLUMINATED S METER.
● MICROVOLT SENSITIVITY. ● 3 WATTS OUTPUT.
● 1.6 AND 100 kc/s. I.F. STAGES. B.F.O.
● EXCELLENT SIGNAL/NOISE RATIO.
Price £48.10.0 HIRE PURCHASE FACILITIES
Prompt Delivery, Home and Export
Operating and Servicing Handbook, 5/-. Illustrated Literature, 2 1/2 stamp
Trade Enquiries Invited.
RADIOVISION (Leicester) LTD.
58 60 RUTLAND STREET, LEICESTER Phone 20167

THE KING OF COIL PACKS.
The letters of praise we receive in our post bag every day confirm our opinion that the MODEL 40 COIL PACK is the best that money can buy, from the point of view of quality, workmanship and performance.
It is, to the best of our knowledge, the only unit on the market with an R.F. stage which can be supplied prealigned and sealed for direct inclusion into a superhet receiver. It uses 3 separate iron-cored high efficiency coils, with high stab. S.M. padders and variable trimmers. The Waveband coverage is 16-50, 200-550 and 800-2,000 metres. Notwithstanding its compact size (5 1/2in. x 5 1/2in. x 2 1/2in.) the internal and external screening is efficient and more than adequate to eliminate any interference between the Aerial, R.F. and Oscillator sections.
The price? Only 2 gns., or can be supplied fully aligned at 47/-. For a further month only, as a special offer, we are supplying FREE with every Model 40 Coil Pack our comprehensive and detailed instruction sheets for the construction of a 6 valve superhet receiver embodying this unit. These sheets are really comprehensive and even if you have never built a radio receiver before, you can go ahead with the knowledge that you cannot fail to complete a highly efficient multi-valve receiver, that will give you years of pleasurable listening or DX roaming.
Send 1/- for the latest issue of "The Home Constructor's Handbook," or a 2 1/2 stamp will bring you our latest lists.
Phone, write or call: **LONDON TELEVISION CO., LTD.,**
694 LEA BRIDGE ROAD, LEYTON, E.10. Telephone: LEY. 4380

C.51 ★
FOR TELE-COMMUNICATION ★
A new Lustraphone Moving-Coil Microphone designed and developed specifically for G.P.O. hand-sets, with mobile tele-communication and P.A. equipment in view. Available as Insert Unit (C.1.51) or complete Hand Microphone (C.H.51). Characterised by sturdy construction, light weight, and high level of performance. Data Sheet on request.
LUSTRAPHONE LTD. 84, Belsize Lane, N.W.3 Hampstead 5515

RADIOMENDERS LIMITED
FOR SPECIAL TRANSFORMERS AND REWINDS
We specialise in
AMATEURS' WINDINGS, TRANSFORMERS
ALL TYPES, CHOKES, PICK-UP COILS,
INSTRUMENT COILS, Etc.
LOUD SPEAKER SERVICE
Highest workmanship Good Delivery
★
RADIOMENDERS, LTD.
Television & Radio Apparatus, Transformer & Coilwinders.
123-5-7 Parchmore Road,
THORNTON HEATH, SURREY
LIV 2261. Trade enquiries invited. Established 16 years.

INDEX TO ADVERTISERS

	PAGE		PAGE		PAGE
Acoustical Mfg. Co. Ltd.	74	Galpins	67	Post Radio Supplies	78
Adcola Products Ltd.	26	Gee Bros. Radio, Ltd.	73	Premier Radio Co.	13, 49
Aerialite, Ltd.	26	General Electric Co. Ltd.	19	Quartz Crystal Co., Ltd.	78
Airmec Laboratories Ltd.	57	General Lamination Products, Ltd.	30	Radio Exchange Co.	68
Albert Mfg. Co.	68	General Sonic Industries	8	Radiomart (B'ham), Ltd.	26
Allan, Richard, Radio, Ltd.	14	Glaser, L.	76	Radiomenders, Ltd.	79
All-Power Transformers, Ltd.	22	Goodmans Industries, Ltd.	8	Radiospares, Ltd.	78
Alpha Accessories, Ltd.	10	Goodsell, Ltd.	58	Radiovision (Leicester), Ltd.	79
Antiference Ltd.	Edit. 315	Gramplan Reproducers, Ltd.	72	Radio Unit.	76
Armstrong Wireless & Television Co., Ltd.	65	Gray, A., Ltd.	14	Ransom, H.	72
Ashworth, H.	54	Hartley, H. A., Co., Ltd.	62	Record Electrical Co. Ltd., The	64
Astor Boisse-lier & Lawrence, Ltd.	36	Haynes Radio, Ltd.	70	Reliance Mfg. Co. (Southwark), Ltd.	80
Automatic Coil Winder & Electrical Equipmt. Co., Ltd.	1	Hazlehurst Designs Ltd.	68	Reousand Eng. & Electrical Co.	79
A.W.F. Radio Products, Ltd.	70	Hely-Mann Electronics Laboratories	72	Rimington Van Wyck, Ltd.	24
Bakers "Selhurst" Radio	24	Henley's, W. T., Telegraph Works Co., Ltd.	75	Ritherdon & Co., Ltd.	55
Barker, A. C.	24	Henry's	65	Ring Laboratories	64
Belling & Lee, Ltd.	45	Hill & Churchill, Ltd.	16	Rogers Developments Co.	16
Bird, S. S., & Sons, Ltd.	38	Holborow & Co.	50	Rolet, H. & Co., Ltd.	78
Birmingham Sound Reproducers, Ltd.	40	Holden Ferrule Co., Ltd.	76	Runbaken Electrical Products	78
Brierley, J. H. (Gramophones & Recordings), Ltd.	58	Holley's Radio Stores	74	Saltord Electrical Instruments, Ltd.	48
Brighton Tele-Services	78	Holt, Stan	68	Sangamo Weston, Ltd.	51
Britain, Chas. (Radio), Ltd.	69	Houghton & Osborne	66	Savage Transformers, Ltd.	58
British Institute of Engineering Technology	72	H.P. Radio Services, Ltd.	50	Schiff, Erwin	14
British Insulated Callender's Cables, Ltd.	Cover ii	Hunt, A. H., Ltd.	34	Sinmonds Aerocessories, Ltd.	20
British National Radio School	68	International Correspondence School, Ltd.	50	Simon Sound Service	24
British N.F. Co., Ltd.	58	Johnson Matthey & Co., Ltd.	27	Smith, G. W. (Radio), Ltd.	52
British Physical Laboratories	34	Kerry's (Gt. Britain), Ltd.	38	Sotter Transformers	77
British Rola, Ltd.	46	Kershaw, S.	79	Sobell Industries, Ltd.	14
Brookes Crystals, Ltd.	74	King, Harold	78	Sound Sales Ltd.	46
Brown, S. G., Ltd.	32	Kolectric, Ltd.	6	Southern Radio Supply, Ltd.	64
Bulgain, A. F., & Co., Ltd.	Edit. 313	Lasky's Radio	75	Sphere Radio, Ltd.	60
Bull, J., & Sons	57	Lawrence, G. & Co.	56	Stability Radio Components, Ltd.	28
Bullers, Ltd.	72	Leak, H. J., & Co., Ltd.	5	Standard Telephones & Cables, Ltd.	45
Cabot Radio Co., Ltd.	18	Lockwood & Co.	78	Stearns & Porcelain Products, Ltd.	9
Candler System Co.	78	Londex, Ltd.	78	Stern Radio, Ltd.	69
Celestion, Ltd.	38	London Central Radio Stores	36	Sugden, A. R., & Co. (Engineers), Ltd.	2
Charles Amplifiers, Ltd.	28	London Radio Supply Co.	75	Supacolls	76
Cinema-Television, Ltd.	11	London Television Co., Ltd., The	79	Szymanski, S.	56
Clydesdale Supply Co., Ltd.	30	Lowther Mfg. Co.	77	Taylor, Tunncliff (Refractories), Ltd.	51
Cohen, D.	35	Lustraphone, Ltd.	79	Tele-Radio (1943), Ltd.	34
Cosmoord Ltd.	44	Lyons, Claude, Ltd.	62	Telegraph Condenser Co., Ltd.	Cover iii
Couplphone Radio	32	Mall Order Supply Co.	71	Telegraph Construction & Maintenance Co., Ltd., The	55
Coventry Radio	76	Marconi Instruments, Ltd.	22	Te'eradio Co.	70
Davis, Alec., Supplies, Ltd.	51	Measuring Instruments (Pulvin), Ltd.	55	Thermionic Products, Ltd.	37
Denco Distributors, Ltd.	77	Metro Pex, Ltd.	10	Transid, Ltd.	36
Desoutter Bros., Ltd.	33	Midland Instrument Co.	60	Trix Electrical Co., Ltd.	Edit. 311
Dubilier Condenser Co. (1925), Ltd.	15	Millett & Holden, Ltd.	62	Truvox Eng. Co., Ltd.	17
Duplex Electronics, Ltd.	72	Modern Book Co.	62	Universal Electrical Instruments Corpn.	71
Edison Swan Electric Co., Ltd.	23, 29	Monochord Radio	74	University Radio, Ltd.	25, 76
Electradix Radios	63	M.R. Supplies, Ltd.	74	Valradio	80
Electric & Musical Industries, Ltd.	22	M.S.S. Recording Co., Ltd.	53	Victoria Instruments	4
Electrical Sound & Television Patents, Ltd.	20	Mullard Electronic Products, Ltd.	6, 42	Vitavox, Ltd.	21
Electrical Trades Union, The	66	Multicore Solders, Ltd.	Cover iv	Voigt Patents, Ltd.	76
Electro Acoustic Developments	74	Murphy Radio, Ltd.	3	Vortexion, Ltd.	47
Electro Technical Assemblies	64	Mycalex, Ltd.	12	Wayne Kerr Labs., Ltd., The	20
Electronic Instruments, Ltd.	16	Northern Polytechnic, The	78	Webb's Radio	2
Electronic Precision Equipment	39	Oliver Pell Control, Ltd.	38	Westinghouse Brake & Signal Co., Ltd.	53
Electrosound Supplies Co.	54	Oxley Developments Co., Ltd.	79	West, Spencer	76
Elmsleigh Radio Co.	74	Painton & Co., Ltd.	16	Wharfedale Wireless Works	28
Endo, Ltd.	72	Park Radio	59	Whiteley Electrical Radio Co., Ltd.	4
Enoch Joseph, Ltd.	72	Partridge Transformers, Ltd.	79	Wilcox Electric Co.	31
Enthoven, H. J., & Sons, Ltd.	30	Peerless Radio, Ltd.	61	Wilkins & Wright, Ltd.	78
Factor, J., Ltd.	70	Pennine Amplifiers	66	Wilkinson, L.	79
Ferranti, Ltd.	7	Phillips Electrical, Ltd.	77	Wilson, M., Ltd.	Edit. 313
Filmer, J. T.	7	Pifco, Ltd.	66	Wimbold Eng. Co., Ltd.	59
Fluxite, Ltd.	Edit. 317	Pike Bros.	52	Wireless Instruments (Leeds), Ltd.	62
Fritch Radiocraft, Ltd.	56	Pill, G. N., & Partners	76	Wireless Supplies Unlimited	74
Furzehill Laboratories, Ltd.	18		70	Woden Transformer Co., Ltd.	56
				Wolsey Television, Ltd.	36
				Wright & Weaire, Ltd.	41

D.C. - A.C. CONVERSION

Frequency stability, R.F. and A.F. suppression, with long working life, are but some of the features of Valradio Vibrator converters. We quote two examples here.

12v. INPUT

Model 230 75, 12 gives a useful A.C. output at 50 or 75 c.p.s., and is ideal for outdoor P.A. work. 230v. 75 watts A.C.

£10. 15. 0

110v. INPUT

Model 230, 300, 110 particularly suitable for television and autoradiograms. A.C. output at 50 or 75 c.p.s. 200-250 v. 300 watts.

£16. 0. 0

VALRADIO LTD.

57, FORTRESS ROAD, N.W.5 GULLIVER 5165

POTENTIOMETERS



Wire-wound and Composition types. Single, Ganged, Tandem Units.

Characteristics: linear, log., semi-log., non-inductive, etc. Full details on request.

RELIANCE MNGF. CO. (SOUTHWARK), LTD., Sutherland Road, Higham Hill, Walthamstow, E.17.

Telephone: Larkswood 3245



'MICROMITE'

The *new* Electrolytic
FOR THE RADIO ENGINEER



This is the new T.C.C. Electrolytic Condenser which, with the "Micropack" and "Lectropack" types form the most complete range of condensers for the use of radio designers and engineers. "Micromite" has certain features of prime importance.

- ★ 'ALL-ALUMINIUM' non-corrosive construction with completely hermetic seal.
- ★ Protective outer cardboard tube eliminating any risk of aluminium tube causing short circuits.
- ★ High-gain etched foil gives you the *smallest and lightest* condenser yet offered for replacement purposes.
- ★ Conservative voltage rating and T.C.C. high quality ensure long and trouble-free life.

Capacity	Voltage		Dimensions (Overall)		Price (each)	
	Peak Working	Surge	Length	Diameter	Retail	Nett Trade
8 μ F	450	550	1 $\frac{13}{16}$ "	$\frac{13}{16}$ "	3/6	2/4
16 μ F	450	550	1 $\frac{13}{16}$ "	1 $\frac{1}{16}$ "	5/-	3/4
32 μ F	450	550	2 $\frac{13}{16}$ "	1 $\frac{1}{16}$ "	7/6	5/-
16 μ F	350	400	2 $\frac{5}{16}$ "	$\frac{13}{16}$ "	4/-	2/8
32 μ F	350	400	2 $\frac{5}{16}$ "	1 $\frac{1}{16}$ "	6/-	4/-

NOTE—"Micropack" and "Lectropack" should be used for the reservoir position where high ripple current may be expected.

THE TELEGRAPH CONDENSER CO. LTD
RADIO DIVISION: NORTH ACTON, LONDON, W.3 · TELEPHONE: ACORN 0061

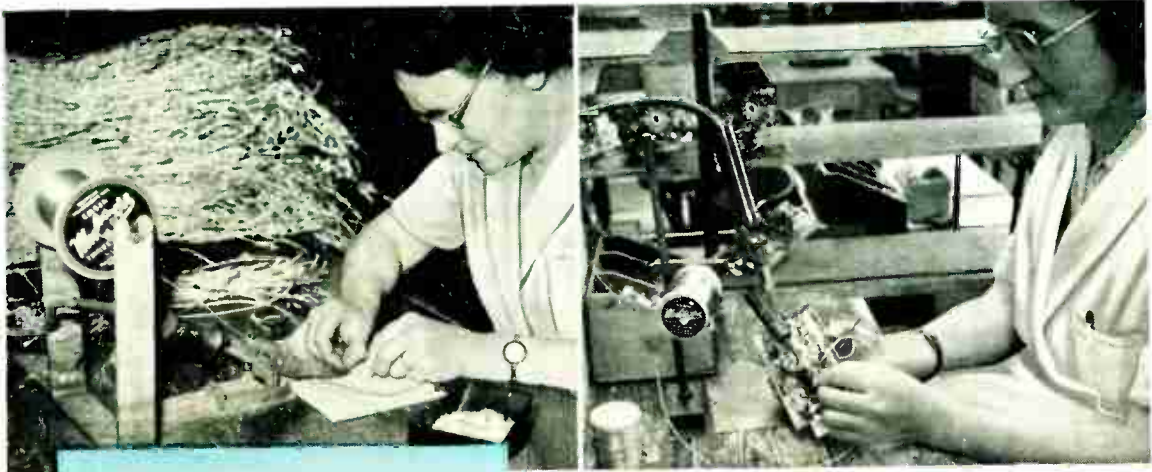

Soldering Processes

WHERE HAND-CONTROLLED IRONS ARE NOT USED

It can often be advantageous in soldering production processes to adopt a different procedure to the usual one of employing a hand iron. Here are illustrations of two methods where production has been speeded up and a higher standard of precision joints obtained.

Only Ersin Multicore contains extra-active, non-corrosive Ersin Flux enabling joints to be made on heavily oxidised surfaces. Only Ersin Multicore with its 3 core construction gives guaranteed flux continuity, instantaneous melting and guaranteed freedom from 'dry' or H.R. joints.

Ersin Multicore Solder as used by the leading Television, Radio and Telephone manufacturers, is available from most retailers in Size 1 cartons in the specifications shown below.

Catalogue Ref. No.	Alloy Tin/Lead	S. W. G.	Approx. Length per Carton	List Price per Carton (subject) s. d.
C16014	60 40	14	32 feet	6 0
C16018	60 40	18	84 feet	6 9
C14013	40 60	13	20 feet	4 10
C14016	40 60	16	44 feet	5 3

(Photo: above, left)

At the works where Garrard Record Changers and Pick-ups are made, ERSIN MULTICORE SOLDER is used for the jointing of screened pick-up leads to tags by a foot controlled pivoted iron. By the adoption of this procedure it is not necessary for wires or screening to be located in holes in the tags. The need for three hands is avoided by this novel method of mounting the iron devised by Garrard engineers.

(Photo: above, right)

75 Joints of the switch unit of the Pye Receiver are soldered at the Pye Works by applying ERSIN MULTICORE SOLDER to the tags, which have been heated by a bench type iron. This procedure avoids the use of a jig for holding the small chassis and is less fatiguing for the worker.

★ New! ARAS MULTICORE SOLDER — the first waterproof acid free solder with the speed of acid flux. For joining thin wire-tag joints, welded difficult metals — e.g. spring steel. Details and samples available for immediate interest. Write to: Works and Sales Dept. 100, ALBEMARLE STREET, LONDON, W.1.

7 lb. reels are preferred by most manufacturers. Bulk prices upon request. Size 1 cartons for service engineers and workshops.



MULTICORE SOLDERS LTD.

MELLIER HOUSE, ALBEMARLE STREET, LONDON, W.1 • Telephone: REGent 1411