

Wireless World

RADIO AND ELECTRONICS

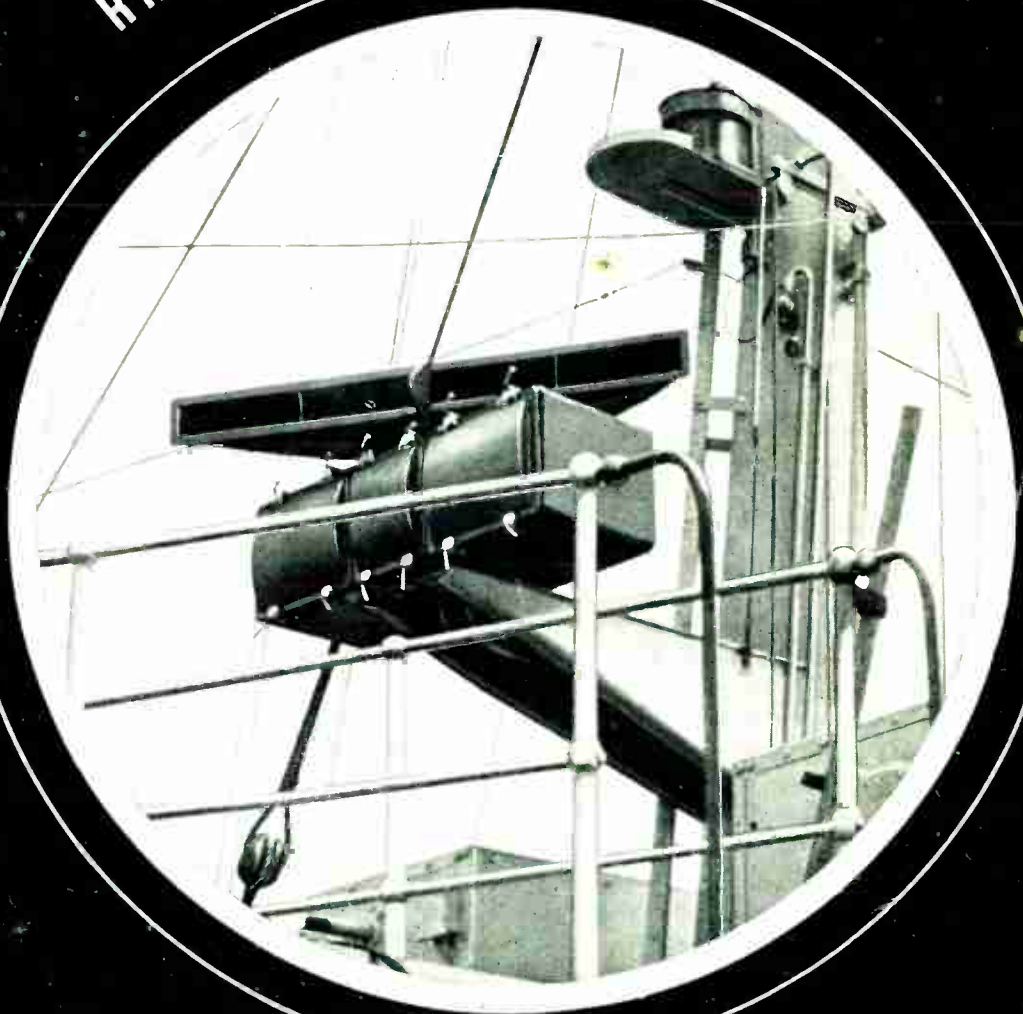

NOV. 1948

1/6

Vol. LIV. No. 11

IN THIS
ISSUE :

NEW EUROPEAN FREQUENCIES : FULL LIST

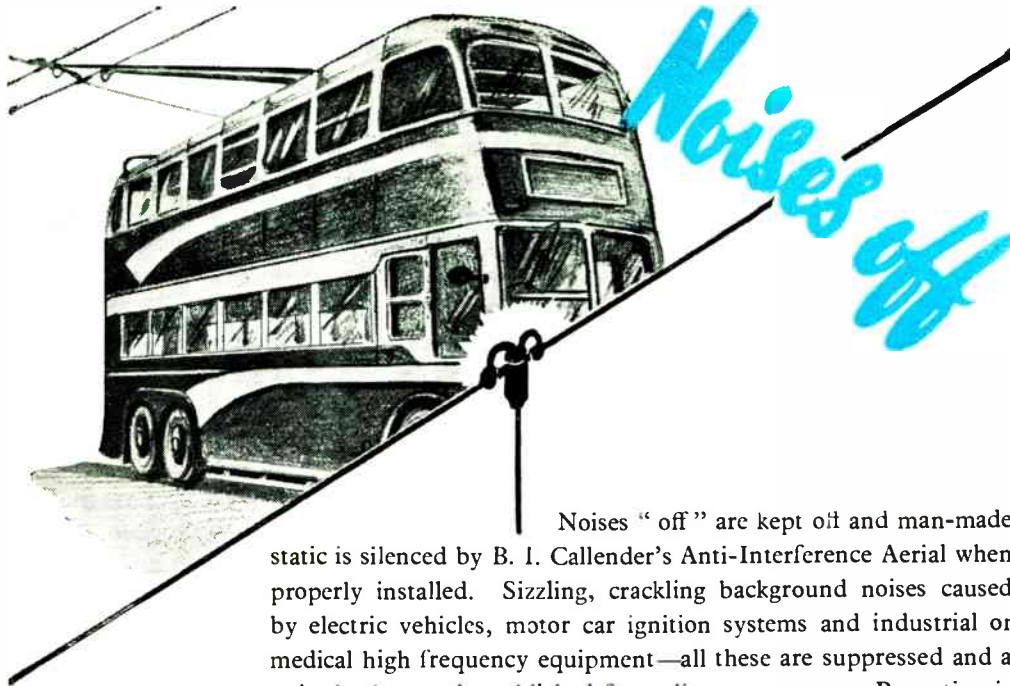

Noises "off" are kept off and man-made static is silenced by B. I. Callender's Anti-Interference Aerial when properly installed. Sizzling, crackling background noises caused by electric vehicles, motor car ignition systems and industrial or medical high frequency equipment—all these are suppressed and a quiet background established for radio programmes. Reception is improved, for a maximum number of programmes can be enjoyed on all wavelengths.

The aerial is a 60 ft. polyethylene insulated dipole type, with suspension insulators and matching transformer. The 80 ft. down lead is a fully screened coaxial cable with polyethylene plugs moulded to each end and is matched to the receiver by a transformer with easily fixed suction mounting.

B. I. Callender's All-Wave Anti-Interference Aerial will give you better listening and reveal many stations you never heard before. Write to-day for the descriptive folder No. 221s on the Anti-Interference Aerial.

Licensed under Amy Aceves & King, Inc. Patents Nos. 413917, 424239 and 491220.

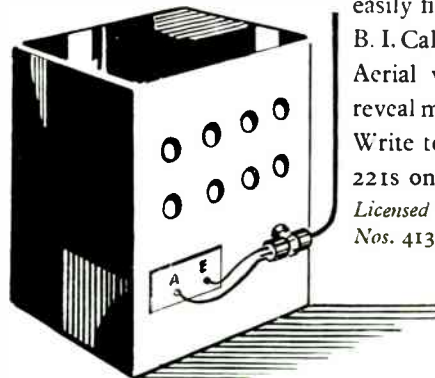

BI
Callender's *All-Wave*
ANTI-INTERFERENCE AERIAL

BRITISH INSULATED CALLENDER'S CABLES LIMITED
NORFOLK HOUSE, NORFOLK STREET, LONDON, W.C.2

Fine Limits of Accuracy



VALVE CHARACTERISTIC METER

A comprehensive instrument built into one compact and convenient case, which will test any standard receiving or small power transmitting valve on any of its normal characteristics under conditions corresponding to any desired set of D.C. electrode voltages. A patented method enables A.C. voltages of suitable magnitude to be used throughout the Tester, thus eliminating the costly regulation problems associated with D.C. testing methods.

A specially developed polarised relay protects the instrument against misuse or incorrect adjustment. This relay also affords a high measure of protection to the valve under test. Successive settings of the Main Selector Switch enable the following to be determined:—

Complete Valve Characteristics including I_a/V_g , I_a/V_a , I_s/V_g , I_s/V_a , Amplification Factor, Anode A.C. Resistance, 4 ranges of Mutual Conductance covering mA/V figures up to 25 mA/V at bias values up to $-50V.$, together with "Good/Bad" comparison test on coloured scale against rated figures.

"Gas" test for indicating presence and magnitude of grid current, inter-electrode insulation hot and cold directly indicated in megohms, separate cathode-to-heater insulation with valve hot. Tests Rectifying and Signal Diode Valves under reservoir load conditions, and covers all the heater voltages up to 126 volts.

The AUTOMATIC COIL WINDER & ELECTRICAL EQUIPMENT CO., LTD.

WINDER HOUSE, DOUGLAS STREET, LONDON, S.W.1. Phone: VICTORIA 3404-9

Avo Precision Electrical Testing Instruments

STABILISED POWER SUPPLY UNITS

TYPES 1930 & 1931

THESE INSTRUMENTS are invaluable in the electronics circuit laboratory. The availability of these types of supply unit can often save days of preliminary work by avoiding the wasteful necessity of an engineer to produce special power packs.

The Type 1931 delivers 280 to 420 volts, 250mA and a series of negative supply voltages, whilst the Type 1930 provides 260-340 volts, 100mA and a stabilised negative output of 150 volts but has additional L.T. heater supplies.

Both models are provided with facilities for measuring current and voltage on the principal outputs. Only high grade components are used and there are no electrolytic condensers.

AVAILABLE
FOR IMMEDIATE
DELIVERY



For further particulars please write for our new brochure of Electronic Instruments.

Furzehill

LABORATORIES LTD



BOREHAM WOOD · HERTFORDSHIRE
TELEPHONE - - ELSTREE 1137

Ten transformers standing in a line, One had faulty 'innards' - then there were nine.



Nine transformers - but one was heavy weight, No-one could lift it - so there were eight.

Eight transformers looking fit for heaven, One could not stand the cold - so there were seven.



Seven transformers - one full of clever tricks, No-one could understand it - so there were six.

Six transformers - one was alive, Until the 'gaffer' touched it - then there were five.



Five transformers - shaken to the core, One shook down to odds and ends - so there were four.



Four transformers - tuned to a 'T', One struck a false note - then there were three.



Three transformers with big jobs to do, One wasn't up to it - so there were two.

Two transformers - all the rest had gone, One worked but a little while - leaving only one.



One PARMEKO withstood every test; so remember when there's work to do -

PARMEKO of LEICESTER

Makers of transformers for the Electronic, Signal Luminous Tube, Oil Ignition Industries, etc.

Introducing...

The **Osram** Miniatures

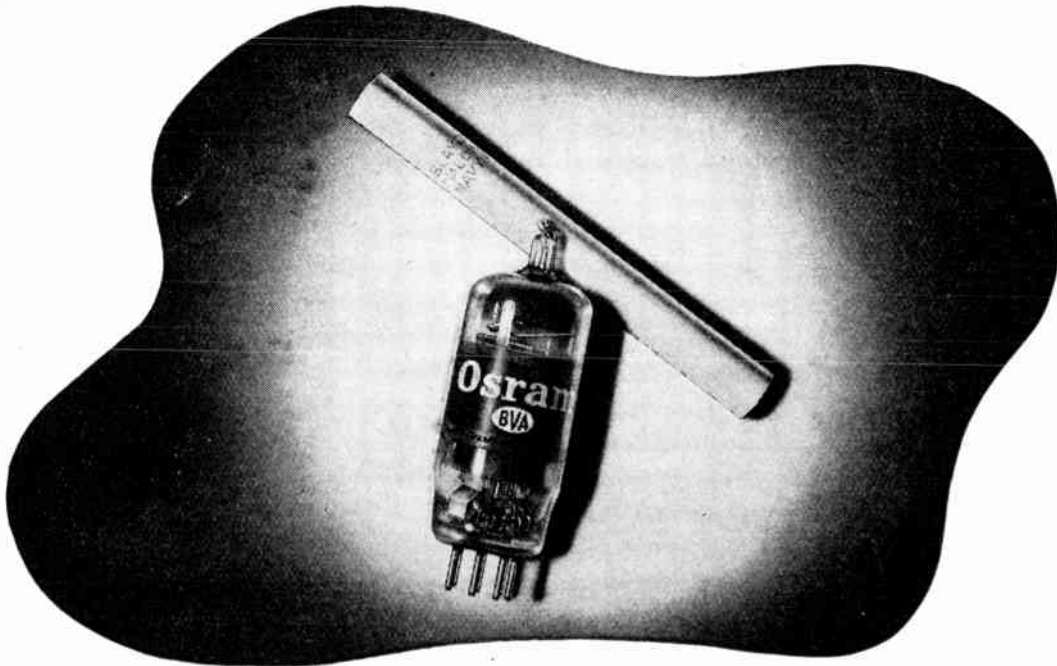

TYPE Z77 HIGH-GAIN PENTODE MOUNTED ON B7G GLASS BASE

THE Z77 is the first of a new range of OSRAM miniatures. It is a high-gain pentode, mounted on the B7G base and is suitable for use in television, wide-band radio, amplifier and electronic instrument circuits.

INTERESTING FEATURES

Small size and rugged construction make it an eminently suitable valve for use in mobile and portable equipment.

Suitable for operation up to 100 megacycles per second.

Owing to smallness of size and low thermal capacity the valve rapidly reaches a stable operating condition.

List Price 17/6. Purchase Tax 3/10 extra.



Osram
PHOTO CELLS

G.E.C.
CATHODE RAY TUBES

Osram
VALVES

THE GENERAL ELECTRIC CO., LTD., MAGNET HOUSE, KINGSWAY, W.C.2.

*The better they are made
the more outstanding the results*

MADE IN THREE PRINCIPAL MATERIALS.

FREQUELEX. An insulating material of low Dielectric Loss, for Coil Formers, Aerial Insulators, Valve Holders, etc.

PERMALEX. A High Permittivity Material. For the construction of Condensers of the smallest possible dimensions.

TEMPLEX. A Condenser material of medium permittivity. For the construction of Condensers having a constant capacity at all temperatures.

Bullers



BULLERS LOW LOSS CERAMICS

Specialize in PRECISION Manufacture

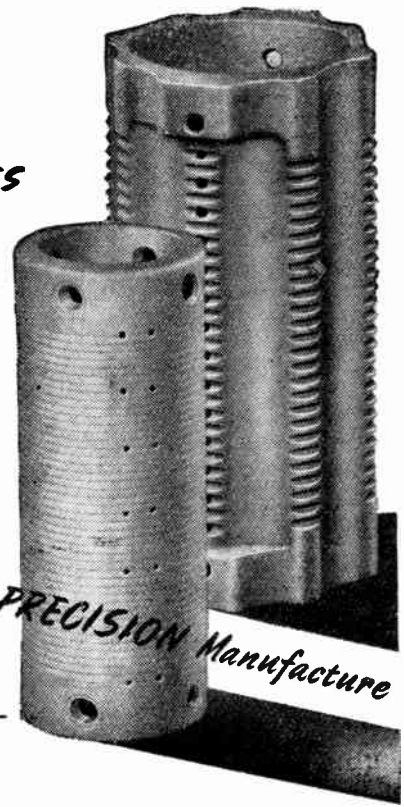

BULLERS LTD., 6, Laurence Pountney Hill, London, E.C.4. Phone: Mansion House 9971 (3 lines)
Telegrams: "Bullers, Cannon, London."

Features of the
'SENIOR' MODEL

P.M. Unit: 9" diameter.
Capacity: 7 watts.
Magnet flux density: 12,000 gauss,
total flux 47,000 lines.
Magnet in Alcomax, one of the
most efficient permanent magnet
alloys yet produced.
Volume controls: constant-
impedance type.
Basins: die-cast in non-ferrous alloy.
Cabinet in polished walnut veneer,
size 14½" x 12½" x 7".
TRANSFORMERS (when
required): Universal ratio type
transformers, tapped to match high
and low impedances or connection
direct to speech coil.
Price £5. 15. 6.
(without transformer), £5. 2. 6.

'JUNIOR' MODEL

Cabinet size: 13½" x 11½" x 6½".
P.M. Unit: 8" diameter.
Capacity: 6 watts.
Magnet flux density: 10,000 gauss,
total flux, 39,500 lines.
Price £5. 0. 0
(without transformer) £4.10.6

Compare Quality & Price
in
**EXTENSION
SPEAKERS**



'CADET' MODEL

Cabinet size: 12½" x 10½" x 5½".
P.M. Unit: 7" diameter.
Capacity: 3½ watts.
Magnet flux density: 8,000
gauss, total flux 31,600 lines.
Price £4.10.0
(without transformer) £4.0.0

Stentorian

The finest EXTRA Speaker for any set



WHITELEY ELECTRICAL RADIO CO LTD · MANSFIELD · NOTTS

"NILO K" — the alloy for sealing glass to metal

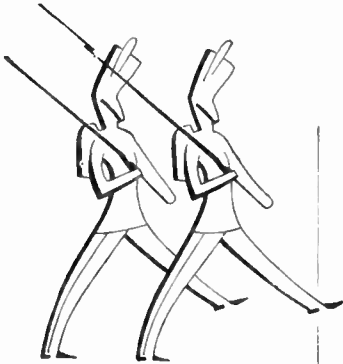

The thermal coefficient of expansion of Nilo K is uniform with that of medium hard boro-silicate glasses over the range 20°-500° C.

Nilo K, the alloy designed for sealing to medium hard boro-silicate glasses, is used most successfully by Associated Electronic Engineers Ltd., in their hermetically-sealed equipment. This alloy makes possible the easy manufacture of vacuum-tight glass-to-metal seals. Write to us for further information about this interesting sealing alloy and for a copy of our publication giving the expansion properties.

Three-stage magnetic amplifier. Associated Electronic Engineers Ltd., Stanmore, Middx.

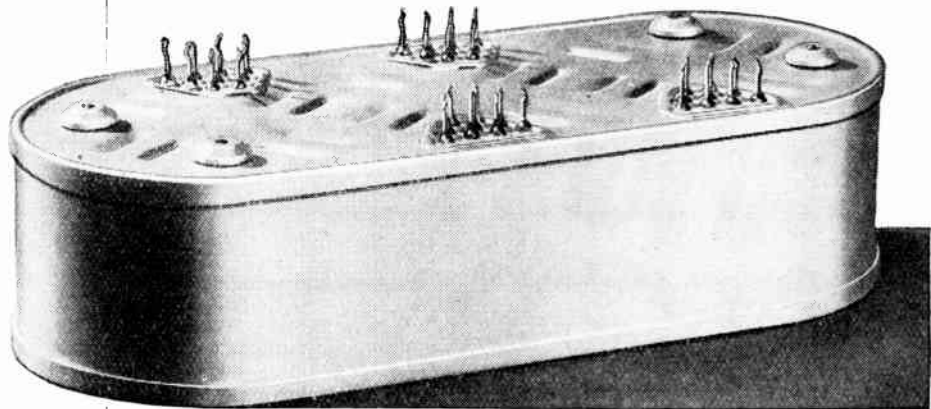

HENRY WIGGIN & COMPANY LTD

WIGGIN STREET · BIRMINGHAM 16

Nilo is a registered trade mark

SILENT POWER

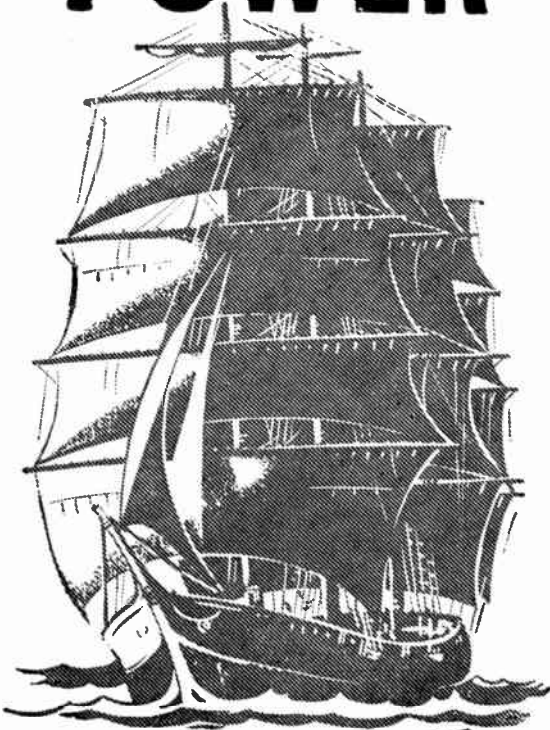

PERTRIX
RADIO BATTERIES
'Always worth more!'

For clean, crisp reception a silent source of power is essential. Pertrix Radio Batteries give silent power.

HOLSUN BATTERIES LIMITED
137 Victoria Street • London • S.W.1



FOR THE RADIO SERVICEMAN DEALER AND OWNER

The man who enrolls for an I.C.S. Radio Course learns radio thoroughly, completely, practically. When he earns his Diploma, he will KNOW radio. We are not content merely to teach the principles of radio, we want to show our students how to apply that training in practical, every-day radio service work. We train them to be successful.

Write to the I.C.S. Advisory Dept. stating your requirements. Our advice is free.

.....*You may use this coupon*.....
INTERNATIONAL CORRESPONDENCE SCHOOL Ltd.
 DEPT. 38, INTERNATIONAL BUILDINGS, KINGSWAY, LONDON, W.C.2
 Please explain fully about your instruction in the subject marked X.
 Complete Radio Engineering Radio Service Engineers
 Radio Service and Sales Advanced Short-Wave Radio
 Elementary Electronics, Radar, and Radio
 And the following Radio Examinations:—
 British Institution of Radio Engineers
 P.M.G. Certificates for Wireless Operators
 City and Guilds Telecommunications
 Wireless Operators and Wireless Mechanics, R.A.F.
 I.C.S. students for Examinations are coached till successful.

Name..... Age.....
 Address..... **ICS**

AN OUTSTANDING ACHIEVEMENT

**THE
SHEFI
MOVING-COIL
PICK-UP**

Licensed under Voigt's Patent No. 538058.
 It uses miniature needles suitable for modern full range recordings. A ferrous coil former concentrates the flux on the coil and also adds armature effect, thus increasing output voltage sufficiently to operate direct into a normal radio set. Free needle movement and low downward pressure ensure long record life. The fundamental simplicity of this robust design keeps down manufacturing costs.

PRICES Model "R" £2 0 0 Output .4 volts.
 "R" de luxe £2 11 0 with spring counter balance.

Model "S" £2 6 0 Output 1.5 volts.
 Plus Purchase Tax, including transformer.

EXPORT ENQUIRIES INVITED
BROOKS & BOHM LTD
 90, Victoria Street, London, S.W.1.
 Phone : VICTORIA 9550/1441



Ignoring the fact that in these days you may well *have* no shirt to put on my little horses, I yet make the suggestion. You may think we only supply drills, screwdrivers and nutrunners. Then you have another think coming.

If your production involves any operation that must be done by hand or with a handtool, it is likely that my little horses will enable you to produce more goods in less time. We make tools to unscrew the moulds in plastic products; to cut sheet metal, to drive woodscrews. In fact whatever your enterprise . . . (No! I shouldn't have said that) . . . whatever your problem (we do still have problems, don't we?) my little horses will come galloping to your aid.



*Specialists in Lightweight Pneumatic
and Electric Portable Tools*

DESOUTTER

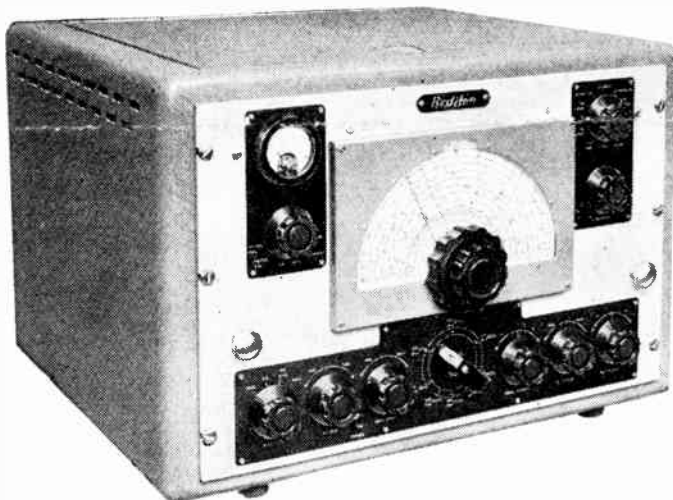

R.50
COMMUNICATIONS RECEIVER

This high-grade communications receiver incorporates the most highly developed techniques, in modern receiver design. Five degrees of selectivity, including a crystal gate and crystal filter are provided, and the sensitivity is such that an input of between 1—5 microvolts gives a signal/noise ratio of at least 10 dB over the entire frequency range of 13.5 to 26 kc/s and 95 kc/s to 32 Mc/s. Separate power units for A.C. or D.C. operations are available.

REDIFFUSION LIMITED, BROOMHILL ROAD, WANDSWORTH, S.W.18
DESIGNERS & MANUFACTURERS OF RADIO COMMUNICATION & INDUSTRIAL ELECTRONIC EQUIPMENT Phone PUTney 5691

RC 201

COMMUNICATIONS
Redifon
Radio

M. R. SUPPLIES Ltd.

draw the special attention of buyers for LABORATORIES, TECHNICAL COLLEGES and UNIVERSITY DEPARTMENTS to the following first-class and brand new material. Immediate delivery from stock held here. All prices nett.

THERMOSTATIC SWITCHES (new ex-A.M.). Capacity 1.5 amp. On at 32 deg. F. off at 49 deg. F. (therefore right for frost protection in labs., garages, greenhouses, households, etc.). Operating temperature can be adjusted. 4/6 each. 45/- dozen.

BATTERY CHARGERS (new—ex-A.M.). For use on 200/250 v. A.C. mains, charging any battery 2 to 12 volts at full 5 amps. Metal rectified, fitted sliding resistance and ammeter, with fuses, leads, etc., in steel housing 15 x 13 x 7in., with wall-mount lugs. 26/18/6 (des. 3/6).

S.T.C. METAL (Selenium) RECTIFIERS, high-duty and suitable for many of the 24 v. D.C. Govt. motors on the market. D.C. delivery 30 volts 28 amps. for inductive load or 22 amps. for battery charging. Half-wave. 25/- each (or four, for bridge connection giving 56 amps., f.w., for 24).

STEP-DOWN MAINS TRANSFORMERS (high duty). Prim.:—210/230 v. Secs.:—53 v. 15 amp., 60 v. 1 amp., 30 v. 1 amp., 6 v. 3 amps. These suit above rectifiers. Owing to weight (about 32 lbs.) and difficulty of packing we cannot despatch these. Price 42/6 ex this address.

CLOSE-RANGE AUTO TRANSFORMERS. Loading 500 va. Give choice of any voltage between 200 and 250 v. in 10 v. taps. 29/6 (des. 2/6).

AUTOMATIC VOLTAGE REGULATORS. Employing carbon-pile unit and controlling any voltage between 180 and 230 volts A.C. or D.C., thus automatically overcoming mains volt-drop. Essential to processing dept., and for television. Instruction diagram sent with each. Loading up to 1 kva. In ventilated housing 10 1/2 in. high by 6 1/2 in. square. 23/15/- (des. 3/6). Only a few.

VARIAC TRANSFORMERS for manual adjustment of mains voltages between 200 and 250 v. A.C. Loading 1.01 kva., oil-filled, 63/- (des. 3/6).

MOBILE POWER PACKS (for No. 19 Trans/Receiver). Operating from 12 v. D.C. Incorporating two Anode Converters, one delivering 250 v. 125 m.a. and the other 490 v. 65 m.a., smoothed, with relay, pilot light, etc., in portable case 10 1/2 by 8 by 6 in. These are new, solid, perfect. 32/6 (des. 2/6).

SIGNAL GENERATORS. Very special offer of R.C.A. Type 710A for U.H.F. Range 300/560 mc/s (continuous). 400 c. internal mod. Output voltage 1 micro-volt to .09 volts. Direct calibration on dial. Accuracy 1/2 of 1 per cent. Operation 100/125 volts A.C. With all leads, etc., and Calibration Charts and Handbook. In original cartons, 217/10/- (des. 3/6). Also a few Marconi TF144, at 275 (ex here). And others, for callers.

SYNCHRONOUS ELECTRIC CLOCK MOVEMENTS, 200/250 v. 50 c. Spindles for hours, minutes, seconds hands. Centre-bush mount. Silent and reliable. Very popular offer for domestic or lab. clocks, 37/6 with dust-cover and flex. Set of three hands, in good style, for 5/6 in. dial, 2/-.

COILS for the BE Mk. III TRANSMITTER, the set of four coils, 8/6.

STIRRES MOTORS, 6/12 v. A.C./D.C. The best of the small motors on the market. Housing 4 x 3 in., spindle 2 1/2 in. long, with concentric mounting brackets. Speed approx. 3,000 r.p.m., considerable torque, 12/6. These are also suitable for cine, sewing machine, models, etc.

STAGE DIMMERS, fitted screw motion and handwheel, controlling stated load from full-bright to blackout at 220/240 v. 500-watt, 23/18/6, 1,000-watt 27/2/6, 1,500-watt 28/12/6, 2,500-watt 29/15/- (des. any one 4/6).

M. R. SUPPLIES Ltd., 68, New Oxford Street, London, W.C.1

Telephone: MUSeum 2958

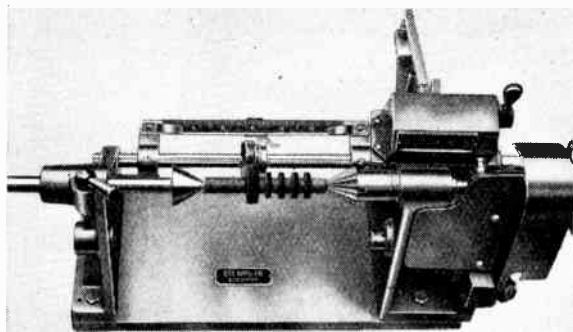

MODEL WX

AUTOMATIC COIL WINDING MACHINES AND HAND WINDING MACHINES

Machines supplied complete with stand motor and Two-Speed Friction Clutch

AGENTS ABROAD

J. P. Fielding Co. (Canada) 131 Ontario Street, St. Catharines, Ontario.	Etahis Octave Honari, 14 Quai de L'Industrie, Scllesmin-les-Liege.	Hettye & Frogg, Oslo, Norway, Storgasen, 15. K. G. Khosla & Co., 22, School Lane, New Delhi, India.
--	--	--

ETA TOOL CO

(LEICESTER) LTD.

16 1/2 METCALF STREET, LEICESTER.

Phone—5386.

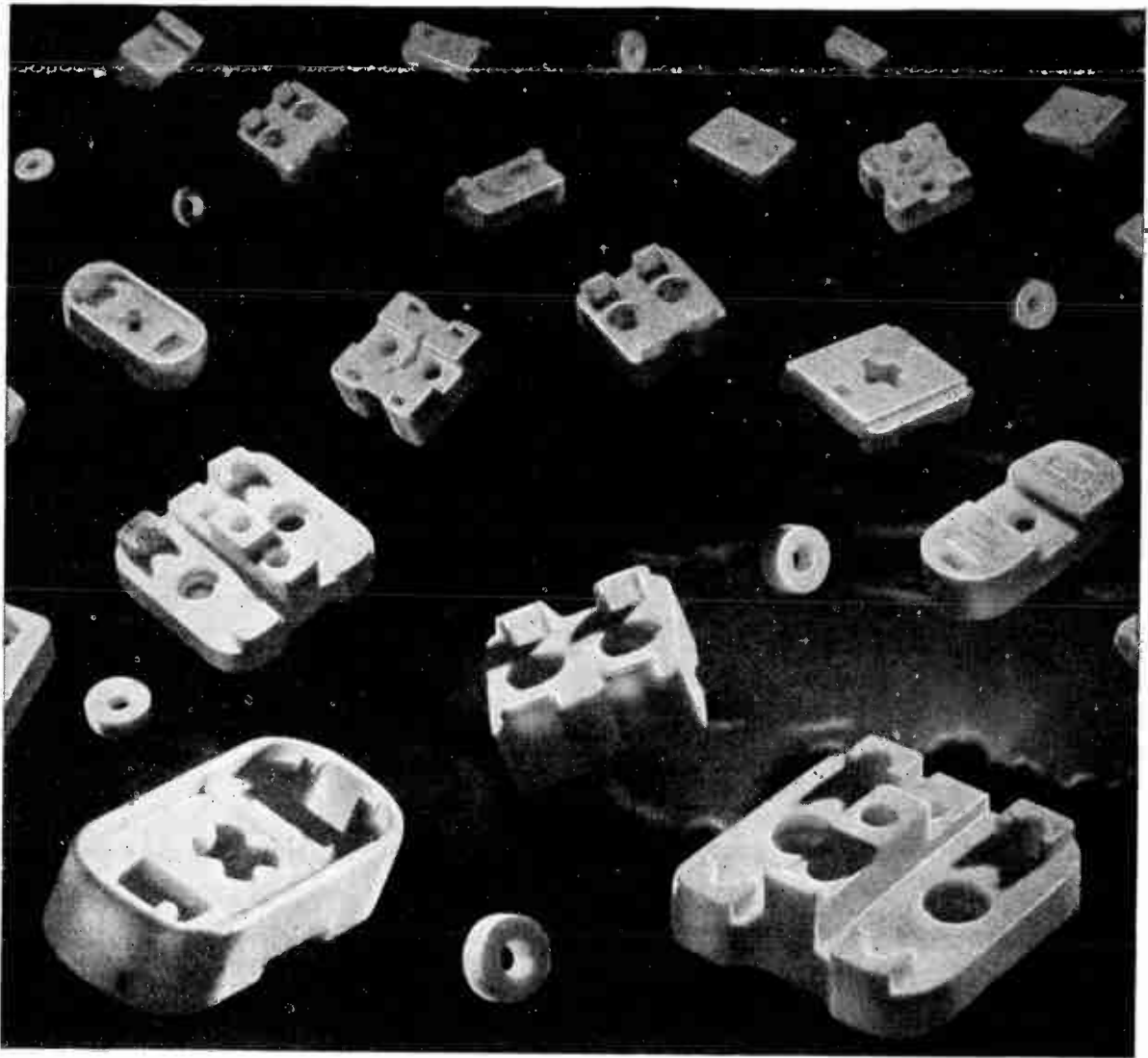

CERAMICS

FOR TRIMMER CONDENSERS
and all radio components
FREQUENTITE-FARADEx-TEMPRADEx

STEATITE & PORCELAIN PRODUCTS LTD.

Stourport on Severn, Worcester. Telephone: Stourport 111. Telegrams: Steatint, Stourport



S.P. 51



Plans for a neighbourly world

Marconi's first wireless messages did more than enable nation to speak to nation. They drew closer the world's boundaries, quickened the tempo of existence and turned distant acquaintances into next-door neighbours. Broadcasting has helped still further to increase our knowledge of our neighbours; wireless navigational aids and radar have brought greater safety and faster travel between Continents. And so Marconi's will continue to pioneer. Their engineers are busy today on developments which will make the world a closer community tomorrow.

Marconi
the greatest name in wireless

MARCONI'S WIRELESS TELEGRAPH COMPANY LTD.,
MARCONI HOUSE, CHELMSFORD, ESSEX.

"Cyldon"
MICA DIELECTRIC TRIMMER Capacitors

Type No. 16 Type No. 14
Type No. 16G

SYDNEY S. BIRD & Sons Ltd.
CAMBRIDGE ARTERIAL ROAD, ENFIELD, MIDD.
Phone: Enfield 2071-2 Grams: Capacity, Enfield.

"20 QUESTIONS"

for the backroom boys...

IS IT: Automatic coolant regulation? Movement for pressure change? Packless gland to seal spindle in high vacua? Reservoir to accept liquid expansion? Dash-pot or delay device? Barometric measurement or control? Pressurised coupling where vibration or movement is present? Dust seal to prevent ingress of dirt? Pressure reducing valves? Hydraulic transmission? Distance thermostatic control? Low torque flexible coupling? Pressure sealed rocking movement? Pressurised rotating shaft seals? Aircraft pressurised cabin control? Refrigeration expansion valves? Thermostatic Steam Traps? Pressure amplifiers? Differential pressure measurement? Thermostatic operation of louvre or damper?

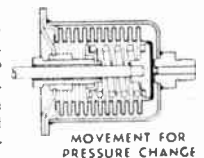
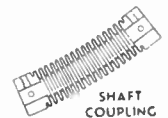

THE ANSWER IS... Seamless, one-piece, metal bellows combining the properties of a compression spring able to withstand repeated flexing, a packless gland and a container which can be hermetically sealed. Made by a process unique in this country; no thicker than paper (the walls range from 4 1000" to 7 1000") they are tough, resilient, with a uniformity of life, performance and reliability in operation unobtainable by any other method.

Write for List No. N 800-1

Drayton Hydroflex METAL BELLOWS

Drayton Regulator & Instrument Co. Ltd., West Drayton, Middx.

WEBB'S

NEW 1948 EDITIONS

Webb's Radio Globe of the World

Whether you are a Short-Wave Listener, or an active transmitter, this globe will give added interest to your hobby, lending a touch of romance as you locate on the globe remote calls such as ZD9—Tristan da Cunha, VP8—Falkland Islands, VR6—Pitcairn. This is a new and improved edition of our famous pre-war globe. The larger diameter of 13½" gives considerably greater area and the compass fitted in the base allows correct orientation. New Continental boundaries and 1948 Amateur Radio prefixes are embodied.

A REALLY HANDSOME AND USEFUL ADDITION
TO ANY OPERATING SHACK



The design and finish is outstanding and the lady of the house (recognised arbiter of money matters) compliments us on good value for a globe that will take its place in the best appointed living room.

PRICE 47/6 TO CALLERS. 50/- BY RAIL

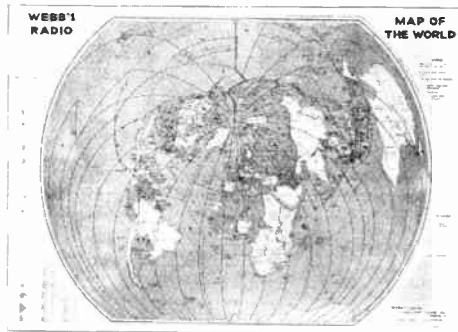

Webb's Radio Map

A new printing with revised amateur call signs, prefixes, coded to country and time-zone. The azimuthal projection is based on the Great Circle or shortest distance projection centred on London, and distances can be approximated in all directions by radial lines from that point to the circumference. The alphabetical list of prefixes is useful to listener and transmitter alike and the time-zone instructions are clearly indicated also on the margin. Printed in full colours on heavy white paper, size 40" x 30".

4/6 PLUS 6d. POSTAGE (Also available on linen with rollers 11/6 plus 9d. postage)

TRANSMITTING AND EXPERIMENTAL U.H.F. VALVES - SPECIAL OFFER

We offer well-known transmitting and experimental types at rock-bottom prices.— YOU WILL NEVER BUY THEM CHEAPER.

Webb's are not "surplus dealers," but this offer is too good to miss. All the valves are in makers' boxes, tested and brand new. They are not unboxed valves culled from broken-down equipment. (Please add 1/- for all post orders).

955 (PRICE 4/-)

ACORN TRIODE. 6.3v-0.15A.
180v-8 m/A. 250 Mc/s.

808 (PRICE 15/-)

TRIODE. 7.5v-4.0A. 1500v-
150 m/A. 30 Mc/s. Dissipation
50 watts.

832A (PRICE 25/-)

DOUBLE PENTODE. 6.3v-
1.6A. 12.6v-0.8A. 750v-48 m/A.
200 Mc/s. Dissipation 15 watts.

8012 ... (PRICE 18/6)

TRIODE. 6.3v-2A. 1000v 80 m/A. 500
Mc/s. Dissipation 40 watts. A most useful
valve for U.H.F. work; note full rating
covers 144 and 460 Mc/s.

807 ... (PRICE 7/3)

TETRODE. 6.3v-0.9
Well-known general purpose R.F. and audio
"bottle."

100TH (PRICE 35/-)

TRIODE. 5v-7.5A. 3000v-225
m/A. 40 Mc/s.

250TH (PRICE 45/-)

TRIODE. 5v-10.5A. 4000v-350
m/A. 40 Mc/s.

832 (PRICE 25/-)

DOUBLE PENTODE. 6.3v-
1.6A. 12.6v-0.8A. 500v-72 m/A.
200 Mc/s. Dissipation 15 watts.

WEBB'S RADIO, 14, SOHO ST., OXFORD ST., LONDON, W.1.

Telephone: Gerrard 2089. Shop hours: 9 a.m.—5.30 p.m. Sats. 9 a.m.—1 p.m.

Measuring Inductance of choke and transformer windings under working conditions

Windings having inductances between 100 m/Hys. and 5,000 Hys. can be measured when carrying D.C. up to 100 milliamps by using an external source and connecting as shown. The use of a high impedance choke in series with the source is necessary to avoid short circuiting the detector input.



COMPONENT BRIDGE B 101
 Capacity: 5 pfd. to 500 mfd. in eight ranges
 Resistance: 5 ohms to 500 MΩ in eight ranges
 Inductance: 0.1 Hy. to 5000 Hys. in four ranges
 Leakage 0 to 1.5 m/a Q: 0 to 30
 Precision Comparator Price 26 Guineas



THE WAYNE KERR LABORATORIES LIMITED, NEW MALDEN, SURREY. • PHONE MALDEN 2207

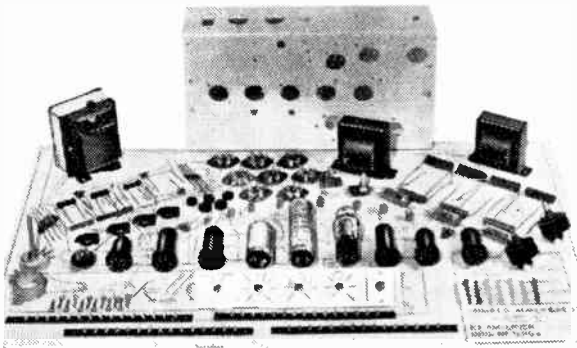

THE KI AMPLIFIER KIT

The KI Kit is undoubtedly the best high fidelity amplifier kit available at the price. Absolutely complete, very simple to construct, the performance matches up to the high standard reached by moving coil pickups. We recommend either moving coil pickups or miniature moving iron types, such as the Connoisseur, which may be used without the transformer. 7 valves are used to ensure a very low distortion level, the output stage being tetrodes with negative feedback. Price 13 gns. Blueprint separately 2.6d.

Our new 16 page catalogue "Living Music"—fully illustrated and showing our complete range of amplifiers and tuning units, and the new Corner Cabinet (which is available without the loudspeaker) is now ready. Write today (enclosing 5d. in stamps—a copy should be in the hands of every music lover.

Charles
AMPLIFIERS
 LTD

DEFERRED TERMS are now available

1e, PALACE GATE
 KENSINGTON
 LONDON W.8
 Telephone: WEstern 3350



Products of Quality & Reliability

MAINS TRANSFORMERS
A. F. TRANSFORMERS
SMOOTHING CHOKES
THERMAL DELAY SWITCHES
POWER RESISTANCES

Made by

OLIVER PELL CONTROL LTD
 Telephone: WOOLWICH 1422
 CAMBRIDGE ROW · WOOLWICH S·E·18



Dubilier

HIGH STABILITY Resistors $\frac{1}{8}$ " Watt

- Absolutely stable in operation.
- Lowest noise level.
- Maximum resistance to moisture in all operating conditions.
- Eminently suitable for use in all circuits where high stability characteristics are essential.

RESISTANCE RANGE

10 Ω	to	0.75M Ω	\pm 5%
50 Ω	to	0.5M Ω	\pm 2%
100 Ω	to	0.5M Ω	\pm 1%

DUBILIER
CONDENSER CO. (1925) LTD.

DUBILIER CONDENSER CO. (1925) LTD., DUCON WORKS, VICTORIA ROAD, NORTH ACTON, W.3
Telephone: Acorn 2241 (5 lines) Telegrams: Hilvoltcon, Phone London Cables: Hilvoltcon, London. Marconi International Code

D.17B

**10 to
310
mcs.**

Light Weight
36 lbs.
Negligible
Stray Field.
Frequency
Calibration 1%
Modulation
30% sine wave
1,000~ and
pulsed 50/50
square wave
at 1,000~.
Attenuation
Max. error at
300 mcs. \pm 2dB
Precision
Slow-Motion
Dial.
Wide Range,
10-310 mcs.
Compact
12½ in. x 13½ in.
x 7½ in.
Dual-Power
Supply
200-250v., 40-100~
80-v., 40-2000~.

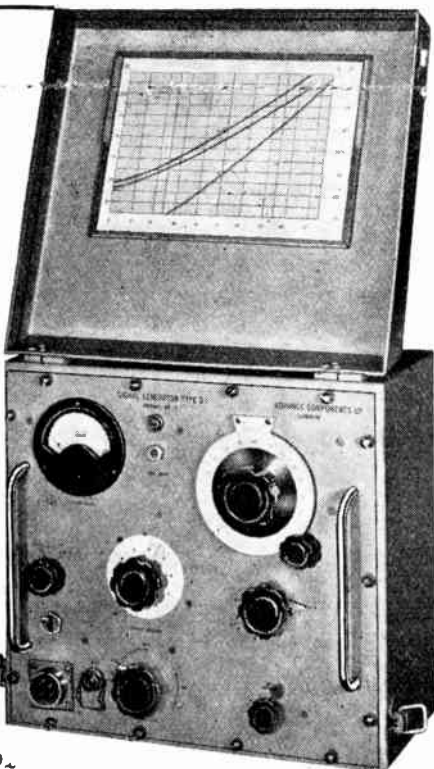

**“Advance”
Signal Generator
type D.1.**

This “ADVANCE” Signal Generator is of entirely new design and embodies many novel constructional features. It is compact in size, light in weight, and can be operated either from A.C. Power Supply or low-voltage high-frequency supplies.

An RL18 valve is employed as a colpitts oscillator, which may be Plate modulated by a 1,000-cycle sine wave oscillator, or grid modulated by a 50/50 square wave. Both types of modulation are internal, and selected by a switch. The oscillator section is triple shielded and external stray magnetic and electrostatic fields are negligible. Six coils are used to cover the range, and they are mounted in a coil turret of special design. The output from the R.F. oscillator is fed to an inductive slide wire, where it is monitored by an EA50 diode. The slide wire feeds a 75-ohm 5-step decade attenuator of new design. The output voltage is taken from the end of a 75-ohm matched transmission line.

The instrument is totally enclosed in a grey enamelled steel case with a detachable hinged lid for use during transport.

Price £80

Delivery ex Stock.

Write for descriptive Leaflet.

**ADVANCE COMPONENTS, LTD.
BACK ROAD, SHERNHALL STREET,
WALTHAMSTOW, LONDON, E.17.**

Telephone : Larkwood 4366-7.

Compact-Efficient



This Vibratorpack developed by Specialists will enable users of battery sets to operate from a 6-volt car accumulator, thus eliminating expensive H.T. battery replacements. Careful design has eliminated all interference. Consumption is less than ¾ amp.

SMALLER
than a H.T.
Battery.
Size : 7 x 5½ x 3



**Masteradio
VIBRATORPACK**

MASTERADIO LTD., Sales Dept., 319/321, Euston Road, London, NW.1

Put a “Q-MAX” V.H.F. CONVERTOR
in front of your Receiver for
2, 5, 6 and 10 metres.

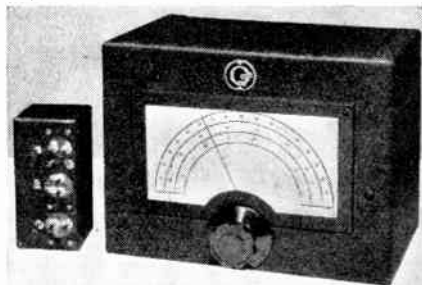

**17
GNS.**

COMPLETE WITH MAINS PACK AND 1 COIL UNIT.
(Extra Coil Units 30/-)

- All components in stock for Williamsons Amplifier, Electronic Television, etc.
- Full range of Woden, R.T.S. Transformers, Denco Coils, Mikes and Stands.
- Gramophone Motors, A.C. and A.C. D.C.
- 31” and 63” Racks complete.
- G.E.C. Home Broadcaster 42 -

BERRYS
(SHORT WAVE LTD.)

25, HIGH HOLBORN, LONDON, W.C.1.
(Opposite CHANCERY LANE.)
Tel. : HOL 6231.

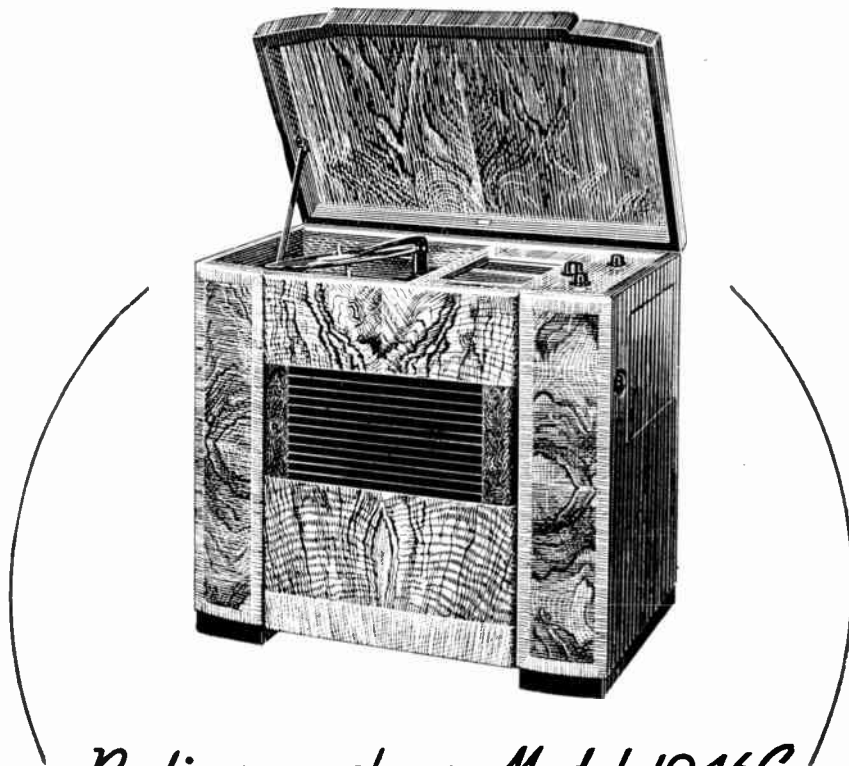

Radiogramophone Model 1046G

A 10-valve, all-wave auto-radio-gramophone with 12 inch duplex cone moving coil loudspeaker having substantial level response from 40-10,000 cycles is an outstanding feature of this superheterodyne model. Five wave bands individually illuminated on the 10 inch vertical dial. Cathode ray tuning indicator and variable selectivity control, lightweight high fidelity pick-up. The automatic record changer plays eight 10 or 12 inch records mixed in any order. Cabinet of figured walnut with cross banding and ebonised sound louvres and base.

RGD *The Aristocrat of Radio*

SALES & SERVICE DEPOTS :

LONDON
3-4, Hampton Court Parade,
East Molesey, Surrey.
Tel. : Molesey 4357-8.

BIRMINGHAM
187, Corporation Street, 4.
Tel. :
CENTral 2403.

MANCHESTER
12, Cateaton Street, 3,
Tel. :
BLAckfriars 1951.

RADIO GRAMOPHONE DEVELOPMENT CO. LTD.
BRIDGNORTH SHROPSHIRE

ANOTHER B.S.R. MASTERPIECE

A MOST SENSATIONAL SELLING LINE

CONGRATULATIONS +



Today's outstanding development - a mains operated record player with inbuilt 3 watt amplifier, speaker and new fool-proof auto-stop motor. The 'Recordmaster' sells on first sight of its attractively styled case - it can be played anywhere, anytime. Send for details now.

Price £11-11-0 list.

Recordmaster

BIRMINGHAM SOUND REPRODUCERS LIMITED, OLD HILL, STAFFS.

DAWE

PULSE GENERATOR



Type 412.

A versatile instrument for use wherever rectangular voltage pulses are required.

Output: 0-75 volts positive or negative.

Pulse Widths: 1, 10 and 100 microseconds.

Repetition Rates: 1-2,500 c.s. (10,000 c.s. from an external source.)

Full technical data from: **DAWE INSTRUMENTS LIMITED**
 130 UXBRIDGE RD., HANWELL, LONDON, W.7 : EALING 6215

AMBASSADOR

4756 Chassis

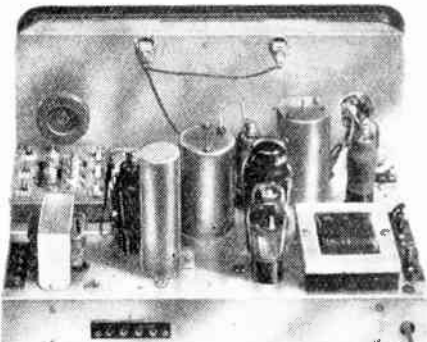

SPECIFICATION:
 5 valve A.C. or A.C./D.C. Super-Het. 6 wave bands covering from 9.4 to 1940 metres. (Electrical Band Spreading.) 10" P.M. Speaker. £22.8.2 TAX PAID. Immediate Delivery can be given.

WRITE FOR FULL DETAILS TO: **R. N. FITTON LTD.**

AMBASSADOR RADIO WORKS
 HUTCHINSON LANE, BRIGHOUSE, YORKS.

Designed to suit the circuit

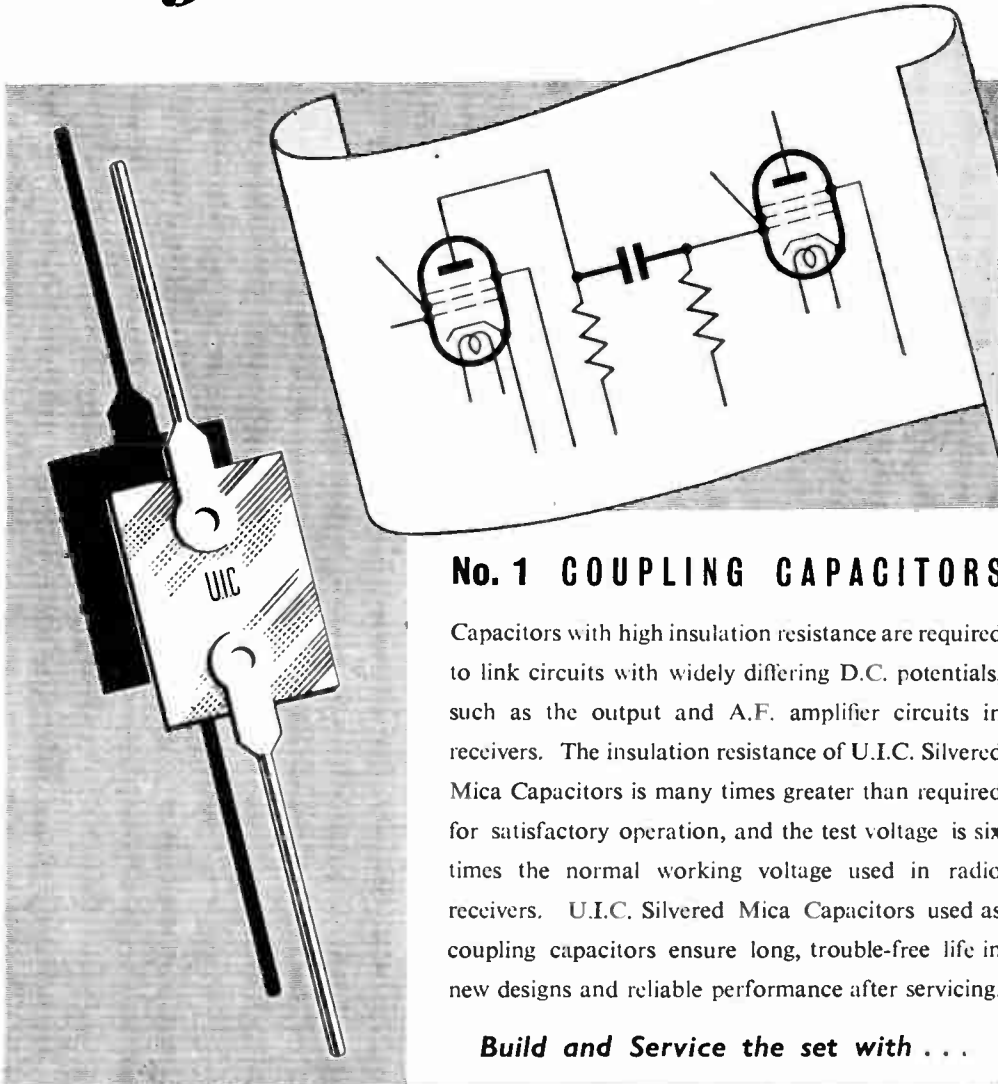

No. 1 COUPLING CAPACITORS

Capacitors with high insulation resistance are required to link circuits with widely differing D.C. potentials, such as the output and A.F. amplifier circuits in receivers. The insulation resistance of U.I.C. Silvered Mica Capacitors is many times greater than required for satisfactory operation, and the test voltage is six times the normal working voltage used in radio receivers. U.I.C. Silvered Mica Capacitors used as coupling capacitors ensure long, trouble-free life in new designs and reliable performance after servicing.

Build and Service the set with . . .

U.I.C. HIGH STABILITY CAPACITORS

UNITED INSULATOR CO. LTD. OAKCROFT RD. TOLWORTH SURBITON SURREY

EDX.16.J.

The best—
HIGH and LOW



Exide
L.T. ACCUMULATORS
and
Drydex
H.T. BATTERIES

*for better
battery radio reception*

ISSUED BY THE CHLORIDE ELECTRICAL STORAGE COMPANY LIMITED

HIVAC
THE SCIENTIFIC
VALVE
BRITISH MADE

Pioneers & Specialists in Small Valves

LONDON H.V.C.
PM
NOV
1948
BRITAIN

Messrs. Hivac Ltd
Greenhill Crescent
Harrow-on-the-Hill,
Middx.

*THE address for:—
Subminiatures—Midgets—Miniatures
and Cold Cathodes*

**For precision alignment of Tuned Circuits
and visual observation of Electrical
Phenomena.**



Illustrated are the latest models of the 1200B Oscilloscope and the 1400B Visual Alignment Signal Generator.

Special features of the Oscilloscope are:

High gain D.C. amplifiers on both axes, linear time base with perfect synchronisation at any frequency. Complete independence of all controls from each other.

The 1400B Unit will show the shape and characteristics of a tuned circuit response curve on the Oscillograph screen. Thus perfect alignment of an I.F. or R.F. amplifier is easily accomplished. Overall size of combined instruments: 7" wide, 11" high, 9" long.

• We also make electronic equipment for special purposes. If you have a problem in this field we will be pleased to co-operate.

Early Deliveries.

• Model 1200B Oscilloscope, £32 0 0 • Model 1400B Unit, £8 10 6
Write for Specifications to:—

INDUSTRIAL ELECTRONICS
229, Hale Lane, Edgware, Middx. Tel.: EDG. 7312
Makers of Industrial Controls and Precision Instruments.

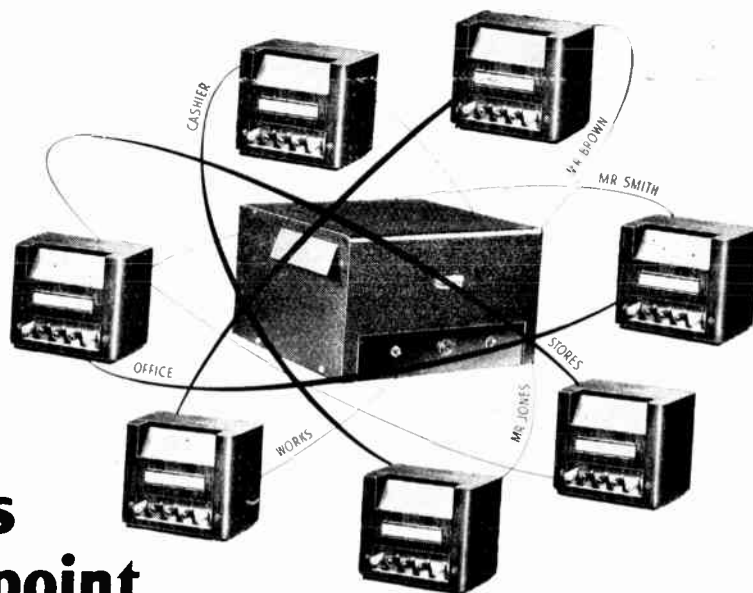

Make calls from any point with the Hadley **MULTICOM**...

The first system of its kind to provide complete loudspeaker intercommunication between all points. Up to seven Departments are instantly in touch with one another by the flick of a switch. All stations are identical. Priority of call is provided on the principal unit.

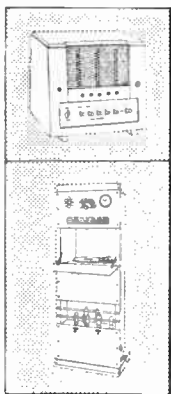

Other Hadley Products

THE HADLEY INTERCOMMUNICATOR

designed for personal communication between master unit and any or all of the sub-stations and also incorporates the novel feature of a desk radio which can be relayed to the sub-stations. An inexpensive aid to efficiency.

THE HADLEY INDUSTRIAL UNIT

proved to be well in advance of any similar equipment. Provides all facilities for 'Staff Location,' 'Music for the Workers,' 'Time Signals,' etc.

All Hadley Equipments are available on Cash Purchase or Rental Maintenance terms.

All export enquiries to be addressed to our export agent :

CHARLES BAGLIN,

411 COVENTRY ROAD, BIRMINGHAM, 10

Telegrams : Pentagons, Birmingham.

Hadley

Sound Equipments

Phone: BEArwood 2575/6 | BEARWOOD ROAD, SMETHWICK, STAFFS.

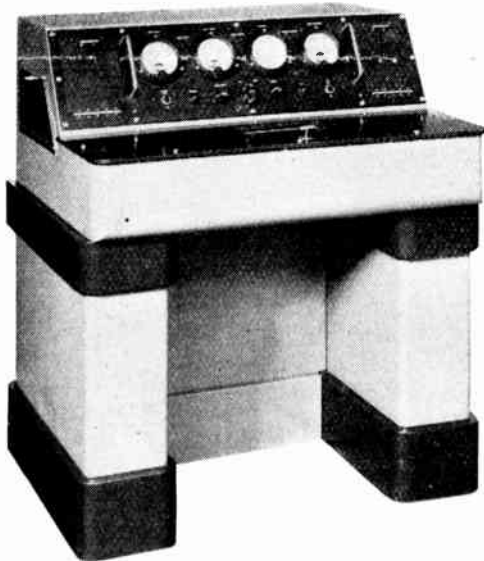

RESISTOR NOISE METER

Manufactured to an approved Ministry of Supply specification for the measurement of inherent noise above one microvolt in fixed and variable resistors.

PLEASE WRITE FOR FULL DETAILS TO
ERSKINE LABORATORIES LTD—SCALBY, SCARBOROUGH, YORKS.

**“You’re CERTAIN to get
it at ARTHURS !”**

★ **VALVES:** We have probably the largest Stock of valves in the Country, including:—

25Z6GT	11 -	CY32	11 -
25L6GT	12 10	6N7	18 3
2A3	11 7	6SN7	18 3

all guaranteed.

Ex-Govt. brand new **A.C. TEST BOARD** approx. 12 in. x 6 in., completely wired comprising:—
A.C. voltmeter, 300 v. 15 amp. bridges and fuses, 15 amp. 2-pin surface sockets, 2 fuse wire holders. Complete..... £1 2 6

PERSONAL RADIO SETS IN STOCK
New Olympic Romac, Long and Medium Wave £17 16 11
Ever Ready

REMINGTON FOURSOME SHAVERS
210-250 v. AC/DC

ALL AVO AND TAYLORS METERS. List on request.

ALSO STOCKISTS OF ALL DOMESTIC APPLIANCES.

London's Oldest Leading Radio Dealers.

Arthur's EST. 1919
PROPS: **ARTHUR GRAY. LTD.** Terms C.O.D. or cash with order.

Our Only Address: **Gray House, 150, Charing Cross Rd., London, W.C.2** Telephone Bar 5833/4.
ELECTRICAL, TELEVISION & RADIO ENGINEERS.



... is it Rotary or Pushbutton or Slider? Is it wanted for circuit selection, band selection, tap switching? Is it for a new design or in quantities for a well-proved circuit?

Whatever it is—the answer is always **OAK!**

The basic design of all Oak switches is one of strength and efficient functioning, including such exclusive features as the double-contact clip and the floating rotor, ensuring self-alignment of each section.

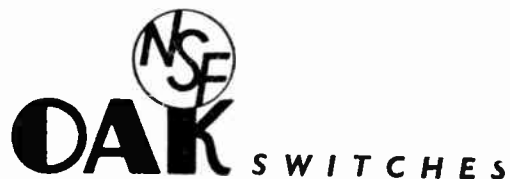

BRITISH N.S.F. CO. LTD., Keighley, Yorkshire
(Sole Licensees of OAK Manufacturing Co., Chicago)



DRY ELECTROLYTIC CONDENSERS

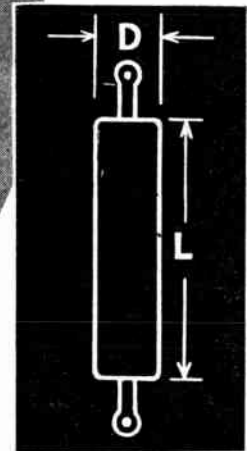

REMEMBER
GENEROUSLY
SAT - NOV 6TH

TROPICAL MINIATURES

CAPACITANCE in Mfds	PEAK W'KG VOLTS	DIMENSIONS IN INCHES		TYPE NUMBER	LIST PRICE EACH
		Body Length	Diameter		
20	12	1.9/16	0.34	CE30B	2/6
30	15	1.5/16	7/16	CE70B	2 9
10	25	1.9/16	0.34	CE30C	2 6
5	50	1.9/16	0.34	CE30D	2 6
3	100	1.9/16	0.34	CE30E	2 6
2	150	1.9/16	0.34	CE30G	2 6
1	350	1.9/16	0.34	CE30N	2 6

The small dimensions, wide temperature range (-30°C to 71°C), and robustness of these fully tropicalised condensers have proved invaluable to designers of the most compact types of portable apparatus. Like the popular T.C.C. "Micropack" range, they are of all-Aluminium plain foil construction and are hermetically sealed into aluminium tubes by means of neoprene rubber bungs.

Full details are available on request.

IN THE BEST SETS YOU'LL SEE 

THE TELEGRAPH CONDENSER CO. LTD.

RADIO DIVISION

NORTH ACTON · LONDON · W·3

Telephone. ACORN 0061

THE LARGEST PRODUCERS of FLEXIBLE SHAFTING

offer you

TORSIONAL REMOTE CONTROL and FLEXIBLE SHAFT ASSEMBLIES

DEFLECTIONLESS SLOW SPEED OPERATION

POWER SHAFTS FOR HIGH SPEED OPERATION

PUSH-PULL OPERATION

TENSION OPERATION

for

- ... speedometers
- ... car radio etc
- ... tachometers
- ... starters
- ... brakes

The S.S. White Company of Great Britain Ltd

BRITANNIA WORKS · SAINT PANCRAS WAY · CAMDEN TOWN · LONDON · N · W · 1

TELEPHONE : EUSTON 5393

W.T. 501

STEWART TRANSFORMERS

RELIABLE TRANSFORMERS AND CHOKES FOR CONTINUOUS SERVICE. OPEN AND TOTALLY ENCLOSED TYPES.

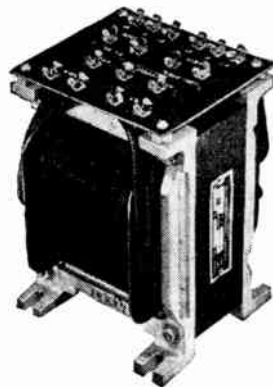

- EHT Transformers for Television. Medium and Low Voltage Types for Radio and Industrial Use.
- Ex Stock: Transformers and Chokes for "Electronic Engineering" Television.

STEWART TRANSFORMERS Ltd.
1021 FINCHLEY RD., LONDON, N.W.11
Tel.: SPEdwell 3000 and 3533

Only with

CO-AX

R.F. CABLES

AIR-SPACED ARTICULATED

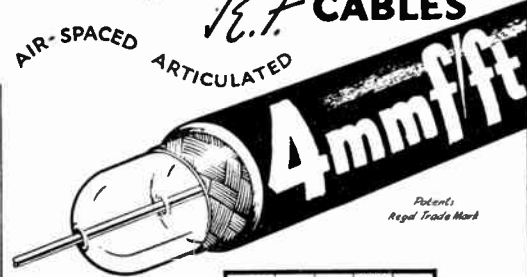

THE LOWEST EVER CAPACITANCE OR ATTENUATION

IMMEDIATE DELIVERIES FOR HOME & EXPORT

TRANSRADIO LTD.
CONTRACTORS TO H.M. GOVERNMENT
138A CROMWELL ROAD LONDON SW7
Cables: TRANSRAD LONDON

LOW ATTEN TYPES	IMPED OHMS	ATTEN dB/100ft	LOADING per 100ft	Q.D.
A 1	74	1.7	0.1	0.36
A 2	74	1.3	0.24	0.44
A34	73	0.6	1.5	0.88
LOW CAPAC TYPES	CAPAC pF/ft	IMPED OHMS	ATTEN dB/100ft	Q.D.
C 1	7.3	150	2.5	0.36
PC.1	10.2	132	3.1	0.36
C 11	6.3	173	3.2	0.36
C 2	6.3	171	2.15	0.44
C22	5.5	184	2.8	0.44
C 3	5.4	197	1.9	0.64
C33	4.8	220	2.4	0.64
C44	4.1	252	2.1	1.03

HIGH POWER FLEXIBLE

PHOTOCELL CABLE

VERY LOW CAPACITANCE

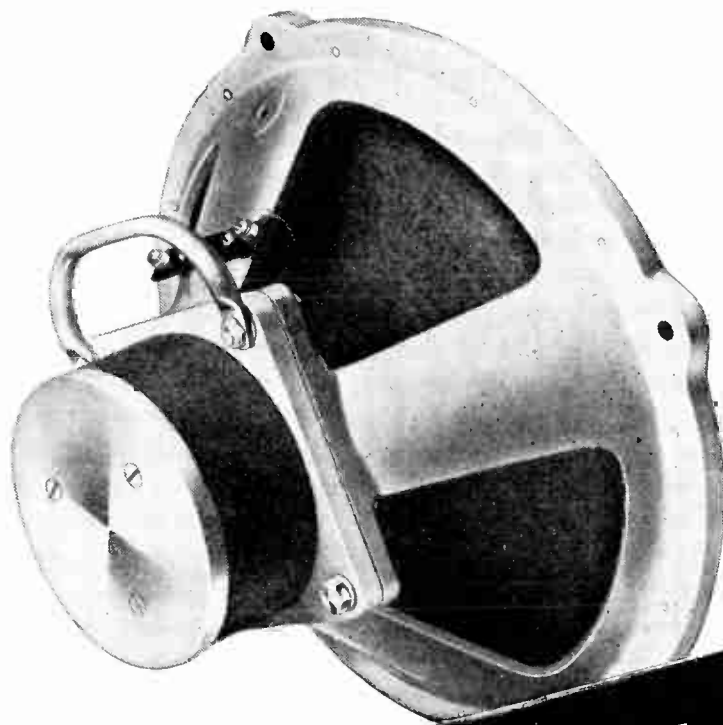

**They speak
for
themselves...**

The SS10A 12-inch Heavy Duty Speaker, illustrated, offering a frequency response from 55 to 11,000 c.p.s. and handling 10 watts is a typical example of TRUVOX workmanship.

Fidelity of response speaks for itself to the discriminating ear. Precision manufacture is no less eloquent to the trained engineer. These qualities are making TRUVOX speakers famous.

TRUVOX

TRUVOX ENGINEERING CO. LTD · EXHIBITION GDS · WEMBLEY · ENG

P. X. 59

HAIG'S FUND · BRITISH LEGION APPEAL



Remember, Saturday, November 6th
PLEASE GIVE GENEROUSLY



This Space has been given by GOODMAN'S INDUSTRIES LIMITED
Manufacturers of Loudspeakers, Lancelot Road Wembley, Middlesex

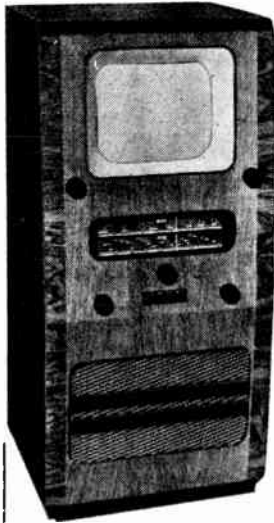

Radio-Television
De-Luxe

- ★ 12" Cathode Ray Tube giving brilliant picture 10 1/2" x 8 1/2" with exceptionally sharp definition.
- ★ Automatic focusing stabiliser.
- ★ Vision unit of advanced design applying principle of push-pull output, utilising high frequency valves.
- ★ Pre-set picture hold. Picture modulated to full brilliance and frequency range.
- ★ Push button selector switches.
- ★ Send for further details of this and other models.

The GARRICK
12 months' generous guarantee backed by unsurpassed service.
Wholesale Distributors

53 FARRINGTON RD.,
LONDON, E.C.1
Tel. HOLborn 2053

JOHN LOGIE-BAIRD LTD., Rayners Lane, Middlesex.
Telephone: Pinner 2051



TRANSFORMERS, Etc. for QUALITY AMPLIFIERS

PARTRIDGE	
500-0-500 180 mA, 4 v. 4 a., 4 v. 8 a., 4 v. 2 a., 4 v. 2 a.	£2 0 0
WWFB/M	
425-0-425 200 mA, 6.3 CT. 2 a., 6.3 CT. 2 a., 6.3 CT. 4 a. 5 v. 3 a.	£5 0 0
T500/220A	
500-0-500 220 mA, 6.3 v. 5 a., 5 v. 3 a.	£5 8 0
T350/120/A	
350-0-350 120 mA, 5 v. 2 a., 6.3 v. 4 a., 6.3 v. 2 a.	£2 11 7
T350/80A	
350-0-350 80 mA, 5 v. 2 a., 6.3 v. 3 a., 6.3 v. 1 a.	£2 4 5
Swinging choke 5-15H 250 mA	50 0
" " 3-8H 150 mA	28 0
Smoothing choke 22H 120 mA	25 10
" " 15 H 100 mA	22 2
" " 25H 60 mA	19 6
" " 30H 40 mA	19 2
Anode choke 300H 10 mA	25 0
Wetler current transformer, 500 mA, 100 mA, 2.5 a.	63 0
As above, but 0-1 a., 100 mA, 10 mA	63 0
Type TRL/FAB 600 ohm-grid	39 0
Intervalve 8CT/AB	42 3
Intervalve 240 1-3 ratio	45 9
Intervalve 60 1-3 ratio	42 3
Type TR PPO/L600 ohms	42 0
Williamson Output trans.	113 0
WODEN	
PTM11A 250-0-250 60 mA, 5 v. 2 a., 6.3 v. 3 a.	39 0
PTM13A 350-0-350 120 mA, 5 v. 2 a., 6.3 v. 4 a.	55 0
PTM14A 425-0-425 v. 150 mA, 5 v. 3 a., 6.3 v. 4 a.	70 0
PTM16 650-0-650 250 mA	87 6
DTM17 750-0-750 250 mA	109 6
DTM18 1250-1000-0-1000-1250 v. 300 mA	172 6
PTF12 2.5 v. 10 a.	38 6
PTF13 4 v. 10 a.	41 0
PTF15 6.3 v. 4 a.	31 6
PTF17 7.5 v. 5 a.	37 6
UM1 30-watt mod.	54 0
UM2 60-watt mod.	72 6
UM3 125-watt mod.	90 0
PCF12 12H 150 mA	31 6
PCF17 20H 150 mA	41 6
PCF13 12H 250 mA	56 0
DT1 Ratio 1-1	34 0
DT2 Ratio 1.56-1	39 6
DT3 Ratio 1-3	34 0

Please include sufficient for postage and packing
Shop Hours—9 a.m.—5.30 p.m. Monday to Saturday. 9 a.m.—1.0 p.m. Thursday
Phone—AMB 5393—PAD 6116—PAD 5606

TELE-RADIO (1943) LTD. 177a Edgware Rd., London, W.2

NINE EXAMPLES

from the
"FLEXILANT"

(RUBBER BONDED
TO METAL)

RANGE
of
MOUNTINGS

OBTAINABLE
FROM STOCK

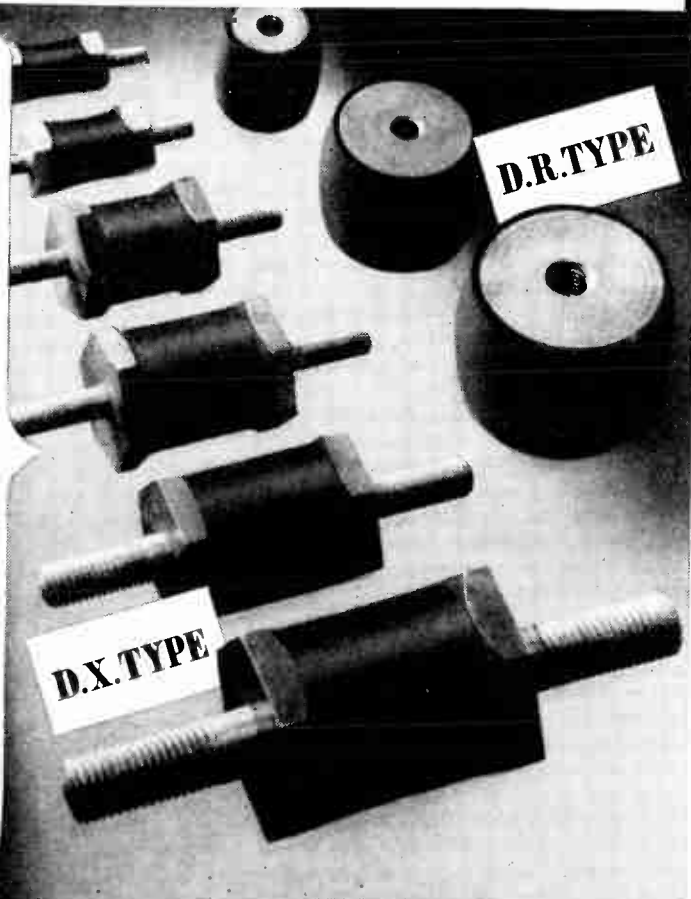

OUR TECHNICAL STAFF investigates
all mounting problems
May it investigate yours?



RUBBER BONDERS LIMITED

ENGINEERS IN RUBBER BONDED TO METAL

FLEXILANT WORKS
DUNSTABLE · BEDS.

TELEPHONE: DUNSTABLE 803-45



**Manufactured to
"ELECTRONIC ENGINEERING"
TELEVISOR SPECIFICATION**

	Retail
VISION CHASSIS fitted with screens, all valve holders, formers and dust cores ...	22/6
SOUND CHASSIS fitted with screens, all valve holders, formers and dust cores ...	18/9
TIME BASE CHASSIS fitted with valve holders and all necessary cut-outs ...	17/5
POWER CHASSIS fitted with all valve holders, 3 point sockets and single sockets ...	25/-
GANTRIES vision and sound fixing straps volume control, support panel ...	10/-
LINE OUTPUT TRANSFORMER ...	32/6
DEFLECTOR COIL ASSEMBLIES ...	32/6
FOCUS COIL ASSEMBLIES ...	32/6

**FOR PRECISION-BUILT
TELEVISION AND RADIO COMPONENTS**

5-VALVE SUPERHET RADIO CHASSIS

Drilled and fitted with 5 Amphenol Octal valve holders, aerial, earth and gramophone sockets, necessary cut-outs for all control mountings, mains transformer and tuning gang condenser. complete with 2 steel fixing feet. Retail 11/-

Can be used in conjunction with our

*Full Vision
Drive Unit*

Insulated Universal flexible drive coupling for direct mounting to condenser shaft (1/4" diameter). Provision for internal illumination. Unbreakable Perspex coloured scale, long, medium and short bands. Calibrated in metres, kilocycles and station names.

Waveband 800-2,000 m., 200-580 m., 16-50 m.

Dimensions—Maximum scale opening 10" x 4 1/2". Distance between centres 10 1/2". Retail 22/6. (2 4BA holes fixing). Total depth of unit 1 1/2". Pointer travel 7".

If you are unable to obtain A.M.C. units from your dealer, kindly communicate with us and we will put you in touch with our nearest Agent.

ALBERT MANUFACTURING COMPANY
5, SHAKESPEARE ROAD, FINCHLEY, LONDON, N.3. ENGLAND
Phones FINchley 2188 and 3332 Telegraphic Address Inland: Alberto Finch London Overseas: Alberto London

MINIATURE METERS

Our stocks of meters are the largest in the U.K. Herewith are listed our main types:

Please add postage and packing according to quantity required.

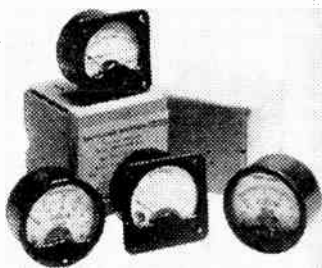

SCALE	TYPE	SHAPE	SIZE	MOUNTING	PRICE
Milliammeters					
0-5	Moving Coil D.C.	Square	2"	Flush	5/-
0-30	" "	Round	2 1/2"	"	6/9
0-40/120 ..	Moving Coil D.C., Dual Reading	Round	2"	Proj.	7/-
0-50	Moving Coil D.C.	"	2 1/2"	"	7/-
0-100	" "	Rectangular with shorting switch.	3" x 2 1/2"	"	12/6
0-150	" "	Square	2"	Flush	7/6
Ammeters.					
0-5	R.F. Thermocouple	Square	2"	"	5/-
0-2.5	" "	Round	2"	Proj.	7/3
0-3	" "	Round with bracket	2"	Flush	6/6
0-4	" "	Rectangular with shorting switch.	3" x 2 1/2"	Proj.	6/6
10-0-20 ..	Moving Coil D.C.	Round	2"	Flush	5/6
0-14	Moving Iron	"	1 1/2"	switchboard	15/-
0-20	Moving Coil D.C.	"	2"	Proj.	5/6
0-25	Moving Iron	"	2 1/2"	Flush	5/6
0-30	Moving Coil D.C.	Square	2"	"	7/-
0-40	Moving Iron	Round	2 1/2"	Proj.	6/6
50-4-50 ..	Moving Coil D.C.	Square	2"	Flush	5/6
Voltmeters.					
0-150	Moving Coil D.C.	Round	2 1/2"	Flush	5/6
0-300	" "	Square	2"	Flush	5/6

Terms: C.W.O. Remittances payable to E. & G. Distributing Corporation Ltd.

M.O.S. MAIL ORDER SUPPLY CO., Dept. W.W.,
3, Robert St., Hampstead, London, N.W.1.
CALLERS TO: 24, New Rd., London, E.1. (Stepney Green 2760-3906)

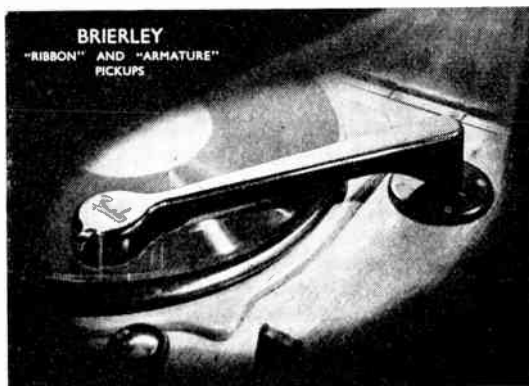

RIBBON PICKUP, type JB/P/R/1

Frequency range, 20 c/s to 40,000 c/s.
Permanent point 6 times harder than sapphire and more robust.
Point pressure, 1/8 oz.
Output voltage, 10 to 15 mV. across 15,000 ohms approx.
"Floating Element" design prevents arm torsional resonance.
Price in U.K. including special mumetal screened transformer and Purchase Tax, £10/14. 11.

Ten years or so ago, the main interest in gramophone reproducing equipment was centred in extending the range from about 4500 c/s to 8 or 9 kc/s.

Today, with the advent of wide range recordings, our interest is in the further octave, 8 kc/s to 16 kc/s.

Users of the Brierley Ribbon Pickup Type JB/P/R/1 are in a position—the rest of the equipment would allow—to add not one but two and a half octaves.

Our concern at the present time however is to reproduce *faithfully* to the present limit of the record and we believe we have gone a long way in this when over 90% of our listeners prefer the extra octave between 8 and 16 kc/s and feel that something very much worth while is lost by its omission.

J. H. BRIERLEY (GRAMOPHONES & RECORDINGS), LTD.,
46, TITHEBARN STREET, LIVERPOOL.

MAZDA AC/DC MINIATURES

10 LD II DOUBLE-DIODE TRIODE

(List price 12/-)

RATING			
Heater Current (amps)	I_h	0.1	
Heater Voltage (volts)	V_h	15	
Maximum Anode Voltage (volts)	$V_a(\max)$	250	
Maximum Cathode Current (mA)	$I_k(\text{av})\max$	5	
Mutual Conductance (mA/V)	g_m	*3.4	
Anode Impedance (ohms)	r_a	*9,300	
Amplification Factor	μ	*31.5	
Maximum Mean Diode Current per diode (mA)	$I_a(d)\text{av}(\max)$	0.1	
Maximum Potential Heater/Cathode (volts rms)	$V_{h-k}(\max)$	150	

* Taken at $V_a=100v$; $V_g=0v$.



10 P 14 OUTPUT TETRODE

(List price 13/-)

RATING			
Heater Current (amps)	I_h	0.1	
Heater Voltage (volts)	V_h	40	
Maximum Anode Voltage (volts)	$V_a(\max)$	250	
Maximum Screen Voltage (volts)	$V_{g2}(\max)$	250	
Maximum Anode Dissipation (watts)	$w_a(\max)$	10	
Maximum Screen Dissipation (watts)	$w_{g2}(\max)$	3	
Mutual Conductance (mA/V)	* g_m	7.2	
Inner μ	* $\mu_{g1, g2}$	*11.2	
Maximum Potential Heater/Cathode (volts RMS)	$V_{h-k}(\max)$	150	

* Taken at $V_a=175$; $V_{g2}=175$; $V_{g1}=-9.4$



10 P 13 OUTPUT TETRODE

(List price 13/-)

RATING			
Heater Current (amps)	I_h	0.1	
Heater Voltage (volts)	V_h	40	
Maximum Anode Voltage (volts)	$V_a(\max)$	250	
Maximum Screen Voltage (volts)	$V_{g2}(\max)$	250	
Maximum Anode Dissipation (watts)	$w_a(\max)$	6	
Maximum Screen Dissipation (watts)	$w_{g2}(\max)$	1.8	
Mutual Conductance (mA/V)	g_m	*7.5	
Inner Mu	* μ_{g1-g2}	*13	
Maximum Potential Heater/Cathode (volts rms)	$V_{h-k}(\max)$	150	

* Taken at $V_a=V_{g2}=150v$; $I_a=30 \text{ mA}$.



U404 HALF-WAVE RECTIFIER

(List price 11/6d.)

RATING			
Heater Current (amps)	I_h	0.1	
Heater Voltage (volts)	V_h	40.0	
Maximum Anode Voltage (volts RMS)	$V_a(\text{rms})\max$	250	
Maximum Peak Inverse Anode Voltage (volts)	P.I.V.(max)	750	
Maximum Mean Anode Current (mA)	$I_a(\text{av})\max$	90	
Maximum Peak Anode Current (mA)	$I_a(\text{pk})\max$	700	
Maximum Peak Potential Heater/Cathode with Heater negative (volts)	$V_{h-k}(\max)$	550	



Other valves in the AC/DC Range—10C1 FREQ. CH.—10F9 VAR. μ H.F. PEN. Further details on application.

EDISWAN MAZDA RADIO RADIO VALVES AND CATHODE RAY TUBES

v78

THE EDISON SWAN ELECTRIC CO. LTD., 155 CHARING CROSS ROAD, LONDON, W.C.2

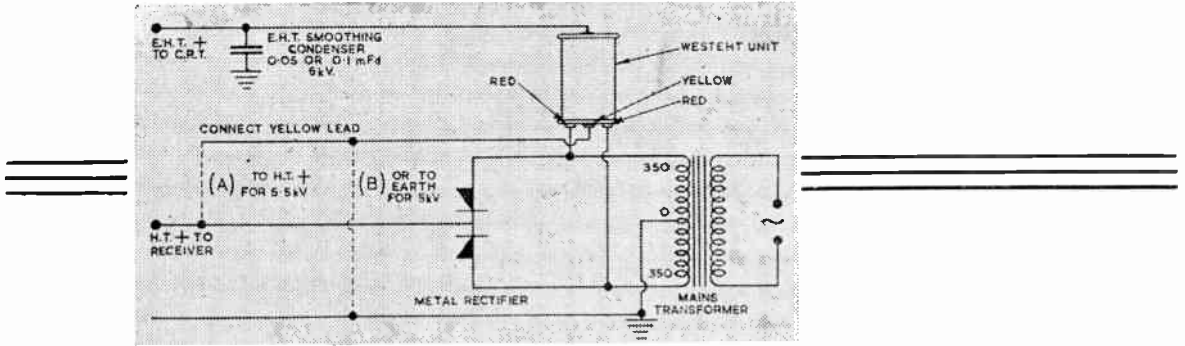

THE SIMPLEST WAY to obtain E.H.T.

is to connect a



to the 350-0-350 volts winding of the normal mains transformer and obtain a 5.5kV DC output without using an E.H.T. transformer and valve rectifier.

Write for data sheet No. 52 to Dept. W.W.11.

Westinghouse Brake & Signal Co., Ltd., 82, York Way, King's Cross, London, N.1

1238



PLAN YOUR CAREER

RADIO • TELEVISION
and other INDUSTRIAL
ELECTRONIC subjects

WRITE NOW FOR FREE BOOKLET summarising the careers available in Electronics and giving particulars of Training Courses offered by E.M.I. Institutes, Ltd.

The booklet contains full details of Correspondence Courses in Radio, Television, Telecommunications and Industrial Electronics.

Daytime and Evening Attendance Courses, and Special Courses for candidates taking I.E.E., Brit.I.R.E., and City & Guilds examinations are also available.

Payment for tuition can be made in easy instalments if required.

E.M.I. INSTITUTES LTD.

Dept. 16, 43 Grove Park Road, Chiswick, London, W.4. Telephone CH1swick 4417/8

E.M.I. Institutes — backed by the Electronic Organisation which includes "H.M.V.", Columbia, Marconiphone, etc.

E.90A



- 22 Ranges.
- Long-life batteries.
- VHF probe and 5000v. D.C. multiplier optional.



The multi-range meter that will measure A.F. & R.F. signal voltages!

ELECTRONIC INSTRUMENTS LTD
17 Paradise Road, Richmond, Surrey

PREMIER RADIO COMPANY

MORRIS & CO. (RADIO) LTD.

**NOW OPEN—COMMODIOUS NEW PREMISES AT
152-153, FLEET STREET, E.C.4**

(No. 169 will remain open as usual). All POST ORDERS to 167, LOWER CLAPTON ROAD, LONDON, E.S.
Terms of Business: Cash with order or C.O.D. over £1. Send 2 d. Stamp for list.

'Phone: AMHerst 472.

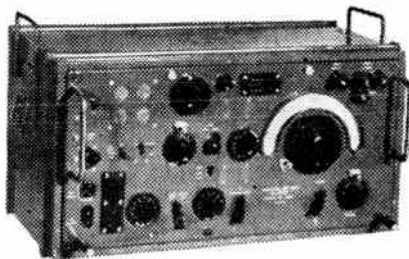

B107. ONE OF THE ARMY'S FINEST COMMUNICATIONS RECEIVERS. (See "W.W.", August, 1945.) 9 valves, R.F. amp. osc. Frequency Changer, 2 I.F.'s (465 kc), 2nd Detector, AVC. Af. amp. B.F.O. A.C. mains, 100-250 v. or 12 v. a.c.m. Frequency range 17.5 to 7 mc/s. 7.25 mc/s to 2.9 mc/s, 3.0 to 1.2 mc/s Monitor L.S. built in. Complete. Write for full details. £16/10/-. Carriage paid.

THE FAMOUS R.1155 RECEIVER. These are all brand new and unused. Frequency range 18.5 mc/s—75 kc/s. in 5 wavebands. Complete with 10 valves (including Magic Eye). Completely enclosed in black cracked metal case, 16in. x 9in. x 9in.

Brand new £12 12 0

R155 POWER UNIT INCORPORATING OUTPUT STAGE. A robust unit contained in a black enamelled case 10in. x 8in. x 6in., which matches the Receiver. The power supply is 250 v. at 80 m.A. which is ample for the R.1155 Receiver and output stage. Primary is for 100-250 v. 50 cycle mains.

Power unit with built-in output stage (6F6) with output transformer £3 10 0
Power unit only £2 10 0

CAR RADIO VIBRATOR PACKS. 12 volts input, 250 v. 60 m.A. output, completely smoothed and fitted with suppressors. All contained in a steel case 10in. x 8in. x 6in. £2 0 0

H.T. ELIMINATOR AND TRICKLE CHARGER KIT. Consists of a complete kit of parts to construct an H.T. Eliminator with an output of 120 v. at 20 m.A., and provision for Trickle Charging a 2 v. Accumulator. Two Metal Rectifiers are employed. With circuit, 35/-.

PREMIER COIL PACK 4-BAND. Consists of a fully wired and calibrated Coil Pack of the latest type. 5-position switch includes a gram. position.

Wavebands covered 13.6-52 metres (22-5.8 mc/s) 31-200 metres (5.9-1.6 mc/s) 200-550 metres and 900-2100 metres. Air Dielectric Trimmers on all Short Wave Coils. Unit consists of 3 screened sections AERIAL, R.F. and oscillator.

Dimensions of Pack, 6in. x 4 1/2in. x 2 1/2in. Also included pair I.F. Transformers with permeability tuned Litz windings of high "Q" 3-gang condenser, drive spindle, drive wheel.

Price with circuit diagram 85/- or complete with coloured glass dial, backplate, pointer, dial light brackets and drilled 7-valve chassis, with blue print, 5/10/-.

PREMIER MAINS TRANSFORMERS. All primaries are tapped for 200-230 v. mains 40-100 cycles.

All primaries are screened. All L.T.'s are centre-tapped.

List No.	Output	Price.
SP.175A	175-0-175 v. 50 m/a., 6.3 v. 2-3 a., 5 v. 2 a.	25/-
SP.175B	175-0-175 v. 50 m/a., 4 v. 1a., 4 v. 2-3 a.	25/-
SP.250A	250-0-250 v. 60 m/a., 6.3 v. 2-3 a., 5 v. 2 a.	25/-
SP.250B	250-0-250 v. 60 m/a., 4 v. 1-2 a., 4 v. 3-4 a.	25/-
SP.300A	300-0-300 v. 60 m/a., 6.3 v. 2-3 a., 5 v. 2 a.	25/-
SP.300B	300-0-300 v. 60 m/a. 4 v. 2-3 a., 4 v. 3-4 a., 4 v. 1-2 a.	25/-
SP.301A	300-0-300 v. 120 m/a., 5 v. 2-3 a., 6.3 v. 3-4 a.	28/-
SP.301B	300-0-300 v. 120 m/a., 4 v. 2-3 a., 4 v. 2-3 a., 4 v. 3-5 a.	28/-
SP.350A	350-0-350 v. 100 m/a., 5 v. 2-3 a., 6.3 v. 2-3 a.	29/-
SP.350B	350-0-350 v. 100 m/a., 4 v. 2-3 a., 4 v. 2-3 a., 4 v. 3-5 a.	29/-
SP.351A	350-0-350 v. 150 m/a., 4 v. 2-3 a., 4 v. 3-6 a. 4 v. 1-2 a. 4 v. 1-2 a.	39/-
SP.352	350-0-350 v. 150 m/a., 5 v. 2-3 a., 6.3 v. 2-3 a., 6.3 v. 2-3 a.	36/-
SP.375A	375-0-375 v. 200 m/a., 6.3 v. 2-3 a., 6.3 v. 3-5 a., v. 2-3 a.	46/-

SP.425A 425-0-425 v. 200 m/a., 6.3 v. 2-3 a., 6.3 v. 3-5 a., 5 v. 2-3 a. 47/-

SP.501A 500-0-500 v. 150 m/a., 5 v. 2-3 a., 6.3 v. 2-3 a., 6.3 v. 2-3 a. 50/-

INDICATOR UNIT TYPE 174 contains: 1 C.R. Tube VCR138, 1 C.R. Tube VCR521, 2 Mu. Metal Screens 1 VT60A (807), 3 VR54, 1 VR116, 5 VR65, 14 Potentiometers, 4 Relays, 2.02 mfd. 5000 v. working Condensers, over 50 resistors, 1 switch 5-pole 2-way, 1 Switch 4-pole 4-way Condensers, Valveholders, Co-Axial Plugs, Transformers, etc. A remarkable radio bargain at 85/-.

RECEIVER TYPE B302A. Radar Unit contains 14 valves: 1 VR137, 4 VR31, 2 VR136, 3 VR65, 1 VU111, 1 VU39, 2 VR92.

Receiver contains 45 mc/s I.F. strip which makes the Unit ideal for conversion to a Vision Receiver. There is ample space for building time bases. Also included in the Unit are the following: 24 volt motor-driven, Switch Unit, over a dozen Co-Axial Plugs and Sockets, Resistors, Heater Chokes, Transformers and 01 mfd. 5,500 volt working Condenser £3 10 0

PREMIER KITS AT REDUCED PRICES

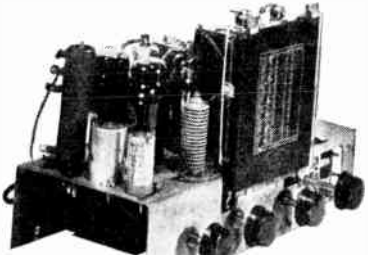

ALL-WAVE SUPERHET KIT. A Kit of Parts to build a 6-valve (plus rectifier) receiver, covering 16-50 metres. Medium- and Long-wave bands. Valve line-up, 6K6, 6K7, 6Q7, 6J7, two 2A5 in push-pull. Metal Rectifiers are incorporated for H.T. supply. Output impedance is for 3 and 15 ohms. The latest Weirite Coil Pack incorporating Iron Dust Coils is used making construction and alignment extremely simple. A pick-up position on the wave-change switch and pick-up terminals is provided. A complete kit, including valves, but without speaker or cabinet. Chassis size, 14in. x 6in. Overall height, 9in. Price £10 16 6. Including Purchase Tax. Wired and tested. £12 10 0.

Suitable loudspeakers are the GOODMANS 10in. 6-watt P.M. at 47/6, or for superlative reproduction, the Goodmans 12in. P.M. at £6 15 0.

RECEIVER TYPE 184. Radar Unit containing 14 valves: 1 CUG7, 4 VR91, 7 VR65, 1 VU111, 1 VR92. Unit contains a 45 mc/s I.F. Strip suitable for use as a Vision Receiver. There is ample space for building Power Packs or Time Bases. Also included are 5 Potentiometers, .01 mfd. 2,500-volt Condenser, 2 Relays, 3 Neon Lamps, a quantity of Resistors, Condensers and Co-Axial Sockets £2 5 0

NEW 2-VALVE ALL WAVE KIT. 16 to 2,000 metres. Switched Coil Pack ready wired and tested. 2 Mazda H123 Valves, Phones, H.T. and L.T. Batteries, Condensers, resistors, diagram and steel case, all ready to assemble, £3 10 0, including Purchase Tax.

ALL WAVE RECEIVER KIT. 7-valve (plus Metal Rectifier for H.T. Supply) Superbet: for AC/DC Mains 200/250 volts, 40/60 cycles. Four wavebands 13.6-52 metres (22-5.8 mc/s), 51-200 metres (5.9-1.5 mc/s), 200-550 metres and 900-2100 metres. The five position switch includes a Pick-up Position, and Pick-up Terminals are provided. Valve line-up 6K7 (R.F.), 6K5 (Frequency Changer), 6K7 (I.F.), 6Q7 (2nd Det. A.V.C. and 1st L.F. Amplifier), 6J7 (Phase Inverter) x 2 25A6 (Push Pull Output). Specially designed Output Transformer to match the 25A6's to Speaker of 8 or 15 ohms impedance. Negative feedback is applied over three stages giving a very high fidelity output. The Coil Pack which is tested and calibrated is of the most modern type. Substantial smoothing gives an exceptionally low hum level. Large illuminated Glass Dial in colour. The Complete Kit of Parts including Valves and Complete Instructions. £13 8 10 inc. tax. Complete, wired and tested £15. Recommended Loudspeaker. Role super G-12 85/-.

OUR NEW ENLARGED CATALOGUE IS NOW READY
Please send stamps for copy

NEW 1948 MIDGET T.F. RADIO KITS with illuminated Glass Dial. All parts including Valves, M/C Speaker and instructions. 3 valves plus Metal Rectifier. 200-557 metres and 700-2,000 metres. 200 to 250 v. A.C. or A.C./D.C. mains. State which is required. Size 10in. x 6in. x 6in. £7 7 6, including Purchase Tax.

NEW 1948 MIDGET SUPERHET RADIO KIT. with illuminated Glass Dial. All parts including Valves M/C Speaker and instructions. 3 valves plus Metal Rectifier. 16-50 metres and 200-557 metres. 200 to 250 v. A.C. or A.C./D.C. mains. State which is required. Size. 10in. 6in. x 6in. £8 5 0, including Purchase Tax.



MIDGET RADIO CABINETS in Brown Bakelite. Can be supplied for either of the above Midget Kits at 25/- including P.T.

E.H.T. TRANSFORMERS. For 200-230 v. 50 c. input Half Wave. For use with Valve or Metal Rectifier. Used in a Voltage Doubling Circuit, these will give slightly over double the half wave output. We can supply suitable rectifiers.

E.H.T.1. Output 800 v. 17/8
E.H.T.2. Output 1,000 v. and 2-0-2 v. 2 a. 25/-
E.H.T.3. Output 2,000 v. and 2-0-2 v. 2 a. 35/-

TANK AERIALS. Seven 2ft lengths of steel tube which fit into each other, making a very efficient aerial. Rubber Bases to fit 3/6 each
..... 2/6 each

MOVING COIL EARPIECES

Comprise a 1 1/2in. Moving Coil Loudspeaker fitted with noise excluding rubber caps. Make excellent Mikes. Phones or Speakers 2- each 18/- doz.

LOUDSPEAKERS BY FAMOUS MAKER

5in. P.M. 2-3 ohms	10/11
6in. " 2-3 "	18/6
8in. " 2-3 "	17/8
10in. " 2-3 "	25/6
12in. " 15 "	85/-

METERS. All meters are by the best makers and are contained in bakelite cases. Prices are about one-quarter the original cost.

Range	Ext.	Diam.	Fitting	Type	Price
40 v.	2 1/2in.	Flush	M.C. D.C.	5/9	
2 1/2 a.	2 1/2in.	Flush	Thermo H.F.	5/-	
20 a.	2 1/2in.	Flush	M.C. D.C.	7/6	
40 a.	2 1/2in.	Flush	M.C. D.C.	7/6	
25 a.	3 1/2in.	Flush	M.I./A.C.D.C.	2/11	
500 µa.	2 1/2in.	Flush	M.C. D.C.	7/6	
5 m/a.	2 1/2in.	Flush	M.C. D.C.	5/-	
1 m/a.	3 1/2in.	Flush	M.C. D.C.	15/11	
500 µa.	3 1/2in.	Flush	M.C. D.C.	19/6	
20 v.	2 1/2in.	Flush	M.C. D.C.	5/9	
15 v.	3 1/2in.	Flush	M.I./A.C.D.C.	6/-	
150 m/a.	2 1/2in.	Flush	M.C. D.C.	7/6	
5,000 v.	4 1/2in.	Flush	Electrostatic	50/-	
1 m/a.	2 1/2in.	Flush	M.C. D.C.	8/6	
50 m/a.	2 1/2in.	Flush	M.C. D.C.	8/6	
30 m/a.	3 1/2in.	Flush	M.C. D.C.	10/6	

TEST UNIT TYPE 73 consists of a special purpose Oscilloscope that requires only rewiring and the addition of a few condensers and resistors to convert into a standard Oscilloscope, input 230 v. 50 c. A 3 1/2in. C.R. tube and 1 SU220A, 1 EB34, 1 5Z4, 3 8F41, 2 EA50. are included. Price £8 8 0.



CONSISTENTLY
Accurate
PULLIN 'S' METER

The Pullin S Meter has been designed for use on amateur band communication receivers. The meter is mounted in a bench stand with terminals on top. Two scales are printed on the dial, thus serving as a dual purpose meter. An instructional leaflet is supplied with each meter. This gives the user full instructions for wiring up and explains in detail the value of the resistors and potentiometer to be used in the circuit. Price, £3.6.0.



Address all Enquiries to

We can give early deliveries — write for full details —

MEASURING INSTRUMENTS (PULLIN) LTD.

Dept. J. Electrin Works, Winchester St., London, W.3. Phone ACOrn 4651/4

THREE FINE OFFERS ! !

FREQUENCY METER LM7

NAVY VERSION OF BC221. 198 kc/s-20,000 kc/s. Black crackle case on Lord mounting base. 1,000 kc/s crystal check points, hand calibrated log book, super vernier drive, internal modulation, stabilised H.T. line.

Power requirements :—250 v. or 350 v. H.T. with internal adjustment for difference. Heaters 12 v. easily modified to 6.3 v. Brand new. PRICE £10 including waterproof dust cover.

KITS OF SPARES including set of 3 valves and neon signal limiter. 1,000 kc/s crystal, transformer, resistance, potentiometers, etc. PRICE £2. Kits of spare **VALVES** only. PRICE £1.

VIBRATOR PACKS

Input 6 volts : Output 230 v. Some smoothed. PRICE 16/6. Postage 1/-. **Mallory Vibrapacks.** Brand new in black crackle case, 6in. x 6in. x 6½in. Self-rectifying type, 12 v. input, 300 v. at 100 mA output. (Built-in noise suppression, includes efficient low frequency hum filter.) PRICE 16/6. Postage 1/-.

TRANSMITTING VALVES

Ex-Government, brand new in original cartons. 807, 8/6 ; 832, 25/- ; 832A, 25/- ; 100TH, 35/- ; 2S0TH, 45/- . Also 808, 30/- ; 86S/S6S, 25/- ; 813, £3/10/- ; 866/866A, 25/-, and many other odd Transmitting Valves too numerous to mention.

Send S.A.E. for Standard Raymart and No. 7 Special Offers List

RADIOMART
G.S.M. (SHAM) LTD.

48, HOLLOWAY HEAD, BIRMINGHAM, 1.

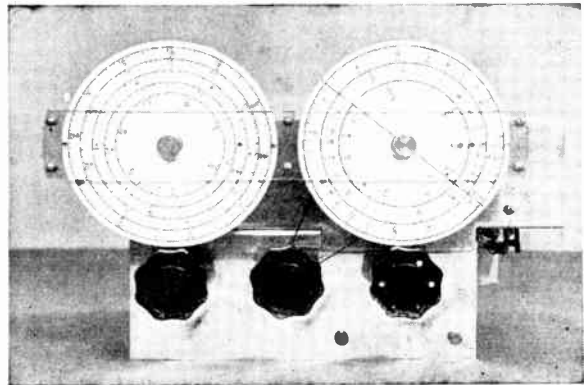

A
Definite Advance
in
TUNING UNITS
for high-grade
COMMUNICATION
RECEIVERS

DENCO

CT4 COIL TURRET

175 Kc/s — 36 Mc/s in 6 ranges. Constant Gain. 1uV Sensitivity.

Too many good features to enumerate here! Ask your Stockist or write direct.

DENCO (CLACTON) LTD., OLD ROAD, CLACTON, ESSEX
Telephones : Clacton 807-8 Telegrams : Denco, Clacton



--They'll like the SOUND of it--

Invite your customers to hear the "De Luxe" Microgram play their favourite records and let its superb reproduction prove to them that there's no finer portable electric gramophone.



The **COLLARO**
"DE LUXE"
Microgram
Portable Electric Gramophone

The "De Luxe" Microgram with the new Collaro lightweight Crystal Pickup, Automatic Stop and 6½ inch Speaker — complete in handsome imitation lizard-skin carrying case. A.C. Supply 200/250 volts.

Retail Price £19 19 0
Plus Purchase Tax,
£8 12 11

Trade Terms and Literature from:

COLLARO LTD., RIPPLE WORKS, BY-PASS ROAD, BARKING, ESSEX

Telephone : RIPPLEWAY 3333

★
Popular Models
 from a
FAMOUS RANGE

SIGNAL GENERATOR, MODEL 65B



For testing audio receivers and for ganging and alignment adjustments on tuned circuits. Mains operated. Frequency range: 100Kc/s to 46 Mc/s. Power consumption approximately 15 watts. A 400 c/s audio signal available for testing audio amplifiers.

PRICE £15. 10. 0.
 H.P. TERMS: £1.10.2 deposit and 11 monthly payments of £1. 9. 8.

CIRCUIT ANALYSER, MODEL 20A

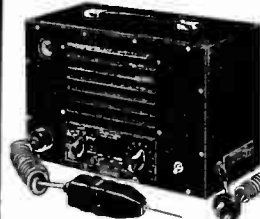

For checking on receivers, radiograms, audio and radio frequency amplifiers. Incorporates a "Magic Eye" Indicator and an audio-amplifier and loudspeaker. Units can be used independently.

PRICE £15. 15. 0.
 H.P. TERMS: £1. 10. 5 deposit and 11 monthly payments of £1. 10. 2.

UNIVERSAL TAYLOR-METER, MODEL 75A



This instrument has a sensitivity of 20,000 ohms per volt on both D.C. and A.C. 50 ranges cover all A.C., D.C. and resistance measurements.

PRICE £14. 14. 0.
 H.P. TERMS: £1. 8. 3 deposit and 11 monthly payments of £1. 8. 2.

CATHODE RAY OSCILLOGRAPH, MODEL 30A



This oscillograph incorporates a 3½" electrostatic tube operating from A.C. mains; power consumption 20 watts; provision made for a time base generator, a vertical amplifier and external coupling to both sets of deflection plates.

PRICE £29. 10. 0.
 H.P. TERMS: £2. 17. 0 deposit and 11 monthly payments of £2. 16. 6

VALVE TESTER AND UNIVERSAL METER MODEL 47A



Similar to Model 45A, but an extra panel has been fitted at the bottom enabling the meter to be used for measurements of A.C. and D.C. volts, D.C. current and ohms.

PRICE £27. 0. 0.
 H.P. TERMS: £2. 11. 9 deposit and 11 monthly payments of £2. 11. 9.

VALVE TESTER, MODEL 45A

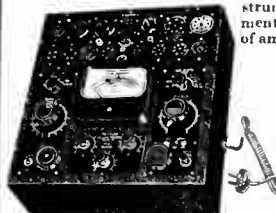

Available as bench or portable instrument giving correct measurements for the mutual conductance of amplifying valves. Sixteen valve holders supplied with each instrument. Bench instrument shown is housed in a strong steel case; the portable is supplied in strong oak case.

PRICE £22. 0. 0.
 H.P. TERMS: £2. 2. 2 deposit and 11 monthly payments of £2. 2. 2.

Further information gladly supplied on request

Taylor
 TESTING &
 MEASURING EQUIPMENT

IMMEDIATE DELIVERY ON ALL THE ABOVE MODELS

TAYLOR PRODUCTS INCLUDE: MULTIRANGE A.C./D.C. TEST METERS ● SIGNAL GENERATORS ● VALVE TESTERS ● A.C. BRIDGES ● CIRCUIT ANALYSERS ● CATHODE RAY OSCILLOGRAPHS ● HIGH AND LOW RANGE OHMMETERS ● OUTPUT METERS ● INSULATION TESTERS ● MOVING COIL INSTRUMENTS

TAYLOR ELECTRICAL INSTRUMENTS LTD
 419-424 MONTROSE AVENUE, SLOUGH, BUCKS, ENGLAND

Telephone SLOUGH 21381 (4 lines)
 Grams & Cables "TAYLINS" SLOUGH

TESTED ★
 TRIED ★
 APPROVED ★

Wireless World

RADIO AND ELECTRONICS

NOVEMBER
1948

38th YEAR OF PUBLICATION

Proprietors : ILIFFE & SONS LTD.
Managing Editor : HUGH S. POCOCK, M.I.E.E.
Editor : H. F. SMITH

Editorial, Advertising and Publishing Offices :
DORSET HOUSE, STAMFORD STREET,
LONDON, S.E.1.

Telephone : Waterlo 3333 (60 lines).
Telegrams : "Ethaworld Sedist. London."

PUBLISHED MONTHLY
Price : 1/6

(Publication date 26th of preceding month)
Subscription Rate : 20/- per annum. Home and
Abroad

Branch Offices :
Birmingham : King Edward House, New Street, 2.
Coventry : 8-10, Corporation Street.
Glasgow : 26B, Renfield Street, C.2.
Manchester : 260, Deansgate, 3

In this Issue

OUR COVER : Kelvin-Hughes Marine Radar (See Page 422)

EDITORIAL COMMENT	391
SCALE DISTORTION—AGAIN By "Cathode Ray"	392
COPENHAGEN FREQUENCY ALLOCATIONS	397
FREQUENCY SHIFT KEYING By Thomas Roddam	400
ELECTRONIC CIRCUITRY By J. McG. Sowerby	403
MANUFACTURERS' PRODUCTS	404
ELECTROMAGNETIC UNITS AND DEFINITIONS By G. Stedman	406
"PERSONAL" RADIO TELEPHONES	409
WORLD OF WIRELESS	411
STABILIZED POWER SUPPLIES—II By M. G. Scroggie	415
RESISTOR RATINGS By H. G. M. Spratt	419
SHORT-WAVE CONDITIONS	423
UNBIASED By "Free Grid"	424
LETTERS TO THE EDITOR	425
RANDOM RADIATIONS By "Diallist"	428
RECENT INVENTIONS	430

2845



New Approach

COMPONENTS

Keeping abreast of fast-moving technical development calls for a new approach to production problems. The "WEARITE" Pressed Circuit System represents a substantial advance in production science to speed assembly and lower costs. The first of these "Wearite" New Approach Components is a Coil Pack comprising coils, switches, trimmers and padders completely wired and ready for instant incorporation into any standard Superhet circuit.

Sides removed for clarity of illustration

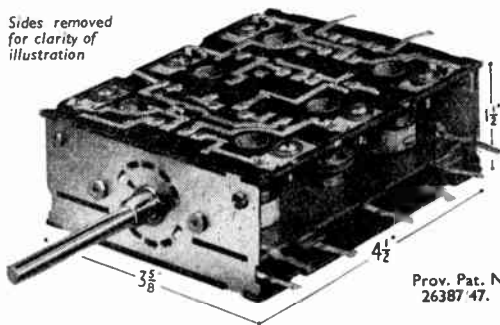

Prov. Pat. No. 26387/47.

- 3 ranges
- Gram switching
- 2-hole fixing at 1 1/8" centres
- All trimmers and adjusters conveniently placed in one surface

Manufacturers are urged to write for full technical details.

Owing to raw material restrictions, supplies, for the time being, are confined to Radio Receiver Manufacturers at home and abroad.

Wright and Weaire Limited

138, SLOANE ST. · LONDON · S.W.1 TEL SLOANE 2214/5 FACTORY: SOUTH SHIELDS, CO. DURHAM

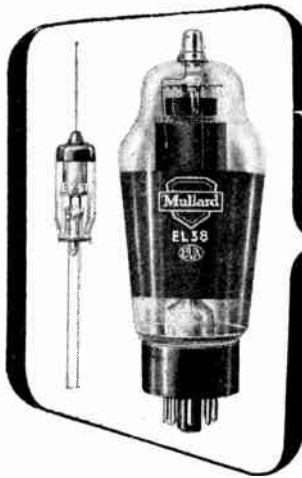

Valves and their applications

THE RINGING CHOKE CIRCUIT FOR E.H.T. GENERATION

When the current through a coil is suddenly interrupted, the oscillatory circuit formed by the coil (L) and its associated capacitance (C_s) will "ring" at a frequency

determined by L and C_s and the resulting voltage waveform will be as shown in Fig. 1 (a). This principle is utilised in what is commonly called the Ringing Choke method of E.H.T. generation.

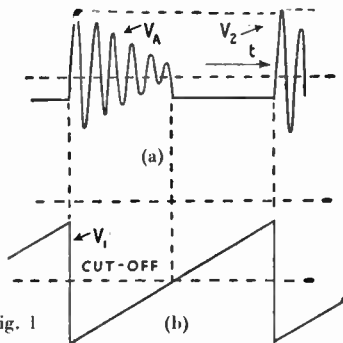

Fig. 1

Fig. 2 shows a practical circuit in which an EL38 operates as a switch which periodically interrupts the current through L. The switching voltage which is applied to the grid of the EL38 may be as shown in Fig. 1 (b).

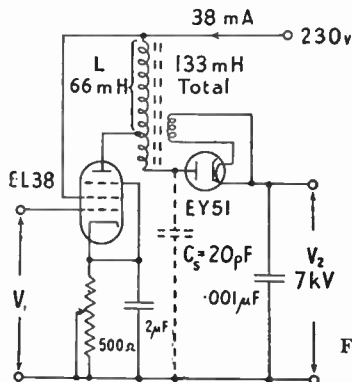

Fig. 2

In the choice of a valve for the circuit, two factors are of primary importance: the valve must be able (a) to supply large peak currents at low anode voltages and (b) to withstand

large pulse voltages on its anode; the EL38 fulfils both these requirements adequately.

The mode of operation of the circuit is as follows:—during the period when the EL38 (V1) is conducting, magnetic energy is stored in L; when V1 is cut off, the oscillation which results may be regarded as an interchange of energy between L and C_s . At the end of the first quarter cycle, the energy stored in L (less the loss due to circuit resistance) has been transferred to C_s and the high voltage produced is rectified by the EY51 diode. The open circuit D.C. output voltage at the peak voltage and will leak away, at a rate determined by the time constant of the external circuit, as shown dotted in Fig. 1 (a). By connecting the anode of V1 to a tap on L, the output capacitance of V1 is transformed into a smaller equivalent capacitance, the contribution to C_s is reduced and the peak voltage will be increased (V_2^2 peak is proportional to $1/C_s$).

It will be noted that the EY51 heater supply is derived from a subsidiary winding coupled with L; the coupling should be adjusted until the colour of the EY51 heater is the same as that of a similar diode fed from a 6.3 V. 50 c/s supply.

The energy loss to the EY51 heater adds to the resistive losses associated with L and C_s and reduces the effective Q of the oscillatory circuit; with a circuit Q as low as 16, however, the peak voltage is reduced by only 5% below that voltage which would result from a loss-free circuit. Since a high Q is, therefore, not of great importance, the physical dimensions of L may be reduced considerably by the use of a high permeability iron-dust core.

The source impedance (R_s) of an E.H.T. supply of this type is approximately equal to $1/(C_s f)$ ohms where f is the repetition frequency of the waveform fed to the grid of V1 (10,125 c/s when this is derived from the line time base generator). The power (P) drawn from the H.T. line for both anode and screen supply may be estimated from the expression $P = V_o^2/R_s$ watts where V_o is the open-circuit E.H.T. voltage.



Reprints of this report from the Mullard Laboratories can be obtained free of charge from the address below:

**MULLARD ELECTRONIC PRODUCTS LTD.,
TECHNICAL PUBLICATIONS DEPARTMENT,
CENTURY HOUSE, SHAFESBURY AVE., W.C.2**

MVM75

Wireless World

RADIO AND ELECTRONICS

Vol. LIV. No. 11

November 1948

Europe's New Broadcasting Frequencies

AFTER deliberations lasting some ten weeks the delegates of twenty-five of the thirty-two nations participating in the European Broadcasting Conference at Copenhagen have signed the Convention which provides for the re-allocation of frequencies to broadcasting stations in what is now known as the European Broadcasting Area.

The Copenhagen Plan, 1948, as it is called, is largely the work of a committee led by H. Faulkner, Deputy Engineer-in-Chief of the British Post Office. The committee, on which L. W. Hayes, B.B.C., also sat, is to be congratulated on producing a plan which, in spite of the prevailing international unrest and rivalry, proved acceptable to the majority of the delegates. The gargantuan task of accommodating in 139 channels some 340 stations and synchronized networks and in addition providing for numerous low-powered stations on two international common frequencies having been completed, it now remains for the governments of the countries concerned to ratify the Convention. Provided this is done the Copenhagen Plan will come into operation on March 15th, 1950—just ten years after the still-born Montreux Plan would have been implemented, had it not been for the outbreak of World War II.

In order to accommodate all the stations within the two bands (long and medium wave), both of which have been extended in accordance with the provisions of the recent Atlantic City Convention, it has again been necessary to allow only 9 kc/s for each channel. There will be general regret that it was found impracticable to increase channel width to 10 kc/s, as is done in the United States, but the alternative plan providing for this was rejected. Its introduction, with the resulting simplification of dial markings, would have been welcomed by both manufacturers and listeners. However, as will be seen from the full list of allocations printed elsewhere in this issue, channels have been numbered arbitrarily, but it seems doubtful in any case if the American practice of

marking channel numbers on receiver dials will become general in Europe.

On paper the Plan appears to be perfectly satisfactory but its implementation bristles with difficulties. The major trouble is the appointment of an organization to supervise its continued operation. When the Lucerne Plan was introduced in 1933 there was one international organization—the Union Internationale de Radiodiffusion—which could and did undertake this formidable task. Since 1946, however, a second body—the Organisation Internationale de Radiodiffusion—set up originally under Belgian sponsorship has sought recognition. Both organizations were represented at Copenhagen, yet neither is in a position to act as the mouthpiece of all European countries; in fact, some countries, including Great Britain, are not members of either organization. It will be seen, therefore, that the provision of the Convention for the appointment of an international organization to “facilitate the entry into force of the Plan and to supervise its effective and regular implementation” is of paramount importance. The fact that the nomination of this organization by the International Telecommunication Union has to be approved by twenty-eight of the participating governments is likely to create an impasse.

Commenting on the Plan, Sir William Haley, B.B.C. Director General, recently told manufacturers: “It will need both statesmanship and technical skill to bring the Plan into operation. Then it should last five years. Whether at the end of that time the answer to Europe's wavelength problems will be F.M. no one can quite say. But at all events Europe by that time should be in a better state to put it into operation if F.M. does prove to be the answer. It is no answer to-day. Not a nation in Europe could face the vast change-over its adoption would demand.” *Wireless World* is not at all sure that F.M. will be the answer, but we are certain that Europe will need some form of E.H.F. if it is to have high-quality broadcasting with a wide choice of local programmes.

SCALE DISTORTION

Clarifying Some

Recent Misinterpretations

—AGAIN

IT is notoriously difficult to find anybody who can repeat with perfect accuracy what Gladstone said in eighteen-hundred-and-whatever-it-was. So perhaps it is only to be expected that what the obscure "Cathode Ray" said about scale distortion in 1937¹ has, with the passage of time, become corrupted². Seeing that my term "scale distortion" seems to have been widely adopted—in fact I have heard of no rival to it—perhaps I may be allowed a post-war say on the subject.

By scale distortion I mean the way in which adjusting the loudness of a sound programme alters the balance of tone. Its most noticeable feature is that when the loudness is reduced the bass diminishes much more than the higher tones. Various schemes of "bass compensation" have been devised for counteracting this effect. The whole subject seems to be a perpetual source of controversy among sound-quality enthusiasts, much of it springing from misunderstandings of one kind or another.

Definitions

First of all one has to be perfectly clear about the distinctions between sound power, intensity, and loudness. Haziness here has led to my being accused of wanting to get as many watts of sound out of my home loudspeaker as the B.B.C. Symphony Orchestra get out of their instruments. What I do claim is that in order to hear a programme reproduced with the same balance of high and low tone as in the original it is necessary that the sound entering

the ears should have the same intensity as when listening to the original. How much sound power is necessary for this purpose depends on circumstances. If the reproducer is a pair of headphones a fraction of a milliwatt may be enough. A loudspeaker playing at the far end of a large well-upholstered hall may have to be

By

"CATHODE RAY"

emitting several watts of sound and need dozens or scores of electrical watts to drive it. The amount of water needed to flood a room to the same depth as a swimming bath is not necessarily as much as is in the swimming bath. It all depends on the size of the room.

How about loudness? Some people speak as if an intense sound and a loud sound were the same thing. That may be all right in ordinary conversation, where "intense" seems a bit pedantic and "loud" is generally used instead. But this must never be done in a technical or scientific context. Intensity refers to the sound itself; loudness to the effect on the listener. To a literally stone-deaf person no sound, however intense, has any loudness whatever. To people who can hear, however, sound faithfully reproduced at the same intensity at the ear as the original is equally loud. But it is a great mistake to conclude that loudness is directly proportional to intensity. It is surprising that the Americans, who have studied acoustics more than anybody, should have practically guaranteed this particular confusion by reckoning both intensity and

loudness in terms of the same unit, already a somewhat over-worked one—the decibel. It is just about as muddling as it would be to specify the speed of a car in horse-power.

For one thing, although sound intensity can be measured fairly accurately, nobody can tell precisely when one sound is twice as loud as another. My estimate might be quite different from yours, and who could prove which was right? By averaging many people's estimates of how much the intensity of a sound has to be increased to make it twice as loud, a result in the region of eight times has been obtained; but individual figures differ widely. Even if everyone could agree on the same figure, it wouldn't hold good at every level of sound. For suppose the intensity of a sound that is just too weak to be heard at all is increased eight times (or whatever the agreed ratio might be). Assuming the sound is thereby made audible, the increase in loudness (i.e. from nothing to something) is not two-fold, because twice zero is zero.

Another thing; experiments show that whereas a sound that is strong enough to seem very loud at one frequency is about equally loud at all audio frequencies, one that sounds soft at high frequencies is entirely inaudible at low frequencies. So when they do become audible, low notes must increase in loudness more steeply than high notes.

Practical Measurements

Evidently there is no hope of any simple formula for connecting intensity and loudness. What has been done is to take as a starting point the intensity of sound that is on the "threshold of audibility"; that is to say, the dividing line between being heard and not heard by people with normal hearing in perfectly quiet surroundings. And since the intensity at this point depends so much on frequency, 1,000 c/s has been chosen, being a good round

¹ "Scale Distortion," *Wireless World*, September 24th, 1937.

² H. S. Casey. "Quality in the Home," *Wireless World*, August, 1948; and letter, September, 1948, p. 346.

number somewhere near the middle of the scale. Intensity is reckoned on a decibel scale, because the zero can be put anywhere that is convenient—in this case at the threshold of audibility at 1,000 c/s. Every 10 db above this represents a 10-fold increase in intensity (20 db is 100-fold, 30 db is 1,000-fold and so on).

Loudness is reckoned in phons. The threshold of audibility is the obvious starting point for a loudness scale, so is marked 0 phons—at all frequencies. Zero phons coincides with 0 db at 1,000 c/s, because 0 db was defined in such a way as to make it so; but sounds of lower frequency have to be made much stronger than 0 db to be heard. That experimental fact is shown by the lowest curve in Fig. 1. A 36 c/s sound has to be about 60 db—a million times—stronger than 1,000 c/s to make itself just heard.

We already know that it appears futile to try to make a distance on the phon scale mean any definite number of times louder. So the whole problem of "How much louder?" has been bypassed by an arbitrary decision to make the phon scale coincide with the decibel scale at 1,000 c/s. Note that although a 60 db sound is 10 times stronger (i.e. more intense) than a 50 db sound, a 60 phon sound is not necessarily 10 times (or any other definite number of times) louder than a 50 phon sound. Nor is the increase from 50 to 60 phons necessarily the same amount of loudness increase as one from 20 to 30 or 100 to 110. In other words, whereas a decibel is a certain definite intensity ratio anywhere on the diagram, a phon has no exact meaning by itself. So nothing could be more confusing than to call these loudness units decibels. Saying that the loudness of a sound is, for example, 60 phons means no more than that it is the same loudness as that experienced by a person with normal hearing when a 1,000 c/s sound is raised 60 db in intensity from the threshold of audibility.

By noting the intensities of sounds of other frequencies that are judged to be equal in loudness to the 60 phon 1,000 c/s sound, the 60 phon curve in Fig. 1 was plotted and similarly for the

others. These curves are known, after the investigators who compiled them, as the Fletcher-Munson curves.

Suppose, then, that a certain programme includes (in succession) sounds of 100 c/s, 1,000 c/s and 6,000 c/s, all at 100 db at the listener's ear. According to Fig. 1 they should all sound, as nearly as he can tell, equally loud, that loudness being denoted by 100 phons. Incidentally, that is about the loudest sound likely to be heard when listening to a large symphony orchestra. Now suppose that the intensity of the whole programme is reduced by 60 db. The loudness of the 1,000 c/s note is now, by definition, what is called 40 phons. But the curves indicate that the 100 c/s will have faded out almost entirely, while the 6,000 c/s is 36 phons. Instead of the loudnesses of all the sounds being reduced equally, as were the intensities, the balance of tone has been radically altered.

the volume control, literally made to shout from the housetops. His crisp tones become throaty and following.

Unless sound is reproduced at the same level as the original, the balance of tone cannot be the same as in the original, no matter how "high-fidelity" the equipment. Altering the scale of the reproduction does more than merely making it louder or softer.

It has been pointed out to me that as this effect is not necessarily connected with reproduced sound, but occurs just the same when one moves towards or away from the orchestra itself, it is wrong to call it distortion. If distortion of a sound is taken to mean some change that cannot occur naturally, in direct listening, that is fair enough. It raises an interesting question, too; one that sound-quality enthusiasts always come round to sooner or later—should the aim be the most natural sound or the most pleasing sound?

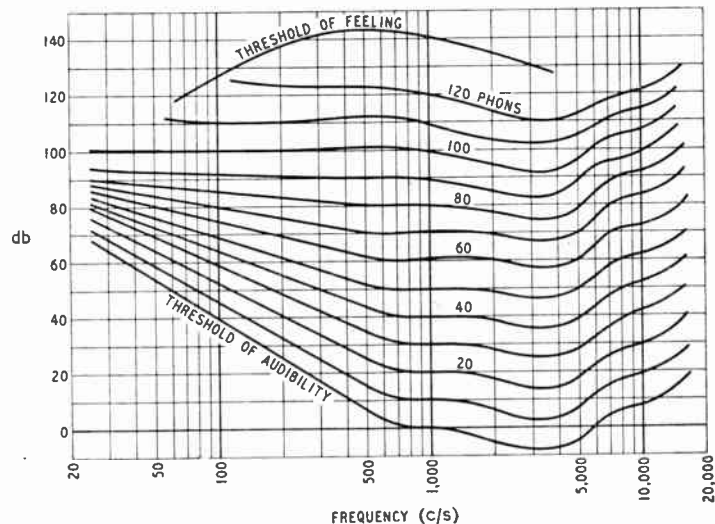

Fig. 1. Equal loudness curves. (After Fletcher and Munson.)

The truth of this is borne out by experience. When the volume control is turned down, the bass more or less disappears. If the original programme were at a low level, enlarging it would cause the loudness of low notes to increase much more than the middle and top. This effect is painfully noticeable when the voice of an announcer speaking quietly in the News studio is, by turning up

I am not going to be drawn off into a general argument on that question just now; I have only raised it to point out that one's attitude to scale distortion—and even whether one calls it distortion at all—depends on how one answers it. If you consider the quality of any natural sound, however unattractive or badly heard, to be sacred, and any modification of that sound by a

Scale Distortion—

reproducer, however pleasing, to be a sin, then "distortion" is not the right word. But if you hold that the job of the sound reproducer is to reproduce the original as heard at the optimum position (and still more if you are so heretical as to believe that the object is to emit the most pleasing sound, regardless of what the original is like) then you will probably accept the term "scale distortion."

Another thing I have been accused of doing is advocating "bass compensation" as a remedy for scale distortion. If the charge had been one of taking every opportunity to discredit bass compensation it would have been nearer the truth. By bass compensation I mean any attempt to counteract the relative loss of low tones when the volume is turned down, especially when such a device is linked with the volume control. From Fig. 1 it is an easy matter to draw a curve showing how the frequency characteristic is modified by a given change of intensity. Suppose, for example, that normal listening loudness is assumed to be 80 phons at all frequencies. The sound intensities required to produce this loudness at various frequencies have been entered on line *a* of the Table. Now suppose that the volume control is adjusted successively to -20 db, -40db, and +20db relative to the original setting. The resulting loudnesses are tabulated on

lines *b*, *c*, and *d* respectively, and when plotted, as in Fig. 2, indicate a striking amount of scale distortion. On lines *e* to *g* are

phons, had not been level over the frequency band, the required compensation characteristics, as calculated above, would have been different. Still, their general trend would have been similar, and that is probably the most that reasonably pessimistic bass-compensation designers hope to achieve.

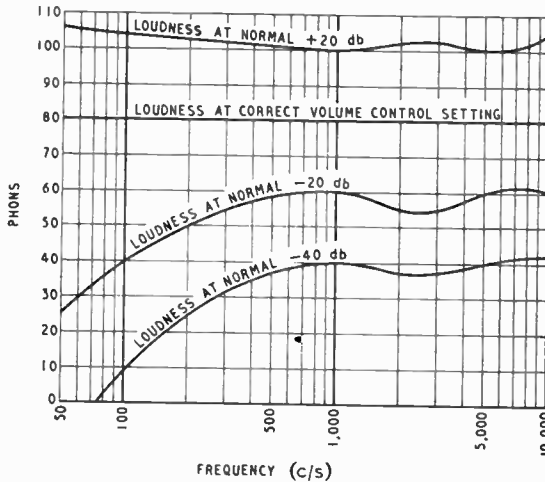

Fig. 2. Scale distortion when 80-phon sound is reproduced at various volume-control settings, derived from Fig. 1.

entered the volume control adjustments that would be necessary at each separate frequency if the original uniformity of loudness were to be preserved at levels of 60, 40, and 100 phons respectively. These are plotted as Fig. 3, and show the combined volume and tone control characteristics required for the specified conditions, according to the calculations of bass compensation exponents.

The first comment is that programmes in which sounds of all frequencies continue at constant strength all the time are fortunately rare. If the original loudness, although averaging 80

The next objection is, I think, more serious. The Fig. 1 curves apply only to comparisons between steady pure tones heard one at a time. Programmes of that character are also rare; unaccompanied flute solos are about the only ones I can think of that come anywhere near qualifying. When two or more sounds are heard together, each tends to "mask" or suppress the other, and the extent to which they do so depends on frequency and intensity in an even more complicated way than loudness in Fig. 1. So with most programmes, which contain many constantly changing sounds, it is impossible to tell theoretically how far Fig. 1 is a guide to scale distortion. Listening tests indicate that even in complex sound patterns the broad result is something like what one would expect if Fig. 1 were valid. But it is a shaky proceeding to base design figures on Fig. 1.

Granting, however, that one is justified in boosting the bass whenever it is necessary for any reason to reproduce sound programmes much below their normal intensity, what is one to say about bass compensation as usually understood, which links the boosting device with the volume control so that the job is done automatically?

It is founded on the assumption that the amount of bass correction required is a function of the

TABLE

Line		Frequency (c/s)							
		50	100	200	500	1,000	2,000	5,000	10,000
<i>a</i>	db for 80 phons	88	85	83	81	80	76	80	93
<i>b</i>	Phons at (original db - 20)	25	40	50	59	60	55	60	60
<i>c</i>	Phons at (original db - 40)	—	9	25	37	40	37	40	42
<i>d</i>	Phons at (original db + 20)	106	104	103	101	100	102	100	105
<i>e</i>	db difference for 60 phons	-7	-10	-13	-19	-20	-17	-20	-20
<i>f</i>	db difference for 40 phons	-14	-20	-27	-36	-40	-37	-40	-43
<i>g</i>	db difference for 100 phons	12	15	17	21	20	18	20	16
<i>h</i>	db for 60 phons	81	75	70	63	60	59	60	72
<i>i</i>	Compensation at 60 phon setting (from <i>e</i>)	13	10	7	1	0	3	0	0
<i>j</i>	Phons with (<i>h</i> + <i>i</i>) db	91	79	70	61	60	63	60	60

volume control setting. But the amount of correction required is actually, as we have seen, a function of the amount of enlargement or reduction in scale of the original sound (presumably at the best position for listening). So, for automatic bass compensation to do what it is meant to do, this change in scale must be a function of the volume control setting.

But is it? Consider an evening's broadcasting. When first switched on we hear, shall we say, a band concert, with announcements between. If we are good neighbours, or the children are trying to get to sleep, we may decide that a "life-size" reproduction is slightly too much. At our setting of the volume control, then, any compensation ought to consist of bass boost. The announce-

(3) that 80 phons also happens to be "life size."

But if now the programme material changes so that "life size" is a level 60 phons, and we turn the volume control down by 20 db in the attempt to reproduce it so (which should require the values given on line *h* of the Table), it automatically introduces compensation to the extent shown on line *i* (difference between -20 and *e*), giving the loudness/frequency characteristic on line *j*, plotted as Fig. 4. Instead of being level, as it should be, it has a rise of over 30 phons at 50 c/s!

There are other things that affect the scale of reproduction at a given volume control setting. Such things as a small aerial, a distant station, an insensitive loudspeaker, and a large well-

not be considered. But whether we approve of it or not, a lot of people do like musical backgrounds, and most of them prefer at least as large a proportion of bass as when the music is full-size. For one thing, low tones are less distracting than high.

Life-sized Intensity

But when programmes are listened to, and circumstances allow, surely the whole purpose of a volume control is to allow one to adjust the sound intensity always to optimum, which is presumably life-size as heard from the best seat in the hall. That is the moment at which some people say "How can you expect to be able to hear a full symphony orchestra at its loudest in an ordinary room at home?" I hope my remarks about intensity and loudness have disposed of the idea that there is necessarily any difficulty about that; but if not I would say that in 1938³ I made tests with a sound level meter during a concert rehearsal in the old Queens Hall in the morning, comparing them with the same music as heard at home in the evening. The general conclusion can be summed up by saying that a receiver capable of giving only 1½ watts maximum output to a loudspeaker in a typical living room was fully capable of giving the same sound level as was experienced in a favourable seat in the concert hall, notwithstanding that some exceptionally heavy music was played.

So, it seems to me, the proper use of the volume control is to set the sound always to the level at which it is intended to be

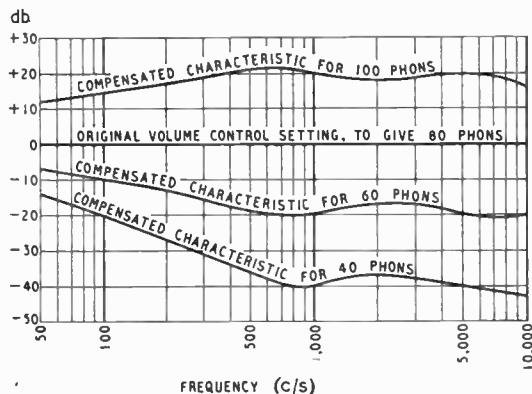

Fig. 3. Modified frequency characteristics necessary to level out the curves of Fig. 2; also derived from Fig. 1.

ments, when they come on, will probably be broadcast nearly if not quite as loudly as the band, and even at the slightly reduced volume may well be an acoustical *enlargement* of the announcer's original quiet tones. So compensation at the same volume control setting should be bass cut.

As I said in 1937, even patent medicine advertisers don't usually go so far as to offer the same dose as a stimulant and also as a sedative.

Fig. 3, as we have seen, shows the correct compensated volume control characteristics, assuming:

(1) that the Fletcher-Munson curves hold good for mixtures of sound as well as for separate sounds.

upholstered listening room tend to reduce the scale, quite independently of the bass compensation if it is linked to the volume control. Tying volume and tone control up together, therefore, is founded on a fallacy.

But, after all, is it often necessary to reduce or enlarge sound? Except in special circumstances, such as the need to avoid disturbing other people, surely it

Fig. 4. If the compensated 60-phon characteristic of Fig. 3 were used, instead of a level one, to reproduce sound life-size at 60 phons, the result would be excessive bass as shown here.

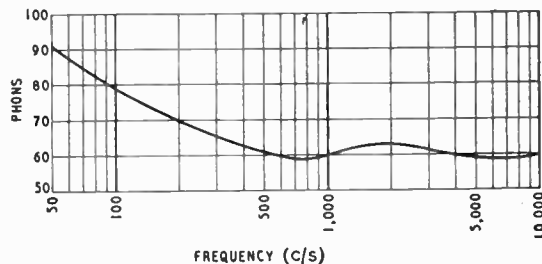

oughtn't to be? A debatable exception is when music is used as a background. One may retort that that isn't listening at all, so refinements of tonal balance need

heard. When that is done, there is no scale distortion, so the
³ "Loud Speaker versus Orchestra," *Wireless World*, March 10th, 1938.

Scale Distortion—

volume control ought not to be tied up with any sort of tone compensation.

But what if there are special occasions when the level at which the programme is intended to be heard differs substantially from the level at which one wants to or is obliged to hear it? What is the correct policy when the scale is reduced? If the tone is left unaltered, then presumably the result will be the same as if the programme were heard at a distance; that is to say, it will be a natural result. (That is not necessarily quite so, because retreating to a distance usually introduces echo effects and unequal attenuation, which are not reproduced by turning down the volume control; but let us ignore them). Boosting the bass may restore the balance of tone, but it will be an unnatural result because it is in the nature of things for the bass to become less prominent when the sound is diminished. Here is the old controversy of Perfect v. Pleasing Sound Reproduction.

If when I go to a piano recital I am unlucky enough to get a seat bang up against the piano, the thought that the bass-heavy music I am hearing sounds exactly like natural piano music as heard bang up against the piano and is therefore a perfectly true and natural article is no consolation to me, and I would gratefully accept some device which would introduce a certain amount of bass cut. If, on the other hand, my ill luck takes me to the back of the hall under the gallery, and all I can hear is a distant tinkling, I would have no conscientious scruples against availing myself of a spot of bass boost.

As for using music as a background to work, persons who do this are so depraved that obviously the finer questions of audio ethics hardly enter into it. I myself favour some bass boost.

Photographic Analogy

One thing more I have been taken to task about⁴ was using photographic enlargement and reduction as an analogy to explain

⁴ Patric Stevenson. "Scale Distortion and Visual Analogies," *Electronic Engineering*, October, 1944.

scale distortion. I likened it to an imaginary and deplorable process of photographic reduction which resulted in a man's feet being reduced 100 times when his body was reduced 10 times. I did not intend this analogy to be scrutinized minutely—few analogies can stand up to that—but only as a rough illustration to introduce the subject. To have gone into the finer points in detail would have involved perspective, orthography, and such matters which would probably have required even more explanation than scale distortion itself. But since Mr. Patric Stevenson has raised some interesting points, and since I myself have recently

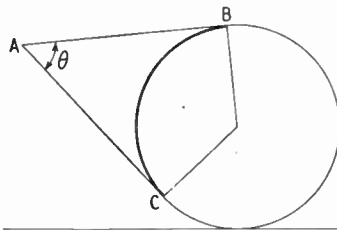

Fig. 5. A visual analogy of scale distortion.

gone fairly fully into the subject of perspective in another connection,⁵ it may be worth discussing now as a sort of tailpiece.

Imagine a sphere about the same diameter as one's height. Viewing it from a distance, one can see practically half its surface—the whole of a hemisphere, in fact. But viewed close up, as at A in Fig. 5, the visible surface is reduced to what lies between B and C. Parts near C, which at a distance can be seen clearly spaced out, appear relatively small or even vanish. Except that it is when the view as a whole is made larger that the bottom part of the view suffers a proportionate loss, and it is a direct view and not a reproduction, this is quite a good analogy of scale distortion, though it is not the same as my earlier one or Mr. Stevenson's.

The visible proportions of the sphere, then, depend on the distance at which it is viewed. If it is photographed by a distortionless camera, the proportions disclosed by the photograph are, of

⁵ "Television Picture Size," *Wireless World*, January, 1948.

course, the same as those seen from the point of taking. And if the photo is viewed at such a distance as to make the angle of view the same as the sphere itself makes at that point (e.g., θ in Fig. 5), the reproduction is perfectly natural, in that it appears the same size as a whole and in all its separate parts as does the original from the direct viewpoint. If the photographic reproduction of the "scene" is regarded as analogous to the loudspeaker reproduction of a programme, then this would correspond to hearing the programme at the correct intensity (angle of view) albeit using a smaller amount of sound power (picture smaller than the original). Ideally one should always look at a picture so as to make the angle subtended by it at the eye the same as the scene did at the camera; then and only then is it in correct perspective.

Out of Focus

But if the photo is taken close up and is printed small, it is generally impossible to view correctly, because it would be too close to the eye to be seen in focus. The ordinary contact print viewed at a comfortable distance therefore makes the size of the scene correspond to a more distant view than at the camera position, yet gives it the same proportions as if viewed close up, and is, therefore, unnatural—something that could not be seen at all without optical intervention. It corresponds to a sound programme that must perforce be heard at a reduced intensity, but has been compensated to give the same tone proportions as if heard close up. We are familiar with the type of snapshot in which the unnaturalness is only too obvious, especially when the nearest objects to the wide-angle camera were feet. That corresponds to a broadcast in which the microphone is too close to the source of sound, with the result that the sound picture is bass-heavy.

If sound were always reproduced at the original loudness and pictures were always viewed at the correct distance to subtend the same angle as the original, what a lot of argument it would save!

COPENHAGEN FREQUENCY ALLOCATIONS

New Wavelengths for Europe's Broadcasting Stations

ALTHOUGH the European Broadcasting Convention signed at Copenhagen last month is not yet generally available, we are able to give below, by courtesy of the Secretariat of the Conference, the frequency allocation plan agreed by the majority of delegates. The signatories were: Albania, Belgium, Byelorussia, Bulgaria, Czechoslovakia, Denmark, Finland, France, Great Britain, Greece, Hungary, Ireland, Italy, Monaco, Netherlands, Norway, Poland, Portugal, Morocco and Tunisia, Rumania, Switzerland, Ukraine, U.S.S.R., Vatican City, and Yugoslavia. Objections were raised by Austria, Egypt, Iceland, Luxembourg, Sweden, Syria, and Turkey, whose delegates did not therefore sign the Convention.

The Plan provides for the re-allocation of wavelengths in the long-wave and medium-wave bands to all broadcasting stations in the European Broadcasting Area—that is, to both the contracting countries and the non-signatories. This area is bounded on the South by parallel 30° N; on the West by a line extending from the North Pole along meridian 10° W to its intersection with parallel 72° N, thence by great circle arc to the point of intersection of meridian 50° W and parallel 40° N, and thence by a line leading to the point of intersection of meridian 40° W and parallel 30° N; on the East by meridian 40° E, so that it includes the western part of the U.S.S.R. and the territories bordering on the Mediterranean Sea.

It will be seen from the footnotes that provision has been made for the use of directional aeriels by a number of stations. Except in cases where a definite power is specified directional aeriels must give a reduction in the radiated power in the direction to be protected of approximately 10db relative to that of a non-directional aerial.

In the last column we have added the frequency at present used by the stations. Space does not permit the inclusion of the present power, but in

general this is lower than the maximum prescribed in the Plan. The power of stations operating in the two international common frequencies is limited in some cases to 2kW and in others to 0.25 kW. Whilst on the question of power, it is noteworthy that, whereas the Montreux Plan prescribed maximum day and night powers, the present Plan makes no such differentiation.

Provision is made for a number of stations not yet in operation, among them eight in this country. They are a third transmitter at each of the following stations: Burghead, Stagshaw and Westerglen; and new stations at Aberystwyth, Hartland Point (N. Devon), Carlisle, Ayr and Dundee.

So far as broadcasting in this country is concerned, the Plan provides for one long and thirteen medium wavelengths. This is three more than allocated in the Lucerne Plan, although at present the B.B.C. is making use of three "borrowed" wavelengths—one long and two medium.

Of the fourteen wavelengths allotted to the B.B.C. three of them (one long and two medium) are exclusive. It is learned from the B.B.C. that the frequencies will be utilized as follows:—The Light Programme will be radiated on 200 kc/s and 1,214 kc/s. Eight frequencies in the medium band, 692, 809, 881, 908, 1,088, 1,052, 1,151, 1,457 kc/s, will be used for the Home Service.

The Third Programme will be radiated on 647 kc/s, where provision is made for three new transmitters, and on 1,546 kc/s by the existing twenty-two low-powered synchronized stations. Incidentally, the power of Droitwich (647 kc/s) may be increased to 150 kW if the three new synchronized transmitters are not in use. The two remaining frequencies (1,295 and 1,340 kc/s) will be used for the European Service.

For ease of reference stations sharing the same frequency are given in the lists in alphabetical order of the countries.

LONG WAVES (150 to 285 kc/s)

Chan- nel	Freq. (kc/s)	Power (kW)	Station	Pres. Freq. (kc/s)	Chan- nel	Freq. (kc/s)	Power (kW)	Station	Pres. Freq. (kc/s)
1	155	10	Tromsø (Norway)	291	12	254	200	Lahti (Finland)	160
		150	Brasov (Rumania)	160	13	263	150	Moscow II, Russia (U.S.S.R.)	232
2	164	450	Allouis (France)	—	14	272	200	Ceskoslovensko (Czechoslovakia)	155
3	173	500	Moscow I, Russia (U.S.S.R.)	174	15	281	100	Minsk, Byelorussia (U.S.S.R.)	269
4	182	100	Reykjavik (Iceland)	271	INTERMEDIATE (415 TO 490 kc/s AND 510 TO 525 kc/s)				
		10	Lulea (Sweden)	392	—	420	10	Ostersund (Sweden) ¹	415
		120	Ankara (Turkey)	182	—	433	10	Oulu (Finland) ²	433
5	191	200	Motala (Sweden)	200	—	520	1	Hamar (Norway) ²	519
6	200	400	Droitwich (Great Britain)	(167)					
			(or Qætringham)	248					
7	209	150	Kiev I, Ukraine (U.S.S.R.)	260					
8	218	200	Oslo (Norway)	224					
9	227	200	Warsaw I (Poland)	208					
10	236	100	Leningrad I, Russia (U.S.S.R.)	240					
11	245	150	Kalundborg (Denmark)						

¹ Directional aerial protecting 5.W. ² Directional aerial protecting 5.W.
³ Directional aerial protecting 5.

(For Medium Waves see next page.)

MEDIUM WAVES (525 to 1605 kc/s)

Chan- nel	Freq. (kc/s)	Power (kW)	Station	Pres. Freq. (kc/s)	Chan- nel	Freq. (kc/s)	Power (kW)	Station	Pres. Freq. (kc/s)
1	529	150	Beromunster (Switzerland)	556	(40)	(881)	150	Washford (Great Britain) ¹⁰	804
2	539	135	Budapest I (Hungary)	546			5	Wrexham (Great Britain)	804
3	548	20	Oukhta, Finno-Karelia (U.S.S.R.)	1,195			20	Cetinge (Yugoslavia)	1,377
		100	Simferopol, Russia (U.S.S.R.)	859	41	890	100	Algiers I (Algeria) ¹¹	941
4	557	20	Cairo II (Egypt)	1,348			20	Bergen (Norway)	260
		100	Helsinki (Finland) ⁴	1,420			20	Kristiansand (Norway)	629
		50	Monte Ceneri (Switzerland)	1,167			20	Trondheim (Norway)	823
5	566	100	Athlone I (Ireland)	565			20	Dnepropetrovsk, Ukraine (U.S.S.R.)	913
		5	Catania (Italy)	1,104	42	899	150	Milan I (Italy)	814
		10	Palermo (Italy)	565	43	908	150	Brookmans Park (Great Britain)	877
6	575	100	Riga, Latvia (U.S.S.R.)	583	44	917	135	Ljubljana (Yugoslavia)	527
7	584	120	Vienna I (Austria)	592	45	926	150	Brussels II (Belgium)	932
8	593	60	Sofia II (Bulgaria) ⁶	767	46	935	100	Lwov, Ukraine (U.S.S.R.)	795
		150	Sundsvall (Sweden) ⁴	601	47	944	100	Toulouse (France)	913
9	602	150	Lyon (France)	895			20	Voronezh, Russia (U.S.S.R.)	356
10	611	5	Eidar (Iceland)	615	48	953	150	Morava (Czechoslovakia)	922
		120	Rabat I (Morocco)	601	49	962	100	Turku (Finland) ¹³	895
		100	Petrozavodsk, Finno-Karelia (U.S.S.R.)	648			120	Tunis I (Tunisia) ¹²	—
		60	Sarajevo (Yugoslavia)	603	50	971	70	British Zone (Germany)	904
11	620	150	Brussels I (Belgium)	620			50	Izmir (Turkey)	704
		50	Moalatyra (Turkey)	—			20	Kalinin, Russia (U.S.S.R.)	1,113
12	629	100	Vigra (Norway)	629			20	Smolensk, Russia (U.S.S.R.)	658
		120	Tunis II (Tunisia) ⁷	823	51	980	100	Algiers II (Algeria) ¹⁴	1,113
13	638	150	Prague I (Czechoslovakia)	638			150	Goteborg (Sweden) ¹⁵	941
		15	Burghead (Great Britain)	—	52	989	10	Rovaniemi (Finland)	—
		100	Droitwich (Great Britain)	583			70	American Zone (Germany)	740
		15	Stagshaw (Great Britain)	—			20	Beirut II (Lebanon)	730
		15	Westerglen (Great Britain)	—	53	998	100	Kishinev, Moldavia (U.S.S.R.)	565
		100	Kharkov, Ukraine (U.S.S.R.)	385	54	1,007	120	Hilversum II (Netherlands)	722
15	656	20	Bolzano (Italy)	536			20	Aleppo I (Syria)	704
		80	Florence I (Italy)	610	55	1,016	150	Istanbul (Turkey)	758
		80	Naples I (Italy)	1,312	56	1,025	100	Graz-Dobl (Austria)	886
		45	Turin I (Italy)	986			20	Jerusalem II (Palestine)	574
		150	Murmansk, Russia (U.S.S.R.)	648	57	1,034	10	Turin II (Italy)	1,357
16	665	100	Vilna, Lithuania (U.S.S.R.)	536			40	Lisbon (Portugal)	1,068
17	674	100	Marseilles (France)	749			100	Tallinn, Estonia (U.S.S.R.)	731
		10	Bodo (Norway)	253	58	1,043	70	U.S.S.R. Zone (Germany)	841
		100	Rostov-on-Don, Russia (U.S.S.R.)	556			5	Kalamata (Greece)	—
18	683	150	Belgrade I (Yugoslavia)	686			20	Agadir I (Morocco)	—
19	692	10	Nicosia (Cyprus)	—			20	Marrakesh I (Morocco)	1,004
		150	Moorside Edge (Great Britain)	668			20	Ujda I (Morocco)	—
20	701	100	Banska-Bystrica (Czechoslovakia)	392	59	1,052	10	Hartland Point (Great Britain)	—
		5	Czechoslovakian sync. network	—			150	Start Point (Great Britain) ¹⁶	977
		120	Rabat II (Morocco)	868			50	Tripoli (Libya) ¹⁷	—
		20	Finnmark (Norway)	347			10	Jassi (Rumania)	1,258
21	710	150	Limoges (France)	648			5	Focsani (Rumania)	—
		150	Stalino, Ukraine (U.S.S.R.)	776	60	1,061	60	Eastern Denmark	541
22	719	120	Lisbon (Portugal)	629			10	Clagliari (Italy)	536
		50	Damascus I (Syria)	592			15	Lisbon (Portugal)	—
23	728	100	Athens (Greece)	601	61	1,070	100	Paris II (France)	776
24	737	1	Akureyri (Iceland)	—			20	Krasnodar, Russia (U.S.S.R.)	1,050
		20	Jerusalem I (Palestine)	677	62	1,079	50	Breslau (Poland)	950
		50	Gliwice (Poland)	1,231	63	1,038	10	Korca (Albania)	1,250
		50	Seville (Spain)	731			10	Shkodra (Albania)	—
25	746	120	Hilversum I (Netherlands)	995			150	Droitwich (Great Britain)	1,013
26	755	20	Kuopio (Finland)	527			20	Norwich (Great Britain)	1,013
		50	Lisbon (Portugal)	722	64	1,097	150	Bratislava (Czechoslovakia)	1,004
		50	Timisoara (Rumania) ⁸	968			5	Czechoslovakian sync. network	—
27	764	150	Sottens (Switzerland) ⁹	677	65	1,106	100	Moghilev, Byelorussia (U.S.S.R.)	870
28	773	50	Cairo I (Egypt)	620	66	1,115	50	Bari I (Italy)	1,059
		150	Stockholm (Sweden) ⁹	704			50	Bologna I (Italy)	1,303
29	782	100	Kiev II, Ukraine (U.S.S.R.)	200			5	S. Remo (Italy)	1,348
		70	Soviet troops in Germany	722			5	Norwegian sync. network	—
30	791	150	Rennes (France)	1,040	67	1,124	20	Brussels III (Belgium)	1,285
		50	Salonika (Greece)	804			5	Varna (Bulgaria)	1,276
31	800	100	Leningrad II, Russia (U.S.S.R.)	1,040			20	Viborg, Russia (U.S.S.R.)	749
32	809	100	Burghead (Great Britain)	767	68	1,133	135	Zagreb (Yugoslavia)	629
		5	Dundee (Great Britain)	—	69	1,142	20	Constantine I (Algeria)	1,087
		20	Redmoss (Great Britain)	767			40	Oran I (Algeria)	1,420
		100	Westerglen (Great Britain)	767			20	Kaliningrad, Russia (U.S.S.R.)	904
		135	Skopje (Yugoslavia)	1,240	70	1,151	5	Carlisle (Great Britain)	—
33	818	100	Poznan (Poland)	868			100	Lisnagarvey (Great Britain)	1,050
34	827	100	Sofia I (Bulgaria)	850			5	Londonderry (Great Britain)	1,050
35	836	150	Nancy (France)	959			100	Stagshaw (Great Britain)	1,050
		20	Beirut I (Lebanon)	730			5	Baia Mare (Rumania)	—
36	845	150	Rome I (Italy)	713			20	Cluj (Rumania)	—
37	854	150	Bucharest (Rumania)	823			5	Oradea (Rumania)	—
38	863	150	Paris I (France)	695	71	1,160	150	Strasbourg I (France)	859
39	872	150	Moscow III, Russia (U.S.S.R.)	832	72	1,169	150	Odessa, Ukraine (U.S.S.R.)	968
40	881	5	Aberystwyth (Great Britain)	—	73	1,178	100	Horby (Sweden)	1,131
		20	Penmon (Great Britain)	804					

⁴ Directional aerial protecting Switzerland.⁵ Directional aerial. Apparent power towards Sweden 10 kW.⁶ Directional aerial. Apparent power towards Bulgaria 20 kW.⁷ Directional aerial protecting Norway.⁸ Power to be reduced to 20 kW if directional aerial protecting Portugal not used.⁹ Directional aerial. Apparent power towards Egypt 20 kW.¹⁰ Directional aerial. Apparent power towards Yugoslavia, 150 kW.¹¹ Directional aerial protecting Norway.¹² Directional aerial protecting Tunisia.¹³ Directional aerial protecting Finland.¹⁴ Directional aerial protecting Sweden.¹⁵ Directional aerial protecting Algeria.¹⁶ Directional aerial protecting Libya.¹⁷ Directional aerial protecting Great Britain.

Chan- nel	Freq. (kc/s)	Power (kW)	Station	Pres. Freq. (kc/s)	Chan- nel	Freq. (kc/s)	Power (kW)	Station	Pres. Freq. (kc/s)
74	1,187	135	Budapest II (Hungary)	1,040	(98)	(1,403)	10	Paris (France)	592
75	1,196	70	French Zone (Germany)	1,031			20	Quimper (France)	—
		15	Kerkyra (Greece)	—			10	Montpellier (France)	1,393
		20	Agadir II (Morocco)	—			20	Nice (France)	1,393
		20	Marrakesh II (Morocco)	—			25	French troops in Germany	—
		20	Ujda II (Morocco)	—			5	Komotini (Greece)	—
76	1,205	100	Bordeaux (France)	1,077			20	Baranovich, Byelorussia (U.S.S.R.)	—
		5	Haifa (Palestine)	—	99	1,412	20	Banja Luka (Yugoslavia)	—
		10	Lublin (Poland)	—			20	Bitolja (Yugoslavia)	—
77	1,214	5	Ayr (Great Britain)	—			20	Maribor (Yugoslavia)	668
		60	Brookmans Park (Great Britain)	1,149			20	Pristina (Yugoslavia)	1,320
		20	Burghead (Great Britain)	1,149			20	Rijeka (Yugoslavia)	770
		5	Dundee (Great Britain)	—			60	Split (Yugoslavia)	—
		10	Lisnagarvey (Great Britain)	1,149	100	1,421	20	Sarrebrucken (Germany : French Zone)	1,267
		1	Londonderry (Great Britain)	1,149			5	Sfax I (Tunisia)	951
		58	Moorside Edge (Great Britain)	1,149			5	Chernigov, Ukraine (U.S.S.R.)	1,013
		2	Plymouth (Great Britain)	1,149	101	1,430	5	Argyrokastrro (Albania)	833
		2	Redmoss (Great Britain)	1,149			70	Western Denmark	—
		2	Redruth (Great Britain)	1,149			10	Copenhagen (Denmark)	1,176
		10	Stagshaw (Great Britain)	1,149			50	Madrid II (Spain)	758
		50	Westerglen (Great Britain)	1,149	102	1,439	150	Luxembourg	232
		70	British troops in Germany	1,095	103	1,448	25	Ancona (Italy)	1,429
		2	Azores (Portugal)	—			3	Florence II (Italy)	1,104
		20	Kursk, Russia (U.S.S.R.)	—			5	Genoa II (Italy)	986
78	1,223	20	Stara Zagora (Bulgaria)	1,402			50	Milan II (Italy)	1,357
		20	Barcelona (Spain)	795			5	Naples II (Italy)	1,068
		100	Falun (Sweden)	1,086			5	Venice II (Italy)	769
79	1,232	5	Budejovice (Czechoslovakia)	1,366			5	Portuguese sync. network	—
		25	Cechy-Zapad (Czechoslovakia)	—			20	Swedish sync. network	1,402
		25	Morava-Vychod (Czechoslovakia)	—	104	1,457	60	Bartley (Great Britain)	1,384
		100	Prague II (Czechoslovakia)	1,113			60	Clevedon (Great Britain)	1,384
80	1,241	50	Vaasa (Finland)	1,522			20	Craiova (Rumania)	—
		20	Bayonne (France)	—	105	1,466	120	Monte-Carlo (Monaco)	731
		20	Clermont-Ferrand (France)	1,321			2	Norwegian sync. network	—
		10	Corse (France)	—	106	1,475	30	Vienna II (Austria)	1,312
		20	Grenoble (France)	1,339			20	Salzburg (Austria)	1,267
		20	Le Havre (France)	1,456			20	Klagenfurt (Austria)	1,285
		20	Montbeliard (France)	1,068	107	1,484		International common frequency*	—
		20	Nice (France)	1,185	108	1,493	60	French sync. network	—
		20	Quimper (France)	832			20	Gomel, Byelorussia (U.S.S.R.)	959
		20	Tiraspol, Moldavia (U.S.S.R.)	1,068	109	1,502	50	Cracow (Poland)	1,022
81	1,250	5	Lower Egypt	—			10	Warsaw II (Poland)	1,339
		10	Nyiregyhaza (Hungary)	—			50	Zaragoza (Spain)	863
		20	Zalaegerszeg (Hungary) ¹¹	—	110	1,511	20	Brussels IV (Belgium)	868
		50	Athlone II (Ireland)	—			5	Chania (Greece)	—
82	1,259	100	Stettin (Poland)	1,384	111	1,520	5	Jihlava (Czechoslovakia)	1,348
83	1,268	135	Belgrade II (Yugoslavia)	1,086			30	Ostrava (Czechoslovakia)	1,158
84	1,277	150	Lille (France)	1,213			30	Plzen (Czechoslovakia)	514
85	1,286	100	Kosice (Czechoslovakia)	1,456			20	Corunna (Spain)	968
		20	Radio Catolica (Portugal)	—	112	1,529	1	Funchal (Madeira Is.)	—
86	1,295	150	Ottringham (Great Britain)	1,122			20	Swedish sync. network	—
87	1,304	20	Constantine II (Algeria)	1,443			100	Vatican City	1,325
		40	Oran II (Algeria)	1,276	113	1,538	70	French Zone (Germany)	827
		50	Danzig (Poland)	1,303			5	Spanish sync. network	—
88	1,313	100	Stavanger (Norway)	850	114	1,546		British sync. network†	1,474
89	1,322	100	Ouchgorod, Ukraine (U.S.S.R.)	1,185			5	Vinnitza, Ukraine (U.S.S.R.)	—
90	1,331	50	Genoa I (Italy)	1,357	115	1,554	70	Germany : U.S. Forces	1,249
		25	Messina (Italy)	1,492			75	Nice (France)	—
		25	Pescara (Italy)	—			20	Turi, Estonia (U.S.S.R.)	—
		50	Rome II (Italy)	1,258	116	1,562	5	Portuguese sync. network	1,547
		25	Venice (Italy)	1,222			20	Swedish sync. network	1,402
91	1,340	5	Alexandria (Egypt)	1,122			5	Swiss sync. network	1,375
		150	Crowborough or Stagshaw (Great Britain)	1,122	117	1,570	70	U.S.S.R. Zone (Germany)	785
		5	Budapest (Hungary)	—			5	Spanish sync. network	1,492
		5	Magyarovar (Hungary)	1,321			5	Sfax II (Tunisia)	—
		5	Miskolc (Hungary)	1,438	118	1,578	10	Italian sync. network	—
		5	Pecs (Hungary)	1,465			10	Fredrikstad (Norway)	1,276
92	1,349	10	Corse (France)	—	119	1,586	70	British Zone (Germany)	1,330
		50	Marseilles (France)	1,339			5	Spanish sync. network	1,500
		10	Nantes (France)	1,366	120	1,594		International common frequency‡	—
		50	Toulouse (France)	1,339	121	1,602	70	U.S. Zone (Germany)	1,195
		20	Kuldiga, Latvia (U.S.S.R.)	1,104			2	Norwegian sync. network	1,357
		20	Modona, Latvia (U.S.S.R.)	1,258			5	Portuguese sync. network	—
93	1,358	100	Tirana I (Albania)	1,474					—
94	1,367	5	Thorshavn (Faroe Islands)	—					—
		25	Caltanissetta (Italy)	—					—
		24	Torun (Poland)	986					—
		5	Oporto (Portugal)	1,411					—
95	1,376	150	Strasbourg II (France)	1,393					—
96	1,385	100	Madrid I (Spain)	1,022					—
		150	Kaunas, Lithuania (U.S.S.R.)	153					—
97	1,394	5	Dornbirn (Austria)	519					—
		15	Graz (Austria)	1,285					—
		5	Innsbruck (Austria)	519					—
		5	Linz (Austria)	1,294					—
		5	Rhodes (Greece)	—					—
98	1,403	20	Swedish sync. network	1,312					—
		20	Bayonne (France)	—					—
		20	Lille (France)	1,456					—

* Shared by: Albania, Austria, Belgium, Cyprus, Czechoslovakia, Denmark, Finland, France, Germany, British Zone, Gibraltar, Great Britain, Greece, Hungary, Ireland, Italy, Lithuania, Malta, Morocco, Norway, Poland, Portugal, Rumania, Russia, San Marino, Spain, Syria, Trieste, Tripoli, Tunisia, Ukraine, and Yugoslavia. Vatican City is permitted to use this frequency with a power of 5kW until receivers covering 1,529 kc/s are more generally in use.

† Belfast (5kW); Bournemouth (2); Brighton (5); Bristol (2); Cardiff (2); Dundee (2); Edinburgh (5); Exeter (5); Fareham (2); Glasgow (5); Hull (5); Leeds (5); Liverpool (5); London (20); Manchester (2); Middlesbrough (2); Newcastle-on-Tyne (5); Plymouth (5); Preston (2); Redmoss (2); Redruth (2); Sheffield (2).

‡ Shared by: Andorra; Austria; Belgium; Bulgaria; Cyrenaica; Czechoslovakia; Denmark; Finland; France; Great Britain; Greece; Ireland; Latvia; Madeira Is.; Morocco (Tangier); Norway; Netherlands; Poland; Portugal; Spain; Switzerland; Syria; Trieste; Yugoslavia.

¹¹ Directional aerial protecting Ireland.

3rd

583

FREQUENCY SHIFT KEYING

Comparison with On-off Keying Methods

By THOMAS RODDAM

IT is not very often that the problems of radio telegraphy are the subject of technical papers. Many readers, especially those with the pile of radar papers which make up the report of the I.E.E. Radiolocation Convention before them, may think that this is because there are no problems in transmitting what someone or other called "those damned dots." Others, more cynical, may suggest that the problems are there, but that no one tries to solve them. The real reason is probably that the main problems of radio telegraphy nowadays are those of high-speed long-distance transmission, which is very largely an affair for a limited number of large administrations whose work is co-ordinated by the International Telegraph Consultative Committee (C.C.I.T.). Improved systems are introduced

the sending of "mark" and "space" signals. The marks may be the dots and dashes of the morse code or the dots which are used in teleprinter working. A group of 5 dots can be used to indicate any one of 31 different characters. If 7 dots are used, or rather, if 3 dots which may appear in any combination of 7 positions are used the number of combinations is 35, although only 31 are used and the receiver can check that it has 3 and only 3 dots and thus can reject any false signals due to atmospheric or other disturbances. All these types of signal, however, have only two possible levels of modulation: zero and 100 per

cent. ever a mark is to be transmitted: in early systems the carrier was switched on, but fast-operating A.G.C. circuits are then left without any signal during pauses, and the gain rises to its full value, giving a large noise output.

The earliest circuits of all, with arc transmitters, were operated on a frequency shift basis. The carrier frequency was changed during a mark by short-circuiting part of the tuned circuit inductance. It was sometimes found convenient to listen to the space frequency rather than the mark frequency when jamming was bad, but there was no attempt to make a deliberate use of both frequencies in receiving the message. The only reason why this method of operation was adopted was that the arc could not be keyed on and off: as soon as valve circuits became available on-off keying, which corresponds to the keying of D.C. on a line, was adopted.

In 1928 Armstrong demonstrated a circuit in which the marks and spaces were transmitted on two frequencies separated by about 100c/s. This system gave a considerable improvement over on-off keying, because it used *both* signals at the receiver. Unfortunately, Armstrong had done the right thing for the wrong reason, and the fact that the system gave an improved performance was overlooked in the triumphant demonstration that he had given the wrong explanation.

The next report of work in this field came in 1939, when K. L. Wood, of Cable and Wireless, described a system then under development. During the war considerable advances have been made, and the system has also been widely applied to multi-channel voice-frequency telegraphy systems on wires.

The important thing about F.S. keying is that it is a coherent carrier system, that is, there is no discontinuity in the carrier when the circuit is switched from mark to space. In double-frequency

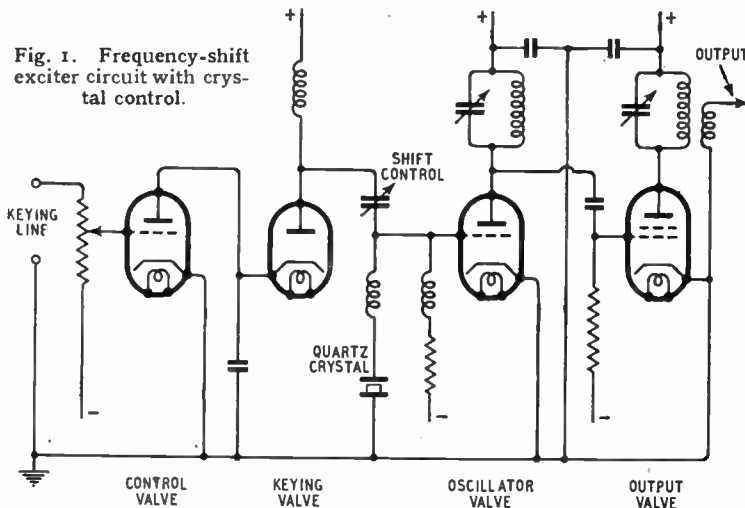

only gradually, and after long periods of service tests. The most recent development has been a tendency to change over from on-off keying to frequency shift keying, which is really a change over from amplitude modulation to frequency modulation. An intermediate keying system, double-frequency keying, was tried at one stage, but this, for reasons which are fairly clear from our modern knowledge of F.M. theory, was not successful.

Telegraph transmission involves

cent. For low telegraphic speeds the radio-frequency carrier may be modulated by a tone which is keyed on and off. This is called "modulated continuous wave" transmission, usually abbreviated to M.C.W. M.C.W. is wasteful in bandwidth and for high-speed commercial circuits C.W. is used. M.C.W. has certain advantages under multipath transmission conditions, as it provides a sort of frequency diversity. An "on-off" C.W. circuit operates simply by switching the carrier off when-

keying one oscillator is switched off and another switched on, so that there is no phase relationship during the transition period. This produces a strong disturbing signal and the system is inefficient. A frequency shift exciter is simply a frequency modulation exciter, driven from 0 to 100 per cent modulation, and there is a smooth transition from one to the other.

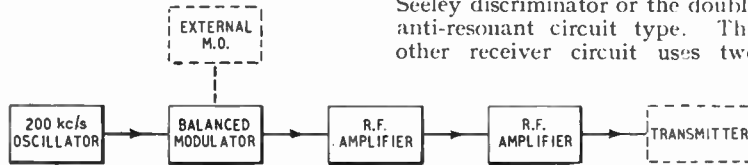

Fig. 2. Mixer-oscillator frequency-shift exciter.

Two circuits have been used. The simplest is arranged to connect a capacitance across the controlling crystal of the master oscillator. The circuit is shown in Fig. 1 (reproduced from the paper by Ruddlesden, Forster and Jelonek, *J.I.E.E.*, Vol. 94, Part IIIA, No. 12, p. 380). The control valve is normally held beyond cut-off by the negative bias, and as there is no current through the control triode the keying diode is an open circuit. The crystal oscillator operates at its normal frequency. When the triode grid is driven positive, the current through the keying diode makes it a low resistance, bringing into circuit the shift-control capacitor in series with the blocking capacitor from the diode cathode to earth. The frequency of the crystal oscillator is lowered by an amount which depends on the size of the shift control capacitor. The output valve acts as a limiter to prevent any amplitude modulation of the output.

The second circuit is shown in Fig. 2 (*loc. cit.*). This circuit is self-explanatory, the only difference between it and a frequency-modulated transmitter for telephony being that the full frequency shift is produced at 200 kc/s and a modulation operation

is used to produce the final carrier frequency, instead of producing only a small frequency shift and then multiplying up. As the shift is only 850c/s, instead of the ± 75 kc/s of broadcast F.M., this difference is quite a logical one.

Two types of receiver circuits have been used. One is simply an ordinary discriminator type, using either the well-known Foster-Seeley discriminator or the double anti-resonant circuit type. The other receiver circuit uses two

separate bandpass filters to separate the mark and space signals, and then rectifies the two separate filter outputs. The discriminator circuit is much more tolerant of frequency drift, but it involves a capacitance coupling in the output circuit, and during long periods without any traffic there is a D.C. drift which produces a "bias" in the receiver. Elaboration of the circuit is required to off-set this.

This illustrates an important difference between telephony and telegraphy: a telegraph signal is

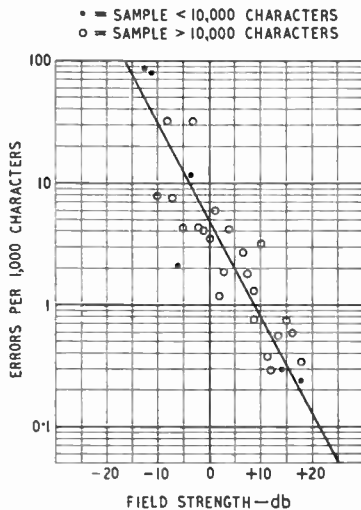

Fig. 3. Field strength/error curve for frequency-shift keying. Two-receiver diversity reception, I.F. bandwidth 1 kc/s. Frequency shift 850 c/s. 0 db = $1\mu\text{V/m}$.

essentially unbalanced, consisting of applied voltages in one direction only. There is no mean level,

any more than there is in a television signal, and D.C. restoration is essential to prevent the floating mean level produced by the A.C. couplings in the receiver, which results in a bias in the recording relays.

Tests made by the Radio Corporation of America gave the results shown in Figs. 3 and 4 (reproduced from *R.C.A. Review*, Vol. 7, March, 1946, pp. 19, 20). These curves show the number of errors during tests involving the transmission of over a million characters from California to New York, using a frequency of about 10 Mc/s and powers of 200 and 800 watts. The improvement due to the use of F.S. keying is about 10 db. About the same improvement was obtained in British tests between Ascension Island and London. Later tests between Melbourne and London gave a better performance for an F.S. channel than for an on-off channel using 2.5 times the power. Here again the improvement must have been of the order of 10 db.

According to Smale, F.S. keying will not give its full advantage when multi-path transmission conditions are encountered. This may be off-set in practical operation by the use of space diversity reception, which is claimed by

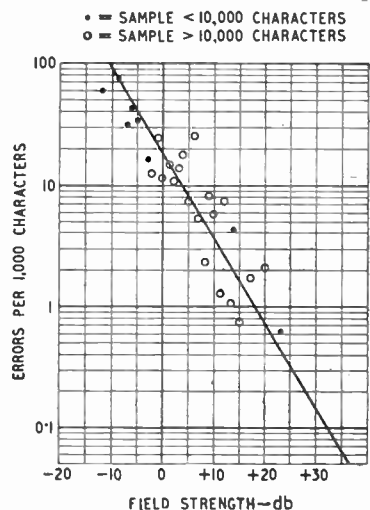

Fig. 4. Field strength/error curve for on-off keying. Three-receiver diversity reception, 1 kc/s I.F. bandwidth. 0 db = $1\mu\text{V/m}$.

R.C.A. to give a considerable improvement for F.S. keying under multi-path conditions.

Frequency Shift Keying—

All the discussion above relates to ordinary telegraphy. An intermediate field in which the frequency-shift technique may have considerable advantages is facsimile, both for the transmission of illustrations and for the sending of pages of typescript. For illustrations, especially, the method would appear to have all the advantages of frequency modulation in the transmission of speech. Multi-path distortion is always troublesome in F.M. problems, but it is also a serious problem in telegraphy and facsimile transmission: most readers will have seen examples of the displaced "ghosts" produced in television by indirect transmission paths.

Apart from the special modulating and demodulating arrangements for F.S. keying, there are some other points of interest in the design of the equipment. One point not immediately realized is that if a transmitter is converted from on-off to F.S. keying the power must be reduced. A transmitter sending "reversals," that is, a steady stream of dots with equal spaces, is actually operating for 50 per cent of the time. In radar language the duty factor is 0.5. When converted to F.S. keying, the carrier is kept on continuously, so that for the same heating in the circuit the power must be lowered from, say, 10 kW to 5 kW. This gives the F.S. system a 3 db handicap, which must not be forgotten in assessing the performance of the system. As far as bandwidth is concerned, there can be a small gain. It is usual to shape the signals in an on-off system so that only the fundamental and third harmonic are transmitted, instead of the infinite number of sidebands corresponding to a square dot. In line telegraphy the signals are rounded even more than this, and on long-distance circuits even squarer waveforms are preferred. Smale described a system using 500 c/s deviation, while the S.R.D.E. system described by Ruddle, Forster and Jelonek uses 850 c/s, which is the same as the R.C.A. value. In the S.R.D.E. system the bandwidth for an on-off channel is given as 1,200 c/s, and for the 850 c/s F.S. channel as 1,100 c/s, but it is

pointed out that by operating with a 300 c/s shift the bandwidth can be reduced to 500 c/s. These figures correspond to rather high keying speeds and are therefore very sensitive to multi-path effects: by using slower speeds and multiplex working a more convenient arrangement is often obtained.

It may appear to the reader that this recent advance in telegraph technique is a rather obvious one, considering how much is now known about frequency modulation. It must never be overlooked, however, that telegraph circuits are highly efficient circuits from the point of view of the transmission of intelligence. They work at relatively low signal-to-noise ratios: if they don't, someone is wasting power, and the cost will be increased. On the other hand, if a false signal is recorded,

code messages will be mutilated, and the message may be unintelligible. Each dot has a meaning in a telegraph message, while in telephony the circuit is quite workable even if only 80 per cent of the syllables are correctly heard. A telegraph engineer is really not satisfied about a new system until it has been tested over a whole sunspot cycle.

References

- "Some Developments in Commercial Point-to-Point Radiotelegraphy," J. A. Smale, *J.I.E.E.*, Vol. 94, Part IIIA, No. 12, p. 345.
 "Carrier-frequency-shift Telegraphy," Ruddle, Forster and Jelonek, *J.I.E.E.*, Vol. 94, Part IIIA, No. 12, p. 379.
 "Observations and Comparisons on Radio Telegraph Signalling by Frequency Shift and On-off Keying," Peterson, Atwood, Goldstine, Hansell and Schock, *R.C.A. Review*, Vol. VII, March, 1946.

NEWS FROM THE CLUBS

Belfast.—The City of Belfast Y.M.C.A. Radio Club (G16YM) celebrates its twenty-fifth anniversary this year. With the exception of the war years, the club transmitter has been on the air every week since 1926. Meetings continue to be held on Wednesdays at 8.0 at the Y.M.C.A., Wellington Place, Belfast. Sec.: F. A. Robb, G16TK, 60, Victoria Avenue, Sydenham, Belfast, N. Ireland.

Bradford.—A demonstration lecture on disc recording will be given by A. R. Land, G2UY, to the members of the Bradford Amateur Radio Society on November 2nd. At the November 16th meeting E. M. Price, M.Sc., will talk on the transmission of signals through lines and filters. Meetings are held on alternate Tuesdays at 7.30 at Cambridge House, 66, Little Horton Lane, Bradford. Sec.: W. S. Sykes, G2DJS, 287, Poplar Grove, Great Horton, Yorks.

Cambridge.—The president of the Cambridge University Wireless Society (G6UW) for the 1948-49 academic year is J. A. Ratcliffe, O.B.E., M.A., of the Cavendish Laboratory. Sec.: F. S. Williamson, 42, South Road, Histon, Cambs.

Darlington.—Meetings of the Darlington and District Amateur Radio Society are held on alternate Thursdays at 7.30 in the Temperance Institute, Gladstone Street, Darlington. Next meeting, October 28th. Sec.: G. Walker, G2AWR, 7, Geneva Crescent, Darlington, Durham.

Holloway.—Lectures covering the syllabus for the City and Guilds amateurs' examination are included in the winter's programme of the Grafton Radio Society (G3AFT) which meets on Mondays, Wednesdays and Fridays at 7.30 at Grafton School, Eburne Road, London, N.7. Morse instruction is given at every meeting. Sec.: W. H. C. Jennings, G2AHB.

Liverpool.—J. H. Brierley will lecture on high-fidelity A.F. equipment

and pickups before the Liverpool and District Short-wave Club at 7.30 on October 26th at St. Barnabas Hall, Penny Lane, Liverpool, 15. Sec.: W. G. Andrews, G3JVV, 17, Lingfield Road, Broadgreen, Liverpool, 14, Lancs.

Rochester.—A radio exhibition has been organized by the Medway Amateur Receiving and Transmitting Society to be held in the Corn Exchange, Rochester, Kent, from November 24th to 27th. In addition to exhibits of a number of manufacturers and traders, Admiralty electronic equipment will be shown. Sec.: S. A. Howell, 39, Broadway, Gillingham, Kent.

Southall.—The West Middlesex Amateur Radio Club has been granted a transmitting licence under the call G3EDH. Meetings of the club are held on the second and fourth Wednesdays of each month at 7.30 at the Labour Hall, Uxbridge Road, Southall, Middlesex. Sec.: C. Alabaster, 34, Lothian Avenue, Hayes, Middlesex.

Warrington and District Radio Society meets on alternate Mondays at 7.30 at the Sea Cadet Headquarters, Warrington. Next meeting, November 1st. Sec.: W. R. Murray, G3CUB, 56, Crow Wood Lane, Widnes, Lancs.

Workshop.—Although called the Swedish DX-fan Club the activities of this organization, which has its headquarters in Workshop, Notts, are not exclusively devoted to reports on Swedish stations. Particulars are obtainable from Eric Good, 5, Aldred Street, Workshop, Notts.

Worthing.—The Worthing Group of the R.S.G.B. has been re-formed into the Worthing and District Amateur Radio Club and thereby overcomes the limitation of its membership to R.S.G.B. members. Meetings are held on the first Thursday of each month at 7.30 at Oliver's Café, Southam Road, Worthing. Sec.: F. T. Toolev, 62, Becket Road, Worthing, Sussex.

BETTER LISTENING BETTER BRIMARIZE!

7A8
7B8



TYPES 7A8 and 7B8 are frequency changers of similar classes, the former being an octode and the latter a heptode. The suppressor grid (G6) fitted to the 7A8 results in higher anode impedance and increased gain.

In A.C. and car radio receivers both valves may be replaced by the 7S7, whilst in AC/DC receivers the 7A8 must be replaced by the 14S7 owing to its low heater current of 0.15 amp. In 12 volt car radios using the 7A8, replacement by type 7S7 will necessitate the fitting of a balancing resistor in the heater circuit.

Types 7A8, 7B8
(7A8 has G6 connected to Cathode)

Type 7S7

CHARACTERISTICS		TYPE	7A8	7B8	7S7*
Heater Voltage			6.3	6.3	6.3 volts
Heater Current			0.15	0.3	0.3 amp.
Anode Voltage			250	250	250 volts
Screen Voltage			100	100	100 volts
Osc. Anode Resistor			20,000	20,000	20,000 ohms
Bias Resistor			300	300	200 ohms
Impedance			0.7	0.36	1.25 Meg.
Conversion Cond.			0.6	0.55	0.53 mA/v

* Type 14S7 is identical to type 7S7 except for its heater ratings of 12.6 volts, 0.15 amp.

VALVE TYPE		CHANGE SOCKET	CHANGE CONNECTIONS	OTHER WORK NECESSARY	PERFORMANCE CHANGE
FROM	TO				
7A8	7S7 (14S7 in AC/DC sets)	Loctal (BBG) NO CHANGE	NO CHANGE	1. Re-align Receiver. 2. 12-Volt car radios — fit balancing resistor in heater circuit. See note.	NEGLIGIBLE
7B8	7S7	Loctal (BBG) NO CHANGE	NO CHANGE	Re-align Receiver.	NEGLIGIBLE

Note: (7A8 only). In 12-volt receivers where pairs of valves are connected across the 12-volt supply, the valve connected in series with the 7S7 must be fitted with a 40 ohm 2 watt resistor across its heater terminals.

PUNCH HOLES HERE

INSTRUCTIONS: Punch holes where indicated and cut away this portion. Cut out and file them in the order in which they appear. This column will then give you a quick reference index.

BRIMAR says...
TYPE 7S7 CAN SUCCESSFULLY REPLACE TYPES X81M & X148

BRIMAR
RADIO VALVES

STANDARD TELEPHONES AND CABLES LIMITED, FOOTSCRAY, SIDCUP, KENT.

MARCONIPHONE "Companion" RECEIVER

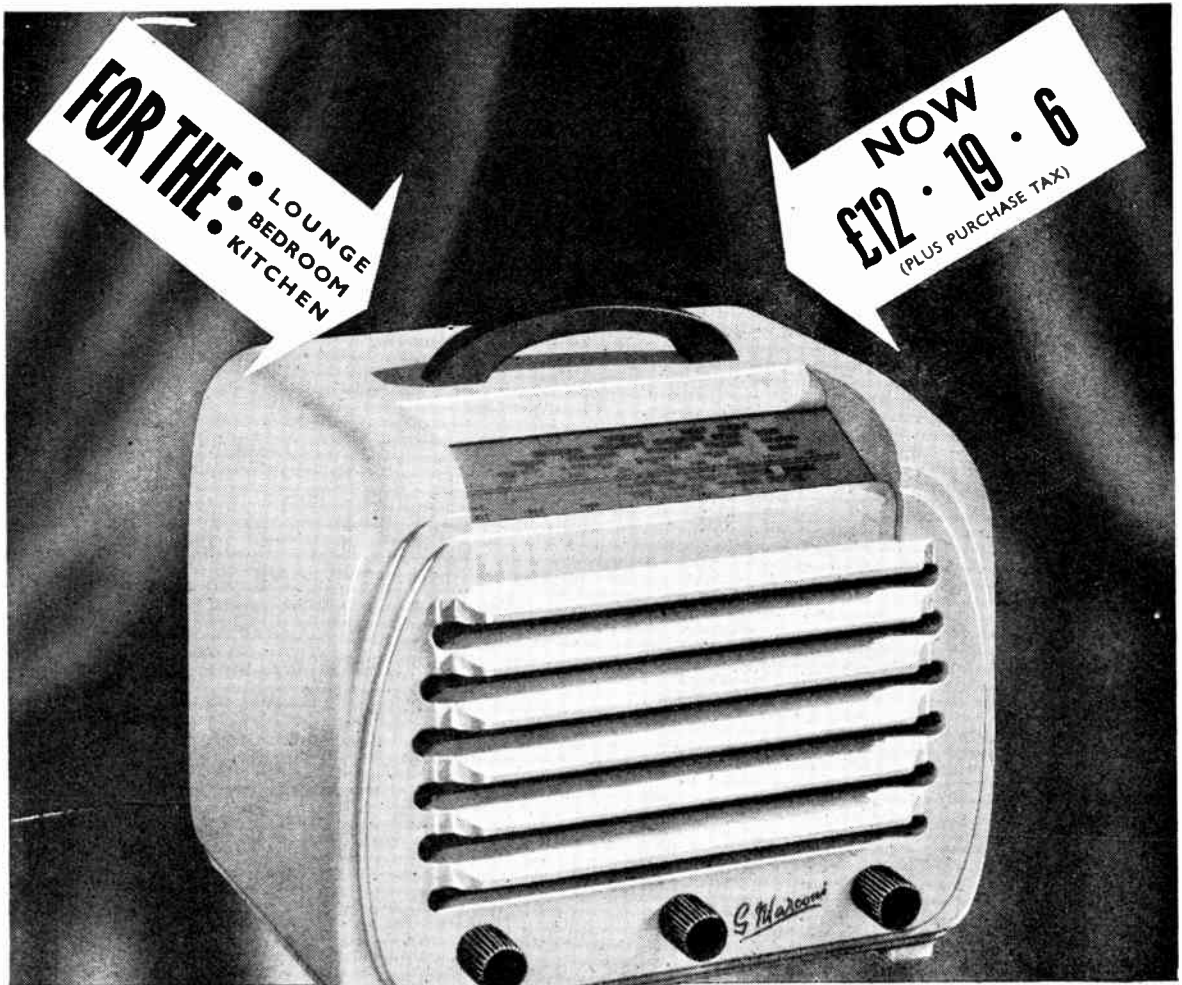

Five-valve, two waveband DC/AC "Companion" receiver T15DA. Weighing only 7½lb. and small enough to stand on the smallest "occasional" or bedside table, this transportable incorporates an inbuilt high "Q" frame aerial and needs only connection to the mains to be immediately ready for operation. Its excellent performance is enhanced by the use of all-glass valves throughout. The

consumption figure is low, a mere 35 watts.

An internal dropping resistor besides eliminating the resistance type of mains lead has three voltage tapings which enable the optimum performance to be obtained on any voltage supply between 195-255 volts DC or AC (25-100 cycles). Hear Model T15DA at your local Marconiphone Dealer.

SEE THE SIGNATURE

G. Marconi

ON EVERY SET

M.68

The Marconiphone Company Limited, Hayes, Middlesex

ELECTRONIC CIRCUITRY

Selection from a Designer's Notebook

By J. MCG. SOWERBY (Cinema Television, Ltd.)

AS most readers will be aware, a beam switch is a device for allowing two or more waveforms to be displayed simultaneously on a single cathode ray tube. In the simplest case of a two-beam switch the two signals are accepted by two amplifier channels, and these are connected alternately (switched) to the deflection plates of the C.R.T. This switching is commonly carried out by means of "gate" circuits under the control of a square wave generator of some sort, and the focal point of the device, on which its success depends, is the development of a satisfactory switching or gate circuit. As these gate circuits have other applications as well, it is proposed to devote a few paragraphs to descriptions of some of them.

Notes on Beam Switches

Probably the simplest of the gate circuits is the pentode arrangement of Fig. 1. Here the signal is applied to the suppressor grid, and the switching waveform to the control grid. The switching waveform must be of sufficient amplitude to cut the valve off during the negative half-cycle, and must allow the valve to conduct—and hence amplify—during the positive half-cycle. Obviously, two such valves may be used, their anodes connected in parallel, and then, if the switching square wave is applied in anti-phase to the two control grids, only one valve will be conducting at any instant. If, in addition, the two valves have different anode currents, the two signals will appear alternately at different standing levels, so that the signals will appear displaced from one another (and not superimposed) on the C.R.T.

There are various "snags" about this circuit. The most obvious of these is that the top of the positive half-cycle of the switching waveform must be quite flat, because any irregularities are subject to the full gain of the

valve, and will be seen superimposed on the signal. Also, when two valves are used in parallel, a square waveform will, in general, be obtained at the anode as well as the signals. This waveform feeds back through the suppressor-anode capacitance to the signal input, and this may often be undesirable.

If, in an attempt to overcome these difficulties, the roles of the

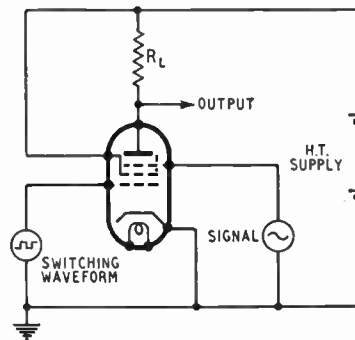

Fig. 1. A simple pentode "gate" circuit.

two grids are interchanged, the output waveform across R_L can feed back into the square wave generator. Also, since both valves are always conducting to their screens, very thorough screen decoupling is needed, for otherwise the signal from one channel can feed across into the other. As before the positive "flat" of the switching waveform may have no irregularities, or these will be amplified and become superimposed on the signals. Generally speaking, this circuit, though often useful, is only suitable for relatively low switching rates.

An alternative is the use of a hexode or other valve with two control grids, but here the designer is rather limited, as most available valves have an undesirable variable-mu characteristic on one of the grids.

An alternative and rather better arrangement—which uses two

valves—is shown in Fig. 2. Here the signal is applied to the pentode and appears across R_L , provided the triode is cut off by the negative half-cycle of the switching waveform. On the positive half-cycle the pentode is cut off by the consequent positive excursion of the common cathode, and the signal disappears. The pentode is only necessary if it is desired to prevent feed back of the output across R_L back into the signal source via the grid-anode capacitance.

There are several disadvantages in this circuit; first, that as R_C has to be relatively large—comparable with R_L —considerable negative feedback is developed and the gain is severely limited. Secondly, every time the stage is switched, the pentode grid-cathode capacitance has to be charged or discharged through the signal source, so that for high switching rates a low-impedance driver (cathode follower) for the signal is essential. Nevertheless, the writer has succeeded in switching this circuit, using EF50 valves at 5-10 kc/s with a turnover time so short that the "haze" between two traces is practically invisible.

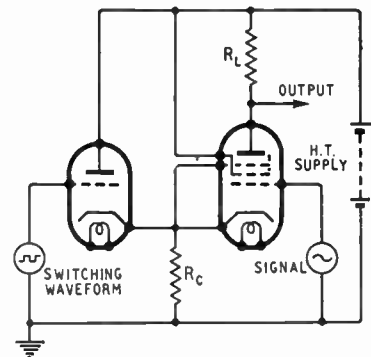

Fig. 2. Cathode-coupled two valve "gate."

A GREAT deal has been written from time to time on the construction of devices for obtaining

Electronic Circuitry—

a constant alternating voltage. A typical example is the so-called constant voltage transformer of which various types are currently available commercially. Less has been said, however, about constant current circuits which are occasionally valuable. A typical application is the supply of valve heaters at the

A "Constant Current" Circuit

end of a length of cable which may vary in length according to conditions of use, so that the total resistance of the circuit is subject to variation.

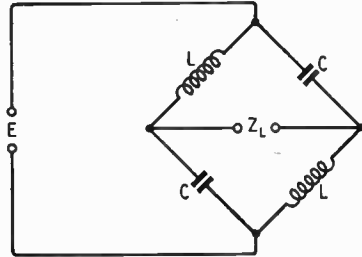

Fig. 3. "Constant-current" bridge circuit.

Fig. 3 shows a rather neat type of constant current device in which Z_L is the load impedance subject to variation, and through which a constant current is required. If this circuit is analysed and resistive losses in the inductances L , and condensers C , are assumed zero, we find that the load current I_L is given by

$$I_L = \frac{E}{X}$$

where $X = X_L = X_C =$ reactance of L or C at the frequency of the applied voltage (usually 50 c/s).

Thus we see that the current is independent of the load impedance. A similar circuit requiring a centre-tapped transformer is shown in Fig. 4. As before,

$$I_L = \frac{E}{X}$$

Of course, losses in the inductances—which are often iron-cored—destroy the independence of

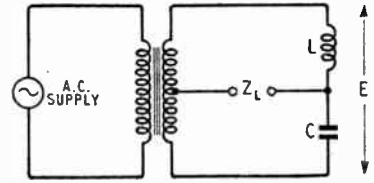

Fig. 4. Another "constant-current" circuit.

load current and load impedance. Nevertheless, a very considerable measure of current stabilization can be obtained in practice over a limited range of variation of load. In using this circuit, care must be exercised in the choice of components, because if Z_L is accidentally open-circuited, the voltages across L and C will rise enormously in an attempt to force the rated load current through the accidental infinite impedance.

MANUFACTURERS' PRODUCTS

E.H.F. Co-axial Connectors

THE Plessey Company have introduced a range of concentric-type connectors which have been designed primarily for use at the extra high frequencies up to 15,000 Mc/s. These connectors, which are mainly for joining and terminating coaxial cables of between 70 and 80 ohms impedance, are available in two styles, major and minor.

Each series contains four types, described as free straight, free right-angle, bulkhead mounting and panel mounting. Male and female versions are available in each type, and to avoid confusion both inner and outer conductors of a particular connector assembly are either both male or both female and both patterns are interchangeable.

An adaptor is available to permit inter-coupling between the major and minor series and, like the actual connectors, this coupler is designed to maintain the correct impedance of 70 to 80 ohms at the junction.

The major series, which are suitable for use up to 5,000 Mc/s, take B.I.C.C. Types CWF81 and SAF78, also Uniradio 18 cables, while the minor range take the Type 1B1/75C/21-4M cable in the same make and are intended for use at frequencies up to 15,000 Mc/s.

Adaptors to junction cables to waveguides are included and all

connectors and adaptors are precision machined from brass and given a burnished silver finish.

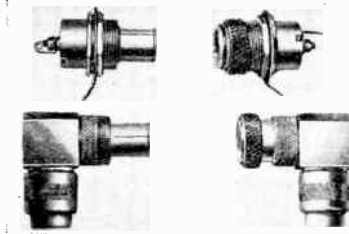

(Top) Plessey male and female panel-mounting E.H.F. connectors and (below) the free right-angled pattern.

The panel mounting types in the major series are suited for signal, video and intermediate frequency circuit connections in television sets.

New Television Receivers

A PICTURE size of 8½in x 6½in on a 10in diameter tube is a noteworthy feature of the Model 912 recently introduced by A.C. Cossor, Highbury Grove, London, N.5. The tube includes an ion trap to protect the screen from heavy ion bombardment. A cathode-follower video amplifier and automatic linearity

control are features of the circuit. The set is housed in a console cabinet 33½in x 18in x 23in and costs £78 15s including tax.

Two new television receivers have been introduced by Philips Electrical, Century House, Shaftesbury Avenue, London, W.C.2. The Model 383A is a table model for vision and sound with a 9-in tube, and the Model 663A with 12in tube is a console incorporating a 7-valve all-wave receiver for broadcasting. The price of the Model 383A is £61 14s 5d and of the Model 663A, £110 4s 4d, both prices include tax.

New Rotary Switches

A RANGE of 12- and 18-way plate-type switches, available as single units or as ganged assem-

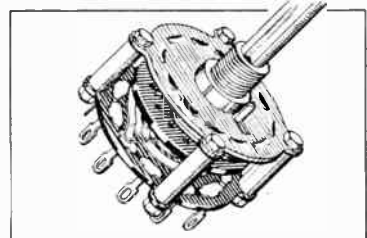

Taylor single-pole nine-way rotary switch.

blies, has been introduced by Taylor Electrical Instruments, Ltd., 419-424, Montrose Avenue, Slough, Bucks.

The fixed plates measure about $1\frac{1}{2}$ in diameter and have contacts arranged in two rings, the outer being the point contacts and the inner the selector pole, or poles. Contact is made by means of split wiper arms secured to a bakelite disc fixed to the spindle.

A 12-way plate can be assembled to give combinations of from 1-pole 12-way to 4-pole 3-way and any number up to four plates can be built up as a ganged assembly.

A range of combinations up to 3-pole 6-way or 4-pole 4-way is available with the 18-contact plates. All contacts are of generous size and silver plated to ensure a low contact resistance.

Television Scanning Equipment

COMPONENTS for the *Wireless World* Television Receiver have been submitted by Handy-Parts, of 226 - 228, Merton Road, South Wimbledon, London, S.W.19. They comprise a line-scan transformer and a deflector and focus coil assembly. The latter consists of

Handy-Parts line-scan transformer and focus- and deflector-coil assembly.

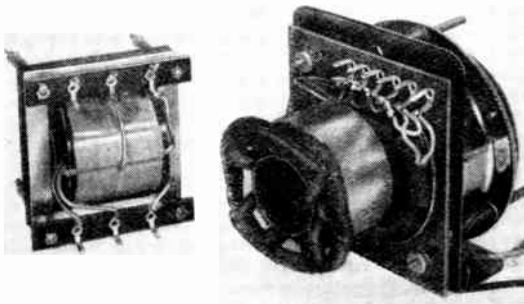

the line- and frame-deflector coil yoke and the focus coil mounted on a bracket. The focus coil is spring-mounted for ready adjustment.

The parts are made to the published specification, with the exception of the focus coil which is of different construction. They have all been tried in the original model of the receiver, however, and were found to be entirely satisfactory.

The line-scan transformer is priced at £3 10s and the focus- and deflector-coil assembly at £6 6s. The focus coil is available separately at 37s 6d, the line coils at 25s and the frame coils at 30s.

New Plastic E.H.F. Insulator

POLYTETRAFLUOROETHYLENE, or P.T.F.E. as it will doubtlessly be known, is a new plastic material having excep-

tionally good R.F. properties, especially at the extremely high frequencies. It is virtually non-hygroscopic, unaffected by the common corrosive acids, alkalis and oils, and does not soften with application of heat. It has a low coefficient of expansion.

When moulded it has a whitish opaque appearance, feels slightly waxy and possesses considerable flexibility, especially in thin strips or film.

Radio components having P.T.F.E. as the insulation are being made by British Mechanical Productions, Ltd., 21, Bruton Street, London, W.1. They consist principally of miniature valve holders such as the B7G, C.R. tube holders, co-axial cable connectors and various types of insulating connectors for hermetically sealed components. In the last-mentioned category are included

far end of the hairpin inductor to an insulator, as at these very high frequencies the slightest vibration can cause very bad frequency flutter.

The hairpin loop fitted is 6in long and spaced $\frac{1}{2}$ in. It is secured to the capacitor by small clamps

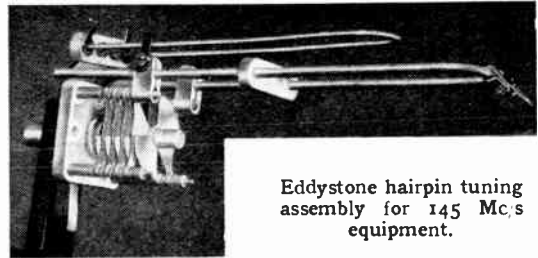

Eddystone hairpin tuning assembly for 145 Mc/s equipment.

which allow easy adjustment for length.

The coupling loop is supported on a sub-bracket which can be removed from the main bracket and mounted separately if required. Adjustment of the coupling can be made by bending the loop towards or away from the tuned hairpin.

Wide spacing (0.052in) is used in the capacitor and as the flashover voltage exceeds 1,500 R.M.S. no special precautions are needed when the unit is used as the tank circuit in a 145-Mc/s transmitter with anode modulation. The maximum capacitance is about 4pF, but this is more than sufficient to cover the full 145-Mc/s band when it becomes available.

All the metal work, except the bracket, is heavily silver plated and ceramic insulation is used throughout.

The makers are Stratton and Co., Ltd., Eddystone Works, Alvechurch Road, West Heath, Birmingham, 31, and the price is 17s 6d.

"RADIO VALVE PRACTICE"

THIS booklet is intended to act as a link between the valve maker and the valve user: it is specially addressed to designers.

The contents comprises largely categorical information on subjects about which most of us are somewhat vague. For instance, what is the permissible variation in heater or filament voltage in relation to the rated voltage? Why is it considered undesirable to mount a valve upside down? What are the appropriate precautions against microphony?

The answers to these and many other questions are given in "Radio Valve Practice," copies of which are obtainable free by bona fide valve users from The British Radio Valve Manufacturers' Association, 16, Jermyn Street, London, S.W.1.

connectors for use in pressurized aircraft cabins.

It is claimed for the new B7G valve holder that, as the mouldings can be produced to very close tolerances and the material has a certain amount of resilience, damage to valves from cracked bases is virtually unknown.

145-Mc/s Tuning Unit

THIS unit consists of a small butterfly-type variable capacitor, a hairpin-shaped single-turn coil and a coupling loop assembled on a single bracket. It is intended for the new amateur band of 145-146 Mc/s and can be used as a local oscillator circuit for a V.H.F. superhet or converter, as an inter-stage R.F. coupling or as the tank circuit in a 145-Mc/s transmitter.

When used in an oscillator it would seem advisable to anchor the

ELECTROMAGNETIC UNITS

Reasons Underlying Recent Changes in Accepted Standards

By GEOFFREY STEDMAN, B.Sc.

THE decision of the National Physical Laboratory to implement on January 1st, 1948, the recommendation of the International Committee of Weights and Measures of 1946, by reverting from the so-called "international" electrical units to units based on the absolute system, brings to the foreground the question of the units and definitions of the electrical quantities. But apart from this topical interest, a knowledge of the history of the electrical units is important in understanding electrical theory. The logical interdependence of the definitions forms a kind of skeleton work upon which electrical theory can be supposed to depend. More than one of the issues which provide perennial difficulty and discussion among students are settled unequivocally by referring to the definitions of electrical quantities. An example of this is given at the end of this article.

The relation between the electrical units is complex, partly because they were originally framed by physicists whose needs in this respect were different from the needs of engineers, and partly because the modifications imposed by engineers have not always been happy ones. In fact, it is difficult, even for those who have the will to do so, to absolve the engineers completely from the charge of short sight or of haziness about fundamental theory in the establishment and use of the practical units.

Unit of Current

The relations between the units are displayed in the diagram opposite. The starting point is the absolute electromagnetic unit of current, placed in a double border at the top left-hand corner of the diagram. This is defined as the current which, flowing in a circular coil of one turn and of one centimetre radius, exerts a force of 2π dynes on a unit magnetic pole placed at the centre, or as the current which, flowing in one centimetre of the arc of such a coil, exerts a force of one dyne on a unit pole placed at the centre. There are other ways of framing

this definition to avoid the objection to the above forms that they rely upon unrealizable circuits. One such form is that unit current is the current which, flowing in *any* circuit, produces the same magnetic field as a magnetic shell of unit strength and whose contour is the circuit. All these forms, and others to be met with in the textbooks, can be shown to be mere mathematical variants of the same definition.

Having fixed in this way the size of the absolute unit of current, all the other absolute quantities are defined in terms of it and of familiar mechanical quantities. Thus there need be, and in fact is in the absolute system of units, only one primary electrical quantity. The way in which the other absolute quantities are derived from the unit of current is indicated in the diagram by the notes on the links connecting them to the unit of current. Thus an absolute unit of charge is conveyed by one absolute unit of current in one second, and one absolute unit of potential difference exists between two points if one erg of work is done by or against the electrical forces when one absolute unit of charge is conveyed from the one point to the other. The absolute unit of resistance is defined from the familiar relation "resistance is the ratio of potential difference to current" which is often referred to as Ohm's Law. The statement is not a law, but a definition of resistance, and one absolute unit of resistance requires one absolute unit of potential difference to pass one absolute unit of current through it. Ohm's Law specifies the conditions (nature of conductor, temperature, etc.) under which the resistance, defined in this manner, is independent of the current through it. All the other absolute units (of capacitance, inductance,

etc.) are derived similarly from the absolute unit of current, but as the relations between the various systems of units can be displayed without considering these, the diagram has been extended no farther vertically.

It is important to notice that nearly all the precision measurements of electrical technology, with potentiometers and bridges, are methods of *comparing* currents or potential differences or resistance. To find the absolute value of any electrical quantity involves measuring it in terms of the absolute unit of current, or comparing its magnitude with a standard whose value has been so measured. It is by way of a reminder of the fundamental position of the absolute unit of current in this respect, that the tangent galvanometer and the Kelvin ampere balance figure so largely in a course of academic physics. In practice, the accurate measurement of a magnetic field presented formidable difficulties up to a few years ago. The British Association, therefore, sought to set up material standards of current and resistance which would be more convenient to realize, and also to measure these standards in terms of the absolute units. While they were doing so they decided to allocate special names, derived from the names of illustrious scientists, to multiples or submultiples by certain powers of ten, of the absolute units. The reason for the last decision was certainly inadequate, and one can only suppose that it was the prestige of the British Association that was responsible for an International Conference in 1881 in Paris adopting the B.A. nomenclature, and adding other names derived in the same way for the so-called practical units. The multiples of the absolute units are given in the second column of the

AND DEFINITIONS

diagram. It was further decided to construct and measure a column of mercury which, under specified conditions, should have a resistance of one ohm, and to determine what weight of silver one ampere would deposit on a cathode in one second from a solution of its nitrate in water, also under specified conditions.

These measurements were made, and in a series of Conferences, culminating in one at London in 1908, the "international" ampere and ohm were set up, defining the ampere as the current which deposits silver at the rate of 0.00111800 grams per

links. The "international" units were defined to be as near as possible identical in magnitude to the absolute ampere and the absolute ohm, and the name "practical units" dates from before any discrepancies had been observed between them. It is now therefore doubtful whether the adjective "practical" refers to the replacement of the absolute units by the multiples by powers of ten of those units, or whether to their replacement by the chemically defined ampere and ohm. Since by modern measurements these units are perceptibly different, it would seem best to abandon the

dard of length. The French Government originally took the length of the quadrant of the earth as the standard of length, and defined a metre as a convenient submultiple (10^{-7}) of this length. A French Commission then prepared a bar of platinum-iridium to be as near as possible to one metre between the fiducial marks on it. Following the discovery of an error in the original measurement, the metre was redefined as the distance between the fiducial marks on the bar. It is, of course, unlikely that the metric system will revert to the earth's quadrant as a basis, as the electrical system has reverted to its absolute basis.

There are two interesting consequences of the fact that only one electrical quantity is required to furnish a system of units, whereas the "international" system supplies two independent units. The first is that by the "Ohm's Law" relation a legal volt is obtained as the product of a legal ampere and a legal ohm. This legal volt is of very nearly the same magnitude as the absolute volt, but is quite distantly related to it, as is indicated by the diagram. On the other hand, the legal ampere and absolute ampere, like the legal ohm and the absolute ohm, are directly related, each by a single measurement. The second consequence is that from the legal ampere and volt, a new unit of energy is obtained, called the joule, but which is only approximately 10^7 ergs. To define a joule as 10^7 ergs, as some writers have done, is wrong, for the Paris Convention of 1881 initiated the term joule, and defined it as the international unit of electrical energy. By analogy with the absolute ohm and the absolute ampere, 10^7 ergs should be called one absolute joule.

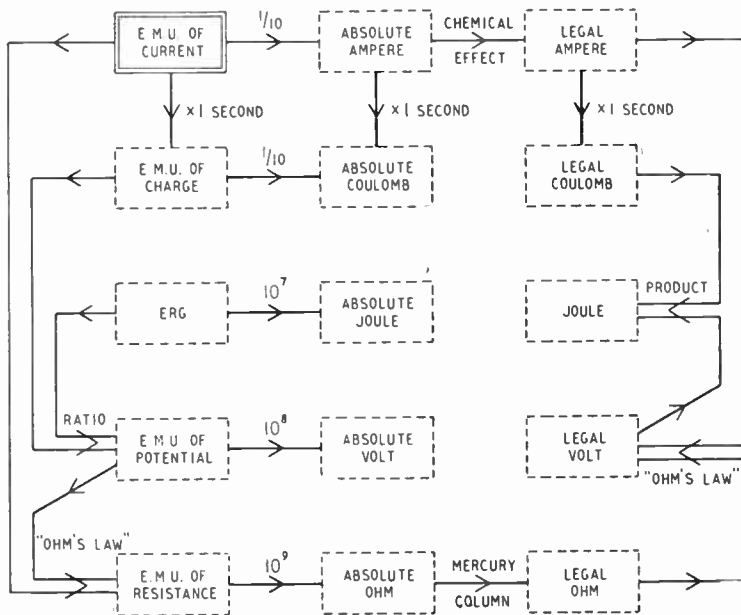

Derivation and relationships of the principal electrical units.

second, and the ohm as the resistance of 14.452 grams of mercury of uniform cross section and of length 106.300 cm, at 0° C. These are known as the International or Legal units, having been made legal by enactments of the United Kingdom and of the other member nations of the Conferences. They are placed in the third column of the diagram, and the nature of the observations which link them to the corresponding absolute units are indicated on the connecting

use of the term "practical" and to use the adjective "absolute" for the one system, and the adjective "international" (or "legal") for the other, although in view of the almost certain loss of legality of the international units in the near future, the terms chemical ampere and mercury ohm may be appropriate.

The change from the absolute units to the international units has an almost exact parallel in the establishment of the metric stan-

Commissions and Conferences

We have stated that the reason for the introduction of the international units was to provide more easily realized standards of electrical quantities. At an International Conference of 1928 it was agreed that electrical quantities could now be measured in terms of the absolute units as accurately as in terms of the international units, so that the primary need for these latter units no longer

Electromagnetic Units and

Definitions—

existed. It was therefore resolved that the numerical relations between these units should be measured with all attainable accuracy, and that a later Commission should effect a formal revision to the absolute system for technical purposes. Accordingly, the American Bureau of Standards published these results of comparisons:—

1934.—One international ampere = 0.999928 ± 0.000020 absolute ampere.

1938.—One international ohm = 1.000468 ± 0.000020 absolute ohm.

A Commission in 1933 implemented the decision of the 1928 Conference by resolving that the change-over should take place on January 1st, 1940, and in the absence of the war, that would, presumably, have been decreed in this country. A Conference of 1946 resolved that the change-over should take place on January 1st, 1948, and in accordance with this, the National Physical Laboratory has announced that it will implement the decision in its measurements from that date. The most recent comparisons are:—

One international ampere = 0.99985 absolute ampere.

One international ohm = 1.00049 absolute ohm.

These figures are of interest to compare with the American estimates of a few years ago to observe the order of accuracy of recent determinations.

In setting up the international units, two changes were made: first, the difficult absolute measurements were replaced by the then simpler ones of the chemical ampere and the mercury ohm, and, second, more convenient multiples by ten of the fundamental units were adopted.

The M.K.S. system of units has been proposed to achieve identity of electromagnetic and practical systems. This system takes the metre, the kilogram and the second as the fundamental units of length, mass and time. If the system is adopted, it is to be hoped that a new name will be substituted for the "kilogram," and so the anomaly avoided of having a fundamental

unit named in terms of another, a thousand times smaller. The new name should also, of course, be derived from the name of a scientist, following the avowed practice for the technical units

"Practical" Units

It may be worth while clarifying here a common misapprehension among engineers in connection with the practical units. If an engineer is asked why powers of ten appear in so many of his formulæ, e.g., the field of a solenoid is $4\pi ni/10l$, and the induced E.M.F. in a circuit is $10^{-8}d\phi/dt$ volts, the writer's experience is that he will generally be told that this is due to the use of practical, instead of absolute, units. This, in fact, is not true. A consistent system of units must give the same formula as any other consistent system. These powers of ten arise in all engineers' formulæ which give the field of a current, and are due to the use of a mixed system of units, viz., practical units for the electrical quantities and absolute units for the magnetic quantities. There is no reason whatever why practical units of field and flux should not be used by engineers, and they would then have formulæ of the same form as those used by physicists, without the powers of ten. To call these formulæ "practical formulæ" is about as near the truth as to call the formula "circumference of a circle = $79.8 \times \text{diameter}$ " a practical formula, for this is the mensuration formula which must be used by one who measures circumferences in millimetres and diameters in inches. The matter was made more difficult by the allocation of the name gauss to the absolute unit of magnetic field, thereby violating the explicit international resolution to use proper names for the "practical" units. But perhaps the limit of culpability in this matter was achieved when a later International Conference, having noted that the name gauss was being used in different senses by different writers, decided to abandon the term, and the new name oersted was allocated to the absolute unit of field, thereby repeating the same error after having been provided with a re-

markably lucky opportunity to right it.

Another interesting light on electrical theory is given by a consideration of units. In the absolute system, the first quantity defined is current, and all the others are derived from it through mechanical relationships. Thus potential difference is the work done per unit charge, or the power per unit current, and resistance is the potential difference per unit current. We can, therefore, express resistance directly in terms of current and power, and the result is that resistance is the power per unit current squared. Thus the relation $R = W/I^2$ is the true definition of resistance. It is logically incorrect to regard this as a result which can be deduced from Ohm's Law, however convenient that viewpoint may be for the purposes of elementary teaching.

The definition of resistance in terms of power and current at once answers the question of the reality of the radiation resistance of an aerial, or of iron-loss resistance in iron-cored coils. These are often thought of as in some way unreal resistances; in fact, some text-books go so far as to distinguish between "ohmic resistance" and "fictitious resistance." The argument appears to run in some such way as this: In the case of an aerial, power is radiated when current flows in it: now, in a direct current circuit, power is developed when current flows, the amount being I^2R . Let us, therefore, pretend that the aerial has a resistance greater than its real resistance, just so great, in fact, as to make the relation $W = I^2R$ true. This value of R is called the radiation resistance of the aerial and is a fictitious resistance introduced to make our equations "come out right." It is, perhaps, unnecessary to say that an equation which needs such pretences to make it come out right is not worth having, and, in fact, the reality of radiation resistance is seen at once from the fact that whenever current supplies power, the circuit has a resistance of $R = W/I^2$ by definition. Any other meaning which the term resistance may acquire by habit is to be regarded with suspicion. It appears that engineers generally acquire another view of resistance which associates it with the fric-

tional forces between molecules and electrons. This point of view was not inconvenient until technical apparatus appeared in which the chief forces on electrons in a wire were not the frictional molecular forces, but the fields in the

wire. The work done against the molecular forces is turned into heat in the wire, while the work done against the field forces is radiated away in the case of the aerial, and transferred to the core in the case of the iron-cored coil.

The distinction between ohmic and fictitious resistance would be justified if the definition of potential difference were the heat produced (instead of the work done) when unit charge passes from the one place to the other.

"PERSONAL" RADIO TELEPHONES

Lightweight Economical "Walkie-Talkies"



WE had an opportunity recently to test and examine two very interesting portable radio telephones of the type often referred to as "walkie-talkies."

These are sets of practical utility, not merely experimental models and, moreover, they are actually being produced on a moderate scale by British Communication Corporation, Gordon Avenue, Stanmore, Middlesex.

Such sets have numerous possibilities and those we saw were of a kind that would serve for the police and fire services, for newspaper reporting, for dispatching trains and, among other applications, for forestry patrol and even for ship to shore communications where a fixed installation is not convenient.

The range of the sets will be more than adequate for these and similar purposes as although up to 10 miles,

according to prevailing conditions, is claimed, from the results obtained during our tests we think this figure is a little conservative.

Tests were made from a mobile installation in a car and although no great range was attempted communication was maintained under widely different conditions: for ex-

British Communications Model L59 "walkie-talkie."

ample, on one occasion from a road passing through dense woodland, then in the midst of houses, and finally in the open country.

Under all conditions the reception in the car was perfect. Some flutter due to reflections from trees

sion systems using V.H.F. Substituting for the normal "whip" aerial a one-inch length of wire enabled communication to be maintained over about half a mile.

During transmission the set takes about 30 mA from a 135-volt battery, but when receiving the consumption is reduced to about 20 mA at 90 volts.

Two models of this radio telephone are available but both contain the same chassis. The only differences are that one is designed for carrying by hand and is about the size of a G.P.O. desk telephone with the hand set resting in a cradle on the top. It weighs about 10 lb and is described as the model L59.

The other is a pack-type set (Model L45) with webbing harness

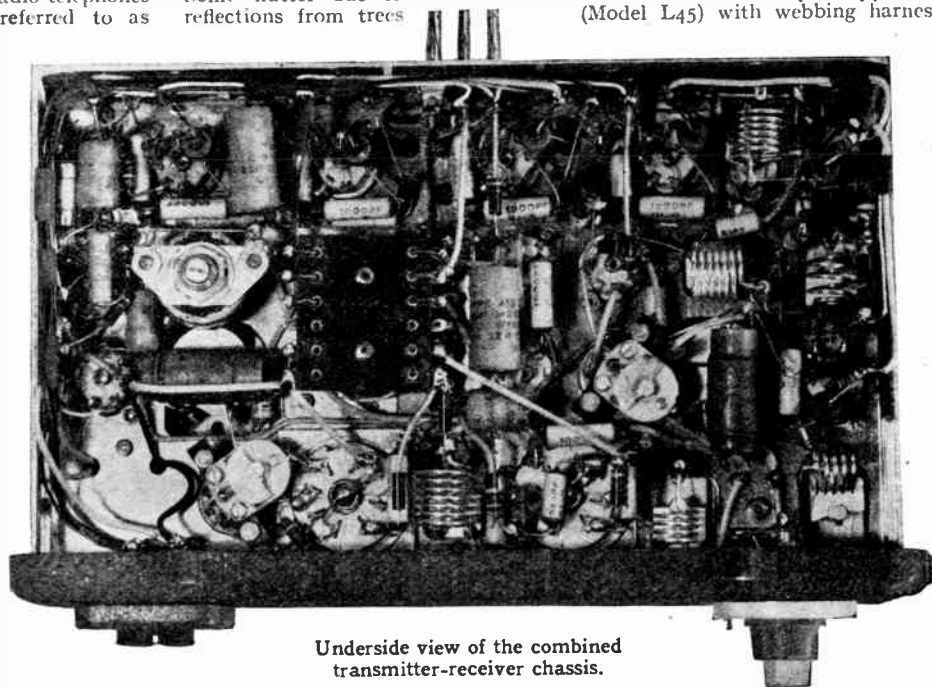

Underside view of the combined transmitter-receiver chassis.

and buildings when on the move was noticeable, but this is quite common with most single-channel transmis-

for carrying on the back, or slung over the shoulder. It has larger capacity batteries than the hand-

Personal Radio Telephones—

portable and uses a separate microphone and head telephones. The all-up weight of this model is just under 16 lb and the overall size is $11 \times 9\frac{1}{2} \times 4$ in.

Despite the fact that space is at a premium in sets of this kind the transmitter and receiver are entirely separate, so far as the circuits are concerned, but a common chassis is employed. Needless to say, really miniature parts are used throughout, for example, the send-receive relay which changes over the aerial, switches L.T. from transmitter to receiver and switches the H.T. batteries is not much larger than a thumb nail. Furthermore the sets are fully tropicalized.

The receiver is a double superhet with a single crystal-controlled oscillator serving for both mixers. It has one R.F. amplifier and three I.F. stages at 1.6 Mc/s. The first I.F. has no separate amplification. Detector, A.G.C. and noise limiter are all germanium crystals. There is one A.F. amplifier.

Four valves are used in the transmitter, which is also crystal controlled. Of these two are R.F. stages and two modulators, the amplitude system being employed. This set gives an R.F. output of not less than 250 milliwatts over the working range of frequencies (75 to 100 Mc/s).

The fine performance of these sets can be attributed to a combination of good design, workmanship and careful attention to small detail.

Model L45 is a pack-set version.



Silver plating is used wherever it has been found to confer any advantage. Incidentally, the vertical aerial is of special design having great flexibility yet always returning to the original position no matter how far it is bent. It can even be coiled up and when released springs out to a straight rod. It also is silver plated.

to the calculation of A.C. circuits. The principles are general to all branches of electrical engineering. Thus, although one-third of the book is devoted to star-delta conversion and the detailed working out of an example of electrical power distribution network, this example can be regarded equally as a solution of the unbalanced bridge. And although resonance is not specifically mentioned, the principles are all there. It is notable that admittance is given equal status with impedance. The distinction between a rotating vector and the vector operator is clearly pointed out.

There are a few misprints, especially in the first booklet. The nomenclature and symbols are on the whole well chosen; an exception is that instead of the standard alternative to heavy type for indicating vector quantities—a bar overhead—a dot is used, which more usually signifies $\frac{d}{dt}$. And a very

strange and unexplained symbol appears on pages 10 and 11. Readers may be confused by the misuse of the symbol \pm in connection with expressions for admittance (but not in the corresponding expressions for impedance). In general, however, the teaching is clear, simple, and painstaking. It is recommended to everyone who has need to make A.C. calculations and is not entirely happy about using "j" for the purpose.

Two commendable features are the Dewey classification numbers on the front covers, and the repeating of diagrams where necessary to ensure that they are always to be seen at the same opening as the related text. M. G. S.

BOOK REVIEWS

The Symbolic Method of Vector Analysis. Pp. 28, with 15 diagrams. Price 3s.

A.C. Network Analysis by Symbolic Algebra. Pp. 41, with 37 diagrams. Price 4s.

Both by W. H. Miller, A.M.I.E.E. Classifax Publications, 9, White Moss Avenue, Manchester, 21.

THESE two booklets are the first in a new series intended to provide students with the essential information on specific subjects without their having to buy large and expensive works containing much that may be unnecessary to them. The titles are perhaps rather alarming to the student who is not strong in mathematics, and a glance at the interiors might confirm the fear that they are too advanced. Actually, however, only very elementary algebra and a mere smattering of trigonometry are required, and the abundance of equations is at least partly a result of

the author's care to place his stepping stones so close together that his weakest followers are not likely to fall down between them.

The first booklet is, as the subtitle says, a simple explanation of the "j" operator. The author dismisses the terms "imaginary" and "complex," which suggest something difficult, and starts from the idea that it is just as easy and logical to use the symbol $\sqrt{-1}$ to mean a 90-degree change in direction as it is to use -1 to mean a change in direction of 180°. From this he goes on to explain the "general number," $a+jb$, and how it is subject to ordinary simple algebra. Each stage is illustrated by diagrams and numerical examples. The "scalar product," which experience shows is a difficulty to some students, is not introduced.

In the second booklet he shows how to apply the "j" technique

BOOKS RECEIVED

Wörterbuch der Electrotechnik. By G. Swoboda and R. Filipowsky. An English-German glossary of electrical technical terms, including radio and television. Pp. 312. Manzsche Verlagsbuchhandlung, Kohlmarkt 16, Vienna. Price 54 30.

The Amplification and Distribution of Sound. By A. E. Greenlees, A.M.I.E.E. A second edition of this standard textbook on sound reinforcement and public address work first published in 1938. The matter has been rearranged and revised and numerous additions have been made in the light of recent developments. Pp. 302, with 108 diagrams. Chapman and Hall, 37, Essex Street, London, W.C.2. Price 16s.

Radio's Conquest of Space. By D. McNicol. A historical account of the development of radio from the earliest days up to the evolution of radar. Pp. 374; 53 figures and many illustrations. Published in Gt. Britain by Chapman and Hall (address above). Price 18s.

WORLD OF WIRELESS**Birmingham Television Frequencies ♦ French 819-Line System ♦ "Old Soldiers . . ." ♦ E.I.F. Broadcasting****B.B.C. Television**

THE frequencies to be employed by the Sutton Coldfield television station have at last been announced by the B.B.C. They are: vision 61.75 Mc/s and sound 58.25 Mc/s. Asymmetric sideband transmission, in which the upper sideband of the vision transmitter will be partially suppressed, is to be used to reduce the bandwidth required. The sound channel will be A.M.

The output of both the 35-kW vision transmitter and the 12-kW sound transmitter will be radiated from a single aerial supported by a steel lattice mast, 750 feet high. This mast, which is being erected by B.I. Callender's Cables, is of novel design. The main triangular support mast will be 600 feet high, at this level the cross section changes to circular, and for the next 110 feet the mast resembles a steel chimney. Above this will stand a short, square tower carrying eight dipoles.

When reviewing the progress of the B.B.C. television service recently the Director-General remarked: "Exactly what is the right order of priority for television in our British economy at present no one can say dogmatically. There is no simple or easy answer . . . All I would dare to say is this. Television is a permanent addition to the twentieth-century way of life. Its extension to cover the whole country and its eventual marriage with sound broadcasting, once the two coverages are approximately similar, will overshadow all other broadcasting problems in importance during the next few years."

French High-Definition Television

WE learn from a correspondent that if present plans materialize, Parisians will have a public television service of 819 lines by the end of the year. This will operate simultaneously with the existing 455-line system. The picture signal (interlaced) will have a waveform which does not differ greatly in shape from the existing systems in Paris and London. A three-van mobile unit which will be used for O.B.s will operate on either standard by a simple switching arrangement. For O.B.s at too great a distance to use existing cables an aerial suspended from a balloon and using decimetric waves will be used. The

actual transmitter for the 819-line system is in the Eiffel Tower and will operate on about 200 Mc/s.

A particularly interesting point is that the new system is stereoscopic. The projected images appear on the screen, one above the other and are separated by a horizontal line. The aspect ratio per picture being 8:3. By viewing the screen with a piece of equipment resembling a pair of opera glasses, the normal aspect ratio of 4:3 is restored and the two images combined stereoscopically.

Better Listening

SOME interesting facts were revealed during the recent "Better Listening" campaign organized jointly by the R.I.C. and the B.B.C.

From a review of sales figures during the past few years it is apparent that 5.5 million householders—43.5 per cent of the country's licence holders—are using sets which are more than ten years old.

An investigation by leading dealers in various parts of the country reveals that the average annual cost of repairs to these old sets is between £2 and £3 10s.

Sir Noel Ashbridge, B.B.C. Director of Technical Services, has expressed the view that listeners become "drugged with bad quality" to such an extent that the high-fidelity reproduction of a modern set is disliked. A pamphlet giving hints on better reception has been issued by the B.B.C.

Radio Recruiting

RADAR operators, supervisors and mechanics, R/T operators and wireless mechanics are urgently needed by the Air Defence Units of the Royal Auxiliary Air Force. These units, manned by 20,000 men and women volunteers, will form part of the Fighter Command raid reporting and control system covering the whole country.

Among the ground trades in the R.A.F. Volunteer Reserve for which recruiting has re-opened is that of radio servicing. At present only men who have served in the R.A.F. will be accepted.

Details regarding both of these Services are obtainable from R.A.F. Recruiting Centres or from the Inspector of Recruiting, Victory House, Kingsway, London, W.C.2. Special units of the Territorial

Army are said to be very short of radio technicians, especially those who served as officers and N.C.O.s during the war. They are required as instructors. Particulars regarding recruitment are obtainable from Territorial Centres.

TELEVISION.—This sketch gives some idea of the construction of the Birmingham mast. The slots in the upper section are for a "slot" aerial for sound broadcasting, probably F.M. A similar mast will be used at Wrotham, Kent.

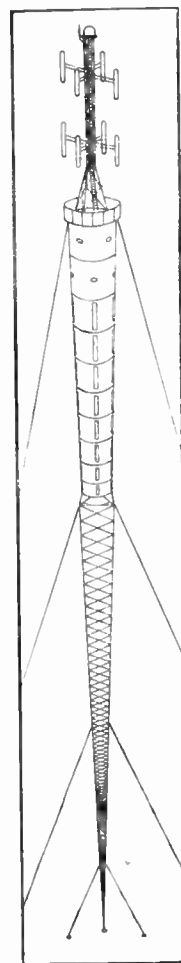
**F.M. or — ?**

WE recently put forward the plea that before embarking on a nation-wide F.M. service the B.B.C. should try another parallel experiment — amplitude modulated E.I.F. It was, therefore, gratifying to learn from a recent B.B.C. statement that a second transmitter, "which can work on A.M. or some other method of modulation" is being installed at the Wrotham (Kent) station where work on the erection of Europe's first high-power F.M. transmitter has begun. By installing the second transmitter the engineers will be able to compare results side by side.

Army Signals

THE Signals Research and Development Establishment of the Ministry of Supply at Christchurch was open for inspection by representatives of industry, the Services and the Press during September. Visitors were shown the various

World of Wireless—

activities of the Establishment ranging from pure scientific research through design and development of communication apparatus to final extensive testing under the equivalent climatic and rough handling conditions likely to be encountered in the field.

The principal Army wireless sets were displayed and a mock battle involving infantry, tanks and aircraft was staged to demonstrate the scope of radio communication in the modern army. The No. 10 set for multichannel pulse communication and the lightweight No. 88 set, which, together with its batteries, stows easily in an infantryman's ammunition pouch, were highlights of the demonstration.

25 Years of Metal Rectifiers

THE Westinghouse Brake and Signal Company recently celebrated a quarter of a century of manufacture of metal rectifiers. It was in 1923 that the first copper-oxide rectifier was evolved and two years later applied to railway signalling. It was not until 1927 that it made its first appearance in a trickle charger and H.T. battery eliminator for radio sets. Subsequent developments produced the bridge-type instrument rectifier and Westector for use at radio frequencies.

Whilst the copper-oxide type still finds many applications as low-power rectifiers the introduction of the selenium rectifier a few years ago largely displaced the earlier pattern in the field of power rectification.

Improvements still continue to be made, the most recent being the double-voltage rectifier which has enabled the size and weight to be considerably reduced. This is manifest in the extremely small size of

some of the Westinghouse E.H.T. rectifiers now being produced for use in television sets. For example, a rectifier 8in long and 7/16in diameter gives an output of 10kV.

OBITUARY

It is with regret we record the death of **K. B. Warner**, W1EH, the managing secretary of the American Amateur Radio Relay League and secretary of the International Amateur Radio Relay League.

PERSONALITIES

Sir Noel Ashbridge, B.B.C. Director of Technical Services, has accepted the invitation to become president of the Junior Institution of Engineers for the 1948-49 session.

Dr. R. L. Smith Rose, D.S.I.R. director of radio research, gave two lectures under the auspices of the British Council on radar and navigational aids during the period of the British radio components exhibition organized by the R.C.M.F. in Stockholm.

Prof. Balth. van der Pol, D.Phys., the new director of the C.C.I.R., was inadvertently referred to as "of Germany" in our last issue. He is, of course, the well-known and highly esteemed member of the board of management of the Physics Laboratory of the Philips organization in Eindhoven, Holland.

Leslie McMichael, director of McMichael Radio, has been made a Fellow of the Institute of Radio Engineers of Australia. He has recently been on a visit to Australasia.

Sydney C. Shaw, who from 1936-1944 was in the Engineering Division of the B.B.C. and from 1944-47 in Royal Signals, has joined R.C.A. Communications, Inc., and is at Tangier, Morocco.

H. A. Lewis, M.B.E., T.D., B.Sc.(Eng.), who served in R.E.M.E. during the war with the rank of lieutenant colonel, has relinquished his appointment with the B.B.C. Engineering Division to join Marconi's W.T. Co., where he is taking charge of the Broadcasting Division, which includes television.

W. J. Lloyd, B.Sc., who resigned his position as chief engineer of Guy R. Fountain, Ltd., in March, has joined Philips Electrical as chief engineer of the com-

pany's Amplifier and Public Address Department. During the war he was in the B.B.C. Recording Department, where he worked on the development of the War Correspondents' miniature recorder.



W. J. Lloyd, B.Sc.

IN BRIEF

Licences.—Over eleven per cent of the month's increase of 31,250 in the number of receiving licences in Gt. Britain and Northern Ireland were for television receivers. The total number of licences at the end of August was 11,324,000, of which 61,700 were for television.

Licence Fees.—In response to a question in the House, the P.M.G. stated that during the 1947-48 financial year the Exchequer received £1,575,417 and the Post Office £070,390 from broadcast receiving licences. As stated in the last issue, the B.B.C. received £8,927,363 from the same source during the same period.

Amateur Exhibition.—Twenty-seven exhibitors have taken space at the R.S.G.B.'s annual amateur radio exhibition which is to be opened at the Royal Hotel, Woburn Place, London, W.C.1, on November 17th at 2.30 by Dr. Smith Rose. Admission to the exhibition, which will continue until the 20th (hours 11.0 a.m. to 9.0 p.m.), is by catalogue, price 1s.

E.H.F. Record?—What is claimed to be an amateur record for E.H.F. two-way communication was set up when a frequency of 2,350 Mc/s was successfully used over a distance of 13 miles. The stations were situated at Brighton Racehill and Salvington Hill, Worthing.

Air-Ground communication channels for civilian aircraft are being moved progressively from the M.F. band to the E.H.F. band. The freed medium frequencies will then be used for essential radio-navigational services. The change-over has been necessary because of the reduced number of medium frequencies available to aeronautical telecommunications at last year's Atlantic City Conference.

Radar Course.—Among the full-time courses in electronics, telecommunications and radio engineering offered by University College, Southampton, during the coming months is one on radar. This eight-week course, which costs



PYE television camera with demountable electronic view finder in use in the temporary studio at the Copenhagen exhibition.

£5, plus one guinea enrolment fee, embraces the full requirements for the Ministry of Transport examination for the certificate in radar maintenance. The college is equipped with two radar sets, the Admiralty Type 268 3-cm, and the 10-cm marine set Type 271. Details are obtainable from A. Orba, B.Sc., University College, Southampton. Information on the M.o.T. certificate is obtainable from the Secretary, M.o.T., Berkeley Square House, London, W.1.

City and Guilds.—Regulations and syllabuses for examinations in telecommunications and electrical engineering, radio servicing and for the radio amateurs' licence are given in a booklet issued by the City and Guilds of London Institute. Obtainable from the Department of Technology, 31, Brechin Place, London, S.W.7, priced 1s 3d by post, it sets forth in considerable detail the courses available.

Radio and Television Courses, including circuit theory and workshop practice, have been arranged by the Sydenham General Evening Institute. Particulars are available from the principal of the Institute at Sydenham Secondary (Central) School, Kirkdale, London, S.E.26.

I.E.E. Publications.—From January 1st changes are being made by the I.E.E. in the publication of its *Journal*, which has for some time been issued in three parts. In future the *Journal* will contain information intended for members only and will continue to be issued monthly. In addition, the institution will issue in three parts the *Proceedings of the I.E.E.*; Part I (General) will be devoted to papers and proceedings of Ordinary Meetings; Part II (Power Engineering) to the activities of the Utilization, Measurements and Supply Sections; and Part III (Radio and Communication Engineering) to the activities of the Radio Section. Each part will be issued in alternate months. Subscription rates will be £1 1s, £1 11s 6d and £1 11s 6d, respectively.

School Broadcasting.—In reply to a question in the House the Minister of Education stated that, according to an estimate made by the School Broadcasting Council, reception in 30 per cent of the 15,000 schools equipped with radio was unsatisfactory.

I.P.R.E.—The South-West Section of the Institute of Practical Radio Engineers was formed at an inaugural meeting in Newton Abbot, Devon. The secretary is F. C. Roberts, "Inglisbrook," South Brent, Devon.

FROM ABROAD

Citizens' Radio.—New rules have been proposed by the U.S. Federal Communications Commission for the operation of transmitter-receivers for private communication purposes. The recommendation proposes two types of station, one operating within the band 460-470 Mc/s with a power of 50 watts and another limited to 10 watts on 465 Mc/s. Until the proposals are adopted only experimental licences are being issued.

South Africa is to have sponsored broadcasting. The South African

Broadcasting Corporation, which is modelled on the lines of the B.B.C., has been requested by the Government to provide for commercial programmes as soon as possible. The service will be in addition to the bilingual service in English and Afrikaans operated by the Corporation.

Radio New Zealand, the short-wave station of the New Zealand Broadcasting Service, started overseas transmissions on Dominion Day, September 27th. The 7.5-kW transmitter, which at present radiates from 0700 to 0900 G.M.T. on 9.54 Mc/s (ZL2), and 11.78 (ZL3) and 15.28 (ZL4), is situated at Titahi Bay, some 17 miles from Wellington. Reports on the transmissions, which are at present primarily for the New Zealand Dependencies in the Pacific, will be welcomed by the Director, Radio New Zealand, P.O. Box 3045, Wellington, N.Z.

"Radio Craft," our twenty-year-old American contemporary, has changed its name to *Radio Electronics*, as the old title "no longer reflects the editorial content of the magazine."

Swiss Broadcasting.—A copy of the annual report of the Swiss broadcasting authority, Société Suisse de Radio-diffusion, has been received. It deals with the activities of the country's three main broadcasting stations which provide a trilingual service. The report on each station is printed in the language used by the station—Sottens (French), Monte Ceneri (Italian), Beromünster (German).

Walkie-Talkie sets are being supplied to the Cable and Wireless staff on the Cocos Islands to provide communication between Home and Direction Islands, which has hitherto been maintained by irregular sailings by the islanders.

I.R.E. (India).—At a recent meeting of the Institute of Engineers (India) in Bombay it was decided to form an independent Institute of Radio Engineers (India).

Brazil's first television station, which is to be erected in Rio de Janeiro, is being equipped with American gear.

Hungary.—A three-year production plan for the Hungarian telecommunications industry aims at increasing production to 120 per cent of the pre-war total. The target for broadcast receivers is 155,000.

MOBILE RECEIVER used by G.E.C. research engineers for measuring the atmospheric absorption of millimetre waves over paths of up to 1.5 miles. Above the aluminium paraboloidal aerial is the telescope used for aligning the aerials. The region investigated was between 4.5 and 6.5 mm.

EXPORT

Scandinavian Television.—A total of 117,000 people attended the television demonstrations given by British radio manufacturers during the British Exhibition which was held in Copenhagen from September 18th to October 3rd. Since leaving Copenhagen the cameras and mobile transmitting equipment have been used for a week in Stockholm, Sweden, where a demonstration of receivers has been arranged by Pye, Ltd., the manufacturers of the transmitter. For the demonstrations in Copenhagen over twenty receivers, provided by twelve British manufacturers, were used.

Competition between American and British manufacturers in the television export market was discussed at the autumn meeting of the American Radio Manufacturers' Association. It is understood that American producers are planning a campaign to persuade other countries to adopt their higher definition system (525 lines) and are endeavouring to keep export markets open until they have met the present demand in the States.

Components in Stockholm.—Thirty-six member firms of the Radio Component Manufacturers' Federation had stands at the exhibition of components, accessories and materials organized by the Federation in Stockholm from October 18th-22nd. Although Sweden is now making nearly all her own receivers, she has imported over a million pounds' worth of British radio gear so far this year.

Whiteley Electrical Radio Co. reports that their exports of Stentorian loudspeakers have shown a marked increase during the past year. Recent shipments were consigned to Argentina, Malta, India and Trinidad.

INDUSTRIAL NEWS

Marconi communication and D.F. equipment is to be installed in Britain's latest airliner—the Handley Page Hermes IV. The transmitter, which operates on both 'phone and C.W., covers the frequency range 2-18.5 Mc/s and 320-520 kc/s. Twenty pre-selected crystal-controlled frequencies are pro-

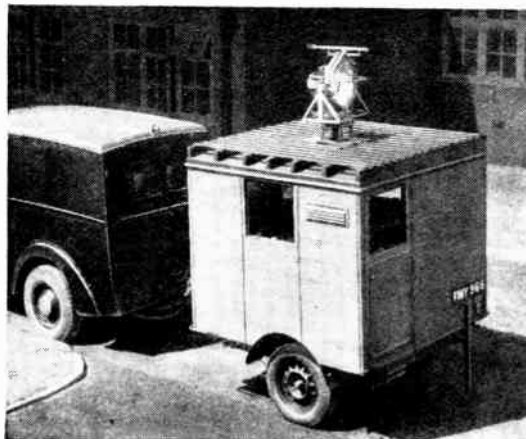

World of Wireless—

vided in the H.F. band and ten in the M.F. band. On H.F. the maximum power is 150 watts and on M.F. 120 watts.

G.E.C.'s recently conducted tests with F.M. equipment on the Thames showed that one low-power transmitter, strategically placed, gave ample signal strength for radio-telephone communication with ships along the entire length of the river which comes within the jurisdiction of the Port of London Authority—some sixty miles.

"Production Engineering," a new 226-page book produced by our associated journal *Machine Shop Magazine*, gives an insight into the various systems of production planning and control. The author, J. S. Murphy, deals with the basic principles and the treatment of the subject is general rather than particular. The book is published by The Louis Cassier Co. and costs 12s 6d.

F. C. Robinson, who some time ago resigned from the managing directorship of Cossor Radar, Ltd., has set up an organization, to be known as F. C. Robinson and Partners, to act as consultants on industrial electronic applications and for the supply and maintenance of electronic equipment. The head office is at Dalton House, Hargate Drive, Hale, Cheshire, and the showroom and service depot at 308, Deansgate, Manchester, 3.

B.E.A.M.A. Catalogue.—The Directory Publications Department of our Publishers has undertaken the production of the 1949-50 catalogue and directory of the products of the members of the British Electrical and Allied Manufacturers' Association. This 700-page reference book, which will be published early next year, will include a classified buyers' guide and a trade directory.

Blind Operatives.—One of the best sources of employment for blind persons is the radio industry, according to a brochure, "Skilled Hands," issued by the National Institute for the Blind.

S. Spencer-West, of Quay Works, North Quay, Gt. Yarmouth, has started a research and manufacturing concern and is developing industrial electronic equipment.

Charles Britain (Radio), Ltd., has moved from Wilson Street, London, E.C.2, to 11, Upper St. Martins Lane, London, W.C.2 (Tel.: Temple Bar 0545).

MANUFACTURERS'

LITERATURE

Descriptive leaflet dealing with the Type 1200 "Strobflash" and accessories from Daws Instruments, Harlequin Avenue, Great West Road, Brentford, Middlesex.

Technical Bulletin D.T.B. dealing with coil turrets CT6 and CT7 and giving complete data and recommended circuits from Denco (Clacton), 355-9, Old Road, Clacton-on-Sea. Price 3s.

Illustrated folder giving complete range of domestic receivers (Autumn, 1948) from the General Electric Co., Magnet House, Kingsway, London, W.C.2.

Literature describing Lustraphone microphone, miniature moving-coil loudspeaker and Model 483 mixer unit, from Lustraphone, Ltd., 84, Belsize Lane, London, N.W.3.

Illustrated leaflet describing the "Motavia" car radio - transportable, from The Motavia Co., Timperley, Cheshire.

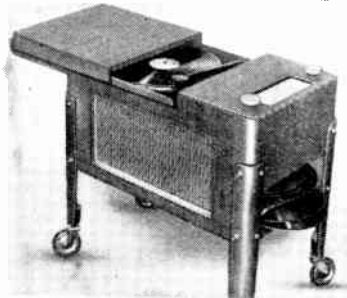

CHAIRSIDE RADIOGRAM made by Telefunken which is an example of the few "special" receivers seen at the Leipzig and Hanover Fairs. A four-valve "Standard Super" costs RM475—three months' wages of the average worker in the British Zone.

MEETINGS

Institution of Electrical Engineers

Radio Section.—"A Storage System for Use with Binary Digital Computing Machines," by Professor F. C. Williams, O.B.E., D.Sc., D.Phil., and T. Kilburn, M.A., on November 2nd.

"Aids to Training—The Design of Radar Synthetic Training Devices for the R.A.F.," by G. W. A. Dummer, M.B.E., on November 3rd.

Continuation of the Discussion on "To what Extent does Distortion really matter in the Transmission of Speech and Music?" re-opened by P. P. Eckersley, on November 9th.

"Printed Circuits, including Miniature Components and Sub-Miniature Valves," by J. E. Rhys-Jones, M.B.E., on November 23rd.

The above meetings will be held at 5.30 at the I.E.E., Savoy Place, London, W.C.2.

Cambridge Radio Group.—Discussion on "To what Extent does Distortion really matter in the Transmission of Speech and Music?" opened by P. P. Eckersley, at 8.15, on November 2nd, at the Cavendish Laboratory, Cambridge.

Address of the chairman of the Radio Section, F. Smith, O.B.E., at 6.0, on November 16th, at the Cambridgeshire Technical College, Cambridge.

Mersey and North Wales Centre.—"Analysis-Synthesis Telephony, with special reference to the Vocoder," by R. J. Halsey, B.Sc. (Eng.), and H. Swaffield, Ph.D., at 6.30, on November 15th, at the Liverpool Royal Institution, Colquitt Street, Liverpool.

North-Eastern Radio and Measurements Group.—Discussion on "To what Extent does Distortion really matter in the Transmission of Speech and

Music?" opened by P. P. Eckersley, at 6.15, on November 15th, at King's College, Newcastle-on-Tyne.

Sheffield Sub-Centre.—"The Design and Construction of a New Electron Microscope," by M. E. Haine, B.Sc., at 6.15, on October 27th, at the Scunthorpe Technical School.

North-Western Radio Group.—"Practical Aspects of Marine Navigational Radar," by A. K. Nuttall, M.A., at 6.30, on November 17th, at the Engineer's Club, Albert Square, Manchester.

Scottish Centre.—"The Wartime Activities of the Engineering Division of the B.B.C.," by H. Bishop, C.B.E., B.Sc. (Eng.), at 7, on November 10th, at the Heriot-Watt College, Edinburgh.

Rugby Sub-Centre.—"Three Dimensional Cathode-Ray Tube Displays," by E. Parker, M.A., and P. R. Wallis, B.Sc. (Eng.), at 6.30, on November 2nd, at the Electricity Showrooms, Rugby.

Southern Centre.—"Analysis-Synthesis Telephony with special reference to the Vocoder," by R. J. Halsey, B.Sc. (Eng.), and J. Swaffield, Ph.D., at 6.30, on November 10th, at the A.S.R.E., Haslemere.

British Institution of Radio Engineers London Section.—"U.H.F. Radio Equipment for Mobile Services," by D. H. Hughes, at 6.0 on November 18th at the London School of Hygiene and Tropical Medicine, Keppel Street, London, W.C.1.

South Midlands Section.—"Measurement and Suppression of Radio Interference," by J. H. Evans, at 7.0 on November 25th at the Technical College (Room A.5), The Butts, Coventry.

Merseyside Section.—"Television Receiver Design Technique," by P. Jones, at 6.45 on November 17th at the Incorporated Accountants' Hall, Derby Square, Liverpool, 2.

Television Society

London.—"Studio and Outside Broadcasting Television Practice," by T. H. Bridgewater, at 7.15, on October 27th, at the G.B. Theatre, Film House, Wardour Street, London, W.1.

Midlands Centre.—"Luminescent Materials for Cathode-Ray Tubes," by Dr. G. F. J. Garlick, at 7.0, on November 2nd, in Room 6, Chamber of Commerce, New Street, Birmingham. Sec.: R. R. T. Baxendale, 50, Alcester Road, Moseley, Birmingham.

British Sound Recording Association

"Some Fundamentals of Magnetic Recording," by E. W. Berth-Jones, B.Sc., at 7.15 on November 19th, at the E.M.I. Studios, 3, Abbey Road, St. John's Wood, London, N.W.8.

Radio Society of Great Britain

"Speech Clipping," by P. F. Cundy, at 6.30, on October 29th, at the I.E.E., Savoy Place, London, W.C.2.

Institute of Physics

Electronics Group.—Discussion on "Valves for Low-Noise Wide-Bandwidth Amplifiers," opened by R. J. Ballantine, M.Sc., and A. E. Widdowson, Ph.D., at 5.30, on October 5th, at the Institute's House, 47, Belgrave Square, London, S.W.1.

Junior Institution of Engineers

North-Western Section.—"The Electron Microscope," by M. Venner, B.Sc. (Eng.), at 2.30 on November 20th at the Manchester Geographical Society, 16, St. Mary's Parsonage, Manchester.

THE "BELLING-LEE" PAGE

Providing technical information, service and advice in relation to our products and the suppression of electrical interference

Suppression of Small Rotary Convertors.

We receive, by almost every post, requests for advice on the suppression of electrical interference caused by small rotary convertors, and we can therefore appreciate the motives behind "DIALLIST'S" remarks on the subject, in the "Wireless World," July issue.

Filtering of all leads will probably be necessary, and this is preferably carried out at the point of entry into the screening box (L.300/3, L.305*2, according to rating).

Although the filters do not cover frequencies above 30 Mc/s, this treatment will normally be effective against interference at T.V. frequencies, provided that the screening

At the present stage of the television studio art, lighting variations at that end may tend to mask the effect of flutter due to lack of rigidity in an aerial, but as the studio technique is continually improving it is better to be on the safe side and be sure to insist on a rigid, robust aerial, one preferably with quarter wave spacing.

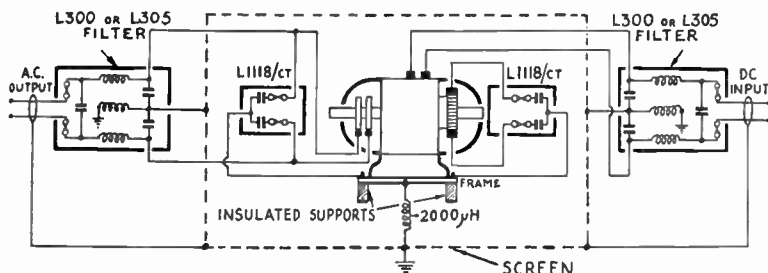

The above diagram shows the recommended suppression methods for small rotary convertors. Standard "Belling-Lee" filters are employed, the L300 (1 amp.) or L305 (2 amp.) being used according to rating.

For those whose electricity supply is D.C., a rotary convertor is, in many cases, a necessary evil, and it may interest them to know how to set about suppressing its principal defects.

Double capacitor suppressors (L.1118/CT)*1 should be connected between the brushes and frame of the machine. Two will be required, one for each set of brushgear. The connecting leads used must be as short as it is possible to make them, never exceeding three inches in length.

The convertor and its capacitor suppressors should be enclosed in a screening box. Expanded or perforated metal is recommended, but wire netting or mesh must be avoided. All joints in its construction should be continuously soldered, and the cover so arranged that multi-point contact with the rest of the screen is assured.

The carcass of the convertor should be insulated from the screen, being earthed, if necessary, through an R.F. choke.

The screen must be solidly bonded to earth, and the convertor so sited that the earth lead is kept short, and independent of the earthing system of the receiver.

The input and output leads may be shielded, with the shield bonded only to the screen enclosing the convertor.

is adequate, since T.V. interference is almost entirely radiated.

In the many thousands of cases of T.V. interference which have passed through our hands, only twice have we encountered instances of such interference being mains borne. If any reader has such a case, we should be glad to hear about it, but we do ask that the nature of the interference shall be confirmed beforehand.

"Flutter" in a Television picture.

It is very gratifying to have received a batch of letters from retailers telling us that our*3 aerials stand up well to severe weather conditions. They are designed with a generous margin of safety which, although contributing somewhat to the overall weight, has from our long experience justified our policy. Of the willow it has been said "it will bend but it will not break." Of the oak, "it will break but will not bend." A good television aerial must do neither.

A television aerial that flaps about in wind, one that "flutters" will give a picture that flutters and may give a great deal of annoyance. This effect may only manifest itself on a windy day or night. If the elements are whippy the effect is more pronounced when eighth wave spacing is employed than with quarter wave spacing.

In Praise of Paint.

The great trouble with a steel aerial is the protective finish. Plating is unsuitable. Continuous exposure to sulphurous fumes in chimney locations, sometimes salt spray as well, all call for paint. Our standard finish is aluminium paint, but we recommend an additional coat at the time of erection. And we have to remind customers and readers that even bridges, iron lamp-posts, park railings, etc., are painted again and again. Yet many people are surprised that a slender "Skyrod"*1 or television aerial will not stand year after year submitted to far worse conditions, and without any attention, just because it is difficult to get at it.

Will those in coastal towns, fishing ports, yachting centres etc., bear in mind that "Belling-Lee" are specialising in suppression on board ship. We have done such work on ships of all sizes from the "Queen" class to trawlers, drifters and yachts.

- 1.* Condenser suppressor for fitting at the source. L.1118/CT. 27/6.
- 2.* Set lead suppressors L.300/3 (1 amp.) all-wave 59/6. L.305 (2 amp.). Short and medium wave 63/-.
- 3.* "Viewrod" television aerial for London frequencies L.502/L, for Birmingham frequencies L.634, each £6/6/-. Both types include dipole reflector and chimney lashings (less mast). Required length of feeder extra.
- 4.* "Skyrod" 18ft. vertical aerial with "Eliminoise" transformers, screened feeder and earth wire, etc., L.638/K for chimney mounting £10/-/-. L.638/CK for mast mounting £8/15/-. The words "Viewrod," "Skyrod" and "Eliminoise" are regd. trade marks.

BELLING & LEE LTD
CAMBRIDGE ARTERIAL ROAD, ENFIELD, MIDDLESEX



PHILIPS

SOUND AMPLIFYING EQUIPMENT

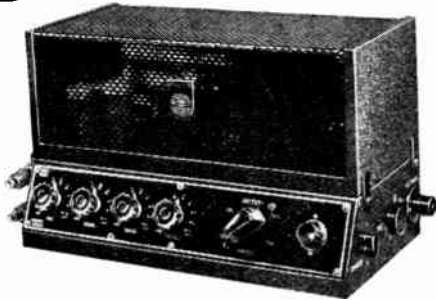

THE "VOXMOBILE" AMPLIFIER

Type 2856R

Mobile — Indoor — Outdoor

Operates from A.C. Mains or 12-volt battery
Output:—12-watts. Self-contained

The Voxmobile is a really versatile amplifier. While it produces excellent quality, it is light, quickly connected, and operated equally as well either from A.C. mains 250 volts or a 12-volt car battery.

One of the outstanding features of this amplifier is the high sensitivity; only 3.5 mV being required into 1 megohm to produce the full output, thus allowing wide pick-up and the use of high quality microphones.

List Price: £38.0.0

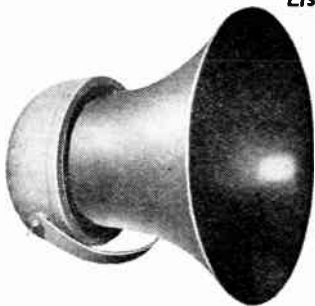

Loudspeaker

Type

9816T

Excellent reproduction and wide angle distribution. Weatherproof — light — robust.

For use Outdoors, Indoors, or on a Vehicle.

No back radiation and therefore minimum feed-back. The ideal "general-purpose" quality P.A. Speaker. Complete with line transformer tapped at either 1, 3 or 6 watts.

List Price: £8.0.0

Complete Voxmobile "All-Purpose" Equipment

The ideal general-purpose equipment for Dealers and for Religious, Political, Social and Sporting Organisations. Comprises:—Amplifier, high fidelity moving-coil microphone, substantial stage-type microphone stand and two type 9816T speakers.

List Price: £70.0.0. Available to all bona fide Traders

PHILIPS ELECTRICAL LIMITED, AMPLIFIER DEPARTMENT,
CENTURY HOUSE, SHAFTESBURY AVENUE, LONDON, W.C.2

TELCON'S LATEST MAGNETIC DEVELOPMENT

H.C.R. ALLOY

is now available in commercial quantities

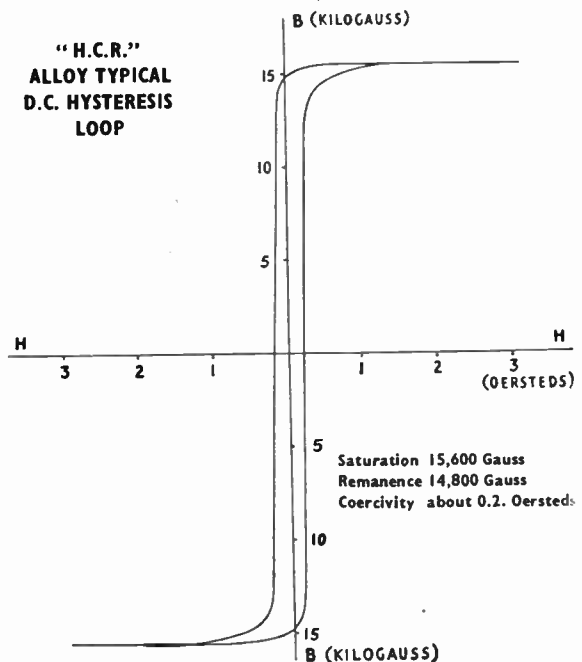

The magnetic properties of this alloy are such that it is invaluable in the design and construction of improved types of mechanical rectifiers, magnetic amplifiers and special forms of reactors.



Full technical details on request from:—

THE TELEGRAPH CONSTRUCTION & MAINTENANCE CO. LTD.

Founded 1864

Head Office: 22 OLD BROAD ST., LONDON, E.C.2. Tel: LONDON Wall 3141
Enquiries to TELCON WORKS, GREENWICH, S.E.10. Tel: Greenwich 1040

STABILIZED POWER SUPPLIES

2. Some Refinements and Modifications

By M. G. SCROGGIE, B.Sc., M.I.E.E.

IN Part I we discussed the design of series-valve units, illustrating it with an example for providing an output voltage adjustable from 200 to 400 V, stabilized against mains fluctuations of +4% to -8% and load fluctuations between zero and maximum, 100 mA. Using a high-gain pentode for output feedback, we found such a unit to be capable of a basic mains-voltage stabilization, even with a source resistance as high as 1000Ω, of around 280:1, and an internal resistance of a few ohms. By the use of properly adjusted input feedback via the screen-grid, we found it possible not only to neutralize the bad effects of the stabilizing tube resistance (giving theoretically infinite mains voltage stabilization), or both source resistance and series-valve resistance (giving zero internal resistance), or a compromise between the two.

In relation to its performance, which is amply good for most purposes, the arrangement arrived at so far is quite a simple one. Most of the component values have already been calculated, but there are a few practical details still to be noted.

Applying output feedback by a simple potential divider, ripple in the unstabilized source is reduced in the same ratio as slow mains fluctuations. It can, as already mentioned, be reduced still more by means of a capacitor across R_1 . The value is not critical; 0.25 or 0.5 μF is generally satisfactory.

We have a considerable gain

in the output feedback loop, and as usual must look out for spurious oscillation. A check on this, and on residual hum, can be made with an oscilloscope connected (with a good blocking capacitor) across the output terminals, using sufficient wide-band amplification to show 1 mV. Stray capacitances that would tend to cause phase shift or positive feedback should be avoided; and it is wise to screen everything connected to the control grid of

the internal impedance of the unit correspondingly increased; so it is advisable to provide a H.F. bypass capacitor across the output terminals, say 0.5 μF.

The heaters of V_1 and V_2 should be connected to their cathodes and fed from separate well-insulated transformer windings.

It will be noted that in the example the maximum V_a rating for V_2 is liable to be considerably exceeded. In a stabilizer with a high voltage output this is almost inevitable, and does not seem to be a cause of trouble⁴.

For close adjustment of V_o it is a good idea to divide R_{1b} into coarse and fine controls, say

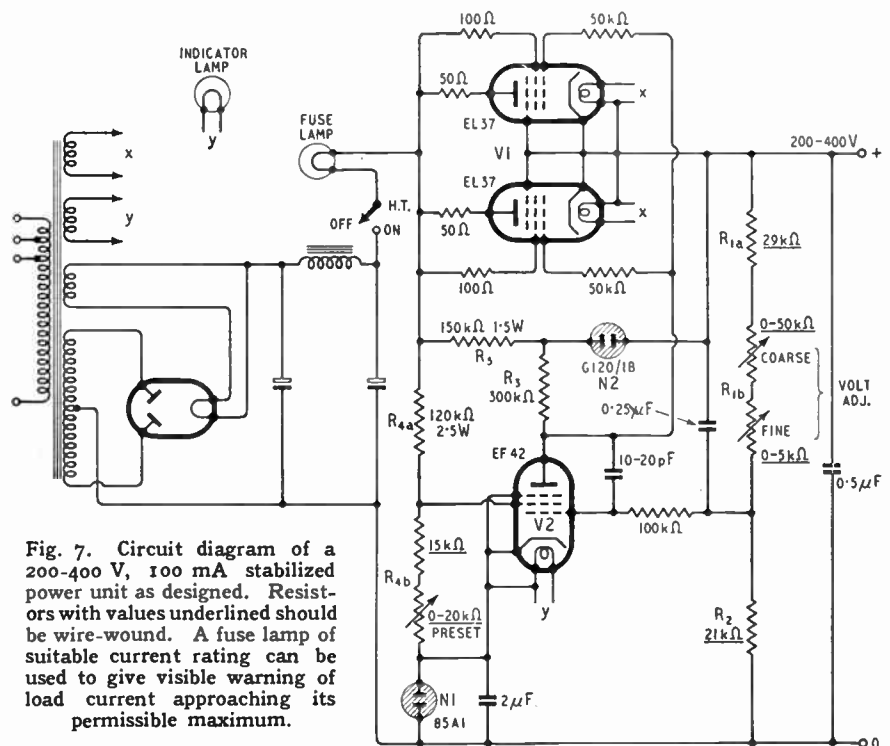

Fig. 7. Circuit diagram of a 200-400 V, 100 mA stabilized power unit as designed. Resistors with values underlined should be wire-wound. A fuse lamp of suitable current rating can be used to give visible warning of load current approaching its permissible maximum.

V_2 , especially if the A.C. power section is on the same chassis. If, in spite of precautions, high-frequency oscillation starts up, add enough capacitance from grid to anode of V_2 to stop it; 20 pF should be ample, assuming a grid stopper of about 100 kΩ. The gain is thereby considerably reduced at high frequencies, and

50kΩ and 5kΩ respectively.

Gathering all our results together we arrive at the complete circuit diagram, Fig. 7. The rectifier and smoother may be on conventional lines. In this design, little margin has been allowed for

⁴ For example see "Voltage-Regulated Power Supplies," A. B. Bereskin, *Proc. I.R.E.*, Feb., 1913.

Stabilized Power Supplies—

tolerances in valves and other components. If it were necessary to ensure effective control over the full working ranges without laboratory checks after renewing valve and neon tubes, and to meet "commercial" conditions generally, it would be desirable to design rather more conservatively. The rather abnormally high source resistance assumed—1000Ω—leaves considerable scope for this, by reducing it.

The observed performance of a unit similar to this one agreed well with expectations. In fact, as regards absence of transients in V_0 on suddenly switching the load on and off it exceeded the highest hopes. With R_{4b} critically adjusted, switching 70 mA or so on and off caused only a flicker of the order of 10 mV, or say 1 in 30,000, corresponding to a mean resistance of $\frac{1}{3}\Omega$. Larger or smaller load changes, or the same change at a different V_0 , without readjustment of R_{4b} , naturally gave less remarkable results, owing to inconstancy of r_{1a} and m , and the reduction of mains fluctuations was only slightly better than "basic"—but that itself was very good. With R_{4b} critically adjusted for mains stabilization, a sudden mains change of 10% caused only a momentary flicker of about 15 mV; but that was followed by a slower drift of as much as 0.8 V due to valve heaters. Where large fluctua-

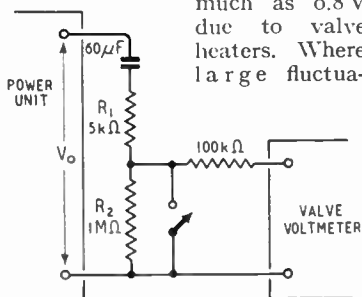

Fig. 8. Method of observing small changes in output voltage V_0 .

tions in mains voltage are liable to occur, a high degree of stabilization can be obtained only by stabilizing the heater supplies too, as described for example in reference 1 (in Part I).

Without any exceptional smoothing in the filter, hum was about 1mV in amplitude; mainly

100 c/s. It depended largely on the layout of the grid circuit of V_2 . Random noise of relatively high frequency and about 2 mV peak was reduced to a negligible

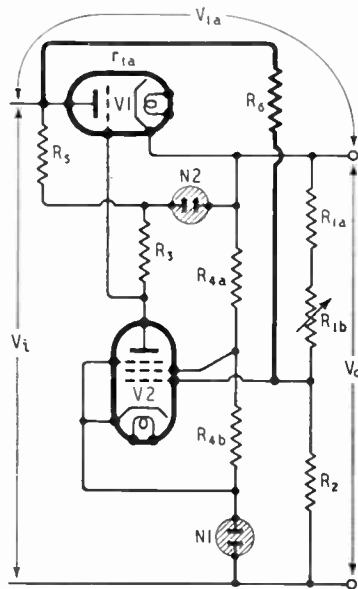

Fig. 9. Input feedback to the control grid of V_2 via the high resistance R_6 , as an alternative to feedback to the screen grid.

level by 2 μ F across N_1 . The performance of the unit depends largely on this, the voltage standard. Some tubes are liable to "flicker" every few seconds, as can be seen on the oscilloscope; or they have discontinuities in the characteristics, and may even set up oscillation. The 85A1 has been designed to avoid these defects, and certainly seems very satisfactory.

Incidentally, the method of observing such small V_0 fluctuations as 1 in 30,000 may be of interest. A bank of paper capacitors totalling 60 μ F, selected for low leakage, was connected across the output as in Fig. 8, in series with a current-limiting resistance R_1 and a high resistance R_2 . The voltage across R_2 , being the difference between V_0 and the practically steady capacitor charge, was observed by a twin-triode Z.F. voltmeter. Except when actually noting the effects of mains and load changes, R_2 was kept shorted by a switch to set

the capacitor charge quickly to equality with V_0 and to protect the valve voltmeter.

With a fixed compromise setting of R_{4b} , the type of circuit described gives a performance which preserves and to a varying extent improves on the basic stabilization conferred by a large amount of output feedback. It is particularly suitable for variable-output units, because the input feedback is independent of the setting of the output voltage control. But some alternatives and refinements may fit certain circumstances better.

If N_1 can be fed from the stabilized output, there are no appreciable voltage changes across its resistance to be neutralized, assuming the variations in I_{2k} are very small. To retain the use of g_2 for neutralizing source resistance, it can still be fed from V_i , but the required value of resistance may be too small by itself to drop the required V_{2g2} without drawing excessive bleeder current. In such a case it may be supplemented by a neon tube.

Alternatively, g_2 can be fed at constant voltage from V_0 and input voltage feedback applied to g_1 , in a method already well known⁵, by means of a high resistance R_6 , as in Fig. 9. If V_0 is to be kept constant when V_i varies, the whole of the variation must occur in V_{1a} . Assuming constant current, this can be brought about by a voltage change μ_1 times smaller at the grid of V_1 , and $\mu_1 m$ times smaller at the grid of V_2 . So the required condition is that $1/\mu_1 m = p_i$, where p_i is the fraction of the V_i change applied to the grid of V_2 . Since V_0 is constant, R_1 and R_2 are in parallel as regards current via R_6 , so—

$$p_i = \frac{R_1 R_2}{R_1 + R_2} / \left(\frac{R_1 R_2}{R_1 + R_2} + R_6 \right).$$

From this, neglecting 1 in comparison with $\mu_1 m$, we get

$$R_6 = \mu_1 m \frac{R_1 R_2}{R_1 + R_2} = \mu_1 m p_0 R_1,$$

p_0 being the fraction of V_0 applied to the grid of V_2 .

In the example we have been considering, $\mu_1 m p_0$ has been of the order of 500, so if R_1 were, say, 60 kΩ, the value of R_6 required to

⁵ "A D.C. Supply Apparatus with Stabilized Voltage," Lindenhovius and Riina, Philips Technical Review, Feb., 1941; described also by Hogg (ref. 3, Part I).

balance out input fluctuations completely would be of the order of 30 MΩ.

Just as with the feedback via g_2 , the optimum adjustment of R_6 for mains variations is not the same as that for load variations. For when I_0 changes there is not only a change in V_i due to source resistance R_i , which is neutralized, but in addition a component of change in V_{1a} due to valve resistance r_{1a} , which is not neutralized, but can be by reducing R_6 . The system is then somewhat over-stabilized for mains variations (see Appendix, Eqn. 14c in final instalment), so that changes in V_i cause small changes in V_0 of opposite sign.

Unlike feedback to g_2 , feedback via R_6 varies when V_0 is adjusted, because p_i is a function of R_1 . Optimum R_6 , as we have seen, is proportional to $p_0 R_1$, which is R_1 and R_2 in parallel. In our example, provision for varying V_0 from 200 to 400 V necessitates varying $p_0 R_1$ in the ratio 1:1.4. The effect of this can be completely avoided by splitting R_6 into two, R_{6a} and R_{6b} , as in Fig. 10. Suppose V_0 is at its minimum, with R_{1b} at zero. Then R_{6a} and R_{6b} are directly in parallel, and if their combined value is the same as optimum R_6 in Fig. 9, their effect is obviously the same. Also if R_{6a} and R_{6b} are respectively

gibly low R_0 . So both ends of R_{1b} are at the same potential as regard input feedback current, and its resistance can therefore be raised to any extent without upsetting

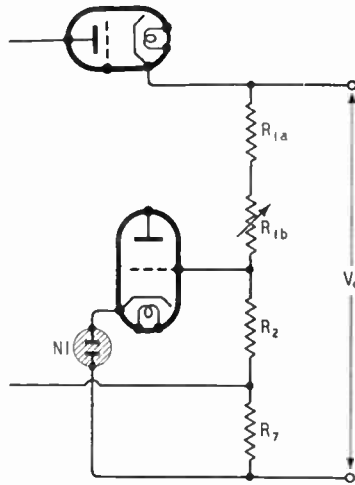

Fig. 11. Output current feedback, normally used together with input voltage feedback, to neutralize the resistance of V_i .

the optimum feedback adjustment.

Fulfilling the conditions just stated gives the following values of R_{6a} and R_{6b} for perfect input voltage stabilization:

$$R_{6a} = \mu_1 m R_{1a}$$

$$R_{6b} = \mu_1 m R_2$$

If it is inconvenient to provide such large values of adjustable resistance (of the order of 60 MΩ in our example), they can be stepped down by taking the feedback voltages from an adjustable tapping on R_5 . Such a tapping also avoids the difficulty of having to vary R_{6a} and R_{6b} simultaneously. But if the latter are below, say, 5 MΩ, it may be necessary to modify the values of R_1 and R_2 to allow for the current coming from R_5 .

All the methods of input feedback described so far have the disadvantage that although they can be adjusted to cancel the residual effects of input voltage changes, or output current changes, they cannot do both completely at the same setting. The former necessitates cancelling the source resistance, R_i , whereas the latter necessitates cancelling the valve resistance, r_{1a} , also.

The two settings, therefore, are in the ratio $R_i : (R_i + r_{1a})$. If input feedback is set to cancel R_i , then it is completely effective against mains fluctuations, and also against that part of the effect of load current fluctuations due to R_i . The effect of r_{1a} can be cancelled by feedback from a low resistance, R_7 , carrying the load current. This device, also described by Lindenhovius and Rinia, is shown in Fig. 11. The voltage change across it, due to changes in load current, when multiplied by $R_i / (R_1 + R_2)$, m , and μ_1 , must be equal and opposite to the voltage change across r_{1a} due to approximately the same current. So

$$R_7 = \frac{r_{1a}(R_1 + R_2)}{\mu_1 m R_i} = \frac{R_1 + R_2}{g_{1m} m R_i}$$

If in our example $R_1 = 60 \text{ k}\Omega$, $R_2 = 21 \text{ k}\Omega$, $g_{1m} = 0.012 \text{ A/V}$ and $m = 275$, the optimum R_7 is 0.41Ω . If input feedback is not used it should be greater, in the ratio $(R_i + r_{1a}) : r_{1a}$.

To render such feedback independent of R_{1b} adjustments, the analogous arrangement to Fig. 10 is shown in Fig. 12. It will be shown (Appendix, Eqn. 18) that the appropriate values for R_{8a} and R_{8b} are

$$R_{8a} = g_{1m} m R_7 R_{1a}$$

$$R_{8b} = g_{1m} m R_7 R_2$$

To avoid upsetting the $R_1 R_2$

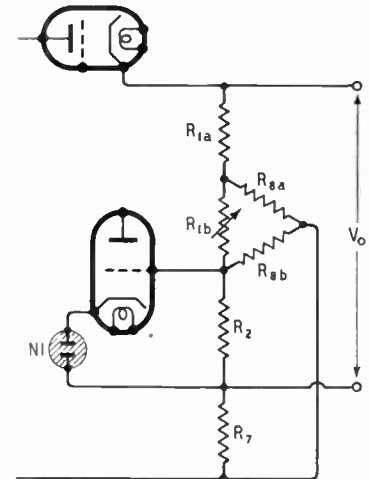

Fig. 12. Modification of Fig. 11 to make it independent of R_{1b} .

potential divider unduly, R_7 should be as large as can be tolerated, say 100 Ω.

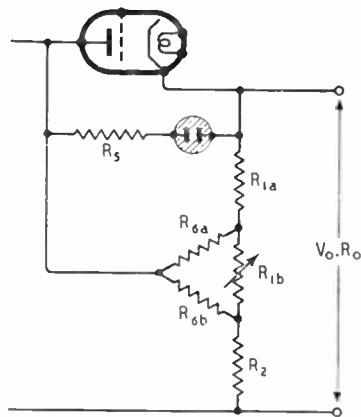

Fig. 10. If R_6 in Fig. 9 is divided as shown here, the input feedback is rendered independent of R_{1b} , the output voltage control.

proportional to R_{1a} and R_2 , these four form a balanced Wheatstone bridge, completed via the negli-

Stabilized Power Supplies—

Fig. 10 and Fig. 12 can be combined. In seeking thus for more and more perfect stabilization, the fact that these critical balances depend on other variable factors must not be forgotten. We saw from Fig. 5 how the gain, m , can not only be much increased (giving greater basic stabilization) but also made far more constant (which we now see enables "perfecting" feedback to be applied more effectively over a

wide range of output voltage) by the use of N_2 . Most of the optimum values for supplementary feedbacks depend on $g_{1m}m$ or r_{1a}/m . This is fortunate, because the remaining inequality in m tends to be offset by simultaneous changes in g_{1m} or r_{1a} . So although it is possible to render m practically constant over a wide range of I_{2a} by using a suitable non-linear resistor for R_3 , the overall result is likely to be worse, especially as m is inevitably less with

such a resistor owing to its A.C. resistance being lower than the D.C.

For a flexible-output unit such as Fig. 7, input feedback would conveniently be via g_2 , rather than R_6 ; but if it were important to stabilize very thoroughly against both mains and load fluctuations it might be well worth while to add Fig. 12, and, if mains fluctuations were large and more than momentary, to stabilize the heater voltages.

(To be concluded.)

RADIO DEVELOPMENTS IN FRANCE

Precision Frequency Meter and Aircraft Sets

EQUIPMENT exemplifying the latest radio technique in France was shown at a recent display arranged by Cossor Radar of the products of the Laboratories Radio-electrique of Paris.

A superhet frequency meter (type 924A) covering 550 to 5 Mc/s attracted considerable interest. The instrument contains two distinct R.F. channels, one is a sensitive superhet which receives the unknown frequency and the other accepts the harmonic output from a crystal-controlled multi-vibrator.

The superhet local oscillator is common to both channels and the circuit arrangement is such that its own variations cancel out in the final determination of the frequency. The accuracy of the meter is the

sum of two independent errors, one being the accuracy of the crystal oscillator, in this case one part in a million, and the other the error due to the direct-reading frequency meter which measures the beat with the selected standard harmonic. It is claimed that with the aid of a special adaptor this error can be reduced to a few cycles.

Included in the display was a V.H.F. transmitter-receiver measuring 17.9 x 13.6 x 7.5ins and weighing about 44lb for use in aircraft. It covers 116 to 126 Mc/s and provides 20 crystal-controlled channels, 10 each for send and receive. Amplitude modulated telephony or M.C.W. telegraphy can be employed with a carrier output of 3 watts and giving an operational

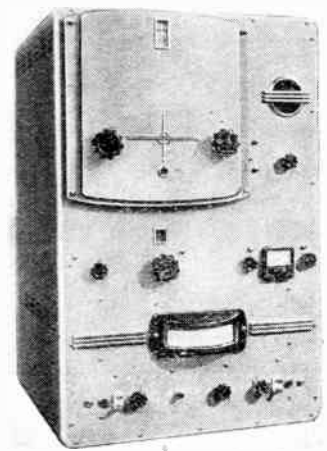

Frequency meter type 924A.

range of about 100 miles at 6,000ft.

Power for the set is obtained from a regulated dynamotor supplying 300 volts D.C. at 300mA and 210 volts A.C. at 50 VA. The latter is stepped down in a transformer and provides 6.3 volts L.T. for the valves, 50 volts D.C. rectified for grid bias and the D.C. regulating voltage for the dynamotor.

One other interesting feature is that when using telegraphy the change over to receive is automatically effected after a brief break in the transmission.

There was also an H.F. transmitter-receiver covering 5 to 10 Mc/s for light aircraft and giving a radio telephone range of about 30 miles. Incorporated in the set is a broadcast receiver with a wave range of 205 to 1,850 metres and having a self-contained loop aerial and a "left-right" pointer-type indicator which gives the approximate bearing of a ground station. It can also be used for "homing" and is a simple form of radio compass for private aircraft.



Books Published for "Wireless World"

	Net Price	By post
GUIDE TO BROADCASTING STATIONS, Fourth Edition ...	1/-	1/1
FOUNDATIONS OF WIRELESS. Fourth revised Edition, by M. G. Scroggie, B.Sc., M.I.E.E. ...	7/6	7/10
RADIO LABORATORY HANDBOOK. Fourth Edition, by M. G. Scroggie, B.Sc., M.I.E.E. ...	12/6	12 11
WIRELESS SERVICING MANUAL, by W. T. Cocking, M.I.E.E., Seventh Edition ...	10/6	10/10
BASIC MATHEMATICS FOR RADIO STUDENTS, by F. M. Colebrook, B.Sc., D.I.C., A.C.G.I. ...	10/6	10/10
TELEVISION RECEIVER CONSTRUCTION. A reprint of 10 articles from "Wireless World" ...	2/6	2/9
TELEVISION RECEIVING EQUIPMENT, by W. T. Cocking, M.I.E.E., Second Edition ...	12/6	12/11
RADIO DATA CHARTS, by R. T. Beatty, M.A., B.E., D.Sc., Fourth Edition—revised by J. McG. Sowerby, B.A., Grad.I.E.E. ...	7/6	7/11
HANDBOOK OF TECHNICAL INSTRUCTION FOR WIRELESS TELEGRAPHISTS, by H. M. Dowsett, M.I.E.E., F.Inst.P., and L. E. O. Walker, A.R.C.S., Eighth Edition ...	30/-	30/8
WIRELESS DIRECTION FINDING. By R. Keen, M.B.E., B.Eng. (Hons.), Fourth Edition ...	45/-	45/9

Obtainable from all leading booksellers or from

ILIFFE & SONS LTD., Dorset House, Stamford Street, London, S.E.1.

Vortexion

"SUPER FIFTY WATT" AMPLIFIER

This **AMPLIFIER** has a response of 30 cps. to 25,000 cps. within $\frac{1}{2}$ db, under 2 per cent. distortion at 40 watts and 1 per cent. at 15 watts, including noise and distortion of pre-amplifier and microphone transformer. Electronic mixing for microphone and gramophone of either high or low impedance with top and bass controls. Output for 15/250 ohms with generous voice coil feedback to minimise speaker distortion. New style easy access steel case gives recessed controls, making transport safe and easy. Exceedingly well ventilated for long life. Amplifier complete in steel case, with built-in 15 ohm mu-metal shielded microphone transformer, tropical finish.

As illustrated Price 36½ Gns.



FOUR-WAY ELECTRONIC MIXER

This unit with 4 built-in, balanced and screened microphone transformers, normally of 15-30 ohms impedance. Has 5 valves and selenium rectifier supplied by its own built-in screened power pack: consumption 20 watts.

Suitable for recording and dubbing, or large P.A. installations since it will drive up to six of our 50 watt amplifiers, whose base dimensions it matches, normally for output line of 20,000 or less load since ample feedback is used.

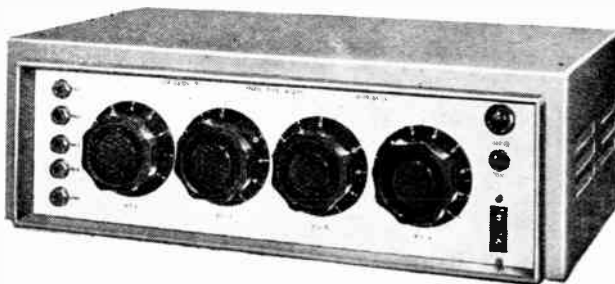

Price in case with valves, etc., £24 0 0

ALL TYPES OF MICROPHONES, STANDS AND SPEAKERS AVAILABLE FROM STOCK INCLUDING 12in. GOODMAN P.M. SPEAKER.

30 WATT RECORD REPRODUCER IN CASE PRICE 30½ Gns.

10 WATT RECORD REPRODUCER WITH MICROPHONE STAGE, IN CASE PRICE 25½ Gns.

SUPER FIFTY-WATT AMPLIFIER PRICE 36½ Gns.

CP20A FOR A.C. MAINS and 12 VOLT BATTERY PRICE £28

Vortexion

LIMITED

257-261, THE BROADWAY, WIMBLEDON, LONDON, S.W.19

TELEPHONES: LIBerty 2814 and 6242-3.

TELEGRAMS: "VORTEXION, WIMBLE, LONDON."

THE NEW **VITAVOX** G.P.1 PRESSURE UNIT

- (1) Forged magnet housing. Bonderized and finished in a wear resistant thermo-setting plastic enamel.
- (2) Centre pole Ticonal G magnet giving a total useful flux of 80,000 lines and a flux density of 16,500 lines per sq. cm with no external field.
- (3) Locator registering pole with relation to top plate and maintaining gap width within .001".
- (4) Pole cap machined to a tolerance of +.000" - .001" to ensure accuracy of assembly.
- (5) One-piece diaphragm of non-corrodible Duralumin with tangential surround. Voice coil wound directly on to diaphragm to ensure strength and reliability. Phosphor bronze lead out strips.
- (6) Satin Chromed top plate secured to magnet housing with socket headed screws and providing accurate registration for throat and pole locator.
- (7) Rubber gasket to prevent ingress of dust and moisture.
- (8) Non-rotating terminals.
- (9) Die-cast throat incorporating phase correction device to ensure maximum H.F. response. Plated and finished as magnet housing.
- (10) Dust cap to protect unit when not in use.

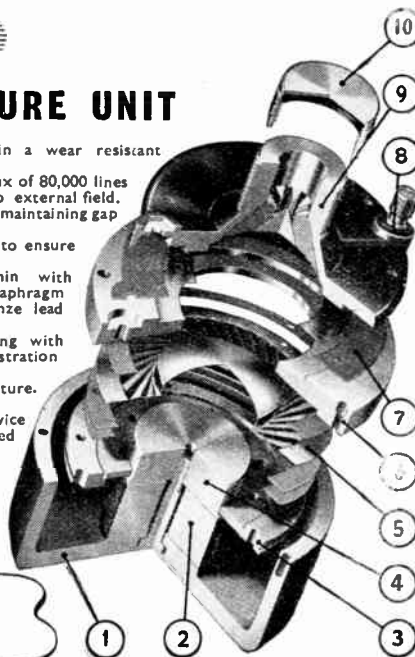

VITAVOX LIMITED,
Westmorland Road, London, N.W.9.
Tel.: COLindate 8671.

Impedance 15 ohms. Peak Power
Handling Capacity 20 watts.
List Price £9.10.0. (Complete in
felt-lined wooden storage box.)

GARDNERS

“AVON”
“BURLEY”
“HENGIST”
“SOMERFORD”

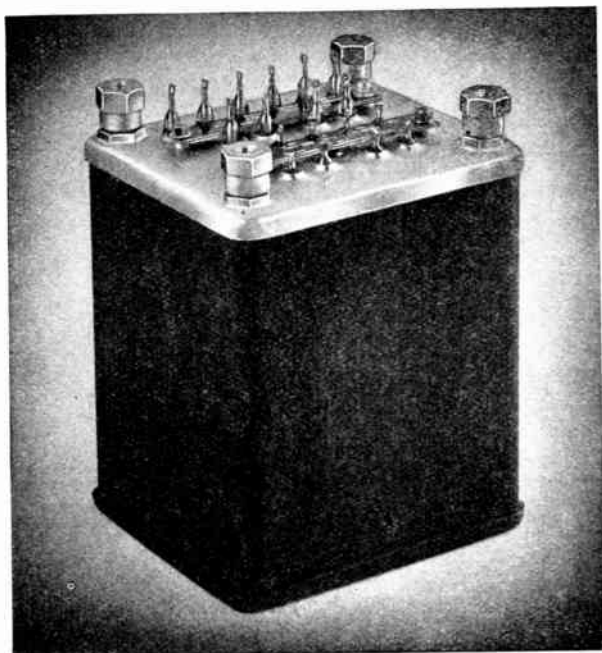

The illustration shows our hermetically sealed transformer, which together with “Hengist,” “Avon,” “Burley,” and the “Somerford” range of transformers and chokes adequately fulfils the requirements of the Electronic industries and National Research establishments.

The “Somerford” range comprises some 141 types of transformers and chokes, most of which are available for immediate or prompt delivery.

Full details will gladly be sent upon request.

GARDNERS —TRANSFORMERS

GARDNERS RADIO LIMITED
SOMERFORD · CHRISTCHURCH · HANTS

Telephone : Christc'hurch 1025.

RESISTOR RATINGS

Characteristics and Operating Conditions

H. G. M. SPRATT,

B.Sc., M.I.E.E.

PRIOR to the invention of the triode and the start of the radio industry the electrical engineer was seldom concerned with the use of non-metallic resistors. He rarely wanted values so high that they could not be obtained from resistance wire; nor did he need really low time constants, except in the instrument field, where wire had to be used anyway. He already had the carbon brush, the carbon pile and the carbon microphone. He was well content to leave it at that.

It was in the early 'Twenties that a widespread demand for a non-wire-wound resistor arose. It was wanted for use as a grid leak; consequently no exacting specification was implied. If it had been written down, it would probably have read as follows: Resistance—to be within the limits 1 to 5 M Ω ; maximum applied voltage—5V; maximum frequency, 2 Mc/s. Carbon was the obvious material to use for this purpose, and it is hardly surprising that manufacturers met this specification requirement without any great difficulty. 1-M Ω carbon resistors led to 0.1-M Ω and then to 10,000- Ω carbon resistors, and these, too, were generally quite satisfactory provided they were not called upon to carry more than a fraction of a milli-ampere. If they were, they usually sank to zero or rose to infinite resistance immediately.

As a result, a considerable amount of research took place and in the late 'Twenties carbon resistors of all values, with ratings of $\frac{1}{4}$ and 1 watt, appeared on the market. Considering the short development time they were remarkably good, standing up to their full loads, and sometimes appreciably more, with a good heart. The next few years saw a steady improvement and no particular setbacks.

During the early days of television development, however, a new application of these resistors was attempted, namely, in the H.T. circuits feeding the C.R. tube. Under any circumstances some permanent leak of the order of 10 M Ω was needed to prevent

the smoothing capacitor from retaining its charge unduly long after switching off. Apart from this, though, the early C.R. tubes generally had up to three auxiliary electrodes requiring intermediate voltages which could not economically be provided except by dropping down from the full H.T. potential. Such values as 1 M Ω , 1 watt, carrying a current of about 0.8 mA (0.64 W) were chosen, but after a short time the intermediate voltages

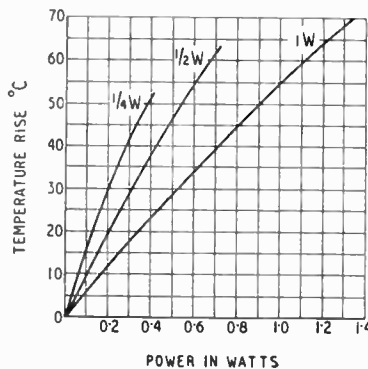

Fig. 1. Temperature rise v. load for insulated resistors.

were found to be quite incorrect. Examination invariably showed that the 1-M Ω resistors had dropped in value some 30-50 per cent, and since this was constantly occurring and the resistors were obviously not being overloaded as regards current, it was finally concluded that the high voltage was responsible. On the manufacturers' advice 700 volts was accepted as the maximum permissible voltage, regardless of loading, for a 1-W resistor and from then on no further trouble of this kind was experienced.

The next event was the drafting, during the war, of the stringent Service requirements as regards ambient temperatures. This brought home forcibly the realization that final temperature, and not temperature rise, was the essential factor determining the satisfactory operation of resistors as of many other components.

To-day a much healthier state of affairs exist, with the appreciation that these two parameters must be taken into account. Their consideration may be an annoyance, but it is the safer course.

Resistors now commonly used fall into two main categories: general purpose and high stability types. Their characteristics and the significance of their ratings are not as widely understood as they should be. In particular, it is not always realized that the "wattage rating" is a purely nominal one and most certainly does not mean that a resistor will dissipate a power equal to its rating under all conditions of use. The actual power at which it can safely be used is severely limited by high voltage or by a high ambient temperature. The products of different manufacturers may vary somewhat in detail, and the figures quoted below apply strictly to Dubilier resistors, to the makers of which the author is indebted for much of the data used in this article.

In the case of the general-purpose resistor the question of maximum permissible voltage has been handled in the way previously found satisfactory, namely, by imposing limits irrespective of resistance value. These limits are 250, 350 and 500 volts for the $\frac{1}{4}$ -, $\frac{1}{2}$ - and 1-watt sizes respectively, and they show up somewhat forcibly at the higher resistance values. For example, a nominal $\frac{1}{4}$ -watt resistor of 1 M Ω cannot be loaded to more than $250^2/10^6 = 1/16$ watt, while its 1-watt counterpart is restricted to $500^2/10^6 = \frac{1}{4}$ watt.

Safeguards against overheating are effected by the provision of two sets of curves. The first, Fig. 1, shows temperature rise against loading, and it will be observed that full load corresponds to 35°.

Resistor Ratings—

45° and 55° C approximately for the three sizes in order. The second curve, Fig. 2, is a plot of

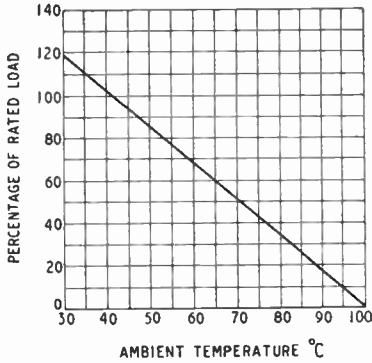

Fig. 2. Variation of maximum load with ambient temperature for insulated resistors.

the maximum permissible percentage of rated load against ambient temperature. The interesting features of this curve are: (1) it is common to all three sizes; (2) it is a straight line; (3) as the ambient temperature falls below 40° C a slight increase over full rated load becomes permissible; and (4) at 100° C and above these resistors cannot be used at all.

These clear-cut restrictions provide salutary safeguards on the life and stability of the resistor, which is quite likely to be surrounded by other heat-dissipating components and may possibly be introduced into equipment intended for the tropics. Thus a ½-watt resistor will be rated down to 68 per cent of its nominal full load for an ambient temperature of 60° C. Under these conditions the resistor temperature, from Figs. 1 and 2, will be 27° + 68° = 95° C. If the resistor were sub-

jected to its full ½-watt load, its temperature would rise to 103° C, which is above the permissible maximum given by Fig. 2. If a ½-watt load is essential, a nominal ¾-watt resistor must be employed and its temperature will be 91° C. Should an ambient temperature of 60° C appear excessive, outside the tropics, it would be worth while to attempt to envisage conditions in the space between the mains transformer and the recti-

reasonably small. As an example, consider a 0.1-MΩ 1-watt resistor. Its temperature coefficient will lie between -0.025 and -0.075 per cent/degree Centigrade. Hence from no load to full load, a temperature rise of 55° C, the resistance change will be from -1.38 to -4.1 per cent.

The high stability and Service type is made up of five different-sized units, which are deliberately designated by symbol and not by

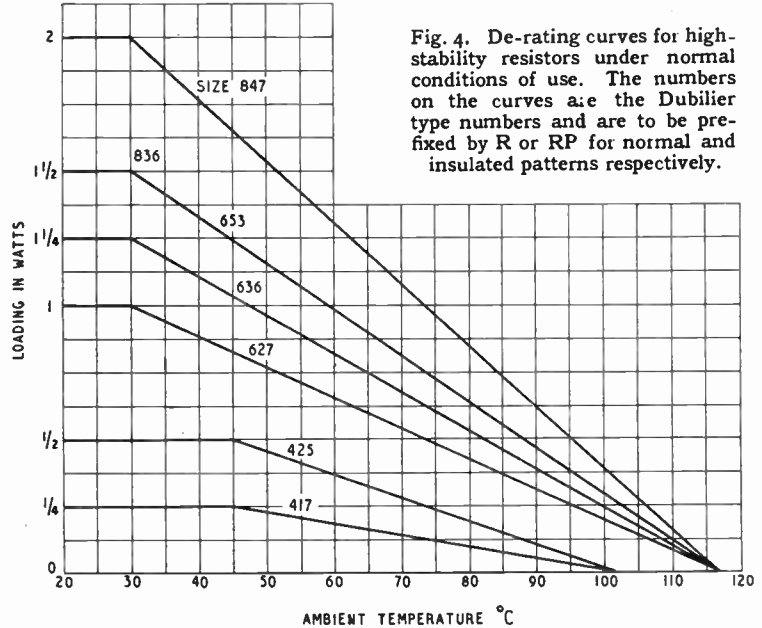

Fig. 4. De-rating curves for high-stability resistors under normal conditions of use. The numbers on the curves are the Dubilier type numbers and are to be prefixed by R or RP for normal and insulated patterns respectively.

fiers in a television receiver on a hot day!

Fig. 3 shows the resistance-temperature coefficients for this type. These figures are given on a statistical basis for 99 per cent of a batch. Little comment is necessary except to state that the coefficient is always negative and

rating. Two distinct conditions of operation are recognized: (1) general industrial and radio uses wherein the maximum stability is desired over long periods of continuous use, with operating temperatures normally below 40° C; and (2) use in Service equipment where ambient conditions up to 71° C must be covered.

Once again maximum voltage limits are given for each size, ranging from 150 volts for a resistor of length about 0.5in to 750 volts for one of about 2in long, and here it is clearly stated that over-voltages are liable to lead to burning or sparking or both.

Consistent with the principle of omitting precise ratings for the various sizes, no curves are provided to show temperature rise against load. On the other hand, two sets of ambient-temperature permissible-loading curves, Figs.

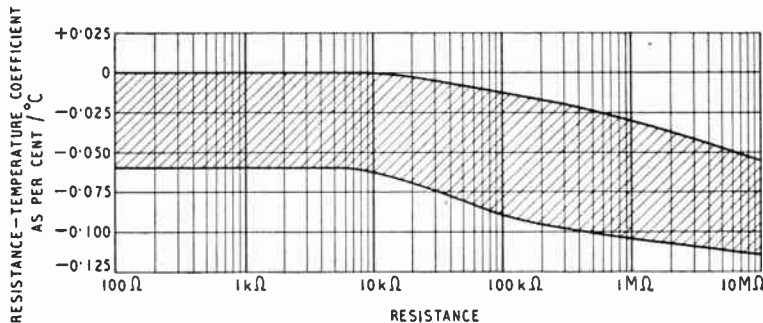

Fig. 3. Temperature coefficient of resistance; 99% of a batch lie within the shaded area.

4 and 5 are given, these relating to the different conditions of use. Under conditions (1), Fig. 4 shows that up to 30° - 45° C, depending upon size, these resistors are capable of carrying constant specific loads from ¼ to 2 watt. Above, the permissible load falls linearly with temperature to zero at approximately 100°-115° C. Thus to ensure high stability and long life the size for a ¼-watt load will have to be increased three times if the ambient temperature is raised from 50° C to 75° C. Fig. 5, which relates to Service use, is similar but shows a common maximum limiting ambient temperature of 71° C for constant maximum loading, above which all sizes are derated linearly to zero loading at 100°-115° C. Not unnaturally the constant loads are not in all cases the same for conditions (1) and (2) while a penalty has to be paid for the severer demands of the latter, this penalty taking the form of a

-0.02 and -0.06 per cent/degree Centigrade. Thus the resistance value of any resistor of this type

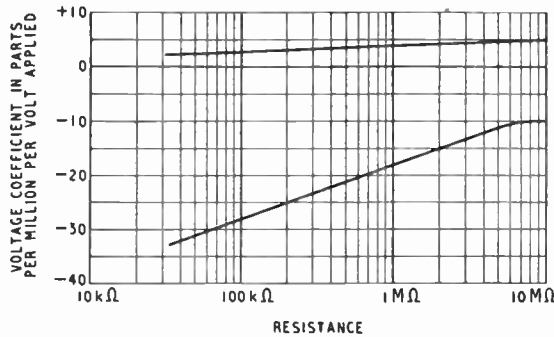

Fig. 6. Voltage coefficient of high-stability resistors; the curves show the limits within which 99% of resistors fall.

would be expected to drop 1.1-3.3 per cent for a temperature rise of 55° C or 1.42-4.25 per cent for a temperature rise of 71° C.

One added advantage arising from the form of construction and the conservative ratings is the fact that short-period overloads of 50 per cent or even 100 per cent will not damage the resistor, though it may cause a permanent change in value of 1-2 per cent. This is a marked improvement over re-

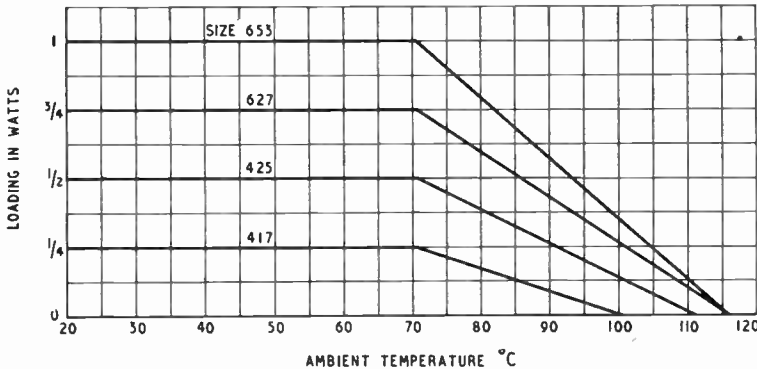

Fig. 5. De-rating curves for high-stability resistors used in Service equipment.

shorter expectation of life for the resistor. Again, at the higher ambient temperatures a slight increase in temperature calls for an increase in size.

As might be expected, the temperature coefficient of this class of resistor is somewhat lower than that of the general-purpose type. It lies approximately between

sistor performance in the past.

The same two factors contribute to a low voltage coefficient and a low noise level. The former is defined as the instantaneous change in resistance value which takes place with a change in the applied voltage and which is quite independent of the change brought about by temperature

ENCLOSED RACK

THE IMHOF STANDARD CASE FITTED WITH STANDARD RACK TYPE PANELS



The type 1022 case is now available in two sizes, fitted with heavy gauge Standard Rack type panels.

1022 A.R.—21½" w. x 10½" h. x 10½" d., with one 19" x 10½" panel .. £3 14 0

1022 C.R.—21½" w. x 22" h. x 10½" d., with two 19" x 10½" panels .. £5 15 0

A Standard Chassis and mounting brackets available for use with the above cases—size 17½" x 10" x 2", plated finish, 15/- the set.

These cases are ideal where small enclosed rack assemblies are required for table or bench mounting.



Write today for our detailed list of Standard Instrument Cases, Case and Panel Handles, and Open Rack Assemblies.



THE INSTRUMENT CASE SPECIALISTS
ALFRED IMHOF LTD.
112-116 NEW OXFORD STREET,
LONDON, W.C.1
Telephone: MUSEUM 7878

Resistor Ratings—

rise. It is customary to measure it in parts per million per volt applied and the curves in Fig. 5 show the limits, again on a statistical basis, within which the coefficient will lie for this type of resistor. Consider a 500,000- Ω 1-watt resistor. Its full-load voltage is 224 volts and its voltage coefficient, according to the curves, lies between -2×10^{-5} and -31×10^{-6} parts per volt.

50,000- Ω 1-watt resistor would be expected to have a noise level of $0.3 \mu\text{V}/\text{V}$ or $67 \mu\text{V}$ at full load. Let us consider a case where noise is likely to be of greater interest, say a 1,000- Ω resistor with 20 volts across it. The noise level here will not exceed $0.15 \times 20 \mu\text{V} = 3.0 \mu\text{V}$, an amount which could in most cases be ignored.

In this type of resistor, the resistance path through the element is of a spiral form. As a result,

than this are required. An ultra-high resistance range meets this requirement partly by virtue of a different form of construction and partly by increased length. For example, a unit 2-in long will provide a resistance value of 5,000 $\text{M}\Omega$, but a 12-in length is needed for 50,000 $\text{M}\Omega$. It is hardly necessary to state that the maximum permissible voltages are higher than the previously quoted figures and in fact extend from 500 volts up to 4,000 volts for the lengths mentioned.

Another class of resistor, the high-voltage type, is made in two sub-types, one with a spiral resistance path to give high resistance values and capable of standing high voltages, while the other has a straight resistance path so providing lower resistance values but at the same time reduced inductive components. The temperature coefficient of this type is of the order of 0.2 to 0.05 per cent per degree Centigrade.

This mass of data is a measure of the lessons learnt from the failures and revelations of the past. The designer, while restricted in the use to which he can put any particular type of resistor, has more types to choose from and should justifiably feel more confidence in the reliability of his final choice. With the increased interest in tropical operation and the gradual entry of electronics into industry this is a matter of some importance. Industry will not be satisfied with equipment whose standard of reliability falls short of that acceptable in the mechanical world and this standard will be reached only if the components used are properly chosen for the job they have to do and to suit the conditions under which they must operate.

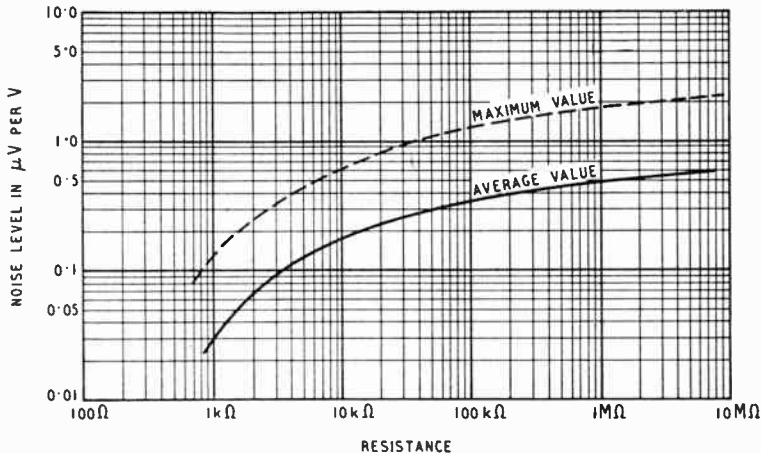

Fig. 7. The curves show the maximum and minimum noise levels for 99% of resistors.

So, with a sudden change for half to full voltage, there will be an immediate resistance change ranging from -0.02 to -0.35 per cent. For a 200,000- Ω 1-watt resistor the corresponding figures are -0.07 to -0.56 per cent. One might be tempted to dismiss these changes as of no consequence, except in measuring circuits, but they are not strictly proportional to the voltage applied and there is some reason to believe that they give rise to cross modulation.

The noise level referred to above is a characteristic of carbon resistors and depends upon the materials used and the type of construction. It is not to be confused with the inherent thermal-noise voltage of a resistance which is proportional to the square root of the resistance and dependent on frequency, bandwidth and absolute temperature. The noise levels characteristic of this type of resistor are given in Fig. 7, where the values in $\mu\text{V}/\text{V}$ are shown against resistance value. According to the curves, a

all resistors have a small but definite inductive component, this component being greater, for any particular resistance value, in the larger sizes. Values range, according to the size, from 0.0007 to $0.017 \mu\text{H}$ at 100 Ω to 0.06 to $2.0 \mu\text{H}$ at 1 $\text{M}\Omega$ corresponding to phase angle ranges of 0.16° - 3.7° and $0.1''$ - $2.5''$ respectively.

General-purpose and high-stability types of resistors are rarely made in value above 25 $\text{M}\Omega$. Cases, however, arise, in industrial rather than radio connections, where higher values

OUR COVER

The trend towards more compact radar equipments for merchant ships is illustrated by this picture of a Kelvin-Hughes installation fitted on a bracket from the mast. The rotating scanner, which has a span of 5ft., is mounted directly on top of the transmitter-receiver unit, which is housed in a weatherproof steel case. This method of construction reduces the length of the vulnerable waveguide to a minimum and eases the problem of excluding moisture.

SHORT-WAVE CONDITIONS

September in Retrospect : Forecast for November

By **T. W. BENNINGTON** and **L. J. PRECHNER** (Engineering Division, B.B.C.)

DURING September, in accordance with the seasonal trend for these latitudes, the average daytime maximum usable frequencies were much higher than in August, and the average night-time M.U.F.s were considerably lower. It may be expected that the M.U.F.s will continue to vary in that manner for the next two months or so.

Owing to the increase in the average maximum usable frequencies the communication on the 28-Mc/s amateur band was much more extensive than in August, contacts having been made as far as New Zealand. Frequencies below 11 Mc/s for distances exceeding 3,000 miles were not often usable at night.

The rate of incidence of Sporadic E was less than in August, and decreased sharply towards the end of the month. This was in accordance with the seasonal trend, and thus rather few contacts were made *via* this medium on the higher frequencies. Long-range tropospheric propagation was observed, sometimes over almost record distances, on many occasions towards the end of the month. This may have been perhaps due to favourable weather conditions.

Sunspot activity in September was somewhat less than in August. Two fairly large groups were observed which crossed the central meridian of the sun on the 3rd and 17th. Ionospheric storms were observed on 1st-7th, 13th, 25th-27th and 30th, those occurring on the 1st, 2nd, 4th, 5th and 25th being particularly violent.

Relatively few "Dellinger" fadeouts have been recorded in September, none of which were really severe.

Forecast. — Daytime M.U.F.s during November should reach very high values which, although exceeding those for October, will be probably below the sunspot maximum values obtained in November, 1947. Long-distance communication on very high frequencies should be therefore possible in all directions from this country. The 28-Mc/s amateur band should be regularly usable at suitable times of day, and considerably higher frequencies than in October may be workable over certain circuits. It is even possible that a long-distance contact or two may take place on 50 Mc/s, though

this is not very likely. Night-time M.U.F.s will, on the other hand, be considerably lower than in October, frequencies as low as 9 and even 7 Mc/s probably being necessary for many night-time circuits.

Below are given, in terms of the broadcast bands, the working frequencies which should be regularly usable during November for four long-distance circuits running in different directions from this country. (All times G.M.T.) In addition, a figure in brackets is given for the use of those whose primary interest is the exploitation of certain frequency bands, and this indicates the highest frequency likely to be usable for about 25 per cent of the time during the month for communication by way of the regular layers:—

Montreal :	0000	7 Mc/s	(10 Mc/s)
	1000	9 "	(12 ")
	1100	15 "	(19 ")
	1200	21 "	(26 ")
	1300	26 "	(32 ")
	1800	21 "	(30 ")
	1900	17 "	(25 ")
	2000	15 "	(21 ")
Buenos Aires :	0000	11 Mc/s	(17 Mc/s)
	0300	9 "	(13 ")
	0700	11 "	(16 ")
	0800	17 "	(24 ")
	0900	21 "	(27 ")
	1000	26 "	(32 ")
	1900	21 "	(31 ")
	2000	17 "	(25 ")
Cape Town :	0000	11 Mc/s	(17 Mc/s)
	0100	9 "	(13 ")
	0600	15 "	(19 ")
	0700	21 "	(33 ")
	0800	26 "	(36 ")
	1700	21 "	(31 ")
	1900	17 "	(25 ")
	2100	15 "	(22 ")
Chungking :	0000	7 Mc/s	(10 Mc/s)
	0500	9 "	(14 ")
	0600	17 "	(22 ")
	0700	21 "	(26 ")
	0800	26 "	(36 ")
	1200	21 "	(26 ")
	1300	17 "	(22 ")
	1400	15 "	(19 ")
1500	11 "	(16 ")	
1800	9 "	(14 ")	
2000	7 "	(11 ")	

Though ionosphere storms are not particularly prevalent during November, those which do occur are likely to be troublesome over the night paths. At the time of writing it would appear that such disturbances are more likely to occur within the periods 10th-11th, 19th-20th, 22nd-25th than on the other days of the month.

The following figures are the pass figures on final test for **Model QA12/P AMPLIFIER**



FREQUENCY RANGE
± 0.3 db 20 — 20,000 c.p.s.

SENSITIVITY
1.5 millivolts for full output (without boosts)
15 millivolts for full output (with boosts)

BASS CONTROL RANGE
— 12 db to + 16 db at 30 c.p.s. relative to 600 c.p.s.

TREBLE CONTROL RANGE
— 30 db to + 18 db at 15,000 c.p.s. relative to 600 c.p.s.

DISTORTION CONTENT
(up to 12 watts output)
2nd Harmonic < 0.2%
3rd Harmonic < 0.3%
Higher order < 0.03%
Total < 0.4%

BACKGROUND NOISE
better than — 66 db at full gain

DAMPING FACTOR
INPUT IMPEDANCE
1.5 megohms

SOURCE IMPEDANCE
Up to 50,000 ohms

OUTPUT IMPEDANCE
7 and 15 ohms

2262

ACOUSTICAL

ACOUSTICAL MANUFACTURING CO., LTD., HUNTINGDON

TEL: 361

Unbiased

By FREE GRID

Rationed Radio

IT is astonishing what a lack of elementary psychology is shown by government officials when they express surprise that their repeated exhortations to smoke fewer cigarettes or drink less beer leads forthwith to a still greater consumption. They don't seem to grasp the fact that the way to make people want a thing, and to want it badly, is to tell them they can't have it. If, for instance, they told the world in general that British goods would not be exported as they were for home consumption only they would be staggered at the demand created in foreign countries. Even Wigan could command an unheard-of influx of foreign tourists by merely taking a leaf out of the book of the Lhasa borough council and calling itself "the forbidden city." I suppose everybody knows that prohibition was introduced into the U.S.A. in the early twenties by the brewing and distilling interests as a sales boosting stunt.

I should, however, have expected a little more common sense from members of the radio industry. Some of them are still naively complaining that in spite of reduced purchase tax and the recent "better listening" campaign, many listeners still seem reluctant to invest in a new set. Surely the reason is obvious and the remedy also. They should get Sir Stafford Cripps to



Gullible American tourists.

make a speech telling people that they must on no account buy new wireless sets or, better still, get Mr. Wilson to ration them and make it as difficult as possible to get a permit to buy an extra one.

I know of at least one dealer who has followed the broad outlines of this scheme by putting his sets under the counter and letting it be known that they are only available

to those who come clandestinely to the door after dark. The result is that he has made enough to set up his own factory and be independent of manufacturers. Success breeds success, as it always does. He has been able to get rid of several hopelessly out-of-date sets to credulous American tourists by representing them to have been used by Queen Elizabeth when listening in one of the innumerable beds up and down the country which were put at the disposal of that formidable female.

I don't want to seem harsh in my judgment of the radio industry, but it is absolutely no use trying to sell sets on their results after the public has been educated for nearly a decade to assess the value or desirability of goods solely by their scarcity. If cars became plentiful tomorrow fully fifty per cent of the people on the dealers' waiting lists would cancel their orders straight away and look about for something else with a healthy waiting list.

What About It, Mr. Bevan?

THERE is a striking similarity between a hospital and a prison; the latter being primarily intended to bring that balm and healing to our erring souls which the former brings to our broken bodies. Moreover, men often find themselves on the wrong side of the entrance gates of both places through their own indiscretions and not infrequently their maladies of body or of morals become chronic, with the result that their first visit is not the last.

But here the comparison ends. Prisons set out to effect their moral cures by stern disciplinary measures in which bodily comfort is at a discount. Hospitals, however, endeavour to offset the unpleasant effects of their noxious healing draughts by providing lily-handed hours to soothe our fevered brows and apply the balm of Gilead to our troubled spirits as they adjust our headphones so that we can listen to the psychotherapeutic symphonies of the Third Programme. Unfortunately, things are not in this ideal state, as not only are hospital hours in short supply—as our non-English-speaking Whitehall bureaucrats call it—but headphones are in a similar plight, though I can see no reason for the latter shortage.

Maybe I am wrong to generalize

from a particular case, but recently having occasion to visit a casualty in one of the largest hospitals in the country I was astonished to find that many patients were unable to listen, solely because it appeared to be nobody's business to see to the replacement or repair of damaged



The balm of Gilead.

headphones. It could scarcely have been a question of financial stringency, as the hospital I visited was never dependent on voluntary contributions but was run by the county council before Mr. Bevan took the burden of it on to his broad Christopher-like shoulders. As it was, when I had supplied headphones to my friend I was met with eager requests from other patients to be told where their relatives could obtain suitable phones, for which they were more than willing to pay. Fortunately, phones are available in plenty for a few shillings a pair, at any rate in the London area.

I cannot help thinking that the matter is one which might well be ventilated by means of a question in the House addressed to Mr. Bevan.

There is also another matter which concerns the radio industry and that is the designing of special headphones and earpieces giving the minimum of discomfort to sick persons and also a special type of flat reproducer for slipping under the pillow of those whose particular malady renders the ordinary headphones difficult to use. I believe one of these has recently been produced. It seems high time, too, that hospital beds were wired so that alternative programmes are on tap to each patient. After all, the musical tastes of gentlemen of the road may be expected to differ from that of Vermin in Ermine from the Upper Chamber who are henceforth to be bedfellows.

LETTERS TO THE EDITOR

Stabilized V.H.F. Broadcasting ♦ Aligning F.M.

Receivers ♦ Television Topics

A.M.—V.H.F.

IN recent editorials you have urged that before the B.B.C. committed itself finally to an F.M. broadcasting service it should set up an experimental A.M. station. With both systems there is the problem of maintaining local oscillator frequency stability. In the case of A.M. this difficulty could be overcome quite simply by having the transmitting station send out not only the normal carrier wave but also a frequency conversion wave. This would, of course, be an unmodulated signal at a suitable difference frequency, such that, when mixed with the modulated signal a suitable I.F. would result. At the frequencies now being considered the band width required cannot be considered great, and the two signals could be easily received, amplified and converted in the usual way. The cost of a receiving set would be low, and it would be free from complications.

E. C. NEATE.

Winchester.

Direct-coupled Amplifiers

THE letter from E. Jeffery (your Sept. issue) seems to provoke a reply. In estimating the relative merits and demerits of rival A.F. amplifying systems one should bear in mind how far the aural results are tolerable after listening to the reproduced sounds for more than ten minutes. The problem of problems is to obtain a really faithful and acceptable reproduction of the sound-patterns consisting of massed frequencies simultaneously and concurrently generated in the studio. The chief difficulty is to secure a satisfactory reproduction of the 1,000- to 4,300-cycle band in such circumstances. Experiments conducted for a period of twenty years have convinced me that the introduction of the blocking condenser in the inter-stage couplings of an A.F. amplifier constitutes an insuperable obstacle to the achievement of the highest standard of upper audio-frequency reproduction. Whatever the snags associated with direct coupling they are quite insignificant compared with this major problem which resistance-capacity coupling is unable to solve. Those who have achieved success by means of a recently developed method of direct coupling will not lightly abandon it for any other method, till a better

has been found. The introduction of tone correction has no bearing on the question, since the filters are not an integral factor in the essential coupling circuit and are usually regarded as optional adjuncts.

NOEL BONAVIA HUNT.

Stagsden, Bedford.

F. M. Alignment

A. G. CROCKER and I have gone on record (*Wireless World*, July and September, 1948) with rather different views about the alignment of F.M. receivers. I agree that with the facilities available to Mr. Crocker satisfactory performance can be obtained, and indeed I have no reason to doubt that the -60db distortion figure needed for multi-channel telephony can be maintained. I agree also that Sturley's alignment procedure is impracticable.

A feature not discussed, however, is the protection afforded against impulsive noise. A single noise peak will set the I.F. circuit ringing, and unless the response is symmetrical and the discriminator is accurately centred on the I.F. mid-band frequency, the noise-reducing properties of F.M. are not realized. This is discussed by Landon (*Electronics*, February, 1941, and "Frequency Modulation," Vol. I, R.C.A.). The oscillograms (Fig. 1 of this paper) show, at I, the effect of a 10-pF unbalance across the 100-kΩ diode loads.

Failure to take account of the special problems of impulsive noise reduction may lead to dissatisfaction with F.M., in view of the general belief that F.M. solves all noise problems.

THOMAS RODDAM.

Aircraft and Television

DURING the war an attempt to "blind with science" on the subject of radar was not unusual, but it is with some surprise that I read "Diallist" in your September number.

Probably the most common form of interference with television from an aircraft is a rhythmic quick fade of the signal, which is surely due to the relative phase of the direct and reflected rays which is changing at a frequency dependent on the speed at which the aircraft is approaching or going away from the receiving station. This is very noticeable with aircraft nearby when the fre-

ACE RADIO

MODEL 600

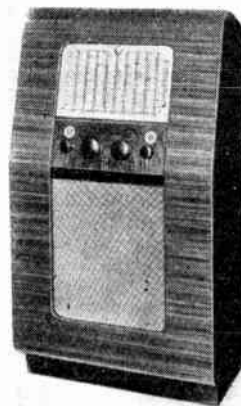

DESIGNED FOR THE DISCRIMINATING LISTENER

Ace Model 600 Console Receiver gives world-wide coverage and ease of tuning on short waves, combined with high quality reproduction. Fitted with a 7 valve chassis (plus magic eye and rectifier).

The receiver with its R.F. stage operating on all short wave bands and full electrical bandsread has an excellent performance with a high order of stability and complete absence of microphonic feedback even at the full audio output of its generous push pull output stage. The tone system, in addition to varying the audio response, broadens the selectivity characteristic of the I.F. amplifier to permit reception of the higher modulation frequencies.

PRICE £45

Plus £9.12.6 Purchase Tax

Full Technical Specification
gladly supplied

ACE RADIO Ltd.

TOWER RD., WILLESDEN,
LONDON, N.W.10.

'Phone :
Willesden 3904-5

Letters to the Editor—

quency of fluctuation slows down as the aircraft is heard to pass (i.e., when it is neither coming towards nor going away from the receiving station at any great speed).

The explanation of a flutter on radar when an aircraft is turning is presumably similar in that separate signals are being received from two or more parts of the aircraft and the relative distance these signals have to cover is varying as the aircraft turns, thus causing large fluctuations of the resultant signal as its two or more components come in and out of phase.

I feel that "Free Grid's" excellent column could well have dealt with the explanation which "Diallist" credits to the pundits (we did not call them that in the Navy!), and it could be elaborated to allow for a four-bladed propeller with each blade $\lambda/2$ in length!

From experience I can assure "Diallist" that no matter whether the aerial switch was working or not, the effect of a turning aircraft was always the same.

G. C. TURNER.

H.M.S. Duke of York.

I FOUND R. M. Staunton-Lambert's letter in the August issue, regarding aircraft interference with television very interesting as I live in the same locality and have experienced similar trouble.

There does not seem to be much purpose in using the usual directional arrays as the aircraft's course is in line between the transmitter and receiver and it is on this line that the bent or refracted signal needs to be eliminated.

Experiments to minimize the trouble seem to prove that providing the receiver is close enough to A.P. an "H" installation with the reflector facing the station (i.e., 180 degrees out of phase) is a great improvement.

For distances greater than this I think the cure will prove to be the use of diversity reception.

Two dipoles mounted at opposite extremes of the house feeding a T joint and thence to the set should prove to be a definite advance, as, at the frequency used, an anti-phase on one aerial would be counter-balanced by a correct signal on the other.

Electronic switching between the two aerials would be the best solution but is likely to be an expensive refinement.

M. A. SALTER.

London, N.W.10.

"High-level Detection"

W. MACLANACHAN evidently believes (your September issue) that his third R.F. stage, consisting of a KT6r and untuned RF transformer, can deliver to the

diode detector signals up to 120 V R.F. without distorting the modulation. But has he proof of this? The net load of the diode circuit on the secondary of the R.F. transformer will be a resistance of value little greater than 10 k Ω , and therefore the power consumed at 120 volts will be nearly 1.5 watts. Also the KT6r will probably have to supply quite a lot of wattless current into the shunt reactances present, whilst it is not very likely that a L.W. R.F. transformer will give an optimum impedance match. It seems to me, therefore, that quite careful design is needed if the third R.F. stage is not to overload on modulation peaks, and I should like to suggest that better coupling could be obtained between the third R.F. amplifier and the detector with the accompanying circuit.

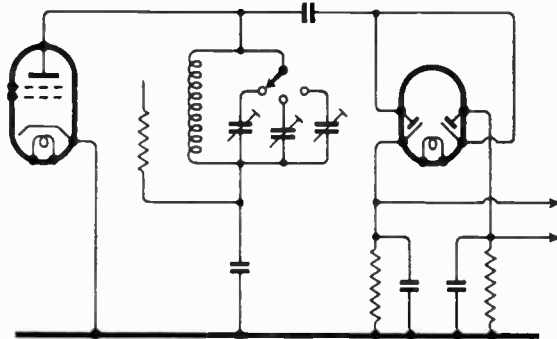

I think better screening and stability would be obtained if an EF55 (CV173) were used in place of the KT6r.

Mr. MacLanachan does not give the ratio of primary turns to feedback turns for the output transformer used in his set, but I guess it is not less than five or ten. The feedback volts are then again reduced in the ratio $R_{19}/R_{19} + R_{20}$ (approx.). It seems unlikely, therefore, that any useful amount of negative feedback is obtained. On the other hand, the effect of such feedback as there is will be to reduce the apparent values of R_{20} and R_{21} , so that the A.C. loading of the diodes will be increased. It seems quite possible, therefore, that the feedback will increase distortion rather than reduce it.

E. F. GOOD.

Malvern, Worcs.

"Series-capacitor Heater Circuits"

I HAVE a receiver which I built over three years ago incorporating a capacitor in the heater circuit in the way described in your September issue. The two original dial lamps are still in use and I have not had one breakdown, although the set is in daily use.

The 6-volt 0.06-amp. dial lamps are shunted across two of the 6-volt 0.3-amp. heaters. I know this is not very good practice since the lamps shunt part of the heater current, but it certainly is trouble-free.

As regards the breakdown voltage of the capacitors: I tested mine first by wiring them in series with a choke and connecting directly across the mains. The voltage across the capacitors was about 600 V R.M.S. during the test. The choke got rather hot after a time, but the capacitors stood up to the test.

S. V. STEPHENS.

London, S.E.24.

"Television Standards"

I WOULD like to draw your attention to an inaccuracy in the above article (October *Wireless World*). The writer states that it has been found practicable to equalize ordinary telephone lines up to some 1.5-2 Mc/s provided only a very few miles is involved.

In actual fact, the average circuit supplied to the B.B.C. over "ordinary telephone lines" has

a response of ± 1 db from 50c/s-2.5 Mc/s, falling to some -6 db at 3 Mc/s, the reference level being 10 kc/s.

GEOFFREY LEES.

London, N.W.1.

Better Listening

THE radio industry, in conducting its recent "Better Listening" campaign, might have combined it with a war against man-made interference. Unfortunately, high-fidelity listening is not just a function of the receiving equipment. Listening can be intolerable with a high-quality R.F. unit in a district where interference is prevalent.

It is my lot to live in such a district and no amount of aerial gear, mains suppressors and help from the Post Office engineers has so far been able to make fidelity listening a practical proposition for me.

RAYMOND E. COOKE.

Doncaster.

Long-range Television

IN your June issue a correspondent gave a detailed report of reception of Alexandra Palace television in Bristol.

My own experiences at a con-

siderably greater distance, in Liverpool city boundaries, may be of interest.

Since last November I have been receiving the sound and vision from A.P., at first very rarely, but, after various aerial experiments, quite often, occasionally exceptionally well.

At the present the vision side is quite fair "amusement value" (note I don't say "entertainment value") on three or four days a week.

To obtain high gain I am using single sideband with 500-kc/s band; this gives quite tolerable definition for most pictorial scenes, but not for written subjects. A signal of 10 μ V/metre gives me a poor quality picture with indifferent synchronism; this seems to be the average condition here, the better

days being about 6-10db better than this. The receiver (video side) uses 2 R.F.—mixer—6 I.F.—video det.—2 video-sync. sep.—D.C. restorer.

The antenna now in use is a combination (with phase compensation) of 3-element beam and Beveridge long-wire directional for A.P. (and incidentally Birmingham, which should "roll in"!) The Beveridge aerial really is useful since the wave front at long distance is decidedly "tilted," also the bandwidth characteristics are admirable for this particular purpose.

Best conditions for this distance and location seem to be cool, still evenings after sunny, clear days. Unstable air-streams from any quarter seem to reduce the field as much as 20 db.

R. A. S.
Liverpool.

MARCONI ON RADAR

A Forecast of 1922

PLAUSIBLE early forecasts of radar are rare, and so particular interest attaches to the following passage in an address delivered by Marconi before the American Institution of Radio Engineers on June 20th, 1922, well over a decade before even the preliminary work on the subject was initiated:—

"Some years ago, during the war, I could not help feeling that we had perhaps got rather into a rut by confining practically all our researches and tests to what I may term long waves, or waves of some thousands of feet in length, especially as I remembered that during my early experiments as far back as 1895 and 1896 I had obtained some promising results with waves not more than a few inches long. The progress made with the long-wave antenna system was so rapid, so comparatively easy, and so spectacular that it distracted practically all attention and research from the short waves, and this I think was regrettable, for there are very many problems that can be solved, and numerous most useful results to be obtained by, and only by, the use of the short-wave system.

"Since these early tests of over twenty years practically no research work was carried out or published in regard to short waves, so far as I can ascertain, for a very long period of years."

Marconi went on to say:—

"In some of my tests I have noticed the effects of reflection and deflection of these waves by metallic objects miles away.

"It seems to me that it should be possible to design apparatus by means of which a ship could radiate

or project a divergent beam of these rays in any desired direction, which rays, if coming across a metallic object, such as another steamer or ship, would be reflected back to a receiver screened from the local transmitter on the sending ship, and thereby immediately reveal the presence and bearing of the other ship in fog or thick weather.

"One further great advantage of such an arrangement would be that it would be able to give warning of the presence and bearing of ships, even should these ships be unprovided with any kind of radio."

Proc. I.R.E., Vol. 10, No. 4.

ABATEMENT OF INTERFERENCE

TWO "Codes of Practice" on reduction of interference to radio reception are not quite so well known as their importance would justify.

The first (No. CP1001; 1947) deals with interference arising from motor vehicle I.C. engines, explaining its nature and describing how it can be suppressed, or at least minimized by suitable design and also by the user.

The other code (No. CP1002; 1947) is concerned with interference generated by electro-medical and industrial R.F. equipment. Guidance is given as to means of suppression in design and manufacture as well as by the user.

The codes, which were prepared jointly by the Institution of Electrical Engineers and the British Standards Institution, cost 2s each by post from B.S.I., 28, Victoria Street, London, S.W.1.

New TRIX Quality SOUND EQUIPMENT

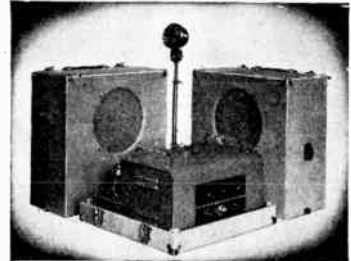

20 watt PORTABLE AC/DC Model U885P

This new model is designed to give a substantially larger power-output than is normally provided in Portable AC/DC outfits. It incorporates an amplifier unit with an output of 20 watts fitted into a detachable case with two 10" loudspeakers, moving-coil microphone, folding stand and cables.

The amplifier is a 3-stage high-gain type having 4 valves in parallel push-pull in the output stage, a total of 10 valves. The control panel carries microphone, gramophone and tone controls, also mains switch and pilot lamps and special three-position switch which provides either change-over or mixer circuit for microphone or gramophone units. Its large power output and high standard of reproduction make this equipment suitable for use in the larger halls where portable, universal apparatus is needed.



TRIX RIBBON MICROPHONE

is designed for high-quality reproduction. Frequency response substantially linear from 60-10,000 c.p.s. Minimum feedback. Send for full details.

THE TRIX ELECTRICAL CO. LTD
1-5 Maple Place, Tottenham Court Road
London, W.1. Phone: MUSeum 5817
Grams & Cables: "Trixradio, Wesdo, London."

AMPLIFIERS · MICROPHONES · LOUSPEAKERS

RANDOM RADIATIONS

By "DIALLIST"

Television Interference

YOU MAY RECALL that not long ago I made a suggestion in these notes about a possible cause of the unpleasant flopping from good to bad and bad to good which occurs in the television image when an aircraft lies more or less on an imaginary straight line joining transmitter and receiver, or its prolongation. "Beating," a similar flopping in the break on the C.R.T. trace, was a fairly common phenomenon in wartime radar sets. We were told by the pundits who conducted the strenuous radar courses during the war that this was due to the fact that the number of r.p.m. of the rotary, aerial switch of GL2 was just about that of an aircraft's propeller. At certain angles this produced a beating effect. Ours not to reason why—and, even if we'd wanted to, the speed of those courses was so breathtaking that there wasn't much time for thinking things out. It was reckoned that the wartime "long" radar course got through in five crowded months what should normally have taken at least two years! Anyhow, the suggestion that in television receivers some form of beating might take place in certain circumstances because the frame sync time base has a frequency of $50 \times 60 = 3,000$ per minute and a common speed for aircraft propellers is 1,500 r.p.m. just won't wash. Reason? Well, several readers have written to say that the same flopping occurs when the aircraft overhead is a jet. And that rules out completely all the propeller r.p.m. business for the very good reason that there's no propeller and no revolutions.

Doppler Effect

This type of interference is undoubtedly due to the arrival of the signal by direct and reflected paths at the receiving aerial. The flopping is caused by the constantly changing phase relationship of the two signals. There would be no variation in this relationship, were the aircraft stationary. But, of course, it isn't. If it's more or less on a

straight line between your aerial and that of the transmitter, it must be either approaching or receding. Hence the reflected signals are as effectively "dopplered" as the sound waves from the whistle of an express locomotive approaching, passing and receding from the station platform on which you may be standing. What all this comes to is that if you're receiving a television signal by the direct path and by reflection from a moving object, the image will flop in queer ways. All of which, though interesting to the physicist, doesn't vastly help the fellow who lives somewhere near an aerodrome and has installed a televisor in his home. Perhaps the back-room boys of Belling and Lee or Antiference will be able to evolve some solution. What seems to be needed is an aerial so screened that it cannot receive signals arriving at vertical angles greater than that of the direct wave.

"Wireless" or "Radio"?

IN THE LAST FEW DAYS I've been severely taken to task by a friend for talking about "wireless." That, he contends, is an obsolete term. In his view "radio" is the word that is used by all up-to-date people when they are referring to communications of any kind made by means of electro-magnetic waves. "Could there be anything more ridiculous than to describe as a wireless receiving set a piece of apparatus which may contain hundreds of yards of wire?" He contends further that it was just as antiquated and absurd to call the equipment which disseminates broadcast a wireless transmitter as to dub the normal conveyance of to-day a horseless carriage. "Wireless," he maintained, was a term crystallizing the amazement of the 1900s that a communication could be sent from here to there without intervening wires, just as "horseless carriage" summed up the amazement of the 1890s that a vehicle could move without the aid of a horse. We'd long ago got over any feeling of surprise about either; this age of progress demanded matter-of-fact terms like motor car,

motoring and radio. I was so flabbergasted by this sudden fierce onslaught that I couldn't think of half the crushing retorts that have since come to mind. I did, however, mention that a certain periodical of world-wide standing was content to retain "wireless" as a part of its title and that the word had, anyhow, the advantage of being exclusively English. Interestingly enough, both the French *sans fil* and the German *drahtlose* are literal translations of wire-less.

Unit of Sales Resistance

IN VIEW OF THE Better Listening campaign I made a kind of minor Gallup Poll amongst friends who live near by, asking in rather more tactful form the question: Why on earth do you go on enduring the unspeakable reproduction of that awful old set of yours? A few (whose loudspeakers I hear blaring at no matter what time I pass their homes) replied that as there was never anything worth listening to on the wireless nowadays, they made hardly any use of their sets, so that the odd chunk of distortion was neither here nor there. The rest were singularly unanimous in the reason they gave. Almost without exception, they said that they'd go in for new sets at once, if only it wasn't for that etc., etc., etc., purchase tax. From which I gather that sales resistance to-day is to be measured in O.I.M.S. I understand their feelings perfectly.

New Works

Lately I've given quite a bit of thought to the question of worn-out broadcast receivers and their periodic replacement. Apart from the purchase tax snag of to-day, what sticks in the gizzards of many people is that they will have to dispose for a song not only of the innards of the old set but also of its cabinet. The cabinet, particularly if it is that of a console or a radio-gram, may represent no small part of the price of the set. And if, as is likely, it has received the same good treatment as the rest of your furniture, it may well be almost as new when its contents have seen their best days. The lady of the house chose that cabinet to fit in with the other bits and pieces; you both like it; you haven't seen a set in the shops with a cabinet you like so much. So perhaps you go on

putting up with poor performances on the part of the set because you can't bring yourselves to "trade in" cabinet and contents for what seems an absurdly small sum. I wonder if those set makers who go in for really good cabinet work wouldn't be well advised to offer complete chassis replacements after, say, two years, to those who have purchased their wares.

Wider Coverage Needed

WE'LL HAVE, I FEEL, to revise a bit our present ideas about the frequency range covered by the pre-set signal-frequency tuning stages of television receivers. It seems all wrong from both the manufacturers' and the users' point of view that it shouldn't be possible to adjust any given receiver to any frequency required within the twenty-odd megacycle limits of the metre-frequency television band. From the manufacturers' angle it would surely be sound policy to design and market models which can be adjusted to any vision and speech range between 40 and 65 Mc/s; it seems absurd that different components will have to be used in the S.F. stages of London and Birmingham sets. Good profits and low prices are best assured by the biggest possible runs in the factory of identical apparatus. Further, if televisors have to be specially made to suit particular areas, it's inevitable that mistakes exasperating to the purchaser will be made. He'll wait, maybe, for weeks for a receiver of the type to which he has pinned his faith, only to find when its delivered that it won't tune to the frequency of his station. Surely, too, the man who invests quite a bit in a television set should have some guarantee that it will tune to the frequency of another transmitting centre, in case he has to move.

Ultrasonics

MY NOTE LAST MONTH, must, I fear, have given a totally misleading impression of J. M. M. Pinkerton's work on ultrasonics at the Cavendish Laboratory, Cambridge. Pinkerton did not, as I stated, discover the existence of cavitation: that was known to be one of the snags by ASDIC workers in World War I. His work is concerned with the absorption of ultrasonic waves in certain liquids; here it is most important to avoid cavitation at all costs.

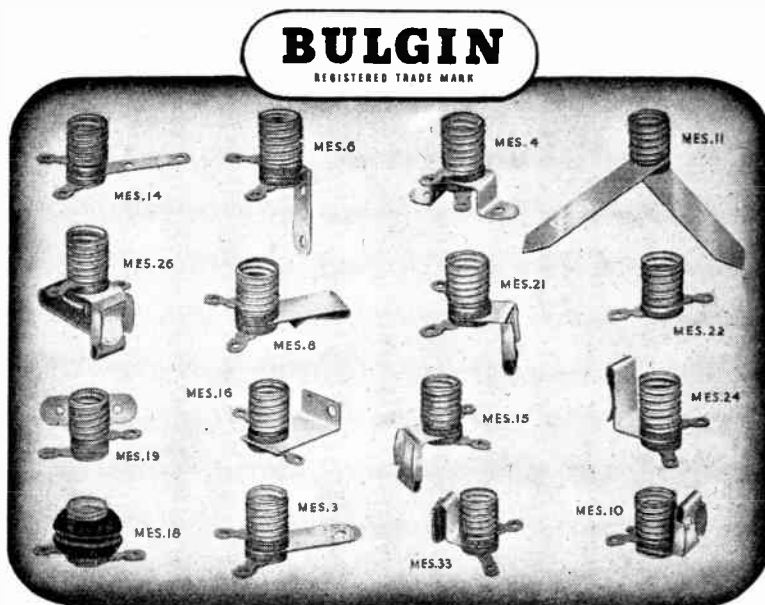

M.E.S. LAMP HOLDERS

IN AN INCOMPARABLE RANGE OF CLIP OR BRACKET MOUNTS

MANUFACTURED in a wide range of types, BULGIN Pilot Lamp Holders accurately conform to B.S. 98/E. 10 (M.E.S.) for lamp-acceptance. The "shell" or socket, in every type, acts as one of the poles. Fitted with centre-contact leaf or plunger; all contacts and tags are silver-plated for easy and efficient connections. The various fixing brackets are not live to either pole. Tested at 500V. peak (= max. test V.) for insulation resistance of not less than 40MΩ dry. For use at 0.1 to 30V. across poles (250V. max. with seriesΩ), 250V. max. to E. Max. Current 2A.

Types with M.B.C. (B.S. 52) and S.E.S. (B.S. 98/E. 14) sockets can also be supplied.

Enquiries for direct—and indirect—export are particularly invited.

"The Choice

BULGIN

REGISTERED TRADE MARK

of Critics"

A. F. BULGIN & CO. LTD. · BYE-PASS RD. · BARKING

Telephone : RIPPleway 3474 (5 lines)

RECENT INVENTIONS

A Selection of the More Interesting Radio Developments

Short-wave Aerials

AN elongated slot, in the shape of a flattened Z, is cut in the side of a closed metal tube, each of the upper and lower limbs of the opening being substantially a quarter wavelength. The inner and outer conductors of a coaxial feeder are connected to the opposite sides of the comparatively short transverse slot connecting the two horizontal limbs.

In effect, the feeder is thus coupled across the two metal parts of the tube defined by the upper and lower edges respectively, of the elongated opening, and since the two parts in question have, at any given moment, different capacities to earth, they can oscillate as dipoles. At the same time, the system is electrically balanced about the transverse slot containing the feed point. The construction provides a robust form of aerial, which is particularly suitable for use on aircraft, or where high mechanical strength is required.

Standard Telephones & Cables, Ltd., and E. O. Willoughby. Application date, Feb. 6th, 1945. No. 592760.

Tone Control

AFREQUENCY-DISCRIMINATING circuit applies tone control in the form of negative feedback between the

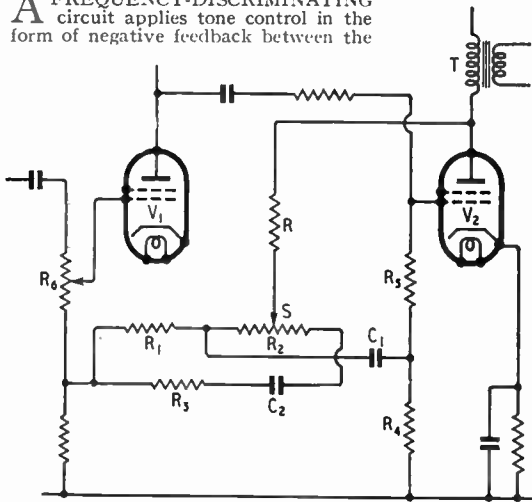

Tone control feedback circuit.

anode and grid of the last A.F. stage, and positive feedback between that valve and the previous amplifier.

As shown, a resistance R, in shunt with the output transformer T of the power amplifier V2, is tapped back at S to a looped circuit R1, R2, C2, R3, of which R2 is much the largest resistance. The other components are so chosen that when the tapping S is at its left-hand limit, frequencies above 150 c/s are fed from the anode to the

grid of the valve V2 through resistance R, capacitance C1, and resistances R4, R5, in phase-opposition, so that their amplitude is reduced. On the other hand, frequencies below 150 cycles pass through resistances R1 and R6 to the grid of V1 in phase to apply positive reaction, the nett result being maximum base response. The right-hand setting of the control S produces no appreciable reaction through either of the above-mentioned paths, though frequencies above 1,000 c/s are boosted by being fed back through C2 and R3 to the grid of the amplifier V1.

E. K. Cole, Ltd., and E. L. Hutchings. Application date, April 25th, 1939. No. 598287.

Receiving F.M. Signals

AFREQUENCY-MODULATED carrier is liable for various reasons to develop disturbing fluctuations in amplitude. A limiter valve can be used to smooth these out, prior to detection, provided a high level of signal input is available, since to be effective the limiter must be operated at saturation point.

As an alternative, according to the present invention, the I.F. pentode amplifier immediately preceding the discriminator stage is arranged to operate also as a grid-leak detector. The rectified voltage built up across the leak resistance, as a result of any amplitude variations that may be present, is tapped off to an auxiliary amplifier, located outside the normal signal channel and from there is fed back to an earlier I.F. amplifier, in the phase required to eliminate or offset the original irregularity. The required correction is thus applied automatically, and without affecting the normal amplification of the F.M. signal.

Marconi's Wireless Telegraph Co., Ltd. (assignees of N. I. Korman). Convention date (U.S.A.), July 29th, 1944. No. 596531.

Dipole Aerials

THE dipoles A, A1 are welded to the upper ends of a pair of tubular quarter-wave supports B, B1, which are mounted firmly on a baseplate D. The dipoles are fed through a looped coaxial line L from a tapping-point P,

which is chosen so that one branch of the loop is 180 deg longer than the other branch, as measured from the plate D. The outer conductor of the coaxial line is connected to the inner end of each of the dipoles, whilst the

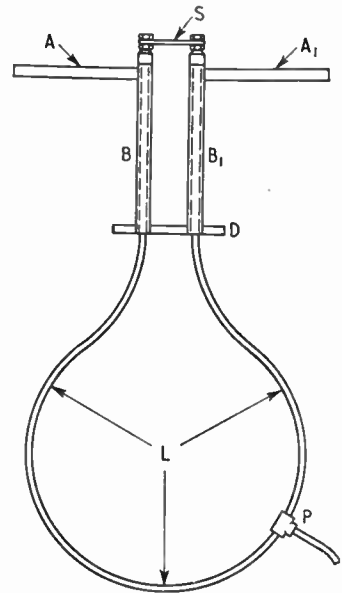

Dipole coupling system.

inner conductor passes up through an insulating cap at the top of the supports to a conducting strap S.

Since the currents in the inner conductor must be 180 deg out of phase at the lower end of the supports B, B1, the latter will present an infinite quarter-wave impedance to the inner ends of the dipoles, thus allowing these to be directly connected to the outer conductor of the looped line, without the use of a transformer or other coupling-network. Moreover, the combination of the parallel-resonant circuit formed by the supports, with the series-resonant load of the two dipoles, serves to broaden the frequency characteristic of the aerial as a whole.

Marconi's Wireless Telegraph Co., Ltd. (assignees of G. H. Brown). Convention date (U.S.A.), February 23rd, 1942. No. 591987.

The British abstracts published here are prepared with the permission of the Controller of H.M. Stationery Office, from specifications obtainable at the Patent Office, 25, Southampton Buildings, London, W.C.2, price 1/- each.

1998

Quality

**ACKNOWLEDGED
THROUGHOUT
THE WORLD**



ERIE

Radio & Electronic Components

**RESISTORS · CERAMICONS · Hi-K CERAMICONS · POTENTIOMETERS
SUPPRESSORS · VITREOUS ENAMELLED WIRE-WOUND RESISTORS**

Erie Resistor Ltd., The Hyde, London, N.W.9, England
Telephone: COLindale 8011-4. Cables: RESISTOR, LONDON.
Factories: London & Gt. Yarmouth, England · Toronto, Canada · Erie, Pa., U.S.A.

Stabilised Insulation BY MODERN IMPREGNATION METHODS

HYMEG

HIGH-SPEED PRODUCTION

Now, special methods of continuous conveyor impregnation and baking developed with the use of HYMEG have still further reduced processing times to a fraction of those previously believed necessary. Often faster than infra-red baking with none of the defects, reduced handling, absence of special jigs, with complete freedom from blistering, bubbling and porosity, are some of the advantages claimed and substantiated for HYMEG High Speed Production methods.

HYMEG Synthetic Insulating Varnishes are recognised and widely used for their mechanical rigidity, improvement of electrical properties of windings; heat, moisture, oil, acid and alkali resistance as well as for the considerably reduced stoving time necessary.

HYMEGLAS REGD.

GLASS FIBRE INSULATION SYSTEM

This integrated system of development is successful in enabling machines to be designed and operated without weak links in the chain of insulation below 200°C. Thus the fullest advantage is taken of modern glass fibre insulation by providing a degree of bonding and insulation at every point in which the uniting of Hymeg impregnation with the Hymeg as used for ordinary insulations gives a solid homogeneous winding of equally efficient characteristics and heat resistance throughout.

After much research in our laboratories and in conjunction with many well-known specialist manufacturers, we have now evolved the Hymeglas system of Insulation which comprises modifications of Hymeg as used for coil impregnation to meet the varying conditions applying to each field of manufacture.

Hymeglas therefore virtually eliminates any risk of insulation failure and enables motors and the like to operate under abnormal conditions for long periods without risk of electrical breakdown.

Due to the excellent space factor of glass fibre as compared with the more usual asbestos and mica Class B insulations, it is often possible in redesigning with the Hymeglas system to employ larger copper sections with well-known advantages.

The Berger Technical Service—the research work of which produced "HYMEG" and "HYMEGLAS" is available to advise manufacturers on all problems of insulation. Get in touch now with—

LEWIS BERGER & SONS LTD. (Est. 1760)
35, BERKELEY SQUARE, LONDON. W.1.

Telephone: MAYfair 9171.

MANUFACTURERS OF HIGH-PERFORMANCE INSULATING VARNISHES AND ENAMELS

RHO-METAL SCRATCH FILTER CHOKE

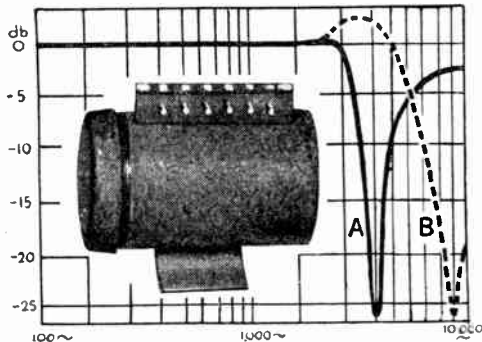

A Tuned for maximum rejection at 4,000 cycles
B Tuned for maximum rejection at 9,000 cycles

TYPICAL RESPONSE CURVES

WHERE SURFACE NOISE IS THE LIMITING FACTOR TO SUPREME QUALITY OF REPRODUCTION, fit a Sound Sales alloy cored steep trough tuneable filter. We know the problem of removing Surface Noise or Heterodyne whistle is not easy to solve, but the steep trough filter has so far produced the most encouraging results we have encountered when using a compact component which can be incorporated in existing apparatus.

CHOKE TYPE. C 5F, Dia. 2 3/4", length 3 1/2". PRICE £1.8.9 each.

SOUND SALES LIMITED

Specialist manufacturers of Transformers and Chokes of all types since 1930

WEST STREET, FARNHAM SURREY
and 57 ST. MARTIN'S LANE, W.C.2. Temple Bar 4284

Headphones which uphold British Prestige



TYPE "K."

S. G. BROWN, Type 'K'

Moving Coil Headphones, supply that High Fidelity Reproduction demanded for DX work, monitoring and laboratory purposes, etc.

OUTSTANDING CHARACTERISTICS.

O.C. RESISTANCE, 47 Ohms.
IMPEDANCE, 52 Ohms at 1,000 c.p.s.

SENSITIVITY, 1.2 x 10⁻¹¹ Watts at 1 kc. = .0002 Dyne/cm².

Descriptive Literature on request.

PRICE £5.5.0 PER PAIR

Your Local Dealer can supply

For details of other S. G. Brown Headphones (prices from 30/- to 63/-) write for illustrated Brochure "W.W."

HEADPHONES WHICH UPHOLD BRITISH PRESTIGE.

Telephone: Watford 7241.

S. G. Brown, Ltd.

SHAKESPEARE STREET, WATFORD, HERTS.

SEE THE COMPLETE EDDYSTONE RANGE AT STAND 3—

-and now, **THE EDDYSTONE MARINE RECEIVER**

AMATEUR RADIO EXHIBITION, ROYAL HOTEL, LONDON, NOVEMBER 17th—20th

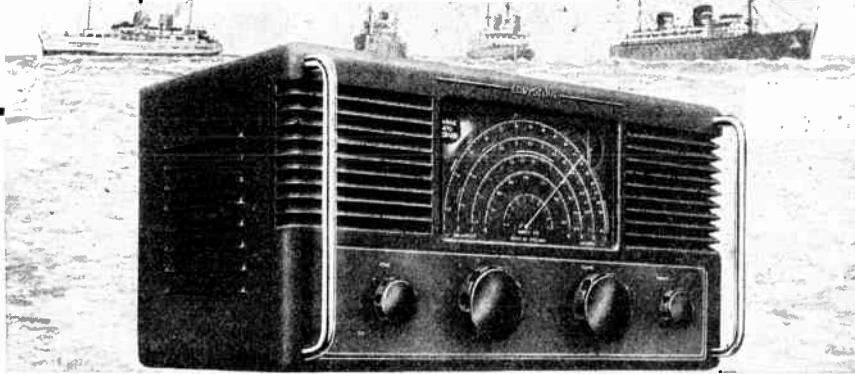

SPECIALLY DESIGNED FOR PERSONAL CABIN USE

The Eddystone "670" receiver is primarily intended for personal use on board ship and in view of this has been designed for operation on either A.C. or D.C. supplies of from 100 to 110 volts or 200 to 250 volts. Particular attention has been given to the performance of the Receiver on the short waves as for long periods these will often be the sole medium for broadcast reception. The "670" complies with safety regulations and careful attention has been paid to the insulation throughout. The circuit is a 7 valve superheterodyne, tuning from 10 to 51.7 metres and 110 to 875 metres. A high grade internal speaker is used, which can be disconnected and headphones substituted to avoid disturbing sleeping personnel. The receiver is robustly constructed and suitable for service in the tropics. A mains filter (Cat. No. 732) is available for reducing interference from ship's electrical plant. The Eddystone special ship's aerial (Cat. No. 731) ensures high efficiency and this together with the mains filter are valuable accessories. The Eddystone "670" Receiver is at present available for Marine Export and Overseas Markets only.

PRICE: £37 10s. 0d. (ex Works)

Mains Filter £2 10 0 Aerial £2 12 6

Send for illustrated brochure and name and address of nearest supplier to

STRATTON & CO. LTD., ALVECHURCH ROAD, WEST HEATH, BIRMINGHAM 31

The 'CINTEL' UNIVERSAL OSCILLOSCOPE

A highly versatile laboratory instrument of outstanding performance

Designed on the unit principle the 'Cintel' Universal Oscilloscope offers a basic instrument which is expandable at will to meet your requirements. Units now available include:

- Basic unit, comprising console, Cathode Ray Tube and power pack and calibration device
- Simple time Base with frequency range from 5c/s to 200 Kc/s.
- Amplitude Stabilised Time Base with calibrated frequency range from 5c/s to 150 Kc/s.
- A.C. Amplifier with frequency range from 5c/s to 1.5 Mc/s.
- D.C. Amplifier with frequency range from 0c/s to 5 Mc/s.
- Double Beam Switch Unit.
- Five Beam Switch Unit.

★ A series of technical papers on the application of electronics in Industry & Research will be read at the York Room, Caxton Hall, Westminster, S.W.1., November 18 & 19th, 1948, under the auspices of the Scientific Instrument Manufacturers' Association of Great Britain Limited. Apply for tickets to The Secretary, S.I.M.A. 26 Russell Square, London, W.C.1

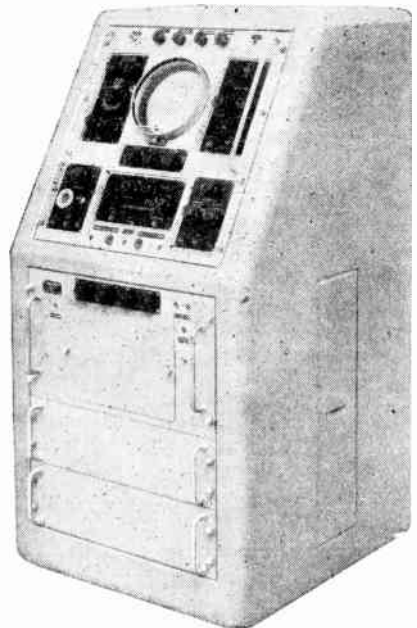

REGISTERED TRADE MARK

CINEMA - TELEVISION Ltd.

WORSLEY BRIDGE ROAD, LONDON, S.E. 26

Telephone: Hither Green 4600

Manufacturers of Scientific Instruments and Photo-electric Cells

LONDON CENTRAL RADIO STORES

Government Surplus—From Stock

10-VALVE COMMUNICATION RECEIVER.
Type R155.
Complete with Power Pack and Speaker.

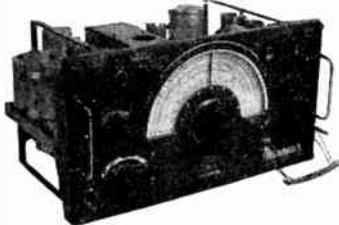

These sets are as new. Freq. range 7.5 mc/s. 75 kc/s in five wavebands. Complete with 10 valves, including magic eye. Every receiver is Aerial Tested. For A.C. mains 200-250 v. The set is enclosed in a metal cabinet and supplied complete with separate Power Pack and Loudspeaker. (Carr. and pkg. 10/6 extra) **£14.10.0**
FREE with each receiver! Complete circuit, description and modifications for civil use, reprinted from "W.W.," July, 1946.

THE FAMOUS EODYSTONE 358 COMMUNICATIONS RECEIVER

Range 31 Mc/s to 90 kc/s, 9 Plug-in coils, 7 valves and rectifier, variable selectivity, B.F.O. stand-by switch, A.V.C. switch, hand-spread dial, valve check meter. In heavy black crackle finished steel cabinet with chrome fittings. Complete with 200-250 v. A.C. Power Supply Unit **£25.0.0**
Carriage and packing 17/6 extra.

VISION UNITS

Consisting of 6in. Electrostatic C.R. Tube, 8 valves, including three EF50's. A most useful unit for experimental purposes. **39/6**
Carriage and packing 7/6.
Model No. 6A. Consisting of 6in. diameter Electrostatic C.R. tube, 7 valves, including four EF50, potentiometers, resistances and other associated components. In metal cabinet 18x8x7 1/2 in. These units are in perfect condition **£3.10.0**
Carriage and packing 10/6.
Model No. 6A. Same as above, but supplied with a Guaranteed New Tube ... **£4.10.0**
Carriage and packing 10/6.

TRIPLET Universal TEST METER

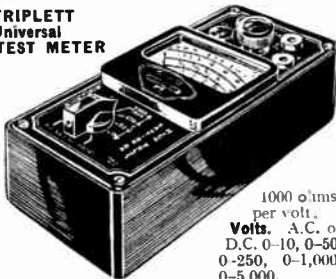

1000 ohms per volt.
Volts. A.C. or D.C. 0-10, 0-50, 0-250, 0-1,000, 0-5,000.
Milliams. 0-10, 0-100, 0-500.
Ohms. 0-300, 0-1 meg.
£4.10.6 carr. paid.

N.B.—All items are carriage paid unless otherwise stated. We do not issue lists or catalogues.

EX-R.A.F. CINE CAMERA, Type G45B.

To take 16 mm. film. Fixed focus lens approx. 5 cm., f/3.5. In metal case. Dimensions 12x3 1/4x2in. with 24 v. motor drive **£57/6**
With 12 v. drive, **£3.5/6**

EX-R.A.F. CAMERA MOTORS.

3x2x1 1/2 in., 24 v. **7/6**

A.C./D.C. FRACTIONAL H.P. MOTORS

24 v. Can be converted for driving grammo. 12/6
turntables **12/6**

CONDENSERS, 8 mfd. 600 v. D.C., 4 1/2 x 4 x 2in. 6/-

OSCILLATOR UNITS, Type 217.

These units contain very useful components: two EF50 Valves, three P.O. type Relays, numerous Condensers including two 20 v. 25 mfd. Electrolytics, Resistors, Potentiometers, etc. **15/-**

SELF-ENERGISING TELEPHONES.

Complete with magneto ringing in steel case, 11x4 1/2x5in. **25/-**

7-VALVE U.H.F. RECEIVER. Type R1147A Range approx. 200 megacycles (with 4 Acorn valves).

A Real Opportunity!
Beautifully constructed and fitted with micro-condenser drive. Valve types: two EF36, one EBC33, three 954, one 955. In black metal case, 8x7x6in. Set complete with valves. Carr. paid. **£27.6**

PHOTO ELECTRIC CELLS—Small infra-red image, glass converter tube. Type C.V. 143 50-100 v. Suitable for all purposes. **14/-**

See April issue for illustration.

SMALL SLIDING RESISTANCES

Suitable for Voltage Controls, Speed Regulators. 50 ohms, 0.5 amp. Dimensions 6in. x 4in. x 2 1/2 in. high **8/9**
Carriage paid.

NEW MILNES H.T. UNITS (Everlasting)

120 v. 60 mA. Will charge from 6 v. accumulator **67/6**
For Callers Only.

See last month's issue for other bargains.

BARGAINS FROM VALLANCE'S

DELIVERY FROM STOCK OF SOUND SALES MAINS TRANSFORMERS.

Suitable for upright, inverted or horizontal mounting, which is facilitated by interchangeable brackets. Double shrouds are provided, thus ensuring a very neat appearance. All primaries wound to suit 50/100 CP5 A.C. Mains from 210/250 v. by means of suitable tapplings. Earthed static shield between primary and secondary provided.

X250 Octal. 250-0-250 v. 80 m/a 5 v. 2 a. 6.3 v. 2.5 a. C.T., £1/17/4.
X250. 250-0-250 v. 80 m/a 4 v. 2 a. 4 v. 4 a. C.T., £1/17/4.
X2/275. 275-0-275 v. 120 m/a 5 v. 2 a. 6.3 v. 1.5 a. C.T., 6.3 v. 2 a. C.T., £2/12/4.
X2/275 Octal. 275-0-275 v. 120 m/a. 4 v. 2.5 a. 4 v. 4 a. C.T., 4 v. 2 a. C.T., £2/12/4.
X300 Octal. 300-0-300 v. 70 m/a. 5 v. 2 a. 6.3 v. 2.5 a. C.T., £1/18/6.
X300. 300-0-300 v. 70 m/a. 4 v. 2 a. 4 v. 4 a. C.T., £1/18/6.
X2/350/120 Octal. 350-0-350 v. 120 m/a. 5 v. 2 a. 5.3 v. 3 a. C.T., £2/14/-.

AUTO TYPE

5K/75 Auto, 75 watts, 0.32 amps. at 250 v. max. Available tapplings 100 v., 110 v., 210 v., 230 v., 250v., £1/5/10.
The following are specially designed for Westinghouse L.T. Rectifiers. LT41. 17-18.25-2-22 v. suitable for charging 6 v., 8 v., 10 v., 12 v., batteries, at 1 amp. with LT41 rectifier, £1/8/9.
LT42. 8.5-10-11 v. suitable for charging 2 v., 4 v., 6 v. batteries at 1 amp. with LT42 rectifier, £1/-/8.
LT42 Rectifiers, 6 v. 1 amp. output, £1/3/-.

OUTPUT TRANSFORMERS

Designed expressly for high quality reproduction (see *Wireless World* test report on the type 036). The latest model is totally enclosed and metal shrouded.

Type 036X. Wound to suit two type PX4 valves in push-pull, with tapplings for PX25 valves. Primary inductance 77 henries. Primary impedance 10,000 ohms, tapped at 6,400 thus rendering the components suitable for use with PX4 valves, working 10,000 ohms anode-anode with 200 v. H.T. or 6,400 anode-anode with 300 v. H.T. Standard impedance 15 ohms tapped 6 ohm, £2/8/10.
Post and packing, 1 trans., 1/6, 2 trans., 2/6.
Speedy Postal Service C.W.O. or C.O.D.

When sending C.W.O. please include sufficient extra for post and packing.

VALLANCE & DAVISON, LTD.

144 BRIGGATE, LEEDS, 1. Phone 29428/9.
Staff call signs: G2HHV, G8SX, G3ABD, G3CML

SOUND REPRODUCERS



For Concert and Domestic Use

Bass and Treble Lift Tri-channel Tone. GP/15w. 16 gns. G/P25w. 19 gns. G/QP15 15 1/2 gns. Amplifiers from 8 1/2 gns. to 30 gns. described in latest brochure with basic circuits, 6d. Blue Prints 2/6. Transformer Lists 2d. Chassis work for "Electronic Telesvisor" 75/- set.

EVERYTHING FOR SOUND AND SCREEN

GENERAL LAMINATION PRODUCTS LTD.

294, Broadway, Bexleyheath, Kent.

23, LISLE ST. (GERard 2969) LONDON, W.C.2

Closed Thurs. 1 p.m. Open all day Sat. and weekdays 9 a.m.—6 p.m.

LIFT TO ALL FLAWS!

In the hands of the radio engineer this universal "Measurtest" instrument will detect and locate the slightest flaw in receiver performance. Yet, weighing only 20lb. and operated from either mains or batteries, it can be lifted with ease for use anywhere, any time.

The PORTABLE RECEIVER TESTER is ideal also for complete tests on audio amplifiers. In one compact assembly it incorporates the facilities of signal generator, output power meter and crystal calibrator—three instruments, in fact, for the price of one. And many novel features contribute to the attainment of unique standards in both performance and operational convenience. Your enquiries are invited and a demonstration can be arranged.

HIRE PURCHASE TERMS AVAILABLE

PORTABLE RECEIVER TESTER (TYPE TF 888)

3 Instruments-in-One

A Combined

- (SIGNAL GENERATOR
- OUTPUT POWER METER
- CRYSTAL CALIBRATOR

COMPACT • PORTABLE • ROBUST

Mains or Battery Operated—

ACCURATE AND RELIABLE

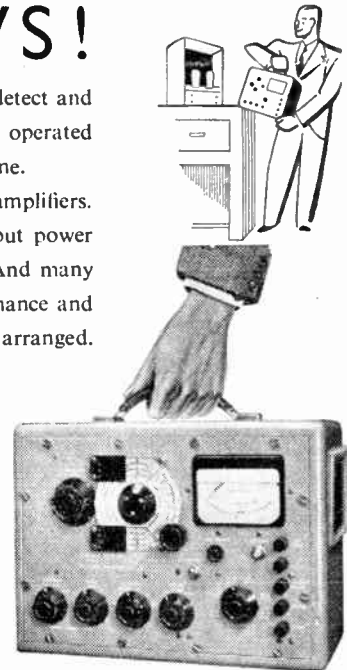

MARCONI INSTRUMENTS LTD

ST. ALBANS, HERTS. Telephone: St. Albans 6161/5. Northern Office: 30 ALBION STREET, HULL. Tel.: Hull 16144.
Southern Office & Showrooms: 109 EATON SQUARE, S.W.1. Tel.: Sloane 8615. Western Office: 10 PORTVIEW ROAD, AVONMOUTH. Tel.: Avonmouth 438.

PRECISION COMPONENTS



CORD DRIVES

Now available in five types as illustrated (left to right) Standard, R/V, Reverse, "D" type and "A" type.

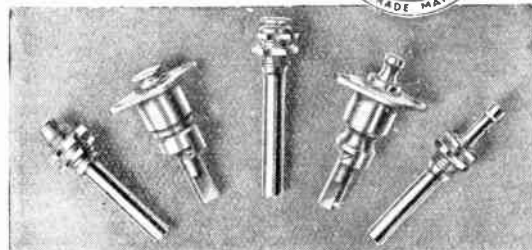

GANG CONDENSERS

A wide range is now available in 1, 2, 3 or 4 gang types of various capacities.

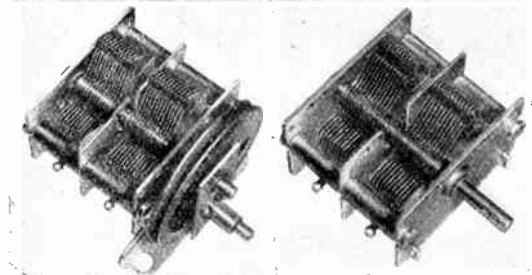

Write for Catalogue No. (W.W.1.)

JACKSON

BROS (LONDON) LIMITED
KINGSWAY · WADDON · SURREY
TELEPHONE: CROYDON 2754-5 TELEGRAMS: WALFILCO.
PHONE: LONDON

You
get
years of
faultless
service
from...

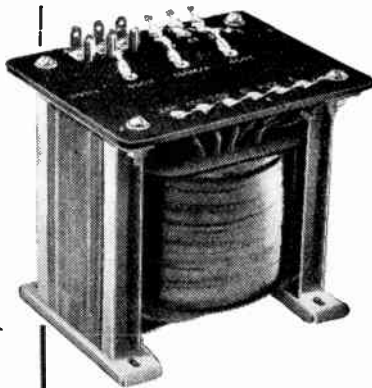

because they are :—
INDIVIDUALLY DESIGNED
RIGOROUSLY TESTED
MECHANICALLY SOUND
ELECTRICALLY PERFECT

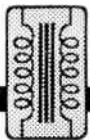

"PURPOSE-BUILT"
Savage
TRANSFORMERS LTD.

51, NORTHGATE STREET, DEVIZES. Phone 536

12113A

A NEW B.P.L. INSTRUMENT



THE VOLTASCOPE—A combined valve-voltmeter and oscilloscope. VALVE-VOLTMETER—Infinite Input Resistance for D.C. ranges 0 to 300 volts. A.C. ranges 0 to 150 volts in 5 ranges. 3½ inch scale meter. OSCILLOSCOPE—3 inch screen tube provided with balanced amplifiers for Y and X plates giving a 5 times trace expansion. Maximum sensitivity 150mV/cm. Response from D.C. to 100 kcs.

Limited quantity available for early delivery.

BRITISH PHYSICAL LABORATORIES
HOUSEBOAT WORKS, RADLETT, HERTS.

Tel: Radlett 5674-5-6

COILS & PACKS

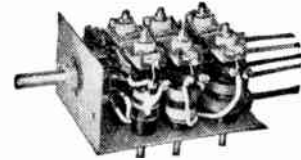

A LARGE variety of Adjustable Iron Dust Core Coils and Packs ranging from 5 to 2,000 metres, in suitable combinations and including high frequency stages together with all necessary padding and trimmer condensers, are available for most needs. Write for descriptive literature stating your particular problem.

LABORATORY



TESTED

H. C. ATKINS Laboratories, 32, Cumberland Road, Kew, Surrey
Richmond 2950

A100

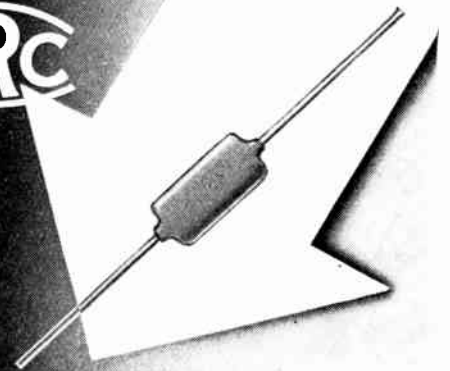

SILVERED MICA CAPACITORS

Extremely Stable

TROPICALLY IMPREGNATED
RANGE OF 7 SMALL SIZES
INDIVIDUALLY POWERFACTOR
TESTED.

STABILITY RADIO COMPONENTS LTD

14, NORMAN'S BUILDINGS,
CENTRAL STREET, LONDON,
E.C.1
TELEPHONE: CLERKENWELL 5977



'co-axial construction'
ensures longer life

The greatly advanced design and production methods employed in the manufacture of the "Series 700" Reproducer ensures long trouble-free life under all climatic conditions. Special purpose machines, tools and jigs ensure mechanically accurate co-axial alignment of all component parts. The magnet assembly is shock proof with virtually no external field. The voice coil and centring member assembly is of moulded Bakelised linen with integral beryllium copper leads. All types are completely dust proof. Each speaker and transformer passes Air Ministry K.110 tropical tests and is made to exacting limits with 100% inspection at all stages.

Reproducers & Amplifiers Ltd., Wolverhampton.

BRITAIN'S FOREMOST REPRODUCERS

R&A

Simon
SOUND SERVICE

THE COMPLETE SERVICE
FOR SOUND RECORDING AND
REPRODUCTION

- ★ Mobile, static and specialised recording units
- ★ Recording amplifiers, speakers, microphones, etc.
- ★ Sapphire cutting and reproducing stylii
- ★ Blank recording discs from 5in. to 17in. Single and Double sided
- ★ Groove locating and cueing devices
- ★ A comprehensive range of accessories to meet every requirement of the sound recording engineer
- ★★ A development of special interest to users of sapphire and delicate pick-ups—THE SIMTROL. This is a controlled micro-movement easily fitted for use with any type of pick-up
- ★★★ OUR CDR 48A RECORDER UNIT complete and self-contained, measuring only 22in. x 14in. x 13½in., incorporating 7-valve amplifier, recorder unit, light-weight pick-up, speaker and microphone and with many exclusive features, is now ready for early delivery



CDR 48A
Portable Disc Recorder

OUR WELL-EQUIPPED WORKSHOPS ARE AVAILABLE FOR
THE DEVELOPMENT OF EQUIPMENT TO MEET SPECIAL NEEDS.

SIMON SOUND SERVICE, Recorder House, 48/50, George St., Portman Square, London, W.1.

CABLES : Simsale, London.

TELEGRAMS : Simsale, Wesdo, London.

TELEPHONE : Welbeck 2371 (4 lines).

MODERN SERVICING METHOD

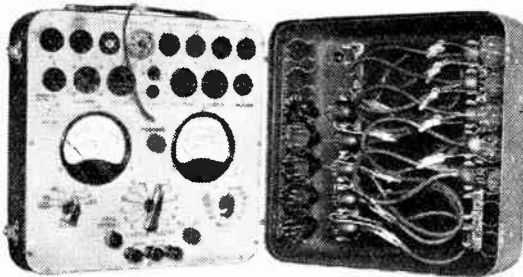

The "L.S.L." Servicing Method is a combined fault analyser and circuit tester; simultaneously capable of indicating all voltage, current and resistance on each valve electrode without removing the chassis from the cabinet. Readings can be taken whilst the set is under actual operating conditions. The "L.S.L." Analyser is a combination of multi-range instrument and valve tester. **PRICE: £18. 18. 0 Subject.**

THE "LSL" PORTABLE ANALYSER

- ★ Saves time and trouble.
- ★ Greatly increases Profit in the Service Department.
- ★ Is portable, can be used on the bench or in the home.
- ★ Is simple to operate.

Send for further particulars from the sole distributors:

Kerry's
(GREAT BRITAIN) Limited

WARTON ROAD, STRATFORD, LONDON, E.15.
Telephone: Maryland 8811 AND BRANCHES
Export Address: 23-26 St. DUNSTONS HILL, E.C.3

If you are after . . .

- I.E.E.,
- BRIT.I.R.E or
- CITY & GUILDS . . .

Write for our FREE BOOKLET

containing full details of Correspondence and Attendance Courses carefully planned to meet the needs of technicians and engineers taking these examinations.

The booklet also covers the requirements of the technically less advanced. It not only outlines careers in Electronics but also gives particulars of the whole range of *POSTAL* and *ATTENDANCE COURSES* which provide sound basic training in Maths, Radio, Television, etc.—the secret of success in these specialised fields.



E.M.I. INSTITUTES LTD.

Dept. 16, 43 Grove Park Road, Chiswick, London, W.4.
Telephone CH15wick 4417/8

E.M.I. Institutes — the Training College with Britain's Leading Electronic Organization behind it. R.94

Wharfedale

LOUDSPEAKER SEPARATOR

Cross-over at 1,000 c.p.s. MAXIMUM INPUT 30 WATTS at 3 to 15 ohms impedance. A new device for dividing the Bass and Treble between two Loudspeakers at low impedance, thus eliminating modulation distortion imposed on the treble by large coil movement in the bass. It is recommended for use with two speakers of equal sensitivity and similar size.

PRICE 65/-

Size: 8 in. x 5 in. x 4 in.



CHOKE-TYPE VOLUME CONTROL

For use on Loudspeakers with Cross-over Units where resistance types are useless, or where distortionless control is essential. Suitable for circuits of 2 to 30 ohms up to 30 watts.

PRICE 27/6

Send for book "Loudspeakers," by G. A. Briggs (5/-), in which acoustic loading is fully explored.

WHARFEDALE WIRELESS WORKS
BRADFORD ROAD, IDLE, BRADFORD
Telephone: Idle 461 Telegrams: Wharfedel, Idle, Bradford

TECHNICAL EXCELLENCE

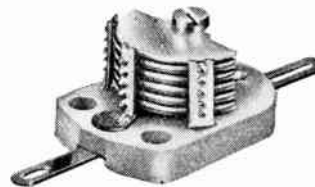

—combines with beauty and soundness of DESIGN in the

OXLEY

AIR DIELECTRIC TRIMMER

Type Approved Cat. A No. 464.

Width: 16.5 m/m. Length: 22 m/m. Height: 1.5 to 8pF—7.5 m/m. 1.8 to 20pF—10 m/m. 2 to 26pF—11 m/m. 2 to 32pF—12 m/m. Low: Straight line capacity. Power Factor: Less than .001. Insulation: Over 2,000 megohms. Voltage: 500 D.C.

OXLEY DEVELOPMENTS CO. LTD.
ULVERSTON, NORTH LANCs. TELEPHONE: ULVERSTON 3306



Resistors produced by the cracked carbon process remain stable to $\pm 1\%$ of initial value.

★ Tolerance $\pm 1\%$
 $\pm 2\% \pm 5\%$

Low temperature co-efficient.

Welwyn

carbon resistor

WELWYN ELECTRICAL LABORATORIES LTD.
Welwyn Garden City, Herts. Telephone: Welwyn Garden.

Rate 6/- for 2 lines or less and 3/- for every additional line or part thereof, average lines 6 words. Box Numbers, 2 words plus 1-. Press Day: December 1948 issue, first post Monday, November 8th. No responsibility accepted for errors.

WARNING

Readers are warned that Government surplus components which may be offered for sale through our columns carry no manufacturer's guarantee. Many of these components will have been designed for special purposes making them unsuitable for civilian use, or may have deteriorated as a result of the conditions under which they have been stored. We cannot undertake to deal with any complaints regarding any such components purchased.

NEW RECEIVERS AND AMPLIFIERS

FEEDER units with R.F. stage, de luxe type with bandspread; 2½d stamp for illustrated leaflet.—Columbia Radio, Ormskirk, Lancs. [1947] [2080]

WAKE the easy way with the Revellie clock-radio; £12 12 retail plus tax; stamp for leaflet.—Thames Valley Products, 28, Camden Ave., Feltham. [1947]

BRAND new R.C.A. 30-watt amplifiers, 250 B.A.C., 3 6J7:2, 6L6:1, 5U4, supero case, chromium fittings, quality product, £25/10.—Lawrence's, 61, Byrom St., L'pool. Cen. 4430. [2002]

LOCAL station high fidelity tuner units, complete with valves, £5/5; 12-watt high fidelity amplifier, £18/16; technical details on request.—E. A. D., 15, Bence Lane, Darton, Barnsley.

MASON'S (W.W.), Wivenhoe, nr. Colchester, can now offer television chassis with 9in tube, ready for use, guaranteed vision 60 miles, by famous makers; also 6in tube television kits, delivery 14 days. [1887]

AMPLIFIERS, new 60-watt heavy duty P.A. models, built for continuous rating and rack mounting; £45; early delivery; send for spec.—Broadcast and Acoustic Equipment Co., Ltd., Tombland, Norwich. [1855]

HIGH quality amplifier and radio tuner units, 15 valve, 12 watts, 30 D.B. bass and treble lift; send for specification.—Broadcast & Acoustic Equipment Co., Ltd., Broadcast House, Tombland, Norwich. [1852]

RGD 1046C luxury console 10-valve 5-wave (see "W.W." Oct., 1946), list £154, brand new used demo only, 121gms, with Garrard latest mixed auto, 141gms; Trix RGA 633B (RC) 30-watt ampl., 5v 3w radio, Garrard auto, in cabinet, list £147, new unused, old tax, £106/5; both guaranteed.—Write details, Worden, Lightfoot Lane, Fulwood, Preston. [1957]

RA.F.F. I.F.F. responder units, complete with 4 mains H.F. pentode valves, 3 Mazda television diodes, 2 twin triode mains valves and 1 EF50 Mullard; also includes 24v motor generator, suitable for modification to universal motor, 2 magnetic relays, several mechanical multi-contact relays; includes resistances, condensers, variable and fixed, and other useful components; 25/- each, carriage paid.—Uncle Tom's Radio Cabin, 5, Seven Stars Court, Manchester, 4. [1887]

MASON'S (W.W.), Wivenhoe, nr. Colchester, 10- and 10-waveband gram chassis, covering 3-60mc/s and 150-1,500kc/s, feeder units with r.f. stage and flywheel tuning, radio kits, auto-stop and 8 mixed changer units, amplifiers 5-500watts, Eddystone and Denco equipment and components, complete television chassis for London or Birmingham transmission and constructors' kits for London area from £45; s.a.e. for details or send 9d. now for our illustrated 54-page catalogue. [2020]

CONNOISSEUR'S receiver—world-wide results on highly sensitive 10-valve communication receiver or by change of switch, very high quality reception of local stations on non-superhet high fidelity receiver; basis rebuilt R1155, 9-1,500 metres, P×4 push-pull quality amplifier, bass and treble controls (boost and cut), gram input, new panel, and other refinements; write for details or call for demonstration; R1155 specialists, receivers repaired and re-aligned, also modified as above, or to your requirements; R1155 circuit and valves, 2/- post free.—R.T.S., Ltd., 5, Gladstone Rd., Wimbledon, S.W.19. Tel. Lib. 3505. [1266]

GOODSELL, Ltd., 40, Gardner St., Brighton, Sk.—Send 6d for our new booklet giving a few views on high fidelity and full details of the Williamson amplifiers with K.T.66 and P×.25 output, together with particulars of tone control units and high fidelity tuners, P×.4 version, at 17/17/6; also included are kit prices and a complete range of components for the Williamson, plus a general range of useful mains transformers, chokes and condensers, etc.; high position variable selectivity (see W.W., Sept., 1942); R.F., F.C., I.F. and special detector, with glass scale 9in×4½in slide rule pattern pointer, full details now available; the quality of this unit is equal to any straight feed; useful booklet, "The Brimar Valve Manual," 2/6; "Loudspeakers," by G. A. Briggs (Wharfedale), 5/-; "Partridge Manual," 5/-; Denco Bulletins, 3/- each; DBT.1 (Practical Design of Receivers using Maxi-O Coils), DBT.2 (Design and Layout for Tuners, including new C.T.7 with 7 wavebands and R.F. stage); post-free 3d; Denco C.T.6, £4 19/6; C.T.7, £7/2/6; C.T.4, £10/10, ex-stock. [1917]



Architect's impression of new factory for Partridge Transformers Ltd. situated at Kingston By-Pass, Tolworth, Surrey.

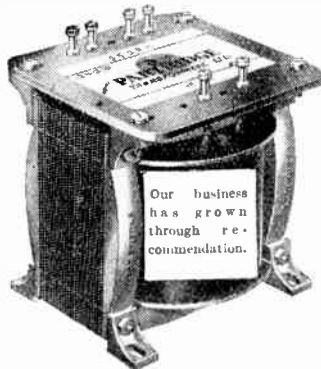

Our business has grown through recommendation.

For the present all correspondence to Brixton address as below:—

Telephone:  Brixton 6506

PARTRIDGE TRANSFORMERS LTD

PECKFORD PLACE, LONDON, S.W.9

BRIERLEY ribbon and armature pick-ups, filters, amplifiers and pre-amplifiers. Arrangements are being made for the demonstration of these products by agents throughout the British Isles. Where arrangements for this have not so far been completed, it is possible for our sales representative to demonstrate in your own home when next in your district.—J. H. Brierley, Ltd., 46, Tithebarn St., Liverpool. [2266]

THE Enock amplifier is expressly designed to obtain the highest standard of performance without regard to first cost; total distortion, including noise, less than 0.1% at 12 watts output, hum level less than -75db, frequency response practically flat from 20 to 50,000 c.p.s., no electrolytic condensers used whatsoever, inputs for radio and gram (any type of pick-up), the pre-amplifier is a separate unit designed to mount on the control panel or motor-board and contains all controls, it is low impedance coupled to the main amplifier, thus flexible couplings and hum troubles due to long leads are eliminated; price £75; tel. or write for demonstration.—Joseph Enock, Ltd., 273a, High St., Brentford, Middlesex, Ealing 8103. [2022]

THE now famous Williamson amplifier as manufactured by Radio Trades Manufacturing Co. (Ealing), Ltd. is definitely acknowledged as the world's finest amplifier at a reasonable price (vide numerous testimonials from famous critics), built to specification from real quality components on extra heavy gauge chassis with cover, this amplifier constitutes the finest product in the trade to-day; if you are seeking searching for quality reproduction your search is ended as we can supply what you want; price complete with cover £27/10; gram, motors, tuners, pre-amplifiers, speakers and pick-ups supplied; trade enquiries invited.—Write or call, R.T.M.C. (Ealing), Ltd., Laurel House, 141, Little Ealing Lane, W.5. [2025]

UNIVERSAL ELECTRONIC PRODUCTS, 56, Marylebone High St., London, W.1. Specialists in the design and manufacture of high grade fidelity gramophone reproducers and radio units. If you are interested in obtaining the finest possible reproduction from recorded music we invite you to hear our equipment demonstrated in conjunction with the Wilkins and Wright coil pick-up and the Wharfedale corner cabinet speaker. We will gladly give you a quotation for the conversion of your existing gramophone into a first-class reproducing instrument, or for the design and construction of equipment to your own special requirements. Write for descriptive leaflets of our range of fidelity amplifiers and radio tuning units. [1900]

RECEIVERS, AMPLIFIERS—SECOND-HAND STOCK sale, R.1155 receiver, modified, including R power pack, £8.—Box 1504. [1879]

RC.A. A.K.88, perfect, 10 spare valves; £85.—Kenya, Barlaston, Stoke-on-Trent. [1879]

BC34d, a.c. power pack and speaker; £12.—Bloomfield, 27, New Rd., Rye, Sx. [1955]

ALLICRAFTERS SX24, O.K. but needs re-aligning.—Muir St., Larkhall, Lanarks. [1955]

DECCA Portroia, perf. radio and gram; £20.—6, Abingdon Rd., Kensington, London. [1955]

OFFERS.—H.M.V. radiogram model No. 531; can be inspected West End.—Box 2035. [1955]

HALLICRAFTERS SX16 with complete literature book one owner, offers.—Box 1995. [2039]

TWO P.C.A. AR88 receivers with cabinets; offers.—Aspinwall Road, Windermere. [2068]

40 watt amplifier (PA.40s), t.t.c.e controls and valve current meters; £25 or offers.—Box 1936. [1936]

SALE, Hallicrafters SX28, £45; SX24, £25; both in first-class condition, any inspection.—Box 2026. [2054]

HAYNES High Fidelity tuner, £10; Williamson amplifier complete, £15.—35, Baden Rd., Brighton. [2004]

MORETON Cheyney Silver Dragon, 19v. H.M.S. nearly new, nearest £50.—40, Hills Ave., Cambridge. [1835]

1155 receivers, 10 valves, new condition, aerial test; £7.—J. A. France, 58, Croydon St., Salford, 5. [2014]

HRO Senior, recent model, new condition, £20 a.c. power pack, 7 coils, 3-metre, crystal, etc.; 35; bargain.—Box 2058. [2101]

PEERLESS 1148 £52 receiver, perf. cond., compl. offers? Elect. gram. motor with p.u., £6.—Oakenshaw Rd., Walton, Wakefield. [1961]

AC. amplifier, 4 watts o.p. high fidelity, incl. tone and v.c., o.p. trans., £6/10.—Haigh 108a, Nightingale Rd., Carshalton, Surrey. [1972]

AR88, two in good condition, for £50 each; completely aligned by us.—R.S.S., Ltd., 68a, Park Rd., London, N.8. Mou. 5533. [1961]

RC.A. AR88 communication receiver for sale, complete with set of 17 spare valves, in perfect condition; £50.—Write to Box 1937. [1972]

WIRELESS World 2 R.F. 3 valve quality tuner for use with quality amplifier; £6/10, including valves; new and unused.—Box 1384. [1973]

PROTOTYPE professional receiver, 0.55-30 I. mc/s, 10 valves, ready for wiring, 15-coil unit complete, heavy power pack, Box 2054. [1973]

RECEIVERS with 8in m.c. speakers, Eddy-stone 640, as new, £25; National NC81X, as new, £25; National NC45, as new, £15.—Box 1938. [1973]

RECEIVERS, R1124, complete with 6 Brimar valves, 13V series, 15/- each; transmitter, T3155, few only, 17/6 each; plus circuit in new case.—Tel. Norwich & Wolsey 30, Connaught Rd., Norwich. [1989]

THE WORLD-WIDE FAMILY OF HARTLEY-TURNER ENTHUSIASTS

Two years ago the post-war Hartley-Turner 215 speaker was introduced to the world. Outside the iron curtain it has been accepted as a well-spoken ambassador of British technical skill and craftsmanship. In every country where the truth free from distortion is demanded it fills the need with satisfaction to its owners.

But in its train has come the desire for information and equipment to equal its performance and this we try to meet by supplying technical brochures and apparatus—subsidiary activities forced on us because, so we are told, the correct results cannot be obtained elsewhere.

This has surprised us, but we suppose it results from never sacrificing performance to expediency and never departing from our self-imposed standards of technical exactitude. The reward is great—complete confidence in us on the part of our customers, but it leaves us with a terrific responsibility. We can't afford to take chances. This should be of interest to overseas high-fidelity enthusiasts.

PRESENT PRODUCTS

The 215 Speaker £9. Overseas packing, carriage and insurance, 10/6.

The T.R.F. Unit £19 10/- (Purchase tax in Britain £4 4/6).

The 25-watt Amplifier £39. Overseas packing, etc., about £2/10/-. Complete catalogue of data sheets free on request.

Home construction of the T.R.F. unit and amplifier is quite easy with the aid of our Technical Bulletins (10/- each) and a complete understanding of the subject of high-fidelity will be found, as its thousands of purchasers will tell you, in "New Notes in Radio." Cheap reprint now available at 2/8, post free anywhere.

READY SHORTLY

The Hartley-Turner Selected Record Catalogue, the final answer to the problem "Which records shall I buy?" The whole world of recorded music examined with minute care to save you disappointment and loss through blind buying. The first issue of lists contains details of 450 major works and a series of supplements properly arranged will complete the survey of the old and new. In a permanent loose-leaf binder. Price about 25/-. You cannot afford to be without it.

H. A. HARTLEY CO. LTD.

152, HAMMERSMITH RD., LONDON. W.6. RIVerside 7387.

SECOND-HAND radios, new valves at list price and components reasonable to clear; send s.a.e.—Mawson, 11, Salisbury St., Peilaw-on-Tyne [1427]

HALLICRAFTER SX-28 Super-Skyrider, £35; also SX-24 Skyrider Defiant, £15; also rack mounting AR-77, £30; all perfect and re-aligned.—Box 1496. [1893]

ONE Cossor television model 1210, completely overhauled, with 3-waveband radio; £85.—A. M. Rushton, 45, Churston Av., London, E.13. Tel. Grangewood 4274. [1945]

SUPERHET tuning unit, 8watt super amplifier, 12in Triplecone speaker, several spare valves; £51, or near, genuine bargain.—Newstead, Sherwood Rd., Bognor Regis. [1901]

1155 at 15/- are all sold, but please send for lists of sets in stock to-day; new supplies arrive daily; s.a.e. please; trade lists.—Duke & Co., 219, Ilford Lane, Ilford, Essex. [2079]

RACK built Tannoy 120-watt amplifiers, two available, in perfect condition, 200-250 volts A.C., only £55 each.—Ledgard, Rolle & Son, Loose Village, Maidstone, Loose 83579.

1155 for sale, completely modified, audio stage and power pack built in, new front panel fitted, complete with 6in energised speaker; must sell, owner going abroad; £10.—D. Dixon, 15, St. Martin's Grove, Bridlington.

1155F new, with power unit gear, £13/10, carr. pd.; 1224A comm. rec., new, 4/10, carr. pd.; 1124 rec. with six new valves, 21/-, carr. pd.—J. Rae, 39, Penn Rd., Wolverhampton.

RADIOGRAM in hand-made unpolished walnut cabinet, 3 wavebands, 2 stages each of H.F., F., and L.F. with P.P. triode output, Baker-Selhurst 12in speaker, Garrard turntable and crystal pick-up; price £65. Tel. Chiswick 3872, after 7 p.m. for demonstration, or write Box 1534. [1920]

45 mc/s i.f. strip (5-VR91) plus 20 valves, etc. R3553 £4; power units, type 539, 200-250 a.c. in, 15v 3a and 300v 40ma d.c. out, £2/10; V.H.F. receivers, 5 valves, 2 sets Lechar bars, 35/-; R1124C, 20/-; modulators, types 29 and 208, 5-KT44, 2-U17, 1-MH41, etc., £2/10; s.a.e. particulars.—G. R. Adcock, Norwich Rd., Watton, Norfolk. [1970]

ADDYSTONE 358X, grey crackle, 10 coils in coil box, 31mc/s to 40kc/s. Xial, power pack, valves, good condition, £17/10; Naval transmitter receiver, 100-230v a.c. or 12v d.c., quality job, 4 compact units, tr. 5v with 4 of 807, 6 switched bands, 1.5 to 9 mc/s, Rx, 5v superhet r.f. stage, B.P.O., etc., 3 bands, 0.4mc/s to 10mc/s, 6w, 6 output, metered, good condition; circuit £11/10 complete.—"Beam Ends," Tregaron Ave., Cosham, Portsmouth. [1896]

TWO Sobell model 615 table radios, brand new condition, but cabinets slightly shop soiled; one Sound Sales Polyphonic radiogram, unused; two C.D.P. (Bourne Instruments) recording machines; one M.S.S. recorder; 11 Constead quick start control units for fluorescent lamps (80watt); 7 1-3amp magnetic cutouts in solid wooden boxes, 5 2-5amp ditto, 6 5-8amp ditto, 6 5-10amp ditto, 4 10-15amp ditto; all the above as new and unused; offers, either for the whole or for any item.—Peter Granet, Stoke D'Abernon, Surrey. [1969]

NEW LOUDSPEAKERS

ROLA 12in mains energised loudspeaker, less transformer; £5.—Bishop, Forthvie House, Dalmeny, West Lothian. [1881]

10 in heavy duty in strong grey wood cabinet, 14in X 15in, 6-way vol. sw., 2-3 ohms, good condition, ex-A.P.O.; 27/-.—"Beam Ends," Tregaron Ave., Cosham, Portsmouth. [1884]

WRITE for details of the new Plexicone conversion which considerably improves reproduction of speech and music to existing speakers.—"Looker's Quality Radio, 106, Davidson Rd., East Croydon. [1923]

HIGH quality, precision-built speakers, die-cast chassis, twin cone.—Broadcast & Acoustic Equipment Co., Ltd., Broadcast House, Tombland, Norwich 26970. [6435]

U.S.A. make re-entrant horn public address speakers, brand new, with built-in transformer 0-250-500-1,000-2,500 (1), complete with collapsible 8ft super tripod and universal fitting bracket, nearest equivalent on home market over £20, our price £8 8 c.p. These can also be supplied in sets of four in special fitted transit case for £30 per set, inc. case, c.p.

FRITH RADIOGRAPH, Ltd., 69-71, Church Gate, Leicester. [2123]

THE Mordaunt Duplex Reproducer has a treble section which employs a high-flux P.M. unit having a specially designed exponential twin cone; this last, together with low-frequency filtering, avoids inter-modulation, feedback effect and decay factor troubles; the frequency response is exceptionally smooth up to 20,000 c.p.s., and the transient response is of a very high order; the unit feeds into a multi-reflector assembly which gives, with the aid of the surrounding walls, the wide dispersion and freedom from point-source effect so essential to realism and atmosphere, price 98gns.; white wood skeleton model, £88. Telephone or write for a demonstration.—Joseph Enock, Ltd., 273A, High St., Brentford, Middlesex, Ealing 8103.

LOUDSPEAKERS, SECOND-HAND

18 in Baker p.n. 15ohm; £6.—Cameron, Muir St., Larkhall, Lanark. [2015]

VOIGT twin unit, 100 200 field, as new; offers, 65, Clayton St., Colne, Lancs.

YOU can become a first-class RADIO ENGINEER

We are specialists in Home-Study Tuition in Radio, Television and Mathematics. Post coupon now for free booklet and learn how you can qualify for well-paid employment or profitable spare-time work.

T. & C. RADIO COLLEGE

King Edward Ave., Aylesbury, Bucks.

(Post in unsealed envelope, 1d. stamp)
Please send me free details of your Home-Study Mathematics and Radio courses

NAME

ADDRESS

W.W.77.



WATTS	VOLTAGES	
65 watts Fitted with oval tapered bit or round pencil bit	100/110 120/130 230/250	110/120 200/220
125 watts Fitted with oval tapered bit or round pencil bit	100/110 200/220	110/120 230/250
240 watts Fitted with oval tapered bit	100/110 200/220	110/120 230/250



Write TODAY for folder Y. 10.

W. T. Henley's Telegraph Works Co. Ltd., Engineering Department, 51-53, Hatton Garden, London, E.C.1.

HARTLEY-TURNER Duode 1250 field with trans., £5.10; ditto 2500 field with trans., £5.—31, Bampton Lane, Darlington. [2028
VOIGT light twin H.C. horn, bass chamber, per. f., nearest £22.10 comp.—Orchards, Summerhill Lane, Hayswards Heath, Lt. 144.
VOIGT corner horn large Halford radiogram chassis, motor and condenser pick-up; £60, or separately; seen Midlands.—Box 1934.

BAKER 12in. triple cone with P.P.X. x4 trans. £5; Williamson output trans. (Gardner's) 30/1, mains trans. condensers, cine camera.—201, Plum Lane, London, S.E.18.

OFFERS for Vitavox Bi-tone cabinet spkr.—
 Vitavox 72in flat exp. horn, Vitavox B type press. units, Rola G.12 chassis spkr., super 50-watt Vortexion ampl.—Aspinwall, Windermere.
BAKER with Ticonal magnet, complete with infinite baffle cabinet in veneered walnut, 15ohms speech coil; £7.10; new and unused, half original price.—Box 1383. [1764

DYNAMOS, MOTORS, ETC.

LX-W.D. A.C. motor, 1.20 to 3hp, 220-400 3-phase; send for lists.—Radiovox, Oxford Place, Leeds. [1939

PLUG on dynamotors for BC453, etc., 14 volts in, 230 volts out, 12/6.—Lawrences, 61, Byrom St., Liverpool, Cen. 4430. [2007

ELECTRIC motors.—Our famous range of motors again available from stock; example, 1hp single phase 250v, 1000 rpm, 1000 ft. from £16/6; send for lists.—John Steel, Bingley, Yorks. Tel. 1066 (4 lines). [9968

BATTERY chargers for home and export, 4 models, 2-6-12v, 1, 2 or 4amp dc, any mains voltage; generous trade terms; write for catalogue.—Tel. Huddersfield 2659, The Banner Electric Co., Ltd., Huddersdon, Herts.

NEW petrol generators, 15v 600-watt, self-starter, 4-stroke engine, air-cooled, auto-cut-out, ammeter, first-class job, £24; Exide 6v 120 a/h batteries, fully charged, with acid, £4/7/6.—Pearce, 66, Gt. Percy St., London, W.C.1. [2084

ALL types of rotary converters, electric motors, battery chargers, petrol-electric generator sets, etc.; rotary transformers, input 12v d.c., output 600v at 250ma price £4/10 each nett, post paid; J.A.P. No. 24 engines, 1.2hp at 2,600 rpm, complete and ready for use, £17 nett, ex works.—Ward, Lordcroft Works, Haverhill, Suffolk, Haverhill 253-4. [7503

A.M. disposals.—New portable petrol electric generators in original overseas wood cases, output 12-15 volts 600 watts d.c., self-starters, hard service metal tool kit, £25; 18i 30c Turnbuckles, 4 for 10/-; rotary converters, input 24v d.c., output 230 a.c., 100 watts, 50 cps, £5; 40-112 unicec cable, single, £10, twin £18; 1,000 yds; Di-pole aerials, 60ft. co-axial, £1; all new, carr. paid.—Wild's Radio, Victoria Rd., Fenton, Staffs. [1544

97/6 charging switchboards, 12v-32v, 500 and 1,260 watts, volts, amps, cut-outs, fuses, resistances, etc., 4 take-offs, superb unit, in case, or send £5 carriage paid; 75/- dynamo, 24 volts, 1,000 watts, 9in x 7in, 1/2in spindle, or send 90/- carriage paid; 75/- 2.5hp 1/50, 1.5hp electric motors, incorporating 1,260 cycle converter, or send 80/- carriage paid; 58/-, mains transformer switchboards, 230v ac to 12v, 5 separate take-offs, complete distribution panel, all switches, fuses, amps, etc., brand new, or send 60/- carriage paid; 75/-, electric motors, 12v and 24v, 1/4hp, 4in x 4in, with 1/2in spindle for drive, beautiful job, or send 60/- carriage paid; 45/-, dynamo units, containing 12v, 24v, 130v and 300v dc dynamo, or suitable as 6v, 12v or 24v motor, approx. 1/2hp, 11in x 5in, with spindle to take small grinds, mop, etc., also contain adjustable 2in cut-out automatic voltage control, smoothing condenser, resistances, and many other extremely useful fittings, beautifully made or send 50/- carriage paid; 38/-, radio wavemeters, adjustment dial, 350-370 Mc/s, beautiful instrument in case, or send 40/- carriage paid; host other valve equipment; lists free.—Benmotors, Summerley St., Earlsfield, S.W.18. Wim. 3833, (100 yds S. Rly, Electric Line; 10 minutes Waterloo.)

TEST EQUIPMENT

WESTON analyser, £8; all-wave osc., £6.—Box 1946. [1998

AVO 7 as new, £15.—Constable, 21, Fourth Ave., Bridlington. [2063

TAYLORMETER 90A, good condition; offer 10gns secures.—Box 2055. [2094

VALVE tester, £7; sig. gen., £7; Avo 40, damaged, £65.—Box 2056. [2095

TAYLOR model 47A valve tester/analyser in carrying case, a.c., as new, £20.—Box 1985.

P.L. signal generator, mains operated, also Avo battery driven, both practically new.—Tel. Bat. 8138. [1956

COSSOR double beam oscillograph model 359, perfect; £20.—rite Cox, 39, West 85, Bognor Regis, Sussex. [1937

COSSOR 3332 4 1/2in c.r.o. internal T. base, amplifier and coils, perf. condition; seen London, £17.—Box 1997. [2047

PULLIN series 100 meter, as new, £8/5; 602, new AC5 Pen, new, 10, ea; "Wireless World," 1948 offers.—Box 1501. [1873

CHAUVIN-ARNAUX universal pocket meter, size 1 1/2in, 3in, 5in, very handy; only £5, also 9in CRT electromagnetic MW22/7, £5.—Box 1483. [1843

SALE, test equipment, Avometers, Avominors, test tubes, signal generators, big reductions; list s.a.e.—Volun 134, Old Shoreham Rd., Southwick, Sussex. [1931

BARGAINS FOR Constructors & Experimenters

METERS. Frequency meters, panel mounting, **Crompton** 2-1/2in, 4in, 3-1/2in C 2-scale, 20/60 cycles and 360/480 cycles, flush fitting £6 each delivery ex-stock. Watt meters, Mer. Vic. range 5-30 K.W. full circular scale 6 1/2in, dia, 230 volts 3 p.h. 50 cycles with compensator £5. Voltmeters 1 C 4in, dia, 5/Bd, G.E.C. 0-60 volts A.C. 45 v. Ammeters 1 C 4in, dia, 5/Bd G.E.C. 0-40 amps A.C. 45 v. Ammeters 5in, dia, 1 C 0-14 amps, A.C. 35 v. Small panel meters, ammeters 50-0-50 amps, 15 v, 20 amps 12, 6, 20 volts 10-, 100-0-100 volts 10-, 25-0-25 m.a. 12/6. Cambridge dial Thermometers 0-70 degrees £4/10. Ohm-meters Evershed in new condition reading 0-0, 1 ohm in polished wood case with space for cell and with leather case and carrying strap £7/10.

SMALL MOTORS. Sewing machine type, square construction with pulley belt and bracket easily connected to ordinary domestic sewing machine, 1/25 h.p., 230 volts A.C. new, £4. Foot control, 55 v., 50 volt A.C. series motors 1/12 h.p., with double ended shaft governor fitted on one end, £3.

DYNAMOS. For windmill work 12 15 volts 10 amps, 600/1,000 r.p.m., C.A.V. make, weight 24 lbs., 10 1/2 x 5in. dia., double ended shaft, £5. 12 volts, 30 amps., 2,000 r.p.m., £4. 12 volts, 10 amps., 1,400 r.p.m., 45 v.

PUMPS. Suds motor pumps, 400/440 volts 3 p.h. 50 cy, 2,800/3,000 r.p.m., 1/6 h.p., 240 g.p.h., 15ft. head, £4/10. 1/4 h.p., 10ft. head, 240 g.p.h., £4/10. 1/2 h.p., 10ft. head, 600 g.p.h., £4.

PRESSURE GAUGES. 7in. dia. vacuum 30 lbs., pressure 15 lbs. per sq. inch, brass case, £15 v. Bourdoin Boost gauges plus 8 and minus 7 lbs., 7.6.

SOLENOIDS. Powerful electro magnetic D.C. iron clad Solenoid 3/4in. core, weight 1 lb. 10 ozs., screw-in core for use on 6-25 volts to lift 7-28 lbs., Type No. 1, 4/-; Type No. 2, with 3 separate windings, 4/6; Wound Solenoid coils, 27 gauge enamelled wire, excellent as H.F. smoothing filter choke, 2/3 each.

CUT-OUTS. Auto non-mercury in bakelite case, 3 x 3 x 2 1/2in., 18 volts 30 amps., 21/- G.E.C. 12 volts 15 amps. non-mercury auto cutouts, 4/6.

CIRCUIT TESTER. Self-contained Govt. model unused 6 1/2 x 3 1/2 x 2 1/2in. almost pocket size, useful for all electrical circuits, totally enclosed in polished wood box with carrying strap and contact switch, 12/6, with battery.

VARIABLE slider resistances 3 ohms 10 amps., 17/6, 1.2 ohms 15 amps., 12/6, 11 ohms 4 1/2 amps., 12/6.

PANEL DIMMER RESISTANCES.

Totally enclosed 100 ohms, 1/2 amp., 2/6, 50 ohms, 1/2 amp., 2/6. Wire wound open type, porcelain former 10 ohms, 1 amp., 2/6.

TELEPHONES for House or Office. Constructors' Parts for your own set-up. Ex-G.P.O. stocks, wall type, comprising Bracket Mike, Transformer and Condenser, Magneto Bell in walnut cabinet, 8in. x 6in. x 3in., fitted terminals and connections, Switch Hook and Contacts, Hand Magneto Generator and G.P.O. Receiver, 35/- per pair, with wiring diagram.

CRYSTAL SETS. The famous Lesdix Boudoir crystal set. Special perspex former wound for crystal reception, variable condenser tuning semi-perm. detector, bakelite case and terminals, 17/6. Headphones, 10 v. pr. sensitive to crystal reception and fitted headband and cord. Order early for seasonal gifts.

MAGNETS. D.C. Electric magnets, weight 10 oz., lift on 2 volts 1 1/2 lb., 4 volts 3 lb., 6 volts 4 lb., new surplus, 7/6 each. Permanent powerful flat bar magnets, 2 1/2in. x 1in. x 1/2in., drilled 2 holes each end and any pole pieces, 2/- pair. The wonder Midget magnets. Alni perm. steel disc; 3/4in. diam. 3/4in. thick, with 3/16in. centre hole, 3/6 each. Large stock of Horseshoe magnets. Send for special Magnet Leaflet.

PARCELS. 10 lbs. useful oddments for the junk box. All clean, dismantled from Government and other surplus apparatus, 7/7 post free. (Not for Overseas buyers.)



CRYSTAL SETS. The famous Lesdix Boudoir crystal set. Special perspex former wound for crystal reception, variable condenser tuning semi-perm. detector, bakelite case and terminals, 17/6. Headphones, 10 v. pr. sensitive to crystal reception and fitted headband and cord. Order early for seasonal gifts.

MAGNETS. D.C. Electric magnets, weight 10 oz., lift on 2 volts 1 1/2 lb., 4 volts 3 lb., 6 volts 4 lb., new surplus, 7/6 each. Permanent powerful flat bar magnets, 2 1/2in. x 1in. x 1/2in., drilled 2 holes each end and any pole pieces, 2/- pair. The wonder Midget magnets. Alni perm. steel disc; 3/4in. diam. 3/4in. thick, with 3/16in. centre hole, 3/6 each. Large stock of Horseshoe magnets. Send for special Magnet Leaflet.

PARCELS. 10 lbs. useful oddments for the junk box. All clean, dismantled from Government and other surplus apparatus, 7/7 post free. (Not for Overseas buyers.)



MAGNETS. D.C. Electric magnets, weight 10 oz., lift on 2 volts 1 1/2 lb., 4 volts 3 lb., 6 volts 4 lb., new surplus, 7/6 each. Permanent powerful flat bar magnets, 2 1/2in. x 1in. x 1/2in., drilled 2 holes each end and any pole pieces, 2/- pair. The wonder Midget magnets. Alni perm. steel disc; 3/4in. diam. 3/4in. thick, with 3/16in. centre hole, 3/6 each. Large stock of Horseshoe magnets. Send for special Magnet Leaflet.

PARCELS. 10 lbs. useful oddments for the junk box. All clean, dismantled from Government and other surplus apparatus, 7/7 post free. (Not for Overseas buyers.)

ELECTRADIX RADIOS

214, Queenstown Road, London, S.W.8. Telephone: MAcaulay 2159.

ONE Ekco television pattern generator, £6; Taylor universal test meter, model 90, £5.—A. M. Rushton, 45, Churston Av., London, E.13. Tel. Grange Wood 4274.

COSSOR D.B. oscillograph, new, £40 or offers; C test set 1-56-c. good condition, complete, £30 or offer.—Page, Briars, Mostyn Rd., Gronant, Prcr., N. Wales. [1968

WEE-MEG insulation testers by E. & V., in leather case, £5, also for s.h. at 5/10; price includes carriage, etc.—Sound Service, Main Rd., Gt. Blakenham, Ipswich, [1905

MAINS operated industrial oscilloscopes with 1 1/2in non-persistent tube in metal console cabinet, £15. A fine selection of standard signal generators from £20 ea.; these two items callers only or delivered London area.

TEST set Type 204. An audio frequency oscillator covering from 20 cycles to 40 Kc/s in four ranges; a precision instrument with a beautifully calibrated dial; ready for use on 230v 50-cycle A.C. mains; price £10 plus 10/- carriage. Full range of components available; send for list W.W. of other bargains. As so see disp. advert in this issue on page 63.—Charles Britain (Radio), Ltd., 11, Upper Saint Martin's Lane, London, W.C.2. Temple Bar 0545. [2043

ALL-WAVE B.P.L. sig. gen., unused, £12; 12 volt 5 amp rectifier, 25/-; unused Douglas F. coil winder, £22; Douglas triple wave winder, £50; both machines complete with motors, R/carriers and c/shafts.—Box 1986.

CRYSTAL Multiplier with 80r oscillator, spare valve accessories, instructions book; this fine American unit is brand new and offered at the exceptionally low figure of 75/- carriage paid.—Wilkinson, 204, Lower Addiscombe Rd., Croydon. [2108

TAYLORMETER 81C (20,000 o.p.v.) with cap and ind., adaptor, £11; Avometer 7, £15; Avo testbridge, £8; Avo mains oscillator, £10; Multirange 100 (oscilloscope moving iron), £20, all in new condition.—Box 1930. [1948

VOLTMETERS, 0-300 a.c. moving iron 2 1/2in. dial, brand new, 17/6 each; also 0-15volts, 15/-; thousands of instruments in stock at low prices, including American Test oscillators, 40/500 megacycles, £12/12, for mains or bat., £14. All in new condition.—Lower Addiscombe Rd., Croydon.

TEST equipment.—Circuit diagrams and drawings available for signal generator, Model 748, 100 kes-50 mcs, signal tracer 848, range 100 kes-20 mcs meter indication, valve voltmeter 848, three ranges 0-100 volt drawings, etc., 3/6 per set, all parts and calibration service available.—Radi Development Co., Moreton-hampstead, Devon. [2033

OSCILLOSCOPE and wobulator complete for £20; T.B. 10 c/s to 350,000 c/s, X and Y plate amplifiers, easy to handle and has outstanding performance, brand new and fully guaranteed. Immediate delivery complete set of leads and booklet on oscilloscope technique.—Write for further details to Erskine Laboratories, Ltd., Scalby, Scarborough. [1648

MICROAMMETER, E.T.E.I. model 23, 0-100 5/32in diam., as new, boxed, 45/-; milli-ammeter, m.c., d.c., 300ma, new, boxed, 10/-; Taylor output power meter, 0.01 to 2,500mw, 205 to 20,000 ohms load, as new, £15; Espy universal test sets, 20,000 ohms/volt, as new, £18; cathode ray tubes, 5 CPI, with base and mural screen, new, unboxed, 45/-.—Box 1477.

METER 21R.C., 500/30 ma, 15/6; 3.5 amp, 2 1/2in, thermo-coupled, 7/6; double reading, 40-120ma, 2in. m.c., 8/-; 20 amp, 2 1/2in. m.i., 9/6; 15 volt, 2 1/2in. m.c., 9/6; 300v, 2 1/2in. m.c., 12/6; 30 amp, 6in. m.i.; Ironclad, 55/-; 6,000v, 3 1/2in. m.c., £7/6; 3,500v, 3in. m.c., £6/6; 2 1/2in. m.c., 10/-; 15v/600v, double reading, 2in. m/c, 8/-; 2 in. motor movements with magnet (500 micro-amp), 2/6; post extra; ex-R.A.F. 2-valve (2-volt) microphone amplifiers, as used in plane inter-com., in self-contained metal case, can be used to make up a deaf aid outfit, intercommunication system, or with crystal set, complete with valves (also unused), 20/-, post 1/6; letters only; new illustrated list sent on request with 1d stamp and s.a.e.

HIGHSTONE UTILITIES, 58, New Wanstead, London, E.11. [2051

NEW ex-Govt. bargains! Send 1d s.a.e. for radio/elec. list! A few examples: All brand new, boxed, m/coil, electrostatic voltmeters (Elec. Inst. Co.) 0-5,000 volts, 3 1/2in round dial, flush fitting, range 4 1/2in, 30/-; ammeters (M.I.P.) 0-20 amps, round 2 1/2in, flush, 7/6; milliammeters (Sangors) 0-350 m.amps, 1 1/2in, 4/6; thermocouple, round 2in proj., 5/6; ditto (Ferranti) 0-200 m.amps H.F. thermocouple, round 2in proj., 7/6; microammeters, visual indicators No. 3 contg. 2 comp. Weston 300 microamp movements in bakelite case, round 2 1/2in dial, 2 scales, 2-2amp, with SBC holder, complete set, 4/6; pair, or 48/- doz; fuel control indicators contg. a single movement with 2 tappings giving i.s.d. 0-300 or 0-500 microamps, 7/6 ea. 12/- pair, or 60/- doz; Wee Meggers, 250 volt, brand new, comp. in leather case (list £13), £7/10 A.C. Ltd, 126, St. Albans Ave., London, W.4 (Chiswick 1601), or 15, Lawrence St., Northampton, [1911

TRANSMITTING EQUIPMENT FOR sale, transmitter, high Q. Max B4,40, complete with 2 crystals and mike, in new condition; £80 or near offer; can be seen in Fleet Street by appointment, APP 7, Box 1929.

AMERICAN C.W. transmitter, £13.10, £9/5, continuous coverage on M.O., can be used up to 240 w, complete with L.T. transformers but no H.T., and in good order; £35, carriage paid.—Box 1533.

THE A.C.R.I. 155 COMMUNICATIONS RECEIVER. This superb R.A.F. 10-valve superhet covering 75 kcs-18.0 mcs in 5 wave bands, converted for use on A.C. mains and complete with speaker in attractive cabinet. is now available at ONLY £18 10/-. Send for fully illustrated descriptive leaflet.

EX-R.A.F. 10 VALVE TX RX. Operates between 155-185 mcs and easily convertible for Amateur use. Contains shoals of TX gear, and 2 valves RK34, 1 type EF50, 4 type 5P41, 3 type D1, and a 20 watt rotary transformer. ONLY 39/6. (carriage 5/-).

EX-R.A.F. BATTERY AMPLIFIERS. A very fine battery amplifier used by the R.A.F., for intercommunication in aircraft. Makes an ideal pre amp stage for gramo pick-up, etc. Complete with valves types QP21 and 210LF. Operating voltages 2 v. LT and 120 v., HT. BRAND NEW in transit cases. ONLY 25/- (carriage etc., 2/6).

INSULATION TESTERS (MEGGERS). Ex-R.A.F. Brand New Insulation Testers by Evershed & Record. Pressure 500 v. Listed at over £12, our price ONLY £8/10/-.

BATTERY SUPERSEDERS. A superb American made Vibrator Power Unit operating from ONLY 2 VOLTS INPUT, and delivering 1.4 v. LT, 90 v. and 180 v. HT, with provision for GB. Fully smoothed and requiring little adaptation for use with normal battery receivers. Complete with two 2 volt accumulator in metal case ONLY £4 10/- (carriage 5/-), or the V.P.U. only at £3 (carriage 2/-). Illustrated leaflet available on request.

C.W.O. Please S.A.E. for lists

U.E.I. CORP.,

THE RADIO CORNER,

138, Gray's Inn Road, London, W.C.1.

(Telephone TERminus 7937)

Open until 1 p.m. Saturdays, we are 2 mins. from High Holborn, 5 mins. from King's X.

COMPLETE transmitter-receiver assembly in rack. details and photograph from Bretherick, 37, Hillcroft Rd., Romford. (2091)

TRANSMITTER-Receiver. Type T.R.9's with valves £4 without valves 50/- carriage 5/-.—Smith, Highworth Rd., Faringdon, Berks.

BRAND new American ex-Army tuning units. T.U. 9D and T.U. 10B.—ix black bakelite cases, 17/6 each, without case 14/6 each; prices include carriage.—Saincock, Beachfield Rd., Grappenhall, Cheshire. [2122]

SCR-522, £9 10 ea.; 832 new, 30/- ea.; TX-RX power packs. 1.200v 200 m a. 220v 110 m a. 6.3v d.c. at 13 amp; new, £10 ea.; mod units. 5 KT44s, 1 MH4, 2 VU17, 25/- ea.; s.a.e. for details.—Hughes, Tonnin, St. Lowestoft, 11926

ANTENNA relay units, BC442, include change-over relay (12-24v), 0.75 amp thermocouple meter, 50pF vacuum condenser, spring terminals, etc., new, boxed, 7/6 each; items separate, relay 4/-, meter 3/-, vacuum condenser 2/-, spring terminals 3d each; send for list transmitting equipment at reasonable prices.—Box 1478

AMERICAN power packs for QRP to QRO at the turn of a single knob. Input 100-250v A.C. 50 cs. output 12v 14a A.C., 12v 2a D.C., 1.000v H.T. constantly variable between 1v and 1.000 at 350ma through auto transformers controlled from front panel, filament and H.T. voltages metered; fitted three circuit breakers, local remote control of H.T., time delay switch, safety door switch, motor blower/extractor thermo controlled, pair 866 rectifiers, cable connectors, magnificent black crackle case, all as new in original transit cases; £14 10 c.; Junior model as above, less meters and H.T. fixed at 1.000v 350ma, £10 c.p.

FRITH RADIOCRAFT, Ltd., 69-71, Church Gate, Leicester. [2124]

GRAMOPHONE AND SOUND EQUIPMENT

SIMON SOUND SERVICE have recorders in stock. [8713]

WILKINS Wright coil, P.U., with trans., £5.

LEXINGTON Senior pick-up, unused, £3.—29, Thwaite St., Cotingham, Yorks. [2046]

24-VALVE Royale radiogram for sale.—St. Gellert, Southport Ave., Bexhill. [2028]

R.G.D. chassis speakers, also gramophone motor and crystal pick-up; £30.—Box 1935.

COLLARD A.C. motor, crystal p.u. autostop 12" in. new, unused, perfect, £9.—Box 2029.

LEXINGTON Senr. pick-up, trans. sapphire, unused, two purchases, £4 10.—Box 2028.

AUDIX motor & Connoisseur v.v. £7; Brierton JB/P/R 1, p.u., £8; Wharfedale separator, £2 10.—Box 1529. [1900]

GARRARD radiogram units, single record, new, type E A.C., with pick-up, £7 10. Marcus, 149, Heron Drive, Ilford. [1933]

DISCS.—12in metal acetate blanks for recording, 4/- each.—Ledgard, Hoile & Son, Loose Village, Maidstone. Loose 83579. [2045]

TRANSFORMERS, tone control and filter chokes for all "W.W." circuits.—R. Clark, 30, Latland Cres., Stanmore, Mdx. Wor. 5321.

WILKINS Wright coil pick-up and scratch filter, £5 10; Micro moving coil microphone and transformer, £3 10.—Tel. New Cross 3973 after 7 p.m. [2065]

MAGNETOPHONE (Dom), band sound recording and reproduction machine for sale, semi-portable, plenty of spare bands, 12 volts 1 amp; offers.—Box 1931. [1949]

V.G. recorder cutting mechanisms, heavy duty, 78 rpm, 220v motor, Dra'owid 1 000-ohm cutting head, output meter on frame, £40; sell separately.—Radiovox, Oxford Pl., Leeds.

C.D.P. recorder, Vitavox, E.T.H. and Rothermel mikes; Quartermaster drill; 2 S.B. p.u.s. etc.; s.a.e. full details; others items cheap.—Bourne, 27, Beaver Rd., Manchester, 20. [2045]

INFINITE Baffle corner deflectors, scientific-ally designed acoustic chambers as reviewed "Wireless World," June; send for catalogue.—Broadcast & Acoustic Equipment Co., Ltd., Broadcast House, Tombland, Norwich 26970.

SIMON SOUND SERVICE can supply your needs. [8712]

GARRARD a.c. motor and pick-up, unused, £7; Wee Megger with case, 500v, £6; latest American 1,000 opv universal meter, £6; Wharfedale 10in golden unit, 15 ohms, new, £3/5.—Wilson, 86, Wilton Rd., Manchester, 8.

MOVING coil hand microphones (No. 13), 2 1/2" in diam., press to talk switch, soft rubber mouthpiece, coil 40 ohms d.c., res. super performance, 4/6 each, 42/- per dozen; meters, 0-5ma, 2in square, 6/- each, 60/- per dozen; all goods in original packing and brand new; prices inclusive of postage.—Dee, 50, Rolls Park Ave., South Chingford, London, E.4. [1878]

PROFESSIONAL recording equipment to the trade; M.S.S. recording machines, recording amplifiers, ribbon and M.C. microphones, blank discs, etc., etc.; gramophone motors and light-weight pick-ups, radio pre-stage units and quality speakers, all from stock on full trade terms; Victor 16mm talkie projectors for immediate delivery.—Sound Discs (Supplies) Ltd, 37, Hoghton St., Southport, Lanes. [1199]

RECORDING equipment.—Bourne C.D.P. recorder, £32; with run-off, etc., £40; the new C.D.R. 48a complete recorder and playback unit with pick-up, m.c. mike, and stand, speaker, price £210/4/-; send for full description of this the latest in recording equip.; good stock of grade 1 discs in stock, 5in 1 6, 6in 2/-, 8in 3/-, 10in 4 6, 12in 6/7, etc., sapphire cutters, 1 gn steel, 12 for 8/-; mikes all types supplied.—Morecambe Sound Service, 1-6 Green St., Morecambe, Tel. 1161. [11819]

THE TELERADIO. MODEL A70 replacement chassis fitted with new dial.



14 gns. plus P.T. £3.3.3.

or as kit of parts for home construction from **£8.10.**

Set of constructional blueprints 4-.

Also available as feeder unit feeding push-pull amplifier.

Special Offer. few only DENCO four wave-band 5-valve superhet chassis at £14 each, including tax. Cabinet to suit, £1.19.6.

TELEVISION. Send for 70-page booklet on television construction 2/6d post free.

Components and chassis available. Focus coil assemblies 30/-. Combined EHT and LHT transformers £5.15s.

Illustrated leaflets gladly sent upon receipt of postage from

THE TELERADIO CO., 157, Fore St., Edmonton, N.18

MOVING COIL

AMMETERS & VOLTMETERS

EXGOVT., NEW, UNUSED & BOXED Offered at a fraction of original cost



FINEST QUALITY PRECISION INSTRUMENTS

by famous makers such as Ferranti, Pullin, Metropolitan Vickers, Sangano Weston, G.E.C.

AMMETERS

2in. Flush, 50-0-50 amp-

VOLTMETERS

2in. Flush, 0-40 volt 2in. Flush, 0-20 volt

All at **3/11** each. Carriage paid.

Cash with order only.

Secure yours now—limited quantity

H. H. LINTON & CO., LTD.

34 Osnaburgh St., London, N.W.1

Telephone: LUSton 8406

Specialists in

HIGH POWER - HIGH QUALITY

PUBLIC ADDRESS SYSTEMS

★

AMPLIFIERS

from 150 W to 1kW

W. Bryan Savage Ltd

WESTMORELAND ROAD, LONDON, N.W.9

Telephone: Colindale 7131

OPPORTUNITIES IN RADIO



Get this FREE Book!

"ENGINEERING OPPORTUNITIES"

reveals how you can become technically-qualified at home for a highly-paid key-appointment in the vast Radio and Television Industry. In 108 pages of intensely interesting matter, it includes full details of our up-to-the-minute home study courses in all branches of TELEVISION and RADIO, A.M. Brit. I.R.E., A.M.I.E.E., City & Guilds, Special Television, Servicing, Sound Film Projection, Short Wave, High Frequency, and General Wireless Courses.

We Definitely Guarantee "NO PASS—NO FEE"

If you're earning less than £10 a week, this enlightening book is for you. Write for your copy today. It will be sent FREE and without obligation.

BRITISH INSTITUTE OF ENGINEERING TECHNOLOGY
388B, Shakespeare House,
17/19, Stratford Place, London, W.1.

SOUTHERN RADIO'S WIRELESS BARGAINS

BENDIX COMMAND RECEIVERS. BC453 (190-550 Kcs.), BC454 (3-6 megs.), and BC455 (60-21 megs.). Six valves, 25K7 (3), 12AK7 (1), 12K6 (1), and 12A6 (1). Brand new in sealed cartons, 85/- each, plus 1/6 postage. Ideal for conversion to Q-Flyers, car radios and A.C./D.C. receivers.

FEW ONLY, BC455 (modified), 28-41 megs. Ideal for television sound, 50/- each, postage 1/6 extra.

DELCO HAND GENERATORS, 4 v. 4 amp. Brand new, with spare brushes, 17/6 each.

CONTACTOR TIME SWITCHES, by Smiths or Venner's. Beautiful 10 hour clockwork movement, adaptable for master clocks or time switches. Brand new in soundproof cases, 15/- plus 1/4 post.

BENDIX RADIO COMPASS, TYPE MN26V. Range 150-925 Kcs., 325-695 Kcs., 3-4.7 megs., 12 valves. 6N7 (2), 6K7 (5), 6B8 (1), 6E6 (1), 6L5 (2), 6L6 (1). 28 volt generator. Brand new, £5, plus 10/- carriage and packing.

R.A.F. BOMBIGHT COMPUTERS, with Sperry gyro, 3-24 volt motors, tearing, pneumatic bellows, counters, etc. Ideal for experimenters and model-makers. Brand new, 55/-, carriage 3/-.

MOVING COIL HEADSETS, with microphone and plug. Brand new and boxed, 12/6.

V.O.R.97 TUBES. Non-peristent, 6j1n, tubes, ideal for television. 47/6 each. Special packing and carriage 5/- extra.

PERMANENT CRYSTAL DETECTORS, 2.6, post 4d.

LUBERA ADJUSTABLE HOLE CUTTERS, for use on wood, metal or plastic. 5/-, post 6d.

WESTECTORS, W.X.8 and W.112, 6/- per dozen, post 4d.

LUCAS INSPECTION LAMPS, with lead and plug, 3/6.

R.A.F. MORSE KEYS, 1/6 each, post 4d.: 15/- per dozen, pos 1/-.

RECORDING DISCS, 5in. dia., 1/- each, post 3d.

TANNAY MICROPHONE INSERTS, 2/6, post 3d.

M.C.R.1 BATTERIES, 90 volts H.T. and 7j volts L.T., 6/6, post 9d.

INDICATOR UNITS, BC1151A. Two 4j1n. Semi-persistent tubes, Type 5FP7, two 6H6 valves, eight double volume controls. Brand new in black crackle finished case, 55/- each, 7/6 carriage extra.

Southern Radio Supply Ltd.
46, LISLE STREET, LONDON, W.C.2.
GERrard 6653

50 only, 3-waveband coil pack, pair iron cored I.F. coils, 0005 tw. gain, full circuit. 21/-; miniature 465k/c I.F.S., fixed iron core, require 100 P.F. trimmers, 1 1/4 in x 1 1/4 in, 4/- pair; iron cored 465k/c I.F.S., 1 1/4 in dia., 3 1/2 in long, high gain, 5/6 pair; Philco standard 465k/c I.F.S., solid core, 6/- pair; twin gang, 0005mf, 10 feet or trimmers, 3/6; money refunded if dissatisfied.—Cohen, 67, Raleigh Ave., Hayes, Middx. [16798]

KITS of radio receivers from £7.8; 4- and 5-wave new materials, table models, semi-midget; our latest kit—Wyn Star 1943 has connections for gramophone pick-up, extensions to loudspeakers, A.V.C., 6 hours average time for constructing; full details, diagrams with each kit; c.w.o. or c.o.d.—Isherwoods, Reme House, 81, Plungington Rd., Preston. Tel. 3348. Estd. 1936.

SELECTED lines in Govt. surplus equipment; Admiralty long range signal lamps, trigger control, fitted with lens and 6 colour selector disc, 7/6; m/coil microphone, hand type, with accessories, off switch, 5/-; m/coil vol meter, 4/6; m/coil amp meter, 4/6; 600hm headphones, 3/3; all items brand new, boxed, and guaranteed, s.a.e. list.—Radio Unlimited, 16, Carnarvon Rd., Leyton, London, E.10. [1724]

EX-M.O.S. camera control units, in wooden case with 24volt motor, 2 24volt M.B.C. bulbs and holders, gear wheels, etc., make time switch, etc., 10/6; switchboxes, 7x4x2, with 16 on-off toggle switches, M.E.S. holder, terminals, etc., 4/9; Hoover 230volt a.c.-d.c. motors, with blow fan, 45/-; condensers, 4mfid 60v 2d.; 2mfid 250v 2d.; 6mfid 100v 12d.; 25mfid 50v 9d.; Octal valve grip clips, 1/6 dozen; miniature 2-pin plugs and sockets, 3/- dozen.—Passingham, North St., Keighley. [2111]

TELERADIO for television; elec. eng. booklet on construction of first class receiver, 2 8 post free; all components in stock, chassis assemblies, £3/15; focus coils, scanning coils, E.H.T. transformers, line transformers and all access. available at keen prices; send stamp for full lists of television and replacement radio units; all material by advert. Albert Manfg. Co. in this issue available from our stock; we are the largest retail distributors.—White, phone or call The Teleradio Co., 157, Fore St., Edmonton, N.18. Tot. 5386. [2121]

TELEVISION—Focus coils and shrouds, 1/6; frame and line deflector coils, line output transformers, blocking oscillator transformers; complete focus and deflector assemblies also available, supplied correct to designer's specification for 'Wireless World' television receiver. Television components of all types, valves, condensers, resistors, tone masks, mains transformers and chokes, etc., etc., in stock at current prices.—For particulars write or 'phone. "Handy Parts," 226, 223 Merton Rd., Wimbledon, S.W.19. Liberty [1929]

NEW ex-Govt. bargains! Send 1d s.a.e. for our list before buying! A few examples: Headphones, double, Bal. Armature units, Reed driven alumn. diaphragms, adjustable double headbands with 8ft cords and jack-plug, d.c. resistance 60 ohms, by Ideal for Xtal sets, note these are brand new, boxed, super-sensitive instruments worth 2 guineas! Our price, 5 6 pr. 2 pairs 10/-; trade: 10 prs. @ 3/6, 100 prs. @ 3/-, 1,000 prs. @ 2/6; rectifiers, metal Westinghouse 12 volt 1 amp. brand new, for 10/-, or 10 for £2; vibrators, Mallory 6 volt, non-synchronous £29C 5 6 ea, 48 - doz. £21 gross.—A.C. Ltd. 15, Lawrence St., Northampton. [1912]

TELEVISION Hams! Once again we can assist you! Focus coils, 32/6; scanning coils, 30/-; line transformers, 17/6; E.E. chassis, complete chassis for "E.E." televisor, 65/- only, finished in mid-grey; Polystyrene coil formers with adjust-iron cores, 8/- each, under to specification 1/3 each; 9 and 12in cr/v tubes @ £1 per inch, plus tax; 9 and 12in rubber masks, 15 and 21/6; combined E.H.T., L.T., H.T. transformers, complete with rectifier valveholder mounted and wired, £6/10, plus 3/6 carriage and packing; all resistors, condensers and valves in stock for the televisors; "W.W." and "E.E." Televisor Manuals, 2/9 each, inc. post; send for lists.—E. A. Porritt, 13-27, Wastdale Rd., Forest Hill S.E.23.

TELEVISION components for E.E. circuits 1/- scanning coil unit, 30/-; line transformers, 30/-; focus coil, 32/6; vision E.E. chassis, with valveholders and control, 22/6; ditto sound chassis, 18/6; time base chassis, 22/6; ditto sound coils fully wound, 15/-; rubber masks for 9in tube, 11/-; E.E. Television Construction Manual, 2/6; Ultra midget 2-gang variable condenser for personal portables, 10/-; glass s.m.l. dial, 6x8in 4/6; pan, 4/6; escutcheon 5/6; 8in P.M., 6x8 trans., 17/6; 6 1/2in P.M., with trans., 22/6; P.P. output heavy duty trans. for 6L6 valves, tapped output 15 and 7.5 and ditto for 6V6 valves at 21/- each; American throat microphones, boxed, 30/- each; condensers, 8mfid 450v 2/6, 8mfid 350v 2/-; 8+16mfid 450v, 5/6; trimmer kit in smart case, 17 tools "Qualrad," 45/-; heavy duty variable resistance, 300 ohms, lamp, 15/-; rotary trans. in 6-12v. out. 200-480v 50ma, or as motor, d.c. mains, 15/-; Collaro a.c. d.c. gram. motor, P.U. on plate, £12/17/6; 4-pin vibrators, 6v, 5/-; switches, Yaxley, 3-pole 2-way 2/-, 4-pole 3-way 3/-, 4-pole 4-way 3/6, 6-pole 4-way 4/6, 14-pole 3-way 7/6; midget switches 4-pole 3-way 3/-, 4-pole 2-way 3/- full list at 2/6d postage all orders.—O. Greenhill, Ltd. 265 Whitcappel Rd., London, E.1. Bus 5074 [1915]

SWITCHES.
Double-throw. Several hundreds all at 3/6 each.
10 amps 125v. 5 amps 250v.
3 amps 460v. 2 amps 600v.
Normally open. As above.

NEW CABLE.
Approximately 25,000 yards for disposal. Price per yard.
5,000 yards. Unistar VIN No. 1, rubber covered, Single 57 036, in 500yd. drums. 3/-
450 yards. Lead Covered rubber insulated 660v., single 7 06, in 50 yd. coils. 3/-
The following are in 100 yard lengths :
1,000 yards. Cab tyre cotton braided Twin Flex, 136 012 5/-
1,700 yards. Rubber sheathed, 12 core, 024. 1 6
1,500 yards. Quadragenmet metal braided, 4 core, 3-136 012 & 1-9 012. 2 6
2,000 yards. Quintoseath 4, Cab Tyre, 5 core, 9 012. 3 6
500 yards. Tricomflex 4, braided cotton flexible, 3 core, 9 012. 1 6
735 yards. Unilowcapmet No. 1, Coaxial H.F. 7 022. 1 6
1,235 yards. Uniradio 18, Coaxial H.F. 022. 1 6
1,600 yards. Uniradio 6, Coaxial H.F. 1 036. 1 -
3,400 yards. A.P. 13806, Coaxial H.F. 1 036. 1 -
3,000 yards. Duradio 11, Twin Core H.F. 7 032. 2 -
500 yards. Flex Cord, 3 Core. 1/-
500 yards. Flex Cord, 2 Core. 1/-
2,500 yards. Duradio 28, Twin Feeder H.F. 7 028 8d.
2,000 yards. 12 Flex Met. 12 core metal braided 14 0092. 2 6
Sample Piece supplied on Request.
24v. Relays, 4 point, approx. 2,400 at 1/6 each.

The Motherwell Machinery & Scrap Co. Ltd.
INSHAW WORKS, MOTHERWELL, SCOTLAND.

MIDLAND INSTRUMENT Co.

BRAND NEW GOVT. SURPLUS STOCK
ELECTRIC PUMPS, centrifugal type, self-priming, delivery 10 c.p.m., ideal for water supply, garden fountains, bilge pumps, etc., two models, for 12-v. or 24-v. A.C. D.C., 25/-, post 1/4. **EX-U.S.A. CONVERTORS,** letter type on paper tape coding and decoding machines by L. C. Smith & Corona Typewriters Inc. converts plain language into 3-letter code by continuously variable alphabet transcription method, also decodes same back into plain language, complete with paper tape, etc., contained in compact and smart crackle green cases, fraction of original cost, 25/-, post 1/-, two for 45/-, post free. **WALKIE-TALKIE AERIALS,** copper wire, 100 ft. length, 1/2 in. dia., tapers to 3/32 in., also makes good fishing rod, 2/6, post 6d., 3 for 6/9, post 9d. **1155 RECEIVER,** slow motion knobs, 210-1 3/6, post 6d. **RESIST RS & CONDENSERS** 100 assorted 10/-, post 6d. **ENAM. COPPER WIRE,** 33-S.W.G., 15oz. reels, 2 6, post 9d. **FILM FOOTAGE INDICATORS,** makes 800 contact, 0-125 with reset control and switch, dual voltage 12 or 24-v., 2 6, post 9d. **MOTORS,** fitted over-load clutch and 4ft. flexible drive, 24-v. A.C. D.C., 1 h.p., exceptional bargain, 20/-, post 1/4. **MAGNETIC COMPASSES** TYPE P-8, alcohol flusgate, engraved 360 deg., and cardinal points, luminous cross-wires in wood carrying cases, 10/-, post 1/4. **HEADPHONE CORDS,** fitted high or low impedance matching unit, 2 6, post 6d. **MAINS MOTORS,** 200-250-v. A.C./D.C., continuous rating, speed approx. 4,000 r.p.m., twin j1n. induction, 20/-, post 1/-, ditto fitted fan-blower and reduction gear-box, 8ml drives of 5 and 25 r.p.m., 30/-, post 1/4. **TRANSFORMERS,** input 230-v. 30 c.p. output 50-v., 11 amp., or with little alteration 190-v. 51 amp., 25/-, carriage 5/-. **ENGINE DRIVEN GENERATORS** (D.C. dynamo) output 24-v. at 350 watt, post 9d. **MOVING COIL MICROPHONES,** fitted switch, 5/-, post 6d. **WEE MEGOBERS** (Evershed & Vignoles) 250-v., 0 to 20 meg., and inf., mottled red bakelite cases, 90/-, post, packing and registration, 1/6. Send for a copy of our current lists, 2d. with S.A.E. Orders over 30/- post-paid, carriage charges are extra in all cases. Our C.O.D. service is cancelled for the time being.

MOORPOOL CIRCLE, BIRMINGHAM, 17
Tel. HARborne 1308 or 2644

GALPINS

ELECTRICAL STORES

408, HIGH ST., LEWISHAM, LONDON, S.E.13.

Telephone Lee Green 0309. Near Lewisham Hospital.
TERMS: CASH WITH ORDER. NO C.O.D.

EX-NAVAL CATHODE RAY RECTIFIER UNITS. New, consisting of the following components: High Voltage Condensers, Chokes, approx. 150 assorted Resistances, and Condensers, solid brass Chassis, 42 6 each. C.F.

EX-R.A.F. I.F.F. UNITS 10 VALVE SHORT WAVE complete with Valves and Motor Generator, 12 volts input 450 volts 40 m/a output, 35/- each, with 24 volt Motor Generator, 30/-. The latter can also be used as an A.C. Motor direct from 200 250 v. mains.

ROTARY CONVERTERS, EX-ADMIRALTY 110 volts D.C. to 230 volts A.C., 50 cys., 1 phase, rated at 200 watts, but capable of 550 watts continuous rating, weight approx. 100 lbs., £3 10/- each, carriage 10/-. Another Ex-R.A.F. 12 volts D.C. input, 220 volts A.C. 50 cys., 1 ph. at 100 watt output, approx. weight 15 lbs., as new, 85/- each, carriage 3/6.

VARIABLE TRANSFORMERS. Input variable between 200/240 volts, output constant at 220 volts at 7 1/2 amps. 90/- each, carriage 5/-.

MAINS TRANSFORMERS, all 200/250 volts 50 cys. 1 ph., input, output 700/0 700 v., 70 m.a. 4 v., 2 1/2 v., 12v. 1 a., 30/- each. Another 525/525 v. 150 m/a. 6.3 v. 5 a., 5 v. 3 a., 37/- each. Another 350/0/350 v. 250 m/a. 4 v. 8 a., 4 v. 3 a., 6.3 v. 6 a., 6.3 v. 2 a. tapped at 2 v. 65/- each. Another 500/0/500 v. 300 m/a. 6.3 v. 6 a., 4 v. 6 a. 5 v., 6.2 v. each. Another tapped output 6, 12, at 24 volts at 10 1/2 amps., 47/- . Another 350/0 350 v. 180 m/a. 4 v. 4 a., 6.3 v. 4 a., 5 v. 3 a., 39/- . Another 2,350 volts at 500 m/a., 85/- each. Mains Smoothing Chokes, 10 Hy. 100 m/a., 6/- ; 150 m/a., 8/6 ; 350 m/a., 25/- ; 5 Hy., 250 m/a., 17/6.

EX-GOVERNMENT (G.E.C.) ELECTRIC FANS. 12 volts, A.C./D.C. laminated field, complete with 5 in. impeller. New, boxed, 20/- each, post 1/-. Transformer to suit, 230 volts input, 12 1/2 volts at 4 amps. output, 32/6 each.

MAINS VARIABLE RESISTANCES (slider type), new, ex-Govt., 14 ohms, carry 1 to 4 amps., graduated, useful as dimmers, etc., 17/6 each; another 0.4 ohms., carry 25 amps., 17/6 each, post 1/6. Ex-Govt. Moving coil Cell Testers, 3-0-3 volts (new), 20/- each.

EX-R.A.F. MICROPHONE TESTERS (new). These consist of a Ferranti 0 to 450 m/amp. 2 1/2 in. scale meter shunted to 1 m/a., incorporated Westinghouse Rectifier, the whole encased in polished teak case, calibrated at present 0 to 10 volts, each, 27/6.

EX-R.A.F. CRYSTAL CALIBRATORS UNITS. Type 18, R.A.F. serial No. 10a/15237. These units contain 100 kcs. xstal. 2-EF 50 valves and numerous other items all new and unused, 35/- each.

EX-R.A.F. TEST SETS, type (211) consisting of 4 EF 50s., etc., new, 27/6 each, post 2/-. Ex-R.A.F. Crystal Monitors, frequency depending on xstal, used, 6/- each. Very useful for components, post 1/-.

ELECTRIC LIGHT CHECK METERS (Watt Hour), A.C. 50 cys., 200 250 volts, 5 amp. load, 18/6, post 2/-. 10 amp., 21/-, post 2/-. 20 amps., 25/-, post 2/-. also a few only Pre-Payment 1/- slot type, 20 amp. load, less coin box, complete with synchronous Motor, 35/- each, carriage 3/6.

EX-R.A.F. INDICATOR UNITS, type 48a, as new, boxed, consisting of 2, 3 1/2 in. tubes, type 138a, also time base, 50/- each.

MOTOR ALTERNATORS, EX-R.A.F., as new, 230 volts 50 cys. 1 phase input, 250 volts 625 cys. 1 phase at .24 amps. output, 75/- each. Ditto, 1,725 cys. output, 85/- each. C.P.

EX-NAVAL 1/2 in. SPARK COILS, approx. 3,000 volts, from 6 volts supply, 8 6. G.P.O. Galvanometers, reading 30 0/30, vertical type, 8/6 each. Ex-R.A.F. Impulse Transformer (Magnatron), output believed to be approx. 15,000 volts at 3 kw., for 1 m/a., 7/6 each. Variometers for No. 19 Mk. II Receivers, 6/4 each.

EX-NAVAL (CROMPTON PARKINSON) PRONG-TESTERS, 0 to 100, and 0 to 400 amps. new, in leather carrying case, 90/- each. A.C. V.Meters, 0 to 300 6 in. scale, calibrated 50 cys., 37/6 each.

FRACTIONAL H.P. MOTORS, 110 volts with LAMINATED fields (Ex-Naval Fan Motors). These need slight attention to brushes or leads, 10/- each. Westinghouse (Blasting) Galvanometers. Moving Coil, very low deflection, 15/- each.

MAGSLIPS from 20/-, large selection, send for interesting leaflet; B.T.H. type SW1406 Selsyns, 33/9 each; Hazlet R.F. E.H.T. supplies, 5-8 kv. 105/-; coils, only 26/8; 10-watt Berco linear wirewound potentiometers, 1k 4/9, 50k 5/-; 2-gang carbon Imeg-Imeg, 3/6; technical correspondence invited; all goods post free and guaranteed.—Hopton Radio, 1, Hopton Parade, Burgess Hill Rd., London, S.W.16.

B combined, 55/- each; Igranit T.P. & N. 5hp contactors O.L. & N.V.R., £5/10 each; ditto, N.V.R. only, 25/- each, 200 amp 0.25 ohm resistances, sliding, £4 each; Crompton Parkinson 6in. ammeters, 0-600, with C.T., 50/- each; 3,000 Burgess micro wattmeters, 1/6 each; 5-way drop indicators, telephone, G.E.C. cat. no. C.3015 C.2E, 30/- each; 2,000 rolls 1/2 in white adhesive tape, 15/- doz; rotary converters, 12v-230v, 100w, 65/-; G.E.C. watertight switches, 10 amp, heavy brass, 6/6 each.—Maswood, Ltd., 55a, Fairfield St., London, S.W.18.

NEW STC Selenium rectifiers, makers' current products, not surplus, circuit and tech. details with every rectifier, from stock: H4/200 EH1 for W.W. television, 28/- ea., p.f.; H.W. 16v 3a 6.8, 1a 8, - 2a 9/6, all p., 6d.; 3a 17/-, 4a 18/-, 5a 21/6, 6a 22/6, 10a 24/6, all p., 10d.; 30v 2a, 14/-, 5a 35/-, 8a 38/6, 45v 5a 48/-, 100v 2a 54/6, 150v 1a, 100v 1/2a, 17v 1/2a, 12v 1/2a 25/-, 2.5a 20/6, 3a 21/6, 4a 25/-, 5a 27/-, all p.f.; 33v 3/4a 18/6, 1a 21/3, 1.5a 28/-, 2a 29/6, 3a 35/-, 4a 42/-, 5a 43/6, 100v 1.5a 72/-, all p., 10d.; H.D. type, 7in sq hns: 16v 10a 43 8, 20a 80/-, 17v 6a 34/1, 33v 6a 64/-, 10a 71/-, 54v 6a 90/-, 60v 10a 130/-, all p., 1/4; industrial 150 type, 17v 12v, 10v 12v, 10v 12v, 30a 188/-, 33v 6a 192/-, 10a 80/-, 12a 124/-, 70v 6a 114/-, 90v 10a 129/-, 100v 6a 160/-, all p. and p., 1/6; valve chargers, conversions to metal rect., from stock, Philips 328 and 367, Tungar 68504, 68550, U600, etc., fitted in 5 mins., charging kits, trans. inc., 50v 10a 6d., 50v 6a 6d., £11 10 (incl. tap switch), 33v 6a £7/19/6, 16v 10a £6 12/6, 17v 6a £4 12/6, 16v 5a £3/10, steel case 7/6 extra, 16v 4a £3, case 7/6, 16v 2a 38/6, case 7/6; transformers: 200-250in., 16v 10a 65/-, p. 1/4, 17v 6a 47/6, p. 1/4, 16v 5a 41/6, p. 1/4, 16v 4a, 35/6, p. 1/4, 16v 2a 25/6, p. 10d.; slider res., all values from 24 6, p. 1/-; chargers, all metal rect., 1/P 200-250a.c. for 12 cells at 4a, with 2m.c. meters, fuses, etc., in steel case, £9, plus carr.; 6-12v 5-6a rheo. and meter in steel case, £6/16/6, carr. 3/6; 6-24v 12a m.c. meter, fuses, steel case, £10, plus carr.; H.D. charger, 24v 25a in steel case with control panel, m.c. meters, rheos. and fuses, £12, plus carr. Terms: c.o.d. post goods only, others c.w.o. or pro-forma invoice, wholesale and retail.—Pearce, 66, Gt. Percy St., London, W.C.1, nr. King's X, Angel; est. 16 yrs. [2083]

SUPREME RADIO, 746b, Romford Rd., Manor Park, London, E.12. Tel. 111 1260. Est. 15 years.—Television components by Porthminster as follows: E.H.T., 4kv or 5kv, 2v fil., tested at 22kv, 55/- ea.; scanning coils, 32/6 ea.; line transformer, 27/6; focus coils, 30/- ea.; h.t. transformer, 350-0-350v, 6.3v 6amp, 4v 8amp, 4v 3amp, 0-2v 6.3v 2amp, 250m.a. with screen, 70/- ea.; 5hy choke, 200m.a., 18/6 ea.; 10hy 80m.a. choke, 8/6 ea.; valve holders for E.H.T. valves, ceramic type, 6d. ea.; retaining rings for E.H.T. valves, 8d. ea.; valve holders for E.A50 valves, bakelite, 1/- ea.; 100v 10a caps, 3d. ea.; co-ax. plug and socket complete, 1/-; Pye type co-ox. plug and socket, 1/- complete. These components are suitable for the E.E. television receiver; also all values of resistances, variable controls and condensers for the E.E. television receiver in stock at the keenest prices. Tubular condensers, 250v 100pF, 1/- ea.; 100v 100pF, 11/- doz.; 0.01mfd 1,000v, 0.02mfd 750v, 0.05mfd 500v, 5/6 doz.; 0.1mfd 350v, 5/6 doz.; 0.1mfd 500v, 6/6 doz.; 0.001mfd and 0.0005mfd midget mica, 5/6 doz.; Metallite cond., 0.002mfd 500v 6/- doz., and 0.01mfd 350v 7/6 doz.; screw base tub. can type cond., 0.5mfd 350v, 6/- doz.; 8mfd 350v tub. cardboard, 26/- doz.; 8mfd 350v tub. metal type cond., 22/- doz.; 16-8mfd 350v can type, 46/- doz.; 16+8mfd 450v midget tubular cond., 56/- doz.; 4mfd 550v screw base can type tub. cond., 15/- doz.; double trimmer type cond., 140pF, 12/6 doz.; and double trimmer type cond., 50pF, 11/- doz.; fixed mica cond., 500pF, 325pF, 590pF, 4,550pF, and 305pF, all at 2/6 doz., or assorted doz. as desired. 1-way resistances, 22k, 27k, 47k, 82k, 120k, 180k, 390k, 820k, 2.2k, 11k, 39k, 470k, 10meg, 1/9 doz., 18 6 gross only or assorted; 1-watt resistances, 100, 150, 200, 400, 500, 1k, 2k, 2.2k, 10k, 10k, 16k, 18k, 150k, 20k, 1k, 500k, 1.5m, 10k, 5m, these in doz. or assorted, 2/- doz., 21/- gross only; also many other values at 1/- doz., 50/- gross only; 1-watt resistances, 47k, 470k, 1k, 3.3k, 8.2k, 18k, 20k, 33k, 56k, 75k, 75k, 68k, 1m, 1m, 4/- doz., 45/- gross only; 2-watt resistances, 2k, 18k, 1m, 5/6 doz., 60/- gross only; 1 1/2 in brown knobs, 4/6 doz.; clip-on pointer hands, 6d. ea.; complete octal screen grid bases, 1/- ea., 11/- doz.; bakelite gram needle cups, 6d. pair, 5/6 doz. pairs; ex-Govt. group boards, 5-way, with 6 resistances, 1-watt 1WX6 Westector, 1 180pF cond., 1/9 ea.; metal panel with 5-pin U.X. ceramic valve holder, 2 1-watt resistances, 5 ass. mica cond., s.w. choke and 2 2-way panels, 1/6 ea. Trade enquiries invited. Terms c.w.o. no c.o.d. Send 6d. extra for postage orders under £5. 21-d. s.a.e. all enquiries and list. [2132]



Still satisfying customers at Home and Abroad. Our **CIRCUIT No. 20** 10 valves, 6 wave-bands, 12 watts (undistorted) Output Superheterodyne Receiver

Brief specification. R.F. stage of Amplification using 6 K7, H.F. Pen., the gain of which is controlled, followed by F.C. Triode Hexode 6K8 followed by I.F. Amp. stage 6K7 feeding into a double diode triode 6Q7 for L.F. Amp. and 2nd detector and noise limiter, followed by Phase inverter feeding 2-6V6 or 2-6L6 in push pull. Rectifier valve 5U4G. Visual tuning indicator (Magic eye EM34). The coil unit consists of 18 high "Q" iron cored coils, 6 each in R.F., H.F. and Osc. stages, all midgey type, designed especially for us. 20 Ceramic trimmers and 3 bank switch, with shorting plates.

A.V.C. is used on all wave-bands with a switch for cutting out when not required. The coil unit is completely screened by 18 s.w.g. aluminium. The output transformer is of multi-ratio type mounted under the chassis. Controls R.F. gain, 6 wave-band coil switch, A.V.C. on/off radio-gram switch, noise limiter, tone-control, Audio gain and mains on/off. Provision for B.F.O. on/off if required. 3 gang tuning condenser Ceramic insulation, rubber mounted. All H.F. valves screened by aluminium cans. Double ratio slow motion drive and 6 wave band dial glass covered Chassis 16 s.w.g. Aluminium, ready drilled 1 1/2 x 7 1/2 x 4.

3 Fuses fitted 2 in mains supply and 1 in rectifier circuit. Provision for dipole Aerial and extension speaker P.U. sockets. This set is noted for its fine quality of reproduction on radio and gram. We have received much appreciation and congratulations from customers on its performance. A demonstration model is available at our premises at 307 High Holborn. **FULL SIZE BLUE PRINTS** (2 practical and 1 theoretical) and priced list of components, 7/6 per set.

A less expensive set which is still pleasing the most critical. Our **6-VALVE SUPERHET CIRCUIT**

3 Wave-bands. A.C. only. This circuit has been designed to receive all worthwhile stations on the medium wave-band (200-540 metres) with a high fidelity output. Short Waves (16-47 metres) are as good as obtained on some purely short-wave receivers. Australia and America have been received regularly by many of our customers at loudspeaker strength. Long Wave: The few stations now operating are well received.

Blue Prints. 2 practical and 1 theoretical with detailed priced list of components, 7/6 per set.

10 MC/S I.F. TRANSFORMERS, small, permeability tuned from the side, aluminium cans. Beautifully made. Especially designed for F.M., Television and all wide band I.F. Amplifiers. High Q. 15/- per pair. Also available in 465 kc/s and 100 kc/s, 15/- per pair.

MIDGET COIL UNIT (size 2 1/2 x 1 1/2). Aerial and Oscillator, complete with trimmers and padders. Litz wound, iron cored. Medium and Long waves or Medium and Short (16-50). Splendid workmanship. Circuit supplied, 15/- per pair.

VARIABLE SELECTIVITY I.F. TRANSFORMERS, 465 kc/s, 18/6 per pair. **BOX TYPE COIL UNIT.** 6 wave bands, 5-2,000 metres, completely screened, size 5 1/2 x 5 x 3 1/2. Aerial, H.F. and Oscillator. Price £7. As used on our world-wide No. 20 circuit. Will fit into almost any chassis.

307, HIGH HOLBORN, LONDON W.C.1. Phone: HOLborn 4631

THESE ARE IN STOCK

- Newnes Television Manual. By F. J. Carmo. 7s. 6d. Postage 4d.
- Ultra and Extreme Short Wave Receptioq. By M. J. O. Strutt. 42s. Postage 4d.
- Radio Receivers and Transmitters. By S. W. Amos and F. W. Kellaway. 25s. Postage 3d.
- The Amplification and Distribution of Sound. By A. E. Greenlees. 16s. Postage 3d.
- Brimar Radio Valve Manual, 1947-8. 2s. 6d. Postage 3d.
- The Short Wave Listeners' Annual, 1948. 3s. 6d. Postage 3d.
- Wireless Servicing Manual. By W. T. Cocking. 10s. 6d. Postage 4d.
- Foundations of Wireless. By M. G. Serociez. 7s. 6d. Postage 4d.
- Telephony, Volume I. By J. Atkinson. 35s. Postage 11d.
- Vacuum Tubes. By Karl R. Spangenberg. 45s. Postage 11d.
- Television Receiver Construction (10 articles from "W.W.") 2s. 6d. Postage 3d.
- Ultra-High Frequency Techniques. By Brainerd, etc. 28s. Postage 3d.
- The Principles and Practice of Wave Guides. By L. G. H. Huxley. 21s. Postage 6d.
- Radio Engineering, Volume 1. By E. K. Sautentan. 45s. Postage 3d.
- Thermionic Valve Circuits. By E. Williams. 12s. 6d. Postage 4d.
- Micro-Waves and Wave Guides. By H. M. Barlow. 15s. Postage 4d.
- Radio Engineer's Pocket Book. By F. J. Catlin. 3s. 6d. Postage 3d.
- High Vacuum Technique. By J. Yarwood. 12s. 6d. Postage 4d.

We have the finest selection of British and American radio books. Complete list on application.

THE MODERN BOOK CO.

(Dept. W.10)

19-23, PRAED STREET, LONDON, W.2

A.C.S. RADIO

SPECIALISTS IN AMATEUR AND EXPERIMENTAL SHORT-WAVE EQUIPMENT, Communications Receivers, Television, High Quality Amplifiers, Speakers, Aerials, Receiving and Transmitting Valves and Meters, etc.

Lid "W" free on request to:-

A.C.S. RADIO, 44, Widmore Rd., BROMLEY, Kent. Phone: RAV 0156

Mr. A. C. BARKER'S MODEL 148 SPEAKER

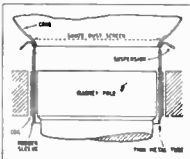

is unique in two respects. Illustrated in this sketch is the patented coil former, latex sleeve and coil which

provide the perfectly graded dual drive and highly efficient damping. This construction is exclusive to Mr. Barker's speakers. The second basic feature is its logarithmically corrugated cone, treated with thermo-setting resin. Model 148 is now to be heard at a number of progressive retailers who appreciate NATURAL sound reproduction and have chosen it as their standard of BETTER LISTENING. Write for details to: BCM/AADU, LONDON, W.C.1

C. A. RYALL, 65, Nightingale Lane, London S.W.12; mail order only; postage or carriage extra; c.o.d. £1 or over; full list, large s.a.e. please; U.S.A. tubular metal cased wire ended 0.1mf. 500v 7/6 doz., 350v 5/6 doz; U.S.A. tubular metal cased wire ended 0.5mf. 350 7/6 doz.; Mansbridge 1mf 500v wkg. 3-2/-; Mansbridge 4mf. 400v wkg. 2/3 each; silver mica 10p.f., 40p.f., 200p.f., 500p.f., 400p.f., 500p.f. 3/6 doz.; mica 0.1mf. 3-1/3; all condensers guaranteed. Ampheno type British 5-pin chassis valve holders 3/6 doz.; international octal chassis valve holders, paxolin. 4 - doz.; bar type 3-gangs 5/-; bar type 4-gangs 5/-; resistors 1/2-watt and 1-watt assorted 100 ohms to 2 meg. leve. assortment 40-5/-; switches, SB. 2P 6w miniature 1/6, SB. 2P 6w. five poles total 2/3 each, SB. 9w 2/-, 2B SP 6w 1/6, SB. SP. 3w 1/-, 2B. 3P. 3w 2/-, SB. 2P. 4w 1/3; twelve-way group boards with 9-1w and 1/2w resistances, etc. 2 - all new; twenty other types in stock; uctal plugs, cap and chassis sockets, 3-3/-, with tags 3-3/6; high resistances, phones with sponge earcaps, with good class microphone, all wired into plug type 10H/10991, 10 9 pair; metal boxes, black finish with quarter inch paxlin panel, fixing lugs and corner sockets, size 8 1/2 x 7 1/2 x 3 1/2; deep, 6/9 each new, 10,000 ohm bakelite cased volume controls medium spindle 1/6; metal cased minimum depth 1 meg vols., short spindle 1/6 each; special list for trade. [1613

SELENIUM rectifiers, charger kits, etc.; new goods, not war surplus; add 7d postage up to 15/-, 13 above; data sheet supplied; Selenium metal rectifiers, 12v 1 amp 10/-, 12v 2 amp 12/6, 12v 3 amp 22/-, 12v 4 amp 25/-, 12v 5 amp 28/6, 12v 6 amp giant lined type 35/-, 6v 10 amp 26/-, 24v 2.5 amp 39/-, 24v 5 amp 45/-; H.I. types, 250v 60ma small space type for a.c./d.c. sets, 7/-; 110v 60ma 7/-, 110v 20ma eliminator type 7/-, 250v 100ma bridge 13/6, 350-0-350v, 60ma i.v. a.c. sets 13/6, 450v 40ma 7/6; eliminator kit, 25-watt trans, rectifiers, 2x6 mfd condensers, for 120v 20ma eliminator with trickle, 39 6, case 10 6; charger kits for 2v to 12v chargers, interleaved and impregnated transformer, selenium rectifier, ballast resistance, rheostat or ammeter needed; 45-watt trans and 12v 2 amp rect. 36/6; 600 watt trans. and 3 amp rect. 45/-; 75 watt trans. and 4 amp rect. 62/-; also for 2v, 6v only, with 2 amp rect. 32/6; with 3 amp rect 42/6, with 4 amp 55/-; above kits with steel case, in back crackle finish, drilled and louvered, incl. all small hardware with 12v 2 amp rect. 52/-; 12v 1 amp or 6v 2a 45/-, 12v 3 amp 65/-, 12v 4 amp 82/-; heavy duty kits, 140-watt trans and 12v 6 amp rect for 6v, 12v, 75/-, or with slider res and ammeter, 105/-; transformer, rectifier, ballast bulb for 1 to 20 cell, one amp charger, 80/-, misc. 6-amp ammeters, superior quality, 14/6; 10 ohm sliders 13/6; crystal diodes, capsuled, guaranteed, 3/9; Aerovox 2 mfd 1.000v oil-filled, 3/6; T.C.C. 24 mfd 450v electrolytics 6/6; Rola 8in P.M. speakers, less trans. 17/6; battery chargers for 12v 1.5 amp and 6v 2 amp, 65/-; guaranteed 18 months.—Champion, 43, Uplands Way, London, N.21. Phone Lab. 4457. [2115

RADIO CLEARANCE, Ltd., 27, Tottenham Court Rd., London, W.1. Mus. 9188. Manufactured by Wilcox-Gay Corporation, U.S.A.: Master oscillators; these V.F.O.s use an 807 electron coupled osc. with grid tuning 1-5 Mc/s. plate tuning 2-10 Mc/s, both by vernier dials, 9-10 mA grid current meter, grid choke and leak, for intermediate stage included, brand new in original cartons, complete with spare 807, instruction book, shielded plug, and accessories, £5/10, carriage 5/-; Xtal multipliers, Xtal osc. which can be tuned 2-6.67 Mc/s; as in the V.F.O. tuning is by vernier, and 0-10 mA grid current meter inc. complete with spare 807, instruction book and accessories, brand new in original cartons, 45/-, carr. 5/-; size in both cases approx 13in x 10in x 7in. Personal receivers, B.C.728c, 7-valve rec. with 1.4v valves, RF VT 175, mixer VT171, osc VT175, I.F. VT 173, det and audio VT172, output VT174, bias rect VT174, covers 2-6 Mc/s, with 4 push-buttons, adjustable 2-2.6, 2.6-3.5, 3.5-4.5, 4.5-6 Mc/s respectively, operates from 2v acc. by 2v vibrator, with 12v vib for charging 2v acc. carried slung on shoulder, supplied brand new with telescopic aerial, 2v acc. 2 vib's, and instruction book; this set has built-in loudspeaker and buttons A and B, are easily adjustable by means of an additional condenser, to operate on M.W., £9/9; U.S. Navy aircraft receiver, RU17, 6 valves, 3-78s, 2-77s, 1-1642; these are straight recs with 3 R.F. stages, using plug-in coil packs, operates from 28v d.c., supplied with 6 coil packs covering 187-305, 281-455, 524-844, 1285-2155, 2960-4620, 3865-6265, 5075-7780 8750-13950 Kc/s respectively, £4/10. Transmitter tuning units, C.A.V. 47154 and 5 type C covers, 1.5-3 Mc/s, 17/6; type F covers, 6-2.9 Mc/s; both these units have vernier M.O. tuning, P.A. tuning, etc., in blk. crackle cases 12in x 10in x 9in, carr. 2/6; B.C. 453s, 6-valve receivers, 6-12v valves, R.F., mixer, 2 I.F.s, det and B.F.O., output 85 Kc/s, I.F.S. the Q Filter, 23/6; mains trans E.H.T., 400v 1mA, 2v 20A, primary 230v, 50 c/s, 45 500-0-500v 120mA 4v 4a c.t., 4v 4a c.t., 4v 3.5a c.t., 10v 1a, primary 200-250 50 c/s 22 6, post 1/-; 400-0-400v 160mA, 5v 3a, 6.3v 3a, primary 200-250 50 c/s, fully shrouded, 30/-, post 1/-.

POTENTIOMETERS

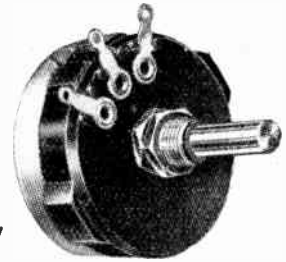

by

RELIANCE

Type T.W. Wire Wound	
Rating	RANGES
5 Watt Max. (linear)	5-100,000 Ω Max. (linear)
3 Watt Max. (graded)	50-50,000 Ω Max. (graded)
	100-10,000 Ω Non-inductive
Type S.G. Composition	
1 Watt Max.	2,000 ohms to 5 megohms

CHARACTERISTICS: (both types) linear log., semi-log., inverse log., non-inductive, etc.

FULL DATA FROM

RELIANCE

Manufacturing Co. (Southwark) Ltd. Sutherland Rd., Higham Hill, London, E.17 Telephone: Larkswood 3245

BRASS, COPPER, DURAL, ALUMINIUM, BRONZE

ROD, BAR, SHEET TUBE, STRIP WIRE.

3,000 STANDARD STOCK SIZES

No Quantity too Small List on application

London: H.ROLLET & Co., Ltd. Liverpool: 6, Chesham Place, S.W.1. Kirkby Estate, SLOane 3463 SIMONSWOOD 3271/3



S.G.C. QUARTZ CRYSTAL UNITS FOR AMATEURS

Type 2 units for 3.5 and 7.0 Mc/s bands. Type JCF.200, 100 Kc/s unit for use as a frequency substandard. Write for List QCA.4805A. A limited number of reprints of the paper entitled "Quartz Crystals" by Edward A. Fielding, B.Sc. Tech. (Hons.), A.M.I.C.T., A.M.I.E.E. read to the Radio Society of Great Britain on November 14th, 1947, are available free on request.

SALFORD ELECTRICAL INSTRUMENTS LTD. Proprietors: THE GENERAL ELECTRIC CO. LTD. England

You're SURE to get it at
STERNS
ESTABLISHED 25 YEARS

Resistances—Special Offer. Parcel containing 100 popular assorted values 1-watt type 8 6 per 100, 1-watt type 11/6 per 100 (Trade enquiries invited).

M. Coil Speakers. Well-known mfr's surplus: 10in. P.M. with Tr. 27/6; 8in. P.M., 2/3 ohms, 17/6; 6 1/2in. P.M., 2/3 ohms, 15/6; 5in. P.M., 2/3 ohms, 10/11. 3in. P.M., 2/3 ohms, 13/9.

Collaro A.C. Gram Motors. 100-130 v., 200-250 v., with 12in. T/Tabl. 25/18/4.

Recified M.Coil A.C. Meter. 0-300 v., 2 1/2in. 11/9. Tuning Cond. (Twin gang), 0-300 mfd, 7/6 (with Trim., 2/6). 0003 mfd with Trim., 8/6 (with Trim. 0001 mfd, 5/-). Midget .0005 mfd. with Trim., 14/6. Midget .00035 mfd. 1 1/2in. x 1 1/2in. x 2in., 12/9. 4 gang .0005 mfd., 5/9.

Coils, T.R.F. Matched pair, M. & L., 8/9. Weymouth ditto, 9/6 pair. 8"Het. matched, M. & L., 8/9, 10/6 and 11/6 pair. All Wearite "P" Coils, 3/- each. Denco Iron core Maxi "Q" Coils, complete range available from 3/9 each.

Vibrator Transf. 6V in, 250-250 v., 100 m.a out (also available in 12 v.), 8/6.

Potentiometers. Centralab, 5K, 10K, 25K, 50K, 100K, 1, 1, 1 and 2 Mez. less Switch, 4/3. With Switch, 6/-. Midget with Switch 4 and 1 Meg., 6/-. Special 75 Meg. with Switch, 4/9.

Electrolytics. B.E.C. Midget, 8-8 mfd. 400 v. 1 1/2in. x 1 1/2in., 5/6, and 32 mfd. 350 v., 1 1/2in. x 1 1/2in. T.C.C. 16 mfd. 150 v., 2 1/2in. x 1 1/2in., 3/3. Dulliber 8 mfd. 500 v., 2 1/2in. x 1 1/2in., 4/-. And all makes and types. T.M.C. 8-16 mfd. 450 v. with clip, 7/6.

Motor Rectifiers. Westinghouse. 0-5 m.a., 3/11; 0-10 m.a., 7/6; 0-1 m.a., 10/6.

Selenium Rectifiers. H.T., h.wave; 250 v. 50 m.a., 5/9; 200 v. 100 m.a., 5/9; 250 v. 100 m.a., 7/6; 250 v. 300 m.a., 12/9; Bridge Rect., 6 v. 1 1/2 amp., 6/3; 12 v. 1 1/2 amp., 12/6; 12 v. 3 amp., 24/-; 12 v. 6 a., 37/6; 36 v. 1 1/2 a., 23/6; 70 v. 1 1/2 a., 37/6. Also L.T. 2 1/2 v. 1 a., h.wave, 3/6.

Television Transf. E.H.T. 4,000 v. 3 m.a., 2 v. 1 1/2 amp., 45/-; 5,000-5,000 v., 250 m.a., 4 v. 5 a., 6.3 v. 8 a., 75/-; 350-0-350 v. 250 m.a., 6.3 v. 6 a., 4 v. 8 a., 4 v. 3 a., 6.3 v. (tapped 2 v.), 2 a., 72/6.

Charger Transf. Input 220-250 v., outputs 4 v., 8 v., 15 v., and 24 v., at 3 amp., 27/6.

Filament Transf. Input 200-250 v., output 6.3 v., 1 1/2 amp., 9/-.

Ex-Govt. T.M.C. Reed-type Headphones. 70 ohms, 1/9 each (3/6 pair with leads). Single earphones, 75 ohms, with adjustable Headband, 1/6. Midget 'O'out Trans., 32-1, and Paraflex Trf., 4-1, both 1 1/2in. x 1 1/2in. x 1 1/2in., 2/- each. P'Full Intervalve 2.5-1 each half, and O'Put Trf. 60-1, both 1 1/2in. x 1 1/2in. x 1 1/2in., 3/- each. Tannoy Transverse Carbon Mike Inset, 3/-. L.F. Choke 15 Hny. 300 ohms, 175 m.a., 12/6. M'Coil Mike, 2/6. L.F. Transf. 6.8 m.c., 6/6 pr. Midget Intervalve Transf. 3-1, 5-1 or 10-1, 3/9 each. Multi-ratio Matching Transf., 4 windings (2 C.T.) over 10 ratios between 100 and 100-1, 2in. x 1 1/2in. x 1 1/2in., 3/9. 12 volt D.C. motor suitable for models, 10/6.

Television. In stock complete range of components as specified for "Wireless World" and "Electronics" television constructors' kits.

★ Send 2/6 stamp for very full Stock Lists. When ordering please cover packing and postage.

STERN RADIO LTD.
109 & 115, FLEET STREET, E.C.4.
Telephone: CENtral 5814 and 2280.

YOU DON'T NEED TEST GEAR!

Many constructors have told us they spend far too much on trying new High Quality circuits, and then are not satisfied with the result, as they lack the necessary gear to check the performance. The E.R.5 4.5 watt at 10gns, and the E.R.10, 10 watt amplifier at 15s, cost very little more than the retail price of the components, and each one is tested in the laboratory before despatch, to ensure rigid adherence to the specification. A post card will bring you details. We regret that due to heavy demand, delivery on the E.R.5 is now 7-10 days.

ELMSLEIGH RADIO CO.,
1102 LONDON RD., LEIGH-ON-SEA, ESSEX
LEIGH 75168.

ANNUAL stocktaking sale now in progress. At the finest value at the lowest prices ever!! Send 2/- to-day for our current catalogue and ask for bargain list, s.a.e. please; note: as usual, we pay all carriage! Here are a few items picked at random from our varied stock; a selection of 4 meters, including volt-meter, milli-amp meter, microamp meter, etc.; 5 in. normal list price 25/6 special price 12/6 the 4; a selection of 6 different flying and other aircraft instruments. original cost of this selection usually over £100; our special price 21/- the 6; Bendix control panel type BC938-A, contains 7-way push-button unit (tel and int) jacks, tone switch, etc., only 5/- a fresh consignment of rotary transformers enables us to repeat this popular item; post orders to Waltons Wireless Stores, 203, Staveley Rd., Wolverhampton. You are invited to visit our warehouse at 65, Tivoli Rd., Bradmore, Wolverhampton. Over 2,000 bargains for you to choose from. [2051]

SPECIAL!—Supacolls present you with 20 1/- cash coupons in their latest catalogue of components and handbook of circuits, hints, constructional information, colour codes, etc.; Send 3/2 stamp for your copy and at the same time obtain full details of how you can save 1/- in the £1 on all your orders! In the meantime, if you need any components urgently, send us your requirements and deduct 1/- for each complete £1 of your order; we append a selection from our stocks: PB30, the latest 3-waveband plus gram push-button superhet coil pack for only 30/-; each pack supplied assembled, wired and tested, complete with engraved escutcheon and suitable circuit diagram; adjustable iron dust cored coils and trimmers for absolute accuracy in tracing; for the DX enthusiast we recommend the model 40 coil pack; this famous 3-waveband superhet pack with provision for H.F. stage incorporates 9 adjustable iron-cored coils, adequately screened, with rotary 2-bank Xalite type trimmers, trimmers padders, etc. completely assembled and wired; now available for only 39/-; model 30 coil pack superhet, 3-waveband coil pack suitable for use in sets without R.F. stage, now only 21/-; "M.M." I.F. transformers, adjustable iron cores, high "Q", extruded efficient at 10/- pair; 0003 2-wang condensers, 7/6; 3-gangs 13/4; coils, all normal frequency coverages, permeability tuned, 2/- each; ma'1 order only.—Supacolls, 98, Greenway Ave., E.17.

WANTED, EXCHANGE, ETC.
URGENTLY required to fulfil overseas order, 4 valves type 802.—Details to Ger 1928.
WANTED. second-hand television receiver; give price and particulars.—Box 2027.
REQUIRED urgently, J.I. E.E.E. Vol. 93 IIIA, No. 5.—Price to Librarian, A. C. Cosser, Highbury Grove, N.5.
WE pay top prices for used test equipment, all types.—University Radio, Ltd., 22, Lisit St., London, W.C.2. Tel. Ger. 4447 and Ger 8582 [2002]

EXCHANGE. Eddystone comm. receiver, type 640, bought Sept. 9th '48, together with radio vision expander 5 and 4 metres, bought Sept. 9th '48, for AR8BD or Hammarlund HQ129X, must be in excellent cond.—Box 1996.
URGENTLY required, Auto-Memota direct starters for 1/4hp 400-440v. list No. 14 A.D., amp rating of trips 0.6 to 0.9 or other amp rating would be suitable.—For quotations, giving price and quantities available, to Denfords Engineering Co., Ltd., Box Trees Mill, Wheatley, Halifax.

REPAIRS AND SERVICE
MAINS transformers rewound, new transformers to any specification.
MOTOR rewinds and complete overhauls; first-class workmanship, fully guaranteed.
F.M. ELECTRIC Co. Ltd., Potters Bldgs, Warner Gate, Nottingham. Est. 1917. Tel. 3855
REWINDS promptly executed, new trans.—R.E.F., 137a, Ashton Rd., Oldham. [3308]
MAINS transformer rewound and constructed to any specification; prompt delivery.—Brown, 3 Bede Burn Rd., Jarrow [3460]
LOUDSPEAKER repairs, British, American, any make, moderate prices.—Sinclair Speakers, 12, Pembroke St., London, N.1. Terminus 4355. [3508]

REWINDS and conversions to mains and output transformers, from 4/6; pp equipment; a speciality.—N.L. Rewinds, 4, Brecknock Rd N 7. Tel. Arnold 3390. [6283]
RADIO MAINTENANCE SERVICE, radio speaker, transformer and motor repair specialists; no delays.—139, Goldhurst Terrace, London, N.W.6. Mal. 6135. [9925]
ELECTRICAL measuring instruments skilfully repaired and recalibrated.—Electrical Instrument Repair Service, 329, Kilburn Lane, London W.9. Tel. Lad. 4168. [F935]
SERVICE with a Smile.—Repairers of all types of British and American receivers; coil rewinds; American valves, spares, line cord.—F.R.I., Ltd., 22, Howland St., W.1. Museum 5675. [1575]

REWIND service which duplicates or modifies as required; transformers, loudspeakers, etc.; prompt returns.—Raldel Services, 49, Lr. Addiscombe Rd., Croydon, Cro. 6537.
REPAIRS to moving coil speakers, cones, coils fitted, field rewound or altered; speaker transformers, clock coils rewound; guaranteed satisfaction, prompt service; no mains trans. accepted. Closed Sat.
L.S. REPAIR SERVICE. 49, Trinity Rd., Upper Tooting, London, S.W.17. Balham 2359



THE "FLUXITE QUINS" AT WORK

"An aerial needing repair!
Set up without FLUXITE, I'll swear.
Pull hard, it's got fixed!"
Cried OO "You're all mixed,
That's the telephone wire you've got there!"

See that FLUXITE is always by you—in the house—garage—workshop—wherever speedy soldering is needed. Used for over 40 years in Government works and by leading engineers and manufacturers. Of all Iron-mongers—in tins, 10d., 1/6 & 3/-

TO CYCLISTS! Your wheels will NOT keep round and true unless the spokes are tied with fine wire at the crossings AND SOLDERED. This makes a much stronger wheel. It's simple—with FLUXITE—but IMPORTANT.

The FLUXITE GUN puts FLUXITE where you want it by a simple pressure. Price 1/6, or filled, 2/6.
ALL MECHANICS WILL HAVE



FLUXITE

IT SIMPLIFIES ALL SOLDERING

Write for Book on the ART OF "SOFT" SOLDERING and for Leaflets on CASE-HARDENING STEEL and TEMPERING TOOLS with FLUXITE. Price 1d. each.

FLUXITE LTD.
(Dept. W.W.), Bermondsey Street, S.E.1

**THE
BRITISH NATIONAL
RADIO SCHOOL**

ESTD. 1940

for
*New World Ideas and Old World
Ideals!*

*The Urge to Serve and the Know-
ledge How!*

*Home Study Specialists with the
Personal Touch.*

Radio, Radar, Maths., Physics.

The B.N.R.S. FOUR YEAR PLAN

covers the full syllabus of :

**A.M.I.E.E., A.M.Brit.I.R.E. and
CITY and GUILDS Radio and
Telecommunications Exams.**

Six months' trial period without
obligation to continue.

Send for free booklet to :—

**STUDIES DIRECTOR
BRITISH NATIONAL RADIO SCHOOL,
65, ADDISCOMBE ROAD, CROYDON**
Phone : Addiscombe 3341

**THE WISE
MAN
BUYS
VOIGT**



H.C. Type Horns with Bass Chambers £19-10-0. Reflector type CORNER HORNS, price £47-10-0, prices in the white and ex-works. Order at once, a gap in Horn production impends P.M. Units available soon.

**VOIGT PATENTS LTD.
LONDON, S.E.26**
P.S. Mr. Voigt is not yet fit.

HILL & CHURCHILL LTD.

BOOKSELLERS

SWANAGE, DORSET

Available from Stock:

"Radio Engineers' Handbook" Terman	42/-
"Principles of Television Engineering" Fink	33/-
"Radar Engineering" Fink	42/-
"Principles of Radar" M.I.T. Radar School	30/-
"Practical Radio Communication" Nilson & Hornung	39/-
"Electronics" Millman & Seely	33/-
"Radio Engineering" Vol. I Sandeman	45/-
"Television Simplified" M. S. Kiver	27/-

Postage extra.

CATALOGUE ON APPLICATION

STURDY rewinds, mains transformers, chokes and fields; we give prompt delivery and guarantee satisfaction; 14 years' experience. Prices on request.—Sturdy Electric Co., Ltd., Dipton, Newcastle-on-Tyne. [4316]

LOUDSPEAKER repairs, any make, reasonable prices, prompt delivery, to the trade and quality fans; 25 years' combined experience with Rola, Magnavox, Goodmans, Celestion.—Sound Service Radio, 80, Richmond Rd., Kingston-on-Thames, Kin. 8008. [4977]

REWINDS, mains transformers, speaker field coils, chokes, high-grade workmanship, 7 day delivery; new transformers constructed to customers' specification, singly or in quantities.—Metropolitan Radio Service Co., 1021, Finchley Rd., N.W.11, Speedwell 3000. [3719]

24-HOUR service, 6 months' guarantee, any transformer rewound, mains outputs and i.f.s., etc.; all types of new transf., etc., supplied to specification; business heading or service card for trade prices.—Majestic Winding Co., 180, Windham Rd., Bournemouth. [9988]

COIL specialists.—Tuning and oscillator coils, i.f., i.f. and mains transformers rewound and wound to specification; waveinding specialists; l.s. repairs, new cones, speech coil rewinds, etc.—Rynford Industries, Ltd. (formerly Electronic Services 17, Arwenack St., Falmouth, Cornwall. [9988]

REWINDS and repairs, mains transformers, C.O.P. trans., clock coils, field coils, pick-ups; vacuum and gram. motors; new transformers to any specification; guaranteed work; competitive prices; delivery 2/3 days.—W. Groves, Manufacturing Electrical Engineer, 154, Ackneld Port Rd., Bham, 16. [1482]

AMPLIFIER testing; we have all facilities for testing and adjusting high-quality amplifiers, no push-pull feed-back amplifier will operate really properly unless rigorously tested and suitably adjusted—with its speaker system. We take a keen personal interest in this work, and gladly cooperate with you in obtaining absolutely optimum performance. We also have facilities for light assembly, construction and production testing of note magnifiers and specialised electronic equipment.—Donald Dun, Ltd., 12, Hollywood Rd., S.W.10, Tel. Flaxman 5705.

WORK WANTED

BAKELITE moulding, capacity available for small industrial mouldings to close limits; own fully equipped toolroom.—Box 709. [1564]

RADIO mfrs. can undertake development and assembly of radio or electronic equipment; winding shop with vacuum impregnating plant; ample space and labour available.—Box 685.

QUALITY enthusiasts!—Are you contemplating a new set this winter?—BCM/HIFIDEL, London, W.C.1. is the address to remember for all types of radio and electronic apparatus built to specification. [179]

ALUMINIUM chassis and panels quickly made to your own sizes, holes punched for valveholders, etc., supplied bright, grey or black crackle finish; est. free; local stn. tunes units, high fidelity amplifiers, precision superhet coil packs, i.f. transformers, gang condensers, etc.; technical data sheets and lists on request.—E.A.D., 13, Bence Lane, Darton, Barnsley.

MISCELLANEOUS

RADIOGRAM cabinets, mfrs. samples; stamp details.—123, King St., Wallasey.

WALNUT radiogram and television cabinets, mfrs. samples, few only; stamp details.—Walters, 501, Hale End Rd., E.4. [1763]

SMALL neon lamps and holders, ideal Christmas tree decoration or indicator lamps; 15/- doz.—Lucas, 22, Hengrove Rd., Bristol, 4.

L. MARCUS, Ltd., 75-77, East Rd., have for disposal a number of radiogram cabinets, 6-valve chassis and Garrard player units with pick-up.—Tel. Cle. 2462. [1977]

SPARKS' data sheets provide complete constructional details and full-size draughtsman-prepared prints showing drilling, assembly and wiring plans of tested and guaranteed designs by L. Ormond Sparks.

LATEST release.—The Challenger portable, an ac/dc 3-valve (plus rect.) T.R.F. circuit having an exceptional performance on med. and long waves, the ideal set for radio in any room, no aerial or earth; 6in Stentorian speaker gives amazing power and quality; no complicated switching or adjustments; data sheet 2/9.

COMPONENTS can now be supplied; send a stamp for list giving full details of the 34 designs available.

SPARKS' DATA SHEETS (W.) 9, Phoebeth Rd., Brockley, S.E.4. Tel. Lee Green 0220.

ONE triple screened compartment having a double screen of perforated zinc built on to a wooden framework, with special door for high frequency screening; having an overall size of 1,000 cubic feet; can be seen by appointment.—Box 1939. [1979]

COPPER wires, enamelled, tinned, Litz, cotton, silk covered, all gauges; BA screws, nuts, washers, soldering tags, eyelets; ebonite and laminated bakelite panels, tubes, coil formers; Tufinol rod; headphones, flexes, etc.; latest radio publications, full range available; list s.a.e.; trade supplied.—Post Radio Supplies, 33, Bourne Gardens, London, E.4. [1454]

NUPLANS announce their first receiver plan, "the Personal Portable"; really small, really works, radio anywhere; much cheaper than the shop "Personal"; all standard parts; circuit, layout, diagrams, notes, etc., 2/6; for Nuplans' testgear plans see past issues of "W.W." or send s.a.e. to E. N. B., "Whinnie Knowe," Escalls Cliff, Sennen, Cornwall.



**NEW G.P.12
CRYSTAL PICK-UP**
with permanent sapphire stylus

—was fully described in *The Wireless World's* recent article "Crystal Pick-ups—Basis of Design for Fidelity Reproduction."

This remarkable pick-up, which represents the ultimate in high-fidelity reproduction, is now available in limited quantities through your radio dealer, price 104/- incl. P.T.



**FREE ILLUSTRATED
FOLDER** describing this new pick-up may be obtained by returning the coupon below.

TO COSMOCORD LTD.
ENFIELD, MIDDXX.

Please send folder of ACOS Pick-ups.

NAME _____

ADDRESS _____

W.W.

PHOTO-ELECTRIC CELLS

for
Talking Picture Apparatus.

Catalogue now available

RADIO-ELECTRONICS LTD.,
St. George's Works, South Norwood,
London, S.E. 25.

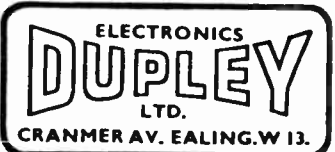

ELECTRONICS
DUPLY
LTD.
CRANMER AV. EALING. W 13.

PHONE EALING S688

**WILLIAMSON AMPLIFIER
COMPONENTS**

**OUTPUT
TRANSFORMER** £4 7 6

TO DESIGNERS' SPECIFICATION

MAINS TRANSFORMER £4 2 6

CHOKE, 15 HEN. 150 MA. £1 7 6

CHOKE, 30 HEN. 30 MA. 9 6

Send for details of above and full range of standard transformers and chokes.

Manufacturers' enquiries invited

HENRY'S

TRANSMITTING VALVES, TYPE 313, by Canadian Westinghouse, Brand new and boxed in original carton, tested, £3 10s. each.

ELECTROSTATIC VOLTMETER, 0-5000 v., 3 1/2in. scale, panel mounting, by leading manufacturer Brand new, 65/- each.

6-volt VIBRATORPACK. Output 180 v. 40 m.A. completely smoothed, synchronous vibrator, size 6 1/2 in. x 2 1/2 in., 21/- only.

SPECIAL OFFER P.M. SPEAKERS. 8in. ROLA, with transformer, 21/-; 3in. TRUVOX, less transformer, 12/6.

SPECIAL OFFER MIDGET ELECTROLYTICS. sizes 1 1/2 in. x 1 1/2 in., 8 x 8 mid., 4 3/4 v., 4/6; 1 1/2 x 8 mid. 4 3/4 v., 5/6; 3 1/2 mid. 3 1/2 v., 4/6 only.

R1626 VHF RECEIVER. Comprising 10 valves EF30, 2 valves EF34, 24-volt Rotary Generator, relays, and hundreds of condensers and resistors. Complete in grey metal case, absolutely brand new, 75/- only.

MIDGET I.F. UNIT. Aluminium can 4 1/2 in. x 2 1/2 in., comprising 1 valve, IT4, midget, iron-cored I.F. transformer, 45K/Cs, and 8 midget resistors and condensers, 12/6 only.

MIDGET B.F.O. UNIT. As above, but comprising one valve 1H5, and midget B.F.O. coil, in lieu of I.F. transformer, 10/- only.

THE E.T.A. FOUR-STATION SUPERHET TUNER Completely self-contained tuner, may be set to select any three medium and one long wave stations. No tuning condenser required. Four-position switch. Tuning by high permeability dust cores. Litz wound coils. Once set requires no further adjustment. The station you want at a flick of a switch. Size 2 1/2 in. high by 3 1/2 in. by 3 1/2 in. Complete with full aligning instructions and suitable A.C. and A.C./D.C. circuit. Only 33/-, plus 7/- Purchase Tax.

TELEPHONE HANDSETS. G.P.O. type (self-energised), with pressed switch. Complete lead and plug. Brand new, 10/6 each only.

B.C.221 FREQUENCY METER. American crystal controlled. 2 6S7, 6K8, plus, complete set spare valves. Coverage, 125-20,000 kc/s. Calibrated charts and instructions booklet supplied. Battery operation 130 v. H.T., 6 v. L.T. Ample space available for easily constructed mains pack. New, £15 only.

MIDGET TWO GANGS 00036. Ceramic insulation, size only 2 1/2 in. x 1 1/2 in., long spindle, 9/- only. 000375 nfd, with trimmers, valves covered perspex, size 2 1/2 in. x 1 1/2 in., long spindle, 10/6 only.

0-1 M/A. MOVING COIL METERS. 2 1/2 in. panel mounting, brand new and boxed, 15/- ea.

ALLADIN COIL FORMERS. Complete with iron dust cores, 9d. ea. only.

DENCO. Please note that we are appointed stockists of Denco products. In addition to the above few items we have probably the most up-to-date stock of Radio components in the trade. Also over 10,000 valves in stock at B.O.T. list prices.

TRADE SUPPLIED

Send stamp for latest Comprehensive Component List-

HENRY'S
5, HARROW ROAD, W.2

PADDINGTON 1008 9

WARD ROTARY CONVERTERS

For Radio, Neon Signs, Television, Fluorescent Lighting, X-ray, Cinema Equipment and numerable other applications.

We also manufacture :-

Patrol Electric Generating Plants, H.T. Generators, D.C. Motors, etc., up to 15 K.V.A.

CHAS. F. WARD

LORDSGROFT WORKS, HAVERHILL, SUFFOLK
Telephone : Haverhill 253 & 4.

STEEL chassis, 11 1/2 in. x 11 1/2 in. x 2 1/2 in. 4-sided, almost undrilled, 3/6 ea post free.—Cooper, 71, Forest Rd., Quinton, Birmingham, 32. [1983
WANTED for sub-contract and high-grade radio servicing, an efficient organisation. smart delivery van essential; must be located within 5 miles of Hyde Park Corner.—Box 1933.
FOR sale, aluminium telescopic masts, 16in enclosed, extending to 8ft 4in; 3/4in base tapering to 1/2in; special wholesale prices; state quantities interested.—Easton Brothers, Contractors, Swansea. Tel. 2717. [1995
TO 250 volts a.c. clockwork time switches excellent condition. £2; mercury sealed tube 10-amp type. £2/10; cash with order.—J. Donohoe, 2, Upper Norfolk St., North Shields. [1172

SITUATIONS VACANT

Vacancies advertised are restricted to persons or employments excepted from the provisions of the Control of Engagement Order, 1947.

MINISTRY of Civil Aviation. Appointment of Radio Mechanics, Grade II.

APPLICATIONS are invited for appointment as radio mechanics, Grade II, at civil aviation radio stations in the United Kingdom. Candidates will also be liable for tours of duty overseas.

Candidates must be at least 21 and under 40 years of age at the time of application, and must possess a knowledge of the fundamental principles of radio and radar with a general knowledge of one or more of the following radio aids for navigation: Direction finding, Loran, Gee, Radar beacons, A.C.F. or G.C.A. They should also have had practical experience in the use of tools, filing, drilling, hard and soft soldering, cabling and wiring, and be experienced in the use of electrical and radio measuring instruments including cathode ray oscilloscopes. The possession of City and Guilds certificates in radio communication and technical electricity will be an advantage; the pay will be 115/- per week, inclusive, rising by annual increments of 5/- a week to a maximum of 150/- a week. Candidates should apply by postcard for a form of application to the Ministry of Civil Aviation, Establishment Division (B), 10, Fleet St., London, E.C.4, quoting reference EST/174. [1988

COMPETENT television engineer, 5-day week; good rates; London area.—Write Box 2065.

QUALIFIED service engineer, excellent conditions; salary from £350 per annum.—Tel. Orpington 2747. [2150

RADIO and television service engineer required, good salary and permanency to capable man.—Killbourn, Abingdon, Berks. [2057

RADIO and television service engineer required, must be experienced; good salary and permanency.—Fox, East Molesey, Surrey. [1985

WEST-END elec. eng. rep. requires repair counter hand and assistant.—Write, stating full particulars, and salary required, Bx 1947.

RADIO mech. accustomed to prototype model wiring needed for London laboratory; perm. post; good salary; interesting work.—Box 2066.

SERVICE engineer for N.W. London retail. Fully experienced radio and television service in every aspect, quick and accurate; state wages.—Box 1987. [2018

WHIZARDS need immediately a skilled television engineer competent to service all makes.—Tel. Welbeck 7995, or write 204, Haverstock Hill, N.W.5. [1950

ENGINEERS required, with experience in all branches of television transmission and reception; specialisation in some of the following subjects is essential:—

(1) Wide-bandwidth, medium and low power transmission.
(2) Vidco amplifier design.
(3) Syne and scanning generators.

APPLICANTS should have had some years' laboratory experience in the subjects outlined, and preference will be given to those holding recognised academic qualifications; London area.—Apply in confidence, giving age, details of education and experience, and salary required, to Box 1375. [1738

FULLY qualified radio, television, electronic engineers required, London area; other positions also available.—Write Technical Employment Agency, 179, Clapham Rd., S.W.9. Tel. Brixton 3487. [2114

RADIO development engineer required, experience on design of radio and television receivers essential.—Full particulars to: Regentone Products, Ltd., Eastern Avenue, Mawneys Rd., Romford, Essex. [1975

SENIOR design draughtsman required for work in connection with commercial radio receivers and electronic equipment.—Write, giving full particulars, to the Labour Manager, Bush Radio, Ltd., Power Rd., Chiswick, W.4. [2005

DRAUGHTSMAN designer required with factory and drawing office experience, capable of undertaking responsibility of mechanical design of radio and television apparatus.—State age, experience and salary required, to Box 1941.

GLASSBLOWER required for research laboratories, must have good all round experience in hard and soft glasses and glass in the experience.—Apply in person or write to Personnel Department, E.M.I., Ltd., Blyth Rd., Hayes, Middlesex. [1985

A LARGE engineering group requires draughtsmen of senior and junior grades in several parts of the country.—Men with sound electrical or mechanical drawing of the experience should apply to Box 1933. All replies are acknowledged. [1960

-towards perfection-**LOWTHER TUNERS**

D.T./4 famous 'dual.'
D.T./5 details shortly.
L.E.I./2 T.R.F. unit.
L.E.S. Superhet unit.
F.M.! Experimental.

LOWTHER AMPLIFIERS

B.5.F. 5 watts, f.35—30 Kc.
A.10.F. 8 watts, f.35—40 Kc.
A.15.F. 15 watts, f.35—35 Kc.
A.50. 45 watts, f.35—30 Kc.

LOWTHER P.M.1 UNIT

High flux, 18,500 — 19,500 gauss (average) drive unit fitted with Voigt light coil diaphragm.

'LOWTHER—VOIGT'

Corner reflector type speaker P.W.I. white wood or veneered.

LOWTHER PICK-UP

Moving Coil (licensed under Voigt's Patent) fitted with Tungsten-Carbide or Diamond Styli.

VOIGT CORNER REFLECTOR

type horn in white wood, veneered or de luxe finish.

MORDAUNT

Duplex Reproducer.

LOWTHER

Bass and Treble Corrector, Pre-Amplifiers, Het-Whistle Filters, etc.

EXHIBITION

daily at

LOWTHER MANUFACTURING CO.
BROMLEY

R.I. 5225

KENT

MORSE CODE TRAINING

There are Candler Morse Code Courses for BEGINNERS AND OPERATORS

Send for this Free "BOOK OF FACTS"

It gives full details concerning all Courses.

THE CANDLER SYSTEM CO.
(Room 55W), 121 Kingsway, London, W.C.1
Candler System Co., Denver, Colorado, U.S.A.

ALLEN COMPONENTS LTD.

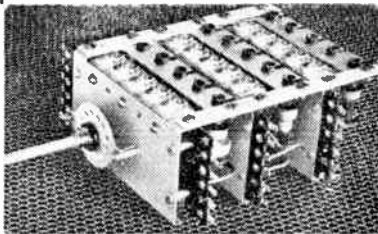

Type 320 5-wave band coil unit.

A comprehensive pre-aligned assembly consisting of switch, complete set of aerial, H.F. and oscillator coils and all associated trimming and padding condensers for 5 wave band operation with tuned H.F. stage on all bands. All coils have dust iron cores for inductance adjustment. A six position switch is used with provision for pick up connections and H.F. muting on the sixth position. For use with any of the standard frequency changer valves (6K8, ECH35 etc.) and an I.F. frequency of 465 Kc.

Ranges : 1, 13—40, 2, 30—100, 3, 80—200, 4, 200—550, 5, 900—2000 metres.

PRICE £5 19 6

Send for latest catalogue of our full range of components for Radio and Television.

ALLEN COMPONENTS LTD.

Tower Road, Willesden, N.W.10

Telephone Willesden 3675

TRANSFORMERS & CHOKES

High Quality Vacuum Impregnated

AUSTIN MILLS LTD.

LOWER CARRS STOCKPORT

Telephone : STO. 3791 (Established 20 years.)

Superb Performance with Great Saving in Cost

Permeability Tuning Units

NO TUNING CONDENSER REQUIRED

B3S (LONG & MEDIUM WAVE)
B3SW (MEDIUM & SHORT WAVE)

PRICE 48/9 each

EXPORT ENQUIRIES INVITED

If your dealer cannot supply, write direct to :

THE WEYMOUTH RADIO MFG. CO., LTD.

CRESCENT WORKS, WEYMOUTH.

SENIOR estimator required by large radio manufacturer in the East London area; the successful applicant must have practical training and be capable of preparing detailed estimates for radio equipment.—State age, experience and salary required to Box 1940. [1980]

SENIOR television development engineer required by well-known manufacturers in the London area; candidates preferred with engineering degree or equivalent qualifications and wide experience of television receiver design for mass production.—Write, Box 1927. [1941]

VACANCIES for senior television development engineers, draughtsman/designer (mechanical), and experienced model shop mechanics.—Write, Personnel Manager, Sobell Industries, Ltd., Langley Park, Langley Bucks, stating age, qualifications, experience and salary required. [1941]

SOBELL INDUSTRIES, Ltd., have vacancies in the main industrial towns for first-class radio and television service engineers, clean driving licence essential; salary £6 p.us. allowances, expenses, and bonus; equipment provided.—Write: Personnel Manager, Langley Park, Nr. Slough, Bucks. [2029]

SERVICE Dept.—Sales assistant for leading hearing aid company in London, age 35-45, good personality, able to give high standard of personal service to clients; order man acceptable if right type.—Full personal details and salary required to Box A.1661, Haddons, Salisbury Sq., London, E.C.4. [2103]

WANTED for large company in West London: Deal-aid engineer able to undertake own research and design of equipment, preferably with considerable previous experience, also television and radio service engineers for field and workshop; remuneration for 5-day week dependent on qualifications.—Apply Box 1926. [1932]

SERVICE manager for leading hearing aid company in London, must have good personality, able to deal with mail and appointments of service dept; thorough knowledge of L.F. midget amplifiers essential.—Full details of age, experience and salary required, to Box A.1658 Haddons, Salisbury Sq., London, E.C.4. [1959]

WAYNE KERR has vacancies for a design draughtsman with varied experience in the electronic field, and a detail draughtsman with some experience of radio and electronic equipment. Apply, stating qualifications and salary required to the Chief Designer, The Wayne Kerr Laboratories, Ltd., New Malden, Surrey. [1959]

TWO senior development engineers required by well-known company in Essex; considerable experience on theory and design of V.H.F. transmitters up to powers of 200 watts or on V.H.F. receivers is an essential requirement.—Applications, giving age, qualifications, experience and salary required, quoting Ref. No. 153, to Box 1392. [1782]

THE College of Aeronautics has vacancies for radar-radio mechanics; essential qualifications: sound technical knowledge of radio apparatus with considerable aircraft maintenance experience; salary according to age and qualifications.—Application forms may be obtained from the Registrar, The College of Aeronautics, Cranfield, Betchey, Bucks. [2026]

SALES engineer/representative for o'd-established West London firm of radio and electrical component manufacturers; applicants must have good personality, initiative and drive and be capable of technical and commercial negotiations with customers of standing.—Write full details of experience, qualifications, age and salary required to Box 1994. [2030]

RADAR engineers required to operate from London headquarters for installation and maintenance of marine installations home and overseas; the essential qualifications are: practical knowledge of electronic circuits and equipment, ability to work without supervision after training, and resourcefulness; initial salary according to experience.—Box 1377. [1751]

PATENT agent or technical assistant required in patent department of company engaged in manufacture of precision instruments, radar, etc.; knowledge of electronics and radar technology desirable; salary according to qualifications and experience.—Full details to Personnel Manager, Sperry Gyroscope Co., Ltd., Great West Rd., Brentford, Middlesex. [1741]

SENIOR development engineers required must have good technical training, preferably with Hns. Degree in Physics or Engineering and radio laboratory experience; able to carry through development, with assistants, to production stage; salary up to £200 according to qualifications.—Apply in writing to Personnel Department, Murphy Radio Ltd., Welwyn Garden City, Herts. [2105]

LARGE electrical engineering firm in South London has vacancy for senior design engineer, applicant must have experience in production design of electronic equipment, he should also have sound technical background in amplifier design; good salary according to qualifications.—Apply in writing to Box WW 872, L.P.E., 110, St. Martin's Lane, W.C.2.

FACTORY representative required by o'd-established group of Midland companies producing specialised radio and electronic components, plastics and metal smallwares; applicants must have good connections with the radio, electronic and associated industries and be competent to conduct business at management level; a London address and car is desirable.—Apply in confidence with particulars of experience, etc., to Box 1945. [1997]

3 AMPLIFIERS

that meet all needs

3 WATT . . . 11 Gns.

P.14.—A highly portable amplifier—it weighs only 10 lbs. and is suitable for outdoor use. Works from a low power supply of 2 amps. at 6 volts. Built into case 13in. x 6½in. x 4in. with controls and sockets at one end

15 WATT . . . 66 Gns.

P.10.—A quality amplifier in which the HT supply is carefully filtered and all components conservatively rated. No electrolytic condensers are used in any part of the circuit. Switch correction is provided for Decca and HMV recordings. Mounted on polished chromium plated chassis.

20 WATT . . . 26 Gns.

P.16.—Designed for universal mains supply, its output of 20 watts is exceptionally high. Total harmonic distortion at full output is only 4 per cent. and hum level is unusually low. Weight, 17 lbs. Overall size 15½in. x 7½in. x 8½in.

Write for leaflets giving full details.

McMURDO

INSTRUMENT CO. LTD.
Victoria Works, Ashtead, Surrey



FOR SPEEDY

LOUDSPEAKER REPAIRS & TRANSFORMER REWINDS

at economical prices

TRANSFORMERS

built to your own specifications, contact

A.W.F. Radio Products Ltd.,

Borough Mills, Bradford, Yorks. Tel.: 22a. 8.

Factors' Terms on Request

ALL NEW GOODS

E.H.T. input 200/250. Outputs 2,500 v. 3 m/a., 450-0-450, 200 m/a. L.T. 6.3 v. 8 amp., 5-4-0 v. 3 amp., 2-0-2 v. 2 amp., 6.3-4-2-0 v. 1 amp. Side tag panels, fully impregnated, at 120/-.

GM4 input 200/250. Outputs 450-0-450, 200 m/a. L.T. 6.3-4-0 v. 8 amp., 5-4-0 v. 3 amp., 6.3-4-0 v. 2 amp., 6.3-4-0 v. 2 amp., fully impregnated, at 95/-.

F6 Filament Transformer, 200/250 in 6.3 v. 2 amp. out. at 7/6.

F4 200/250 in 4 v. 2 amp. out. at 7/6.

F8 6.3 v. in 4 v. 2 amp. out. at 7/6.

F9 4 v. in 6.3 v. 2 amp. out. at 7/6.

Terms : C.V.O. (add 2/6 carriage and packing for orders under £2).

H. ASHWORTH
676, GREAT HORTON ROAD,
BRADFORD, YORKS.

Special quotations for quantities.

L-R'S IN STOCK

CASH or EASY TERMS

Concans "Axiom Twelve" Speaker Unit
One of the finest quality speakers available to-day. Cash price £8 8 0

Avo Model 7 ... Cash price £19 10 0
Valve Tester, complete ... £18 10 0

And practically the whole AVO range.

Electrix A.C. or O.C. Spray Unit for spraying Paint, Disinfectant, Crocote, Insecticides, etc. Most efficient. Complete outfit £8 10 0

Specifications of the above on request.

We can supply on convenient terms

much of the Radio and Electrical Equipment at present available, all transactions being strictly between customers and ourselves.

Please let us know your requirements and whether for cash or on easy terms.

The LONDON RADIO SUPPLY CO.

Est. 1925

BALCOMBE, SUSSEX

£15 TELEVISION RECEIVER

This is the title of our latest publication giving wiring diagrams and constructional notes of an excellent little T.V. receiver. You can make this from Government surplus equipment and the total cost should not exceed £15. A demonstration receiver can be seen at our address. To avoid disappointment order your copy immediately, the price is 7.6d. post free.

BULL'S EX-GOVERNMENT DEPOT.
42-46 Windmill Hill, Ruislip, MIDDLESEX.

THE COIL PICK-UP
"Is Outstandingly Good"

according to users.

We mean to keep it so.

WILKINS & WRIGHT LTD.,

Utility Works, Holyhead Rd., Birmingham 21.

100 kcs.
QUARTZ
CRYSTAL
UNIT
Type
Q5/100



For Secondary Frequency Standards

- ★ Accuracy better than 0.01%.
- ★ New angles of cut give a temperature coefficient of 2 parts in a million per degree Centigrade temperature change.
- ★ Vitreous silver electrodes fired direct on to the faces of the crystal itself, giving permanence of calibration.
- ★ Simple single valve circuit gives strong harmonics at 100 kcs. intervals up to 10 Mcs.
- ★ Octal based mount of compact dimensions.

PRICE 45/- Post Free

Full details of the Q5/100, including circuit are contained in our leaflet Q1. Send stamp to-day for your copy

THE QUARTZ CRYSTAL Co., Ltd.

63-71 Kingston Road,
NEW MALDEN, SURREY
Telephone: MALden 0334

SENIOR mechanical draughtsman.—The South-western division of a leading company in the electronic equip. field require a draughtsman (age 25/40) for work in their development drawing office. Applicants should have had experience in laying out and detailing electronic equip. be capable of preparing quickly and accurately sketch drawings at development stage, and of making, with a minimum of supervision, full manufacturing drawings for production runs; salary according to qualifications and exp.—Pull details to Box 1932.

ELECTRICAL engineer with factory and design experience, capable of undertaking responsibility and design of television apparatus; preference will be given to applicants of 28 years and over with 1st- or 2nd-class honours degree and with some practical experience of television receiver design; salary will be according to qualifications and experience.—Apply in the first instance for a form of application to Works Personnel Officer, Philips, Mitcham Works, Ltd., New Road, Mitcham Junction, Surrey, quoting the reference R.3. [1936]

THE Civil Service Commissioners invite applications for permanent appointments in Ministry of Supply, London. 1. Principal scientific officer to control research and development of radio and radar navigation devices and aircraft approach and landing aids. 2. Principal scientific officer to control research and development of radio communications systems, airborne and ground, electro-acoustic and sound-recording equipment, special test equipment for such devices. 3. Principal scientific officer to control development of general radio test equipment for service use and special radio and electronic test equipment for research purposes. 4. Senior scientific officer in development of components for new radio equipments, a good knowledge of the radio components industry is essential. Experience of chemical and physical processes is required. Candidates must have been born on or before 1st August, 1917, and must possess 1st or 2nd Class Honours degree in physics or electrical engineering; their experience should cover a field of work appropriate to one of the posts; inclusive salary scales: Principal scientific officer, £900-£1,220; senior scientific officer, £650-£850; rates for women are somewhat lower.—Further particulars and application forms from The Secretary, Civil Service Commission, Science Branch, 27, Grosvenor Sq., London, W.1, quoting No. 2300. Completed application forms must be returned by 11th November, 1948. [2131]

VACANCIES exist for technically qualified staff in an Admiralty Establishment near Warrington, Lancs, as follows: (a) To take complete charge of testing section handling either all types of Naval radar equipment or all types of Naval communication and D/F equipment. The work will include the organizing of the testing of new equipment, the maintenance of existing stock, technical investigations, liaison with the scientific staff and designers, and the design of special test equipment. Applicants must have had a regular engineering training and be fully qualified for Corporate Membership of the Institution of Electrical Engineers. They should be between 35 and 50 years of age, and have had experience in a responsible position on radio or radar equipment. (b) To take charge of sub-sections engaged on the testing of communications, D/F and radar equipments, radio components, valves, C/R tubes, power-supply machines, distribution boards, transformers, etc. Applicants should have served a full engineering apprenticeship and hold Higher National Certificate or have passed the N. Dockyard Inspectors' examination. They should be between the ages of 30 and 40, and have had responsible experience in some of the branches of work mentioned above. Appointments are likely to be for at least two years in the first instance. Entry will normally be at the minimum of the range £720-£960 per annum for vacancy (a), and £595-£720 per annum for vacancy (b), but a higher rate may be offered exceptionally according to age and experience.—Write, quoting D.342/48-A for vacancy (a), or D.345/48-A for vacancy (b), to Ministry of Labour and National Service, Technical and Scientific Register (K), York House, Kingsway, London, W.C.2, for application form, which must be returned completed by Nov. 8th, 1948.

SITUATIONS WANTED

EMIGRATING Australia, serviceman would rep. or sell. 384, Meadow La., Nottingham. **R**ADIO eng. 15 yrs' exp., all branches of trade, man of init., take charge service dept., staff, costing, etc., refs., pref. Southern countries.—Box 1942. [1987]

YOUNG Swiss radio technician wishes to exchange positions for a few months with English technician.—Write Stuker, 9, Chemin des Peres, Neuchatel. [1963]

ENGINEER, 26, City & Guilds Telecommunications Grade III, Mathematics Grade III, and 3 parts of Grad. Brit. I.R.E. exam., seeks progressive post.—Box 1943. [2001]

SCOTSMAN, 26, far frae hame, 8 yrs' experience radio, electrical and T.V. servicing, ex-R.A.F., good driver, excel. refs., keen to return to an country anything considered.—Box 1943. [1990]

EX-R.A.F. tech. sigs. off. ex-R.A.F. wireless and elec. mech. apprentice, age 27, single, 10 years' exp. rhboe, and ground str., radio equip. Installation and maintenance practical and supervisory, desires position.—Box 1993.

WESTERN GATEWAY HEADQUARTERS
for Radio Equipment and Components

VIBRATOR PACKS, suitable for battery sets (Car Radios, 12v. input 150/120v. output at 30/50 mA. In Black crackle case, size 7in. x 6in. x 4in., 19/6 each plus 1/6 post.

L.T. TRANSFORMERS for use as soil heating, pipe-dewatering, and low voltage lighting. Primary 230v. 50 cps. Secondary 12v. 20 a. 50/- each, carr. paid. Also variable tapped primary transformer 230v. input, 11-12.6v. output at 70/100 amps. £4/10/- each, plus 7/6 carriage.

E.C.A. PLATE TRANSFORMER, input 190/250v. 50 cps. Sec. 2,000-1,500-0-1,500-2,000 at 800 mA. Size 9in. x 9in. x 7 1/2in. £8/10/- each, carr. paid.

E.C.A. MODULATION TRANSFORMER, Primary 10,400 ohms, suitable for 805, T2-49, 813 valves in Class B. Secondary 4,300 ohms, suit large modulator or P.A. equipment. Size 9in. x 9in. x 7in. £4/15/- each, carr. paid.

PERMADOR MODULATION TRANSFORMER, Primary 6,700 ohms, sec. 4,500-6,000-5,800 ohms shrouded, ceramic standoff connections. Size 6in. x 6in. x 6in. £2/10/- each. Plus 9/6 carriage.

All the above Equipment is Brand New and Guaranteed.

ARTHUR H. RADFORD
(G6YA), A.M.I.E.E.

28, BEOMINSTER PARADE, BRISTOL, 3.
Tel.: 64314.

(Open Saturdays: 9-5.30 p.m.)

FORREST

(EST. 1922)

FOR QUALITY

- TRANSFORMERS
- CHOKES, ETC.
- REWINDS (all makes)

SHIRLEY, BIRMINGHAM. SHL. 2483

"PERIMET" ELECTRODE

Soldering and Brazing Tool
Operates from 6 or 8 Volt Accumulator or Transformer



15s. Post free.
MAINS TRANSFORMER, 3 Heats. 35s. Post free.
HOLBOROW & CO.,
71, Weymouth Bay Avenue, Weymouth.

CLYDESDALE

For Ex-Service Electronic Bargains.

Brand New, in maker's original packing.
EX-U.S.A.A.F. PANORAMIC GUNNERY TRAINER, MARK I, comprising; 35 mm. Sound Film Projector, soundhead photo-cell, CE2, etc., Sound Amplifier, 4 valves, 6Z4, 6J7, 6F8, etc., Control Amplifier, 4 valves, V1150/30, 6X3, 6SJ7, 20E1, etc., two photo-cells, 6X-25, etc., in wood cabinet 48 1/2 x 19 1/2 x 10 1/2 in., for 115 v. 60 c/s. 405 watts. Operating Manual plus A reel safety Film, Spare's kit, with 6 each lamps, 3 photo-cells, 12 valves, etc. **CLYDESDALE'S PRICE ONLY £35 each. CARRIAGE PAID.** Packed in wood case.

Brand new, in maker's carton.
EX-U.S.A.S.C. CRYSTAL MULTIPLIER, TYPE MI-1946B, Range 3-6.67 mcs. Two 807 valves, Grid Current meter, Service Instruction Books, etc., used with Xmt. ET-4306. In metal case 13 x 10 x 8 in. **CLYDESDALE'S PRICE ONLY 45/- each. CARRIAGE PAID.**

Brand New, in maker's carton.
EX-U.S.A.S.C. MASTER OSCILLATOR, TYPE MI-1946F-A, A "ready-made" V.F.O. Unit, Ranges 1-5 mcs. 2-10 mcs. Two 807 valves. Grid Current Meter. Service Instruction Books, etc. Used with Xmt. In metal case 13 x 10 x 8 in. **CLYDESDALE'S PRICE ONLY £5/15/- each. CARRIAGE PAID.**

Also large selection Components, Transformers, etc. Send now for illustrated list, print name and address.

CLYDESDALE SUPPLY CO., LTD.

2, Bridge St., Glasgow, C.5. 'Phone SOUTH 2706/9
Visit our Branches in Scotland, England and Northern Ireland.

CHARLES BRITAIN (RADIO) LTD.
11, UPPER SAINT MARTINS LANE,
LONDON, W.C.2



Telephone: TEMple Bar 0545

BEST BUY AT BRITAIN'S

RECEIVER TYPE 3170A

A 15 Valve receiver which will easily modify to television frequency. Contains 8 EF50, 2 R127, 1 RL16, 1 HVR2, 1 R1, 1 EA50, 1 CV188. Brand new, with instructions and circuit for conversion to television conjunction with type 6 indicator unit. Price £42/6, plus 7/6 carr. and packing.

INDICATOR UNIT TYPE 6.

Absolutely brand new, with tested tube. Contains VCR97, non-persistent 6in. C.K.T., 4 EF50, 3 EB34, for use in conjunction with the above receiver or for oscilloscope as described in May issue of "Wireless World." Price £41/0, plus 15/- carriage.

Note.—We have a few of these indicators in good condition, for callers only, at £37/6 ea. All C.R.T.s will be demonstrated.

INDICATOR UNIT TYPE 97

Contains 6 EF50, 3 EB34, 4 EA50, 1 6in. C.R.T. Type VCR517, numerous pots., resistors, etc. A bargain at only 39/6, plus 15/- carr.

SPECIAL NOTE.—We have stated on numerous occasions that type 617 tubes as supplied in Indicator units types 102, 184, 102, and type 97 are suitable for television. We are now in a position to demonstrate television programmes on this tube to callers during the hours of television broadcasting.

APNA INDICATOR UNIT (American)

Contains 26 valves types 3, 8L7, G.T.14, 6SN7, G.T.F., 6HG, G.T.1, 6J7, G.T.1, 5in. C.R.T. Type 5CP1 and 100 K/c crystal. Price £31/10/6. Callers only.

VIDEO FILTER UNIT. A Perfect Power Pack.

Contains transformer working from 50 cycle mains giving 280-0-280 v. 120 mA., 6.3 at 3.5 amps., 6.3 at 1.5 amp., 4 v. at 2 amps., and 32 v. Valve line up, 5 EF50, 1 EF55, 8 EA50, 1 R1. Numerous switches, pots., resistors, condensers, etc. Brand new at £217/6, plus 7/6 carr. and packing.

SHOP HOURS 9 TO 6. NOW OPEN ALL DAY SATURDAY.

Note New Address as above.

THE HEART OF A FIRST-CLASS RADIO-GRAM

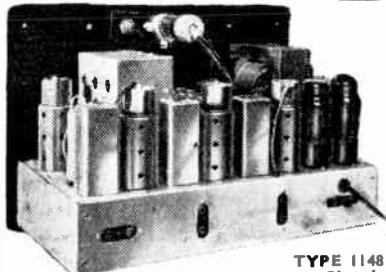

TYPE 1148 Radio-gram Chassis

Developed from the popular type 1047, this receiver will form the basis for a Radio-gram of unsurpassed performance, and at great saving in cost. Principal features include: 12 stage superhet circuit • 11 valves with magic eye indicator • 4 wavebands (11-2,000 metres) • R.F. Amplifier • 2 I.F. stages • 4 stages AVC • 10 watts push-pull output • Separate treble and bass controls • Tropicalised components.

Other Peerless equipment of interest to the enthusiast includes: 16-valve Communications Receiver Type 1546 • R/F Feeder Unit (comprising R/F portion of Type 1148 Receiver) • A.I.F. Unit and Power Pack Type 1. All details on request.

PEERLESS RADIO LIMITED

374 KENSINGTON HIGH STREET, LONDON W.14

Telephone: WEStern 1221

EX-CHIEF Radio Officer, M.N., 29. 1st-class P.M.G., C. & G. (Int.), air licence, sitting final Brit. I.R.E., Nov., '48, exp. commercial broadcasting, HF/DF, motion picture service engineer, radio instructor; anything considered, U.K. or abroad.—Box 1394. [2011]

AGENTS WANTED REPRESENTATIVES calling on radio dealers, offered additional advertised line, attractive, quick selling, with repeat orders assured; generous commission basis.—Write for details, stating area covered, to Box 1366. [1719]

TECHNICAL TRAINING A.M.I.E.E., City and Guilds. on "No Pass No Fee" terms; over 95% successes; for full details of modern courses in all branches of electrical technology send for our 112-page handbook, free and post free.—B.I.E.T. (Dept. 388A), 17, Stratford Place, London, W.1. [6270]

TUTOR THE British National Radio School

OFFERS you a career. WRITE to-day for free booklet describing our wide range of training courses in radio, Radar, telecommunications, principles, mathematics, physics, and mechanics; correspondence and day classes for the new series of C. & G. examinations; we specialise in turning "operator" into "engineers," and for this purpose our "Four Year Plan" (leading to A.M.I.E.E. and A.M.Brit.I.R.E., with 9 C. & G. Certificates as interim rewards) is unsurpassed; our "guarantee has no strings attached."—Studies Director, B.Sc., A.M.I.E.E., M.Brit.I.R.E., 66, Addiscombe Rd., Croydon, Surrey. [6811]

ENGINEERING careers and qualifications. BOTH Government and industry have announced and emphasised that young men with technical knowledge and qualifications must receive every chance to rise to the highest positions within their capacity, in post-war engineering and allied industry; write to-day for "The Engineer's Guide to Success"—200 courses free—which shows you how you can become A.M.I.E.E., A.M.Brit.I.R.E., A.F.E.S., etc., and covers all branches in radio, automobile, mechanical, electrical, production, aeronautical, etc. THE Technological Institute of Great Britain, 82, Temple Bar House, London, E.C.4. [1776]

RADIO training.—P.M.G. exams, and I.E.E. & Diploma; prospectus free.—Technical College, Hull. [0611]

ELECTRICAL and eng. common prelim. exams., matric and special entrance; invest in knowledge to fit you for a real career; free advice without obligation; tuition by specialists; write to—Comprehensive Correspondence Schools, Ltd., 411, Oxford St., W.1.

POSTAL courses of instruction for amateur radio transmitting licence, P.M.G. Certificates in wireless telegraphy, Ministry of Civil Aviation Certificate, radio engineering and television; also instruction at school.—Apply British School of Telegraphy, Ltd., 179, Clapham Rd., London, S.W.9 [Estad. 40 years.]

THE RADIO ENGINEERING SCHOOL, air service training, Hamble, Southampton, offers full-time residential training for radio engineers seeking responsible positions in industry or civil aviation; students are coached for C and G telecommunications or Brit. I.R.E. exams, as preferred; tuition also available to M.C.A. requirements in radio and radar.—For full details apply to the Commandant. [9265]

THE Institute of Practical Radio Engineers have available Home Study Courses in every phase of radio and television engineering, specialising in the practical training of apprentices in the retail trade; enrolments limited, fees moderate.—The Syllabus of Instructional Text may be obtained post free from the Secretary, I.P.R.E., Fairfield House, 20, Fairfield Road, Crouch End, London, N.8. [1614]

BUSINESS AND PROPERTY RADIO business, central position East Devon resort, shop premises and workshop, leading agencies held; good lease, moderate rental; price £1,750, includes good will, lease and delivery van; s.a.v.—Apply E. Hayne, 4, Johnson's Place, Exmouth. [1995]

PROFITABLE radio hire business, good position, double-fronted corner shop, net profit £1,500, audited accounts, stock and equipment value £6,000; good living accomm.; price £9,000 "all at." Includes freehold premises.—Apply E. Hayne, Johnson's Place, Exmouth. [1994]

LIGHT Industrial Premises, opposite Reigate station, 10,000 ft. super ground floor plus 2,000 first floor. Modern structure (brick and steel), also cottages; classified light industry under 1947 Act; freehold £25,000.—Sole Agents, Watkin & Watkin, Reigate and Tonbridge. [2075]

BOOKS, INSTRUCTIONS, ETC.

THE Home Constructor's Handbook is a phenomenal success! So make sure of your introductory copy of this 2/6 book of circuits, hints, formulae, etc. For only 3/6d stamps, Hurry, while stocks last! Here are a few selections from our huge stock of mail order lines: I.F. transformers (465), 5/- ea.; 3-wave push button coil pack, 30/-; 3-wave coil pack with RF stage, 39/-; 1/C coils, 2/- ea.; L.F. transformers, 2/6 ea.; output trans., 4/- ea.; 6/6in. loudspeakers with trans., 15/-; 8in. less trans., 17/6 ea. etc. Our prices are cheaper—we deal direct! Send for that item you want. We have it cheaper.—Roding Laboratories, Dept. W.70 Lord Ave., Ilford. [2078]

LASKY'S RADIO LEAD WITH THE BIGGEST BARGAINS

INDICATOR UNITS, TYPE 6E. Brand new in maker's cartons. Containing 7 new valves; EF50, and 3 EB34. 6in. cathode ray tube type VCR97 (short persistence). Numerous components, potentiometers, resistances, condensers, coils etc. Totally enclosed in grey metal case size: 18in. x 8 1/2in. x 7 1/2in. Weight 20 lbs. Whole unit is enamelled grey with coloured control knobs. **LASKY'S PRICE 90/- complete. Carriage 10/- extra.**

THE FAMOUS LORAN SET. Manufactured in the U.S.A. by Emerson.

INDICATOR UNIT. Contains 26 valves: 14 6SN7, 1 6J7, 8 6H6, 3 9317. 6in. cathode ray tube type 5CP1 (short persistence), 100 kc/s crystal. Dozens of various other components including resistances, condensers, etc. Unit enclosed in black crackle metal cabinet size: 12in. x 9in. x 10in. Weight 40 lbs. **LASKY'S PRICE 79/6. Carriage 20/- extra.**

RECEIVER UNIT. Contains 16 valves: 1 6SN7, 1 6SL7, 1 6H6, 1 6A7, 1 6J7, 1 6U4G, 4 6XK7, 3 6H4 (large output triodes), 2 2X2, 1 VR105. Hundreds of components, condensers, resistances, transformers, coils, potentiometers, etc. Unit is enclosed in metal cabinet black crackle finished size: 18in. x 8 1/2in. x 7 1/2in. Weight 30 lbs. **LASKY'S PRICE complete with all valves, 69/6. Carriage 7/6 extra.**

EX-U.S. ARMY. BRAND NEW in maker's carton. NATIONAL VIBRATOR POWER UNITS. Operating off 6 volts. Output 165 volts D.C. 80 mA (max.). Fully smoothed input and output. Contains Mallory vibrator pack 6 v., complete with vibrator and 6X5GT, or OZ4, (rectifier), output taken to a pin-socket. Circuit and working instructions supplied with each one. Totally enclosed in metal case, black crackle finish. Size: 6in. x 8in. x 10in. approx. Weight 17 1/2 lbs. **LASKY'S PRICE complete 59/6. Carriage 2/6.**

EK-A.M. RECEIVER TYPE 3515. (Containing 21 valves: 10 VR65, 1 EA50, 1 EB34, 7 VR66, 2 VR43. Hundreds of components, resistances, condensers, coils, etc. Also 1 Mc/s I.F. Strip. This strip can be removed and used as a separate unit. The whole unit is built on a strongly constructed chassis. Totally enclosed in grey metal case size: 14in. x 12in. x 9in. Weight 35 lbs. **LASKY'S PRICE 39/6. Carriage 4/6 extra.**

We regularly publish a complete "Bulletin" of our stock of Ex-Gov. gear, why not drop us a line, enclosing a 2jd. stamp and your name and address, and we will send it to you regularly. We also have a large stock of valves at B.O.T. list prices. We probably have the valve you have been scouring the country for. Let us know what you want and we will do our best to supply.

LASKY'S RADIO

370, HARROW RD., PADDINGTON, LONDON, W.9. (Opp. Paddington Hospital).

Telephone:- GUNNINGHAM 1979.
Hours. Monday—Sat. 9.30 a.m. to 6 p.m.
Thursday—Half-day.

THE WILLIAMSON AMPLIFIER

and **GOODMANS and BARKER BASS REFLEX CABINETS**

The above are now being demonstrated daily. Illustrated leaflets dealing with both are available on request.

The Williamson amplifier is built by craftsmen, the workmanship being of the finest standard, with Partridge transformers and chokes used throughout in its construction.

ROGERS DEVELOPMENTS CO.

106 HEATH STREET, HAMPSTEAD, LONDON, N.W.3.
Telephone: HAMPstead 6901

The "ADCOLA" Soldering Instrument



Designed for Wireless Assembly and Maintenance.

3 1/2" diam. Copper Bit, working temperature reached in 1 1/2 mins., consumption 25 watts, weight 2 1/2 ozs.

Supplied in voltage ranges from 6/7v. to 230 250v. Price 22/6 each.

British and Foreign patents pending.

Sole Manufacturers:

ADCOLA PRODUCTS LIMITED
Alliance House, Caxton Street, London S.W.1
Write or Phone: WHI. 0030.

TRANSFORMERS & COILS TO SPECIFICATION.

MANUFACTURED OR REWOUND
Filter Coils \pm 1% a Speciality.

JOHN FACTOR LTD.
9-11 EAST STREET, TORQUAY, DEVON.
Phone: Torquay 2162

WE OFFER

A large range of used and new Test Equipment, Converters, Recorders, Amplifiers, Motors, Transformers, etc.

All guaranteed and at very attractive prices.

We buy good modern used equipment of all types for spot cash.

UNIVERSITY RADIO LTD.
22 LISLE STREET, LONDON, W.C.2.
Tel.: GER 4447 & 8582.

COVENTRY RADIO

COMPONENT SPECIALISTS SINCE 1925

A FEW ITEMS FROM OUR 1948/9 COMPONENT CATALOGUE—ALL NEW, NO SURPLUS—

- Metal 8-8MFD 450 Volt Condensers ... 4/9
- Metal 30MFD 350 Volt Condensers ... 4/11
- Tubular 2MFD 350 Volt Condensers ... 1/9
- 100 Assorted 1/2 watt Resistors ... 15/6

Hundreds of bargains in our new list; do not fail to send for your copy now. 3d. post paid.

PROMPT SERVICE,
COMPLETE SATISFACTION.

COVENTRY RADIO
DUNSTABLE ROAD, LUTON, BEDS.

WEBB'S 1948 radio map of world, new multi-colour printing, with up-to-date call signs and fresh information, on heavy art paper, 4 6. post 6d; on linen on rollers, 11/6, post 9d.—Webb's Radio, 1-4 Soho St., W.1. Gerrard 2089.
BRANS' "Radio Valve Vade-Mecum," 1948 edition, two volumes, listing over 10,000 types, including CRTs, now available, price 18 6 post free, only one copy per address; also Brans' "Radoschema's" five volumes of circuits and servicing data for over 1,100 English and Continental radio receivers, Vol. 1 13 6. Vol. 2 17 6. Vol. 3 20 -. Vol. 4 14 -. Vol. 5 15/-, postage 10d per vol. extra; five volumes complete for £4, plus 2/6 postage and packing; remittance should accompany each order; all publications despatched direct from the publishers, Antwerp, Belgium; non-receipt within 30 days of acknowledgment should be notified to advertiser, not to publishers.—Peter Armstrong, 136, Bickenhall Mansions, London, W.1. (Welbeck 4893.)



COPPER WIRE. Enamelled, silk, d.c.c., etc. 13-42 S.W.G. TRANSFORMERS & CHOKES. Standards or Specials supplied. A.G. TURNTABLE UNITS. Now in stock. ALL COMPONENTS for the Radio and Television Constructor.

Send S.A.E. for list to:

STAN. HOLT,
349, HIGH ST., SMETHWICK, STAFFS.

TELEVISION SCANNING COILS



Technical Publication No. 29. Post FREE
HAYNES RADIO Ltd., Queensway, Enfield

A.B. OAK wafer switches

The wave-change switch with silver-plated double contacts.

A.B. METAL PRODUCTS LTD.,
Great South-West Road, Feltham, Middx.

VIBRO-ARC ELECTRIC METAL ENGRAVING TOOL

Engraves, etches, marks, writes... on

- BRASS, COPPER,
 - SILVER, NICKEL,
 - ALUMINIUM,
 - CHROMIUM.
- Hardened Steel



Operates from 4 or 6 v. Accumulator or A.C. Transformer.

Order with crossed P.O. or cheque.

Post Free. **BULLS (W)** 246 High St., Harlowden RM10. with full instructions.

B. & H. RADIO HUNTLEY ST., DARLINGTON

To those who want the best possible quality from Radio Set and Gramophone Record at the lowest possible price

we offer

THE VARIABLE SELECTIVITY 5

Ask your dealer or send S.A.E. for further particulars or complete diagram 3/-

RADIO BATTERY TESTER

Use "Quixo" method of battery testing.

Reliable results. Guaranteed.

Send for interesting leaflet R115 on battery testing.



RUNBAKEN • MANCHESTER

EDDYSTONE

'640' £27 10s. Od.

H.P. Terms available.

Full range of components.

All C.O.D. orders promptly executed. Send for Catalogue, 1/- post free.

SPECIAL OFFER

P.M. Speakers

5 inch 13.- 6 inch 14.- including packing and postage.

B.T.S.

THE Radio firm of the South.
63, London Road, Brighton 1, Sussex.
Phone: Brighton 1555.

TELEVISION

The advance in Radio Technique offers unlimited opportunities of high pay and secure posts for those Radio Engineers who have had the foresight to become technically qualified. How you can do this quickly and easily in your spare time is fully explained in our unique handbook "Engineering Opportunities." Full details are given of A.M.I.E.E., A.M.Brit.L.R.E., City & Guilds Exams, and particulars of up-to-date courses in Wireless Engineering, Radio Servicing, Short Waves, Television, Mathematics, etc., etc.

We Guarantee "NO PASS—NO FEE"

Prepare for to-morrow's opportunities and future competition by sending for your copy of this very informative 112-page guide NOW—FREE.

BRITISH INSTITUTE OF ENGINEERING TECHNOLOGY (Dept. 388)

17, Stratford Place, London, W.1

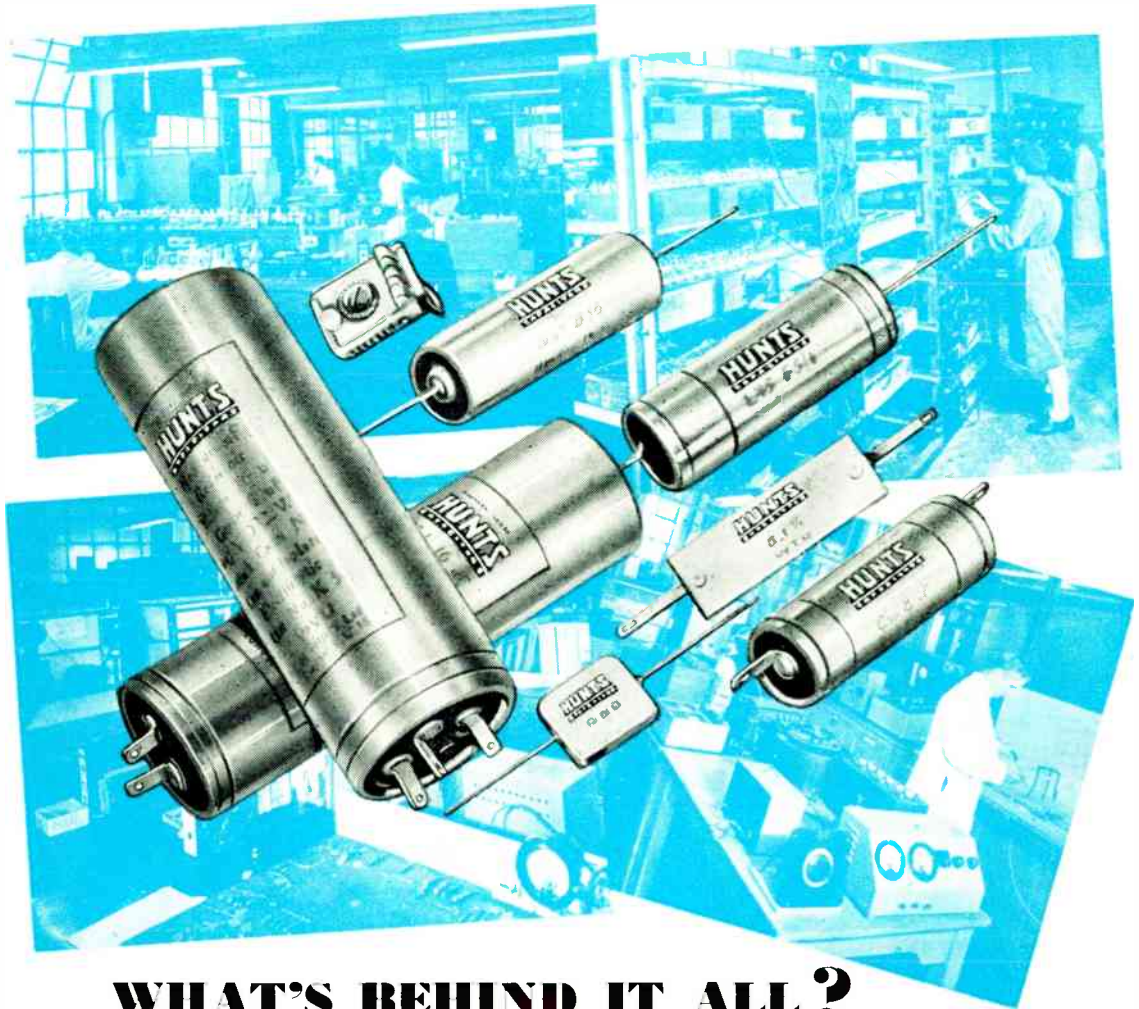

WHAT'S BEHIND IT ALL?

Extensive research laboratories, special design and development departments, wide manufacturing resources—all at your service, but not on your overheads! When you use any Hunt Capacitor, whether a normal type or as advanced as the Hunts exclusive Metallised Paper series, you are benefiting from



everything that Hunt's have achieved in many years of whole-hearted specialisation in capacitor design and manufacture. To specify Hunts as standard, to choose Hunts for replacements, to decide on Hunts for special purposes—all are the wise actions of people who demand nothing but complete reliability.

A. H. HUNT LTD · LONDON · S.W. 18
Established 1901

1 QUALITY
Ersin Multicore Solder is made to an accuracy of .002 of an inch. Only the purest tin and lead are used. Every stage of production is precision controlled. The flux contained in the three cores is Ersin, a high grade rosin subjected to a complex chemical process to increase its fluxing action.

2 STANDARD ALLOYS
Ersin Multicore Solder is supplied in Size 1 Cartons for service and maintenance purposes in two standard alloys. 40 60 Tin Lead is in most demand for general maintenance work, whilst for precision soldering on radio and telephone equipment, 60 40 Tin Lead is recommended.

3 CORES
The three cores of flux in Ersin Multicore provide thinner solder walls and ensure rapid melting thus speeding up soldering operations. The three cores also ensure flux continuity so that there is always a supply of flux available.

4 SPECIFICATIONS
Size 1 Cartons for Service Engineers are available in the four specifications shown below. Manufacturers are supplied on 7lb. reels in five alloys and nine gauges. Prices of bulk supplies on application

Catalogue Ref. No.	Alloy Tin Lead	S.W.G.	Approx. length per carton	List price per carton (subject)
C 16014	60 40	14	37 feet	6 0
C 16018	60 40	18	95 feet	6 9
C 14013	40 60	13	23 feet	4 10
C 14016	40 60	16	50 feet	5 3

ERSIN Multicore THREE CORE SOLDER
CONTAINS 3 CORES OF NON-CORROSIVE FLUX
MADE IN ENGLAND

YOUR INSURANCE
Whether you are manufacturing 10,000 radio receivers or repairing one, you can be sure of getting sound soldered joints when you use Ersin Multicore, "the Finest Cored Solder in the World".

MULTICORE SOLDERS LTD., MELLIER HOUSE, ALBEMARLE ST., LONDON, W.1. Tel: REGent 1411