

Wireless World

RADIO AND ELECTRONICS



FEB. 1947

1/6

Vol. LIII. No. 2

IN THIS
ISSUE:

WINDING TELEVISION DEFLECTOR COILS

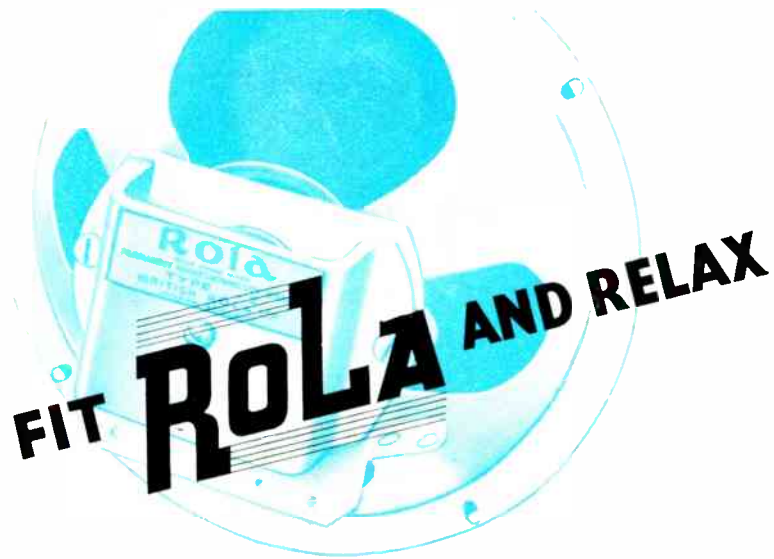

The Research Engineer knows that the best speaker for any set is one that offers complete reliability plus true tonal fidelity. After exhaustive tests his advice is always the same—fit Rola and re'ax!

ROLA SPEAKERS
THEIR QUALITY SPEAKS FOR ITSELF

BRITISH ROLA LTD • GEORGIAN HOUSE • BURY ST • ST JAMES'S • LONDON. S.W.1



AVO
REGD TRADE MARK

MODEL 7
UNIVERSAL
AvoMETER

MODEL 40
UNIVERSAL
AvoMETER

THE AVO
TEST
BRIDGE

THE "AVO"
VALVE TESTER

THE
ALL WAVE
"AVO" OSCILLATOR

RADIO manufacturers, service engineers, workshop and laboratory technicians are familiar with the precision and dependability of "AVO" Electrical Testing Instruments. Long years of successful experience in the design and manufacture of first-grade instruments have produced a consistently high standard of accuracy which has become a tradition as well as a standard by which other instruments are frequently judged.

THE AUTOMATIC COIL WINDER & ELECTRICAL EQUIPMENT CO., LTD.
WINDER HOUSE · DOUGLAS STREET · LONDON · S.W.1 TELEPHONE: VICTORIA 3404/7

WESTINGHOUSE
WESTALITE
L.T.
RECTIFIERS

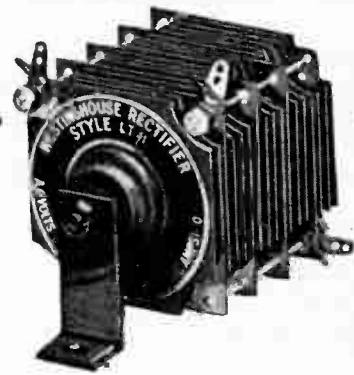

For
 BATTERY CHARGERS, TRICKLE
 CHARGERS, ANY APPLICATION
 WHERE A LOW VOLTAGE
 SUPPLY AT CURRENTS UP TO
 4 AMPS. IS REQUIRED FROM
 AN A.C. SOURCE.

Write to Dept. W.W. for a copy of data sheet No. 30.

Westinghouse Brake & Signal Co. Ltd., 82 York Way, King's Cross, London, N.1

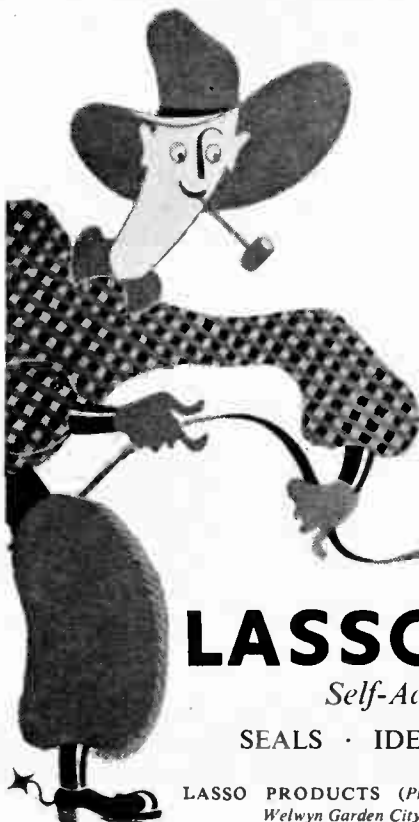

Lasso it . . .

Manufacturers requiring an airtight seal for containers; industries needing an easily attached name label; and engineering concerns seeking a quick way to identify components, will find Lassolastic Self-Adhesive Tape the answer to their problems.

With only light finger pressure, Lassolastic clings with binding firmness to any smooth dry surface—wood, rubber, metal, fibre or plastic. It is resistant to water, oil and solvents and, being slightly extensible, moulds itself to seams, beadings and other irregularities. In a wide range of indelible colours, either plain, or printed to suit any requirements. Printing cannot be erased. An informative booklet is free on request.

LASSOLASTIC

Self-Adhesive Tape

SEALS · IDENTIFIES · LABELS



LASSO PRODUCTS (Proprietors HERTS PHARMACEUTICALS LTD.)
 Welwyn Garden City, Herts. Tel: Welwyn Garden 3333 (6 lines)

(6)

THE FINEST CORED SOLDER IN THE WORLD
IS NOW AVAILABLE EVERYWHERE IN

The most convenient pack FOR THE RADIO AMATEUR AND SERVICE ENGINEER

NOTE THESE ADVANTAGES:

1. Ersin Multicore Solder wire pulls out as required without becoming tangled. Can be carried easily in service engineer's kit.

2. Windows enable user to see when contents are nearly exhausted.

3. Available in four specifications at fixed prices. Sold by length instead of weight.

Only Multicore Solder contains 3 cores of extra active non-corrosive Ersin Flux. No extra flux is required and joints can be readily made on oxidised surfaces. The 3 cores of Ersin Multicore ensure rapid melting and flux continuity, thus speeding up soldering operations and eliminating waste.



NEW SIZE 1
CARTON
Workshop Size.

Catalogue Ref. No.	Alloy Tin/Lead	S.W.G.	Approx. Length per carton	List Price per carton (subject)
C 16014	60/40	14	56 feet	s. d. 6 0
C 16018	60/40	18	151 feet	6 9
C 14013	40/60	13	36 feet	4 10
C 14016	40/60	16	83 feet	5 3

Available from leading radio shops. In case of difficulty write to:—

MULTICORE SOLDERS LIMITED
MELLIER HOUSE, ALBEMARLE STREET, LONDON, W.1. Tel.: REGent 1411

**THE
COSSOR
HIGH VACUUM
DOUBLE BEAM
OSCILLOGRAPH**

giving

VISUAL TWO-DIMENSIONAL
delineation of any recurrent law.

RELATIVE TIMING OF EVENTS
and other comparative measurements
with extreme accuracy.

PHOTOGRAPHIC RECORDING
of transient phenomena

and

SIMULTANEOUS INDICATION
of two variables on a common time axis.

Completely embracing all the above functions, of which the last is unique, the Cossor Double Beam Oscillograph is inherently applicable to all problems arising in

RECORDING, INDICATING & MONITORING
when the effects examined can be made available as a voltage.

**A. C. COSSOR LTD.,
INSTRUMENT DEPT.,
HIGHBURY, LONDON, N.5**

Phone: CA Nonbury 1234 (30 lines)
Grams: Amplifiers, Phone, London

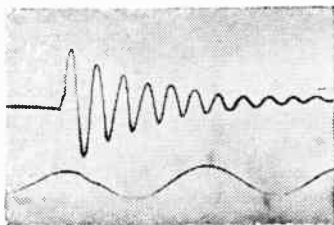

TIME ALONE WILL TELL!

**R.S. PUBLIC ADDRESS EQUIPMENT
IS DESIGNED FOR YOUR FUTURE**

The greatest test for any P.A. Equipment is TIME . . . how will it stand up to the passing of the years? We know that our equipment will pass this test with flying colours as it has done all others because it is designed for the future . . . your future. R.S. P.A. Equipment will give the utmost service for many years to come . . . the well thought-out design and specification of each component ensures it.

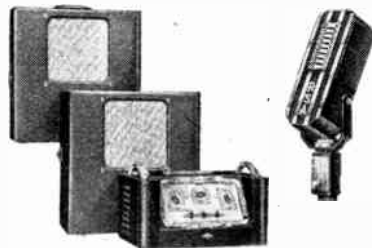

SEND TO-DAY
FOR FULLEST
INFORMATION

MICROPHONES		LOUDSPEAKERS
RADIO		RADIOGRAMS
AMPLIFIERS		PORTABLE EQUIPMENT

R.S. AMPLIFIERS, LIMITED
REYNOLDS ROAD, ACTON LANE,
LONDON, W.4. Phone: CHISWICK 1011

METALLISED CERAMICS

Two additions to the S.P. range of FREQUENTITE bushes



R.50650

R.50764

★ R.50844

★ R.50855

TYPE	A mms.	B mms.	C mms.	D mms.	E mms.
R.50650	9.5	9.5	6.4	6.25	2.75
R.50764	9.5	16.7	6.4	6.25	2.75
★ R.50844	9.5	12.7	9.5	6.25	2.75
★ R.50855	12.7	22.2	12.7	9.5	3.9

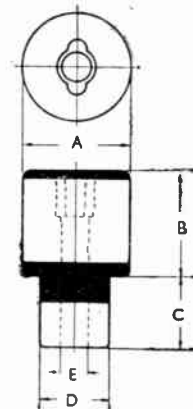

★ Recent additions to the range

For full information and prices please write to :

STEATITE & PORCELAIN PRODUCTS LTD.

STOURPORT-ON-SEVERN, WORCS. Telephone: Stourport III. Telegrams: Steatite, Stourport.



S.P.43

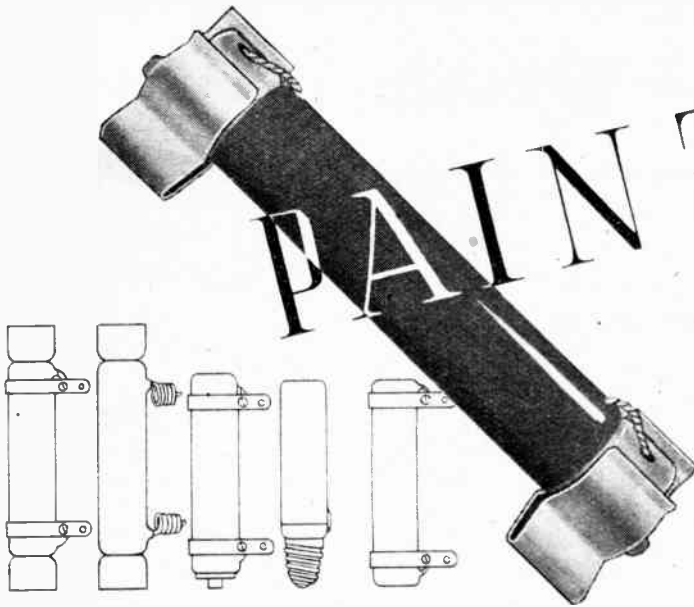

PAINTON

VITREOUS RESISTORS

These resistors comprise a ceramic former on which a winding of high grade alloy resistance wire is firmly held in position by a coating of durable vitreous enamel. The units are impervious to moisture, and type approval has been given for their use in the most severe tropical conditions.

Notable features are the variety of fittings available; the range of ohmic values, extending from $\frac{1}{2}$ ohm to 100,000 ohms; and the winding of the lower value resistances with nickel-copper wire of negligible temperature co-efficient.

The resistors are available in a variety of sizes ranging from 150 watts dissipation to the smallest type, which although only $\frac{1}{8}$ " long x $\frac{3}{16}$ " diameter, dissipates $4\frac{1}{2}$ watts, at a temperature rise of 250° C.

PAINTON & CO. LTD

KINGSTHORPE NORTHAMPTON

No. 1

POINTS OF LOW CONTACT RESISTANCE IN CIRCUIT DESIGN

CLIX

RADIO & TELEVISION COMPONENTS . . .

. . . ARE USED BY ALL THE LEADING SET MANUFACTURERS

BRITISH MECHANICAL PRODUCTIONS LTD.
21 BRUTON ST., LONDON, W.1
 Telephone : MAYfair 5543
Foremost in Valveholder design

RADAR—
TELEVISION—
ELECTRONICS

CLIX B9G valveholder for use with EF50, etc.
 Cat. No. VH359/9, Polystyrene Body.
 VH369/9, Ceramic Body.

BODY—Silica-loaded Polystyrene.

CONTACTS—Phosphor Bronze, silver plated.

SADDLE—Steel, zinc plated and passivated.



Queen of Loudspeakers

Main Details of the Range of
CELESTION PERMANENT MAGNET LOUDSPEAKERS

CHASSIS DIAMETER	MODEL	SPEECH COIL IMPEDANCE OHMS	POLE DIAMETER	FLUX DENSITY GAUSS	TOTAL FLUX	POWER HANDLING CAPACITY
2½"	P2V	3.0	7/16"	8,500	8,000	25W
3½"	P3C	3.0	¾"	7,700	24,000	1W
5"	P5Q	3.0	¾"	8,500	26,000	3W
5"	P5T	3.0		10,500	32,000	3W
6½"	P6Q	3.0	¾"	8,500	26,000	4W
6½"	P6T	3.0		10,500	32,000	4W
8"	P8D	2.3	1"	6,200	24,000	5W
8"	P8M	2.3		8,000	31,000	5W
8"	P8G	2.3		10,000	39,000	6W
10"	P10M	2.3	1"	8,000	31,000	6W
10"	P10G	2.3		10,000	39,000	8W
12"	P64	12.0	1¾"	12,500	140,000	15W
18"	P84	10.0	2½"	13,500	350,000	40W

From the range of Celestion Loudspeakers most manufacturers are able to meet their requirements. The smallest model, a midget weighing 3½ oz. is intended for small personal radios and the largest, capable of handling 40 watts, for public address purposes. Between these extremes, the range is balanced and well considered.

PUBLIC SALES

Several Loudspeakers of this range are available to the public in chassis form or housed in attractive cabinets. All enquiries for these must be directed to our sole wholesale and retail distributors, Cyril French Ltd.

SOLE DISTRIBUTORS

to the Wholesale and Retail Trades:
CYRIL FRENCH LTD.
29 High Street,
Hampton Wick,
Middlesex.
KINGSTON 2240.

CELESTION LTD., KINGSTON-ON-THAMES

SURREY • PHONE: KINGSTON 5656-7-8

Robert Sharp & Partners

C.1.

Webb's RADIO

Efficiency at HIGH FREQUENCIES

DENCO HORIZONTAL MOUNTING PLUG-IN COILS on polystyrene formers

Range. Approximate coverage in Mc.

1.	1—2	2 tuned	100 pf	Each range available in 4 types : "BLUE"—Grid and aerial windings (4-pin) ... 3/6 "YELLOW"—Grid and reaction or Primary (4-pin) ... 3/6 "GREEN"—Grid, reaction and Primary (6-pin) ... 4/6 "RED"—S.H. oscillator, 465 kc's (4-pin) ... 3/6
2.	2—4.5	"	100 pf	
3.	4—9	"	100 pf	
4.	7—18	"	100 pf	
5.	16—34	"	100 pf	
6.	30—60	"	50 pf	
7.	50—90	"	50 pf	
8.	70—125	"	50 pf	

Specify range and colour code when ordering Denco.

DENCO RIBBED LOW-LOSS FORMER	1/0
" " " fitted to 4-pin sub-base	2/0
" " " " 6-pin	3/0
" socket base 4-pin	1/0
" " 6-pin	1/6

3-GANG CERAMIC INSULATION TUNING CONDENSER, capacity 160 pf, with incomplete 5.M. mechanism needing adaptation (condenser with $\frac{1}{2}$ in. spindle readily detachable) ... 14/6

3-GANG PAXOLIN INSULATION TUNING CONDENSER, capacity 60 pf, with flexible coupler ... 7/6
SINGLE 200 P.F. TUNING CONDENSER paxolin insulation, complete with epicyclic drive ... 7/6

MULTI-RANGE METERS (ex-STOCK) :-

Avo Meter Model 40	£17 10 0
Taylor 85A—20,000 ohms per volt	£19 19 0
Avo Minor (D.C.)	£4 10 0
Avo Minor Universal A.C./D.C.	£8 10 0
Taylor Junior (1,000 ohms per volt A.C./D.C.)	£8 10 0
Evershed "Wee Megger"	£11 0 0

"SATOR" SILVER MICA CONDENSERS
 Recommended as precise and stable capacitors. To your own specified assorted values. Price per doz. 4/6

40 PF ... 3 per cent.	590 PF ... 1 per cent.
307 PF ... 1 per cent.	680 PF ... 1 per cent.
425 PF ... 1 per cent.	700 PF ... 10 per cent.
435 PF ... 10 per cent.	800 PF ... 1 per cent.
580 PF ... 1 per cent.	900 PF ... 1 per cent.

"WELWYN" HIGH STABILITY CARBON RESISTORS (1 watt) ... Price, each 2/6

10 ohms ... 5 per cent.	50,000 ohms ... 1 per cent.
100 ohms ... 1 per cent.	100,000 ohms ... 5 per cent.
1,000 ohms ... 2 per cent.	.25 meg. ... 1 per cent.
10,000 ohms ... 1 per cent.	.5 meg. ... 1 per cent.
25,000 ohms ... 2 per cent.	1 meg. ... 1 per cent.

"WELWYN" WIRE-WOUND RESISTORS.

AW 3111 (6 watts) 100, 250, 1,250, 5K, 15K ohms	2/9
AW 3112 (12 watts) 500, 750, 2,500, 12,000 ohms	2/9
AW 3124 (45 watts) 500, 1,000, 3K, 5K, 10K, 20K, 30K, 50K ohms	3/9
B. 3141 (115 watts) 10K, 20K, 25K, 30K, 50K ohms	3/-

Write, phone or call

14 SOHO ST., OXFORD ST., LONDON, W.1.

Phone : GERrard 2089. Shop hours : 9 a.m.—5.30 p.m. Sats. 9 a.m.—1 p.m.

A "Laboratory" INSTRUMENT... but NOT "Laboratory" Price!

The newest addition to the "Advance" range of Signal Generators places an instrument of laboratory class within the financial scope of every radio service engineer and experimenter.

The discerning engineer will appreciate its accuracy and stability, its exceptionally wide range which covers all frequencies required for radio and television receivers, and its accurate attenuating system which enables sensitivity measurements to be made on highly sensitive receivers up to 60 Mc/s. Send for fully descriptive pamphlet.



Price 19 Gns

Range: 100 Kc/s—60 Mc/s on fundamentals (up to 120 Mc/s on Second Harmonic).

Accuracy: Guaranteed within $\pm 1\%$.

Attenuation: Constant impedance system embodying a matched 75 ohms transmission line.

Stray Field: Less than 3 microvolts at 60 megacycles.

Illuminated Dial: Total scale length 30".

Power Supply: 110-210-230-250 volts.

Dimensions: 13" x 10 $\frac{1}{2}$ " x 7 $\frac{1}{2}$ " deep.

Weight: 15 lbs.

The New

Advance Signal Generator

ADVANCE COMPONENTS, LTD., Back Road, Sthernhall Street, Walthamstow, London, E.17. Telephone: LARKSwood 4366/7

ROTHERMEL

HIGH FIDELITY PIEZO-ELECTRIC PRODUCTS

available from stock.

- PICKUPS
- MICROPHONES
- HEADPHONES
- THE HUSHATONE
- DEAF AID MICROPHONES
- CONTACT MICROPHONES
- A.C. AMPLIFIERS

Also the new ROTHERMEL GENUINE SAPPHIRE High-Fidelity Gramophone Needle—over 2,000 playings.

Send for Informative Literature on all ROTHERMEL Products.

★ TWO NEW AMPLIFIERS

For many years R. A. ROTHERMEL has made intensive research in Amplifier design and we present with confidence two new A.C. Amplifiers, the VR/2 4 $\frac{1}{2}$ -watt and the HG/308 8-watt, which have been specially designed for use in connection with all types of Crystal Microphones and Crystal Pickups. They are compact, robust, and represent the ultimate in design, workmanship, material, and quality of reproduction.

Write for Bulletin.

R. A. ROTHERMEL LTD.,
 ROTHERMEL HOUSE, CANTERBURY ROAD, KILBURN, N.W.6.
 Telephone: MAIDA VALE 6066 (6 lines).

Radio Towers



This 600-foot steel radio tower, one of three which we built for the G.P.O., was designed by Blaw-Knox Ltd. The erection of such towers and masts demands a high degree of specialized knowledge and a vast experience. B. I. Callender's have built some of the tallest radio towers in existence and are prepared to undertake further work in any part of the World.

Further information is available on request.

BRITISH INSULATED CALLENDER'S CABLES LIMITED

NORFOLK HOUSE, NORFOLK STREET, LONDON W.C.2



The **PIFCO**
ALL-IN-ONE
RADIOMETER

tests everything electrical
**RADIO, HOUSEHOLD APPLIANCES
& MOTOR CAR LIGHTING ETC!**

25/-

Ask your local Factor to show you one of these remarkable instruments and to put your name down on his waiting list.

THE STATIC
CONDENSER Co. Ltd.

★ *Manufacturers of*
STATIC
CONDENSERS

TOUTLEY WORKS,
WOKINGHAM, Berks
Telephone: WOKINGHAM 708

CLARITY



PERSONIFIED

WITH THIS SENSITIVE
GRAMPIAN MIKE

The Gramplan M.C.R. Type Microphone reproduces voices with that crystal clearness which gives full value to every word and accentuates the "personality" of the speaker. Those who still have "make do" microphones on their P. A. Systems, should take advantage of this up-to-date, highly sensitive model which Gramplan are now in a position to supply. The M.C.R. is mounted in a spring suspension frame with the Unit Assembly housed in cast metal case. In crinkled black and nickel standard finish. Write for details now.



GRAMPIAN
LOUDSPEAKERS

Type M. C. R. Frequency Range 80-7,500 cycles. Sensitivity Minus 45 d.b. Impedance 20 ohms. Size 2½ ins. by 3½ ins. frame, 6 ins. square with Base Adaptor threaded ¼ ins. B.S.F. weight 3½ lbs. List £4. 4 - 0

GRAMPIAN REPRODUCERS LTD. Hanworth Trading Estate, Feltham
Phone: Feltham 2657 Telegrams: Reamp, Feltham. Middlesex

Scientific G12

WEIGHT REDUCING



THAT'S Fixed THAT! You may say the NB 1455 is obvious. So it is once it exists—like a lot of other good ideas. The Spire nut device is made part of the component and so these cable clips are screwed direct to their base without need of separate washer or nut. The NB 1455 was developed for a Government Department but it has found wide uses throughout industry.



WHEN you adopt some form of Spire fixing for a light assembly job, you certainly save weight. For one thing you won't need washers. For another the Spire nut is lighter than an ordinary nut. And if we can make the Spire device part of the component you won't even need a Spire nut. You may say that weight saving in your case is a minor matter any way. But is it a minor matter to cut out all that fiddling and fumbling with nuts and washers? Is the saving in cost a minor matter? Or the strength and permanence of the fixing?

Spire

(REGD.)

* **A BETTER way of fixing**

Simmonds Aeroaccessories Limited • Great West Road • London • A Company of the Simmonds Group



S E R I E S 1 0 0
M U L T I - R A N G E
T E S T S E T *by*

PULLIN

A Service Engineers' instrument, having very low consumption, i.e., 100 Microamps full scale on all voltage ranges A.C. and D.C. Sensitivity 10,000 Ohms per Volt.

The instrument is housed in a strong metal case with carrying handle and is complete with test leads and prods.

Ranges :—
Milliamps, D.C. only 2.5, 10, 25, 100 and 500.
Volts D.C. and A.C. 10, 25, 100, 250, 500 & 1000.
Resistance from 100 Ohms to 1 Megohm with 13,500 Ohms at mid scale. Price **£8.10.0.**



**MEASURING INSTRUMENTS
(PULLIN) LTD**

Address all enquiries to : Dept. J, Phoenix Works,
Great West Road, Brentford, Middlesex. Ealing 0011.

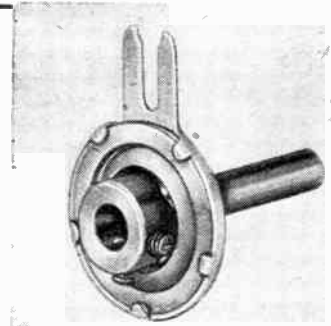

BALL DRIVE

- SMOOTH, RELIABLE & VERY POWERFUL
- Epicyclic friction drive, ratio 6 : 1
- May be used to increase ratios on other drives or attached direct to component spindle ($\frac{1}{4}$ " shaft).

PRICE 3/3 RETAIL



JACKSON

BROS (LONDON) LIMITED
KINGSWAY · WADDON · SURREY
TELEPHONE: CROYDON 2754-S TELEGRAMS: WALFILCO, PHONE, LONDON

★ AداSTRA ★
GALVANISED SECTIONAL STEEL
RADIO MASTS
Send for Catalogue W0/530
POLES LTD TYBURN RD ERDINGTON BIRMINGHAM 24



THE STANDARD OF TECHNICAL EXCELLENCE QUALITY AND RELIABILITY

Dubilier Capacitors have been known and selected by Radio Engineers since the early days of radio. The development and extension of their range during the years has proceeded step by step with, and often in anticipation of, the progress of radio and electronics. The result is that today Dubilier Capacitors cover, with the highest degree of efficiency, the entire field in which Capacitors are used.

With the rapid growth of scientific knowledge during the past few years, important internal improvements have been effected in the Dubilier range of Capacitors. Many of these improvements are not always apparent until the Capacitors are actually in use, but their excellent performance gives final proof of the essential quality of these improvements.

MAKERS OF THE WORLD'S
FINEST CAPACITORS

DUBILIER
CONDENSER CO. (1925) LTD.

DUBILIER CONDENSER CO. (1925) LTD., DUCON WORKS, VICTORIA ROAD, NORTH ACTON, W.3
Phone: Acorn 2241 Grams: Hilvoltcon, Phone, London. Cables: Hilvoltcon, London. Marconi International Code.



FIDELITY
EFFICIENCY

behind the blueprint...

..... lies Goodmans research, skill, craft and equipment. Goodmans take justifiable pride in a production organisation that faithfully interprets—for your service—the well-founded conclusions of their team of specialist acoustic engineers. That is why, Goodmans Loudspeaker performance is strictly “to specification,” why unfailingly it conforms to published data. *The 15ins. illustrated, handles 25 watts of undistorted power.*

GOODMANS
Loudspeakers

GOODMANS INDUSTRIES LIMITED, LANCELOT ROAD, WEMBLEY, MIDDX.

PYROBRAZE

has been designed to meet the increasing demand for a universal and portable electric soldering and brazing machine

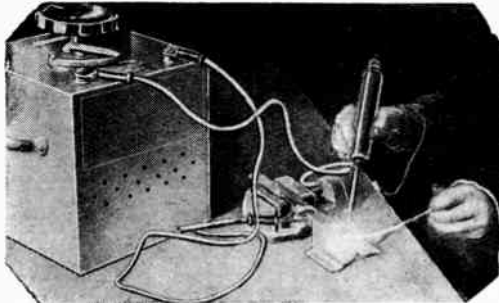

It is indispensable in every Factory or workshop where soldering has to be done.

Solders heaviest gauges of all metals and even heavy castings, where every soldering iron fails. Brazes up to 16 S.W.G.

PYROBRAZE 2 in operation

Represents the latest development in contact soldering

The AGRU
ELECTRIC TOOL MANUFACTURING CO. LTD.,
Manufacturers of speciality Electrical Apparatus
123 HYDE ROAD, ARDWICK, MANCHESTER, 12
Tel: ARDwick 4284

LABGEAR announce

“The RANGER”

OHMS
2.2 M
1.0 M
470 K
220 K
100 K
75 K
56 K
39 K
22 K
15 K
10 K
5.6 K
3.3 K
0.1 K VAR

CAPACITY
.00005
.0001
.0005
.001
.005
.01
.02
.05
.10
.25
1.0
8.0
16.0
25-50 V

MFDS

RESISTANCE

FOR COMPARISON CHECKING

- **TIME IS MONEY**—Why waste it looking
 - for components you require? Here they are, all
 - in one unit, ready at your elbow for instant use.
- Write now for list B. 2019 W.W. to*

WILLOW PLACE LABGEAR CAMBRIDGE, ENG.
Telephone No. 2494 (2 lines)
TEST EQUIPMENT for USE of RADIO ENGINEERS

PREMIER RADIO COMPANY

MORRIS & CO. (RADIO) LTD.

ALL POST ORDERS to 167 LOWER CLAPTON RD., LONDON, E.5. Phone: Amherst 4723
ALL CALLERS to 169 FLEET STREET, LONDON, E.C.4. Phone: Central 2833

Send 2½d. stamp for our September, 1946 list

Terms of Business: Cash with order or C.O.D. over £1

ITEMS MARKED WITH AN ASTERISK CAN BE SUPPLIED IN QUANTITY FOR TRADE OR EXPORT. PLEASE STATE QUANTITY REQUIRED WHEN MAKING AN ENQUIRY

MIDGET RADIO KIT. Build your own Midget Radio. A complete set of parts, including valves, loudspeaker and instructions. In fact, everything except cabinet necessary to build 4-valve Medium and Long Wave T.R.F. Radio operating on 200-250 v. Mains, A/C or D/C. Valve line-up, 6K7, 6J7, 25A6, 25Y5. Wavelengths covered 200-557 and 700-2,000. Size 10 x 6 x 6 in. Completely drilled chassis. Price, including tax, **£8 17s. 6d.***
An attractive bakelite cabinet can be supplied at 25/- extra.

SUPERHET MIDGET RADIO KIT. A complete kit of parts for a 5-valve superhet. Covers 18-50 and 200-557 metres. AC DC 200-250 v. 6K8, 6K7, 6J7, 25A6, 25Y5. Size: 10 x 6 x 6 in. Completely drilled chassis. Price, including tax, **£8 5s.**
An attractive bakelite cabinet can be supplied at 25/- extra.

COMMUNICATION RECEIVER KIT. We can accept orders for January delivery of our new 8-valve kit. Valve line-up 6K7, R.F. amp. 6KX Frequency Changer, 6K7 R.F.O., 6K7 1st I.F. amp., 6K7, 2nd I.F. amp. 6Q7 det. 6V6 output, 5Z4 rect. covers 13-10, 38-120, 200-557 metres, complete with drilled chassis. Crackle finish, steel cabinet, speaker, valves, etc. Price, including tax, **£18 18s.**
A 6-volt battery and a AC/DC version will be available shortly.

COMPLETE 1-VALVE LISTENING POST. Consists of 1-valve Receiver completely wired with coils covering 12-170 and 255-550 m. Valves, Headphones, Dry Batteries, Aerial Wire. Nothing else to buy. **£3 17s. 6d.***

2-VALVE, SHORT-WAVE BATTERY KIT. A complete kit of parts for 2-valve receiver, covering 15-600 metres, including valves, coils, drilled chassis, H.T. and L.T. dry batteries to last approximately 6 to 12 months. A pair of double headphones and full instructions. Price **£3 10s.***. An extra coil can be supplied, covering 600-1,900 metres at 4/-.

ALUMINIUM CHASSIS. Substantially made of bright aluminium, with four sides.

7 x 3½ x 2½ in.	4/8	9½ x 4½ x 2½ in.	5/6
10 x 8 x 2½ in.	7/6	10 x 9 x 2½ in.	7/9
14 x 9 x 2½ in.	8/3	16 x 8 x 2½ in.	8/6
20 x 8 x 2½ in.	10/6	22 x 10 x 2½ in.	13/6*

FERRANTI MOVING COIL METERS. 2½ in. diameter, flush mounting, calibrated 0-500 microamps. **21.***

LOUDSPEAKERS

Trans.	Make	Diam.	Capa.	Coil	Price
Nil	Rola	5½ in.	2w.	2-5 P.M.	21/6
Nil	Rola	6½ in.	3w.	2-3 P.M.	22/6
Nil	Rola	8½ in.	4w.	2-3 P.M.	24/-
Pentode	Rola	6½ in.	3w.	2-3 1140 ohms	35/-
Nil	Grampian	9 in.	6w.	15 P.M.	38/-
Pentode	E.A.	10½ in.	5w.	2-3 P.M.	45/-
Nil	Celestion	10 in.	4w.	4-5 2100 ohms	50/-
Nil	Goodmans	12 in.	15w.	15 P.M.	£6 15/-
Nil	Vitavox	12 in.	12w.	15 P.M.	£7
Nil	Vitavox	12 in.	20w.	15 P.M.	£11*

RADIOGRAM CABINETS



Dignified appearance and good workmanship. Size, 34½ in. high, 18 in. deep, 36 in. wide. Cabinet only **£26**, with motor and pick-up, **£32 16s.**

PREMIER MAINS TRANSFORMERS. All primaries tapped 210-250-260 v. All I.T.'s centre tapped. All have screened primaries.

	Output	Price
175-0-175 v. 50 m/a.	6.3 v. 2-3 a. 5 v. 2 a.	25/-
175-0-175 v. 50 m/a.	4 v. 1 a. 4 v. 2-3 a.	25/-
250-0-250 v. 60 m/a.	6.3 v. 2-3 a. 5 v. 2 a.	25/-
250-0-250 v. 60 m/a.	4 v. 1-2 a. 4 v. 3-5 a.	25/-
300-0-300 v. 60 m/a.	4 v. 2-3 a. 4 v. 3-5 a. 4 v. 1-2 a.	25/-
350-0-350 v. 100 m/a.	5 v. 2-3 a. 6.3 v. 2-3 a.	29/-
350-0-350 v. 100 m/a.	4 v. 2-3 a. 4 v. 3-5 a. 4 v. 3-5 a.	29/-
350-0-350 v. 150 m/a.	4 v. 1-2 a. 4 v. 2-3 a. 4 v. 3-5 a.	36/-
350-0-350 v. 150 m/a.	4 v. 2-3 a. 4 v. 3-5 a. 4 v. 1-2 a.	39/-
350-0-350 v. 150 m/a.	5 v. 2-3 a. 6.3 v. 2-3 a. 6.3 v. 2-3 a.	36/-
420-0-425 v. 200 m/a.	4 v. 2-3 a. 4 v. 2-3 a. 4 v. 3-5 a.	47/-
425-0-425 v. 200 m/a.	6.3 v. 2-3 a. 6.3 v. 3-5 a. 5 v. 2-3 a.	47/-
500-0-500 v. 150 m/a.	4 v. 2-3 a. 4 v. 2-3 a. 4 v. 2-3 a.	47/-
500-0-500 v. 150 m/a.	4 v. 2-3 a. 4 v. 3-5 a.	47/-
500-0-500 v. 150 m/a.	5 v. 2-3 a. 6.3 v. 2-3 a. 6.3 v. 3-5 a.	50/-
500-0-500 v. 250 m/a.	5 v. 2-3 a. 6.3 v. 2-3 a. 6.3 v. 3-5 a.	65/-
300-0-300 v. 120 m/a.	5 v. 2-3 a. 6.3 v. 3-4 a.	28/-
300-0-300 v. 120 m/a.	4 v. 2-3 a. 4 v. 2-3 a. 4 v. 3-5 a.	28/-
375-0-375 v. 250 m/a.	6.3 v. 2-3 a. 6.3 v. 3-5 a. 5 v. 3 a.	46/-
375-0-375 v. 250 m/a.	4 v. 2-3 a. 4 v. 2-3 a. 4 v. 3-5 a.	46/-
750-0-750 v. 250 m/a.		67/6
1,000-0-1,000 v. 200 m/a.		70/-

COLLARO PORTABLE RECORD PLAYERS. Consist of a super quality induction type gramophone motor 200-250 v. A/C with autostop and high-grade magnetic pickup. Mounted in a leatherette carrying case. Price **£11 5s.** A few only. Delivery from stock.

MANSBRIDGE TYPE CONDENSERS. Huge purchase of Military Surplus Paper Condensers. Super quality, oil filled.

Capacity	Working Voltage	Size H	Price Each	Per Doz.
2 mf.	1,000	4½ x 1½ x 1	2/6	20/-*
2 mf.	600	3½ x 1½ x 1	1/3	10/-*
1 mf.	600	2½ x 1½ x 1	1/-	8/-*

GRAMOPHONE PICK-UPS.

Bothwell Senior Crystal Pick-up, **£2 18s. 3d.**
Cosmopolitan Crystal Pick-up, **£1 17s.**
Goldring Magnetic Pick-up, **£1 10s. 6d.**

OUTPUT TRANSFORMERS. A super production. By means of ingenious series-parallel arrangements, all windings are used at all times. Match any tube, single or push-pull to any voice coil 2-30 ohms. 7 watt, 22/6; 15 watt, 30/-; 30 watt, 49/6; 60 watt, 59/6. **TYPE 103.** Rotary Transformer. Normal rating is 15 v. D/C input. Output 300 volts 30 m/a and 6.5 volts 3 a. D.C. By applying between 200 and 250 volts D/C to the H/T output side, the two low-tension windings may be used to charge accumulators. The 18-volt side will charge a 6-volt accumulator at 2-3 amps, the 6.5 side a 2-volt accumulator at 1-2 a. With a 12-volt input to the 18-volt side, 180 v. at 30 m/a and 4 v. at 3 a. may be obtained. With a 6-volt input to the 6.5 side, 160 v. at 30 m/a may be obtained. By extending the spindle which is flush with the frame and applying 200 to 250 v. D/C mains to the 300 v. side, the unit becomes a powerful high-speed electric motor, suitable for small drilling machines, etc. Similarly, it may be used with 6 or 12 v. input to the 6.5 v. or 19 v. side. It employs a powerful ring magnet and is of substantial construction costing originally over **£5**. A fortunate purchase enables us to offer these fine units at **10/-**.

TYPE No. 111. A Rotary Transformer designed for the input of 6 or 12 volts D/C. With 6 volts input the output is 200 v. 50 m/a. With 12 v. input the output is 480 v. 40 m/a. These ratings are continuous. This unit may be run for up to 3 hours with 12 v. input when 80 m/a may be drawn at 400 v. **20.***

TYPE 101. A ½ h.p. motor coupled on a bedplate to a 250-watt generator. Input 12 or 24 v. D/C. Output 850 or 1,700 v. 150 m/a. Complete with starter. **£8***. Motor only available at **£4 10s.***

TYPE 100. A Rotary Transformer with completely smoothed output, contained in a soundproof metal screening box. Input 6 v. D.C. output 220 v. 50 m/a D/C. **£3 10s.***

TYPE 106. A Rotary Transformer with extremely efficient smoothing, contained in a steel case. Input 12 v. D/C. Output 240 v. 100 m/a. **£3 10s.**

TYPE 113. A Rotary Transformer input 6 or 12 volts. With 12 v. input, output is 600 v. 250 m/a, with 6 v. input, output is 300 v. 200 m/a. **£3***

TYPE 114. Input 6 v. D/C. Output 230 v. 50 cycles A/C 30 w. **45/-***

TYPE 115. Input 6, 12 or 24 v. Output 200, 500 or 1,200 v. 72 m/a. **40/-***

Perfect by Ardenite

Simplification

Ardenite have the most modern Public Address systems—fixed or mobile—for EVERY purpose, indoor or out. Combining technical quality with attractive appearance, the wide range available represents the very finest P.A. Equipment obtainable to-day. Simple to operate, easy to instal.

● Write for trade terms direct to Sales Manager.

ARDENITE ACOUSTIC LABORATORIES LTD.
London Office: 309, OXFORD ST., W.1. Mayfair 1380.
Works: GUILDFORD, SURREY. Guildford 3278-D.



CLEAR AS
THE BELL OF
BIG BEN
WHEN YOU'RE
USING

Exide
L.T. ACCUMULATORS
AND
Drydex
H.T. BATTERIES

*The perfect pair for
battery Radio sets*

THE CHLORIDE ELECTRICAL STORAGE CO. LTD.,
CLIFTON JUNCTION, NR. MANCHESTER

BDX3D

**SWITCHES ARE
CONDEMNED**

to
*Hard Labour
for Life —*



**OAK EXCLUSIVE
DOUBLE CONTACT
SELF-ALIGNMENT
ENSURE RELIABILITY**



OAK
SWITCHES

★ Only genuine when
bearing these Potent Nos:—
478391, 478392 NSF OAK.

Head Office & Export Sales:
BRITISH N.S.F. CO. LTD., Keighley, Yorkshire
London Office: 9 Stratford Place, W.1. Phone: MAYfair 4234.
(Sole Licencees of OAK Manufacturing Co., Chicago)



**THE COMPLETE SERVICE
FOR SOUND RECORDING
AND REPRODUCTION**

- ★ Mobile and Static Continuous Recording Outfits.
- ★ Recording Amplifiers.
- ★ Moving Coil and Crystal Microphones.
- ★ Sapphire Cutting and Reproducing Stylus.
- ★ Blank Recording Discs from 5" to 17" Single or Double sided.
- ★ Light-weight moving iron, permanent sapphire and "Lexington" moving coil pick-ups.
- ★ Label and Envelope Service.
- ★ A comprehensive range of accessories to meet every requirement of the sound recording engineer.
- ★★ And our latest development (of special interest to users of sapphire or delicate pick-ups)—The **Simetrol**. This is a controlled micro-movement easily fitted for use with any type of pick-up to eliminate the danger of damage to the record or pick-up. This is achieved by a vernier lowering action of the pick-up head to the record.

*Write for comprehensive lists or call at
Recorder House for demonstration.*

**RECORDER HOUSE, 48/50 GEORGE ST.,
PORTMAN SQUARE, LONDON, W.1.**
Telephone: WEL 2371/2 Telegrams: Simsale, Wesdo, London

EDDYSTONE AND THE AMATEUR

IMPORTANT ANNOUNCEMENT

We have known for some time the urgent requirement for a first-class Communications Receiver essentially for Amateur use. In collaboration with expert Amateurs, men who are fully alive to the exacting and special needs of the Amateur movement, we have designed just such a receiver. This new receiver is the "EDDYSTONE" '640'. It is BRITISH throughout. The star features are:—

- ELECTRICAL BAND SPREAD
- OUTSTANDINGLY GOOD SIGNAL-TO-NOISE RATIO
- EXCEPTIONALLY HIGH IMAGE RATIO
- ADAPTOR TO ALLOW FOR LOW VOLTAGE OPERATION

In addition, the set possesses everything expected in a first-class Amateur Bands Communications Receiver, i.e., Crystal Filter, 1,600 Kc/s I.F. High Gain R.F. Stage. Adjustable B.F.O. Stand-By-Receive switch and provision for "S" meter. Construction follows the traditional Eddystone high standard which is already well known and universally accepted.

Although this receiver will not be available for some months, we feel that you should know of its existence. We are not making any rash promises regarding supplies, but you may be sure that the "Eddystone" staff are doing their utmost to bring about its release and we aim to have this set distributed to all Registered "Eddystone" Retailers by August, 1947.



STRATTON & Co., LTD

EDDYSTONE WORKS

WEST HEATH

BIRMINGHAM 31



NEW WESTON DEVELOPMENTS

No. 1. *First Grade Moving Coil Switchboard Instruments*

An extremely sensitive but well damped movement . . . new type spring loaded jewels . . . magnetic shielding . . . dust and moisture proof bakelite cases . . . boldly figured 6 inch scales . . . guaranteed First Grade accuracy . . . These are some of the features of the latest Weston switchboard instruments which combine the sensitivity of a laboratory instrument with the robust qualities of a switchboard pattern. They are available in the D.C. Moving Coil, H.F. Thermocouple and A.C. Rectifier Types, and are supplied as Microammeters, Milliammeters, Millivoltmeters, Ammeters and Voltmeters in a wide variety of ranges from values as low as 50 Microamps D.C. All the instruments conform with British Standard Specification No. 89. Please ask for details of Models S57, S58 and S59.



SANGAMO WESTON LIMITED

GREAT CAMBRIDGE ROAD, ENFIELD, MIDDLESEX • Telephone: Enfield 3134 & 1212

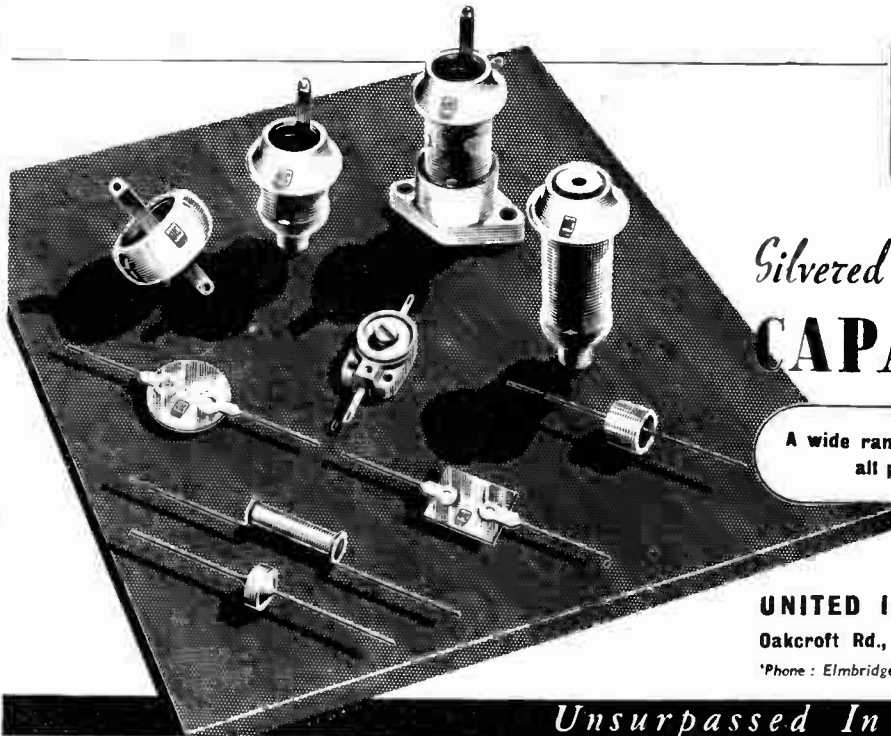

U.I.C.

Silvered Mica & Ceramic
CAPACITORS

A wide range of types for
all purposes

UNITED INSULATOR CO. LTD.

Oakcroft Rd., Tolworth, Surbiton, Surrey

*Phone : Elmbridge 5241 *Grams : Calanel, Surbiton

Unsurpassed In Ceramics

AERIALS

"EXSTAT"
SHORT-WAVE
TELEVISION
CAR RADIO

STOCKED BY ALL THE
LEADING DEALERS

ANTIFERENCE
LIMITED

SALES DIVISION:
67, Bryanston St., Marble Arch, London, W.1
Telephone : Paddington 7253/4.



Pioneers in public address loudspeakers, TRUVOX now introduce a range of permanent magnet radio speakers of unique and very efficient construction under the name "MONOBOLT". First supplies, in 5", 6½", 8" and 10" sizes, will be available to the radio amateur early in the New Year.

TRUVOX
ENGINEERING CO. LTD.

- Entirely new patented construction with single bolt fixing of components concentrically locates the chassis and complete magnet assembly.
- Brass centring ring prevents magnet being knocked out of centre.
- Special magnet steel gives powerful flux with compactness and light weight.
- Speech coil connections carried to suspension piece, ensuring freedom from rattles, cone distortion and cone tearing.
- Clean symmetrical surfaces, no awkward projections.
- Speech coil and former bakelised to prevent former distortion and speech coil turns slipping or becoming loose.
- Two point fixing to the suspension piece with four point suspension for the speech coil.
- Widely spaced fixing points for the suspension permit maximum movement of the cone, producing the lowest response physically obtainable from each size of speaker.

TRUVOX HOUSE, EXHIBITION GROUNDS, WEMBLEY, MIDDX.

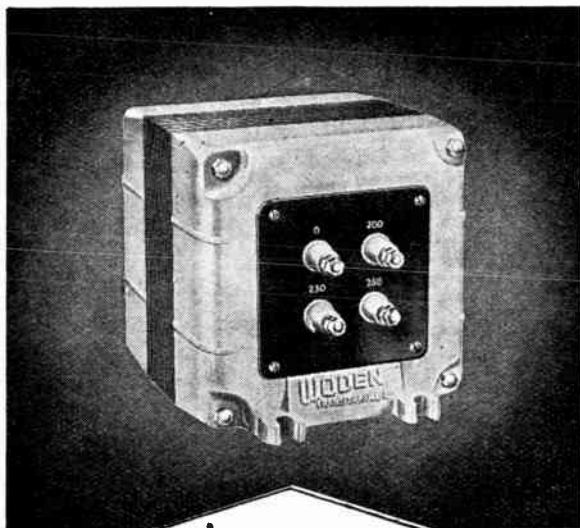

HERE IS THE NEW
TRANSFORMER
 THAT HAS *Everything!*

- SUPERB TECHNICAL DESIGN
- FINEST QUALITY MATERIALS
- HIGH OPERATIONAL EFFICIENCY
- GUARANTEED RELIABILITY
- BEAUTIFUL APPEARANCE

BRIEF DETAILS OF THE RANGE
 Mains Transformers, 5—5,000 Watts ; Input and Output Transformers : Filter Chokes.

. . . . AND OF THEIR CONSTRUCTION
 High Quality Silicon iron laminations ; wire to B.S.S. Standards ; finest grade insulation ; Die Cast Streamline Shrouds ; Black bakelite Terminal panels ; High Vacuum Impregnated coils layer wound with condenser tissue interleaving ; Porcelain terminals Insulated and/or silver plated soldering tags.

WODEN *de Luxe*
TRANSFORMERS

WODEN TRANSFORMER CO. LTD.,
 MOXLEY ROAD, BILSTON, STAFFS.
 Telephone : BILSTON 4188

A NEW
OSCILLOSCOPE



TYPE 1684B

PRINCIPAL FEATURES

- ★ TUBE. 3½ in. diam. Blue or green screen.
- ★ Shifts. D.C. thus instantaneous on both axes.
- ★ AMPLIFIERS. X and Y amplifiers are similar. D.C. to 3 Mc/s 24 mV. r.m.s. per cm. or D.C. to 1 Mc/s 8 mV. r.m.s. per cm.
- ★ TIME BASE. 0.2 c/s. to 200 Kc/s. Variable through X amplifier 0.2 to 5 screen diameters. Single sweep available.

The Type 1684B Oscilloscope has proved itself an exceptionally useful Instrument in the television laboratory—it is provided with high gain, wide band amplifiers on both axes which serve to portray pulses such as those associated with television excellently and good pulse widths are obtainable on the screen.

PRICE £100



FURZE HILL LABORATORIES LTD

TELEPHONE
 ELSTREE
 1137

BOREHAM WOOD
 HERTS

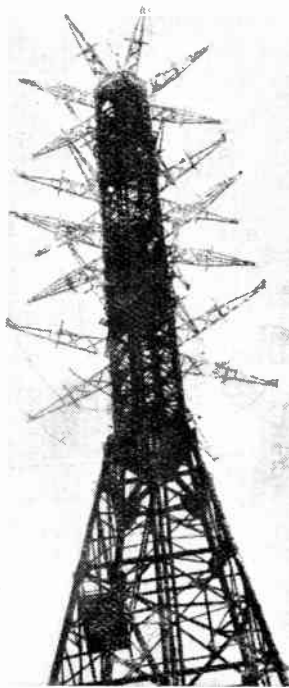

TELCON R.F. CABLES

for all Television and Radio requirements

CABLE			CHARACTERISTICS
CODE AS 72 M	Z ₀ 120 140 ohms.	CAPACITY 9.5 μ u.F per foot.	ATTENUATION At 1 Mc/s 0.5 db/100 Ft. " 10 " 1.7 " " " " 100 " 5.0 " " "

DIAMETER :—0.225 inches.
"TELCO" Dielectric

TYPE :—
Flexible. PVC Sheath

Further details of this and other R.F. Cables on application

THE TELEGRAPH CONSTRUCTION & MAINTENANCE CO. LTD.

Founded 1864

Head Office : 22 OLD BROAD ST., LONDON, E.C.2. Tel : LONDON Wall 3141
Enquiries to TELCON WORKS, GREENWICH, S.E.10. Tel : GREENWICH 1040



ISOLATION FROM VIBRATION

NEW
VIBRATION
ELIMINATORS

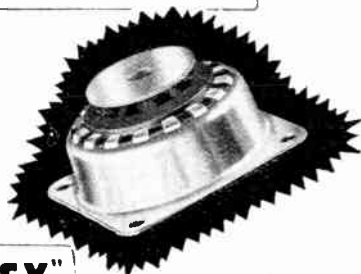

"EQUIFLEX"
PATENTED AND FOREIGN PATENTS PENDING
MOUNTINGS

AN **AV** PRODUCT

electrical apparatus, motors, etc., and wherever elimination of vibration and shock is required.

SPECIAL FEATURES

Flexible in all directions at an equal deflection. Can be loaded on any side, thus eliminating vibration in Vertical, Horizontal and Longitudinal planes employing best quality natural rubber spring elements and complete with snubbing device. Special Fittings made to suit customers' requirements.

Also available as previously advertised, the ALL-METAL construction comprising an ingenious Damped Spring System.

Illustrated brochure shortly available.
Write us to be placed on the mailing list.

A. WELLS & CO. LTD. (Dept. W.W.),
STIRLING ROAD, WALTHAMSTOW, LONDON, E.17
Phone : Larkwood 2691

"Equiflex" Mountings are invaluable for the mounting and suspension of machines, equipment, instruments,



Manufacturers
of
LOUDSPEAKERS
•
LAMINATIONS
•
SCREENS
In
RADIOMETAL
•
PERMALLOY
•
SILICON ALLOYS

ELECTRICAL SOUND & TELEVISION PATENTS LTD.
12, Pembroke Street, London, N.1. Terminus 4355
2/4, Manor Way, Boreham Wood, Herts Elstree 2138

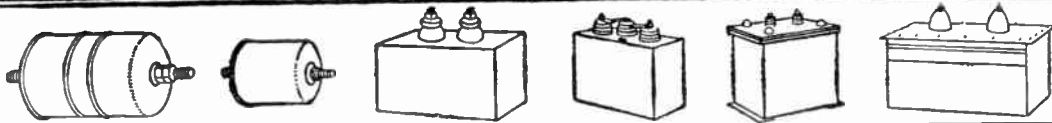

Wego CAPACITORS

★ CALCULATED TO ANSWER
THE MOST EXACTING DEMANDS

★ FOR ALL RADIO
AND ELECTRICAL PURPOSES

WEGO CONDENSER CO LTD · BIDEFORD AVE · PERIVALE · GREENFORD · MIDDX · Tel. PERIVALE 4277



MARCONI INSTRUMENTS LTD
pioneer designers of
Communications Test Equipment
can now supply their

VALVE VOLTMETER TYPE TF428B

The instrument measures
both direct and alterna-
ting currents at audio
and radio frequencies; its performance
exemplifies Marconi proficiency in com-
munications technique.

**FOR
IMMEDIATE
DELIVERY**

Full specification available on request.

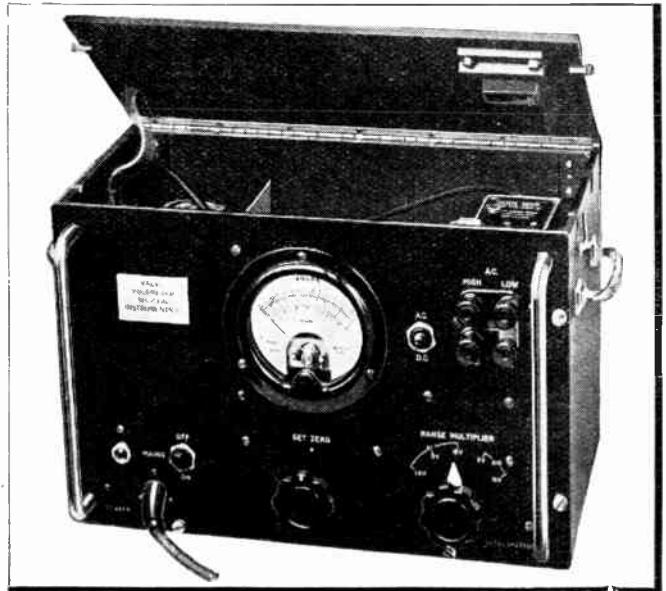

MARCONI INSTRUMENTS LTD

ST. ALBANS, HERTS. Phone: ST. ALBANS 4323/6

Northern Office: 30 ALBION STREET, HULL. Phone: Hull 16144

Western Office: 10 PORTVIEW ROAD, AVONMOUTH. Phone: Avonmouth 438 Southern Office: 109 EATON SQUARE, LONDON, S.W.1. Phone: Sloane 8615

Rm UNIVERSAL OUTPUT TRANSFORMER TYPE U.O.T. 41

Available through usual Wholesalers

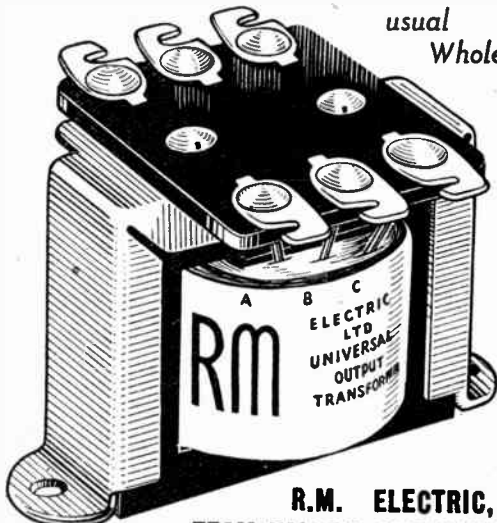

R.M. ELECTRIC, LTD.
TEAM VALLEY, GATESHEAD, 11.

M.R. SUPPLIES Ltd.

*We only bring new and guaranteed material, with immediate delivery from stock. All prices nett.

RECTIFIERS (Instrument type) Westinghouse 1 m.a. and 5 m.a., either, 12/6. Also the new miniature S.T.C. (Selenium) 2 m.a., 5 m.a., 25 m.a. and 75 m.a., any one, 10/-.

RECTIFIERS (High Tension). 25 v. 100 m.a. FW (For Relays), 4/6. 130 v. 40 m.a. (HW or bridge), 8/6. 280 v. 80 m.a. HW, 16/- (All by STC). Also the new STC high voltage selenium Rectifiers for CRT work, all HW. 1,000 v. 4 m.a., 13/9. 2,000 v. 4 m.a., 25/-, 1,000 v. 10 m.a., 37/6. 2,000 v. 10 m.a., 63/-.

RECTIFIERS (L.T. for charging, etc.). All for charging up to 12 v. All FW. 1.5 amp, 12/6 (A), 4 amps, 22/6 (B), 6 amps, 39/6 (C), 10 amps, 49/6 (D). The letters refer to appropriate Transformers—below. Also 26 v. 5 amps, 82/6 (desp. 1/6), and 30 v. 8 amps, 24 17/6 (desp. 2/-). All of the above rectifiers are the latest products of Standard Telephones and Cables, Ltd.

STEP-DOWN MAINS TRANSFORMERS. All primaries tapped 200/230/240 v. Sec.—7, 11 and 15 v. at 2 amps (A), 22/-, 6, 8 and 14 v. at 4 amps (B), 32/6. 5, 12 and 17 v. at 6 amps (C), 5 1/6 (des. 1/6), 7 and 15 v. at 10 amps (D), 77/6 (des. 2/-). **HEATER TRANSFORMERS**, Prim. 200/240 v. (tapped), sec. 6.3 v. 5 a., CT and 5 v. 3 amps, 29/6.

BATTERY REESTATS. Space saving, front of panel mtg. (3-holes). Large range. 5 examples:—5 ohms 3 amps, 22/-, 4 ohms 4.5 amps, 23/6. 1,500 ohms 0.25 amp, 25/6. 118 ohms 1 amp, 25/6. Also double former type (same mtg.), 10 ohms 3 amps, 28/6. 230 ohms 1 amp, 32/6. 920 ohms 0.4 amp, 31/6. These are exceptionally well constructed, with 2 1/2 in. control knob, continuously rated.

PANEL AMMETERS, by well-known maker, 2 1/2 in. flush panel, 0/10 amps D.C., 13/6. P.O. type RELAYS (Brand new ex Govt.). Large selection. Examples:—Coil 250 ohms, 2-pole make, 5/-, 250 ohms, 4 makes, 6/-, 2,000 ohms 1-pole C.O. and 1 make, 6/6. **LUNDEL RELAYS**, with 6 v. D.C. or 230 v. A.C. coil (please state which required) and 10-amp mercury switch 1-pole make, in steel housing, with terminal blocks, 47/6.

VIBRATOR PACKS. Input 6 v. D.C. Fully smoothed output 200 v. 100 m.a. in steel cabinet 8 1/2 in. by 6 1/2 in. by 5 in., with fuses, switch, etc., very efficient units for mobile radio, 25 10/- (des. 2/-).

MINIATURE PIEZO-CRYSTAL MICROPHONES (Rothermel-Brush). Only 1 1/2 inches diameter, with 5 megohm loading incorporated, made for deaf-aids but suitable for all mic. purposes, 29/6.

PULSE TRANSFORMERS, prim. 200/220/240 v. Sec.—350/0/350 v. 150 m.a., 4 v. 5 a., 4 v. 3 a., in cast brackets with terminal board, 35/-, Also 450/0/450 v. 150 m.a., 6.3 v. 4 a., 6.3 v. 2 a., 5 v. 3 a., in brackets with loose leads, 45/-, Also 260/0/260 v. 75 m.a., 6.3 v. 3 a., 5 v. 3 a., 27/6. Special c.f.r.x Admiralty, Prim. 230 v. Sec.—500/0/500 v. 170 m.a. (250 m.a. can be safely drawn) 4.4 a. CT., 35/ (des. 2/6).

L.F. CHOKES:—5 henries with 300 m.a. passing, in cast brackets with terminal board, 75 ohms, 32/6. 30 henries 100 m.a. 500 ohms, fully shrouded, 21/-, 1/6.

R THERMEL PIEZO-CRYSTAL PICKUPS, Replacement Heads for Garrard and Collare arms, giving much improved performance and minimum record wear, 46 1/2.

R THERMEL SAPPHIRE GRAMO-NEEDLES, the best permanent needle for any pickup, 12/6 each.

HEAVY DUTY OUTPUT TRANSFORMERS. The improved 'W.W.' model handling up to 95-watts, 1:1 ratios from 12:1 to 75:1 with c.t. for P.P. Tapped prim. and sec. Weight 6 1/2 lbs. Undoubtedly the best for high fidelity work. 59/6 (desp. 1/6).

IN STOCK:—Vitamox K12/10 (27) and K12/20 (21) Speakers, G.E.C. Omnidirectional Speakers for central suspension, 210. Stuart Turner Electric Water Pumps, 120 g.p.h., 25/6.-; 300 g.p.h., 28 12/6.

Please include sufficient for packing and despatch.

M.R. SUPPLIES Ltd., 68, New Oxford Street, London, W.C.1
Telephone: MUScum 2938

SPHERE INSTRUMENTS

Introducing the

ALL WAVE

TYPE 505

SIGNAL GENERATOR

A portable Signal Generator for AC. Mains operation. Specially developed by SPHERE as a high class instrument, for general Laboratory and Workshop use, it is the ideal instrument for the aligning and testing of radio receivers and amplifiers.

This is a specially designed Generator embodying several new and unique features and improvements, which radio engineers will find invaluable.

All "SPHERE" Test-instruments are entirely British made with highest quality materials and workmanship, and carry a SIX Months' guarantee.

- Continuous Frequency coverage from 110 Kilocycles to 56 Megacycles, in six bands.
- Built in ladder attenuator, with fine control, giving 1 Volt maximum, in five steps, in multiples of 10 Microvolts.
- Exclusive "SPHERE" "SEE AT A GLANCE" Band and Attenuator indicators.
- Radio and Audio Frequency Voltages can be switched via single Test-lead.

- Variable control of 400 C.P.S. audio, from 0 to 1 Volt.

FOR RADIO SERVICE, RADIO ENGINEERING AND LABORATORY USE.

Write for List No. 505 S.G.

SPHERE RADIO LIMITED
Radio Instrument Manufacturers
HEATH LANE, WEST BROMWICH



FOR THE RADIO SERVICEMAN DEALER AND OWNER

The man who enrolls for an I.C.S. Radio Course learns radio thoroughly, completely, practically. When he earns his Diploma, he will KNOW radio. We are not content merely to teach the principles of radio, we want to show our students how to apply that training in practical, every-day radio service work. We train them to be successful!

Write to the I.C.S. Advisory Dept. stating your requirements. Our advice is free and places you under no obligation.

You may use this Coupon

INTERNATIONAL CORRESPONDENCE SCHOOLS Ltd.

DEPT. 33, INTERNATIONAL BUILDINGS, KINGSWAY, LONDON, W.C.2

Please explain fully about your instruction in the subject marked X

Complete Radio Engineering Radio Service Engineering Elementary Radio

And the following Radio Examinations:—

British Institution of Radio Engineers.
P.M.G. Certificates for Wireless Operators.
City and Guilds Telecommunications.
Wireless Operator and Wireless Mechanic, R.A.F.

Name..... Age.....

Address.....

Steady as a Rock!

VITAVOX MICROPHONE STANDS have been designed, not only to look attractive in all surroundings, but to do the all-important job of holding that microphone "steady as a rock." Built, as usual with all our products, in traditional VITAVOX quality. Obtainable from your usual Vitavox wholesaler. If any difficulty is experienced, please write direct to us.



DESK MODEL
 ... designed for use when the speaker is seated. Finish—Black and Bronze Crackle.
 Retail price £1 1s. 0d.

BANQUET MODEL
 ... designed for occasions when the speaker is to stand at a table. Extension 17-24 Ins. Finish—Black and Chromium, or Florentine Bronze.
 Retail price .. £2 15s. 0d.

PEDESTAL MODEL
 ... dignified floor stand extending from 4-7 ft. Cable through stand. Finished as Banquet Model.
 Retail price £4 5s. 0d.

VITAVOX

MICROPHONE STANDS
 VITAVOX LIMITED
 WESTMORELAND ROAD, LONDON, N.W.9
 Telephone - Colindale 8671

It's easy to make Pick-ups if you know how.

The know-how in the manufacture of

Lexington

MOVING COIL PICK-UPS

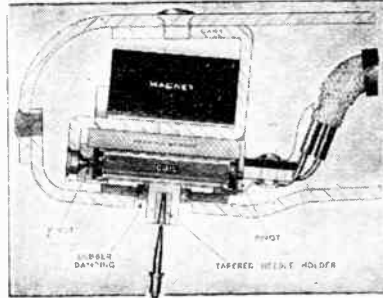

is the result of long experience and precision watch-making standards which give a finely constructed instrument the details of which are shown in the sectional diagram.

DE LUXE MODEL ● Robust design. Accidental dropping on record will not damage Pick-up ● Extremely low moment of inertia (80 milligrams total weight of movement) ● Pure sine wave with no harmonic distortion ● Automatic needle or sapphire changing opens new fidelity field to the amateur ● Can be used with normal record changer without fear of damage.

Price (without sapphire) £5 plus 25/- P.T.

Sapphire Needle with specially tapered shank, price 15/3 extra (including P.T.)

JUNIOR MODEL. Identical in design and workmanship to the De Luxe, the only difference being that it is not equipped with the Automatic Sapphire needle inserter and Extractor device and metal sole plate. Made to take standard steel and fibre needles this model enables every music lover to enjoy the fine reproduction which only a moving coil pick-up can give. £3. 3. 0 plus 15/9 P.T.

See November issue for Curve of Pick-ups

● PLUG-IN HEADS ●



These are available in both Junior and De Luxe types to fit Collaro and Garrard arms, thus providing easy change-over from Magnetic types. Input conversion may be required. (See our Technical Brochure.) Price 45/-, plus 11/3 P.T.

Separate Ejector for De Luxe type, 28/-, plus 7/- P.T.

● PRE-AMPLIFIERS ●

having an inverse of the recording characteristic incorporated are available for use with pick-ups. These are necessary with some amplifiers.

Illustrated Technical Brochure upon request.

Export and Trade Enquiries Invited.

PLEASE NOTE NEW ADDRESS:—

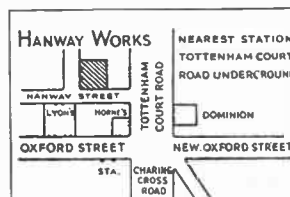

COOPER
 MANUFACTURING CO.
 17-20 HANWAY WORKS,
 HANWAY ST., LONDON, W.1
 Telephone: MUSeum 9779
SALES OFFICES—Top Floor

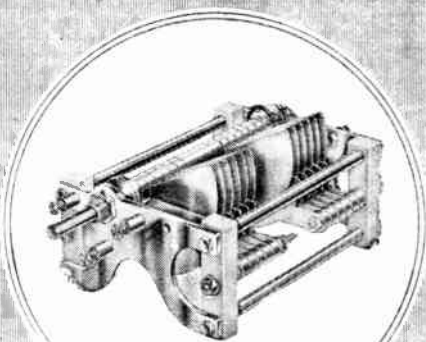

TYPE SSTR — SQUARE LAW

"Cyldox"
TRANSMITTING Capacitors

SYDNEY S. BIRD & SONS, LTD.
CAMBRIDGE ARTERIAL ROAD, ENFIELD, MIDDX
Phone: Enfield 2071/2. 'Grams: "Capacity, Enfield."

A HAPPY NEW YEAR
TO ALL OUR FRIENDS



The Connoisseur

Faithful reproduction of all recordings from 12,000 c.p.s. to 30 c.p.s. will win many new friends for the CONNOISSEUR miniature moving iron Pick-up in 1947.

The CONNOISSEUR reveals a wide range of notes and instruments that has hitherto been hidden by bass and treble resonance. The CONNOISSEUR will reproduce every sound on the record. Try it and prove it.

Note new prices. Pick-up 54/- plus 11/8½ P. tax
Transformer 13/- nett

Apply to
Albion Electric Stores, 125, Albion Street, Leeds 1
or to
Lawton Bros. (Sales) Ltd., Henry Square, Ashton-under-Lyne

Made by
A. R. SUGDEN & Co. (Engineers) Ltd., Brighouse, Yorks

"PETER PAN"
MIDGET ELECTRIC RADIO

YOU CAN BUILD IN THREE HOURS

The "Peter Pan" model 461U is an entirely new conception of home constructor's kit. When completed the constructor has a receiver of the highest performance and appearance of the best factory-built model. Designed by experts for ease of assembly and wiring.

TECHNICAL SPECIFICATION:

- H.F. AMPLIFIER. A 6K7G valve is used as variable MU pentode giving maximum sensitivity.
- DETECTOR. A 6J7 or (KT263) valve being used as an anode bend detector which in conjunction with specially designed high "Q" coils gives excellent sensitivity.
- OUTPUT STAGE. A 25A00 valve is used which with careful matching gives approximately 2 watts undistorted output.
- RECTIFIER. A half-wave rectifier U31 is employed.
- WAVE RANGES. 200-650 metres. 1,000 to 2,000 metres.

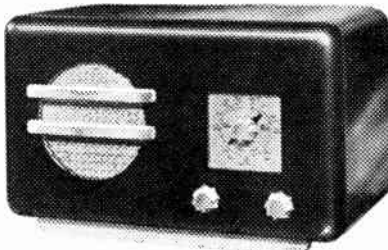

Price 9 Guineas
plus Tax (£2 - 0 - 7)

DESCRIPTIVE CATALOGUE IN COLOUR ON RECEIPT OF 2½d. STAMP.

- MAINS SUPPLY. 200-250 volts AC or DC mains.
- OVERALL SIZE. Height 7". Width 12½". Depth 6½".
- CABINET. Black and white plastic of modern styling, giving a very attractive finish to the completed receiver.

An up-to-the-minute luxury radio receiver at less than factory price
DELIVERY PER RETURN

H. P. RADIO SERVICES LTD.
Tel.: Aintree 1445 55, County Road, Liverpool, 4 Estab. 1935

5 mmf/ft

NEW LOW LEVELS in capacity and attenuation of CO-AX Cables mean new possibilities in electronic equipment design both for the war effort and for the post-war electronic age.

Write for characteristics

BASICALLY BETTER
AIR-SPACED

CO-AX LOW LOSS CABLES
TRANSRADIO LTD. 16 THE HIGHWAY BEACONSFIELD 4-BUCKS

Wharfedale

Public Address LOUDSPEAKER W.12

Now fitted with NEW MAGNET

Die Cast Non-resonant Chassis with accurate rear suspension. Impedance, 15 ohms, Diameter, 12". Weight, 11½ lbs. Peak input, 15 watts. 13,000 lines flux density. Price 135/-

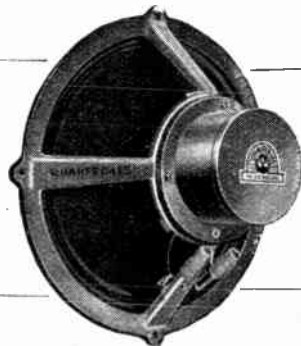

W.12 TRANSFORMER

Designed for use with speakers, up to 15 ohms impedance, where the output does not exceed 10 watts.

Ratios : 45, 22 and 15 to 1, all centre tapped. Max. D.C. 80 m'amps.

Inductance 50 Henrys, no D.C. Inductance 8 Henrys, 50 m/a
Inductance 20 Henrys, 25 m/a Inductance 5 Henrys, 75 m/a

Fixing Holes, 3½" centres.

Leakage Inductance .07 Henry. Weight, 2 lbs. Price 21/-

Special Ratios to order at 4/- extra.

Made and Guaranteed by

WHARFEDALE WIRELESS WORKS
BRADFORD ROAD, IDLE, BRADFORD.

'Phone : Idle 461.

'Grams : "Wharf. Idle, Bradford."

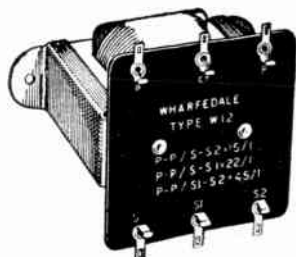

TAYLOR *for the Best in Test Equipment*

MODEL 65B



ALL WAVE SIGNAL GENERATOR

1. Six wavebands cover from 100 kc/s to 46 mc/s.
2. Scale directly calibrated in frequency.
3. R.F. output controlled by coarse and fine attenuators.
4. 400 c/s internal oscillator provides 30 per cent modulation if required.
5. Unmodulated or externally modulated R.F. output available.
6. Up to 1 volt output of 400 c/s available for Audio tests.
7. Main filters are fitted reducing direct radiation to a minimum.
8. Operates from 110 or 200-250 volts A.C. mains, 40-100 cycles.
9. Dimensions: 12½in. x 8½in. x 6in. deep. Weight about 10lbs.

Taylor Model 65B is a reliable and accurate mains-operated portable Signal Generator. It is designed for all general Radio frequency and Audio frequency tests on Radio receivers or amplifiers.

Price **£15.10.0**

Please write for technical brochure.

Taylor Electrical Instruments Ltd.
419-424 MONTROSE AVENUE, SLOUGH, BUCKINGHAMSHIRE
Tel: Slough 2138 (4 lines) Grams: "Taylins" Slough

Remember-



RADIO STAMPINGS

RADIO CHASSIS

RADIO PRESSINGS

FARM LANE, FULHAM, S.W.6. TELEPHONE: FULHAM 5234

Here at last!
A REAL GEM

KILLICK'S
Sapphox
REPRODUCING INSTRUMENT
P.D. PATENT NO: 28214/45

REDUCES SURFACE NOISE

PRESERVES THE LIFE OF THE RECORD

DOES AWAY WITH NEEDLE CHANGING

STRETCH LIFE REPRODUCTION FROM 100% TO 14,000%

This scientifically designed Patent Sapphire Instrument cannot touch the bottom of the groove thus leaving it undamaged.

Gives high fidelity reproduction and is guaranteed through Laboratory Tests to play 2,000 Records before needing replacement.

KILLICK & COMPANY, 118 FLEET STREET, E.C.4

Telephone: CENTRAL 3307

Manufacturers of Scientific Recording Instruments, Amplifiers, Radiograms, Cutting Stylus, Discs, Playback Sapphires, etc.

Sound Specialties

W.W.2

Miniature or Midget

ACTUAL SIZE

50%
10%
XY 1-4A

24%
10%
XW 0-75A

HIVAC
THE SCIENTIFIC VALVE

BRITISH MADE

NEW TYPES FOR
MIDGET RECEIVERS
HEARING AIDS
METEOROLOGICAL
INSTRUMENTS
ETC.

HIVAC LIMITED Greenhill Crescent. Phone HARROW Harrow on the Hill, Middx. O895

SIFAM
RADIO SERVICING
D.C. TEST SET
Type RT.10.

- 12 D.C. Ranges.
- No switches to go wrong.
- Long clear scales.
- Positive push-button selection.
- Accurate in any position.
- Made to stand heavy overload.
- 1,000 Ω per v.

22 Years Specialised Experience

RANGE 8:
100 MV. 2, 6, 120, 300 volts D.C. 1, 6, 600 MA. 6 amperes D.C., 50 000 ohms. 2,000 ohms at mid-scale.

SIFAM ELECTRICAL INSTRUMENT Co. Ltd.
TORQUAY, DEVON.

AL UNIT OSCILLOSCOPE
A NEW CONCEPTION OF INDUSTRIAL NEEDS

Interchangeable Amplifiers and Time Bases with a wide range of accessories cover every application. No loose wires, no unwanted controls, no complex switches, but standard snap-on units give rigid assembly with tailor-made performance.

LYDIATE ASH LABORATORIES
RESEARCH AND DEVELOPMENT ENGINEERS
Nr. BROMSGROVE
Telephone: Rubery 168/169

DID YOU READ

Wireless World July, 1946

Test Report

SOBELL Type 615

A.C. Table Model Superhet
(Five Valves + Rectifier)

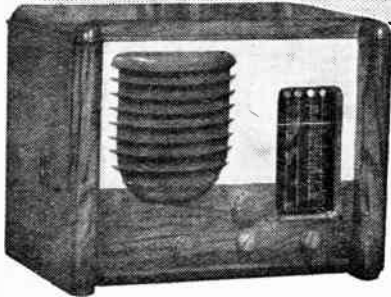

The following are brief extracts from a report which appeared in the July 1946 issue of "Wireless World" on the Sobell 615 6-valve A.C. Table Model Superhet :-

"The quality of reproduction is decidedly above the average for a table model . . . The lower register has breadth and an extended top response gives clarity and brightness without being shrill . . . With two I.F. stages there is no lack of sensitivity and the selectivity is exceptionally good. The division of the short-wave range into two parts gives a degree of band spread which makes for ease of tuning and both ranges provide a wide choice of stations. The sensitivity is well maintained at the high-frequency end . . . The chassis is of ample size and components are well spaced . . . The finish of the cabinet work is of a high order . . . The set is backed by a comprehensive free maintenance scheme for two years. In the event of breakdown the fault will be remedied or the chassis changed on the spot by one of the maker's servicemen"

Price 24 Gns., plus £5. 8. 4d. purchase tax.



TWO YEARS' FREE ALL-IN SERVICE IN THE HOME

SOBELL INDUSTRIES LTD., LANGLEY PARK, NR. SLOUGH, BUCKS.

LONDON CENTRAL RADIO STORES

Special Purchase—A Few only
MINIATURE COMMUNICATION RECEIVER
and **POWER PACK** Type MRC1

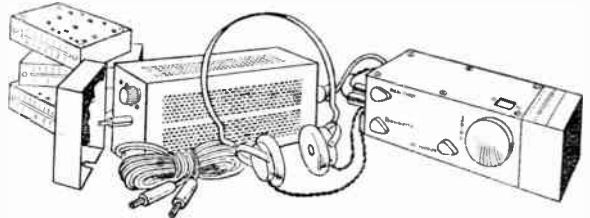

5-valve Superhet, using Midget valves (4, 1T4s, 1, 1R5) for A.C. or D.C. mains, 97-250 volts input. These sets are complete with aerial and earth equipment, lightweight headphones, mains lead, etc. Dimensions: Receiver, 7 1/2" x 3 1/2" x 2 1/2". Power Pack approx. same size. Range 100 kc/s - 20 mc/s in four stages. These sets are brand new, ex-100V, and sealed in metal containers complete with operating instructions. **10Gns.**

SELF-ENERGISING TABLE MICROPHONE & HEADSETS

The microphone is mounted on a fully adjustable stand with on-off switch. No batteries or current required to operate.

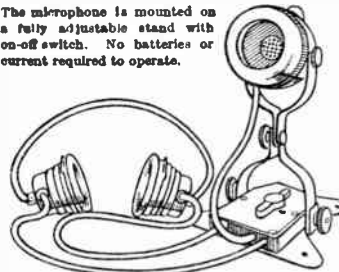

UNUSED IN CARTONS . . . £1.15.0

EX-R.A.F. AIRBORNE G.P. TRANSMITTERS

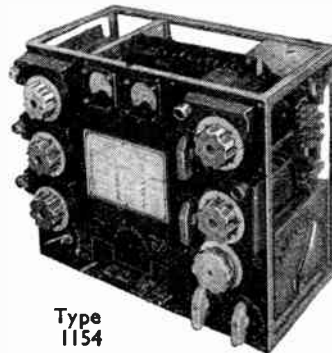

Type 1154

Complete with 4 valves. Frequency coverage: 500 kc/s - 200 kc/s, 10 mc/s, 3 mc/s 2.35 mc/s, 8 mc/s, 2.5 mc/s. Power input 1,200 v., 200 ma. H.T., 6 v. 4 amp. L.T. Chassis size, 16in. x 13 1/2in. x 8 1/2in. In metal cabinet. Supplied in strong wood case, with metal bound covers and carrying handles easily adapted. **£7.0.0**
Automatic inc. Lamp Power Pack
WITHOUT VALVES & METERS 30/-

FOR CALLERS ONLY

We have a large stock of Ex-EN-A Amplifiers, 5-30 watts, and Microphones, also a variety of Ex-Govt. Radio and Electrical Equipment.

Closed Thursdays 1 p.m. Open all day Saturday.

23, LISLE ST. (GER 2969) LONDON, W.C.2

PLUGS AND JACKS

These Ex-Govt. Jacks have powerful phosphor-bronze springs ensuring a perfect contact. Overall length including 1/2in. threaded shank, 3 1/2in. Supplied with nut for panel mounting. Price complete with best quality Plug (as illustrated) **2/9**
Post. etc. 3d.

EX-U.S. ARMY ULTRA LIGHTWEIGHT HEADSETS



Head-aid type earpieces 1/2in. dia. with soft rubber ear fittings. 100 ohms. Brand new **27/6** and packed

EX-GOVT. TELEPHONE HANDSETS

Self Energising. Needs no battery or current. Less wall bracket. Price per pair handsets **30/-**

EX-ARMY REFLECTOR P.M. LOUDSPEAKER

By Tannoy and Truvox Suitable for small P.A. work, factories, etc. A robust job in heavy wooden case 9 1/2in. x 9 1/2in. x 7 1/2in. Bargain! **2.17.6**
price

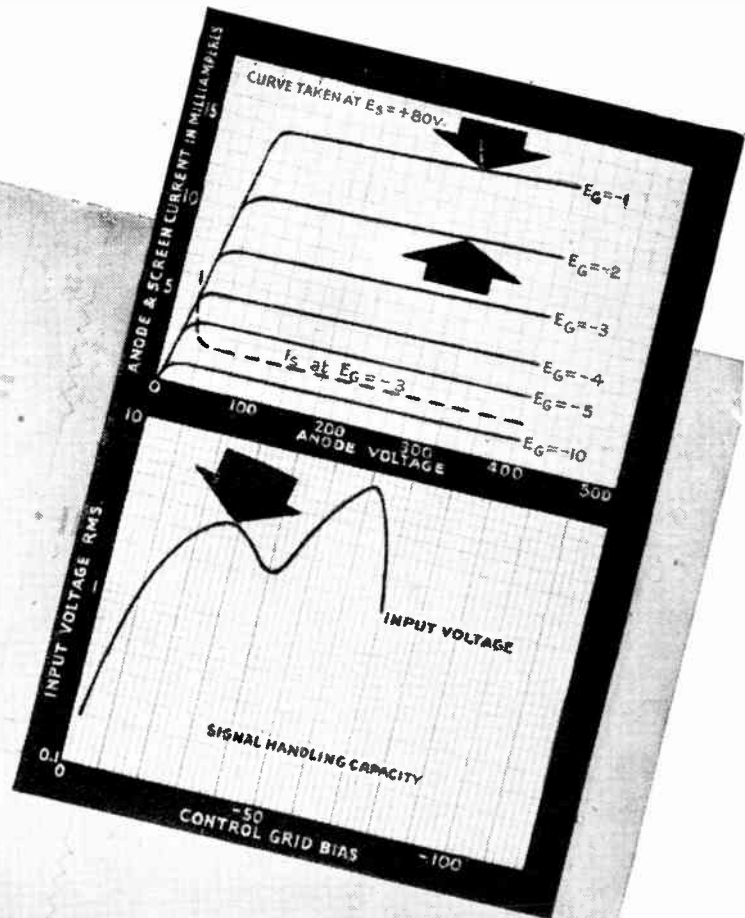

POINTERS FOR DESIGNERS

THE KTW61

A screened tetrode with suppressor plates and with variable-mu characteristics, the OSRAM KTW61 is specially suitable for use as an R.F. or I.F. amplifier in superhet receivers. Its outstanding features include:—

- ▶ High order of mutual conductance (2.9 mA/Volt) combined with low leakage capacitance (0.0025 $\mu\mu\text{F}$), which facilitates high stage gain.
- ▶ Negligible distortion with the maximum signal likely to be encountered in practice. Conditions of use — as an I.F. amplifier with screen dropping resistance, and in conjunction with OSRAM frequency changer X61M.
- ▶ Marked improvement in signal to noise ratio, particularly on the short waves, when used as an R.F. amplifier with fixed screen voltage.

A detailed technical data sheet is available on request.

Osram
PHOTO CELLS

G.E.C.
CATHODE RAY TUBES

Osram
VALVES

Wireless World

Radio and Electronics

36th YEAR OF PUBLICATION

FEBRUARY 1947

Proprietors:
ILIFFE & SONS LTD.

Managing Editor:
HUGH S. POCKOCK,
M.I.E.E.

Editor:
H. F. SMITH

Editorial, Advertising
and Publishing Offices:
DORSET HOUSE,
STAMFORD STREET,
LONDON, S.E.1.

Telephone:
Waterloo 3333 (50 lines).

Telegrams:
"Ethaworld, Sodist, London."

△
PUBLISHED
MONTHLY

Price: 1/6

(Publication date 26th
of preceding month)

Subscription Rate:
Home and Abroad
20/- per annum.

MONTHLY COMMENTARY	39
TELEVISION RECEIVER CONSTRUCTION—2 ..	40
IS "ELECTRONICS" OVERWORKED? By	
"Cathode Ray"	43
A.V.C. CALCULATIONS By S. W. Amos ..	46
DESIGN DATA (11) Aerial Coupling in Wide Band Amplifiers	50
MAINS TRANSFORMER PROTECTION By	
F. R. W. Strafford	51
SHORT-WAVE CONDITIONS By T. W. Benning- ton	53
TEST REPORT: EKCO MODEL A28	54
HUM IN HIGH-GAIN AMPLIFIERS By P. J. Baxandall	57
NAVAL RADIO GEAR By G. M. Bennett ..	62
H2S TRAINER By G. W. A. Dummer ..	65
WORLD OF WIRELESS	67
BROADCASTING AT V.H.F. By Thomas Roddam	70
UNBIASED By Free Grid	72
KEYING MONITORS By W. A. Roberts ..	73
LETTERS TO THE EDITOR	74
RANDOM RADIATIONS By "Diallist" ..	76
RECENT INVENTIONS	78

Branch Offices:

COVENTRY:

8-10, Corporation Street.

Telephone: Coventry 5210.

Telegrams:

"Autocar, Coventry."

BIRMINGHAM:

King Edward House,
New Street.

Telephone:

Midland 7191 (7 lines).

Telegrams:

"Autopress, Birmingham."

MANCHESTER:

260, Deansgate, 3.

Telephone:

Blackfriars 4412 (4 lines).

Telegrams:

"Iliffe, Manchester."

GLASGOW:

26B, Renfield Street, C.2.

Telephone: Central 4857.

Telegrams: "Iliffe, Glasgow."

△
*As many of the circuits and
apparatus described in these
pages are covered by patents,
readers are advised, before
making use of them, to satisfy
themselves that they would
not be infringing patents.*

A NEW ADVENTURE FOR

Hams

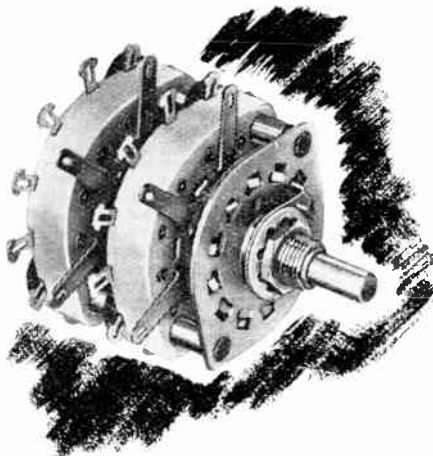

YOU CAN NOW GET CERAMIC SWITCHES IN A NUMBER OF USEFUL COMBINATIONS FROM YOUR DEALER

Wearite Ceramic Switches, hitherto restricted to Government and other priority uses, are now released. See your dealer and have your Ceramic Switches built to your specification from his kit of Wearite Switch Components. The finished job will be robust, trouble-free, and backed by the famous Wright & Weaire reputation. If any difficulty is encountered, please contact us.



NOW AVAILABLE FROM

Premier Radio	LONDON
Webb's Radio	LONDON
Brighton Trades Services	BRIGHTON
Amateur Radio	BURNLEY
Clydesdale Supply Company	GLASGOW
F. J. Ansell	IPSWICH
Jack Bryant	NORFOLK
Southern Radio	SALISBURY

CERAMIC SWITCHES

See your dealer today

WRIGHT & WEAIRE Ltd., High Road, Tottenham, London, N.17. Tel.: Tottenham 3847/8, and Simonside Works, South Shields, Co. Durham



VALVES AND THEIR APPLICATIONS

By M. G. SCROGGIE, B.Sc., A.M.I.E.E.

No. 2: Mullard SINGLE ENDED SHORT WAVE PENTODE EF54

WHEN, not long before the War, the EF50 was introduced, it shook a commonly-accepted belief that really useful VHF amplification was impossible without a complete departure from the conventional form of valve. The scale on which the EF50 was used during the War must have settled any doubts as to its practicability. Although the details of its construction were in fact considerably unusual, it plugged in like any ordinary valve, even to the extent of having all its connections at one end.

The EF54 is an EF50 with improvements. By reducing the grid-to-cathode clearance to the minimum capable of mass production, it has been possible to increase the slope to 7.7 mA/V. And the inductance of the cathode lead has been reduced by making parallel connections to four of the pins. Both of these changes are important in extending the useful range of frequency. Also, because the suppressor grid has not been designed, as in the EF50, to fit into a slope-controlling scheme, it has been wound with optimum pitch. This, and an adjustment of the screen grid pitch, have reduced the screen current, a result that does more than merely economize supply — it improves the signal/noise ratio, which is the essential matter. Useful amplification is obtainable at a frequency of 300Mc/s or even more.

Such results used to be thought possible only with acorn valves, which are so much more fragile and expensive. In some respects—notably

signal/noise ratio — the performance of the EF54 is even better. The larger size of the electrodes and leads does mean, however, that a greater proportion of the tuning circuits is inside the valve. So it is necessary to design the external circuits accordingly. Radar mechanics may have been intrigued, perhaps, by the circuits of 200Mc/s pre-amplifiers using the EF54, with tuning coils and condensers apparently in series instead of in the more orthodox parallel positions. These circuits make sense if they are redrawn, showing the valve internal reactances.

One of the difficulties with all valves at VHF, of course, is their very low input resistance, which damps the tuned circuits heavily. A useful thing to know is that the gain can be increased several-fold by positive feedback, conveniently obtainable by connecting a small pre-set condenser across the cathode bias resistor. This is generally more convenient than the alternative method, of putting inductance in the screen grid lead.

This is the second of a series — written by M. G. Scroggie, B.Sc., A.M.I.E.E., the well-known Consulting Radio Engineer. Reprints for schools and technical colleges may be obtained free of charge from :

**THE MULLARD WIRELESS SERVICE CO., LTD.,
TECHNICAL PUBLICATIONS DEPARTMENT,
CENTURY HOUSE, SHAFTESBURY AVE., W.C.2**

Wireless World

Radio and Electronics

Vol. LIII. No. 2

FEBRUARY, 1947

Price 1s. 6d.

Monthly Commentary

Symmetry or Circuitry?

ONE of the results of the recent "Britain Can Make It" exhibition has been to focus attention on the outward form of broadcast receivers. We comment on such matters of aesthetics with the greatest diffidence, but think that few will disagree with our opinion that manufacturers generally have shown great skill in producing acceptable cabinet designs in the face of severe shortages. Even better, in several cases a virtue has been made of necessity, and technical advantages have been secured by ingenious layouts using smaller quantities of our precious materials than in conventional practice.

Although efforts to improve the looks of broadcast sets are entirely praiseworthy, we believe there is some danger in placing too much emphasis on externals—if only because it amounts to following the line of least resistance, which is proverbially beset with perils. Everyone knows that a large section of the public now regards a receiver almost as an article of furniture, and certainly as something to be selected primarily on its external appearance. Taking the long view, this is an idea that should not be fostered too assiduously, or a state will be reached where the public loses all interest in performance or technical development.

Quite naturally and not unreasonably, the average citizen refuses to install in his living-room something that "looks like a scientific instrument." But—and this is the root of the problem—the broadcast receiver is a scientific instrument. In some of the latest models, with short-wave band-spreading and other refinements, it becomes increasingly difficult to camouflage this fact and at the same time to provide the user with a control system that enables him to obtain the full benefit of the facilities provided. Control knobs with no indication of function and (except for tuning) with no kind of indicating scale, are almost universal. Presumably for the sake of appearance, knobs of

the wrong size and shape are fitted, often in the wrong places.

There is no slick and easy answer to all the questions implicit in external design. Compromises are needed at every point, but it is perhaps worth while pointing out that the public attitude as to what is and is not appropriate to the home is changing. This is, of course, due partly to a general tendency towards mechanization and electrification, but still more to the upheaval of war, which has brought untold thousands of men and—more important—women into close association with scientific instruments. As to how far we can go in meeting this change is a matter for careful consideration, but it would be a bad day for the future of radio if symmetry were allowed entirely to overshadow circuitry, or aesthetics to predominate over acoustics.

Variable-Mu

THE idea held by most of us that the term "variable-mu," as applied to an R.F. amplifying valve, stands for "variable mutual conductance" is finally disposed of by a letter from an American correspondent, published elsewhere in this issue. It now seems clear that the originators of this type of valve decided to call it a variable amplification factor valve, using the Greek letter μ as a symbol in its accepted sense.

What are we to do now? Respect for etymology requires that the term be spelled with a μ , but to do so would be confusing and unhelpful, as μ is rarely used or measured with such valves. Circuit design is carried out and the characteristics of valves are measured in terms of mutual conductance.

Whether we spell it μ or mu, the term is a particularly unhappy example of wireless jargon. Even at this late hour, and in the face of well-established usage, we venture to suggest the simple name of "variable-gain valve" as an alternative,

TELEVISION RECEIVER

2.—Line Deflector Coils : CONSTRUCTION Winding Data

IT was shown in Part I that the most suitable form of deflector-coil assembly consists of a pair of former-wound low-inductance coils for the line scan and a pair of bent high-inductance coils for the frame. The choice of high-inductance coils for the frame is dictated largely by the desirability of economizing in wire and laminations.

The construction of the coils is

carefully. The line and frame coils are of quite different construction and the latter will be treated in the next article.

Full details of the individual parts of the former for the line coils are given in Fig. 1 (a) and (d). The main body can be cut from a solid block of wood, but it is easier to fabricate it from two side members, two $\frac{1}{8}$ -in spacers and one V-block as shown. They

$\frac{1}{8}$ -in sheet. This material has been chosen on account of its strength and the ease with which it is worked, but is by no means essential. Brass is just as suitable, but more difficult to work.

The end cheeks and core pieces are most easily made by cutting circular discs with a tank-cutter and then cutting off the appropriate segments.

The edges of the end cheeks

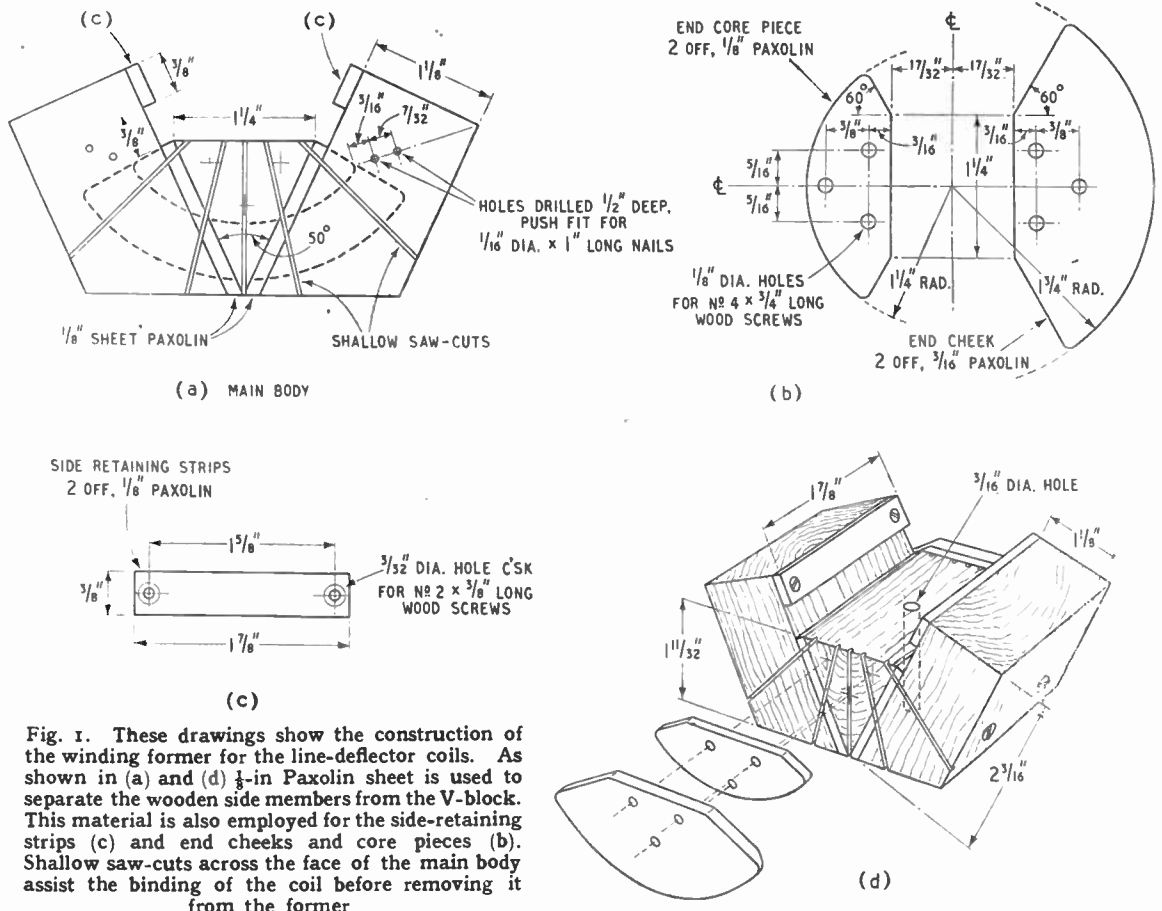

Fig. 1. These drawings show the construction of the winding former for the line-deflector coils. As shown in (a) and (d) $\frac{1}{8}$ -in Paxolin sheet is used to separate the wooden side members from the V-block. This material is also employed for the side-retaining strips (c) and end cheeks and core pieces (b). Shallow saw-cuts across the face of the main body assist the binding of the coil before removing it from the former

by no means difficult but it is necessary to make certain formers and a jig and to adopt a definite procedure. No difficulty should be experienced if the instructions given in this article are followed

are held together by four long screws passing into the V-block.

The two side-retaining strips (c) and the two end core-pieces (b) are cut from $\frac{1}{8}$ -in Paxolin sheet and the two end cheeks (b) from

must be carefully rounded and smoothed, to avoid damaging the enamel of the wire should it be allowed to scrape along an edge. If a buffing pad is available, the edges should be polished.



THE CONSTRUCTION STEP BY STEP

Fig. 2. (a) The former mounted ready for winding ; (b) the first few turns in place ; (c) after fitting the first pins ; (d) with the second pins ; (e) the fully-wound coil ; (f) end-cheek and core pieces removed ; (g) the end of the coil bound ; (h) taking the coil off the former ; (i) the bound coil ; (j) the taped coil ; (k) the finished coil tied to a mandrel to dry.

Television Receiver Construction—

Assemble the side-retaining strips, end cheeks and core pieces on the main body, and mount it on a spindle so that it can be turned easily by hand. One simple way of arranging this is to pass a length of 2BA rod through the centre of the main body and to clamp it with a nut on each side. The rod can be held in the chuck of a hand-drill, which is itself clamped vertically in a vice,



Fig. 3. This sketch shows the correct way of looping the binding thread.

as shown in Fig. 2 (a). While winding, the former is held in the left hand and rotated by it while the right hand guides the wire and maintains the tension.

The winding must start at one curved end, pass round it in the slot formed between the main body and the end cheek, up and into the straight side. Then down into the slot at the other end and so on. The winding finishes on the same end as the start and the coil has a total of 150 turns of No. 28 enamelled wire and requires some 2½oz of wire.

Care must be taken about the disposition of the wire along the straight sides. The first turns will naturally lie at the bottom of the slot, but after a time it will be found that there is a tendency for them to build up along the bottom of the slot (the ⅜-in side) instead of to pile up to the full depth (½ in). This must be resisted as far as possible and the aim should be to build up the winding to the full ½-in depth as soon as possible so that the winding grows gradually at its full depth along the width.

It is not possible fully to achieve this, but if the winding is kept in triangular section an adequate approach to it can be secured, Fig. 2 (b). After some 50 turns have been wound it will be found that the wire starts to bunch at the corners. At this stage, insert a pin (1-in nail) at each corner, and continue winding, passing the wire over the pins, Fig. 2 (c).

After a further 50 turns bunching again starts, so a second pin, Fig. 2 (d), is inserted at each corner and the winding continued.

It is at this stage that difficulty will be experienced if the winding has not been kept to the full depth of the slot as it has progressed. The turns passing over the second pins can only lie naturally in the end third of the sides, and if this has already been partly filled by the earlier turns there will not be room for them here. Some adjustment is quite possible, but not a great deal.

When the winding is complete, Fig. 2 (e), give the coil a coat of shellac varnish* and leave it until the varnish is only just tacky but not hard. Remove one end cheek and core piece (the latter will have to be gently prised out), as shown in Fig. 2 (f). Then tie up the end with thread, using a needle to pass the thread between the turns and the former in the saw-cuts provided, Fig. 2 (g). The correct method of binding is illustrated in the sketch of Fig. 3.

Do the same thing at the other end and then take off the side-retaining strips and remove the whole coil from the former, Fig. 2 (h). It will spring to a slightly greater size when doing this, but this is unimportant, as it is corrected later. Now tie up the sides, taking care not to bind too tightly and so pull them out of their rectangular shape, Fig. 2 (i).

Sleeve the end wires in 5-in lengths of sleeving of distinctive colours, noting which is start and finish, and bind the sleeving to the top of the rounded end. Then tape the coil with 1-in linen tape and give the whole a coat of shellac varnish. The coil then has the appearance shown in Fig. 2 (j).

Take a piece of round wood of 1½-in diameter as a dummy former, wrap a piece of paper round it and mark off lines parallel to the axis and 180° apart. Draw lines parallel to these and ⅜-in away on the same side so that the angle between them is less than 180°.

* Shellac varnish consists of shellac dissolved in methylated spirit. Ordinary methylated spirit is not very suitable, however, since it contains substances which may affect the enamel of the wire. Commercial spirit should be used, but is not obtainable. The way out is to use french polish. The high-grade uncoloured variety is just shellac in commercial methylated spirit and is eminently suitable.

Take the coil while it is still soft and place it on the cylinder so that the outside of each straight side coincides with the lines and bind it firmly in place, Fig. 2 (k). Slight final adjustment can be done after the binding. The sides must be parallel and the curved ends at right angles to them.

The coil is then left to dry. If heat is not applied this will take 48hrs or more, but can be accelerated to some 6hrs or so by drying in front of a hot fire, or even less in an oven.

Two coils of identical construction are required.

Details of the frame coils and of the assembly of the coils to form the deflection yoke will be given in the next issue.

"RADIO NAVIGATION"

DETAILED information on radio aids to marine navigation, unobtainable elsewhere in a single volume, is provided in the second of two books prepared by the Ministry of Transport covering the proceedings of the International Meeting on Radio Aids to Marine Navigation held in London last May.

This book, "Radio Navigation: Radar and Position Fixing Systems for use in Marine Navigation" published by H.M. Stationery Office, price 5s, is based on the technical papers presented at the meeting and deals very fully with existing radio navigational aids and, too, with those being developed.

The introductory chapters deal with "the navigational problem" and wave propagation as it affects radio aids to navigation. The second part deals with D.F. systems, including Consol. In the third section hyperbolic systems of navigation, including Loran, Gee, Decca and P.O.P.I. are reviewed.

By far the largest section of this 200-page book is devoted to marine radar systems. This section, which occupies nearly 100 pages, includes a specification for a merchant ship's radar set revised last November after meetings between the Government departments concerned and the radio industry.

The concluding section of this useful textbook and work of reference gives tabulated summaries of the principal characteristics of the various marine radio navigational aids which are based on the report of a technical committee representing the various Government scientific research establishments. A comprehensive index is also included.

IS "ELECTRONICS" OVERWORKED?

A Useful Word, But . . .

AT any given moment the lay Press has one or more favourite words. Enthusiasm for them is capable of overruling almost any absurdity or lack of fitness in their use. Familiar examples in recent years are "streamline," "pattern," "wonder" (as an adjective), and "bottleneck." ("Bottlenecks must be ironed out," as one leading article put it). In pre-*Wireless World* days, to call a thing "electric" was enough to raise it at once to the level of the mysterious and magical. Nowadays electric appliances are so common that nobody can get much of a kick out of the mere word, though the same cannot always be said for the equipment itself. So something a little more recondite is needed to take the place of "electric," and "electronics" seems to be doing it.

There is, of course, the usual time-lag before the popular journals discover words such as this. I have been unable to find out who first used the term "electronics," and when; it was certainly in use in America by 1930, when the monthly journal of that name began publication. Although the electron itself was not clearly recognized before J. J. Thomson did so in 1897, it was actually named as long ago as 1891, by Johnston Stoney, who more than hinted at its existence in 1874. Crookes had been playing about with electrons in 1870, and was certainly one of the founders of electronics.

But it still sounds "modern" and mysterious to the man in the street. Even in the technical Press the word is used more often than strict sense would seem to require; at least, if I have the correct idea of what electronics is. There are not many definitions to choose from, but this one by the American Institute of Electrical Engineers seems about right:—

"Electronics is that branch of science and technology which relates to the conduction of

electricity through gases or *in vacuo*."

Less precisely, it is the glass-ware department of electrical engineering.

In my poetic youth (*Wireless World*, 29th Nov., 1935) I likened the sort of electricity that is bound by hard metallic conductors to Caliban, a slave suited

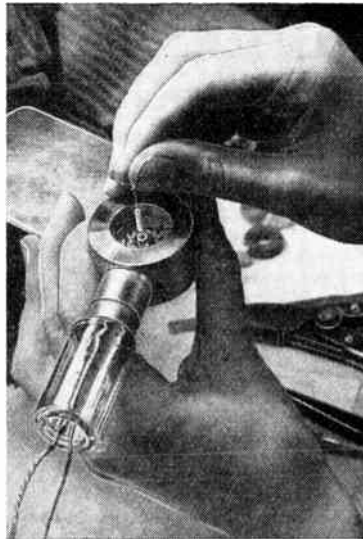

"Magnetrons . . . and other trons are really distinct groups of electronic devices." The heater and cathode of a magnetron being assembled in the valve laboratory of Marconi's W. T. Co.

to hauling trams along streets and other labour of a menial and unimaginative kind. Released from this bondage into free space, he is transformed into the fleet and dainty Ariel—electronics.

The earliest examples of this transformation were accompanied by an undesirable display of brute force. The electrons were torn from their material conductors by the irresistible tension of many thousands of volts. This was what was done in the first practical application of any importance—the X-ray tube. While the doctors were amusing them-

selves with this, other people were finding the secret of a more gentle spell—heat. Once released by it, the electrons needed only quite small voltages to control them. In fact, the first use made of thermal emission, by Ambrose Fleming in 1904, was as a detector of the very small radio-frequency voltages that could be received in those days of weak transmitters and no amplifiers. The idea was developed so fruitfully in the interests of radio communication that we radio people came to assume that we had almost a monopoly of electronic devices, and outsiders were only entitled to use them on sufferance and after making due acknowledgment. But the non-radio applications have gradually increased so far beyond the frontiers of the most imperialistic radio engineer that even the lay journalist couldn't keep on calling all of it "radio." Hence "electronics."

Looking under "Electronic Applications" in the *Wireless Engineer Abstracts and References Index* for 1945 I found the following diverse samples: area calculator; detonation indicator; electrometric titration; flame cutter; hopper control for ore crusher; paint spraying; petroleum plants; precision gauges for the blind; survey; temperature control in aircraft; water-in-petrol indicator; vulcanization; and—a lovely one this—thermal behaviour of houses. So it is a good idea to have a word for it all.

But would there be much sense in describing, say, boots as Metallurgical Applications, on the ground that they were protected with "tackets," which were the products of metallurgical processes? Some of the so-called electronic devices seem to me of this order. Take "electronic heating." A power oscillator valve is indisputably an electronic device. The people who design and manufacture it are workers in electronics. But does that

Electronics—

apply to the people who make R.F. oscillators incorporating such valves? Perhaps it does, because they may have to know something about valve technique in order to apply the valve effectively. But the stage having been reached at which a range of oscillators capable of delivering n kilowatts of R.F. is available, it seems to me to be stretching the meaning of "electronics" rather far to apply it to all of the uses that may be made of such R.F. oscillators, just because they incorporate an electronic device, to wit, a thermionic valve. Is it really any business of electronics whether the R.F. power so obtained is used to melt an alloy,

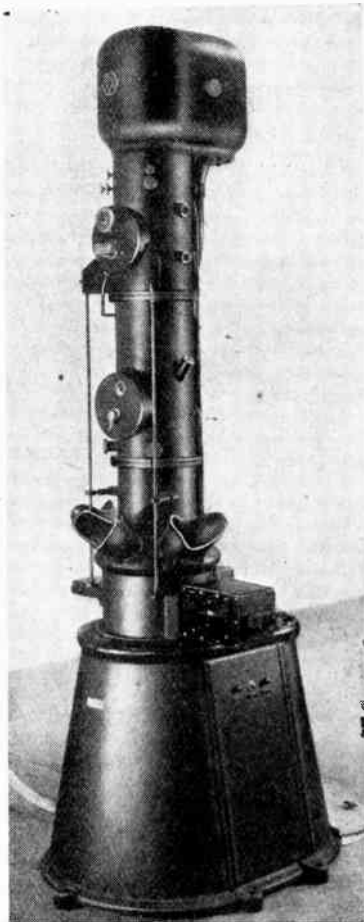

"The new science of electron optics." This Metropolitan-Vickers electron microscope is used for metallurgical research by Firth-Brown of Sheffield.

or warm up a patient's thorax, or transmit a picture of Winifred Shotton? If it is, then at least it must be a somewhat remoter order of electronics than the production of distinctly new and different ways of usefully controlling electrons in bottles. After all, the essential features of this sort of heating result from the application of R.F. fields, irrespective of the precise means adopted for maintaining those fields

Then, of course, any hearing aid becomes an electronic aid immediately someone spots a valve somewhere inside it. (Admittedly this is a step in the right direction from the practice of calling it "radio"). And there is electronic music. Soon we shall have the electronic museum, so called because its chief treasure is guarded by an "invisible-ray" burglar alarm. And the electronic fried-fish shop, because it has an extension loudspeaker in it, and loudspeakers are generally worked by valves, which are electronic devices.

Even using the term fairly strictly, electronics has become a pretty extensive technology, of which the radio part (including radar and television) is only a fraction. Valves, in which the electrons are separated from matter by heat and controlled with ingenious complexity by a variety of grids, screens and anodes, are of course applied in millions to line communication, biology, industrial processes, calculating machines, and thousands of other non-radio purposes.

Although commonly called valves, magnetrons and klystrons and other trons are really distinct groups of electronic devices. The cathode-ray tube, with brute-force emission, was a much earlier invention than the valve, appearing in rudimentary form around

the 1870s, due to Crookes. Now it has a hot emitter, and very refined focusing and deflection, and

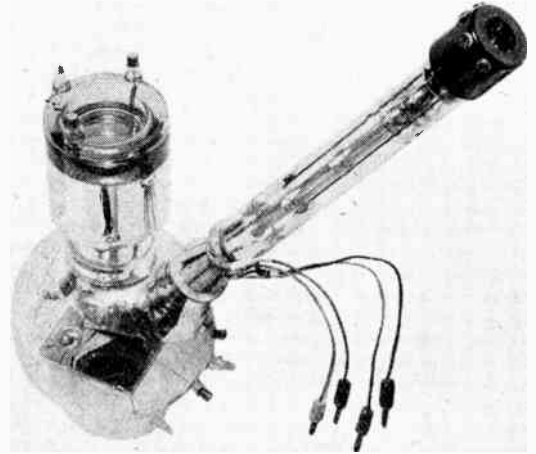

A combination of electron optics and the photoelectric effect is the basis of television cameras. The Super-Emitron tube as used in the latest E.M.I. television cameras.

has become almost as ubiquitous as the valve. The X-ray tube, too has adopted a heated cathode; and surgeons are only some of the people who use it. For instance, it has been one of the chief tools in the progress of atomic theory, and is used industrially on quite a large scale for detecting flaws, to say nothing of showing you what the pair of shoes you propose to buy does to your toes.

The control of electron beams, especially in cathode-ray tubes, is closely analogous to the control of light by lenses, and as a result the new science of electron optics has arisen. One of its most spectacular applications is the electron microscope, giving actual magnification far exceeding the utmost theoretical limit with light or even with ultra-violet rays.

In the foregoing electronic devices, heat is applied to the cathode merely for the purpose of turning out a working-party of electrons for duty. What chiefly matters is how they are manipulated after having been assembled. The releasing of electrons by light, noticed in 1888, is far less effective for assembling purposes, but does provide one of the most useful methods of detecting and measuring light. Simple photo-electric

cells, which are really diodes with light-sensitive instead of heat-sensitive cathodes, are used for making films talk, apprehending burglars, matching colours, detecting smoke, opening doors as they are approached, turning on lights when it gets dark, counting bales of newspapers or visitors to an exhibition, and a few hundred other purposes. In more complex form, combined with electron optics, the photo-electric effect is the basis of television cameras.

In these devices, a third method of releasing electrons is sometimes used along with the other two. The electrons are brought out by the peaceful picketing of their fellows; a process commonly referred to as secondary emission. If an electron hits anything hard enough it may knock out a dozen others. It is rather like the first stroke in snooker. The oldest application of this sort of emission is the dynatron. But more often it is suppressed, as in the pentode. The obvious amplifying possibilities are a little difficult to control, but the electron multiplier is one successful device, though not widely used. I shouldn't

Two-colour stereoscopic television reception is provided by this cathode-ray tube used by the late J. L. Baird in his Telechrome system. With this tube the picture is visible on both sides of the screen.



be surprised if we hear a lot more about secondary emission.

Lastly, there is a very large and varied group of devices that come within the scope of the A.I.E.E. definition of electronics, and exemplify the principle that it is better to put 100 people to work than to try to do the work of 100 people. For the former is the role of the emitted electrons in such things as mercury-arc rectifiers, thyatrons, and fluorescent and vapour lighting. In these the

function of the small initial working party of electrons is to dash in among the gas or vapour molecules and knock other electrons out of them. What is left of the molecule is an ion, and the process is ionization. Minus negative being positive, these robbed molecules are positive ions. Nothing succeeds like success, and each electron knocked out joins the crowd of beaters-up, until the space inside the tube is alive with a vast crowd of them.

Such a crowd would need an enormous cathode to yield it by thermal emission alone; and, when formed, would tend to defeat its own purpose by constituting a negative charge so great that a very high positive anode voltage would be needed to overcome it. But the ions, being positive, and relatively so heavy that they take a long time to reach the attracting cathode,

neutralize the electron space charge so that an enormous space current can be set up by very little anode voltage (and hence very little loss of power) and very little cathode heating power. On the other hand, like all mobs, this one very soon gets out of control. So gas-filled tubes are the thing to use when heavy current, rather than fine control, is wanted.

The expression "gas-filled" sounds as if gas were pumped in under pressure, as indeed it is in

ordinary electric lamps of that description. But in gas-discharge or ionization tubes the gas filling differs from a perfect vacuum by much less than 1 per cent. of atmospheric pressure. Nevertheless, it is enough to provide I don't know how many trillions of ions (and not American or short trillions either). Besides them, many electrons, though not detached, get such a shake-up that they are jerked into different atomic orbits and give out radiant energy. If the wavelength happens to come within the tuning range of the eye, the radiation can be used for lighting, as with the mercury and sodium street lamps. Radiation too short in wavelength to be seen can be used to excite visible radiation in fluorescent substances, as in the tubular lights coming into popular use.

Electronics, in the form of the mercury-vapour rectifier, invades even "heavy" electrical engineering, by providing A.C.-to-D.C. plant capable of handling thousands of amps with very high efficiency.

So the main fields of electronics activity are: communications; measurement and control; lighting; power. Yes, it did need a word for it.

MANUFACTURERS' LITERATURE

THE first of a new series of booklets — "Electrons" has been issued by the Edison Swan Co., 155, Charing Cross Road, London, W.C.2. It deals with "Electrons in Diodes" and is intended for elementary educational purposes. Applications from education establishments should be made to the Technical Service Dept.

The Mazda Valve Equivalents List has been produced in pocket form printed on glossy plastic material and is for general distribution.

An illustrated catalogue of components has been issued by M.O.S. (Mail Order Supply Co.) 24, New Road, London, E.1, price 1d.

Pending the production of a new illustrated catalogue, the Trix Electrical Co. have issued a duplicated list of their amplifiers and sound equipment in conjunction with a booklet of photographic reproductions.

A comprehensive sound recording service, with five studios giving the acoustic conditions necessary for every type of recording from talks to full orchestra is described in a brochure issued by Star Sound Studios, 17, Cavendish Square, London, W.1.

A.V.C. CALCULATIONS

Graphical Methods of Estimating the Performance of Circuits

By S. W. AMOS, B.Sc., (Hons.), Grad. I.E.E., A.M.Brit.I.R.E.

(Engineering Training Department, B.B.C.)

THE aim of this article is to show that it is possible to prepare a family of curves for any particular sequence of variable-mu valves, and that from this it is possible to deduce the A.V.C. characteristic of the receiver (i.e., the curve of aerial input volts plotted against detector input volts). The method is reasonably quick and is applicable to almost any type of A.V.C. circuit, with or without delay or amplification. It enables the performance of the A.V.C. circuit of the receiver to be assessed at the design stage. Although the author developed this method independently, it had something in common with work by Cocking¹ and

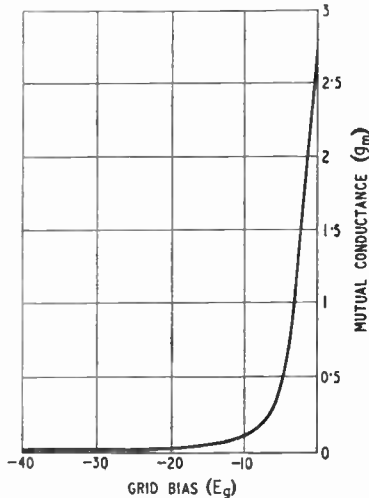

Fig. 1. Variation of mutual conductance with grid bias (g_m-E_g curve) for a variable-mu R.F. pentode.

an article by James and Biggs,²

¹"The Design of A.V.C. Systems," by W. T. Cocking, *Wireless Engineer*, Aug., Sept., Oct., 1934.

²"A.V.C. Characteristics and Distortion," by E. C. James and A. J. Biggs, *Wireless Engineer*, Sept., 1939, p. 435.

to which his attention was drawn subsequently. James and Biggs discuss in detail the calculation of the amount of harmonic distortion introduced by variable-mu valves which are controlled from the A.V.C. line—a point which is not dealt with here.

This article is based on a knowledge of the shape of the g_m-E_g curves of the controlled valves. To illustrate the method we will first consider a very simple case, that of applying A.V.C. to a T.R.F. receiver having only one controlled valve, namely, a variable-mu pentode preceding a diode detector. There is, of course, very little to commend the use of such a circuit in practice, but this example is chosen as a convenient means of introducing the method of deducing the form of the A.V.C. characteristic.

Suppose the g_m-E_g curve of the particular R.F. pentode it is intended to use, for the particular screen potential planned, is as given in Fig. 1. This shows that, as the grid bias is increased negatively from -1 volts to -30 volts, g_m falls from 2.3 mA/volt to 0.0035 mA/volt. As it is very inconvenient to represent such a large variation in g_m accurately on a linear scale as in Fig. 1, this curve is repeated in Fig. 2 with a logarithmic scale for both g_m and E_g . This curve is interesting, for the long, almost straight portion shows that over a wide range of values of E_g the relationship

between E_g and g_m is approximately exponential. As R.F. pentodes are generally used with anode loads the value of which is small compared with their value of R_a the stage gain M obtained from them is given by $M=g_m R_L$ approximately, where R_L is the value of the anode load. M , then, is proportional to g_m for a given value of load resistance and so Fig. 2 may be taken as representing the relationship between M and E_g (with a suitable readjustment of the vertical scale, of course). We can carry this argument further, for it is possible to include the voltage step-up of the

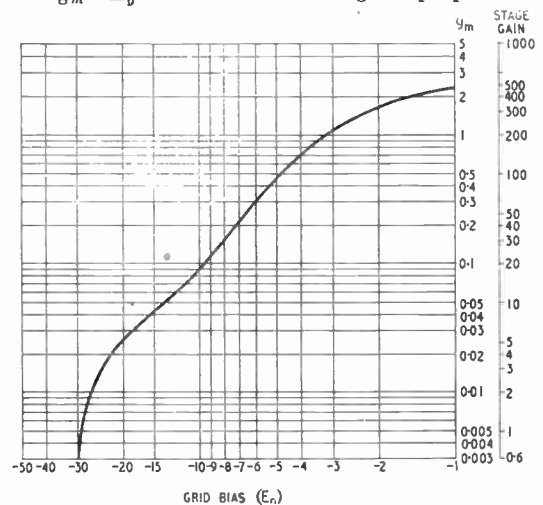
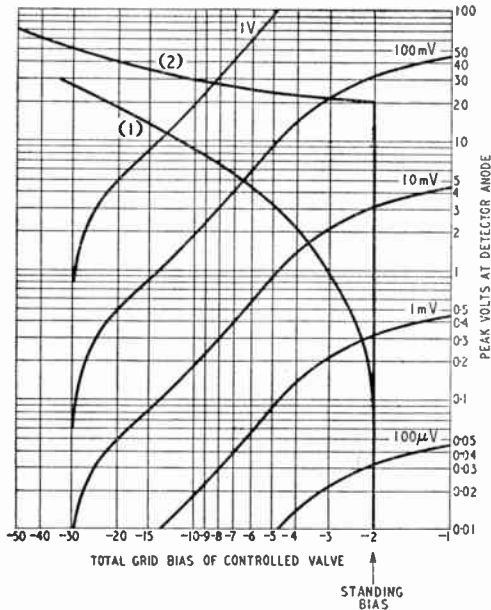

Fig. 2. Curve of Fig. 1 re-drawn with logarithmic scales for g_m and E_g .

aerial coupling circuit in the vertical readings also, so that they represent the overall gain from aerial terminal to the anode of the diode detector. If, for example, the effective value of the load of the R.F. pentode is $20,000$ ohms, then the gain of the valve when $E_g = -1$ volt is $2.3/1,000 \times 20,000 = 46$. The gain of the aerial input circuit we will take as 10 , giving an overall gain, at $E_g = -1$, of 460 .

A second vertical scale giving the value of overall voltage gain is indicated in Fig. 2. Now the overall gain is equal to the number of volts obtained at the diode anode for one volt input at the aerial terminal. This would, in



grids of the controlled valves are 2 volts negative with respect to their cathodes and there is hence no possibility of grid current. A vertical line is drawn in Fig. 3 at a bias of -2 volts as a reminder of the fact that the bias never becomes less negative than this value.

Now consider a simple A.V.C. system, such as that given in the circuit diagram in Fig. 4, in which there is no

Fig. 3. Diagram for estimating the performance of an A.V.C. system with one controlled valve.

assume that the A.V.C. voltage equals the peak value of the applied R.F. signal. Then a 1-volt signal gives -1 volt A.V.C. bias, which, together with the -2 volts standing bias on the controlled valve, gives a total bias of -3 volts. Similarly a 10-volt signal gives -22 volts and so on.

The relationship between the signal on the detector anode and the total bias voltage of the controlled valve is indicated by curve (1) in Fig. 3 and the intersections between this and the nest of curves previously drawn illustrates the performance of the A.V.C. circuit of Fig. 4. The intersections show, for example, that an input signal of 10 mV gives 1.7 volts at the detector anode and -3.7 volts total bias on the controlled valve, whereas a 1-volt input signal gives an output of 11 volts and a bias of -13 volts.

These and the data from other intersections are best represented on another diagram as in Fig. 5. From this we can see that there is no A.V.C. action for inputs smaller than about 1 mV: in other words this system is of little use

practice, overload the R.F. valve for all but the largest values of grid bias, but neglect this for the moment. So the second vertical scale, of Fig. 2 may also be taken as giving the number of volts at the detector anode for one volt applied between the aerial-earth terminals. This curve is repeated in Fig. 3 in this new form and is labelled "1V." Obviously if the input to the aerial-earth terminals were reduced to 0.1 volt then we should get 1/10th of the number of output volts obtained previously; i.e., 46 volts at a bias of -1 volt. This is indicated by the curve labelled "100mV" in Fig. 3. This process can be continued further and a nest of curves prepared for various input voltages. Because of the vertical logarithmic scale all the curves so obtained are of exactly the same shape, being merely displaced from each other vertically. This is a convenient feature for it considerably simplifies the preparation of such diagrams as Fig. 3.

Fig. 2 showed that there was little improvement in gain to be had by reducing the grid bias to less than -2 volts. This fact is usually made use of in receiver design by including self bias circuits in the cathode leads of valves to give a standing bias of approximately this value. Even in the absence of A.V.C. bias the

delay and no amplification of the A.V.C. bias. The negative bias given by this system is directly proportional to the amplitude of the R.F. carrier applied to the diode anode, and, in fact, if the detection is 100 per cent

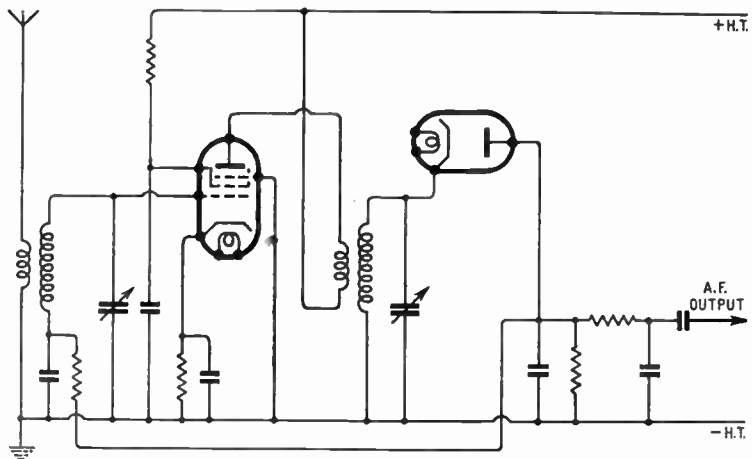

Fig. 4. Simple A.V.C. system with one controlled valve, giving the performance predicted by Fig. 3.

efficient, is equal to it.³ We shall ³This is only approximately true for small inputs to the detector, but is more justified for large inputs. We shall neglect the non-linearity of the diode, however, for the sake of simplicity in the preparation of these A.V.C. curves. We shall also neglect the fact that the anode current of a diode usually begins even when its anode is slightly negative.

in combating fading. For inputs exceeding 1 mV the A.V.C. system compresses a 1,000:1 variation in signal strength to a 40:1 variation in the signal applied to the detector anode.

The performance of circuits giving delayed A.V.C. can be deduced just as easily. Suppose, for example, in Fig. 4, that the anode

A.V.C. Calculations—

of the A.V.C. diode is made 20 volts negative with respect to —H.T., and that the cathode is

one-quarter, of the value of g_m of an R.F. pentode for the same value of bias. For example, the maximum value of g_c (at $E_g=0$) is generally about 0.75 mA/volt compared with 3 mA/volt for an R.F. pentode at $E_g=0$. This means that when the g_c-E_g curve for a frequency changer is plotted using a logarithmic scale for g_c the resulting curve is of exactly the same shape and

ture of this diagram is that the nest of curves given there does not appear to have been produced by repeating the same shape over and over again at different positions, but such is indeed the case. The overall amplification here (at $E_g = -2$ for both valves) was assumed to be 30,000, made up of 100 from the I.F. valve, 30 from the frequency changer, and 10 from the aerial input circuit, all of which are quite reasonable values. Curve (1) in Fig. 7 is for simple undelayed and unamplified A.V.C. and curve (2) for A.V.C. delayed by 2 volts, the type of circuit commonly used in broadcast superhets, in which the bias voltage of the A.F. amplifying triode is used as the delay voltage.

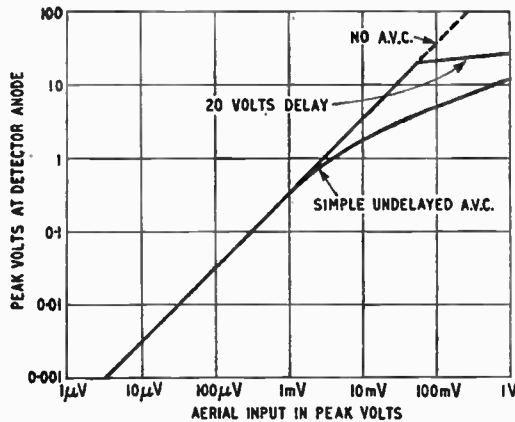

Fig. 5. Performance of a simple A.V.C. system such as that of Fig. 4, with and without delay.

returned as shown, via the tuned circuit, to —H.T. This gives a delay of 20 volts and no conduction (and hence no A.V.C. volts) will occur until the R.F. signal applied to the diode anode exceeds 20 volts in peak value. A 21-volt signal will give —1 volt on the A.V.C. line and hence a total bias on the controlled valve of —3 volts. A 30-volt signal will give —12 volts, and so on. Curve (2) in Fig. 3 shows the relationship between the detector input and the total bias on the controlled valve, and the performance of such an A.V.C. circuit, deduced from the intersections of curve (2) with the nest of valve characteristics, is given in Fig. 5. The chief difference between the two types of A.V.C. represented in Fig. 5 is that the control voltage does not appear, with delayed A.V.C., until the signal at the detector is large, and so there is no limiting of the sensitivity of the receiver.

Now consider a receiver having two valves controlled from the A.V.C. line such as the usual broadcast superheterodyne type, in which the frequency changer and the I.F. valve are controlled. The curve of the conversion conductance, g_c , plotted against control grid bias for a frequency changer with a variable- μ characteristic has the same shape as that given in Fig. 1, except that the value of the conversion conductance for any particular value of E_g is smaller, usually about

size as that given in Fig. 2, but the readings of the vertical scale are always one-quarter of those given in Fig. 2.

For convenience this curve is given in Fig. 6. As before, the vertical scale may be taken to represent the stage gain of the valve. Hence the way in which the gain varies with the total bias in a receiver with a frequency changer and an R.F. pentode, both controlled from the A.V.C. line, is obtained by multiplying the ordinates of Fig. 2 by the corresponding ones of

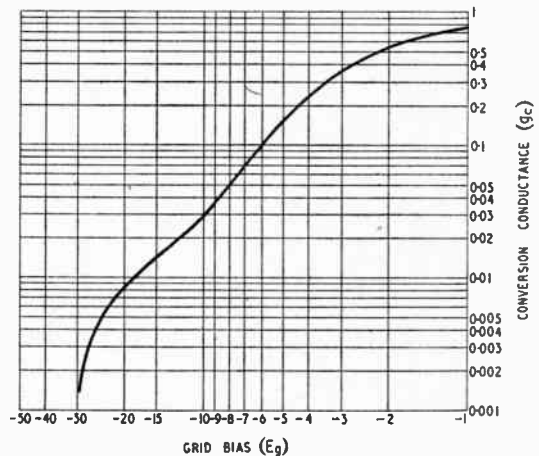

Fig. 6. Variation of conversion conductance (g_c) with grid bias (E_g) for a frequency changer valve.

Fig. 6, it being assumed that both vertical scales have been adjusted to give the stage gain of each valve and its associated coupling circuits. As both vertical scales are logarithmic, this multiplication merely means that the distances between the ordinates are added. From the resulting curve we can deduce a nest of curves for various input voltages, corresponding to those of Fig. 3.

Fig. 7 gives a set of curves deduced in this way. A strange fea-

ture of this diagram is that the nest of curves given there does not appear to have been produced by repeating the same shape over and over again at different positions, but such is indeed the case. The overall amplification here (at $E_g = -2$ for both valves) was assumed to be 30,000, made up of 100 from the I.F. valve, 30 from the frequency changer, and 10 from the aerial input circuit, all of which are quite reasonable values. Curve (1) in Fig. 7 is for simple undelayed and unamplified A.V.C. and curve (2) for A.V.C. delayed by 2 volts, the type of circuit commonly used in broadcast superhets, in which the bias voltage of the A.F. amplifying triode is used as the delay voltage.

In Fig. 8 the performance of these two types of A.V.C. system is exhibited graphically and on this graph are also plotted some points determined experimentally with a domestic superhet, the amplification of which (up to the diode) was known to be about 30,000. The agreement with the calculated curve is seen to be quite good, such divergencies as do occur, being probably due to the standing biases not being equal to each other and equal to —2 volts, to the loss of standing bias when A.V.C. bias increases negatively, to the fact that the delay voltage was not known accurately, and finally—though probably most important—due to the shape of the g_m-E_g and g_c-E_g curves of the valves not being precisely those postulated at the beginning of this article.

Evidently the many simplifying assumptions made in this graphical method do not affect the accuracy of the final result unduly.

A number of other A.V.C. curves—numbers (3), (4) and (5)—have been included in Figs. 7 and 8. Curve (4) illustrates a system with 20 volts delay, and should be compared with curve (2) of Fig. 3, where the same system controls a single valve.

Fig. 7. Curves for determining performance of A.V.C. systems with two controlled valves.

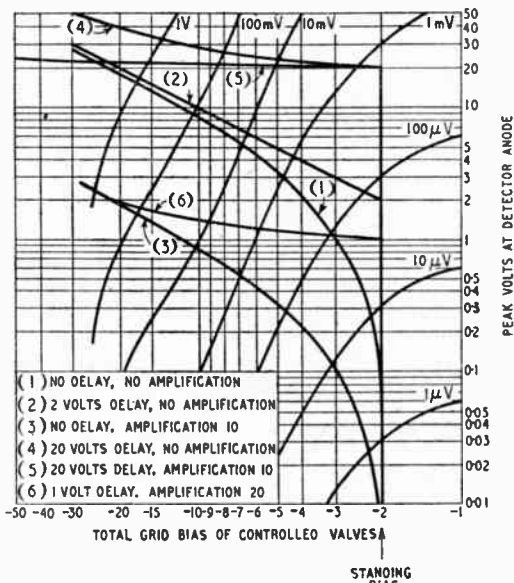

Curves (3) and (5) show the effect of amplifying the A.V.C. voltage. Suppose, for example, the A.V.C. voltage is amplified 10 times, but is not delayed. Thus a signal input of 1 volt peak value to a diode will produce 10 volts negative bias, which, together with -2 from the standing bias system, gives a total negative voltage of 12 volts. Curve (3) shows how total bias depends on detector input for such a system and its intersections with the nest of characteristics is shown by curve (3) of Fig. 8. This system possesses the defect of the simple undelayed form of A.V.C. in an aggravated form in that it seriously limits the amplification of the receiver for small input signals, since even a small voltage at the diode anode produced a large control bias. In curve (5) we have assumed 20 volts delay and an amplification of 10 times. Here a 20-volt signal (or a smaller one) at the diode produced no A.V.C. bias, so only the standing bias is applied to the pre-detector stages and no limiting of sensitivity occurs. A 21-volt signal, however, gives -10 volts bias, making -12 volts in all. The performance of this system, given by curve (5) in Fig. 8 is very good. For inputs exceeding about 700 μ V the output remains constant no matter how the input

increases. An ingenious circuit providing amplified and delayed A.V.C. is described in Paragraph 38, Section N of Volume II of the *Admiralty Handbook of Wireless Telegraphy*, and the performance

given by the constants mentioned there, namely, a delay of 1 volt and an amplification of 20 times, is illustrated by curves (6) in Figs. 7 and 8.

The method just described of deducing A.V.C. characteristic is capable of general application to all receivers, no matter what the number of controlled valves, provided that they all have the same standing bias and that the full A.V.C. voltage is applied to all of them. For receivers in which the controlled valves do have different standing biases and where only part of the full A.V.C. voltage is used for control purposes for some of them, it is still possible to deduce the A.V.C. characteristics provided that a nest of g_m-E_g curves is drawn out for each controlled valve.

To conclude, an account will be given of the general method of

preparing a single nest of curves for a receiver with any number of controlled valves. From this the deduction of the A.V.C. characteristic is a simple matter.

(1) It is assumed that all the controlled valves possess the same shape of g_m-E_g (or g_c-E_g) curve when this is constructed with a logarithmic scale for g_m (or g_c). Plot this curve, making it occupy a fairly large overall height. The vertical height of the final nest of curves will be equal to one-half of the height of this g_m-E_g curve for a system employing two controlled valves, to one-third of it for three controlled valves, and so on. So if the final diagram is required to be 4in high, and if there are three controlled valves, then the original g_m-E_g curve should be about 12in high. This statement assumes that the original g_m-E_g curve occupies three complete cycles of the vertical logarithmic scale. The curve now obtained is similar to Fig. 2, and should occupy about three complete cycles of the vertical scale (for a bias range of 0-30 volts). This simply means that the maximum value of g_m is one thousand (10^3) times the minimum.

(2) Suppose the receiver is to have four controlled valves. On a sheet of tracing paper construct another vertical logarithmic scale with the length of each cycle

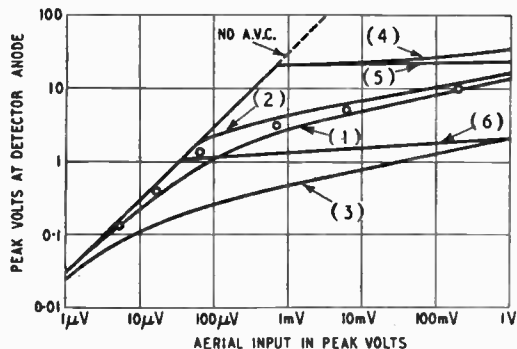

Fig. 8. Calculated performance curves of various types of A.V.C. systems (see Fig. 7) with two controlled valves. The points represent measurements from an actual receiver.

equal to one-quarter that of the existing scale of the g_m-E_g curve. (For three controlled valves each cycle of the new scale should be one-third of the scale of the g_m-E_g curve—and so on). Only about three cycles of this new logarithmic

A.V.C. Calculations—

mic scale need be constructed, and the values 0.05 volts to 50 volts can be marked in. This will give the value of the detector input signal. The horizontal (E_g) scale of this new graph on the tracing paper should be the same as that of the original $g_m - E_g$ curve.

(3) Estimate the total gain, from aerial input to diode anode, expected from the controlled valves at their standing bias. Choose a value of input signal, say $1 \mu\text{V}$, and trace the original $g_m - E_g$ curve on to the tracing paper so that the grid bias scales agree and so that the output voltages as indicated on the new logarithmic vertical scale are correct. Choose a new input ($10 \mu\text{V}$) and repeat the process. All that is necessary in order to do this, is to move the original $g_m - E_g$ curve

underneath the tracing paper up a vertical distance of one cycle on the new logarithmic scale. Repeat again for inputs up to one volt, drawing in only these parts of the original $g_m - E_g$ curve which give outputs between 0.05 and 50 volts.

(4) Draw in the curve for the A.V.C. system it is intended to use and from the intersection of this with the nest of curves obtained by (3) deduce the A.V.C. characteristic as explained above.

Where a number of theoretical determinations of A.V.C. characteristics are wanted it would seem a good plan to have a number of frameworks similar to that of Fig. 7, in which the diode input signal—total bias volts curves for various A.V.C. systems are already plotted. These curves could preferably be the results of experiments on diode detectors,

OUR COVER

A complete deflector coil assembly on the neck of a television C.K. tube is illustrated on the cover. Coil winding data for one pair of the coils included in it is given elsewhere in this issue and details of the other pair will be given next month.

for, by this means, any errors due to the non-linearity of the diode for small inputs would be eliminated. The $g_m - E_g$ curves could be drawn on the framework as described above, with the exception that in this case the vertical scale of the $g_m - E_g$ curve will have to be "expanded" according to the number of controlled valves before the curves are copied, whereas in the previous method the framework is reduced to accommodate the $g_m - E_g$ curves.

Design Data (11)**AERIAL COUPLING IN WIDE-BAND AMPLIFIERS**

INTERSTAGE couplings for wide-band amplifiers have been dealt with in Design Data (2), (3), (4) and (10). It was shown in the last that the aerial-to-first-grid coupling must be included as a stage in bandwidth computation, but not when assessing gain. As a result of this a figure is obtained for the inductance L of the circuit and its total shunt resistance R for a given capacitance C and bandwidth requirement.

Since wide-band transmissions are nearly always on V.H.F. or higher frequencies, a resonant aerial connected to the receiver by a feeder is invariably employed. The problem then becomes that of matching the feeder to the first circuit.

Most feeders have an impedance of about 75Ω and it is substantially resistive. Maximum power transfer occurs when it is so coupled to the circuit that the circuit shunt resistance is halved by the presence of the feeder.

If the total resistance set by the bandwidth requirement is R , then the circuit must be built for a resistance of $2R$ in the absence of the feeder and the feeder must be so coupled that it reflects a resistance of $2R$ into the circuit.

If the effective voltage ratio of tuned-secondary/primary is n , and R_f is the feeder impedance, the maximum transfer occurs when $n^2 = 2R/R_f$ and, by definition, the ratio of voltages at the grid of the valve to the feeder is n . In the ideal case, n would

also be the turns ratio of the transformer; that is, if the coil L between grid and earth has N turns, the feeder would be tapped on at N/n turns from earth, or a separate coupling winding would have N/n turns. In practice, at high frequencies the coupling is very far from 100%, and the feeder connection must be at rather more than N/n turns. It is hardly practicable to calculate the right number, and N/n should be taken as giving only a rough approximation to it.

As an example, suppose L is found to need 9 turns and R is $2k\Omega$ with $R_f = 75\Omega$. Then $n = \sqrt{(4,000/75)} = 7.3$ and the tapping is at about 1.23 turns above earth. In practice, it would probably be at about 1.5-1.7 turns. The artificial damping, apart from the feeder, must be arranged to be $4k\Omega$; it includes coil resistance losses, valve input resistance, and any additional damping resistor. The circuit is shown in the figure and the resistance R is thus rather more than $4k\Omega$.

The overall amplification from the feeder is then n times the amplification measured from the first grid. It will be seen that the step-up in the coupling is considerable and of the same order of magnitude as the gain of a valve stage.

It should be pointed out that it is sometimes possible to improve the signal/noise ratio by using somewhat tighter coupling than is indicated here. The improvement is small, however.

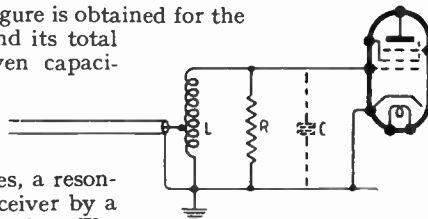

★ THE TREND OF MODERN ELECTRONICS ★

THE PINT VALVE

HALF-PINT GLASS

IN THE



BRIMAR

BVA

VALVES

Bantam Range

STANDARD TELEPHONES AND CABLES LIMITED, FOOTSCRAY, SIDCUP, KENT



● When you buy a MARCONIPHONE you buy 25 years unparalleled experience in Domestic Radio design.

Public broadcasting began with MARCONIPHONE receivers —they are still the best from every standpoint. See your Dealer about post-war models.

This signature on the Radio you buy indicates the REAL thing in Radio.

G. Marconi



THE MARCONIPHONE COMPANY LIMITED, HAYES, MIDDLESEX

MAINS TRANSFORMER PROTECTION

Fuses Designed to Withstand Initial Switching Surges

IT is a significant fact that the great majority of radio sets and electronic instruments embodying a mains transformer do not include fuse protection in series with the primary winding. The socket connection to the mains is generally backed by a fuse in the electric wiring of the building, but these fuses are invariably of 5 amp. or 15 amp. rating, and any defect in the apparatus giving rise to abnormal loads on the transformer would burn out the transformer long before the 5- or 15-amp. fuse cleared.

Since the cost of a small cartridge fuse and its holder is quite small compared with the cost of a mains transformer there do not appear to be economic grounds for its omission, particularly in high-grade laboratory equipment.

The reason for its omission is not difficult to establish. The simple type of cartridge fuse (Fig. 1 (a)) consisting of a filament of wire enclosed in a glass tube is not capable of withstanding the switching surge if its rating is equal, or near to, the rated current consumption of the equipment. This leads to the inclusion of a fuse of higher rating which will not clear on the switching surge. Unfortunately, the rating now becomes so high that the fuse will sustain overloads capable of burning out the mains transformer before the fuse clears.

At this stage it will be of interest to discuss the mechanism by which these switching surges are produced. An investigation was undertaken in which a number of pieces of laboratory apparatus were individually connected to the mains via a suitable recording device, to trace the amplitude and waveform of the primary current from the moment of

switching on. It was observed that quite a large number of switchings could be made in which no surge occurred. This indicated that the moment of switching relative to the cycle of the applied E.M.F. is important.

The exact moment of switching, to provide the desired test surge is in the neighbourhood of that part of the applied E.M.F. wave where it is falling through zero amplitude and is also partly dependent upon the effective R/L ratio of the transformer referred to the primary circuit. The phenomenon has been analysed for an air cored inductance, and it is found that if an inductance of low R/L ratio (high Q) is connected to a source of alternating E.M.F. at the instant it rises through zero amplitude, the current which flows will rise to exactly twice the steady-state peak amplitude during the first half-cycle, rapidly falling thereafter to steady-state equilibrium conditions. The presence of the iron circuit, however, will increase the amplitude of the surge to more than twice the steady state if the iron is being worked near the bend of its B-H curve under steady-state conditions.

For reasons of economy, it is usual to select a cross-section of iron that gives this condition, so that any current over and above the rated current for the transformer will reduce the inductance. But this reduction in inductance will tend to cause the current to

rise to an even higher value, and it is easy to visualise that this will tend to give a cumulative effect which comes into equilibrium by somewhat complicated energy transfer processes. For the types of transformers we are discussing, the surge can attain amplitudes some twenty times greater than the steady-state peak values of input current.

In examining the results of the tests carried out on a number of representative transformers two important characteristics were noticed. First, the duration of the surge never exceeded one half-period of the frequency of the applied E.M.F. The experiments were conducted using the 240-V, 50-c/s mains supply so that the surge never lasted longer than 0.01 sec. Secondly, the amplitude of the surge was not materially changed by "hot" or "cold" switching; i.e., whether the switching operation took place when the apparatus had been previously operated or not.

At this stage we will neglect the question of these surges and consider whether the simple type of fuse, as previously described, is likely to protect the average mains transformer of the type we have in mind, when faults arise causing excessive secondary loads.

Now, in accordance with British Standard Specification 646, a "B" category fuse (60 mA to 5 A) shall rupture within 1 minute where the current is 1.75 times the rated current. Starting on this basis first transformers were tried loaded on their secondaries

until their design rating was attained, and a fuse of appropriate rating was included in series with the mains supply. The transformer was allowed to run for at least one hour under these conditions to attain temperature equilibrium. Inciden-

By
F. R. W. STRAFFORD, A.M.I.E.E.
(Belling & Lee, Ltd.)

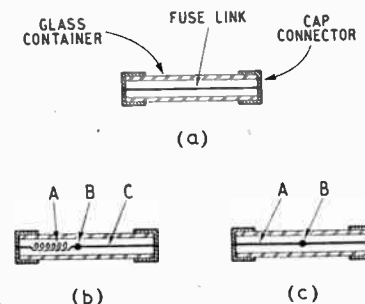

Fig. 1. (a) Simple cartridge fuse. (b) Spring-loaded fuse with low melting-point connection. (c) Magnesium-loaded nickel fuse.

Mains Transformer Protection—

tally, the transformers tested were of the conventional type employing two valve heater secondaries and a 350-0-350-V H.T. secondary.

fuses and maintain the 75 per cent overload for exactly 1 min, which is the top limit of the specification. Under these conditions the average temperature of the windings did

transformer with which the radio and electronic industry are concerned) appear to reach, in the worst cases, some twenty times the normal rated peak current.

not rise by more than 10° C. By holding the overload for 3 mins the temperature rose by 20° C.

It is clear that these temperature rises are not dangerous for a well-designed transformer, so that

The simple type of cartridge fuse, covering ratings from 100 mA to 3 A, appears to possess a surge factor from 5 to 10 times the peak rated current. In a large majority of cases, therefore, such fuses will be blown by switching surges if their current rating is matched to the transformer rating.

The problem of protecting a transformer is thus one of designing a fuse which will meet the B.S. 646 specification in regard to the 1 min. overload test, but which will carry at least thirty times its rated current for a period of 0.1 sec.

In Germany a popular method of meeting this surge-resisting requirement is obtained in the manner indicated in Fig. 1(b). A coil of springy wire, A, is soldered by means of a blob, B, of low-temperature solder (e.g. Woods' Metal) to a fine manganin resistance wire C. The assembly is mounted under the spring tension in a glass tube and capped as in the familiar fuse construction. Under a prolonged overload of, say, two minutes, sufficient heat is generated by the resistance wire to melt the solder blob and the spring thus snatches the junction of A and C apart and clears the fuse. The temperature rise to cause disruption need only be of the order of 100° C, whereas

By short-circuiting any one of these three windings the fuse cleared instantly. It was noted, by separate measurement without a fuse in circuit, that short-circuiting a 4-volt winding caused the primary current to rise by 140 per cent. Short-circuiting the 6.3 volt winding caused a 300 per cent increase, and short circuiting the 350-0-350-V winding a 700 per cent rise. Fuses designed to B.S. 646 (category "B") will clear instantly on 100 per cent or greater overloads, a result verified by the foregoing short-circuit tests.

in the event of a fault causing the primary current to rise by a factor of 75 per cent or greater, a simple cartridge fuse designed in accordance with B.S.646 (category "B") would undoubtedly protect the mains transformer from breakdown.

Thus the only deterrent to the wider use of B.S. 646 cartridge fuses for the class of application

Reverting to the previous set-up (where the transformer was correctly loaded) each secondary winding was individually loaded until the primary current was 1.75 times the rated current. As would be expected the fuses cleared within 1 minute in each test. During the period prior to fuse clearance the average temperature of the windings was checked by noting the rise in winding resistance and employing the formula $R_T = R_0 [1 + \alpha T]$, from which one obtains $T = \frac{R_T - R_0}{\alpha}$, where

R_0 is the resistance at 0° C, and α is the temperature coefficient of resistance. Most of the fuses cleared within 15 secs. and it was difficult to determine the temperature rise because of the lack of time to make observations. It was decided, therefore, to remove the

we have been discussing is their inability to withstand large current surges for a period of up to about 0.01 sec.

It was previously pointed out that these surges (for the type of

for the filament-type fuse this may be 900° C or more according to the metal or alloy employed. Very sudden surges of large amplitude will not generate sufficient heat in the blob to cause it

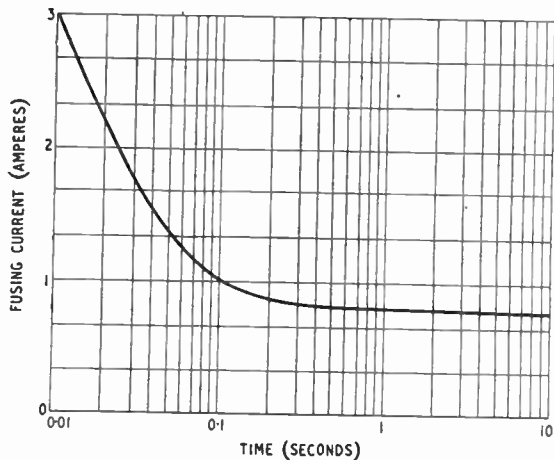

Fig. 2. Time taken to blow fuse at various currents for a 0.5 amp fuse to specification B.S.646.

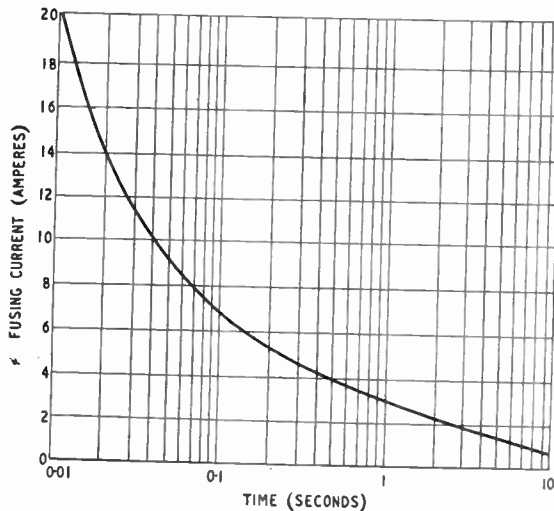

Fig. 3. Fusing current/time curve for magnesium-nickel fuse rated at 0.5 amp.

to melt, due, of course, to its large diameter relative to that of the wire, and its consequent high thermal inertia. The limit to the surge-handling capacity is set where the heat produced by the current is sufficient to raise the fine manganin wire to its melting point.

Naturally the greater skill and time taken to manufacture this type of fuse is reflected in its greater cost of production as compared with the single-filament conventional fuse. Fuses constructed in this manner will, however, protect transformers, and themselves, by virtue of their complete ability to withstand switching surges.

Another method* has been developed which permits of a construction whose difficulty lies about midway between the German fuse and the conventional type. The physics of its operation is quite different, however, and is as follows. A high melting point nickel wire A in Fig. 1(c) is made up into a conventional type fuse with the exception that it carries a small blob B of magnesium powder held together by a suitable binding varnish.

Now magnesium has a very great affinity for oxygen when its temperature is elevated, and at about 500° C it burns spontaneously, generating an intense heat. By careful manufacturing control of the diameter of the magnesium blob it is possible to manufacture fuses which will satisfy B.S. 646 long-time blowing requirements, but which will possess, in addition, a surge factor of approximately 40 times the rated current, thereby removing completely the disadvantage of the simple fuse.

Fig. 2 depicts the relationship between the fusing current and time for a 0.5 amp. rating fuse of the conventional type. This should be compared with Fig. 3 which represents the short time performance of a delay fuse embodying the magnesium nickel principle and designed also for 0.5 amp. rating.

While both fuses clear in about 10 seconds at 0.875 amps. (75 per cent overload) the delay fuse requires 20.0 amps. to clear it

in 0.01 secs. as compared with 3.0 amps. for the simple fuse.

In practice it is usual to employ two blobs of magnesium per fuse, and these are respectively at about $\frac{1}{4}$ and $\frac{3}{4}$ of the length of the nickel element. The reason for this is to provide insurance

in the event of one blob failing. The reason blobs are not placed in the centre is because, where the wire heats and expands, this region is obviously the more liable to touch the glass walls of the fuse container and inhibit blowing.

SHORT-WAVE CONDITIONS

Expectations for February

By T. W. BENNINGTON (Engineering Division, B.B.C.)

MAXIMUM usable frequencies for this latitude during December followed the expected trend, i.e., they decreased during both day and night-time. Whilst the daytime decrease was, however, only slight, the night-time M.U.F.s were quite considerably lower than during the previous month. Despite the slight decrease in daytime M.U.F.s, conditions were such that on most days high-frequency communication to most parts of the world was good for considerable periods. At night frequencies as low as 7 Mc/s were the highest that could efficiently have been used over many circuits.

There was very little ionosphere storminess during the month and only one disturbance of even moderate intensity occurred—during the period 19th-20th. Disturbances of minor intensity occurred on 3rd-4th, 11th-12th, 22nd and 25th-27th.

Forecast.—During February there should be a considerable increase in the daytime M.U.F.s and an appreciable increase in the night-time M.U.F.s, as compared with those for January. Both the seasonal and the sunspot cycle effects are such as to produce these increases. Communication on very high frequencies should therefore be good for considerable periods over most long-distance circuits, though the change in frequency as between daytime and night-time working frequencies will still be relatively great. Night-time M.U.F.s should however be such that frequencies lower than about 9 Mc/s will only be necessary over circuits traversing relatively high northern latitudes, and then only for limited periods.

Below are given, in terms of the broadcast bands, the working frequencies which should be regularly usable during February for four long-distance circuits running in different directions from this country. In addition a figure in

brackets is given for the use of those whose primary interest is in the exploitation of certain frequency bands, and this indicates the highest frequency likely to be usable for about 25 per cent of the time during the month for communication by way of the regular layers:—

Montreal :	0000	9 Mc/s	(14 Mc/s)
	0500	7 "	(12 ")
	0800	9 " or 11 Mc/s	(13 ")
	1000	15 " or 17 Mc/s	(19 ")
	1200	21 "	(29 ")
	1300	26 "	(36 ")
	1800	21 "	(30 ")
	2000	17 " or 15 Mc/s	(21 ")
2200	11 "	(16 ")	
Buenos Aires:	0000	11 Mc/s	(16 Mc/s)
	0200	9 "	(14 ")
	0700	11 " or 15 Mc/s	(16 ")
	0900	17 " or 21 Mc/s	(26 ")
	1100	26 "	(37 ")
	1900	21 " or 17 Mc/s	(26 ")
	2100	15 "	(21 ")
	2200	11 "	(17 ")
Cape Town :	0000	11 Mc/s	(16 Mc/s)
	0200	9 "	(14 ")
	0600	11 "	(18 ")
	0700	21 "	(29 ")
	0800	26 "	(38 ")
	1700	21 " or 15 Mc/s	(31 ")
	1800	17 "	(21 ")
	2100	11 "	(17 ")
Chungking :	0000	7 Mc/s	(12 Mc/s)
	0500	11 "	(17 ")
	0800	17 " or 21 Mc/s	(26 ")
	0900	26 "	(35 ")
	1100	21 " or 17 Mc/s	(28 ")
	1300	15 " or 11 Mc/s	(16 ")
	1800	9 "	(14 ")
	2100	7 "	(12 ")

Though February is not usually a particularly disturbed month the effects of any ionosphere storms which do occur are still likely to be troublesome over dark transmission paths, especially those which traverse high latitudes. At the time of writing it would appear that storms are more likely to occur during the periods 3rd-5th, 11th-13th, 18th-19th, and 22nd-23rd than on the other days of the month.

* Patent No. 473,335.

TEST REPORT

EKCO MODEL A28

Table Model Receiver for A.C. Mains

(Four Valves + Rectifier and Tuning Indicator)

THIS is a receiver which caters for every class of listener. Push-button tuning is provided for five stations, three on medium and two on long waves, so that the main programmes are instantly available without knob twiddling. In-veterate "ether-combers" will find the system of bandspread tuning very much to their liking, for it enables long-distance short-wave stations to be tuned-in with the facility of medium-wave stations. Quality enthusiasts have been provided with a tone control of unusual design, negative feedback in the output stage and a 10-inch loudspeaker.

gang condenser is disconnected and the oscillator is converted to the Colpitts type of circuit. Tuning is effected by "master" variable inductances in aerial and oscillator circuits with cores ganged to the main tuning drive, and inductances are connected in parallel to bring the frequency to the required ranges. A similar parallel arrangement is used for the push-button settings on medium and long waves. The aerial circuit is tuned by capacit-

the second harmonic of the oscillator when working on the 13-metre band. A fixed tuned circuit connected next to the grid of the frequency changer and working in conjunction with the valve input capacitance serves to tune the aerial input to the sound channel.

The intermediate frequency amplifier operates at 460 kc/s and together with the frequency changer is controlled by A.V.C. from the double-diode-triode valve. A muting terminal is pro-

Complete circuit diagram. The inductively-tuned short-wave ranges are selected by shunting fixed inductances across master tuned circuits.

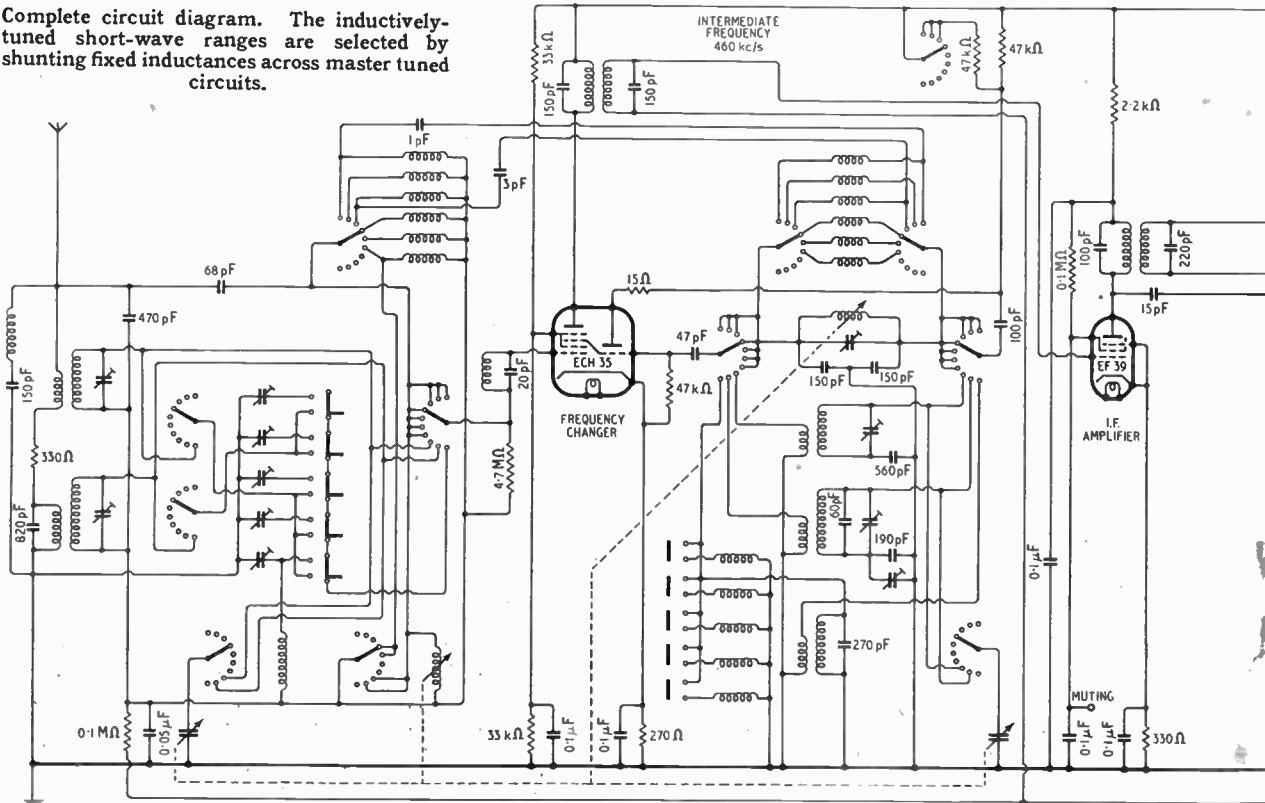

Circuit.—On medium and long waves the circuit follows normal superheterodyne practice with ganged condenser tuning and magnetic coupling in the oscillator circuits. On short waves the

ance trimmers for the push-button stations and a parallel inductance is used to reduce the wavelength for the lowest range on the medium-wave band.

Television sound is received by

vided for earthing the screen grid of the I.F. valve when using the set for gramophone reproduction. A Mullard EM34 is used as tuning indicator and provides two degrees of sensitivity.

The output stage has a 9-kc/s whistle filter permanently connected between anode and earth. Negative feedback is applied over two stages from a third winding on the output transformer. The feedback circuit is divided into two branches containing continuously variable R-C filters for bass and top boost. Simultaneous control is effected by a single potential divider. The volume control includes a simple form of tone compensation.

Performance.—The outstanding feature of this receiver is undoubtedly its short-wave performance. Freedom from frequency drift and the unusually wide degree of bandspreading on each of the principal broadcast bands make tuning easier, if anything, than on the medium-wave band. The automatic volume control is particularly effective and gives a

VLB8 on 13.89 metres was received steadily for over two hours during the late morning—not a particularly favourable time for signals from the Antipodes.

Sensitivity and selectivity on the medium- and long-wave bands are up to the



WAVERANGES :

Short : 13.8-14 m. ; 16.6-16.98 m. ; 19.4-20.0 S. ; 24.6-25.9 m. ; 30.2-32.4 m. ; 38.4-43.0 m. ; 44.5-52 m. Medium : 200-550 m. Long : 900-2,000 m. Price: £31 10s. plus £6 15s. 6d. tax.

standard one expects from a modern four-valve super-heterodyne. Self-generated whistles

“top lift” was considerable and seemed to be accompanied by an appreciable loss of bass. To our ear the best balance was obtained at about three-quarters of the full rotation from the “bass lift” setting of the control.

Constructional Details.—Separate sub-assemblies, which are detachable from the main chassis, are used for (1) the press-button switches and coils, (2) the gang tuning condenser, bandspread mechanism, drive and scale, (3) the aerial and oscillator coils and the waverange switch.

The indirectly illuminated Perspex tuning scale is provided with a series of pointers operating simultaneously on the vertical waverange scales. The range in use is indicated by a bar of light at the bottom of the scale. A neat cumulative stop mechanism is fitted to the tuning control spindle so that it is impossible to strain the tuning mechanism through the slow-motion reduction gear.

Instructions are given for fitting an external switch for muting the radio side when reproducing gramophone records. Alternatively, the user can search for a dead spot on one of the waveranges, or disconnect his aerial. We feel that in a receiver in this price category, the makers might

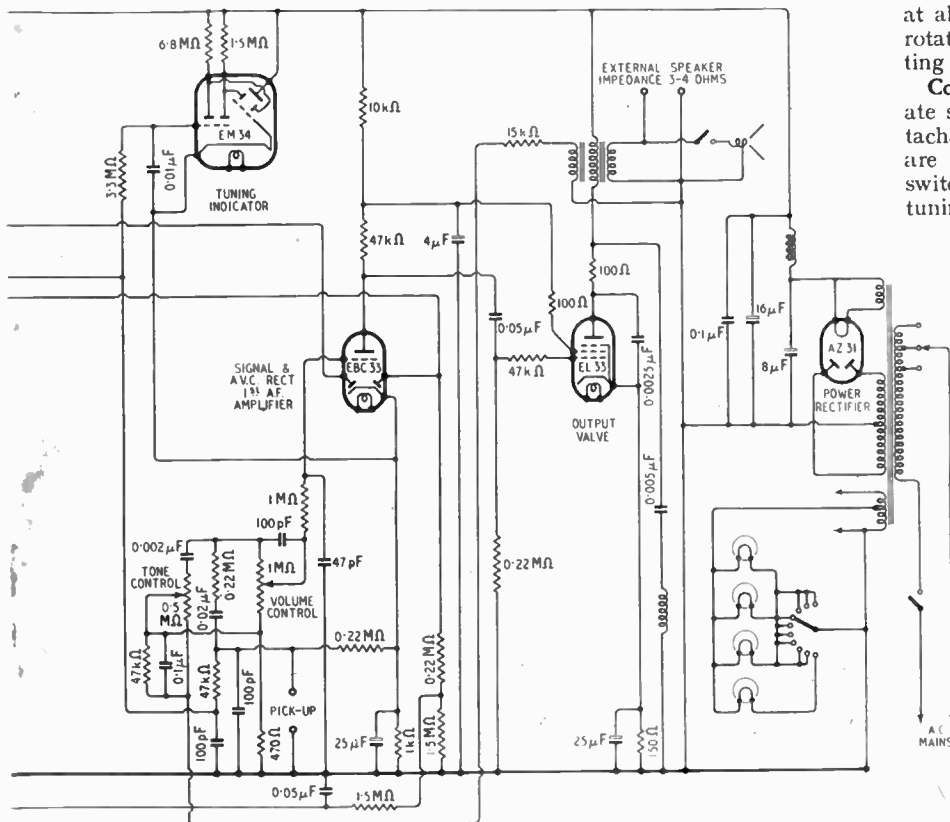

steady audio-frequency output from signals which show very wide fluctuations on the cathode-ray tuning indicator. During the course of our test the programme from the Australian station

were few and far between.

The loudspeaker delivers ample volume from the 2½-watt output stage and the tone control gives a wide choice of tonal balance. In the extreme clockwise position the

Ekco Model A28— have found a tidier solution to the problem. When the external loudspeaker

be used in making use of this facility for damage may result if the receiver is switched on without a load in the anode circuit of

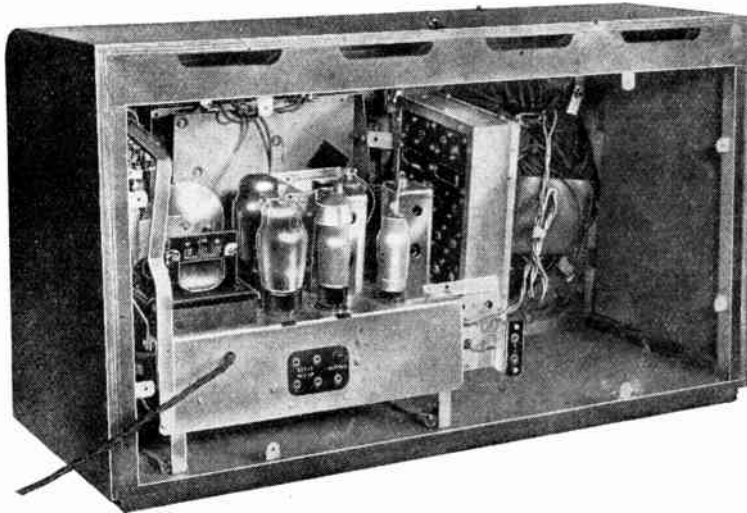

A separate screening box to the right of the chassis contains the tuning coils and waverange switch. The inductive tuning mechanism and gang condenser are mounted with the slow-motion drive on a detachable plate.

is in use the internal speaker can be silenced by unscrewing slightly a small black terminal screw at the back of the set. Care should

the pentode used in the output stage.

Makers.—E. K. Cole, Southend-on-Sea.

Moving Coil Headphones

THE design of the Type K headphones now being produced by S. G. Brown, Victoria Road, North Acton, London, W.3, is based on that of the moving coil microphones and head sets used by the fighting forces during the war. The response of the Services instruments was given a rising characteristic to ensure good intelligibility through extraneous noise, but in the Type K headphones the average response with constant input voltage is, according to the maker's curve, level within ± 6 db from 200 to 5,000 c/s and tails off 10db between 5,000 and 8,000 c/s and about 20 db between 200 and 50 c/s. There is a sharp cut-off at 8,500 c/s.

Modification of the response has been effected by a perforated cover plate shaped to fit the contours of the diaphragm. A thin plastic film prevents the ingress of moisture without interfering with the output.

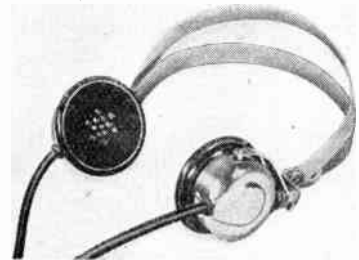

S. G. Brown moving coil headphones, Type K.

The impedance at 1,000 c/s is 104 ohms per pair and a matching transformer will generally be required. We understand that transformers will be available for matching to 5,000, 7,000 and 10,000 ohms or 2, 6 and 15 ohms. The price of the Type K headphones without transformer is £5 5s.

Industrial News

An Electronics Section has been formed by fourteen member firms of the Scientific Instrument Manufacturers' Association with Capt. A. G. D. West, director of Cinema-Television, Ltd., as chairman. The companies forming the Section are: Baird & Tatlock; Baldwin Instrument; Cinema-Television; Adam Hilger; Henry Hughes; Kelvin, Bottonley & Baird; Marconi Instruments; Mullard; Scophony; Short & Mason; Sperry

Gyroscope; Sunvic Controls; Taylor Electrical Instruments; and Taylor, Taylor & Hobson.

E.M.A.—A revised schedule of subscription rates for membership of the Electronic Manufacturers' Association was recommended at the Annual General Meeting of the Association on January 22nd, this provides for a reduced subscription for smaller firms. Details are available from the Secretary, H. MacDougall, Vernon House, Sicilian Avenue, London, W.C.

"SIMPLE VALVE VOLTMETER"

In Fig. 2 of the article which appeared on page 9 of the January issue, one or two errors occurred in the connections of the switches. The corrected circuit diagram is given here.

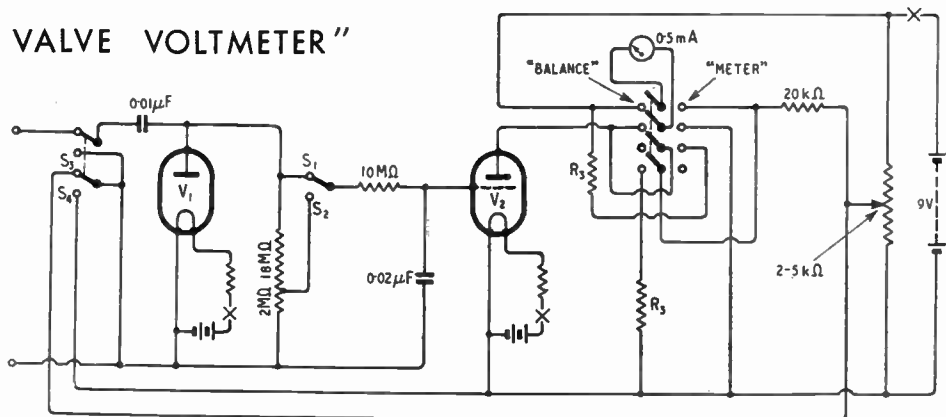



Ribbon Microphone, Type MR/415, freq. range 40-10,000 c.p.s. A high quality microphone suitable for relaying music or speech with excellent fidelity.

A 'SOUND'



PROPOSITION!

ARE YOU A TANNOY STOCKIST ?

A restricted number of qualified dealers and P.A. specialists are being appointed as approved stockists for the main trade distribution of Tannoy Sound Equipment. Having declined to jeopardise the reputation of TANNOY by the production of interim equipment to meet insistent demands for "anything at any price," the extensive post-war range of TANNOY Sound Equipment which is now becoming available embodies all the latest technical developments in design and the highest quality of manufacture. The trade mark "TANNOY" remains a guarantee of reliability to you and your customer.

Illustrated is the second representative group of TANNOY Equipment as detailed in our latest catalogue. Write for the qualifications required of stockists, and for complete details of the full range of TANNOY Equipment.

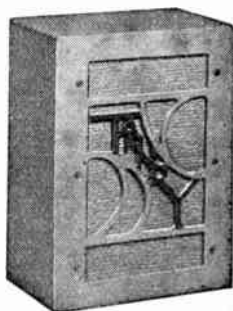

Wide Range Dual Unit Loudspeaker, Type LS/HF/5c, ideal for low level distribution systems.

TANNOY

"THE SOUND PEOPLE"

GUY R. FOUNTAIN LTD.,

"TANNOY" is the registered Trade Mark of equipment manufactured by

GUY R. FOUNTAIN LTD.,
WEST NORWOOD, S.E.27, & BRANCHES,
Gipsy Hill 1131.



Radiogram, A.C. mains, Type RGG/AC/ML, Medium and Long waves, low output.



25 Watt Universal Transportable Amplifier, Type AUH/25, A.C. or D.C. supply of 200 to 250 volts.

gramophone milestones

Three dates stand out as important milestones in the history of the gramophone, the making of records and their reproduction.

In 1925 electrical recording was introduced, and Brunswick announced the "Panatrope," the world's first electric record reproducer.

The second milestone came twenty years later in 1945 when Decca announced *ffrr*—*full frequency range recording*. Twelve months later came the Decola, the world's first electric record reproducer having a frequency response range of thirty to fourteen thousand cycles per second.

Thought by some people to be a stunt, *ffrr* records had been made and marketed nearly twelve months before the announcement was made. Both critics and "man-in-the-street" music lovers had noticed a difference, and letters of appreciation showed that even when played on ordinary reproducers the outstanding qualities of *ffrr* definition and frequency coverage were immediately apparent.

Alongside the making of the new records a reproducer, equally revolutionary was taking shape, the desired characteristic being the distortionless reproduction of the full range of *ffrr* frequencies.

The result was the Decola, the coming of the gramophone into its own; a record reproducer ranking in musical qualities with the highest grade of pianoforte, bringing to the home and enriching family life with a range and variety of music impossible to obtain by means other than the Decola and Decca *ffrr* records.

There need be no secret about all this. It is the total sum of vision, enterprise, the ability to turn advanced theories into practical facts, and the co-ordination of the thinking and benchwork of a small team of enthusiasts. All of this will be explained clearly by word and diagram in this journal as soon as space permits . . . information which will enable you to bring your own reproducer as close to the Decola ideal as your resources permit.

General *ffrr* recording technique, record groove shape, frequency characteristics, correction and bass compensation methods will all be explained, together with design details of the patented *Decca needle armature pick-up, amplifier and acoustical system*. This is the information you will be given to enable you to reproduce the living music of the concert hall from your Decca *ffrr* records . . . the music of the concert hall brought to your own home, just as the composer intended you to hear it, and true to the playing and singing of Decca international artists.



The Decca Record Company, Limited, 1-3 Brixton Road, London, S.W.9

HUM IN HIGH-GAIN AMPLIFIERS

Reducing Pick-up in the First Stage

By P. J. BAXANDALL

B.Sc. (Hons)

WITH sufficient care, it is possible to make an A.C. mains-operated audio amplifier in which the hum level is quite negligible in comparison with the thermal-agitation or Johnson noise generated in the impedance of the input grid circuit, assuming the latter to be of the order of $50k\Omega$.

The Johnson noise itself is, unfortunately, just a fundamental fact of nature, and nothing can be done to reduce it, short of operating the whole equipment at a very low temperature!¹ To give an idea of the order of magnitude of Johnson noise in an amplifier, the R.M.S. noise voltage across a $50k\Omega$ resistance at ordinary temperatures is about 0.003 millivolt, the component frequencies being distributed throughout the audio spectrum. Now, 0.003mV is about the output obtained from a ribbon microphone transformer secondary, assuming an impedance of about $50k\Omega$, for a very quiet whisper at several feet from the microphone, so that if it is desired to be able to reproduce sound intensities down to this



Fig. 1. Hum and noise output from microphone pre-amplifier, using SP41 valve with $100k\Omega$ resistor between grid and earth.

very low level, it is essential to ensure that hum is inaudible, or nearly so, compared with the Johnson noise.

One helpful fact is that due to the relative insensitivity of the human ear at low frequencies, an amount of hum which looks serious in comparison with the Johnson noise when displayed on a cathode-ray tube, may be almost completely inaudible on a loud-speaker. Fig. 1 is a reproduction of the output waveform of a micro-



Typical microphone pre-amplifier and (right) experimental ribbon microphone.

phone pre-amplifier made by the writer, using an SP41 valve, with a $100k\Omega$ resistor across the input terminals. The hum was then just comfortably audible in a loud-speaker, but was quite faint compared with the "mush" due to Johnson effect.

It is not always necessary in practice to secure this degree of freedom from hum, since in many applications, such as P.A., the minimum sound intensity is high, but there are obviously occasions when it is desired to reduce all background noises to the absolute minimum. The writer has found that the factors requiring careful attention if this result is to be achieved do not seem to be very widely known by those who build audio amplifiers, and it is the aim of this article to give some practical information on the subject.

Some of the causes of hum, when an A.C. heater supply is used, are due to effects occurring within the valve itself.² Care must be taken to choose a suitable type, and further information on this will be given later in the article. It is also essential, however, to adopt the right layout of the internal circuit if serious hum is to be avoided.

In general, assuming that the obvious requirement of adequate smoothing of the H.T. supply has been attended to, there are two ways in which hum can arise in the external circuit, i.e.:—

(a) Pick-up of hum voltages by unscreened leads in the grid-cathode circuit, due to stray capacity between these leads and parts of the circuit carrying mains alternating potentials. This is often called "electrostatic hum"—though the ending "static" is rather a misnomer.

(b) Induction of hum voltages into wiring "loops" in the grid-cathode circuit, due to the presence of stray A.C. magnetic flux from mains transformers, chokes, heater wiring, etc. This is often called "magnetic hum."

Obviously these effects can also occur in screen and anode circuits, but owing to the much higher signal level the result is often negligible.

The cure for electrostatic hum is simply to provide screening for all high-impedance parts of the grid-cathode circuit, together with adequate values of by-pass condenser for cathode and screen. (There is also the matter of using a "hum-dinger" across the valve heater, but this is dealt with later). The main part of this electrostatic

¹ "Valve and Circuit Noises," *Wireless World*, May, 1940.

² "Valve Hum," by C. E. Cooper. *Electronic Engineering*, July, 1944.

Hum in High-Gain Amplifiers—

screening is provided by using a screened lead between the grid of the valve and the amplifier input connection, and a screened top-cap connection if the valve has the grid connection on top. A complete valve-screen is also essential if the valve is unmetalized.

With regard to the signal input

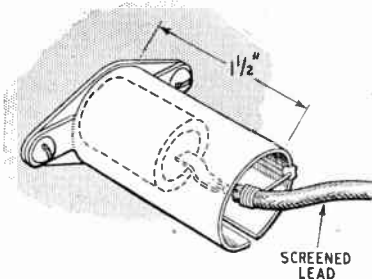

Fig. 2. Home-made sheet-metal screen for input terminal.

connection to the amplifier, the writer strongly recommends the use of a coaxial plug and socket. If ordinary screw terminals or a socket-strip are used, then part of the high-impedance input circuit becomes unscreened and may give rise to hum, especially if the whole equipment is not connected to a good earth. (Though it is always desirable to earth a high-gain amplifier system, there may be occasions when it is not practicable to do so, and if all precautions have been taken, freedom from hum should still be obtained.) The use of a coaxial system also avoids the forming of a "magnetic loop," as explained below. A short length of unscreened lead can be treated by the use of a small sheet-metal shield. See Fig. 2.

Wiring Loops

We now come to "magnetic hum" and its prevention. First, it should be realized that ordinary screened leads, valve screens, etc., give very little, if any, reduction.

Fig. 3 is intended to represent a bad layout from the magnetic hum point of view; screening has been omitted, since, for the moment, we are not concerned with the prevention of electrostatic hum.

It will be seen that the connec-

tion from the earthy input terminal to the valve cathode is via the chassis, whereas the connection from the other input terminal to the grid follows a very different path. Now if stray magnetic flux is present, some of it will probably pass through the loop, or "one-turn coil," *abcd*, labelled L_1 . Similarly, there will be flux linking with loops L_2 and L_3 . Since alternating magnetic flux passing through a coil causes an alternating E.M.F. to be induced in it, L_1 , L_2 and L_3 will all have induced E.M.F.s in them; this state of affairs has been represented diagrammatically in Fig. 3 (b), where e_1 , e_2 and e_3 are the induced E.M.F.s.

Whether the hum voltages e_1 , e_2 and e_3 will be in phase cannot readily be prophesied, for the exact distribution of the stray flux is unknown, but if we take the worst possible case, then a total hum voltage of $e_1 + e_2 + e_3$ will appear between the grid and cathode of the valve.

That a voltage of any consequence could be induced in so small a loop by the weak and comparatively slowly changing stray magnetic flux may at first be surprising; but calculation shows that an E.M.F. of 0.01mV R.M.S. (about 10db up on the Johnson noise level in a 50 k Ω resistance) is induced in a loop of area 10 sq cm by a 50 c/s

small enough to be caused by a mains transformer a considerable distance away, for the usual peak flux-density in a mains transformer is about 10,000 lines/sq cm.

From the above it will be clear that magnetic hum can be prevented, or at least greatly reduced, in the following two ways:—

(a) By arranging the wiring of the input grid-cathode circuit so that loops are reduced to the absolute minimum area.

(b) By arranging the equipment so that the stray field from mains transformers and chokes is kept away from the highly sensitive input circuits.

The most completely satisfactory layout known to the writer is that shown in Fig. 4. By using the metallizing of the valve as a connection from the screening of the input lead to the bias resistance and condenser the system is made coaxial all the way, thus almost completely avoiding loops and at the same time providing good electrostatic screening.

It will be noticed that there is only *one* connection between the

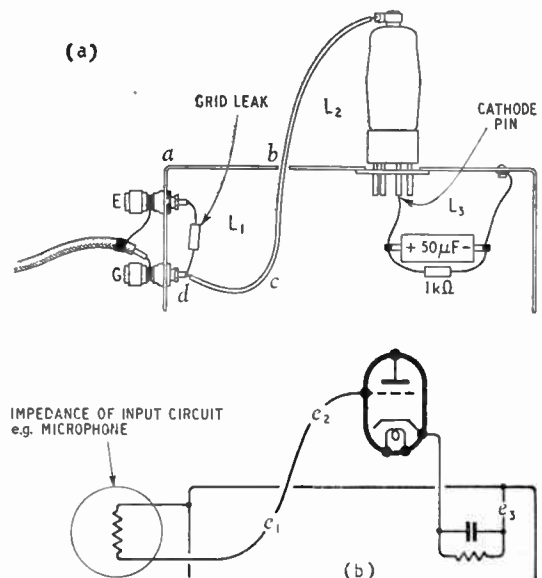

Fig. 3. (a) Shows a poor layout from the point of view of magnetic hum.

(b) E.M.F.s induced by stray magnetic flux into loops L_1 , L_2 and L_3 act in series between grid and cathode.

magnetic flux, at right angles to the plane of the loop, of peak density only about 0.5 lines-per-square-centimetre; and this is

earthy side of the input and the chassis, i.e., at "E." It may be tempting to "make doubly sure" and put a second earthing point,

say, at "P," but it is almost certain that this will cause a considerable increase in magnetic hum, because there will then be two paths in parallel from the earthy side of the input to the cathode—one via the input lead screening and the other through the chassis. That through the chassis will probably be of much lower resistance than the other, and will "take charge," so to speak, so that one will really have reverted to an arrangement almost as bad as that in Fig. 3.

Fig. 5 shows a layout which, though not quite as good as that in Fig. 4 from a theoretical point of view, is often quite adequate in practice, especially when the mains transformer is a considerable distance from the input circuit. The screened lead should be kept as near to the valve as possible to reduce the area of the loop formed with the cathode lead in the valve.

Fig. 4. Recommended layout. If valve metallizing is joined internally to cathode, the hood must be insulated from the metallizing and earthed via an insulated wire running close to valve.

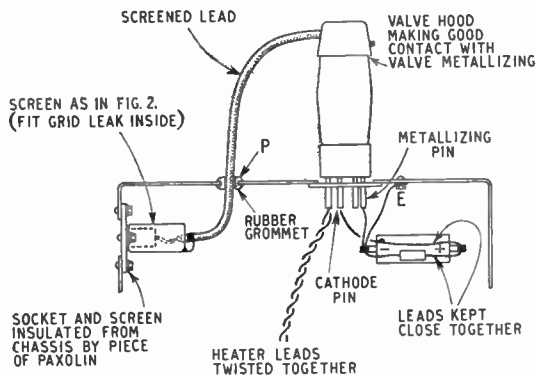

Another point is that it is preferable to use a non-magnetic metal for the chassis of the low-level part of the amplifier; this is specially the case when the mains components are near, or in equipment mounted on a steel rack, in which case the uprights of the rack may provide easy paths for magnetic flux from transformers in other units of the rack assembly.

We now come to causes of hum associated with the valve itself. The main effects are:—

- Stray capacity coupling between grid and heater leads.
- Leakage between heater and cathode, and/or electron emission from heater to cathode.
- Direct influence of the electron stream by magnetic fields, either from the heater or from external sources.

Factor (a) may be reduced by using a valve with a top-cap grid connection. For grid impedances of about 50 k Ω and below, it is usually possible to obtain quite satisfactory results with valves having the grid brought out to a base-pin; but for high-impedance microphones, such as crystal microphones, it is essential for good results to use the top-grid type of valve.

The common practice of earthing one end of the heater winding is quite inadequate in low-level microphone amplifiers, and will usually give rise to serious electrostatic hum. The correct procedure is to connect a potentiometer of 50 to 500 Ω across the heater, and take the slider either to earth, or in some cases to a point about 6 volts positive to earth. (This is explained later.) If the poten-

tiometer ("hum-dinger") is carefully adjusted, the electrostatic hum, due to stray capacity coupling between the grid and heater circuits, can be made to balance out almost perfectly, leaving only a trace of hum, mostly magnetic in origin.

Fig. 6 shows how the hum in an amplifier built by the writer, using an SP41 valve, varied with the setting of the "hum-dinger"; each curve being for a different grid circuit impedance. It will be noticed that the setting for minimum hum is not necessarily exactly at the centre of the element, and in fact it was found to vary by about 20% for different valve samples. It will also be noticed that the setting is much more critical for high grid impedances than for low ones; it may therefore sometimes be reasonable

to replace the potentiometer by a couple of fixed resistors of equal

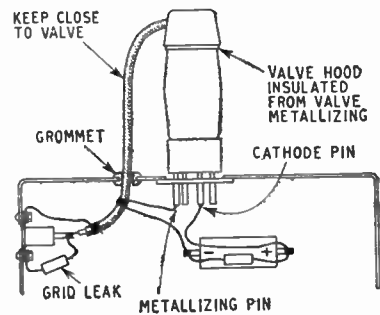

Fig. 5. A good practical layout—often quite adequate.

value, or use a centre-tapped transformer winding, if the grid circuit impedance is fairly low.

The purpose of taking the slider of the "hum-dinger" to a point positive to earth is to prevent electron emission from the heater to the cathode. Fig. 7 shows the improvement produced by doing this in the SP41 amplifier mentioned above. Different valves, even of the same type, vary greatly in the degree to which they produce this effect. Another way of curing the trouble, which is sometimes equally effective, is to reduce the heater voltage slightly, say to 3.7 volts for a 4-volt valve.

Serious leakage between heater and cathode can naturally be cured only by substituting a better valve!

Direct influence of the electron stream by the magnetic field from the heater is largely dependent on the type of heater employed, the best type being the "non-inductive helix." However, the writer's experience is that the amount of hum due to this effect in a carefully selected SP41, which has a "triple-hairpin" heater, is negligibly small if the grid impedance is greater than about 50 k Ω .

If it is unavoidable to have mains transformers, etc., fairly near to the first amplifier stage, then it is sometimes possible to remove most of the resultant magnetic hum by wrapping pieces of Mumetal (e.g., cut from transformer laminations) round the valve.

Coming now to the choice of specific valves, the writer has

Hum in High-Gain Amplifiers—

found that the best readily available valve is the Mazda SP41. However, it seems that the earlier SP41s, having green markings, are on the whole better for this purpose than the more recent sort with black markings; but in either case it is usually necessary to select from several valves that give the lowest hum. If a 6.3-volt heater is preferred, the SP61 or the R.A.F. VR65, now obtainable from surplus stores, are very good; these are in other respects the same as an SP41. Of American valves, the metal 6J7, or preferably the 1620, are very good, the latter being usually less microphonic than an SP41. For low-impedance grid circuits (i.e., 50 k Ω or less) the 6AC7, with a base grid connection, is satisfactory.

The best valve of all, if it can be obtained, is probably the Mazda ACSP3. This was designed with a special view to low hum and microphony, and is widely used by the B.B.C. for microphone amplifiers. Even with this valve it is found that individual specimens vary in their hum properties, and selection is again desirable.

Other things being equal, valves with high-voltage low-current heaters give less magnetic hum than low-voltage high-current types. The Osram H30 triode,

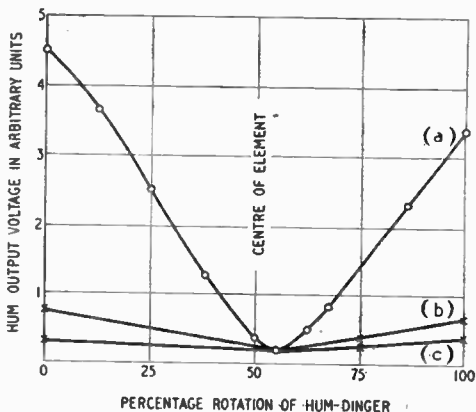

with a 13 volt 0.3 amp heater, is very good as a first-stage microphone amplifier and is still used to some extent.

However, the writer believes that a pentode is almost always the best choice for this purpose, for the following reasons:—

(a) Much higher stage-gain can be obtained.

(b) There is no appreciable Miller effect, and therefore the input impedance is high enough to suit any type of microphone.

(c) Owing to the relatively high signal level in the anode circuit when a high-slope pentode is used, an ordinary type of carbon resistor can be used for the anode load without trouble from the "carbon noise" generated by the passage of the anode current through it.

In connection with (c), experiments have shown that the amount of noise from a carbon resistor of say 100 k Ω with 1 mA current, is many times greater for a small $\frac{1}{4}$ -watt type than for a 1 or 2-watt resistor, the noise voltage becoming progressively less as the physical size of the resistor is increased.³

The general order of noise voltage is 0.1 mV for a $\frac{1}{4}$ -watt resistor of 100 k Ω with a voltage drop of 100 volts, falling to under 0.01 mV for a 2-watt resistor under the same conditions. The Johnson noise voltage across a 100 k Ω resistance is about 0.004 mV R.M.S. Thus if the stage gain is 100 to 200 times, and the grid impedance not much less than about 50 k Ω , one is quite safe in using a $\frac{1}{4}$ -watt anode load resistor of the ordinary carbon type.

The circuit diagram of the single-stage pre-amplifier used by the writer is given in Fig. 8. The gain is slightly over 200 when feeding into a following stage having a 250 k Ω input potentiometer, and the response flat to within 1 db from 30 c/s to

Fig. 6. Reduction of electro static hum by use of potentiometer across heater (a) with 1M Ω grid leak, (b) with 47k Ω grid leak, (c) with input short-circuited.

220,000 c/s, provided the input capacity of the next stage does not exceed about 40 μ F.

It will be noticed that a paper decoupling condenser is used for the second stage of decoupling.

³ "Carbon Resistors," by R. H. W. Burkett, *Wireless World*, January, 1944.

This is not really essential, but is the best practice, since electrolytic condensers sometimes give rise to "frying" noises, particularly if not new. Trouble from

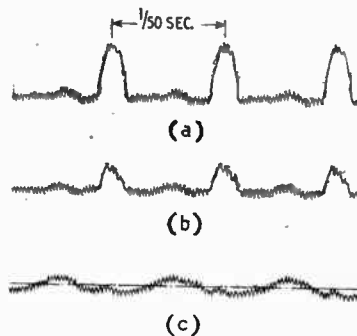

Fig. 7. Oscillograms of hum and noise with and without positive bias on heater. (a) Slider of hum-dinger earthed, (b) slider of hum-dinger at +1.5V to earth, (c) slider of hum-dinger at +4.5V to earth

electrolytic cathode by-pass condensers seems to be rare, but naturally only the best quality new condensers should be used.

Another very prevalent cause of hum is the induction of hum voltages into the microphone coupling transformer, due to stray magnetic hum fields.⁴ When a ribbon microphone is used under conditions of maximum gain, it will be found essential, if an un-screened input transformer is used, to have the transformer at a distance of at least 12 feet from the power-pack; and even then it may have to be carefully orientated for minimum hum.

In cases where the microphone never has to be used at very great distances from the amplifier, an economical and very satisfactory arrangement is to use only one transformer, inside the microphone casing, wound to give a secondary impedance of about 20 k Ω . Up to 20 feet of cable can then be used between the microphone and the amplifier, without losing more than a decibel or two of response at 10,000 c/s. This is assuming a low-capacity cable is used, of about 20 μ F per foot. Some of the recent polythene-insulated R.F. coaxial cables are quite suitable.

A useful reduction in hum

⁴ "Pick-Up Coupling Transformer," by J. Bierley, *Wireless World*, July, 1943.

TELEGRAPH KEY DESIGN

Scientific Analysis of Fundamental Requirements

pick-up can be obtained by using the "astatic" type of transformer construction. The improvement may amount to about 30db in practice.⁵ The core of the transformer must be earthed to avoid electrostatic hum, and, unless the transformer has an internal electrostatic screen, the primary winding may in some cases be earthed with advantage.

A further trouble often experienced with low-level audio amplifiers is valve microphony. If the loudspeaker is used near to the amplifier, then the presence of microphony may cause a howl to build up, due to acoustic feedback from the loudspeaker to the input valve. Individual valves vary greatly in this respect, and occasional samples are very bad indeed.

However, even with good valves, it is always advisable to adopt some sort of anti-vibration

OF all the component parts of the earliest wireless stations of fifty years ago, the morse key is the only one that has survived to the present day in unchanged, or at least in recognizably similar, form. So it would seem a fair assumption that keys are not susceptible to any great improvement; also that we know all that need be known about them.

Faith in the correctness of these assumptions is rudely shaken by an article in the *Marconi Review* (July-September, 1946) by H. J. H. Wassell. The author makes a detailed analysis of the factors involved in the manipulation of a telegraph key, and concludes that the desirable features are: (1) a moving arm of small mass and of "dead" metal; (2) arm length not less than 2½ in, but not greater than is necessary to keep down the amplitude of transverse vibration; (3) a small

tions of the arm which might confuse the operator are thus quickly damped out. It has been found



New Marconi telegraph key with calibrated adjustment of spring tension and contact gap.

that in some older keys the natural period of vibration is comparable with the transit time of the key at the highest keying speeds (say 35 words per minute).

The minimum arm length of 2½ inches is dictated by the divergence of the circular movements of the key arm and the hand of the operator, pivoting on the wrist. With an arm radius of more than 2½ inches and small contact clearances, the divergence from vertical motion is negligible and does not induce unnatural movement of the hand and consequent fatigue.

Contacts should be mounted close to the knob so that the pivots are relieved of resultant forces and there is less risk of setting up complex vibration in the arm.

All these factors have been taken into account in designing the latest Marconi key, the leading dimensions of which are compared with a representative older key ("A") in the table below.

Knife-edge pivot bearings loaded by the tension spring are used, as it is found that ball races show a tendency to dent with long use. The spring tension is adjustable by a knurled knob at the side of the key, and the gap is varied by rotating the skirt of the operating knob.

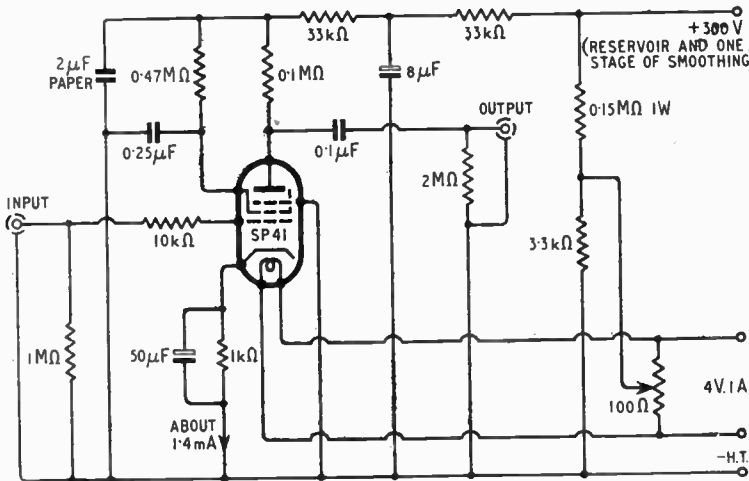

Fig. 8. Circuit diagram of the writer's microphone amplifier. All resistors ½ watt except where otherwise stated.

mounting, and the best system is probably to mount the input valve, together with its decoupling condensers, etc., on a small sub-chassis, and suspend this by means of rubber cords attached to some convenient part of the main amplifier structure.

In conclusion, the writer would like to thank C. G. Mayo, D. O. Roe, and A. Tutchings, as a result of discussions with whom some of the points mentioned above were first fully appreciated.

⁵ "Notes on Transformer Design," by E. B. Harrison. *Electronics*, February, 1944.

gap, consistent with electrical loading; (4) contacts at or about the centre of percussion.

The need for a low moment of inertia is obvious if fatigue over long periods of working is to be avoided.

Aluminium meets this requirement and also has the requisite "deadness," as measured by the inverse of the specific acoustic resistance. Transverse vibra-

	"A" Key.	New Key.
Weight	3 lb 2 oz	1 lb 3 oz
Volume (Overall cuboid)	158 cub in	23.5 cub in
Plan (Overall)	49 sq in	19 sq in
(Body)	40 sq in	14 sq in
Mass of Moving Arm (less pivot bar)	4½ oz	2 oz
Length between Knob and Pivot	3 13/16 in	3½ in
Height of knob skirt above Bench...	2½ in.	1 1/16 in
Nat. period of transverse vibrations	470 cps	4,200 cps
Amplitude of transverse vibration for given impact	1 unit	1/8 units
Nat. period of bar as pendulum	0.72 sec	0.57 sec

NAVAL RADIO GEAR



Communication Equipment of British Warships

By G. M. BENNETT

A WHOLE book could be written on the British Navy's radio communication system: The world-wide network of big shore stations linking the Admiralty with every Command; the chains of shore stations within each Command linking the naval bases and providing communication with ships at sea; and, finally, the radio organization required within each fleet. The latter needs many channels for inter-ship operational and administrative traffic, for manoeuvring signals, for radar reporting, for gunnery control, for the direction of aircraft and many other purposes.

In practice the equipment to be fitted in ships must necessarily be a compromise, for the amount which can be installed in the smaller vessels is restricted by their size. But then, for example, a destroyer screening the fleet is not required to man the large number of channels needed in a battleship carrying the admiral-in-command or an aircraft carrier which, in addition to maintaining communication with other ships, must also be able to work with aircraft.

Transmitting and Receiving Rooms

There is little difference between the equipment fitted in battleships and cruisers, the majority of which is arranged in five compartments. In the forward superstructure, conveniently adjacent to the Command, is the Bridge Receiving Room (B.R.R.). This contains nearly a dozen receivers covering the low-, medium-,

high-, and very-high-frequency bands; i.e., from the 16 kc/s, used by Rugby for the Admiralty's simultaneous morse transmissions to the whole fleet, up to the 100-150 Mc/s band used for radio-telephone communication with aircraft. There is also the medium-frequency direction-find-

ing set used for navigational purposes and a 50-watt emergency transmitter and associated receiver which can be operated off batteries in event of a failure of the ship's normal power supplies.

Also fitted high up in the bridge structure, in order to reduce to a minimum the length of the aerial feeders, is a small compartment containing the V.H.F. radio-telephone transmitters used for communication with aircraft and on the short-distance inter-ship manoeuvring wave.

The majority of the ship's



Bridge Receiving Room of an aircraft carrier. All-wave receivers are mounted in a row above the operators' bench on the right. The larger set in the left foreground is the medium-frequency D.F. outfit.

transmitters covering the medium- and high-frequency bands, are, however, divided, on the principle of not putting all one's eggs in one basket, between two transmitter rooms aft below the mainmast. The Lower Transmitter Room (L.T.R.) is well below armour for protection against bomb hits and shell-fire. It contains a 400-watt medium-wave W/T transmitter, a H.F. set of similar power for either W/T or R/T and two 50-watt sets. There is also a crystal wavemeter of high accuracy.

Whilst the L.T.R. is protected by armour, it is liable to damage by torpedo, mine or other underwater explosion. Furthermore, the efficiency of its transmitters suffers from the lengths of the trunks needed to carry the aerial leads to the upper deck. A second transmitter room (the Upper T.R.) is, therefore, sited in the after superstructure. Here are fitted a 5-kW medium-wave W/T transmitter, a 2-kW H.F. set for W/T or R/T, a similar set with an output of 400 watts and two 50-watt sets.

Finally, and chiefly as a standby for the B.R.R., a second receiving room (the Lower R.R.) is sited below armour adjacent to the L.T.R. Apart from receivers, this contains the perforators, undulators and relays needed for high-speed morse transmission.

An extensive remote control system is provided to allow the sets in the three transmitter rooms to be controlled from any receiving position in either the B.R.R. or the L.R.R. and from such points as the bridge for manoeuvring purposes and the operations room for the direction of aircraft.

Power for all the equipment is supplied by three 40-kW motor alternators widely spaced in the ship providing a 50-cycle three-phase 400-volt A.C. supply.

Aerial Arrays

It will be appreciated that with so much equipment installed within the limited space of a warship, not to mention the radar equipment which does not fall within the scope of this article, special measures are necessary to avoid interference. This is the reason for fitting all the medium- and high-frequency transmitters in

two compartments aft. For, thereby, the aerials can be concentrated on the mainmast and separated from the receiving aerials on the foremast which feed direct to the B.R.R. forward, and via feeder lines to the L.R.R. aft.

Unfortunately the arrangements of a ship's masts, the necessity to avoid fouling the arcs of gunfire

the case of the V.H.F. sets, however, dipoles are practicable and, since here the interference problem is not so acute, these are arranged at the foremasthead and at the extremities of the forward yards. Other measures necessary to obviate interference with a ship's receivers include elaborate aerial filters and special circuits

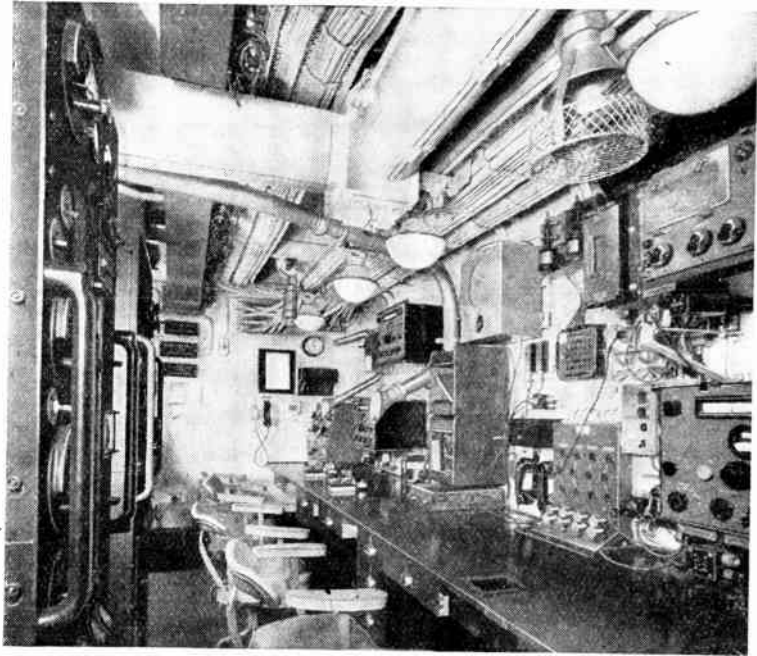

Main W/T office of a modern destroyer. The transmitters are on the left. Mounted above the bench on the right are the medium-frequency D.F. equipment, a number of all-wave receivers and the aerial and control circuit exchanges.

and the obvious fact that, with a ship which may at any time be altering course, directional transmissions are impossible, only the simple types of aerial are possible. Furthermore, owing to the wide range of frequencies which the medium- and high-frequency sets are required to cover these aerials cannot be cut to their optimum length for any particular frequency. In consequence the medium-frequency transmitters are provided with roof aerials run between the two masts but terminating at such a distance short of the foremast as will obviate interference with the single wire, vertical receiving aerials rigged thereon for the B.R.R. The high-frequency transmitters all use single wire, vertical aerials grouped on the mainmast. In

designed to eliminate the shock impulse received from radar pulse transmissions.

Aircraft Carriers

In aircraft carriers the amount of equipment installed, particularly for working on the 100-150 Mc/s band, is more extensive to meet the needs of aircraft operations. The peculiar structure of these ships necessitates a slightly different arrangement of the offices. The B.R.R. is sited in the island on the starboard side of the flight-deck just below the bridge. The three transmitter rooms are below the flight-deck separated as widely as possible in order to avoid more than one being put out of action by the same bomb or shell hit. And the stand-by receiving room is sited

Naval Radio Gear—

adjacent to one of these. Three masts on each side of the flight-deck, which fold outboard down to a horizontal position when aircraft are either landing on or flying off the deck, carry the medium- and high-frequency transmitting aerials. Single wire, vertical receiving aerials on the tripod mast mounted before the funnel on the island feed the B.R.R. Others rigged horizontally from booms jutting out each side of the flight-deck feed the stand-by receiving room. The extensive V.H.F. equipment requires a large number of dipole aerials erected on the many yards and spurs provided on the island's tripod mast.

D.F. sets working on the high- and very-high-frequency bands are also installed to give bearings to aircraft. And there is an automatic wireless beacon working in the V.H.F. band which enables the pilots of planes to determine instantaneously

The Navy's new compact 50-watt H.F. transmitter. Each of the four units can be easily withdrawn from the front for maintenance. When a 400-watt output is required an additional power amplifier is provided.

at any time the bearing of their parent ship.

In destroyers the amount of radio communication equipment is on a smaller scale. With the exception of a small office aft containing a battery-fed, low-power transmitter and associated receiver for emergency use, the whole of the equipment is fitted in the main W/T office normally sited below the bridge on the level of the upper deck. The installation includes a 400-watt transmitter, which can be used for either medium- or high-frequency work, two 50-watt high-frequency sets, three V.H.F. sets, four all-wave receivers plus three for V.H.F., a medium-frequency D.F. set for naviga-

tional purposes and a high-frequency D.F. outfit for locating U-boat transmissions.

It is impossible to describe in one article the arrangement of the equipment in the many other types of warship now in service. But it may be mentioned in brief that these include depot ships, which carry the necessary high-power transmitters to enable them to perform the duties of a shore station at an advanced base, and headquarters ships for amphibious operations which carry the extensive equipment required to communicate not only with all the craft which take part in landings on a hostile shore, but also with R.A.F. planes operating over the beaches.

Then there are frigates and cor-

panies themselves by development contract to meet specific Admiralty requirements.

Space will not permit any detailed description of modern naval radio communication equipment but a few of the more interesting developments may be mentioned in conclusion.

Since considerable difficulty was experienced in finding suitable mast sites for the large number of V.H.F. sets now required in the larger warships, the Admiralty Signal Establishment has developed a method of operating up to four such transmitters of 200 watts output simultaneously on a single rod dipole aerial without appreciable detriment to performance. Similarly, to relieve the position as regards H.F. aerials and to provide aerials which are not susceptible to breakage due to mast-whip when a ship is struck by bomb or shell, vertical "whip" aerials (in the form of a thin flexible rod supported at one end only) are now being used. These can be mounted in suitable positions on the superstructure or, to gain height, on the funnels.

The Navy's latest M.F. and H.F. transmitters are designed on the unit system. The basic units—50-watt sets covering, respectively, the M.F. and H.F. bands—are used where low-power sets are sufficient. Where higher power is needed, additional units in the form of power amplifiers are added.

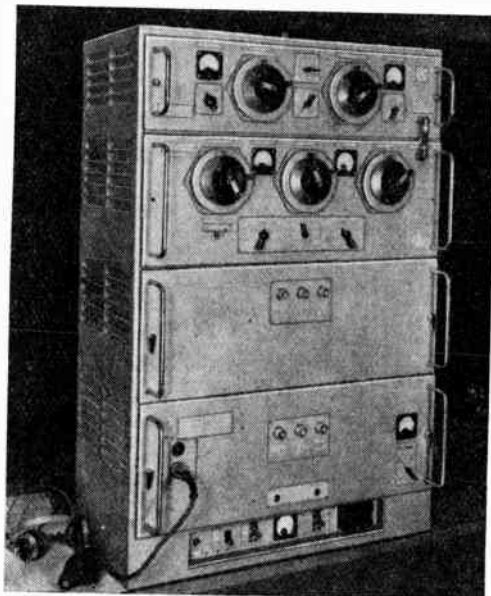
**MINIATURE SUPERHETERODYNE**

AN interesting range of multi-purpose valves is employed in the Philips Model 209U superhet for A.C./D.C. mains. The Mullard UCH21 is used in the frequency changer stage and also for I.F. and A.F. amplification. A Mullard UBL21 serves as double-diode rectifier and output pentode, and the power rectifier is a UY21.

The receiver is housed in a neat plastic cabinet with rounded corners and the indirectly-illuminated tuning scale (which is removable) projects from the top. The dimensions excluding dial are only 11in x 7in x 6in and there are three waveranges, including short waves from 16.5 to 51 metres. The price is £12, plus £2 11s 7d purchase tax, and the makers are Philips Lamps, Ltd., Century House, Shaftesbury Avenue, London, W.C.2.

vettes which are equipped on a similar scale to a destroyer, and submarines for which all equipment has to be especially designed in order to be fitted within the restricted space of the rounded hull.

Developing Communication Gear

The majority of the radio communication equipment installed in warships is designed by the staff of the Admiralty Signal Establishment, Haslemere, and manufactured by commercial companies. A proportion is, however, designed by the commercial com-

BELLING-LEE QUIZ (No. 8)

Answers to questions we are continually being asked by letter and telephone



1* The Belling-Lee twin unscreened feeder when sold in bulk is known as L.336. Price 7½d. per yard. When supplied with 65ft. on reel the list number becomes L.344. Price 13/6.

Q. 33. Is it preferable to use co-axial or balanced feeder with a television dipole?

A. 33. This was covered briefly in question 3, to amplify the answer we can do no better than extract part of an article by F. R. W. Stratford, A.M.I.E.E., from the current Technical Bulletin published by the Radio Component Manufacturers Federation, entitled "The Choice of Transmission Lines for Connecting Television Receiving Aerials to Receivers."

"At 45 mc/s the radiation losses of a *1 twin unscreened line of 75 ohms impedance are very small compared with the transmission loss, and for this reason, assuming a balanced termination, the screening efficiency against local electromagnetically propagated interference is high.

"The screening efficiency of the co-axial line is greater, but it is important to realise that this only obtains when the line is balanced with respect to earth and dipole and, in my opinion, herein lies the most serious charge against its economic adoption for television reception purposes.

"The dipole aerial possesses electrical symmetry, so that coupling such a symmetrical system to a co-axial cable (which is asymmetrical in its properties when placed in an electro-magnetic field) calls for two features to be introduced. Firstly, the line must be connected symmetrically to the dipole. This can be achieved by the use of

a folded back element which corrects the impedance termination of the outer conductor. The introduction of such a folded portion will increase considerably the cost of the aerial structure. Secondly, the receiver input must be balanced with respect to earth to maintain electrical symmetry at its terminals. While it is not very difficult to balance a symmetrical type of feeder to an input tuned circuit, there appear to be considerable difficulties in balancing any asymmetric line such as the co-axial line, due to the high radiation losses of the outer conductor as compared with the inner conductor.

"If the balancing features are not introduced in the co-axial line the effect of electro-magnetic interference concentrated in the vicinity of the line will be to set up unequal currents in the inner and outer conductors respectively. This will give rise to a potential difference at the receiver input, thus vitiating to some extent the screening properties of the line, and so decreasing the signal-to-interference ratio in practice.

"If a balanced twin transmission line is employed on the other hand, the termination at the dipole end is inherently correct. It is necessary, however, that the receiver input circuit shall be balanced in order to maintain the highest possible signal-to-interference ratio. Because the twin transmission line is inherently symmetrical electrically, it does not appear to be very difficult to match this to a conventional type of tuned input circuit and at the same time maintain balance with respect to ground.

"Supposing one neglects completely the matter of balancing at the dipole and receiver. Then for equal line loss there is nothing to choose between the two methods on the score of signal-to-interference ratio, with one possible exception. This exception occurs when the twin unshielded line is in close proximity to various metal objects and in different degrees of proximity throughout its route from the aerial to the receiver.

"Theoretically there will be small changes in the characteristic impedance at various points along the line, and these will give rise to reflections and subsequent attenua-

tion. Measurements at 45 mc/s however, do not substantiate this prediction, not because they do not exist but because the magnitude of the subsequent attenuation due to reflection effects are small, and are masked by reading errors and small inconsistencies in measurements. If one were working with a twin balanced line whose characteristic impedance was of the order 400 ohms, and typified by a spacing of a few inches between the conductors, undoubtedly the close proximity of other conductors would show measurable attenuation, but the very close spacing necessitated by a 70 ohms line is probably the best reason for the immeasurable effect of proximate conductors. The same applies to the preservation of balance in the line, where it is not difficult to see that the close proximity of a twin 70 ohms feeder to another conductor would not effect much change in the balance of the line until the distance of the proximate conductor was at least comparable with the spacing between the wires of the line itself."

Q. 34. Does an *2 anti-interference aerial suppress unwanted noises caused by H.F. interference?

A. 34. No.—no aerial can suppress interference. But with a well-designed anti-interference aerial it is possible to "run away" from the cause of trouble by erecting the collector outside the field of interference, or at any rate, to get it in such a location that the interference is so attenuated as to be negligible.

... To be continued

*2 Skyrod (Reg. Trade Mark).

Types L.355/CK 12' collector, downlead, 2 transformers, pole clamps, and earth wire £7 7 0

L.355/LK with chimney lashings and brackets in addition £8 8 0

L.370/LK with chimney lashings for 2" mast in addition to L.355/CK £8 17 6

Also supplied with 18' collector.

All prices quoted are subject to alteration without notice.

BELLING & LEE LTD
CAMBRIDGE ARTERIAL ROAD, ENFIELD, MIDD.

Vortexion

"SUPER FIFTY WATT" AMPLIFIER

This AMPLIFIER has a response of 30 cps. to 25,000 cps., within $\frac{1}{2}$ db, under 2 per cent. distortion at 40 watts and 1 per cent. at 15 watts, including noise and distortion of pre-amplifier and microphone transformer. Electronic mixing for microphone and gramophone of either high or low impedance with top and bass controls. Output for 15/250 ohms with generous voice coil feedback to minimise speaker distortion. New style easy access steel case gives recessed controls, making transport safe and easy. Exceedingly well ventilated for long life. Amplifier complete in steel case, with built-in 15 ohm mu-metal shielded microphone transformer, tropical finish.

As illustrated. Price 36½ Gns.

A.C.20 AMPLIFIER CHASSIS.—This well-known model has been retained, and has a response 30—15,000 cps., mixing arranged for crystal pick-up and microphone, large output transformer for 4—7.5 and 15 ohms to deliver 15 watts at less than 5 per cent. total harmonic distortion to the speakers. Metal Cabinet for above, if required, £3 6 0. Price £21 0 0.

C.P.20A. 15-watt Amplifier for 12 volt battery and A.C. Mains operation. This improved version has switch change-over from A.C. to D.C. and "stand by" positions and only consumes 5½ amperes from 12 volt battery. Fitted mu-metal shielded microphone transformer for 15 ohm microphone, and provision for crystal or moving iron pick-up with tone control for bass and top and outputs for 7.5 and 15 ohms. Complete in steel case with valves. Price £28 0 0.

DEALERS AND EXPORT AGENTS should write for special terms to:—

VORTEXION LTD.

257-261 THE BROADWAY,
WIMBLEDON, S.W.19.

Telephones: LIBerty 2814 and 6242/3

Telegrams: VORTEXION, WIMBLE, LONDON.



RECORD REPRODUCER CHASSIS.—This is a development of the A.C.20 amplifier with special attention to low noise level, good response (30—18,000 cps.) and low harmonic distortion (1 per cent. at 10 watts). Suitable for any type of pick-up with switch for record compensation, double negative feedback circuit to minimise distortion generated by speaker. Has fitted plug to supply 6.3 v. 3 amp. L.T. and 300 v. 30 m/A. H.T. to a mixer or feeder unit. Metal Cabinet for above, if required, £3 6 0. Price £21 0 0

AD/47 10-VALVE TRIODE CATHODE FOLLOWER AMPLIFIER.—For this recording and play-back Amplifier we claim an overall distortion of only 0.01% as measured on a distortion factor meter at middle frequencies for a 10-watt output. Damping factor 40 times.

PRECISION CONTROLS

for COMMUNICATIONS AND MEASURING EQUIPMENT



SLOW-MOTION DRIVE

A Unique Control giving complete 360° rotation
Double friction epicyclic mechanism — enclosed
in dust-proof bakelite housing.
Torque — 12 inch-ounces before slipping
Ratio — 44 to 1 approximately
Supplied with dials up to 6 inches diameter —
any engraving.

PRICES ON APPLICATION

DECADE SWITCH

A Precision Component embodying all the best design features
Very low contact resistance. Positive location. Sturdy action.
Twelve positions — providing two extra contacts — 30°
angular spacing simplifies dial calibration. Two types available
— 416A (Shorting) and 416B (Non-Shorting).

Can also be supplied in ganged units of two or more switches
PRICES ON APPLICATION



SALFORD ELECTRICAL INSTRUMENTS LTD.

PEEL WORKS, SALFORD 3

Telephones: BLAckfriars 6688 (6 lines).

Telegrams and Cables: "SPARKLESS, MANCHESTER"

Proprietors: THE GENERAL ELECTRIC Co. Ltd., of England

H₂S TRAINER

Use of Ultrasonic Reflections from Submerged Relief Maps

By G. W. A. DUMMER, M.B.E., M.I.E.E. (Telecommunications Research Est.)

ONE of the most important of the radar navigation devices designed during the war was H₂S. This system was used by R.A.F. Bomber Command for "blind" navigation over Germany and made possible the accurate and heavy bombing of Berlin and other targets beyond the effective range of "Gee" and "Oboe." To use this device training was necessary, and navigator/operators could be trained either by flying training aircraft equipped with H₂S or by using a synthetic training device on the ground.

The first method was obviously expensive in petrol consumption, etc., and meant the use of a number of four-engined bombers which could not, at that time, be spared. In addition, extra maintenance and wear and tear of aircraft on non-operational flights was undesirable. It was obvious, therefore, that the use of a satisfactory synthetic trainer would save the country an enormous amount of training time and expense.

It had been the practice at TRE to design synthetic trainers in conjunction with the design of the radar equipment, so that when the equipment was ready to be introduced into the Services a training device was also ready to train operators. The H₂S training device, originated in Feb., 1943, was the first to use the new principle of a "miniature" radar system using ultrasonic waves propagated through water in place of electro-magnetic waves propagated through air. The long delay time of transmission of ultrasonic waves through a liquid

was used to represent the radar delay times normally encountered in the operation of H₂S. The velocity of ultrasonic waves in water is 1.5×10^5 cm/sec, and as that of electro-magnetic waves in air is 3×10^{10} cm/sec, the scale on which the trainer operated was

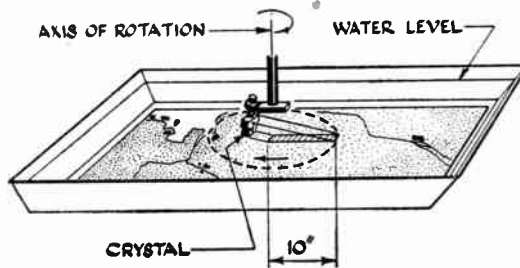

Fig. 1. Basic form of H₂S trainer

$$\frac{1.5 \times 10^5}{3 \times 10^{10}} = \frac{1}{200,000} \text{th}$$

of the radar scale. This meant that one "ultrasonic" mile = 0.315in, and a radar range of fifty miles could be simulated in a physical distance not exceeding 15 inches approximately.

The requirements for the training device were that a narrow beam of energy should illuminate an area of the ground as shown in Fig. 1, and that the beam should also be rotated at the same scanner rotation frequency as H₂S; the reflected signals were to be picked up as though from land, town or sea and fed as intensity modulation to the Navigator's Plan Position Indicator. The whole synthetic picture should be capable of movement in

any direction at any aircraft speed so that navigation training could be carried out. These requirements were achieved in the trainer by using this new principle as described below.

If an X-cut quartz crystal is pulsed at its resonant frequency under water and a reflecting object is placed in the path of the transmitted wave, an echo will be re-radiated from the object in the same way as in radar and picked up on the crystal.

The intermediate frequency of H₂S was 13.5 Mc/s, and a crystal of that frequency was chosen for ultrasonic propagation so that the existing H₂S I.F. amplifier could be used. At a frequency of 13.5 Mc/s and with a velocity of 1.5×10^5 cm/sec the wavelength is of the order of 0.1 mm.

The crystal was made long and narrow to simulate the aerial coverage of H₂S and with $\lambda = 0.1$ mm and the crystal 5 mm \times 25 mm, this was equivalent to an aerial array of $50\lambda \times 250\lambda$. The beam was thus quite sharp and rectangular.

The crystal beam was projected on to a glass relief map so that the projection covered a range of 0.30 miles (0.10in approximately), the crystal being used for both transmission and reception. The crystal was set back 1.25in from the

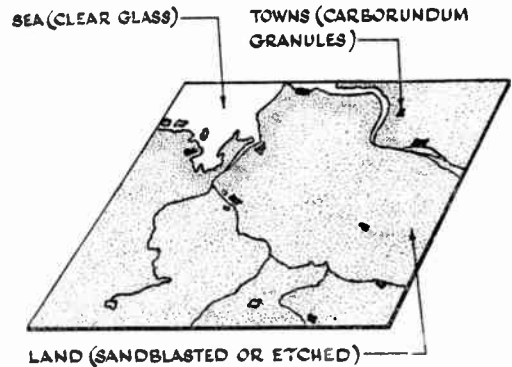

Fig. 2. Etched-glass map used in trainer

axis of rotation to simulate "ground returns," and picture as seen from an aircraft flying at 20,000ft. On the glass map was

H₂S Trainer—

reproduced (to a scale of 1:200,000) a simulation of the area in Germany over which training was to be effected. (See Fig. 2). The amount of reflection of the radiated energy was proportional to the "roughness" of the glass surface, and the map was sand-blasted or etched to represent land masses. Towns were built up of granules of carborundum glued to the glass and the sea areas were left as plain glass. The map was placed at the bottom of a tank of water. The pulsed crystal was then rotated at 60 r.p.m. synchronously with the radial time base, and the signals received from the map were fed from the crystal to the input stage of the IF amplifier in the H₂S receiver and thence to the PPI.

The display produced was an excellent simulation of the actual H₂S picture seen in the air when flying over Germany. The rotating crystal was mounted on a gantry and made to travel over the surface of the synthetic map at controlled speeds and directions on the trainee's instructions, so that full navigation training could be given. A duplicate plotting map (not relief), with frosted underside and suitably illuminated, was mounted above the crystal assembly and a recording pen was arranged to mark the underside to record the track of the "aircraft."

A record of the bombing run on any chosen target was achieved as follows:— When the bomb release was pressed, the recording pen was magnetically pulled away from the underside of the plotting map. For a period corresponding to the time of fall of the bomb the pen continued to move and at the instant of bomb impact the pen snapped back on to the map. Points of bomb release and impact could easily be seen in relation to the target and errors in bombing procedure could be assessed.

Complete crew training was achieved by the pilot flying a Link Trainer (coupled to the H₂S trainer) under the operator's or navigator's instructions. The operator saw a continuous change of radar "picture" as the synthetic aircraft flew over the target area. It is estimated that the majority of the H₂S navigators in

R.A.F. Bomber Command received training on these devices, which were manufactured by two of the leading radio firms in this country on "top" priority. Slight modifications and the use of a "sea" map and synthetic "ship" targets enabled the trainer to be used for "ASV."

The scheme was widely adopted in the U.S.A. and used for American versions of H₂S. There is little doubt that without a device of this type the quality and quantity of H₂S-trained operators in R.A.F. Bomber Command could not have been maintained during the war.

VARIABLE-RESISTANCE PICK-UP

Applying the Principle of the Strain Gauge

THE principle of the strain gauge, in which deformation of a conductor and its consequent change in resistance is used as a measure of the applied strain, has been used in a pickup which is described by K. J. Germeshausen and R. S. John in the November, 1946, issue of *Electronic Industries*.

A horizontal polystyrene bar of

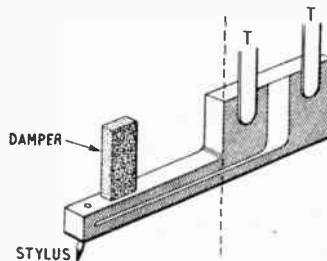

Fig. 1. Resistance element shaped to give "go and return" paths for the current. Fixed terminal connections are provided where the beam is clamped to the tone arm.

$\frac{1}{8}$ -inch square section and $\frac{1}{2}$ -inch long is clamped to the tone arm at one end and provided with a short stylus at the other (Fig. 1). The vertical faces of the bar are coated with a film of carbon powder in a plastic medium, and lateral bending causes alternate increase and decrease of resistance depending on whether the film is in tension or compression. Over the range of deflections resulting from the playing of a record the relationship between strain and resistance is stated to be linear. Push-pull connections between the resistance elements is used and a pre-amplifier circuit incorporating negative-feedback frequency compensation is reproduced in Fig. 2.

It will be appreciated that output is proportional to displacement; like the piezo-crystal pickup it is a

constant-amplitude rather than a constant-velocity device, and its uncorrected response curve will be flat from the lowest frequencies up to the cross-over point (say 250c/s) on a standard frequency record, and above this frequency the output will fall at 6db per octave. Compensation calls for a judicious mixture of electrical and mechanical correction—the latter in the form of a rubber or plastic damping block which can be applied in a variety of ways to give the desired frequency response.

Figures for voltage output are not given, but it is stated that a stage of pre-amplification is required before the input terminals of the usual two-stage audio section of a radio receiver.

Recommended values for the resistance elements are 75,000 to 100,000 ohms per side. The applied voltage should be as high as possible, but will generally be limited to 100 V by the current-carrying capacity of the carbon film. It is stated that carbon layers have been prepared which are

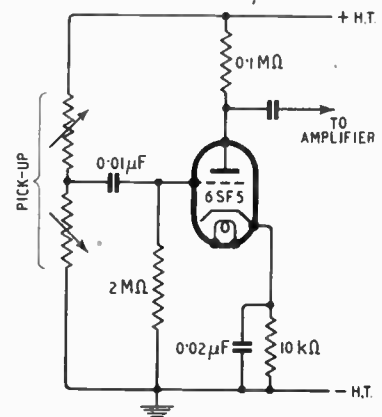

Fig. 2. Suggested pre-amplifier stage with frequency correction negative feedback.

free from the background hiss usually associated with carbon elements.

World of Wireless

RADIO INTERFERENCE

DELEGATES from eleven countries recently met in London at the invitation of the British Standards Institution to discuss the problem of radio interference suppression.

The work undertaken by the various countries represented—Austria, Belgium, Canada, Czechoslovakia, France, Netherlands, Switzerland, South Africa, Sweden, U.K. and U.S.A.—since the last meeting of the International Special Committee on Radio Interference (C.I.S.P.R.) in Paris in July, 1939, was reviewed.

The measurement of interference at frequencies from 1,500 kc/s to 30 Mc/s, which are not covered by the C.I.S.P.R. standard measuring set, was discussed and it was agreed that at the next meeting consideration should be given to the best method of making measurements on each type of equipment giving rise directly to interfering fields.

DECCA NAVIGATOR

THE Decca Navigator has been approved by the Ministry of Transport for the purposes of general marine navigation, exclusive of pilotage, in specified areas, which extend up to 275 statute miles from London. This decision has been made after extensive trials, directed by the Ministry of Transport, with equipment fitted in thirty-five merchant ships. A new marine receiver is being produced and will be available to shipping companies on a hire-maintenance basis.

Consideration is now being given to the erection of a Scottish chain of stations which will, in conjunction with the present English chain, provide a navigational service in all the waters of the British Isles.

A chain for Iceland is being considered by the Icelandic Government, and a New York chain has been sited and an application made to the F.C.C. for the required frequencies.

GOVERNMENT SURPLUS

REFERRING to the disposal of Government radio components a Ministry of Supply announcement states: "The Ministry's policy is to satisfy public demand. But where the surplus is very heavy in relation to current production and requirements, it may be against the national interest to release the whole of the surplus stocks, especially if they could be sold only at such low prices as would cause serious harm to the industry concerned and lead to unemployment.

Unfortunately it is not a proposition to hold surpluses for any long period, because of shortage of accommodation and, sometimes, the risk of deterioration in store. For those reasons it is occasionally necessary to scrap goods in serviceable condition, although this seldom happens.

"Certain types of fixed condenser, such as paper tubular, are a case in point. The stocks represent many months' normal production. It has been decided after full enquiry to release for sale another twelve million of these types. The balance will be disposed of by dumping in disused mineshafts, as it is impracticable and uneconomical to break the condensers down to recover raw materials."

E.M.I. DEVELOPMENTS

ARRANGEMENTS have now been concluded with Major Edwin Armstrong, the F.M. pioneer, whereby Electric and Musical Industries, Ltd., and its subsidiary companies throughout the Empire, may manufacture and supply F.M. transmitting and receiving equipment under Armstrong patents.

Another invention for which the company has secured patent rights is a noise suppression system for gramophone reproduction due to H. H. Scott in which the audio-frequency bandwidth of the amplifier is controlled automatically by the volume level. At high levels noise is generally masked, and the full frequency range may be used, but at low levels surface scratch and low-frequency motor rumble intrude. Reduction of bandwidth to eliminate these noises does not seriously affect the aural impression, since the response of the ear to both high- and low-frequency components in the original sound is progressively reduced as the volume decreases.

A new method of televising motion picture films has been developed in E.M.I. laboratories and was recently demonstrated to the B.B.C. and members of the Television Advisory Committee.

R.S.G.B. GROWTH

A FOURFOLD increase in the membership of the Radio Society of Great Britain since 1939 is recorded in the Society's Report for the year ended September 30th, 1946. The year's increase of 2,924, compared with 1,900 in the previous year, brought the total to 12,570, of which 380 are overseas members and 675 associates and junior associates.

CONSOL

AFTER extensive tests, conducted by the R.A.F., the first Consol D.F. station, at Bush Mills, Co. Antrim, Northern Ireland, now provides a 24-hour service. It was taken over by the Ministry of Civil Aviation on January 1st and is now operating under the call sign 7H7 on a frequency of 263 kc/s. There is a break in transmission from 1500-1515 daily for routine maintenance.

The keying cycle of 60 dots and dashes—lasting 30 seconds—is followed by the transmission of a continuous note—interrupted by the call sign—for 28 seconds. Transmission cycles are spaced by a 1.5-second break.

A description of the system was given in our issue of July last year.

B.R.E.M.A. AND F.M.

"THE ultimate employment of F.M. transmissions is inevitable." This statement is included in the technical section of the recent report of the British Radio Equipment Manufacturers' Association, where it is also stated that "development of the F.M. system should be supported." Two provisos are, however, made:—

- (1) That it is used as an addition to, and not in replacement of, existing transmissions;
- (2) That inter-regional and international broadcasts in, or from, this country are not curtailed in consequence.

An expenditure of £2,000 was authorized by the Council of B.R.E.M.A. on an F.M.-A.M. investigation.

PERSONALITIES

G. M. Garro-Jones, who is chairman of the Television Advisory Committee, received a Knighthood in the New Year Honours. He was also chairman of the Production Planning and Personnel Radio Committee, one of the two main working committees of the Radio Board when it was set up by the Government in 1943.

H. Townsend, G.P.O., Director of Telecommunications, who is also a member of the Television Advisory Committee, is created a C.B.

S. L. Hulme, Deputy Director of Telecommunications, Ministry of Civil Aviation, is created an O.B.E.

Among those appointed Members of the Order of the British Empire in the Honours List are:—

A. D. Kent, chief of the Testing Department of Marconi's W.T. Co. He has been a member of the company's engineering staff for 35 years; R. N. Fox, wireless officer with the British

World of Wireless—

Mission in Lhasa, Tibet; F. S. Sellek, regional radio controller in the Civil Aviation Department of the Government of India.

Sir Robert Watson Watt has relinquished his appointment as Vice-Controller of Communications Equipment, Ministry of Aircraft Production, which he has held since 1942, and that of Scientific Adviser on Telecommunications to the Air Ministry and is forming a private company of technical consultants to be known as Sir Robert Watson Watt & Partners, Ltd. It is understood he will continue to act as scientific adviser on telecommunications to the Ministries of Supply, Civil Aviation, Transport and Air.

Col. Sir A. Stanley Angwin, K.B.E., D.S.O., who has been Engineer-in-Chief G.P.O. since 1939, has resigned on his appointment as chairman of the new Board of Directors of Cable and Wireless. He joined the Post Office Engineering Department in 1906. On his return to civilian life after the 1914-18 war he took a large part in the design and construction of the Leafield, Cairo and Rugby stations. Sir Stanley, who was President of the I.E.E. in 1943, was created a Knight Bachelor in 1941 and a K.B.E. in 1945.

A. J. Gill, B.Sc. (Eng.), who has been Deputy Engineer-in-Chief of the G.P.O. since 1944, has succeeded Col. Sir Stanley Angwin as Engineer-in-Chief. He entered the Post Office Engineering Department as an assistant engineer in 1913 and in 1925 was appointed executive engineer in charge of the Radio Experimental Section at Dollis Hill. He became Staff Engineer of the Radio Branch in 1932. A. J. Gill was chairman of the Wireless Section of the I.E.E. in 1938 and was elected a vice-president of the Institution in 1945.

J. Innes, C.B., B.Sc. (Eng.), has been appointed managing director of the Board of Cable & Wireless and has therefore resigned his directorship of the G.P.O. Telecommunications Department.

G. W. Entwisle has been appointed Engineer-in-Chief of Cable and Wireless following the vacation of the post by



G. H. Entwisle.

W. G. R. Jacob, O.B.E., on the Government's acquisition of the company. Mr. Entwisle has been joint deputy engi-

neer-in-chief since the merger of the cable and wireless companies in 1929. He joined the Marconi Co. in 1910 and became chief communications engineer, a post which he held until the merger.

Dr. C. F. Bareford, M.Sc., Ph.D., has been appointed manager and head of the new Mullard Electronics Research Laboratory at Salfords, near Horley, Surrey. In 1934 Dr. Bareford joined the B.T.H. Company as a vacuum physicist. Two years later he went to, what is now known as, the Admiralty Signal Establishment, where he has been engaged on radar and telecommunications research.



Dr. C. F. Bareford, M.Sc., Ph.D.

Charles R. Denny, who has been acting chairman of the U.S. Federal Communications Commission since the resignation of Paul Porter last March, has been appointed chairman. His term of office is until June, 1951.

E. J. Bell, of Belling & Lee, has gone to South Africa to supervise the final stages of the work of fitting suppressors to the Royal train and the pilot train.

Louis Gerard Pacent, American pioneer radio engineer and one-time contributor to this journal, has received the U.S. War Department's Certificate of Appreciation for services to the Signal Corps.

W. E. Warrilow, who has been associated with the radio and electrical industries for many years has retired on reaching the age of 70. Since 1925 he has been special electrical commissioner for Odhams Press.

OBITUARY

We regret to record the death of R. N. Vyvyan, formerly Engineer-in-chief of the Marconi Company, at the age of 70, at Falmouth, where he has been in retirement for the past ten years. One of the pioneers of trans-oceanic radio-communications, he joined the Wireless Telegraph and Signal Company (later to become Marconi's W.T. Co.) in March, 1900, and was one of a band of seventeen technical assistants that Marconi gathered around him for the purpose of putting his inventions on a commercial basis. He was responsible for the building of the stations at Poldhu, Cornwall, Cape Cod, America and Glace Bay, Canada (1900-1902). His book "Wireless over Thirty Years," published in

1933, recalls the experiences of those early days.

It is with regret we record the death of E. F. (Frank) Heaver, after a long illness, at Bideford, Devon, where he had been conducting his business as agent for many well-known American manufacturers since he moved from his Bush House office, London, during the war. Prior to starting the company of Frank Heaver, Ltd., he was for many years sales manager of R. A. Rothermel, Ltd.

IN BRIEF

Air Radio.—The three State-owned British air-line corporations, B.O.A.C., B.E.A. and B.S.A.A., have formed a non-profit-making company—International Aeradio, Ltd.—with the object of installing and operating in this and other countries radio navigational aids and telecommunications equipment.

Television Tests.—The B.B.C.'s television test transmissions are now made between 10 and 11 a.m., instead of the half-hourly periods before and after the afternoon transmissions. The transmission of the demonstration film continues from 11.0-12.10.

Television Production.—A sharp rise in the production curve for television receivers during August, September and October is shown in the latest Board of Trade figures. The monthly output was 235, 754 and 1,334, respectively.

"This Year, Next Year . . ."—The Postmaster-General recently stated in the House of Commons that no forecast of the date of the opening of the Birmingham television station could be given, but it was unlikely to be earlier than two years hence.

Standard Telephones and Cables is to provide two major wireless stations for the Turkish Government at Ankara and Istanbul, respectively. The £400,000 order is for long-distance radio-telephone and telegraph equipment.

Radio Launching.—Radio as an aid to the launching of ships was successfully tried out at the Clydeholm shipyard of Barclay Curle & Co., Glasgow, when the 9,430-ton *Sangola* was launched for the British India Steam Navigation Co.

"F.B.I. Register."—The first post-war issue of the "F.B.I. Register"—the official directory of manufacturer members of the Federation of British Industries—will appear this summer. Our Publishers, Iliffe & Sons Ltd., and Kelly's Directories, Ltd., will be jointly responsible for the compilation, production and sale.

Consultants Wanted.—J. Mort, B.Sc., A.M.I.E.E., proposes to start a Technical Advisory Bureau, and would like to hear from specialists in various radio branches who are willing to act as part-time consultants. Address: 42, Barn Lane, Golborne, near Warrington.

Shore Radar.—Plans have been prepared by the Mersey Docks and Harbour Board for the Port of Liverpool to be equipped with radar. The P.P.I. will provide dock officials with a continuous picture of the movement of shipping in the 15-mile channel.

Acoustics.—A meeting has been arranged by the Physical Society for February 19th at the Royal Institute of British Architects, 66, Portland Place,

W.I. to discuss the formation of an Acoustics Group of the Society. H. L. Kirke, head of the B.B.C. Research Department, will be in the chair. It is proposed that membership of the Group will be open to members of other societies at a nominal fee. Provision is also planned for group membership by firms. The acting secretaries are A. T. Pickles and W. A. Allen, 1, Lowther Gardens, Prince Consort Road, London, S.W.7.

Eire's S.W. Station.—The new high-power short-wave broadcasting station being erected by the Irish Government to replace the present low-power transmitter is expected to be ready to begin transmission by the end of April.

Institute of Physics.—The address of the Institute and of its *Journal of Scientific Instruments* is now 47, Belgrave Square, London, S.W.1. Tel.: SLO 9806.

CLUBS

Bromley.—The Hon. Editor of the *R.S.G.B. Bulletin*, A. O. Milne, G2M1, will give a demonstrated lecture on frequency measurement at the meeting of the North-West Kent Amateur Radio Society on February 28th at 8.0 at the Aylesbury Road School, Bromley. Secretary, L. Gregory, G2AVI, 18, Upper Park Road, Bromley, Kent.

Glasgow.—In the list of clubs published in the January issue the Hi-Q Club, Giffnock, was indicated in error as being affiliated to the R.S.G.B. It is a private club with a limited membership of licensed amateurs. The Glasgow Amateur Radio Club, formed about two years ago, which was affiliated to the R.S.G.B., is defunct. There is, however, a need for such a club in Glasgow, and J. D. Gillies, GM2FZT, Hi-Q Club secretary, is therefore compiling a register of interested Glaswegians. His address is 3, Berridale Avenue, Glasgow, S.4.

Grimby.—Regular meetings of the Association of Grimby and District Radio Engineers, which was formed in 1937 under the presidency of Sir Walter Womersley, have recommenced. The secretary, H. Crampin, 268, Victoria Street, Grimby, will be glad to hear from manufacturers willing to send a lecturer to address the association.

Ilford.—At the next meeting of the Ilford and District Radio Society on January 30th, F. H. Haynes (Haynes Radio, Ltd.), president of the Society, will lecture on "The 100-watt Transmitter." Meetings are held every Thursday at 8.0 at St. Alban's Church Room, Albert Road, Ilford. Secretary, C. E. Lagen, 44, Trelawney Road, Barkingside, Ilford, Essex.

Manchester.—At a meeting in Manchester on December 21st the Radio-Controlled Models Society was formed. Officers are to be elected at the next meeting (January 25th). Correspondence regarding the Society should be sent to R. Lawton, 10, Dalton Avenue, Whitefield, nr. Manchester.

Southall.—The next two meetings of the West Middlesex Amateur Radio Club will be held on Feb. 12th and 26th at 7.0 at the Labour Hall Rooms, Southall. At the first meeting A. Gott, a committee member, will speak on radar and at the second F. Charman,

G6CJ, will give a demonstrated lecture on aeriols. Secretary, N. S. C. Priest, 7, Grange Road, Hayes End, Middlesex.

MEETINGS

Institution of Electrical Engineers

Radio Section.—"The Calculation of Field Strength over a Spherical Earth," by C. Domb, M.A., and M. H. L. Pryce, M.A., Ph.D., on February 5th.

"The Design of High-Fidelity Disc Recording Equipment," by H. Davies, M.Eng., on February 19th.

"The Economics of Transmitting Station Design," informal lecture by B. N. MacLarty, O.B.E.

The above meetings will be held at 5.30 at Savoy Place, London, W.C.2.

Alexander Graham Bell Centenary Lecture, by Col. Sir A. Stauley Angwin, K.B.E., D.S.O., on March 3rd at 5.15 at the Central Hall, Westminster. This meeting will be open to the public.

Cambridge Radio Section.—"The Use of Electronics in Nuclear Physics," by E. S. Shire, M.A., on February 25th at 6.30 at the Cavendish Laboratory.

Students Section.—"Radio Modulation Methods—Amplitude, Phase, Frequency and Pulse," discussion to be opened by G. Dawson, R. F. Howard and D. Deacon on February 18th, at 7 p.m., at Savoy Place, London, W.C.2.

British Institution of Radio Engineers

North-Eastern Section.—"Deaf Aid Systems," by Dr. R. T. Craig, on February 12th at 6.0 at Neville Hall, Westgate Road, Newcastle-on-Tyne.

Scottish Section.—"Electronics in Nuclear Research," by J. M. A. Lenihan, M.Sc., on February 13th at 6.45 at the Institution of Engineers and Shipbuilders in Scotland, Elmbank Crescent, Glasgow, C.2.

London Section.—"A. C. Behaviour of the Barrier-Layer Photo Cell," by J. A. Sargrove, on February 20th at 6.0 at the London School of Hygiene, Keppel Street, London, W.C.1.

North-Western Section.—"D.C. Amplifiers," by R. A. Lampitt, on February 21st at 6.30 at the College of Technology, Manchester, 1.

Physical Society

Acoustics Group.—"The Contribution of Acoustical Science to Allied Studies," by Dr. Alex Wood on February 19th at 3.0 in the Jarvis Hall of the Royal Institute of British Architects, 66, Portland Place, London, W.1.

Television Society

"The Film in Relation to Television," by Marcus F. Cooper on February 12th at 7.15 at Film House, Wardour Street, London, W.1. Joint meeting with the British Kinematograph Society.

"The Television Outside Broadcast Service," by T. H. Bridgewater, on February 28th at 6.0 at the I.E.E., Savoy Place, London, W.C.2.

Radio Society of Great Britain

"Noise Limiters," by R. H. Hamans (G2IG) on February 14th at 6.30 at the I.E.E., Savoy Place, London, W.C.2.

British Sound Recording Association

"Problems of Sound Reproduction," by L. E. C. Hughes, Ph.D., President of the Association, on February 28th at 7.0 at the Royal Society of Arts, John Adam Street, Adelphi, London, W.C.2.

Now available
NEW
IMPROVED
1946 MODEL

Gramophone Cabinet Amplifier
TP.633B (RC)

As illustrated) 30-watts output, incorporating Garrard Automatic Record Changer, is typical of the Trix range. Other models with outputs from 15-30 watts, with or without Automatic Record Changer, are available. Also AC/DC types. Substantial cabinets, in light natural oak finish, afford easy access to valves. All controls are conveniently grouped in a recessed panel on the front.

Full details of this and other models sent on request.



TRIX
Quality
SOUND EQUIPMENT

THE TRIX ELECTRICAL CO. LTD.
1-5 MAPLE PLACE-TOTTENHAM COURT ROAD-LONDON, W.1
TELEPHONE: MUSEUM 5817 GRAMES & CABLES: TRIXADIO, WESDO, LONDON.

BROADCASTING AT V.H.F.

Is F.M. the Answer?

By THOMAS RODDAM

IT seems that we are going to have V.H.F. broadcasting fairly soon. On July 16, 1946, Mr. Herbert Morrison told the House of Commons that "within a year or so" there would be "detailed plans for the establishment of frequency-modulation stations in various parts of the country."¹ A long series of tests has been carried out by the B.B.C. and some of the results have been published.²

There are, of course, many people like the writer who do not believe that V.H.F. will be a good thing. It is a bit too much like a wire-broadcasting system from a political point of view. The only redeeming feature may be that when most of the stations have left the medium waveband for the ultra-short waves, we shall be able to find a dozen really good channels in the medium waveband for the old-fashioned listeners who can't afford new sets. Like air travel and dehydrated potatoes V.H.F. broadcasting is to be with us in the near future; is frequency modulation the best answer?

There can be no doubt that, considered purely from a technical standpoint, F.M. has considerable advantages. For radio links, in which accurate tuning and stable circuits are incorporated the noise-suppression feature of re-quency modulation pays its way. The cheap broadcast receiver may not be so satisfactory, for even with magic-eye tuning many people, and women especially, seem incapable of tuning a set properly, and an F.M. set is more difficult to tune and yet demands closer tuning than an ordinary A.M. receiver. The cost of an F.M. receiver will normally be rather higher than that of a normal broadcast receiver, and it is possible that attempts to keep the price down will result in skimping of the features that would permit the full advantages of F.M. to be realized.

The alternative of pulse modu-

lation deserves, in the writer's opinion, a full series of tests. This system of working was first adopted by the British Army in the Number Ten set, and the basic principles have already been described in *Wireless World*. The transmitter, which in the army set operated on a frequency of about 3,000 Mc/s, is modulated with a train of pulses. These pulses are not quite regularly spaced in time, but depart from regular spacing according to the audio-frequency modulation to be transmitted. It is quite feasible to use this system for what is known as multiplex working, in which, say, four separate programmes are applied to one transmitter, and the pulses corresponding to the four programmes are interlaced. The Number Ten set actually carried eight telephone channels, but for broadcasting we need a wider audio-frequency band, and a choice of four programmes should satisfy anybody. Pulse modulation, like frequency modulation, is wasteful in bandwidth, for to transmit audio frequencies up to 15 kc/s we must use a bandwidth running into hundreds of kilocycles (per second). Consequently it is only possible at V.H.F.

Multipath Distortion

The chief technical advantage of pulse modulation is that it does not seem to be so liable to what is called multipath distortion. Television viewers in outlying suburbs may know what the effect is: a double or multiple image of the picture. In America it has been found that the most appalling distortion can be caused to an F.M. signal when the energy reaches the receiver both directly and by a reflected path either from the lower atmospheric levels or from the local gasworks or other large reflector. This effect did not cause much trouble in the B.B.C. tests.

Another defect of F.M. is the possibility of occasional "capture" by a distant station when propagation conditions are abnormal: this is probably not very serious, although on the rare occasions when it happened it would be very irritating, because there does not seem to be anything the listener can do about it.

Pulse modulation has, however, one very great advantage, and it is for this feature that the writer hopes that it will be very carefully examined, and that a decision will be postponed until after a detailed series of tests has been carried out. The advantage is in multiplexing. If we are to have, say, four programmes in any area, we shall need, with F.M., four transmitters and four aerial systems. These aerial systems may consist of up to eight stacks at a height of up to 1,000 feet. It is most unlikely that all four aerial systems can be mounted on the same mast, so that four large masts will be needed. As the range of V.H.F. broadcasting is limited, these masts must be planted down in the middle of the densely populated areas to be served. If they are all close together, this makes a rather cumbersome set-up: if they are widely separated, we shall not be able to use directional receiving aerials unless we twist them round when we change from one programme to another. Directional arrays, however, will help a great deal in avoiding multipath distortion and "bursts."

With pulse modulation, on the other hand, only one transmitter and one aerial system is used. We can, if we wish, put up a ten-element Yagi aerial, although in my Pimlico garret I shall continue to use a piece of wire laid along the floor. The possibility of getting up to an extra six decibels at the receiver by the use of a directional aerial must be seriously considered.

The other great advantage is in this question of tuning. With pulse modulation, programme selection is made by circuits which

¹ *Hansard*, Vol. 427, No. 177, Col. 1099.

² See *Wireless World* October 1946 p. 318.

Broadcasting at V.H.F.—

choose one or other of the interlaced trains of pulses. The radio-frequency circuits can be pre-set, and they are not critical in tuning, so that there is no real reason why the receiver should not have completely fixed tuning with trimmers only. There is no way of making a set of this type give poor quality by maladjustment by the user. This seems to be a most desirable feature, for it is the people who don't tune in properly who also grumble the loudest; the less chance they have of ruining their reception the more hope there is of evolving a satisfactory permanent scheme.

It is possible, of course, to have multiplex transmission with F.M., using "frequency multiplex" instead of "time-division multiplex." This involves rather a lot of complication, and is only suitable for radio links such as may be used in colonial telephone services and the like. It need not be considered as a possibility in ordinary broadcasting.

This discussion of V.H.F. broadcasting is intended to act as an

antidote to an attitude which has been fostered by the lay press, of which the following quotation is typical.

"Frequency modulation offers not only virtually unlimited wavelengths, but infinitely superior reception."³

It is true that frequency modulation has a lot of advantages, but it is only one possibility. Once a service is started it will be very difficult to make a change: the present status of disc recording and of television give us a guide as to what happens once a system is generally adopted by the public. It took the B.B.C. a long time to escape from the idea that the average listener used a crystal set. We must be absolutely sure before we settle down to V.H.F. that we have found the best answer from all points of view, and that it will not be too easy for either the unskilled listener or the shoddy set manufacturer to give the new service a bad name. The writer confesses freely that he is doubtful about F.M. for this reason; only large-scale tests will reassure him.

³ *The Spectator*, July 26, 1946.

FOR ALL-DRY PORTABLES

Light-weight P.M. Speaker of High Efficiency

DESIGNED with the object of making the most of the 200-odd milliwatts which represents the

Electro Acoustic Industries' 5-inch P.M. speaker for light weight portables and car radio receivers.

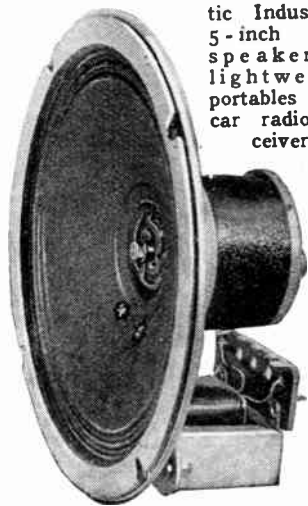

maximum undistorted power available from 1.4-volt output pentodes, this new 5-inch loudspeaker also has

the virtues of small size and low weight. From back to front the depth is 2½ in and the weight (without transformer) is only 12½ oz.

Special attention has been given to the economical use of Ticonal alloy in the magnet, in which the average flux is 9,500 gauss. The centre pole is tapered and the profile is designed to minimize leakage flux.

The shallow-angle cone is centred by the well-tryed "front" spider which is found to give reliable service under conditions of high humidity. Damp-proof adhesives are used throughout and the cone is impregnated with a chemical which inhibits the growth of fungus. Metal parts are either cadmium plated or stove enamelled.

On test the unit gave a well-balanced response with a surprisingly full bass, and the electro-acoustic efficiency was definitely higher than that of several 6-in and 8-in standard P.M. speakers with which it was compared.

The price is 25s, or 32s 6d with transformer, and the makers are Electro Acoustic Industries, Stamford Works, Broad Lane, Tottenham, London, N.15.

Hearing aids in Parliament

During a debate on the Welfare of Deaf Persons in the House of Commons on the 20th November, 1946, Mr. Edward Evans, the Labour Member for the Lowestoft Division of East Suffolk, formerly Head Master of the East Anglian School for the Deaf, made a speech, part of which we have much pleasure in reprinting below, as we feel that it should receive a wider publicity:—

"Above all, while I am discussing aural aids, may I say that it is important to get the right type? This can only be done by consultation with qualified otologists and by purchase from a reliable firm whose ethical standards of sale have been approved by the National Institute for the Deaf. Many of the firms supplying these instruments in the past have done valuable work. Their standards are high, their research investigations worthy of the highest praise and they do not exploit their customers. It is highly unfair that they should receive the odium merited by the more disreputable elements in the business.

It is all nonsense to suggest that the Americans produce a better instrument than our own best. I have compared many samples and I can assert that the British product is quite as good, and is better in most cases, as well as being cheaper, than the American instrument in the same category. The Americans are doing their best to capture the Dominion markets. I hope that our people will be given every encouragement to continue developments and to maintain and increase their overseas connections."

As the largest manufacturers of Hearing Aids in Europe we feel grateful to Mr. Evans for his appreciative remarks.

MULTITONE

(On the National Institute for the Deaf list of approved suppliers. Members of the Hearing Aid Manufacturers Association).

There are
Multitone Hearing Aids
at prices from 12 guineas,
and Multitone Agents in
most parts of the World.

MULTITONE
ELECTRIC COMPANY LIMITED

223/7 St. John Street, Clerkenwell, London, E.C.1
Telephone: Clerkenwell 8022

UNBIASED

By FREE GRID

Quizologists Forward Please

I WONDER if any of you "scolards" can help in tracing the origin of the suffix "tron" which seems to have become as much a disease as our old friend "dyne." In my innocence I have



American Publicity Wallah

always supposed "tron" to have been started on its career by the publicity wallah of an American radio firm who simply chopped off the final syllable of the Hellenogenic (copyright reserved) word electron and used it as a synonym for the word valve or tube. If such be the case it has long since shed its commercial and arbitrary origin and has for many years been used in very exalted circles to describe atom-investigating apparatus like the cyclotron.

In this respect its history has been the very opposite to "dyne" which started life in the aristocratic and rarefied atmosphere of the research laboratory as the final syllable of words like homodyne and heterodyne, but rapidly sank in the social scale until it was freely used by any and every type of "inventor" to describe some allegedly new circuit which he had thought of in his bath.

In spite of the perversion of its true meaning, "dyne" is at least a dignified adaptation of "dynamis" (δυναμις). It is not merely the back legs of the horse like "tron," unless, as I have recently been told, my fondly cherished etymological beliefs concerning "tron" are quite erroneous and that it has no connection at all with electron or any other word of Greek origin. If so, matters are even worse than I thought, for, since it is always allied with a Greek word to form names like thyatron, it seems that we have a whole host

of horrible hybrids in our midst, which have the effrontery to defy the canons of decent society and shamelessly flaunt their mixed parentage in our faces.

I am even told that "tron" is far older than the science of wireless and was used in the heyday of Crookes and Röntgen and their like; in fact, one correspondent even asserts that it is merely a rearrangement of the first four letters of Röntgen's name.

If we can get the true parentage of this word settled I should be much happier as I have nothing but admiration for the sheer ingenuity and hard thinking which has been put into certain words in which "tron" is used. The most outstanding example is undoubtedly the word klystron. This word so exactly and yet so poetically describes the functioning of the device, the man who evolved it must have put as much research work into it as the inventor of the tube itself; in fact, his effort can only be described as Homeric.

Peccavi

IT was with very serious misgivings that I received confirmation from the Editor's pen in a recent issue of *Wireless World* of an uneasy suspicion which I have long held concerning my broadcast receiving licence. It undoubtedly confers no authority upon me to receive such things as telegraphic transmissions even though they may be addressed to "CQ," nor

Public Enemy No. 1.

apparently am I permitted to receive broadcast telephony from any but an authorized station. It is true that the law as expounded on the back of the licence form does not say explicitly that I mustn't do certain things, but it obviously implies it.

None of these things worries me personally, however, as I have always endeavoured to be a law-abiding citizen, even to the extent of eschewing the temptation to use fuel by switching over to a battery set when Mr. Shinwell switches off the current in the middle of my

favourite programme. Even during the war, owing to my suspicions of what the Editor now confirms, I endeavoured, although without much success, to check the disregard for law and order displayed by the local Home-Guard Commander who used the C.W. morse transmissions picked up on his home broadcast receiver to give code practice to a signals unit. I did, however, persuade him to communicate with the P.M.G. admitting his offence and asking for a plenary indulgence and a retrospective permit. The matter is, I am glad to say, receiving attention and there is every hope of the permit forthcoming in the near future, thus enabling him once again to go about among his fellow citizens without the hang-dog "I dun it" expression.

The thing which does trouble me is that, after diligently studying the licence conditions, I find no authority whatever is conferred on me to receive any form of atmospheric disturbance no matter whether man-made or otherwise.

Everytime, therefore, I hear the noise of the next-door vacuum cleaner or a passing car creates a snowstorm on my television screen I realize that I am no less a law breaker than the most hardened malefactor whose waxen torso is exposed to view in a building not very far from Sherlock Holmes' old

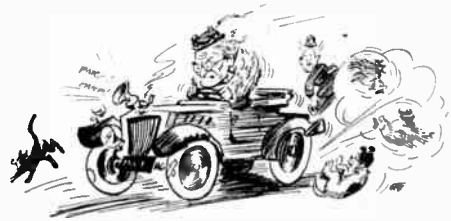

flat in Baker Street which any London guide worthy of his salt will point out to you.

Worse still, I have even used my radio set for the conveyance of messages to me, thus infringing the P.M.G.'s monopoly, for every time I hear a racket some ten times worse than usual emanating from my L.S., or see a blizzard of more than Arctic severity on my viewing screen, I know that Mrs. Free Grid's mother is approaching in the decrepit equipage which has more notches on its bumpers than a Chicago gangster has on his gun stock.

KEYING MONITORS

Radio Oscillator Triggered by the Transmitter

By W. A. ROBERTS

A RELIABLE keying monitor is a most useful aid to good operating as it enables the amateur, and especially the beginner, to maintain a constant check on his morse transmissions.

There are many varieties of monitors but most of those in general use can be grouped into one of two main categories (a) R.F. oscillators beating with the radiated sig-

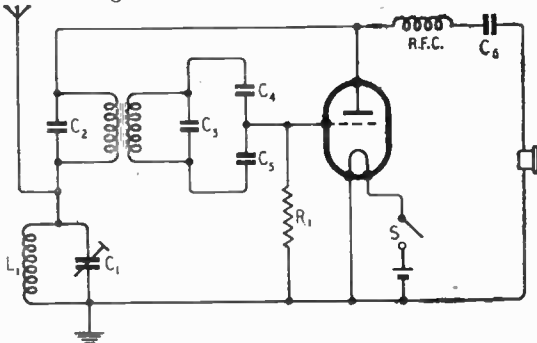

nals and (b) A.F. oscillators keyed simultaneously with the transmitter.

The former serve as a check on both the operator and the transmitter, but in order to serve a really useful purpose in the dual role they must possess a very high degree of frequency stability.

Whilst the latter do not demand such care in design, the type generally used gives no warning of a breakdown in the transmitter, and so they act merely as a check on the operating style.

A particularly attractive keying monitor, which differs from those in general use since it combines some of the attributes of the A.F. and the R.F. pattern, is shown in the circuit diagram.

It is, in effect, an A.F. oscillator with the H.T. obtained by self-rectification of the signals radiated from the transmitting aerial and picked up by the monitor. This is effected by the tuned circuit L_1C_1 which must, therefore, be tuned to the same frequency as the transmitter. High accuracy of tuning, or circuit stability, is, however, unnecessary as the pick-up can be controlled by the length of the short vertical rod aerial.

Best results have been obtained with the grid artificially tapped down the audio oscillator coil, this tapping being effected by a condenser potentiometer C_4 and C_5 . With an average intervalve transformer C_5 can be made $0.05\mu\text{F}$ and C_4 some value from $0.0005\mu\text{F}$ upwards. It should be chosen to give reliable, but not too fierce, oscillation; an average value is about $0.002\mu\text{F}$. With this method of adjustment it does not seem important whether the transformer is connected to step up from the anode to the grid or to step down.

Audio-type keying monitor with H.T. obtained by rectifying the signals picked up by the self-contained aerial.

The resistor R_1 is the usual grid leak and a value of about $50k\Omega$ is suggested, but it may have to be lowered if there is a tendency to squegger.

The capacitance of C_3 will have to be found experimentally as both C_4 and C_5 , as well as the inductance of the grid winding, combine to determine the frequency of the audio signal generated. Capacitor C_2 is merely an R.F. by-pass condenser and may or may not be needed. If used about 100pF should suffice.

With this form of oscillator the output load should be of reasonably high impedance and this can conveniently be achieved by using a comparatively small capacitance at C_6 , for example, $0.001\mu\text{F}$. The R.F. choke must be effective at the radio frequency of the transmitter.

A telephone ear piece secured to the monitor is preferred by the writer to plug and socket connections for external headphones, as it helps to render the unit more self-contained. No electrical connection is needed to the transmitter so that the monitor might quite well include its own dry cell L.T. battery.

• ALL-POWER • Regulated H.T. Supply Units

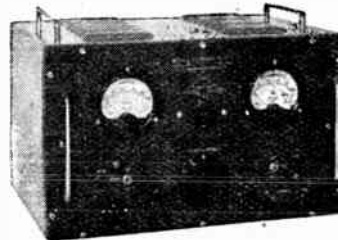

STANDARD MODELS

A range of standard models is available, of various output voltages and current ratings. Illustrated is the Model 101-A, which provides an output voltage from 250 to 400 volts at up to 250 mA, with a Stabilization Ratio greater than 100 and an Internal Resistance less than 1 ohm. This unit also provides unregulated A.C. outputs of 6.3 volts 3 amps. and 4 volts 5 amps.

SPECIAL MODELS

Electronic Stabilization provides the answer to many of your most difficult power supply problems. We are the only manufacturers specialising in the production of Electronically Stabilized Power Supplies and our unique experience in this field is at your instant service.

Special power supply units can be constructed to meet any specification. Let us quote for your individual requirements.

ELECTRONIC INSTRUMENTS

We are prepared to collaborate or assist in the design and manufacture of all types of specialised electronic apparatus. Your enquiries are invited.

FILTER INDUCTANCES

The design of Audio-Frequency Filter Networks calls for the use of iron-cored inductances of high Q and high stability, adjusted to very precise values. Our standard range of small filter inductances uses 0.005 inch laminated Rhometal cores, and all inductance values are normally adjusted to within ± 0.5 per cent. We can supply inductances accurately matched to your specification, or complete Filter Networks having any desired characteristic.

ALL-POWER TRANSFORMERS LTD.

8a, Gladstone Rd., Wimbledon, S.W.19.

Telephone: LIBerty 3303.

LETTERS TO THE EDITOR

Variable- μ v. Variable- μ : Result \blacklozenge Standard Valves Criticized \blacklozenge What Are "Technical Assistants"?

μ -Confusion

MAY I add one further point to the delightful article on " μ " by "Cathode Ray"? Precisely what he anticipated has happened to the American "micromho." In valve data sheets it is frequently given as " μ mho." However, these sheets are typewritten and mimeographed, and few typewriters talk Greek; so it is often typed "umho," a stroke being added later to make the "u" into μ . This stroke is now as often as not omitted. If the result is pronounced "Um! Ho!" some eyebrows may be raised, but there can be no misunderstanding.

Dublin.

G. F. DALTON.

THE significance of "variable- μ " (which was touched on by "Cathode Ray" in your November issue) was discussed in *Wireless Engineer* in May and June, 1944. The conclusion there reached was that "the significance of the ' μ ' appears to have undergone a change on crossing the Atlantic."

"The Electronics Dictionary" (by Cooke and Marcus, published in U.S.A. in 1945) contains the following definitions:—

mu—Greek letter μ used as symbol for *amplification factor*, for micron (a unit of length) and for the prefix micro-;

high- μ tube—A vacuum tube having a high *amplification factor*.

These definitions confirm the opinion that " μ " means "amplification factor" (at least in U.S.A.).

Some confusion is apparently introduced by the definition of "variable- μ " which reads:—

Variable- μ tube—A type of thermionic tube having a grid so designed that the amplification factor and mutual conductance can be varied by adjusting the grid-bias-voltage value.

A diagram in the dictionary shows "Close spacing for High-Mu Action—Wide Spacing for Low-Mu Action." It is suggested that the use of the term High-Mu in the illustration shows that the words "amplification factor" are more important than "mutual conductance" and, further, that the last part of this definition was inspired by B.S.204:1943, definition No.

1782—"A valve the mutual conductance of which can be altered smoothly over a wide range by variation of grid bias."

The "vastly sillier and more confusing" name (see "Cathode Ray's" article) was given to the valve by the inventors (Ballantine and Snow)—*Proc. I.R.E.*, Vol. 18, 1930—in describing their types 550 and 551 tubes.

L. BAINBRIDGE BELL.

Witley, Surrey.

IN your November, 1946, issue, "Cathode Ray" offers interesting criticisms of the use of μ to represent, among other things, variable- μ , which, he concludes, stands for variable mutual conductance. As one of the original sinners I wish to make the following explanation in the nature of a feeble defence. In 1931, at a conference with the late Stuart Ballantine, we were discussing the then new Type 551 tetrode, the first variable- μ tube made. Mr. Ballantine, Mr. Snow and myself designated the tube as a variable- μ (or μ if your typewriter had Greek letters) tetrode. The reasoning was as follows. The tube depended for its action on the irregular spacing of the control grid wires, this spacing determining what was then as now called μ or amplification factor, and this construction led to the amplification constant varying with grid bias when the tube was tested as a triode in a Miller bridge with the plate and screen connected together. This was the customary way to read amplification factor for the purpose of standardizing the tubes, although admittedly the tube was never operated in that way. The term variable- μ (or μ) never meant mutual conductance, a term which was anathema to Mr. Ballantine since he said that there was nothing mutual about it and he was instrumental in having it changed to transconductance after a long struggle with the I.R.E.

Incidentally there was a battle of μ versus k in the early 20's. General Electric and Bell Telephone Laboratories used μ (or μ) for amplification factor while Westinghouse would have none of it and used k . Many hours of argument were required to settle the issue and to this

day one can spot a Westinghouse-trained man by his use of k whenever possible.

I would like to make a suggestion here that all technical people learn the Russian alphabet as they have learned the Greek, since a dozen or more new symbols, easily printable, could be had and perhaps the first six or seven could be used to relieve the burden of μ without treading on some otherwise preserved ground. The use of the *modern* Japanese alphabet has been suggested also and seems to have some merit as upwards of twenty new symbols could be used. German Gothic is too hard to print and read.

W. R. FERRIS.

Washington, D.C., U.S.A.

Standard Values

AFTER several weeks of trepidation concerning the latest B.V.A. moves at valve standardization, I was greatly encouraged by J. Sparrow's letter in your January issue. I share his views on yet another awkward and irritating addition to an engineer's troubles.

"Standard" seems a very optimistic word to use for the new valve base, especially when it has to be divided into two types to accommodate the normal range of valves.

Surely a very convenient and practical base type has been evolved for us by the widespread success of the international octal base. Such a base will accommodate a large variety of valves without requiring different sizes of holders. The new standard, using a bayonet-type valve holder, on the other hand, limits the diameter of the base within close limits unless recourse is had to the use of different size holders.

The point that seems to be most difficult to understand is the necessity for placing the locating boss on the side of the shell, instead of on the spigot; and thus having to use a bayonet-type base.

With the very lengthy spigot and the bayonet-type base, more headroom will be required above the valve for the removal and replacement than need be. This does not seem helpful when considering the compact apparatus designers promise in the future.

The international octal base has been very successful, and the "international" quality ought to be an important point in these post-war days of high exports. The vast majority of service equipment uses the international octal, and this base is also appearing in many new sets.

Why not adopt that which experience has shown to be acceptable, simplify all our present valve types into a standard range, and make an

important step towards progress?

As it is, wireless dealers will have to add yet another shelf for their valve stocks, *Wireless World* another page to its "Valve Data," and the enthusiast will have a still larger collection of oddities to choose from!

London, W.5. R. G. PARR.

Protecting Pilot Lamps

IN the "Random Radiations" columns of the September issue of your journal, "Diallist" mentions, under the cross-heading "Pilot Lamps," a need for a protective device for pilot lamps.

It may be of interest if I point out that such a device already exists in the form of Thermistors, a product of my company. In suitable circumstances Thermistors give adequate protection against surges to pilot lamps and the like.

B. J. AXTEN.

Standard Telephones and Cables, Ltd., London, W.C.2.

B.B.C. Quality

SOME very interesting points regarding the quality of present-day B.B.C. transmissions are raised by H. A. Hartley in your January issue. I should like to endorse his remarks regarding the frequency discrimination and harmonic distortion present in most broadcasts. I have conducted similar experiments to Mr. Hartley's and can vouch for the accuracy of his figures. It is noteworthy that the B.B.C. programmes of commercial discs show a consistently higher fidelity than many of their live studio broadcasts, which shows that there is something radically wrong with either studio or studio equipment.

Whilst admiring Mr. Hartley's curt dismissal of B.B.C. recordings, it must be realized that approximately 50 per cent of programme material during peak listening hours is recorded. Incidentally, not all recorded features are announced as such in the *Radio Times* and over the air.

Some of the "top" shows are never presented "live" nowadays; i.e., Music Hall, Navy Mixture, Have a Go, Robinson Family, etc. As all these recordings are usually of an extremely low standard, action of some sort is long overdue. In any case, the only legitimate use of a recording is for a repeat performance of some popular item: only then if the quality is sufficiently good. A defect which Mr. Hartley omitted to mention, but which he must have noticed, is hum. Most B.B.C. transmissions are marred to

some extent by this form of distortion, particularly recordings, despite the fact that they are usually weak in the lower end of the frequency spectrum.

The B.B.C. has consistently neglected its duty to the public in respect of transmission quality, and it would appear that a real improvement can only be secured by appointing some outside body like the American F.C.C. to lay down standards to which the B.B.C. must be forced to conform.

HARRY TEMPLE.

Bedlingtonshire, Northumberland.

Technical Assistants

THE "technical assistant" is a comparatively new form of radio life. He is so far the product, not of special training or even necessarily of special aptitude, but of erratic selection from the upper fringe of the mechanic-serviceman band of ability. That, and the very poor financial inducements offered, are the reasons why Thomas Roddam (your December issue) finds a shortage of these strange creatures in research and development spheres. Nevertheless, they are likely to increase in numbers, since their work is most attractive to the keener and more intelligent of non-degreed (surely "unqualified" is a little harsh?) technicians; it is time that they began to be officially recognized and classified as a special genus, and some sort of specialized training provided to ensure an adequate supply of them in industry. For they can be most useful when they know their work properly—which can be assured by suitable tests, both written and manual, and certification on the lines of other recognized professionals.

Ideally, the "technical assistant (radio)" would be a mongrel (or perhaps "hybrid" is the less offensive term). He would be partly pukka engineer, capable of grasping what his Head Wizard was driving at with "cos and tan and all that" and translating it into workshop English; partly draughtsman, able to play with ideas on paper and prepare working diagrams; and quite 50% skilled mechanic and tester, since he must be able to handle materials to make models and prototypes and to find out by measurements what their performance was. Altogether, a man of considerable parts, and invaluable to the highly trained academic specialist who did not want to come out of the clouds to tell somebody how many turns to put on or how to dispose of valve holders.

W. H. CAZALY.

London.

ONE LOUDSPEAKER —360° COVERAGE



CIRCORN—Redg. Trade Mark

This new type, called the CIRCORN, has horn-speaker efficiency together with completely uniform distribution throughout 360 deg.

Typical advantages:—ONE centrally placed will cover the whole of a medium-sized area; used on a moving vehicle results are equal approaching, passing or receding, thus ideal for street processions, elections, etc.
List price—Horn only £7 0 0.
Complete £14 5 0.



M.5
Moving Coil
MICROPHONE

No polarising current, adequate frequency response, low impedance, high output due to a very efficient magnet and careful design.
List price £5 15 0.



L.5.7 HORN LOUDSPEAKER
Maximum sensitivity and volume. Impedance 10 ohms; handles 12 watts 170-10,000 c.p.s. 40 in. horn. List price £13 10 0.

F.I. for P.A.
FILM INDUSTRIES LTD.
60, PADDINGTON ST., W.1
Telephone: WELbeck 2385

RANDOM RADIATIONS

By "DIALLIST"

A Lifer?

THE French wireless magazine, *Toute la Radio*, asks: "Are we to be sentenced to the 4 + 1 receiver for ever and ever?" From which you will no doubt gather that the French radio industry is at the moment suffering from much the same lack of vision as our own. Somehow I don't think that our sentence will be a lifer, for our manufacturers are even now slowly beginning to realize that putting a conventional 4 + 1 combination into an unprepossessing box and labelling the confection "The World's Best Set, £15 15s." is not going to produce that post-war money for jam which so many of them had expected. That realization is being brought about by the failure of Mr. and Mrs. Broadcast Listener to queue up for the 4 + 1s—unless they're something very special in the way of 4 + 1s. The only really ready market, in fact, that such sets are finding is amongst people who are setting up home for the first time and have never owned wireless sets before. On the other hand, there is a big demand for high-priced receivers of good performance, which can't be turned out fast enough to meet it. I am sure that I'd have no difficulty, if I feel like it, in buying to-morrow a dozen assorted 4 + 1s off the shelves of the three radio shops of the little town in which I live; but if I wanted a more elaborate set I'd have to put my name down on a waiting list.

The Reason Why

There are over ten million owners of wireless sets here. The great majority of the receivers in use must be six years old or more, since supplies have been short from the autumn of 1939 until quite recently. There should therefore be a pretty considerable demand for replacements, one would think. Then why the rather sticky sales? Simply because, so long as the old set continues to work, people are not going to spend good money on a replacement which shows no very striking improvements in design or performance. Manufacturers possibly forgot that during the war the servicemen who remained in civvy street became adepts at fettling up elderly receivers. And, after all, is there so much that can wear out in a year or two in a reasonably well-made re-

ceiver? Replace the valves, the volume control (almost certainly required), the wave-change switch (nearly as likely), one or two resistors and capacitors, clean up and re-align, and the set will probably be nearly, if not quite, as good as ever it was. Its owner is hardly likely to discard it in favour of a new one unless that new one is obviously a much better thing. The price, I am sure, does not matter very much, so long as the receiver offered is good value. Wages have never been so high as they are today, and there is a pent-up urge resulting from the years of austerity to spend money on worth-while things—if they are available.

□ □ □

What is Radar?

THIS question does need to be settled and I was glad to see "Cathode Ray" raising it again in the December issue. As things are now almost any new-fangled system of direction or position finding or course indication is loosely classed as radar by folk who ought to know better. In the days when it was called R.D.F. and the term radar hadn't been invented echoes returning from the target to a receiver on the same site were an essential part. That is basically what radar should mean to-day. Radar should include such systems as H.S. and A.S.V.: it should certainly not include Gee, Loran and Decca. The beginning of the confusion came when I.F.F. made its bow. I.F.F. was part and parcel of every radar station, or at any rate of every gun-control and fighter-control radar station. It was developed by research folk concerned with radar, operated by radar teams and serviced by radar mechanics. Hence it was rather naturally lumped in with radar. Also it operated on exactly the same principle as many of the radar training devices—the triggering of a transmitter at the target by the outgoing pulse. And naturally again, these trainers were classed with radar.

The Slippery Path

Thus I.F.F., like the trainers, was not itself a radar device in the true sense, though it was part of many radar equipments. Once feet had been set on the slippery path towards inaccuracy by the classifica-

tion of I.F.F. and training devices with radar, progress in this undesirable direction was rapid. Before long anything evolved by T.R.E. or A.D.R.D.E. (now R.R.D.E.) which used pulses and was concerned with position-finding or aircraft control from the ground became almost automatically an acknowledged, though illegitimate, member of the radar family. The next step was to dispense with echoes, whether primary or induced, as a criterion. Then the pulse was dropped as a birthmark proving radar legitimacy. Finally, systems using no pulses and no echoes and operating on the long waves claimed family rights to the name radar, and few save "Cathode Ray" and my humble self called attention to the triple bar sinister in their ancestry. Genuine radar is indisputably concerned with the out-and-home journeys of radio pulses. It is thus limited to systems operating on the ultra-short waves and the micro-waves in which the received pulse is an echo of the transmitted pulse.

□ □ □

Programme Quality

MY sympathies are entirely with those who inveigh against the quality of reproduction obtainable from the B.B.C. transmissions to-day. Occasionally an item is pretty well transmitted and one can make the most of it with a receiver designed for high-quality reproduction. But how often does this happen? The answer, I am afraid, must be that it happens distressingly seldom. In common with most members of the male sex I maintain (though it is far from easy at times to make one's nearest and dearest believe it!) that I do a good day's work. The bulk of home listening is therefore done from about 9 p.m. onwards. Many of the directly transmitted items are not too bad, though harmonic distortion is far too prevalent. But what rouses me to wrath is the average recording, of which we have many more than should come the way of those paying a hundred-percent post-war increase in the cost of their receiving licences. Not to put too fine a point upon it, the generality of recordings are just foul!

Need They Be?

Often I ask myself why recordings should be so entirely bad; why they should scratch and/or crackle; why they should make speech sound like no human speech; why they should turn music into a travesty of its real self. I don't know

the answers; I just go on wondering. The B.B.C. knows all about the magnetophon and possesses at least one working instrument. The magnetophon, we have been told, eliminates all surface noises and deals faithfully with all frequencies from about 25 to 10,000 cycles a second. Then if the magnetophon is there and is all that good, why on earth isn't it used regularly? It is reported to have been used lately for experimental transmissions. Anyway, it is no credit to the B.B.C. that we should have so many recorded items, for one of the great appeals of wireless is that it enables sounds to be broadcast as they occur. It is even more of a slur that the quality of the recordings should be at so low a general level.

□ □ □

French-English Terms

WHEN I read the letter from M. Aisberg which appeared in the last issue I made a note to break a lance with him next time I set pen to paper. I can't and won't agree that "un self" is nothing more than technicians' slang in French for an inductor. I'll admit that it ought to be, since there are correct French terms for the same thing. But I've come across "self d'antenne" or "self de 200 μ H," or "self de 50H" scores of times in reputable French text books and in circuit diagrams. I should hate to arouse the enmity of M. Aisberg, who took a very active part in the resistance movement and spent much time in devising methods intended (as he put it to me) "pour enquiquiner le Boche"—if you can translate that one, your colloquial French isn't too bad—and pretty effective methods they were. Still, I'm not going to let him get away unchallenged with his claim that "un self" is just slang and nothing more.

ALL-DRY PORTABLE

A NEW battery portable with 1.4V valves has been introduced by the Rees Mace Manufacturing Co., 40, Welbeck Street, London, W.1. Known as the "Cameo" Model AD70 the set employs a 4-valve superheterodyne circuit and has two waveranges. The price will be £15 plus £3 5s purchase tax.

"NOISE FACTOR": A Correction

It is regretted that in formula (1) on page 393 of the December, 1946, issue the denominator of the third term was given inadvertently as G_2 instead of G_1G_2 .

RESPONSIBLE MEN



must rely upon
responsible components

CAPTAIN of an 85,000-ton "Queen" or skipper of a 2,000-ton tramp, the man on the bridge is as good as his ship's equipment. Power and communications, radio, radar and the latest electronic devices are his trusted and responsible servants. In storm and fog the ship's safety is increased by Britain's finest technicians. Such men in the Bulgin Research Laboratory produce reliable components for every branch of radio and television. You will know a Bulgin component by its sterling performance.

BULGIN

(REGD. TRADE MARK)

Famous since Broadcasting Began

A. F. BULGIN & CO., LTD.

BYE-PASS ROAD - BARKING - ESSEX

RIPpleway 3474 (5 lines)



ERIE

Electronic Component Products

RESISTORS · CERAMICONS · Hi-K CERAMICONS

SUPPRESSORS · POTENTIOMETERS

VITREOUS ENAMELLED WIRE-WOUND RESISTORS

ERIE RESISTOR LIMITED

CARLISLE ROAD
TELEPHONE: COLINDALE 8011-4
FACTORIES: LONDON,

THE HYDE · LONDON · N.W.9 · ENGLAND
TELEGRAMS: RESISTOR, PHONE, LONDON
ENGLAND · TORONTO, CANADA

N.W.9 · ENGLAND
CABLES: RESISTOR, LONDON
ERIE, PA., U.S.A.

MICRO-VARIABLE CONDENSERS

Finest quality, as made for the Air Ministry. All have ceramic insulation, silver plated vanes, and have standard $\frac{1}{2}$ " spindles.

STRATTON MICROCONDENSERS (Eddystone)

Code E18. 18 mmfd double spaced, 3/9. E40. 40 mmfd double spaced, 4/3
Code E60. 60 mmfd single spaced, 4/3. E100. 100 mmfd single spaced, 4/6
Code E160. 160 mmfd single spaced, 5/-

MIDGET POLAR CERAMIC

Baseboard mounting with double end plate, bar type, ball bearing.
Code BB25. 25 pf, 2/9. BB50. 50 pf, 3/-, BB100. 100 pf, 3/6
Ditto panel mounting type.

Code P25. 25 pf, 2/9. P50. 50 pf, 3/-, P100. 100 pf, 3/3
Ditto but 2 Gang or Split Stator. The ideal band spread condenser, both double spaced.

Code 2P6.4. 2 x 6.4 mmfd, 3/9. 2P3.5. 2 x 3.5 mmfd, 3/9
Baseboard 2 Gang or Split Stator.
Code 2BB25. 2 x 25 mmfd, 4/-, 2BB100. 2 x 100 mmfd, 4/9

Midget 2 Gang or Split Stator. All ceramic end plates, ball bearing, panel mounting.

Code 2C5. 2 x 5 mmfd single spaced, 3/9. 2C25. 2 x 25 mmfd, 4/3
Code 2C10D. 2 x 10 mmfd double spaced, 4/3. 2C15D. 2 x 15 mmfd, 4/3

SINGLE MIDGET SILVER MICROVARIABLES

Smallest air-spaced condenser made. Panel mounting.
Code T100. 100 pf, single spaced, 3/3. T20. 20 pf, double spaced, 2/4

Other offers include:—
YAXLEY TYPE SWITCHES.
CONCENTRIC CABLE.
ROTARY TRANSFORMERS
ETC.

RADIOMART
GENT (GRAM) LTD.

Send for List W/3.
48 HOLLOWAY HEAD, BIRMINGHAM, 1

**DUE TO VAST INCREASES
IN PRODUCTION—
DENCO COMPONENTS**

including the ever-popular
MAXI-Q, COILS are now
available from stock.

Coil turrets, we regret to say, are still subject to a slight delay.

MAXI-Q B.F.O. UNIT. (465 Kcs. or 1.6 Mc/s.) A complete beat frequency oscillator unit to operate with a triode valve and giving the compactness and high efficiency of the Maxi-Q series of components.

Overall Dimensions: 2" high 1" square.
Price **12/6**

POLYSTYRENE INSULATION.

Quantities of $\frac{1}{2}$ ", $\frac{3}{8}$ " and $\frac{1}{4}$ " Sheet now available from stock; supply position of rod and tube has improved considerably, and small quantities can now be supplied.

AGENCIES.

A few vacancies exist for dealers with the right qualifications, to stock and sell our components in certain areas. If there is no retailer in your area we will be pleased to have your recommendation as to a suitable dealer.

DENCO (CLACTON) LTD.
OLD ROAD, CLACTON-ON-SEA, ESSEX
Telephone: Clacton 807 and 808

M. ALLEN (Radio) Ltd

113, CHARING CROSS ROAD, LONDON, W.C.2



BANDMASTER U18 Universal Test Meter

1,000 ohms per volt (B.S.S.I. Spec.)
18 RANGES—INCLINED DIAL. DIRECT READINGS TO 2 MEGOHMS.
OPERATES IN ANY POSITION.

Ranges:—Milliamps D.C. 5-20-100-500.
Volts D.C. 1-10-100-500-1,000.
Volts A.C. 10-100-500-1,000.
Resistance. From .2 ohm to 2 Megohms. In 3 ranges.
Capacity 0.005 to 2 mfd.
Millivolts D.C. 0-100.

All ranges are controlled by one master rotary switch.
PRICE (including leads and test prods) £14 0 0
(Replacement batteries—1 Ever Ready No. 8. 1 Ever Ready B.105).
Write for particulars of full range of
Radio, Television, Electronic, Electrical instruments and components.
M. ALLEN (Radio) Ltd., 113, Charing Cross Rd., London, W.C.2
Tel.: Gerrard 8734

ERG'S HAVE THE URGE TO GO ABROAD

SPEAKING EXPORTLY...



ERG Resistors have an exceptional electrical specification and performance, with mechanical strength.

High-grade Vitreous Enamels used on our Tropical Resistors give long life, and definitely assist in the trouble-free manufacture and performance of Radio Receivers, Television and Test Equipment.

ERG Resistors are processed up to the highest Service Standards at a competitive Price.

ERG INDUSTRIAL CORPORATION LTD.
SALES OFFICE: 10 PORTMAN SQUARE, LONDON, W.1 TELE.: WELBECK 8114/5

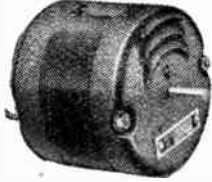

NEW FRACTIONAL H.P. MOTOR

Precision built from first class materials. A robust unit with many uses. Ideal for driving models.

Technical Data—1/75th H.P., 1750 R.P.M., 230/250 Volts A.C., Shaded Pole, Diameter of Motor 3", Length 2 1/8", Diameter of Spindle 3/16", Projection of Spindle 11/16", Black Crackle Finish.

Motor will be forwarded by return of post and post free on receipt of remittance for 49/6d.

THE DOMESTIC SUPPLY CO.,
341, Regent's Park Road, London, N.3.

WHERE YOU NEED IT!

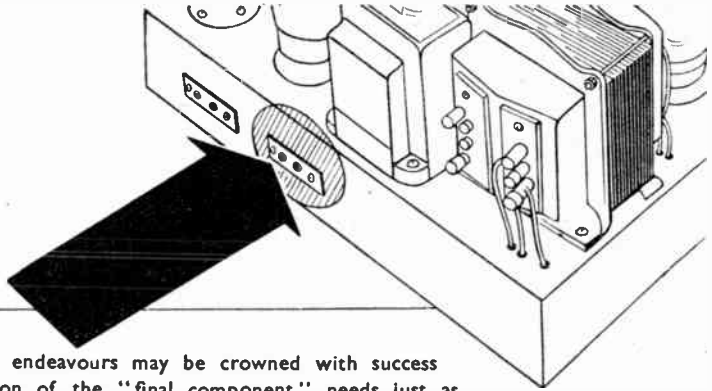

So that your endeavours may be crowned with success your selection of the "final component" needs just as much discrimination as do the other details of your circuit. Stentorian speakers are specially designed to match any desired impedance. As you listen to the faithful reproduction from your Stentorian, you will be delighted at the results you are obtaining. Ask your dealer to demonstrate.



PERMANENT MAGNET MOVING COIL SPEAKERS



Stentorian

THE FINEST EXTRA SPEAKER FOR ANY SET

PRICES			
Minor Type HX (for Low Impedance Extension)	39/6	Baby Type BX (for Low Impedance Extension)	53/6
Minor Type HC (with Universal Transformer)	45/6	Baby Type BC (with Universal Transformer)	59/6

WHITELEY ELECTRICAL RADIO CO. LTD., Mansfield, Notts.

INTRICATE PARTS



but not too intricate for

Bullers

Made in Three Principal Materials

FREQUELEX

An insulating material of Low Dielectric Loss, for Coil Formers, Aerial Insulators, Valve Holders, etc.

PERMALEX

A High Permittivity Material. For the construction of Condensers of the smallest possible dimensions.

TEMPLEX

A Condenser material of medium permittivity. For the construction of Condensers having a constant capacity at all temperatures.

BULLERS LOW LOSS CERAMICS

BULLERS LTD., 6, Laurence Pountney Hill, London, E.C.4

Telegrams: "Bullers, Cannon, London"

Phone: Mansion House 9971 (3 lines)

OUR FIRST POST-WAR PRODUCT
THE ROMAC 106

"Personal" RECEIVER

£14 14 0 Complete, Plus-P.T. £3 6 0

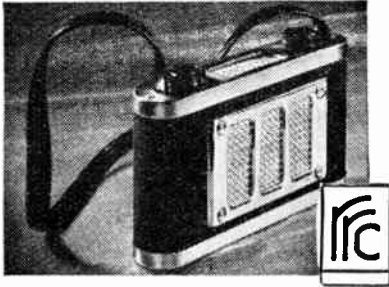

This Receiver was selected as an Exhibit at the "BRITAIN CAN MAKE IT" Exhibition.

Home and Export enquiries should be directed to :

ROMAC RADIO CORPN. LTD.
THE HYDE · HENDON · LONDON, N.W.9.

**IF YOU USE
WAX**

We Are At Your Service

THE WIDE RANGE OF
OKERIN DI-ELECTRICS

created in our own laboratories fulfils almost every need of the Electrical Industries. Grades have been designed for the most severe and varied conditions. Most are resistant to mould and fungus growth, whilst special types are evolved whenever new applications arise.

We invite discussion on problems of Insulating, Impregnating, Waterproofing, Filling Finishing, etc.

**ASTOR BOISSELIER
& LAWRENCE LTD.**

(Sales Dept.), Norfolk House, Norfolk Street, Strand, W.C.2

Telephone : Temple Bar 6927.



BIRMINGHAM SOUND REPRODUCERS LTD

CLAREMONT WORKS, OLD HILL, STAFFS. TEL: CRADLEY HEATH 6212/3

LONDON OFFICE: 115 GOWER STREET, W.C.1. TEL: EUSTON 7515

M-W 88



... **IRON
DUST
CORES**

High performance, Strength, Stability. Close electrical and mechanical tolerances. Grades to suit various applications.

neosid Limited

23 & 25, Hyde Way,
Welwyn Garden City, Herts.
Tel. : Welwyn Garden 925.

W.W.2

Rate 6/- for 2 lines or less and 3/- for every additional line or part thereof, average lines 5-6 words. Box Numbers 2 words, plus 1/-. Press Day: March 1947 issue, first post Thursday, February 6th. No responsibility accepted for errors.

WARNING

Readers are warned that Government surplus components which may be offered for sale through our columns carry no manufacturer's guarantee. Many of these components will have been designed for special purposes making them unsuitable for civilian use, or may have deteriorated as a result of the conditions under which they have been stored. We cannot undertake to deal with any complaints regarding any such components purchased.

NEW RECEIVERS AND AMPLIFIERS

NEW 176 mc/s 10 valve superhets, ex-radar; stamp details.—Box 5766. (6848)

W.W. pre-tuned receiver, £5/10; Rola G12. p.c.f.; £6.—59, Lindum Rd., Cleethorpes.

COMMUNICATION receivers.—As soon as civilian supplies recommence we shall be at your service.—A.C.S. Radio, 44, Widmore Rd., Bromley, Kent. (4528)

COMMUNICATION receivers.—“Dale” will have them as soon as trading conditions allow.—Remember—Dale Electronics, Ltd., 105, Bolsover St., W.1. Mus. 1023.

DORIC “Trutone” 5-valve ac/dc 3 wave-band superhet, 16.50, 200-550, 1,000-2,000 metres, complete in polished figured oak cabinet, size 13in x 8in x 6in approx; retail price, £13 incl. tax.

DORIC RADIO Co., Lowson St., Darlington.

AMPLIFIERS, 6 watts push-pull output. Complete with 10in speaker, for use on ac mains, good quality job, tone control, etc.; call and hear one or send for descriptive leaflet “W”.

CHARLES BRITAIN (RADIO), Ltd., 2, Wilton St., London, E.C.2. (6835)

AMPLIFIERS; new 1947 model Hi-Fi units, with triple tone controls, built to customer's specification.—Broadcast & Acoustic Equipment Co., Ltd., Broadcast House, Tombland, Norwich 26970. (6433)

EDDYSTONE 504 communication receiver now in stock, £58/18/7; Short Wave Manual No. 5, 2/7 post free; stocks of Eddystone, Denco and Raymar components.—K. L. W. Cook, Bush and Murphy Dealer, 25a & 27, High St., Swindon, Tel. 3164. (6784)

R.107 comm. receiver, 9v, 3 bands, 17.5 v 1.2mc/s, IIF stage, sep. osc., 2-1.1' internal speaker, v. select, 100-260 A.C., 12v D.C., H.F.O., etc., £30; S.X.28 with Hellicrafter speaker, SX.16, with matched speaker; offers.—20, Clifton Ave., London, E.17. (6798)

1946-7 new radios.—Brand new Universal Midgets, a.c.-d.c. mains, med.-long waves, 4v, perfect goods, in makers' sealed cartons with guarantees; £12/17/6; cash with order; executed rotation; send s.a.e. for list leading makes sets.—Radio Bargains, 261-3-5, Lichfield Rd., Aston, Birmingham, 6. (6545)

14 watt amplifiers for mike or gramo operation, low intermodulation distortion, 25µs; transformers (bakelite impregnation, special stalloy), from £1/2/6; castings, turning, durakumamine cases and decks to customer's specification.—R.R. Development Laboratories (consulting engineers), Barnard Rd., Bradford. (5801)

TELERADIO. — Replacement radiogram chassis, model 50A, ready for immediate delivery, 7-stage all-wave superhet, with negative feed back, size 13½ x 5½ x 7, factory assembled and tested, £12/12, plus P.T. £2/14; amplifier for mike or records, a.c./d.c., 4.5 watts output, assembled and tested, £5/15; all dry; midget superhet for car radio, etc., complete in aluminium case, size 10 x 6 x 6, £10/10, plus P.T. 45/-; all above and many others available for home construction with considerable cash saving; stamp will bring full lists.—Telorado (Dept. W.W.), 157, Fore St., N.18, Tottenham 3386. (6627)

CHARLES AMPLIFIERS.—Announcing a new version of their famous HFA1 amplifier—the HFA3 incorporating a pre-amplifier to enable the use of moving coil pick-ups direct; this amplifier in conjunction with the Lexington moving coil pick-up and the B.A.E.C. twin cone speaker provides the highest obtainable fidelity of reproduction; the complete range now comprises amplifier HFA1 7 watt cathode follower output for crystal pick-ups; HFA2 single-ended for crystal pick-up; the HFA3 for moving coil pick-ups; tuner unit TU2 combination superhet t.r.f. feeder unit; full constructional blueprints 2/6 each; full kits or separate components available or supplied ready assembled; stamp for comprehensive catalogue.—Charles Amplifiers, 1e, Palace Gate, Kensington, W.8.

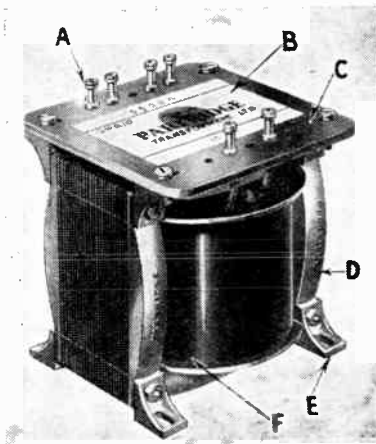

**PARTRIDGE
Precision Built
TRANSFORMERS**

famous for high electrical performance incorporate the following external features—

- A** Silver plated turret terminals giving a low potential drop and carrying up to 15 amps. Adequate room on each for easy soldering of several external circuit wires.
- B** Permanent indelible marking of terminals by means of a transfer.
- C** Laminated plastic panel of the highest electrical grade.
- D** Firm clamping of the laminations by means of scientifically designed precision steel pressings with a large margin of strength.
- E** Fixing feet interlocking with the clamps so as to provide horizontal or vertical mounting.
- F** Bobbin with flanges of optimum shape for the protection of windings and location of the outleads.

The above illustrates mounting style D.N. which can be employed on all transformers wound to special order.

It should be noted that accurate fixing centres and overall dimensions are ensured by close manufacturing tolerances.

Telephone:  Abbey 2244

**PARTRIDGE
TRANSFORMERS LTD**

76-8, PETTY FRANCE, LONDON, S.W.1

1947 radios in sealed cartons with maker's guarantee; 4 valve, ac/dc mains, med.-long waves, colours in black, brown, blue, green or red, with white accessories; £12/12, including tax; perfect tone, volume, and very selective.—The Radio Service, 5, Penn Rd., Wolverhampton. (6819)

BRIERLEY “Ribbon” and “Armature” pick-ups. Please write your name and address in block letters and include 5d. for booklet containing illustrations, responsive curves, technical details, delivery and prices. These booklets explain aspects of pick-up design, developments, including the “floating element” design leading to the use of ¼ and ½ oz downward pressures; the importance of adequate and constant point pressure and its practical achievement; correct point shape; the relation of pick-up weight, point pressure and vertical motion, etc., etc.—J. H. Brierley, Ltd., 46, Tithebarn St., Liverpool, 2. (570)

RECEIVERS, AMPLIFIERS—SECOND-HAND R.C.A. AR88 14-valve receiver, perfect condition; £55—Box 5738. (6820)

CR100 receiver wanted for spare parts.—Particulars and price to Box 5584.

£5—Brierley qual. tuning unit, M. & L., a.s. new.—Belmont, Belgrave Rd., Torquay

1155 Receiver, new, perfect; what offers? —367, Stradbroke Grove, Ilford.

HAMMARLUND Comet Pro, Xial gate. £30.—Scott, Millhaven, Queensway, Redcliffe Bay, Somerset. (6844)

COMMUNICATIONS receiver 7v superhet, C brand new, £20.—Burgess, 119, Wembley Pk. Drive, Wembley. (6672)

AMPLIFIERS & spkr., high qual., metrs., misc. apparatus; £18/10.—12, Palatine Rd., Cleveleys, Blackpool. (6675)

A.C.S. RADIO, 44, Widmore Rd., Bromley, Kent, offer small selection com. sets, radio receivers and amplifiers; list free.

PETO-SCOTT Trophyd 8 communication recr., 6w panels, 43 megs to 550 kc/s; best offer secures.—127, Kennington Park Rd., S.E.11. (6741)

EDDYSTONE All World Eight 8-valve superhet, fully tropicalised, recently overhauled, electrical performance as new; £25.—Stainforth, Box 5587. (6731)

AR-88 communications receiver, brand new, in case, complete with R.C.A. speaker; what offers?—A. Maurice, 221, Goldhawk Rd., London, W.12, Tel. She. 5126. (6678)

HR.O. Senior, 4 coils, 1.7 to 30 mc/w with bandspread, £55; H.R.O. extended range coils, 2 m/c to 50 k/c, £12/10; D.B.20, £15; all perfect; GSKM.—H. H. Eyre, 32, Locke Ave., Barnsley. (6814)

HALLICRAFTER Sky Traveller 829 portable receiver, 0.5 to 30 mc/cycles, mains or battery operation, telephony and BFO, hardly used; offer or exchange radiogram.—Box 5631. (6753)

DYNATRON T1014 tuner, in cabinet, complete with Monitor loud speaker, Volt corner horn with 20watt unit, ac gram. motor and pick-up in separate cabinet, the lot £120 or best offer.—Cross Key Hotel, Barnsley

HALLICRAFTER SX-16, Grey DB-20, W.W. Quality amplifier, H.M.V. Hypersensitive and Telefunken 1001 pick-ups, fitted Garrard induction motor, Rola 11in speaker in baffle-box; Taylor 65a signal generator, Avo 7; offers (Dorset).—Box 5580. (6718)

R.1155 R.A.F. receivers as described in *Wireless World*, July, excellent condition, £15; can be supplied modified for civilian use, receivers already purchased expertly modified to your requirements, and amplifier/power packs supplied.—R.T.S., Ltd., 8, Gladstone Rd., Wimbledon, S.W.19. Tel. Lib. 3303 (5659)

OUTSTANDING receiver, McMurdo Silver, 1940 model 15-17, 6 wavranges (including television sound), 16 valves, all controls, 200-250 ac, chromed chassis, beautiful table cabinet, separate speaker, connections for additional spkr. and for gram., perfect cond.; buyer collects Chelmsford; offers over £35; exceptional opportunity.—Box 5577. (6711)

READER purchasing new R.G.D. radiogram has for disposal a Murphy A78C console, 10 valves, bandspread short-wave tuning, alphabetical scale, 15 watts, push-pull output, twin speakers, variable selectivity, television sound, armchair control, handsome cabinet, 36in x 29in x 14in, rosewood and thuya burr, new condition throughout; £80.—Box 5737. (6818)

FOR sale, 15 valve Stromberg Carlson super radio receiver, large console cabinet, in excellent condition, size—height 43in, width 29in, depth 15in, 15-20 watts output from two 6E6's in push-pull feeding Auditorium loudspeaker and acoustical labyrinth, 5 wavebands; a real bargain for the connoisseur; cost approximately £120 in 1939.—Best offers to A. J. Harvey, Raleigh House, Newbiggin, Hornsea, E. Yorks. (6850)

PITMAN BOOKS

THERMIONIC VALVES IN MODERN RADIO RECEIVERS

By ALFRED T. WITTS, A.M.I.E.E.

Here is the special handbook on Thermionic Valves for all engaged in commercial radio work. Every aspect of modern theory and practice in the application of thermionic valves to radio receivers is fully and clearly explained. Second Edition. 10s. 6d. net.

THE SUPERHETERODYNE RECEIVER

By ALFRED T. WITTS, A.M.I.E.E.

An outstanding book giving expert practical information on construction and maintenance. Now in its sixth edition, it should be studied by everyone interested in up-to-date receiver design and construction. 6s. net.

PITMAN

Parker Street, Kingsway, London, W.C.2

YOU can become a first-class RADIO ENGINEER

We are specialists in Home-Study Tuition in Radio, Television and Mathematics. Post coupon now for free booklet and learn how you can qualify for well-paid employment or profitable spare-time work.

T. & C. RADIO COLLEGE

North Road, Parkstone, Dorset

(Post in unsealed envelope, 1d. stamp)

Please send me free details of your Home-Study Mathematics and Radio courses.

NAME

ADDRESS

W.V. 50

EDDYSTONE 504 communications receiver complete speaker, used once, £63; Garrard autochanger, complete crystal pick-up, sapphire needle, first-class condition, £20.—Box 5668.
10WATT amplifiers, 5 valve (inc. rect.), complete chassis, Goodman's T2/1205/15 12in speaker, external power supply for receiver, new quality apparatus; £20; quotations given for supplies of components, any quantity, at competitive prices.—Box 5593.

TEST EQUIPMENT

WEE Megger, 500Volts, as new; £6; approval.—Box 5586. [6729]

WESTON analyzer, complete valve adaptors and case; £14.—Box 5670. [6786]

UNIVERSAL Avomitor, £6.—Dawson, 101, Harwood Rd., Rishton, Blackburn.

AVO all-wave osc., unused, £13/10; R.K. spkr., 2,000 ohms, 65%.—14, Valance Av., E.4. [6676]

TAYLOR 65B signal generator and 45A valve tester, new, surplus, Weston F665; £40 lot, will separate.—Box 5707. [6799]

R.C.A. Volt. Ohmyst Junior (electronic meter), A.C. D.C. 0-3-1,000v. 0-1,000Ω, new, with spare tubes; £22.—Box 5706. [6797]

WESTON analyzer, new, 20,000 o.p.v., £20; R.C.A. Junior VoltOhmyst, electronic voltohmmeter, new, £20.—Box 5629.

OSCILLOGRAPH linear time base, 20-10,000 cyc/sec, single-stage amplifier, ×70, £14/10.—Goom, 55, Ashley Rd., Parkstone, Dorset. [6781]

LABGEAR electronic fault tracer, sig-gen, sig. tracer, insulation test. C.R. bridge, new and unused £30 or near offer.—Astra Radio, Electra House, Haslemere, Surrey.

FOR sale, Philips single beam oscilloscope, 2 1/2in tube, internal T.B. and Y amplifier; £30.—Call evenings or s.a.e. Woodhouse, 332, Ivydale Rd., Nunhead, London, S.E.15.

FOR sale, Avometer No 7, perfect, £13; universal Avomitor, £5; communications receiver, 14 to 1,500 metres a.c. and 6volt d.c. packs, £15; 9in Magnavox mains, 50/-.—Write 30, Stanhope Rd., Sidcup. [6733]

WAVEMETERS, ex-Govt., class D No. 1 Mark II ranges 1,900-4,000 kc/s, 4,000-8,000 kc/s, check frequencies at intervals of 1 mc up to 25 mc/s, oscillator crystal check, battery operated, supplied with spare vibrator, spare valve, and instruction book, brand new; £6/15, carriage paid; send for fully descriptive leaflet; also a few only less spares at 85/- (carriage 3/-).—U.E.I. Corp'n., 32, St. Gabriel's Rd., London, N.W.2. [5910]

ALL-WAVE signal generator, non-drift coil turret (pat. pending), 400 cps. anode modulation, cathode stabilised oscillator, scale calibrated 30 mc/s-100kc/s, 10-3,000m, ruggedly constructed for use in vertical or horizontal position, self-contained handle, integral storage for mains and output leads; 10 1/2gns; orders in rotation.—R.R. Development Laboratories, Ltd., 26, Hawes Rd., Bradford. [5929]

1,000 kc oscillators, complete with precision 1,000 kc crystal, only require valve inserting, connecting to filament supply and 90 volts H.T. for perfect 1,000 kc signal generator, 17 1/2 complete (less valve); genuine 6F5 valves, sealed boxes, 4/6; s.a.e.—Welsby, Colnar Drive, Sheffield. [6684]

TEST EQUIPMENT WANTED

METERS, 0-5 ma. moving coil, 2 1/2in flush mounting, bakelite cases, brand new; 22/6 each, post paid.—J. W. Forrest, 292, Accrington Rd., Intack, Blackburn, Lancs.

NEW LOUSPEAKERS

HIGH quality, precision-built speakers, Ticonal magnets, detachable diaphragms, die-cast chassis, twin cone.—Broadcast & Acoustic Equipment Co., Ltd., Broadcast House, Tombland, Norwich 26970. [6435]

£5 /18/6.—New Baker Super Quality 12in Auditorium permanent magnet speaker with triple cone, manufactured by Bakers Selhurst Radio, the pioneer manufacturers of moving coil speakers since 1925, wide frequency range, even response, ideal for quality reproduction, fitted with magnet, having exceptionally high flux density in the air gap suitable for public address equipment when quality reproduction is first consideration; send 2 1/2d. stamp for leaflet giving details of above and constructional details of a new acoustic chamber designed to extend loud speaker frequency range.

£8/19/6.—New Baker super power cinema permanent magnet speaker with 18in triple cone of new design, giving wide frequency response free from objectionable resonances; speech is clear and natural and music is reproduced with exceptional realism; fine engineering job, extremely sensitive; ideal for public address equipment when power handling capacity, plus realistic reproduction, is required, prompt delivery per pass. train.—Bakers Selhurst Radio, 75, Sussex Rd., S. Croydon (Croydon 42261).

HENRY'S RADIO

Offer the following Outstanding Lines

MIDGET H.F. UNIT.

Comprising 185, 1T4 Valves, 4 pole, 3 way switch-Twin Volume Control, 500 mfd., 15 v. wkg. O/Trans and 20 Midget Resistors and Condensers. 25/- New and unused.

MIDGET I.F. UNIT IN ALUMINIUM CAN.

Comprising 465 K/C's Midget I.F. Iron-Cored Transformers, 1T4 Valve and 8 Midget Resistors and Condensers. 15/- New and Unused. Also B.F.O. Unit with 185 Valve. Iron-Cored Osc. Resistor and Condenser. 12/6.

5in. P.M. Speaker, less Trans. 10/-

6in. P.M. Speaker, with Trans. 27/6

Pico-Facts 20 mfd. 12 v. wkg. 2/8

6 Volt Car Radio Transformers, 15/-

5 m/a. Meter Rectifiers, 7/6

W6 and W26 Westectors, 4/-

6 and 12 Volt Vibrators, 4 Pin, 9/6

Telescopic section aerial with screened leads, 25/-

Headphones, with plug, 100 ohms, 7/6

M. & L. Wave Coils, with reaction, 8/6 pr. Complete with circuit.

I.F. Trans., 465 small can, 15/- pr.

Midget Choke and S.F. Trans. 40 m/a., 5/- ea.

Standard Chokes, and 84 Trans. 60 m/a., 6/6 ea.

Colvern W V Vol. Controls, sizes 50 ohms to 50,000 ohms, 5/-

2 Pole 6 way min. switches, 2/6

Line-Cord, 0.3 three way 60 ohms, 1/- per foot

Lido holders Pax, 9d., 10ythers, 2/-

/R Tube Holders, 12 pin, 2/-

Cash with order for C.O.D.

Send stamp for 1947 Price List

Wholesale and Retail

5 HARROW ROAD, W.2

PFDdington 2194

COULPHONE RADIO

The Return of Post Mail Order Service

Proprietor C. COULBORN G3AJM

Coils. TRF. 9/6 pr. 8/Het. 11/6 pr. "P" type 2/9

Output Transformers. Standard Univ. P/P 6/6

Unbeatable range of British and American Valves.

Loud Speakers. 5" PM 20/6. 8" PM W T 29/6

Prices—lowest for "SOUND" goods.

H.T. Metal Rectifiers, 325v. 65mA. 6/6.

Over 20,000 satisfied clients.

New goods only.

Everything previously advertised still available

Resistors, 1w. 6d. 1w. 9d. Droppers 3 a., 4/6; 2 a., 4/3.

Amplifiers. Moreton Cheyney Super, 10 watt £22.10.0

Drives with scales. 2w.B. 11/6. 3w.B. 12/6

I.F. Transf. 465, Iron Cored, 15/0 pr. Midget 18/9.

Offers full range Mains Transformers from 300v. 60mA., 19/6, to 450v. 200mA., 42/6, with 4 or 6.3v. and 5v. L.T.S.

Send 2 1/2d. stamp for 18-page Catalogue

Note New Address:

58, DERBY STREET, ORMSKIRK, LANCs.

BAKER'S.—New 7-valve "Wireless World" Quality amplifier with tone control stage, 8 watts push-pull triode output, price includes super Quality triple cone 12in permanent magnet speaker, with large output transformer and all valves; also as above but with 15 watts tetrode output, ideal for realistic reproduction for public address; 2½d. stamp for parties., prices, etc.—Bakers Selhurst Radio, 75, Sussex Rd., S. Croydon, Croydon 4226.

LOUDSPEAKERS, SECOND-HAND
VOICET corner horn, in figured walnut, with special Ferranti M1+; £45.—3rd Floor, 120, Drury Lane, W.C.2. [6737]

VOICET unit decorative corner horn, field supply, hypersensitive P.U., electric turntable; offers.—Box 5192. [6681]

SPECIAL offer; 3½in Goodman's P.M. loudspeakers, 25/-; Multiratio output transformers, 5/-—Radio Electrical Services, 266, Church Rd., London, E.17. Lewtonstone 6068.

GOODMAN'S 12in twin cone hi-fi auditorium P.M. speaker (perfect), and handsome polished blockboard, 60in x 48in x 1½in baffle mounted on stand; £21.—A. A. Henson, 28, Signhills Av., Cleethorpes. [6737]

SALE, Goodman's Auditorium spkr., 12 in, twin cone, 15ohm, £8; Lexington De Luxe M.C. pick up matching trans. (Mu-metal case), two sapphires, £7; Dixoncote with 8 shunts, £2/10.—Higgins, 27, Avon Rd., Worcester. [6800]

HARTLEY TURNER (original), perfect condition, with rectr., £5/10; H.T.P.P.O.P. transformer and whistle filter for above, 25/- each; sound Sales P.M. Auditorium, practically new, £5/10.—Blake, Mere Heath House, Davenham, Northwich. [6845]

VALVES
18S's 1.4v diode pentodes, new; 15/-—Everett, B. Ditchling Rd., Brighton. [6813]

QUANTITY P.P. 50 valves, new; maker's list price and p.t.—Box 5736. [6817]

FOR disposal, 3A4, 6AG5, 307A, 804, 805.—Offers to 24, Melmore Gdns., Cirencester. [6817]

U.S. trans. valves 813s (250w), 807, 866, many U.S. receiver types; best offers secure.—Box 5516. [6695]

DYNAMOS, MOTORS, ETC.
ROTARY converter, Crypto filter, cabinet, dc 220v, ac 230v, 180w reced., 1 offers.—Siggers, London Rd., Bracknell, Berks. [6677]

ROTARY converter, G.E. Co., 230v D.C. 240v A.C., 250w complete silent cabinet, filters, starter, transformer, reconditioned; £20 or offer.—Box 5588. [6732]

M. Gen. Set, with 2 gens., motor, 110-220 ac, ½hp, 50cy, 1ph, 1,425 revs, rat. cont.; outputs 110 dc, ¼ amp, and 7.5-15 amps; offers.—Box 5632. [6754]

ROTARY converter, Guydon, 250v D.C. to 230v A.C., 150w, 50cy on standard rack-mounting chassis with remote control relay, etc, little used; £14.—Smith, 50, Manchester St., W.1. [6806]

ALL types of rotary converters, electric motors, battery chargers, petrol-electric generator sets, etc., in stock, new and second hand.—WARD, 37, White Post Lane, Hackney Wick, E.9. Tel. Amherst 1393. [4677]

BATTERY chargers for home and export, 4 models, 2-6-12v, 1, 2, or 4amp dc, any mains voltage; generous trade terms. Write for catalogue. Tel. Hoddesdon 2659.—The Banner Electric Co., Ltd., Hoddesdon, Herts.

GRAMPHONE AND SOUND EQUIPMENT
RECORDING.—Complete portable outfit, make 5in to 13in records; £78.—Box 5708.

NEW Meico m.c. microphone; £3/10.—Field, 130, Florence Rd., Parkstone, Dorset. [6778]

MARCONI Autochange unit, ac induction motor, pick-up and mounting board; £17.—Box 5669. [6785]

SCOTT automatic radiogram 20-valve superhet, ac model, push-pull, 15watt output, twin speakers, gram motor 60 cy.—Box 5745.

BELL and HOWELL/G.B. Hi16 projector, perfect condition, as new; £250.—Burgess, 119, Wembley Park Drive, Wembley.

A STATIC microphone type G, grip-to-talk A desk stand, as new; offers?—Write Latham, Little Hill, Much Hadham, Herts.

TECHNIFON, Ltd., direct discs recording equipment and accessories.—Details from 99, Belgrave Rd., S.W.1. Tel. Vic. 8814.

H.M.V. radiogram, walnut case, automatic change, bought 1937, good condition, just been overhauled, owner going abroad; £65.—Box 5190. [6676]

FOR sale, Lexington lightweight moving coil pick-up, with own preamplifier and two sapphires, cost £14, as new; best offer secures.—Box 5571. [6704]

L EXINGTON n/c senior pick-up, Sapphire transformer, screening box, perfect condition; £5/10.—35, Colebrooke Av., West Ealing, Middlesex. [6778]

COLEBROOK gram motor (heavy duty), A.C. with old-type Marconi pick-up; £7/10 or Baker's super power A.C. speaker, £7/10 or offer.—Box 5628. [6747]

ELECTRADIX OFFERS Something you want here?

TELEPHONES for House and Office.
CONSTRUCTORS PARTS FOR YOUR OWN SET UP!

- WALL TELEPHONE SETS.**
Bracket Mike, vertical or horizontal 10/-
Transformer and Condenser for same 5/-
Magneto Bell fitted 5/-
Switch hook and contacts 2/6
Walnut Cabinet 8" x 6" x 3" fitted terminals and connections 5/6
Two L.R. watch pattern earphones 10/-
Hand Magneto Ringer 10/-
SET As above 30/- or 50/- per pair.

G.P.O. CANDLSTICK MICROPHONES.
Latest armoured carbon inset in moulded bakelite case, on pedestal with Switch hook, 7/6, postage 1/-. Single receiver with loop, 5/-.

BUZZERS, Cambridge Townsend. The highest note and smallest buzzer made, platinum contacts, 10/-. Keep up your Morse speeds with one of our small practice outfits; Buzzer, Key and single Phone, 15/- the set. Buzzer only, 3/6. High note tunable buzzer, 7/6. Test buzzer, robust construction, double contact blades for distant signals or converting for vibrators, 7/6.

HEADPHONES, Single low resistance phone for circuit testing or house telephone, 60 ohms, bakelite case and cap, best British make, with headband and cord, 8/6.

High resistance double headphones, as new, with headband and cord, type S.G.B. light weight, sensitive to crystal, 22/6, delivery from stock.

VIBRATORS and Transformer. Mallory 12 volt, 60 ma. New, in metal can, 15/-. Special transformer, 37/6. Transformers for small welding jobs or soil heating, 230 volts 50 cy. to 12 volts 250/300 wats, totally enclosed, 37/6. Transformers double wound for Model work, 230/12v. 3 amps, 32/6, 20 volts 2 amps, 30/-.

RELAYS. G.P.O. 1,000 ohms 2-S.P.C.O., 5/-, 500-1,000 ohms, 2-make, 5/-. 30 ohms 2-make 2-break, 5/-. Telephone type 2-coil polarised S.P.C.O., 32S ohms 5/-. Siemens high-speed keying relays, two 500 ohm coils, 7/6 each. Siemens slugged 200 ohms 1-break S.P.C.O., 5/-. We have a large stock of Relays for immediate delivery; send us your enquiries.

SWITCHES. Dewar key panel type 8-pole C.O. flush fitting, 5/-. Yaxley 3-pole 3-way 3/6; 8-pole 1-way, 3/6. D.P.C.O. Toggle switch 250v, 1 amp, flush panel, 3/3. 8-way Lucas switch box, 3/6; 6-way, 3/-.

SMALL MOTORS for model work, 3-8 volts, work off battery or transformer, 17/6 each.

FANS. D.C. Table Fans, 110 volts, 12" blade and guard, 45/-. Oscillating type, 55/-. Few 220 volt D.C., 12", 55/- each. Fan Motors only, bulkhead type 110/220 volts, 35/- each.

AUTO-TRANSFORMERS. New, 230/110v 85 wats, 25/-, 150 wats, 35/-. 300 wats, 60/-, 1KW, £7 10s. 3KW (second-hand), £9 10s.

G.P.O. Connection strips of solder tags, telephone type moulded mounting 60-watt, 3/6 each.

MAGNETS. D.C. Electric magnets, weight 10oz., lift on 2 volts, 1½lb., 4 volts 3lb., 6 volts 4lb., new surplus, 7/6 each. Permanent powerful flat bar magnets, 2½" x 1" x ½", drilled 2 holes each end, for any pole pieces, 2/- pair. AC/DC mains magnets, 2-pole 220 volts, 7/6 each. The wonder midget Magnet, alni perm. steel disc, weight only ½oz., ½in. dia., ½in. thick, with 3/16in. centre hole, 3/6 each. Large selection of horseshoe Magnets in stock. Send for leaflet "W."

PARCELS. 7lbs. useful odds from the junk box. All clean and dismantled from Government and other surplus apparatus. 7/6, post free.

BATTERY CHARGERS, DYNAMOS, ROTARY CONVERTERS, SWITCHBOARDS, TRANSFORMERS, LAB GEAR, ETC., ETC. SPACE DOES NOT PERMIT US TO LIST THE NUMEROUS LINES WE CAN OFFER. SEND US YOUR ENQUIRIES.

ELECTRADIX RADIOS
214, QUEENSTOWN ROAD, LONDON, S.W.

Telephone: MACaulay 2159

VOICET patent horn, serial 129, without speaker unit, excellent condition; £22/10.—Dunn, Cranmore Cott., W. Horsley, Surrey.

SPECIAL Phico all-wave ac twin speaker. Autochanger radiogram, very fine walnut cabinet indeed, 46in high, completely overhauled, new appearance; record storage space; £100.—Box 5735. [6816]

COILS for "W.W." tone control and filter circuits (Brierley & Hartley spec.), high fidelity, mic. line and output transformers; s.a.e. full list.—R. Clark, 30, Langland Cres., Stanmore, Middx. Wor. 5321. [6403]

INFINITE Baffle corner deflectors, scientifically designed acoustic chambers as reviewed "Wireless World," June; send for catalogue.—Broadcast & Acoustic Equipment Co., Ltd., Broadcast House, Tombland, Norwich 26970. [6434]

PICK-UP coil service replacement kit; six assorted coils covering most types in common use and one 10/1 midget step-up trans for needle armature types; 27/6 nett; individual coils, 4/6 each.—Radio Services, Field St., Works, Blackpool. [6787]

EXPERT non-metallic needles.—We have twenty-five years' experience in the selection, grading and special treating of Thorn needles; for use in pick-ups, type A thick, type B thin, 3/- per 10, including purchase tax; sharpener, 7/4; guaranteed harmless to the record.

EXPERT GRAMOPHONE & RADIO, Ltd., Ingerthorpe, Great North Rd., London, N.2.

PROFESSIONAL recording equipment, M88. Recording machine, 20watt amplifier, complete, £100, new, from stock; blank discs, etc.; full range Sound Sales equipment available; Garrard transcription motors and playing desks.—Liverpool Sound Studios, 83a, Bold St., Liverpool. [5348]

VALRADIO moving coil pick-up, response 25-12,000cs, £6/10, plus £1/10/6 P.T.; high gain quality amplifier, 2 PX4s in push-pull, 2 inputs, 2 output impedances, £18; sapphire needles for Valradio pick-up, 15/-; for standard pick-ups, 12/6.—Valradio, 57, Fortess Rd., London, N.W.5. [6397]

BRITISH Sound Recording Association covers all interests of the professional and amateur recording engineer and quality reproduction enthusiast.—Details of information bureau, meetings, publications and membership application form from Hon. Secretary, BCM/BSRA, London, W.C.1.

TELEVOX playing desks, incorporating high quality interference-free totally enclosed induction motor, 12in turntable, auto-stop, superior magnetic pick-up, speed regulator, mounted on strong metal chassis; 8½gms includes tax, cash with order.—Available in limited quantities from Telex Sound Service, 37 Albert Rd., Southsea, Hants. Tel. Portsmouth 73348. [6793]

CHARLES AMPLIFIERS welcome lovers of recorded music to their new premises where their high fidelity amplifiers can be heard together with Lexington Connoisseur and Rohermel pick-ups and B and A.E.C. Vitavox, and Wharfedale speakers, B and A.E.C. acoustic chambers, infinite corner baffle deflectors, etc.; we like you to bring your own familiar records for comparison; this is a service devoted entirely to the high fidelity reproduction of music; one minute from the Albert Hall and Kensington High St. Station; buses 73, 49, stop at the door.—Charles Amplifiers, 1e, Palace Gate, Kensington, London, W.8. [6642]

MORSE EQUIPMENT
individual tuition; keys, audio oscillators for both batt. or main operation.—Webb's Radio, 14, Soho St., W.1. Ger. 2089. [2291]

TRANSMITTING EQUIPMENT
HARTLEY, 10w phone/ICW/CW transmitter, complete valves, power pack, mike, new condition; £20.—Teal, Old George Hotel, Stoney Stratford. [6701]

FOR sale, Marconi medium frequency apparatus, comprising one combined transmitter (type T.P.8) and receiver (type R.P.42/1), complete with valves, control panel, speaker and microphone, separate power unit for 230v ac; transmitter two-position, crystal controlled, using two 807 valves; receiver has pre set tuning; two other similar receivers for use with above, one for 12v operation and one for 230v ac supply.—Offers to Chief Constable, East Suffolk Police, County Hall, Ipswich

COMPONENTS—SECOND-HAND, SURPLUS
MINISTRY of Supply.—Government surplus stores.

FOR immediate disposal, a quantity of mine detectors and amplifiers for detecting hidden metals; British, Polish and American types Nos. 3, 625 and No. 4A amplifiers.—For further details, forms of tender and permit to inspect, application should be made to Ministry of Supply, Room 602, Great Westminster House, Horseferry Rd., London, S.W.1. [6714]

LASKY'S RADIO

P.M. LOUD SPEAKERS, 3 ohms, less trans. 2/10. 27"-; 3 1/2". 29/8; 5in., 21-; 6in., 23/6; 8in., 21-; 10in., 29/6.

MIDGET OUTPUT TRANS. Power and pentode. 4/9 each. 3/2.

MULTI RATIO OUTPUT TRANS. 6/9 each. 3/2.

HEAVY DUTY OUTPUT TRANS. 10/8 each. 15/2.

WEARITE MIDGET I.F. TRANS. 465 kc/s. 10/8 each.

WEARITE I.F. TRANS. 450 kc/s. 10/- each.

I.F. TRANS. 465 kc/s. air-spaced trimmers. 7/6 each; 14/- pair.

WEARITE "P" COILS. Most types. 3/- each.

MEDIUM AND LONG WAVE COILS. with reaction A.E. and H.F., with circuit. 8/6 per pair.

LONG, MEDIUM AND SHORT WAVE COILS. A.E. and osc. Best quality, complete with circuit. 10/6 per pair.

B.F.O. UNITS IN METAL CASE. Size 4 1/2in. x 2 1/2in. x 1 1/2in., consisting of: One Midget valve, 185; Midget Ceramic Valveholder; Midget B.F.O. coils; resistances; condensers; group boards. Price: 12/6 each. **LIMITED QUANTITY.**

L.F. SMOOTHING CHOKES.
Midget type, 60 m.a., 300Ω. 4/11 each (8C1).
Standard type, 75 m.a., 460Ω. 6/9 each (8C2).
Heavy Duty, 100 m.a., 240Ω. 10/8 each (8C3).
Heavy Duty, 70 m.a., 2,000Ω. 11/6 each (8C5).

AVO TEST GEAR. Immediate delivery.

D.C. MINOR TEST METER. 24 4s. Od.

A.C. D.C. MINOR TEST METER. 48 10s. Od.

MODEL 40 TEST METER. 17/17s. Od.

MODEL 7 TEST METER. 19/10s. Od.

THE AVO ALL-WAVE OSCILLATOR. 13/3s. Od.

MARCON TWIN TWISTED FLEX. Cotton covered. 14/30 Finest quality. 40/- per 100yd. drum.

6,000 RADIO VALVES OF ALL TYPES, ENGLISH AND U.S. METAL GLASS, MIDGET, BANTAM, etc. SEND US YOUR REQUIREMENTS.

We have space for only a few items from our extensive stocks. Send id. for our current List and Bulletin. Terms: Cash with order, pro forma and C.O.D. (No C.O.D. under £1 Os. Od.). Orders over £5 Os. Od. post free. It will pay you to pay us a visit. All goods covered by our unconditional guarantee.

LASKY'S RADIO

370, Harrow Road, Paddington, W.9
(Opp. Paddington Hospital.)
Telephone: Cunningham 1777



Designed by engineers for engineers, the Solon Electric Soldering Iron gives neater, cleaner, more efficient work in less time. The heating element is right inside the bit, giving constant heat at the point — where you want it. All internal connections housed at end of handle — away from heat and easy to get at. Complete with 6ft. of Henley 3-core flexible. Made for the following standard voltages: —200/220. 230 250.

Made in England



W. T. HENLEY'S TELEGRAPH WORKS CO. LTD.
61/63, HATTON GARDEN, LONDON, E.C.1.

SOUTHERN RADIO'S wireless bargains

LATEST radio publications.
"RADIO Valve Manual," equivalent and alternative American and British types with all data, 3/6; "Radio Circuits," fully illustrated receivers, power packs, etc., 2/-; "Amplifiers," fully descriptive circuits, 2/-; "Radio Grid and Transformer Manual," 2/-; "Short-Wave Handbook," 2/-; "Manual of Direct Disc Recording," 2/-; "Test Gear Construction Manual," 1/6; "Radio Pocket Book," formulae, tables, colour code, etc., 1/-; "Ten Hows for Radio Constructors," 1/-; "Radio Reference Handbook," cloth bound, comprehensive and up-to-date, covering all branches of radio, 12/6; "American Service Manuals," Sparton-Emerson, Crosley-Belmont (Parts 1 & 2), Stewart-Warner-Fada, Emerson, 12/6 per volume; "Radio Resistor Chart," colour codes at a flick, 1/- each; "Bulgin Radio Service Manual," 2/6; "Radio Constructor's Manual," 3/-; postage extra.

VAXLEY type 11-way rotary switches, 5/-; tubular condensers, 0.1+0.1+0.1 (cans), 2/6; resistances, brand new wire-ended, 1/4, 1/2 and 1 watt, assorted values, 30/- per 100; 1/4-watt only, assorted values, 20/- per 100; 1/2-watt, 22/6 per 100.

ACE "P.O." microphones, complete with transformer, usable with any receiver, 7/6; permanent crystal detector, 2/6; insulated push back wire, 25 yards, 5/-; insulated sleeving, assorted sizes and colours, 3/6 per doz yard lengths; single screened wire, 7/6 per doz yards; twin screened, 15/- per doz yards; aluminium panels, undrilled 16 gauge, 18in x 7in, 3/6; 18in x 9in, 4/6; ceramic and paxoline postage stamp trimmers, 30pf, single, 1/3 ea, double bakp 2/-; Cutler Harmer power rheostats, 30ohms, 4/6; power rheostats, 10ohms, 4/6.

LUFBRA adjustable hole cutter, use on metal, wood and plastics, etc, 5/- ea, including postage; a large assortment of ex-Government material in stock.

R.A.F. 1155 receivers available from stock, these have been pre-tested and guaranteed, complete with plug, £15/15 (carriage and packing 7/6 extra); spare 1155 plugs, 8/6 ea.

SOUTHERN RADIO SUPPLY Co. 46, Lisle St., London, W.C. Gerrard 6653. [6411

SCOTLAND'S largest stockists.—Anything radio we have it.

EDDYSTONE—agents—Raymart.

SEND for parts and kits list.

BUCLEUCH RADIO MANUFACTURERS, Melville Terr., Edinburgh, Tel. Edinburgh 42803. Grams, Thern, Edin. [5139

RADIOGRAPHIC, Ltd., 66, Osborne St., Glasgow, C.1.

TRANSMITTING valves. — 100TH, 46/5; T200, £9 9; RK20A, 44/14/6; 866/866A, 27/6; 35T, 45/-; RK25, £2, etc., etc.; all U.S.A. types; also Mullard and Standard TX valves, R-1155, with power plug and modification details, £15/15; rotary transformers, £2, 35/-, 27/6; Class D wavemeters, £6; control units, 15/-; flexible couplers, 2/6; valve screens, 2/-.

TRANSMITTING valves a speciality; write for lists, s.a.e.

RADIOGRAPHIC, Ltd., 66, Osborne St., Glasgow, C.1. [6710

G. W. SMITH & Co. (RADIO), Ltd., offers the following:—

WESTON .4in 0-250 microamp meters, 57/6; Weston 2in 0-20 volt, 12/6; S.T.C. 0-2 amp, 15/-; selector relays, 4 bank, 25 contact, 37.5 ohms, 22/6; IF coils, 100 kc/s, ironed core, 5/6 each; wire-wound resistors, 1 watt, 100, 5,000, 7,000, 35,000 ohms, 6d each; wire-wound, 5 watt, 100, 150, 200, 250, 400, 500, 800, 50 ohms, 1/6 each; transformers, 230 input, 350-0-350, 90 ma, 5v 2a, 6.3v 4 amp, 3 times, 35/- each; 200-250 input, 540v, 4v, 6.3v, 22/6 each; 7/22 heavy duty hard twin rubber cable, 60/- per 100 yards; Sec. self-starting electric clock movements, 1min per rev, 32/6; Tannoy hand microphones, multi-cell service type, with switch in handle, 7/6 each; sil mica con., 500, 440 100, 80, 50, 40, 25, 15 P.F., 4d each, 3/- per doz; chassis, 10 1/2 x 6 x 3, 2/- each; 2mfd 250 volt, 1/6; 2mfd 400 volt, 1/9; 0.1, 1,000v, 0.25, 2,500v, 3/6 each; 0.25, 3,000v, 0.1, 3,000v, 4/- each; 0.25, 8,000v, 7/6; 0.1, 10,000v, 0.02, 10,000v, 10/- each; sieving, 1mm, 2d per yard; Westinghouse Meter rectifiers, 5ma, 7/6 each; air-spaced IF trimming condensers, 2/- each; screening cans, 3x2 1/2 x 2 1/2, 1/3 each; short reach jack plugs, 1/6 each; single headphones, low resistance, 3/- each; 1:1 intervalve transformers, 2/- each; mica discs, various sizes, very useful for condenser and insulating purposes, 2/-; 250 mixed sizes; post paid.

G. W. SMITH & Co. (RADIO), Ltd., 2, Ceell Rd., Southgate, London, N.14. Ent. 5463.

SURPLUS of all types new radio components for sale; great opportunity.—Box 3521.

AMERICAN MAGAZINES

We have pleasure in informing readers of The Wireless World that we are authorised to accept subscriptions for the following well known American Magazines.

POPULAR MECHANICS

A complete science survey. There have been 300 pages, nearly 500 illustrations and more than 150 articles in each of the recent issues.

12 Monthly Issues 17/6 post paid

RADIO MAINTENANCE

A publication the radio serviceman cannot afford to be without. Regular articles dealing with alignment, fault finding, P.A. Systems, F.M., Test equipment, etc. etc.

12 Monthly Issues 17/6 post paid

RADIO AMATEUR CALL BOOK

A quarterly magazine containing call signs and addresses of over 100,000 amateur transmitters. (See page 26 of January 1947 Wireless World.)

4 Quarterly Issues 30/- Post Paid

(Single copies 8/9 Post Paid.)

All magazines are posted to you direct from the U.S.A. so as to avoid delay.

Subscriptions to:—

DALE ELECTRONICS LTD

105 Bolsover Street, London, W.1
Telephone: MUSeum 1023

R.R.

DEVELOPMENT LABORATORIES LTD.

CONSULTING ENGINEERS

OFFER THE FOLLOWING:

TRANSFORMERS TO YOUR SPECIFICATION.

DELIVERY 7 DAYS.

ALL WAVE SIGNAL GENERATOR.

DELIVERY AFTER COMPLETION OF PRESENT ORDERS.

DECKS AND CASES TO YOUR REQUIREMENTS.

R.R.

DEVELOPMENT LABORATORIES LTD.

BARNARD ROAD, BRADFORD

VIBRATORS, 12v 40m, cheap for quantity; also speakers.—Box 5765. [6847]
CHARLES BRITAIN RADIO.—A few selected lines from our latest list.
TRF coils, with reaction, medium, long wave, with diagram, 8/6 pr; superbet coils, all-wave, Ae. and Osc. with diagram, 10/6 pr; i.f. transformers, 465 kc, 12/6 pr; 2-gang condensers, 0.0005, less feet and trims, 9/- ea.
SPECIAL offers.—Moving coil mikes, undamaged, with metal grille, 5/- ea. damaged 1/6 ea; parcel of 36 assorted tubular condensers from 0.0001 to 0.5 mfd, all new, 10/6; parcel of 72 new assorted resistors, 1, 1/2 and 1/4 watt, from 100 ohms to 1 meg, 12/6; special parcel of new and used goods, exceptional value, £1; money refunded if not satisfied.

SPECIAL purchase of brand new ex-Government miniature radio receivers, covering 4 wavebands 20 metres to 3,000 metres, for ac/dc or dry battery operation, supplied complete with ear phones, power pack, instructions and all accessories, £7 19/6; these receivers were used by the Resistance Movement, limited number only available. Please order c.o.d.

NUMEROUS other lines in stock, including amplifiers, pick-ups, etc.; callers always welcome; trade supplied; terms, cash with order or c.o.d. over £1; send for latest list "W."—Charles Britain (Radio), Ltd., Radio House, 2, Wilson St., London, E.C.2. Tel. Bis. 2966.

SUPREME RADIO, 746B, Romford Rd., Manor Park, London, E.12. Est. 15 yrs.

NEW lines for the service engineer: Small 2-gang condensers with fixing feet 9/6, 3-gang 13/-; 8mfd 500v cans 30/- doz., .05mfd 500v 3/9 doz., .1mfd 350v 3/6 doz., .5mfd 350v 11/- doz., .25mfd 350v 9/- doz., .2mfd 250v 2/6 doz., .01mfd 500v 3/9 doz.; resistances by well-known maker, 1 watt, 1,000Ω, 10,000Ω, 20,000Ω, 22,000Ω, 27,000Ω, 51,000Ω, 100,000Ω, 220,000Ω, 279,000Ω, 560,000Ω, 1meg, 1 1/2meg, 2.2meg, at 3/9 doz.; 5watt, 10,000Ω, 5/6 doz.; 1watt, 27,000Ω and 75,000Ω, 4/- doz.; assorted wirewound 1 and 2watt handy sizes, 2/6 doz; line droppers, .2 or .3 with fixing feet, 3/9; line cord, 60Ω-70Ω ft, 16/- doz yds; volume controls with sw 4/-, less sw 3/9; wirewound 10,000Ω, 1/6 sw. 5/-; all-wave Ivorine dials, 3 1/2x4in, 1/5; midjet chokes, 60ma 6/-, 100ma 10/-; midjet speaker transformer, 4/6; sleeving, assorted colours, 3/- doz yds; screen caps, 8/6 doz; International octal valveholders, 3/6 doz; special job lines: midjet volume controls, 10,000Ω and 250,000Ω, less switch, 9/- doz; earphones complete with headband, 50Ω, 4/- pair; moving coil earphone inserts, 30Ω, for midjet speaker, 2/6; Philips' knobs, 1in shank, 2/6 doz; carbon microphones, 2/- 6/5 non-B.V.A., 7/6.

S.A.E. all enquiries; terms, cash with order, no c.o.d.; send 6d extra for postage and packing, all orders under £5. [6843]

UNIVERSAL ELECTRONIC PRODUCTS (881 Q), 36, Marylebone High St., London, W.1. Tel. Wel. 4058.

SLOW motion drive units, precision built, 2 ratios, 4½ and 40-1, free from backlash, limited quantity only at 15/6, postage 6d; miniature metal rectifiers, 25v, 75ma, 2/6 ea, post 3d; send sae for full list of components, R1155.—We specialise in the conversion of this receiver into a really efficient communications set; write for details.

OUR works are available for the construction of radio and electronic equipment to specification, from an extension spindle to a complete 500-watt transmitter. [6773]

15 AMP double-pole mains fuse box and switch; 15/-, c.o.d.—A. C. Summers, Seaward Av., Barton-on-Sea, Hants. [6735]

DOUGLAS hand op. coil winder, with rev counter, perfect; also quantity enamel wire.—Helm, 10, Silver St., Bury, Lancs. [6720]

ROILA 8in p.m., 16/-; Celestion 10in p.m., £25/-; 10in n.e., 2.5 voice, 2,500Ω, 4/1, new, boxed.—Rodmell, 25, Ormonde Av., Hull.

LARGE A.R. components, including inductances, condensers, Xtal calibrator, absorption wavemeters, etc.; also a host of other useful items.

MAIL in your requirements or send stamp for complete list to R. S. Robinson, Radio Components, East St., Darlington, Co. Durham.

AVO model 7, Ferranti AF5, OPM6r (multi-ratio output); Rothenmel de Luxe p.u., all as new; offers.—36, Elm Park Av., Romford.

COUPLER RADIO. Please note new address: 58, Derby St., Ormskirk, Lancs.—All goods previously advertised still available. See display advt., page 42.

TUNING units with r.f. stage, model B3, completely aligned with station named scale, short, medium, long wave P type coils, iron cored i.f.t.s., £8/15; complete kit of parts with circuit, £6/12/6; 2 1/2 stamp 1947 catalogue. [6762]

ARMSTRONG

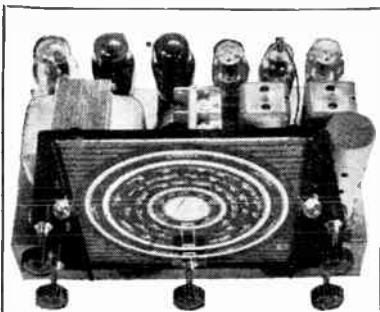

Model EXP83

As announced in November, we have developed an 8-valve Universal Chassis on the lines of our now popular EXP83. This was in response to many requests for a good quality receiver for use on either D.C. or A.C. mains. This new chassis is our

Model UNI-83

ALL-WAVE 8-VALVE SUPERHET CHASSIS

incorporating wave-band expansion, e.g. the 16-50 m. band covers just over 20 inches on the large glass scale, treble boost control, gram switching, all controls work on both radio and gram, high quality push-pull output giving 6 watts audio. For 200-250 v. D.C. or A.C. mains.

Provisional Price 14 gns. plus tax.

Model EXP83

ALL-WAVE 8-VALVE SUPERHET CHASSIS

incorporating wave band expansion. Large glass scale treble boost control. Gram, switching. High quality push-pull output gives 10 watts audio. For 100-250 v. A.C. mains.

Price 14 gns. plus tax

Model EXP53

ALL-WAVE 7-STAGE RADIOGRAM CHASSIS

This new radiogram chassis incorporates wave-band expansion on all bands. Volume and tone controls work on both Radio and Gram. 4½ watts R.C. coupled output. Supplied complete with full size loudspeaker. This chassis has a lively performance, good quality reproduction, and represents excellent value. For 200-250 v. A.C. mains.

Price, with speaker 13 gns. plus tax.

Model EXP43

ALL-WAVE SUPERHET FEEDER UNIT

incorporating wave band expansion manual I.F. gain control, etc.

Price 11 gns. plus tax.

● We very much regret that, owing to the continual rise in cost of materials, it may be necessary to increase the above prices slightly by the time this advertisement appears.

Demonstration Sets are now available for interested callers to hear and illustrated technical specifications are now ready.

ARMSTRONG WIRELESS & TELEVISION CO. LTD.
 WALTERS ROAD, HOLLOWAY, LONDON, N.7

Phone: NORth 3213

AMPLIFIER push-pull PX4s, first grade parts, £9; Wharfedale spkr. Goodmans Tweeter, well made solid cabinet, £25/5.—Heath, 2, Queen's Rd., Salisbury. [6783]

ALUMINIUM chassis, panels, cabinets, metalwork for the amateur by precision engineers; trade enquiries invited; s.a.e. lists.—G.L.G. Radio, Morchard Bishop, nr. Crediton. [6822]

CABLE, well insulated, 3 copper, 4 steel, suitable aerials, low tension wiring, 500ft lengths, 12/6; also headphones and hand microphones.—Hopkins, 63, Pembroke Place, Liverpool. [6808]

GARDEN aerial poles, ex-Government stock, ready for immediate erection, 20ft length (jointed) or 9ft and 11ft lengths; 12/- each complete.—Enquiries to Pikes Wharf Timber Co., Roiney 4048. [6756]

TELEVISION cabinet, Baird type, mirror in lid, splendid condition, offers; 300 W.W., few '30-31, also '32, '33 and '37-45, some missing; also 30 "Television," offers, in one lot.—Box 5590. [6740]

TELEVISION home constructors kit service is second to none; stamp will bring full details, including amplifiers, superhets and car radio.—Write now to Dept. W.W., Tele-radio Co., 157, Fore St., N.18. [6757]

GRAM, motors, pick-ups, speakers, mikes, rotary converters, meters, precision dials, transformers, large quantity unused components for sale at reasonable prices; enclose stamp with list of wants.—Box 5585. [6727]

100% tried and tested design for a 5v ac/dc med. and long-wave midjet superhet, 2 6 post free; all parts absolutely standard and easily obtainable; trade enquiries invited.—Frith Radiocraft, Ltd., Leicester.

CIRCUITS.—"Dorset" series, new battery superhet 4-valve all dry 3-wave; AC 5-valve 3-wave superhet; AC/DC 5-valve 3-wave superhet; AC/DC amplifier, 6-8 watts; AC/DC 4-valve t.r.f. medium wave with l.w. conversion.

MANUSCRIPTS containing 5 or 6 pages of drawings, point to point wiring instructions, etc., 5/- each, post free. Theoretical circuit of superhets with price list, 2/6d, each.

WELDONA Radio Accessories, Ltd., Swanage, New Boxed S.T.C. metal rects., makers rats.

List price: 12v O/P 1a 11/1, 1.5a 12/9, 2.5a 16/-, 4a 20/8, 5a 28/6, 8-10amp 34/2; can quote to 500v 4a, post 1/- over 2.5a; trade supplied.—Pearce, 66, Gt. Percy St., Angel, W.C.1. [6807]

VORTEXION transformers and chokes, etc., supplied to B.B.C., G.P.O., L.P.T.B.; why not you?; wound to any specification; imitated but unequalled.—Vortexion, Ltd., 257, 261, The Broadway, Wimbledon, S.W.19. Tel. Liberty 2814-6128. [4536]

B. & H. RADIO offer small quality amplifier at very competitive price, kit of parts or assembled, tested and guaranteed; particulars on application; usual range of reliable components; trade only, list available.—Huntley St., Darlington. [6780]

WODEN de luxe transformers in stock! DTM 11, 12, 13, 16, 17; DTF 12, 15, 16, 20; DCS 14, 16, 17; PCS 11, 12, 13; DT3, UM1; UM2; 6,000 and 10,000Ω 15w CT, OPT; all at list prices.—Frith Radiocraft, Ltd., 69-71, Church Gate, Leicester. [6166]

LONG and medium Midjet superhet, coils mounted with trimmers, padders and switch, etc., boxed with full circuit diagram and instructions; quote Type M1, 2/6; manufacturers' and dealers' enquiries invited.—Douglas Electronic Industries, Ltd., Brink low, Rugby. [6663]

OSMOR Radio Heart equals complete first class 5-valve superhet, positively only small condensers and resistances to find, super efficient components, building instructions; £5/16; cabinets; trade invited.—Morgan Osborne, Ltd., Southview Rd., Upper Warringham 2560, Surrey. [6226]

VOLUME—Matt has it.—Speakers, 5in, 15/6, 8in 1/1 22/6, all p.m.; Rothenmel crystal pick-ups, De Luxe £2/16/3 inc. P/Tax; condensers, 0.1, 0.01, 0.05mfd, 9/- per doz; line cord, 3-way 2/- per yd, 0.3amp 60ohms per ft.; shuttered sockets, flush 5amp 3-pin, 4/- each, volume controls, Centralab.

HEADPHONES, special offer, 5/6 per pair, 2 pairs in box, complete with lead and jack plug; various values, 1/s 2/6, w/s 3/6; largest stock of B.V.A. and U.S. valves in England; let us have your enquiries.

MATT'S RADIO SERVICE, 152, Richmond Rd., Kingston-on-Thames, Surrey. [6759]

WRITE for details of straight and superhet tuner units and ac and ac/dc output power units, 16g. sheet aluminium, cut to size, at 3/- per sq ft; send for requirements all sizes of aluminium chassis constructed to requirements; singles or quantities to order.—R. T., 64, St. Leonard's Rd., S.W.14. [6830]

RELIANCE POTENTIOMETERS

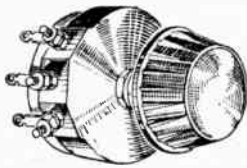

TYPE T.T.
Continuous Wire-Wound
(as illustrated)

Rating: 5 watts (linear)
3 watts (graded)

Ranges: 10-100,000 Ω linear Max
100-50,000 Ω graded ..
100-10,000 Ω Non-Inductive

Characteristics:
Linear, tapered, graded, log., semi-log.
inverse log., non-inductive, etc.

Write for full details to:

RELIANCE
Manufacturing Co. (Southwark) Ltd.
Sutherland Road, Higham Hill,
Walthamstow, E. 17
Telephone: Larkwood 3245

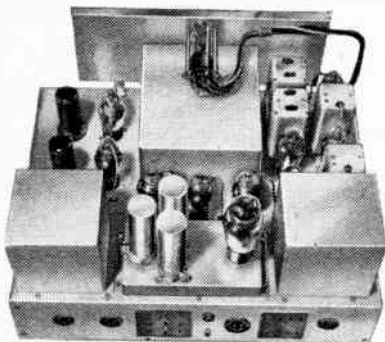

To all enquirers for the
PEERLESS TYPE 1546 CHASSIS
Demonstration Model

will shortly be available at our
Showrooms. Write or phone for
appointment.

The "Peerless" Chassis employs 15 Valves in a circuit comprising precision communications facilities with high-fidelity broadcast reception technique, with frequency range from Television to long waves, and is completely "tropicalised" to H.M. Government approved Standards Complete specification on request.

Trade & Export Enquiries invited

TELEMECHANICS LIMITED
374 KENSINGTON HIGH ST., LONDON, W.14
Phone: WESTern 1221

FOR sale, Vortexion 50-watt modulator, £24; Reslo moving coil mike, £4; C.R.100 receiver, 100kcs to 30mcs, £40; Sky Champion receiver, £28; Goodmans' 12in p.m. speaker, £6; also transformers, etc.; s.a.e. for lists.—T.E.C. 2, Outgang, Aspatria, Cumberland. **SANGAMO** synchronous motors, self-starting, exceptionally good torque, rotor speed 200 r.p.m., 200-250v ac, 50c, consumption 2½ watts, size 2¼x2, geared 1 rev 60 min, can be reset to zero by friction drive from front or back, shaft ⅝in x 1/10, to run clockwise, ideal movements for making electric clocks, time switches, etc., nickel plated finish; price 22/6 each.

12 TO 1 dial trains to fit above spindle; per set, 2/6.
MAKE your own dark room clock.—Sangamo synchronous motor, self-starting, 200-250 ac, 50c, geared 1 rev. 60 seconds, can be reset to zero by friction drive from front or back, shaft ⅝in x 1/10, to run clockwise; 22/6 each.

15AMP mercury switches, enclosed bakelite tubular cases, 2½in x ⅝in, fitted swivel saddle, connector block, etc.; 5/6 each.
CASH with order post paid on all above goods.

TO callers only.—A comprehensive stock of scientific instruments, meters, gears, relays.

H. FRANKS, Scientific Stores, 53, New Oxford St., London, W.C.1. Tel. Museum 9594.

KITS of radio receivers from £7/8; 4- and 5-valve, new materials, table models, semi-midget; our latest kit—Wylwyn Star 1947 has connections for gramophone pick-up, extensions to loudspeaker A.V.C., 6 hours average time for constructing; full details, diagrams with each kit; c.w.o. or c.o.d.—Isherwoods, Reme House, 81, Plungington Rd., Preston. Tel. 3348. Estd. 1936. [6788

HARRY JAMES PRODUCTIONS, 270, Leith Walk, Edinburgh, 6.—Mail order only, c.o.d. or cash with order; condensers, 8mids 2/10, 8+8mids 5/6, 16mids 4/9; .1mf 500v 7d, .01 and .05mf 6d; volume controls, w/s ¼ and ½meg, 4/6; valveholders, 5, 7-pin and octal, 6d each; dropper resistances with feet, 2 and 3amp 4/6; standard multi-ratio speaker transformers, 6/6; resistances ¼watt 3d, ½watt 4d, 1watt 6d; all standard values. **VALVES**, c.o.d.; most English and American types in stock; give us your enquiries for anything in radio; quotations by return. [6841

FENWICK for speaker backing, 6in square 1/-, 12in 2/6, 18in 4/-, post 3d.; Westinghouse instrument rectifiers, 1 and 5ma, 10/3, post paid; 12in Goodman speakers, £6/15; Goldring pick-ups, magnetic type, 30/7, post 9d.; Weymouth all-wave coil packs, 36/6, circuit supplied, 46s k/cs, 1F5, 18/9, post 6d.; mains transformers, 4v and 6v, 30/-, post 1/-; Perspex 18in x 13½in x ½in, 21/-; Hivac midget valves, 1.5v, XH, XL, XD, 10/6; XP, 12/10; XSG, XW, XY, 15/6, post 6d.

FENWICK, Dept. P, Gt. Brickkiln St., and Snowhill, Wolverhampton. Tel. 24607. [6746

EX-R.A.F. "Identification Friend or Foe" receiving and transmitting units, covering 155-185 mcs, complete with 10 valves and 20 watts motor generator, 12v input, 480v 0ma output, 75/- ea, carriage 4/-; the famous Canadian type 58 Mk. 1 Walkie Talkie, complete with valves, aeriels, headphones and microphones, batteries, etc., ready to switch on, £10/10 ea, carriage 5/-; vibrator units, 2v input, 90v output, i.t. and g.b., complete with 2 accumulators, easily adaptable for any use, brand new and unused, £4 ea; s.a.e. for component lists and refer to our offer of ex-Army wavemeters under Test Equipment column.—U.E.I. Corpn., 32, St. Gabriel's Rd., London, N.W.2. [6824

COPPER wires, cotton-covered ¼lb reels, £ 18, 20g, 1/6; 22, 24g, 1/9; 26, 28g, 2/-; 30, 32g, 2/3; 34g, 2/6; enamelled ditto, same prices, including 36g, 2/6; 38, 40g, 2/9; silk-covered 2oz reels, 24, 26g, 1/6; 28, 30g, 1/9; 32, 34g, 2/-; 36, 38g, 2/3; 40, 42g, 2/6; 44, 45g, 1oz, 2/-; 18g, 1lb, 7/-; 22g, ¼lb, 2/6. **LAMINATED** bakelite panels, ¼in thick, 6in x 4in, 1/6; 6in x 6in, 2/-; 8in x 6in, 2/6; 10in x 6in, 3/-; 10in x 8in, 3/9; 12in x 8in, 4/6; ditto ½in thick, same sizes, 1/-, 1/4, 1/8, 2/-, 2/6, 3/-; polished ebonite panels, ¼in thick, sizes as above, 2/-, 3/-, 3/9, 5/-, 6/6, 7/6 respectively; B.A. screws, gross useful sizes, 2/6; ditto, nuts, 2/6 gr.; assorted gross screws and nuts, 2/6; brass washers, 1/6 gr.; fibre washers, 1/6 gr.; assorted soldering tags, 2/- gr.; assorted small eyelets and rivets, 1/3 gr.; finest quality stranded and single push-back wire, 12 yds, 2/3; resin-corned solder, ¼lb 1/-; new ex-G.P.O. hand telephone with microphone, switch and cord, 12/6; used ex-R.A.F. low resistance earphone with switch, bargain, 2/6; all postag. extra; trade supplied.—Post Radio Supplies, 33, Bourne Gdns., London, E.4. [6760

Specialists in

HIGH POWER - HIGH QUALITY

PUBLIC ADDRESS SYSTEMS

AMPLIFIERS

from 150 W to 1kW

W. Bryan Savage Ltd

WESTMORELAND ROAD, LONDON, N.W.9

Telephone: Colindale 7131

DALY ELECTROLYTICS



Tube—size 2½" x 1"



Can—size 4½" x 1½"



Block—size 4½" x 1½"

The DALY range covers all requirements

Note—All Condensers bear the date made

DALY (CONDENSERS) LTD

Condenser Specialists for over 20 years

West Lodge Works, The Green, Ealing, W5

'Phone—Ealing 4841

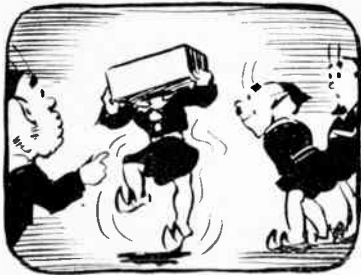

THE "FLUXITE QUINS" AT WORK

Cried O! "All I wanted to know
Was why this old set wouldn't go!"
Cried the lads "Is it sound?
Whilst you're there, look around..."
"Does the wiring need FLUXITE?" grinned OH.

See that FLUXITE is always by you — in the house — garage — workshop — wherever speedy soldering is needed. Used for over 30 years in Government works and by leading engineers and manufacturers. Of all Ironmongers—in tins, 10d., 1/6 & 3/-.

Ask to see the FLUXITE
POCKET BLOW LAMP.
price 2/6.

TO CYCLISTS! Your wheels will NOT keep round and true unless the spokes are tied with fine wire at the crossings AND SOLDERED. This makes a much stronger wheel. It's simple—with FLUXITE—but IMPORTANT

The FLUXITE GUN puts FLUXITE where you want it by a simple pressure. Price 1/6, or filled, 2/6.



**ALL MECHANICS WILL HAVE
FLUXITE
IT SIMPLIFIES ALL SOLDERING**

Write for Book on the ART OF "SOFT" SOLDERING and for Leaflets on CASE-HARDENING STEEL and TEMPERING TOOLS with FLUXITE. Price 1d. each.

FLUXITE LTD.
(Dept. W.W.), Bermondsey Street, S.E.1

A. SUMMERSBY, late general manager of Weymouth Radio, Ltd., designer and originator of the Weymouth coil pack, i.f. transformers, etc., has pleasure in giving the data of the Summersby i.f.s. type S.1 can, size 1x1x3 1/2, eyebolts 1/2 centres, coils Litz wound, iron dust permeability tuning cores, these cores are covered with a compound to prevent self-rotation; Q=130. QK=1 (approx), tuned to 465 kc, supplied in pairs, one i.f. has a flying lead; 15/- per pair; trade enquiries invited.—Write to A. Summersby, 6, Florence Rd., Bromley, Kent. [6758]

SELENIUM metal rectifiers, guaranteed charger kits, h.t. rectifiers; no surplus goods. Selenium metal rectifiers, damp proof finish, best make, new and with full manufacturers' guarantee, circuit and interesting data supplied, 12v 3 amp, 21/-, post 9/-; 12v 2amp, 15/-; 12v 1.5amp, 10/-, post 6/-; 12v 4amp, 27/6; 12v 5amp, 32/-, post 9/-; h.t. rectifiers, new, small space selenium type, 250v 60ma, ideal replacement for all ac/dc rectifier valves, 9/6, post 7/-; also small eliminator type, 120v 25ma, 7/-, post 4/-; others in stock; 40 different types of metal rectifier available, state requirements; instrument rectifiers for meters, 1ma M.B.S.1 type, also 5ma for Avo, Avonior, 12/6, post 3d.

METAL rectifiers in stock for converting valve type chargers to metal rectification.

CHARGER kits.—Large 12v 3amp metal rectifier, with 50-watt transformer and ballast bulb for 2v to 12v charger, weight 7lb, no ammeter or rheostat required, 47/6, post 1/-; ditto 2amp rectifier, 39/-; ditto, with 4amp rectifier and 75-watt transformer, 59/6, post 1/-; new 6v charger kit for 2v and 6v charging, 35/-, post 11d.

HEAVY duty type transformer, 150-watt, with 12v 5amp rectifier for 6v and 12v charging, £4 5/-; for small radio store, transformer, metal rectifier, ballast bulb, for 1 to 20 cells at 1amp, £4/19/6; ditto for 2amps, £6/15/-; 2v to 12v chargers in steel case, 4amp max., weight 30lb, £8/8/-; crate and carriage extra.

TRICKLE charger rectifier for 2v cell, with transformer, 13/6 the two parts; make ideal trickle charger for a single 2v cell, postage 8d.

FLOHESCENT lighting chokes, 80-watt, boxed and impregnated, 230v, 19/6; tapped, 21/6, post 1/-.

(HAMPHON, 43, Uplands Way, London, N.21. Tel. Lab. 4457. [6832]

RADIO CLEARANCE, Ltd., 27, Tottenham Court Rd., W.1. Mus. 9188.—Mains trans., 350-0-350v, 80ma, 6.3v, 3a, 5v 2a, tapped pri., 21/-; p.m. speakers, all well known makes, 2 1/2in 25/-, 3 1/2in 25/-, 5in 25/-, 8in, less trans., 25/-, 8in with trans., 27/6; 10in with trans., 42/6; 10in less trans., 40/-; 2-gang conds., 0.00035, short spindle, 6/11; 3-gang, 0.0005, 7/6; superhet. coils, m.w., a.e., m.w. osc., 1w, a.e., 1w, osc., former size 1/2in x 1 1/2in, 2/6 each; iron cored 265 kc/s trap, 2/9; set of 4 coils and trap, 11/6; volume controls, with switch, 10k, 50k, 100k, 500k, 4/6; less switch, 10k, 20k, 30k, 50k, 100k, 2/6; miniature, 1k, 20k, 100k, 250k, 500k, 2/-; wire wound, 3w, 100Ω, 200Ω, 500Ω, 1k, 2k, 5k, 10k, 20k, 2/6; electrolytics, 8mf 500v 3/3, 20mf 50v, 250mf 25v 2/-; Mansbridge conds., 1mf 500v 9d, 1mf 1,000v 1/3, 2mf 300v 1/-, 4mf 600v 4/6, 4mf 1,500v 5/-, all wkg. 2/5 switches, 1p 3w, 1/9, 2p 4w 2/9, 4p 3p 3/-, 6p 2w 3/-, 4p 3w 2b 4/-; tubular conds., 0.001-2.5, 0.01 2-5 6d, 0.1350 7d, 500v 9d; mica conds., 0.0001-5 4d, 0.001-5 5d, 0.01 6d; silver micas, 5-6,000pf 6d; ceramics, 2, 10, 20, 50, 100 pf, 6d; resistors, 1w 3d, 1/2w 4d, 1w 6d, 2w 10d, 3w 1/3, most values in stock; 3w wire-wound, 5Ω, 45Ω, 470Ω, 3-9k, 6-8k, 47k, wire ended, 1/- each; 10w, 50Ω, 250Ω, 500Ω, 1k, 1,200Ω, 1/6; 20w with clips, 120Ω, 200Ω, 2k, 8k, 2/-; 25w 350Ω, 5k, 2/6; 40w 14k, tapped at 2k, 3/-; Bakerised tubulars, 0.1, 250v 3d, 0.1 600v 6d, 0.5 400v 6d, 100mf 12v electrolytic 1/-; Ally chassis, 10 1/2in x 10 1/2in x 2 1/2in, part drilled, 3/6; wgaids droppers, 2 sliders, 0.2a 1,000Ω, 3/6; 0.3a 800Ω, 4/-; h.f. chokes, 1/6; u.h.f. chokes, 1/-; ceramic trimmers, 1/15p.f. and 3/50 p.f., 9d; padders, 600p.f., 750-1,250p.f., 1/-; valveholders, 4-pin pax., 1d, 5pin amph. 6d, Int. or Mazda oct. 6d., EF50 pax. 6d, UX, 4-pin amph. 6d, ceramic 5 or 7-pin UX, EF50, 1/6; television line trans., 12/-; 10w flat P.O. type res., 350Ω, 1k, 2k, 4k, 1/-; stranded centre rubber ins. screened single, 8d yd.; 465 kc/s iron-cored i.f.s., 12/- pair; output trans., tropicalised, c.t. sec. giving 30 and 15 to 1, 4/-; 2-gang pots., double 1m, 4/-; moving coil headphones, slightly used, 10/6 pair; power carb. mikes, with switch in handle, 10/6; sub-assemblies, carrying 2 or 17 350v tubulars, 1 Bakerised tub. elect. 8mf 150v, 1 Bakerised tub. elect. 100mf 12v, and tag panel, 2/- each complete; uncalibrated a.m. dials, 2 ratios, 2/1 and 250/1, 5/6 each; all orders under 10/- to include postage. [6833]

BERRY'S
SHORT WAVE LTD

for Quality
components

SLOW MOTION DIALS

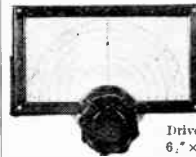

"Q-MAX" FULL VISION SLOW MOTION DIALS FOR INDIVIDUAL CALIBRATION. Complete with dial engraved 5 blank scales and 1 calibrated 0-180°, glass and escutcheon. SMDA. 9-1 Slow Motion Drive with large fluted knob (dial 6" x 3 1/2") 15/6 (dial only, 3/-).

The "Q-MAX" Chassis
Cutter

Does away with tireome drilling and scraping. Holes cut easily and cleanly. Punch cuts through chassis, die prevents distortion, spanner turns but not holes. Size of holes 1 1/2" (octal) 10/6
" " " " 1 1/2" x 1 1/2" 12/6
(1 stage 9d, extra)



The "Q-MAX" Tank Coil Unit

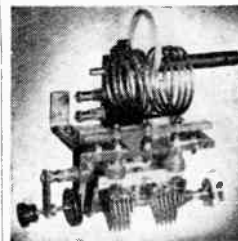

These units are designed for maximum efficiency on all "HAM" Bands and consist of:—
1. Split Static Condenser.
2. Tank coil mount and swinging link.
3. Plug-in tank coils.
4. Plug-in link coils.
5. Neutralising condenser.
MK1. for powers up to 50 watts with 34 M. plus 34 p.f. split stator.
MK11. for powers up to 150 watts with 60 p.f. plus 60 p.f. split stator and built-in R.F. choke and By-pass condenser.

The "Q-MAX" Absorption Wave-Meter and Phone Monitor

An Absorption Wavemeter for checking frequency harmonics and parasites in Oscillators, Doubblers and Power Amplifiers.

All amateur bands covered by plug-in inductances. Incorporated in the Wavemeter is a WX6 Westector—automatically connected across the tuned circuit by inserting phone jack plug for monitoring phone transmitters. Size 3 1/2in. x 2 1/2in. x 2 1/2in. PRICE 35/-. (Price includes one inductance. Extra inductances 3/9 each.)

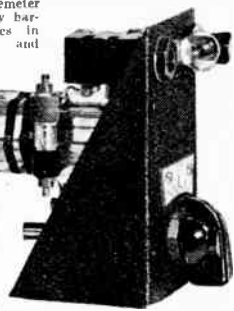

Obtainable from your local "Q-Max" Dealer or direct from

BERRY'S (Short Wave) LTD.
25 High Holborn, London, W.C.1

Tel.: Holborn 6231
ILLUSTRATED CATALOGUE
"W.W." 6d. Post Free



DESIGN for P.A.

The MB.31 amplifier incorporates the Cathode-anode output circuit developed by Acoustical, resulting in a total distortion content incapable of detection by the human ear. A flat frequency response from 40—15,000 c.p.s. is obtainable, modified by a microphone volume control so weighted that "natural" reproduction is maintained at all levels.

Introducing compression near full output, a higher average output level can be handled without the distress caused by overload peaks. Operating from AC mains or 12-volt battery, and having alternative input and output impedances, the MB.31 amplifier is extremely versatile and suitable for most types of general public address work.



MANUFACTURING CO. LTD.
HUNTINGDON, TEL: 361.

LONDEX for RELAYS

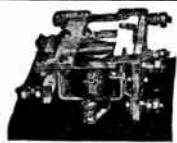

AERIAL CHANGE-OVER RELAY
for Radio Frequency
Type A.E.C.O. 4.

3 V.A. Coil Consumption especially designed for Transmitters, High Frequency Heating, Amateur Stat.ons, experimental purposes, etc.

Ask for leaflet 112 WW

LONDEX LTD SYDNEY
MANUFACTURERS OF RELAYS 6258-9
207 ANERLEY ROAD LONDON S.E.20

CROYDON 4870.

WINDING & REWINDING

A.F. TRANSFORMERS, CHOKES, E.H.T. TELEVISION, FIELD COILS & LOUD SPEAKER REPAIRS

SOUTHERN TRADE SERVICES LTD.,
297/299 HIGH ST., CROYDON.

WRITE FOR DETAILS OF OUR "TELECRAFT" COMPREHENSIVE TRADE TELEVISION AERIAL INSTALLATION.

INCLUSIVE CHARGE FOR EVERYTHING

G. A. RYALL, 65, Nightingale Lane, London, S.W.12.—Mail order only; no c.o.d. under £1 please; special wholesale list now ready for the trade only; please note that postages are strictly extra; U.S.A. make 0.1mf 500v tubular wire end, metal cased condensers, 5/6 per dozen; Mansbridge 4mf 250v made for A.M., will work on 350v O.K., 1/6 each; 2mf 600v, 1/6 each; tubular 0.5mf 500v, 3 2/6; tubular wax dipped 0.002mf, 3/6 dozen; best make mica 0.002 and 0.005 wire ends, 2/6 dozen; and 0.01mf mica, 3 2/-; resistances, 1/2 watt, best make, sizes 100, 180, 220, 270, 1,000, 2,000, 3,500, 4,300, 11,000, 50,000, 82,000, 100,000, 270,000, 470,000, 1meg, 2meg, 2/6 dozen; also 2,000ohm 1/2 watt, 1/- dozen; 82ohm 1 watt, 2/- dozen; 33,000 ohm 3 watt, 3/- dozen; and 1,800ohm 1 watt, wire wound, 1/- dozen; vitreous 20 watt with clips, 2/- each; panels with screened 0.1mf and 12 1/2 watt resistances, 2/3 each; twin trimmers 30mm, separate connections, 3 2/-(6); octal plugs with metal caps and chassis type sockets, 3 2/6; with solder tags, 3 3/-; valve holders, British type 7-pin, U.S.A. 4-5-6-pin, all 4/- dozen; volume controls, less switches, metal cased 1/2 meg short spindle, 1/6; bakelite 1/2 meg short slotted spindle, 1/6; bakelite 1 meg short spindle, 1/6; bakelite 300ohm preset, 1/6; instrument rectifiers, 10ma., 7/6; Yaxley type short spindle switches, 9-way, 2/3; special type 3-bank, 4-way, with middle screen, 2-pole, 3/9, post 8d. on singles; double type mike and phone transformers, secondaries, 175, 45, 10ohms, 5/-, postage 9d.; power microphones, work direct into speaker 20/- each; Yaxley switches, some require alteration, single and double-bank, 12/- dozen to clear; ex-Govt control boxes with Yaxley switch distribution blocks, etc., 2/6 each, post 8d.; assorted resistances, 1 watt, 1/2 watt, 1/4 watt, from 82ohms to 2megohms, 30 sizes for 3/9; Paxolin strips, polished, Govt. quality, about 4ft long, 2 1/2 in to 4 1/2 in wide, about 3/8 in thick, prices 2 1/2 in 3/9, 4 1/2 in 4/9, both post free; panels, 4ft by 2ft, standard qual., 1/4 in, 30/- ca.

ROTARY transformers, brand new, ex-Govt. R stock, with 6v input, output 200v at 50ma continuous, or 150v at 80ma up to three hours, with 15v input, output 480v at 40ma continuous or 400v at 80ma up to three hours, size, length 7 1/2 in, height 3 1/2 in, weight 6 1/2 lb, ideal for car radios, mobile amplifiers, etc., original price £7/7, each 25/-; midget m. wave, t.r.f. coils, high gain, 5/-; m.l. wave, with reaction, circuit, 7/6; m.l. wave, iron cored, adjustable cores, circuit, 10/6; s.m.l. aer. and osc. coils, circuit, 10/6; Weymouth midget i.f.s., iron core, 465 kc/s, per pr. 18/9; standard i.f.s., 465 kc/s, per pr. 15/-; Weymouth all-wave coil pack, 36/6; 2-gang condensers, 0.0005mf, 12/6; speakers, minus tran. p.m., 5in, 21/-; ditto p.m., 6in, 27/-; speaker fabric, heavy quality, 8in squares, 1/-; volume controls with switch, long spindle, 10,000 ohms, 25,000 ohms, 1/4, 1/2, 1 meg, 5/-; wire-wound pots., 2,000 ohms and 50,000 ohms, 4/-; ditto, short slotted spindle, 1,000 ohms, 2/6; Paxolin valveholders, English-America, all types, 9d each, 8/- doz; screened valve top caps, English and octal, 9d each; coloured ivoryine dials, s.m.l. wave, 4x3 1/2 in, 2/-; 5x5 1/2 in, 2/6; 6x5 in, m.l. wave, 1/6; slow motion drum drive, 3/-; epicycle drives, 3/3; Rothermel Senior piczo crystal pick-ups, 56/3; car aerials, roof mounting, chromed, screened lead-in, 30/-; midget cabinets, cream and green, 13 1/2 x 7 in x 6 in, 40/-; amplifier cases, undrilled, with perforated cover, 17 1/2 x 8 1/2 x 9 1/2 in, 35/-; electrolytics, tubular, 8mf 150v, 2/6; 200mf 12v, 2/-; 50mf 12v, 1/6; block, 24 plus 24mf, 8/6; fixed condensers, tubular, 0.01, 0.02, 0.05, 0.1mf, 8d each, 8/- doz; miniature rotary switches, d.n.d., 3/-; 2-pole 6-way, 3/6; chokes, midget 50ma, 5/6; standard, 80ma, 8/6; heavy 150ma, 12/6; Simplex chassis, 11x4 1/2 x 2 1/2 in, 6/-; W5V chassis for coil packs, 11 1/2 x 5 1/2 x 2 1/2 in, 6/6; all chassis with 6in speaker cut-out and fully drilled all component holes; nuts, screws, 6BA or 4BA, per gross (gross nuts, gross bolts), 6/-; heavy duty output P.P. trans., 6,600. A to A load, tapped output, 7.5 and 15 ohms, each 21/-; all Bernard's radio publications in stock; monthly comprehensive lists, well worth having, 2/4 stamp; postage all orders.

O. GREENICK, Ltd., 34, Bancroft Rd., Cambridge Heath Rd., London, E.1. Tel. Stepney Green 1334. [6836]
MIDGET TRF ac/dc kits, 4v, m. and l., parts mounted, best value obtainable, £6, incl. valves and speaker; in lots of 6 £5 10; Midget superhet kits, 4v, m. and l., valves and speaker but less power unit, £6/10; power units, ac/dc £1 1/10, ac £2/10, 6volt dc £2/10.—Cook, Old Barn Rd., Christchurch, Hants. [6728]

"We Were Greatly Impressed"

This phrase was used by a leading Electrical Instrument concern in connection with

TRANSFORMERS and CHOKES

supplied by us, and is praise to which we have become accustomed. Our modern factory is fully equipped with vacuum and pressure impregnators, and all the latest test equipment.

POWER RATINGS 8 V.A. to 8 K.V.A.

AUDIO RATINGS 3 watts to 200 watts.

We shall be pleased to quote for your requirements, large or small.

PROMPT DELIVERIES

AUSTIN MILLS LTD. LOWER CARRS, STOCKPORT

Established 20 years Phone: STO 3791

MORSE CODE TRAINING



There are Candler Morse Code Courses for **BEGINNERS AND OPERATORS.**

Send for this Free "BOOK OF FACTS"

It gives full details concerning all Courses.

THE CANDLER SYSTEM CO., (Room 55W), 121 Kingsway, London, W.C.2
Candler System Co., Denver, Colorado, U.S.A.

HARTLEY-TURNER HIGHEST FIDELITY SPEAKER

One in 20 pre-war H-T users think the Model 215 is not so good. One complains of no name on the speaker; another that there is no muslin bag; a third that a real high-fidelity speaker must cost more than £9. Production difficulties are great, but we may be able to put it in a bag, and even get labels to name it. Meanwhile, we concentrate on essentials—faithful reproduction "in the bag" at the lowest possible cost, and all our other customers think we have succeeded. Send for descriptive leaflet now.

MODEL 215—£9.

High-grade Push-Pull O.P. Transformer 55/-

H. A. HARTLEY CO. LTD.
152 HAMMERSMITH RD., LONDON, W.6



RADIO VALVES. British and American from 5/10, all at official List Prices, not increased since 1940.

BRIMAR.—1D6, 5B, 260A, 6B6, 6G8, 6K6, 6K7, 6R7, 6SNT, 6T7, 6V6, 7B5, 7B7, 7B8, 7C6, 7D5, 7Y4, 8D2, 9D2, 10D1, 11D3, 11D5, 12SR7, 20D2, 25Z4, 32.

COSSOR.—4TPB, 4TSP, 138PA, 41MP, 41MPT, 41MRC, 420p/Pen, 42-OT-DD, 42TTB, 26C7HA, 210D0, 210LF, 2201PT, 220P, 220PA, 220TH, 506BU, 807, DD14, MP/PEN, MS/PEN, MS/PEN/B, MVS/PEN, MVS/PEN/B, OM6, PT4.

HIVAC.—XD, XH, XL, Y, X6G, MARCONI/OSRAM.—B30, D41, D42, D63, DA30, DL03, DL7AM, DN41, G7IC, GU50, H30, H63, HA2, HD24, HL2, KT2, KT24, KT33c, KT41, KT61, KT63, KT66, KT74, KTW61, K761M, KTW63, KTZ41, KTZ63, KTZ73M, L63, LP2, MH41, ML4, M8A4, M8P4, N14, P2, PT25H, PX25, QP21, S23, U10, U16, U17, U18, U20, U31, U50, U52, U74, VMP4G, VMS4B, W21, W42, X14, X41, X61M, X63M, X65, X71M, Y63, Z14.

MAZDA.—AC2PenDD, AC5pen, AC5penDD, AC6pen, ACHL, ACHLDD, AC/P, AC/Pen, ACTH1, ACVP1, ACVP2, D1, D1207, DD020, HL2DD, HL2E3, HL23DD, H141, HL11DD, HL42DD, HL133DD, HL1D1320, P41, Pen23, Pen45, Pen45DD, Pen46, Pen383, Pen453DD, PenDD4020, QP23, QP230, QG215, SP22, SP41, SP2220, TH41, TH233, TH2321, TP22, TP25, TP26, TP220, U403, U5, U6, U7, U8, U9, V914, VP23, VP41, VP133, VP1322, MULLARD.—21D4, 21A3, 5Y3, 6C5, 6D6, 6J7, 6L6, 6Q7, 6R7, 164V, A21, AZ31, CCH35, OL33, CY1, CY31, D40 2, DF35, DF51, DK32, DL35, DW2, DW4/500, EA50, EB34, EBC3, EBC33, EOC31, PCH35, PF6, PF9, PF30, PF39, PF90, EK2, EL2, EL3, EL32, EL33, EM34, EM35, PC13, PW4/500, HL3c, LW4/352, PW4/500, KBC32, KF35, KK32, KL35, Pen4DD, Pen4VA, Pen428, PenA4, PenB4, PM2, Pm2HL, Pm12M, Pm202, QP22B, SP2, SP4, SP4B, SP13, T6D, TDD2A, TDD13c, TH2, TH4B, TH2IC, TH30C, T74, UR3C, VP2B, VP4, VF4A, VF4B, VF13A.

TUNGSRAM.—5Z4, 6B8, 6J5, 6TH8, 6V6, 6X5, 25Y5, 807, APF4, APF4G, CB2168, DD13, DD818, BCH2, EF12, EH2, EL5, EL11, EM4, EZ4, HL13, HP13, HP1018, HP1118, HP2018, HP2118, HR210, MH118, MH4105, LD1210, LL28, P2018, PP6, PF62, SP238, SP42B, SP48, S8210, VP48.

AMERICAN.—OZ4, 1A4, 1A5, 1A7, 1B4, 1B5, 1C5, 1D7, 1E5, 1E7, 1F4, 1F5, 1F6, 1F7, 1H4, 1H5, 1H6, 1L4A, 1L4C, 1LX5, 1N5, 1R5, 1S5, 1T4, 1T5, 2A6, 2A7, 2B5, 2B7, 5U4, 5V4, 5Y3, 5Z3, 5Z4, 6A4, 6A6, 6A8, 6A9, 6A9G, 1B9, 1B, 6C5, 6C6, 6D5, 6D6, 6E5, 6E6, 6E7, 6E8, 6E9, 6F5, 6F6, 6F7, 6F8, 6F9, 6G5, 6G6, 6K7, 6K8, 6L2, 6L6, 6L7, 6X7, 6Q7, 6P3, 6R7, 6S47, 6S67, 6S7, 6S7, 6S7, 6T7, 6V6, 6V6, 6X5, 7F5, 7A6, 7A7, 7B1, 7B6, 7B7, 7B, 7C5, 7C6, 7H7, 7S7, 7Y4, 10, 12A, 12A5, 12A6, 12B7, 12J5, 12K7, 12K8, 12Q7, 12SA7, 12SA8, 12SA9, 12Z3, 12Z5, 14A7, 15, 17, 18, 20, 22A, 22B, 24, 24, 29, 33, 34, 35Z5, 37, 38, 42, 46, 48, 49, 50, 53, 55, 57, 59, 71A, 77, 79, 81, 81, 82, 83, 89, 807, 954, 955, 956, 117Z6, 1229A, 9001, 9002, 9003, 9001, 9005, and 101 more types.

Order C.O.D. above listed numbers or equivalents (subject to stock). Please enquire for any valve you require, even if not listed. We may have it. Old and new types are arriving daily.

THIS MONTH'S SPECIAL.

PETER PAN MIDGET RADIO KIT, complete from cabinet (black and white plastic) to the last screw. All components and valves guaranteed. 4 valves, medium and long waves. A.C. P.C. Printed circuit, diagrams and full instructions. #11 9s. 7d., post free. C.O.D. or remit with order.

J. BULL & Sons (W.W.) 246 High St., Harlesden, N.W.10

COVENTRY RADIO COMPONENT SPECIALISTS SINCE 1925. SPECIAL OFFER CONDENSERS, 20 ASSORTED SIZES OF BEST QUALITY TUBULAR .002 TO .5 MFD. SATISFACTION GUARANTEED... 10/- POST PAID. PROMPT SERVICE. COVENTRY RADIO 191, DUNSTABLE ROAD, LUTON

EXPERIMENTERS! Service engineers! Nuplans announce their television test pattern generator! Built from the spares box to our full data sheets; self synchronizing separate and combined horizontal and vertical patterns—Full details, circuit, layout and plans, 2/6, from E. N. Bradley, "Whinnie Knowe," Escalls, Sennen, Cornwall. More circuits to follow. [6696]

WEARITE coils and transformers in stock! "P" coils, PA1, 2, 3, PHF1, 2, 3, PO1, 2, 3, 3/- ea; 465k/c IFTs, 10/-; M400 miniature tube, 10/6; M405 1.6m/c IFT, M411 2.1m/c IFT, 10/6; 207 60:1 mike transformer, 15/-; 209 4:1 inter-valve, 15/-; 3-wave s/ret coil pack on sub chassis, 39/6.—Frith Radiocraft, Ltd., 69, Church Gate, Leicester.

MISCELLANEOUS

SERVICING required on South Coast for 1154 and T.R.9.—BM/BNV, W.C.I. TIME Recorders.—Write for particulars.—Gledhill Brook Time Recorders, Ltd., 84, Empire Works, Huddersfield. [2419] TRANSPARENT and opaque Perspex sheet for sale, plain or coloured; large or small quantities.—47, Stoney Lane, Birmingham, 12. SPARKS' data sheets offer the widest range of tested and guaranteed designs, in full-size data sheet form, obtainable in this country.

TINY 'Two, just released, a 2-valve all-dry self-contained portable, med. waves. DESIGNED for individual listening to local stations on speaker, size 5 1/4 x 5 1/2 x 5 1/4 in, 18 volt HT; 2/6. THREE-valve all-dry portable, m/l waves. 9x6x4 in, a most popular set; 2/6. Send a stamp for full list (W).

SPARKS' Data Sheets (W), 9, Phoebeth Rd., Brockley, S.E.4. Tel. Lee Green 0220. [6509] ELECTRIC open and tubular heaters, etc., supplied to stores and shops.—Write, Matthias Rivlin, 69, Albion St., Leeds, 1. Tel. 25972. [5947]

"WIRELESS WORLD," 13 vols, 1935-44, few extra, index to 1938; what offers? —Peter Edwards Radio Service, 39, Park Rd., Crouch End, N.8. [6770] "WIRELESS Engineer," 1935 to 1942 complete except Nov., 1940, and Aug., 1942; 1932 complete; part 1930, 1931, 1934 and 1943; £5.—Box 5630. [6751]

CLASSISTS and panels in aluminium from 3/9 each; prompt delivery, any size, plain or punched for valveholders, etc.—Meal, 13, Bruce Lane, Darton, Barnsley. [6680] CIRCUIT diagrams (individual designs), home-built apparatus tested; theory explained.—R. G. Young, 3a, Bridges Rd., Wimbledou.

ALUMINIUM sheet, 14g, 16g and 18g, aluminium gauze, 12 mesh, aluminium hinges, 1/2 in, closed, lengths 3in-5ft; aluminium rivets, various sizes.—Baker, Market Place, Irlthingborough, Wellingborough. [6697] MATHW Bros. offer very large quantity, brand new, Tiny Tim 12v 20 amp petrol charging sets, in maker's boxes; £25 each, plus 10/- carriage; reduction for quantities. MATHRO Works, Sandy Lane North, Wallington. Tel. Wallington 4050. [6301]

AMERICAN magazines can now be supplied on a subscription basis; cost of one year's supply, including postage, "FM & Television," 30/-; "Popular Mechanics," 17/6; "Radio Craft," 16/6; for complete list send stamped addressed envelope (1d) to Willen, Ltd., WW Dept., 120, St. George's Rd., E.10.

WANTED, EXCHANGE, ETC. WIRE recorder, full particulars please.—Box 5191. [6679] WANTED, good service sheets, all makes.—Details Box 5573. [6706] SERVICE sheets wanted, 1937 onwards.—Details, price to Box 5589. [6739] WANTED, W.W. March, 1942.—Noble Springponds, Ongar, Essex. [6738] SERVICE sheets, all makes from 1936; condition and price to Box 5667. [6772] WANTED, one disk type television receiver and transmitter.—Write Box 5709.

METAL cabinet for AR.77, wld consider buying unserviceable complete set.—Box 5583. LATE model whistle filter or top cut.—Blake, Mere Heath House, Davenham, Northwich. [6846] WE offer cash for good modern communication and all-wave receivers.—A.C.S. Radio, 44, Widmore Rd., Bromley, Kent.

WTD, for cash, Quality meters, Westons, Avos, etc, cond. unimportant; exchanges, sales, repairs.—HGM/MEFRS, Luton, W.1. SERVICE sheets wanted on 7-day loan (three pence each plus postage, deposit if desired); all makes from 1934.—Box 5705. WANTED, Cossor double beam oscilloscope and ganging oscillator, in good condition.—Box 146, Parris, 121, Kingsway, W.C.2.

M. WILSON LTD OUR NEW A.C. 6-VALVE SUPERHET CIRCUIT A circuit that will please the most critic! Three wavebands, Short 16-50, Medium 200-500, Long 800-2,000 metres. 6 Valves, including tuning eye and rectifier. Valve sequence F.C. ECH35, I.F. Amplifier, EF39, 2nd Detector and 1st L.F. Amplifier EBC33, Output Pentode, EL33, Rectifier, AZ31, Tuning Eye EM35. Neg. feed-back, A.V.C. Gram-PU. Strong 16 swg. Aluminium chassis. All new (no surplus) components. Three fuses, two in mains leads, one in rectifier circuit. Very good quality reproduction. Customers report that they are very satisfied with the performance of this set. BLUE PRINTS NOW AVAILABLE. Two practical (full size) and one theoretical, with priced list of parts, 3/6 per set. A.C. HIGH FIDELITY GRAMO-RADIO AMPLIFIERS 5 valves, 8 1/2 watts undistorted output, TRIODES OR BEAM TETRODES in PUSH-PULL. Balanced phase-inverter valve fed from high amplification input triode. Neg. feed-back in the case of beam tetrodes. Radio-gram. switch, variable tone control, on-off switch. Transformer equipped with 2 fuses in A.C. mains lead and one in rectifier circuit. Overall dimensions, 8 1/2 in. height, 9 1/2 in. width, 7 in. depth. Complete with multi-ratio matching transformer to suit almost any speaker. Input 200-250 v. A.C. 50-100 cycles. B.V.A. valves. No "surplus" components used. Carefully packed and registered against damage. Workmanship and performance far above average commercial production for this class of amplifier. Delivery from stock. Price £14. 0. 0 6 WAVEBAND COIL KIT (covering 5-2,000 metres) When assembled this Coil Unit consists of three separate sections, AERIAL, H.F. and OSCILLATOR screens, with 18 Iron Cores Coils, 18 ceramic trimmers, and three switch wafers all ready mounted for wiring up. A.V.C. resistors and condensers, 2-pole 6-way 3-bank switch with shorting plates, distance pieces, etc. Screens 18 swg. aluminium, wire, sleeving. Overall dimensions 5 1/2 x 5 1/2 x 3 in. Price with full size blue print, £5. This Coil Unit is the same as used in our very successful No. 20 Circuit, two full size practical blue prints and one theoretical of which are available together with list of parts. Price 5/- per set of 3.

307, HIGH HOLBORN, LONDON W.C.1. Phone: HOLborn 4631

111 Pages PACKED WITH INTEREST The most comprehensive Radio and Electronic Component Catalogue ever offered is yours for the asking. All lines are by well-known manufacturers including a complete valve range—No job clearance lines whatsoever. A shilling postal order will bring you this catalogue post-free. SEND TO-DAY B : T : S 63, London Road, Brighton 1, Sussex. Tel.: Brighton 1555.

M. O. S.
(Mail Order Supply Co.)
24, NEW ROAD, LONDON, E.1

**THE MARCONI
MIDGET COMMUNICATIONS
RECEIVER !**

As used by Resistance movements throughout the war. One of the smallest communications receivers ever made.

Brand New Ready for use. Dimensions of set 2 1/2" x 3 1/2" x 9".

Frequency Ranges : 150 Kcs.—1,600 Kcs.
2.5 Mcs.— 4.5 Mcs.
4.5 Mcs.— 8 Mcs.
8 Mcs.— 15 Mcs.

These are available in 3 forms as detailed below :—

1. Complete with miniature type valves, headphone set of plug-in coils, aerial, earth, etc., and with batteries, ready for use as a battery operated unit. (Carriage 1s. 6d.) only **£8 19 6**
2. As above, but with midget AC/DC power pack instead of batteries, ready for use as a mains operated (80v. 250v.) unit. (Carriage 1s. 9d.) only **£10 9 6**
3. As above, but with power pack and batteries ready for use either as battery or mains operated unit. (Carriage 2s. 0d.) only **£11 19 6**

We have only been fortunate enough to secure limited quantities of these receivers, therefore ORDER NOW so that you will not be disappointed.

Send Stamp for latest Catalogue. Orders by post C.W.O.

L-R-S IN STOCK!
(Immediate dispatch)

Stuart centrifugal Electric Pumps
for all pumping purposes, garden fountains, etc.

Morphy Richards Auto-electric Irons
post free 35 -

Morphy Richards Cydon Door Chimes
post free 49 6

Avomitor DC Test Meters. £4 4 0

Avomitor AC/DC Test Meters. £8 10 0
(Supplied on Easy Terms if desired)

Leaflet of any item on request

The LONDON RADIO SUPPLY CO.
(The L.R. Supply Co. Ltd.) Est. 1925
BALCOMBE SUSSEX

THESE ARE IN STOCK

Radio Tube Vade Mecum. By P. H. Brans 12s. 6d., postage 6d.

Classified Radio Receiver Diagrams. By E. M. Squire. 10s. 6d., postage 4d.

The Wireless World Valve Data. 2s., postage 2d.

Radio Engineering Handbook. By Keith Henney. 30s., postage 7d.

The Radio Laboratory Handbook. By M. G. Scroggie. 12s. 6d., postage 5d.

Foundations of Wireless. By M. G. Scroggie. 7s. 6d., postage 4d.

Practical Wireless Service Manual. By F. J. Camm. 8s. 6d., postage 6d.

The Technique of Radio Design. By E. E. Zepler. 21s., postage 6d.

Radio Service Test Gear. By W. H. Cazaly. 6s., postage 4d.

Basic Mathematics for Radio Students. By F. M. Colebrook. 10s. 6d., postage 4d.

Basic Electrical Engineering. By A. E. Fitzgerald. 19s., postage 7d.

Thermionic Valve Circuits. By Emrys Williams. 12s. 6d., postage 6d.

WE HAVE THE FINEST STOCK OF BRITISH AND AMERICAN RADIO BOOKS. WRITE OR CALL FOR COMPLETE LIST

THE MODERN BOOK CO.
(Dept. W.19), 19-21, PRAED STREET,
LONDON, W.2

WILL any manufacturer able supply cardboard cartons please contact us; urgent.—Doric Radio Co., Lawson St., Darlington.

WANTED, bound "W.W." volumes XLII-XLVI, incl., must be in good condition.—Price to Smith, 50, Manchester St., W.1.

WANTED. Hallicrafters SX28 or 28A, accurate sound, with speaker; offer fine radiogram, cash adjustment if required; Croydon area.—Box 5742. [6839]

WANTED, Proc I.R.E. journals, 1935-45, also straight coil winding machine.—Liaison Officer, British Telecommunications Research, Taplow Court, Taplow, Bucks. [6812]

G. W. SMITH & Co (RADIO), Ltd., require the following: new or second-hand radio receivers and radiograms; all classes of radio test equipment; highest cash prices paid.

G. W. SMITH & Co. (RADIO) Ltd., 2, Cecil Rd., Southgate, London, N.14. Tel. Enterprise 5465 [5116]

FOUR electric public clock movements up to 12in hands preferably with remote control for adjustment.—Henry Wood & Co., Cape St., Winson Green, Birmingham, 18.

20-WATT high-fidelity Tri-channel amplifier, inputs for mike, gram, and radio; exchange radiogram cabinet with motor or sell. £18.—"Somerset," Dorking Rd., Chilworth, Surrey. [6821]

TRACTIONAL H.P. motors, large quantities required but open to purchase any quantity; cash with order or advertisers would consider financial assistance to manufacturers in production.—Write BCM/MTL, London.

47SWG enamelled copper wire very urgently wanted in large and small reeled quantities, good prices paid, cash by return.—Send immediately to Televox Sound Service, 37, Albert Rd., Southsea, Tel. Portsmouth 73348.

STRATTON & Co.—Wanted, any quantity up to 2cwt of Litz wire 27/48 swg double silk covered.—Anyone who can supply, kindly write Stratton & Co., Ltd., Eddystone Works, Alvechurch Rd., W. Heath, Birmingham, 31.

LAMINATIONS, Lohys or similar, E's 1 1/2in x 1in x 1/8in limbs, U's 2 1/2in x 1 1/2in x 1/8in, T's to match with 1/8in limb, all 0.014 or 0.018 thick, required urgently for transformers holding up overseas orders.—Tel. call or write, Pole, 419, Montrose Avenue, Slough, Bucks. Tel. Slough 21381. [6689]

WE buy for cash, new, used, radio, electrical equipment, all types, especially wanted, radios, radiograms, test equipment, motors, chargers, recording gear, etc.—If you want to sell at the maximum price, call, write or phone to University Radio, Ltd., 22, Lisle St., Leicester Sq., W.C.2. Ger 4447.

REPAIRS AND SERVICE

LOUDSPEAKER repairs, British, American, any make; moderate prices.—Sinclair Speakers, 12, Pembroke St., London, N.1. Terminus 4355. [3308]

MAINS transformers rewound, new transformers to any specification.

MOTOR rewinds and complete overhauls; first class workmanship, fully guaranteed.

F. M. ELECTRIC Co., Ltd., Potters Bldgs. Warner Gate, Nottingham. Est 1917. Tel. 3855

MAINS transformers rewound and constructed to any specification; prompt delivery.—Brown, 3, Bede Burd Rd., Jarrow. [3460]

WE magnetise P.M. speaker units for the trade, large or small quantities, present delivery within 7 days; consult us with your magnetising problems.

A. J. PRATT & SONS, Ltd., 7, Woodbridge St., London, E.C.1. [6419]

COIL winding machines for hand and power operation; reasonable delivery times.—Radio & Electrical Services, 39, St. George's Rd., Reading. [6763]

REWINDING and conversions to mains and output transformers, fields, etc., from 4/6; pp equipment a speciality.—N.L. Rewinds, 4, Brecknock Rd., N.7. Tel. Arnold 3390. [6283]

ELECTRICAL measuring instruments skillfully repaired and recalibrated, immediate delivery.—Electrical Instrument Repair Service, 329, Kilburn Lane, London, W.9.

REPAIRS to moving coil speakers, cones, coils fitted, field rewind or altered; speaker transformers, clock coils rewound, guaranteed satisfaction, prompt service.

L.S. REPAIR SERVICE, 49, Trinity Rd., Upper Tooting, London, S.W.17. [4819]

SERVICE with a Smile.—Repairers of all types of British and American receivers; coil rewinds; American valves, spares, line cord.—F.R.I. Ltd., 22, Howland St., W.1. Museum 5675. [1575]

LOUDSPEAKER repairs, any make, reasonable prices, prompt delivery to the trade and quality fans; 25 years' combined experience with Rola, Magnavox, Goodmans, Celson.—Sound Service Radio, 80, Richmond Rd., Kingston-on-Thames. Kin. 8008. [4977]

'WEYMOUTH' MIDGET I.F.

Q = 120

Size 2" x 1" x 1" Tropically impregnated pots, cores and coils (Litz). Of outstanding efficiency and stability. Available from your local dealer.

RETAIL PRICE 18/9 pr.
WEYMOUTH RADIO Mfg. Co. L'd.
CRESCENT ST., WEYMOUTH

Announcing—
ORMOND SPARKS' W.B. SPEAKER

A New 12in. Wide-Band Fidelity Speaker. Specially designed and produced by the makers of the famous "Stentorian" Speaker for use with several of my Data Sheet Designs. This New Model, Type 5/WB.12, is an improved version of the one so often inquired about at my demonstrations.

Rigid Die-cast Chassis. Precision rear suspension. Alcomax II Magnet. Flux density 14,000 gauss. Impedance 15 Ohms at 1,000 c.p.s. Max. Power Capacity, 15 watts peak. 12in. Model.

PRICE £7-0-0.

Transformer 30/-. (Packing and Carriage extra.)
Demonstrations arranged. Phone: Lee Green 0220.

SPARKS' DATA SHEETS
9 PHOEBETH RD., BROCKLEY, LONDON, S.E.4

V 55 R COMMUNICATION RECEIVER
An All-British Designed and Modified Ex-R.A.F. 1155
Superheterodyne

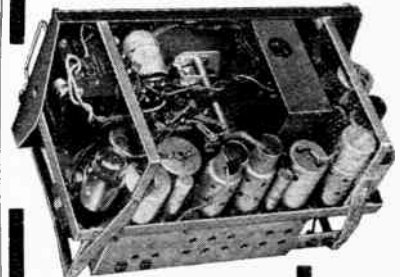

9 Valves. 5 Switched Bands
3 1/2 Watts Output A.V.C. B.F.O.
FULLY TROPICALISED

A Receiver for Commercial, Amateur, or Overseas Listener.
EARLY DELIVERY

Write **RADIOVISION (LEICESTER) LTD.**
58-60 RUTLAND STREET,
LEICESTER, ENG.

BRYCE TRANSFORMERS

(Patent Applied for)

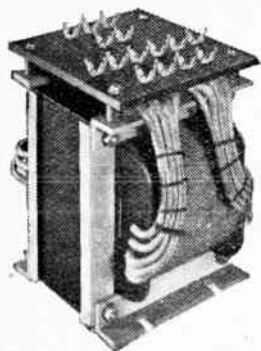

The AA2 Series of Bryce Transformers have been designed to cover a very wide range of application consistent with high percentage efficiency performance under difficult conditions. All windings are layer wound and interleaved, and coils are finally pre-heated and thoroughly dried out before being vacuum waxed or varnish impregnated.

Send for leaflet giving full specification.

W. ANDREW BRYCE & CO. LTD.
Shenley Road, Boreham Wood, Herts
Telephone: ELStree 1875 & 1117.

EX-GOVT. SETS OFFERED AT FRACTION OF ORIGINAL COST!

1 1/2 METRES 10 VALVE SUPERHET UNITS



7 GNS.

Carriage paid. Cash with Order

Special discounts to Trade, Radio Societies, etc., in lots of 25 or more receivers.

IDEAL FOR CONVERSION INTO

TELEVISION RECEIVERS

CIRCUIT COMPRISES

1 Pre. amp., Osc., Mixer, 5 I.F., Det., Video Amp. I.F. Frequency 12 Mc/s, Band-Width 4 Mc/s, Co-axial input and output sockets. External source of L. T. and H.T. supply is required. Manufactured to stringent Government specification by such famous makers as R.G.D., Pye and Murphy. Brand new and unused in Manufacturers' sealed cartons. Complete with 10 Mazda Valves.

WIRELESS INSTRUMENTS (LEEDS) LTD.

54-56 THE HEADROW, LEEDS, I

— Tel.: 22262 —

COLL specialists.—Tuning and oscillator coils, i.f. transformers, etc., rewound or wound to specification.—Electronic Services (R.T.R.A. Service Section), 17, Arwenack St., Falmouth, Cornwall. [6586]

STURDY rewinds, mains transformers, chokes and fields; we give prompt delivery and guarantee satisfaction; 14 years' experience; prices on request.—Sturdy Electric Co., Ltd., Dipton, Newcastle-on-Tyne. [4316]

REWINDS, mains transformers, speaker, field coil chokes, high-grade workmanship, 7-day delivery; new transformers constructed to customers' specification, singly or in quantities.—Metropolitan Radio Service Co., 1021, Finchley Rd., N.W.11. Speedwell 3000. [3719]

24-HOUR service, 6 months' guarantee, any transformer rewind, mains outputs and i.f.s., etc., all types of new transf., etc., supplied to specification; business heading or service card for trade prices.—Majestic Winding Co., 180, Windham Rd., Bournemouth.

LOUDSPEAKER repairs.—A.W.F. give prompt service on most types of loudspeakers and horn units, at reasonable charges, to the trade.—Don't write, send complete speakers and horn units only to A.W.F. Radio Products, Borough Mills, Bradford, Yorks. Tel. 11926. [5455]

REWINDS, mains transformers, layer wound wax impregnated, O/P transformers, chokes, fields, clock coils, pick-ups, fractional hp motors, competitive prices; prompt delivery; guaranteed work.—W. Groves, Manufacturing Electrical Engineer, 154, Icknield Port Rd., Birmingham, 16. [4547]

LOUDSPEAKER repairs. All types repaired at keen competitive prices, field coils rewound to any resistance and fitted; send your speakers for guaranteed satisfaction to I. Cottenham, Loudspeaker Repair Factory, Whetley Lane, Bradford Yorks. Your enquiries will receive our immediate attention.

ALL makes and kinds of electrical and radio measuring instruments repaired by skilled technicians. A.I.D. approved; all work quoted by return without charge. Also for sale, large variety of voltmeters, ammeters, milli-ammeters, 2in and 2 1/2in dial, reconditioned ex-Air Ministry stock.—W. O. Prescott, Ltd., Dept. D, 29-31, Cowcross St., E.C.1. Tel. Cle. 6783. [6205]

NATIONAL RADIO SERVICE & TELEVISION CO.—Trade service engineers; immediate service any district; rewinds to all types transformers, armatures, motors, loudspeaker cones, speech coils fitted; British and American components and valves; enquiries invited for contract trade service; multiple transformer winding.—63, High St., St. John's Wood, N.W.8. Primrose 6725. [6752]

TRANSFORMER rewinds, trans. replacement coils, machine layer wound on bakelite former, interleaved, impregnated and clearly marked; rewinds 21, standard windings to 70watts, coils 15/£, extra secondaries and larger types pro rata; new transformers or chokes to specification singly or in quantity; trade list on application; delivery by return of post most types; state model and iron sizes when ordering coils, pick-up coils, O/P trans., field coils, etc., rewound or replaced; fully guaranteed.—Radio Services, Field St., Works Blackpool. R.T.P.A. Service members Ph 1250

DEGALLIER'S, Ltd.—Service with a guarantee; if you cannot get your receiver serviced, let American specialists do the job; first-class workmanship only; specialising in Air-King, Belmont, Challenger, Delco, Detrola, de Wald, Emerson, Ferguson, Garod, Hallcraftler, Hammerlund, Lucille, McMurdo Silyer, Midwest, Majestic, Pilot, Philco, Scott, Spartan, Stromberg Carlson, R.C.A., etc., also any British or Continental set; due to lack of accommodation our service branches are still dispersed; therefore apply for forwarding instructions before despatching sets; s.a.e. with all enquiries.

DEGALLIER'S, Ltd., 9, Westbourne Court, London, W.2. [6410]

WORK WANTED.

RADIO consultant at your service, moderate fees, s.a.e.—Box 5741. [6829]

RADIOGRAMS and wireless cabinets made to order for home and export.—Box 3033.

ARTIST-DESIGNER, experienced in modern interior design, seeks contact with manufacturers interested in new ideas for cabinet design.—Box 4406. [6513]

FOXWINDERS, 74A, East Hill, Wandsworth, S.W.18, are now able to quote you for your light press work, blank form or piercings, also castpan work, milling, turning and guillotining. [6211a]

TECHNICAL illustrations, production drawings and circuit wiring diagrams prepared promptly and confidentially.—Ashley Drawing Office, Ltd., 4, Totnes Villas, Telford Rd., London, N.11. [6679]

Summary of

G.L.

Equipments

1. AC/Gram. 4 valve, 6 watts Home reproducer for records only Chassis built, complete with valves 6 gns.
2. AC/18. 12/15 watts P.P. Concert gram. amplifier, in case with cover 11 gns.
3. AC/18HG. Small P.A. Outfit. As No. 2, but with mic. stage £13 5 0
4. SOF/18. Cine Amplifier. As above plus P.E.C. input 15 gns
5. AC/24. General P.A., 20 watts P.P. with mic. stage. Electronic mixing, master gain control £16 5 0
6. TRF/AC Unit, in steel case with large tuning dial, for adding to any A.C. amplifier 5 gns.

Fully illustrated leaflets available on each. All equipments are wired and tested.

Microphones, stands, speakers, and all accessories to suit above equipments.

Transformers, chokes and outputs, for those who prefer to build their own designs—the finest range you could wish for.

FOR SERVICE ON SOUND LINES, CONTACT—

General Lamination Products

294, BROADWAY, BEXLEYHEATH, Kent.

RADIO CORNER

(Proprietor, T. B. WILLIAMS)

133 GRAY'S INN RD., LONDON, W.C.1
Terminus 7937

MAIL ORDER. Delivery by return. THE BANNER CHARGER, Type 1/1, 1 amp, ideal for Motorists, a really first-class job. Input 240 v A.C. Output 2, 6 or 12 v D.C., at £3. Designed for the motorist who likes to keep his batteries in tip-top condition.

RADIO VALVE MANUAL, giving American and British Valve Equivalents and Data. Price 3/6.

Radio Constructors Manual. Price 3/6.

Radio Tuner Unit Manual. Price 2/6.

Engineers and Electricians Handbook. Price 1/-.

Cathode Ray Oscilloscope Manual. Price 2/-.

Radio Reference Book. Price 12/6.

American Radio Valves. Types as under at controlled prices. 45Z5GT, 5Y3G, 1A5GT, 1C5GT, 1Q5GT, 1T5GT, 80G, 35Z5, at 11/- each. 6J5GT, 12J5GT, 1H5GT, 125F5GT, at 9/2 each. 6Q7GT, 12Q7GT, 125Q7GT, 75G, at 11/7 each. 125K7GT, 6K7GT, 6K6GT, 6V6GT, 42G, 43G, at 12/10 each. 6A7G, 6A8GT, 6K8GT, at 14/- each. Postage paid. Other types as they become available for distribution.

AMERICAN RADIO SERVICE MANUALS

Volume I. Spartan Emerson.

II. Crosley Belmont. Part I.

III. Crosley Belmont. Part II.

V. Emerson. Part II.

VI. Stewart Warren. FADA.

At 12/6 per Volume, or complete set of six manuals £3 12s. 6d. These Manuals cover the complete range of American Radio Receivers as given and are invaluable and contain all the technical data necessary.

Terms. Cash with Order only. We regret that we are unable to send goods C.O.D.

HILL & CHURCHILL LTD

BOOKSELLERS

SWANAGE, DORSET

Available from stock:—

Ghirardi, "Modern Radio Servicing"	37/6
Ghirardi, "Radio Physics Course"	37/6
Simon "Radio Service Trade Kinks"	17/6
Millman & Seely "Electronics"	27/6
Maloff & Epstein "Electron Optics in Television"	21/-
Cooke & Orleans "Mathematics Essential to Electricity and Radio"	18/-
Rider "Automatic Frequency Control Systems"	12/6
Aharoni "Antennae" Introduction to Their Theory	25/-

We have a large selection of English and American Books on RADIO and TELECOMMUNICATION.

CATALOGUE ON APPLICATION

QUARTZ CRYSTALS.

MAXIMUM ACTIVITY.
PRECISION BUILT UNITS.
GUARANTEED ACCURACY.
OSCILLATORS—RESONATORS
LABORATORY TYPES.
AMATEUR RANGES.
MANUFACTURERS SUPPLIED

BROOKES CRYSTALS LTD.

(ESTABLISHED 1929)
51/53 GREENWICH CHURCH ST., LONDON, S.E.10
PHONE: GREENWICH 1828

AMERICAN VALVES (NEW)

METAL—OZ4, 15/3 ea. 6S67, 6S17, 6SH7, 6F6, 6L7, 12/10 ea. 6SA7, 6K8, 14/- ea. 6SC7, 6L6, 18/3 ea. 12SK7, 12SJ7, 12SR7, 11/7 ea. 12SG7, 12A6, 12/10 ea. 12K8, 14/- ea. 6AC7/1852, 21/4 ea. 6C5, 6J5, 9/2 ea. 6H6, 6/9 ea. GT.—6SK7, 6K7, 6J7, 6K6, 12/10 ea. 6NS7, 6SL7, 18/3 ea. 12J5, 9/2 ea.
BUTTON BASE.—1R5, 1T4, 1S5, 1S/- ea. 9001, 9002, 9003, 1S/- ea. 6AG5, 6AK5, 6C4, 6J6, 1S/- ea.
ACORN.—955, 25/- ea. 954, 956, 35/- ea. BASON.—International Octal (Ceramic), 2/6 ea. BTG button bases (Ceramic) for 1R5, 6AK5, and 9001 series, 1/6 ea. American Acorn bases for 955, 954 and 956, 2/- ea. B9G Ceramic or Siliconised Polystyrene bases for EF50, etc., 3/- ea.
CERAMIC BASES for 832, 829B, etc., 5/3 ea. for 813 or S.T.C. 5C/100 A, 8/9 ea.

Packing and Carriage extra.
LARGE STOCKS OF TRANSMITTING TUBES

TELE-RADIO (1943) LTD.

177, Edgware Road, London, W.2
Telephone: PADdington 6116

PLEASE NOTE.—Above is our only address—we are in no way associated with any other company of similar name.

THE name to note for all kinds of radio, and electrical metal work to specification, modern rustproof, all shapes and sizes undertaken, and for tropical use; components and sub-assemblies executed to meet recognised wiring and material standards; consultation, advice without obligation.—Write Dept. 23, Sea Rescue Equipment, Ltd., Chiltern Works, Clarendon Rd., Watford, Herts. [5977]

TUITION

ENGINEERING careers and qualifications.

BOTH Government and industry have announced and emphasised that young men with technical knowledge and qualifications must receive every chance to rise to the highest positions within their capacity, in post-war engineering and allied industry; write to-day for "The Engineer's Guide to Success"—200 courses free—which shows you how you can become A.M.I.E.E., A.M.I.A.E., A.M.I.Mech.E., A.F.R.Ae.S., etc., and covers all branches in radio, automobile, mechanical, electrical, production, aeronautical, etc.

THE Technological Institute of Great Britain, 82, Temple Bar House, London, E.C.4. [4918]

RADIO training.—P.M.G. exams, and I.E.E. Diploma; prospectus free.—Technical College, Hull [0611]

RADIO Engineering, Television and Wireless Telegraphy, comprehensive postal courses of instruction.—Apply British School of Telegraphy, Ltd., 179, Clapham Rd., London, S.W.9 (Est. 1906). Also instruction at school in wireless for I.I.M. Merchant Navy and R.A.F. [9249]

ENGINEERING Opportunities, free 112-page guide to training for A.M.I.Mech.E., A.M.I.E.E., and all branches of engineering and building; full of advice for expert or novice; write for free copy and make your peacetime future secure.—B.I.E.T. (Dept. 387B), 17, Stratford Place, London, W.1. [6272]

THE Institute of Practical Radio Engineers have available Home Study Courses covering elementary, theoretical, mathematical, practical and laboratory tuition in radio and television engineering; the text is suitable coaching matter for I.P.R.F. Service entry and progressive exams; tuition fees at pre-war rates—are moderate.—The Syllabus of Instructional Text may be obtained, post free, from the Secretary, 20, Fairfield Rd., Crouch End, N.8. [6222]

SITUATIONS VACANT

R.F. EQUIPMENT, Ltd., has vacancies in their Radio Development Laboratories. 1. ENGINEER to carry through to mass production coil designs to requirements of Receiver Design Department. Capable of working to general guidance and controlling non-technical assistants.

2. ENGINEER with experience in testing of radio receivers for testing of prototype models and also general development work.

WRITE Personnel Manager, R.F. Equipment, Ltd., Langley Park, near Slough, Bucks, stating age, experience and salary required. [6736]

ELECTRONIC technician for development laboratory in West Country; experience with television and allied circuits essential.—Apply Box 4940. [6585]

RADIO production testers required for 12-valve advanced radiogram, first-class men only. 5-day week.—Apply Dynatron Radio, Ltd., Ray Lea Rd., Maidenhead. [6691]

TECHNICAL author required, with experience in writing radio servicing technical literature.—Write, giving experience and salary required, to Box 5569. [6694]

COMPETENT radio service engineer required with experience on all makes receivers; television knowledge useful; North London area.—Write Box 5572. [6705]

LABORATORY assistant required immediately by manufacturers of mercury vapour discharge appliances; experience in electronics an advantage.—Detailed application to Box 5633. [6755]

"TIME and motion study."—Well-known radio component manufacturers require time study man with experience in similar production.—Write, stating age, experience and salary required, to Box 5574. [6707]

WANTED, radio relay manager for new concession in northern town, must have some technical knowledge of the business, good appearance; reply stating experience, qualifications, age, etc.; expenses paid for interview.—Box 5581. [6721]

DRAUGHTSMEN, senior and junior, are required by large firm in London area; men with good experience of radio or light electrical engineering should apply, stating age, full details of experience and salary required, to Box 5570. [6699]

A.C.S. RADIO

A.C.S. RADIO have for many years catered for the enthusiastic radio experimenter and listener. In the short-wave field we offer a large range of components including such well-known makes as EDDYSTONE, RAYMART, HAMRAD, LABGEAR and WODEN. Prior to the War we imported many of the famous American Communications Receivers and hope to resume this side of our business as soon as importation is permitted, but in the meantime we hold a good selection of second hand equipment including NATIONAL HRO, NC81X, NC45, RME69, DB20, DM36; HALLICRAFTERS SX24 and similar types.

We invite your enquiries for all-wave receivers and radiograms and can usually offer such types as the American SCOTT and similar high-quality equipment.

Our fully detailed list "W" is revised every few weeks, and a copy will be posted free on application to A.C.S. Radio—

44 WIDMORE RD BROMLEY, KENT
Phone RAVensbourne Q156

POST-WAR TELEVISION

The advance in Radio Technique offers unlimited opportunities of high pay and secure posts for those Radio Engineers who have had the foresight to become technically qualified. How you can do this quickly and easily in your spare time is fully explained in our unique handbook.

Full details are given of A.M.I.E.E., A.M.Brit.I.R.E. City & Guilds Exams, and particulars of up-to-date courses in Wireless Engineering, Radio Servicing, Short Waves, Television, Mathematics, etc., etc.

We Guarantee "NO PASS—NO FEE"

Prepare for to-morrow's opportunities and post-war competition by sending for your copy of this very informative 112-page guide NOW—FREE.

BRITISH INSTITUTE OF ENGINEERING TECHNOLOGY (Dept. 388)

17, Stratford Place, London, W.1

RADIO HAMS!

If you have a radio query, and you need technical advice, send us S.A.E. with 2s. P.O. Reply by return. We have a large range of radio components, including Raymart Agencies.

10,000 VALVES 10,000

B.V.A. Controlled Prices—American.
One of the best selections in the country, sent by return of post. Send for free lists of Valves, and Comprehensive Book of Radio Components and Information.

PARCEL 1.—50ft. Aerial Wire, S.P. Flush switch, 1 dozen Valve Holders, Yaxley Type Switch 1 P., 3 W., 1 dozen yards Slewing, 2A 950 ohm Dropper, 12/6.

PARCEL 2.—2 dozen Assorted sizes .001 to .5 Condensers, 2 dozen 4-pin B.V.A. Holders, 3 Coils 50ft. Aerial Wire, 3 2A 950 ohm Dropper, 27/6.

VOLUME CONTROLS, all sizes, without switch, 2/6; with switch, 5/7.
Condensers, .0006 to 1.104.

1 mfd. 350 v. 1/9 4 mfd. 200 v. 1/6 8 x 8 mfd. 500 v. 6/6
1 " 450 v. 2/4 " 450 v. 3/6 8 x 16 " 500 v. 6/3
1 " 150 v. 2/3 4 " 600 v. 4/6 16 mfd. 450 v. 4/6
2 " 500 v. 3/3 8 " 150 v. 1/9 32 " 450 v. 5/9
" 8 " 500 v. 4/4

2A 950 ohm Droppers 4/6 50ft. Aerial Wire, evd. 1/-
3A 900 ohm Droppers 5/3 Slewing, dozen yds. 2/-
Fusulin 9d.; Amphenol 1/-; Valve Holders, all sizes. Speaker, 5in. P.M. 20/6. All sizes to 12in. in stock. Champion "Planet" Radio A.C./D.C. Midget, £16 6s. 8d.
Carriage paid under 10s. or over. C.O.D. or C.W.O. or Accounts opened.

H. RANSOM,

34, BOND STREET, BRIGHTON.
Phone: B'ton 5803.

DYNATRON RADIO, Ltd., Ray Lea Rd., Maidenhead, have vacancy for junior draughtsman required for advanced radio engineering, previous experience essential, excellent opportunity; 5-day week.—Apply Personnel Manager. [6692]

RADIO engineers for radio and television aerial installations in Greater London area; working knowledge of radio theory, good head for heights and driving experience; excellent opening for right men.—Box 5568. [6685]

FEMALE laboratory assistant required for electrical component and materials testing; age 25 or over.—Write, stating qualifications and experience, to Personnel Manager, E. K. Cole, Ltd., Southend-on-Sea.

ROYAL AIR FORCE—There are still several hundred vacancies for short service officers in the recently formed Education Branch. Candidates should be between 23 and 31 and should have a university degree in mathematics, physics or engineering.

A MAN age 25 may draw pay at £310, £347 or £420 a year on entry, according to qualifications and experience. In addition to pay single men receive free furnished accommodation and married men receive married allowance of £228; in both cases rations are provided in kind or a ration allowance of £57 a year paid in lieu.

A **GRATUITY** is payable on completion of 5 years' service. This will ultimately be £500 but for officers appointed until further notice it will be £562/10. Gratuity will be reduced for men in contributory service for civil teacher's superannuation by the amount of the superannuation contributions, which will be paid by the Air Ministry.

OPPORTUNITIES will arise for appointment to permanent commissions.

FULL details and application forms from Air Ministry (A.R.1), Kingsway, London, W.C.2.

SENIOR radio engineer required for laboratory of well-known firm in London area; required for the development of commercial radio for home and export markets; applicants must have ideas and initiative; a good salary & position for right man.—Box 5592.

PHYSICIST or electrical engineer required, with university degree or equivalent, for development and manufacture of small transmitting valves; recent graduate without experience interested in the above problems considered; work near London.—Box 5575.

DYNATRON RADIO, Ltd., Ray Lea Rd., Maidenhead, have vacancy for senior inspector (electrical and mechanical) for complete radio production, previous radio experience and exceptional abilities essential; ex-A.I.D. senior examiner preferred.—Apply Personnel Manager. [6690]

LARGE London firm requires engineer to take charge of electrical standards laboratory, previous experience in ac and dc bridge techniques, meter standardising and frequency of measurement is essential.—Reply, stating full details of technical qualifications, experience, age and salary required, to Box 5578.

DYNATRON RADIO, Ltd., Ray Lea Rd., Maidenhead, have vacancies for the following technicians: Senior inspector, production testers, junior designing draughtsman, production wiring foreman; only first-class men required for exceptionally advanced radio work, excellent prospects, good pay and amenities.—Apply Personnel Manager. [6693]

MURPHY RADIO, Ltd., have vacancies for engineers who should possess sound academic qualifications, and also have gained some years of experience in the development of radio and/or radar equipment.—Apply in the first place by letter, giving full particulars and indicating salary required, to Murphy Radio, Ltd., Welwyn Garden City, Herts.

RADIO instructors required to teach circuit theory and servicing of radio and radar apparatus, theoretical knowledge equivalent to City and Guilds intermediate standard with preferably some Radar and instructional experience; salary £275-£300, depending on age and experience plus consolidated bonus at present £78 per annum.—Write, giving age and full details of education, qualifications and experience, to the Captain, H.M.S. Collingwood, Fareham, Hants. [6823]

CONSULTING service, in course of formation, invites applications from experienced radio and electronic engineers willing to undertake spare time consulting work at home, remuneration by agreement; fullest confidence guaranteed. Applicants should have special knowledge of some branch of radio or electronics.—Write for further details, giving brief summary of qualifications, to Technical Advisory Bureau, 42, Barn Lane, Colborne, N. Warrington. [6664]

GALPINS

GOVERNMENT SURPLUS ELECTRICAL STORES

408 HIGH STREET, LEWISHAM, LONDON, S.E.13

Telephone: Lee Green 0309. Near Lewisham Hospital.

TERMS: CASH WITH ORDER. NO C.O.D.

ELECTRIC LIGHT CHECK METERS, for 200/250 A.C. mains, 50 cycles 1 phase, for garages, sub-letting, etc. 5 amp. type, 12/6; 10 amp., 15/-; 15 amp., 20/-; 20 amp., 25/-; 25/30 amp., 30/-; 50 amp., 45/-; 100 amp., 55/- All 1/6 each carriage.

"**WESTON**" Moving Coil Meters, edge type, 2 1/2 in. scale, 0 to .3 amps, 30/-; 0 to 2 amps., 27/6; 0 to 60 volts, 27/6; 0 to 150 volts, 27/6; all have F.S.D. of 2 m/amps.; 0 to 1 volt, 1 m/a. F.S.D., 35/-; another 3 1/2 in. scale reading decibels 50 microamps., F.S.D., 70/-, another 301 model 0 to 3 m/a., 40/-; 0 to 50 m/a., 35/-; 0 to 200 m/a., 35/-.

EX-G.P.O. REPEATERS, CARRIER TELEPHONE TYPE No. 2. These are complete with valves and power pack for A.C. mains or battery working, consisting of 2 6v6's, 2 EF50, 12-volt Mallory Vibrator with necessary smoothing. New and unused, size 14 x 16 1/2 x 20 in., weight 127 lbs. £7/10/- each. Carriage 10/-.

ERNEST TURNER, moving coil m/amp. meters, 2 in. scale, 0 to 10 m/a., 0 to 20 m/a., 0 to 50 m/a., 27/6 each; all fully guaranteed. Standard Telephone 3 in. scale m/coil meters, calibrated to read 0 to 25, 100 volts movement, 1 m/a., incorporating metal rectifier, 45/- each.

EX-G.P.O. PORTABLE SINGLE CHANNEL CARRIER TELEPHONE SYSTEM, TYPE SOG-1A (Active). These units are new and unused, consisting of all valves, 6D6, and cold rectifier, A.C. mains input, complete in metal case, 14 1/2 x 11 1/2 x 11 in., price £3/10/- Carriage 5/-.

SMALL ELECTRIC MOTORS for A.C. or D.C., 80/100 volts, useful for sewing machines, Pathe Cine's, etc., double ended shaft, 30/- each.

PUBLIC ADDRESS RIBBON MICROPHONES, by well-known makers, £3/10/- each.

LARGE TYPE RECTIFIERS "METAL" Outputs 12 volts 4 amps., 42/6. 12 volts 6/8 amps., 55/-; 50 volts 2 amps., 42/6; 12 volts 2 amps., 32/6. "Mains Transformers" tap to input 200/250 volts, 6, 12, 24 volts 6/8 amps. output to suit the anode, 12 volt Rectifiers, 40/- each. 2/- carriage. Transformer to suit the 50 volt type, 42/6. Carriage 2/6.

VOLTAGE CHANGER TRANSFORMERS. Auto-wound, fully guaranteed, immediate delivery. 350 watts, 55/-; 500 watts, 70/-; 1,000 watts, £5/15/-; 2,000 watts, £8/15/- All tapped 0, 110, 200, 220 and 240 volts.

MAINS TRANSFORMERS, all by well-known makers and fully guaranteed, input 200/250 volts, 50 cy. 1 phase: output 2,000/2,000 volts at 250 m/amps. with 2 L.T. tappings, 75/- Ditto, 475/0/475 volts at 150 m/amps., with 3 L.T. tappings, 4 v. and 6 v., price 47/6. Ditto, 80, 100, 120, 140, 200, 220, 240 volts at 3,000 watts, £12/10/- Ditto, 6, 16 volts at 14/90 amps. output, £15. Transformer cores, suitable for winding 2,000 watts, 27/6; 100 watts, 7/6 each.

EX-R.A.F. CHASSIS 10 VALVES (sold for components only), consisting of octal valve holders, 28 resistances (various), 30 condensers (various), all mounted on a metal chassis, size 12 in. x 8 in. x 2 1/2 in., price 8/6 each. Carriage 1/-.

EX-G.P.O. PRE-UNISELECTORS, 3 ohm automatic relay operating a 4-way Yaxley switch, fitted with 2 condensers, 01, 1 1/2 M.F., new, boxed, 5/- each. G.P.O. Polarised Telegraph Sounders in new condition, 15/- each. G.P.O. Polarised Relays, operating on 10/20 m/amps. coil resistance, 230 ohms, 15/- each, as new.

SHORT WAVE H.F. CHOKES, 1/6; H.F. chokes, 1/-; 01 condensers, 4/- per doz. R.I.3 to 1 L.F. transformers, 6/-; condensers, 1 M.F., 1/3; 2 M.F., 2/-; 4 M.F., 3/6; 10 M.F., 5/6 each; smoothing chokes, 20/30 henrys, 80/100 m/amps., 8/6; electrolytic condensers, 80 M.F. 350 v. wkg., 7/6; 500 M.F. 50 v. wkg., 8/6.

USEFUL PANELS, consisting of chokes, resistances, mod. transformers, condensers, calibrated to decibels, and various other components, all mounted on metal baseplate, size 19 x 5 x 5, 10/- each, post 2/6; 19 x 8 x 5, 15/- each, post 2/6; 19 x 12 x 5, 20/- each, carriage 3/6. All components as new. Makers Standard Telephone.

EX-GOV'T. ROTARY CONVERTERS, input 12 to 18 volts D.C. at 3 1/2 amps., output 450 volts

60 m/amps., fitted with automatic switching and smoothing, 32/6 each. 2/6 carriage. Also a few only to clear, as above, but without brushes or brush caps, at 20/- each, post 2/6.

INDUCTION MOTORS, approx. 1/16th h.p. 100 volt A.C. mains only. Can be used with a series resistance of approx. 50 ohms to work off 200,230 volts A.C., price 25/- each. Carriage 1/6.

ROTARY CONVERTERS, D.C. to A.C., 20 volts D.C. to 75 volts A.C. at 250 m/amps., large size, weight 45 lbs., well-known makers, make useful rewinds, 45/- each. 5/- carriage.

X-RAY TRANSFORMERS, 100/250 volts 50 cy. 1 ph. input, 90 kv. at 2 1/2 kW. output, with Coolidge winding, small size, in oil, £25 each Carriage forward.

D.C. MOTORS, approx. 1/4 h.p., either 110 v. or 230 volt, D.C. mains, series wound, 20/- each. Post 1/6. Mostly with laminated fields.

EX-G.P.O. 2-TONE CONTROL UNITS. Consisting of 3 6v6's in Class AB—2 6v5G's, 8 WX6 Westectors, power pack, consists of Mallory 12-volt rectifier with all the necessary smoothing gear, numerous condensers and resistances, all in new condition, £5/12/- each C/P.

STEEL RACKS. Useful as transmitter racks, size 40 in. x 2 1/2 in. x 16 in., 30/- Ditto, 58 in. x 33 in. x 18 in., 70/- Carriage on all types, 7/6.

ELECTRIC DESK FANS. Large type, 220 volts D.C., with a 15 in. blade, 50/- each, carriage 5/- Ditto, 100 volt, induction type, for A.C. only, 12 in. blade, 35/-, carriage 3/6.

MOVING COIL HORN SPEAKER UNITS, by well-known makers, 15 ohm. speech coil, permanent magnet type, 12/6 each, post 1/6. Smoothing chokes, 20 henry, 40/60 m/a., 4/- each Bakelite Valve Holders, 4-pin type, in lots of 50 only, 12/6. Post 1/-.

EVERETT EDGUMBE 3 READING VOLT-METERS, 0 to 5, 25, and 250 volts, 4 in. scale, complete in teak wood carrying case, 50/- each. One only, Ship's Sextant (Makers, H. Hughes), condition as new, £8/10/-.

ROTARY CONVERTERS. Ex-Gov't. 80 volts at 16 amps. D.C. input, 80 volts at 8 amps. 2,000 cycles output, £5 each, carriage 10/- Another. 460 volts D.C. input, output 300 volts 50 cycles 1 phase at 4 kilowatts, constant rating, condition as new, £20, C/F.

LARGE SIZE 1 MFD. CONDENSERS, at 4,000 v. wkg., 10/- each, carriage 2/6. "Selenium Rectifiers," output 200 volts at 1 amp., half-wave type, 27/6 each. Instrument Rectifiers, 5 m/a., and 10 m/a., 4/6 each. Ex-G.P.O. Multi-Contact Relays, 5/- each.

EX-G.P.O. HANDSETS. The latest type (black bakelite), 10/6 each, post 1/- Single earphones, low resistance, with headbands, 4/6 each. Ditto, 2,000 ohms, 7/6 each. Bell Boxes, standard pattern, 6/6 each. Ballast lamps, 125 volts 30 watts or 100 ohms resistance, F.S. holder, 6/- per dozen.

EVERETT EDGUMBE 2 1/2 in. METERS, 0 to 5 volts AC/DC, incorporating Westinghouse Rectifier, 47/6. Ditto, calibrated in decibels +3-10, with rectifier, 65/- Another reading 15-0-15 m/amps., 35/- Ditto, 30-0-30 m/amps., 35/- These meters are all first grade moving coil instruments.

VARIABLE RESISTANCES, worm wheel drive, 2,000 ohms, to carry 250 m/amps, 35/- each. Electrolytic Condensers, 2,500 mf., 25 v. wkg., 25/- each; 250 mf. 250 v. wkg., 15/- each.

MAINS TRANSFORMER, 200/250 v. Primary, 500/0/500 v. at 150 n.a., 4 v. 4 a., 5 v. 3 a. and 6 v. 5 amps., 55/- Ditto, 350/0/350 volts at 100/120 m/amps, 4 v. 4 a., 5 v. 2, 6.3 v. 4 amps., 32/6. Ditto, 6 and 12 volts at 3/4 amps., 30/- each.

MALLORY 12-VOLT VIBRATORS. New and unused, 7/6 each. Twin gang, .0001 mf. Variable Condensers, 10/- each. Ditto, .00015, 12/6 each (well-known makers).

Other items in stock, for which please let us quote. 250 watt Transmitter Valves, Battery Valves, Switchboard Volt and Ampmeters, Dynamos, Regulators, Transformers to your requirements, complete X-Ray Apparatus, etc., etc. Please note that all items advertised are guaranteed unless otherwise stated. Terms strictly cash with order. C.O.D. not accepted.

DEMONSTRATIONS DAILY
of
"Lowther-Voigt"
RADIOGRAMPHONES
TUNERS
AMPLIFIERS etc.
at
LOWTHER MANUFACTURING CO.
BROMLEY, KENT
Ravensbourne 5225

THIS — Does these —



ACCURATELY and QUICKLY (hasas, Brackets, hoods, Condenser and Transformer clips — **TREPPANING** Steel or Aluminium. Five sizes—12" to 36" Full particulars from:
A. A. TOOLS, (W),
197A, WENTWICK ROAD
ASHTON-UNDER-LYNE

MIDLAND INSTRUMENT CO.
Specialists in the supply of highest grade:—
INSTRUMENT WIRES
Send for current stock list. Trade supplied. A'so hundreds of other interesting Radio and Electronic items. Lists 2d. with s.a.e.
18, Harborne Park Rd., Birmingham, 17.
Tel: HARborne 1308 or 2664.

METAL CABINETS
Now delivering ex stock, latest design Steel Cabinets with louvred back and sides, hinged lid. Complete with Aluminium Front Panel size 19" by 10 1/2" and finished in Black Ripple. Supplied packed flat for safe transit, can be assembled in a few minutes. Price only **60/-** each, plus 2/6 packing and postage. Aluminium Chassis to fit, size 17" by 10" by 2" deep **6/-** (if ordered separately, plus 1/- packing and postage). Aluminium Panel Brackets 7" by 7 1/4" per pair (separately. 9d. extra packing and postage).

Please include P.O. or M.O. with orders for despatch same day, and give name and address in block letters. Smaller sizes will be announced later, also metal handles.

Do try to VISIT us—we're the top of the list for components!

WIRELESS SUPPLIES UNLIMITED
264-286, OLD CHRISTCHURCH ROAD,
BOURNEMOUTH, HANTS.

**MIDGET IRON
CORED COILS**
GIVING MAXIMUM GAIN & SELECTIVITY

AERIAL AND OSCILLATOR, short, medium, or long wave, size 1 1/2 in. x 1 1/2 in. 7/6 pair.

AERIAL AND OSCILLATOR, medium or long wave, size 1 1/2 in. x 1 1/2 in. 6/9 pair.

DUAL WAVE COILS, medium and long wave aerial and h.f. 9/6 pair.

I.F. TRANSFORMERS, Standard Frequency. 465 K/c/s. Size, 1 in. diam. x 1 1/2 in. high. 9/6 each.

All coils fitted with adjustable iron cores.

TERMS : Cash with order or C.O.D. on orders over £1. Postage free

MONOCHORD RADIO
235, Streatham Road, London, S.W.16

CHIEF research engineer required by established company of repute manufacturing deaf aids and acoustic equipment, experience of circuit design, audio-oscillators, acoustic measuring instruments, excellent laboratory facilities available in modern factory W. London; salary £650-£800 with expansion; only first-class men should apply, stating age and full experience.—Box 5576. [6709]

THE Civil Service Commissioners announce that a special competition will be held for appointments as Assistant Engineer (new style)—male—in the Post Office Engineering Department and Assistant Traffic Superintendent in the Telephone Department of the General Post Office. Approximately 100 vacancies in each grade will be filled by examinations spread over a period of two or three years.

CANDIDATES must have been born on or after the 2nd August, 1915, and have attained the age of 18 by the 1st January of the year in which they compete. Allowance will be made for service in H.M. Forces prior to 3rd September, 1939.

MEN only are eligible to compete for appointment as assistant engineer (new style).

THE salary scales are as follows:—**ASSISTANT** engineer (new style): London, £280, rising by annual increments of £20 to £580; Provinces, £265, rising by annual increments of £20 to £560 (including consolidation addition).

ASSISTANT Traffic Superintendent:—Men: London, £190, rising by annual increments of £18 to £465; Provinces, £180, rising by annual increments of £18 to £435. Women, London, £190, rising by annual increments of £12 to £375; Provinces, £180, rising by annual increments of £12 to 345, to which is added a consolidation addition ranging from £78 at the minimum to £90 at the maximum for men over 21, with corresponding addition from £63 to £72 for women over 21. For men and women below the age of 21 the additions are as follows:—Age 18, men £47, women £47; age 19, men £55, women £55; age 20, men £63, women £59.

MALE candidates may apply to compete for appointment as assistant engineer (new style) and assistant traffic superintendent at the same examination.

THERE will be prospects of promotion to higher grades.

CANDIDATES now serving in H.M. Forces must send in their application forms in time to reach the Civil Service Commission not later than six months after the completion of their service. All other candidates must send them in by 1st April, 1947, except that for candidates who are under 18 years old on the 1st April, 1947, the latest date for sending in the form is the 1st January following their 18th birthday.

COPIES of the regulations and forms of application may be obtained from the Secretary, Civil Service Commission, Burlington Gardens, London, W.1, or from the Chief Officer, Civil Service Commission, at the following addresses, quoting No. 1679:—

(INDIA): 10, Underhill Lane, Delhi.
(EGYPT): 8, Sharia Tolombat, Garden City Cairo.

(ITALY): C/o G.H.Q., C.M.F.
(GERMANY): C/o 2nd Echelon, G.H.Q., B.A.O.R. [6723]

ENGINEERS with experience of design of electronic test equipment required by large London firm; previous experience in the design of test equipment for radio or radio components industry is essential.—Reply, stating full details of technical qualifications, experience, age, salary required, to Box 5579.

MODEL shop foreman required for large manufacturing group; tool room and press shop experience essential and at least five years' experience in development of small electro-mechanical devices; applicant must have initiative and be able to take charge; position offers interesting work and good prospects for the successful applicant.—Box 5666.

BRITISH OVERSEAS AIRWAYS CORPORATION require radio and radar mechanics overseas, Grade 1 City and Guilds standard, essential, starting basic salary £25/16, plus overseas pay £104 per annum, and substantial station allowances which approximate to a further £300 a year.—Write, with details of experience and equipment serviced, to Staff Appointments Superintendent, Stratton House, Piccadilly, W.1, marking envelopes "Radio" and enclosing stamped addressed envelope [6730]

SITUATIONS WANTED

SIGNALS officer (R.A.F.), 26 yrs., married, requires remunerative and progressive post. ex-app. (R.A.F.), 10 yrs. experience all R.A.F. radio comms. C. & G. Final standard, first-class administrator and organiser, available March.—Box 4901. [6570]

ENGINEERING OPPORTUNITIES



This unique handbook shows the easy way to secure A.M.I.Mech.E., A.M.Brit.I.R.E., A.M.I.E.E., City and Guilds, etc.

WE GUARANTEE—
"NO PASS—NO FEE."

Details are given of over 150 Diploma courses in all branches of Civil, Mech., Elec., Motor, Aero., Radio, Television and Production Engineering, Tracing, Building, Govt. Employment, R.A.F. Maths., Matriculation, etc.

Think of the future and send for your copy at once—FREE.

B.I.E.T., 387, SHAKESPEARE HOUSE,
17, STRATFORD PLACE, LONDON, W.1.

BEEHIVEN ELECTRIC EQUIPMENT LIMITED



Beethoven RADIO

BEEHIVEN WORKS, CHASE ROAD, LONDON, N.W.10



WE APOLOGISE to those who have been waiting months for replies. Our post-war plans have been frustrated so far. Sorry!

VOIGT PATENTS LTD.

Be WISE and PATIENT

WARD ROTARY CONVERTERS

For Radio, Neon Signs, Television, Fluorescent Lighting, X-ray, Cinema Equipment and innumerable other applications

We also manufacture:—

Petrol Electric Generating Plants, H.T. Generators, D.C. Motors, etc., up to 25 K.V.A.

CHAS. F. WARD

37, WHITE POST LANE, HACKNEY WICK, E.9
Telephone: Amherst 1393

TRANSFORMERS & COILS TO SPECIFICATION.

MANUFACTURED OR REWOUND.

STANLEY CATTELL LTD.

9-11 East Street, TORQUAY, Devon

Phone: Torquay 2162.



BATTERY CHARGERS and TRICKLE CHARGERS

Trouble-free Chargers fitted with selenium all-metal rectification. Good allowance on your old Charger. Thirty years experience behind every Runbaken product. Booklet R. 15 describing 12 Models on request.

RUNBAKEN MANCHESTER 1

EX-RADAR specialist officer (27), married, seeks technical-executive post in progressive concern; C. and G. Final standard in tele-communications, wide practical and administrative experience including research; interest in reorganising and direct control where initiative is essential.—Box 5704. [6795]

PETTY officer telegraphist, diploma City and Guilds final radio communication, release early February, 1947; practical experience transmitter maintenance, but any technical position with prospects considered, preferably Scotland, licensed amateur, willing work hard.—Box 5317. [6698]

EX-R.E.M.E. staff sergeant, armament artificer, 31, 2 years' theory Military College Science, 4 years charge large Radar workshop, awarded B.E.M. for Radar work, 8 years' pre-war radio experience, excellent testimonials, seeks progressive position, Southern Counties preferred.—Box 5591.

CHIEF engineer with leading hearing aid manufacturers seeks executive position in electronic field with wider scope for setting up research, production and service depts. on sound engineering lines; ex-R.A.F. F./Lt. Radar latterly directly responsible for all British development on M.I.T. designed, American built, G.C.A. equipment; extensive pre-war laboratory experience in radio, television and measuring instrument fields.—Box 5703. [6794]

PUBLIC NOTICE

UNIVERSITY College, Southampton.

DIPLOMA in Electronics.

AN advanced course of honours degree standard covering the entire field of electronics, with special emphasis on receiver design and line technique, will commence on October 6th, 1947. THE course will be full-time for one academic year. The College will grant a diploma by examination to students who successfully complete the course. Entry qualification is normally a University degree or its equivalent. Further details may be obtained from the Registrar. [6810]

TECHNICAL TRAINING

A.M.I.E.E. City and Guilds, etc., on "No Pass—No Fee" terms; over 95% successes; for full details of modern courses in all branches of electrical technology send for our 112-page handbook, free and post free.—B.I.E.T. (Dept 388A), 17, Stratford Place, London W.1 [6270]

PATENT AGENTS

A. E. HILL, chartered patent agent, 27, Chancery Lane, London, W.C.2 [4368]

BUSINESSES FOR SALE OR WANTED

RADIO, cycle and electrical business for sale, in developing neighbourhood; modern double-fronted shop with flat containing 3 bedrooms, 1 reception room, kitchen and bathroom; gross takings £1,000 per annum, audited accounts; price for goodwill, fixtures and fittings, £350 s.a.v.; price for freehold of the premises £3,000; mortgage can be arranged.—H. D. S. Stiles, F.S.I., F.A.I., 22, Ship St., Brighton. [6764]

AGENCIES

RHODES.—Radio engineer setting up wholesale and retail business wishes to contact first-class radio set manufacturers to arrange import.—Manolacakis Apostolas, Rhodes, Doleranese, Poste Restante. [6688]

AGENCIES WANTED

RADIO and electric goods manufacturers interested appointing sole distributors in India, may correspond, with full terms, etc., with Bhagwan Dass Verma, 56, Lower Bazaar, Simla (India). [6712]

BUSINESSES FOR SALE OR WANTED

SMALL, progressive radio manufacturing business, West Central district, with complete plant, stocks and goodwill; owner going abroad.—Write Box 3537. [6298]

BOOKS, INSTRUCTIONS, ETC.

THE British National Radio School

OFFERS you a career. WRITE to-day for free booklet describing our wide range of training courses in radio, Radar, tele-communications, principles, mathematics, physics, and mechanics; correspondence and day classes for the new series of C. & G. examinations; we specialise in turning "operators" into "engineers," and for this purpose our "Four Year Plan" (leading to A.M.I.E.E. and A.M.Brit. I.R.E., with 9 C. and G. Certificates as interim rewards) is unsurpassed; "our guarantee has no strings attached."—Studies Director, B.Sc., A.M.I.E.E., M. Brit. I.R.E., 66, Adiscombe Rd., Croydon, Surrey. [6811]

WEBB'S radio map of the world locates any station heard, size 40x30in. 4/6, post 6d.; on linen, 10/6, post free.—Webb's Radio, 14, Soho St., W.1 Gerrard 2089. [9947]

Crystal Pick-ups



Licensed by Brush Crystals Co. Ltd.



Mod. GP-10 is Cosmocord's first post-war Crystal Pick-up.

Resonance-free response from 50-8,000 cps, using commercial steel or permanent needles. Output 1.5 v.

at 1,000 cps. Needle pressure 1½ oz. Vibration-free arm movement. Screened lead. List price in Gt. Britain, 36/- plus P.T.

acos products combine the reliability of Brush crystals with the experience in manufacture and design of

COSMOCORD LTD · ENFIELD · MIDDX · ENGLAND



★ From your Radio Dealer when supplies are more plentiful.

NON-MAGNETIC TURNTABLES

with
STROBOSCOPIC MARKING
An essential accessory for serious
PICK-UP DESIGN RESEARCH

SOUND SALES LIMITED

57 St. Martin's Lane, London, W.C.2

Temple Bar 4284

Works: Farnham, Surrey

HIGH VOLTAGE COMPONENTS

Half Wave Valve Rectifiers, 6,000 volts.....	10/8
4-pin Ceramic Bases for same	1/3
.1 MFD 8,000v. working Tubular Condensers..	12/6
.1 MFD 6,000v. working Square Can Type	8/6
.03 MFD 3,000v. working 8,000v. Test Tubular	5/6
.02 MFD 5,000v. working 10,000v. Test Tubular	6/8
.001 MFD 5,000v. working 10,000v. Test Tubular	4/6
.001 MFD 5,000v. Test Micadon Flat Moulded..	2/9
Moving Coil Meter, 3½in. square face, 20,000	
0 P.V. scale calibrated 0-5 kv. and 0-10 kv.	87/6
Moving Coil Meter, 3½in. round face, 1,000	
0 P.V. scale calibrated 0-5 kv.....	35/-

* Cash with order or C.O.D. Send stamp for illustrated comprehensive price list.

V.S. CO., RADIO HOUSE, RUISLIP, MIDDX



'TESTGEAR'

MAINS RESISTANCE

1,000 Ω .2a
600 Ω .3a

Nickel-Chrome wire, space-wound on robust Ceramic former only 3" x 1 1/2".
3 Heavy Brass Clips (one adjustable) One-hole fixing.

**ROBUST
COMPACT
RELIABLE**

4/9
Post Free

Trade enquiries welcomed

MORTON & DISMORE
52c Oldchurch Rd., Chingford, E.4

RADIO BATTERY TESTER

Use "Quixo" method of battery testing.
Reliable results. Guaranteed.
Send for interesting leaflet R115 on battery testing.



RUNBAKEN • MANCHESTER 1

REWINDS

Armatures, Fields, Transformers, Pick-ups, Vacuum Cleaners, Gram, Motors, Speakers Refitted New Cones & Speech Coils.

All Guaranteed and promptly executed. New Vacuum Cleaners, most popular makes. Send stamped addressed envelope for list of Radio Spares, and C.O.D. Service.

A.D.S. Co. 261-3-5, Lichfield Road, ASTON, BIRMINGHAM, 6

★
'Radiospares'
Quality Parts

**The
Service Engineer's
First Choice**

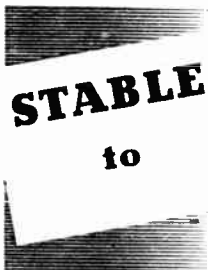

STABLE
to



Resistors produced by the cracked carbon process remain stable to $\pm 1\%$ of initial value.

★ Tolerances $\pm 1\%$
 $\pm 2\%$ $\pm 5\%$

Low temperature co-efficient.

Welwyn carbon resistor

WELWYN ELECTRICAL LABORATORIES LTD.
Welwyn Garden City, Herts. Telephone: Welwyn Garden 3816-8

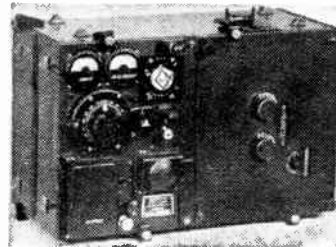

EX-R.A.F.

Transmitter receiver for short waves 20-40 metres Provision for crystal control. Uses standard headphones and microphone. Battery operated, requiring standard 120 volts h.t. and 2 volts l.t. Includes 9 valves standard English types. Six valves in receiver and three in

transmitter. Circuit RX, 2r.f., det., 2 Audio and Power. TX Osc. P.A. and Modulator. **CARRIAGE PAID . . . £6**

THE STAMFORD RADIO CO.
199 Stamford Street, Ashton-u-Lyne, Lancs.
Telephone: ASHton 1964.

MOVING-COIL MICROPHONES

BRIT. PAT. No. 566137

The outstanding performance of these scientifically designed and precision-built instruments makes them the choice of discriminating experts. Write Dept. W. W. 2 for full descriptive leaflet.

LUSTRAPHONE LTD., 84, BELSIZE LANE, LONDON, N.W.3.
Telephone: HAMpstead 5389 and 5515.

FOR: NEW DESIGNS
THEORETICAL PROBLEMS
PROTOTYPE CONSTRUCTION

Consult **TAB**

A Panel of Specialists to help You

TECHNICAL ADVISORY BUREAU
42, BARN LANE, GOLBORNE, Nr. WARRINGTON

Write for details of our Service to the Trade and Amateur

THERMAL DELAY SWITCHES
Protect Your Radio Equipment

4 VOLT • 5 VOLT • 6.3 VOLT HEATERS

OLIVER PELL CONTROL LTD
Telephone: WOOLWICH 1422
CAMBRIDGE ROW WOOLWICH S.E.18

THE 40 COIL PACK
Includes H.F. stage. 9 Iron-cored coils in All-wave Superhet circuit. 15-50, 200-550, 750-2,000 metres. For 465 Kc/s I.F. Aligned and tested before dispatch. Id. stamp brings price list.

Designed by creators of the Famous 30 coil pack.
Price 3 gns.

ALIGNED INSTRUMENTS SERVICES, 1, COLWORTH RD., LETTINGSTONE, E.11



Wise...
foolish?

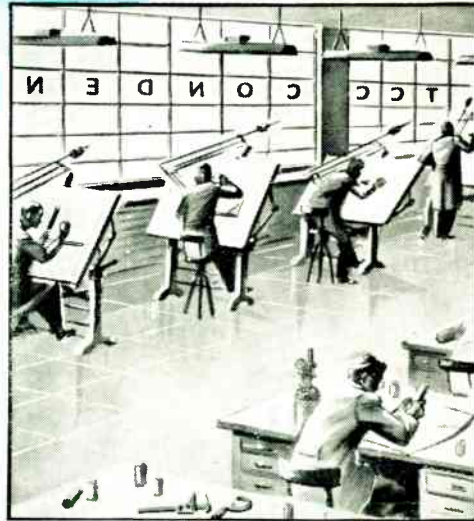

Research Engineers and Draughtsmen, picked for their superior knowledge and technical skill, are continually engaged in efforts to improve the design and efficiency of the finest Capacitors made. Working methodically and with patient persistence, they are equipped with costly apparatus and backed by modern manufacturing methods.

All this costs money, but

It is an investment that manifests itself in T.C.C. Capacitors. Long-term economy and long-time trouble-free service are characteristic features of the T.C.C. products. Inevitably they cost a little more, but in the long run they cost more than a little less, for once they are fixed T.C.C. Capacitors will last for years. Superior design and high-grade materials *must* produce better Capacitors It *must* pay you to buy the best!



CAPACITORS

THE TELEGRAPH CONDENSER CO. LTD.

RADIO DIVISION

NORTH ACTON · LONDON · W·3

TELEPHONE: ACORN 0061



Pen. 45. DD

Filament Voltage	4.0V
Filament Current	2.0A
Maximum Anode Voltage	250V
Maximum Screen Voltage	250V
Mutual Conductance	9.0mA/V



Pen. 453. DD

Filament Voltage	45.0V
Filament Current	0.2A
Maximum Anode Voltage	200V
Maximum Screen Voltage	200V
Mutual Conductance	12.0mA/V

The Pen.45.DD, designed for use in A.C. Mains Receivers, and the Pen.453.DD, in AC/DC Receivers, are Double-diode Beam Power Amplifiers.

In either valve the double-diode section is completely screened within the valve from the tetrode section, so that the two sections may be treated as two separate valves as far as circuit considerations are concerned. They are designed to combine the functions of Detector, A.V.C., and Output Valve.

Under normal operating conditions the Pen.45.DD will give a Power Output of 4.85 watts and the Pen.453.DD of 4.3 watts for 5% Third Harmonic Content and with the Second Harmonic not exceeding 5%.

MAZDA

RADIO VALVES AND CATHODE RAY TUBES

THE EDISON SWAN ELECTRIC CO. LTD., 155, CHARING CROSS ROAD, LONDON, W.C.2

R.M.47.