

Wireless World

RADIO AND ELECTRONICS



NOV. 1945

1/6

Vol. LII. No. 11

IN THIS ISSUE:

RADIO AIDS TO CIVIL AVIATION : A Survey



prefers



PRODUCTS

Our products for the Radio Industry range from the tallest steel radio towers to 0.001 μ F capacitors. If you're not interested in morsters or midgets we make a lot of other things besides, including every type of cable and wire used in radio work. You get the benefit of 60 odd years research and manufacturing experience when you specify B.I. Callender's.

BRITISH INSULATED CALLENDER'S CABLES LIMITED

NORFOLK HOUSE, NORFOLK STREET, LONDON W.C.2

AVO
REG. TRADE MARK

MODEL 7
UNIVERSAL
AVOMETER

MODEL 40
UNIVERSAL
AVOMETER

THE "AVO"
VALVE
TESTER

THE
ALL WAVE
"AVO" OSCILLATOR

THE world-wide use of "AVO" Electrical Testing Instruments is striking testimony to their outstanding versatility, precision, and reliability. In every sphere of electrical test work they are maintaining the "AVO" reputation for dependable accuracy, which is often used as a standard by which other instruments are judged.

THE AUTOMATIC COIL WINDER & ELECTRICAL EQUIPMENT CO., LTD.
WINDER HOUSE · DOUGLAS STREET · LONDON · S.W.1 · TELEPHONE: VICTORIA 3404/7

REDIFON G.32 TRANSMITTER/RECEIVER

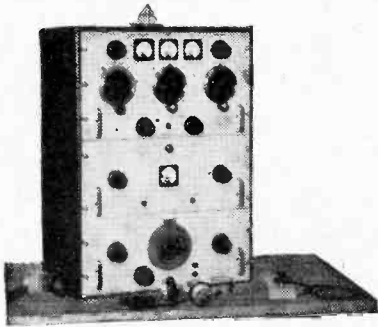

This compact, transportable, 50 watt Transmitter/Receiver is used by Colonial and other authorities for medium range communications over land, sea, and to aircraft by telephony and C.W., or M.C.W., telegraphy.

The transmitting unit in the Redifon G32 covers from 4 to 16 m/cs (75 to 18.75 metres) in two bands. An electron-coupled oscillator is used, operating as an oscillator frequency doubler. The very sensitive receiver covers from 150 k/cs to 20 m/cs (15 to 2,000 metres) and incorporates a crystal gate, three I.F. band-widths, beat frequency oscillator and other features.

The entire transmitter/receiver is contained in a single robust steel housing, finished to service tropical specifications, 28 inches high by 21 inches wide and 12 inches deep. The net weight of this unit is 130 lbs. Power can be taken from 24 volt accumulator batteries or 180-250v. 50-cycle, single phase A.C. mains, through alternative power units.

This transmitter/receiver is available for *early delivery*. Further particulars can be supplied on request to Communications Sales Division.

REDIFFUSION Ltd.

Designers and Manufacturers of Radio Communication and Industrial Electronic Equipment

BROOMHILL ROAD, LONDON, S.W.18

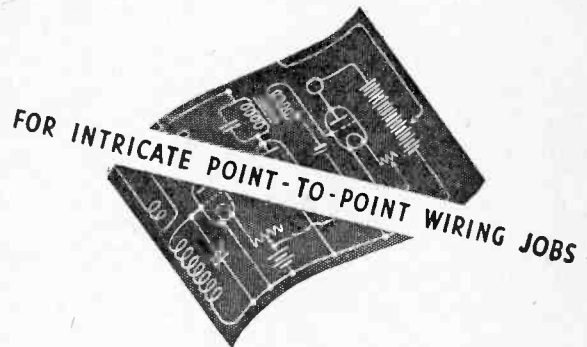

Available in solid and stranded tinned copper conductors with rubber insulation, HAMOFIL wires are specially designed for efficient, economical wiring of electrical, radio and electronic apparatus.

A popular inexpensive grade known as HAMOFIL "Push Back" permits the cotton braiding to be slid back along the wire to facilitate joining or soldering.

Seven colours—Plain and striped.



De La Rue Insulation Limited

IMPERIAL HOUSE · REGENT STREET · LONDON W.1 · ENGLAND
Tel.: REGent 2901 Cables: Delinsul, Piccy, London

POINTERS FOR DESIGNERS

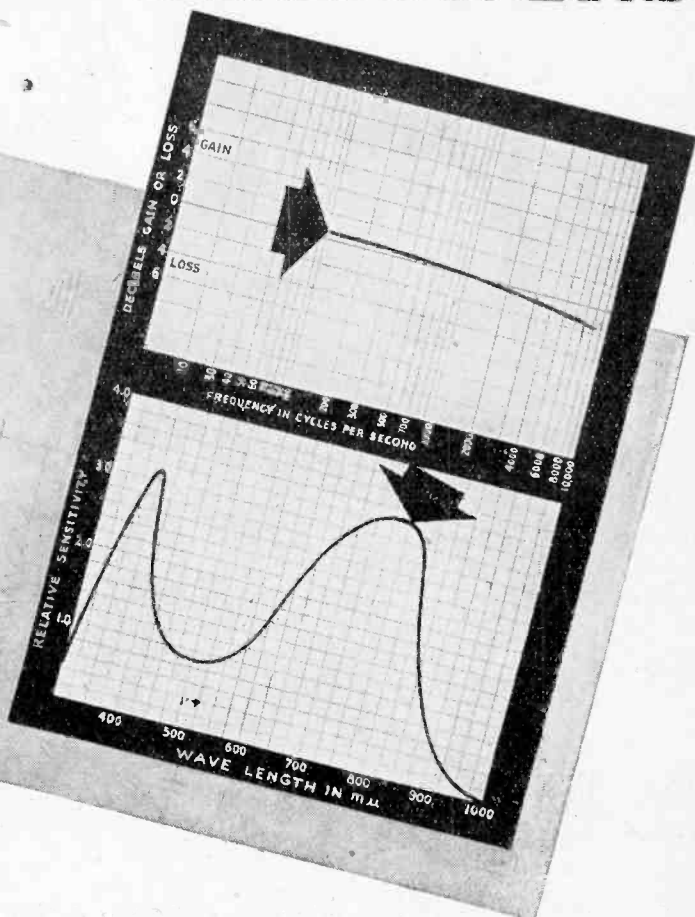
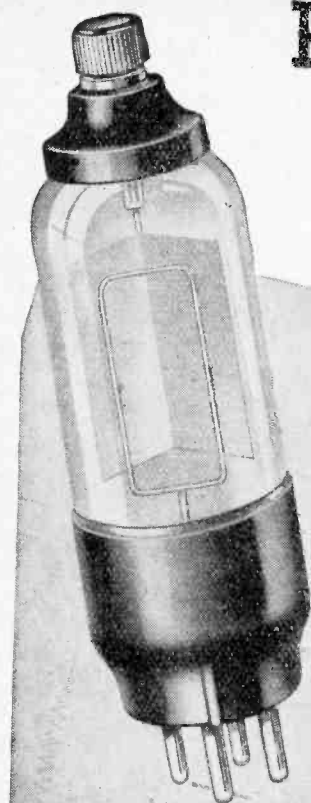

THE CMG8

The CMG8 is a typical example of the OSRAM range of emission-type photocells which constitute the essential means of converting light changes into electric current. Widely used in sound projectors and industrial apparatus they are non-microphonic and of convenient size. Outstanding features include:—

- ▶ Linear response for sound reproduction giving undistorted output.
- ▶ High sensitivity to artificial light.

A detailed technical data sheet is available on request.

Osram
PHOTO CELLS

G.E.C.
CATHODE RAY TUBES

Osram
VALVES

Adv. of The General Electric Co., Ltd., Magnet House, Kingsway, London, W.C.2.

WHAT HAVE THEY in common?

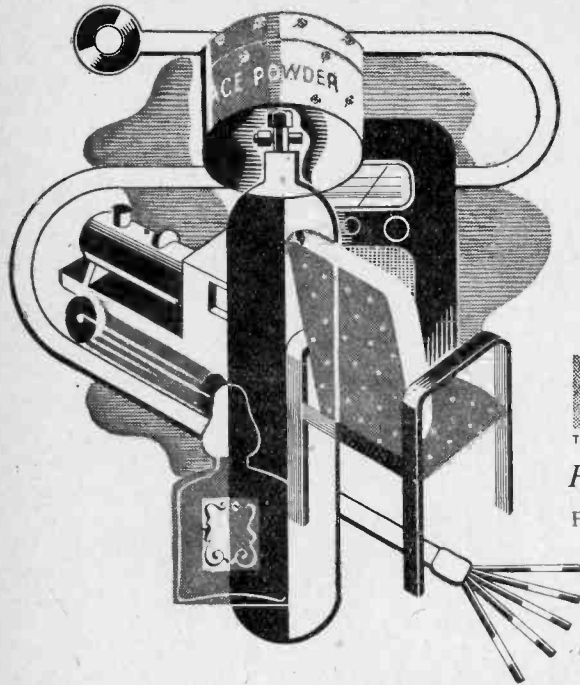

They all have name-tabs of Lasso Tape, which adheres without moistening to any surface, flat or moulded; of metal, wood, glass, plastic, textile or rubber. Simply press on firmly with the fingers. No tools are required.

Lasso Tapes name-tabs are obtainable in 10 yd. lengths in various widths, or as separate labels measuring up to 6" x 6". In a wide range of colours, they are printed with your own inscriptions at suitable intervals and the wording cannot be erased. The ideal method of attaching name-tabs, numbers and similar information to furniture, carpets, plastics, toys, tools, electrical equipment, motor car fittings, bottles and cartons. Guaranteed resistant to water, oil and solvents. An informative booklet is free on request.

LASSO PRODUCTS

TRADE MARK
Pressure Sensitive Tapes
 FOR LABELLING, SEALING
 AND IDENTIFICATION



LASSOLASTIC · LASSOBAND · LASSOTHYL · LASSOPHANE

Herts Pharmaceuticals Ltd., Welwyn Garden City, Herts.

Tel.: Welwyn Garden 3333 (6 lines) (5)

Wharfedale

15-inch
 SPEAKER
 W. 15

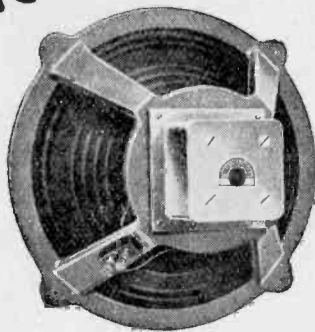

An entirely new model, having the following main characteristics:—
 Flux density 13,500 lines. Total flux 180,000 lines. Speech coil 12/15 ohms, 2" diameter. Peak input 20 watts. Bass resonance about 60 c.p.s. Dust-proof assembly. Weight 16½ lb. Response almost level between 50 and 5,000 cycles. Price 250/-.

Made and Guaranteed by
**WHARFEDALE WIRELESS
 WORKS**

BRADFORD RD., IDLE, BRADFORD
 'Phone: Idle 461. 'Grams: Wharfedel, Idle, Bradford

EARTH FREE & Silent as the Stars

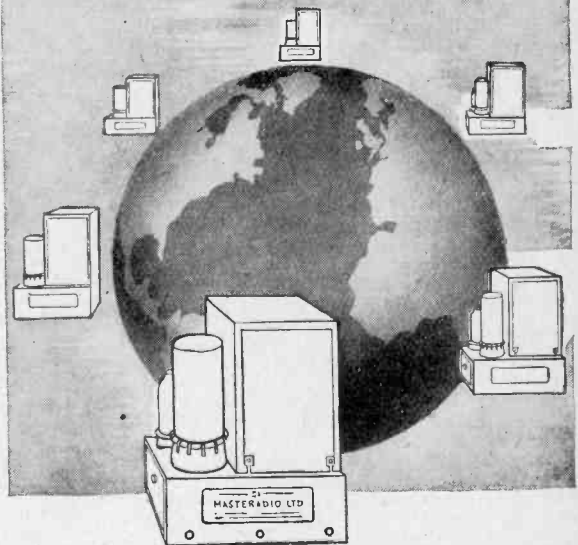

Masteradio VIBRATORPACKS

PROMPT DELIVERY NOW ASSURED

MASTERADIO LTD · VIBRANT WORKS · WATFORD · HERTS

TCC

CAPACITORS

PAPER
ELECTROLYTIC
MICA

SILVERED MICA
CERAMIC

*Capacitor
Specialists
for over
40 years*

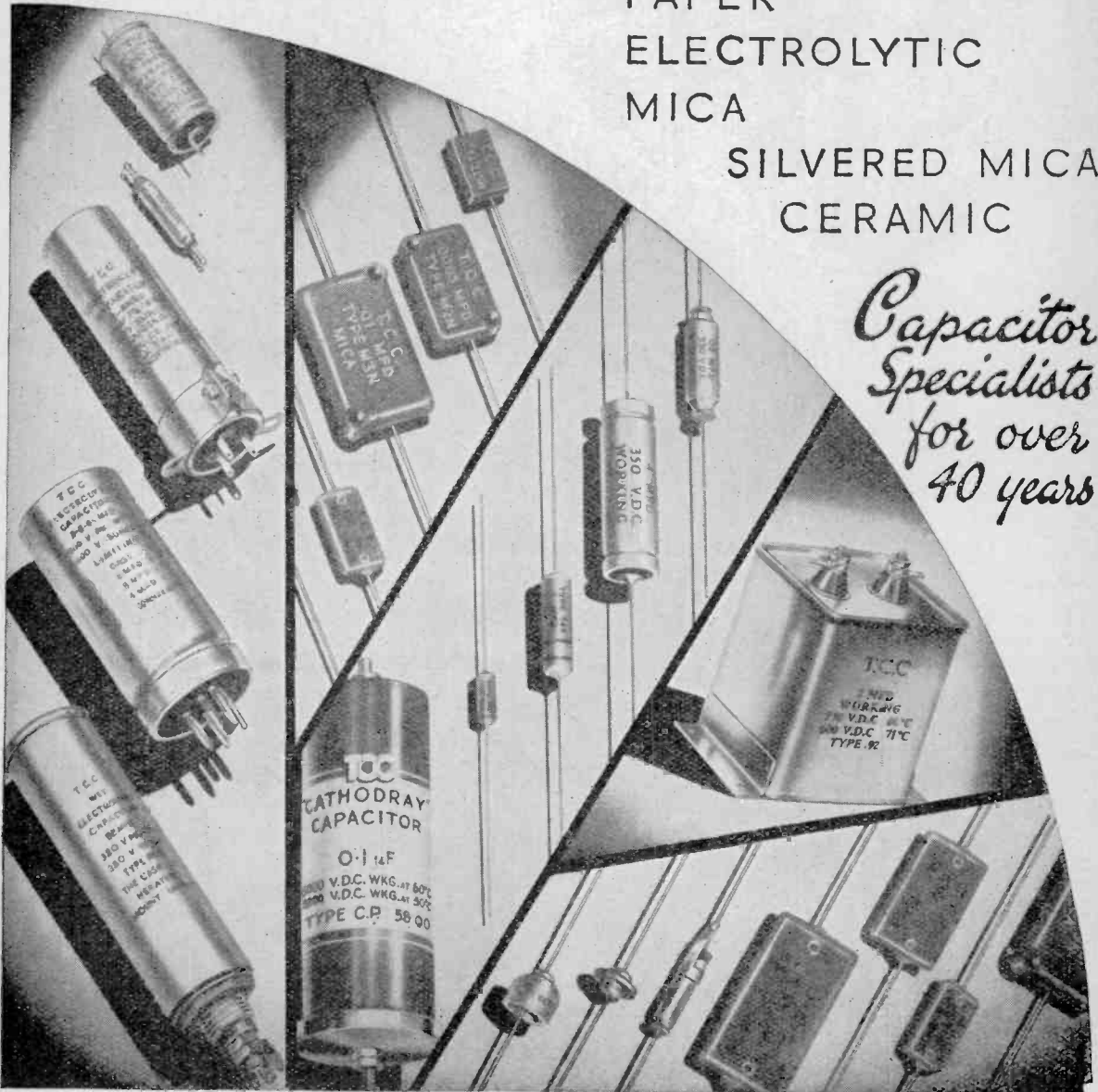

THE TELEGRAPH CONDENSER CO., LTD.

RADIO DIVISION

NORTH ACTON · LONDON · W. 3

Telephone. ACORN 0061



CLEAR AS
THE BELL OF
BIG BEN
WHEN YOU'RE
USING

Exide
L.T. ACCUMULATORS
AND
Drydex
H.T. BATTERIES

The perfect pair for
battery Radio sets

THE CHLORIDE ELECTRICAL STORAGE CO. LTD.,
CLIFTON JUNCTION, NR. MANCHESTER

3DX3D

R & A
BRITAIN'S FOREMOST
REPRODUCERS

Reproducers and Amplifiers Ltd.
WOLVERHAMPTON,
ENGLAND.

M.R. SUPPLIES Ltd.

continue to offer only material of the utmost dependability, all goods being new and perfect. Immediate despatch. Prices nett.

ROTHERMEL PIEZO-CRYSTAL MICROPHONES (exclusive offer). The well-known D.104 specially housed with knuckle-joint for angle adjustment, with 1/4 in. (20) threaded boss. Response 50/7,500 c/s. Output level minus 60 DB. With 5ft. screened lead, 75/- . Also same make P.C. deaf-aid type inserts, 1 1/4 in. dia., 29/6.

MOVING COIL MICROPHONES. Gramplan MCR, spring-suspended in square frame. Fine performance and value, £4 4s. The new Resle VMC, only 2 1/4 in. dia., with local on-off switch, imp. 12 ohms, recommended for its really excellent response, 25 10s. **FLOUR STANDS**, to suit all above microphones, collapsible, ext. to 5ft. 6in., 49/6 (all chromium).

GRAMOPHONE PICKUPS. Rothermel replacement heads for Garrard and Collaro arms, providing easy change-over from magnetic type—giving far better performance. Either 46/11 (please state which required). Also new ball-bearing Senior, complete model, with black streamlined bakelite arm, 57/6. Also from stock, the new Lexington Moving Coil pickups, with needle charger and ejector, sapphire needle and input transformer (mu-metal housed), £8 10s. 3d. (Please note that in most cases a one-valve preliminary amplifier is necessary for M/coil pickups). Instructions sent with each. **SAPPHIRE NEEDLES** (Rothermel), 12/6.

STROBOSCOPES (50-cycle), showing 78, 79 and 80 r.p.m.—cardboard only. 1/- . **OUTPUT TRANSFORMERS**. Our improved "W.W." model is still supreme. Level 30/9,000 c/s, handling 25-watts A.C. Provides 11 ratios from 12/1 to 75/1 with C.T. for P.P. Tapped prim. and sec., generous core section, weight 9 1/2 lbs., 59/6 (despatch 1/6).

MICRO-AMMETERS, new ex-Govt., well-known maker deflection 0/500 micro-amps. 2in. flush panel mtg. Int. res. marked on each (mostly 500 ohms). Very special offer, 37/6. **B.P.L. COMBINED MEASURING INSTRUMENTS** (new model). 17 ranges: A.C. and D.C. volts, 10, 50, 100, 500 and 1,000. D.C. Milliamps: 1, 10, 100, and 500. Ohms: 0/1,000 and 0/100,000. Also output volts. In the polished black plastic case 5 1/2 in. x 4 in. x 3 1/2 in. with range switching, terminals and carrying handle. 1,000 ohms/volt, 55 15s.

SMALL MOTORS (ex-Govt.), 12/24v. D.C. Housing, 2 1/2 in. by 2in. sq. Double-ended shaft with pulleys each end. Excellent torque. Suitable for cine, laboratory use, boat motors, etc., only 15/- . **ROTARY TRANSFORMERS**, input 12v. D.C., output 480v. 40 ma. (cont.) or 400v. 80 ma. (4-hr. periods), new, ex-Govt., 22/6. **MALLOY VIBRATORS**, type 650. 6-volt, 4-plate. For 250v. 50 m.a. delivery (in conjunction with appropriate transf. and rect.), 12/6.

METAL (Selenium) RECTIFIERS by S.T.C. (A) up to 12v. 1.5 amp., 12/6. (B) 12v. 6 amps., 39/6. (C) 12v. 10 amps. 49/6 (letters refer to appropriate mains transformers, below).

STEP-DOWN MAINS TRANSFORMERS (all 24-hour rated). Primaries all tapped 200/220/240 v. Sec.: 7, 11 and 15v. at 2 amps. (A), 21/- . Sec. 5, 12 and 17v. at 6 amps. (B), 49/6. Sec.: 7, 8 and 15v. at 10 amps. (C), 75/- . (Desp. 2/6). Also Sec.: 2, 4, 6, 8, 10 and 12v. at 3.3 amps., 37/6. Sec.: 22v. 2 amps., 19/6. Sec.: 30v. 4 amps., 45/- .

SLIDING RESISTANCES, open tubular type, 1 ohm 12 amps, 17/6. 14 ohms graded 1 to 4 amps, 19/6. **STAGE LIGHTING DIMMERS**, with screw motion and hand-wheel, controlling stated load from full-bright to blackout at 220/240 v. Now supplied from stock held here. 500-watt, £3 13s. 6d. (despatch 2/6). 1,500-watt, £8 8s. (desp. 4/6). 2,500-watt, £9 13s. 6d. (desp. 6/-). Large range of Sliding Resistances always in stock.

Please include sufficient for packing and despatch.

M.R. SUPPLIES Ltd., 68, New Oxford Street, London, W.C.1.

Telephone: MUSeum 2958



TH. 41	
Filament Voltage	4.0V
Filament Current	1.3A
Hexode Maximum Voltage	250V
Hexode Mutual Conductance	3.1mA/V
Triode Maximum Voltage	150V
Triode Mutual Conductance	5.3mA/V



TH. 233	
Filament Voltage	23.0V
Filament Current	0.2A
Hexode Maximum Voltage	250V
Hexode Mutual Conductance	3.0mA/V
Triode Maximum Voltage	150V
Triode Mutual Conductance	5.3mA/V

The TH.41 designed for use in A.C. Mains Receivers and the TH.233 in AC/DC Receivers, are Triode-Hexode Frequency Changers.

They have been specially designed to meet the requirements of All-Wave Receivers and the inter-action between the input and oscillator circuits has been reduced to a minimum.

A high Conversion Conductance is provided with a large initial grid bias, thus ensuring that no grid current is taken on the Short Wave bands.

The characteristics have been so designed as to provide large signal handling capacity with low cross modulation and low harmonic content.

MAZDA

RADIO VALVES AND CATHODE RAY TUBES

THE EDISON SWAN ELECTRIC CO. LTD., 155, CHARING CROSS ROAD, LONDON, W.C.2

Difficult Problems?

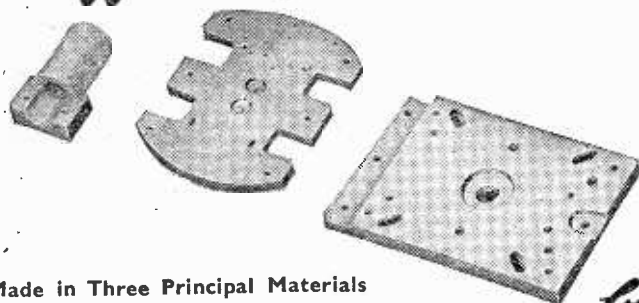

Bring them to ...

Made in Three Principal Materials

FREQUELEX

An insulating material of Low Di-electric Loss, for Coil Formers, Aerial Insulators, Valve Holders, etc.

PERMALEX

A High Permittivity Material. For the construction of Condensers of the smallest possible dimensions.

TEMPLEX

A Condenser material of medium permittivity. For the construction of Condensers having a constant capacity at all temperatures.



Bullers

BULLERS LOW LOSS CERAMICS

BULLERS LTD., 6, LAURENCE POUNTNEY HILL, LONDON, E.C.4
 Telephone: Manslon House 9971 (3 lines) Telegrams: "Bullers, Cannon, London"

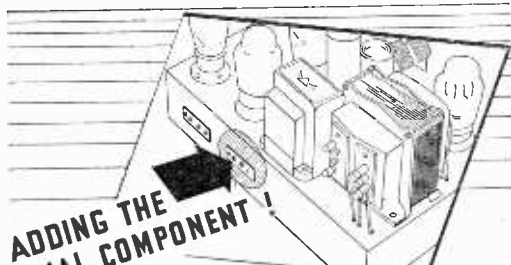

ADDING THE FINAL COMPONENT!

Whether the building of your receiver is a hobby or to provide entertainment in the home, selection of the final component demands the same attention as other details of the circuits. Stentorian Speakers are designed to match any desired impedance. They give such a faithful reproduction that you will at once appreciate the difference.



PERMANENT MAGNET MOVING COIL SPEAKERS

Stentorian

PRICES

- Minor Type MX (for Low Impedance Extension) 29/6.
- Minor Type MC (with Universal Transformer) 35/6.
- Baby Type BX (for Low Impedance Extension) 43/6.
- Baby Type BC (with Universal Transformer) 49/6.



WHITELEY ELECTRICAL RADIO CO. LTD., Mansfield, Notts.

"Cyldon" Transmuting Capacitors

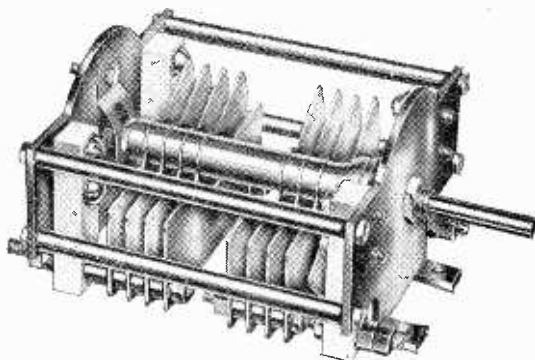

TYPE TRMSS

Max. Capacity	List Price
30 + 30 pF	£1 : 7 : 6 each
60 + 60 ,,	£1 : 10 : 0 ,,
80 + 80 ,,	£1 : 12 : 0 ,,
100 + 100 ,,	£1 : 17 : 6 ,,

Air Gap .082"

SYDNEY S. BIRD & SONS, LTD.

Cambridge Arterial Road, Enfield, Middlesex.
 *Phone: ENField 2071-2. Telegrams: "Capacity, Enfield."



cater for the
EXPERIMENTER
pursuing not merely
results—but the
BEST POSSIBLE
RESULTS . . .

The Gramophone enthusiast should study the important NEW TREND in PICK-UP RESEARCH

The moving coil design shows a great advance in frequency response, attack and general clarity. Assuming a good amplifier and loudspeaker these pick-ups do really show to advantage the recent improvements in recording technique. Bass is "clean" and the "top" discriminates between orchestral instruments instead of the conglomerative shrillness we have too often accepted. We show two makes of these new pick-ups:—

1. THE WILKINS & WRIGHT MOVING-COIL PICK-UP TYPE "N." Uses easily changed commercial hard-steel needles, playing approximately 20 records. Needle pressure adjustable from ¼ oz. to 1 oz. Complete with coupling transformer and equalizer in screened case, arm rest, instructions and fixing screws.

PRICE (including Purchase Tax) £7 0 7

WILKINS & WRIGHT "SCRATCH" FILTER—not merely a "top" tone control, but a low-pass filter cutting above 8.5 Kc/s. (Frequency of cut-off is adjustable.)

PRICE (including Purchase Tax) £2 11 4

2. THE LEXINGTON MOVING-COIL PICK-UPS.

"De Luxe" Model, automatic insertion and rejection of sapphire needles. Needle pressure approximately ¼ oz.

PRICE (including Purchase Tax) £6 5 0

"Junior" Model. Similar construction to the "De Luxe," but without mounting base and automatic needle device. Uses commercial steel needles, easily replaced. PRICE £3 18 9

LEXINGTON ACCESSORIES:—Sapphires, 15/3. Input transformer, 16/-. Mu-metal-screening box for transformer, 14.2. (We also stock a special two-stage pre-amplifier and equalizer either complete or in parts).

NOTE: MOVING COIL PICK-UPS give a small output usually necessitating one or two additional amplifier stages. For larger output we recommend:—

Rothermel "Senior" Crystal £2 16 3 (Including Tax)
B.T.H. Magnetic £1 11 9 (Including Tax)

★WANTED: Technical Sales Staff . . .

Through expansion we need a Senior and Junior Salesman. Technical background essential for both positions. Commercial experience an advantage. Write, giving full details to: Manager (W.W.) Webb's Radio, 14, Soho Street, London, W.1.

WEBB'S AMPLIFIER CASES

Well constructed portable type, removable top cover with ventilating louvres and carrying handles. Removable bottom plate on chassis completes total shielding. Overall size 16 x 8 x 2½ ins. high, finished black crackle; chassis punched for seven valve-holders and transformer. PRICE £2 12 6 (Carriage 2/- extra).

WEBB'S "HI-FI" OUTPUT TRANSFORMERS

Secondary tapped 2½, 7½ and 15 ohms; 20 watts—in four push-pull types for anode to anode loads of:—
PPHF4—4,000 ohms. PPHF8—8,000 ohms.
PPHF6—6,000 ohms. PPHF10—10,000 ohms.
PRICE (each type) £1 7 6

GOODMAN'S 12in. PERMANENT MAGNET LOUD SPEAKER.

A heavy duty reproducer capable of excellent quality, speech-coil 15 ohms. PRICE £6 15 0

MATCHED VALVES.

Another Webb's Service. We supply matched pairs of valves for push-pull working without additional charge.

PX 4's £1 3 2 per pair
PX 25's £2 8 8 per pair
KT66's or 6L6G's £1 16 6 per pair
6V6G's £1 5 8 per pair

(Owing to fluctuating deliveries we reserve right to supply direct equivalent valves in other recognised British makes).

MATCHED RESISTORS

Welwyn high-stability, carbon resistors, 1-watt rating, tolerance 1 per cent., 2/6 each. Erie 1-watt resistors in pairs matched to 2 per cent. Absolute values plus-minus 20 per cent., 2/- per pair. Stock values of matched pairs, 20,000, 25,000, 33,000, 50,000 ohms.



14, SOHO ST., OXFORD ST., LONDON, W.1
Telephone: GERRARD 2089. Write, phone or call.
Shop hours: 9 a.m. to 5.30 p.m. (Sats. 9 a.m. to 1 p.m.)

PERTRIX REDRESSED FOR PEACE



PERTRIX BATTERIES have emerged from the testing ground of war as more reliable, more efficient than ever before. You will soon see them in the smart new post-war pack shown above. It denotes the finest battery for radio use yet made.



HOLSUN BATTERIES LIMITED

137 Victoria Street, London, S.W.1.

P.I.A.

A few more Specialities

CONTINUOUSLY VARIABLE
WIRE WOUND
POTENTIOMETERS



PRESET RESISTORS



FIXED ATTENUATORS



PLUGS & SOCKETS

from the
HOUSE
of



PAINTON & CO. LTD.
KINGSTHORPE
NORTHAMPTON



Manufacturers
of
LOUDSPEAKERS
•
LAMINATIONS
•
SCREENS
in
RADIOMETAL
•
PERMALLOY
•
SILICONALLOYS

ELECTRICAL SOUND & TELEVISION PATENTS LTD.

12, Pembroke Street, London, N.1. Terminus 4355
2/4, Manor Way, Boreham Wood, Herts. Electree 2138

U.I.C.

CERAMIC *Pot* CAPACITORS

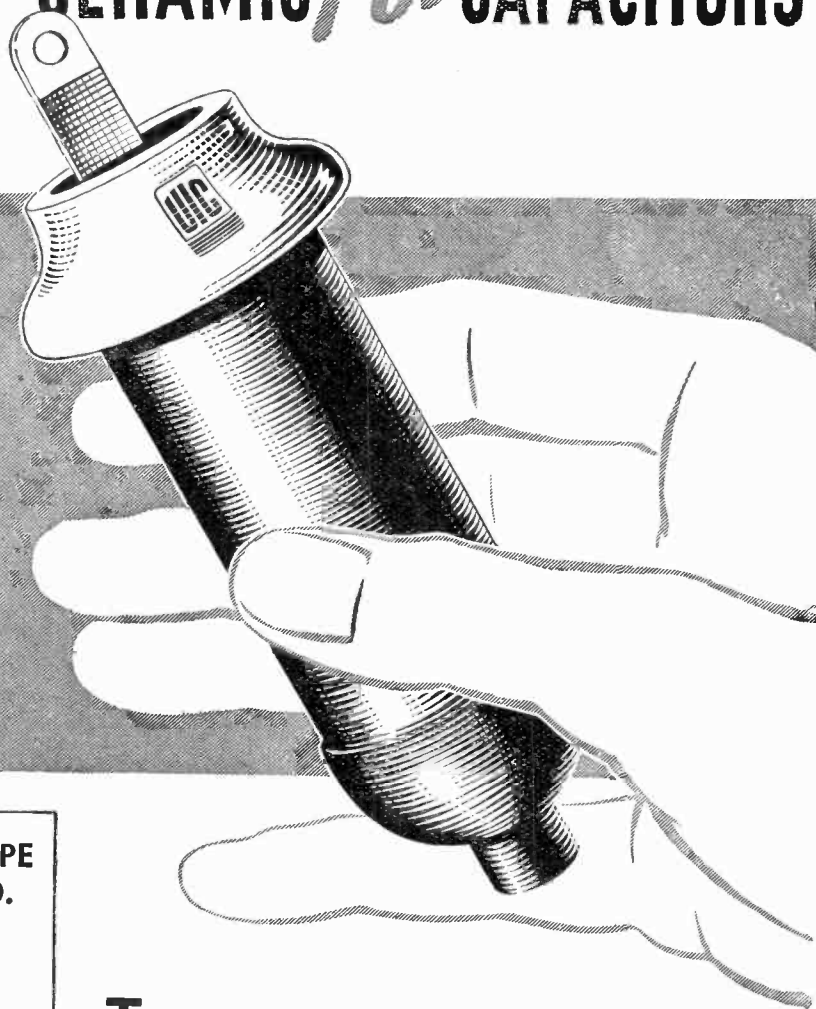

*Small in size
but High in
R.F. Rating*

DISC TYPE H.V.D.

*Specially
suitable for*

PULSE WORKING

Capacitance Range
3 pF - 50 pF

Working Voltage
2 kV R.M.S.

RF. Load

Up to 10 pF 2 kVA with 2 amps.
Up to 50 pF 0.8 kVA with 1.5 amps

THE U.I.C. Fixed Ceramic Pot Capacitor—KO 2944—illustrated above, has been primarily developed for use in transmitter circuits. Made only from the highest grade raw materials and subjected to the most rigorous tests, its rating for its size is unsurpassed. *Capacitance Range: 120—250 pF. RF Load: 26 kVA with 14 amps. Working Voltage: 5 kV R.M.S. Further details on application.*

UNITED INSULATOR CO. LTD., OAKCROFT RD., TOLWORTH, SURBITON, SURREY
Telephone: Elmbridge 5241 (6 lines) Telegrams: Calanel, Surbiton

Unsurpassed In Ceramics

RUBBER - TO - METAL BONDING

The Problem of Insulating delicate instrument panels from vibration and shock by means of Flexilant Mountings

"FLEXILANT" Mountings: Examples from the SERIES.

The "Flexilant" Mounting of which several varieties are illustrated here is so accurately made that its displacement under load can be calculated to within .010" of requirements. The series is designed to carry loads of from 1 to 45 lbs. per mounting and these may be arranged with bolt axis at 90° to position, or the complete mounting may be inverted. The mountings can be supplied with or without holder and they can be arranged so that two utilize the same bolt.

We should appreciate the opportunity of helping with your vibration problems.

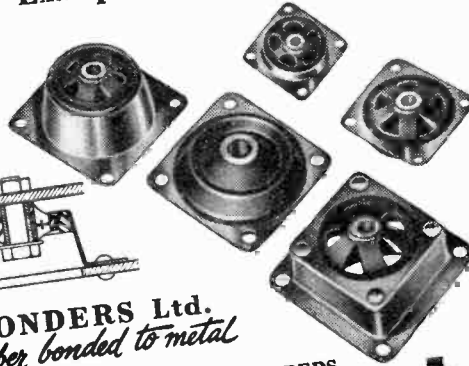
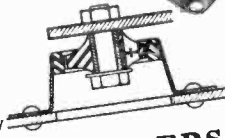

RUBBER BONDERS Ltd.
Engineers in Rubber bonded to metal

FLEXILANT WORKS • WATLING STREET • DUNSTABLE, BEDS.
TELEPHONE: DUNSTABLE 803

TELEGRAMS: FLEXILANT, DUNSTABLE



R.B.12

Sole Distributors of all "Q-MAX" PRODUCTS

"Q-MAX" CHASSIS CUTTER



Ends all your tire-some scraping and drilling. Cuts holes easily, cleanly, and quickly.

For octal holes (1 1/8").

10/6 (Pstg. 9d.)



"Q-MAX" SLOW MOTION

DIAL for individual calibration. Comprises an 8-1 slow motion drive, dial (6 1/2" x 3 1/2") engraved 5 blank scales and one 0-180 scales escutcheon glass and fluted knob.

15/6 (Pstg. 9d.)

OUR NEW CATALOGUE IS NOW READY
6d. Post Free.

Applications for territorial dealerships invited.

"Q-MAX" MEASURING INSTRUMENTS

- 0-1mA M.C. - - £2 19 6
- 0-5mA M.C. - - £2 9 6
- 0-50mA M.C. - - £2 9 6
- 0-250mA M.C. - - £2 9 6
- 0.100mA M.C. - - £5 5 0
- 0-1A Thermo C - - £3 17 6
- 0-1A Hot wire - - £1 19 6
- 0-5A Hot wire - - £2 2 0
- 0-250mA—M. Iron - - £2 2 0
- 0-10v A—M. Iron - - £2 2 0
- 0-1mA M.C. 6" x 5" - - £6 16 6

BERRY'S
(SHORT WAVE) LTD.

25, HIGH HOLBORN, LONDON, W.C.1
(Opposite Chancery Lane.) Tel.: HOLborn 6231

Sound Understanding

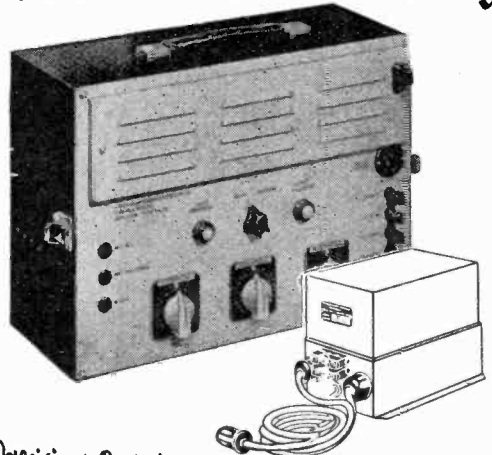

Precision Built for Perfect Reproduction

A Portable Amplifier capable of providing an undistorted output of 20 watts. Separate volume control for microphone and pickup. AC Mains or from 12 volt accumulator, used with the B.S.R. Vibrator Power Unit VP 60.A.

BSR

BIRMINGHAM SOUND REPRODUCERS LTD.
CLAREMONT WORKS
OLD HILL STAFFS.

M-W-58

METALLISED CERAMICS

Two additions to the S.P. range
of FREQUENTITE
bushes



R.50650

R.50764

★ R.50844

★ R.50855

TYPE	A mms.	B mms.	C mms.	D mms.	E mms.
R.50650	9.5	9.5	6.4	6.25	2.75
R.50764	9.5	16.7	6.4	6.25	2.75
★ R.50844	9.5	12.7	9.5	6.25	2.75
★ R.50855	12.7	22.2	12.7	9.5	3.9

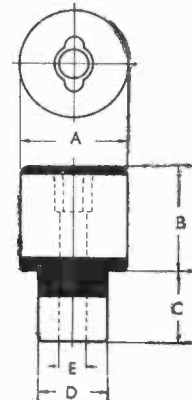

★ Recent additions to the range

For full information and prices please write to :

STEATITE & PORCELAIN PRODUCTS LTD.

STOURPORT-ON-SEVERN, WORCS. Telephone: Stourport III. Telegrams: Steatoin, Stourport.



S.P.43

Comfort and Concentration!

There is nothing more conducive to getting full pleasure from your radio than wearing a pair of lightweight yet highly sensitive headphones.

When you are searching the short-wave bands, or for that matter enjoying any broadcast programme without disturbing others in the room, you will appreciate using a pair of the world-famous S. G. Brown type "F"

FEATHERWEIGHT HEADPHONES

Light in weight, highly sensitive and inexpensive. They will give you years of service and are most comfortable to wear.

Price 23/- per pair.

YOU CAN GET THEM FROM YOUR LOCAL DEALER.



Type "F"

S.G. Brown, Ltd.

Phone :
ACOrn
5021

VICTORIA ROAD, NORTH ACTON, LONDON, W.3



THE ENTIRELY NEW CHASSIS with an incomparable specification

To be known as the "Peerless 1546," this receiver sets a new high standard in modern radio practice. It has many points of outstanding interest, including:

- All the necessary technical features of the modern long range communications receiver.
- Every conceivable refinement essential for high fidelity broadcast reception.
- Completely tropicalised to Government approved standards for overseas use.

Write for further advance information—trade and export enquiries invited.

TELEMECHANICS LIMITED
374, KENSINGTON HIGH STREET, LONDON, W.14

*Phone : Western 1221.

R.T. 10.

*No Hint
of Doubt*

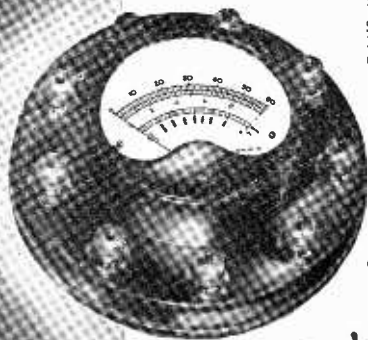

...with Sifam precision—
The ideal D.C. Radio Service Tester. Longscale $3\frac{1}{2}$ " Moving coil instrument mounted on a black bakelite base. The circular design allows terminals to be well spaced, positive contact being obtained without switching. Ten ranges and a resistance scale as follows:—
100 mV, 2, 6, 120, 320
Volts D.C., 1, 6, 60,
600 mA, 6 Amperes
D.C. 50,000 Ohms 2,000
Ohms at mid scale reading.

PRICE :
£6. 0. 0 TYPE R.T. 10.

with
SIFAM

SIFAM ELECTRICAL
INSTRUMENT
CO., LTD.,
TORQUAY

21
YEARS
SPECIALISED
EXPERIENCE

S.E.M. Chokes and Transformers

MANUFACTURING facilities are available for producing power transformers and smoothing chokes from 10 V.A. to 10 K.V.A., designed and manufactured by S.E.M. engineers.

These components can be designed to meet individual customer's special requirements.

All windings are interleaved and vacuum-impregnated. Both transformers and chokes are tropically finished to latest specifications.

In common with all S.E.M. machines, these chokes and transformers are manufactured to the highest standards of mechanical detail, and are subject to rigid inspection tests.

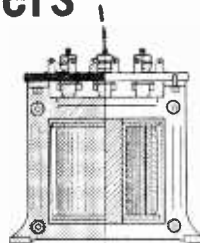

A typical S.E.M. vacuum-impregnated transformer.

SMALL ELECTRIC MOTORS LTD.

have specialized for over 30 years in making electrical machinery and switchgear up to 10 kW. capacity. They are experienced in the design and manufacture of ventilating fans and blowers, motors, generators, aircraft and motor generators, high-frequency alternators, switchgear, starters and regulators.

A SUBSIDIARY OF BROADCAST RELAY SERVICE LTD.
BECKENHAM · KENT

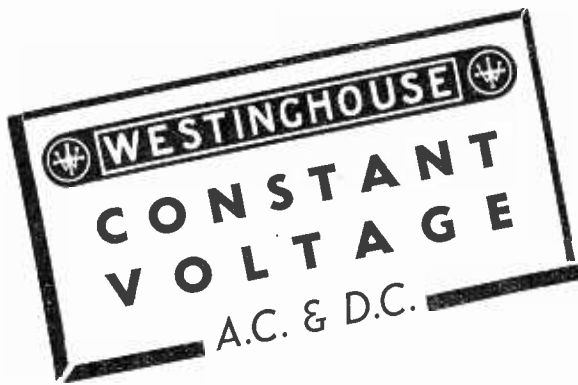

In the following systems, automatic compensation is provided for the effects of mains fluctuations and/or load variations.

The "Stabilistor"

This device provides an A.C. voltage of good waveform, maintained within limits of $\pm 2\%$ for all loads between no load and full load and any input between 190 and 260 volts 50 c.p.s. single-phase A.C. Closer limits are obtainable if either the input or the load are constant. Response is almost instantaneous and efficiency is about 85%.

Where the load is constant, a special frequency-compensated model is available, which will hold the output voltage constant to within a few parts in 1,000 in spite of variations of $\pm 6\%$ in mains voltage and simultaneous or independent variations of $\pm 2\%$ in mains frequency.

"Westat"

A special fully automatic battery charger, which maintains the battery voltage within fine limits despite simultaneous variations of mains and load. Action is instantaneous and, after a power supply interruption, the Westat automatically provides a heavy charge until the battery voltage reaches its normal value. No moving parts, saturated chokes gas discharge tubes or barretters.

"Noregg"

Similar to the Westat but for direct operation of D.C. apparatus from the A.C. mains. High efficiency and power factor; low percentage ripple.

Write for publications E.E.2 and D.P.111 to Dept W.W.

Westinghouse Brake & Signal Co. Ltd.
82, YORK WAY, KING'S CROSS, LONDON, N.1

A MINE OF INFORMATION

...yours for the asking



These up-to-date lists give complete specifications and prices of Somerford Transformers and Chokes available for

IMMEDIATE DELIVERY!

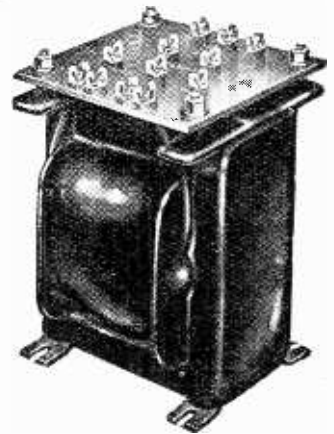

GARDNERS 'SOMERFORD' TRANSFORMERS AND CHOKES

COUPON

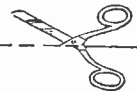

PLEASE SEND, WITHOUT OBLIGATION, COMPLETE LISTS OF SOMERFORD TRANSFORMERS & CHOKES.

Name

Address

GARDNERS RADIO LTD., SOMERFORD, CHRISTCHURCH, HANTS.

FOR RADIO • INDUSTRY • LABORATORY

A Selection of Bargains from our
SPECIAL OFFER LIST "W"

- AERIALS.** Brand new R.A.F. 100ft. Dipoles complete with insulators. Super quality. 100ft. rubber twisted. Pair cost £5. Our price 15/-
- MICROPHONES.** Special Throat Microphones. Ex R.A.F. Comprise two midget microphones and strap. Each mike being small can be concealed anywhere. The pair... .. 3/11
- R.A.F. Moving Coil assembly in bakelite case with 3in. bakelite grill. Can be also used as midget speaker. Genuine Alni magnet. Worth £3 4/6
- Moving Coil Hand Mikes, with switch. Worth £3 each 6/6
- METERS.** Square 2in. 0-40 Voltmeters, 21/- . Square 2in. 0-3.5 Thermo-Ammeters, 21/- . Square 2in. 100 mA full scale, 15/- . Voltmeters and Millammeters can be re-shunted for any reading above 5 mA.
- POTENTIOMETERS.** Heavy duty 5 watt, screw driver slot in shaft, 10,000 ohms. (List 15/-) 5/6. 15,000 fully screened, 1in. x 1/2in. spindle, 2/6. 5 watt C.T.S. (Finest make). Screw driver slot. 2,000, 5,000, 20,000 ohms, 3/6. 2 meg. Volume Controls, 1in x 1/2in. shaft, 2/- . Humdimming Pots, 9d. All other values Volume Controls, 4/- . Ditto with switch, 5/6.
- RADIO TRANSMITTING REMOTE CONTROL UNITS.** Comprising metal cabinet containing 1 high grade Morse Key, 1 high grade Adjustable Buzzer, Dual and Press-button Switches, 1 Microphone Transformer, 2 R.F. Chokes, Microphone and Headphone Jacks, etc. 15/-
- R.A.F. RECEIVER FILTER UNITS.** Interposing a filter between aerial and receiver, complete with concentric line and concentric plug. (This latter alone is worth 10/-) 2/6

Don't forget to send us a stamped addressed envelope for our List "W" SPECIAL OFFERS.

RADIOMART
Sole (CHAM) LTD.

48 HOLLOWAY HEAD, BIRMINGHAM, 1

FOR YOUR INFORMATION

We regret that we have found it necessary to revise our price list

DENCO PRICE LIST

October, 1946

	£	s.	d.
Maxi-Q Coils, Chassis Type Green, with cores			each. 4 3
" " Other Ranges, with cores			4 3
Maxi-Q Formers, Chassis Type, with cores			1 9
NOTE: Plug in Type coils and formers, are charged 3d. extra. Coils and formers supplied without cores, are charged 3d. less.			
I.F. Transformer, I.F.T.6A. 465 Kcs. 1.6, 3, 5, 10 Mcs.			8 0
I.F. Transformer, I.F.T.6B " " " " " "			8 6
Maxi-Q Miniature I.F.T.7. 465 Kcs. and 1.6 Mcs.			9 6
R.F. Chokes, R.F.C.5. 2.6 MH.			2 0
R.F. Chokes R.F.C.7A. 56 MH.			3 0
R.F. Chokes R.F.C.7B. " " " "			3 6
R.F. Chokes, R.F.C.8. 4.85 micro H			1 8
Feed Through Insulators, F.T.I.1.			1 6
Feed Through Insulators, F.T.I.2. " " " "			1 3
Feed Through Insulators, F.T.I.3. " " " "			3 0
Feed Through Insulators, F.T.I.4. " " " "			3 6
Stand (2 Insulators, S.O.I.1.			11
Stand (2 Insulators, S.O.I.2. " " " "			1 0
Stand (2 Insulators, S.O.I.3. " " " "			1 3
Stand (2 Insulators, S.O.I.4. " " " "			1 6
Stand (2 Insulators, S.O.I.5. " " " "			1 6
Variable Condensers, V.C.R.15.			6 3
Variable Condensers, V.C.R.25. " " " "			6 8
Variable Condensers, V.C.R.50. " " " "			7 2
Variable Condensers, V.C.R.100. " " " "			8 9
Coil Turrets Type C.T.1. or C.T.2. with 2-gang Condenser			2 15 0
Coil Turrets Type C.T.3. with 3-gang condenser			5 10 0
Calibrated Dials for Turrets			3 6
Drum and String Drive for Turrets			2 8
Pointers			2
Feeder Spacer, 1/2in. F.S.1. 2d. per inch. (Up to 3in. 11d. per inch over.)			
Feeder Spacer, 1/2in. F.S.2. " " " "			

Full catalogue of components available, price 6d., from

DENCO (CLACTON) LTD.

355, OLD ROAD, CLACTON-ON-SEA

Phone 807 or 808

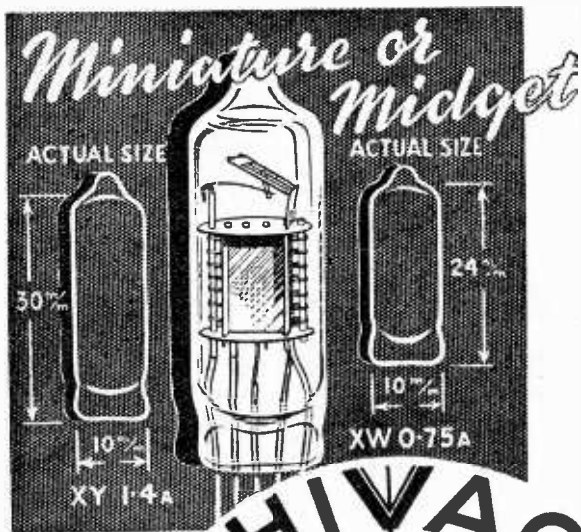

NEW TYPES FOR
MIDGET RECEIVERS
HEARING AIDS
METEOROLOGICAL
INSTRUMENTS
ETC.

BRITISH MADE

HIVAC LIMITED Greenhill Crescent. Phone HARROW
Harrow on the Hill. Middx. 0895

Varley
REGD. TRADE MARK

Products of
Quality & Reliability

MAINS TRANSFORMERS
A. F. TRANSFORMERS
SMOOTHING CHOKES
THERMAL
DELAY SWITCHES
POWER RESISTANCES

Made by
OLIVER PELL CONTROL LTD
Telephone: WOOLWICH 1422
CAMBRIDGE ROW · WOOLWICH S.E.18



Opening of the new world of adventure

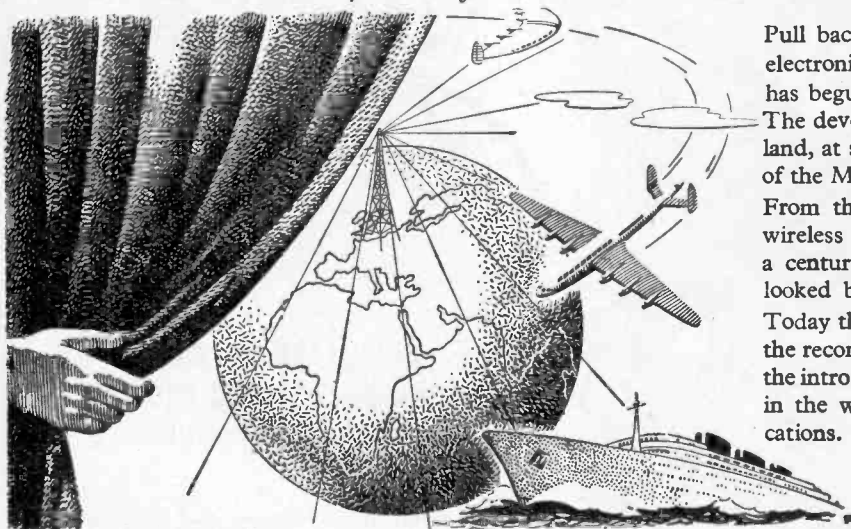

Pull back the curtain on the age of electronics—the era of industry that has begun with the end of the war. The development of new services on land, at sea and in the air are all part of the Marconi post-war plan.

From the first great adventure of wireless communication nearly half a century ago Marconi's have never looked back.

Today they are looking forward—to the reconstitution of old services and the introduction of new achievements in the world of wireless communications.

MARCONI the greatest name in wireless.....

THE MARCONI INTERNATIONAL MARINE COMMUNICATION COMPANY LTD

MARCONI'S WIRELESS TELEGRAPH COMPANY LTD.
MARCONI HOUSE, CHELMSFORD, ESSEX

Your products, too, can be assured of a longer life under all working conditions....

USE **HY-MEG** THE MODERN TIME-SAVING IMPREGNATING MEDIUM



Executives in charge of the production of electrical apparatus calling for impregnation, should send for the HY-MEG Booklet "Stability in Insulation". It describes fully how HY-MEG scientifically overcomes problems arising both in production and operation. Apply on Business Heading or Card and enclose 2d. to comply with the Control of Paper Orders.

LEWIS BERGER & SONS LTD. (Established 1760) 35 BERKELEY SQUARE, LONDON, W.1
Telephone: MAYfair 9171

MANUFACTURERS OF INSULATING VARNISHES AND ENAMELS

PAPER Capacitors

THE STANDARD OF TECHNICAL EXCELLENCE QUALITY AND RELIABILITY

The Dubilier low inductance Tubular Paper Capacitors, with extended foil elements, cover the wide field of general commercial requirements; their construction providing inexpensively the highest degree of excellence.

The Metal-Cased Tubular Paper Capacitors, specifically designed and developed for stringent tropical conditions, satisfy the most exacting requirements. Neoprene sealed and impregnated for use at high operational temperatures they effectively meet exceptional demands.

The Metallised Paper Capacitors are extremely compact and efficient, setting a new standard in their own class.

Where miniature capacitors are necessary and where minimum size and weight are imperative together with electrical performance and mechanical strength, the "Minicaps" are the most satisfactory selection.

The Metal-Cased "Minicaps" are Neoprene sealed and capable of withstanding the most severe conditions of tropical temperatures and humidity and fully justify inclusion in all designs.

MAKERS OF THE
WORLD'S FINEST CAPACITORS



DUBILIER

CONDENSER CO. (1925) LTD.

D4

DUBILIER CONDENSER CO. (1925) LTD., DUCON WORKS, VICTORIA ROAD NORTH ACTON, W.3

Phone: Acorn 2241.

Grams Hivoltcon, Phore, London.

Cables: Hivoltcon, London.

Marconi International Code.

Wireless World

Radio and Electronics

36th YEAR OF PUBLICATION

NOVEMBER 1946

Proprietors:
ILIFFE & SONS LTD.

Managing Editor:
HUGH S. POCOCK,
M.I.E.E.

Editor:
H. F. SMITH

Editorial, Advertising
and Publishing Offices:
DORSET HOUSE,
STAMFORD STREET,
LONDON, S.E.1.

Telephone:
Waterloo 3333 (50 lines).

Telegrams:
"Ethaworld, Sedist, London."



**PUBLISHED
MONTHLY**

Price : 1/6

(Publication date 26th
of preceding month)

Subscription Rate:
Home and Abroad
20/- per annum.

MONTHLY COMMENTARY	351
AIR NAVIGATION	
By M. G. Scroggie	352
R.M.S. "QUEEN ELIZABETH"	357
SHORT-WAVE CONDITIONS	
By T. W. Bennington	359
DEFLECTOR COIL COUPLING	
By W. T. Cocking	360
μ IS OVERWORKED	
By "Cathode Ray"	364
AVIATION RADIO EQUIPMENT	366
THE TRAVELLING WAVE VALVE	
By R. Kompfner	369
MINIATURE SPOT WELDING TOOLS	
By R. W. Hallows	373
TELEVISION RECEIVERS	374
VALVE STANDARDIZATION	375
WORLD OF WIRELESS	376
LETTERS TO THE EDITOR	380
RANDOM RADIATIONS	
By "Diallist"	382
RECENT INVENTIONS	384

Branch Offices :

COVENTRY :
8-10, Corporation Street.
Telephone : Coventry 5210.

Telegrams :
"Autocar, Coventry."

BIRMINGHAM :
King Edward House,
New Street.
Telephone :
Midland 7191 (7 lines).
Telegrams :
"Autopress, Birmingham."

MANCHESTER :
260, Deansgate, 3.
Telephone :
Blackfriars 4412 (4 lines).
Telegrams :
"Iliffe, Manchester."

GLASGOW :
26B, Renfield Street, C.2
Telephone : Central 4857.
Telegrams : "Iliffe, Glasgow."



As many of the circuits and apparatus described in these pages are covered by patents, readers are advised, before making use of them, to satisfy themselves that they would not be infringing patents.



1093

ERIE *Electronic Components*

The engineering resources which produced hundreds of millions of Erie components for war-time needs are now at your service. May we advise you, quote you, or send you samples?

ERIE RESISTOR LTD.
CARLISLE ROAD, THE HYDE,
LONDON, N.W.9.

Telephone : Colindale 8011

FACTORIES : London, England
Toronto, Canada • Erie, Pa., U.S.A.

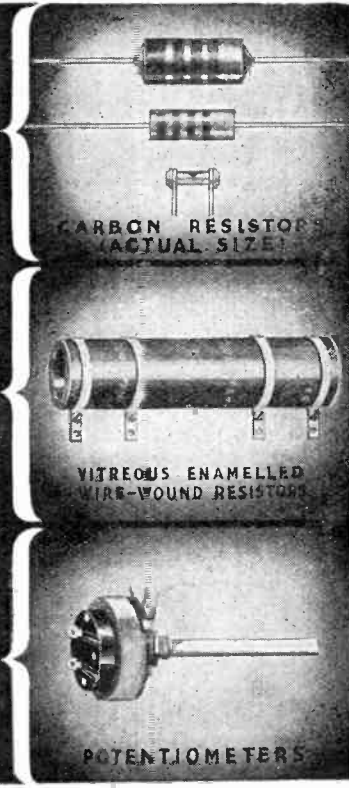

DEPENDABILITY

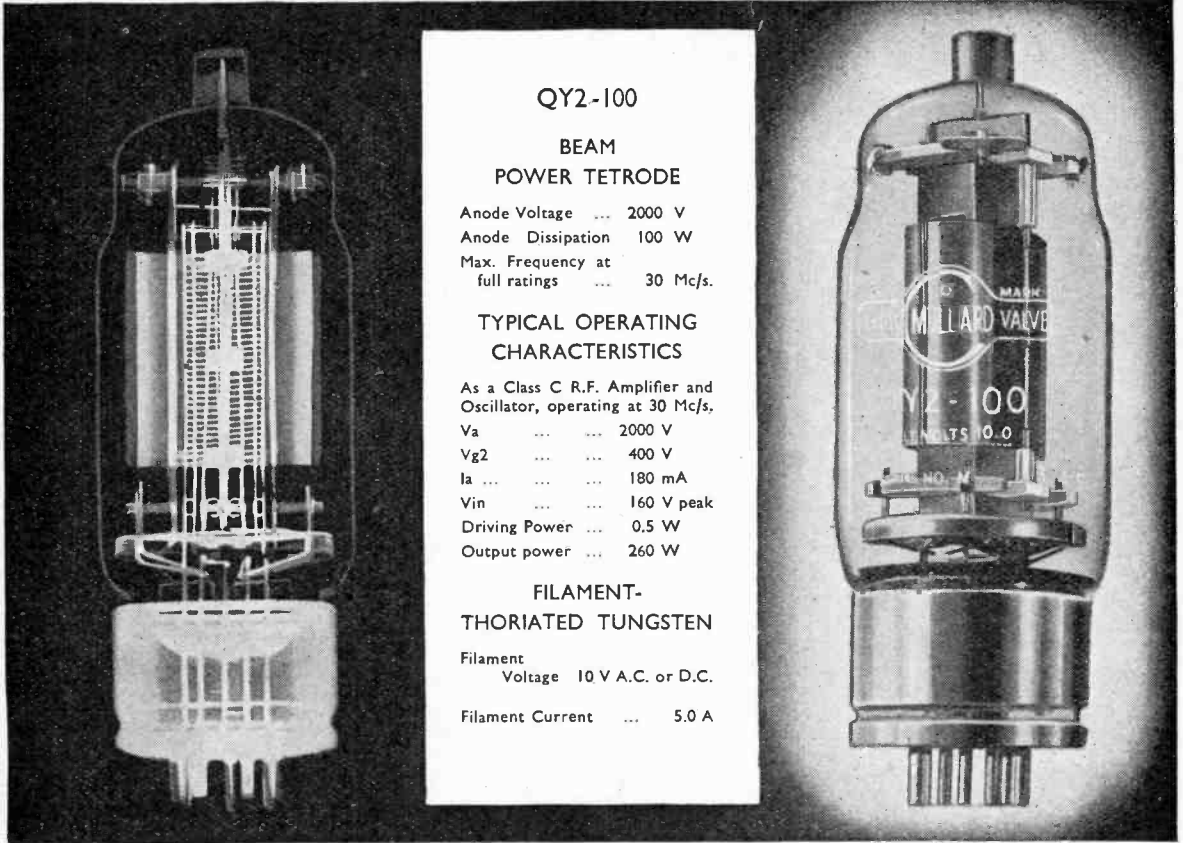

QY2-100

**BEAM
POWER TETRODE**

Anode Voltage ... 2000 V
 Anode Dissipation ... 100 W
 Max. Frequency at full ratings ... 30 Mcfs.

**TYPICAL OPERATING
CHARACTERISTICS**

As a Class C R.F. Amplifier and Oscillator, operating at 30 Mcfs,

Va ... 2000 V
 Vg2 ... 400 V
 Ia ... 180 mA
 Vin ... 160 V peak
 Driving Power ... 0.5 W
 Output power ... 260 W

**FILAMENT-
THORIATED TUNGSTEN**

Filament Voltage 10 V A.C. or D.C.
 Filament Current ... 5.0 A

... and here's the reason why

The characteristics of a thermionic valve are a problem of design. The maintenance of these characteristics under long and trying operating conditions is a question of production. At Mullard, where manufacturing methods and processes keep pace with development, the result is a valve as reliable in service as it is advanced in technique.

The QY2-100 Beam Power Tetrode, illustrated

For further developments watch

here, is a valve with a wide variety of applications in the communications and industrial fields. The advantages of its exceptional power gain, constant emission and sturdy construction are obvious to the discerning designer.

Mullard

THE MASTER VALVE



Technical data and advice on the applications of the QY2-100 Beam Power Tetrode can be obtained from—
 THE MULLARD WIRELESS SERVICE CO., LTD., TRANSMITTING & INDUSTRIAL VALVE
 DEPT., CENTURY HOUSE, SHAFTESBURY AVENUE, LONDON, W.C.2

Wireless World

Radio and Electronics

Vol. LII. No. 11

NOVEMBER, 1946

Price 1s. 6d.

Monthly Commentary

Restrictive Licences

ALMOST autocratic control of all forms of radio communication is conferred on the Postmaster-General by the Wireless Telegraphy Act. Fortunately, these sweeping powers have almost always been wielded competently and wisely, and it is seldom that this journal has found occasion to complain of restrictive Post Office practices. But an exception exists in the conditions laid down in the broadcast receiving licence, which we were impelled to criticize in last month's issue. We now think our criticism was too mild.

Put quite simply, the licence means precisely what it says. It does not confer authority to receive "CQ" telegraphy or "pirate" broadcast telephony. In reply to our question, posed last month, as to what form of licence is needed for the reception of broadcast telegraphy, we are informed that a new form of licence, intended evidently for newspapers, news agencies, and the like, is now under consideration. It will permit the reception of both telegraphic and telephonic broadcast and multi-destination wireless press messages, but seems to be of little use to private individuals.

In the interests of secrecy, some case can be made out for discouraging indiscriminate listening to telegraphy, but we have no sympathy with the restriction of listening to "authorized" telephonic broadcast stations. When a Post Office spokesman volunteers the statement that the licence does not permit listening to the "Voice of Israel" station, we must admit that the lay Press has some excuse for describing the P.O. attitude as totalitarian. What is the difference, one is tempted to ask, between the regimented German citizen who, during the war, listened to the broadcasts of his country's enemies and the citizen of this country who listens to-day to the Jewish rebels in revolt against the British mandate in Palestine? It is difficult to see any difference except in the penalties to which they render themselves liable; the Wireless Telegraphy Act provides much milder pen-

alties than decapitation of offenders by the headman's axe! And it is equally difficult to avoid reaching the conclusion that the Post Office has assumed the right to censor our listening and guard us from dangerous thoughts; surely, the idea of conferring such powers was never in the minds of those who framed the 1904 Act.

The most charitable explanation is that the Post Office, in drafting the licence, was animated by a spirit of over-cautiousness and showed excess of zeal in guarding its monopoly in radio communications. We are in no way concerned in the political issues in the background, but we are very much concerned with the fact that the unnecessarily restrictive provisions of the licence may hinder the free development of wireless. It is small consolation to have the assurance of the Post Office that individual applications for "dispensations" will have sympathetic consideration.

Television Receiver Construction

RECENTLY we have had many requests for information on the construction of television receiving equipment, and so we feel that a large number of readers may wish to know our plans. It may be said at once that it is intended to describe fully a complete television receiver, and a design is now being developed for publication in *Wireless World*. Some details are set out elsewhere in this issue.

It should be made clear that sufficiently detailed information will be given to enable anyone experienced in wireless construction and adjustment to build the apparatus. But it is not intended to encourage the inexperienced to construct the set, by providing practical wiring plans. This does not imply any intention to divide our readers into professional and amateur camps; the design is to be presented in a form that, it is hoped, will appeal to all readers who have sufficient experience to enable them to gain a practical first-hand knowledge of all that is involved in television reception.

AIR NAVIGATION: Survey of Radio Aids

By M. G. SCROGGIE, B.Sc., A.M.I.E.E.

SINCE the possibility of direct observation can seldom be counted on for long, radio is the only adequate basis for aircraft navigation. During the war, development of the art was greatly intensified; and it branched out along so many new lines that today there is an abundance of systems not yet fully developed—or else suited primarily to military needs—whilst comparatively few civil flying aids suitable for present and near-future conditions are at present available.

There is, in fact, almost an embarrassment of riches as regards techniques, and it is mainly a matter of embodying them in appropriate and fully-engineered equipment. Systems that have reached at least an experimental stage are already more numerous than is necessary, since many perform similar or overlapping functions; and if such development went on more or less unco-ordinated all over the world, the result would soon be a situation in which an aircraft fitted to use the ground services wherever it went would have little room for anything but radio gear. As it is, B.O.A.C. aircraft are decorated with some 17 different aerials!

The need for world-wide standardization and co-ordination being so obvious and urgent, the appropriate authority (at present the Provisional International Civil Aviation Organization) recently met in London, and has re-assembled in the U.S.A. prior to a meeting in Canada, to study the state of the art and to try to decide which systems should be chosen for international standard use.

This field of radio is already so vast, and most of the equipment so new, that there may be some use in attempting to render the outlines of the wood discernible rather than the innumerable trees. Some of the latter have already been described in these pages; and concise details of fifty of them (if related communications and auxiliaries are included) are contained in an excellently produced Stationery Office publication.¹ Many of these details are only tentative,

and some of them have already been superseded.

First of all, what are air navigational aids required to do? They should enable the pilot to keep closely on the desired track, and to know his position at any time en route and should warn him of obstructions. They should also enable him to make the correct approach to a clear runway at the destination and (if necessary) land "blind." In between these two phases there is another, which

complete harmony and with precise positional knowledge of one another. During the other two phases, while it is desirable for the aircraft to be self-sufficient, it should be able in the event of failure of equipment to fall back on accurate information from the ground.

Although cathode-ray tube displays were largely used in the air during the war, it is now generally accepted that nothing other than easily interpreted meter presentation direct to the pilot will do. In achieving this operational simplicity, however, it is difficult to avoid making the "works" more complicated, which tends to add also to bulk and weight. But great advances have been made in "miniaturization," and equipment that before the war would have been thought fantastically complex for use in the air proved quite practical even in battle. And while it is obviously a bad thing to be obliged to carry a large number of different sets of equipment, the opposite extreme of using a single set to do everything entails the risk that if it fails one has "had it." The best compromise, perhaps, is a few sets (maybe only two), each of which can, to some extent, substitute for the other in an emergency.

Considering now the basic sorts of information provided by navigational aids, these are comparatively few. There is the *bearing*, with respect to North, of a known point from the aircraft. This information is sufficient to locate the aircraft on a *position line*. Two intersecting position lines give a *fix*. This is the basis of ordinary D.F., as known before the war. Alternatively, a *fix* may be derived from one bearing plus distance or *range*. This is the facility that radar introduced. A class of information closely related to bearing is *course* or *heading*; i.e., an indication when the aircraft's nose is pointing in a certain direction. It is even more useful than bearing if it happens to be the direction in which one wants to go, but not otherwise.

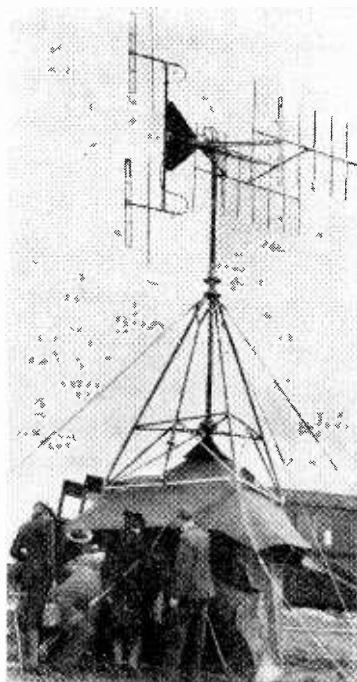

Fig. 1. V.H.F. Rotating Beacon, which can quickly be set up on a site. The Yagi aerial (right) transmits sharply beamed speech, and the cardioid aerial a continuous tuning note in all directions outside the beam.

may begin fifty miles or more from the destination, during which it may be necessary for the aircraft to be "stood off" until its turn to land is due. During this phase, if confusion and risk of collision are to be avoided, pilot and ground controller must work in

Civil Aviation

Lastly, there is the relative distance from two fixed points, which is the foundation of the *hyperbolic* systems—so-called because lines of constant difference in distance are hyperbolæ. Readings from two pairs of points give a fix—if one possesses a map on which the relevant hyperbolæ are drawn.

The present tendency is to convert these basic sorts of information, by means of some type of automatic computer, into what the pilot actually wants to know, e.g., his closeness to a prescribed track, and his distance along it from his destination.

Still another basis for classification is the type of radio transmission employed, such as unmodulated C.W. (Decca system), keyed or amplitude-modulated C.W., or pulses (not necessarily radar). The wavebands occupied generally increase in that order. One system to be referred to later (A.S.M.I.), with a pulse duration of one-eighth microsecond, requires a band of about 16 Mc/s.

An important subdivision distinguishes primary radar, which works on the echo principle, from secondary radar, in which the outgoing pulse triggers a responder into replying with pulses, usually on a different frequency. The range for a given power is thereby greatly increased, and the responder can be coded for purposes of identification.

Before the war direction-finding by loop aerial was the main navigational aid. D.F. facilities can easily be incorporated with the communication radio; and there are plenty of transmitters on which to take bearings, besides the radio beacons set up for the purpose. But its accuracy is somewhat variable, depending on sites and aspects of aerials, time of day and operational skill; and it is not continuously direct-reading or instantaneously-fixing. Recent D.F. developments include the radio compass, in which the loop aerial automatically orientates itself and gives continuous readings of bearing; and cathode-ray direction-finders (C.R.D.F.), in which a radial trace on the tube screen shows

directly the bearing of the transmitter tuned in. C.R.D.F. is being given a rôle in airport ground control systems to supplement radar locating and identifying apparatus; while the radio compass and even earlier forms of

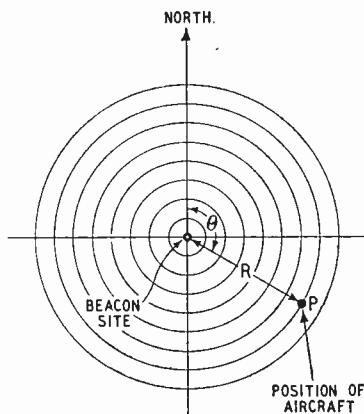

Fig. 2. In the "spider's web" system of navigation, the position, P, of an aircraft is determined by polar co-ordinates, R and θ , with reference to a central origin, which is the site of two beacons, one for measuring R and one for θ .

D.F. are likely to be widely used for some time.

As long ago as 1929 a beacon with a rotating directional transmitting aerial came into service at Orfordness. The Morse signals transmitted are related to the aerial's orientation, so that one's bearing can be obtained by merely listening to it. The same idea in modern form, shown in Fig. 1, with a recorded voice calling out its bearings on the V.H.F. band, appeals to pilots—because they have only to switch to the appropriate channel on their V.H.F. receiver, and to the authorities—because the ground gear is automatic and cheap.

A further elaboration is Consol,² with a range of 1,000-1,500 miles and much greater accuracy, provided that one possesses a special map and a rough idea of one's bearing from the beacon.

Since no apparatus is needed in the air beyond the ordinary receiver, there seems no reason why beacons in this class should not continue to be used, at least as auxiliary aids for the benefit of aircraft in which equipment for more refined systems is either

absent or unserviceable. They are sometimes called Radio Ranges (presumably because they have nothing to do with range!).

All-round direction-giving beacons of more refined types are being developed as the " θ " parts of the polar-co-ordinate or "spider's web" systems of navigation (Fig. 2). The "R," or distance-measuring, parts employ secondary radar. Between them they fix positions relative to the site of the ground beacons.

One type of experimental θ beacon ("John Gilpin") has a U.H.F. pulse transmitter which at intervals of about 30 pulses is switched from one aerial to either of two others about 500ft away. A special airborne receiving equipment notes the phase discontinuities between these groups of pulses, and from them computes the bearing of the beacon and displays it on a meter. The system is something like Gee with the transmitting aerials so close together that the hyperbolæ are radial straight lines.

Another line of development (Omni-directional Radio Beacon, O.R.B.) uses C.W. in the V.H.F. band. The phase difference, in degrees, between two 60-c/s signals on the beacon carrier wave is equal to the bearing, in degrees, of the beacon. This is because one of the 60-c/s signals is generated by the rotation at 60 r.p.s. of the aerial, which radiates asymmetrically in azimuth. The other, a constant reference signal, is borne by the same carrier wave, but is separable in the receiver because it takes the form of a 60-c/s frequency modulation of a 10-kc/s amplitude modulation of the carrier. The two signals can therefore be compared in a phase discriminator and made to actuate a direct-reading bearing indicator.

P.O.P.I. (Post Office Position Indicator) is not, as one might suppose from the name, a facility for the general public on the ground, but yet another beacon—designed by the P.O. Engineering Dept.—from which a receiver gives direct readings of bearing. Its technique is intermediate between the last two, but as it works in the M.F. band its range is much greater, probably 1,000-1,500 miles in daytime, like Con-

Air Navigation—

sol and Decca, and, like them, not dependent on flying height. It is not part of a spider's web scheme; positions are determined by the bearings of *two* stations.

The other polar co-ordinate needed to give a spider's web fix; i.e., distance, and also identification of the origin, are supplied by

An advantage of having Rebecca in an aircraft is its versatility. Besides giving distance from Eureka beacons, and their identity, its semi-directional aerials enable homing indication to be provided. This applies not only to the all-round Eureka beacons but also to the sharply beamed short-range beacons "Babs,"

height above ground. Better still is information on whether the aircraft is at all times at the correct height for landing; in other words, is in the glide path. The pre-war Lorenz system, using a single C.W. approach beam and two vertical distance-marker beacons, was one of the first instrument-landing schemes. The present-day American SCS-51 (of which the Pye "Abas" is a modified version), by using independent beams to mark the horizontal and vertical approach planes, defines the landing path more precisely, and indicates it to the pilot by cross-pointer meters (Fig. 4).

But blind landing is still the most acute problem, and one that cannot yet be said to be completely solved. It is one thing to demonstrate satisfactory blind landings, and quite another to guarantee them under all working conditions.

If all pilots had instruments enabling them to keep to the prescribed tracks at the correct heights, and if the ground staff

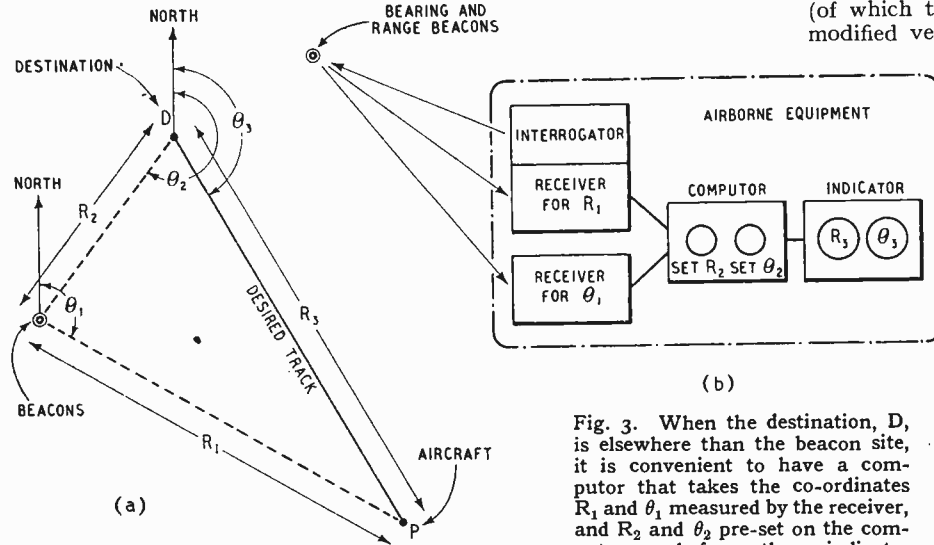

Fig. 3. When the destination, D, is elsewhere than the beacon site, it is convenient to have a computer that takes the co-ordinates R_1 and θ_1 measured by the receiver, and R_2 and θ_2 pre-set on the computer, and from them indicates the range and bearing, R_3 and θ_3 , of the destination.

a secondary radar beacon "Eureka."³ The airborne equipment "Rebecca"³ interrogates the beacon, which responds as already described. Wartime Rebecca displayed the information on a calibrated C.R.T.; but other wartime techniques, using the time displacement between the outgoing pulse and the responding pulse from a selected source to control a meter-deflecting current, are being applied to make Rebecca direct-reading.

Even this is not enough, because a pilot who wants to fly somewhere other than to the site of the R and θ beacons would be left with a nasty geometrical problem; viz., origin-shifting of polar co-ordinates (Fig. 3a). Great strides are being made with electro-mechanical computers, and an experimental unit has already been made up for continuously indicating the R and θ of any desired point, provided that the track to that point lies wholly within the service area of the R and θ beacons, and that the R and θ of the beacon site have been pre-set on the unit (Fig. 3b).

giving left/right and distance indications for helping pilots to approach the runway in bad visibility. There are other facilities, too, such as interrogation of I.F.F.,³ giving identity of other aircraft, ships, etc.

A gadget that is being fitted to Rebecca in R.A.F. aircraft has a switch that can be set to any desired radius from 3 to 12 miles, whereupon a left/right indicator shows the departure from an orbit of that radius. It is even possible to feed this meter current into an automatic pilot so that the aircraft flies round and round until further notice without any human effort. The main object of orbiting is to kill time until permission can be given to land.

Although radar beam approach systems such as Babs have the advantage over C.W. systems of giving continuous readings of distance from destination, this is not so very helpful, at least for actual landing, without accurate simultaneous information on

organized all flights to schedule, and had equipment to show the positions of all aircraft, especially

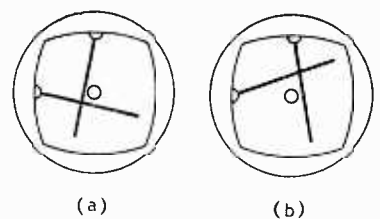

Fig. 4. The centre of the SCS-51 instrument-landing dial represents the position of the aircraft relative to the radio beams marking vertical and horizontal approach planes. With an indication such as a before him, the pilot should turn left and lose height; with b, vice versa. Flashing lights indicate when he is passing over distance marker beacons.

near airfields, risk of collisions in the air or on the ground would in theory be excluded. To help fill the gap between this ideal and the reality, especially on long-distance flights, and where tropical clouds may be encountered, airborne primary radar giving warning of high ground, storm clouds, and other aircraft is an obvious extension of war-time practice. A light X-band (3 cm.) set is now being tested in S.E. Asia.

On the ground there are several forms of primary radar. Size and complexity do not matter so much there. Ability to cope quickly with a large amount of information is the chief requisite. The American G.C.A. (Ground Control of Approach), Fig. 5, successful during the war, uses two radar sets. One enables Traffic Directors to locate all aircraft within about 25 miles, and marshal them by spoken instructions on a V.H.F. channel. As each one in turn reaches the beginning of the approach, it is handed over to an approach controller who, by the use of separate precision radar equipment, can follow the aircraft exactly enough to bring

the pilot down over the runway by his instructions. The only airborne equipment needed, therefore is V.H.F. communication, which at a pinch need not

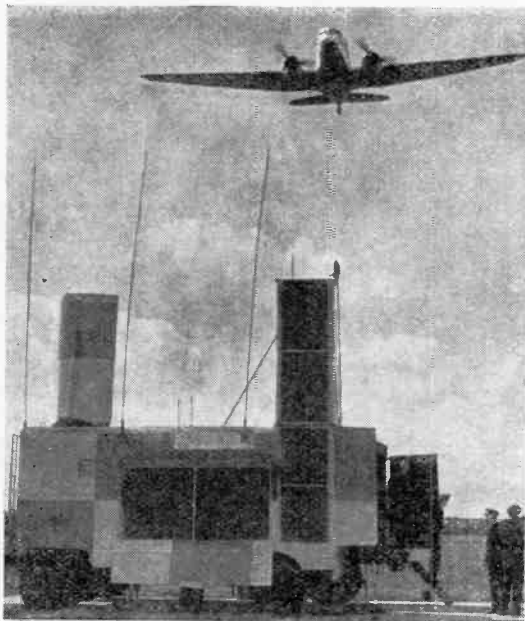

Fig. 5. The G.C.A. dual radar installation for "talking down" aircraft, though elaborate, is completely mobile.

even be two-way, as replies from the aircraft are not essential.

For general airfield control, several types of A.C.R. (Airfield Control Radar) have reached the experimental stages (Fig. 6). They include primary search radar with P.P.I. displays for locating aircraft, and C.R.D.F.

and/or secondary radar for identifying them. The C.R.D.F. display can be superimposed on the P.P.I. and points out which of the echoes corresponds to the aircraft that is talking by V.H.F. Secondary radar necessitates the aircraft to be fitted with a responder, the equivalent of war-time I.F.F.

Before a controller can confidently authorize a landing, he must know that the runway is clear. A.S.M.I. (Airfield Surface Movement Indicator) enables him to do so when direct vision fails. As one would expect, it is a high-resolution, very-low-angle short-range radar installation. It is now in the experimental stages.

The Standard Telephones and Cables, Ltd. "Condar" system, although it gives a P.P.I. display of range and bearing on a C.R.T., is not radar. It is a special type of C.R.D.F. in which the radial C.R.T. trace, due to the V.H.F. signal from the aircraft, is used also as a time base, on which a bright spot marks the range. The position of this spot along the range scale is controlled by the phase difference between a 809-c/s signal taken direct from an oscillator in the ground apparatus and a similar signal derived by demodulating the aircraft's carrier wave, which has been modulated by the ground oscillator signal received on a separate radio channel.

Hyperbolic systems are now more or less well known. Gee⁴ and Loran both use pulses, and differ chiefly in their radio frequencies: 20-85 Mc/s for Gee,

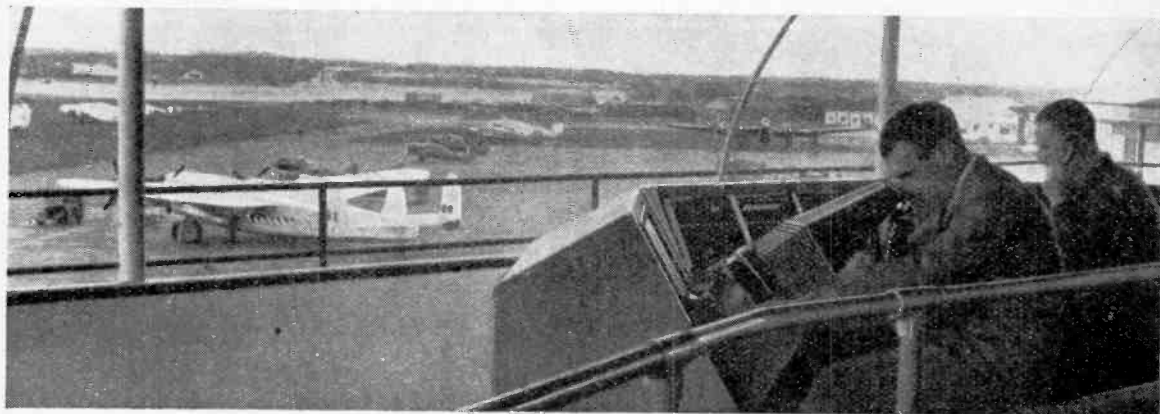

[Fig. 6. Experimental flying control tower at R.A.E., Farnborough, showing radar (A.C.R.).

Air Navigation—

and 1.75-1.95 Mc/s for ordinary Loran. So Loran gives a longer range and rather less precision. It is possible to produce a combination receiver for working on either. At present both display their results on a C.R.T. in a form that is not directly interpretable by the pilot, and a certain amount of operation is needed to obtain them. To overcome this objection, it is intended to put in hand a programme of development whereby Gee, by the addition of ingenious equipment, is to be made direct-reading, and ultimately to give continuous readings without operation, as does Decca. The accuracy and range are somewhat less than with Decca, however, especially at low altitudes, and the wave band occupied is, of course, vastly greater.

Owing to the scale on which Gee was produced during the war, it has the advantage of being available in quantity at the present time.

The Decca system,⁵ using unmodulated C.W. on frequencies of the order of 0.1 Mc/s, is now in regular 24-hour service in England, giving a useful radius of about 300 miles at night and over 1,000 miles by day. It is equally applicable at sea and even on land, as the effect of terrain screening is relatively slight. A disadvantage is that if one flies into the service area not knowing the position within a few miles, the lane and zone number indicators cannot be set, so the pointer readings are ambiguous. The same may happen if for any reason functioning is interrupted for a while. Methods of zone and lane identification now undergoing trial should overcome this difficulty.

The system has from its start provided automatic direct continuous readings. These readings refer to special co-ordinates on a map, enabling a navigator to determine his position with great accuracy, but not directly useful

to the pilot unless he homes on predetermined lattice lines. An auxiliary device is already being tried, however, which among other things gives the pilot direct readings of his displacement from a track of any desired shape, or selected approach orbit, and indicates miles to destination, actual ground speed, and time ahead of or behind schedule (Fig. 7). It is also believed possible, by using still lower radiated frequencies (10-14 kc/s), to obtain a working day and night range of at least 1,500 miles.

Radio communication between

ject to night errors at certain ranges.

An example of the former, especially suitable for the shorter routes, is a combined V.H.F. equipment giving speech communication with the ground, "spider's web" location, and glide path landing. The ground controller, using information received from the aircraft and from his own radar and other aids, could from time to time instruct the pilot what co-ordinates to set on his computer in order to make a route that would avoid obstructions and, if necessary, delay him sufficiently to clear preceding arrivals.

Alternatively a similar procedure can be applied on hyperbolic systems. Decca, especially if lane identification and track control prove successful, has much in its favour, because it combines a good range at low altitudes with remarkable accuracy, and is very flexible.

Private owners are reluctant to fit additional radio for navigation only, and are naturally much attracted by devices such as the V.H.F. rotating beacon, and ground D.F. and G.C.A. systems. These navigational facilities are "thrown in" with the essential air-to-ground speech communication provided by a set such as the STR9* (Standard Telephones) which, weighing only 22lb, operates on four crystal-controlled channels in the 115-145 Mc/s band.

[* Illustrated in our review of the S.B.A.C. exhibition on page 367.—ED.]

REFERENCES

- ¹ "Demonstrations of Radio Aids to Civil Aviation." His Majesty's Stationery Office, Sept. 1946. 80+vii pp. Price 5/-.
- ² *Wireless World*, July 1946, pp. 223-5.
- ³ *Wireless World*, Feb. 1946, pp. 55-6.
- ⁴ *Wireless World*, Jan. 1946, pp. 23-6.
- ⁵ *Wireless World*, March 1946, pp. 93-5 and Aug. 1946, pp. 260-2.

WIRELESS WORLD DIARY

COPIES of the 1947 Diary are expected to be ready by the end of November, when they will be distributed through booksellers and stationers. Price is 3s 4½d, inc. purchase tax.

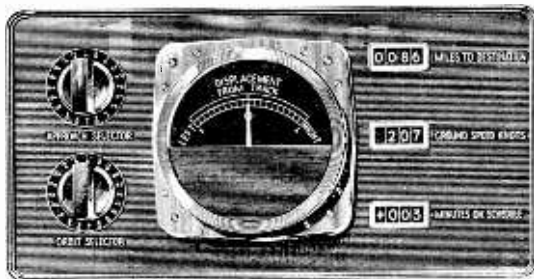

Fig. 7. Decca Track Control Unit indicator.

air and ground is an essential part of some navigational systems, and an invaluable stand-by when all else fails. The outstanding advance during the war was the general introduction by the R.A.F. of V.H.F. speech for short- and medium-range communication. This is now accepted on its merits as standard practice. A recent model (TR 1407) gives automatic selection of 336 crystal-referenced channels, with either A.M. or F.M.

Diversity of language is a difficulty in some areas, however, and to meet it automatic telephone technique has been applied to radio for communicating by visually displaying figures and obvious pictorial symbols. Transmission of messages and acknowledgments is automatic, by button-pushing; and many other facilities are ingeniously provided.

It remains to be seen how aircraft radio installations will develop as integrated systems. A major choice lies between V.H.F. systems, which have a very restricted range at low altitudes, and those working at lower frequencies, which are generally sub-

R.M.S. Queen Elizabeth

Radio and Radar Installations on the Grand Scale

THE maiden voyage of the Cunard White Star Liner *Queen Elizabeth* as a passenger vessel after her years of war service affords an opportunity of reviewing the ship's radio and radar installations. It is not possible, however, to give a detailed description of the equipment; we will, therefore, confine ourselves to a brief outline of the main features of the installation, for the operation of which the vessel carries ten radio officers.

In order to permit simultaneous transmission and reception of messages, handling of radiotelephone calls, and observation of safety-of-life requirements, the radio station is divided in two. The main office, situated approximately amidships on the sun deck, is the centralized control point for the whole station and contains all the receivers, telephone equipment, and transmitter control gear. The four main transmitters, covering the H.F., M.F. and L.F. bands, are housed in a separate room on the same deck just forward of the mainmast and about 250 feet from the main control room. This also houses a complete emergency station which can be put into operation instantaneously in the event of any failure in the ship's power supply or main equipment.

In a third room, adjacent to the ship's engine-room, are two 3-phase motor alternators for converting the ship's D.C. supply to A.C. at 220 V, 50 c/s, from which all the main radio equipment is designed to operate.

The main control office has an area of approximately 600 sq ft, and is provided with four main operating positions; two radiotelegraph and two radiotelephone, all of which may be used simultaneously without mutual interference. During peak traffic periods the number of operating points can be extended considerably by a system of inter-position control. All points in operation can be checked by the supervisor at a central control unit.

An automatic dialling system is employed, both at the engineer's control position and in the operating room, whereby the transmitters are switched on, the service (C.W. or M.C.W.) selected and the frequency changed. Ten channels are provided by the 3-kW M.W. and L.W. transmitters and six by each of the three 1-kW S.W. transmitters which operate in the 3-18-Mc/s band.

passengers may pick up their bedside telephone and call any country whose telephone service is connected to an international exchange. They may also converse with passengers on other ships fitted with radiotelephones. In addition to room telephones similar calls may be made from the booths in various parts of the vessel. A special telephone booth adjacent to the main control office is fitted with a loudspeaker—a useful feature in the case of family groups wishing to hear a distant caller.

The radiotelephone equipment embodies such devices as compressor and expander units, permitting calls to be handled under the most difficult of atmospheric conditions. Two telephone calls may be handled simultaneously; thus one passenger may be speaking to America whilst another is speaking to Europe.

The future probability of a pas-

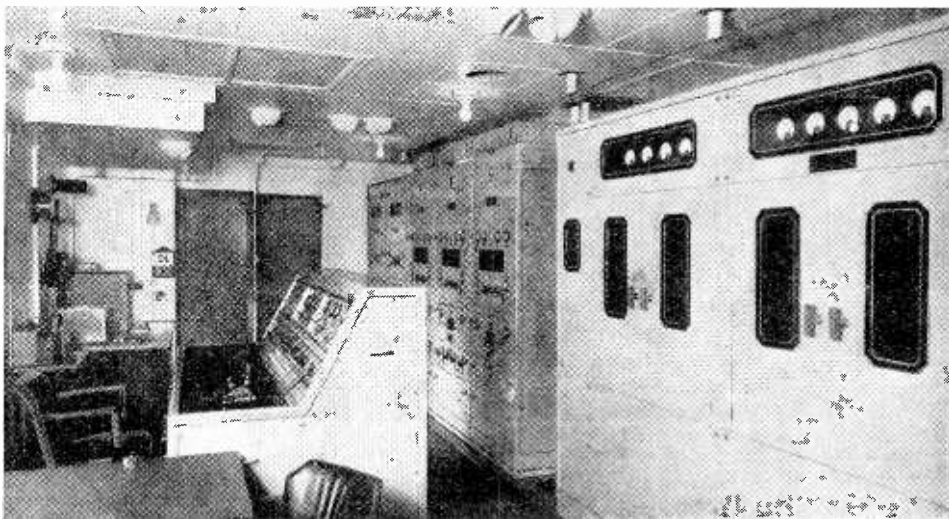

A view of the main transmitting room in the *Queen Elizabeth* showing, in the centre, the engineer's control desk. Mounted against the right-hand bulkhead are, left to right, three high-frequency W/T and R/T transmitters and the M.F./L.F. telegraphy transmitter.

The small emergency station is located in the left-hand corner. Her call-sign is GBSS.

An outstanding feature of the whole installation, which was provided by the International Marine Radio Company, is the elaborate radiotelephone system, whereby

passenger radiotelephone and radiotelegraph service between commercial aircraft and ships is also envisaged, and provision for such service has been made in the ex-

R.M.S. "Queen Elizabeth"—tensive bands covered by both transmitters and receivers.

In order to maintain the graceful lines of the vessel the number of aerials has been reduced to a minimum. Above the main control office there is only one dipole to which all receivers are connected through a special coupling

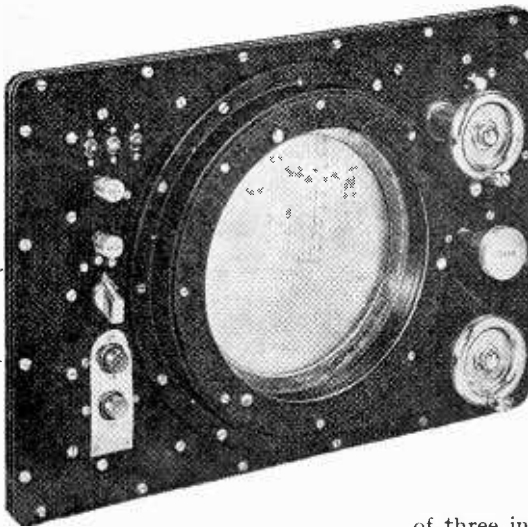

Control panel of the Cossor P.P.I. The top hand-wheel rotates the display in relation to the ship's heading line and that below rotates the cursor on the Perspex screen. To check that the apparatus is operating when on the open sea and no reflections are shown, a test button is provided. The control unit measures only 19 in wide \times 27 in high \times 12½ in deep

system in the lead-in trunk. The number of transmitting aerials has been reduced by the simultaneous operation of one H.F. transmitter and the L.F. transmitter into one aerial. The two aerials used for the radiotelephone service are of the inverted "V" type mounted in a fore-and-aft line, thus giving east-west directivity when the vessel is on the Atlantic.

Two motor-lifeboats are fitted with complete radiotelegraph and radiotelephone equipment operating in the International distress frequency bands. In addition the vessel carries two of the well-known hand-operated portable transmitters designed by I.M.R.C. to the Ministry of War Transport specification, of which some 6,000 were supplied during the war years. Supplementary to these transmitters is the I.M.R.C. rocket kite aerial system.

Docking operations are greatly facilitated by the installation of a low-power radiotelephone equipment on the bridge, enabling the captain, navigation officers or

pilot to talk directly to tugs, dock master, or officials awaiting the vessel's arrival.

The public-address equipment comprises a complete system for the origination and diffusion of programmes throughout the ship. Four 30-watt amplifiers are installed and can be grouped or used individually for the relaying

of three independent programmes originating on board and a broadcast programme. Supplementary to this equipment is a separate emergency announcement system controlled from the bridge.

In addition to the standard I.M.R.C. direction finders operating in the M.F. band, the *Queen Elizabeth* has been fitted with Gee and Loran equipment and Admiralty Type 268 and Cossor radar gear.

The Cossor equipment comprises four units: the indicator, or P.P.I., which is housed in a special radar room in the wheelhouse; the main transmitter and

Our Cover

SCANNERS for the "Queen Elizabeth's" two radar sets are illustrated on the front cover of this issue. On the left is that for the Cossor gear, alongside which is the Admiralty 268 scanner enclosed in Perspex. A thermostatically controlled de-icing heater is incorporated in the Cossor scanner, which is constructed to maintain its scanning rate of 30-40 r.p.m. in wind speeds up to 80 knots.

receiver rack contained in a hermetically sealed tank 30in \times 25in \times 25in; the scanner, erected above the wheelhouse; and the alternator with an A.C. output of 180 volts at 500 c/s.

The 30-kW radar transmitter, working in the 9.425—9.525-Mc/s band, has a pulse recurrence of 1,000 on the 12-mile range and 2,000 on the 3- and 1.2-mile ranges. Its minimum range is given as 50 yds with an accuracy of ± 5 per cent of the maximum range of the scale in use. This is defined as making it possible to separately distinguish two small objects with a range difference of only 70 yards.

Calibration rings of 0.2 nautical mile separation are provided for the 1.2-mile range and 0.5- and 1-mile rings, respectively, for the 3- and 12-mile ranges.

This prototype of a compact standard equipment conforms in all essentials to the recommendations laid down by the Ministry of Transport.



FERRANTI Model 146

A three-waveband super-het circuit (4 valves + rectifier) is employed in this new receiver which is rated for an output of 4 watts undistorted. It is for A.C. mains and costs £18 18s, plus 4s. rod. tax.

SHORT-WAVE CONDITIONS

Expectations for November

By T. W. BENNINGTON

(Engineering Division, B.B.C.)

DURING the undisturbed part of September there was a very considerable increase in the daytime maximum usable frequencies for this latitude, while the night-time M.U.F.s decreased appreciably as compared with August. These variations were such as would be expected, having regard to the seasonal effect in the Northern Hemisphere.

The increase in daytime M.U.F.s was, however, enhanced by the high solar activity, and long-distance communication on exceptionally high frequencies was more frequent than of late, though, towards the latter half of the month, it was often prevented by ionosphere disturbances. Sporadic E, though it was often prevalent, was less so than during the past few months.

A large amount of ionosphere storminess occurred, though during the first half of the month only the 7th-8th and 10th were disturbed, and then not seriously. On the 16th, however, a disturbed period set in; on most of the remaining days of the month conditions were subnormal, particularly during darkness. The ionosphere storms took place as follows:—16th-21st (severe 17th), 21st-25th (very severe 22nd and 23rd) and 27th-30th (very disturbed 28th). "Dellinger" fade-outs were reported on 13th, 19th and 23rd.

During these ionosphere storms the Aurora Borealis was seen at several points in England, and Cable and Wireless states that on 22nd earth currents interfered considerably with cable traffic, though the cables were working normally on 23rd. Some delay to the company's direct radio traffic occurred on the circuits from this country to Montreal and New York due to the disturbance, but it was possible to maintain communication with Australia via the relay station at Colombo and with Canada and Australia via the Barbados relay station. Direct communication to Cairo and Capetown was not interrupted, these circuits passing through ionospheric regions remote from the zone of disturbance, which is centred on the North Magnetic Pole.

Forecast.—Daytime M.U.F.s during November should be even higher than during October over many paths, and communication on ex-

ceptionally high frequencies by way of the regular layers will be possible for long periods. On the other hand, the night-time M.U.F.s will generally be considerably lower than during October, so that the change-over from day to night frequencies and *vice versa* will be large in degree and relatively rapid in time. Night-time frequencies below 9 Mc/s will in many cases be required, though it is not expected that those below 7 Mc/s will often be really necessary.

The effects of any ionosphere storms which occur during November are likely to be particularly noticeable during darkness, for then the ionisation is, in any case, rather low and any further abnormal decrease may well interrupt communications. Although one cannot be at all certain, it would appear that such disturbances are more likely to occur within the periods 9th-12th, 14th-16th, and 21st-23rd than on the other days of the month.

Below are given, in terms of the broadcast bands, the working frequencies which should be regularly usable during November for four long-distance circuits running in different directions from this country. In addition, a figure in brackets is given, which indicates the highest frequency likely to be usable for about 25 per cent of the

time during the month for communication by way of the regular layers:—

Montreal :	0000	9 Mc/s	(14 Mc/s)
	0400	7 "	(12 ")
	0900	11 "	" or 15 Mc/s (16 ")
	1100	17 "	" " (24 ")
	1200	21 "	" " (30 ")
	1300	26 "	" " (36 ")
	1800	21 "	" or 17 Mc/s (28 ")
	2000	15 "	" " (22 ")
	2100	11 "	" " (16 ")
Buenos Aires:	0000	11 "	(16 ")
	0300	9 "	(15 ")
	0600	11 "	(16 ")
	0800	17 "	" or 21 Mc/s (24 ")
	1000	26 "	" " (36 ")
	1800	21 "	" or 17 Mc/s (28 ")
	2000	15 "	" " (20 ")
	2100	11 "	" " (17 ")
Cape Town :	0000	9 "	(15 ")
	0500	11 "	" or 15 Mc/s (17 ")
	0700	21 "	" " (30 ")
	0800	26 "	" " (37 ")
	1600	21 "	" or 17 Mc/s (32 ")
	1800	15 "	" " (22 ")
	1900	11 "	" " (17 ")
Chungking :	0000	7 "	(11 ")
	0400	9 "	" or 11 Mc/s (13 ")
	0600	17 "	" or 21 Mc/s (23 ")
	0800	26 "	" " (35 ")
	1100	21 "	" or 17 Mc/s (28 ")
	1300	15 "	" " (20 ")
	1400	11 "	" " (17 ")
	1600	9 "	" " (15 ")
	2000	7 "	" " (12 ")

Footnote.—The forecasting of disturbed ionospheric periods is based on the fact that as the sun rotates in an average period of 27.3 days any area upon it which gives rise to terrestrial phenomena will be in a similar position at time intervals of that duration. Thus there is the well-known recurrence tendency for magnetic storms to occur. But it is well to point out the limitations of this method. It requires that the solar area should be in an active state every time it enters the central zone of the sun's disc, and also

does not take immediate account of new active areas which may come into being. At the present time the sunspot activity is increasing rapidly, so, when the forecasts are made for so long a period as two months ahead, the data is particularly liable to error at present.

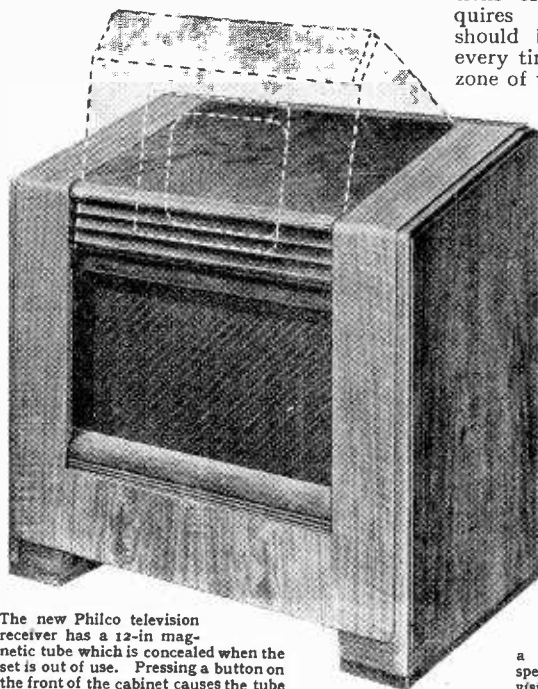

The new Philco television receiver has a 12-in magnetic tube which is concealed when the set is out of use. Pressing a button on the front of the cabinet causes the tube to rise into view and at the same time

switches on. The "user" controls—sound volume and tone and picture controls—are mounted alongside the tube while the pre-set controls are behind a removable panel under the speaker grille. Both sound and vision receivers are of the straight type.

DEFLECTOR COIL COUPLING

Correcting Distortion by the Valve Characteristics

IT was shown in a recent article that it is almost impracticable to obtain a linear saw-tooth current at frame frequency in a deflector coil by the "ideal" method of making each small group of elements linear in itself. This is because the requirements are so stringent that the design becomes uneconomical. In practice, therefore, it is necessary to balance inverse distortions in different elements so that they cancel and provide an overall result which is undistorted.

When a positive-going saw-tooth voltage is applied to the grid of a valve, the curvature of the valve characteristics makes the anode current tend to change more rapidly with time than a linear function. When a linear saw-tooth current wave is applied

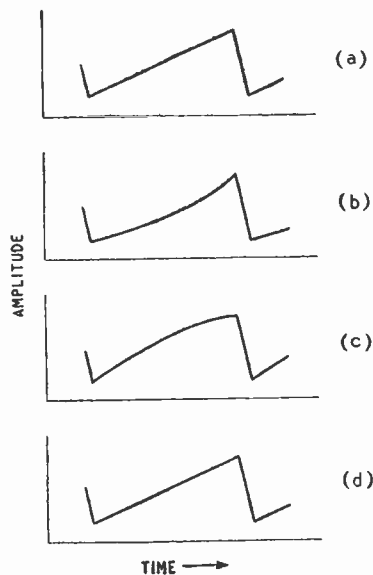

Fig. 1. A perfect saw-tooth grid voltage wave is shown at (a) and the anode current wave at (b). The latter rises too quickly because of valve curvature. If the valve were linear the anode current wave would be the same as (a) and the coupling to the deflector coil would distort the coil current to (c). With a non-linear valve distortion (b) corrects for distortion (c) and a linear coil current (d) is obtained.

By W. T. COCKING,
M.I.E.E.

to the deflector coil through a coupling containing inductive or capacitive elements, the coil current tends to change more slowly with time than a linear function. It is, therefore, theoretically possible so to proportion the elements that the property of the circuit of reducing the rate of current change offsets the property of the valve of increasing the current rate of change.

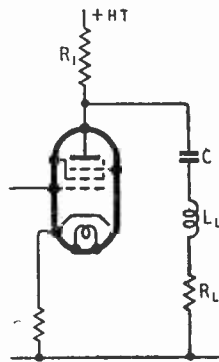

Fig. 2. Circuit of resistance-capacitance fed deflector coil.

This is shown in Fig. 1 where (a) represents a linear saw-tooth wave applied to the output valve. The resulting anode current has the form (b) because of the valve curvature. If the current were still linear like (a), the coil current would be distorted to the form (c) by the capacitive or inductive elements in the coupling. The distorted wave (b), however, is inversely distorted by the coupling and the resulting coil current is linear (d).

In practice, of course, perfect compensation is not to be expected, but a considerable improvement is easily obtained. Unfortunately, exact calculation of the output current resulting from the application of a linear saw-tooth wave to a non-linear valve with an inductive or capacitive output coupling is exceedingly

difficult. In fact, it is practicable only when the valve characteristic can be expressed by a fairly simple equation.

It is possible, however, to solve the inverse problem fairly simply by semi-graphical means. If a perfect output current is assumed it is not difficult, but may be a little laborious, to calculate the grid voltage wave necessary to produce it. Arrangements can then be made to provide this grid voltage or, if it should prove to be one which is too troublesome to generate, by a process of trial and error the conditions demanding an easily generated grid voltage can be found.

The first step is to calculate the changing current which the valve must provide and the back e.m.f. on its anode. This is easily done. For a capacitive coupling, Fig. 2, the equivalent circuit has the form of Fig. 3; in the former R_L and L_L represent the resistance and inductance of the deflector coil assembly. In Fig. 3, R and L equal R_L and L_L of Fig. 2. The current through the deflector coil is assumed to be $\Delta i t/T_1$ where Δi is the total change of current required, T_1 is the period of the scan (19 msec for the frame, 84.5 μ sec for the line) and t varies from 0 to T_1 .

The transformer-coupled circuit is shown in Fig. 4 and has the equivalent of Fig. 5 in which L_p is the primary inductance, r_p and r_s are the primary and secondary winding resistances, n is the ratio of primary/secondary turns and $k = M/\sqrt{L_p L_s}$ is the coupling coefficient. Only the case of a unity ratio transformer for which $n = 1$ will be considered; any other ratio can be brought to this by multiplying the secondary impedances by n^2 and dividing the secondary current by n .

The equations relating the in-

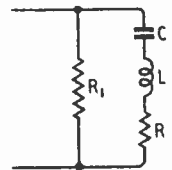

Fig. 3. Equivalent of Fig. 2 apart from the valve.

put current I and the back e.m.f. E across the input terminals to the coil current are given in the Appendix and it will be seen that the expressions are of identical form for both methods of coupling. This means that if the circuit values are such that the coefficients are the same the performance of the circuits is identical.

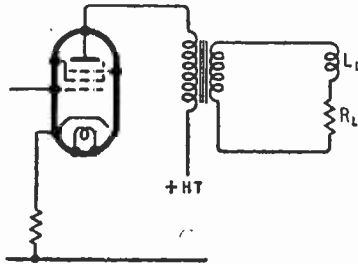

Fig. 4. Circuit of transformer-coupled deflector coil.

However, in practice, it is not usually possible so to choose the circuit values that the coefficients are the same, and the two circuits thus do behave somewhat differently.

The procedure for determining the grid voltage needed by the output valve to produce a linear coil current is quite straightforward, but rather tedious. From the known circuit values, A , B , D , a , b and d (see Appendix) are enumerated and equations (1) and (2) are evaluated for a series of values of t . As Δi , the total amplitude of saw-tooth current required in the coil, is known this gives the values of input current I and back e.m.f. E at a number of intervals of time during the scan.

The voltage and current are related through time, but as during the interval considered they are uniquely related, time can be dropped and voltage and current considered as being directly related. Their ratio has the form of an impedance which is a function of time.

The current is not the anode current of the valve, nor is the voltage the anode voltage. However, they become these when certain constants, at present unknown and dependent on the valve operating conditions, are added to them. The simplest way of determining these unknowns is graphically, and is best ex-

plained by means of an example. For this the circuit of Fig. 2 will be

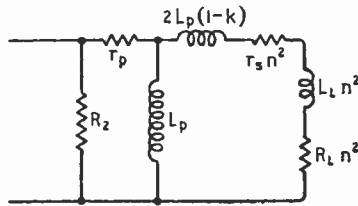

Fig. 5. Equivalent circuit of transformer-coupled deflector coil.

taken with $R_1 = 5 \text{ k}\Omega$; $C = 16 \mu\text{F}$; $L = 0.6 \text{ H}$; $R_L = 1.25 \text{ k}\Omega$; $\Delta i = 50 \text{ mA}$; and $T_1 = 19 \text{ msec.}$, corresponding to the period of the frame scan. Then the values of the coefficients in equations (1) and (2) are: $A = 31.6$; $B = 1,250$; $D = 593$; $a = 0.00634$; $b = 1.25$; and $d = 0.119$. Taking a series of values of t between 0 and 19 msec., Table I is prepared in which columns (3) and (4) are calculated from equations (1) and (2). The values selected for t are purely arbitrary and it is convenient to choose them to give round figures to t/T_1 since this simplifies the arithmetic.

A set of anode-volts/anode-current characteristics of the

valve which it is proposed to use is required and these are shown in Fig. 6 for the 6V6. Now plot the figures of columns (3) and (4) of Table I on a piece of tracing paper to the same scale as the valve curves. This is shown in Fig. 7 labelled "load line."

This curve can now be superimposed on the valve curves where it forms the load line. Its current and voltage scales must always be parallel with those of the valve curves, but its position otherwise depends only on the operating conditions of the valve.

It is important that the valve rating is not exceeded and therefore the mean current should be marked on Fig. 7. The time at which this occurs is given by equation (3) in the appendix and in the example is at $t/T_1 = 0.51$, or $t = 9.7 \text{ msec.}$ Equation (1) then gives 33.77 mA for the mean current.

The D.C. load line for R_1 can now be drawn through this current. With $R_1 = 5 \text{ k}\Omega$ the voltage drop across it is $33.77 \times 5 = 168.85$ volts. The mean current corresponds to a back e.m.f. of -40.73 volts; therefore, the load line is drawn through the points $I =$

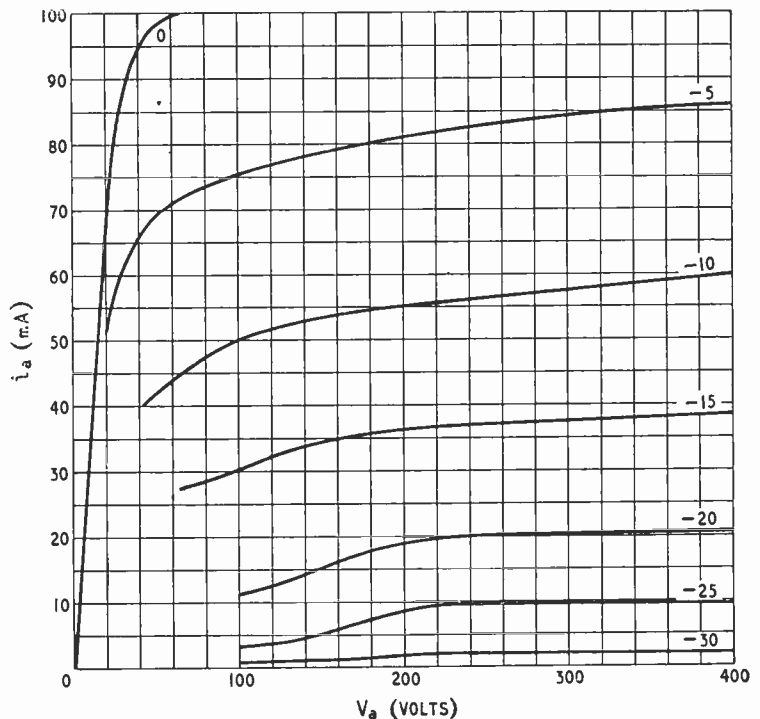

Fig. 6. Characteristics of 6V6 output valve.

Deflector Coil Coupling—

33.77 mA, $E = -40.73$ volts and $I = 0$, $E = 168.85 - 40.73 = +128.12$ volts.

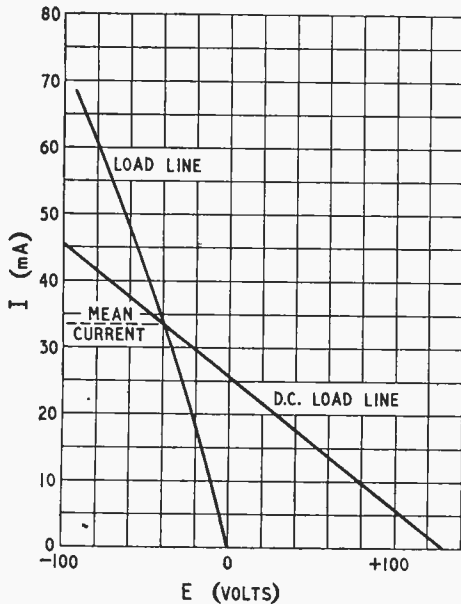

Fig. 7. The load line shows the relation between the saw-tooth current and the back voltage across the circuit.

scale, list the currents and grid voltages corresponding to the intersections of the load line with the valve curves. Plot them as a curve, Fig. 9, and from this read off the grid voltages corresponding to the currents of column (3) in the Table. This intermediate stage of plotting Fig. 9 is necessary only because it is difficult to interpolate between the valve curves. These grid voltages are listed in column (5) and can now be plotted as a curve against time, column (1) as shown in Fig. 10.

This is the input grid voltage waveform needed to produce a linear coil current taking into account valve curvature. It will be seen that the curve is quite reasonably straight for a first attempt. The general shape is of a grid input voltage rising with time rather less rapidly than linearly, so that the valve is actually over-correcting slightly. The use of negative current feed-

back by a variable resistance in the cathode circuit of the valve enables the linearity of the valve to be varied at will and so gives a practical control of the linearity. It is, however, still better to feedback from the coil current. By

TABLE I

(1) t (msec)	(2) t/T_1	(3) I (mA.)	(4) $-E$ (V.)	(5) V_g (V.)
0	0	0.317	1.58	-21.4
1.9	0.1	6.626	8.120	-19.6
3.8	0.2	13.05	15.27	-17.3
5.7	0.3	19.6	23.0	-15.4
7.6	0.4	26.27	31.3	-13.5
9.5	0.5	33.05	40.23	-11.6
11.4	0.6	39.96	49.73	-9.8
13.3	0.7	46.98	59.8	-8.2
15.2	0.8	54.17	70.5	-6.6
17.1	0.9	61.39	81.8	-5
19.0	1.0	68.77	93.7	-3.4
9.7	0.51	33.77	40.73	-11.4

making the valve correct as nearly as possible for the effect of the coupling capacitance or inductance and then using negative feedback from the coil current almost any desired degree of linearity can be achieved.

Now in the case of transformer coupling the same general considerations apply. It is not possible to apply the example above

The position of Fig. 7 on Fig. 6 is now limited by these points. It must be so placed that the mean current ordinate on Fig. 7 does not lie above the maximum rated anode current on Fig. 6, and so that the extension of the D.C. load line of Fig. 7 does not cut the zero anode current ordinate to the right of the maximum H.T. voltage available. The permissible positions for the load curve are considerably restricted by this, and it will often suffice to place it so that it lies on these limits.

This is shown in Fig. 8, which consists of the valve curves of Fig. 6 with the load lines of Fig. 7 superimposed so that the mean current of Fig. 7, 33.77 mA, lies on the maximum rated anode current of 45 mA for the 6V6 and so that the extension of the D.C. load line cuts the zero anode current ordinate at 340 volts, which is here assumed to be the maximum H.T. voltage. The scales of Figs. 6 and 7 are both shown in Fig. 8, so that this represents exactly the superposition of the two graphs.

Now reading from the "Fig. 7"

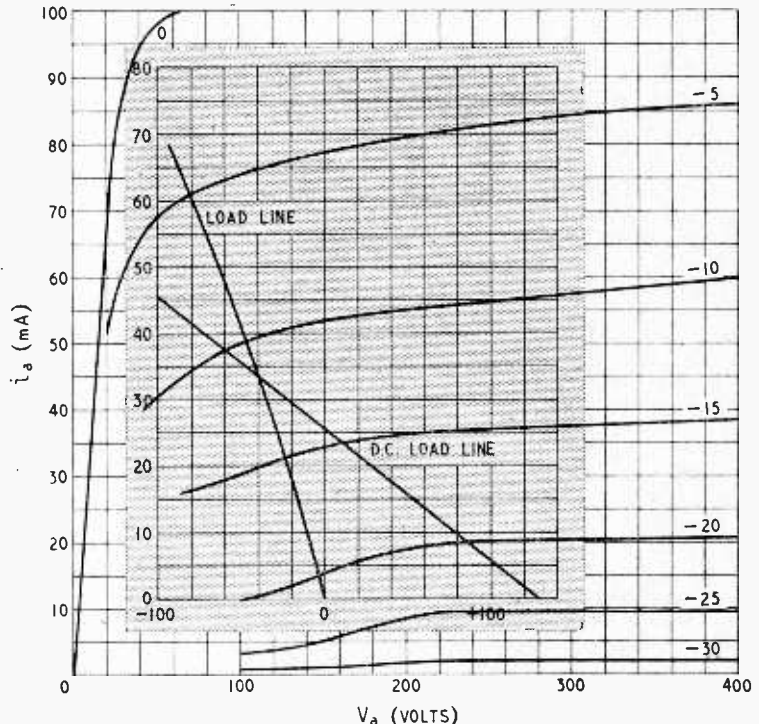

Fig. 8. The load lines of Fig. 7 are here shown superimposed on the valve curves of Fig. 6.

exactly to this case, however, for no constants in the transformer circuit will give coefficients in the equations equal to those adopted in the example. However, the results obtainable are very similar and in a calculation for transformer coupling carried out in the same manner as for a resistance-capacitance feed very similar results were secured. The values assumed for the transformer were $L_p = 100$ H; $k = 0.99$; $r_p = r_s = 750 \Omega$; $R_2 = 50$ k Ω ; $L_L = 0.6$ H; $R_L = 1.25$ k Ω ; $n = 1$; $T = 19$ msec;

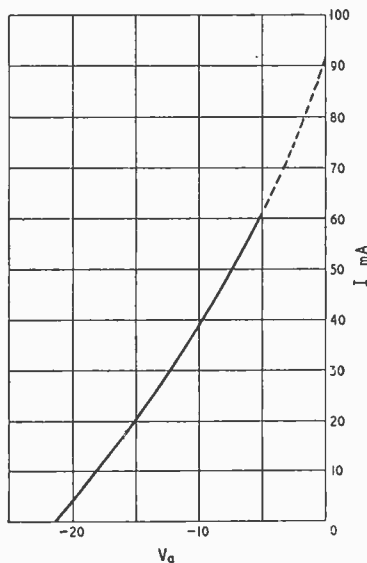

Fig. 9. The dynamic grid-volts—deflector-coil current curve produced by plotting the intersections of the load line of Fig. 8 with the valve curves.

$\Delta i = 50$ mA; and $E_{HT} = 250$ V. A lower H.T. voltage is permissible with transformer coupling because there is less voltage drop in the 750Ω of the primary winding resistance than in the 5 -k Ω coupling resistor of the resistance-capacitance feed. The same valve—a 6V6—was assumed with the same mean anode current of 45 mA.

In practice one would not use a 1-1 ratio transformer. This does not affect the calculation, however, for any ratio is easily reduced to the equivalent of a 1-1 ratio. Thus, if L_L were 3 mH then the ratio would be $n = \sqrt{0.6/0.003} = \sqrt{200} = 14.14$. The coil resistance and secondary re-

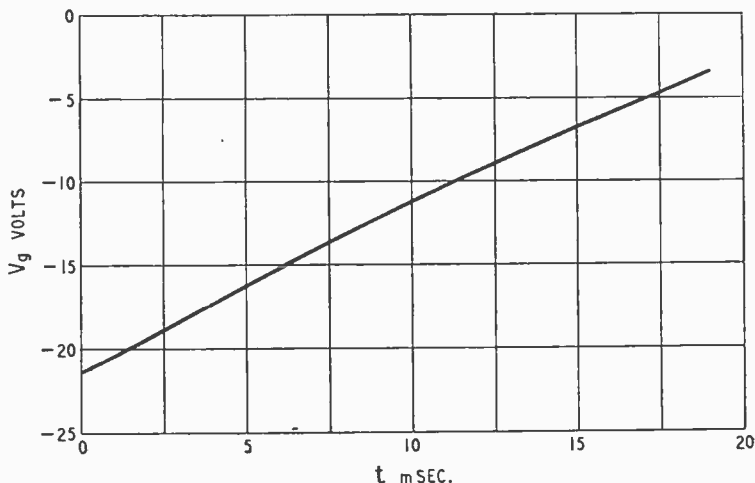

Fig. 10. The curve of input grid voltage against time is nearly a straight line showing that the valve and circuit distortions nearly compensate each other.

sistance should then be $1,250/200 = 6.25 \Omega$ and $750/200 = 3.75 \Omega$ respectively, and the current would be $0.05 \times 14.14 = 0.707$ A.

It will thus be seen that whichever form of coupling be adopted it is possible to reduce the inductance and capacitance to practicable values by allowing the curvature of the valve characteristic compensate for the distortion of the coupling. It is usually desirable, however, to utilize fairly heavy negative feedback in order to increase the linearity and to make the design non-critical.

APPENDIX

In the circuits of Figs. 3 and 5, the input current and the back e.m.f. across the input terminals are

$$I = \Delta i [a + bt/T_1 + dt^2/T_1^2] \dots (1)$$

$$E = -\Delta i [A + Bt/T_1 + Dt^2/T_1^2] (2)$$

when the coil current is $\Delta i t/T_1$. In the above, for resistance-capacitance coupling (Fig. 3)

$$\begin{aligned} A &= L/T_1; & a &= L/R_1 T_1; \\ B &= R; & b &= 1 + R/R_1; \\ D &= T_1/2C; & d &= T_1/2CR_1; \end{aligned}$$

while for transformer coupling (Fig. 5)

$$\begin{aligned} A &= L/T_1; \\ B &= R + r_p (1 + L/L_p); \\ D &= T_1 r_p R/2L_p; \\ a &= L/R_2 T_1; \\ b &= (1 + L/L_p) (1 + r_p/R_2) + R/R_2; \\ d &= (1 + r_p/R_2) T_1 R/2L_p; \end{aligned}$$

where $R = n^2(R_L + r_s)$ and $L = n^2 L_L + 2L_p (1 - k)$.

The mean anode current occurs when

$$\frac{t}{T_1} = -\frac{b}{2d} + \sqrt{\left[\frac{b^2}{4d^2} + \frac{b}{3d}\right]} (3)$$

The units are volts, amperes, ohms, henrys, farads and seconds.

Useful Test Meter

A NEW version of the Pifco "All-in-One Radiometer" is now available and supplies are being distributed through the trade. The moving-iron movement is suitable for A.C. or D.C. supplies and three ranges are available: 0-30 mA, 0-6 V and 0-240 V. In addition, an internal battery is provided for continuity tests, and a socket on the front of the bakelite case enables the filaments of 4- and 5-pin valves to be tested. The price is 25s.

Twelve-watt Amplifier



The TYPE 12 amplifiers made by R.S. Amplifiers, Reynolds Road, Acton Lane, London, W.4, have been redesigned and are housed in an all-metal cabinet with carrying handles. The amplifiers, which are suitable for use with the R.S. Type R.L.1 ribbon microphone, have two input channels and are available for A.C. only, or universal mains operation. The price in each case is £21.

μ IS OVERWORKED

Some Examples of the Confusing Jargon of Radio

By "CATHODE RAY"

ONE might very well suppose that there had been overwhelming feline influence at the back of radio, judging from the prevalence of μ in its language. This conclusion is supported by the fact that some of the μ 's exhale an odour of red herring.

The first μ , which I think antedated radio, was *permeability*. That meaning may be considered to have a good title and right to the use of the symbol. And it is entirely appropriate that a concern manufacturing an alloy having a particularly high permeability should give it the distinctive trade name "Mumetal."

Amplification factor and *micro* seem to have almost tied for second place in the race to claim μ . If anything, "micro-" led. It was chiefly in radio that very small fractions of electrical units were of practical importance, and people soon tired of writing strings of noughts after the decimal point, or, alternatively, "micro-" and even "micro-micro-." " μ " was an unlucky choice of abbreviation, however, because one of the fundamental formulæ in magnetism is:—

$$B = \mu H$$

and when " μH " also means "microhenry," which is a unit of inductance, well . . . !

μ for Magnification

Whoever applied μ to denote the newly discovered amplification factor of a valve may have thought the subject-matter was far enough from inductance to be safe. The choice presumably arose from the idea of *magnification*; μ being the Greek "m." (What a mercy some benefactor thought of "Q" before μ got roped in to mean resonant-circuit magnification! It must have been touch and go!)

In America, where you can more or less buy over the counter a 100,000-watt broadcasting station (why not 100,000,000,000-microwatt, I wonder?), they are

very fond of reckoning the mutual conductance of valves in micro-mhos. It only wants somebody to abbreviate this "micro-" to " μ " to increase the confusion.

Actually, a vastly sillier and more confusing thing was done, when the name "variable- μ " was coined. Of the three things about a valve, μ , r_a and g_m , the least variable of them in a variable- μ valve is μ . The whole point of a variable- μ valve is that its *mutual conductance* can easily be varied over a wide range. So presumably "variable- μ " is an abbreviation for "variable-mutual-conductance." Admittedly an abbreviation is just what was wanted; but the abbreviator cannot be credited with much sense for failing to realize that as "mu" is the way " μ " is pronounced, it wouldn't be long before misguided people started writing "variable- μ ." Which is exactly what they did! (A rather similar indiscretion was the name "transitron," derived, I believe, from the American term "transconductance," but inevitably suggesting that the device in question is based on the transit-time effect in a valve.)

But even that isn't the worst. It certainly is rather a nuisance to have to warn every new generation of students about "variable- μ ." If some of them are not warned, however, the consequences are not likely to be very serious. Quite otherwise is the way people use μ (as if it didn't stand for enough things already) to mean *amplification*, particularly the voltage amplification of a stage.

Their doing so says, in effect, that the internal resistance of a valve is always zero. Which is absurd, especially with pentodes. You will, no doubt, suppose that the people who do this lived long ago, before it was agreed that the meaning of μ in connection with valves should be *amplification*

factor. Or that they are ignorant persons who only need a little patient instruction to put them right. Or that it was a mere slip on some casual occasion. Or that they are independent spirits who exclaim, "To the devil with all you who slavishly adhere to a hide-bound custom; I am going to write " μ " to mean what you understand by $\frac{\mu R_1}{R_1 + r_a}$." Not at

all. Believe it or not, they include doctors of science, solemnly contributing their considered learning to journals of the highest standing. Examples could be quoted in which a distinguished leader in the radio art and science has, as recently as this Year of Our Lord, 1946, used μ indiscriminately to signify amplification factor or stage amplification, not just in the same paper, but on the same page and in the same paragraph thereof.

Pity the Plodders!

The unquestionable standing and qualifications of such persons greatly aggravates the offence, because thousands of earnest plodders like ourselves are forced to spend a lot of time trying to make sense of the thing on the pardonable assumption that such an authority couldn't possibly be wrong, or perhaps build a considerable superstructure of error and confusion on this apparently secure foundation before suspecting the flaw.

For example, it is of considerable importance in everything concerned with negative feedback—and what branches of telecommunications are not so concerned nowadays?—to distinguish between the factor by which the use of feedback divides *amplification*, viz. $(1 + AB)$, and that by which it apparently divides the internal resistance of the stage $(1 + \mu B)$. (A stands for stage amplification, and B for the fraction fed back.) Typical values for a pentode are $A = 100$ and $\mu = 3,000$. So to make μ sometimes mean μ

μ is Overworked—

and sometimes A is not really very excusable.

The Miller effect is another notoriously sticky patch for students. Can you wonder, when the whole essence of the thing is obscured by misuse of the overworked μ ?

What can be done about it? Short of trying at this late date to reverse generally accepted usages, the following can and ought to be done:—

(1) Use the abbreviation " μ " for "micro-" with discretion, especially where magnetic formulæ are concerned.

(2) Scrap " $\mu\mu$ " altogether and substitute " p " ("pico-." It is much easier and more euphonious to adopt the habit of talking about using "50 puffs" rather than "50 mu-mu-eff" or—worse still—"point 4-oze 5.")

(3) If, as I fear, it is too late to change "variable-mu," at least refrain from "variable- μ ."

(4) Agree internationally that any person convicted of misusing μ to mean stage gain shall be banished for life to an island inhabited exclusively by cats and be compelled to talk no other language than theirs.

MANUFACTURERS' LITERATURE

THE Mullard Valve and Service Guide (published for use by the trade only) gives base connections, characteristics and equivalents of Mullard receiving valves and a table of replacements for obsolete types, with notes on circuit changes where necessary.

Illustrated catalogues of the "Philharmonic" range of sound equipment (amplifiers, microphones, loudspeakers, etc.) and of "Intercom" loudspeaker call systems have been issued by Arden Acoustic Laboratories, Guildford, Surrey.

Technical details of silvered mica capacitors are given in an illustrated brochure received from Stability Radio Components, 14, Norman's Building, Central Street, London, E.C.1.

The Type DS10 short-wave 5kW transmitter (2.5 to 22 Mc/s) for air and sea communications is described in an illustrated booklet issued by Standard Telephones and Cables (Radio Division), Oakleigh Road, New Southgate, London, N.11.

New price lists giving specifications and sizes of "Somerset" power transformers and smoothing chokes have been issued by Gardners Radio, Somersford, Christchurch, Hants.

EMPIRE RADIO SCHOOL

Unified Methods of Training

THE latest training establishment formed under the joint auspices of the Air Ministry and the Dominion Governments is an Empire Radio School. Located at Debden, Essex, it has as its principal objects the unifying of radio training methods throughout the British Commonwealth and the training of signals and radar officers in all types of Service equipment, including the most up-to-date types.

Commonwealth Air Forces are eligible for these courses and its facilities are also available to members of civil aviation signal services and of foreign air forces.

The Liaison Branch was recently responsible for organizing a mission, consisting of the Commandant of the school and a team of R.A.F. signal specialists, to tour the Antipodes with brief visits *en route* to R.A.F. headquarters in Palestine, Iraq,



Interior of the converted Halifax bomber showing the location of the principal items of radio equipment.

In addition to ground instruction, the operation of equipments is studied in special radio equipped flying classrooms.

Personnel of any of the British

Burma and South-East Asia. A converted Halifax bomber was specially fitted for the flight with all the latest radar and radio equipments in Service use.

AVIATION RADIO EQUIPMENT

Review of the S.B.A.C. Exhibition

AIRBORNE and ground radio installations were included in the aircraft equipment shown at the exhibition held in September by the Society of British Aircraft Constructors. This equipment comprised three main types: general-purpose communication sets, V.H.F. apparatus and radio aids to navigation.

Airborne communication sets are designed, as a rule, in the form of separate units, the number of units in an installation depending on the actual service required; this in turn is governed largely by the size of the aircraft and the space available.

The transmitters and receivers are capable of operation over a wide range of frequencies, although in the case of airborne transmitters operation on a number of pre-selected spot frequencies is the customary procedure. The accompanying receivers, however, give continuous coverage throughout the recognized aircraft wavebands and often beyond. Many of the receivers embody D.F. and homing facilities.

On the other hand the V.H.F. equipment is mostly of single-

mitters and receivers, so that continuous tuning is not included. Operation is by remote control, the change from one frequency to another being relay-operated. Thus the main items of the installation can be accommodated in any convenient part of the aircraft, with only the remote control unit accessible to the pilot or radio operator.

Navigational aids shown consisted mainly of ground D.F. installations and beacon transmitters, but there were some examples of blind approach airborne equipment and simplified systems for taking radio bearings in the air.

Marconi's Wireless Telegraph Company showed a new design of aircraft racking, having extreme adaptability. It consists largely of perforated channel-section members which can be cut to the required size and bolted together to form a complete installation. Into this slide the various items of equipment and each unit carries plugs, which engage with sockets on the racking, thereby making all inter-unit electrical connections.

Marconi's showed also a new communication receiver, the type Rg44, having a frequency range of 2 to 20 Mc/s in four bands. A feature of this set is a novel

spiral form. As the drum rotates pointers move transversely across the drum and follow the spirally engraved scales. There are four separate scales, each with its own pointer, and their combined lengths amount to about 30 feet.

Included in the Marconi exhibit was a compact V.H.F. transmitter-receiver covering 78 to

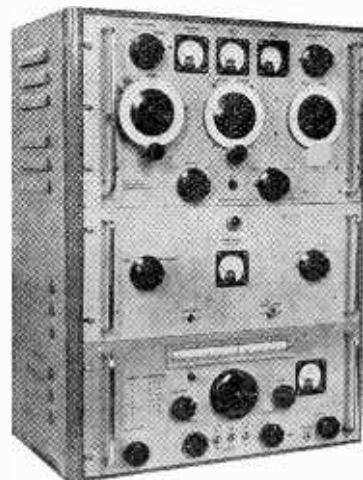

Rediffusion G32 transmitter-receiver for ground control stations. The carrier output is 50 watts.

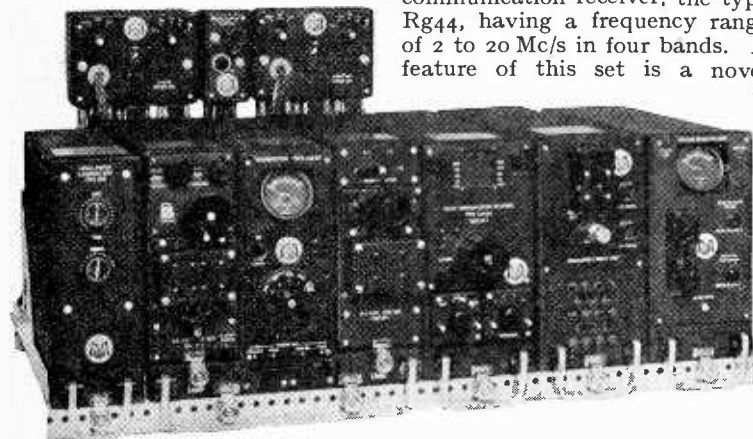

Marconi lightweight radio installation for a medium size civil air liner. It comprises transmitter, receiver and D.F. equipment. Overall length is only 24in.

unit construction and operates on a limited number of spot frequencies, both as regards trans-

tuning system which embodies a drum scale having the entire tuning range engraved on it in

100 Mc/s for mobile use for aerodrome control, ground and airborne equipment for blind approach and other navigational radio aids.

Standard Telephones and Cables showed a general-purpose aircraft installation, Type STR11/13. Designed for fitting into medium size aircraft, where space is at a premium, wide use is made of miniature components in order to reduce the overall size of the individual units, in addition to which the design is such that the main items can be stowed in any convenient part of the aircraft and only the control units need be accessible.

On transmission the frequency range is 2 to 9.1 Mc/s and 320 to 520 kc/s, with provision for the selection of 12 spot frequencies in

these bands. Continuous tuning is provided in the receiver, where the coverage is 2 to 11 Mc/s and 150 to 1,500 kc/s. Operation on C.W., M.C.W. or R.T. is possible, whilst D.F. facilities can also be included if required.

Other S.T.C. equipment comprised ground station direction-finding apparatus and two V.H.F. transmitter-receivers. One, the STR9, provides for R.T. operation on four spot frequencies in the band 115 to 145 Mc/s with full electrical remote control. It gives 4 watts R.F. output, weighs 22lb and consumes 180 watts at 26 volts D.C. It embodies a sensitive superheterodyne receiver.

The other V.H.F. set is the STR12, also remote controlled, but with the choice of 12 spot frequencies in the range 122 to 132 Mc/s. Facilities are included for M.C.W. as well as for R.T. operation. Both these sets are crystal stabilized on transmission and on reception.

High power transmitters for medium- and short-wave operation and for installation in ground control stations on airfields, were shown by Rediffusion. The Model G40 is a recent development and this gives an R.F. output of 800 watts on C.W. or 500 watts when modulated.

This transmitter can be assembled for single channel operation over a wide band of frequencies, with or without a modulator, or as a two-channel set with both channels operating independently on different frequencies. In this form the output is 500 watts on C.W. from each channel.

Rediffusion were showing a new communication receiver, the R44, having a frequency coverage of 150 kc/s to 20 Mc/s in six bands. Three degrees of I.F. selectivity are provided, these being 9 kc/s, 3 kc/s and 400 c/s respectively, the last-mentioned being with the aid of

a crystal filter in the I.F. amplifier.

There was also a specimen layout of the Rediffusion R.A.F. aircrew radio D.F. trainer and some radio heating apparatus for use in the manufacture of airframe parts.

The G.E.C. radio exhibit included a Glide Path Receiver for landing aircraft in conditions of poor visibility on aerodromes equipped with appropriate transmitting apparatus. There was also a Range and Localizer Receiver

which is a companion unit to the glide path set for use in directing the aircraft to the aerodrome from a distance.

Both these sets are remotely controlled and visual indications of height and approach path are provided. The G.E.C. "Asac" system of frequency selection, using a variable oscillator and one crystal controlled master oscillator, is employed in the Range and Localizer Receiver. Fifty channels

Two airborne sets were shown by Philips, one is a transmitter, the type SVZ142, giving 100 watts output on C.W. and 40 watts when suppressor grid modulated. Designed for remote control operation, selection can be made of any one of 12 spot frequencies within the range 2.8 to 18.1 Mc/s. Provision is made to shift the operating frequency by about 1 per cent in the event of interference, so that in effect this gives 24 operating frequencies, all of which are crystal controlled.

The other Philips product consists of an airborne direction finder, the type SVP101. This uses a pair of crossed loops, a goniometer, and covers the frequency range 150 to 1,750 kc/s. Provision is made for remote or direct control and for omnidirectional reception, aural or visual indication of bearing, or automatic direction finding, using visual indication and motor drive for the goniometer.

There was demonstrated on the Philips stand a new development for control of radio frequencies which is described as Philips "Igo" system. A single quartz crystal is used to stabilize the output from a variable frequency oscillator on spot frequencies over a very wide band. This gives an almost unlimited choice of sta-

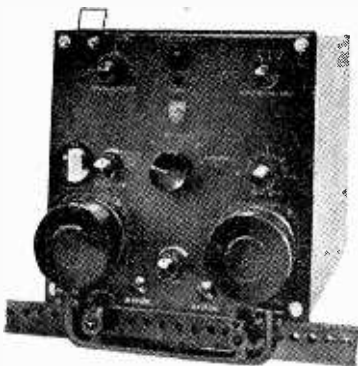

Philips aircraft direction finding receiver, Type SVP101.

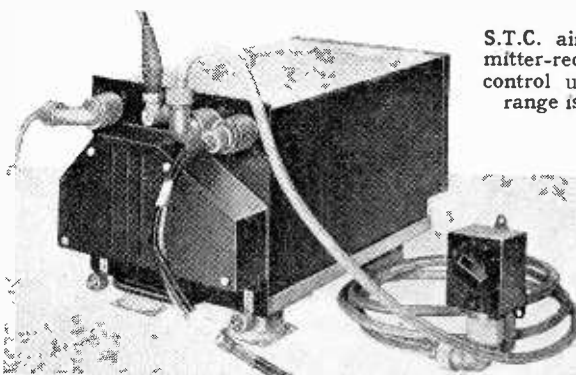

S.T.C. aircraft V.H.F. transmitter-receiver with remote control unit. The frequency range is 115 to 145 Mc/s.

bilized frequencies, without the necessity to control each with a separate crystal.

Airborne radio apparatus is in

having crystal stability are available.

There was also included in the G.E.C. exhibit a lightweight V.H.F. receiver with remote control by push-buttons for operation on any one of four pre-set crystal controlled frequencies in the bands 100 to 124 Mc/s or 118 to 132 Mc/s.

the main operated from the 12- or 24-volt accumulator battery which supplies the power for the electrical equipment in the aircraft. A wide range of rotary transformers giving both H.T. and L.T. were shown by Newton Bros., which firm also included many examples of the carbon-pile regulator which is used with these

Aviation Radio Equipment—

machines. This regulator maintains the output of the rotary generator practically constant over a wide range of load conditions, or with a fluctuating input voltage. It operates on the principle of varying pressure on a stack of thin carbon discs, the varying pressure being applied by an electro-magnetic control in the input leads.

Rotary transformers for radio power supplies were shown also by B.T.H., Delco-Remy and English Electric.

The appearance at the exhibition of engine-driven alternators, giving 115 and 200 volts A.C. at 400 c/s to replace the existing 12- and 24-volt D.C. machines foreshadows a change in the design of future power supply units for airborne radio equipments. They were shown for single- and three-phase supplies by B.T.H. and English Electric.

The application of electronic equipment in the production of aircraft components was seen on the stand of Reid and Siegrist. Here a cathode-ray oscilloscope was used, in conjunction with two beams of light and photo-electric cells, to balance dynamically the high-speed rotors of gyroscopes. Speedy results with a constant standard of accuracy is obtained and its operation demands no special skill.

Another example of electronics in industry was the Supersonic Flaw Detector developed by Henry Hughes & Son. An operating frequency of about 2 Mc/s is used and minute cracks and flaws deep in a solid metal bar can be located by measuring the depth of penetration, before reflection, of the supersonic oscillations. Flaws can be detected from a depth of a fraction of an inch down to 20 feet or more in materials having a reasonably flat surface.

connections are employed throughout. Incidentally, the overall size of this unit is only 12in x 11in x 11in, which is made possible by the use of miniature components wherever practicable. All components are made to a tropical specification.

The receiver, which has a sensitivity of better than 1 μ V, has one R.F. stage, a 3-valve frequency changer consisting of a mixer, crystal oscillator - tripler and another tripler, 3 I.F. stages, double diode detector and A.V.C., another double diode for noise limiting, and A.F. and output stages. The audio output is 3 watts into a P.M. moving-coil loudspeaker.

In order to allow for frequency tolerances in the crystals and also to permit multi-channel operation, as described in *Wireless World* for February last, the band-width of the I.F. amplifier is set to approximately 60 kc/s.

The switching system allows the modulating amplifier to be used separately if required as a P.A. system, or as a loud hailer in a boat. The audio output is between 10 and 12 watts. Operating power is obtained from a 12- or 14-volt accumulator, the H.T. being supplied by rotary transformers, one for the transmitter and receiver alternately, as most systems are worked simplex, the other supplies the modulation amplifier.

Modified versions of the equipment, together with a 100-watt transmitter, are available for installation at fixed stations.

Mobile V.H.F. Gear

New Pye Communication Equipment

DESIGNED by Pye to Home Office specification, the apparatus illustrated here is intended for the use of police, fire and other services requiring a mobile radio telephone for installation in motor cars, small craft, etc. Amplitude modulation is employed. It operates in the V.H.F. band on a fixed frequency between 27 and 100 Mc/s and both transmitter and receiver are crystal controlled.

The mobile installation comprises a 6-valve transmitter giving 12 watts R.F. output, an 11-valve superheterodyne receiver, a modulating amplifier, a power supply unit,

prise the bulky units, are designed for assembly on a framework fitted with shock absorbers and intended for stowage in any convenient part of the vehicle, such as the luggage boot of a motor car. Only the remote control unit, measuring 4in x 3 $\frac{1}{2}$ in x 2 $\frac{1}{2}$ in, and the microphone need be accessible to the crew.

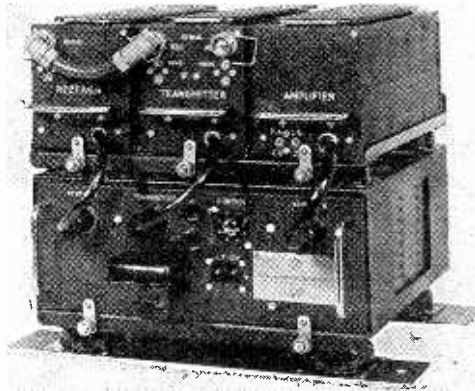

Four main items of Pye mobile radio telephone assembled on shock absorbing mountings.

microphone, loudspeaker and a quarter-wave vertical aerial.

The first four items, which com-

Each of the four items of the composite unit can be quickly removed for servicing, as plug-and-socket

ELECTRONIC WATCH TIMER

AN instrument for rapidly checking and adjusting the rate of clocks and watches has been produced by Furzehill Laboratories, Boreham Wood, Herts. A cathode-ray tube with a circular rotating time base is used and the tick from the timepiece under observation is picked up by a microphone, amplified and causes a bright spot to appear on the trace.

The time base is derived from a crystal-controlled oscillator associated with a number of frequency dividers and rotates at 10 c/s with an accuracy of 20 parts in a million (equivalent to 1.7 sec per day). Precession of the spot in a clockwise direction indicates that the watch is gaining and a scale is provided from which the rate can be calculated.

The microphone and watch clamp can be rotated through 90 degrees, so that the rate can be checked with the watch working in different planes. A small loudspeaker is included which enables the operator to listen to the amplified tick.

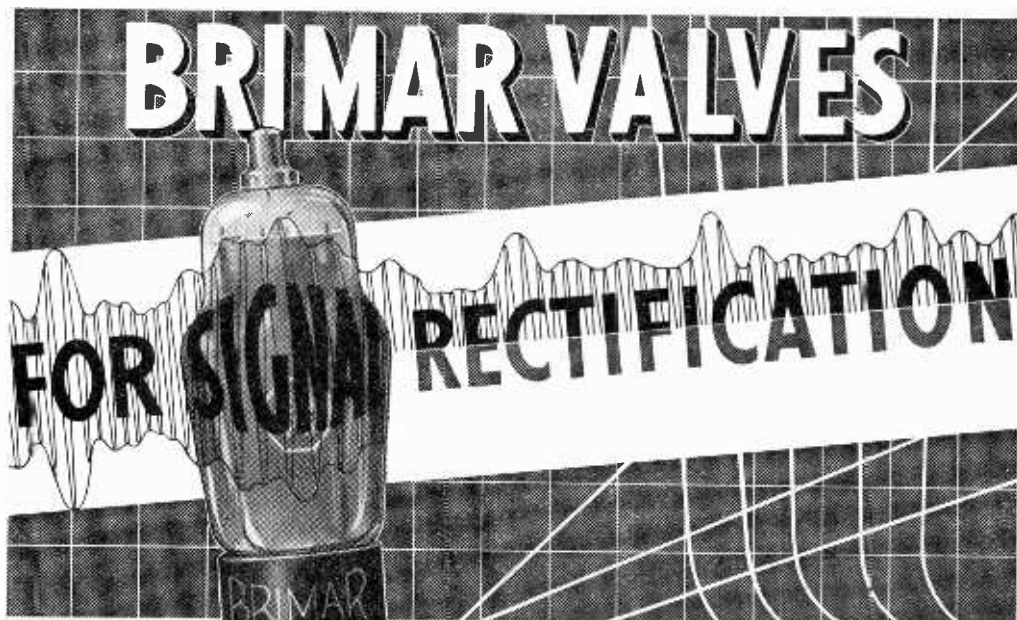

TYPE 6Q7G

BRIMAR VALVES FOR SIGNAL RECTIFICATION

TYPE	E/F	ENGLISH	
		I/F	PURPOSE
10D1	13	0.2	DOUBLE DIODE
11D3	13	0.2	D/DIODE TRIODE
11D5	13	0.15	D/DIODE TRIODE
11A2	4	1.0	D/DIODE TRIODE
AMERICAN U.X.			
6B.7	6.3	0.3	D/DIODE PENTODE
75	6.3	0.3	D/DIODE TRIODE
85	6.3	0.3	D/DIODE TRIODE
INTERNATIONAL OCTAL			
1H5G	1.4	0.05	Batt. DIODE TRIODE
6B8G/GT	6.3	0.3	D/DIODE PENTODE
5B6G	6.3	0.3	D/DIODE TRIODE
6H6G	6.3	0.3	DOUBLE DIODE
6Q7G/GT	6.3	0.3	D/DIODE TRIODE
6R7G	6.3	0.3	D/DIODE TRIODE
12Q7GT	12.6	0.15	D/DIODE TRIODE
12C8GT	12.6	0.15	D/DIODE PENTODE
LOCTAL			
7B6	6.3	0.3	D/DIODE TRIODE
7C6	6.3	0.15	D/DIODE TRIODE
1LH4	1.4	0.05	Batt. DIODE TRIODE
MINIATURE			
1S5	1.4	0.05	Batt. DIODE PENTODE
6AL5	6.3	0.3	DOUBLE DIODE

THE valve which we illustrate, the 6Q7G, is a 6.3 volt, indirectly-heated, high impedance, double-diode-triode which gives its full output with a grid swing of 3.0 volts.

The list on this page shows other diodes with and without subsequent amplification. Equally comprehensive are our ranges for other purposes.

BRIMAR

(BVA)

RADIO VALVES

STANDARD TELEPHONES AND CABLES LIMITED, FOOTSCRAY, SIDCUP, KENT.

Study television at its source! ★



★ read about
this new
opportunity

E.M.I. Research and Development Laboratories were largely responsible for the Marconi-E.M.I. system of television transmission used by the B.B.C. Service—the first in the world.

E.M.I. Factories produce the finest television receivers in the world.

E.M.I. Service department is the largest and most expertly equipped in the country.

NOW—E.M.I. have set up a TRAINING ORGANISATION to provide immediate courses on practical TELEVISION (Postal and College Courses.)

SOON this new Training College will extend its syllabus to cover all branches of Electronic Science.

This is **your** opportunity to secure a thorough training in Television from the very pioneers of the Science.

Ask your local H.M.V. dealer for further details or send for our free pamphlet which gives full details of this and other courses.

Associated Company of:

THE GRAMOPHONE CO. LTD.
("HIS MASTER'S VOICE")
THE MARCONIPHONE CO. LTD.
MARCONI-E.M.I. TELEVISION CO. LTD.
RADIOMOBILE LTD., ETC. ETC.

E.M.I. INSTITUTES, LTD.

Dept. W.W.1 • 43 GROVE PARK ROAD • CHISWICK • LONDON • W.4

**SCIENTISTS DEMAND...
SCIENTISTS BUILD...**

Wego

CAPACITORS

Our technical and scientific advice is at your disposal. Please write for full details to—
WEGO CONDENSER COMPANY LIMITED
Bidford Ave • Perivale • Greenford • Middx.
Tel.: Perivale 4277

Standard Cases for DELIVERY NOW

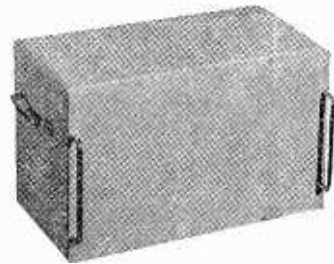

Superbly finished model of highest quality heavy gauge sheet steel, strongly welded and complete with internal metal chassis. Finished in light grey, brown, yellow, red or black.

Type 1053A	15½" w. × 8" d. × 9" h.	£4 15 0
Type 1053B	17½" w. × 9" d. × 10½" h.	£6 15 0
Type 1053C	24" w. × 12" d. × 15" h.	£8 17 6

IMHOF'S

112-116 NEW OXFORD ST. LONDON, W.C.1. Dept. 2

THE TRAVELLING WAVE VALVE

New Amplifier for Centimetric Wavelengths

By R. KOMPFFNER

TWO main urges lie behind the trend to ever higher frequencies: the need for a wider range of frequencies in the transmission of intelligence of ever-increasing complexity, and the need for narrow beams of radiation. For instance, in order to transmit intelligence such as television signals, which at present comprise practically all frequencies up to four or five megacycles per second, we have to use carrier frequencies many times

before the war, and considerable effort was directed towards developing valves which could be used as amplifiers at these wavelengths. Oscillators, it was thought, would follow more or less automatically from amplifiers, since to convert an amplifier into an oscillator all that would be needed would be some feed-back from the output to the input in the correct phase to sustain oscillations.

The Klystron (see Fig. 1) was

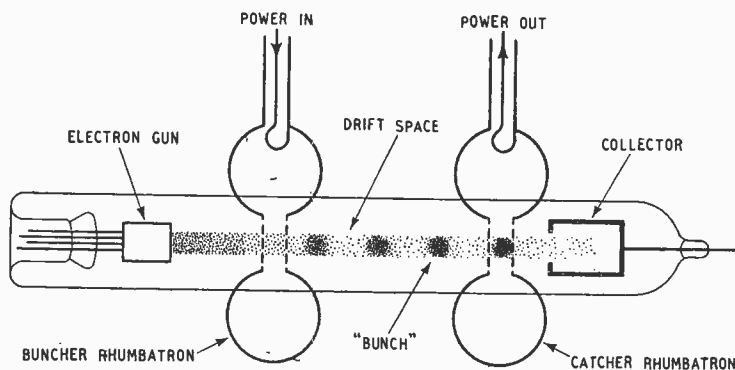

Fig. 1. Operation of the Klystron amplifier.

higher than the highest signal frequency. When the definition of the television picture is increased, as it surely will be, carrier frequencies will have to go up, too, in order to accommodate the wider band of frequencies which will have to be transmitted. The other main reason is that very high frequencies, or wavelengths of the order of centimetres, are essential for radar or radar-like applications if the structures which are to be used as aerials for transmitting and receiving are to be of reasonable size. Such structures have to be of a size of many wavelengths if a beam of radiation sufficiently narrow is to be produced. The valve is the heart of modern wireless, and the key to all these developments.

The need for centimetre waves became apparent some time be-

fore the war, and considerable effort was directed towards developing valves which could be used as amplifiers at these wavelengths. Oscillators, it was thought, would follow more or less automatically from amplifiers, since to convert an amplifier into an oscillator all that would be needed would be some feed-back from the output to the input in the correct phase to sustain oscillations.

Klystron as an oscillator and as an amplifier. As an oscillator not enough power was forthcoming.

The work forming the subject of this article has been carried out for the Admiralty and is published by permission. It was initiated at the Physics Department, Birmingham University in 1942 and carried on, after a move in 1944, at the Clarendon Laboratory, Oxford University. All the investigations described were completed before the end of 1944, unless otherwise stated.

The conversion of the D.C. power of the beam (i.e., the product of beam current and beam voltage) into available R.F. power was considerably less efficient than simple theory predicted, and further, the D.C. power itself is very limited, due to the necessity for a long and narrow electron beam. Space-charge forces set a definite and rather low limit to the beam current, which can be passed through a number of small apertures such as occur in the Klystron. Thus the power output from Klystrons is frequently reckoned in watts rather than in kilowatts.

This was not good enough for radar and the invention of the multi-resonator Magnetron (see Fig. 2) superseded the Klystron in an incredibly short time as a high-power oscillator.

Apart from the utilization of a novel principle, the reasons for the enormous R.F. powers which can be obtained from the mag-

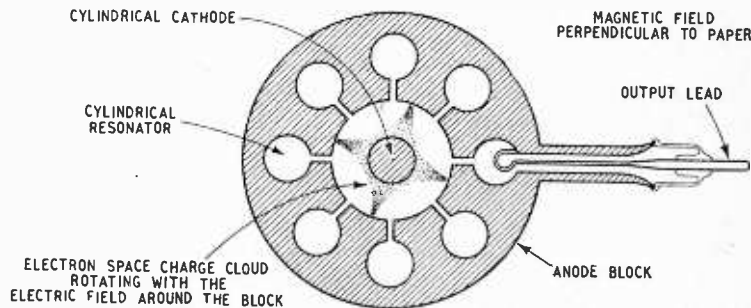

Fig. 2. The Magnetron oscillator.

netron are: the circulating electron current in the valve is very largely due to its cylindrical

The Travelling Wave Valve—

geometry and the efficiency as a converter of D.C. into R.F. power is very high. Thus the power output of magnetrons is usually reckoned in hundreds of kilowatts, and it is certainly true that, without the magnetron, radar as we know it now could never have arisen. How the Battle of the Atlantic, and the Battle of the Ruhr would have gone without radar, is not difficult to estimate, and how the war would have gone without winning these two battles is left to the reader's imagination. The writer apologises for this digression, but believes that it has some bearing on the story.

Insensitive Receivers

It is due to the enormous R.F. powers obtainable from the magnetron as transmitter, that comparatively little attention was paid to the receiving end of radar. Putting it in a somewhat exaggerated way: it just was not important enough to put any great effort into improving the sensitivity of radar receivers, since there was enough power—and some to spare—available from the radar transmitters to do most of the jobs radar was required to do. As an R.F. amplifier, the Klystron is very insensitive, and when it was shown that the ordinary crystal-and-cat's-whisker detector, used as a mixer or converter in a superheterodyne receiver, was better in respect of sensitivity than the Klystron, or any other valve, interest in R.F. amplification dwindled to next to nothing.

One of the main reasons for the lack of sensitivity of the Klystron as an amplifier was the inevitable inefficient energy exchange between the electron beam and the electric field in the rhumbatrons.

Before examining this question, it will be advantageous to define what is meant under sensitivity. The sensitivity of a practical receiver is defined in terms of how many times the noise power at the input exceeds the noise power at the input of an ideal receiver (i.e., one with the hypothetical minimum noise power). This factor is called the noise factor; radar receivers using crystal mixer input

have noise factors somewhere between 10 and 100, while if a Klystron is used as R.F. amplifier at the input, the noise factor is somewhere between 1,000 and 10,000.

Little was therefore to be gained by improving radar receivers in respect of noise factor, since, at the most, an improvement of a factor 3 or 4 could be expected over a noise factor of, say, 10. (It seems unlikely that the ideal will ever be reached at the centimetric wavelengths.) On the transmitter side, with magnetrons, an increase in output power of 3 or 4, however, was relatively easily obtainable, and hence most of the research effort went in this direction.

Therefore it is not surprising that it was relatively late when it was realized that one of the basic principles of the magnetron, namely, that of interaction between a travelling field and an electron stream travelling at about the same velocity, could also be applied to the amplification of weak signals at the receiving end, making possible an amplifying valve of sensitivity comparable to that of the best crystal mixer receivers.

Klystron Shortcomings

A detailed examination of the Klystron as R.F. amplifier showed that the inefficient energy exchange between the electron beam and the electric fields in the rhumbatrons is due to the long time taken by the electrons in crossing these fields. Once this time, often called the transit time, approaches the time of a period of the oscillation, it is clear that the electron will gain during one-half of the time as much energy as it will lose during the other half, and the net result of the energy exchange will be nil. This is the same difficulty that lies behind the decrease in efficiency of the conventional valve at the higher frequencies.

It was therefore a very inviting thought to use the signal in the form of a travelling electric field (instead of a stationary one) and utilize the energy exchange between the travelling field and electrons which travel at about the same velocity.

Here we can find an analogy

between valve development and wireless on the one hand, and engine development and flying on the other; it can, perhaps, be said that the step from interaction between stationary fields and electrons to interaction between travelling waves and electrons is reminiscent of the step from the reciprocating internal combustion engine to the gas turbine. And just as in the case of engines, the idea of travelling waves had been suggested many times in many different forms, but little had been done about it. However, with the advent of the centrimetric wave technique the time was ripe and the logical development followed.

The first point to be noted about waves travelling with about the velocity of electron beams is that "reasonable" electron beams travel much slower than ordinary electro-magnetic waves. Under "reasonable" we understand electron beams of voltages between a few hundred and a few thousand volts. The actual relation between velocity v of an electron and voltage V needed to give it that velocity, for non-relativistic velocities, is:—

$$v = 5.95 \times 10^7 \sqrt{V} \text{ cm/sec}$$

where V is the beam voltage.

Thus 2,500 volts will give electrons a velocity of about 3.10^9 cm/sec; just about one-tenth of the velocity of light in free space.

Means therefore had to be developed for slowing down waves by roughly a factor 10, and the simplest and the most readily available structure was found to be a helix of conducting wire. Within wide limits, a wave will follow the wire, clinging to it, as it were, and therefore the progress of the wave in the axial direction is considerably slowed down as compared with the velocity along the wire, which is near enough equal to the velocity of light.

Slowing-down Process

A picture of the actual lines of electric force, which constitutes the travelling wave, is given in Fig. 3. It has to be realized that these lines of force move in the following way: they rotate about the axis of the helix and they progress from left to right. However, if we imagine ourselves also

The Travelling Wave Valve—

moving from left to right, with the same velocity in the axial direction as the wave, we will continuously experience the same force. For instance, if we choose to travel with the point A, we will always experience an accelerating force (if we are negatively charged), whereas at the point B we would always experience a retarding force. At other points we would experience appropriate other forces as indicated by the direction and density of the lines of force.

Now let us consider what will happen to a thin electron beam travelling along the axis of the helix. Some portions of the beam will continuously be accelerated, others will be continuously retarded and the regions in between these two will experience neither one nor the other force. The inevitable result of the action of these forces is a displacement modulation of the beam, or, as it can be regarded, a density modulation. There are regions of the beam to the left of which the electrons are accelerated and to the right of which they are retarded. In these regions the density of charge will increase above the average. Correspondingly, there will be regions in which the converse conditions apply and the density of the charge will decrease below average. Thus the beam can be considered to have become amplitude modulated—the actual amplitude of the A.C. component of beam current growing at first approximately with the square of distance, reckoned from the beginning of the helix.

Experiments which were carried out with a helix of 18-S.W.G. copper wire of 9mm outside diameter, and an electron beam of a few microamperes and 2,400 volts, showed that this view of the action of wave on beam was substantially correct, and that the resulting modulation of the beam could be made considerably more effective than the modulation to be expected from any practicable rhumbatron.

Now since it has been shown how A.C. energy can be imparted to an electron beam by means of a wave travelling along a helix, the opposite process, namely the extraction of A.C. energy from a

modulated beam by means of a helix can be expected to occur with equal efficiency.

A rough picture of this process is as follows: Imagine a charge brought suddenly into the space within the helix. This charge will connect to the helix by means of lines of force, and these lines of force will spread out in time, one lot travelling along the helix in one direction, say, from left to right, the other lot travelling in the opposite direction. In other words, two waves are excited. Now, let the charge move along the axis of the helix, from left to right, with the axial propagation velocity of the waves. Then fresh lots of waves are continuously being excited; the ones

and the real picture is one of interaction between beam and wave. Suppose we start with a wave and an unmodulated beam. Almost at once there will be an amplitude modulation in the beam, and this will, also almost at once, induce a wave in the helix. This induced wave will again cause a beam amplitude modulation, and so forth, *ad infinitum*.

The theory which describes the complete process gives as result a wave which increases exponentially with distance, after some initial deviation from the exponential law.

In any real helix, in the absence of an electron beam, a wave will be attenuated; that is, its amplitude will decrease exponentially.

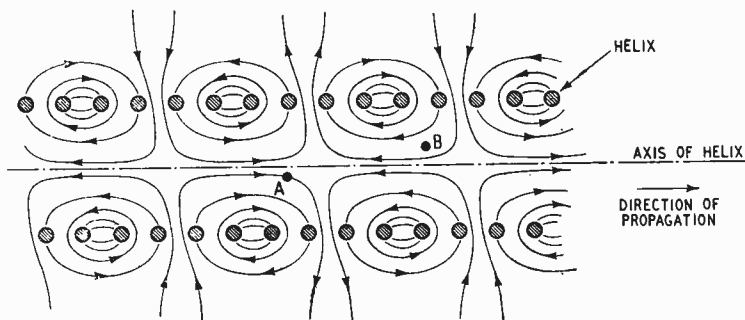

Fig. 3. Lines of force of a wave travelling along a helix (not to scale).

travelling from right to left annihilate each other. The ones travelling from left to right, however, reinforce each other, building up a wave front of continuously increasing amplitude.

Now an amplitude-modulated beam can be regarded as a continuous uniform beam upon which there is superimposed a system of alternate positive and negative charges distributed in a sinusoidal manner. Each of these positive or negative charges will excite a wave as described before; the complete "induced" wave can be synthesized from the contributions due to the individual charges.

The pictures given so far, of the action of the wave on the beam, and the action of the beam on the wave, are only first-order approximations. They are nearly true when either the beam is very weak, or the helix very short; in reality these two actions are always present simultaneously,

In the presence of an 'electron beam travelling at about the same velocity as the wave, the wave will increase exponentially. Hence one is justified in saying that the presence of the beam causes negative attenuation to be introduced into the helix.

Thus, by making either the helix long enough, or the beam current large enough, one can obtain a wave amplitude at the end of the helix which is substantially larger than that at the beginning. Hence the system helix—electron beam is an amplifier. Some of the D.C. energy of the beam is converted into A.C. energy in the wave by means of the interaction between wave and beam. A detailed examination shows that more electrons are being retarded than speeded up and thus the law of conservation of energy is satisfied.

The travelling wave tube, (see Fig. 4), as the complete device is

The Travelling Wave Valve—

called, consists in practice of nothing but a long and straight helix of wire supported in an evacuated glass envelope, containing also an electron gun for producing an electron beam and a collector for collecting as much as possible of the beam. Outside the tube proper are devices for matching the input and output leads to the helix, which may take many forms and are only indicated symbolically. It is, of course, important to procure proper matching (that is, reflectionless transitions) from input and out-

which it amplifies is mainly determined by the "broadness" of the matching arrangements at input and output. Therein lies the importance of the travelling wave tube for the communications of the future.

The initial work undertaken here in England was mainly concerned with the travelling wave tube as a sensitive amplifier and the first tube—a demountable model continuously evacuated—was first tested in December, 1943, at the Nuffield Laboratory, Physics Department, Birmingham University.

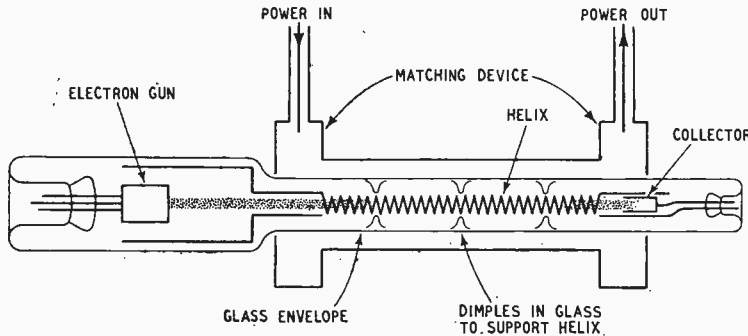

Fig. 4. Layout of the travelling wave amplifying tube.

put to the helix, as otherwise oscillations are easily excited when the helix is effectively an integral number of half-wavelengths long. Even if oscillations are not excited reflections at the ends will cause selectivity of the tube—that is, enhanced amplification at particular frequencies, destroying the broad-band amplification characteristic of the travelling wave tube, which may be a desirable property on occasion.

With Klystrons, amplification and bandwidth are conflicting requirements, each being roughly inversely proportional to the other. This is chiefly due to the fact that rhumbatrons are resonant structures, usually having rather high "Q"-values, in order to get high field strengths across the gap; but this unfortunately means that they will only amplify a relatively narrow band of frequencies.

The travelling wave tube, on the other hand, is in principle, a completely untuned device and the range of frequencies over

The helix, 60 cm long, of 18-S.W.G. copper wire, 5 turns/cm, was wound on a $\frac{1}{4}$ in mandrel, and a power amplification of 6 was given with a noise factor of 20. This happened at a beam voltage of 1,830 volts and with a beam current of 110 microamperes. The signal wavelength was 9.1 cm.

A short magnetic coil was used to focus the beam so that it impinged on the collector with the loss of only a few microamperes on the helix. Thick soft-iron shielding was necessary to keep away stray magnetic fields which are very troublesome with such a long and narrow beam.

A later tube, also continuously evacuated, gave a power amplification of 14 with a noise factor of 12, thus coming very close to the performance of a good crystal when used as a mixer.

The physical reason for the good noise factor of the travelling wave tube lies in the superior efficiency of energy transfer between electron beam and wave. Thus sufficient amplification is obtained

with but a fraction of the beam current that would be required for a Klystron giving comparable gain. Less beam current means less shot-noise, and therefore less noise is added to the signal in the process of amplification than in a Klystron.

Work similar to that reported on above has since been undertaken by Bell Telephone Laboratories, New York, and results obtained there with travelling wave tubes have been quoted recently by J. R. Pierce and L. M. Field on the occasion of an Electron Tube Conference convened by the Institute of Radio Engineers of America.

Using a helix of iron wire of 30cm length, with an initial attenuation of 33db, and an electron beam of 1,600 volts and 10 milliamperes, a power amplification of 200 was obtained over a bandwidth of 800 Mc/s to points 3db down on the gain/frequency curve. No particular attention was paid to noise factor. However, an R.F. output of 200 milliwatts was obtained. A long solenoid was used to get the beam through to the collector. The mid-frequency was 4,000 Mc/s.

At this early stage of the development of the travelling wave tube, it is difficult to foresee all the possible applications and the consequences which will undoubtedly follow in their train. However, one particular field seems to have been waiting for just such a tube as the travelling wave tube, and that is television and multichannel communications transmission via centimetre-wave links or waveguides. Here the travelling wave tube might eventually play a part not unlike that of the magnetron in centimetric wave radar.

Acknowledgments

The writer is indebted to many for very helpful discussions and interest; at Birmingham chiefly from Professor P. B. Moon, Dr. R. R. Nimmo, Professor J. Sayers and Dr. G. Voglis, and at Oxford Dr. J. H. E. Griffiths, Dr. A. H. Cooke and Dr. B. Bleaney. Very able assistance in the actual work, experimental as well as theoretical, was given by Mr. E. E. Vickers, Mr. J. Hatton and Mr. H. Ashcroft at various times.

BELLING-LEE QUIZ (No. 5)

A selection of answers to questions we are continually being asked by letter and telephone

Wot no interference from Television. Thanks to B & L.

Q.23. Can Television interfere with the normal broadcast programme?

A.23. Yes, within a few miles of Alexandra Palace the television transmission may be imposed as an unwanted background on normal broadcast programmes. In this form it is untunable and must be rejected by a wave trap. This consists of a $\frac{1}{4}$ -wave inductance in series with the aerial.

Such a filter is marketed by Belling & Lee Ltd. under the trade mark of Telefilter.

The other day we received anonymously a packet of twenty cigarettes together with the above "Chad," presumably from someone who was grateful for the relief obtained after fitting Belling Lee Telefilter. Should the donor recognise his handwriting reproduced above, we would like him to accept the thanks of the Service Department.

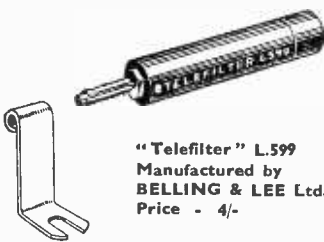

"Telefilter" L.599
Manufactured by
BELLING & LEE Ltd.
Price - 4/-

Q.24. If a "Skyrod"*1 or Television**2 Aerial is erected on a building is there any added risk of being struck by lightning?

A.24. Since the number of T.V. and Skyrod aerial installations has become considerable and following a period of thundery weather with lightning, the service department has been inundated with enquiries as to what users can do to protect themselves and their property against damage by lightning. These enquiries

come in from members of the public, wireless dealers and wholesalers.

First of all, the nomenclature is unfortunate, in so far that a lightning conductor does not conduct or attract lightning, and a lightning arrester cannot arrest lightning.

One would expect interested people to realise that architects do not fit "lightning conductors" to chimneys, factories or other buildings to increase their chances of being struck, therefore why should those who fit a T.V. or Skyrod aerial, presumably with some visual resemblance to a "lightning conductor," expect increased danger?

Readers who have visited Switzerland (and presumably other alpine countries where isolated wooden buildings are commonplace) will have noticed two or three spikes several feet high on roofs of isolated hillside dwellings, these are not aerials but "lightning conductors" to minimise the risk of a strike which inevitably would result in fire.

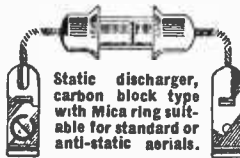

Static discharger, carbon block type with Mica ring suitable for standard or anti-static aerials.

Manufactured by BELLING & LEE Ltd.
List No. L.350 selling at 8/6.

If a house is struck, in nine cases out of ten, it is a chimney that takes it. Technically this is due to the column of ionised (slightly conductive) warmer air which—winter or summer—is rising from it and drifting away down wind, ultimately rising far above any aerial. This is happening from every house all the time, therefore when a house is struck the first solid matter encountered by the charge is the chimney, which is usually shattered. Sometimes the charge travels down the chimney shaft and damages the decorations of the rooms en route. If the unfortunate house is on the phone the wires are generally fused, in spite of the proven "lightning arrester"*** fitted by the G.P.O. All this happens whether or not there is an aerial lashed to the chimney.

When you take into account the many millions of houses, and the

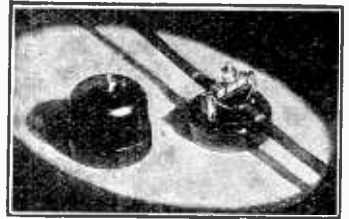

Another type of static discharger specially designed for use with Television aerials and Belling & Lee**3 twin-feeder. List No. L.376. Price 9/6.

odd one or two that are damaged by lightning, you realise that the risk is negligible. As tangible proof of this, damage by lightning is generally included in every householder's comprehensive insurance policy, and no increased risk is recognised by the addition of an aerial, T.V., Skyrod, or horizontal.

As an additional "vote of confidence" every Belling-Lee aerial system is insured by us for a period of twelve months, up to a sum not exceeding one hundred pounds, against damage to the aerial system or radio or television receiver due to lightning. Following normal procedure this comes into operation only in the event of there being no collateral insurance or after any existing insurance cover has been exhausted.

- *1 Skyrod (Reg. Trade Mark)
Type L.355/CK 12ft. collector, download, 2 transformers, pole clamps and earth wire, £7 2 6
Also supplied with chimney lashings and brackets or with an 18ft. collector at additional cost.
- *2 Viewrod (Trade Mark).
Dipole, reflector and cross arm with chimney lashings, L.502/L each £5 5 0
Supplied also without reflector and/or chimney lashing from £2 3 6
- *3 L.336 Balanced twin feeder per yard 6d.
All prices quoted are subject to alteration without notice.
- *4 Static discharger is a more accurate title.

TO BE CONTINUED.

BELLING & LEE LTD
CAMBRIDGE ARTERIAL ROAD ENFIELD MIDD.

*It's easy to make Pick-ups
— if you know how.*
The know-how in the manufacture of
Lexington
MOVING COIL PICK-UPS

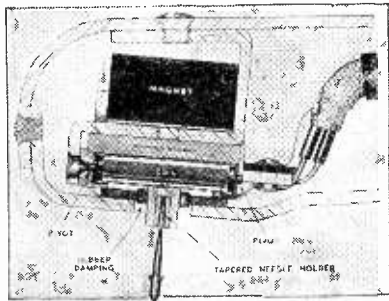

is the result of long experience and precision watch-making standards which give a finely constructed instrument the details of which are shown in the sectional diagram.

DE LUXE MODEL

- Robust design. Accidental dropping on record will not damage Pick-up.
- Extremely low moment of inertia (80 milligrams total weight of movement).
- Pure sine wave with no harmonic distortion.
- Automatic needle or sapphire changing opens new fidelity field to the amateur.
- Can be used with normal record changer without fear of damage

£5.0.0 plus 25/- P.T.

Sapphire needles with specially tapered shanks are available, price 15/3, including P.T.

JUNIOR MODEL

Identical in design and workmanship to the De Luxe, the only difference is that it is not equipped with the Automatic Sapphire needle Inserter and Extractor device and metal sole plate. Made to take standard steel and fibre needles this model enables every music lover to enjoy the fine reproduction which only a moving coil pick-up can give.

£3.3.0 plus 15/9 P.T.

CURVE OF LEXINGTON MOVING COIL PICK-UP TAKEN WITH STANDARD PRE-AMP FROM H.M.V. 4036-7 STANDARD FREQUENCY RECORD

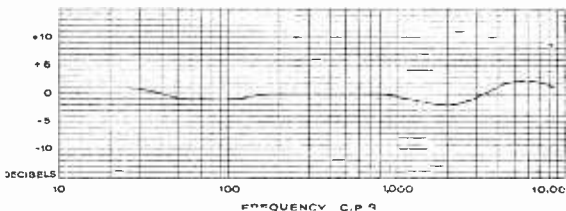

PRE-AMPLIFIERS having an inverse of the recording characteristic incorporated are available for use with these pick-ups when connected to commercial apparatus.

POWER AMPLIFIERS. Our new range giving the highest fidelity yet obtainable is now available in three models, 8, 15 and 30 watts.

Illustrated brochure upon request. Trade enquiries invited. Obtainable through your local Dealer

COOPER MANUFACTURING CO.
134, WARDOUR STREET, LONDON, W.1
Phone: GERrard 7950



FOR POLISHING THE SPURS ON THE HIGH HEELED BOOTS OF A COWBOY NAMED D'ARCY FROM WYOMING . . .

We have never received quite such a foolish enquiry and we use it only to attract your amused attention and to show you that we make Transformers for almost every purpose. So no matter how simple your requirements - no matter how small or large - do let us have a look at the problem next time. Illustrated is a special Transformer for Aeronautical Research designed for operation at three cycles per second.

* PARMEKO LTD
OF LEICESTER.

MAKERS OF
TRANSFORMERS.



MINIATURE SPOT-WELDING TOOLS

For Jointing in Radio Assembly

By R. W. HALLOWS, M.A.Cantab., A.M.I.E.E.

HAVING noticed a mention in the *Wireless World* of a miniature spot-welding tool which was brought out in Germany during the war, I determined to obtain particulars of it by hook or by crook. Thanks to the good offices of "F.I.A.T." and "B.I.O.S.," I have at length succeeded in so doing. Readers will remember that the use of the "Smallweldpencil," as it was called, was suggested as a possible alternative to soldering in radio assembly work.

The tool, which is made in the two forms illustrated in the figures, is about 10 in. in length overall

is designed for larger jobs. It will, in fact, tackle almost any kind of spot-welding, provided that the surface area of the joint does not much exceed 10 square millimetres — say $\frac{1}{8}$ in \times $\frac{1}{8}$ in.

The construction of the welding pencil is illustrated in Fig. 1. A hollow body made of insulating material serves as a grip for the tool. Fixed to its business end is the steel welding head, also hollow. The actuating knob allows a rod lying centrally within the handle to be pushed forward, thus carrying the

carbon electrode into the aperture at the end of the welding head. Mounted on the rod is the iron core of a solenoid. The tool is worked from 110 V or 220 V 50-cycle mains by means of a transformer. As the voltage for welding does not exceed 35V there is no risk of shock.

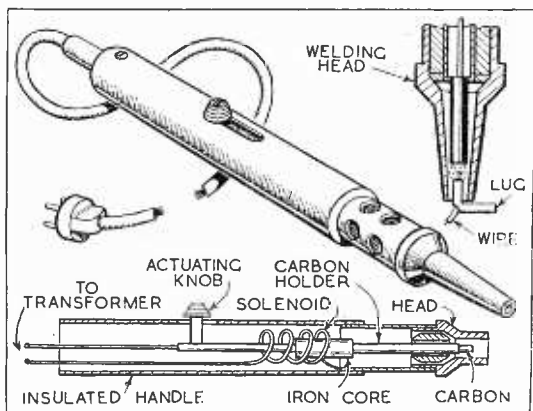
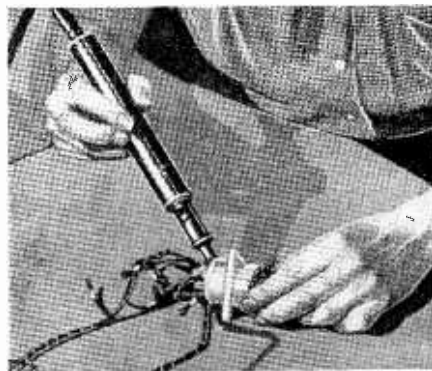
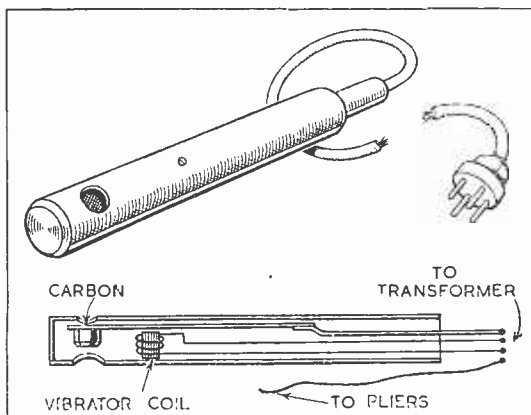

Fig. 1. The welding pencil, with details of its construction.

Fig. 2 (right). "Vibro-electrode" welder; the sectional sketch shows the vibrator.



by one inch in diameter. The vibro-electrode welder (Schwing-elektrode) is intended for joining wires up to 0.8 mm in diameter; say, No. 21 S.W.G. and smaller. The Welding Pencil (Kleinschweissgriffel)

A simple example, such as the fixing of a lead to a tag, will serve to explain the action of the weld-

ing pencil. The wire having been positioned on the tag, the aperture of the head is placed over both and the tool is so held that the walls of the head make good electrical contact with at least one part of the "work." The actuating knob is now pressed gently downwards with the forefinger until the carbon makes contact with the work. The circuit is: transformer secondary — carbon — work — head — solenoid — transformer secondary.

As the "making" of the circuit brings the solenoid into play the carbon is slightly retracted and an arc is formed. The actuating knob rebounds off the cushion of the finger tip (it is emphasized by the makers that the pressure on the knob *must* be gentle) and so the process continues for $\frac{1}{4}$ sec to 2 secs, according to the nature and cross-section of the work. The finger then releases the knob, which returns to its "off" position under the pull of the solenoid. The head is left covering the weld for $\frac{1}{2}$ sec or so to minimize oxydation.

In the vibro-electrode tool (Fig. 2) the movements of the carbon electrode are not brought about by opposing the pull of a solenoid by light fingertip pressure; instead, a small electro-magnet is used to produce the necessary vibration. As this tool is generally employed for joining one lead to another the work is held in a special pair of pliers connected by a flex and a plug to an earth socket on the terminal board of the transformer.

For the larger tool interchangeable welding heads with

Miniature Spot-Welding Tools—

apertures of various diameters are available and 2mm, 3 mm or 4mm carbon electrodes may be used according to the work in hand. Besides the joining of wire to wire and wire to tag, small metal parts and sheet metal of the gauges normally used in wireless construction may be firmly fixed by means of a series of welded joints. The following direct welds are possible; it is necessary to use heads and carbons of the smallest sizes for those marked with an asterisk.

Iron to iron, nickel and brass*.

Copper to copper, silver and bronze.

Nickel to nickel, brass,* iron.

Silver to silver, copper and bronze.

Brass to brass*, nickel and iron.

Bronze to bronze, silver and copper.

In most cases where welding is impossible (e.g., iron-copper, silver-nickel, copper-brass) hard-soldering can be done with the aid of the welding pencil, silver, bronze or copper being used as the medium. Zinc does not lend itself to either welding or hard-soldering. Aluminium can be welded to itself and to iron, copper or bronze by the use of a special carbon electrode.

Both tools are, or at any rate were, made by the Siemens-Halske A.G. of Berlin.

to suit those parts which he can obtain.

The photographs will indicate a layout which has been found satisfactory and will illustrate important points of detail, and so amplify the text. In the case of some components, which are not purchasable at all at the moment, rather greater detail will be given. These components are mainly special coils and transformers.

The present plan is, first, to continue the articles on the theory of the individual stages; secondly, to describe the construction of special components; and, thirdly, to describe the various units comprising the complete receiver. These stages will actually overlap and merge into one another, and the plan is not a rigid one, but is open to modification as circumstances dictate.

It will be appreciated that the development of high-quality television apparatus and of the special components is quite a lengthy business. It will be clear, too, that the description of all this must occupy quite a large amount of space in *Wireless World*. The paper supply position is likely to

improve soon, but it will still be impossible to devote very many pages in each issue to the one subject of television. Consequently the description of the set and components must necessarily take a good many months to complete.

This explanation of the television plans for *Wireless World* is being given largely because it is impossible to provide a fully

Television Receivers

Publication of Constructional Articles

THEORETICAL explanations of the individual parts of a television receiver are now being given regularly in *Wireless World*. But, although these articles make clear the requirements of individual stages, it is not always apparent how these stages fit together to form a complete equipment, nor is it always obvious how the integration of the parts to form a whole reacts on the design of the stages themselves. It is thought that these difficulties are best removed by the study of a complete design, and a receiver is being developed with this end in view.

The set will be of a high-quality type with electromagnetic deflection, and the design will be such that a good deal of flexibility in construction is permissible. So far as possible critical circuit arrangements will be avoided, even if this entails the use of more valves, and a unit construction will be adopted. This last offers many advantages, for the smaller size of the individual chassis makes the construction easier, and with careful arrangement the accessibility for adjustment and maintenance is improved. More important, perhaps, is the flexibility which it gives, for widely differing conditions can easily be catered for by the use of alter-

native units. Thus alternative receiving units can cater for long- and short-range reception, and the requirements of both 9in and 12in tubes are easily met.

The presentation of the design

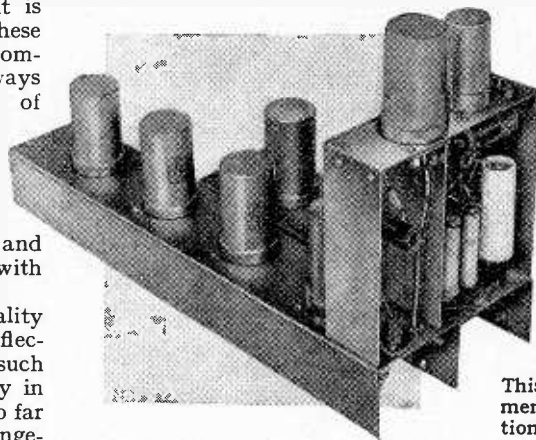

This photograph shows a development model of the receiver portion of the equipment. It comprises vision and sound R.F. channels and detectors together with the V.F. stage.

in the pages of *Wireless World* will be in the form of circuit diagrams and detailed photographs rather than as mechanical drawings and practical wiring diagrams. There are various reasons for this. One of the chief of these is the present component supply position. As one cannot guarantee the availability of any particular part, a rigid mechanical design is impossible, and it is necessary for any individual constructor to modify the layout and dimensions

detailed description of a receiver within any short period, and it is felt that those readers who are keenly interested in this branch of electronics should understand the position. For their guidance it may be added that it is hoped to start dealing with the special components—probably deflector coil construction—in the January, 1947, issue.

Valve Standardization

First Steps by the B.V.A.

DISCUSSION is still proceeding on the types and characteristics of the valves which will be included in the new standard range to be

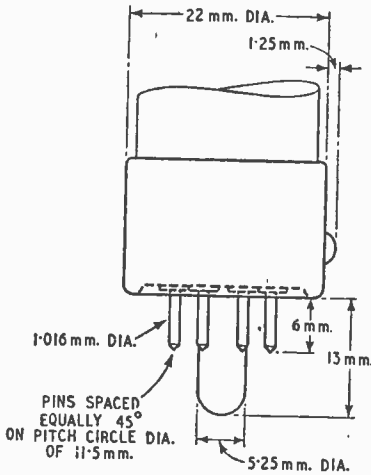

Principal dimensions of the new type B8A standard B.V.A. valve base.

produced by the British Radio Valve Manufacturers' Association. In the meantime a sufficient measure of agreement has been reached on the physical dimensions of the bases which will be used for some details to be published. The B.V.A. emphasizes that the proposals are

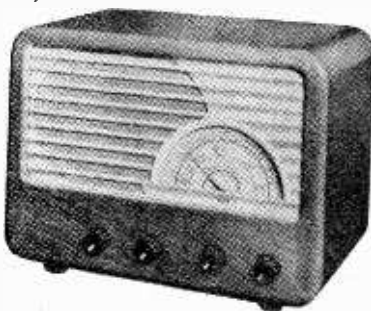

A FOUR-VALVE, plus rectifier, superhet for A.C. mains (Model 516) has been introduced by Sobell Industries, Plantation Road, Amersham, Bucks. It covers the usual short, medium and long waveranges and has an output of 4 watts. The price is £20, plus tax £4 10 4. An A.C./D.C. version will also be available, price, £21, plus tax £4 14 10.

tentative, but it is thought that any future modifications will be of a minor character.

The first point of interest is that the bases will be of "all-glass" construction in which thin solid pins are sealed directly into bosses in the glass base.

Most of the new standard types will have an entirely new small eight-pin base (type B8A) with a central spigot and a locating boss on the side of the shell. A bayonet-type valve holder will be required and a side elevation of the new base is shown in the drawing.

Where a valve with a large bulb is required, as in the case of output valves and power rectifiers with higher heat dissipation, a larger base (type B8B) will be used. The dimensions of this base are similar to the existing eight-pin "Loctal" base, and from a tentative schedule of pin connections for use with all B.V.A. valves it would appear that existing conventions have been followed.

Tentative base allocations for the proposed B.V.A. standard valves are as follows:

Type	Base
Variable- μ R.F. pentode ...	B8A
High-slope R.F. pentode (wide band amplifiers) ...	B8A
Self-oscillating frequency changer(s) ...	B8A
Double diode triode ...	B8A
Output pentode(s) ...	B8A and B8B (according to type)
Rectifier(s) ...	B8A and B8B (according to type)
Oscillator triode (television) ...	B8A
Double diode, separate cathodes ...	B8A

SHORT WAVE CONSTRUCTORS' MANUAL

THE reappearance of the Eddystone Short Wave Manual is a welcome sign of the better availability of new components for the construction of amateur transmitting and receiving equipment.

While the designs given are modern in conception, the circuit technique is of necessity on strictly economical lines. A well-planned 28 Mc/s crystal-controlled transmitter is included, as well as one for 58 Mc/s, but this relies on a master oscillator for its frequency stability.

Other equipment includes a frequency meter covering 56 to 60 Mc/s, a 3-valve 5- and 10-metre converter and a 4-valve T.R.F. versatile short-wave receiver. base connections for the post-war special types of short-wave valves of particular interest to the amateur.

The manual is issued by Stratton and Co., Ltd., West Heath, Birmingham, 31, and the price is 2s 6d.

A 'SOUND' PROPOSITION!



ARE YOU A TANNOY STOCKIST?

A restricted number of qualified dealers and P.A. specialists are being appointed as approved stockists for the main trade distribution of Tannoy Sound Equipment.

Having declined to jeopardise the reputation of TANNROY by the introduction of interim equipment to meet insistent demands for "anything at any price", the extensive post-war range of TANNROY Sound Equipment which is now becoming available, embodies all the latest technical developments in design and the highest quality of manufacture. The trade mark "TANNROY" remains a guarantee of reliability to you and your customer.

Write for the qualifications required of stockists and for complete details of the full range of TANNROY Equipment.

TANNOY

—SOUND EQUIPMENT—

GUY R. FOUNTAIN LTD.,

"THE SOUND PEOPLE"

"TANNOY" is the registered trade mark of equipment manufactured by

GUY R. FOUNTAIN LTD.,
WEST NORWOOD, S.E.27.
GIPSY HILL 1131.

The largest Organisation in Great Britain specialising SOLELY in Sound Equipment.

Branches throughout the British Isles.

World of Wireless

TELEVISION RADIO LINK

FURTHER confirmation that the G.P.O. has not abandoned the idea of employing radio links to extend the television service to the provinces was provided during a recent conference when W. A. Burke, the Assistant P.M.G., stated that both cable and radio links were being developed.

He mentioned this when referring to a demonstration of a television radio link which he and A. J. Gill, G.P.O. Deputy Engineer-in-Chief, had seen during their recent visit to the U.S.A. and Canada. The demonstration provided by the N.B.C., was over a distance of 84 miles using three intermediate transmitters working on a frequency of 7,000 Mc/s. In their opinion the received picture was indistinguishable from the original.

A citizens' mobile radio-telephone service, which is being inaugurated in 47 cities and on five major highways in the States, was also tested by Mr. Burke and Mr. Gill who made calls to their respective homes in this country from moving cars in Washington. It is stated that by the end of 1947 some 4,500 cars will have been fitted with the necessary equipment.

METEOR DETECTION BY RADAR

THE arrival in our atmosphere of an unusually large shower of meteors from the comet Giacobini-Zinner, which had been predicted for October 9th, was taken advantage of by the ionosphere research group of the Ministry of Supply to test a theory that meteors were detectable by radar.

Recent investigations carried out by the Department of Scientific and Industrial Research and the ionosphere research group, had associated spurious transient echoes from a height of about 60 miles with meteors. Many photographic records taken on October 9th have yet to be examined, but the visual observations confirm that the expected increase in echoes did occur.

As a matter of exactitude the echoes are not reflections from the meteors themselves, but from the accompanying streak of incandescent gas.

The apparatus at the Richmond Park, Surrey, station of the ionosphere research group consists of a modified G.L. (gun laying) radar set operating on 70 Mc/s and pulsed 150 times a second. This low pulse frequency is necessary as the C.R.T. time base in the receiver is ex-

tended to cover the equivalent of about 150 miles.

PRINTED WIRING

THE reference by "Diallist" in our October issue of a method for printing receiver wiring, which has been developed in America, has revealed that a similar system was evolved in this country as far back as 1941 by Henderson and Spalding, 32, Shaftesbury Avenue, London, W.C.2.

Circuit connections are printed with acid resisting ink on a thin bakelite panel, which is either metallised or coated with metal foil according to requirements, and the printed panels are immersed in acid to remove the exposed metal. A further process removes the ink leaving a clear metal pattern of the circuit wiring. Cross-over connections are made by printing on the reverse side and connecting through by means of small soldered-in rivets.

Bakelized paper, metallized or foil-coated, has also been used.



PERSONAL PORTABLE. This four-valve M.W. superhet, Model 106, produced by the Romac Radio Corporation, weighs approx. 4½ lb and is carried by a P.V.C. shoulder strap in which the aerial is wound. The dimensions are: 9½ in long, 5½ in high and 2 in deep.

RADIOPHONE TO SHIPS

A SHORT-RANGE radiotelephone service between inland telephone subscribers and coasting and other short-voyage ships was introduced by the G.P.O. at the end of September.

The service area of each of the four transmitters at Cullercoats, Humber, Portpatrick and Seaforth, has a radius of approximately 150 miles. It is proposed to extend the service to other ports later.

MARCONI EXPORTS

MANY valuable contributions to the country's export drive are announced by Marconi's W.T. Co.

The company is to instal a complete station on the island of Timor, which will form the first link in a new radio network for the provision of a telegraph/telephone service between Portugal and her colonial possessions in Timor, India, Africa and China. The three transmitters will be erected near Dili.

Short- and medium-wave transmitters and studio equipment for a broadcasting and telecommunications system in Iraq are to be installed by Marconi's at a cost of approximately £35,000.

Broadcasting equipment for the Jornal do Commercio of Recife, Brazil, consisting of one 20-kW medium-wave transmitter and two 25-kW short-wave transmitters, together with studio apparatus, is also to be installed by Marconi's. The installation includes a frequency-modulated V.H.F. link between the studios in Recife and the transmitters some 20 miles away. Another 20-kW transmitter has been ordered by the Brazilian Radio Sociedade da Bahia.

Six 5-kW medium-wave broadcasting transmitters valued at £40,000 are to be supplied to the South African Broadcasting Corporation, which is expanding its services in the Union.

Four telegraph/telephone transmitters, complete with aerial equipment, are to be supplied to the Chinese Government to supplement the country's internal communications. They are fitted with remote control equipment enabling them to be operated from a distance of up to 25 miles.

PERSONALITIES

Lord Reith has been appointed chairman of the Commonwealth Communications Council, which, with the nationalization of Cable and Wireless, will become the Commonwealth Telecommunications Board. Since his resignation from the director-generalship of the B.B.C. in 1938 he has held various Ministerial posts and was, for a short while prior to leading the Government commission of investigation into commonwealth telecommunications, a director of C. and W.

W. Duncan, senior maintenance engineer at the B.B.C. station at Westerglen, Scotland, has been appointed engineer-in-charge of the Londonderry, Northern Ireland, station.

Frank S. Adams has severed his connection with the McElroy-Adams Group

and is forming a company to manufacture radio and telecommunications equipment. His address is The Croft, Wilton, Salisbury. Tel.: Wilton 3283. He is not related to H. R. Adams, the managing director of McElroy-Adams.

IN BRIEF

Guernsey Television.—We hear from F. T. Bennett, of Guernsey, that the interference caused by the local G.P.O. transmitter with the reception of television in Guernsey, to which reference was made in our last issue, has now been completely overcome. He is loud in his praise of the G.P.O. engineers' efforts to provide interference-free reception "for one receiver well outside the service area."

Scientific Films.—A catalogue of films of general scientific interest has been compiled by the Scientific Film Association, 34, Soho Street, London, W.1, and published by Aslib (Association of Special Libraries and Information Bureaux), 52, Bloomsbury Street, London, W.C.1. A few of the 595 films listed cover radio subjects. The catalogue, giving data regarding hire, distribution and suitability for different audiences, is obtainable from S.F.A. or Aslib, price 5s 3d, by post.

West Indies.—With the opening by Cable and Wireless (West Indies), Ltd., of a direct circuit between the British island of St. Kitts and the Dutch island of St. Maarten—both in the Leeward Islands—nine radiotelephone circuits now interlink West Indian islands.

Marconi transmitters, receivers and Marconators—direct-reading direction-finders—are to be fitted in eighty Vickers-Armstrong "Viking" aircraft.

China's Telecommunications.—Two-thirds of North China's telegraph and telephone lines having been destroyed, commercial telecommunications are now conducted by radio, with the exception of the Peiping-Tientsin-Tangshan lines.



SPECIAL ATTENTION has been paid to the quality of the sound channel in the Ekco Model TSC30 television console which employs a 9-in tube. The cabinet is fitted with an anti-resonant chamber and the frequency response is said to be substantially flat from 80 to 8,000 c/s. Price, £58 16s., plus £13 7s. 7d. tax

Society of Inventors.—A Midland branch of the society has been formed in Birmingham and meets on the fourth Thursday of the month at 7.0 in the Chamber of Commerce, New Street.

G.R.S.E.—At the annual general meeting of the Guild of Radio Service Engineers it was announced that the membership had more than trebled since January.

School Broadcasting.—The Central Council for School Broadcasting announces that there are now over 13,000 schools registered as listening to the B.B.C. schools broadcasts. This total—a record—is some 1,300 more than last year. There are, in addition, 1,684 schools registered in Scotland.

City and Guilds.—The 1945 report of the City and Guilds of London Institute records that, although there was a slight decrease compared with 1944, the number of examinees for the five subjects grouped under telecommunications was 15,033—almost half the total number of examinees for all subjects. The year's total of 256 entrants for the radio service work examination was an increase of 41 on the previous year.

"Electronics."—The January, 1946, issue of *Electronics* is required to complete a library's volumes. Offers should be addressed to "E. H. B.," c/o The Editor.

Back Numbers.—Our Publisher asks us to state that he will be pleased to purchase from readers 1946 issues of *Wireless World* prior to the current number.

British Telecommunications Research, Ltd., is the title of the new research organization formed by British Insulated Callender's Cables and the Automatic Telephone and Electric Co. (See our September issue.)

An **Overseas Edition** of *Murphy News*, printed on air-mail paper, has been produced for the Company's distributors outside Britain.

Glasgow Exhibition.—Among the radio manufacturers exhibiting at the Technical exhibition, to be held in the Kelvin Hall, Glasgow, from November 15th-27th, are: Allander Industries, Arden, Coastal Radio, Measuring Instruments (Pullin), Morgan Crucible Co., Marconi Instruments, Radio-Aid, Laypak, Truvox, and Scopphony.

British Industries Fair.—The first post-war Fair is to be held from May 5th to 16th, 1947. The lighter industries, including radio, will be exhibited at Earls Court and Olympia, London, and the engineering and hardware sections at Castle Bromwich, Birmingham. Enquiries regarding the London exhibition should be addressed to the Export Promotions Department, Board of Trade, 35, Old Queen Street, S.W.1. Tel.: VICTORIA 9040.

M. WILSON LTD

A NEW COMPACT COIL UNIT

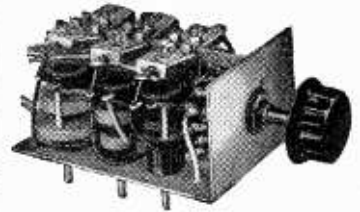

In response to the demand for a smaller COIL UNIT we have designed this model which measures only 3½ in. deep x 2½ in. wide x 2½ in. high, with lin. spindle and knob as illustrated.

This is a 3-waveband A. and Osc. 460Kc.s. Unit, iron-cored (adjustable) complete with padders and trimmers and is aerial-tested in a standard 5-valve superheterodyne circuit. Blue-prints of this circuit are 3/6 per set of 3 (one theoretical and two practical).

Also available

T.R.F. COIL UNIT

Specification as above but with Aerial and Tuned Grid with reaction. Set of 3 Blue-prints for 4-valve T.R.F. A.C. or Battery Receiver, 3/6.

All connections are Colour coded.

COIL UNIT 39/6 EITHER TYPE

ANNOUNCEMENT

We are temporarily suspending advertising until the repairs to our war-damaged workshops are completed.

When they are once again in full production we shall speedily clear the arrears of outstanding orders and resume our advertising with a further range of new products, now being developed, and of which we shall be able to give delivery from stock.

To those customers who have experienced delay in receiving the goods ordered we express our thanks for their patience and assure them they are being dealt with in strict rotation.

Immediate delivery of the above Coil Units, Standard Components, Amplifiers and Blue-prints can still be made.

TO OVERSEAS TRADERS

Wholesale and retail enquiries are invited.

All essential components for EXPORT.

ORDERS are tropicalized if required.

Orders can be executed for B.A.O.R., C.M.F. and S.E.A.C. customers.

307, HIGH HOLBORN.
LONDON W.C.1. Phone: HOLborn 4631

World of Wireless—

Aerialite, Ltd., has now opened a sales office and showroom at 91-93, Baker Street, London, W.1. Tel.: WELbeck 7986.

Marconi Instruments, Ltd., has opened offices and a showroom at 109, Eaton Square, London, S.W.1.

Masteradio.—The service department of Masteradio, Ltd., has been transferred from the company's works at Watford to 319-321, Euston Road, London, N.W.1.

MEETINGS

Institution of Electrical Engineers Radio Section.—Symposium of papers on direction-finding by Drs. R. L. Smith-Rose, R. R. Pearce and F. Adcock and W. Ross and C. Clarke on October 30th.

"Pulse Testing of Wide-band Networks," by Dr. D. C. Espley, E. C. Cherry and M. M. Levy, on November 6th.

"Voltage Characteristics of Polythene Cables," by R. Davis, Dr. A. E. W. Austen and Prof. Willis Jackson, on November 20th.

"The Economics and Subjective Requirements of Television Picture Sizes," discussion to be opened by D. C. Birkinshaw, M.B.E., on November 26th.

Ordinary Meeting.—"Colonial Telecommunication Systems," by C. Lawton and V. H. Winson, on November 21st.

The above meetings will be held at 5.30 at Savoy Place, London, W.C.2.

Cambridge Radio Group.—"Ground Radar," by Dr. D. Taylor, on October 29th at 6.30 at the University Engineering Laboratory.

"Radar Navigation," by Dr. R. A. Smith, on November 19th at 6.0 at the Cambridgeshire Technical College (Room 301).

London Students' Section.—"Trend of Modern Telecommunications," by A. H. Mumford, C.B.E., on November 18th at 7.0 at the I.E.E.

Television Society

"An Improved Television Signal Generator and its Uses," by F. H. Townsend, G. B. Goff and S. R. Kharbanda, on October 29th at 6.0 at the I.E.E.

Amateur Activities

SLOW MORSE PRACTICE

SINCE publishing the note in the September issue giving the R.S.G.B. schedule of slow morse transmissions for practice reception we have received the following additional information. Three additional stations in Essex: G3MD, 1,960 kc/s; G5FW, 1,915 kc/s; and G2QI, 1,820 kc/s; and one in Lancs: G6AI, 1,819 kc/s, are participating. The frequency employed by G2BJY (Staffs) is 1,905 kc/s, not 1,930.

As the revised schedule gives additional transmitting times we are publishing it in full:—

Sundays:	0900	G3LP, G3JK
	1000	G8MD
	1030	G5UM
	1130	GW3GL
	2100	G6AI
Mondays:	2100	G6AI
	2130	G2CPF, G2BJY
Wednesdays:	2130	G2CPF, G3LP, GW3GL
	2200	G5FW
Thursdays:	2100	G6AI
Fridays:	2200	G2QI
Saturdays:	2130	G2BJY

41-METRE BAND

COMPLAINTS have been made on both sides of the Atlantic about the continued "encroachment" of broadcasting stations into the 41-metre band. Likewise broadcasting authorities have accused transmitters of causing interference with their transmissions—as was instanced during the recent B.B.C. broadcast of the Nuremberg trials.

Commenting in its overseas journal *London Calling* on the complaints from American amateurs the B.B.C. states:—

"The complainants appear to have overlooked the revised allocations of frequencies made at Cairo in 1938. Under the Madrid regulations of 1932, the whole band from 7,000 kc/s to 7,300 kc/s was reserved exclusively for amateur use,

but under the Cairo Conference regulations, which became effective on September 1st, 1939, the band from 7,200-7,300 kc/s was shared between amateurs and broadcasting.

"While, therefore, the B.B.C. is justified in using these frequencies for its broadcasting services, it naturally does not wish to interfere with the activities of amateurs, and will always seek to avoid such interference by choosing frequencies in other broadcasting bands when these are suitable and available.

"As solar activity is now increasing, the B.B.C. expects to be able to maintain its services to the Americas during the next few years without recourse to the 41-metre band, thus reducing to a minimum interference with amateur activity."

It should be stated that broadcasting in the 7.2-7.3-Mc/s band in the "American continent and the territories and possessions of the States of that continent" is not permitted under the Cairo regulations.

"Q" CODE

RECOMMENDED additions to the "Q" code have been published by the R.S.G.B., which asks that publicity should be given to these recommendations.

They are:—

- QHI.—Move higher in frequency.
- QII?.—Shall I move higher in frequency?
- QLO.—Move lower in frequency.
- QLO?.—Shall I move lower in frequency?
- QBK.—I can work break-in.
- QBK?.—Can you work break-in?

It is also stressed that the use of the following existing signals should be encouraged:—

- QSQ.—Send words once.
- QSV.—I will send a series of Vees.
- QHM.—I am searching for replies from the high frequency end of the band to the middle.
- QLM.—I am searching for replies from the low frequency end of the band to the middle.
- QMH.—I am searching for replies from the middle of the band to the high frequency end.
- QML.—I am searching for replies from the middle of the band to the low frequency end.

NEW ZEALAND AMATEURS

ADDITIONAL frequencies were recently made available for New Zealand amateurs, who are now permitted to operate in the following bands (frequencies in Mc/s):

3.5—3.96	} W/T
7.0—7.3	
14.0—14.4	
29.0—30.0	} W/T and R/T
50—54	
106—170	
420—450	
1345—1425	

Transmissions on 80 metres (3.5-3.96 Mc/s), which were previously restricted to New Zealand contacts only, may now be made overseas.

The use of the 5-metre band (58.5-



PART OF AN EXHIBIT arranged by the T.C.C. Television Society in the factory canteen. Various television components and chassis were shown and four television sets were working. The purpose of the exhibit was to demonstrate to employees just how T.C.C. capacitors are used in television equipment.

60 Mc/s) is discontinued, but in lieu of it the 50-54 Mc/s band has been allocated.

The 160-metre band has not been restored, but it is hoped that the 21.1-21.5 Mc/s portion of the 14-metre band will shortly be made available.

New Zealand amateurs are permitted to transmit in certain low-frequency bands for the first six months of operation, after which, if considered proficient by the New Zealand Amateur Radio Transmitters' Society, they are granted "high-frequency" permits. Special permits were also issued just prior to the war for W/T operation in the 20-metre band only.

Amateur Transmitters.—The number of licensed amateur transmitters in Great Britain and Northern Ireland at the middle of October showed an increase of nearly a thousand on the pre-war total. The present figure is 3,869.

Chinese Amateurs.—We hear from K. T. Chu, acting president of the Chinese Amateur Radio League, that it has now returned to the capital, Nanking, from Chungking, the wartime capital. The address of the C.A.R.L. is 40, May Yuan Villa, Kuo-Fu Road, Nanking (2), China. A copy of the League's journal, "Radio World," has also been forwarded to us.

Czech Amateurs.—The headquarters' station of the Czechoslovak Amateur Radio Society (C.A.V.) transmits on 3.6 Mc/s every Thursday between 2000 and 2100 G.M.T. News relating to amateur activities is transmitted on C.W. and R.T.

A British Amateur, C. G. Allen, G8IG, conducted two-way communication with the American superfortress, *Dreamboat*, during her non-stop flight from Honolulu to Cairo via the North Pole. Working on 14,290 kc/s, with a power of 120 watts, G8IG, who is sales manager of McMichael Radio, contacted the aircraft when she was over Alexandria at 7.15 a.m. on Sunday, October 6th.

"Sponsored" Amateur Radio?—The QSL cards used by members of the Bournemouth and District Amateur Radio Club sports an illustration of Bournemouth with the inscription "Bournemouth—Britain's All-Season Resort." They have been supplied by the Corporation to transmitting members of the Club.

CLUBS

Aberdeen.—The temporary secretary of the recently formed Aberdeen Amateur Radio Society is A. G. Anderson, 87, Braemar Place, Aberdeen, from whom details can be obtained.

Birkenhead.—Details of the re-formed Wirral Amateur Transmitting and Short-Wave Club, which meets monthly at the Y.M.C.A., Whetstone Lane, Birkenhead, are obtainable from the Sec., B. O'Brien, G2AMV, 26, Coombe Road, Irby, Heswall, Cheshire.

Blackpool.—Meetings of the Blackpool and Fylde Amateur Radio Society are now held on the first and third Tuesday of each month at the Bellevue Hotel, Whitegate Drive, Blackpool, at 7.30. Hon. Sec., H. D. Ashworth, G4PY, 4, Albion Avenue, Blackpool.

Ilford.—Meetings of the Ilford and District Radio Society are now held weekly on Thursdays at 8.0 at St. Albans Hall, Albert Road, Ilford Lane. The November meetings are:—14th, "Measurements in the Radio Field," by J. De Gruchy, of Everett, Edgumbe and Co.; 21st, "Television Receiver Construction," by E. G. Coe; 28th, "New Developments in Speakers and Records," by H. A. Hartley.

Jersey.—Details of the recently formed Jersey Radio Society, which has a membership of over 40, are obtainable from the secretary, E. Banks, GC2CNC, "Fort Rock," Tabor Lane, Route des Genets, St. Brelades, Jersey, C.I.

Leicester.—A demonstration of the Wilkins and Wright "Coil" pick-up is to be given at the meeting of the Leicester Radio Society on October 29th at Charles Street United Baptist Church at 7.30. Sec.: O. D. Knight, 16, Berners Street, Leicester.

Manchester.—Readers in the Manchester, Prestwich, Whitefield and Bury areas are invited to the meetings of the Whitefield and District Radio Society on Mondays at 7.30 at the Stand Grammer School for Girls, Higher Lane, Whitefield. Hon. Sec., E. Fearn, 4, Partington Street, Newton Heath, Manchester, 10.

Reading.—Meetings of the Reading and District Amateur Radio Society will in future be held on the second Wednesday and last Saturday of the month at 6.30 at Palmer Hall, West Street, Reading. The new secretary is L. A. Hensford, B.E.M., G2BHS, 30, Boston Avenue, Reading, Berks.

Stoke-on-Trent.—Meetings of the Stoke-on-Trent and District Amateur Radio Society, re-formed in May, are held on Thursdays at 7.0 at the Tabernacle Church, High Street, Hanley. Sec.: D. Poole, 13, Oldfield Avenue, Norton-le-Moors, Stoke-on-Trent, Staffs.

Surrey.—Members of the Surrey Radio Contact Club were recently afforded an opportunity of seeing at the Mullard valve works, Mitcham, the latest methods of producing small transmitting valves suitable for amateur use. Of particular interest was the testing section, where life tests were being conducted on the valves at frequencies of 100 Mc/s or more.

West Middlesex.—Meetings of the West Middlesex Amateur Radio Club, of which Sir Ernest Fisk is president, are held on the second and fourth Wednesdays in each month at 7.0 at the Southall Labour Hall Rooms. Hon. Sec., Norman Priest, 7, Grange Road, Hayes, Middlesex.

Yeovil.—Amateurs in the Yeovil district interested in the formation of a club are invited by W. Kirkland, of 31c, Middle Street, Yeovil, to communicate with him.

VORTEXION

"SUPER FIFTY WATT"

AMPLIFIER



30 cps. to 25,000 cps. within $\frac{1}{2}$ db. under 2% distortion at 40 watts and 1% at 15 watts, including noise and distortion of pre-amplifier and microphone transformer. Electronic mixing for microphone and gramophone of either high or low impedance, with top and bass controls. Output for 15-240 ohms, with generous voice coil feedback to minimise speaker distortion. New style easy access steel case gives recessed controls, making transport safe and easy. Exceedingly well ventilated for long life. Amplifier complete in steel case, as illustrated, with built-in 15 ohms mu-metal shielded microphone transformer, tropical finish. Price 29½ gns.

C.P. 20A 15 Watt AMPLIFIER for 12-volt battery and a.c. mains operation. This improved version has switch change-over from A.C. to D.C. and "stand-by" positions, and only consumes 5½ amperes from 12-volt battery. Fitted mu-metal shielded microphone transformer for 15-ohm microphone, and provision for crystal and moving iron pick-up with tone control for bass and top and outputs for 7.5 and 15 ohms. Complete in steel case, with valves. £22.10.0.

A.C. 20 AMPLIFIER.—This well-known model has been retained and has a response 30—15,000 cps., mixing arranged for crystal pick-up and microphones, large output transformer for 4—7.5 and 15 ohms to deliver 15 watt at less than 5 per cent. total harmonic distortion to the speakers Price £15 15 0
Case for above model, Price £3 0 0.

RECORD REPRODUCER.—This is a development of the A.C. 20 amplifier with special attention to low noise level, good response (30—18,000 cps.) and low harmonic distortion (1 per cent. at 10 watts). Suitable for any type of pick-up with switch for record compensation, double negative feedback circuit to minimise distortion generated by speaker. Has fitted plug to supply 6.3 v. 3 amp. I.T. and 300 v. 30 M.A. H.T. to a mixer or feeder unit..... Price £18 0 0
Case for above model, Price £3 0 0.

We very much regret that owing to increased costs we are reluctantly compelled to advance the above prices by 10%.

Dealers and Export Agents should write for special terms to:—

VORTEXION LTD.
257-261, THE BROADWAY,
WIMBLEDON, LONDON, S.W.19

Telephones: Liberty 2814 and 6242/3.
Telegrams: "VORTEXION, WIMBLE., LONDON."

LETTERS TO THE EDITOR

Is "Security" Dead? ♦ Wartime Inventions

Aftermath of "Security"

SINCE the end of the war your contributors and correspondents have at intervals pointed out with some force the discrepancy between the rates of release of the results of war research to the British and American technical Press. Their criticisms appeared to be allayed by the announcement of the Radiolocation Convention of the I.E.E., at which it was tacitly assumed that all results of value would be made public.

How rash that assumption was became immediately obvious to those who had been responsible for the radar research involved, especially to those few who, as I did, had to listen to every word of the Convention. Large parts of every subject were omitted; many topics were dealt with very sketchily. And the natural assumption after the Convention was that a security level was still being maintained on the mass of information which had been withheld.

Now it appears this assumption was incorrect. It will be remembered that at the Convention Dr. F. C. Williams gave an "Introduction to Circuit Techniques for Radiolocation." A delightful lecture—but as those in that particular line of business recognized, it only skimmed over the surface. The Miller or Blumlein Integrator, perhaps the most important single circuit development of the war, was dismissed in ten minutes, with no hint of the thousand and one ways in which it can be used—most surprising for Dr. Williams, who more than anyone might have been expected to dwell on it! Its use in the form of the Phantastron was not mentioned.

Until yesterday I, and I have no doubt thousands of others "in the know," had assumed that the Phantastron was still Secret with a capital S; and I should have no more dreamed of writing about it in this letter than I should have

of handing the Nazis a centimetre magnetron in 1941. But in *Proc. I.R.E.* of August, 1946, you will find a paper on "Radar," by Schneider, in which the Phantastron is fully described. A British development—an American periodical.

We do not begrudge our American friends the knowledge of our war developments, nor yet (obviously) of those of their own country. But surely we, the British company of radio technicians and scientists, especially those who served their country outside the barbed wire, instead

of inside it—surely we should know, too, what British enterprise, skill and cunning (radar pulse work *does* need a modicum of craftiness, as well as academic and practical skill!) have produced. Most vital is this, I think, in the circuit field, since it affects television to such a large extent. And many still have their time-base condensers connected between anode and cathode. Cannot we enlighten them? (I have often thought that a television receiver designed by T.R.E. would be a most beautiful creation!).

There is, finally, the question of why this information, and literally reams of parallel "gen," has not yet been published here. First of all, it may be that the papers composing the I.E.E. Convention are to be so expanded for publication that they will furnish just that outlet for which

U.S. TELEVISION GEAR

TWO of the latest additions to the television transmission equipment produced by the Radio Corporation of America are shown in the accompanying illustrations.

Among the many points of interest in the new R.C.A. Image

parabola houses either a transmitter or receiver, the controls for which are in a small separate case. Micro-meter adjustment of the parabola is provided in both the horizontal and vertical planes to ± 15 deg.

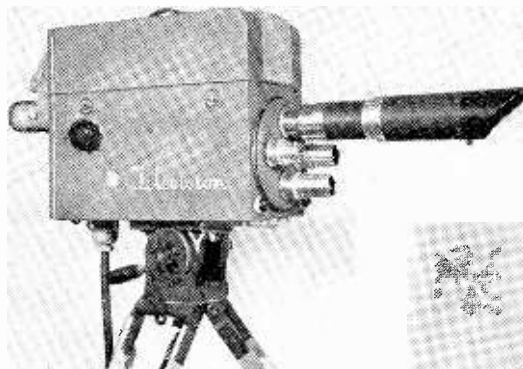

parabola houses either a transmitter or receiver, the controls for which are in a small separate case. Micro-meter adjustment of the parabola is provided in both the horizontal and vertical planes to ± 15 deg.

Orthicon camera is the revolving lens turret which permits of speedy changing from one lens to another by means of a control at the back of the camera. Just below the turret are the "ready" and "on the air" lights.

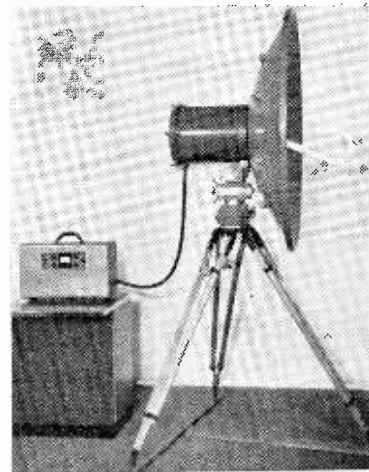

A telephoto lens has been fitted in one of the four openings in the lens turret of the R.C.A. camera. Below: In the O.B. transmitter the output from a hooked waveguide is fed into the parabola.

I have been pleading. If so, well and good. If not, it is fairly obvious that either the right method was not chosen in the first place for dissemination of information—that criticism was made in your columns as soon as the plan was proposed—or that a Security Level higher than Restricted is still being maintained on large quantities of technical information. If the former—surely the columns of the *Wireless World* are still open? If the latter—why Secret here and Open in the U.S.A.?

ROBERT A. GORDON.
London, N.W.2.

"Miller" or "Blumlein" Integrator?

IN questioning the right of A. D. Blumlein to the credit for the so-called "Miller" Integrator circuit, R. J. F. Howard, writing in your September issue, cites British Patent 575,250. The provisional application for this patent was dated February 17, 1942, whereas I have it on what I believe to be very good authority that A. D. Blumlein used a condenser from anode to grid to obtain a linear fall of voltage not later than November, 1940, and that from that date other workers developed a variety of linear time-base circuits on the same principle.

NEW "QUALITY" RECEIVER

THE new "Silver Dragon" receiver announced by the Morton Cheyney Co., Stafford, is designed to combine the functions of a high-fidelity receiver with those of a communication receiver. There are sixteen valves excluding the rectifiers and each set is individually constructed and calibrated. There are six degrees of selectivity with bandwidths of 5 to 24 kc/s, the latter given by a T.R.F. circuit consisting of the R.F. stage and an infinite impedance detector feeding the audio-frequency amplifier. The output stage consists of two triodes in push-pull giving 10 watts with less than 2 per cent distortion.

Automatic frequency control and volume expansion have been included, and there are independent bass and treble tone controls. In addition to medium and long waves the set covers 10.5 to 80 metres on three short-wave ranges.

Most circuit development work done during the war years was, of course, under cover of secrecy, which makes it even more difficult than usual to establish proof of original invention. So that the matter should not be left in a rather ambiguous position, it would be helpful if anyone having further evidence would come forward with it.

M. G. SCROGGIE.
Bromley, Kent.

Surplus Components

THE fears expressed in your Editorial in the June issue that the release of surplus components jeopardises the livelihood of the industry is surely unfounded. If an impecunious experimenter like myself can collect together a few parts at low cost as the nucleus of, say, a signal generator, he will not mind paying "new" prices for the components required to complete the job. The sale of a new signal generator will not be lost, for he could not afford the professionally turned-out product anyway; but if he is stimulated by the possession of a few basic components to exercise his ingenuity and keep alive his interest in experimental radio within his modest means, who can possibly be the loser?

HENRY MORGAN.
London, S.E.

The console is available in two alternative cabinets and costs, complete with 12in loudspeaker, £78 plus £16 15s 4d tax. The chassis may be obtained separately for £52 plus £11 3s 7d. tax.

BOOKS RECEIVED

"Radio Valve Vade Mecum—1946," by P. H. Brans. The latest edition of this comprehensive valve data book contains, in addition to the British, American, Russian and Continental receiving valves listed in earlier editions, the civil equivalents of American as well as British service types and also a list of valves used in the German and Italian armies during the war, together with their characteristics or civil equivalents.

Purchasers of the 1946 edition are entitled to a free copy of the quarterly supplements which it is proposed to issue. The agents in this country are Ritchie, Vincent and Telford, Ltd., 136a, Kenton Road, Harrow, Middlesex, and the price is 12s 6d, postage paid.

LONDON CENTRAL RADIO STORES

EX-ARMY No. 58 Mk. 1 Self-contained 8-v. Short-wave TRANS-RECEIVER

Frequency Range 6-9 mc/s with B-4 Aerials.
Panel Test Meter, 8 Valves, Wire, etc. **£7.0.0**

OR

Complete with 8 spare valves, spare Vibrator and fuses, 2 non-spill accumulators, 9 noise limiting Mikes, 2 gr. Headphones, cables and Vibrator **£15.0.0**
H.T. power supply

Ex.-R.A.F. Typ R1155

COMMUNICATION RECEIVERS

Comparatively new. These receivers are made to the stringent specification of the Air Ministry and are fitted with a large-scale dial calibrated from 7.5 mc/s to 1,500 kc/s. Complete with 10 valves, including magic eye. Fitted in a strong metal cabinet. They require only a **£17.10.0** power pack to be ready for immediate operation. Aerial tested. These have been thoroughly overhauled and are in good clean condition.

SIGNALLING TORCHES

Ex - Admiralty, 3-cell (type 112). Coloured lenses red, green and amber; easily unscrewed for use as ordinary torch. powerful beam. Strong metal case. Highly plated 2in. reflector, 1in. lens with 3.5 v. bulb and spare bulb. Less batteries **12/6**

EX-GOVT. TELEPHONE HANDSETS, self encasing, need no battery for excitation. With wall bracket. Per pair handsets **35/-**

PORTABLE UNIVERSAL AMPLIFIERS, 200-250 volt input, 5 valves, 12-tube output, 6-8 watts, in Rexine covered carrying case. Complete with mike and floor stand, loudspeaker, etc., size when closed 13in x 15in. x 10 1/2in. Bargain **£19.10.0**

D.C. MICROAMMETER, central zero **£3.0.0**
0-100. 1in. Dial panel mounting

MOVING COIL MICROPHONE INSERTS **5/-** each
D.C., res. 30 Ohms

SINGLE ALUMINIUM TUNING CONDENSERS, Cap. 0.0045. 1in. spindle **4/6**

12 VOLT VIBRATORS, 4 pin UX base **9/6**
New

A.C./D.C. UNIVERSAL TEST METER, By E.P.L. Ranges 0-10, 50, 100, 500, and 1,000 volts 0-500 u.s.c. Resistance test 0-100,000 Ohms. **£8.17.6**
1,000 Ohms. per volt.

EX - G.P.O. RELAYS, multi-contact **5/-** each
resistance of bobbin 750, 5,000 or 7,000 Ohms

P.M. LOUDSPEAKERS. New 8in. with output transformer **27/6**

EX-GOVT. WIRELESS REMOTE CONTROL UNIT comprising: Morse key, magnet for ringing bell, warning light, relay, etc., in steel case with carrying strap size, 12in. x 6 1/2in. x 6in. Few **19/6** only

TO CALLERS. We have a varied stock of Ex-Govt. Radio, Electrical and Radar Equipment. A call will pay you.

N.B. We do not issue lists and cannot deal with correspondence on the goods we offer.

Closed Thurs. 1 p.m. Open all day Sat.
23, Lisle Street
LONDON GERard 2969 W.C.2.

RANDOM RADIATIONS

The Ignition Menace

IF you ask a number of live radio salesmen what has been the greatest brake on the popularity of television in the past, you will, I fancy, receive the same answer from most of them. They will tell you that what did more than anything else to put off the prospective buyer was the snowstorm on the screen and the volley of hateful noises from the loudspeaker that occurred whenever a motor vehicle went past. Most likely they will add that there is not going to be a boom in television sales until something is done about it. We are, I firmly believe, on the verge of the era of the very high frequencies. Years ago I predicted that, though long-wave and medium-wave stations would continue to be used for some time, the bulk of the broadcasting of both sound and vision would eventually be done on frequencies of 30 Mc/s and above. The general V.H.F. broadcasting of sound would bring many boons; but the same enemy that has done so much to hinder the progress of television stands in its way. On frequencies of 40 Mc/s and above almost the only kind of interference that is at all serious is that from motor car ignition systems. Ordinary atmospheric are virtually unknown—though I have known charged raindrops blown against the aerial by a gusty wind to cause similar effects on rare occasions. The one really baleful influence is the combination of battery, coil, distributor and sparking plug with which every driver of a motor vehicle has now a perfect right to broadcast interference where and when he pleases. And though it is so easily preventable we allow it to

By "DIALLIST"

go on! Some readers may not know that the ignition systems of all Service vehicles have been fitted with suppressors for some years. Vehicles used for war purposes must be efficient and suppression has had no evil effect on their performance. That it has succeeded in "silencing" them electrically I can testify from personal experience with 55-84-Mc/s radar. Why a Defence Regulation did not make suppression compulsory for civilian vehicles is a mystery. No one would have grumbled and it could have been kept in force once the war was over. It is certainly a matter of urgent importance that action should be taken without delay; every new car that goes on to the road with its ignition system unsuppressed increases the difficulty of setting matters right.

□ □ □

Pilot Lamps

AS readers have pointed out, the initial heavy flow of current through a cold filament for two or three milliseconds after switching on cannot possibly lead to burning-out, so long as the filament is of uniform thickness throughout. The resistance increases as the temperature rises and so cuts down the flow of current. Microscopic examination of a filament that has been in use for some time shows often that its diameter is far from being the same from end to end and there may be pronounced thin spots here and there. It is at one of these thin spots that the filament eventually gives way at the

moment of switching on. Some pilot lamps, particularly those with short, stout filaments, last far better than others. At the present time pilot lamps, like so many other things, are not easy to obtain in large quantities and manufacturers have to take what they can get. Actually most pilots, if run at their rated voltage, give more light than is needed and it is sound policy to cut down the voltage to the lowest figure that will provide adequate illumination.

□ □ □

Sunspot Hiss

DID you happen to hear Sir E. V. Appleton's talk on sunspot hiss which was broadcast a week or two ago? Most likely you didn't, for it was part of "Science Survey" and his subject was not previously announced. What he had to say was of great interest to S.W. and U.S.W. enthusiasts. For some time now a team of British physicists has been investigating sunspot hiss. Their work is not yet completed, but already they have reached conclusions of considerable importance. It has been found that during their passage across the face of the sun large spots may be the scenes at intervals of markedly violent outbursts of activity. Such outbursts, which are usually accompanied by the projection of "flares," last for half an hour or so and coincide with both short-wave radio fade-outs and the occurrence of sunspot hiss. Fade-outs and hiss have been found to begin at the exact moment when the start of an outburst of activity is observed visually through the telescope. Therefore, both must be due to radiation travelling at the speed of light. Such radiation affects the F reflecting layer like breathing on a mirror. A day or so after such an outburst displays of Aurora Borealis are commonly seen. Therefore, the Aurora is due, not to electromagnetic radiation, but to a bombardment of the ionosphere by atoms ejected from the surface of the sun and travelling much more slowly.

—and the Milky Way

It is found that the electromagnetic radiation responsible for fade-outs and hiss "peaks" at about 5 metres. As the type of anti-aircraft radar known as GL2 is designed for working on frequencies of this order and has a directional aerial array, the British team found an excellent instrument for their investigations ready to

Books issued in conjunction with "Wireless World"

	Net Price	By Post
FOUNDATIONS OF WIRELESS. Fourth Edition, by M. G. Scroggie ...	7/6	7/10
TELEVISION RECEIVING EQUIPMENT, by W. T. Cocking ...	10/6	10/10
RADIO LABORATORY HANDBOOK, by M. G. Scroggie. Third Edition ...	12/6	12/11
WIRELESS SERVICING MANUAL, by W. T. Cocking. Seventh Edition ...	10/6	10/10
HANDBOOK OF TECHNICAL INSTRUCTION FOR WIRELESS TELEGRAPHISTS, by H. M. Dowsett and L. E. Q. Walker. Seventh Edition ...	30/-	30/7
BASIC MATHEMATICS FOR RADIO STUDENTS, by F. M. Colebrook ...	10/6	10,11
RADIO DATA CHARTS. Third Edition, Revised by J. McG. Sowerby ...	7/6	7/10
LEARNING MORSE. 335th thousand ...	6d.	7½d.
RADIO WAVES AND THE IONOSPHERE, by T. W. Bennington	6/-	6/3

Obtainable from leading booksellers or by post from
 ILIFFE & SONS LTD., Dorset House, Stamford Street, London, S.E.1

hand. They are working, too, on Milky Way hiss, which was first observed in America about 15 years ago. A hiss, much less intense than that due to sunspots, is found to be audible when the aerial array is directed towards the Milky Way. Areas of maximum intensity have been discovered in Sagittarius and in one other portion of the Milky way. The cause of this kind of hiss is still a matter of controversy. One school of physicists holds that it is due to spots and outbursts of activity in the stars themselves. Others maintain equally stoutly that it originates in the inter-stellar activities of atoms and electrons. Sir Edward Appleton said that he had so far taken no active part in the argument; but he indicated that at the moment he was inclined to favour the latter theory.

More American Service Equivalents

SINCE the original list on page 305 of the Sept. issue went to press the following additional valve types have come to hand and we give them in the hope that they may be of use until complete lists are available.

Service Number	Civil Type	Service Number	Civil Type
VT2	WE-205B	VT149	3A8GT
VT4B	211	VT181	7Z4
VT5	WE-215A	VT195	1005
VT17	860	VT196	6W5G
VT19	861	VT204	HK24G
VT22	204A	VT208	7B8
VT34	207	VT217	811
VT38	38	VT218	100TH
VT39	869	VT220	250TH
VT41	851	VT227	7184
VT43	845	VT230	350A
VT51	841	VT232	E-1148
VT54	34	VT239	11E3
VT80	850	VT240	710A
VT67	30	VT246	918
VT72	842	VT248	1808P1
VT106	803	VT249	1006
VT108	450TH	VT251	441
VT128	1630(A-5588)	VT252	923
		VT254	304TH
VT129	304TL	VT256	ZP486
VT130	250TL	VT257	K-7
VT141	531	VT266	1616*
VT142	WE-39DY1	VT267	578
		VT277	417
VT143	805	VT279	GY-2
VT144	813	VT282	ZG489

* Not 866 Jr. as in previous list.

"Linear Saw-Tooth Oscillator"

TWO errors appeared in the component values for Fig. 5 of the article published in the June issue under the above heading. The third paragraph in the centre column of p. 178 should read:—"The arrangement of Fig. 5 is satisfactory at 10 kc/s with $C=C_1=100\text{ pF}$; $C_2=0.1\text{ }\mu\text{F}$; $R=4\text{ M}\Omega$, $R_1=R_2=R_3=10\text{ k}\Omega$;...."

PREMIER RADIO Co.

MORRIS & CO. (RADIO) LTD.

CALLERS to 169 FLEET STREET, E.C.4. Phone: Central 2833
ALL POST ORDERS to 167 LOWER CLAPTON RD., E.5. Phone: Amherst 4723

ALL GOODS IN NEW CONDITION AND GUARANTEED.
TERMS OF BUSINESS, CASH WITH ORDER, OR C.O.D. OVER £1

RADIOGRAM CABINETS. Dignified appearance and good workmanship. Size 34 1/2 in. high, 19 in. deep, 36 in. wide. Send for illustration. Cabinet only, £28. With Electric Motor and Pick-up, £32/16/-. With Record Changer, £42/16/-.

BUTARY TRANSFORMERS. Size only 7 in. by 4 1/2 in. diameter. With 6 v. input; output 200 v. 50 m/a. With 12 v. input; output 400 v. 80 m/a. Price 20/-.

ROTARY TRANSFORMERS. With 12 v. input; output 600 v. 250 m/a. With 6 v. input; output 280 v. 250 m/a. Price £3.

PLAYING DESKS.—Consist of an Electrical Gramophone Motor with 12 in. table, and speed regulator, a quality magnetic Pick-up mounted on a strong metal frame. Price complete, £6/15/-; without Pick-up, £5/7/6. No auto stops available for either above. Delivery from stock.

MIDGET RADIO KITS.—Complete with drilled chassis, valves and loudspeaker, only cabinet required, medium and long wave T.R.F. Size 10 in. x 6 in. x 6 in., 4 valves, inc. rect., tone control, AC/DC operation, 200/250 v. Circuit and constructional details supplied. Price including tax, £8/17/6. Cabinet, if required, 25/- extra.

FIRST GRADE OIL FILLED PAPER CONDENSERS with miniature stand-off insulators and fixing clips, 2 mfd. 1.0 v.w., 2/6 or 20/- per dozen; 2 mfd. 600 v.w., 1/3 each or 10/- per dozen; 1 mfd. 600 v.w., 1/- each, 8/- per dozen. Super quality Oil Filled Tubulars. Insulation as good as Mica. 1 mfd. 500 v.w., 3 mfd. 350 v.w. Either type, 9d. each or 7/6 per dozen.

CANADIAN R103 CAR RADIOS at £23/10/-, and No. 58 WALKIE TALKIES at £15/15/- still available.

ALUMINIUM CHASSIS.—Substantially made of bright aluminium, with four sides, 10 in. x 8 in. x 2 1/2 in., 7/-; 12 in. x 9 in. x 2 1/2 in., 7/6; 16 in. x 8 in. x 2 1/2 in., 8/6; 20 in. x 8 in. x 2 1/2 in., 10/6; 22 in. x 10 in. x 2 1/2 in., 13/6.

SUPERSENSITIVE DOUBLE HEADPHONES. Balanced armature with reed driven aluminium diaphragm. 60 ohms, 8/6.

LOUDSPEAKERS.

Make	Dia.	(Capacity) Power handling	Type	Field	Trans.	V/Coll	Price
Rola	5"	2 watts	PM		Nil	2-3 ohm	27/6
Plessey	5"	2 watts	Energised	1,000	Penode	2-3 (or 15) ohm	30/-
Goodmans	8 1/2"	1 watt	PM		Nil	2-3 ohm	22/6
Rola	6 1/2"	3 watts	PM		Nil	2-3 ohm	35/-
Rola	6"	3 watts	Energised	1,140	Penode	2-3 ohm	24/-
Rola	8"	4 watts	PM		Nil	2-3 ohm	38/-
Gramplan	8"	6 watts	PM		Nil	15 ohm	45/-
E. & A.	10"	6 watts	PM		Penode	2-3 ohm	50/-
Celestion	10"	8 watts	Energised	2,100	Nil	4-5 ohm	£8/15/-
Goodmans	12"	15 watts	PM		Nil	15 ohm	£11/-
Vitavox	12"	20 watts	PM		Nil	15 ohm	£7/1/-
Vitavox	12"	12 watts	PM		Nil	15 ohm	

TUBULAR CONDENSERS. Super quality oil-filled, wire ends, 01 1,000 v.w., 02 750 v.w., 1 500 v.w., 5 350 v.w. All 9d. each, or 7/6 per doz.

SILVER MICA CONDENSERS. Any value available from 5 PF to 4,300 PF. 9d. each, or 7/6 per doz.

2-VALVE SHORT WAVE BATTERY KIT. A complete kit of parts for a 2-valve receiver, covering 15-600 metres, including valves, coils, drilled chassis, H.T. and L.T. dry batteries, to last approximately 6 to 12 months. A pair of Double Headphones and full instructions. Price £3/10/-. An Extra Coil can be supplied, covering 600-1900 metres at 4/-.

BATTERY CHARGE KITS. All incorporate metal rectifiers, input 200-250 v. AC. 40/100 cycles.

To charge 2 v. accumulator at 1 amp.	Price 15/-
" 6 v. " 1 amp.	17/6
" 12 v. " 1 amp.	22/6
" 6 or 12 v. " 4 amp.	

Complete with variable resistance and meter to charge 6 or 12 v. Accumulator at 6 amps ditto..... £3/15/-

H.T. ELIMINATOR AND TRICKLE CHARGE KIT. Consists of a complete kit of parts to construct an H.T. Eliminator with an output of 120 v. at 20 m/a and provision for trickle charging a 2 v. accumulator. Two metal rectifiers are employed. With circuit, price 30/-.

PREMIER MAINS TRANSFORMERS.

All primaries are tapped for 200-250-250 v. mains 40-100 cycles. All primaries are screened. All LTRs are centre tapped.

List No.	Output.	Price.
SP.170A.	175-0-175 v. 50 m/a. 6.3 v. 2-3 a. 5 v. 2-3 a.	25/-
SP.175B.	175-0-175 v. 50 m/a. 4 v. 1 a. 4 v.	25/-
SP.250A.	250-0-250 v. 60 m/a. 6.3 v. 2-3 a. 5 v. 2 a.	25/-
SP.250B.	250-0-250 v. 60 m/a. 4 v. 1-2 a. 4 v. 3-5 a.	25/-
SP.300A.	300-0-300 v. 60 m/a. 6.3 v. 2-3 a. 5 v. 2 a.	25/-
SP.300B.	300-0-300 v. 60 m/a. 4 v. 2-3 a. 4 v. 3-5 a. 4 v. 1-2 a.	25/-
SP.350A.	350-0-350 v. 100 m/a. 5 v. 2-3 a. 6.3 v. 2-3 a.	29/-
SP.350B.	350-0-350 v. 100 m/a. 4 v. 2-3 a. 4 v. 2-3 a. 4 v. 3-5 a.	29/-
SP.361.	350-0-350 v. 150 m/a. 4 v. 1-2 a. 4 v. 2-3 a. 4 v. 3-5 a.	36/-
SP.351A.	350-0-350 v. 150 m/a. 4 v. 2-3 a. 4 v. 3-5 a. 4 v. 1-2 a. 4 v. 1-2 a.	39/-
SP.352.	350-0-350 v. 150 m/a. 5 v. 2-3 a. 6.3 v. 2-3 a. 6.3 v. 2-3 a.	36/-
SP.425B.	425-0-425 v. 200 m/a. 4 v. 2-3 a. 4 v. 2-3 a. 4 v. 3-5 a.	47/-
SP.425A.	425-0-425 v. 200 m/a. 6.3 v. 2-3 a. 6.3 v. 3-5 a. 5 v. 2-3 a.	47/-
SP.501.	500-0-500 v. 150 m/a. 4 v. 2-3 a. 4 v. 2-3 a. 4 v. 3-5 a.	47/-
SP.501A.	500-0-500 v. 150 m/a. 5 v. 2-3 a. 6.3 v. 2-3 a. 6.3 v. 3-5 a.	50/-
SP.503.	500-0-500 v. 250 m/a. 5 v. 2-3 a. 6.3 v. 2-3 a. 6.3 v. 3-5 a.	65/-

ELECTROLYTIC CONDENSERS. Miniature metal can type. 8 mf. 600 v.w., 3/-; 16 mf. 500 v.w., 4/-; 8 x 8 mf. 500 v.w., 6/6; 50 mf. 12 v., 1/9.

VARIABLE CONDENSERS. Single Gang .0005 mfd. size 3 x 2 1/2 x 1 1/2 in. dia., 5/-, Small Type 3 gang .0005, 11 x 2 1/2 x 2 1/2 in., 8/6, Standard Type 3 gang .0005, 4 1/2 x 2 1/2 x 1 1/2 in., 10/-, Standard Type 4 gang .0005, 2 1/2 x 3 x 1 1/2 in. Ceramic insulation. Bar type, 10/-.

CIRCLE CUTTER. Used with ordinary hand brace will cut circles between 1/2 in. and 3 1/2 in. in diameter in aluminium or steel up to 16 gauge, 4/6.

I.F. TRANSFORMERS.—Iron core, litz wound, with or without flying lead, £60/450 kc/s, 7/6 each. Miniature type, 1 in. x 1 in. x 2 in., 9/9.

OUTPUT TRANSFORMERS. A super production. By means of ingenious series-parallel arrangement, all windings are used at all times. Match any tube, single or push-pull; up to any voice coil 2-30 ohms. 7 watts, 22/6; 15 watts, 30/-; 30 watts, 49/6; 60 watts, 59/6.

B.P.L. SIGNAL GENERATOR.—100 Kcs to 30 mc/s in six bands, 1 Per cent. calibration, 1 volt into 10 ohms. 30 per cent. modulation by 400 cycle osc., mains driven, £21.

ROTARY TRANSFORMERS, input 12 v., output 180 v., 30 m/a. 4 v. 2-3 a. with 19 volts input, output is 50 per cent. higher. May be used on D.C. mains as L.T. Charger. With small conversion could operate as D.C. Motor. Original cost over £5. Employ powerful ring magnet. Price 10/- each.

RECENT INVENTIONS

A Selection of the More Interesting Radio Developments

CATHODE-RAY INDICATORS

SIGNAL voltages to be compared are fed cyclically to two pairs of condensers, each pair being connected in series across the X and Y plates respectively of a cathode-ray tube.

As applied to a direction-finder, N-S and E-W aeriels are coupled in rapid succession through a rotary switch S_1 to a receiver R , which is also fed by a sense-determining aerial A. One end of the output coil OC is connected, through a rectifier Q and the rotating arm of a synchronous switch S_2 , first to one and then to the other of the two series condensers C_1 , C_2 across the Y-plates, and then similarly to the two condensers C_3 , C_4 across the X-plates of the C.R. indicator. The other end of the output coil is taken to the midpoints of each pair of condensers, suitable shunt or leak resistances being provided as shown. The relative direction of the distant transmitter is then shown as a

strength of the desired signals. As shown, one anode D of a double-diode rectifier feeds a load resistance R ; the other anode D_1 feeds two resistances R_1 and R_2 , of which R_1 is (like R) equal to 100,000 ohms, whilst R_2 is 10 megohms. The mid-point between R_1 and R_2 is earthed, so that the voltages developed across R and R_1 are of opposite polarity to ground.

During normal reception, the A.F. and D.C. voltages built up across R_1

quencies, consists of a pair of conductors shunted by a series of equally spaced resistances of graded value. By way of example, two conductors each 10 inches long are bridged by thirteen parallel resistances, which vary in value from 3,400 ohms at the input end to 60 ohms at the far end; this will dissipate 10 watts of energy at a frequency of 330 megacycles, without appreciable end-reflection, the surge impedance of the line being 215 ohms. The characteristics of the line can be varied within limits by immersing it in a cooling fluid having a selected dielectric constant.

Standard Telephones and Cables, Ltd. (assignees of C. B. Watts, jun.). Convention date (U.S.A.), August 17th, 1942. No. 573451.

NOISE ELIMINATORS

DISTURBING noises are eliminated by a circuit arrangement which does not appreciably affect the full

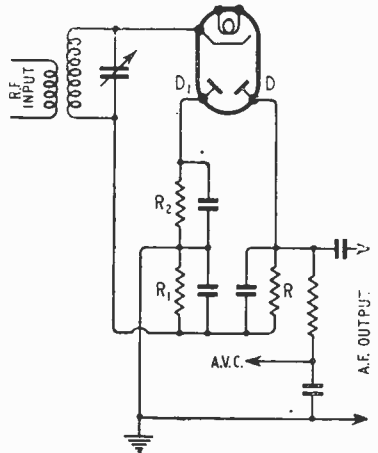

Noise suppression circuit.

ground are thus passed on to the A.F. amplifier in full strength, subject only to the 1 per cent loss due to the reversed polarity of the R_1 voltages.

On the other hand, an impulsive disturbance is short-circuited by the comparatively large condenser shunting R_2 so that it appears at full strength across R_1 , where it is nullified by the corresponding voltage developed across R .

The British Thomson-Houston Co., Ltd. Convention date (U.S.A.), October 31st, 1942. No. 575188.

RADIATOR FOR MICROWAVES

ACCORDING to the invention, an aerial showing maximum field-strength in the end-on direction consists of an unsheathed rod of polystyrene, or like insulating material, made of constant cross-section for part, preferably half, of its length, and then tapered down towards the free end, where it is rounded off. The aerial is energized by a wire, which is passed through the butt end of the dielectric and connected to the inner and outer conductors of a coaxial feeder.

A suitable rod for a wavelength of 9.8 cm is made circular in cross-section and 71 cm long. Its diameter is kept constant at 4.44 cm for half its length, and is then gradually tapered to 3.2 cm at the free or open end.

Western Electric Co., Inc. Convention date (U.S.A.) December 17th, 1942. No. 5755354.

The British abstracts published here are prepared with the permission of the Controller of H.M. Stationery Office, from specifications obtainable at the Patent Office, 25, Southampton Buildings, London. W.C.2, price 1/- each.

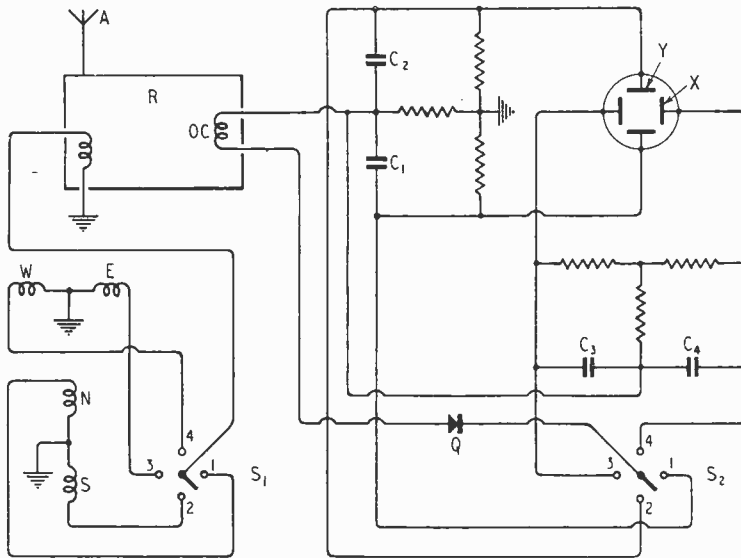

Direction-finding display circuit.

spot-point on the fluorescent screen; or the spot can be drawn out into a radial line.

Marconi's Wireless Telegraph Co., Ltd., and N. H. Clough. Application date, October 16th, 1940. No. 574710.

ARTIFICIAL LINES

A SMALL network, simulating a line many wavelengths long, and suitable for attenuating very high fre-

quencies, consists of a pair of conductors shunted by a series of equally spaced resistances of graded value. By way of example, two conductors each 10 inches long are bridged by thirteen parallel resistances, which vary in value from 3,400 ohms at the input end to 60 ohms at the far end; this will dissipate 10 watts of energy at a frequency of 330 megacycles, without appreciable end-reflection, the surge impedance of the line being 215 ohms. The characteristics of the line can be varied within limits by immersing it in a cooling fluid having a selected dielectric constant.

During normal reception, the A.F. and D.C. voltages built up across R_1

IN THE HEART OF LONDON

Musical Radio

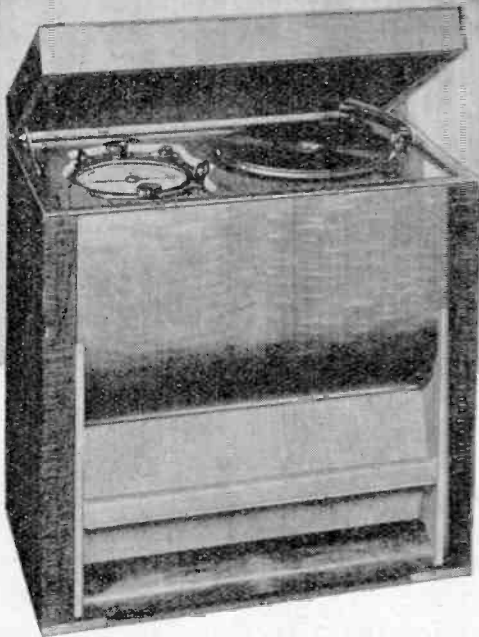

The **POLYPHONIC RADIOGRAM** WILL PLAY ITS WAY INTO THE HEARTS OF MUSIC LOVERS

A combined quality Instrument without cabinet "dialect," incorporating the phase inverter speaker, and seven valve three band tandem coupled variable selectivity super-het with paraphase **£67.10.0** triode output.

Plus Purchase Tax.

Sound Sales Ltd.

SALES DIVISION — 57, St. MARTIN'S LANE, W.C.2

WORKS: FARNHAM, SURREY

TEMPLE BAR: 4284

Agents: MAYFAIR: Messrs. Wallace Heaton, Ltd., 127, New Bond Street, W.1.

KENT: Messrs. Potter Bros., 49, High Street, Tenterden.
S. WALES: Messrs. Sound Ltd., 46, Charles Street, Cardiff.

SURREY: West End Radio, West Street, Farnham.

Weybridge Radio Electric, 15, Temple Market, Weybridge.

CHANNEL ISLANDS: Sound Services, 16, Charing Cross, St. Helier, Jersey.

CELESTION

LOUDSPEAKERS

Chassis Diameters range from
2½" to 18"

Power Handling Capacities range from
.25 Watt to 40 Watt.

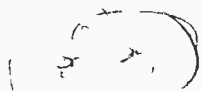

Celestion Limited
Kingston-upon-Thames
Telephone: KINGston 5656-7-8

OAK KWIZ

Did you know

that no other switch has double contacts and self-alignment?

Do you know

That other N.S.F. products include Paper Capacitors, Mica Capacitors, Wire-wound Resistors and Volume Controls?



OAK

SWITCHES

★ Only genuine when bearing these Patent Nos.:— 478391, 478392 NSF OAK.

BRITISH N.S.F. CO. LTD., Keighley, Yorkshire

London Office: 9 Stratford Place, W.1.

Phone: MAYfair 4234.

(Sole Licensees of OAK Manufacturing Co., Chicago)

5 mmf/ft

NEW LOW LEVELS in capacity and attenuation of CO-AX Cables mean new possibilities in electronic equipment design both for the war effort and for the post-war electronic age.

Write for characteristics

BASICALLY BETTER AIR-SPACED

CO-AX LOW LOSS CABLES

TRANSRADIO LTD. 16 THE HIGHWAY, BEACONSFIELD, 4-BUCKS.

Discriminating Electronic Engineers use— RADIO-AID EQUIPMENT

- ELECTRONIC VOLTMETERS
- OSCILLATOR CRYSTALS
- OSCILLOSCOPES
- CRYSTAL CALIBRATORS
- BAND-PASS CRYSTALS
- BEAT FREQUENCY OSCILLATORS

Write us for details:

RADIO-AID LTD., 29 Market St., Watford, Herts.
Phone: Watford 5988

ERG'S HAVE THE URGE TO GO ABROAD

SPEAKING EXPORTLY...



ERG Resistors have an exceptional electrical specification and performance, with mechanical strength.

High-grade Vitreous Enamels used on our Tropical Resistors give long life, and definitely assist in the trouble-free manufacture and performance of Radio Receivers, Television and Test Equipment.

ERG Resistors are processed up to the highest Service Standards at a competitive Price.

ERG INDUSTRIAL CORPORATION LTD.
SALES OFFICE: 10 PORTMAN SQUARE, LONDON, W.1 TELE: WELBECK 8114/5



Rate 6/- for 2 lines or less and 3/- for every additional line or part thereof, average lines 5-6 words. Box Numbers 2 words, plus 1/- Press Day: December 1946 issue, first post Thursday, November 7th. No responsibility accepted for errors.

WARNING

Readers are warned that Government surplus components which may be offered for sale through our columns carry no manufacturer's guarantee. Many of these components will have been designed for special purposes making them unsuitable for civilian use, or may have deteriorated as a result of the conditions under which they have been stored. We cannot undertake to deal with any complaints regarding any such components purchased.

NEW RECEIVERS AND AMPLIFIERS WELDONA does it again.

THIS time we proudly present another masterpiece from the pen of our famous designer—the "Dorset" ac/dc 5-valve 3-wave superhet manuscript, 6 sheets crystal clear drawings, explicit constructional details, parts list, etc.; same price as ac model (still available), 5/- post free; theoretical sheet and price list, either circuit, 2/6. Also ac/dc amplifier, 6-8-watts, manuscript 5/-.

WRITE Weldona Radio Accessories, Ltd., Swange. [6232

COMMUNICATION receivers.—As soon as civilian supplies recommence we shall be at your service.—A.C.S. Radio, 44, Widmore Rd., Bromley, Kent. [4528

COMMUNICATION receivers.—"Dale" will have them as soon as trading conditions allow.—Remember—Dale Electronics, Ltd., 105, Bolsover St., W.L. Mus. 1023.

FERGUSON model 99 universal ac/dc 5-valve superhet, 100-250volts, walnut cabinet, new; 12gns, plus purchase tax £2/14/3.—West Central Radio Supplies, 259, Grays Inn Rd., London, W.C.1. Tel. Ter. 6777.

AMPLIFIERS.—Complete equipment for P.A. industrial, dance and stage installations and portable apparatus 15 to 150w; early deliveries; illustrations and spec. on request.—Broadcast & Acoustic Equipment Co., Ltd., Broadcast House, Tombland, Norwich 26970.

1946 Airmaster 5v chassis with 6in ME speaker, all ready to switch on; 13/30, 30/60, 200/550, 800/2,000 meters, first-class job; £16/10, carr. paid pass. train.—Cash with order to R. J. Newey, 158, Vicarage Rd., Oldbury, Birmingham. [6152

14 watt amplifiers for mike or gramo operation, low intermodulation distortion. 25gns; transformers (bakelite impregnation, special alloy), from £1/2/6; castings, turning, duraluminium cases and decks to customers' specification.—R.R. Development Laboratories (consulting engineers), Barnard Rd., Bradford. [5801

KITS, kits, kits, 2 waveband, all mains 4 valve, tube line-up, 6K7, 6J7, 6Z6, 25L6, polished aluminium chassis, really first grade components, station named dial, delivered complete to last nut, full wiring instructions; price £7/8, o.w.o. or c.o.d.—Isherwoods, 81, Plungington Rd., Preston, Lancs. Tel. 3348 Preston. Radio repairs etc. 1936.

MIDGET 4v TRF M and L wave kits, complete with valves, speaker, ac/dc, £6 each; 6 kits for £30; car radio and Midget ac/dc superhet kits in production; details on request; line cord, 3 amp, 3-way, 180Ω, 1/4 yd; resistors, 1/2 watt, 3/- doz. £1 for 100; 1 watt, 5/- doz, £1/10 for 100.—Cook, Old Barn Rd., Christchurch, Hants. [6156

AMPLIFIERS.—New De Witt 1946 amplifiers, 20 and 30watt, models, with the new HiFidelity tone control circuit; prices from £7/19/6 to 10gns complete ready for use; six different models to choose from; superb performance; amazing value; send s.a.e. for illustrated catalogue and price list; trade terms available.—Obtainable from British Radio Co., 410, Dudley Rd., Edgbaston, Birmingham. Willingly demonstrated to callers. Hundreds of satisfied users have sent highest testimonials. [5957

BRIERLEY "Ribbon" and "Armature" pick-ups. Please write your name and address in block letters and include 3d. for booklet containing illustrations, responsive curves, technical details, delivery and prices. These booklets explain aspects of pick-up design, developments including the "floating element" design, leading to the use of 1/4 and 1/8 oz downward pressures; the importance of accurate and constant point pressure and its practical achievement; correct point shape; the relation of pick-up weight, point pressure and vertical motion, etc. etc.—J. H. Briery Ltd., 46, Tithern St., Liverpool, 2. [5701

PARTRIDGE Precision Built TRANSFORMERS

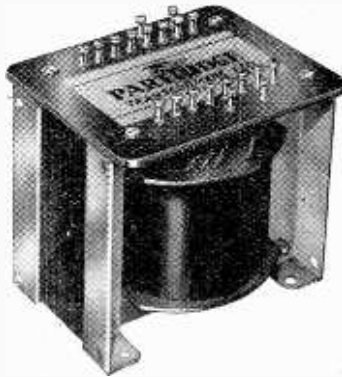

Incorporating the following features:—

- Silver plated turret terminals giving a low potential drop and carrying up to 15 amps. Adequate room on each for easy soldering of several external circuit wires.
- Permanent indelible marking of terminals by means of a transfer.
- Laminated plastic panel of the highest electrical grade.
- Firm clamping of the laminations by means of scientifically designed precision steel pressings with a large margin of strength.
- All metal fittings protected by cadmium or nickel plating.
- Bobbin with flanges of optimum shape for the protection of windings and location of the outleads.

It should be noted that accurate fixing centres and overall dimensions are ensured by close manufacturing tolerances.

Telephone:  Abbey 2244

PARTRIDGE TRANSFORMERS LTD

76-8, PETTY FRANCE, LONDON, S.W.1

COSSOR console television rec., £80; also Ekko television unit, £60; both new; delivered free.—Box 2441. [5967

RECEIVERS, AMPLIFIERS—SECOND-HAND

H I.R.O. with ac pack, 5 coils, 900kc/s 30mc/s; offers over £40.—Box 2529. [5967

H R.C.A. AR77E communications receiver, 10-watts as new; offers.—Box 3389. [6196

N ATIONAL N.C.80A, 10 valves.—Tiv-tara Hill Top Rd. Herne Bay, Kent.

R C.A. AR77 communications receiver, £50; perf. condition, after 6 p.m.—Pinner 7733.

L ELAND B.F.O. Model 27 Mk II, new; £65.—Gurney, Belmont, Wateringbury, Kent.

R C.A. general purpose receiver, HR88, 17v, 6-band; details.—31, Dunstable Rd., Caddington, Beds. [6199

A R.88D receiver and speaker, in first class condition, some spare valves; best offer over £50.—Box 2442. [5962

H I.R.O. Junior receiver, new condition, ac power pack, range .05/30mega, panel units.—Offers to Box 3399. [6216

T WO Vortexion 50watt amplifiers, each in leatherette covered cabinets, complete with gram, motor and pick-up.

O NE Vortexion 15watt amplifier, in metal case; one Collaro mixed record changer.

T WO moving coil microphones with stands; one 12in Goodman loud speaker; all the above in perfect condition and very little used; offers.—Box 2305. [5960

A C.S. RADIO, 44, Widmore Rd., Bromley, Kent, offer small selection com. sets, radio receivers and amplifiers; list free.

A R.88D, 535k/c-32m/c, 6 bands, xtal. b.f.o., noise-limiter, v. selectivity; £55.—20, Clifton Av., London, E.17. [6197

H ALLICRAFTERS Sky Traveller, per. cond., original carton.—Offers to Warwick, Uffdown, St. Mary's Rd., Bowdon, Cheshire.

S ALE, P. amp. 2x6L6, 230 ac, plus 2 10in spkrs., x-tal, mic, and stand; £17 or offers.—Gwen, 23, Comptonide, Keston, Kent.

N ATIONAL H.R.O. receiver, crystal gate, full set 9 coils, ac power pack, good condition; £55 or near offers.—Box 3034. [6164

M ARCONI receiver, 11-valve, 6-waveband, 58 k/c-31.5 m/c, passband, mod./c.w., b.f.o., etc., perfect.—Details from Box 3388.

M URPHY 15-valve A40 console, all-wave, perfect order; buyer collects; offers.—Hodgetts, 30, Edmund Rd., Hastings. [6142

A MERICAN 9v communication receiver, 2 R.F., 3 I.F., Xtal B.F.O., 230v A.C.; £35.—30, Norman Court, Manchester 12. [6026

A BSONI television and radio set, mod. M 705 in perfect condition, recently overhauled.—Write in first place to Box 2165.

COSSOR model 1210, 1939, all-wave radio and television receiver, recently overhauled, per. order; £80.—Ring Batterssea 5773.

M ODIFIED R1155-6V6 o.p., 10in Plessey spkr. and cab. 200-240v, power pack, ready for immediate use; £20.—187, Newton Drive, Blackpool, Lancs.

A MPLIFIER (25watt), pick-up and turntable, speakers, moving coil mike, and records, all ac; £40 complete.—266, Wellington St., Long Eaton, Notts. [5973

B RIERLEY high fidelity JB/5 amplifier, £7; pickups Rothermel S.8, £2; Garrard, £2; Hyper-Sen; offers.—26, Kings Drive, Leicester Forest East, Leicester. [6154

N ATIONAL H.R.O. Senior, 1.7 to 30 mc/s, crystal gate, with A.C. power pack and speaker; best offer over £45.—Western, 35, Portland St., Lincoln. [6031

W EBB'S 15w quality amplifier, T.R.F. feeder unit in steel case, G.E.C. 10in speaker, in oak cabinet, M/C mike; £45, or offers.—Bird, Ryeford Hall, Stonehouse, Glos.

H RO National Senior and 2 sets of 9 coils, 50kc/s-30mc/s; I.E.E. Journals, 1936-45; a few 6SG7, 646, EF50, M14 valves; will sell anything separately; what offers?—Box 3411.

A MPLIFIER, B.S.R. 20watt, mains and battery complete with vibrator 2 projection speakers and microphone, perfect, used once only.—Hughes, Brookfield, Bath, Caris.

F OR sale, R.C.A. AR88 comm. rec., 100w, 6 wavebands, 10 valves, 540 k/c-32mc, valves, little used; £75.—Parks, Waking House, Gt. Waking, Essex Tel. Gt. Wak. 242.

A LERT RADIO Co. for communication receivers, H.R.O. R.M.E. and Hallicrafters; inquiries invited for all other types.—7, Temple Fortune Mansions, N.W.11. Speedwell 452. [6195

W IRELESS World 12 watt quality amplifier, 4 valve radio unit, Magnavox 66 speaker, lot £28; solid oak diagram cabinet for above, £12.—King, Rob Roy, Jawwick Lane, Clacton. [6144

V OIGT speaker, cream corner horn with panel lighting, quality tuner and amplifier, field supply, television sound, elec. turntable, hyper-sensitive P.U., tone control unit, all in cabinet, approx. 60 12in (symplothes, etc.), 50 10in records; best offer over £150.—Box 3460. [6206

BAKERS 'Selhurst' RADIO

18" and 12" P.M. QUALITY SPEAKERS
8 and 15 WATT AMPLIFIERS

TICONAL
MAGNET

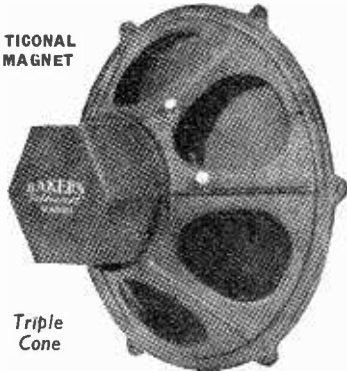

Triple
Cone

PIONEERS OF MOVING COIL SPEAKERS

Improved 1946 MODELS available.
CINEMA Model - - - £8 19 6
AUDITORIUM Model - - - £5 18 6
Send 2½d. stamp for Illustrated List to:
BAKERS 'SELHURST' RADIO
75-77 Sussex Road, South Croydon, Surrey
Telephone: OROydun 4226.



FOR THE RADIO SERVICE MAN, DEALER AND OWNER

The man who enrolls for an I.C.S. Radio Course learns radio thoroughly, completely, practically. When he earns his diploma, he will KNOW radio. We are not content merely to teach the principles of radio, we want to show our students how to apply that training in practical, every-day, radio service work. We train them to be successful!

Write to the I.C.S. Advisory Department stating your requirements. Our advice is free and places you under no obligation.

INTERNATIONAL CORRESPONDENCE COURSES

Dept. 38, International Buildings
Kingsway, London, W.C.2
Please explain fully about your Instruction the subject marked X.
Complete Radio Engineering
Radio Service Engineering
Elementary Radio Television
And the following Radio examinations:
British Institution of Radio Engineers
P.M.E. Certificate for Wireless Operator
City and Guilds Telecommunications
Wireless Operator & Wireless Mechanic, R.A.F.
Name.....Age.....
Address.....

PHILIPS superheterodyne, 6-valve, all-wave, also Plus-a-gram (electric), complete with record cabinet, walnut finish, extra loud-speaker offers.—Brewer, 17, Ravenswood Close, Havering Park, Romford. [6305]
HALLICRAFTER Skyrider Diversity Receiver, model DDI, complete Audio amplifier, power pack, de luxe 18in Jensen dynamic speaker and Diversity Action meters; offers over 300gns.—Fullagar, Storrington, Sussex. [5999]
R.1155 R.A.F. receivers as described in *Wireless World*, July, excellent condition, £15; can be supplied modified for civilian use, receivers already purchased expertly modified to your requirements, and amplifier/power packs supplied.—R.T.S. Ltd., 8, Gladstone Rd., Wimbledon, S.W.19. Tel. Lib. 3303. [5659]
EX.R.A.F. transmitter-receivers, model TR9, complete with 9 valves, new condition, ready for operation, or contains many useful items for your rig, relays, short-wave condensers, silver-plated inductances, thermo-coupled meter, milliammeter, etc.; £6 carriage paid; trade enquiries invited.—Stamford Radio Co., 199, Stamford St., Ashton-under-Lyne.

TEST EQUIPMENT

COSSOR gauging oscillator 343, Cossor D.B. scope 339a, both in excellent condition; offers.—Box 2693. [6151]
PYE all-wave signal generator, complete with batteries; 29.—Harris, 83, Commercial Rd., E. 1. Bis. 4593. [5982]
AVOMINOR dc, good condition, £2/10, HLDD/1320, AC/VP2, unused, 7/6 each.—6, Elmhurst Ave., Northampton. [5998]
AVOMETERS, model 7, new, £19/10; few for immediate delivery; sent c.o.d.—Massey, 58, Wakefield Ave., Hull. [5982]
AVOMETER No 7, in case, new and unused, £16; Ferranti 0-15 m/ammeter, flush, 30/-—1223, Christchurch Rd., B'mouth.
MICROAMMETERS, 0-250, 600ohm; 500-0 500 600ohm, 3in scale; 0-250, 500ohm, 2in.—Offers to Barnes, 64, Brightwell Avenue, Westcliff, Essex. [6147]
TAYLOR 110A capacity and resistance bridge, latest model, nearly new, perfect condition, £12/10 or best offer.—Mogridge, 5, Market Rd., N.7. [6157]
TAYLOR 65A A.C. mains all-wave oscillator, £12; oscilloscope (surplus), £15; or £25 the two; wanted, Voigt spir. unit, A.C. gram motor.—Particulars, 51, Fairway, Stamford.
VALVE testers and signal tracers of new design are described in our latest 10-page lists, which also contain particulars of oscillators, multimeters, bridges, etc.—MacLachlan & Co., Strathyre. [6005]
OSCILLOSCOPE.—Constructor offers drawings and full instructions to build your own oscilloscope; all details of circuit, components values and lay-out, 3/6.—20, Malzeard Rd., Luton. [5599]
THERMO-COUPLE R.F. ammeters, range 0-5amp, 15-1 dc moving coil meters, 50 milliamm scale, 0.5ma movement, 15/-; Relays 2-volt coil depo, 2/6; U.S.W. tuning condensers, 3-gang, 50mmfd per section, 7/6; add 1/- for post orders.—Stamford Radio Co., 199, Stamford St., Ashton-u-Lyme, Lancs. [6304]
WAVEMETERS, ex Govt. class D No. 1 Mark II, ranges 1,900-4,000 kc/s, 4,000-8,000 kc/s, check frequencies at intervals of 1 mc up to 25 mcs, oscillator crystal clock, battery operated, supplied with spare vibrators, spare valve and instruction book, brand new; £6/15, carriage paid; send for fully descriptive leaflet.—U.E.I. Corp'n., 32, St Gabriels Rd., London, N.W.2. [5910]
ALL-WAVE signal generator, non-drift coil turret (pat pending), 400 cps. anode modulation, cathode stabilised oscillator, scale calibrated 30 m/s/100kc/s, 10.3,000m, ruggedly constructed for use in vertical or horizontal position, self-contained handle, integral storage for mains and output leads; 10½gns; orders in rotation.—R.R. Development Laboratories, Ltd., 26, Hawes Rd., Bradford. [5929]
NEW instruments, shop suited only: Mullard B100 oscilloscope with 3in tube, listed 12gns., to clear £10; Mullard universal A.C. measuring bridge, listed 15gns., to clear £13/10; Pullin 0-1 MA meters, 2½in flush mounting, to clear, 50/-; 4 only, brand new 9in magnetic cathode ray tubes, £7/10; Plessey 8in P.M. speakers, 18/6; utility 4v. battery sets, £10/19; delivery per return.—H.P. Radio Services, Ltd., 55, County Rd., Liverpool, 4, Tel. Aintree 1445. [6252]

DYNAMOS, MOTORS, ETC.

ALL types of rotary converters, electric motors, battery chargers, petrol-electric generator sets, etc., in stock, new and second-hand.—WARD, 37, White Post Lane, Hackney Wick, E.9. Tel. Amherst 1393. [4677]
BATTERY chargers for home and export. 4 models 2-6-12v. 1. 2 or 4amp dc, any mains voltage; generous trade terms. Write for catalogue. Tel. Hoddesdon 2659.—The Banner Electric Co., Ltd., Hoddesdon Herts.



Designed by engineers for engineers, the Solon Electric Soldering Iron gives neater, cleaner, more efficient work in less time. The heating element is right inside the bit, giving constant heat at the point—where you want it. All internal connections housed at end of handle—away from heat and easy to get at. Complete with 6ft. of Henley 3-core flexible. Made for the following standard voltages:—200/220, 230/250.

Made in England

Model shown is a standard 125 watt roton pencil bit Solon.



Other sizes and types available.
W. T. HENLEY'S TELEGRAPH WORKS CO. LTD.
51/53, HATTON GARDEN, LONDON, E.C.1.

LASKY'S RADIO

OUR AIM—SATISFACTION, VALUE AND SERVICE

THIS MONTH'S SPECIALS

- 5in. Moving Coil Loud Speakers, less O/T 21/6
- 8in. Moving Coil Loud Speakers, less O/T 21/-
- 8in. and 6in. Moving Coil Loud Speakers, with trans. 27/6

RADIO VALVES. MANY SCARCE TYPES IN OUR HUGE STOCK. A FEW EXAMPLES

- CL38, EK2, ECH3, 12K7, 12J7, 25A6G, 25Z8GT, EB11, KT32, X31, X41, 1D8, 25Z5, 46Z5, 35Z24, 35Z25, Pen 383, EA50, EL50, DO30, DF51, 4TP6, 4TSP, 405BU, CL4, F62A, TP2820, URIC, etc.
- All new and boxed and at B.O.T. controlled prices. Send us your requirements

SERVICE KITS. POST FREE. TOP VALUE.

FOR THE SERVICE MAN

- No. 1. 48 Assorted Condensers, including 1.8 mfd., 1.16 mfd. and 1.8 + 8 mfd., 500 v.w.,
- 48 Assorted Resistances, 1, 1½, 1 and 2 watt, 24 yds. Systoflex. Assorted colours and sizes. 1 lb. reel Tinned Copper Wire... The parcel 52/6
- No. 2. 24 Assorted Condensers, including 1.32 mfd., 500 v.w., 1.32 mfd., 450 v.w., 2.16 mfd. 500 v.w., 6.8 mfd. 500 v.w., 2.4 mfd. 350 and 4.2mfd. 350, 2.8 + 8 mfd. 500 v.w., 24 assorted 1, 1.1 and 2 watt Resistances. Price less Iron. 29/6.—The parcel 72/-
- No. 3. 1 Pyrobit Electric Soldering Iron, 1 lb. red resin cored solder, 3 doz. yds. Assorted Systoflex, 1 lb. Reel Tinned Copper Wire, 1 doz. yds. Push Back Wire, 1 gross Nuts and Bolts, assorted sizes, 1 gross Rivets and soldering tags, 3 doz. Rubber Grommets, 1 gross Washers, ordinary and shakeproof, and 8 doz. Grub Screws. Price less Iron. 29/6.—The parcel 36/6

ALL GOODS SOLD BY US CARRY OUR UNCONDITIONAL GUARANTEE. SATISFACTION OR MONEY REFUNDED

Send Id. for our Current List and Bulletin. Large stocks of all Radio Components, Valves, etc. Everything for the radio amateur, serviceman and experimenter

TERMS: CASH WITH ORDER. PRO FORMA or C.O.D. NO C.O.D. under £1 (ORDERS OVER £5 POST FREE)

LASKY'S RADIO
370, Harrow Road, Paddington, W.9
(Opp. Paddington Hospital), Phonel, Omningham 197.

PINCOR motor generator, 12 volt dc input, 110 volt ac output, brand new; offers.—Box 2569. [6009]
ROTARY converter by E.D.C., 110v and 220v D.C., 230v A.C., 180w; unused; best offer over £25.—Erskine Labs., Scalby, Scarborough. [6022]

NEW LOUDSPEAKERS WANTED
THREE public address equipments, each consisting of Vortexion low watt amplifier C.P.20A, for 12volt car battery or ac mains, latest type Reslo hand microphone with switch, latest Vitavox 12in speaker in short metal direction baffle with nickel carrying handle and feet, complete set leads and quick connection plugs, designed for highest quality speech and music, p.a. on cars or in halls; £42 each.—Write Box 2216. [5944]

LOUDSPEAKERS, SECOND-HAND
VOIGT corn horn, polished.—Duffy, 93, R. land Gdns., Harringay, N.4. [6008]
MAGNAVOX 6s, 2RF straight set, lot £12-28, Newgate St., Bishop Auckland.

GRAMPIAN 10in M.C. speaker, hardly used, 55/- or nearest offer.—Tel. Edgware 3007.

HARMARLUND 120X, 1944, perfect order, complete.—22b, Kilburn Priory, N.W.6.

BAKER corner-horn m.c. loud speaker, ac, triple cone, walnut, as new.—220, Hall, 7, Westbourne Rd., Walton, Warrington.

R.K. speaker, £4; mains transformer, 425v, and 3 ll chokes, £1.—Braywood, Freya Av., Geding, Notts. [5974]

PUBLIC address unit, Trix, complete with microphone remote control, 3 foot and one stand microphones, 4 ball-type metal loudspeakers, one Monitor speaker.—Box 2637.

VITAVOX £12/10 loud speaker mounted on moulded oak pedestal baffle, area 25in x 30in x 1in thick, excellent quality; £10 or best offer; seen in Surrey.—Box 3393. [6204]

EXPERIMENTER offers Hartley-Turner speaker in slag wood lined solid oak box. Garrard universal electric turntable with crystal and E.M.I. pick-ups in oak veneered box, 10-watt push-pull chassis in oak box valves K766, 573, 523 PX4, diodes, screen grids, 12 transformers, gramophone records, etc.; send for complete list.—Box 3456. [6261]

GRAMOPHONE AND SOUND EQUIPMENT
RADIOGRAMS! Radiograms! Radiograms! Superb new 1946-7 all-wave.

MODELS—R.G.D. Auto, £179/14/4; Dynatron Ether Conqueror Auto, £195/11/3; Decca Decola Auto, triple speaker, £216/11/3.

POST orders and genuine enquiries welcomed; safe delivery guaranteed (rotational); a pleasure to send full details; large a.s.e. speeds reply.—SNELL, Arcade, Swansea. Established 1900. Tel. 3784. [6183]

SYNCHROPHONE, 500w 16mm, s.o.d projector, walnut cabinet; £50.—Box 3045.

NEW 5-valve Gramplan amplifier set, complete with H.M.V. record player, 2 speakers; £45 or nearest.—Box 3398. [6212]

BELL & HOWELL, 16mm sound projector, 500 watt separate amplifier, projector recently overhauled; price £200.—Box 2497.

AUTO-CHANGE radiogram R.G.D., 7-valve, a walnut cabinet, 36in x 24in x 23in, twin speakers, excellent cond.; price £85.—Box 2498.

LEXINGTON moving coil pick-up, sapphire stylus, as new. £5; E.M.G. pick-up for fibre needles £2/10; Meltrone pick-up with coils, £2.—Solomon, Town Hall, Worthing.

VOIGT pick-up and amplifier P-25's push-pull, £28; A.C. gramophone motor for Voigt speaker, four feet square baffle available.—Harvey, Chichester House, Chichester Terrace, Brighton. [5981]

COILS for "WW" tone control and filter circuits (Brierley & Hartley spec.) high fidelity, mic line and output transformers; a.s.e. full list.—R. Clark, 30, Langland Cres. Stanmore, Middx. Wnr 5321 [5985]

MOST sell: MSS 12in recorders, Woden 15w amplifier adapted, m.c. microphones, 'phones, radio unit, mixer panel, all as new; seen Weybridge; letters (s.a.e.)—BM/JCHA, London, W.C.1. Best offer secures. [6297]

HOLLEY'S RADIO.—Now demonstrating, sound sales, phase inverter and Coodman Infinite Baffle loudspeakers, Vortexion amplifiers, feeder units and latest moving coil pick-ups.—285, Camberwell Rd., S.E.5. Rod ney 4988. [5919]

HIGH grade amplifiers of special design for recording, modulation or transmitting, musical instruments, P.A., shortly available, push button operated automatic disc recording machines.—Recorimat Co., Ltd., 19, Exmouth Market, E.C.1. Terminus 7802-2.

EXPERT non-metallic needles.—We have over twenty-five years' experience in the selection, grading and special treating of Thorn needles; for use in pick-ups, type A thick type B thin, 3/- per 10, including purchase tax; sharpener, 7/4; guaranteed harmless to the record.

EXPERT GRAMOPHONE & RADIO, Ltd., Ingerthorpe, Great North Rd., London, N 2.

ELECTRADIX OFFERS

Something you want here?

TELEPHONES for House and Office.
CONSTRUCTORS PARTS FOR YOUR OWN SET UP!

- WALL TELEPHONE SETS.**
 Bracket Mike, vertical or horizontal..... 10/-
 Transformer and Condenser for same..... 5/-
 Magneto Bell fitted..... 5/-
 Switch hook and contacts..... 2/6
 Walnut Cabinet 8" x 6" x 3" fitted terminals and connections..... 5/6
 Two L.R. watch pattern earphones..... 10/-
 Hand Magneto Ringer..... 10/-
SET As above 30/- or 50/- per pair.

G.P.O. CANDLESTICK MICROPHONES.
 Latest armoured carbon inset in moulded bakelite case, on pedestal with Switch hook, 7/6, postage 1/-. Single receiver with loop, 5/-.

BUZZERS. Cambridge Townsend. The highest note and smallest buzzer made, platinum contacts, 10/-. Keep up your Morse speeds with one of our small practice outfits; Buzzer, Key and single Phone, 15/- the set. Buzzer only, 3/6. High note tunable buzzer, 7/6. Test buzzer, robust construction, double contact blades for distant signals or converting for vibrators, 7/6.

HEADPHONES. Single low resistance phone for circuit testing or house telephone, 60 ohms, bakelite case and cap, best British make, with headband and cord, 8/6.
 High resistance double headphones, as new, with headband and cord, type S.G.B. light weight, sensitive to crystal, 12/6 and 22/6, delivery from stock.



VIBRATORS and Transformer. Mallory 12 volt 60 ma. New, in metal can, 15/-. Special transformer, 37/6. Transformers for small welding jobs or soil heating, 230 volts 50 cy. to 12 volts 250/300 watts, totally enclosed, 37/6. Transformers double wound for Model work, 230/12v. 3 amps, 32/6, 20 volts 2 amps, 30/-.

RELAYS. G.P.O. 1,000 ohms 2-S.P.C.O. 5/-, 500-1,000 ohms, 2-make, 5/-. 30 ohms 2-make 2-break, 5/-. Telephone type 2-coil polarised S.P.C.O., 325 ohms, 5/-. Siemens high-speed keying relays, two 500 ohm coils, 7/6 each. Siemens slugged 200 ohms 1-break S.P.C.O., 5/-. We have a large stock of Relays for immediate delivery; send us your enquiries.

SWITCHES. Dewar key panel type 8-pole C.O. flush fitting, 5/-. Yaxley 3-pole 3-way, 3/6; 8-pole 1-way, 3/6. D.P.C.O. Toggle switch 250v. 1 amp, flush panel, 3/3. 8-way Lucas switch box, 3/6; 6-way, 3/-.

SMALL MOTORS for model work. 3-8 volts, work off battery or transformer, 17/6 each.

FANS. D.C. Table Fans, 110 volts, 12" blade and guard, 45/-. Oscillating type, 55/-. Few 220 volt D.C., 12", 55/- each. Fan Motors only, bulkhead type 110/220 volts, 35/- each.

AUTO-TRANSFORMERS. New. 230/110v, 85 watts, 25/-; 150 watts, 35/-; 300 watts, 60/-; 1KW, £7 10s. 3KW (second-hand), £9 10s.

A.C. PREPAYMENT METERS. C. & H., 200/250 volts 10 amps, as new, for 1/- coin, 75/-; G.P.O. Connection strips of solder tags, telephone type moulded mounting 60-way, 3/6 each.

MAGNETS. AC/DC mains magnets, 2-pole 220 volts, 7/6 each. The wonder midget Magnet, alni perm. steel disc, weight only 1/8 oz., 3/4 in. dia. 3/4 in. thick with 3/16 in. centre hole, 3/6 each. Large selection of horseshoe Magnets in stock. Send for leaflet "W".

PARCELS. 7 lbs. useful oddments for the junk box. All clean and dismantled from Government and other surplus apparatus. 7/6, post free.

BATTERY CHARGERS, DYNAMOS, ROTARY CONVERTERS, SWITCHBOARDS, TRANSFORMERS, LAB GEAR, ETC., ETC. SPACE DOES NOT PERMIT US TO LIST THE NUMEROUS LINES WE CAN OFFER. SEND US YOUR ENQUIRIES.

ELECTRADIX RADIOS
 214, QUEENSTOWN ROAD, LONDON, S.W.8

Telephone: MACaulay 2159

THE C.D.P. Recording Unit, comprising machine, amplifier, microphone and stand, complete in wooden cabinet, £52; cutlink heads, discs, steel and sapphire cutters, trailer needles.—Spondon Sound Serv., Spondon, Derby.
PROFESSIONAL recording equipment, MSS recording machine, 20 watt amplifier, complete, £100, new, from stock; blank discs, etc.; full range Sound Sales equipment available; Garrard transcription motors and playing decks.—Liverpool Sound Studios, 83a, Bold St., Liverpool. [5348]

VALRADIO moving coil pick-up, the most advanced pick up on the market to-day; yours for £9/0/6, including purchase tax, complete with built-in transformer and base compensating unit; responds practically flat from 25 cycles to 12 kc; come and hear it; demonstrations every Monday at 3 o'clock; send for descriptive leaflet.—Valradio, 57, Fortress Rd NW 5 Gulliver 5165. [5547]

DYNATRON supreme reproducer, new 1946-7 12-valve all-wave A.C. Ether Conqueror, autoradiogram, fitted with revolutionary pick-up, with sapphire point; variable sensitized output, 12in speaker, separate bass and treble tone controls; £195/11/3, including tax; those genuinely interested in purchasing an instrument of this calibre are invited to write for illustrated folder; production limited early application respectfully advised.—Snell, Arcade, Swansea, Est. 1900.

DECOLA full frequency range recording reproducer by Decca, frequency response 30-14,000 cycles per second; three 12in speakers, 4 pairs matched triodes, distortionless reproduction, mixed automatic changer, revolutionary pick-up, sapphire point, storage space for 350 records, £216/11/3, including tax; inbuilt radio available; those genuinely interested in purchasing an instrument of this calibre are invited to write for illustrated folder in colour; production limited, early application respectfully advised.—Snell, Arcade, Swansea, Est. 1900. [6027]

VALVES
 IR5, 1T4, 1S5, 1299A, £1 each, all unused.—Alan Bloom, 24, Fleye Ave, N.16.

VALVES new and used incl. U.S.A. metal and miniatures, some CRT's singly or bulk; state requirements.—Box 2688. [6141]

MARCONI Stabilivolt STV 280/80 STV radio, 260/40, offers EF8 6L6 10/-, 807, 9001, 9002, 9003 17/6, 832 25/-, all unused.—Box 2694. [6153]

IR5 1T4, 1S5 button valves, 12SA7, 6SA7, AC/8TH, 1299 valves, PenDD4020, AC/2PenDD valves, MKT4, Pen4VA valves, 5 or 7 pin; many other types in stock, 6L6, 6N7, 6N6, etc.; list prices; Avo model 7 test meters, £19/10; Avo model 40 test meters, £17/10; Avo Universal Minor test meter, £8/10; other test gear available, new and guaranteed; carriage paid, cash with order.—Radio Sales & Services, 29-31, Southampton Row, W.C.1. Hol. 4025. [5984]

JAMES S. KENDALL, A.M.I.R.E., can supply most types of receiving valves and spares at current prices; Erie kits of 48 assorted 1/2 watt in steel case, 24/-; transformers, 350-0-350, 80ma, 4+4v or 6.3+5v, 29/-; multi-ratio O.P., 5/6 and 6/6; oil filled condensers, 1,000v dc, 4uf, 10/6; 600v dc, 1u1, 1/6, 2uf 2/6, 10uf 10/6; orders over £1 post free.—James S. Kendall, A.M.I.R.E., 49, High St, Harborne, Birmingham, 17. **COMPONENTS - SECOND-HAND. SUPPLUS VALUE!** Matt has it!

SPEAKERS: 5in L/T, 15/6; 6in L/T, 17/6; 8in L/T, 22/6; all P.M.

ROTHERMEL crystal pick-ups, de luxe £2/16/3, including purchase tax.

VOLUME controls: Centralab, all values, 2/6 L/S; 3/6 W/S.

CONDENSERS: all 500v working, 8mfd, 2/10; 8+8, 0.01, 0.02, 0.1mfd, 6/- per doz.; 4+4 100mfd, 350 working, 2/6

INTERNATIONAL Octal valve holders, 3/- per doz, 30/- gross lots; 4-, 5- and 7-pin, 6/- doz.

LINE CORD, 2-way, 1/- per yard; 3-way, 2/- per yard; 0.3amp 60ohms per ft. 100 YD. coils 3mm flex, 12/6 a coil; 5amp 3-pin flush shuttered switch plugs, 8/6 each.

LARGEST stock of B.V.A. and U.S. valves in England. We supply anything in radio.

MATV RADIO SERVICE (1614 4881) 152, Richmond Rd., Kingston-on-Thames, Surrey. **SCOTLAND'S largest stockists.**—Anything S radio we have it.

EDDYSTONE—agents—Raymart SEND for parts and kits list. **BUCCLEUCH RADIO MANUFACTURERS,** Melville Terr., Edinburgh. Tel. Edinburgh 42803. Gams, Thrm, Edin. [5139]

ALUMINIUM chassis, panels, cabinets; 49 tuning, etc. for the amateur by precision engineers; components; s.a.e. lists.—G.L.G. Radio, Orchard Bishop, nr Crediton.

NEW LINES FROM VALLANCE'S

Build your own superhet receiver around the "Weymouth" coil pack, 3 wavebands, 19-50 metres, 200-650, 800-2,000. A gram position is provided, complete with 5-valve superhet circuit, 38/6, 465 k/cas. iron core high Q. I.F. transformers for the above, 15/- per pair.

Kit Sets.—Peter Pan "Black Rhapsody, 4-valve A.C./D.C. T.R.F. Receiver, long and medium wave. Complete with all valves, wire, screws, black modern plastic cabinet with white speaker bars, circuit, wiring diagram and full instructions for building, 9 gns., plus £2 Os. 7d. tax.

Soldering Irons.—Pyrobit (wireless), 200/20 v. or 230/50 v., 45 watt, 22/- (instrument) 45 watt, 22/-; Solon (industrial), 65 watt, 13/4, 200/20 v.; 125 watt, 25/8, 200/20 v. Eloc.—200, 230 v., 16/9; small 230 v., 11/8. Pyrobit spares: bits, 3/- to 5/-. Elements, instrument, 3/6; wires, 4/6.

Trimmer Tool Kits, very best quality, complete in leather case, 45/-.

P.A. Equipment.—We stock a comprehensive range of amplifiers from 5 to 60 watt, portable or otherwise, manufactured by Trix, Tannoy, Woden, Acoustical, B.S.R. Gramphon, Rothermel, A.O.F., Philips, Ambassador, Romac, Fann, and others, available with or without radio units; high fidelity speakers, Goodman, Wharfedale, Vitavox, etc., exponential horns, flare baffles, always in stock.

Junosero Construction Outfits
No. 1, 25/-, comprises all-purpose tool and materials.
No. 2, 42/-, comprises all-purpose tool, shears, die, scroll tool and supply of material.

Material—sheet, rod, angle corrugated, and circular, always available in 1/- packets. Ideal for making radio brackets, etc.

Pick-ups—Goldring magnetic, 30/7; B.T.H., 33/9. Pick-up heads for attachment to ordinary tone arm, 25/7.

Other Lines include test equipment, mains transformers, textbooks, raxiplug outfits, chargers up to 8 amp., and many more lines too numerous to mention.

Immediate attention to all orders and enquiries.

Goods sent C.O.D. or against C.W.O., whichever best suits you.

When sending C.W.O., please include sufficient for packing and postage.

VALLANCE'S
144, BRIGGATE, LEEDS, 1.

PRECISION INSTRUMENT WORK DEMANDS A SOLDERING IRON SUCH AS THE :— PYROBIT

Operates like a Pencil.

Ask for full descriptive leaflet.



For all voltages from 6—250 volts.

4 Models are manufactured by

THE

ACRU ELECTRIC TOOL MFG. Co. Ltd.,
123, HYDE ROAD, ARDWICK,
MANCHESTER, 12 Phone: ARDWICK 4284

CHARLES BRITAIN (RADIO), Ltd.

Lines of interest and special offers!
8MFD 500v wkg. B.I. blocks. 3/- each; metal-cased ditto, 3/- each; 25mfd 25v wkg. 1/9 ea; 50mfd 12v wkg. 1/9 ea; 75mfd 12v wkg. 1/6 ea; mains transformers, Woden 100ma 6v 27/6 ea; Porthminster 80ml 4v or 6v fully shrouded. 27/6 ea; mains droppers, 3-amp, 2 sliders and fixing feet, 4/9 ea; 2-amp ditto, 4/6 ea; warchange switches, 2-pole 2-way, 2/9 ea; 4-pole 2-way, 2/9 ea; 4-pole 3-way, 3/- ea; two-gang condensers with feet, less trimmers, 12/- ea; ditto without feet, 11/- ea; good stocks available. Amphenol valveholders, Int Oct, Mazda Oct, Brit 5-pin, 7/6 doz; coils, T.R.F. medium and long-wave with reaction, iron-cored, 465kcs, 12/6 per pair; metal-cased 0.1 tubulars, first-class quality. 350v wkg. 5/6 doz; 0.5 350v wkg. 6/- doz; 0.01 1,000v wkg. 4/6 doz (note: please order in dozens); bridge chassis, 9 1/2 x 4 1/2 in, drilled for 5 valves, etc., 2/6 ea; two-colour M. & L. dials, 1/3 ea.
LARGE stocks of speakers, pick-ups, amplifiers, etc., many bargains for callers; send for list "W"; trade supplied; terms, c.w.o. or c.o.d. £1.—Charles Britain (Radio), Ltd., Radio House, 2, Wilson St., London, E.C.2. Tel. BIA 2966. [6003

SPECIAL mail offers, new goods.

SWITCHES, toggles, S.P. 1/6, D.P. 2/6; v. controls, most values, L.S. 2/5, W.S. 3/-; condens., metal, 3mt 500v, 2/9; tubulars, 350-450v, 0.01-0.05 5/6, 0.1 6/- doz; mains trans., 350v 100 ma 4v or 6v, 22/6; speakers, P.M. 8in 21/-, 12in Hi Fi 90/-.

POST orders only; stamp for lists. R.I.S. Co. (Reg. Office), Dept. G. 116, Littleheath Rd., Bexleyheath. [6208

SOUTHERN RADIO'S wireless bargains.

LATEST radio publications:

"RADIO Valve Manual," equivalent and alternative American and British types with all data 3/6; "Radio Circuits," fully illustrated, receivers, power packs, etc., 2/-; "Amplifiers," fully descriptive circuits, 2/-; "Radio Coil and Transformer Manual," 2/-; "Short Wave Handbook," 2/-; "Manual of Direct Disc Recording," 2/-; "Test Gear Construction Manual," 1/6; "Radio Pocket Book," formulas, tables, colour code, etc., 1/-; "Ten Hows for Radio Constructors," 1/-; "Radio Reference Handbook," cloth bound, comprehensive and up-to-date, covering all branches of radio, 12/6; "American Service Manuals," Sparton-Emerson, Crosley-Belmont (Parts 1 and 2), Stewart-Warner-Fada, Emerson, 12/6 per volume; "Radio Resistor Chart," colour codes at a flick, 1/- each; "Buigun Radio Service Manual," 2/6; "Radio Constructors Manual," 3/-; postage extra.
VAXLEY type 2-way rotary switches, 5/-; tubular condensers, 0.1+0.1+0.1 (cans), 2/6; Resistances, brand new wire ended, 1/4, 1/2 and 1 watt, assorted values, 30/- per 100; 1/2 watt only, assorted values, 20/- per 100; 1/2 watt, 22/6 per 100

SOUTHERN RADIO SUPPLY Co., 46, Lisle St., London, W.C. Gerrard 6653. [5903

ALIGNED INSTRUMENTS SERVICES, 1, Colworth Rd., Leytonstone E.11.

TUNING Heart kits.—Each kit includes a coil pack and i.f. transformers which have been pre-aligned and gain tested, matched gang condenser, and the components specified in the recommended circuit which is supplied; i.f. transformers are iron cored and permeability tuned; for coil pack details see below; superhet types: Kit No. 5, 16-50, 200-550, 750-2,000 metres; Kit No. 6, 12-30, 30-75, 75-200 metres; Kit No. 7, 16-50, 200-550 metres; Kit No. 8, 200-550, 750-2,000 metres. T.r.f. types: Kit No. 9, 16-50, 200-550, 750-2,000 metres; Kit No. 10, 12-30, 30-75, 75-200 metres; Kit No. 11, 16-50, 200-550 metres; Kit No. 12, 200-550, 750-2,000 metres. Prices: Kits 5 and 6, 12/6; Kits 7 and 8, 6/6; Kits 9 and 10, 60/-; Kits 11 and 12 50/-; Matched valves supplied for Kits 5, 6, 7, 8, at 38/3 extra; Kits 9, 10, 11, 12, at 25/8 extra; circuit diagrams supplied separately, price 2/6.

I.P.R. KT44's, 3 prs. 807's, all new and un-used; what offers?—Box 2578. [6014

WE undertake to reply to all correspondence enclosing stamp.

SEND stamp for most complete list of tested radio bargains.—Carters, 67, Bell Lane, Marston Green, Birmingham. [6198

ALUMINIUM radio panels, 18in x 12in 4/-, 18in x 8in 2/6, 18in x 6in 2/-, 18 gauge; also 18in x 12in 5/6, 18in x 8in 3/6, 14g; 18in x 8in foil, 1/-; add 6d extra for postage.

FINEST quality speaker gauze, 12in square 2/6, 18in 4/-; 6d extra postage.

FENWICK'S RADIO STORES, Dept. P. Gt. Brickkiln St. and Snowhill, Wolverhampton, Ten. 24607. [5936

G.L. TRANSFORMERS & AMPLIFIERS

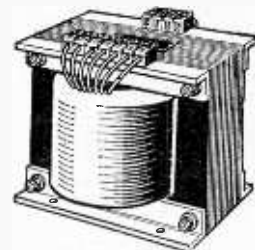

PRICES FROM 30/-

The latest addition to our range of power transformers illustrated above. Available in twenty varied ratings.

AMPLIFIERS

The new AC/18 Gramo. 10w. £11 7 0
With mike stage, AC/18 HG £16 4 0
Nine watt AC/DD with mike stage... £12 12 0
All with P.P. Output, ready for use.

Larger models see catalogue (6d.)
Also TRF Feeder Units to add-on.

General Lamination Products Ltd.

WINDER HOUSE,
BROADWAY, BEXLEYHEATH
Bexleyheath 3021

YOU can become a first-class RADIO ENGINEER

We are specialists in Home-Study Tuition in Radio, Television and Mathematics. Post coupon now for free booklet and learn how you can qualify for well-paid employment or profitable spare-time work.

T. & C. RADIO COLLEGE

North Road, Parkstone, Dorset

(Post in unsealed envelope, i.d. stamp)

Please send me free details of your Home-Study Mathematics and Radio courses.

NAME

ADDRESS

W.W.53.

G. W. SMITH & Co. (RADIO), Ltd., offers the following:—
 81L mica condensers, 2%, 500, 440, 100, 80, 50, 40, 25 P.F. 4d ea. 3/- per dozen; 0.1, 0.02 tub, 6d; 0.1, 1,000v, 1/-; 0.02, 1,500v, 1/-; 0.01 mica, 1/-; resistances, 7,000, 5,000, 100 ohms, 1 watt, 4d; 15/45pf ceramic double trimmers, 1/-; Westinghouse metal rectifiers, 5 m/a, 7/6; sleeving, 1 m/m, 2d yard; transformers, 500, 450, 400ct, 12, 6v C.T., 4v 2a, 4v 2.5a, input 200/250, 45/-; Tannoy service hand-type microphones with built-in switch, multi carbon, 7/6; chassis 10x6x3, 2/-; 2 mid 250v, 1/-; 1 mid 400v, 1/6.

PLUS postage.
G. W. SMITH & Co. (RADIO), Ltd., 2, Cecil Rd., Southgate, London, N.14. Tel. Enterprise 5463. [6268

HAM'S surplus for sale. 30w amplifier, Voho tester-analyser, components—Box 2526.

SELENIUM metal rectifiers, guaranteed charger kits, etc.; no surplus goods stocked.

LARGE selenium metal rectifier, 12v 3amp type, with 50-watt transformer and ballast bulb for 2v to 12v charger, weight 7lb, no rheostat or ammeter required, 47/6, post 1/-; ditto with 2amp rectifier, 39/6; ditto with 1.5amp, 37/6; ditto with 4amp rectifier and 75-watt transformer, 59/6, post 1/-; heavy duty transformer and rectifier for 12v 5amp, tapped at 6v, 24/6; trickle charger rectifier, 2v 1/2amp type with transformer, makes ideal trickle charger for 2v cell, guaranteed one year, 13/6, post 7d.; transformer, metal rectifier, ballast bulb for 1 to 20 cells at lamp, ideal for small radio store, one year guarantee, £2/5; ditto for 2amp charger, £7/5; rectifiers, selenium type, 12v 1.5amp, lume proof finish, 10/6, post 7d.; 12v 0.75amp, trickle type, 7/6, post 4d.; 12v 2amp, 15/-; 12v 3amp, 21/-, post 9d.; 12v 4amp, 27/6; 12v 5amp, 32/-.

ELIMINATOR rectifiers, latest type, 120v 20ma, 7/-, post 4d.; also eliminator kit, transformer, rectifier, two 8mids condensers, for 120v 20ma, 32/6; ditto with 2v trickle charge, 37/6, post 8d.

CHAMPION, 45, Uplands Way, London, N.71. Tel. Lab. 4457. [6136

UNIVERSAL ELECTRONIC PRODUCTS (G8UQ), 36, Marylebone High St., London, W.1. Tel. Wel. 4058.

WE can supply from stock those components which are essential to the requirements of the amateur transmitter and experimenter, including polystyrene sheet and tubes, paxolin, meters, Denco coils, I.F. transformers, etc.; we stock and thoroughly recommend Gardners transformers and chokes; send s.a.e. for list. Weymouth 3-waveband coil pack, £1/17/6.

OUR works, which are under the personal supervision of G8UQ, have recently been enlarged and we are now in a position to offer speedier deliveries on constructional work of all types; no job is too small and we trust, not too large; if you require anything from an extension spindle or a small chassis to a complete 500watt transmitter why not consult us first? [6244

A MATEUR'S surplus.—Few 807s, 10/6 each; also other types, and various meters, all perfect.—Box 3039. [6173

SUPREME RADIO, 746b, Romford Rd., Manor Park, London, E.12.—Goods for every-day service, deliveries from stock, no waiting.

0.1 TUBULAR condensers, 500v working, 5d ea. 4/- doz.; 0.01 ditto, 4/- doz.; 1/4watt and 1/2w resistances, useful sizes, assorted, well-known makes, 3/- doz.; wire wound resistances, 1 and 2watt, assorted, 3/- doz.; 0.25 tubular condensers, wire ends, 9/- doz.; 25-25, 18/- doz.; 50-12, 18/- doz.; 8mid 50v working, 30/- doz.; line cord, 60-70ft, 15/- doz. yards, 3-way; 0.0003 reaction condensers, 16/- doz.; 0.005 2-gang, wire wound, 16/- doz.; trimmer, fixing fig. 11/- 3-gang, 13/- doz.; 2 droppers, 2/6; 0.3 droppers, 4/-; v/cs, best makes, with switch, 4/3; less switch, 3/9; job line 2,000v wire wound v/cs, to clear 18/- doz.; Pye replacement droppers, 24/- doz.; fluorescent chokes, 200-250v, 24/-; 30w p.p.t. transformers, 22/-; m. and l. coils, midgeet circuit, 6/6; m.w., 6/-; s.m.l. 8/6; dials, 3/4x4in, all wave, 1/6; m.w. 1/6; all-wave glass, 9/4in x 4/4in, 3/-; ivorine 6x6 all-wave, 2/-; switches for same, 2/3; heavy chokes, 100mils, 10/-; 60mils, 6/-; mains transformers, from £1 each; job line I.F. transformer, 1/- ea.; 0.01 Mansbridge condensers, 2/6 doz.; 14mid condensers, 250v working ac, 350 dc, 6/- doz.; valves, job line, 5/5, 80 3D5, and many other odd makes, to clear 7/6 ea.; we stock all types of B.V.A. valves; send for list, enclose s.a.e. all enquiries; send 6d. extra for postage all goods; no c.o.d.

HOBART'S potential battery charger, 1hp, 72 accumulators and car batteries, cost £98, a.c. mains.—After 6.30, G. 115, Crookston Rd., Eltham Park, S.E.9. [6193

GALPINS

GOVT. SURPLUS ELECTRICAL STORES

408 High St., Lewisham, London, S.E.13

Telephone: Lee Green 0303. Near Lewisham Hospital
TERMS: CASH WITH ORDER, NO C.O.D.

"WESTON" Moving Coil Meters, edge type, 2 1/2in. scale, 0 to 3 amps, 30/-; 0 to 2 amps, 27/6, 0 to 60 volts, 27/6; 0 to 150 volts, 27/6, all have F.S.D. of 2 m/amps; 0 to 1 volt, 1 m/a, F.S.D., 35/-; another 3 1/2in. scale reading decibels 50 microamps, F.S.D., 70/-, another 301 model 0 to 3 m/a., 40/-; 0 to 50 m/a., 35/-; 0 to 200 m/a., 35/-.

LARGE TYPE RECTIFIERS, 12 volts, 4 amps., 45/-; 12 volts 6/8 amps., 55/-; 6 volts 1 amp., 12/6; 50 volts at 2 amps., 42/6. All fully guaranteed.

MAINS TRANSFORMERS, to suit the above 12 volt rectifiers, with tapped output of 6, 12 and 24 volts at 6 to 8 amps., 40/-. Carriage 2/-.

ELECTRIC LIGHT CHECK-METERS, guaranteed electrically, 200/250 volts 50 cy., 1 phase, input 5 amp. type, 12/6; 10 amp. type, 15/- each. Carriage 1/-.

ERNEST TURNER, moving coil m/amp. meters 2in. scale, 0 to 10 m/a., 0 to 20 m/a., 0 to 50 m/a., 27/6 each; all fully guaranteed. Standard Telephone 3in. scale m/coil meters, calibrated to read 0 to 25, 100 volts movement, 1 m/a., incorporating metal rectifier, 45/- each.

EX-G.P.O. MAGNETO GENERATORS, hand-driven, approx. output 75 volts 20m/amps. A.C., useful to the experimenter, small pattern, 7/6 each.

USEFUL PANELS made by Standard Telephone for the R.A.F., size approx. 19in. x 8in. x 5in. consisting of condensers calibrated to decibels, chokes, mod. xformers, resistances and many other useful components, condition new, 12/6 each, post 2/6.

VOLTAGE CHANGER TRANSFORMERS. Auto-wound, fully guaranteed, immediate delivery. 350 watts, 55/-; 500 watts, 70/-; 1,000 watts, £5 15s.; 2,000 watts, £8 15s. All tapped 0, 110, 200, 220 and 240 volts.

TRANSFORMERS BY WELL-KNOWN MAKERS, input 200/250 volts 50 cy. 1 phase output 1,500 volts at 3 Kilowatts twice, £12 10s. each. Voltage Regulation Transformer oil type 200/250 volts 50 cy. 1 phase, £15 each, new condition.

LARGE POWER UNITS BY WELL-KNOWN MAKERS, input 100 to 260 volts 1 ph., 50 cycles output 24 volts 11 amps and 130 volts 600 m/amps., smoothed all fitted in metal cabinet size, 57in. x 19 1/2in. x 12 1/2in., fitted cutout, fuses, relay and switches, new condition, £12 10s. each, carriage forward.

MAINS TRANSFORMERS, all by well-known makers and fully guaranteed, input 200/250 volts, 50 cy. 1 phase; output 2,000/0/2,000 volts at 250 m/amps with 2 L.T. tappings, 75/-; Ditto, 475/0/475 volts at 150 m/amps., with 3 L.T. tappings, 4v. and 6v., price 42/6. Ditto, 80, 100, 120, 140, 200, 220, 240 volts at 3,000 watts, £12 10s. Ditto, 6, 16 volts at 14/90 amps output, £15. Transformer cores, suitable for winding 2,000 watts, 27/6; 100 watts, 7/6 each.

EX-R.A.F. 10-VALVE CHASSIS (sold for components only). Consisting of: 2, 150 ohm Mult. Contact Relays, 9 British type Octal Base Valve Holders, 30 Tubular Condensers, ranging from 10 P.F. to 1 M.F. 25/30 Resistances 1, 1 and 2 watts all mounted on chassis, size 12in. x 8in. x 2in. Components all in good condition. "A real bargain" at 12/6 each, postage 1/6.

EX-GOVT. ROTARY CONVERTERS, Input 12 to 18 volts D.C. at 3 1/2 amps. output 450 volts 60 m/amps. fitted with automatic switching and smoothing, 32/6 each. 2/6 carriage.

BALLAST LAMPS (GOOD MAKERS), new 125 volt 30 watts E.S. fitting, 6/- per dozen.

EX-G.P.O. PRE-INSULATORS, 3 ohm automatic relay operating a 4-way Yaxley switch, fitted with 2 condensers, 0.1, 1 1/2 M.F., new, boxed, 5/- each. G.P.O. Polarised Telegraph Sounders in new condition, 15/- each. G.P.O. Polarised Relays, operating on 10/20 m/amps. coil resistance, 230 ohms, 15/- each, as new.

SHORT WAVE H.F. CHOKES, 1/6; H.F. chokes, 1/-; .01 condensers, 4/- per doz. R.I. 3 to 1 L.F. transformers, 6/-; condensers, 1 MF, 1/3; 2 MF, 2/-; 4 MF, 3/6; 10 MF, 5/6 each; smoothing chokes, 20/30 henrys, 80/100 m/amps, 8/6; electrolytic condensers, 80 MF 350 v. wkg., 7/6; 500 MF 50 v. wkg., 8/6.

ARMY 58 transceiver, complete with head-phones, microphone, aeriels, batteries; £11/10.—66, Braxted Park, Streatham, S.W.16

HENRY'S RADIO & ELEC. COMPO NENTS, 5, Harrow Rd., Edgware Rd., London, W.2. Pad. 2194. Hours: 9.30-6 o'clock, Mon-Sat. Thurs. 1 o'clock. T.C.C. and B.I. 8mid 500v wkg., 3/-; 8x8mid 500v wkg., 6/-; 16mid 500v wkg., 4/- Metal rectifiers, input 200-600v, output 300ma, 30/-; 280 volts 60ma, 10/-; 4mid 1,000v wkg., 7/6 ea.; oilfilled 1mid 1,000v wkg., 3/-; oilfilled 2-gang 0.005 standard condenser with trimmers, 12/6; 4-gang 0.005 standard condenser, 17/6; 5 Amphenol w/holders, 4 5 and 7-pin English and Mazda Octal and Int. Octal 4 and 5-pin U.K., 9d. ea., 7/6 doz. [6162

E.M.I. Exco, R.K., energised speakers recon-ditioned, 45/- each; 3in C.R.T.s with 2 controls, case, I.I.T. network, £3; packing 2/-; Houlgrave, 178 Highgate Rd., Birmingham, 11.

COULPHONE RADIO, Station Rd., New Longton Nr. Preston.—The return of Post Mail Order Service. New goods only. C.O.D. or cash with order. Orders over 5/- not filled.

EDDYSTONE Model 504 communications receiver. Rotational deliveries now commenced. ALL Tungsram and B.V.A. valves; list prices. LINE Cord 3 amp, 600 per foot, 2-way 1/6 yd., 3-way 1/9 yd.; mains droppers, Feet, 2 sliders, 2 amp 4/3 3 amp 4/6.

GOODMANS T2/1205/15 12in P.M. quality speakers, £6/15; Goodman's Moreton Cheyney super quality 8-valve gram amplifiers, £22/10; battery chargers, 6 and 12v at 3 amp, 2/6; Plessey 8in P.M. speakers, 10,000 lines with pentode trans., 29/6; T.R.F. tuning coils, M. & L., with reaction, A. and H.F., 9/6 pair; superhet coils, Ae and O.C.S.M.L., 11/6 pair; "P" type coils, all types, 2/6 ea.; aluminium chassis, 16 gauge, 3in deep, 10inx8in 8/6, 12inx9in 9/6, 14inx9in 10/6, 16inx8in 10/6, 20inx8in 12/6; Pyrobit instrument soldering irons, 21/-.

MAINS transformers, highest quality, primaries tapped, 200/250 volts, 300/0/300, 60 m.a. 4v 3a, 4v 2a or 6.3v 2a, 5v 2a, 10/6; 350/0/350 100 m.a. 4v 6a, 4v 2.5a, or 6.3v 3a, 5v 2a, 24/-; bobbins 15/6; 450/0/450 200 m.a. 4v 8a, 4v 4a, or 6.3v 4a, 6.3v 4a, 5v 3a, 42/6; or 6.3v 4a, 4v 2a, 5v 2a, 5v 2a, 45/-.

EDDYSTONE short-wave components. BPL Test Sets, 17 range, latest type, £8/8/8 nett.

TUNING units; model A3, R.F. stage, 16/50, 200/550, 800/2,000, completely assembled and aligned with 3-gang condenser, drive scale and escutcheon, £5/15; model B3 as above, but with I.F. stage and D.D. stage, £8/15. Everything from a grid clip to a Vortexion 50-watt amplifier.

SEND 2/6d. stamp for new 12-page catalogue. **LOOK**, mains transformers, 22/6; valves, L ECC31 10/6, EL35 13/6; Octal bases, 6/4; and a host of other component bargains, at Allen & Gould, Lewisham (opp. Gaumont Cinema). Tel. Lee Green 4038. [6269

RADIOGRAPHIC, Ltd. (B.R.S. 12040), of Glasgow, are forging ahead in getting supplies of vital interest to all radio enthusiasts; keep in constant touch for the latest news of still greater supplies. **TRANSMITTERS**, transceivers, valves (RX and TX), and all components. **RADIOGRAPHIC, Ltd.**, 66, Osborne St., Glasgow, C.5. [5516

A MATEUR surplus gear for disposal, including meters, valves, 9000 series, acorns, 807 and others, valve tester, Cossor D.B. oscilloscope, R.C.A. receiver, AR8B, recording outfit; please send s.a.e. for detail list.—Box 2691. [6148

VORTEXION transformers and chokes, etc., supplied to B.B.C., G.P.O., I.P.T.B.; why not you?; would be any specification; imitated but unequalled.—Vortexion, Ltd., 257-261, The Broadway, Wimbeldon, S.W.19. Tel. Liberty 2814-6128. [4536

RADIO components of all descriptions; comprehensive stocks condensers, resistors, transformers, valves, parts for Midget sets, etc.; everything for the service man and constructor; trade only.—B. & H. Radio, Huntley St., Darlington. [5908

GOVERNMENT surplus, ex R.A.F. secret sets, comprising 10 valves, 2 relays, 62 fixed condensers 10df to 1mid, 59 resistors 4 to 10watt, 5 brass vane tuning condensers, rotary transformer 12 to 480v 40/60ma, reduction gearing, etc., complete, in new condition. £7/10.

EX-ARMY type remote control units with W/T key, microphone transformer, switches, buzzer, in steel case with shoulder strap; £1/5; both items c.w.o. or c.o.d.—Cuttriss Radio & Electrical, Ltd., 1.178, Warwick Rd., Acocks Green, Birmingham. 27. [6012



DESIGN for P.A.

The MB.31 amplifier incorporates the Cathode-anode output circuit developed by Acoustical, resulting in a total distortion content incapable of detection by the human ear. A flat frequency response from 40—15,000 c.p.s. is obtainable, modified by a microphone volume control so weighted that "natural" reproduction is maintained at all levels.

Introducing compression near full output, a higher average output level can be handled without the distress caused by overload peaks. Operating from AC mains or 12-volt batteries, and having alternative input and output impedances, the MB.31 amplifier is extremely versatile and suitable for most types of general public address work.



MANUFACTURING CO. LTD.
HUNTINGDON, TEL: 361.

'ASTRONIC' HERMETICALLY SEALED TRANSFORMERS

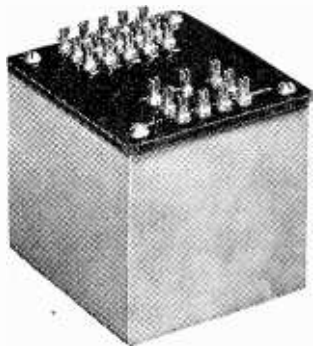

- Direct fixing to component structure —no strain on container to cause distortion or leaks.
- No unsightly fixing lugs external to container.
- Male or female threads, for upright or inverted mounting at will.

ASSOCIATED
ELECTRONIC ENGINEERS Ltd.
DALSTON GDNS. STANMORE MIDDX
Wordsworth 4474-5-6.

e.h.W.S.

G.13, 5000 Ω field, £3/10; 12in R.K. 1a 8v with field unit and multirate transf., £4; matched pair Magnavox 2,500 Ω field with multimeter trans. and field unit, £3/10; 6in Robe and 500 Ω field, 15/-; Garrard A.C. record changer piezo p.v.; offers.—F. Forcellini, 19, Campion Rd., Isleworth, Middx.

BUILD a "super" set. "Dorset" all-dry battery 4-valve 3-wave superhet circuit. USES latest 1.4 volt Mullard valves; short, medium and long waves; no accumulator; wonderful tone and volume; price 5/-; theoretical circuit only with price list, 2/6d.

"DORSET" 5-valve 3-wave ac superhet circuit, price 5/-; theoretical circuit only with price list, 2/6d.

ABSOLUTELY the finest sets of drawings and instructions ever produced for the home constructor; six pages of full size drawings, point to point wiring instructions and parts list; we supply 3 wave coil pack, group board and chassis specially designed for the above two sets.

ALSO "Wizard" 4-valve TRF medium wave with conversion for long wave ac/dc circuit, 5/-; "Dorset" amplifier 6-3 watt ac/dc circuit, 5/-.—Weldons Radio Accessories, Ltd., Swanage. [5803

GOVERNMENT surplus.—Headphone with G headband, 2/6, post free; Post Office type carbon microphones (as new), 2/6 ea., post free New 4-way flexible telephone leads, tagged ends, 2 yds. long, 6d. each, post 2d., 5/- per doz. New 2ft twin leads, tagged ends, 1/- doz., post 4d.—HAY & SON, 123, [6174 St., Brighton.

ELECTROLYTICS 500v working, 8mfd 2/10, 8x8mfd 5/6, 16mfd 4/9; mains transformers 500-0-500, 200ma, 6.3v 4a, 6.3v 2½a, 5v 3a, 45/-; 350-0-350 80ma, 6.3v 3a, 5v 2½a, 4v 4a, 4v 2½a, 32/6; vibrator units 2v input 180v output, L.T. and G.B., easily adaptable for any use, with 2 accumulators, £4; miniature valves, 1S5, 1T4, 1R5, 1299, 17/6 ea; 102in telescopic aerials, 17/6; ex-R.A.F. Identification Friend units, complete with ceiving and transmitting units, complete with valves and containing components worth over £20, a few only, 75/-; s.a.e. for component lists.—U.E.I. Corp., 32, St. Gabriel's Rd., London, N.W.2. [6296

COTTON-COVERED copper wire, ¼lb reels, 18, 20, 22, 24g, 1/6; 26, 28g, 1/9; 30, 32g, 2/-; 34g, 2/3; enamelled ditto, same prices, including 36g, 2/3; 38, 40g, 2/6; silk-covered ditto, 16g, 11b, 5/-; 18g, 11b 7/-; 22g, ¼lb, 2/6; 2oz, reels, 24, 26, 28g, 1/6; 2/3; 32, 34, 36g, 1/9; 38, 40g, 2/-; 42g, 2/3; 44, 45g, 1oz, 2/-; laminated bakelite panels, ¼in thick 6inx4in, 1/3; 6inx6in, 1/9; 8inx6in, 2/3; 10inx6in, 2/9; 10inx8in, 3/6; 12inx8in, 4/-; ditto, ¼in thick, same sizes, 10d, 1/2, 1/6, 1/10, 2/4, 2/8; polished ebonite panels, ¼in thick, sizes as above, 1/9, 2/9, 3/6, 4/6, 6/-, 7/- respectively. B.A. screws, gross useful sizes, 2/6; ditto, nuts, 2/6 gr; assorted gross screws and nuts, 2/6; brass washers 1/6 gr; fibre washers, 1/6 gr; assorted soldering tags, 2/ gr; assorted small eyelets and rivets, 1/3 gr; finest quality stranded and single push-back wire, 12yds 2/3; resin cored solder, ¼lb, 1/-; ne ex-G.P.O. hand telephones with microphone, switch and 6ft cord, 12/6; lead-in tubes, 4in 9d, 6in 5/-, 9in 1/4, all postage extra, trade supplied.—Post Radio Supplies, 35, Bourne Gardens, London, E.4.

SANGAMO synchronous motors, self-starting, exceptionally good torque, rotor speed 200 rpm, 200-250vac, 50c, consumption 2½ watts, size 2¼x2, geared 1 rev 60 min, can be reset to zero by friction drive from front or back, shaft ⅝inx1-10, to run clockwise; ideal movements for making electric clocks, time switches, etc., nickel-plated finish, price 22/6 each, 12 to 1 dial trains to fit above spindle; per CHAMBERLAIN & Hookham synchronous motors (enclosed type), self-starting, exceptionally good torque, rotor speed 200rpm, 200-250vac, 50c, consumption 3 watts, size 2¼x2, geared 1 rev 6 min, can be reset to zero by friction drive from front or back; shaft ⅝inx1-10, to run clockwise; ideal movements for making electric clocks, time switches, etc., nickel-plated finish, price 25/- each; 12 to 1 dial trains to fit above spindle, per set 2/6. MAKE your own darkroom clock Sangamo synchronous motor, self-starting, 200-250vac, 50c, geared 1 rev 60 secs, can be reset to zero by friction drive from front or back, shaft ⅝inx1-10, to run clockwise; 22/6 each. SANGAMO synchronous motors, self-starting, exceptionally good torque, rotor speed 200 rpm, 200-250vac, 50c, consumption 2½ watts, size 2¼x2in, 2/6 each. 15AMP mercury switches, enclosed bakelite tubular cases, 2½inx¼in, fitted swivel saddle, connector block, etc.; 5/6 each. CASH with order post paid on all above goods. TO callers only.—A comprehensive stock of scientific instruments, meters, gears, relays. H. FRANKS, Scientific Stores, 58, New Oxford St., London, W.C.1 Tel. Museum 9594.

RADIO CORNER

(Proprietor, T. R. WILLIAMS)

138 GRAY'S INN RD., LONDON, W.C.1
Terminus 7937

MAIL ORDER. Delivery by return. THE BANNER CHARGER. Type 1/1, 1 amp, ideal for Motorists, a really first-class job. Input 240 v A.C. Output 2, 6 or 12 v D.C., at £3. Designed for the motorist who likes to keep his batteries in tip-top condition.

RADIO VALVE MANUAL, giving American and British Valve Equivalents and Data. Price 3/6. Radio Constructors Manual. Price 3/-. Radio Tuner Unit Manual. Price 2/6. Engineers and Electricians Handbook. Price 1/-. Cathode Ray Oscilloscope Manual. Price 2/-. Radio Reference Book. Price 12/6.

American Radio Valves. Types as under at controlled prices. 45Z5GT, 5Y3G, 1A5GT, 1C5GT, 1Q5GT, 1T5GT, 80G, 35Z5, at 11/- each, 6J5GT, 12J5GT, 1H5GT, 12S5GT, at 9/2 each, 6Q7GT, 12Q7GT, 12SQ7GT, 75G, at 11/7 each, 12SK7GT, 6K7GT, 6K6GT, 6V6GT, 4ZG, 43G, at 12/10 each. 6A7G, 6A8GT, 6K8GT, at 14/- each. Postage paid. Other types as they become available for distribution.

AMERICAN RADIO SERVICE MANUALS

- Volume I. Spartan Emerson.
II. Crosley Belmont. Part I.
III. Crosley Belmont. Part II.
V. Emerson. Part II.
VI. Stewart Warren. FADA.

At 12/6 per Volume, or complete set of six manuals £3 12s. 6d. These Manuals cover the complete range of American Radio Receivers as given and are invaluable and contain all the technical data necessary.

Terms. Cash with Order only. We regret that we are unable to send goods C.O.D.

DALY

ELECTROLYTICS



Tube—size 2½" x 1"



Can—size 4½" x 1½"



Block—size 4½" x 1½"

The DALY range covers all requirements
Note—All Condensers bear the date made

DALY (CONDENSERS) LTD
Condenser Specialists for over 20 years
West Lodge Works, The Green, Ealing, W5
Phone—Ealing 4841

BIG display of Government surplus material offered at fraction of original cost.—Central showrooms situated top of Tottenham Ct Rd., Norman Rose, Norman House, 53, Hampstead Rd., London, N.W.1. Eus. 6886-7. [5013

EAST Anglian Hams.—Components for transmitters, receivers, etc., in stock; agents for Hamrad, Raymart, Eddystone, Labgear; if you cannot call send your order by post, delivery against cash with order or c.o.d.: s.a.e. with all enquiries.—Newson, G3GY ex-G3GF, 28, Market Place, N., Walsham, Norfolk. Phone 219. [5961

TRANSFORMERS for every purpose, high test grade workmanship, competitive prices, immediate delivery; microphone, inter valve and P.P. driver trans. O.P. trans. 1 to 60 watts; chokes, all sizes. Fluorescent light chokes; mains trans to 2kva auto-trans, 60va to 2kva (200-230v, 115v and 24v at max. current); test gear trans for bridges, oscilloscopes, valve testers, etc.; list 1d.—Radio Services, Field St. Works, Blackpool. Tel. 1250 15602

100 cases of German make telephone equipment, comprising 20 small exchanges, and 80 cases of associated equipment, including telematic dials, interconnecting cables, termination boards, relays, etc., all new and unused, original estimated cost about £2,500; price £350 the lot, including cases value £150.—Apply Pearson, 263, Gallowgate, Glasgow. [6223

CHARLES AMPLIFIERS have pleasure in announcing the opening of their new premises at 10, Palace Gate, Kensington, on November 4th; customers old and new will be welcome to try our famous amplifiers and tuner unit, the latest in high fidelity speakers, decorative baffles and equipment, and the latest records; meanwhile, our blueprints are still available from the address below; 3 and 7-watt cathode follower amplifiers which are meeting with an extraordinary enthusiastic response, and our newest tuning unit which is both an all-wave superhet and a high fidelity T.R.F. unit; prints with full size point to point wiring diagrams, 2/6 each, the three for 5/-; complete kits or separate components supplied.—Charles Amplifiers, 14, Lapstone Gdns, Kenton, Mdx.

RADIO CLEARANCE, Ltd., 27, 1st Barnham Ct. Rd., W.1. Museum 9188.—Selenium rectifiers, 24v, 2a; bridge, 12/6; 250v, 60ma, h.w. 6/6; 3-section metal rect., 108v 50ma per section, 5/6; Mansbridge condensers, 1mf 350v, 9d.; 1mf 1,000v wkg., 1/3; 2mf 450v, 1/6; 4mf 500v, 3/9; 4mf 1,500v wkg., 6/-; wire wound pots, heavy duty, 441 12watt, 4/6; 3-watt type, 1001, 2001, 3000, 5001, 1k, 2k, 3k, 5k, 10k, 20k, 50k, 100k, 2/6 each; with switch, 50k, 100k, 250k, 4/- each; switches 1p, 2 or 3w, 1/9; 1p, 12w, 5/-; 1p, 9w, 3-bank, 5/-; Minibank 2p, 6w, 2/6; electrolytics, 2mf 250v, wire ends, 1/9; 20mf 50v or 25mf 25v, 1/9; 4mf 350v, 2/-; 8mf 500v, 3/3; 250mf .25v, 2/-; 500mf 12v, 2/6; vitreous resistors, 25w, 1201, 2001, 2/6; 3w, 8,0001, 2/- each with clips, wire ended 3w, 4701, 3.9k, 47k, 1/- each; wire wound fixed P.O. type 10w, 1k, 2k, 4k, 1/6 each; vitreous 25w, 3501, 5k, 2/6; 40w, 14k, tapped at 2k, 3/-; condensers, high voltage mica, 0.002, 1.000v, 1/-; 0.002, 2.000v, 2/-; 0.004, 1.750v, 2/-; 0.004, 5.000v, 2/6; mains dropping resistors with 2 sliders, 0.2a, 1,0001, 3/3; 0.5a, 8001, 4/-; sleeving, 1 doz. assorted lengths, 1.6mm, 1/6; h.i. chokes, 1/6

ROTARY transformers, brand new, ex-Govt. R stock, with 6v input, output 200v at 80ma continuous, or 150v at 80ma up to 3 hours, with 12v input, output 480v at 40ma continuous or 400v at 80ma up to 3 hours, size, length 7/8in, height 3/4in, weight 6/4lb, original price £7/7, each 25/-; midget m. wave t.r.l. coils, high gain, 5/-; m.l. wave, with reaction circuit, 7/6; m.l. wave, iron core, adjustable cores, circuit, 10/6; s.m.l. aer. and osc. coils, circuit, 10/6; Weymouth midget i.f.s., iron core, 465kcs, per pr. 19/6; standard i.f.s., 465kcs, per pr. 15/-; Weymouth all-wave coil pack, 38/6; coloured Ivorine dials, s.m.l. wave, 3x3/4in, 2/-; 5x5/8in, 2/6; slow motion drum drive, 3/-; epicycle drive, 3/3; square plane drive assembly, complete with station named dial, 4 1/2 x 3 1/4 in., m.l. wave, pointer, glass, escutcheon, etc., 11/6; miniature rotary switches, 4p, 3w, 4/-; 2p, 6w, 2/6; d.p.d.t., 3/-; chokes, midget 50ma, 5/6; standard 80ma, 8/6; heavy 150ma, 12/6; Simplex chassis, 11x4 1/2 x 11 1/2 at 6/-; W5 chassis for coil packs, 11 1/2 x 5 1/2 x 2 1/4 in. at 6/6; 5V chassis for superhets, 10 1/2 x 6 1/2 x 1 1/4 in. at 6/6; all chassis with 6in speaker cut-out and fully drilled all component holes; nuts-screws, 8 BA, 4 BA, per gross (2 gross in all), 6/-; heavy duty output P.P. trans., 6.600 A to A load, tapped output, 7.5 and 15ohms, each 21/-; monthly comprehensive lists, well worth having, 2/6d stamp; postage all orders.

GREENLOCK, Ltd., 34, Bancroft Rd., Cambridge Heath Rd London E.1. Tel. Stepany Green 1354 [6134

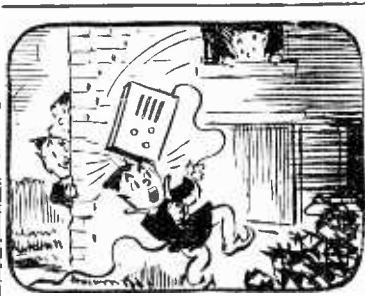

THE "FLUXITE QUINS" AT WORK

"Just a little more earth-wire. Heave Ho!
Then I'll fix it with FLUXITE, just so.
It's got caught," shouted Oi,
"I'll tug it, old boy..."
"You've got more than you want," chuckled OH.

See that FLUXITE is always by you—in the house—garage—workshop— wherever speedy soldering is needed. Used for over 30 years in Government works and by leading engineers and manufacturers. Of all Ironmongers—in tins, 10d., 1/6 & 3/-.

Ask to see the FLUXITE POCKET BLOW LAMP, price 2/6.

TO CYCLISTS! Your wheels will NOT keep round and true unless the spokes are tied with fine wire at the crossings AND SOLDERED. This makes a much stronger wheel. It's simple—with FLUXITE—but IMPORTANT.

The FLUXITE GUN puts FLUXITE where you want it by a simple pressure. Price 1/6, or filled, 2/6.



ALL MECHANICS WILL HAVE
FLUXITE
IT SIMPLIFIES ALL SOLDERING

Write for Book on the ART OF 'SOFT' SOLDERING and for Lists on CASE-HARDENING STEEL and TEMPERING TOOLS with FLUXITE. Price 1d. each

FLUXITE LTD.
(Dept. W.W.), Bermondsey Street, S.E.1

G. A. RYALL, 65, Nightingale Lane, London, S.W.12. Mail order only, at present, no c.o.d. under £1 please. Postages extra. U.S.A. make 0.1mf 500v tubular metal cased wire condensors, 5/- doz; 0.5mf 3 2/- Resistances, carbon type, best make, 1/2 watt sizes, 47, 100, 220, 270, 500, 1,000, 2,200, 5,000, 15,500, 50,000, 1.5meg, 2meg, 3/- doz. Best makes 2watt carbon resistors, 6,800, 36,000, 43,000, 140,000, 150,000, 220,000, 470,000, 820,000, 4/- doz. Good assortment 15 sizes of 1/4w, 1/2w, 1w resistances, at 1/6 doz, and 1,800 wire wound 1/6 doz, 2,200 1/- doz. Vitreous 30ohm and 470ohm, 1/6 doz. Vitreous 4,700ohm 20w with clips, 2/- each. Panels with screened 0.1mf and 12 1/2 w resistances and condensers, 2/3 each. Set five 30mm trimmers on metal base, 1/- Pairs of ditto, 8d. Octal plugs with metal caps 3 1/-, with solder tags 2 1/-; chassis mounting valve holders to suit plugs, 3 1/-; Miniature 4-pin plugs, sockets, metal caps, 4/6 doz complete. Relays, 150ohm 2v 15ma, 2p, M & B, 1p CO high class ceramic insulation, British make, unused, 5/- each. Volume controls less switches, best makes, 1/4meg, bakelite cased, 1/4meg metal cased, 1meg bakelite cased, short spindles, all 1/6 each: 1meg with 2 1/2in spindle, 2/-; Switches, Yaxley type single bank 1p 9-watt, 2/3; 10-watt, 2/6, single bank, 2p, 2/-; three bank 4-watt 2p with middle screen, etc., 3/9.

BARGAINS in new radio goods.—Cossor 3in scope, £25; 1ma moving coil meters, £2. 2v accumulator, 25/-; resistors, 2 watt, 5/- doz; 1/2, 1/4, 1/8 watt, 3/- dozen; bargain parcels worth £25, only £10, all new items including electrolytics; television condensers, 3-5,000w wkg., 10/- each; television transformers, weight 18lb., 230v input, £5, worth double.—Brown, 63, Salisbury Avenue, Farnham Rd., Slough, Bucks. S.a.e. for lists. [5978

UNIT construction radio, 5-wave superhet tuner unit, complete 3 valves, dial, etc., £6/10; output units, A.C. or A.C./D.C., 2-valve, 4-watt, with output transformer, £2/10; 4-wave, 8-watt ditto, £3/15; A.C. power unit, £3/10; A.C./D.C., £2/10; sub-chassis to mount 3 units, 6/-; 3-wave coil packs, 37/6; midget high Q IFTS, 21/- per pair; 2-gang with S.M. drive 15/6; 16E aluminium, 2/6 per sq ft, cut to size; chassis made to order.—R. T., 64, St. Leonard's Rd., S.W.14. [6161

MISCELLANEOUS volumes for sale.

"WIRELESS Engineer," 1930-37 inclusive, bound; 1938-41 inclusive, unbound. "JOURNAL of I.E.E.," 1928 34 inclusive, bound; 1935-40 inclusive, unbound. "R.C.A. Review," 1937-41 inclusive, unbound, including "Radio at U.H.F.—Television," vol. 1 and 2, facsimile. "PROCEEDINGS of I.R.E.," 1931-37 inclusive, bound; 1938-40 inclusive, unbound; all in perfect and new condition.—Write with offer for each of the four pups complete (no odd volumes) to Advertiser, Bull Lane House, Gerrards Cross, Bucks. [5933

MICROPHONES: New Rothermel BR2S, £9; B.T.H. carbon, £2/10-4. Chalgrove, 45, Morden. [6015

45 Maker's Service Manuals, 32 loose 15 W.W.s, minus adverts., 70/- or offer.—Box 3394. [6207

ELECTRIC open and tubular heaters, etc., supplied to stores and shops.—Write, Matthias Rivlin, 69, Albion St., Leeds, 1. Tel. 25972. [5947

SPARKS data sheets.—These data sheets provide complete constructional details together with full size prints, etc., of tested and guaranteed designs.

ELECTRIC guitar units (3rd edition), 5/-; **ELECTRONIC** one-string fiddle, 3/6; 6.8watt ac/dc amplifier; phase inverter; push-pull output; neg. feed-back; portable for use with above or mike, p.u., etc., 3/6.

A.C. two-valver, med. wave, coil details, 2/6; 3 1/2 watt ac amplifier, 2/6.

SPARKS' DATA SHEETS (W.) 9. Phoebeith Rd., Brockley, London S.E.4. [3622

ALUMINIUM chassis and panels made to your dimensions, plain or punched, for valveholders, etc., from 3/9 each.—Mead, 13, Bence Lane, Darton, Barnsley, Yorks. [5940

IDEAS mean money!—If you have an idea, I can help you to make the most of it; write at once for full information on the technical, legal and financial services we offer to inventors.—Technico-Legal Services Bureau, 55, Romney St., Westminster, S.W.1. [4948

Routput 275 volts, 110 ma and 500 volts 50/80 m/a simultaneously, ideal for P.A. or mobile transmitters; bargain, £3/17/6 each carriage extra; tough rubber 3-core flexible cable, 7d per yard; 50 mfd 12 volt tubular electrolytics 11d. each; 0.5 mfd 450 volts tubular paper.—Austin Mills Ltd Lower Carra Stockport [5458

THESE ARE IN STOCK

Radio Engineers' Handbook, F. E. Terman, 35s. Postage 8d.
 Radio Laboratory Handbook, by M. G. Scroggie, 12s. 6d. Postage 4d.
 Practical Wireless Circuits, by F. J. Camm, 6s. Postage 4d.
 Mathematics for Electricians and Radiomen, by Nelson M. Cooke, 22s. 6d. Postage 7d.
 Time Bases, by O. S. Puckle, 16s. Postage 4d.
 Pulsed Linear Networks, by Ernest Frank, 15s. Postage 7d.
 Wireless World Value Data, 2s. Postage 2d.
 Transmission Lines, by Fred. C. Dewesse, 17s. 6d. Postage 7d.
 Practical Wireless Service Manual, by F. J. Camm, 8s. 6d. Postage 4d.
 Worked Radio Calculations, by A. T. Witts, 6s. 6d. Postage 3d.
 Short Wave Radio, by J. H. Reyner, 10s. 6d. Postage 4d.
 The Cathode Ray Oscilloscope in Industry, by W. Willson, 18s. Postage 6d.
 WE HAVE THE FINEST STOCK OF BRITISH AND AMERICAN RADIO BOOKS. WRITE OR CALL FOR COMPLETE LIST.

THE MODERN BOOK CO.
 (Dept. W.16), 19-21, PRAED STREET, LONDON, W.2.

PHOTO-ELECTRIC CELLS

SeTe on gold-alloy, super-sensitive to light, gas-filled, permanent, operate relay direct or with Valve Amplifier, perfect reproduction of Speech and Music from sound track of films; large tube 3 1/4 in. from glass top to valve pin base, lin. diam., 38/-; same type 2 1/4 in. long, 35/-; small tube, 2 in. from top to terminal base, 1/4 in. diam., 30/-; miniature cell, glass top to cap base, lin. overall, 1/4 in. diam., thin flex leads, 28/-; all cells operate on 40-100 volts. Connections diagrams free.

OPTICAL SYSTEM FOR SOUND FILM
 Operating from any car headlight bulb. Our patent external adjustment of interior light-slit permits setting of slit image from 1/4 to 2 thousandth inch wide, for scanning film sound track direct into Photo-cell, nickel tube 2 in. long, 1/4 in. diam., 1/4 in. focus, 55/-. Full instructions free.

GEFA INSTRUMENTS, 38a, York Street, TWICKENHAM, Middx. POPPerroce 6597

QUARTZ CRYSTAL UNITS

FOR AMATEURS
 For your
 TRANSMITTER

HIGHER
 ACCURACY
 COMPETITIVE
 PRICES

Delivery FROM STOCK

For your
 FREQUENCY STANDARD

SALFORD ELECTRICAL INSTRUMENTS LTD.
 PEEL WORKS, SALFORD 3

TIME Recorders.—Write for particulars.—Gledhill-Brook Time Recorders, Ltd., 64, Empire Works, Huddersfield.

WIRELESS World, 1928 to 1938, twelve bound volumes, lovely condition; "Radio News," 1930 to 1939, seven bound volumes, spotless condition; Fleming's "Outline of Electrical Engineering," three volumes; offers please.—EZZI Central Café, Blackburn, Bathgate, West Lothian. [5965]

TELEPHONE manufacturers and wholesalers.—Telephone hand-sets for intercom communication; complete telephone units for ships, factories and mines; carbon insets, switch keys, jack plugs and chokes; all new material; export enquiries invited.—Jack Davis, 30, Percy St., London W.1. Mus 7960

PURCHASE of supply co.'s watt-hour meters, contain 230v disc motor on frictionless self-centring bearings, precision 6 ratio gear train registering from 1 to 100,000 to 1, current and volt coils wound 1/4 mile 40 s.w.g. copper, permanent narrow gap magnet, vernier adjustments, etc., all in 1st order; 10/6 plus 9d. post.—W. & S., 11, Hawley Crescent, N.W.1.

MAINS transformers, first-grade and brand new, screened primary, 350-0-350v 80ma, 4v 4a and 4v 2.5a or 6.3v 5a and 5v 2a. 21 ea, post 1/-; larger type 120ma 6.3v tapped 4v, and 5v tapped 4v, unbeatable value at 27/6, post 1/-; similar quantity multi-ratio output transformers, 6/-; 30watt multi-ratio, 18/6, post 1/-; s.a.e. for list of other bargains.—Aneloy Radio, 36, Hindmans Rd., E. Dulwich, London, S.E.22 [5378]

SEND stamped addressed envelope for free copy of Weymouth high fidelity AC/DC circuit; complete constructional diagrams of this receiver free with every coil pack, 38/6, or 2/6 plus 2/4d. postage; 2-speed 2-gang 0.0005 condensers, 17/6; 8in., 10,000 line speakers, 35/-; 3-wave dial, 3/6; 16x8 condensers 6/-; all above suitable for the high fidelity receiver and can be sent c.o.d.—Castle Radio, 101, Poverest Rd., Orpington, Kent.

WANTED, EXCHANGE, ETC.

WANTED, radiogram cabinet, any style.—Particulars to Box 3037. [6171]

WANTED, a.c. or universal gram unit.—16, Carnarvon Rd., Leyton. [6219]

WANTED, 815, state price.—Hamilton, 33, Brancepeth Avenue, Newcastle-on-Tyne.

WTD., 500 microamp 4in meter, in ex. for Brush crystal 'phones.—Box 1982. [5905]

AIRMAN requires 70L7G.T. radio valve.—Townsend, 28, Waverley Rd., S.E.25.

SERVICE sheets, all makes, from 1936.—Condition and price to Box 1860. [5855]

E.M.I. hypersensitive pick-up units; state price, condition, etc.—Box 1887. [5892]

WANTED, auto. changer with Hypersen pick-up, and P.U. trans., etc.—60, Ice St., Blackburn. [6212]

42 or 43 s.w.g. copper enamelled wire, large or small quantities; best price given.—Box 3041.

WANTED, Voigt i.s. units, horns, reflector speakers, any condition.—Lowther Mfg. Co., Bromley, Kent. [5625]

WANTED, scanning and focussing assembly for Baird 15in Cathovisor tube.—Dawson, Burnham-on-Crouch. [5995]

WANTED, all types of laboratory and testing equipment; all letters replied to.—Harris, 29, Butc St., Aberdeen. [6021]

WANTED, Voigt corner reflector horn with or without mic.—Details to 233, Durants Rd., Enfield, Middx. [6240]

WANTED, Hartley Turner receiver; for sale, sound sales high fidelity PM speaker with transformer (new)—Box 2440. [5971]

ENAMEL wire.—Advertiser wishes to contact source of supply of enamelled wire in the following gauges, 18, 20, 22, 26, 31, 37, 38 and 39 s.w.g.—Box 2528. [5994]

WANTED, G.E.C. type magnetrons, in working condition, type Nos. CW.10 and CW.11.—Southall Technical College, Beaconsfield Rd., Southall, Middlesex. [6237]

WANTED—25D8G.T., 25B8G.T., 12B8G.T., 6M8G.T., 1B8G.T., 1D8G.T., 1171.7G.T., 117N7G.T., 117N7G.T., 117P7G.T., 12A7.—Leete, Geraldine Rd. Hostel, Malvern, Worcs.

RAVEN RADIO, 376a, Gt. Cheetham St. (Salford, l.), want 2nd-hand all-wave sets, communication receivers, electric motors, pick-ups and auto-change units, highest prices paid.

G. W. SMITH & Co. (RADIO), Ltd., require the following: new or second hand radio receivers and radiograms; all classes of radio test equipment; highest cash prices paid.

G. W. SMITH & Co. (RADIO), Ltd., 2, Cecil Rd., Southgate, London, N.14. Tel. Enter prise 5463. [5116]

WE buy for cash, new, used, radio, electrical equipment all types; especially wanted, radios, radiograms, test equipment, motors, chargers, recording gear, etc. If you want to sell at the maximum price, call, write or phone to University Radio, Ltd., 22, Lisie St., Leicester Square, W.O.2. Ger 4447.

RADIO SPARES

MAINS TRANSFORMERS. Primaries 200/250 volts
 Secondaries 350-0-350 volts.

TYPE C. 100 ma. 4v. 5a., 4v. 3a. ... 34/6
TYPE D. 100 ma. 6.3 v. 5 a., 5 v. 3 a. ... 34/6
TYPE E. 120 ma. L.T.s as Type D ... 37/6
TYPE F. 120 ma. L.T.s as Type D ... 37/6
TYPE G. 200 ma. Three L.T.s of 4 v. 8 a. x 4 v. 3 a. Rectifier ... 47/6
TYPE L. 200 ma. Three L.T.s of 6.3 v. 8 a. x 5 v. 3 a. Rectifier ... 47/6

Secondaries 500-0-500.

TYPE J. 200 ma. Three L.T.s of 6.3 v. 8 a. x 5 v. 3 a. Rectifier ... 56/-
TYPE K. 200 ma. Three L.T.s of 4 v. 8 a. x 4 v. 3 a. Rectifier ... 56/-
TYPE L. 250 ma. Three L.T.s of 6.3 v. 8 a. x 5 v. 3 a. Rectifier ... 59/-
TYPE M. 250 ma. Three L.T.s of 4 v. 8 a. x 4 v. 3 a. Rectifier ... 59/-

Secondaries 400-0-400.

TYPE R. 120 ma. 4 v. 5 a., 4 v. 3 a. ... 42/6
TYPE S. 120 ma. 6.3 v. 5 a., 5 v. 3 a. ... 42/6

Please note Types H to M have 2 of the L.T.s centre tapped. Owing to dimensions and weight of these types, kindly add 2/6 for carriage and packing.

HEAVY DUTY MULTI-RADIO OUTPUT TRANSFORMER. 120 ma., 15 watts, tapping for 6L6s in push pull, PkAs in push-pull, low impedance triodes, low impedance pentode, high impedance triode, 27/6; complete instructions with each unit.

SMOOTHING CHOKES. 20 henrys 100 or 120 ma., 14/6
 30 henrys 150 ma., 16/8; 30, 35 or 40 henrys 200 ma. or 250 ma., 27/6.

WOULD FRIENDS PLEASE NOTE THAT OWING TO DEMAND FOR OUR TRANSFORMERS AND CHOKES WE HAVE CEASED TO STOCK OTHER RADIO COMPONENTS

H. W. FIELD & SON, Colchester Road, HAROLD PARK, ESSEX

Telephone: INGrebourne 2642.

POST-WAR TELEVISION

The advance in Radio Technique offers unlimited opportunities of high pay and secure posts for those Radio Engineers who have had the foresight to become technically qualified. How you can do this quickly and easily in your spare time is fully explained in our unique handbook.

Full details are given of A.M.I.E.E., A.M.Brit.I.R.E. City & Guilds Exams, and particulars of up-to-date courses in Wireless Engineering, Radio Servicing, Short Waves, Television, Mathematics, etc., etc.

We Guarantee "NO PASS—NO FEE"

Prepare for to-morrow's opportunities and post-war competition by sending for your copy of this very informative 112-page guide NOW—FREE.

BRITISH INSTITUTE OF ENGINEERING TECHNOLOGY (Dept. 388)

17, Stratford Place, London, W.1

AMBASSADOR



Now for the first time:—
 ● Extended Tuning Scale—exclusive to Ambassador—makes micro-tuning simplicity itself.
 ● Superior electrical and mechanical construction, employing advanced technique.
 ● List Price, £16. Plus Purchase Tax £3-8-10

AMBASSADOR RADIO,
 Hutchinson Lane, Brighouse, Yorks.

V55R COMMUNICATION RECEIVER

An All-British Designed and Modified Superheterodyne

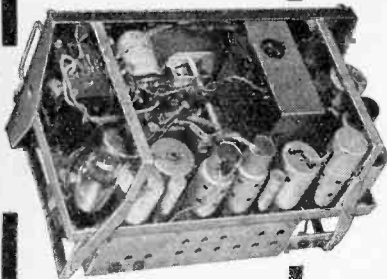

9 Valves. 5 Switched Bands
3 1/2 Watts Output A.V.C. B.F.O.
FULLY TROPICALISED

A Receiver for Commercial, Amateur, or Overseas Listener.
EARLY DELIVERY.

Write **VOICE & VISION CO.**
58-60 RUTLAND STREET,
LEICESTER, ENG.

A.C.S. RADIO

SPECIALISTS IN AMATEUR AND EXPERIMENTAL SHORT-WAVE EQUIPMENT,

Communications Receivers, Television, High quality Amplifiers, Speakers, Aerials, Receiving and Transmitting Valves and Meters, etc.

List "W" free on request to:-

A.C.S. RADIO, 44, Widmore Rd., BROMLEY, Kent.
Phone: RAV 0156.

PUBLICATIONS FOR SERVICEMEN

- AMERICAN MIDGETS HANDBOOK ... 2/8
- VALVE EQUIVALENTS CHARTS with quick ref. index ... 1/7
- ESSENTIAL VALVE DATA giving base data and diagrams of all valves listed in our valve equivalents charts ... 2/7
- RUNNING A RADIO REPAIR BUSINESS, with notes on starting, and including lists of valves and essential stock ... 7/6

V.E.S., Radio House, Ruislip, Middx.

TRANSFORMERS & COILS TO SPECIFICATION.

MANUFACTURED OR REWOUND.

STANLEY CATTELL LTD.

9-11, East Street, TORQUAY, Devon

Phone: Torquay 2182.



W. BRYAN SAVAGE LTD.

Expert assistance in the solution of problems relating to

- TRANSFORMERS, CHOKES
 - AMPLIFIERS
 - POWER UNITS
- and Specialised Equipment embodying

ELECTRONIC CONTROL

WESTMORELAND RD., N.W.9
COLINDALE 7131

AMPLIFIERS, etc., made to specification, yours or ours.—Doggett, 43, Southbourne Rd., Boscombe, Bournemouth. [6185]
LABELS—For the Rig plastic, cardboard, or metal engraved to your requirements; various colours.—Details, "Supervox" Service 29, Market St., Watford, Herts. [5856]

SITUATIONS VACANT

TECHNICIANS required for the development and processing of quartz crystals; state age, training, qualifications and practical experience.

APPLY Research Laboratories, West Hanningfield Rd., Great Baddow, Chelmsford, Essex.

DEVELOPMENT laboratory assistant required; must have thorough knowledge and experience of L.F., H.F., and acoustics; London area.—Box 2135. [5926]

VACANCIES exist in the research laboratories, situated 25 miles from London, of a large group of engineering and scientific companies, for senior engineers take charge of:
(1) **LABORATORY** engaged on the design and development of industrial control equipment.
(2) **LABORATORY** engaged on the design and development of communication type radio receivers and transmitters.
(3) **LABORATORY** concerned with the theoretical design of electrical circuits embodying electronic devices.

APPLICANTS should hold 1st Class Honours Degrees in engineering or science and have had at least 6 years' experience in a laboratory. Age not less than 30 years. Initial salary £600-£800 per annum. Applicants for vacancy 3 should have a good knowledge of advanced mathematics.—Box 3391. [6202]

EXPERIENCED buyer required by progressive radio factory in North London area; sound knowledge of trade essential; apply fully stating age, qualifications, experience and salary required.—Box 3410. [6251]

ASSISTANT buyer required accustomed to purchasing for light engineering industry, radio and domestic appliances; London S.E. area; state qual., age, salary reqd.—Box 3040.

EXPERIENCED toolmakers required by progressive radio factory in North London, five-day week.—Apply, stating fully qual., experience, wages required, Box 3043. [6181]

PRODUCTION engineer required by well known London firm of condenser manufacturers; good salary and scope for right man; must have radio (preferably component) manufacturing experience.—Box 1892. [5897]

NATIONAL Company require radio service engineers of proved technical ability for permanent situations in various parts of the country.—Write, giving full particulars and area preferred, to Box 3400. [6222]

A PERMANENT position is offered to a skilled radio service engineer by the foremost radio store in the Harrow area; Murphy and H.M.V. dealers; good wages and pleasant working conditions.—Write Box 3042. [6179]

PICTURE transmission office of national newspaper requires operator technician; previous experience not essential; must have good knowledge of thermionics, networks, optics, etc.; salary £430 approx.—Box 3564

VACANCIES exist in the purchasing department of well-known electrical firm in the Warrington area for buyers and chasers.—Reply, stating age, experience and salary required to Warrington G.P.O., Box No. 20.

EXPERIENCED foreman required by progressive radio factory, N. London area for electrical dept., able control labour, previous identical exp. essential.—Apply, stating age, qual., salary required, to Box 3044. [6182]

TELEVISION service engineer, vacancy in established expanding retail firm in North Surrey for applicant, preferably with pre-war experience; radio service engineer also required with experience and able to drive.—Box 3035.

A.M.I.E.E. City and Guilds, etc., on "No Pass—No Fee" terms; over 95% successes, for full details of modern courses in all branches of electrical technology send for our 112-page handbook, free and post free.

B.I.E.T. (Dept. 388A), 17, Stratford Place, London, W.1. [6270]

JUNIOR radio or electrical engineer required for development work on loudspeakers, transformers and associated equipment, sound training in general physics and fundamentals of electro-magnetic circuits is essential; preference will be given to applicants having experience with vacuum tube circuits; good salary and excellent prospects; S.W. London area.—Box 3032. [6189]

FERRANTI, Ltd., require urgently for their new laboratories in Edinburgh, research personnel, with or without industrial experience; applicants must be Hons. Graduates or have equivalent qualifications, and be of British nationality; experience of radar desirable; salary scale, linked up with new C.S. White Paper; good prospects of advancement under excellent working conditions.—Apply Personnel Manager. [6239]

MORSE CODE TRAINING



There are Candler Morse Code Courses for **BEGINNERS AND OPERATORS.**

Send for this Free 'BOOK OF FACTS'

It gives full details concerning all Courses.

THE CANDLER SYSTEM CO., (Room 55W), 121 Kingsway, London, W.C.2
Candler System Co., Denver, Colorado, U.S.A.

REWINDS

Armatures, Fields, Transformers, Pick-ups, Vacuum Cleaners, Gram. Motors, Speakers Refitted New Cones & Speech Coils.

All Guaranteed and promptly executed Valves, B.V.A. and American, Good stocks. Send stamped addressed envelope for list of Radio Spares, and C.O.D. Service.

A.D.S. Co. 261-3-5, Lichfield Road, Aston, BIRMINGHAM, 6

Aladdin RADIO CORES
for all purposes

GREENFORD, MIDDx. WAXLOW 2300

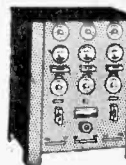

BATTERY CHARGERS and TRICKLE CHARGERS

Trouble-free Chargers fitted with selenium all-metal rectification. Good allowance on your old Charger. Thirty years experience behind every Runbaken Product. Booklet R.15 describing 12 Models on request.

RUNBAKEN MANCHESTER 1

THE COIL PICKUP

of all metal construction

IS IDEAL FOR TROPICAL USE

WILKINS & WRIGHT LTD.,

"Utility Works," Holyhead Road, BIRMINGHAM, 21.

ENGINEERING OPPORTUNITIES



This unique handbook shows the easy way to secure A.M.I.Mech.E., A.M.Brit.I.R.E., A.M.I.E.E., City and Guilds, etc.

WE GUARANTEE—'NO PASS—NO FEE.'

Details are given of over 150 Diploma courses in all branches of Civil, Mech., Elec., Motor, Aero., Radio, Television and Production Engineering, Tracing, Building, Govt. Employment, R.A.F. Maths., Matriculation, etc.

Think of the future and send for your copy at once—FREE.

B.I.E.T., 387, SHAKESPEARE HOUSE, 17, STRATFORD PLACE, LONDON, W.1.

ILLUSTRATED CATALOGUE



NOW AVAILABLE

Please send 2½d. stamp for post free copy.

Our staff includes: G3AD A. N. Simmonds, G8ZD E. P. Appleby, SPIHH/SP2HH M. Kasia.

TELE-RADIO (1943) LTD.

177, Edgware Road, London, W.2
Telephone: PADdington 6116.

MIDLAND INSTRUMENT CO.

Lewco Copper Instrument Wires, current stock, 20-28-29-30-32-34-36-g. enam., 13-20-22-24-29-34-37-g. Lewmar. 12-22-24-28-g. D.C.C. 26-31-38-g. enam. s.s.e. 20-23-30-g. Eureka. 22-g. Nickel Chrome. Also ex-R.A.F. Landing Lights, I.F.F. Responders, T.1396 Trans-Receiver, 1,082 Receivers, Wireless Remote Control Units, ex-R.N. Amplifiers, and hundreds of other Radio and Electronic Items. Send for new October Lists, 2d., with s.a.e. 18, HARBORNE PARK ROAD, BIRMINGHAM, 17. Tel.: HARBORNE 1308 or 2664.

RADIOGRAPHIC

The Mail Order Specialists
HAVE GOT THE STUFF

LABGEAR AGENTS

Raymart, Q.C.C., Demco and Hamrod Stockists.

Transceivers, Wavemeters, all Components.

★ Radio Metal Work Specialists.

RADIOGRAPHIC LIMITED

66 OSBORNE ST. GLASGOW

LONDEX for RELAYS



AERIAL CHANGE-OVER RELAY
for Radio Frequency
Type A.E.C.O. 4.

3 V.A. Coil Consumption especially designed for Transmitters, High Frequency Heating, Amateur Stations, experimental purposes, etc.

Ask for leaflet 112 W.W

LONDEX LTD

MANUFACTURERS OF RELAYS
207, ANERLEY ROAD, LONDON S.W.20

TECHNICAL writer required with experience of Radar navigational equipment, including Geos for the compilation of technical brochures, service and installation manuals; Manchester area.—Reply, stating age, experience, salary req. when available, to Box 3036.
RADIO service engineer required, N.W. London; must be thoroughly capable at fault tracing in radio and television receivers, and familiar with modern testgear and methods; excellent prospects.—Full details and salary reqd. in strict confidence to Box 2443. [5983]

AVACANCY exists in our laboratory for a valve designer who would be interested in the problems of radio receiver valve design and the installation of a factory production unit for their manufacture.—Apply by letter to Frank Murphy of London, Ltd. (Radio Laboratory), 15, Sun St., Hitchin. [6001]

SOBELL INDUSTRIES, Ltd., Langley Park, nr. Slough, invite applications for full-time employment from skilled radio service engineers resident within 3 miles' radius of each of the following towns: Motherwell; Durham City; Hull; Oldham; Croydon; Maidenhead.—Write Service Manager. [6218]

SENIOR and junior radio engineers with experience of electrical and mechanical development factory production of domestic receivers; salary according to qualifications and experience.—Apply to Personnel Manager, Airmed. Ltd., Wadsworth Rd., Perivale. [6186]

ASSISTANT (male) required for West-End offices of leading sound equipment manufacturers for sales records, order correspondence and trade showroom; suit young ex-Service man with clerical experience and basic radio knowledge.—Write age, experience, salary required, Box 3038. [6172]

DEVELOPMENT engineer required to supervise laboratory and development staff; must have thorough knowledge and experience of L.F., H.F., and television technique, with particular emphasis on audio frequency and acoustic work; practical ability to direct and supervise is essential; London area.—Box 2134. [5925]

"ENGINEERING Opportunities," free 112-page guide to training for A.M.I.Mech.E., A.M.I.E.E., and all branches of engineering and building; full of advice for expert or novice; write for free copy and make your peacetime future secure.—B.I.E.T. (Dept. 387B), 17, Stratford Place, London, W.1. [6271]

EXPERIENCED radio and television service engineer required immediately to take complete charge of London service station; excellent opportunity to join staff of National Company; living accommodation provided.—Send full particulars of qualifications, experience and remuneration required, to Box 2644, Greenly's, 5, Chancery Lane, W.C.2. [6145]

INSTRUMENT makers required N.W. London area; applicants must have considerable previous experience in model making for development of electro-mechanical apparatus and must be capable of working to sketches and instructions in addition to fully detailed drawings; write, giving full particulars of past experience, age, and salary reqd.—Box 2680.

DRAUGHTSMAN required by engineering firm, N.W. London area; applicants must have previous experience in design and development of light electro-mechanical equipment from schematic sketches or specifications and must be able to prepare detailed drawings; previous experience in tele-communication equipment or small electro-mechanical components an advantage, and a knowledge of their electrical application desirable; write, giving full particulars of past experience, age and salary required.—Box 2681. [6160]

THE MIDDLESEX HOSPITAL MEDICAL SCHOOL, LONDON, W.1.—Technician required by department of Physiology for construction and maintenance of electronic apparatus, including high-gain amplifiers and cathode ray oscillographs, used for research and diagnostic purposes, experience in wireless, radar or related branches of physics essential; initial salary £6 p.w.; duties commence October 1st, 1946.—Applications to the Secretary of the Medical School. [5791]

RADIO and audio frequency engineers required by engineering company, North London district; 5 years' pre-war experience on actual development of domestic radio receivers or audio frequency amplifiers and recording equipment with a firm of repute essential; B.Sc. engineering degree an advantage.—Applicants should write in confidence, stating age, complete details of past experience and salary required, to Box 389, Arthur S. Dixon, Ltd., 229-231, High Holborn, W.C.1.

SITUATIONS WANTED

EX-FOREMAN of signals, 27, C. & G. finals. radio comm. and technical electricity, stud. I.E.E., two year gen. eng. stud., 6 years' exp. radio and telephony opt., requires progressive technical position.—Box 3453.

HILL & CHURCHILL LTD

BOOKSELLERS

SWANAGE, DORSET

Available from stock:—

- Terman—Radio Engineers Handbook 35/-
- Terman—Radio Engineering - - - 30/-
- Terman—Fundamentals of Radio - - 20/-
- Terman—Measurements in Radio - - 22/6
- Everitt—Communication Engineering 27/6
- Fink—Principles of Television Engineering 27/6
- Glasgow—Principles of Radio Engineering 22/6
- Henney—Radio Engineers Handbook 30/-

We have a large selection of English and American Books on RADIO and TELECOMMUNICATION.

CATALOGUE ON APPLICATION

BEETHOVEN ELECTRIC EQUIPMENT LIMITED



BEETHOVEN WORKS, CHASE ROAD, LONDON, N.W.10

HARTLEY-TURNER HIGHEST FIDELITY SPEAKER

The success of this speaker, new in design but old in tradition, has been immediate. In one short month many have proved to their own satisfaction that we have not only far surpassed our previous efforts but everyone else's as well. We still do not claim perfect reproduction—we never shall; but the Model 215 is so great a step forward as to make it an essential part of a musical connoisseur's electronic equipment. No room here for our pre-war "pep talks," but our literature is very interesting. Send for it!

MODEL 215 — £8.5.0.

High-grade Push-Pull O.P. Transformer 55/-.

H. A. HARTLEY CO. LTD.

132 HAMMERSMITH RD., LONDON, W.6

MATRICULATION

brings Success & Security

Whatever your age, you can now study for the all-important Matriculation Examination at home on "NO PASS—NO FEE" terms. "MATRIC" is the accepted passport to all careers, and opens up opportunities which would otherwise be completely closed to you. Ensure the success and security of you and yours through post war difficulties by writing for our valuable "Guide to Matriculation" immediately—FREE

B.T.I. (Dept. 114)

356, Oxford Street, London, W.1.

EX-R.A.F. wireless operator, knowledge of servicing, installation and turning, 6 yrs. service, seeks position.—Box 2606. [6019]
EX-CPL radar mech. (R.A.F.), 25, C. & G. qualifications, B.I.E.T. student, seeks progressive post anywhere U.K.—Box 3392.

RADAR mech. "Gee," etc., holds metric. knowledge higher maths, reqs. progressive post radio/electronics.—Box 3457. [6262]

EX-R.E.M.E. Arm. Art. (wireless and radar) desires position of responsibility in radio-television trade.—Pugh, 112, Mackintosh Place, Cardiff. [6138]

SERVICE engineer, age 24, 6 yrs. exper. incl. R.A.F., W/T, R/T, V.H.F. radar, etc., war training, good refs., drive regis. progressive post, any area.—Box 2527. [5992]

RADIO communication engineer seeks progressive post, qualified radio relay engineer, City & Guilds' certs., full sales experience, would consider partnership.—Box 3403.

A.M. Brit. I.R.E., Grad. I.E.E., R.E.M.E. capt. age 31, 6 yrs. civil, 5 yrs. Army communications, engineering experience, desires communications engineering work, development preferred, good references.—Box 3465. [6282]

LIEUT.-CDR., R.N.V.R., 28, inter-B.Sc. standard, seeks progressive technical or admin. post; experience of naval radar radio electrical work since 1940 includes administration; additionally in particular, design and construction fidelity reproducing equipment, considerable chemical, pathological laboratory work.—Box 3769. [6158]

LECTURER, 20 yrs' teaching radio comm., physics, maths., P.M.G. certs., etc., contemplates change; present employers know of pending change; active amateur transmitter; apart from lecturing would also consider any engineering, technical sales, consulting, appointment offering scope for ability; age 40, own car.—Box 3397. [6211]

AGENCIES WANTED
RADIO mfrs. Serviceman, 25 yrs' experience, own car and test equipment, desires servicing and demonstration agency for Badenoch district, Scotland.—Mathews, Kintraig, Inverness-shire. [6140]

PATENT AGENTS
A. E. HILL, chartered patent agent, 27, Chancery Lane, London, W.C.2. [4368]

BUSINESSES FOR SALE OR WANTED
ADVERTISER wishes to purchase as a going concern, small well-established radio or sound equipment manufacturing company having B.O.T. licence.—Full particulars from principals only, Box 3395. [6209]

"VIBRO-ARC" Engraving Pen

15/- For rapid engraving any metal—hard or soft.
 Post Operates from 4-6v.
 Free Battery or A.C. Trans. former giving 6-10 amps.

HOLBOROW & CO.,
 8, Mossley Avenue, Wallisdown, Bournemouth.

NEW DUAL TESTSCOPE

Ideal for high and low voltage testing; 1/30, 100/850 A.C. and D.C. Allowance made on old models

Send for interesting leaflet (R.14) on Electrical and Radio Testing, from all Dealers or direct.

RUNBAKEN-MANCHESTER

VOIGT

WE APOLOGISE to those who have been waiting months for replies. Our post-war plans have been frustrated so far. Sorry!

VOIGT PATENTS LTD.

Be WISE and PATIENT

SMALL progressive radio manufacturing business, West Central district, with complete plant, stocks and goodwill; owner going abroad.—Write Box 3537. [6298]

PATENTS
THE proprietor of British Patent No. 537689, entitled Improvements in wave signalling systems, particularly applicable to facsimile telegraphy, and No. 537699, entitled Improvements in frequency modulation systems, offers same for licence or otherwise to ensure their practical working in Great Britain.—Inquiries to Singer, Ehlert, Stern & Carlberg, Chrysler Building, New York City 17, N.Y., U.S.A. [5932]

TUITION
BRITISH NATIONAL RADIO SCHOOL.
PRACTICAL training in radio physics. A three months' laboratory course is now available at the British National Radio School, a long established and highly successful institution specialising in converting "operators" and "mechanics" into radio engineers. Correspondence courses in radar, radio and television. Ask for details of our unique "Four Year Plan" leading to Brit. J.R.E. and I.E.E. examinations with five City and Guilds certificates as interim rewards.—Studies Director, B.N.R.S., 66, Addiscombe Rd., Croydon, Sy.

RADIO training.—P.M.G. exams. and I.E.E. Diploma; prospectus free. — Technical College, Hull. [0611]

RADIO Engineering, Television and Wireless Telegraphy, comprehensive postal courses of instruction—Apply British School of Telegraphy, Ltd., 179, Clapham Rd., London, S.W.9 (Estd. 1906). Also instruction at school in wireless for H.M. Merchant Navy and R.A.F. [9249]

THE Tuitionary Board of the Institute of Practical Radio Engineers have available home study courses covering elementary, theoretical, mathematical, practical and laboratory tuition in radio and television engineering; the text is suitable coaching matter for I.P.R.E. Service-entry and progressive exams, tuitionary fees—at pre war rates are moderate.—The Syllabus of Instructional Text may be obtained post free from Secretary, 20, Fairfield Rd., Crouch End, N.8.

WALTER SWITCHES ARE MADE FOR

Life

WALTER INSTRUMENTS LTD.

GARTH RD., LOWER MORDEN, SURREY
DERWENT 4421. Grams: WALINST, MORDEN, SURREY

Manufacturers of

- Plugs and Sockets
- Panel Mounting Sockets
- Coil Pins and Valve Pins
- Chassis Mounting Strips
- Panels
- Terminals and Connectors
- Tag Strips
- Cartridge Fuses
- Valveholders
- Cathode Ray Tube Holders
- Valve Bases

Radio & Television Components

BRITISH MECHANICAL PRODUCTIONS LTD.
 21 BRUTON STREET, BERKELEY SQUARE, W.1
 Grams: Trolinx, Wesdo, London' Phone: Mayfair 5543

Even a double load doesn't shorten the life of a

Welwyn Resistor

"No property of the resistance presented any apparent alteration." Such is the independent report after testing a Welwyn Vitreous Resistor for 670 hours at continuous double load. (Normal load gives working temperature of 450°C.) Sizes:—1 w. to 300 w.

New Trade catalogue available
WELWYN ELECTRICAL LABS. LTD
 Welwyn Garden City, Herts. Pho: Wel. Car 3816

Superspeed

SPECIAL

CORED SOLDER

A.I.D. APPROVED

H. J. ENTHOVEN & SONS LTD.
 230 THORNTON ROAD, WEST CROYDON, SURREY
 THORnton Heath 2462

ALL*You've ever asked for***NOW IN ONE INSTRUMENT!**

DEVELOPED in the light of Hunt's experience as capacitor makers, this instrument, with its wide range of application, and simple operation with accuracy, is a valuable asset to the Service Engineer.

One dial reading without charts or graphs. Complete and portable, with accommodation for all accessories. 210-250v. A.C. 50 cycles. Dimensions: 6½" x 9½" x 5".

List Price £18 . 18 . 0

MEASURES CAPACITY

... of all types of Capacitors, and circuit wiring. Range: 0.00001 mfd. to 50 mfd.

MEASURES POWER FACTOR

... of all types of electrolytics. Scale calibrated zero to 50% power factor.

MEASURES RESISTANCE

... of all types carbon and wire wound resistors from 50 ohms to 5 megohms.

MEASURES INSULATION RESISTANCE

... of paper and electrolytic capacitors, and all types insulation.

DETECTS DEFECTIVE CAPACITORS

... leaky, shorted, low and high capacity and high power factor capacitors of usual and intermittent types.

TESTS CONTINUITY

... can be used as continuity meter to test all types of circuits.



A. H. HUNT LTD · LONDON · S.W.18 · ESTABLISHED 1901

WHY



**CORE
SOLDER**

Because only with a solder wire having more than one core of flux can you be sure that the flux is always present. The 3 cores of Ersin Multicore Solder are filled with Ersin—the extra active non-corrosive flux. Only Ersin Multicore Solder can guarantee you freedom from dry joints, elimination of waste, rapid melting and speedy soldering. Write for technical information and free samples to Multicore Solders Ltd., Mellier House, Albemarle Street, London, W.1 or phone REGent 1411.