

Wireless World

RADIO and ELECTRONICS

Mes. 11. 29. 07

CHERBOURG
PENINSULA

VIRE

LE HAVRE

CAEN

ORNE

SEPT. 1945

1/6

Vol. LI. No. 9

IN THIS
ISSUE:

NEW PLAN FOR EUROPEAN BROADCASTING

PRIMER ON RUBBER BONDING

NUMBER
11
IN SERIES

An Aero-Engine Mounting required the following characteristics:

FLEXIBILITY was needed to insulate the airframe from—

- (a) Torsional movements of engine about longitudinal C.G. axis.
- (b) Vertical forces and couples in the vertical plane.

STIFFNESS was needed to prevent—

- (a) Fore and aft movement of engine due to airscrew "pull" which would upset control settings.
- (b) Transverse "yawing" of engine.

SPACE WAS LIMITED—therefore a multi-bush type of mounting was adopted.

PRECAUTIONS had to be taken to limit the vertical shear movement.

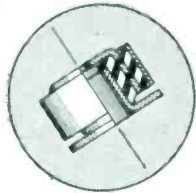

As Moulded

Simple three-bush moulding.

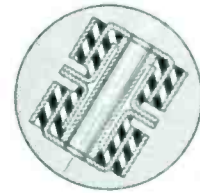

As Assembled

Two mouldings with loose central tube.

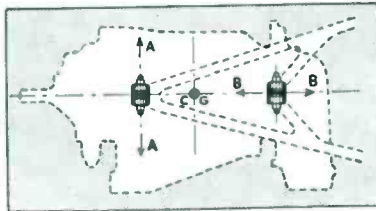

As Installed

Vertical shear movement in direction of arrow "A" (limited by stops); horizontal compression movement in direction of arrow "B" (high resistance).

You may wonder whether a bonded product would solve your problem. We should know — if you asked us.

R.R.34



RUBBER BONDERS LTD.

ENGINEERS IN RUBBER BONDED TO METAL
FLEXILANT WORKS · DUNSTABLE · BEDS.



Regd. Trade Mark

PRECISION

TESTING INSTRUMENTS

HIGH accuracy, simplicity, exceptional versatility and proven reliability have won for "AVO" Instruments a world-wide reputation for supremacy wherever rapid precision test work is demanded. There is an "AVO" Instrument for every essential electrical test.

Orders can now only be accepted which bear a Government Contract Number and Priority Rating..

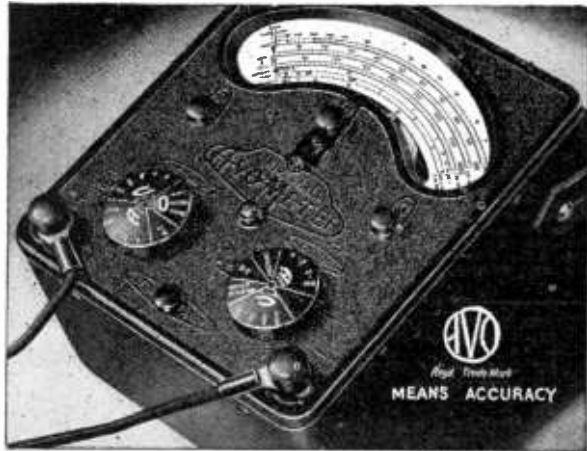

The MODEL 7 50-Range Universal

AVOMETER

Electrical Measuring Instrument

A self-contained, precision moving-coil instrument, conforming to B.S. 1st Grade accuracy requirements. Has 50 ranges, providing for measuring A.C. & D.C. volts, A.C. & D.C. amperes, resistance, capacity, audio-frequency power output and decibels. Direct readings. No external shunts or series resistances. Provided with automatic compensation for errors arising from variations in temperature, and is protected by an automatic cut-out against damage through overload.

Sole Proprietors and Manufacturers

THE AUTOMATIC COIL WINDER & ELECTRICAL EQUIPMENT CO. LTD., Winder House, Douglas Street, London, S.W.1. 'Phone: VICTORIA 3404/8

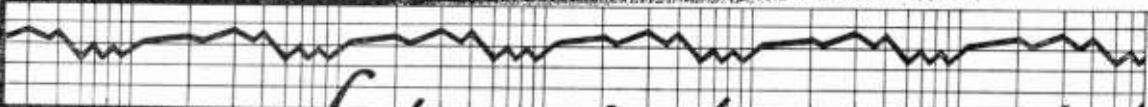

Let's get this straight!

FROM THE RANGE
OF GOODMAN'S
LOUDSPEAKERS
TYPE T/12/2

Diam. 12½ in.; Voice Coil
Imp. 15 ohms at 400 CPS
Power Handling Capacity 12
watts Peak AC on 4ft. baffle
(15 watts horn loaded).



EVER since Loudspeakers were, the sound engineer has been trying to straighten out that response curve. Before the War Goodman's, always pioneering the way, had succeeded in knocking out quite a number of those troublesome kinks. Then came the War with its object to straighten out many things, and here, too, some troublesome kinks have gone for good. But the response curve was not forgotten. War's critical demands of the Loudspeaker designer have called forth such intensive research as has made possible a very much greater control of the response curve: or to put it another way, you can look forward with confidence to a range of speakers for all uses, each one of which has the best possible response for its particular use. And rest assured the label will be Goodman's.

Goodman's Loudspeakers
include types from ½
watt to 20 watts output
and sizes 2½ to 18 in
diameter.

GOODMANS
Loudspeakers

GODDMANS INDUSTRIES LTD · LANCELOT ROAD · WEMBLEY · MIDDX ·

LINAGLOW LIMITED

LINTONE 5-VALVE MIDGET SUPERHET CONSTRUCTOR'S KIT. Completé with Cabinet

16-50, 200-450 metres. A SUPER-SENSITIVE AND SELECTIVE CIRCUIT. Brief specification: Frequency changer, 6 tuned circuit, 465 K.C.s iron-cored I.F.s, 4-watt output. P.M. speaker and output transformer, all valves, chassis, practical and theoretical diagrams. Parts list, nuts, bolts and wire and modern cabinet, dimensions, 12in. x 8in. x 6in. deep. Ready to assemble. 200/250 volts A.C. Inc. purchase tax, 13; gns. Case and packing, 5/- extra.

VARIABLE CONDENSERS. 2-gang, .0005, slow-motion drive, dial frame and pointer, 17/9. Midget 2-gang, .00035, 8/6.

TUBULAR PAPER CONDENSERS. 350/500 v. D.C. working. .0001, 3d.; .0025, 4d.; .01, 7d.; .04, 8d.; .08, 9d.; .1, 10d.; .25, 1/-; .5, 1/9; .05, 9d. each. Parcel of 50 assorted, 27/8.

AERIAL AND OSCILLATOR COILS. Best D.S.O. wire wound, colour coded on bakelite formers. Short, medium and long wave, 16/50 m., 200/550 m., 1,000/2,000 m.; with circuit diagram, 15/- the set.

I.F. TRANSFORMERS. 465 K.C.s iron-cored, Litz wound, aluminium can. Limited quantity, 17/6 matched pair; 9/6 each.

S., M. and L. T.E.F. COILS. Philips, best quality in screened aluminium can; 17-51, 220-585, 725-2,000 metres. (These coils equal to performance of superhet.) Complete with circuit diagram, 9/6 the pair.

M. and L. T.R.F. AERIAL COILS. Aluminium screened Philips. 200-585, 725-2,000 metres. Complete with circuit diagram, 2/9 each.

WAVE CHANGE SWITCH. To suit all above coils, 5/9 each.

SCREENED INTERLACED FLEXIBLE MICROPHONE CABLE. Twin, 6 yards for 6/9; single, 1/- per yard.

VOLUME CONTROLS. 1, 5, 10, 20, 25, 50 and 100 thousand ohms; 1, 1 and 2 meg. without switch, 4/3 each. As above, with switch, 8/-; 100,000 ohms, 1 meg., double pole switch, best American, 6/6; 2,000 ohms only, wire wound, 2/6; 1,000 ohms only, carbon screw adjustment, 1/6. Midget 1 meg. with switch, 5/6; less switch, 2/6.

MAINS TRANSFORMERS. 350-0-350 4 v. 6 amp. O.T., 4 v. 2 amp., 100 m.a.; heavy laminations; pre-war stock. Bargain, 27/6. 350-0-350, 6.3 v. 3 amp. C.T., 5 v. 2 amp., 100 m.a., 32/6.

SLOW-MOTION DRIVE. 8-1, complete with drum and spindle, 3/-.

WESTINGHOUSE METAL RECTIFIERS EX-G.P.O.

Suitable for chargers, etc. H/wave, H.T., 150/400 v., 50/200 m.a., 15/-.



2 SPECIAL KIT OFFERS

KIT 1.—Tuning heart suitable for 6-valve superhet, comprising variable condenser and slow-motion drive, set of iron-cored I.F.s 465 K.C.s Litz wound, aerial coil, R.F. transformer and oscillator coil. All trimmers and padders with wave change switch for 3-wave bands, 8.M. and L. Also circuit diagram for complete set, 23 9s. 6d.

KIT 2.—Tuning heart for 5-valve superhet, comprising variable condenser, and slow-motion drive, set of iron-cored I.F.s 465 K.C.s, Litz wound, aerial coil and oscillator coil. All trimmers and padders with wave change switch for 3-wave bands, 8., M. and L. Also, circuit diagram for complete set, 22 19s. 6d.

PUSH-BUTTON UNITS. Complete with escutcheon and knobs, 4-way. New, 4/6 each.

WANDER PLUGS. In 2 colours, 2/- per doz.

LINE CORDS. 3-way heavy duty, 3 amp., 360 ohms, 9/9; 490 ohms, 13/8; 600 ohms, 15/9; 2-way, 360 ohms, 5/8; 490 ohms, 7/8, 600 ohms, 9/3.

T.E.F. 3-WAVEBAND 4-VALVE CONSTRUCTOR'S KIT. 17-2,000 metres. Parts new, ex-television, aluminium screened coils, excellent short-wave reception (the special coils used in this circuit give a performance equal to a superhet.), 4j watt output, complete with loudspeaker, all parts, wiring and theoretical diagram—nothing extra to purchase. Chassis dim., 12in. x 8in. x 6in. to top of dial, 200/250 v. A.C., 11j gns., inc. tax. Case and packing, 5/- extra.

DE LUXE ALL-WAVE SERVICE SIGNAL GENERATOR

A.C. mains, 200/250 v. 50 cycles, range covers from 20 M.C. to 100 K.C.s, all fundamentally in 6 bands without gaps, 8/M dial. Direct calibration in frequencies. Coarse and fine output attenuator. Internal modulation. 400 C/8 iron-cored coils. The generator is entirely screened in heavy metal cabinet. Dim., 10in. x 10in. x 12 in., 16 gns.



SPECIAL OFFER BATTERY CHARGERS. 1-amp. type, 2, 6 or 12 volt, 200/240 volt input. Finished in black metal cabinet. Small and compact, 43 19s. 6d. each.

ELECTRIC IRONS. Best quality. Vitreous enamel finish. 230/250 v. 450 watt. 5 1/2 lbs., with lead and plug, 38/6. Light weight. All nickel, 21/-.

ELECTRIC KETTLES. 4-pint. Vitreous enamel. 950 watt, 200/220, 230/250 v., complete with lead and adaptor, 41/3.

CAE AERIALS. Telescopic scuttle fixing, extending to 4ft. 6in.; ebonite insulators, nickel-plated, 22/6.

VIBRATORS. 4-pin, 6-volt, best quality American, 10/6.

WE CAN NOW OFFER FROM STOCK THE FOLLOWING ELECTROLYTICS

6 mfd. x 50 v., tubular, 1/3; 25-mfd. x 35 v., tubular, 1/9; 25-mfd. x 25 v., tubular, 2/-; 50-mfd. x 12 v., tubular, 2/-; 8-mfd., 500 v., tubular tag end, 4/9; 8 x 8-mfd., 500 v., tubular tag end, 6/9; 32-mfd., 350 v., tubular tag end, 6/9; 4-mfd., 450 v., tubular tag end, 4/6; 8-mfd., 500 v., block, 4/4; 4-mfd., 440 v., wet, aluminium can, 7/8; 8-mfd., 440 v., wet, aluminium can, 9/6; 16-mfd., 440 v., wet, aluminium can, 11/6.

MIDGET VANE TYPE. Variable trimmers, 60 m mfd., 3/-.

VALVE HOLDERS. Amphenol type. International or English octal chassis mounting, 1/- each. 10/6 per dozen. English wafer type, 4 or 8-pin, 6 for 2/6.

BREAKFAST COOKERS. Vitreous enamel finish, hot-plate and oven. Dual switches, 200/250 v., 57/6.

LOUDSPEAKER TRANSFORMERS. Pentode output 40 m.a., 50 m.a., 4/-; Midget multi-ratio, 60:1, 80:1, 40 m.a., 7/6; Multi-ratio, 40:1, 60:1, 80:1 and push-pull, 80 m.a., 10/6; Pentode Output, 12/15 ohms, 100 m.a., 12/6. Heavy duty, multi-ratio, 24:1, 41:1, 48:1, 58:1, 82:1, 116:1 and T.F. 80 m.a., 15/6; 8:1, interval, 10/6; push-pull output, 20-watt, 4,000-0-4,000 primary, 2s. 7.5 and 12/15 ohms, secondary, 25/-.

P.M. LOUDSPEAKERS. 3 ohm Voice coil, Rola, Goodman and Celestion, 6j in. with transformer, 30/-; 8in. with transformer, 32/6; 2 1/2 in., 27/6; 3 1/2 in., 30/-; 5in., 22/6; 8in., 24/-; 12in., 28 16s.; 10in. Mains energised, 250 ohms, 35/-; B.T.H. Model, R.K. 10in. Mains energised loudspeakers, 1,000 ohms field, 15 ohms speech, weight 28 lb., reconditioned as new, ideal for P.A. work, 28 06; 10in. Mains energised, 1,140 ohms, with transformer, 45/- See transformers above to suit.

VALVES. American types at B.O.T. controlled retail prices. For replacement purposes only. 6F5, 12X5, 12X5, 12X5P5, 1X5, 9/9; 105, 11/-; 607, 12/7, 11/7; 6K6, 6V6G, 12/10; 6A8, 6B8, 14/-; Also British valves at manufacturers list prices. U4, U6, 11/-; TDD4, 11/7; AO/VP2, EF39, KT61, PEN 45, 8P41, 8P42, T41, VP41, 12/10. Di diode 1-in. Peanut valve with valveholder, 12/10. EO39, X68, 14/-; AO/ME, 11/-; AC6/Pen, EL36, PEN 46, U31, G1A, 13/3. Prices include purchase tax. Add 3d. per valve post.

DPDT SWITCHES, panel mounting, ex-G.P.O., 3/-.

MAINS TOGGLE SWITCHES. Panel mounting, 2/-.

5-WAY CIRCULAR RUBBER CABLE. D.V. 14/36, 104. per yard.

METAL RECTIFIERS EX-G.P.O.

Suitable for small chargers, relays, etc., 12 v. full wave, 100 m.a., 5/-; 6 v. H/wave, 50 m.a., 5/-; 4 v. H/wave, 30 m.a., 4/-; 2 v. H/wave, 15 m.a., 4/-; H1, 2 1/2 v. D.C., 10 m.a., 3/6.



LINAGLOW LTD.

Hours of Business: Mon. to Fri. 9 a.m. to 5.30 p.m.
Closed 1-2. Nearest Tube—Archway

◆ CALLERS to Show Rooms, 2, HIGHGATE HIGH STREET, N.6

Phone: MOUnview 9431

◆ POST ORDERS to Dept. MO 48, 61, HIGHGATE HIGH ST., N.6

Phone: MOUnview 9432

PYROBIT
POCKET TESTER
WITH SCREWDRIVER & NEON INDICATOR

THE INDISPENSABLE SAFETY TOOL FOR
WIRELESS ENGINEERS, ELECTRICIANS,
ETC.

Twelve supplied in each display box.
For 100-750 volts.

ACRU ELECTRIC TOOL MFG. CO. LTD.
123, HYDE ROAD, MANCHESTER 12
Telephone: ARDwick 4284

List Price - - 9/6 each

POST-WAR TELEVISION

The advance in Radio Technique offers unlimited opportunities of high pay and secure posts for those Radio Engineers who have had the foresight to become technically qualified. How you can do this quickly and easily in your spare time is fully explained in our unique handbook.

Full details are given of A.M.I.E.E., A.M.Brit.I.R.E. City & Guilds Exams, and particulars of up-to-date courses in Wireless Engineering, Radio Servicing, Short Wave, Television, Mathematics, etc., etc.

We Guarantee "NO PASS—NO FEE"

Prepare for to-morrow's opportunities and post-war competition by sending for your copy of this very informative 119-page guide NOW—FREE.

BRITISH INSTITUTE OF ENGINEERING TECHNOLOGY (Dept. 388)
17, Stratford Place, London, W.1

ELECTRONICS



made it possible!

Ten-tenths cloud and thick smoke over the target—but still the giant bombers droned their way to a pin-point and released their bombs on the scheduled spot. The science of electronics made it possible, for at the heart of every electronic aiming device lies the valve. OSRAM VALVES have been in the forefront of electronic development during the war, and will bring to the pursuits of peace many well-tried electronic devices to speed, smooth, and make safer our way of life.

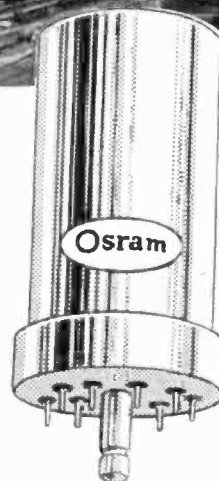

An OSRAM VALVE of pressed-glass-base construction with many attractive features to the peacetime circuit designer.

Osram

PHOTO CELLS

G.E.C.

CATHODE RAY TUBES

**Osram
Valves**

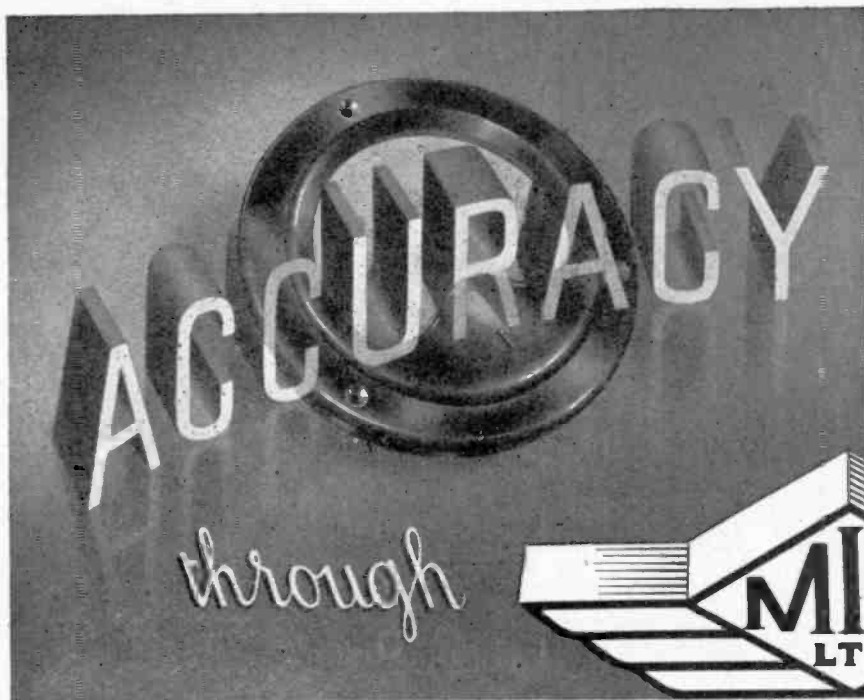

Manufacturers
of

Switchboard and Portable Pattern Microammeters : Milliammeters : Ammeters : Voltmeters : Wattmeters and Testing Sets.

MEASURING INSTRUMENTS (PULLIN) LTD.
ELECTRIN WORKS, WINCHESTER STREET, ACTON, W.3.

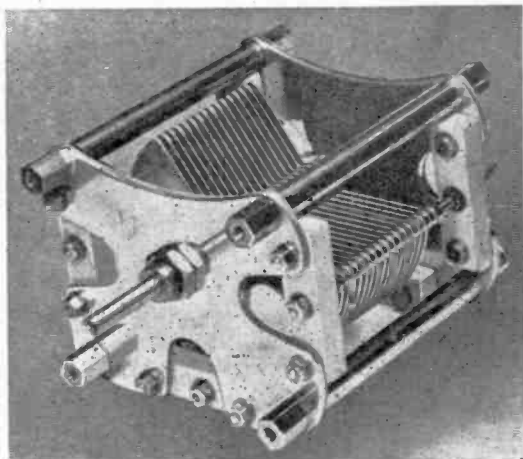

TYPE S.L.C. LINEAR CAPACITY

"Cyldon"
Variable Capacitors

SYDNEY S. BIRD & SONS LTD.
CAMBRIDGE ARTERIAL ROAD, ENFIELD.

THERE ARE TRIK AMPLIFIERS FROM 5-500 WATTS FOR PRIORITY WORK

Critical users

Trust
TRIK

Quality SOUND Equipment

THE TRIK ELECTRICAL CO. LTD.
15 MAPLE PLACE TOTTENHAM COURT ROAD,
LONDON, W.1.
Tele. MUSEUM 5E17 *Speakers & Cables* TRIXRADIO-WESDO LONDON.

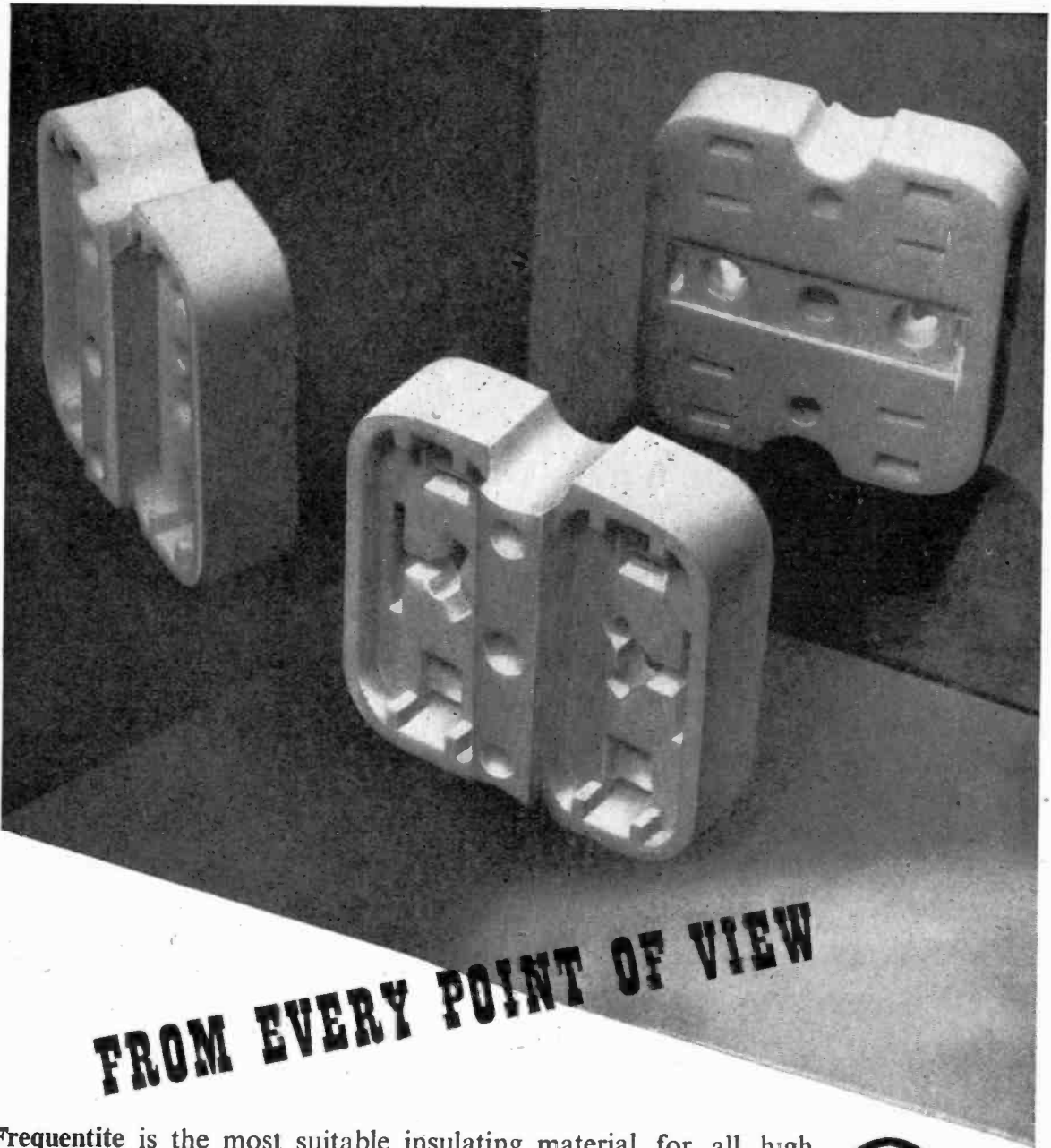

FROM EVERY POINT OF VIEW

Frequentite is the most suitable insulating material for all high frequency applications. Ten years ago we introduced the first British-made low-loss ceramic, and consultation with us before finalising the design of new components is a wise precaution.



STEATITE & PORCELAIN PRODUCTS LTD.

Head Office: Stourport-on-Severn, Worcester.

Telephone: Stourport 111.

Telegrams: Steatint, Stourport.

B.P. 52



Your products, too, can be assured of a longer life under all working conditions

USE **HY-MEG** THE MODERN TIME-SAVING IMPREGNATING MEDIUM

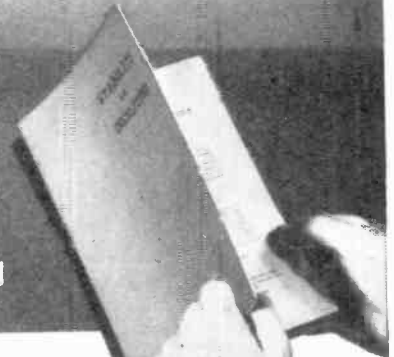

Executives in charge of the production of electrical apparatus calling for impregnation, should send for the HY-MEG Booklet "Stability in Insulation". It describes fully how HY-MEG scientifically overcomes problems arising both in production and operation. Apply on Business Heading or Card and enclose 2d. to comply with the Control of Paper Orders.

LEWIS BERGER & SONS LTD., (Established 1760) LONDON, E.9 'Phone: AMHerst 3321

MANUFACTURERS OF INSULATING VARNISHES AND ENAMELS



B.S.R. PORTABLE TYPE LO.50A. OSCILLATOR

Frequency range - 0-600 c.p.s.
0-15,000 c.p.s.

Two 4½" dia. Scales fitted with slow motion. Output Impedance 600 ohms or to customer's specification. Total harmonic content less than 1%.

Output constant with Frequency to within 2 d.b. from 20 to 15,000 c.p.s. Output meter, single Range Rectifier Type. Mains operation 200/250 v. 50 cycles. Power output ½ watt.

BIRMINGHAM SOUND REPRODUCERS LTD.

CLAREMONT WORKS, OLD HILL, STAFFS. Cradley Heath 6212/3. 'Grams: Electronic, Old Hill



MINIATURE or MIDGET



Originators, designers & manufacturers of Midget Valves

HIVAC LIMITED, Greenhill Crescent, Harrow on the Hill, Middx. Phone. 0895

F.W.S.CO.

TRADE MARK
REG. U.S. PAT. OFF.

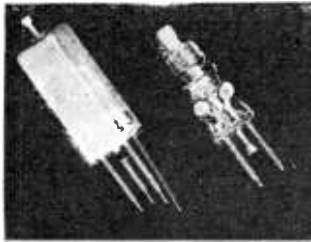

WORLD'S LARGEST RADIO COIL MANUFACTURERS

RADIO FREQUENCY INDUCTORS
INTERMEDIATE FREQUENCY TRANSFORMERS
RADIO FREQUENCY COIL CHOKES

MICA COMPRESSION CONDENSERS
AIR DIELECTRIC CONDENSERS
MICA MOULDED CONDENSERS
SICKLES SILVER CAP

CONDENSERS
GANGED PERMEABILITY TUNING COMMUNICATIONS EQUIPMENT
F.M. EQUIPMENT PARTS
U.H.F. RADIO EQUIPMENT
SPECIAL ELECTRONIC EQUIPMENT

The F. W. SICKLES Co.
CHICOPEE, MASS., U.S.A.



RAYTHEON "FLAT" HEARING AID TUBES

These tiny Raytheon high-fidelity tubes deserve "all of the superlatives in the book." Their clarity and dependable performance are the result of Raytheon's vast tube-engineering experience . . . and they're made with painstaking care by the most expert workers.



P. R. MALLORY & CO. Inc.
MALLORY VIBRATORS
ARE ALWAYS DEPENDABLE

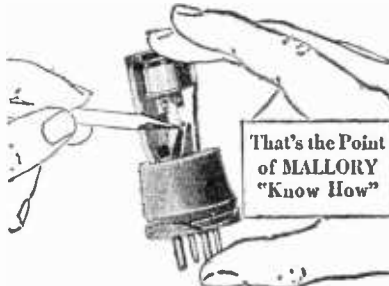

That's the Point of MALLORY "Know How"

Contacts in a vibrator take a lot of punishment. They must operate under widely varying conditions of temperature and must "make and break" 115 times a second. Small wonder that alert engineers think of contacts first when selecting a vibrator!

For over 20 years, Mallory has been industrial headquarters for every type of electrical contact. It has introduced new contact compositions . . . evolved better designs . . . formulated improved surface finishes.

As a result of this wide experience, Mallory equips its vibrators with special grade tungsten contacts which are cut in its own plant from material made to its own specifications. They give longer life, are subject to a minimum of erosion and transfer.

Mallory is ready to apply its special vibrator "know how" to your specific applications.

P. R. MALLORY & CO. INC.
INDIANAPOLIS, INDIANA,
U.S.A.

Radio and Electronics Division

ALSO
"MYKROY" CERAMIC INSULATING MATERIALS
GENERAL ELECTRONIC VACUUM CONDENSERS

FOR THE FUTURE

These Manufacturers will help solve your post-war problems. Register your name now for full details which will be sent you when supply conditions again permit.

FRANK HEAVER LIMITED
Kingsley Road, BIDEFORD,
N. Devon

G.I.

VICTORY PRODUCTION

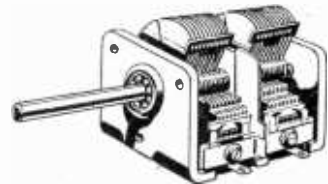

TYPE 2600 MIDGET VARIABLE CONDENSER

WHEN the mission of complete victory is accomplished, General Instrument will help "Win the Peace" by making the best use of still greater knowledge and experience in the manufacture of variable condensers and drives.

THE GENERAL INSTRUMENT CORPORATION
ELIZABETH, N.J., U.S.A.



THE SHAPE OF THINGS TO COME..

TWO-WAY radio communication systems, like the plastic-cased beauty illustrated,

are one of the new developments leading industrial designers are thinking of to speed the work of a busy post-war world. Applications of this compact, plastic-cased "walkie-talkie" are almost unlimited. Naturally, this is only one of thousands of uses plastics will be put to after the war, but it will serve to remind you that post-war planning is being done . . . Kurz-Kasch designers, engineers, tool-makers and moulders . . . specialists for a generation in plastic planning and moulding will help you with your problems.



KURZ-KASCH INC.
Planners and Moulders for the Age of Plastics
DAYTON · OHIO · U.S.A.



Clear as a
Crystal

AND HERE IS THE REASON . . .

. . . the answer has been found in Bullers Low Loss Ceramics to the problem of Dielectric Loss in High Frequency circuits.

Years of Laboratory research and development have brought these materials to a high degree of efficiency. To-day they are in constant use for transmission and reception, and play a vital part in maintaining communications under all conditions.



Made in
Three
Principal
Materials

FREQUELEX

An Insulating material of Low Dielectric Loss, for Coil Formers, Aerial Insulators, Valve Holders, etc.

PERMALEX

A High Permittivity Material. For the construction of Condensers of the smallest possible dimensions.

TEMPLEX

A Condenser material of medium permittivity. For the construction of Condensers having a constant capacity at all temperatures.

BULLERS, LTD.
THE HALL,
OATLANDS DRIVE,
WEYBRIDGE, SURREY
Telephone :
Walton-on-Thames 2451
Manchester Office :
196, Deansgate, Manchester.

Bullers

LOW LOSS CERAMICS



STEADY

your A.C. SUPPLY WITH A



STABILISTOR

the only constant voltage equipment giving a constant UNDISTORTED output with changes in mains voltage and load.

Write for literature to Dept. W.W.

WESTINGHOUSE BRAKE & SIGNAL CO. LTD.,
Pew Hill House, Chippenham, Wilts.



When the boys
come home -

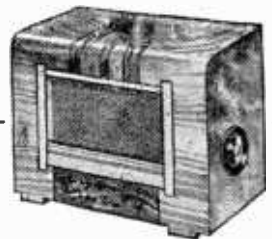
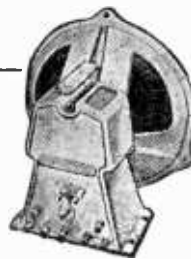

Stentorian
S P E A K E R S



**WHITELEY ELECTRICAL RADIO
CO. LTD., MANSFIELD, NOTTS.**

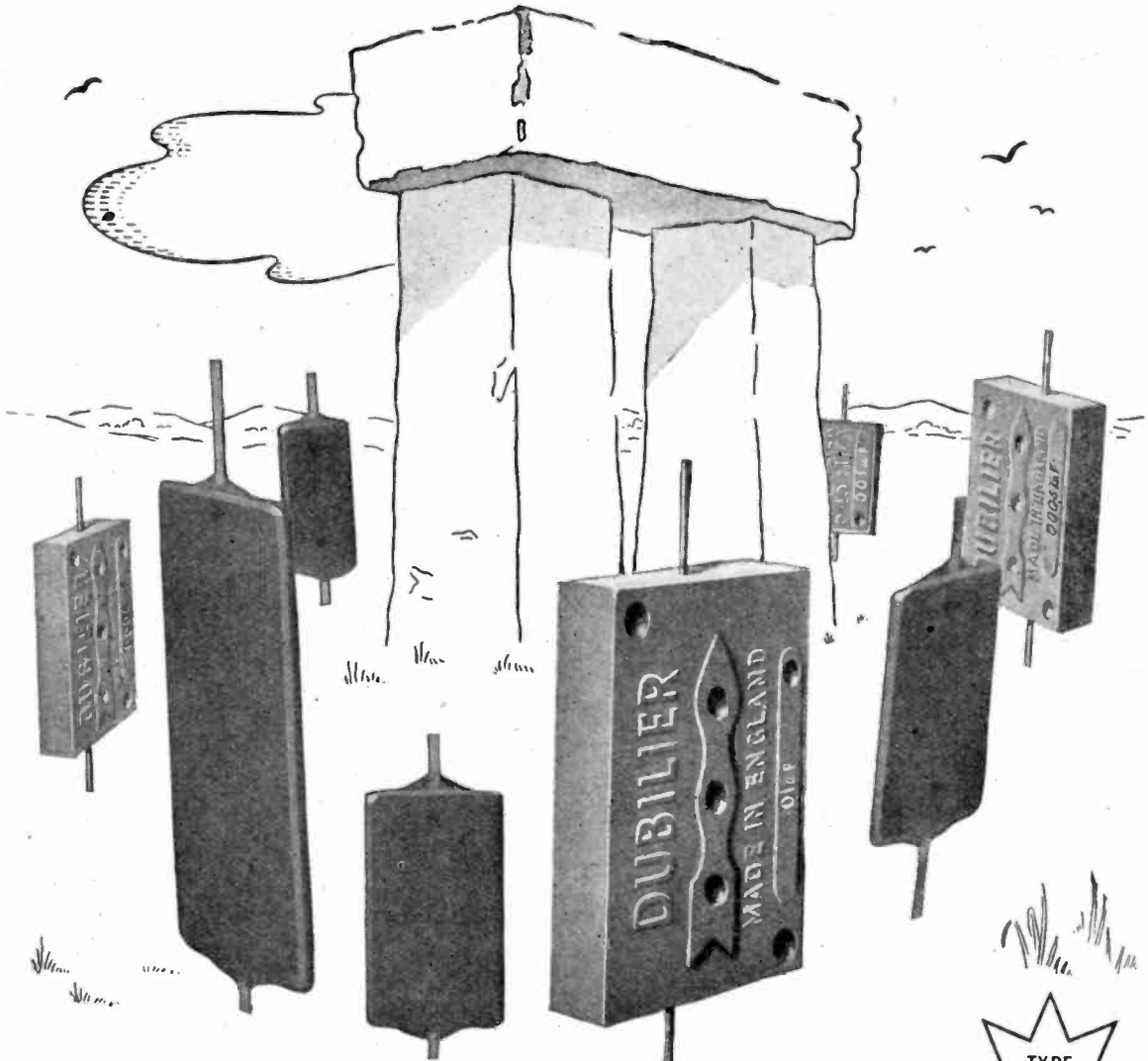

Staying put...



Such a 'vulgar' phrase may shock the technical purist but we don't know any better or more vivid one to describe Dubilier metallized Mica Capacitors. They are made of course to very fine tolerances and once sealed they do literally "stay put"; maintaining that pre-determined accuracy for their whole life.



The name is ... Dubilier

A COMPACT AND PRECISE WAVEMETER FOR USE IN ALL CLIMATES

EVERY ship and shore radio station must have, as an essential part of its equipment, a wavemeter that is absolutely reliable under all conditions.

The Rediffusion 605A Wavemeter has been constructed to have a discrimination of 0.1 per

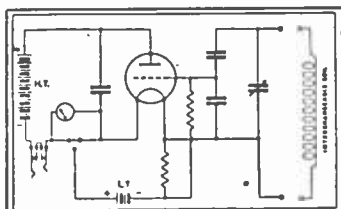

CIRCUIT OF THE REDIFFUSION
605A WAVEMETER

cent over a range of frequencies from 100 to 43,000 kilocycles (3,000 to 7 meters). This range is covered by using 8 coils, which are carried in a separate case and are

used in conjunction with a graph card made out for each individual coil. Tuning is by means of a variable condenser.

The 605A Wavemeter is normally used for frequency measurement of a transmitting station, and as a standard by which to tune a transmitter output. It can also be used to indicate the resonance of modulated carrier waves, and to indicate the functioning of a very low-power radiating circuit.

The wavemeter unit is light and compact, weighing only $7\frac{1}{2}$ pounds, and is 5" x 8" x 8". The construction throughout has been designed to resist severe variations of climate in most parts of the world. The eight coils are carried in a case of similar size weighing 4 pounds. In use the coils are attached to two terminals placed on the side of the wavemeter.

This instrument is available now. Further details can be sent on request.

REDIFFUSION Ltd.

Designers and Manufacturers of Radio Communication
and Industrial Electronic Equipment

SUBSIDIARY OF BROADCAST RELAY SERVICE LIMITED

VICTORIA STATION HOUSE, LONDON, S.W.1 (Phone Victoria 8851)

Wharfedale P.A. LOUD SPEAKER

Flux Density
11,500
lines/CM².

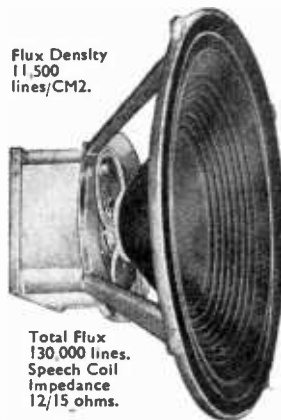

Total Flux
130,000 lines.
Speech Coil
Impedance
12/15 ohms.

W.12.

Made by

WHARFEDALE WIRELESS WORKS

HUTCHINSON LANE, BRIGHOUSE, YORKS.

'Phone : Brighouse 50.

'Grams : WHARFDEL

Letter from
J. F. Field, Esq., B.Sc.,
M.I.E.E., Edinburgh.
5th July, 1945.

"Mr. Churchill spoke to some 50,000 people last week in Princes Street Gardens at the end of his National Tour. We had 2 x 30 watt Amplifiers feeding 4 of your W.12 Units fitted with our large steel horns. He was clearly heard for several hundred yards each way along Princes Street."

It is clear from the above that W.12 Speakers can not only take it but can also hand it out!

Doing vital service
amidst the battle smoke
**DAGENITE AND
PERTRIX
BATTERIES** D11C/44

Sole Concessionaires:
HOLSUN BATTERIES LIMITED, 137 Victoria St., London, S.W.1



EDDYSTONE apparatus and components have played a worthy part in the second World War, upholding in unbelievably rigorous conditions the traditional British qualities of steadfastness and dependability.

EDDYSTONE plans for peace-time production and development will be adequately progressive to maintain their predominant position as manufacturers of Communications Equipment.

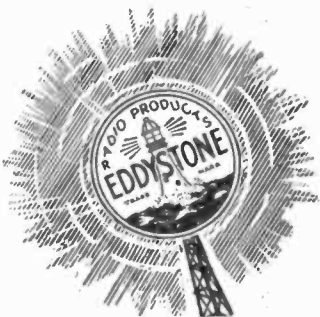

MANUFACTURED BY
STRATTON & CO., LTD. EDDYSTONE WORKS **BIRMINGHAM.**
 TELEPHONE: PRIORY 2231 CABLES: 'STRATNOID' BIRMINGHAM.
 LONDON AGENTS:-
WEBB'S RADIO. 14, SOHO STREET, OXFORD STREET, LONDON. W. I.
 TELEPHONE: GERRARD 2089



LASSO is making a mark for itself

Lasso Self-Adhesive Tape solves all your marking problems. These brilliant filmic markers can be cut off to length desired, are easy to apply, are ever-legible and are impervious to heat and fluids. Supplied in 10-yard rolls or individual labels, in colours to B.S. Specification and in shades matched to customers' requirements. Any type of wording, lettering or diagram produced.

TYPICAL USES

<p>IDENTIFICATION : Numbering of parts to simplify assembly of complicated circuits. Stores reference numbers, etc.</p> <p>INSPECTION : Facilitates inspection by indicating treatment of components.</p> <p>INSTRUCTIONS : Labels with full details for assembly work or finished components.</p> <p>NAME TAPES : Ideal for sealing and labelling packages or finished components with your name.</p>	
--	--

Full details from **CABLE ASSEMBLIES LTD.** (Subsidiary of Herts Pharmaceuticals Ltd.) **BESSEMER ROAD, WELWYN GARDEN CITY**
 Telephone: Welwyn Garden 3333/6 Telegrams: Cablesembly, Welwyn Garden City

EARTH FREE
& Silent as the Stars



Masteradio
VIBRATOR PACKS

MASTERADIO LTD · VIBRANT WORKS · WATFORD · HERTS



Manufacturers of
 the famous
DAIK
SWITCH
 The only switch with
FLOATING & DOUBLE
ROTOR & CONTACT

Available in a wide range of circuit combinations for radio, television and other applications.

BRITISH N.S.F. CO. LTD.
 KEIGHLEY, YORKS.

'Phone: Keighley 4221/4. 'Grams: "Enesef, Keighley,"

Exide

IN PARLIAMENT

In the House of Commons :

Mr. EVELYN WALKDEN asked the President of the Board of Trade why 120-volt Exide Batteries which are sold at 11s. 1d. are in short supply and other 120-volt batteries of less reliable make, and sold at 15s. 6d., only are available . . .

Mr. DALTON : Wireless batteries are now in short supply, owing to the heavy demands of the Services, and it is necessary, therefore, to make use of the output, although small, of the higher cost producers. Prices are controlled under the Price of Goods Act, 1939, and those charged for both classes of battery referred to by my Hon. Friend have been investigated and approved by the Central Price Regulation Committee.

Mr. WALKDEN : While appreciating what my Right Hon. Friend has said, is he not aware that batteries are used largely by people in small homesteads who cannot understand why good batteries cannot be obtained while there is a plentiful supply of inferior ones. . . ?

Mr. DALTON : I am very anxious to get a fair distribution of whatever supplies there are, but the best batteries are required for the Services in a very great and increasing quantity . . .

(Extracts from Hansard, Jan. 16)

THE CHLORIDE ELECTRICAL STORAGE COMPANY LIMITED

GROSVENOR GARDENS HOUSE · LONDON · SW1

Designed and Built to meet
EXACT requirements

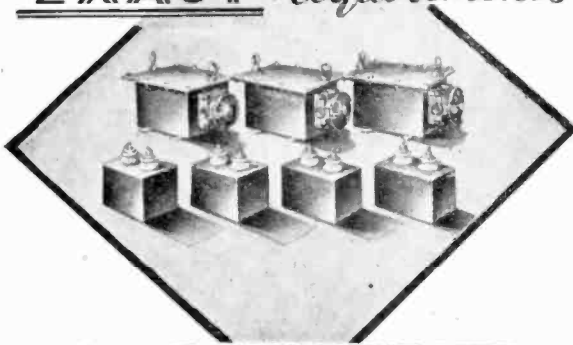

WEGO CONDENSERS
"BUILT BY SCIENTISTS FOR SCIENTISTS"
WEGO CONDENSER CO. LTD.
BIDEFORD AVENUE · PERIVALE · GREENFORD · MIDDX.
TELEPHONE: PERIVALE 4277

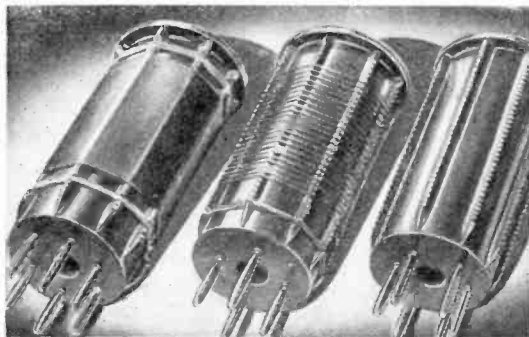

RAYMART COILS & FORMERS

When choosing your components for short and ultra short wave work, remember you can place full confidence in the efficiency of Raymart products. RD4 low-loss dielectric material is used exclusively in Raymart Coils and Formers.

4-Pin Coils.		Price.	6-Pin Coils.		Price.
Type	CA 11 to 25 metres	2/6	Type	CA6. 11 to 25 metres	2/9
"	CB. 20 to 45 "	2/6	"	CB6. 20 to 45 "	2/9
"	CC. 44 to 100 "	2/9	"	CC6. 44 to 100 "	3/-
"	CD. 80 to 180 "	2/9	"	CD6. 80 to 180 "	3/-
			"	CE6. 100 to 250 "	3/3

These coils have an extra primary winding.

Raymart Coil Formers: 4-, 6- and 7-pin types are available. Full details and prices, on request.

Telephone: Midland 3254. **RAYMART** Please add postage on orders valued 5/- or less. **CRAFT A CREED**

48, HOLLOWAY HEAD, BIRMINGHAM, I.

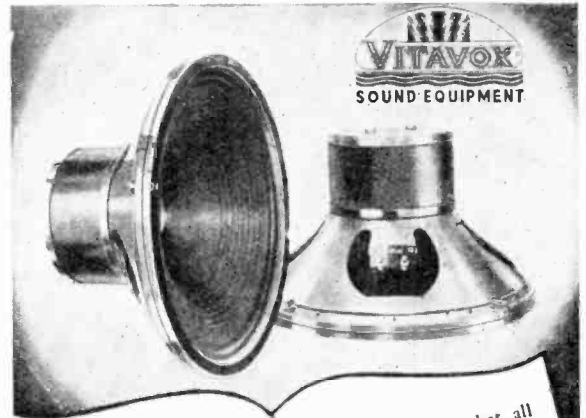

IT is a fact that although VITAVOX K12/10 and K12/20 P.M. Speakers are not available in unlimited quantities, their quality is such that they are well worth waiting for.

It is a fact too that all specification figures are actual and not nominal.

VITAVOX LIMITED,
WESTMORELAND
RD., LONIXON, N.W.9.
Phone Colindale 8671/3



NEW LOW LEVELS in capacity and attenuation of CO-AX Cables mean new possibilities in electronic equipment design both for the war effort and for the post-war electronic age.

Write for characteristics

**BASICALLY BETTER
AIR-SPACED**

CO-AX LOW LOSS CABLES
TRANSRADIO LTD. 16 THE HIGHWAY · BEACONSFIELD · 4-BUCKS.

STABILITY MAINTAINED

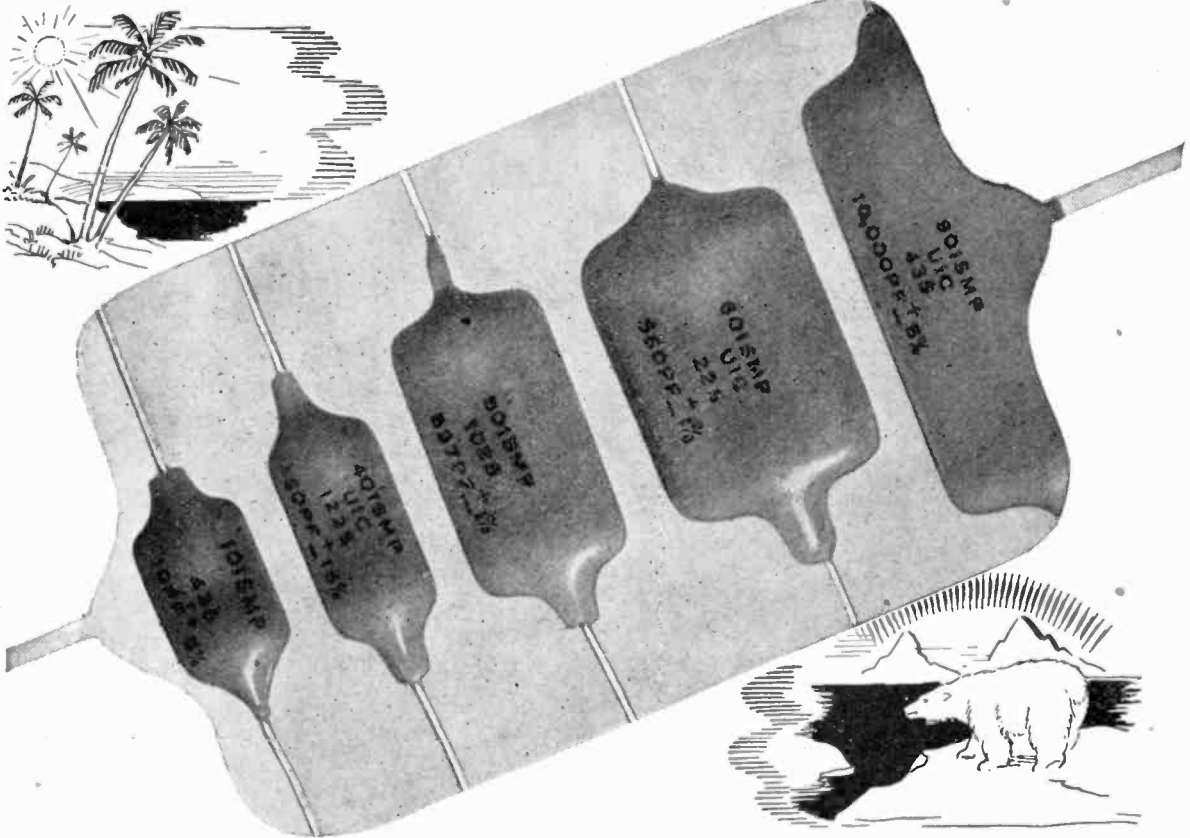

under all climatic conditions

In Tropic heat or Arctic cold, U.I.C. Silvered Mica Capacitors can always be depended upon to maintain the highest mechanical and electrical stability. Available in all standardized sizes ranging in capacitance from 5 pF to 10,000 pF. Full details on request.

UNITED INSULATOR CO. LTD.,
12-22 LAYSTALL STREET, LONDON, E.C.1.

Tel: TBRminus 7383 (5 lines) Grams: Calanel, Smith, London.



SILVERED MICA CAPACITORS

TYPE APPROVED

THE PIONEERS OF LOW-LOSS CERAMICS

Hermetically sealed
to resist heat
and moisture



**B.I. MOULDED
TUBULAR
CAPACITORS**

Manufactured in a wide range of capacities and for working voltages up to and including 6,000 D.C. For high-voltage operation they provide the most effective solution where size and weight are important considerations and are designed to operate continuously in extremely arduous conditions of temperature and humidity. Manufactured in three sizes and supplied with soldering tags at each end, or alternatively with one soldering tag and a stud for base fixing.

BRITISH INSULATED CALLENDER'S CABLES LTD.

Prescot, Lancashire.

YOU CAN STILL GET

PORTABLE P.A. EQUIPMENT

IF YOU ORDER NOW

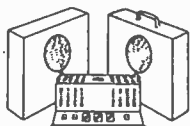

The R.S. "Universal Fifteen" is the most truly portable "portable" outfit yet made available.

Operating equally successfully on either AC or DC at all voltages from 200 to 240, the two loudspeakers, microphone, amplifiers and cables are quickly assembled into one compact unit ready for easy transport. Write now for fullest details—but, a word of warning, only limited supplies are available.



R.S. Amplifiers

R. S. AMPLIFIERS LTD., 9-4, HIGHFIELD RD., SHEPPERTON, MIDDLESEX
TELEPHONE WALTON · ON · THAMES 1019

The
TAYLOR A·C· BRIDGE
MODEL 110A



**6 RANGES OF CAPACITY
RANGES OF RESISTANCE**

The six Capacity ranges cover from .00001 to 120 mfd. and the six Resistance ranges from 1 ohm to 12 Megohms. Power factor can be measured on all Capacity ranges. Please write for technical leaflet.

Price £14 14s. 0d.



Send enquiries to :—

TAYLOR ELECTRICAL INSTRUMENTS LTD

419-424 Montrose Avenue, Slough, Bucks.
Tel.: Slough 21381 (4 lines) Grams: "Taylins", Slough

CELESTION

**VALVEHOLDERS
LOUDSPEAKERS**

Celestion Limited
Kingston-upon-Thames
Telephone : KINGSTON 5656-7-8



A. H. Broly . . . Chief Engineer of Television Station WBKB, Chicago, adjusts the grid circuit of the Eimac 304-TL's in the Class B linear stage of the video transmitter.

**IT'S EIMAC AGAIN!
FIRST CHOICE FOR
THE KEY SOCKETS
AT TELEVISION
STATION WBKB**



Mr. Broly calls attention to the Eimac 1000-T's in the final stage of the Audio FM Transmitter which operates at 65.75 megacycles. It is a very stable amplifier of good efficiency.

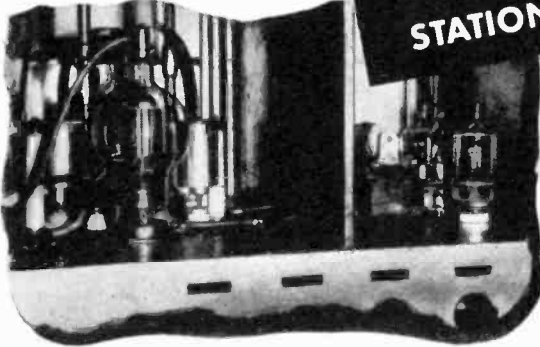

The video transmitter operates at 61.25 megacycles; peak power output is 4 KW which provides a television service throughout metropolitan Chicago and reaches suburbs out to 35 miles or more.

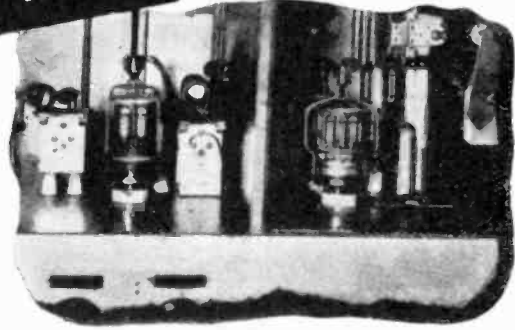

Eimac 152-T's are used in the modulated stage and 304-T's in the first Class B linear amplifier of the video transmitter.



E. F. Caution and W. R. Brock are operating the station which has been broadcasting television programs with the present equipment since 1942 and began operation on a commercial schedule in October, 1943.

Grid modulation is employed at WBKB and a broad band of frequencies must be passed in all stages following the modulated amplifier. Multiple-tuned resistance loaded coupling circuits are used between stages.

Performance, stability, dependability are good reasons why Eimac valves are to be found in the key sockets of the outstanding new developments in Electronics. Balaban & Katz, owners of television station WBKB of Chicago, offer potent confirmation of the fact that Eimac valves are first choice of leading Electronic Engineers the world over.

FOLLOW THE LEADERS TO



ELECTRONIC TELESIS—fully illustrated.
Send for a copy now. The Science of Electronics written in simple language. You'll find it of valuable assistance in explaining electronics to the layman. No obligation.

EITEL-McCULLOUGH, INC., 1032 San Mateo Ave., San Bruno, Calif.
Plants located at: San Bruno, California and Salt Lake City, Utah
Export Agents: Frazer & Hansen
301 Clay Street, San Francisco 11, California, U. S. A.

Authorised Distributors: BERRY'S (SHORT-WAVE) LTD., 25 HIGH HOLBORN, LONDON, W.C.1.

WEIGHT REDUCING

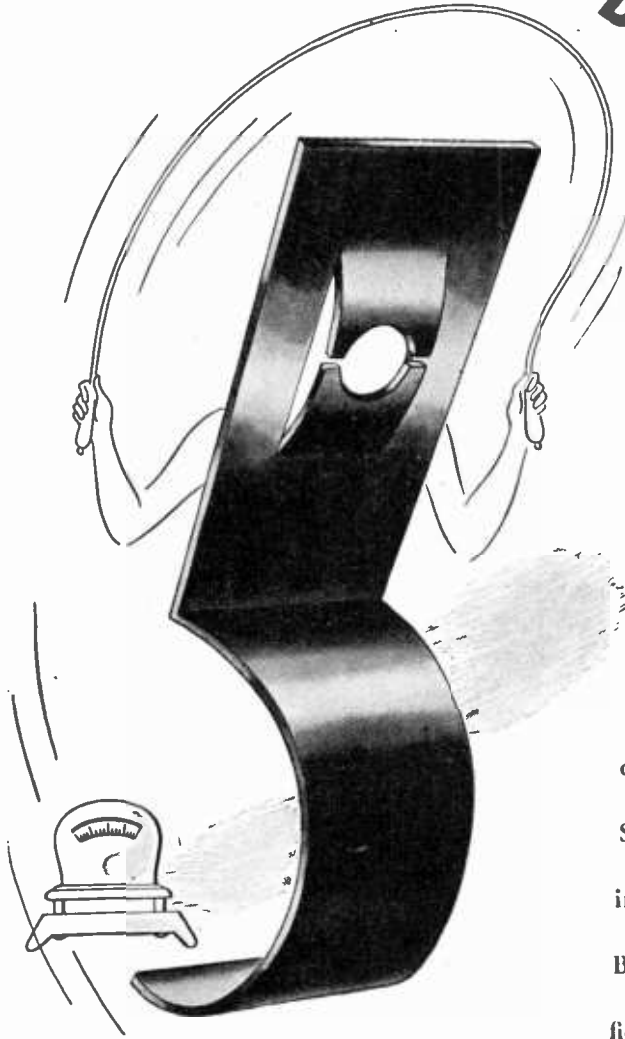

THAT'S Fixed THAT! You may say the NB 1455 is obvious. So it is once it exists—like a lot of other good ideas. The Spire nut device is made part of the component and so these cable clips are screwed direct to their base without need of separate washer or nut. The NB 1455 was developed for a Government Department but it has found wide uses throughout industry.



WHEN you adopt some form of Spire fixing for a light assembly job, you certainly save weight. For one thing you won't need washers. For another the Spire nut is lighter than an ordinary nut. And if we can make the Spire device part of the component you won't even need a Spire nut. You may say that weight saving in your case is a minor matter any way. But is it a minor matter to cut out all that fiddling and fumbling with nuts and washers? Is the saving in cost a minor matter? Or the strength and permanence of the fixing?

Spire

* **A BETTER way of fixing**

Simmonds Aerocessories Limited · Great West Road · London · A Company of the Simmonds Group

Wireless World

Radio and Electronics

35th YEAR OF PUBLICATION

SEPTEMBER 1945

Proprietors :
ILIFFE & SONS LTD.

Managing Editor :
HUGH S. POCOCK,
M.I.E.E.

Editor :
H. F. SMITH

Editorial, Advertising
and Publishing Offices:

DORSET HOUSE,
STAMFORD STREET,
LONDON, S.E.1.

Telephone :
Waterloo 3333 (35 lines).
Telegrams :
"Ethaworld, Sedist, London."



PUBLISHED
MONTHLY

Price : 1/6

(Publication date 26th
of preceding month)

Subscription Rate :
Home and Abroad
20/- per annum.

MONTHLY COMMENTARY	257
PLAN FOR EUROPE	258
"SEE-SAW" OR "PARAPHASE" ? By R. E. H. Carpenter	263
EMERGENCY LIFEBOAT TRANSMITTER	266
ACHIEVEMENTS OF RADAR	269
VALVE VECTORS AGAIN By Dr. K. R. Sturley	271
UNBIASED. By Free Grid	274
CONTRAST EXPANSION By J. G. White	275
WORLD OF WIRELESS	279
LETTERS TO THE EDITOR	282
RANDOM RADIATIONS By "Diallist"	286
RECENT INVENTIONS	288

Branch Offices ;

COVENTRY :
8-10, Corporation Street,
Telephone : Coventry 5210.
Telegrams :
"Autocar, Coventry."

BIRMINGHAM :
Guildhall Buildings,
Navigation Street 2.
Telephone :
Midland 2971 (5 lines).
Telegrams :
"Autopress, Birmingham."

MANCHESTER :
260, Deansgate, 3.
Telephone :
Blackfriars 4412 (4 lines).
Telegrams :
"Iliffe, Manchester."

GLASGOW :
26B, Renfield Street, C.2.
Telephone : Central 4857.
Telegrams : "Iliffe, Glasgow."



As many of the circuits and apparatus described in these pages are covered by patents, readers are advised, before making use of them, to satisfy themselves that they would not be infringing patents.

WE know HOW OUR SEALS WILL PERFORM



The first requirement of a seal is that it shall be a perfect seal. The second—that it shall continue to be a perfect seal for the period of its useful life.

The "STRATOSIL" sealing of Wright & Weaire VIBRATORS ensures effective operation in all situations irrespective of climatic conditions. Other principal features include: All-steel construction, Sponge-rubber lined metal can, Non-tarnishable precious metal driving contact, Contacts ground almost to optical limits, Mica and steel stack assembly.

"Wearite" Vibrators are available now for commercial purposes in both non-synchronous and self-rectifying types.



STRATOSIL Sealed VIBRATORS

W R I G H T & W E A I R E L I M I T E D 
High Road, Tottenham, N.17. Telephone: TOTTENHAM 3847-8-9.

The **MULLARD** *all-glass technique*

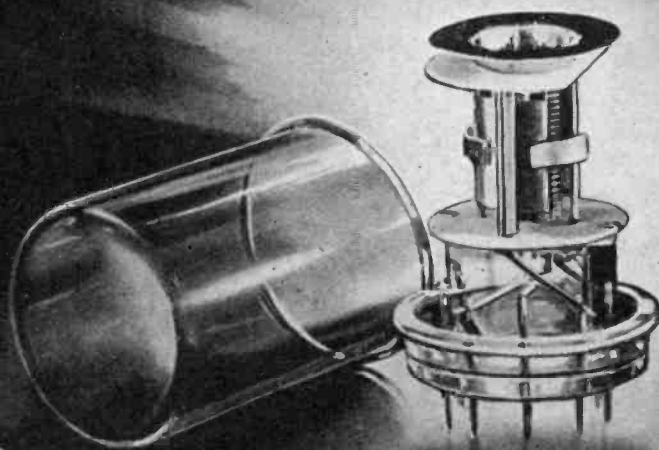

By a complete departure from the conventional form of valve construction, Mullard have effectively reduced the losses due to H.F. resistance, inductance and capacity effects within the valve itself and in the leads coming from the electrodes. The all-glass technique makes use of an almost flat circular glass pressing for the base of the valve, into which short pins are sealed, the electrodes being welded directly to the pins. By thus reducing the length of the lead-out connections, considerably improved efficiency at the higher radio frequencies has been achieved.

A
DEVELOPMENT
OF THE
MULLARD
LABORATORIES

Wireless World

Radio and Electronics

Vol. LI. No. 9

SEPTEMBER 1945

Price 1s. 6d.

Monthly Commentary

The Industry's Plan for Broadcasting

EVER since the time when the end of the European war appeared to be coming within measurable distance, this journal has urged the need for removing all barriers likely to stand in the way of quick industrial transition to peacetime conditions. It has been stressed that designers and manufacturers of almost every kind of wireless equipment are completely dependent on matters outside their control; without knowing precisely what bands of frequencies are involved and the nature of the emissions to be dealt with, nothing approaching a final design can be produced. We even went to the length of advocating what, for want of a better word, was described as an "international" conference to settle some of the more acute problems that affect large-scale production. Perhaps we were over-optimistic; at any rate, most of the problems still remain unsolved. Even in America, where the question was promptly and most energetically tackled by industrial and other wireless interests, with the fullest support, encouragement and guidance from the U.S. government, a final settlement has barely been reached in producing a complete national plan. As a result, manufacturers everywhere are in the unenviable position of being held up, not only by shortages of man-power and materials—that is more or less inevitable—but also by lack of detailed knowledge of the conditions of use for which their productions must be designed.

But, if there has been a lack of enthusiasm in British official quarters for discussing the post-war re-organisation of radio, industrial interests have shown more concern in its problems. Soon after the tide of battle turned in favour of the United Nations, the Cossor Research Laboratories produced an interesting and highly detailed plan for a new technical set-up of British broadcasting. This was followed by much useful public discussion, generally originated by engineers of manufacturing firms, of proposals for the technical re-organisation of sound and vision broadcasting.

It is all to the good that those who make wireless

equipment should put their views before those whose task it is to determine the conditions under which the gear will be used. If only for that reason, we welcome the Report on "Post-war European Broadcasting," recently issued by the Radio Industry Council. A summary of this Report, printed elsewhere in this issue, shows that it presents a Plan for complete re-organisation.

Engineering: not Politics

In many respects the Plan follows established convention; it employs none of the newer techniques of transmission and is restricted virtually to a re-allocation of the existing "long" and "medium" broadcast wavebands. Where it differs from earlier plans is in the fact that it is based on a close adherence to engineering principles and not on political considerations. The authors modestly disclaim complete knowledge of the political, cultural and geo-physical considerations involved, and freely admit that the Plan is in many respects tentative, and subject to modification in matters of detail. We agree with the authors in thinking that non-technical considerations should be regarded as entirely subsidiary to the engineering basis of the Plan; if that basis be sound, the details should settle themselves. As is stated in the Report, the history of wavelength allocation in Europe shows it "has been successively an unidentified, then an imperfectly understood, and finally a politically obscured problem." And, we may add, so it will remain unless politics be divorced from engineering in these matters.

Perhaps the greatest advantage of a plan for channel allocations based on clearly defined technical principles is that it stands a better chance of acceptance without undignified wrangling than does a system which attempts to take into account such things as national aspirations and prejudices. The R.I.C. Plan, so far at least as the allocation of "national" channels is concerned, seems to leave few grounds for quarrelling.

PLAN FOR EUROPE

Broadcasting Allocations on Engineering Principles

BBROADCASTING has grown as a planless thing, with few attempts to establish clear-cut technical principles on which channels should be allocated. At first these principles were not understood; witness the fact that one of the first "plans" was based on a 5-metre separation of carriers, applying equally to the 200-metre and 500-metre ends of the "medium" band. It is a sad reflection that, when we had mastered the principles, their application was hampered by political pressure.

Clearly, these facts have been fully realised in the preparation of a Report entitled "Post War European Broadcasting," prepared by the British Radio Equipment Manufacturers' Association and recently issued by the Radio Industry Council. The Report is the work of a sub-committee under the chairmanship of C. S. Agate, with R. G. Clark, C. A. W. Harmer, H. A. Brooke and G. Bernard Baker as members. In the introduction, great stress is laid on the need for allocating channels and transmitting power on engineering principles, rather than on the political and other considerations that have prevailed in the past.

Broadly, the aim of the plan is to provide every European country with two "national" programmes, as well as a system of localised transmissions to suit the special needs of any important regions or language groups in each country. It is urged that allocations would be made in such a way as to ensure better quality of reception and greater freedom from interference than in the past; the whole system would be planned to give every listener easy reception of foreign stations as an adjunct to the domestic service.

According to the plan, these objects are attained by reserving the longer wavelengths, which give the greatest service areas, for the "national" stations. The actual wavebands suggested are virtually the existing "long" and "med-

ium" bands as at present used for broadcasting, with slight extensions. The order of wavelength, and the power to be used, would be related strictly to the area to be served. Thus the largest country would have the longest wavelength for its "national" services. Shorter wavelengths would be reserved mainly (and the shortest exclusively) for regional services or for the "national" services of very small countries. A station separation of 11 kc/s is allowed for, instead of 9 kc/s as at present.

The Report is issued by the R.I.C. as a 20-page booklet, including a bibliography and several appendices; there are also two maps, which are reproduced here on a reduced scale as part of the summary of the suggested plan which follows.

Principles of the Plan.—The Report confines itself to considering only existing transmitting means. Such expedients as partial single side-band transmission, emphasis or de-emphasis of part of the modulation spectrum with subsequent correction, narrow-band FM or other methods rendering obsolete all existing receivers, have not been considered.

The coverage of stations is assumed to be determined by the "fading radius." This means that sufficient power is assumed at the transmitter to provide within the fading radius a signal great enough effectively to overcome static noise. A minimum signal greater than 2mV per metre should be aimed at, because in some industrial areas the present noise-level would constitute an appreciable background on such a signal.

The average fading radius cannot be exactly determined, since it depends on soil conductivity and to some extent on the contours of the ground. Even if an average value of 10^{-13} is taken for the conductivity—a value which is applicable for large tracts of Europe—various authorities show considerable differences of opinion

on the performance to be expected. Also the maximum tolerable ratio of space- to ground-wave is a matter which must be settled arbitrarily. Various authorities place this ratio as 1:2 and 1:5; therefore, 1:3 has been adopted as a mean value.

Based on these assumptions, the primary service area of medium-wave broadcasting stations is roughly given by:—

$$\text{Range (miles)} = \frac{\lambda \text{ (metres)}}{4}$$

A plot of range against wavelength for the medium-wave band is found to be nearly a straight line, and this has been extrapolated to include the long-wave band as well. Practical experience shows this to be justified.

It is appreciated that geographical distribution is frequently an important factor in the allocation of wavelengths, and known difficulties with terrain have been taken into account.

No claim is made that the frequency allocations proposed are a unique solution to the problem. The authors are aware that they have not full knowledge of all the factors which must be taken into account in making such a plan, but they feel that the allocations provide adequate support for the argument. Changes can be made without upsetting the plan as a whole, so long as the general principle of relating wavelength to area is treated as fundamental.

The Problem.—A successful broadcasting system must attempt to satisfy the following criteria:—

1. It must provide for every nation at least one, and in most cases two programmes.
2. Where a nation possesses more than one main language group, a separate regional programme (in some cases two) must be provided for each language.
3. It must provide localised programmes for each important region.
4. It must so allocate the

available spectrum that a minimum of station interference is experienced at any listening point, and so that reasonable quality of reproduction is possible.

5. It must arrange the powers of the various stations so that they provide signals over the whole of their service areas large enough to over-ride interference. Powers in excess of this amount must be forbidden, since they are likely to cause unnecessary interference.
6. The whole system should aim at providing for every listener good signals from foreign stations in addition to his own.

It is obvious that whether all the criteria can be satisfied or not depends on the width of the frequency spectrum allocated to broadcasting, and on the number of nations, languages and regions which have to be covered. Experience of the pre-war system showed that the medium waveband alone cannot solve the problem, and even the addition of the long waveband did not, with the then allocations, provide a very satisfactory solution. For example, in the Montreux Plan, on 1375 kc/s (218 metres) there was proposed a Luxembourg station with a power of 200 kW, which was unsuitably high for the wavelength selected, as well as being excessive for the size and needs of the country concerned; on 240.5 kc/s (1247 metres) a station was allotted to Denmark, which is one of the smallest countries in Europe, and could be adequately covered by a shorter wavelength. The Montreux Plan did, on the other hand, propose certain small improvements on the state of affairs as it was in 1939. For example, the 160 kc/s (1875 m.) transmitter at Hilversum was deleted, thereby saving a valuable channel for more efficient use.

The total number of separate broadcasting stations envisaged in the Montreux Plan was about three hundred, and it is almost certain that the number alone was quite sufficient. It is interesting to note that this number of transmitters, each with a service radius of only fifty miles, would more than cover the entire area of

Europe, including European Russia, if evenly distributed.

Since there is obviously not room for such a large number of non-shared channels within the broadcast bands, any broadcasting plan must inevitably use shared frequencies. Both the Montreux Plan and the actual arrangement in use at the moment naturally tend to confine the use of shared channels to the higher frequencies (shorter wavelengths), but the result is not altogether satisfactory, due, at least in part, to the use of excessive power.

Proposed National Services.—

There are in Europe thirty countries, excluding small principalities such as San Marino, Andorra, Monaco, etc. It is likely that the policy adopted in countries like Switzerland, Belgium, Czechoslovakia, will follow past practice, as it is probable that the cost involved in providing dual national programmes in each language would be considered prohibitive. In a number of cases, therefore, countries which have more than one language should be considered on a regional basis. In practice Russia appears to be the only country which requires a national service in more than one language. It is extremely difficult to estimate Russia's probable requirements in this direction, so for the purpose of this Plan a dual service in two languages has been assumed for that part of Russia which lies west of longitude 55 deg. E.

Proceeding on these assumptions, the allocations are obtained by examining the areas occupied by the various nationalities in Europe and writing down a list giving the approximate wavelengths of the stations required in each country to cover its area. In cases where the nature of the country is mountainous, special allowances have to be made, while the longer wavelengths are to be avoided in latitudes lower than 40 deg. N. owing to the prevalence of atmospheric low frequencies in low latitudes.

The next problem is to find sufficient separate channels of the right order of wavelength to cover the areas with a dual national programme service, and with the largest possible separation.

Proceeding along these lines, it was soon found that more long-wave channels were required than could be contained within the commonly-used band of 150-290 kc/s (2000-1000 m.). There are, however, broadcasting stations allocated between 330 kc/s (910 m.) and 450 kc/s (667 m.) in the Montreux Plan, and these are distributed all over Europe. It is proposed, therefore, to add these frequencies to the normal long-wave band, stopping short at 432 kc/s (700 m.) so as to leave a reasonable gap for intermediate frequency use between the "long" and "medium" wavebands. An economy also derives from the fact that Russia and Iceland already share one wavelength; and in the same way common-wave working lower down the "long" waveband can be arranged without danger of interference for Spain and Russia, and Finland and Turkey.

By these means it is finally possible to allocate two national channels for each of the thirteen large countries, with the frequency separation increased from 9 kc/s to 11 kc/s. This allocation is given in the appendix.

It might at first sight appear that the design of radio receivers covering the band of 156-432 kc/s (with an unused gap between 288 kc/s and 344 kc/s) is a difficult problem. Actually such receivers have been manufactured in quantity at trifling extra cost.

It is appreciated that the operation of some of these transmitters would have to be the subject of agreement with other operating authorities, but the proposals are not very different from those contained in the Montreux Plan, and it should not be politically or technically impossible to rearrange the frequencies involved so as to meet the requirements of all services at present operating in this band.

We are now left with a number of smaller countries whose size does not require long wavelengths, and to these have to be allotted channels in the "medium" waveband in precisely the same way. Starting from the rough order of wavelength in relation to area, determined in accordance with the principles already laid down, the tentative allocations shown in the

Plan for Europe—

appendix have been compiled. These cover the remaining seventeen European countries.

So far, then, pairs of national channels separated by 11 kc/s have been allocated to every nation in Europe with little necessity for sharing channels. We can, therefore, designate the bands from 150 kc/s to 1157 kc/s (2000 to 260 m.) as the "national wavebands," although, in fact, certain gaps have been left in the medium "national" band to accommodate some of the regional services required in the bigger areas in Europe and for a chain of stations along the North African coast.

As we shall see later, when we discuss briefly the regional systems, the requirements of certain localities—e.g., Western Russia and Turkey—cannot easily be predicted, and it may be desirable to use some of the "exclusive" national channels to provide proper regional coverage. Present practice has given us some experience of such workings, and, in view of the enormous distances involved, no interference need be feared on these shared national channels if the proper power limitations are observed.

Regional Services.—The requirements of regional broadcasting are not so easy to define, but, taking Great Britain as representative, and roughly comparing the areas and population distribution of other countries, we can arrive at a list showing the number of regional wavelengths required in every country. This list comprises a total of 93 channels, plus an undetermined number for European Russia.

The frequencies at our disposal lie between 1157 and 1560 kc/s (260 and 192 metres)—a band of 403 kc/s. The maximum fading radius in this band ($\lambda/4$) is 75 miles; therefore, provided that the transmitter power is not allowed to exceed that required to give the minimum signal at the edge of the service area, the use of common waves in this band will cause no trouble. This is borne out in practice.

If we allow two stations per channel, we obtain a total of exactly 72 stations with a frequency separation of 11 kc/s.

This, with the "regional" frequencies reserved in the medium wave national band (see the appendix) would satisfy the requirements for Europe, excluding Russia. But experience in the past has shown that common-wave working is practicable provided that stations are separated by 1,500-2,000 miles; it is therefore clearly possible in a large number of cases to operate three, and in some cases four, stations per channel, so that a satisfactory solution to the regional allocation problem should not be difficult.

It is obviously outside the scope of this Report to attempt to allocate either the exact wavelengths or positions of all the regional services required in Europe, but as a check on the plan, the regional system proposed for the United Kingdom can be roughly outlined. It will be assumed that 11 regional transmitters are required in Great Britain and Northern Ireland. Of these, four (Glasgow, Huddersfield, London and Washford) will require allocations from those reserved in the medium-wave national band. The remaining seven regions must therefore be covered in the regional band above 1157 kc/s. Since there are 403 kc/s in the band, these seven channels could be evenly spaced 80 kc/s apart. Suggested positions for these regional stations are shown in the accompanying map. Should any area be insufficiently covered by its transmitter, it is entirely within the scope of the plan for additional transmitters to be installed giving the programme appropriate to the area and synchronised with one of the other limited-power regional stations at a suitable distance away.

This band, therefore, from 1157-1560 kc/s appears to be ample to provide an expanded regional service for the whole of Europe. Following the proposal to call the range between 150 kc/s and 1157 kc/s (2,000-260 metres) the "national wavebands," it would be convenient to refer to this second band as the "regional waveband." But, as already mentioned, it has been necessary because of special considerations in certain localities to allocate on the longer wavelengths a limited number of regional services in five small groups. In addition, alloca-

tions have to be provided for Cairo, Algiers, Tunis, Jerusalem, Tripoli and Morocco. Despite these requirements, the majority of regional services are allocated in the 1157-1560 kc/s band, and the broad classification of the waveband as "regional" may be considered applicable.

It is interesting to observe that these allocations greatly simplify both the handling of radio receivers by the public and the designing of scales for the receivers. Thus from 150 kc/s to 1157 kc/s (2,000 to 260 metres), where there are few shared channels, the user may reasonably expect at night time to find clear programmes subject only to natural fading.

It is also worth pointing out that if it proves possible to re-engineer the broadcasting services of Europe on the lines described, due attention should be given to the relation between national and regional allocations (particularly the latter) and the intermediate frequencies used in broadcast receivers. In the past designers have always been faced with the problem of finding suitable intermediate frequencies after any wavelength plan has become a *fait accompli*. The problem would be simplified by collaboration, so that certain undesirable combinations of frequencies would always be avoided in any one area.

Finally, it has long been realised that for the success of any European broadcasting scheme the frequencies of transmitters must be rigidly kept if interference is to be avoided. In general, this state of affairs has been reached, and a close check is kept on the emission frequencies of broadcasting stations. There is, however, an unchecked and virulent source of interference—overmodulation. It is possibly desirable, with an 11-kc/s gap, to avoid radiating side-bands outside ± 8 kc/s. Audio filters can easily achieve this at the transmitter, but they are useless if the modulation is allowed to exceed 100 per cent. The authors feel that it is vital to enforce control of modulation depths, and would point out that automatic engineering means of achieving this are well known, and that there is no need to rely

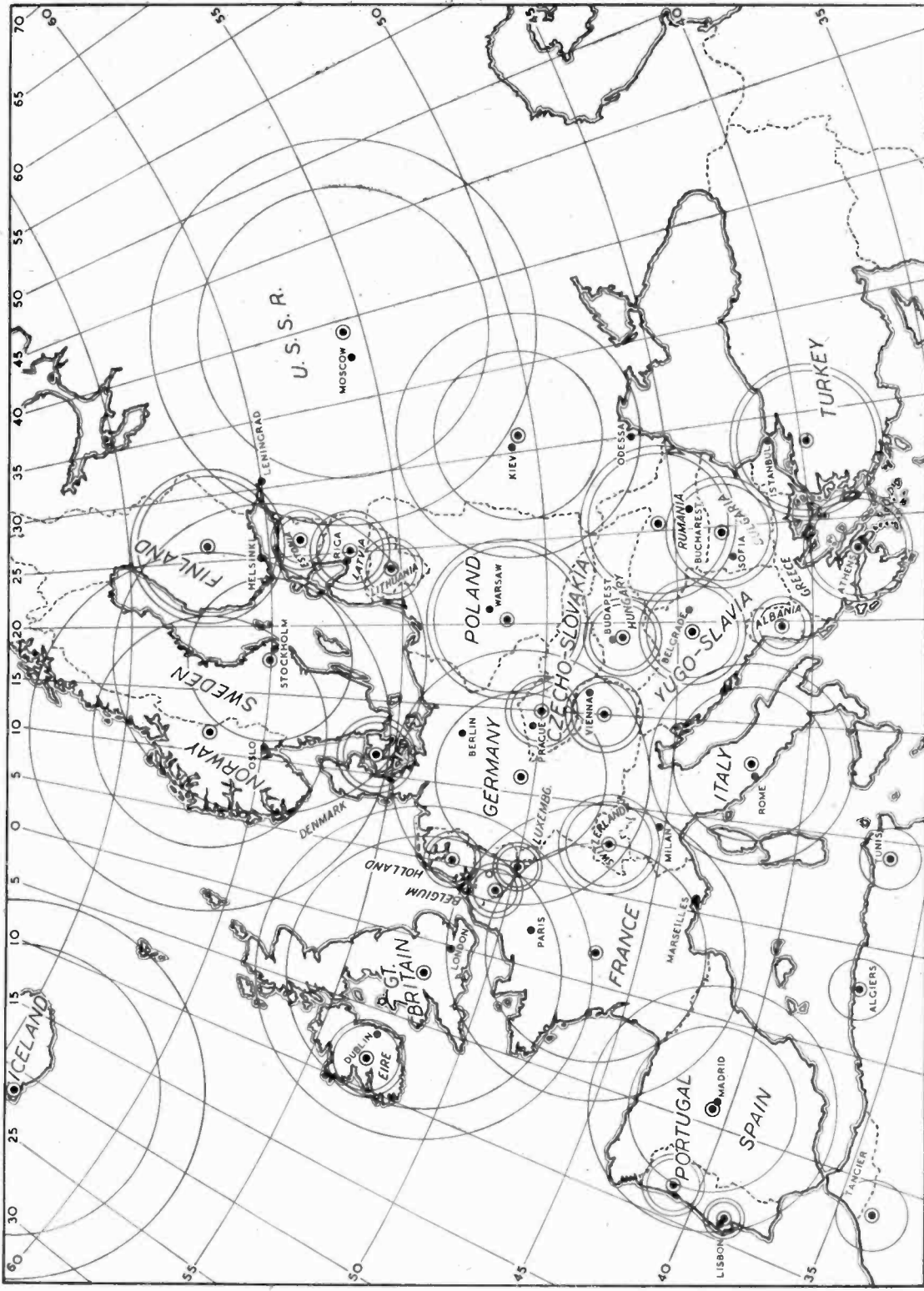

National stations : the concentric circles indicate service areas of each transmitter of the twin national stations suggested for each country. Wave-lengths are chosen in relation to the area to be covered, and station range is related to wavelength in accordance with the principles explained in the text. Stations at Tripoli, Alexandria and Jerusalem (not shown on the map) are also proposed.

Plan for Europe—
on the manual dexterity of a
monitoring engineer.

APPENDIX

Tentative National Frequency
Allocations

Providing two national pro-
gramme services for 30 countries.
(European Russia is regarded as two
countries as it has two main lan-
guages.)

Extended Long-wave Band

kc/s.	Country		
156 ...	Iceland	A
167 ...	Russia	1A
167 ...	Norway	A
178 ...	Great Britain	A
189 ...	Sweden	A
200 ...	France	A
211 ...	Iceland	B
211 ...	Russia	1B
222 ...	Great Britain	B
233 ...	Germany	A
244 ...	Spain	A
244 ...	Russia	2A
255 ...	Norway	B
266 ...	France	A
277 ...	Sweden	B
288 ...	Italy	A
344 ...	Germany	B
355 ...	Spain	B
355 ...	Russia	2B
366 ...	Poland	A
377 ...	Italy	B
388 ...	Finland	A
399 ...	Turkey	A
399 ...	Rumania	A
410 ...	Poland	B
421 ...	Finland	B
421 ...	Turkey	B
432 ...	Rumania	B

Medium-wave Band

552 ...	Yugoslavia	A
563 ...	Greece	A
574 ...	Bulgaria	A
585 ...	Switzerland	A
596 ...			
607 ...		Regional	
618 ...			
629 ...			
640 ...			
651 ...	Yugoslavia	B
662 ...	Greece	B
673 ...	Bulgaria	B
684 ...	Switzerland	B
695 ...			
706 ...			
717 ...		Regional	
728 ...			
739 ...			
750 ...	Hungary	A
761 ...	Lithuania	A
772 ...	Czechoslovakia	A
783 ...	Eire	A
794 ...	Austria	A
805 ...	Denmark	A
816 ...	Cairo	A
827 ...	Morocco	A
838 ...			
840 ...		Regional	
860 ...			
871 ...	Hungary	B
882 ...	Lithuania	B
893 ...	Czechoslovakia	B
904 ...	Eire	B
915 ...	Austria	B
926 ...	Denmark	B
937 ...	Cairo	B
948 ...	Algiers	B
959 ...	Tripoli	B
970 ...	Jerusalem ...	Regional	
981 ...	Tunis ...		
992 ...	Latvia	A
1003 ...	Portugal	A

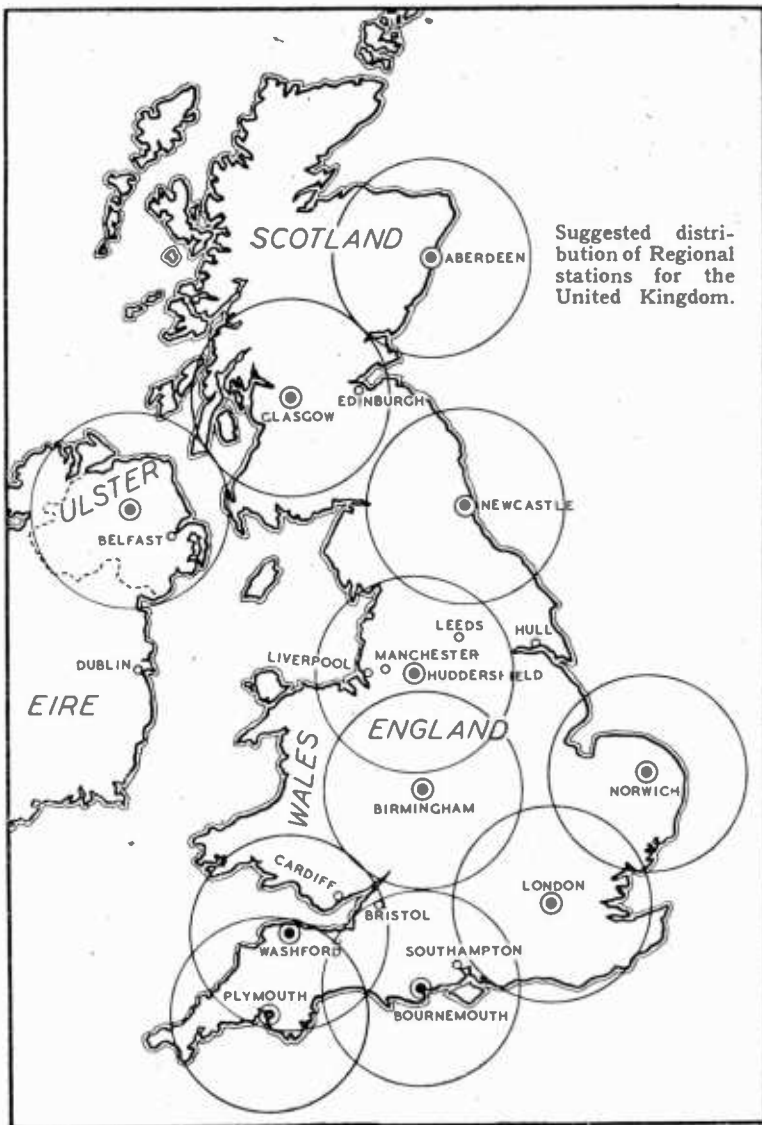

Suggested distri-
bution of Regional
stations for the
United Kingdom.

kc/s.	Country		
1014 ...	Albania	A
1025 ...	Holland	A
1036 ...	Estonia	A
1047 ...			
1058 ...			
1069 ...		Regional	
1080 ...			
1091 ...			
1102 ...	Latvia	B
1113 ...	Portugal	B
1124 ...	Albania	B
1135 ...	Holland	B
1146 ...	Estonia	B

Russia and Iceland are given
common frequencies (as now).

As explained in the text, very
small countries are regarded as
"regions" and excluded from the
"national" allocations suggested in
this list. Frequencies from 1157 to
1553 kc/s are exclusively "re-
gional"; in addition, those regional
stations serving the larger areas are
given some channels from the
"national" band.

Notes.

Alternative programmes for each
country are denoted by the letters
A and B.

Separate language divisions
(Russia only) shown by numerals 1
and 2.

It is realised that in one or two
cases national coverage is slightly
inadequate, and so extra very-low-
power transmitters will have to be
provided to fill the gaps, as is com-
mon practice in Great Britain to-
day.

"SEE-SAW" OR "PARAPHASE"?

Origin of the Circuit : Some Practical Points

By R. E. H. CARPENTER

IN the July issue of *Wireless World* Squadron Leader Scroggie describes a circuit which he aptly calls the "See-Saw" circuit, but which he distinguishes from the "Paraphase" circuit.

In British Patent No. 325833 I coined the word "Paraphase," and if comparison be made between Fig. 6 of the patent and Fig. 4 of the article just mentioned, the two circuits will be found to be essentially identical: the only difference of any importance is that, in the patent drawing the tapping point on the resistance path connected between the two anodes from which the grid voltage of the second valve is derived is displaced, as it ought to be, a little towards the anode of the input valve. This was of course obviously essential in 1929 when high-gain valves were not in common use, but in my opinion it still is for reasons which will be given later. The self-balancing properties of this circuit were well known to me, and it was

drawing public attention to it. The circuit as such has, however, been described by various writers; see, for example, L. W. Hayes on page 950 of *World Radio* for 12th December, 1930, and *Radio Designers' Handbook*, p. 12. The circuit was used in the Science Museum receiver in 1930 and was chosen because of its self-balancing properties to which I drew attention at the time.

Turning now to S/Ldr. Scroggie's proposal to use a fixed centre-tapping from which to derive the grid voltage for the second valve, I fear that in practice this may give very bad results for the following reasons.

First, it is stated that "so long as the resistors R5 and R6 are equal within commercial limits . . . the voltage balance adjusts itself." A pair of resistors marked "1 MΩ" taken at random might easily differ by 40 per cent., which is 10 per cent. more than the maximum

cross-connected anode-to-anode resistance lying between the tapping point and the electrical fulcrum—obviously this is only a small matter if valves of very high voltage gain be employed, but it operates to impede the balance.

Thirdly, the anode resistances may be unequal. It is therefore very much better to employ an adjustable tapping point, which is readily done by connecting a wire-wound potentiometer type resistor between R5 and R6 and taking the grid lead off from the movable connection: the correct balance point is then very easily found in one of two ways.

If the two anode resistances (50,000 Ω in S/Ldr. Scroggie's diagram) are known to be equal within, say, 5 per cent., a pair of low-resistance phones (or better, a step-down transformer with phones across its secondary) is connected in the common anode supply lead to the two valves and signals are applied to the grid of the first. On adjusting the tapping point a position will be found where the signals heard show a sharply defined minimum, which indicates of course that the phase-opposed alternating components of the anode currents are equal, and hence, that the alternating voltages at the points A, B, are equal to the same degree of accuracy as the values of two anode resistors.

Alternatively, if two precisely equal high-value resistors say of 1 MΩ each be connected in series between the two anodes and a condenser in series with a pair of high-resistance headphones be connected between the centre point and earth, the balance point can be determined as before. Whatever method is employed, it is important to do nothing which will affect materially the magnification given by the valves, or the balance will change on removal of the balancing components.

Once the correct tapping-point has been set with a pair of reasonably similar valves, the self-balancing effect is quite sufficient to compensate for subsequent

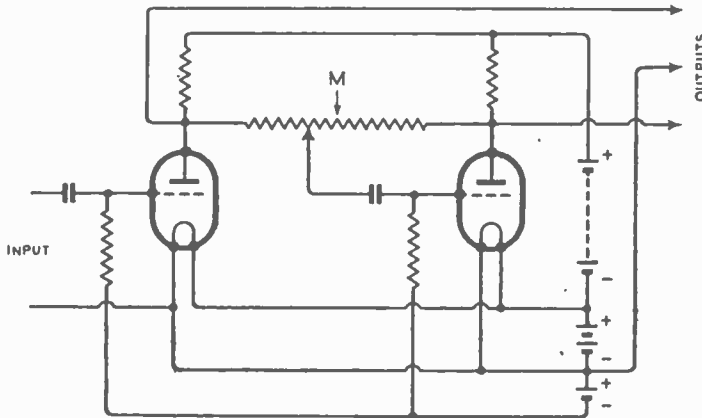

This circuit diagram is redrawn from Fig. 6 of the Patent specification mentioned in the text.

always used in commercial designs in preference to the more obvious connection given for example in Fig. 2 of the patent, but it is only fair to S/Ldr. Scroggie to mention that the self-balancing effect is not mentioned in the Patent, and, I am indebted to him for

difference contemplated in Fig. 5 of the article.

Secondly, the calculation of which the results are presented graphically in Fig. 5 take no account of the grid leak R7; clearly this is effectively in parallel with that part of the

"See-Saw" or "Paraphase" ?—

changes in valve characteristic or for valve replacement; it is chiefly in this that the real value of the circuit lies.

When two valves of similar characteristics are not available or when the characteristics are not known, a good approximation to the optimum tapping point may be made by interchanging the two valves, and noting the change, if any, in the point of balance: the mean of the two settings may then be employed. If, however, a re-balance can be made whenever a valve is to be replaced it is obviously undesirable to adopt this practice.

Referring to Fig. 4, it is in many cases better to omit the condenser shown in shunt with the common cathode resistor since this carries no alternating component when the valves are balanced and the omission of the condenser helps the self-balancing effect.

The manuscript of the above article, together with several letters of comment on the article "The See-Saw Circuit" have been passed to S/Ldr. Scroggie. He replies as follows:—

I AM indebted to several correspondents for pointing out that my calculations of the "See-Saw" circuit did not take into account the loading effect of the grid leak (R7 in Fig. 1), and

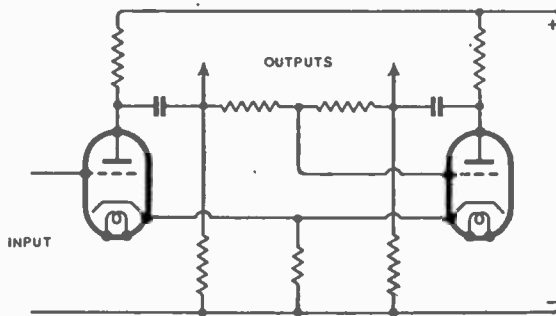

that they are correct only when its resistance is infinite. As one of them has pointed out, this condition can be achieved by a modification of the circuit, shown as Fig. A. But I must admit

that my original circuit (Fig. 4) showed R7 equal in value to R5 and R6 (1 megohm). This is a reasonable practical assumption,

effect, which is an additional reason for using a tetrode or pentode.

A correspondent has suggested the application of the see-saw

system direct to the output stage. This would seem to be an economical and quite satisfactory arrangement provided that (a) the external grid drive can be provided at the required amplitude without distortion (this should not be a serious difficulty), and (b) the tapping from which the other grid drive is ob-

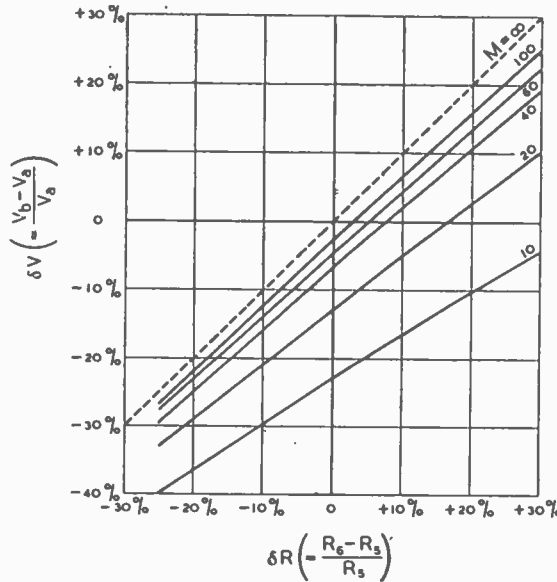

Fig. B. Percentage departure from voltage balance under conditions given in the text.

and several readers have worked out the balance conditions for it. When plotted, they yield Fig. B, which should be compared with my original Fig. 5. It will be seen that the general character of the results is similar, but numerically the departure from balance when R5 and R6 are equal is somewhat increased. It is interesting to note that this increase is exactly neutralised if the valve gain, M, is increased by 50 per cent.

As one reader has hinted, if the resistances of R5, R6 and R7 are very high, it may not be permissible to ignore the input capacitance of the valve. For example, it is unlikely to be less than 10 μμF,

Fig. A. A modification of the original "See-Saw" circuit.

which at a frequency of 10,000 c/s is 1.6 megohms reactance, comparable with the resistances. If a high-amplification triode were used, the capacitance would be many times greater owing to Miller

tained is suitably adjusted, as it is unlikely that the voltage gain of an output stage would be sufficient to ensure a good enough balance otherwise.

Mr. Carpenter has rightly pointed out, that it is better to omit the cathode resistor by-pass condenser when it is common to two similar push-pull valves. If it is not common, however, it is desirable to fit the condenser in order to avoid loss of amplification.

In referring to resistors equal "within commercial limits" I did not mean that resistors of unlimited tolerances should be used without any check, but that ordinary commercial types could be used after a rough test for equality within, say, 10 per cent., and that it was unnecessary to use precision resistors, or a wire-wound potentiometer as advocated by Mr. Carpenter. I assume, of course, that the amplifier is to be used for ordinary purposes, and not in some precision measurement system.

The name "Paraphase" has often been understood to apply to the particular phase-splitter circuit in which the grid drive for one valve is obtained from a

tapping on the anode resistor of the other; and I confess that I have used it in this sense. I am glad to have it on the authority of the inventor himself that he gave it a much wider meaning, covering practically all RC push-pull amplifiers. This being so, the name "see-saw" is useful for distinguishing one particular form of Paraphase circuit.

Some correspondents made the mistake of saying I assumed the characteristics of the two valves in this circuit to be identical. On the contrary, I said "There is obviously no necessity for this

valve (i.e., the driver) to be of the same type as the phase-splitter valve," and to emphasise this point I started by showing the former as an arbitrary generator, which need not even be a valve at all! Except for an output stage, the question of equality of valve characteristics, on which Mr. Carpenter lays stress, therefore does not arise. Nor does the necessity for equal anode resistances. There are, of course, some incidental advantages in symmetry.

Mr. Carpenter's tests for balance both necessitate close equality

of two resistors. If facilities exist for obtaining such resistors (or, better still, resistors differing by a specified percentage) it is simpler to use them as the anode-to-anode resistors in the see-saw circuit; and provided the stage gain is not less than about 40 (as it will be with tetrode or pentode) a satisfactory and permanent balance is automatically ensured, without the trouble of making periodical tests and adjustments. It was to draw attention to this great advantage of the see-saw circuit that my article was written. M. G. S.

SILICONES

Organic Silicon Compounds with Exceptional Properties as Insulators

A NEW range of chemical compounds known as silicones has been developed in America by the Dow Corning Corporation, and is described in a paper in the July 1945 issue of *Proceedings of the I.R.E.* These possess the heat stability associated with conventional inorganic silicon insulators such as glass, quartz, mica and ceramics, yet are available as liquids, greases and "resins" with physical properties usually found only in the organic group of insulators such as transformer oil, waxes and thermoplastic resins.

The production of organic compounds with silicon is not in itself new, but hitherto it has been of rather academic interest. Recent developments have been along the lines followed in producing new plastics, namely, the building of large polymerised molecules having different physical characteristics. At one end of the scale are a series of volatile liquids with freezing points down to -68 deg. C. and at the other, a range of thermosetting resins with transition temperatures in the region of 250 deg. C. All are characterised by chemical inertness and resistance to oxidation; they do not affect rubber and are non-corrosive to metals. While being soluble in most organic solvents they are unaffected by

water. The surface tension of the liquids is low and they show a preferential wetting power for the surfaces of silica compounds such as ceramics, glass, etc.

The latter property combined with the fact that the power factor is less than 0.0002 below 100 Mc/s has been exploited in waterproofing ceramic and glass coil formers to maintain surface resistivity under conditions of tropical humidity. Surfaces so treated exhibit water repelling properties reminiscent of paraffin wax.

Another possible use in radio apparatus is for liquid-filled condensers. The dielectric strength is of the order of 250 to 300 volts per mil and the volume resistivity does not fall below 10^{12} at 200 deg. C. Further, the temperature coefficients of power factor and viscosity are much lower than those of conventional hydrocarbon transformer oils.

The silicone greases have been used as a sealing and insulating compound for high tension equipment and also as a lubricant for control spindles in radio instruments, since they do not melt or harden over a temperature range from 200 deg. C. to -40 deg. C.

It seems likely that the use of silicones may revolutionise the design of rotating electrical ma-

chinery. Hitherto the limit of working temperature has been set by the slow carbonising or charring of conventional insulating materials like impregnated tape, shellac and plastic varnishes. Now it is possible to use glass fibre, mica or asbestos with silicone resins to fill voids and exclude moisture. Machines of half the usual size for a given horsepower have been built by Westinghouse in America and have shown no sign of deterioration when run at 175 deg. C.

OUR COVER

ONE of the first published pictures of the image received on the viewing screen of an aircraft's radar apparatus, which traces a dim picture of the earth below, is reproduced on our front cover.

The photograph, taken in a reconnaissance aircraft flying above dense cloud on D-Day, June 6th, 1944, shows the Normandy coastline. The concentric rings are a fixed scale for measuring distance, whilst the straight line from the centre is a rotating scanner beam.

Other pictures in the series showed scattered blobs of light on the sea which, to radar operators, revealed the Allied invasion fleet approaching the coast.

The illustration, which is taken from the overseas Service edition of *Life*, first appeared in the U.S. Army Air Forces magazine *Impact*.

Emergency

LIFEBOAT TRANSMITTER

*Auto Transmission of Tone-modulated Distress Signals
with Provision also for Telephony*

A VERSATILE radio transmitter radiating a tone-modulated signal on the international distress frequency of 500 kc/s (600 metres), with provision also for transmission on the marine short-wave bands of 24, 36 and 63 metres, is being produced in this country by the Société Anonyme Radio Belgique.

Transmission can be effected either by an automatic device operated by a spring motor, which sends out the SOS signal, or by a hand-operated morse key, both these items being built into the set.

Until recently only tone-modulated signals could be transmitted, but in the most up-to-date models provision is made for telephony transmissions also. This latter facility does not entail any major changes in the circuit, which in all essential respects is the same in both transmitters. Incidentally the tone-modulated set is described as the type RB4, which with the

extra speech facility, becomes the type RB4-P.

Reduced to its fundamentals the circuit used is a master oscillator driving an RF power amplifier, the latter being grid modulated. There are, however, several interesting features about the actual arrangement of the circuit for the different frequencies available that are worthy of a more detailed description.

The master oscillator, which is the valve V1 in the simplified circuit diagram, is a 6V6 tetrode. On 500 kc/s it is used as a triode oscillator, but on the three high frequencies it is converted into a tritot oscillator, which of course requires tetrode connections.

Three single-pole-four-way switches S1, S2, and S3 make the required circuit changes to V1 and their respective functions can

quite clearly be followed in the circuit diagram. It need only be said that a Hartley oscillator is used for 500 kc/s, while on the short waves the oscillator is crystal controlled. The tuned circuit, C5L2, in the cathode-earth lead of V1 is not short-circuited on 500 kc/s, as its impedance is too low at this frequency to justify the added complication.

The RF output from V1 is fed via C6 to the grid of V2, which is an 807 valve, operated as an RF power amplifier. On 500 kc/s the output from the PA is fed to a variometer, L6, which combines the functions of anode circuit and aerial matching transformer. On the short waves these two functions are separated and L4, shunted by one of the pre-set condensers C15, C16, or C17,

The transmitter unit removed from its box showing, through the perspex window, the PA valve V2 with top cap lead, adjacent to which is V1, the 6V6, vibrator unit and the two multi-vibrator valves V3 and V4. A spare for each valve is contained in the set and these can be seen in the illustration. The auto-keying mechanism is just visible on the right of the spare 807.

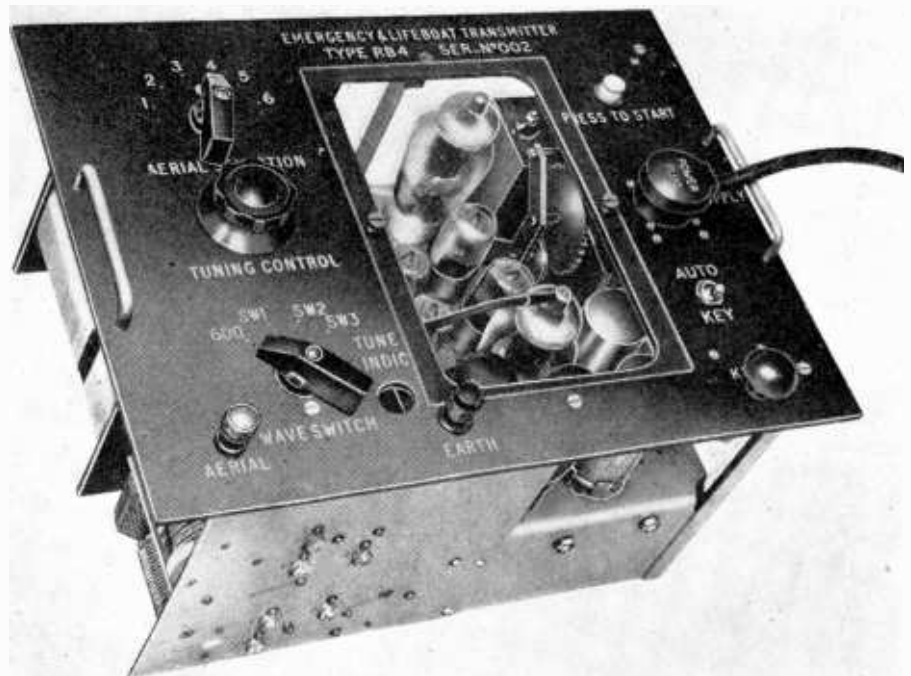

becomes the PA anode circuit, while L7 and C18 form the aerial matching transformer. These two circuits are link-coupled by the small coils L5 and L8.

With this output arrangement an aerial power of 10 to 15 watts is obtained on 500 kc/s and be-

tappings on the upper portion of L6. Likewise S8 and S9 are six-way switches but shown for simplicity in our diagram as tappings.

In position 2 of the four-way switches, which corresponds to SW1 of the waveswitch marking,

(one of the six-point switches), whilst on the short waves adjustment for maximum radiation is effected by the six-point switch S9. This selects the appropriate tapping on the aerial matching transformer which, as already mentioned, is link-coupled to the PA anode circuit. The switch S9 is ganged with S7 and S8 and comprises the tuning control on the panel

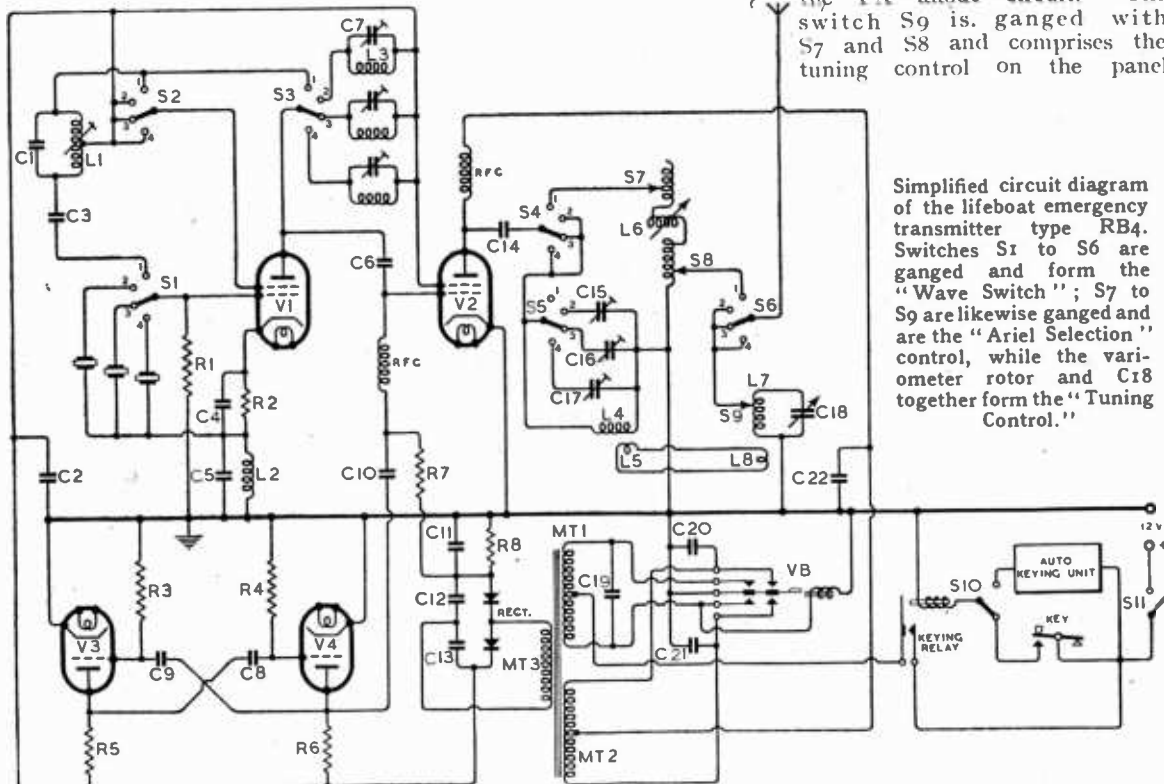

Simplified circuit diagram of the lifeboat emergency transmitter type RB4. Switches S1 to S6 are ganged and form the "Wave Switch"; S7 to S9 are likewise ganged and are the "Aerial Selection" control, while the variometer rotor and C18 together form the "Tuning Control."

tween 20 and 25 watts on the short waves. The difference in aerial power is accounted for by the fact that with an elevated wire of practical length very little loading is required to bring it into resonance on the short-wave frequencies, whereas on 500 kc/s a considerable portion of L6 has to be used as a loading inductance.

The operation of the circuit is not difficult to follow in this simplified form for it need only be remembered that all the four-way switches, S1 to S6 inclusive, are on a common spindle and when one is in the position marked 1 all are in this position. Thus on 500 kc/s the variometer is brought into use by means of S4 and adjustment for resonance is made by means of S7. Actually S7 is a six-way switch going to

marked "Aerial Selection." This control may be regarded as a coarse tuning of the aerial and PA anode circuits, the final adjustment being made by a knob marked "Tuning Control," which consists of the rotating coil of the variometer, L6, and the short-wave tuning condenser C18 ganged on the one spindle.

This apparently elaborate aerial tuning system is really necessary in the present case as provision has to be made for efficient operation on several different kinds of aerial. Two main types of aerial are catered for in the design, one is a long elevated wire held aloft by a kite or balloon, both of which are included in the equipment, and the other is a short emergency aerial rigged from the lifeboat's mast when conditions preclude

marked "Aerial Selection." This control may be regarded as a coarse tuning of the aerial and PA anode circuits, the final adjustment being made by a knob marked "Tuning Control," which consists of the rotating coil of the variometer, L6, and the short-wave tuning condenser C18 ganged on the one spindle.

marked "Aerial Selection."

This control may be regarded as a coarse tuning of the aerial and PA anode circuits, the final adjustment being made by a knob marked "Tuning Control," which consists of the rotating coil of the variometer, L6, and the short-wave tuning condenser C18 ganged on the one spindle.

This apparently elaborate aerial tuning system is really necessary in the present case as provision has to be made for efficient operation on several different kinds of aerial.

Two main types of aerial are catered for in the design, one is a long elevated wire held aloft by a kite or balloon, both of which are included in the equipment, and the other is a short emergency aerial rigged from the lifeboat's mast when conditions preclude

the use of the kite or balloon.

The type of modulation used for this transmitter is of particular interest since it is designed to produce a broad band modulated signal, which is more easily detected than the usual sine-wave modulation.

It will have been observed that the two modulating valves V₃ and V₄ are connected as a multi-vibrator, and this form of tone generator is employed in order to produce a square wave for modulating the PA valve.

A study of the multi-vibrator circuit will reveal that if C₉ be disconnected the valves V₃ and V₄ then become a straightforward two-stage RC amplifier. It now only needs a microphone to be connected to the grid of V₃ for speech modulation of V₂ to be effected. When a carbon microphone is used, and this is the one normally supplied, a microphone transformer will be required and a polarising voltage for the microphone has to be provided. The set is battery-operated so this presents no difficulty.

The battery is contained in a separate compartment in the transmitter box and consists of a 12-volt dry-charged inert accumulator of 12 Ah capacity. This battery will hold its charge for a minimum of two years without attention even in tropical zones. Needless to say the battery is not an orthodox pattern but a special type developed by Exide for uses of this kind.

Each accumulator cell consists of two separate compartments one above the other. In the lower one are the plates which, although dry, are in a fully charged state. In the upper compartment is the acid electrolyte. When the transmitter is required to be brought into operation seals between the two compartments of each cell are pierced by a knife, or any spiked tool available, the acid pours into the plate compartment and the battery is ready for use.

The 12-volt supply from this battery is taken to the transmitter through a cable and plug, this arrangement being adopted in order to enable an external source of HT and LT to be used as an alternative to the built-in battery. The LT supply feeds to the valves

heaters, which are arranged in series-parallel, and also to a built-in vibrator HT unit.

Two HT supplies are provided by this vibrator unit, one at 650 volts for the 807 PA valve and another at 250 volts for operating the master oscillator, V₁, and the multi-vibrators V₃ and V₄. The former is obtained by synchronous rectification on the vibrator unit, while the 250-volt supply comes from a separate winding on the vibrator trans-

former feeding a metal rectifier and two capacitors C₁₂ and C₁₃ arranged as a voltage doubler. Grid bias for the PA valve, V₂, is obtained from the 250-volt HT supply, it being provided by the voltage drop across the resistor R₈.

The transmitter complete with battery, kite and emergency aerials, and spare valves, is contained in a watertight buoyant wooden box of rugged construction, weighing about 55 lb.

SOLAR RADIATION

Variation in Intensity of Daylight and Ultra-Violet Rays Over the Solar Cycle

THE interesting findings of Dr. J. R. Ashworth in regard to the variation over the solar cycle in the intensity of daylight and ultra-violet rays reaching the earth's surface, have been mentioned before in these pages.¹ Briefly, the findings are that a minimum intensity of both daylight and ultra-violet rays occurs at the sunspot maximum and a maximum intensity at the sunspot minimum. Yet the sun's ultra-violet radiations are known to be largely responsible for the ionisation of the upper atmosphere, and this is at a maximum at the sunspot maximum, following the variation in solar activity more or less directly!

In a recent letter to *Nature*² Dr. Ashworth gives further particulars, and also offers an interesting explanation of the effects observed. He states that, while the curve showing the intensity of the daylight rays has the same period as that for the sunspot activity but is in inverse relation to it, that for the ultra-violet rays exhibits two weak maxima on either side of its minimum and so the curve appears to show a double fluctuation over the cycle.

The explanation given—subject, of course, to modification—is as follows. The daylight rays are assumed to be emitted from the sun in a fairly constant manner, and their emission not to be subject to any large fluctuation over the sunspot cycle. But during their passage through the earth's atmosphere they are subject to absorption and the absorbing agent is the ionisation existing there, which has the same period as the sunspot variation. Thus the absorption is greatest at

the sunspot maximum and the intensity of the rays at the earth's surface is therefore at a minimum at that time.

The ultra-violet rays, on the other hand, are subject to two sorts of fluctuation: (a) their emission varies in a direct relation to the sunspot curve, and (b) their absorption in the earth's atmosphere varies according to the ionisation existing there, which again is in direct relation to the sunspot curve. So that, when the sunspot activity begins to increase the intensity of the ultra-violet rays would at first increase due to the increase in their emission. But, early in the cycle, their absorption would begin to increase due to the increasing ionisation of the upper air, and so a point would be reached when their intensity at the earth's surface would begin to diminish, and would continue doing so until the sunspot maximum, when the ionisation is greatest. After the sunspot maximum the intensity of the rays would at first increase due to the reduction in the impeding ionisation, and, later on, would diminish due to their decreased emission. There are thus two periods in the cycle, Dr. Ashworth states, when the intensities of the daylight and ultra-violet rays are moving in opposite directions, the one increasing and the other decreasing.

The ionisation of the upper air is at the present time increasing extraordinarily rapidly, the sunspot minimum being now well past, and so observations made in the near future should be of great interest in the light which they may throw upon this matter. Incidentally all this information should also be of great value in helping to increase our knowledge of the ionosphere and radio propagation by its means.

¹ *Wireless World*, December, 1943.

² *Nature*, July 28th, 1945.

ACHIEVEMENTS OF RADAR

Its Part in the War

IN the issues of *Wireless World* for February and March this year we were able to describe the basic principles of radiolocation or radar, and also to trace briefly the history of its development. A "release" of somewhat more detailed information on its operational uses in the war has now been issued, and it becomes more evident than ever that it was no exaggeration to claim that the part played by this offshoot of radio communication has been truly decisive. All the fighting Services have paid glowing tributes to the help it has given them.

Much additional information has also been disclosed on the origins of radiolocation, and it is gratifying that no unseemly or contentious claims are made as to British priority. No one individual, group or even nation can claim to have "invented" such a thing as radiolocation, but it seems clear that Britain, under the spur of stern necessity, had a working system ready for the war; in this she was first.

A very pleasing picture is presented of the most wholehearted co-operation with America; in this matter it has been to a great extent a case of Lend-Lease in reverse. Many of the devices to be described were originated in the U.K., and were subsequently exploited in the U.S.A. To quote the official British statement, our main contribution to the United States war effort in radar was in the form of ideas, blueprints and prototypes, but quite a large amount of British-made equipment was "lease-lent"; for example, the first U.S. 8th Air Force aircraft to aim their bombs with the help of "H2S" radar gear did so with British-made apparatus.

Radiolocation as a weapon of war, it is now disclosed, arose from an almost accidental contact between a member of the Committee for the Scientific Survey of Air Defence and an official of the National Physical Laboratory. The next step was in 1935, when senior representatives of all three Services discussed the matter. By the end of the year, experimental work was sufficiently far advanced for the Air Ministry to decide on establishing a chain of five radar stations on the East coast of England—the first operational system anywhere in the world. In 1937 radar figured in the annual air exercises and fifteen more stations were authorised in August of the same year.

This was the chain of stations which, as we all know, played such a decisive part in the Battle of Britain. They operated on wavelengths of the order of 10 metres: distance was measured by pulse travel time and bearing (azimuth) by modifications of existing DF methods. Height-finding was a separate development, made possible by a method involving a comparison of strength of the received echo at two sets of aeriels at different heights above the ground.

The 10-metre stations were unable to detect aircraft flying at very low heights; for this purpose an equipment using a much shorter wavelength (about 1.5 metre) and with an aerial system rotating on a



Underground radar stations combined the dual functions of locating enemy raiders and the control of our fighter aircraft.

turntable was evolved. This apparatus was later adapted for installation in night-fighter aircraft; by manœuvring his machine so as to centre the indicating spot, the pilot was able to reach a position sufficiently close to the enemy aircraft to enable the pilot to close for the attack. Gear of this kind, and subsequent developments of it, was largely responsible for the enemy decision to call off the intensive night bombing of Britain. The toll of his losses to our night fighters rose steadily, until in May, 1941, it amounted to 102 bombers.

Centimetre-wave radar was the next big step. It is the basis of almost all the later applications, and was largely made possible by the development of the modern magnetron valve, devised during the war by a research group working at Birmingham University. The transmission of high pulse powers in centimetre wavelengths and the detection of the reflected energy has involved an entirely new technique, full details of which cannot yet be fully disclosed. It can be stated, however, that a magnetron valve adapted to use cavity resonators generates powers of the order of hundreds of kilowatts in the transmitter, and that the receiver is a superheterodyne in which the local oscillator is a tunable cavity resonator excited on the

Achievements of Radar—

velocity modulation principle, with a crystal detector as first detector or frequency changer.

Centimetre technique not only provided the night-fighter pilot with more practical equipment; it made possible the map-like device which helped our



One of the mobile equipments used for emergency purposes and in locations where permanent stations could not conveniently be erected.

bombers to find their targets and also increased the accuracy of the gear used in naval warfare. It also enabled anti-aircraft and coastal artillery fire to be directed with much greater precision—surpassing the inherent accuracy of the guns themselves. Success in this direction can be gauged from the fact that, during the flying-bomb episode, radar-aided batteries were, towards the end of the attacks, able to account for between 80 and 100 per cent. of the bombs that came into their field of fire.

Not the least important contribution of centimetre radar was in conquering the U-boats. Here the problem was to sweep many square miles of sea and to locate a piece of metal projecting above the surface of the water by little more than the height of a man. In any case, it had earlier been realised that very short wavelengths, with their correspondingly compact aerial systems, were essential for naval purposes, and an experimental aircraft detection equipment had been installed on a battleship and cruiser as early as 1938.

Naval uses of radiolocation take many other forms; hostile aircraft detection, direction of carrier-borne fighters, for gunlaying at night and in fog, navigation, minelaying and the presentation of complete tactical pictures of shipping in convoy or fighting units in fleet actions. For most naval purposes narrow beams are needed, and, so far as gunlaying is

concerned, the accuracy achieved is at least as great as can be made use of by the guns.

The Naval "Plan Position Indicator" presents, by scanning a considerable volume of space many times a minute, a complete picture of the relative positions of all aircraft in the vicinity; also the shape of any coastline within range is accurately delineated.

The extraordinary and immediate success which followed the application of centimetre radar to long-range bombing deserves special mention. Analysis shows that airborne equipment multiplies by five times the effectiveness of an air fleet costing ten times as much as the gear. For the results achieved by our intensive attacks on Germany we have, first, to thank the so-called "Gee" equipment, which provided navigational aid regardless of visibility. From navigation to "blind" bomb-aiming by radiolocation is a short step, and two equipments for this purpose soon came into being. With the "Oboe" system ground stations guide the aircraft to the target and give the signal to release bombs.

The parallel development which made blind bombing a reality at distances beyond the effective range of Gee or Oboe was an entirely self-contained airborne equipment known as "H2S" which reproduces in the aircraft a shadow map of the terrain below. Land, water and built-up areas can be interpreted from the images on the tube.

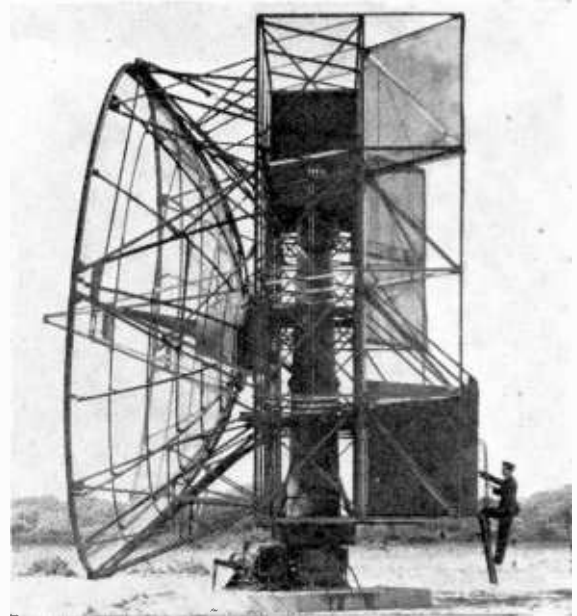

Large parabolic-type reflector mounted on a rotatable tower on which is also carried a cabin containing the radiolocation equipment.

When so many persons have made notable contributions to the development of radiolocation, it would be invidious to single out any individuals for personal mention. Indeed, the whole story has been one of successful team-work, and much of the credit must go to those who organised the teams.

VALVE VECTORS AGAIN

Amplified Explanation for Students

By K. R. STURLEY,

Ph.D., B.Sc., M.I.E.E.

I CANNOT ignore the plea of "Student" in the correspondence columns of the August *Wireless World* to amplify my statement on valve vectors.* I ought to state that the question at issue is one of convention, but as far as I am aware the only point about which there can be any argument is whether E_g and μE_g (the generated voltage imagined to exist inside the valve) are to be represented as vectorially 180° out-of-phase or as in-phase with each other. Either convention may be chosen, but the results, so far as grid voltage E_g , anode current I_a , and output voltage E_o are concerned, are

a sinusoidal (to be pedantic cosinusoidal) voltage of $-\hat{E}_g \cos 2\pi ft$ applied to the grid of an amplifier valve of constants μ and R_a , and the time instant corresponds to $t = 0$. This input voltage will be at its maximum negative value of $-\hat{E}_g$ and will be illustrated by a vector to the left of point o in Fig. 3. By my convention the generated voltage inside the valve is represented by $\mu \hat{E}_g \cos 2\pi ft$ and will be at its maximum positive value. It is therefore a vector to the right of o in Fig. 3. This voltage produces a current $\hat{I}'_a \cos 2\pi ft$ in the load resistance R_o such that $\hat{I}'_a = \frac{\mu \hat{E}_g}{R_o + R_a}$, and it is obviously in phase with $\mu \hat{E}_g$. The current from the generator is also represented by a vector \hat{I}'_a to the right of o in Fig. 3. The output voltage $\hat{E}_o \cos 2\pi ft$ is in phase with \hat{I}'_a and is clearly 180° out-of-phase with \hat{E}_g . So far then this is in agreement with facts, for we know experimentally that an input voltage wave-shape suffers a complete 180° phase shift (of all its components equally if it is a complex wave shape) in the amplifier, and the output voltage is therefore a magnified mirror image of the input. For example, in Fig. 4a, the wave-shape shown for the input voltage is flattened at the top and peaked at the bottom and

it can be resolved into a fundamental and 2nd harmonic frequency. The output wave shape is the magnified inverted image of Fig. 4b; it will be seen that both fundamental and 2nd harmonic have been given a 180° phase shift. It is worth stressing

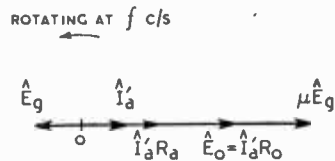

Fig. 3. Vector diagram for a valve with resistance load.

that 180° phase shift of the 2nd harmonic is represented on the time scales of Figs. 4a and b by a time-interval change of one-half that of the fundamental; i.e., for both frequencies it represents a half-cycle shift.

Reverting to the vector diagram of Fig. 3, we find that what is missing is a vector for anode current in phase with \hat{E}_g ; instead we have a vector current \hat{I}'_a 180° out-of-phase with \hat{E}_g . To understand what this means we must turn to the voltage and current-time relationships shown in Fig. 5a and b. From Fig. 2 it is clear that the AC current from the generator subtracts from the DC anode current; i.e., when $\hat{I}'_a \cos 2\pi ft$ is increasing, the total anode current is decreasing and *vice versa*. We, therefore, see from Fig. 5b

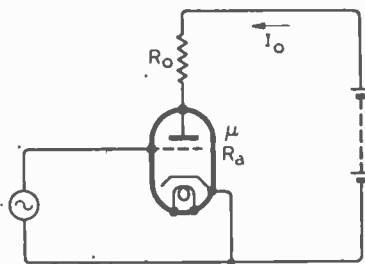

Fig. 1. Triode valve amplifier with resistance anode load.

the same whichever convention is assumed. I still stick to the view that it is better to show E_g and μE_g 180° out-of-phase with each other. Anyone who is interested in a comparison of the two conventions should refer to the correspondence columns of *Wireless Engineer* (August 1945) in which I examine one against the other.

Before passing to the specific query on the vector analysis of a reactive anode load raised in "Student's" letter, it is worth while recapitulating the vector analysis for the resistive anode load according to my convention.

In Fig. 1 and its equivalent in Fig. 2, let us imagine that we have

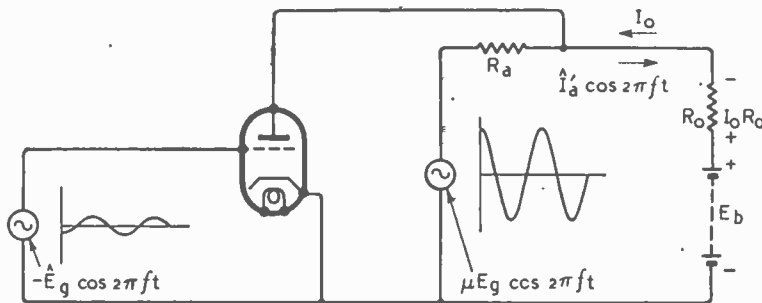

Fig. 2. Equivalent circuit for Fig. 1.

* *Wireless World*, May, 1945, p. 140, and July, 1945, p. 210.

Valve Vectors Again—

that the total anode current $I_o = I'_a \cos 2\pi ft$ decreases when E_g decreases and increases when E_g increases and we can therefore say that the anode current is in phase with the grid voltage.

earlier article. There are objections, as Dr. Parnum pointed out,* because a student may then be confused by seeing two apparently cancelling vectors I'_a and I'_a . I think therefore that from most points of view it is better

(the output voltage from anode to cathode) has a phase relationship to μE_g dependent on R_a , and the resistive and reactive components of the load.

An inductive-resistive parallel-connected load is illustrated in the equivalent circuit of Fig. 6, using again my convention but dropping the cosine factor in the AC voltages and currents.

A vector diagram for this circuit is shown in Fig. 7. The generated voltage phase relationship to E_g is unaffected by the addition of inductance and is still 180° out

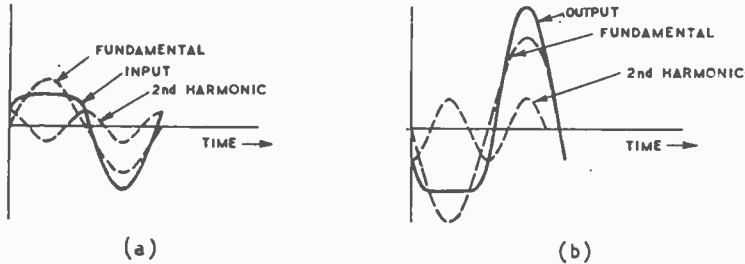

Fig. 4. Illustration of the 180° phase change from input to output of a resistance loaded valve. (a) Input signal; (b) Output signal.

We can represent this condition on the vector diagram of Fig. 3 by putting a vector $I_a = -I'_a$ in phase with E_g and saying that this is the true anode current vector, and this I did in my

to omit it and merely draw attention to Fig. 5b, which indicates quite clearly the relationship of I'_a to the actual anode current. What we are mostly interested in is the voltage vector $E_o \cos 2\pi ft$ and the need to show a vector for true anode current only arises in current negative feedback problems.

To complete the vectorial picture presented by Fig. 3, it should be stated that the set of vectors shown are actually continuously rotating in an anti-clockwise direction in time, completing f revolutions per second at an angular velocity of $2\pi f$ radians per second.

The answer to "Student's" query "does the connection of a reactance in parallel with a resistive load affect the phase of the anode voltage E_o ?" is a very emphatic "yes." His difficulty seems to arise because he has not appreciated that the phase relationship of E_g and μE_g is unaffected by the anode load impedance, and also that μE_g is not the anode-cathode voltage but is the actual generated voltage, which has between it and the anode-cathode terminals the internal or slope resistance of the valve (see Fig. 2). Once this idea is accepted we have the straightforward case of a generator of μE_g with an internal resistance R_a feeding into a reactive load impedance; the terminal voltage

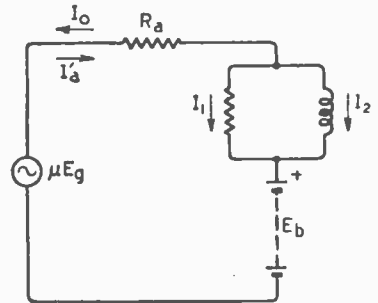

Fig. 6. Equivalent circuit for a valve with a parallel circuit of resistance and inductance in its anode.

of phase. The current I'_a it produces (in opposition to I_o) lags behind μE_g because the circuit is inductive, and it divides between R_o and L_o to give two current vectors I_1 and I_2 , respectively mutually at right angles. The output voltage vector E_o is naturally in phase with I_1 , and adds to $I'_a R_a$ to make μE_g , upon which it leads by an angle dependent on the magnitudes of R_a , R_o and L_o . The voltage and current-time relationships are shown in Fig. 8a and b, for which it is assumed that there is no DC voltage across I_o ; i.e., the DC anode voltage equals E_b , the battery voltage. Again it is seen that the actual anode current

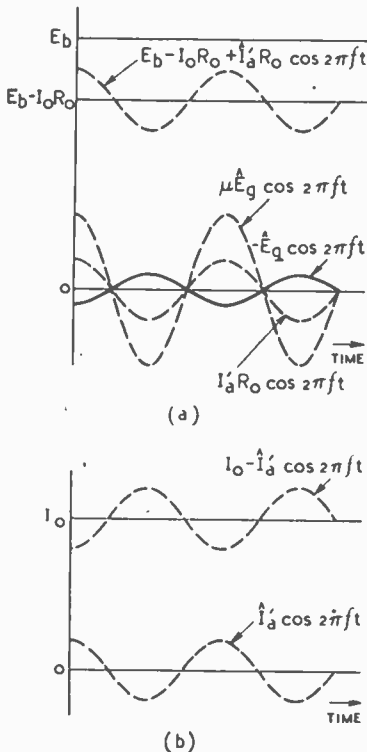

Fig. 5. Voltage and current-time relationships for a resistance loaded valve. (a) Voltage-time; (b) current-time.

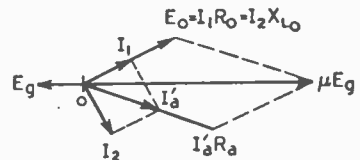

Fig. 7. Vector diagram for a valve with an inductive impedance in its anode circuit.

* Wireless World, July, 1945, p. 209.

is $I_o - I'_a$ and, if we wish, may be represented by a vector $-I'_a$ lagging behind E_g by the same angle as I'_a lags behind μE_g ; i.e., it is 180° out of phase with I'_a .

For a parallel resistive-capacitive load the output voltage vector E_o lags behind μE_g , and there will be a DC voltage loss in R_o .

The main point which needs to be stressed is that the phase of E_g and μE_g (be it zero or 180°) is unaffected by the anode load, but the current I'_a produced by μE_g lags or leads upon this voltage when the anode load impedance is inductive or capacitive respectively.

If "Student" has any doubts as to whether this theory applies in practice, I would recommend

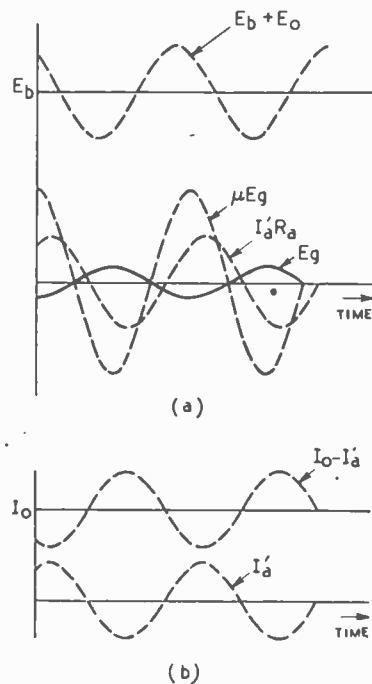

Fig. 8. Voltage and current-time relationships for a valve with an inductive anode load. (a) voltage-time; (b) current-time.

that he borrows a cathode-ray oscilloscope and makes up an amplifier valve, preferably a pentode of high internal resistance, with a low load resistance, about 3,000 ohms, as in Fig. 9. Apply an input voltage to the valve from the 50-c/s mains supply through an

L.T transformer secondary and use this same voltage to lock the CRO time base. Use battery grid bias (not cathode self-bias), be-

reactance of 3,140 ohms). He will see the output voltage wave reduce in amplitude to about 70 per cent. of its original value,

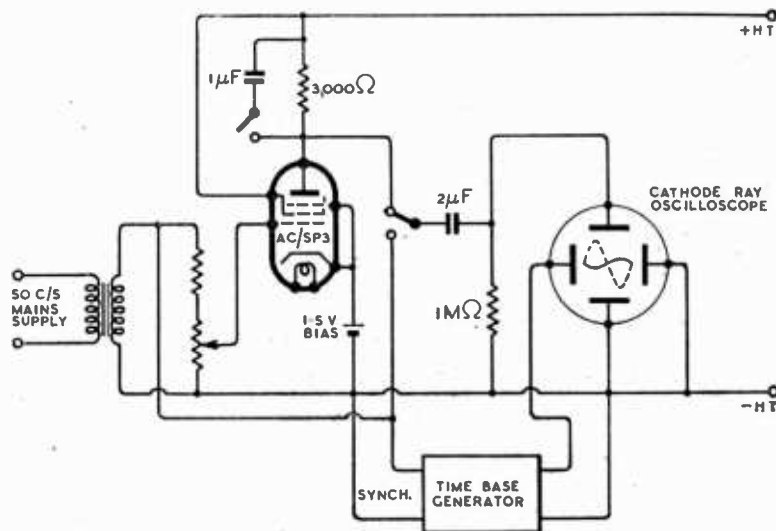

Fig. 9. A circuit for verifying vector phase relationships with a capacitive anode load impedance.

cause the self-bias capacitance is not an adequate by-pass at 50 c/s. Connect the Y plate of the CRO through a large capacitor ($2\mu F$) first to the input voltage and then to the anode of the valve. "Student" will see that the output voltage shape is a mirror image of his input, thus showing the 180° phase shift. Now let him, while looking at the output voltage, place a $1\mu F$ capacitor in parallel with the 3,000-ohm anode load. (Note that $1\mu F$ at 50 c/s has a

and will also see the wave move backwards by about $\frac{1}{4}$ of a cycle (45°) against the direction of the travel of the CRO spot. This is exactly what one would expect by theory, for a parallel connection of resistance and capacitive reactance of equal magnitudes, connected to a generator of high internal resistance, produces a voltage across them lagging on the generated voltage (and the voltage across the resistance when C is removed) by 45° .

Books issued in conjunction with "Wireless World"

	Net Price	By Post
FOUNDATIONS OF WIRELESS. Fourth Edition, by M. G. Scroggie	7/6	7/10
TELEVISION RECEIVING EQUIPMENT, by W. T. Cocking	10/6	10/10
RADIO LABORATORY HANDBOOK, by M. G. Scroggie. Second Edition	12/6	12/11
WIRELESS SERVICING MANUAL, by W. T. Cocking. Sixth Edition	7/6	7/10
HANDBOOK OF TECHNICAL INSTRUCTION FOR WIRELESS TELEGRAPHISTS, by H. M. Dowsett and L. E. O. Walker. Seventh Edition	30/-	30/7
RADIO DATA CHARTS. Third Edition, Revised by J. McG. Sowerby, B.A., Grad. I.E.E.	7/6	7/10
RADIO INTERFERENCE SUPPRESSION, by G. W. Ingram	5/-	5/4
LEARNING MORSE. 335th thousand	6d.	7½d.
INTRODUCTION TO VALVES, by F. E. Henderson	5/-	5/4
RADIO WAVES AND THE IONOSPHERE, by T. W. Bennington	6/-	6/3

Obtainable from leading booksellers or by post from
ILIFFE & SONS LTD., Dorset House, Stamford Street, London, S.E.1

UNBIASED

Urim and Thummim

THIS radar business seems to be a lot more complicated than either the Editor of *Wireless World* or myself are aware, judging by the account of it given by the "special correspondent" of a very well-known morning newspaper who has apparently been turned loose on the subject. After telling us that in 1940 the "silent watchers of the night, gazing at their screens were able actually to see the enemy planes sneaking snakelike and sinister amid the banks of cloud," he waxes lyrical over the question of post-war applications of radar.



"Our Special Correspondent."

His description of the way in which radar spotted the enemy aircraft is so entirely devoid of scientific truth and accuracy that it reminds me of nothing so much as the equally unscientific methods of radiolocation employed by one of Macbeth's lady friends ("By the pricking of my thumbs, something wicked this way comes"). The lady's remark might, I think, well serve as the motto of the Royal Radar Corps or whoever were responsible for anti-raider radar, if their work were indeed so closely akin to crystal gazing and suchlike as the "special correspondent" would have us believe.

The only antidote to this sort of thing to my mind is for the government to go on releasing more of the proper dope on radar. One thing, for instance, which has not yet been made public but which is not on the secret list is that radar is going to revolutionise entirely our nonsensical and utterly unscientific way of describing colours. At present we talk of delicate shades of pink when we ought properly to

By FREE GRID

describe the colour we mean by giving its wavelength clearly and precisely in Angstrom units. Poor prunes like Homer, who lived before the age of science, can be forgiven for talking a lot of nonsense about "rosy-fingered dawn arising from the wine-coloured sea." Nowadays he could be taught to render his report as "0500 hours GMT; XY Angstrom units, etc., etc."

The way radar is going to help us bring about this revolution is that if we see a flower or anything of which we wish to know the exact colour we shall simply aim a calibrated radar unit at it and twiddle the knob which adjusts the length of the emitted wave. All waves will be reflected by the object and show up on the screen until we hit on the exact wavelength of the colour concerned. This wave will, of course, be promptly absorbed and we shall read its length straight off the dial or calibration chart. I am not pretending that there is not a lot of work to do before we get radar right down among the Angstrom units, but don't forget that a few years ago there was a lot of work to do before radar was possible at all.

Stentor Outstentored

ALTHOUGH the general election has long since joined the late lamented Queen Anne I am still feeling the exhausting effects of the campaign into which I was drawn quite against my will and intentions by my righteous indignation at a very grave injustice to the general public which was being impartially perpetrated by what Mr. Churchill has called "men of all parties and men of no party."

I refer to the pernicious pandemonium of P.A. with all its cacophonous caterwauling and raucous roaring which was inflicted on us during the campaign. In my opinion it was nothing but a perversion of the power and knowledge which we radio men unwittingly placed in the hands of politicians when we developed the thermionic valve. Were I a master of English like the late Lord Justice Darling I would express my feelings far more pointedly, as did that friend of punsters and exponents of accusatory alliteration on one occasion when he made a particularly pun-

gent and pertinent pronouncement by protesting publicly against "the pernicious practice of certain proprietors of newspaper and periodicals of pandering to the prurient proclivities of the public by publicising pictorially and otherwise the personal peccadilloes of prominent persons."

Mind you, I am not complaining at the legitimate use of P.A. to enable a speaker to be heard clearly in all parts of the meeting which he is addressing; in fact, I am all in favour of it even if he does use it "to pander to the prurient proclivities of the public," etc., as so many did during the campaign. After all, this sort of thing was done long before the days of P.A. What I object to is that whereas in the good old days any member of the audience had a fair chance of protesting vocally and vegetably, he is now, owing to P.A., just unable to compete vocally, and vegetably he is equally at a disadvantage owing to the shortage of vintage tomatoes.

I had not attended many meetings before I began a great salvage drive in my neighbourhood in order to collect enough material to improvise hastily a number of personal P.A. outfits which I distributed freely to the crowd before the meeting started. I may say at once that although waff for waff my home-made contraptions were at a grave disadvantage they were able to counter the speakers' P.A. polemics with a very effective "so what."



I am a firm believer in giving even the devil his due, and I make no attempt therefore to following the degrading example of many politicians and claim as my own creation ideas which I have derived elsewhere even though the "elsewhere" in this particular case happened to be Germany.

Angles on **BRIMAR PRESTIGE**

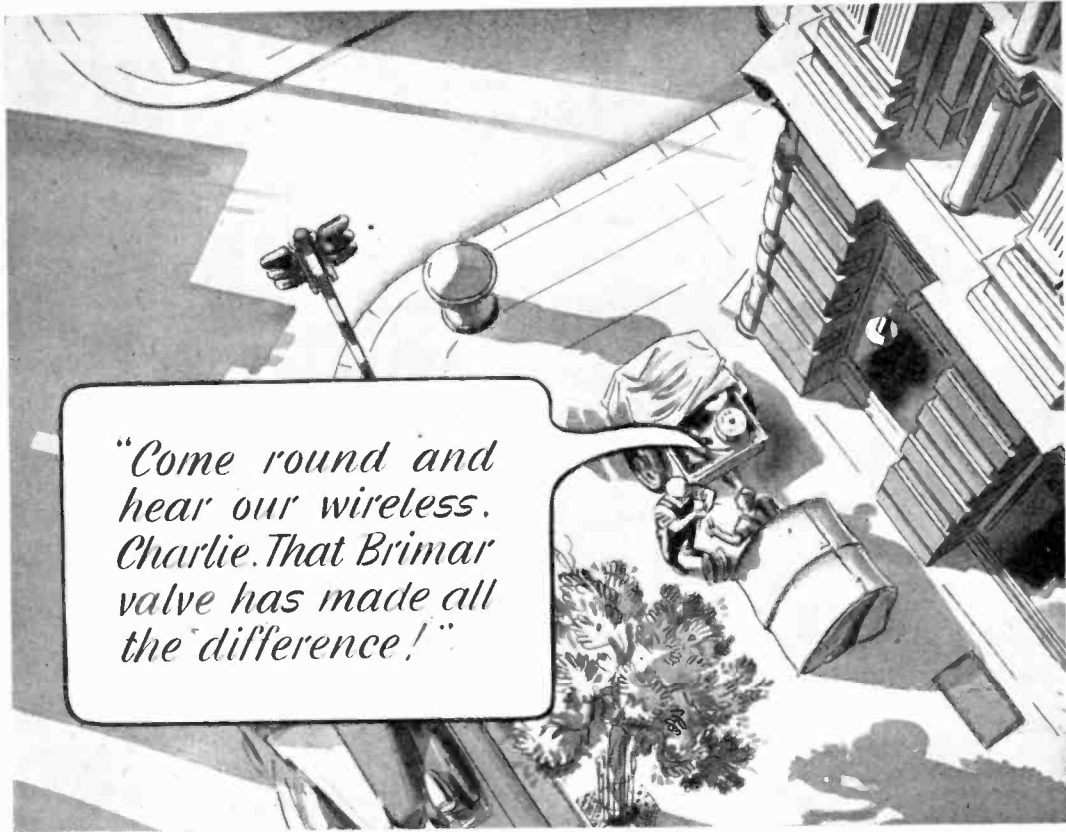

Brimar Valves have an unequalled reputation for brilliant performance plus reliability. Still in short supply, but they are obtainable.

BRIMAR

BVA

VALVES

STANDARD TELEPHONES AND CABLES LIMITED, FOOTSCRAY, SIDCUP, KENT.



Hail fair Microns

this is the
sunday afternoon
off for the microns
so this is a good oppo-
rtunity to really tell you
what all this advertisement
nonsense means!

'Micron', when used in relation
to transformers is a little
invisible something which
measures a vacuum. Now a vacuum
is something which is essential
to a good transformer - without
it they either wilt and fade
away or they struggle on grimly
against impossible odds and all
the time you're wondering why
this and that is breaking down
or not functioning accurately.

The point is that no
equipment can be better than
its transformer - the transf-
ormer sets the standard!

Of course you see what we
are getting at - we dislike
mentioning this so openly but
really you ought to know that
a Parmeko transformer has got
what it takes-
including a }
most fetching }
line in microns!

... all you have to re-
member really is that we
specialise in Transformer
production and that our
whole research staff is at
your disposal.

PARMEKO LTD., LEICESTER. Makers of Transformers.

Technical Reasons Why

★ **ERSIN**
MULTICORE SOLDER

Is the Finest Cored Solder in the World

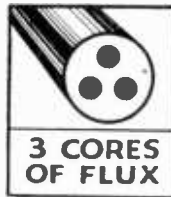

Three Cores of Flux ensure flux con-
tinuity. No lengths without flux are
wasted. Consistent high quality joints
are obtained with comparatively unskilled
labour. Exactly the correct proportions
of solder to flux are provided. Separate
fluxing operations are obviated and no
extra flux is required. The three cores of
flux being evenly distributed over the
cross section of the solder provide thinner
solder walls than otherwise. This gives rapid melting and
speeds up soldering. The flux does not tend to run out of
the cores; so there is always a supply available for the next
joint. The utmost economy of solder and flux is achieved.



Ersin, contained in the three cores of Ersin
Multicore Solder, is the fastest non-
corrosive flux. Possessing all the non-
corrosive advantages of rosin, it enables
joints to be speedily made on oxidised
or "difficult" surfaces such as nickel.
Ersin not only avoids oxidation during
soldering but removes surface oxide
already present—this is particularly
advantageous in respect of materials that

have been in stock or apparatus that is being serviced. The
use of Ersin Multicore, with correct soldering technique,
avoids "HR" or dry joints.

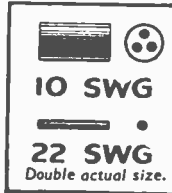

Ersin Multicore Solder is made in most
gauges between 10 and 22 S.W.G.
(.128—.028") (3.251—7.109 m/ms). For
general radio and electrical production
and maintenance 13 and 16 S.W.G. are in
most demand.



Five alloys of Ersin Multicore Solder, made
from virgin metals, are available—all
antimony free. Under present circum-
stances 45% tin and 55% lead is the
most widely used alloy.

Technically, Ersin Multicore Solder is far superior to any
other cored solder. A practical
laboratory or production test
will demonstrate this and show
you that it is the most economi-
cal solder to use. The majority
of British and overseas manu-
facturers already enjoy the
advantages of Multicore. If
you do not, and are engaged
upon Government contracts,
write for further technical
information and free samples.

Single reel rate nominal
1 lb. reels.

13 SWG - 4/10

16 SWG - 5/3

Above prices subject to
usual trade discount.

‡ cwt.—ton lots at bulk
rate. 8d. cartons for home
use, available at most
good radio and electrical
dealers, ironmongers, etc.

MULTICORE SOLDERS LTD. Commonwealth
House,
New Oxford St., London, W.C.1 Tel.: CHAncery 5171-2

CONTRAST EXPANSION

The Use of Negative Feedback : Its Advantages Over Earlier Methods

By J. G. WHITE

IN amplitude-modulated radio transmitters, limitations are imposed upon the volume range of the modulating signal by the minimum noise level attainable in the communication system as a whole. The volume range of a symphony orchestra may easily be 70 decibels, and at times may exceed that figure. This means that, where the peaks corresponding to maximum volume may cause the RF carrier to be modulated 100 per cent., the softest passages would fall below the lowest noise level attainable under the most favourable circumstances. Similar limitations occur in laterally-cut sound recordings.

In order to avoid the loss of soft passages in the general background noise and to prevent loud passages from causing over-modulation, the gain of the modulating amplifier is increased during the former and decreased during the latter. The operation, known as volume compression, is normally carried out manually by a control engineer who has some knowledge of music and is armed with a score; thus it is subject to variations dependent upon the control engineer's ability, musical taste, power of anticipation and other personal characteristics. The range of volume ordinarily attained is 35-40 decibels.

In public-address systems a similar control is often used in order that variations in volume due to the movements of a speaker towards or away from the microphone during his speech may be levelled out. Unlike volume compression in broadcast transmitters and recording, the operation is usually automatic.

At the reproducing end of the broadcast or recording chain, the result of the compression is a lack of life and naturalness in the reproduction. To counteract this result, expansion of the audio-frequency signal in the reproducer has been advocated, and several systems have been devised and

used in which an increase of audio signal amplitude has resulted in an increase in amplifier gain. The results obtained have been more or less satisfactory, depending on the characteristics of the individual system, and some general criticisms will be offered later in this paper.

The chief criticism of expansion advanced by its opponents is that, as the original compression is dependent upon an individual, no system of expansion can be devised which will automatically provide accurate correction. The argument is unanswerable from an academic standpoint, but in practice is not so unassailable as its supporters believe. It is possible to introduce into a reproducing

concerned with the frequency range necessary for "life-like" reproduction. The various stages need not be recapitulated here, but the present state of the argument is pertinent to the discussion of volume expansion.

Wide agreement has been reached that "straight-line" amplification and accurate reproduction of the original are not necessarily complementary. Tone control—real tone control, not "top-cut"—is generally admitted to be desirable and necessary. It has further been recognised that factors such as the acoustic properties of the listening room may completely upset the design engineer's attempts to provide electrically accurate reproduction of the original, and that such factors are substantially uncontrollable. (Readers may remember

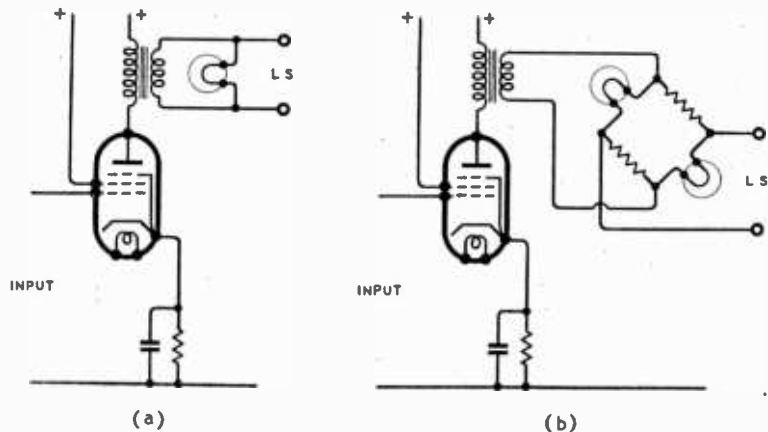

Fig. 1. Lamp-operated contrast expansion circuits.

system a measure of expansion which contributes to a pleasing reproduction of the original, and provides a closer simulation of the intended effect of the original than can be obtained without expansion.

One of the greatest controversies which has raged among designers and critics of broadcast and record reproducers is that

Scroggie's "reductio ad absurdum," when he described a "super" home set with control even over the cubic capacity of the listening room.) Reproducers of advanced design are therefore so equipped that the frequency response is under the listener's control.

It is suggested that a similar attitude is the only practical one

Contrast Expansion—

to assume at the present time with regard to volume expansion. It is impossible to correct accurately for the arbitrary compression introduced at the transmitting or recording end, and, as has recently been pointed out, the properties of

are others which are largely a matter of individual opinion. The following are some of the main considerations, listed in a suggested order of importance.

The system should introduce negligible distortion. A moderate degree of expansion with negligible

distortion is obviously better than a greater degree which introduces a high percentage of unwanted harmonics.

The degree of expansion should be under the control of the listener. As a minimum, it should be possible to cut out the expansion at will. Speech, singing, and solo instruments, except the organ, are normally not compressed, and chamber music and similar programmes rarely so to any extent.

The degree and control of expansion should be independent of the volume level at which the amplifier is operated.

It may be desirable to arrange for the gain to increase more rapidly than it falls. It is usually desirable for expansion to operate with a minimum of delay, the delay introduced normally resulting from precautions against undesirable effects such as "fluttering." A rapid fall in gain may, however, detract from the result.

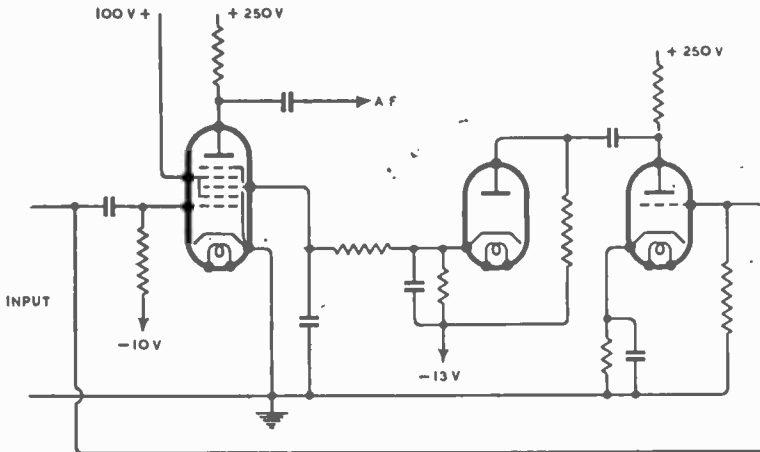

Fig. 2. Variable-gain amplifier.

the listening room and its situation may make full expansion undesirable. However, it is also certain that a good system of expansion can improve considerably the reproduction of orchestral programmes, unless the listener is a die-hard of the old straight-line reproduction school.

Desirable Features of an Expansion System

Certain features are generally agreed upon as being desirable in any expansion system, and there

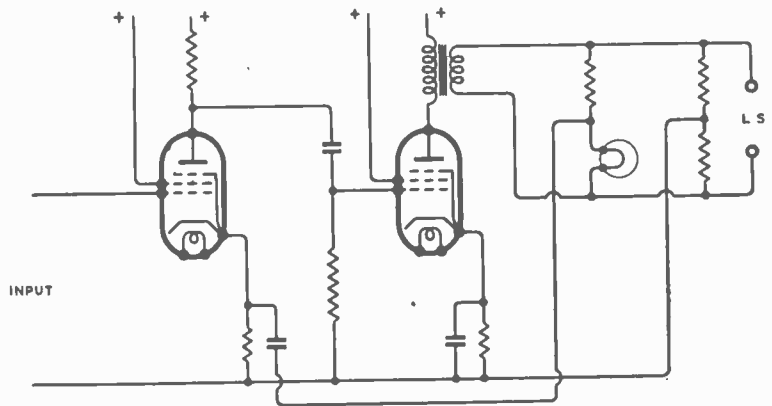

Fig. 4. Lamp-operated negative feedback circuit.

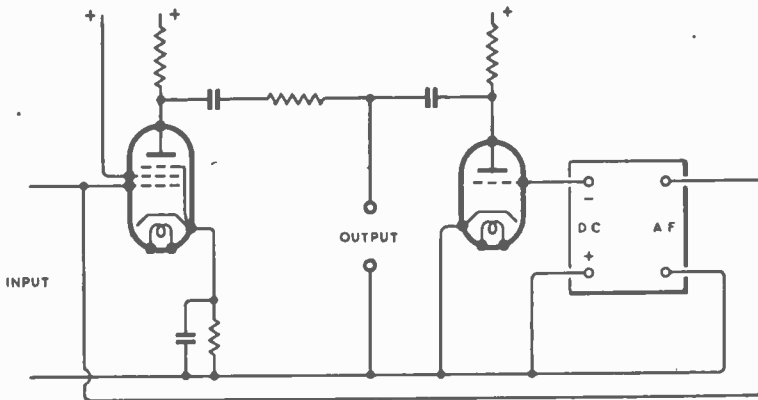

Fig. 3. Variable output potential divider with contrast gain in earlier stages

As the maximum volume at which a reproducer can work is usually fixed by other than purely technical reasons, the expansion must take effect not only by an increase over normal volume on the expanded peaks, but by a reduction below normal volume on soft passages. It thus becomes important to reduce the noise contributed by the reproducing system to the lowest amount possible. The desired result is more easily achieved if the noise level is reduced by the expander as the soft passages are reduced. Thus it is preferable to introduce

expansion at such a point in the amplifying chain that the minimum amount of amplification follows it.

Expansion systems like tone-control systems introduce a net loss in over-all gain. This should be kept down to a minimum.

Existing Systems of Expansion

Lamp-operated systems.—In the ordinary electric lamp the resistance of the filament varies over a wide range with temperature, the resistance increasing as the temperature rises. The simplest systems of volume expansion have made use of this property in various ways, some having the lamp connected in parallel with the loudspeaker speech coil, Fig. 1 (a); others, of greater complexity, use the lamp as one arm of a bridge which controls the over-all gain, Fig. 1 (b).

Several disadvantages attach to this class of expander. Usually the system has to be operated at a high level, which may not always be desirable. The lamp may be difficult to select for a particular operating condition, and it is impracticable to provide any worthwhile measure of control over the expansion range. The time constants of the arrangement cannot be chosen by the designer unless special lamps are obtainable, and no system of control can be provided easily for the listener. It is essential to use the lamp at a low-impedance point in the amplifying chain, which means that unless step-down and step-up transformers are introduced, the lamp can be connected only in the secondary circuit of the output transformer. In this case manual control of volume level also changes the expansion characteristic.

Lamp-operated systems have, however, the merits of simplicity and cheapness, and may readily be added to existing reproducers.

Amplifiers using variable-gain valves.—Of all systems of expansion, those employing a variable-gain amplifying stage have been most popular. By these methods, of which an example is given in Fig. 2, it is possible to obtain any reasonable degree of expansion, to provide independent volume and expansion controls, and to

arrange the time-constants of the circuit to give the desired rates of rise and fall of gain.

Disadvantages are the introduction of harmonic distortion unless the stage is operated at extremely low input levels, and the conse-

quence of the potential of the control grid with respect to cathode. This characteristic may be used for volume expansion by arranging such a variable-impedance valve as one arm of a potentiometer, which is connected between two

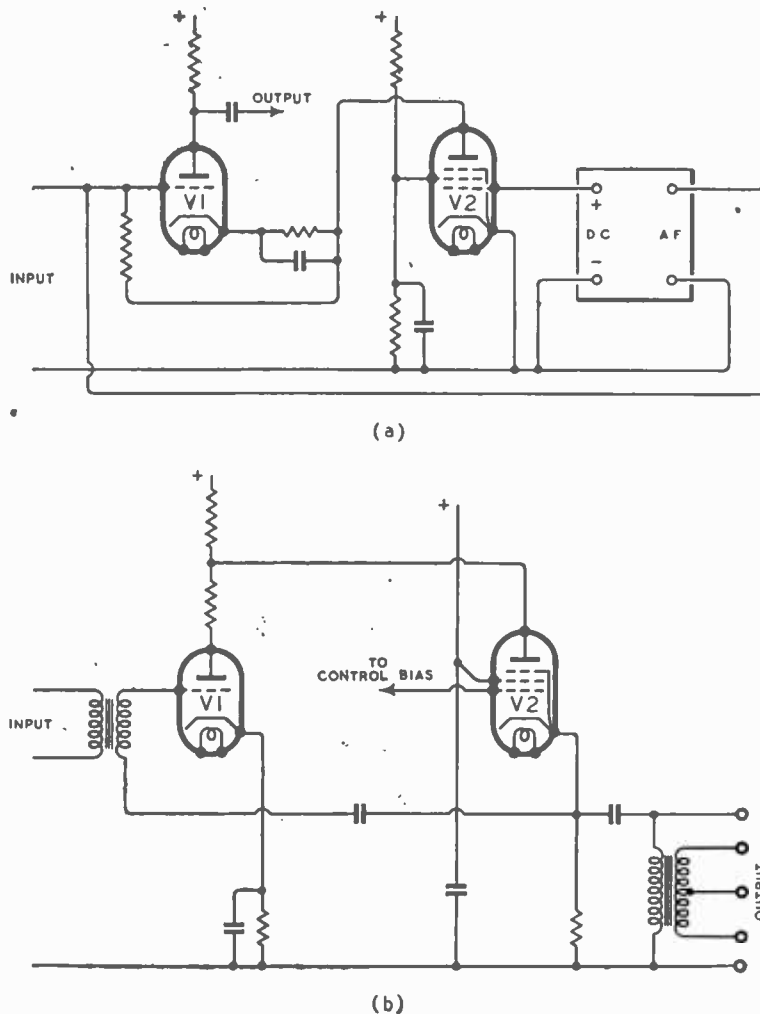

Fig. 5. Valve-operated negative feedback contrast expanders.

quent necessity of introducing the expander at the beginning of the audio chain. Harmonic distortion can be reduced by the use of a push-pull expansion stage, but this does not reduce the odd harmonics, and increases the number of valves necessary.

Amplifiers of constant gain but varying output voltage.—The impedance of a valve may be varied between wide limits by changing

consecutive stages of an amplifier (Fig. 3). This system has substantially the same advantages as that using variable-gain valves, and, in addition, may be used at a higher signal level. It is much less prone to introduce harmonic distortion, but care must be exercised to ensure that, when the impedance of the controlling valve is low, the load reflected into the anode circuit of the preceding

Contrast Expansion—

stage does not fall below that necessary for satisfactory distortion-free operation.

Amplifiers with variable negative feedback.—Both valve and lamp operated systems have been devised in which the over-all gain, of the AF amplifier is modified by negative feedback, the amount of feedback varying inversely as the applied signal.

By the use of this system the total harmonic distortion may be kept at least as low as that in a similar amplifier without feedback. If the system is valve-operated, the degree of expansion and the time-constants of the circuit may be controlled within wide limits, and the control can be made independent of the volume level of the reproduced signal. In addition, it is practicable to arrange the expansion to take place immediately before the output stage, or even the loud-speaker, thus reducing the average noise level. Finally, the additional complexity and cost of the system need not exceed, and may be less than, those of other valve-operated systems.

A lamp-operated negative feedback expander is shown in Fig. 4. It has many of the disadvantages already attributed to lamp circuits although having the advantage of comparative cheapness and probably introducing less distortion than other systems using lamps.

In Figs. 5 (a) and (b) are given outline circuits of two valve-operated negative feedback expanders due to Stevens of the South African Broadcasting Corporation. In each case a valve of which the impedance is dependent upon the amplitude of the signal is introduced into the feedback network in such a manner that the feedback varies inversely as the applied signal.

In the circuit of Fig. 5 (a) the feedback voltage is developed across the impedance in the cathode circuit of V_1 , and is proportional to the circulating audio-frequency current. In common with current feedback circuits in general, the output impedance, Z_0 , is high. It can be shown that $Z_0 = R_1 + (\mu + 1) R_k$, where R_1 and R_k are the anode load resistance and cathode resistance

respectively. This necessitates great care in design to avoid excessive high-note attenuation due to the Miller effect in the succeeding stage. It should be noted that expansion is obtained by effective variation of R_k , the latter rising to a high value during soft passages. Thus Z_0 is also at its highest value and high-note loss will be greatest when, owing to the frequency response characteristic of the human ear, it can be least easily tolerated. The disadvantage of high output impedance could most easily be counteracted by feeding into a cathode-follower stage.

To overcome the problem of high output impedance, the voltage feedback circuit, of which Fig. 5 (b) is typical, was produced by Stevens. The expansion due to changes in the degree of negative feedback is modified by taking the output voltage from across part of the feedback potential divider, so introducing the principle of operation outlined in Fig. 3.

This circuit has the disadvantage that, except as the initial stage of an amplifier, it cannot readily be used without an input transformer, which is necessary to ensure the correct polarity of feedback. This may introduce undesirable characteristics, including an increased hum level.

(To be concluded.)

BOOK REVIEW

Waveform Analysis. By R. G. Manley. Pp. 275 + xi; 103 diagrams and 3 plates. Chapman and Hall, 37, Essex St., London, W.C.2. Price 21s.

THE subject of this book lies on the fringe of the radio engineer's field of work. The vibration engineer, for whom this book is intended, is concerned with the analysis of waveforms which may contain high harmonics of several fundamental frequencies, and the proportion of these harmonics is usually very high by radio standards. The methods described here for examining complex waveforms are of value, however, in the design of very low frequency systems and in impulsive testing. This is an excellent guide to the interpretation of periodic waves. The first chapter discusses the synthesis of complex waveforms from their components and in the later chapters methods

of analysis are discussed in great detail. The worker who must examine numbers of waveform records will find the very close discussion a constant aid. An interesting detail is the author's description of how to determine whether the minor component of a beat system is of higher or lower frequency than the major component.

There are some points with which this reviewer finds himself at variance with the author. On page 219, *et seq.*, the use of a harmonic analyser with crystal filters is discussed. The user of a harmonic analyser would certainly not rely on the calibration to the extent suggested; his trouble would rather be that unless the components to be analysed were of constant frequency, the variations would bring them outside the narrow pass-band and make it impossible to get a steady reading. Reference 3 of Chapter VIII should be replaced by a reference to a fuller account of the Optical Harmonic Analyser.* This makes it clear that a variable density record can also be used. An advantage of variable density recordings with this machine is that other orthogonal functions can be used in the analysis, and variable area slides are more easily produced for such functions. For some work analysis into Bessel functions is particularly convenient and this machine would perform this analysis. Estimation of phase from Lissajou figures and the use of paper rather than film for photographic recording are two of the other details where the author's views are open to question. The use of C.P.S., C.P.M., Kc. and Mc. for frequency expressions must be strongly deprecated. The main value of this book is in no way affected by these minor defects, and it is to be hoped that there will be in due course a second edition which will be safe from even the sourest reviewer.

T. R.

* *Bell System T. Jour.*, July 1938.

ARMY SET TYPE R107

OWING to an error in the official circuit diagrams supplied to us of the R107 receiver, there is a lead missing from the vibrator in the power unit in the circuit reproduced on page 237 of our August issue. The vibrating reed should be joined by a short lead to the earthed junction of R42 and R43.

The vibrator contacts short-circuit first one and then the other of these resistors, thus allowing the full IT voltage to be applied alternately to each half of the MT1 winding on the transformer.

WORLD OF WIRELESS

C.E.R.C.A.

THE third conference arranged by the organisation with the above initials, which stand for Commonwealth and Empire, Radio for Civil Aviation, previously arranged to be held in Australia, was opened in London on August 7th. It aims at formulating within the Commonwealth and Empire tentative conclusions on all matters relating to the immediate and ultimate international standardisation of radio aids to civil aviation. This includes not only the standardisation of ground and air equipment, but also that of rules relating to its use.

Lord Winster, the new Minister of Civil Aviation, presided at the opening of the conference, which was attended by delegates from Australia, Canada, the Colonial Office, India, New Zealand, Newfoundland, Southern Rhodesia, and South Africa. Representatives from the U.S.A. and the U.S.S.R. were also present.

To quote from the speech of the chief American representative, "This is not an aviation conference in the broad sense, but it is restricted to the difficult questions, largely technical, as to how we can most effectively, and at the same time most inexpensively, guide commercial and private planes from their starting place to their destination in

safety and in all kinds of weather."

Among the many problems tackled by C.E.R.C.A. since the meetings in London and Ottawa in February and November last year is that of frequency allocations for civil aviation and recommendations have been prepared.

Among the United Kingdom's twenty-three representatives and technical advisers are Sir Robert Watson Watt, Deputy Chairman of the Radio Board, who has been elected Chairman of the conference, and Grp. Capt. H. G. Leonard-Williams, Chairman of the Wireless Telegraphy Board.

MONOPOLISTIC U.S. BROADCASTING

THOSE who advocate commercially-sponsored broadcasting for Britain generally contend that it would give relief from the B.B.C. monopoly, and cite America as the one country where "the ether is free for all." But it would appear that not all American citizens are satisfied that their system gives complete freedom from the monopolistic octopus. In the July *Harper's Magazine*, in an article deploring the fact that sources of public information are being concentrated into fewer and fewer channels, Morris L. Ernst complains that America is being dominated by four principal networks. These networks, it is implied, are in their turn dominated by fewer than 150 advertisers, from whom 97 per cent. of the networks' revenue is derived. "And in reality the concentration is greater than even that figure would indicate. Both NBC and the Blue Network receive about 60 per cent. of their total business from only ten advertisers; and one-eighth of NBC's total advertising volume in 1943 came from just one advertiser."

RADIO LENINGRAD

SOME of the difficulties successfully encountered by Russian engineers in maintaining a broadcasting station during the siege of Leningrad were recently given by Frank Gillard, B.B.C. Reporter, after a visit to the Soviet Radio War Reporting Organisation.

The Leningrad station having suffered heavily in the early stages of the bombardment, a mobile station was brought into use. Barrage balloon cables were used for the aerial, thereby enabling the transmitter to be moved from one balloon site to another around the city. It was a simple matter to connect the lead



CLANDESTINE LISTENING. This photograph, taken by a reader of *Wireless World* in a German P.o.W. camp (presumably after liberation) shows how the prisoners' broadcast receiver was hidden in a bucket fitted with a false bottom.

SOUND SENSE!

This business of saving time—LOOK AT IT THIS WAY!

AVERAGE TIME TAKEN TO LOCATE AN EXECUTIVE

The Old Way	The Tannoy Way
5 MINS.	20 SECS.

Six Executives :	
The Old Way	The Tannoy Way
30 MINS.	2 MINS.

Average four times per day each :	
The Old Way	The Tannoy Way
2 HRS.	8 MINS.

Per Week :	
The Old Way	The Tannoy Way
11 HRS.	44 MINS.

Per Year :	
The Old Way	The Tannoy Way
550 HRS.	36 H. 40 M.

Result—
513 HRS. 20 MINS.
YOU PAY FOR—
FOR NOTHING!



The Answer—

THE
'TANNOY'
CALL SYSTEM
SAVES ITS
COST OVER
& OVER AGAIN!

TANNOY
The Sound People
GUY R. FOUNTAIN, LTD.

"TANNOY" is the registered trade mark of equipment manufactured by Guy R. Fountain, Ltd. West Norwood, S.E.27 and Branches.
Phone: Gipsy Hill 1131

The largest organisation in Great Britain specialising SOLELY in Sound Equipment.

World of Wireless—

from the transmitter to the cable so that the station could be on the air within a few minutes of arriving on a new site.

NEW RECEIVERS

ACCORDING to an announcement by the Radio Industry Council, the first of the industry's post-war civilian receivers are expected to be available in the autumn. Not until well into 1946, however, will there be any substantial supplies.

The first of the sets will be very similar to the immediate pre-war receivers and will be issued under trade names. Prices are likely to be higher than pre-war and in addition purchase tax will be chargeable.

I.E.E. ELECTIONS

THE constitution of the Council of the Institution of Electrical Engineers and of the Section committees for the ensuing year have been announced.

The new President is Dr. P. Dunsheath, O.B.E., who is Director and Chief Engineer of W. T. Henley's Telegraph Works Co. He joined the company in 1919, at the age of 33, to reorganise the Research Department. In 1929 he was appointed Research and Technical Manager and in 1934 Chief Engineer.

The new Vice-Presidents are V. Z. de Ferranti, Chairman and Managing Director of Ferranti, Ltd., A. J. Gill, Deputy Engineer-in-chief, G.P.O., and P. Good, C.B.E., Director of the British Standards Institution.

A. J. Gill was Chairman of the Wireless Section in 1938. He entered the Engineering Department of the G.P.O. in 1913 as assistant engineer, in 1925 he was appointed executive engineer in



P. DUNSHEATH, O.B.E., M.A., D.Sc. (Eng.), President of the I.E.E. for the 1945-46 Session.

charge of the Radio Experimental Section, and in 1932 staff engineer of the Radio Branch. He is Chairman of the B.S.I. sub-committee on Graphical Symbols for Telecommunications and is a member of the Operations and Technical Committee of the Radio Board.

A. H. Mumford, the new Chairman of the Radio Section, has been with the G.P.O. since 1923 and has been engaged on the introduction of ultra-short-wave links into the trunk telephone network, the development of the co-axial carrier system and investigations into



A. J. GILL, B.Sc. (Eng.), one of the new Vice-Presidents of the I.E.E.

radio interference. He has been G.P.O. Radio Branch since 1936.

The new vice-chairman of the Radio Section is F. Smith, of the M.O. Valve Co.

The three vacancies on the Section Committee are filled by G. E. Condliffe, of E.M.I., D. C. Espley, of G.E.C., and C. E. Strong, of Standard Telephones.

WHAT THEY SAY

SERVICE, PLEASE.—What arrangements are being made to prepare technicians for the imminent arrival of television? . . . I find no evidence at all that this country is laying foundations for the technical knowledge we shall need to cope with what we are assured will be a boom.—*Writer in "Bristol Evening World."*

RECANTATION.—The difference between you and me is that I have a mind to change. . . . Wire broadcasting offers an awful temptation to those who possess power to give us what they want us to hear.—*P. P. Eckersley, pleading at the Radio Industries Club for a "sponsored" broadcasting service competitive with the B.B.C.*

60-kW MOBILE STATION

ALL the facilities of a modern high-powered fixed station are combined in what is claimed to be the world's largest mobile transmitter, now being operated by the U.S. Signal Corps in Europe.

Built by Le Materiel Telephonique, the French associate company of the International Telephone and Telegraph Corporation, this 60-kW station, which occupies seventeen large trailers, was delivered within three months of the order being placed.

The station, known colloquially as "Sig. Circus," is capable of handling 200,000 words daily. In addition to the normal radio-teletype channels the station is equipped with complete short- and medium-wave broadcasting facilities, wire, film and disc recording gear and apparatus for facsimile transmission and reception.

A feature is that all radio services can be carried on simultaneously. To prevent mutual interference the transmitting and receiving sections are placed a considerable distance apart and a VHF inter-unit communication system, including voice-frequency carrier equipment, is employed.



A. H. MUMFORD, B.Sc. (Eng.), the new Chairman of the Radio Section of the I.E.E.

TRADE NOTES

A BELGIAN importer wishes to obtain sole agencies or sole selling rights for British broadcast receivers, valves and components.

A company in Madeira offers its services to British manufacturers of radio and gramophone accessories wishing to find a market in the island.

An Indian firm of importers asks

for offers of all-India agencies for radio and allied products.

[Replies to the above enquiries, addressed c/o The Editor, will be forwarded.]

The United Radio Company, Sandhurst Bridge, Bombay 4, India, asks for catalogues from British exporters of wireless goods.

Change of address: Hensons (Radio Wholesalers) to 43, Rosebery Avenue, London, E.C.1.

PERSONALITIES

The Earl of Listowel has been appointed Postmaster-General in the new Government. Educated at Eton and Balliol, he was Whip of the Labour Party in the House of Lords from 1941 to 1944, after which he became Under-Secretary of State, India Office.

L. A. Woodhead, who has been with Corcor for 15 years, is now manager of their newly revived Technical Service Department.

A. C. Cameron, Secretary of the Central Council for School Broadcasting since 1935, is retiring for health reasons. R. N. Armfelt, an Assistant Controller in the B.B.C., is succeeding him.

OBITUARY

It is with regret we record the death in July of O. S. Pratt, who has been with the Mullard Radio Valve Co. for 21 years. He became head of their Technical Department in 1934 and in 1938 became Chief Valve Engineer. During the last two years he had been Technical Adviser on valves and was engaged on liaison work with Government Departments and on Government Committees.

IN BRIEF

Radio Interference—*Wireless World* understands it is probable that the question of radio interference will be discussed at the next meeting of the United Nations Co-ordinating Committee to be held in the United States in October.

New Radio Works.—A large factory for the manufacture of radio receivers and components is nearing completion at Hamilton, Lanarkshire. A subsidiary company of Philips has been formed for the project—Philips Hamilton Works, Ltd.

Radio Colour-photography.—The first news picture in colour to be transmitted by radio has appeared in Washington. It shows the Big Three in Berlin. Three negatives, one for each of the prime colours, were exposed simultaneously. Black-and-white prints were made from each and transmitted from Berlin to America, where the received pictures were utilised to reproduce the colour photograph.

Russian Radio.—The Soviet newspaper *Trud* discloses that a giant radio station was built in the Soviet Union during the war. No details are given as to its position and power, but its masts are stated to be 650ft. high.

Radio Station Removal.—Five special L.M.S. trains were needed in the removal of a complete Admiralty radio station to its port of embarkation en route to India. 700 tons of equipment included generators, transmitters and masts.

BETRO Members.—More radio firms have been elected as members of the British Export Trade Research Organisation, amongst whom are included: London Electric Wire Company and Smiths, Metropolitan-Vickers Electrical Export Co., A. Reyrolle and Co., and Sterling Industries.

Eire Radio.—In the Dail recently it was stated that the revenue from wireless licences amounted to approximately £107,000, and the income from advertising was approximately £3,700. In contrast to Great Britain's increasing number of licences there was a decrease of 1,528 during the year which ended March 31st last.

Mountain Television.—Plans for the development of Mount Wilson, the Californian site of the observatory, as a centre for television have been announced. Negotiations are being made by three of the major broadcasting networks for station sites.

Will.—The late Sir Ambrose Fleming, who died in April at the age of 95, left £56,651 gross.

Indian Licences Increase.—200,534 broadcast receiving licences were in force in British India at the end of April—an increase of 18,686 over the previous year.

Change of Address.—The new address of the Institute of Physics and its *Journal of Scientific Instruments* is 19, Albemarle Street, London, W.1. Tel.: Regent 3541.

Telegraphic Service Reopened.—The restoration of the public telegraph service with Yugoslavia is announced by the Post Office and Cable and Wireless.

I.E.E. Students' Section.—The following officers were recently elected at a meeting of the London Students' Section of the Institution of Electrical Engineers, for the 1945-46 session: Chairman, H. Shorland, B.Sc. (Eng.); Vice-Chairman, R. G. F. Stefanelli; Hon. Secretary, R. V. Darton, B.Sc. (Eng.); Hon. Asst. Secretary, G. S. H. Mogford.

MEETINGS

Institute of Physics Electronics Group.—Annual General Meeting followed by a lecture on "Electronic Conditions in the Sun and Stars" by Dr. D. S. Evans, on September 14th at 5.15, at the Royal Society, Burlington House, Piccadilly, London, W.1.

Institution of Electronics North-West Branch.—"The Theory, Design and Application of Magnetron Valves" by R. G. B. Gwyer on September 21st at 6.30 at the Reynolds Hall, College of Technology, Manchester. Non-members can obtain tickets from L. F. Berry, 105, Birch Avenue, Chadderton, Lancs.



H.A.5 DEAF-AID
CRYSTAL MICROPHONE

ASTATIC will be ready to serve you again with high quality piezoelectric devices when the 'All-Clear' of Victory sounds. Astatic deaf-aid microphones can be supplied only if Import Permits are established. Model H.A.5 illustrated is used as standard by America's leading hearing-aid instrument makers.

ASTATIC

THE ASTATIC CORPORATION
CONNEAUT, OHIO, U.S.A.

and
TORONTO, CANADA.

— Exclusively Represented by —

Frank Heaver Ltd. Kingsley Road,
Bideford, N. Devon

**SOON
CRONAME**

*Designing and
Engineering*

will again be a factor in the plans of far-sighted manufacturers of electronic equipment. From building precision parts for wartime devices the Croname group will turn to the processing of mechanical and decorative items for the electronics industry.

A place in the Crowe schedule has meant attractive, practical, saleable merchandise to many. Our facilities may be valuable to you.

Dial Seals.
Tuning Mechanisms.
Pointers. Escutcheons.
Precision Controls. Knobs.

*
Exclusively Represented in
Great Britain by

FRANK HEAVER LTD.
Kingsley Road, Bideford,
N. Devon.

Croname Incorporated
FORMERLY
(Crowe Name Plate & Manufacturing Co.)
CHICAGO, ILL. U.S.A.

Letters to the Editor

Reducing Amplification Interference • Communication Channel Capacity • Service Valve Types

Physiological Amplifiers

IN answer to the letter from George H. Bell in your July issue, may we say that the situation is not perhaps as difficult as he suggests? For some years there have been available circuits designed for the purpose of eliminating interference with electro-physiological experiments. All these circuits depend on having the two input connections either balanced with respect to earth or earth-free, and, together with this, some arrangement to give great discrimination against signals appearing in phase at the two input leads.

The important feature of interference due to most alternating current mains and the like is that one side of the source of the interference is earthy. Therefore, with circuits such as those mentioned above, even when the subject or preparation is not earthed, it can be arranged easily that the wanted signal will be amplified up to 1,000 times as much as the interference. If the subject is

earthed, this ratio can be greatly increased. However, it should be noted that high discrimination ratios of 1,000 to 1 or more can rarely be maintained in practice owing to uncontrollable variations in electrode characteristics. These variations often introduce errors in balance of the order of 1 part in 1,000, depending on the type of electrodes used and the input impedance of the amplifier, and are likely to render sterile any attempts further to reduce interference by circuit design. No circuit can give better results than those allowed by the goodness and balance of the pick-up contacts. Some circuits (Schmitt: 1935) allow alteration of balance whilst in use. Such alteration will "clean up" the record as regards interference, but may also balance out or distort some of the wanted signal.

There is a considerable body of literature on this subject, some of the references being:—

Offner, F., *Rev. Sci. Inst.*, Vol. 8, p. 20, 1937.

Schmitt, O., *Rev. Sci. Inst.*, Vol. 8, p. 126, 1937.

Matthews, B. H. C., *J. Physiol.*, Vol. 93, p. 25, 1938.

Toennies, J. F., *Rev. Sci. Inst.*, Vol. 9, p. 95, 1938.

and a review of circuits of this type is given by:—

Saunders, M. G., *Electronic Engineering*, May, 1942, p. 760.

As a practical contribution to your correspondent's enquiry, the circuit shown in the accompanying diagram has been found to fulfil most requirements. Using this circuit, provided the inter-electrode resistance is low ($<10^4\Omega$), completely interference-free records may be obtained within a few feet of unscreened mains-driven equipment. The principles of the circuit are typical of those put forward in the papers referred to above. The cathode follower output is only of value when it is convenient, as is often the case, to have a considerable separation and long-

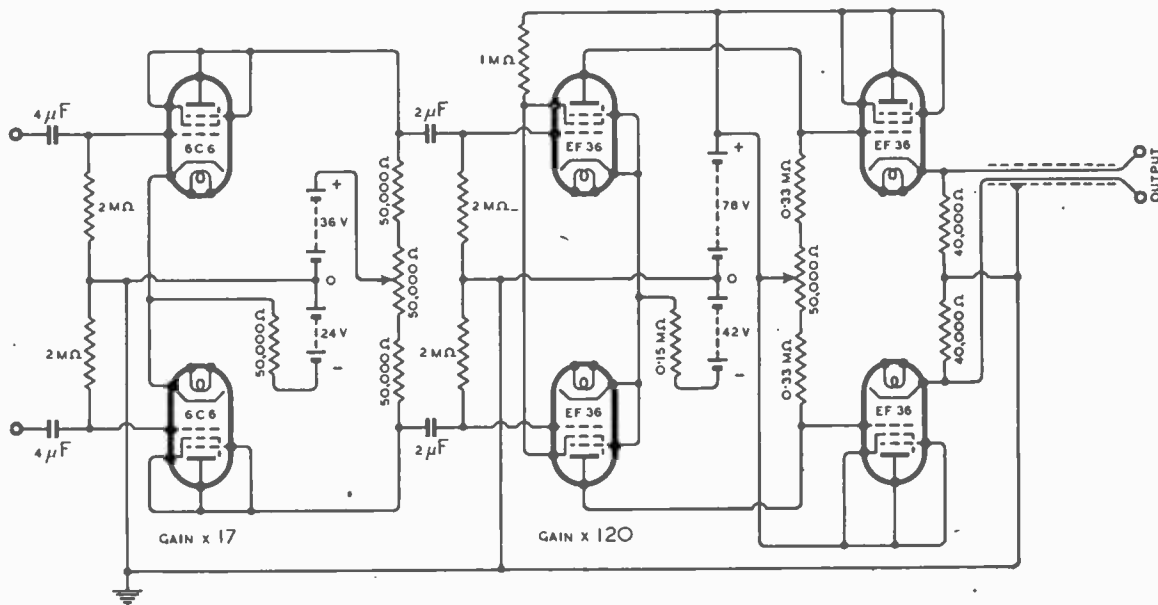

Balanced amplifier circuit-referred to by Dr. G. D. Dawson and W. Grey Walter.

screened leads between the first two stages and succeeding stages. The design of the succeeding stages will, of course, depend entirely on the overall sensitivity required and the type of recording instrument to be used.

The subject of noise is not so well documented, so far as biologists are concerned, for they are worried by components in the frequency band from less than 1 up to 50 c/s, as well as those of higher frequency. Most valves, even those quiet at higher frequencies, appear to generate considerable random potential differences in this frequency band, and the source of this noise is apparently not clear to electronic engineers. It has been observed that high-slope valves are disproportionately more noisy in this band than low-slope valves, and it has been suggested that this is due to the proximity of the grid to the cathode, with consequent heating and contamination of the grid wires and resulting random grid emission. Resistance noise is, of course, inevitable. Cathode noise may be reduced to a very low level by selecting an optimum cathode current, usually 0.2 to 0.5 mA., where the gain of the circuit has not fallen seriously (see figure). Reduction of the very low-frequency noise can, however, only be achieved by selection of valves. The best results seem to be obtained with valves selected from the class of old-fashioned low-slope triodes such as the Osram MH40 and the Mazda V312, at least 75 per cent. of which are good. About 25 per cent. of 6C6s (English or American), used triode-connected, are also up to the same standard. The type 1603 is also good, but does not appear to be obtainable at the moment.

While on the subject of electro-physiological methods, some comment seems to be necessary on the article by "Radiophare" in the same issue. Questions about possible relations between brain EHF's and telepathy are frequently raised and speculated upon. There are three powerful arguments against the existence of any such relation. First, the extremely small size of any induction or radiation field due to the electrical brain rhythms, which

may be represented as a current fluctuating at 10 c/s with a peak value in the tissues of the head of about one microamp. Even with a receiving circuit Q of the order of a million, the amount of energy that could be transferred from sender to receiver would be far less than that known to be necessary for the excitation of nervous tissue. Secondly, telepathic and "extra-sensory perception" effects have not been shown to be attenuated by the interposition of magnetic or electrostatic screens between the sender and receiver. Thirdly, in the published accounts of experiments on the transference of thought, no diminution of the effect with distance has been established. These considerations should re-direct speculative and experimental minds into more profitable fields.

G. D. DAWSON,
The National Hospital,
London, W.C.1.
W. GREY WALTER,
The Burden Neurological
Institute, Bristol.

High-speed Radio-telegraphy

THE description of the Romac 3,000-w.p.m. system in the July, 1945, issue of *Wireless World* is interesting, but the limitations of any such system deserve some comment. A transmitted speed of 3,000 w.p.m. of Morse code corresponds to transmitter modulation at 1,200 c/s. The length of a dot in such a system will be of the order of 0.4 millisecond. For radio transmission we may allow "ether bias" of say 20 per cent., so that the interval between the shortest and longest transmission paths should not exceed 0.1 millisecond: that is, if multi-path transmission is taking place the path difference should not exceed 30 km. This requirement just cannot be met: it is, indeed, tantamount to asking for single-path transmission. Thus the long-distance radio link itself gives no opportunity for this system to work.

There are other disadvantages. The high modulation frequency precludes the use of modulated CW to protect against fading, and no magic box can restore a signal which has faded right out.

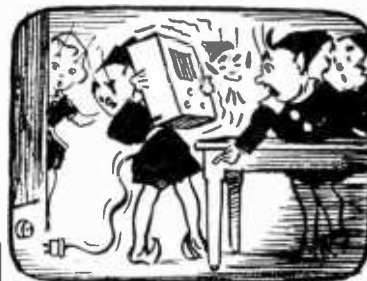

THE "FLUXITE QUINS" AT WORK

"The fault in this set, I've detected,
Much sooner than I half expected."
"It's FLUXITED" said OH,
"Yet the darn thing won't go!" ...
"Why don't you try it connected!"

See that FLUXITE is always by you—in the house—garage—workshop—wherever speedy soldering is needed. Used for over 30 years in Government works and by leading engineers and manufacturers. Of all Iron-mongers—in tins, 8d., 1/4 & 2/8.

Ask to see the FLUXITE POCKET BLOW LAMP. Price 2/6.

TO CYCLISTS! Your wheels will NOT keep round and true unless the spokes are tied with fine wire at the crossings AND SOLDERED. This makes a much stronger wheel. It's simple—with FLUXITE—but IMPORTANT.

The FLUXITE GUN puts FLUXITE where you want it by a simple pressure. Price 1/6, or filled, 2/6.



ALL MECHANICS WILL WANT

FLUXITE

IT SIMPLIFIES ALL SOLDERING

Write for Book on the ART OF "SOFT" SOLDERING and for Leaflets on CASE-HARDENING STEEL and TEMPERING TOOLS with FLUXITE. Price 1d. each.

FLUXITE LTD.
(Dept. W.W.), Bermondsey Street, S.E.1

Letters to the Editor—

Furthermore, it is fundamental that a given bandwidth can only transmit a given amount of intelligence. The use of crystal-controlled transmitters and receivers would allow close spacing of WT channels and the operation of ten 300-w.p.m. channels in the same band as is used by the 3,000 w.p.m. channel. Recorders and the like are eliminated, the propagation difficulties do not arise, and standard equipment can be used throughout.

I have drawn attention before to the fundamental fact that you do not get something for nothing, except just before an election. The problem of WT transmission is that of getting maximum channel efficiency, maximum band efficiency and maximum value for the money spent on equipment and staff. A system which gets more words per channel at the cost of fewer channels per band and with low economic conversion efficiency (for there are so many intermediate operations) is not a useful system.

THOMAS RODDAM.

Telepathy or Radio-Telepathy?

AS one who, to use "Radio-phare's" words (your July issue), "understands action at a distance," I am compelled to protest. Telepathy has no connection with radio, and your readers should be warned against indulging in the futile pastime of flogging a dead horse. The rationale of the subject does not lie within the field covered by *Wireless World*, and so cannot be given here. It is only necessary to point out that the mechanism is a product of the mind, and, unfortunately, cannot be described in simple terms unless the reader has studied the subject of astral phenomena fairly deeply.

It can be pointed out that telepathy can be used to "transmit" and "receive" quite complicated thoughts, but this requires either a "sensitivity" in both parties such as can only be acquired after long training and practice, or natural gifts, which are very rare. The one explanation is to be found in the domain of what is usually known as occult science, but the subject is so vast that

suitable references cannot be given here.

This is an unsatisfactory and inadequate statement, but it must be taken as an implication that I flatly contradict the notion that radio has any connection with telepathy. H. A. HARTLEY.

Isleworth.

[This subject is also referred to in the letter headed "Physiological Amplifiers" on page 282.—Ed.]

"Valves in the Services"

IN your August issue you published an "equivalent list" of Services and commercial valve types.

This list was prepared without the knowledge of the valve manufacturers and it is felt to be desirable to draw particularly to the attention of your readers the fact that a list of this nature must be interpreted with some care, or else it may serve only to mislead.

The commercial type which is shown against any particular Services type may well be a basically similar valve but, in many cases, the two valves will be selected from the current production to specifications which are significantly different. Thus it should not be assumed that the valves shown as equivalents will in fact give similar performances in various circuit applications.

The second point which should be emphasised applies wherever two or more commercial types are shown as being equivalent to one Services type. There is a risk in such a case of the several civilian types being regarded as exact equivalents to each other.

J. R. HUGHES,

Technical Secretary, British Radiq Valve Manufacturers' Association.

London, S.W.1.

Television/Cinema Comparisons

THE comparisons between the definition of the cinema film and the television picture made by H. W. Lee in the August *Wireless World* seem to be based upon a fundamental error. There is a vital difference between the moving images formed by the two systems. The television picture consists of a fixed mosaic which remains identical from frame to

frame, while the cinema film consists of a random mosaic (the grain of the film), the grain structure of one frame not being the same as the grain structure of the preceding or succeeding frame.

Because of the persistence of vision of the human eye, a cinema picture therefore gives a much better definition than would be supposed from an analysis of the picture elements. This is not so with the television picture where the same "grain structure" persists from frame to frame and is thus much more noticeable to the eye.

The comparison between the definitions of the cinema and the television picture is, therefore, only valid if we compare the television picture with one frame (a still) from the film. When this is done the shortcomings of the film are apparent.

This means that the definition of the television image to give results as good as the cinema film *in motion* will have to be considerably higher than the definition of one frame of the film.

J. M. T. EVANS.

London, S.W.19.

"Self-healing Paper Condensers"

WITH reference to the notes which appear in the July *Wireless World*, I suggest that many radio and condenser engineers will feel uneasy after reading it, because of the failure to acknowledge the pioneer work of Dr. G. F. Mansbridge. It is certainly going a bit far to describe the miniature condensers which have been developed for wartime apparatus as "a new development in the manufacture of paper-dielectric capacitors." The mechanical principles embodied in the "new" condensers, and probably the materials, are similar to those described by Mansbridge before the I.E.E. on May 7, 1908, and it may be of interest to note that such condensers were on sale to the general public a few years before the war started, and possibly up to 1939.

When very small paper-dielectric condensers were required for certain apparatus during the war there were three obvious ways of effecting the desired reduction in dimensions: (1) by reducing the

thickness of the tissues in normal types; (2) the employment of an impregnant with a higher dielectric constant than petroleum jelly, and (3) adoption of the Mansbridge type. The first proposal is impracticable because condensers made with interleaving tissues thinner than the normal 10 microns would be unreliable; the second is theoretically the correct way of attaining the desired result, and impregnant with dielectric constants of at least twice the value of paraffin are actually known, but they have other disadvantages which are too serious to permit their use in positions where absolutely first-class reliability is essential. The Mansbridge type is a perfect solution, because it permits a single tissue to be used; in the modern foil/tissue type two interleaving papers are always employed because, if one were used, a single small hole or other imperfection in the strip of tissue in any condenser would inevitably cause breakdown.

The self-healing properties of the Mansbridge type result from the melting away of the metallising on the tissue around a "fault," or short-circuit, and it is part of the process of manufacture of condensers of this type to "break-down" the foiled tissue by putting it through a machine which impresses a voltage between the tissue side and the metallising, thus burning out the larger imperfections, i.e., places where the metallising has penetrated, or partly penetrated, the tissue.

The unsuitability of these condensers for AC circuits arises from their comparatively high power factor, due to high electrode resistance—a characteristic which might be expected in a film of metal thin enough to melt away at the passage of a current that is too small to burn the tissue.

C. E. WHITE.

Bournemouth.

Sets for Export

MAY I indicate a few points to which manufacturers might give attention, so far as broadcast receivers for Kenya Colony are concerned?

We need short-wave receivers. A range of, say, 10-60 metres would cover most European

stations, as well as our own station at Nairobi, about 300 miles away. "All-wave" sets are a waste of space and components. Plain calibrated dials are wanted. My set has 53 useless names on it.

Adequate band-spreading and the highest attainable selectivity are needed, with freedom from frequency drift. Accessibility and robustness are essential; qualified service-men are rare.

By the way, why do I always see American sets in the crews' quarters of British merchant ships? The ships' supply is generally 110 volts DC.

F. V. CRIBB.

Mombasa, Kenya Colony.

Re-organising the Industry

I SHOULD be glad of an opportunity to comment briefly on certain of H. A. Hartley's proposals for re-organisation of the radio industry.

Leaving on one side, for the moment, the question as to the desirability of the changes, it is doubtful wisdom to advocate a scheme that has no chance of acceptance, and to address to engineers a plan (Research Centre and Standard Chassis) that would, for most of them, spell the end of their livelihood, is hardly tactful.

It is also doubtful whether such a plan has the economic advantages which are claimed for it, either to the consumer or to the manufacturer. The present position in the industry is that the bulk of production is concentrated in very few firms—E.M.I., Philips, etc. Production in these firms is on such a level that the benefits of standardisation and mass production are already fully realised. Moreover, any of these large units could easily deal with Mr. Hartley's programme (if they thought it sound), irrespective of what other firms might do.

Mr. Hartley's scheme would find small favour with the small manufacturer who competes with the larger one by touches of individuality that a standardised chassis would render impossible, and to divorce cabinet and chassis would only aggravate this position further. There would, in fact, be no place for the small manufacturer in such a scheme.

D. C. BURTON.

London, W.5.



The new Vortexion 50 watt amplifier is the result of over seven years' development with valves of the 6L6 type. Every part of the circuit has been carefully developed, with the result that 50 watts is obtained after the output transformer at approximately 4% total distortion. Some idea of the efficiency of the output valves can be obtained from the fact that they draw only 60 ma. per pair no load, and 160 ma. full load anode current. Separate rectifiers are employed for anode and screen and a Westinghouse for bias.

The response curve is straight from 200 to 15,000 cycles in the standard model. The low frequency response has been purposely reduced to save damage to the speakers with which it may be used, due to excessive movement of the speech coil.

A tone control is fitted, and the large eight section output transformer is available to match, 15-60-125-250 ohms. These output lines can be matched using all sections of windings, and will deliver the full response to the loud speakers with extremely low overall harmonic distortion.

PRICE (with 807, etc., type valves) £18.10.0

Plus 25% War Increase

MANY THOUSANDS ALREADY IN USE

VORTEXION LTD.
257, THE BROADWAY,
WIMBLEDON, S. W. 19.
Phone: LIBerty 2814

RANDOM RADIATIONS

By "DIALLIST"

Not Too Easy

A MAN who always has my deepest sympathy is the wireless retailer who really knows his job. He recommends one set which he knows to be a really sound piece of work and an excellent performer on the local stations (which his customers will use for 95 per cent. of their radio entertainment) and has to grin and bear it when they reject his advice and choose another because it "gets" more foreign stations. He must remain cheerful and polite when summoned urgently to deal with breakdowns (!) due to failure to switch on the wall-socket into which a receiver is plugged, to connect the aerial, or to efforts to receive B.B.C. programmes when the set is switched to "Gram." He must suffer gladly the folk who bring in an accumulator with the electrolyte at half its proper level and the plates covered with sulphate deposit, saying that of course he'll be able to have it charged and in working order by 10 o'clock the next morning, which is the only time when they can call. He has had to persuade customers that the unattractive-looking austerity receiver is a sound set and good value for money, both of which it is. And now those who took this advice are bullying him because they can't receive the Light Programme satisfactorily. My hovel is under 20 miles from Brookman's Park but I can't get respectable reception on 261 metres—from which, rightly or wrongly, I deduce that the 261-metre transmitter is not at B.P.

□ □ □

The Litz Problem

MANY thanks to the readers who have so kindly sent descriptions of methods of soldering Litzendraht stranded wire. The crux of the problem is, of course, that you may have to deal with many strands of fine wire—27 of No. 42 SWG, for instance—each separately insulated by a silk wrapping. You must bare every strand and you must not break any of them if the special HF qualities of Litz are not to be impaired. With the simpler and stouter kinds of Litz it is just possible (provided that you have a delicate touch and a patient nature) to scrape the wrapping off each strand separately with a penknife; I've done it with 3/40 and even with 9/40 in the old days when Litz

first began to be used for wireless purposes. But it is a fiddling and uncertain job and you are more than likely to break the last strand after having dealt successfully with the others. Had Job himself done that twice running, even his patience would have been as exhausted as Hitler's was wont to be. The method that I evolved and found pretty satisfactory was to singe the silk by moving a match flame to and fro under it and then to rub it gently off with the fingers. But readers have sent other and, I think, altogether better ideas.

"Meths" or Caustic Soda?

One school of thought plumps for methylated spirits, though there are variations in the methods of use suggested. Here is one scheme which seems to be popular; it is, I believe, used in some factories, at any rate. The part to be bared is dipped into meths. and then lighted so as to burn off the insulation. I am told that a little experimenting is advisable to discover the optimum dipping time. When you get that just right the wrappings are charred without damage to the wire. One reader suggests a *modus operandi* which should ensure this almost automatically. Some meths. is poured into a teaspoon; the Litz is then dipped and fired with a match. As soon as the ends of the wire glow red hot the flame is quenched in the spirit remaining in the spoon. Another school pins its faith to caustic soda. The caustic soda scheme looks attractive in many ways. In this the Litz is dipped into a warm solution of caustic soda in a shallow evaporating basin. It is then held in the stream of running water from a tap and the "sludge" gently removed with the fingers. One great advantage of this process is that the strands are left clean and bright—in perfect condition for soldering; but I don't altogether like the idea of wetting the insulation and one wonders how far the caustic soda solution might creep up the wrappings. One meths. enthusiast, by the way, recommends burning until the bared ends are fused into a "blob." Wouldn't this be liable to make the Litz brittle? It seems to me that it might be asking for subsequent trouble in the shape of a break near the soldered connection. I'm sorry that I haven't been able to try out the various suggestions so as to report practical

results. Unfortunately I haven't an inch of Litz in my workshop at the moment and can't get any.

Confirmation

Those paragraphs had just been written when a fresh batch of letters from readers arrived. Several of these mention that the dip-and-quench method with meths. is that used by radio and instrument manufacturers. One correspondent kindly sends samples of Litz stripped in this way and they leave no doubt that it is a completely satisfactory means of doing the job. These letters, too, contained a new suggestion, which may be useful for other end-baring jobs. The sender is good enough to enclose a sample of a very fine abrasive paper which, he tells me, goes by the name of "Speed Grip." Its full title is Waterproof Abrasive Paper, Silicon Carbide, Grade T.1. I'm not sure that it would be as quick, sure and effective for Litz stripping as the meths. method; but it would certainly be ideal for baring the ends of very fine, single enamelled wires. The sender tells me that he uses it regularly for dealing also with 0.0076 inch diameter (No. 36 SWG) silk-covered aluminium wire. His method is to hold the doubled paper lightly in the right hand and to draw the end through it with the left. The correct pressure quickly comes with practice, he says. He finds that he never has to make more than two draws. I make no apology for devoting so much space to the Litz problem, for it is clearly one that interests many readers.

□ □ □

Text Book Troubles

A CORRESPONDENT writing in last month's *Wireless World* put his finger upon one of the main difficulties in writing *and* in selecting text books: some authors don't seem able to decide what sort of people their readers are going to be. Large sales mean large royalties and there is always the temptation to write with at any rate half an eye on appealing to the widest possible public. To try to cater in one and the same book for the beginner and the expert, the brilliant and the dull, is a fatal mistake. Yet how often does one find a work with a pretentious title devoting page after page to fourth-form stuff? On the other side of the medal you have the "Primer" of this or the "Ele-

mentary Handbook" of that, whose titles lure the unfortunate beginner into parting with hard cash, only to find himself well out of his depth in Chapter 1 because the author has assumed, despite his title, that all readers of primers and elementary handbooks are thoroughly familiar with Fourier series, or such terms as "negative resistance," "decrement," "mutual inductance" and "Miller effect." Every writer of a technical book should decide at the outset for whom he is writing; should make this clear and unmistakable in his introduction, and should match manners of his elucidation to the company of his selected readers.

□ □ □

Trying It On the Dog!

With the correspondent who suggested that the best writers of text books were those who had practical instructing experience I could not agree more. There is no other way of discovering (a) what is dark to the minds of students and (b) how to lighten that darkness. When I was instructing in this war and in the last one I used to give one tip to my assistants: collect students' notebooks twice a week during your first month and at least once a week after that. Read what they have written down as the gist of your talks and you'll learn, on the one hand, what their real difficulties are and, on the other, whether or not you have been successful in smoothing them out. Similarly, writers of text books might do a lot worse than let students of various mental calibres read the MS or the proofs and give an account of their reactions.

□ □ □

Bow-wow Latin

THOUGH scientific folk to-day affect to scorn the classics, various bodies connected with wireless seem to have a perfect passion for adopting alleged Latin mottoes. And having concocted something of the worst dog-Latin type they are wont to publish "translations" containing bloomers which would have earned fourth-form schoolboys a sound spanking in my young days. The R.M.A.'s *Radio maximo arvo* is perhaps the worst example. If I remember aright, the official translation is "by radio to the farthest shore"! And now we are told that the Radio Industries Club's *Spectemur agendo* means "By our deeds we shall be known." I'm afraid it doesn't, not nohow! It might mean several things, but that's not one of them, for *spectemur* isn't the future indicative and *spectare* doesn't mean "to know."

It's the hidden details that count

140
TYPES
IN
PRODUCTION

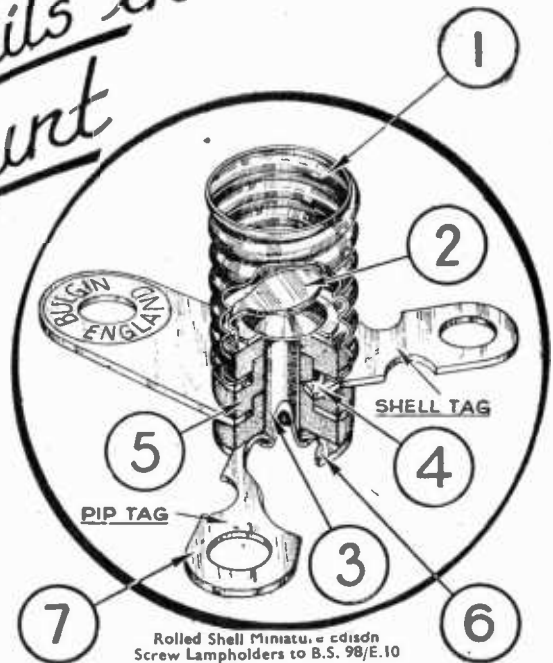

- 1 — Threaded shell with dimensions and details to B.S. 98—10 mm. "MES," silver-plated finish.
- 2 — Central "pip" contact of spring phosphor-bronze to ensure good contact, silver-plated.
- 3 — Central rivet of solid steel ensuring permanently tight and positioned assembly.
- 4 — Locking teeth on "shell" contact solder tag, ensuring contact and preventing unintended rotation.
- 5 — Stepped insulating washers preventing short-circuit and permitting comparatively high-voltage working conditions.
- 6 — Toothed solder tag locks to rivet turnover, fixing position and ensuring contact to "pip" contact.
- 7 — Dual purpose soldering tags coated pure tin and accepting "threaded" or "wound" wiring; fixing bracket, normally "dead," may contact with shell and replace the shell tag.

The choice of Critics



A. F. BULGIN & CO. LTD., BYE PASS RD., BARKING, ESSEX
RIPpleway 3474 (5 lines)
(The name "BULGIN" is a registered Trade Mark)

RECENT INVENTIONS

DECOUPLING CIRCUITS

THE value of the resistance and capacity elements required to decouple the valves of a multi-stage amplifier from the impedance of the common HT source becomes inconveniently large when low frequencies are to be handled. The inventors describe an alternative arrangement in which impedances inserted in the HT supply line serve the same purpose.

In the resistance-coupled amplifier shown, the anode currents of the last two valves, which are in phase-opposition, flow through separate impedances Z_1 , Z_2 , of such value that the back-EMF's developed across them and the common impedance Z_3 of the HT source balance-out at the junction points J_1 , J_2 . The anodes and screen-grids of the preceding valve are supplied from bus-bars connected to these junctions, which being balanced to earth contain no undesirable "ripple"

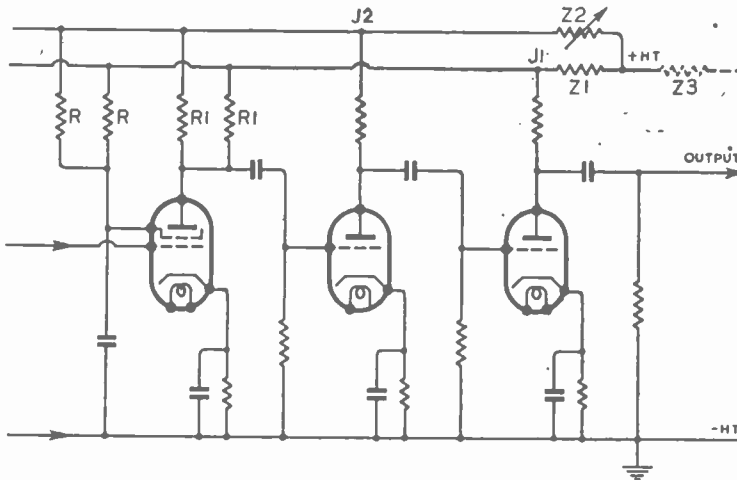

Balanced decoupling circuit.

voltage. To offset the double supply line, the connections to the electrodes of the first valve are made through pairs of resistances, such as R and R_1 , each one of which is of normal value.

Furzehill Laboratories, Ltd.; F. R. Milsom; and S. Smith and Sons (Motor Accessories), Ltd. Application date, July 27th, 1943. No. 567021.

OXIDE-COATED CATHODES

THE barium content of the coating tends to evaporate at the working temperature, thus reducing the effective life of the valve. One possible remedy is to provide a pellet of barium inside the tube where it evaporates as the tube is operated and so supplies free molecules to replace those lost by the cathode. Unfortunately, it seems that the molecules also deposit themselves on the grid and other electrodes and so give rise to undesirable emission.

It has now been found possible to re-activate the cathode by placing a positively charged pellet of barium at

A Selection of the More Interesting Radio Developments

a point inside the tube where it is subjected to bombardment by the main electron stream, without, however, being heated to the point of evaporation. In a cathode-ray tube, for instance, the pellet is fixed on the inside of the first accelerating anode, facing the cathode. Under these conditions, the barium is liberated in the form of positively charged ions, which are then focused directly on to the cathode by the prevailing electrostatic field.

The General Electric Co., Ltd., and L. Jacob. Application date May 21st, 1943. No. 567718.

OSCILLATION GENERATORS

WHEN the tuning of the main oscillatory circuit of a valve generator is varied, as in frequency modulation, the reactance of the circuit also changes, so that the full resonant voltage no longer appears across it. In practice this variation is usually offset by including some circuit element which is adjusted concurrently with the change in tuning.

According to the invention, the desired effect is secured by including in the anode circuit of the generating valve a "static" stabiliser, i.e., one that requires no specific resetting. The stabiliser consists of an inductance in series with a condenser, the resonant frequency of the combination being fixed either slightly above or below the tuning range of the signals, according as the tuning of the main oscillation circuit is varied by an inductance or by a condenser. Under these conditions, the impedance of the stabiliser changes with frequency in the same sense as the main circuit, and so keeps constant the output voltage across the latter.

The General Electric Co., Ltd., and J. M. W. McBride. Application date June 18th, 1943. No. 567189.

RF INDUCTANCES

AN iron-dust core for a variable tuning inductance is made in two parts, as shown, the coil being wound around the centre limb of the pot B. The lid or upper part A is recessed, so that when it is moved closest to the part B there will still be a gap in the magnetic circuit, over the centre limb.

This construction is stated to reduce the overall size of the unit required for a given range of tuning inductance and "Q." It also allows the coil to be

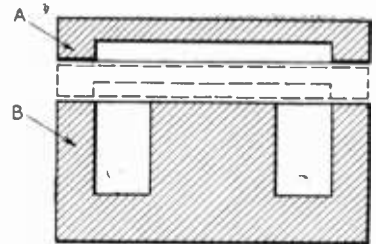

Gapped dust core.

impregnated after it has been fitted in position.

Neosid, Ltd., and M. Grenly. Application date, October 18th, 1943. No. 567963.

ELECTROLYTIC CONDENSERS

IF over-run, this type of condenser will develop internal heat and generate gases.

To meet this contingency, one wall of the container is slightly thickened to allow for a small flat recess, which is perforated at the centre and bordered by an upstanding rim of metal. A small disc of rubber, in which a slit has been made without removing any of the material, is dropped on to the seating over the aperture, and is then fixed firmly in position by turning or spinning-over the edges of the surrounding rim. This leaves the centre of the rubber free to allow the sides of the slit to gape sufficiently to relieve any internal pressure, and to close up tightly again under normal working conditions.

P. A. Sporing; C. P. Johnson; and The Telegraph Condenser Co., Ltd. Application date, August 9th, 1943. No. 567602.

The British abstracts published here are prepared with the permission of the Controller of H.M. Stationery Office, from specifications obtainable at the Patent Office, 25, Southampton Buildings, London, W.C.2, price 1/- each.

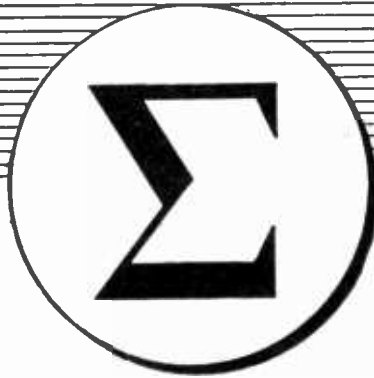

*The capital Sigma,
in mathematics, is a symbol
meaning 'the sum of'*



*The Philips emblem,
in everyday life is a symbol meaning
the sum of expert design, skilled
workmanship and good materials.*

PHILIPS

LAMPS · RADIO · X-RAY · COMMUNICATIONS EQUIPMENT
AND ALLIED ELECTRICAL PRODUCTS

Rate 6/- for 2 lines or less and 3/- for every additional line or part thereof, average lines 5-6 words. Minimum 2 words, plus 1/- Press Day: October, 1945 issue, first post Monday, September 10th. No responsibility accepted for errors.

NEW RECEIVERS AND AMPLIFIERS

COMMUNICATION receivers.—Remember "Dale" after the war—Dale Electronics, Ltd., 152-6, Gt. Portland St., W.1. Mus. 1023.
CIVILIAN supplies recommence we shall be at your service.—A.C.S. Radio, 44, Wildmore Rd., Bromley, Kent. [3805]

W.W.—3-bnd. ac s-het. tuner, Octal Osram's of KTW63; fc X65, if KTW63 (465kc Varleys), det. D63, brand new spare X65; £15 or offer; brand new, perfect; less than cost.—10, New Rd., Gaywood, King's Lynn.

T.R.F. medium wave kit of parts, with drilled chassis and all components, condensers, etc., and circuit, nothing else to buy, £4; valves, £2/10; 5in speaker, trans., 27s.

HENRY'S, 5, Harrow Rd., Edgware Rd., W.2.
QUANTITY amplifiers, 200-250v ac, 5 watt 8Bggns., 12 watt, £14; s.a.e. for fully illustrated leaflet and copy of "Design for Quality"; immediate deliveries.—J. H. Briery (Gramophones and Recordings), Ltd., 403, Mill St., Liverpool, 8. Lark Lane 1709. [3796]

RECEIVERS, AMPLIFIERS—SECOND-HAND OFFERS, National HRO Senior, 230v ac, 5 coils.—Write Box 1128. [3863]

HALLICRAFTERS Super Defiant 3BX25 communication receiver; best offer accepted.—Box 3519. [3675]

AUSTIN twin-speaker super het. receiver, excellent condition; £25.—Write Y. T., c/o Charles Barker and Sons, Ltd., 31, Budge Row, London, E.C.4. [3992]

AMERICAN Scott Phantom radiogram, bought new 1945 as new; £120 or near offer.—Tel. Arncliffe 3287. [3980]

FOR sale, 4 Eddystone 358 sets, in good working order, complete with coils and loudspeakers; £35 ea. cash.—Box 1364. [4025]

PETO-SCOTT preselector 0.5 to 43mc, 5 bands, 2 rf, 230 ac, £7/15; B.T.S. tuner, 0.15mc to 30mc, 4 bands, rf, fc, 465 ft, £3.—Owens, 64, Southern Rd., Bham, 8. [3956]

DELCO, RU1119, 11-valve, 23watt, 4 bands, Magic Eye, tone and distance/local controls, large round tuning dial, complete with makers' 2 speakers, manual; £25.—40, Upfield, Addiscombe. [3974]

£12—Amplifier chassis, drilled tone control stage, PX4's, all valves, power pack built up, separate chassis, oil conds., double smoothing.—Write W. Acteson, Croftside, Cartmel, Grange-o'-Bands, Lancs. [3638]

Q.A. Super with ht stge. and sw, needs servicing, £12; Power Unit, 350v 120ma, well smoothed, 4v 10a, lt, £6; PX25, 15/-; 12ABGT, 14/- (new).—Full particulars from Hiscock, Crossways, Shottermill, Haslemere, Sy.

ADAPTABLE 12-valve 12watt, high fidelity sound system, 3 chassis, bass, treble tone compensation, etc., also 1 set 954, 955, 956 phone, £45; also 1 set 954, 955, 956 Acorns, £6; all new.—J. Rogers, 30, Mulberry Close, S.E.7. Tel. 2075 Greenwich. [3693]

NATIONAL HRO communications receiver outfit, Powerpack speaker, coil container, 6 coils, continuous coverage, 0.5mc to 30mc, mounted standard table rack, grey enamel finish, with 230-100v 100w mains transformer, perfect condition; offers over £80.—Box 1133.

HALLICRAFTERS 8.29 latest portable, 550kc to 30.5mc, bandspread, phones, etc., perfect order; also Hallicrafters latest Super Skrider, 8X.28, as new, transformer, R.12 speaker, etc., 1.610kc to 42mc; and GE (U.S.A.) latest broadcast band portable, LBS-530, one dry condenser defective; best offers wanted. Owner leaving abroad immediately. Temple Bar 3628 during office hours. [4006]

RME 69 communication receiver, with R matched speaker, offers! Hallicrafters' Sky Champion communication receiver, 8 valves, offers! Universal ac-dc communication receiver, 7 valves, AVC BFO, 11 to 200 metres, takes speaker or phones, £30; Eddystone "All-World" 4, battery operation, Colonial model, with full set of coils, £20; 5-valve superbet, 3 wavebands, table model, extension for p.u., in fine walnut case, nearest offer to 29gns.—Box 125, Parre, 121, Kingsway, London, W.C.2. [3962]

NEW MAINS EQUIPMENT—VORTEXION mains transformers, chokes, etc., are supplied to G.P.O., B.B.C. L.P.T.B.; why not you? Imitated but unequalled; orders can only be accepted against Government contracts.

VORTEXION, Ltd., 257, The Broadway, Wimbledon, London, S.W.19. Lib. 281.

VALVES
ALL B.V.A. valves available, also number of discontinued types; list prices; pro forma or c.o.d.—David Robinson, Ltd., 100, High St., Bedford. [3421]

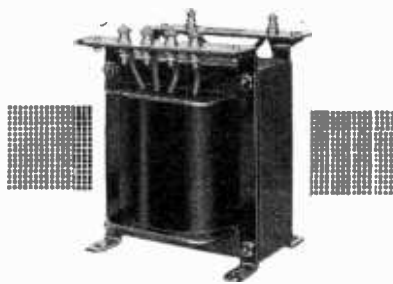

For the past 15 years we have devoted our energies exclusively to the manufacture of Transformers and Chokes. Although we continue to be very active in the field of Research and Development, we are nevertheless giving much of our attention to increasing our range of mounting facilities.

Illustrated above is one of the varied range of styles shown in our Catalogue which is now in preparation. If you would like a copy, please write to us (enclosing 1d. stamp) and we will send you one immediately it is ready.

Telephone: Abbey 2244

PARTRIDGE TRANSFORMERS LTD

76-8, PETTY FRANCE, LONDON, S.W.1

READY NOW

A new
AMBASSADOR

AMPLIFIER with SUPER-HET RECEIVER GIVING 20 WATTS ON MEDIUM & SHORT WAVES

Further details will gladly be supplied on request. Orders can only be accepted for Priority purposes.

R. N. FITTON, LTD

HUTCHINSON LANE, BRIGHOUSE, Tel. 283. Scottish Distributors

BRITISH ELECTRICAL & Mfg. Co. Ltd. 133, West Campbell St., GLASGOW. Tel. Cen. 3286.

LOOK out for valves and circuit analyser; details latr.—London Sound Labs., Ltd., 40, South Molton Lane, Bond St., London, W.1.

NEW LOUDSPEAKERS

LATEST model broadcast pm loudspeakers, standard model, 12in, 15watt, £7/10; Hi-Fi model, 12in, 15watt, £8/15; 15in and 19in models to follow shortly. Ticonal magnets, detachable diaphragms, die-cast chassis; early deliveries; spec upon request.—Broadcast and Acoustic Equipment Co., Ltd., Broadcast House, Tombland, Norwich 26970. [4027]

£5 18/6—New Baker Super Quality 12in Auditorium permanent magnet speaker with triple cone, manufactured by Bakers Selhurst Radio, the pioneer manufacturers of moving coil speakers since 1925, wide frequency range, even response, ideal for quality reproduction, fitted with magnet, having exceptionally high flux density in the air gap, suitable for public address equipment when used in reproduction is first consideration; send 2/6d. stamp for leaflet giving details of above and constructional details of a new speaker frequency range; also constructional details of an infinite baffle cabinet; very music lover interested in realistic reproduction should write for leaflet.

£8/19/6—New Baker super power cinema permanent magnet speaker with 18in triple cone of new design, giving wide frequency response free from objectionable resonances; speech is clear and natural and music is reproduced with exceptional realism; fine engineering job, extremely sensitive, ideal for public address equipment when power handling capacity, plus realistic reproduction, is required; prompt deliveries by passenger train.—Bakers Selhurst Radio, 75, Sussex Rd., S. Croydon, Tel. Croydon 6813.

LOUDEAKERS, SECOND-HAND
HARTLEY-TURNER duode, 2500W, £5.—"Fairfield," Chestfield Rd., Whitstable.

PAMPHONIC, 18in twin cone, ac; offers.—115, Hazel Rd., Longview, Liverpool.

5IN, 6in and 8in energised and p.m.s at 20/- each.—Sinclair Speakers, 12, Pembroke St., London, N.1. [3986]

BEST offers secure Rola G.12 p.m. speaker, no trans; Rothermel standard & Junior pick-ups, perf.—Traver, "Kinsey," Hassocks, GRAMOPHONE AND SOUND EQUIPMENT

HM.V. Hyper Ben. P.U., trans, £8.—Harvey, 79, Huntercombe Lane, Burnham.

GARRARD auto-change record player, also extension loud speaker in polished oak cabinet.—Box 1376. [4032]

PARMEKO recording machine, Parmeko recording amplifier, 25watts, Amperite ribbon mike, all latest models and as brand new; £75 or would separate.—Box 1356. [3999]

CAPEHART record changer, fitted Marconi C pick-up head, £14; Savage 50watt amplifier with valves, high gain, £20; Bowyer-Lowe Mark III pick-up, 50n coil, £2.—Courtenay Davis, Harpenden. [3689]

ROLA G12, RK 12in, 190v-240v dc fields, perf. cond., £5/10 ea.; Celestion W.5 magnetic pick-up, exc. cond., £4/5, inc. stand; crystal microphone, high fidelity, satin finished case, perf. super-sensitive instrument, £5/10. Wanted, ac-dc record changer.—Price & cond. to D. Fraser, 18, Rangemore Rd., Inverness. [3953]

DYNAMOS, MOTORS, ETC.
ALL types of rotary converters, electric motor, battery chargers, petrol-electric generator sets, etc., in stock, new and second-hand; supplied against priority orders only.—WARD, 37, White Post Lane, Hackney Wick, E.9. Tel. Amherst 1393. [1988]

NEW ac motors, 1/4hp, high starting torque, 200-250v, £4/15; 1/2hp, £5/5; 1/2hp, £7/5; 1hp, £9/7/6; all other sizes available; also machinery.—John W. W. Steel, Bingley, Yorks.

ROTARY converters.—Crompton, 1,500watts Mackie 110v dc to 110v ac, £25; 500watts Mackie 110v dc to 110v ac (motor-alternator), £12/10; Crompton alternator, 5kVA, 110v, £17.—H. Harris, Stroud, Stroudfield, Berks.

TEST EQUIPMENT
AVO all-wave oscillator, latest mod., as new; 14gns.—Box 1125. [3952]

MODEL 40 Avo and 500volt Wee megger, both as new; £25.—Dawson, 59, Alfred St., Gloucester. [4020]

AVO model 40, perfect, £15; 1 1/2in C.R. tube, G.T. ic relay; offers.—Purvis, 11, Rawnook Rd., Huddersfield. [3988]

FOR sale, one Cossor double-beam oscilloscope and one Cossor ganging oscillator, complete in rack, in perfect condition; what offers?—Box 1126. [3955]

UNIVERSAL Avo 40, in perf. wkg. cond., £18 or near offer; also 3 unused Acorns R.C.A. 954, 955, 956, 30/- ea.—110, Alexandra Rd., London, N.W.8. [4008]

TAYLORMETER 83a, as new, £20; amplifier power pack, 475/475V 150ma, 4r2-5a, ct, 4v5-8a, ct, £4; H.M.V. enclosed ac record player, £9.—Box 1357. [4002]

AVO latest model 40, nearest £20; Cambridge 6-dial portable Wheatstone bridge, £20; Smith stop watch (tenths), offers; as new; Weston 5-range output meter, £7.—Box 1363

OSCILLOSCOPES, signal generators, multi-range test meters, etc., test gear of every description, British or American, repaired, serviced, recalibrated.—A. Huckelsbee, "Hazeljohn," Crofton Lane, Orpington, Kent. [3031]

MULTI-METERS, ac/dc, volts, milliamps and ohms, £8/17/6; immediate delivery; the infinite impedance adaptor, makes your multi-meter suitable to check A.V.C., volts, oscillator, auto-bias and detector volts, and many other equally useful functions; manu-script giving full constructional details 7/6 post free.—V.E.S., Radio House, Ruislip, Mdx.

AVOMINOR, dc, £3; new 45Zgt, 9/-; brand new B.I. electrolytics, 500 volt working, 32mfd, 9/6; 8x8mfd, 7/6; 8mfd, 6/-; 2½ inch wide yellow presspan, 0.02in thick, 2/6 lb; Kraft coil winding paper, widths 1½in, 2 5/16in and 2 11/16in, 3/9 lb; black bias cut tropical dampproof varnished cloth, widths per dozen yds, 1½in and 1¾in, at 2/-, 2in at 2/3, 2 7/16in and 2¾in at 2/9; 12volt 10amp metal rectifiers, 35/- ea.—Box 1359.

COMPONENTS—SECOND-HAND, SURPLUS VALUE! Matt has it!

LINE CORD—2-way 2/6 per yd., 3-way 3/- per yd. (approx. 600mhs per foot).

SPEAKERS—Celestion P.M. 2¼in, less trans, 27/-; 8in P.M. with trans, 27/6; 6¼in P.M. (multi-ratio trans), 28/6; Rola 6¼in P.M. with trans, 28/6.

TWO gang condensers, 0.0005 with trimmers, 12/6; Midget coils b.f. and aerial, 5/- per pair.

VOLUME controls (all values), 1-switch 2/9, 2-switch 3/9; mains transformers, 4v and 8v, 2/6; Roetherm (crystal) pick-ups, metal, 58. £3/13/6; Senior de luxe, £3/18/9; condensers, all types in stock, 2s, 8s, 16s, 20/20, 500v working; 0.1, 0.01, 0.25, 0.05, 25x25, etc. Resistances, ¼ and 1 watt; all values 1/- each, 10/6 per doz.

LET us quote you for all your requirements. Cash with order, plus postage.

MATT RADIO SERVICE, 152, Richmond Rd., Kingston-on-Thames, Surrey. [3758]

SOUTHERN RADIOS wireless bargains.

LATEST radio publications.—"Radio Valve Manual," equivalent and alternative American and British types with all data, 3/6; "Radio Circuits," fully illustrated, receivers, power packs, etc., 2/-; "Amplifiers," fully descriptive illustrated manual of circuits, 2/-; "Radio Coil and Transformer Manual," 2/-; "Short Wave Handbook," 2/-; "Manual of Direct Disc Home Recording," 2/-; "Test Gear Construction Manual," 1/6; "Radio Pocket Book," formulas, tables, colour code, etc., 1/-; "10 Hows for Radio Constructor," 1/-.

SWITCHES, 3-way 4/-, 8-way 6/- (all complete with knobs), escutcheons for 8-way press button switches 1/6; knobs, pointer type, black or brown instrument types, ¼ inch holes, 1/- each; all types of set knobs, black and brown, ¼ inch holes, 1/- each; resistances, brand new, wire ended, ¼, ½, 1 and 2 watt, assorted value, mainly low, 30/- per 100; heavy duty chokes, 1.1, 30 henries, 250 ohms, 120ma, 14/-; 500 ohms 15/-, 1,000 ohms 17/6.

YAXLEY type rotary switches, 11-way, single bank, 6/6; one lb assorted screws, 5/-; assorted soldering tags, including spade ends, 6/- gross; Multicon mica condensers, 28 capacities in one from 0.0001 upwards, 4/-; international octal base valve holders, moulded and paxoline types, 1/- each, 10/6 per dozen; postage stamp trimmers, 30 pf, ceramic and paxoline, 1/- each.

SOUTHERN RADIO SUPPLY CO., 46, Lisle St., London, W.C. Gerrard 6653. [3630]

ELECTROLYTICS, dry, 450v working; 8mfd 6/-, 8x8 7/6, 20x20 9/-—Box 1124.

RADIO and electrical sundries for sale, by list.—Box 1354. [3997]

MILNES h.t. units, 100v 75/-, 120v 85/-, reconditioned by makers.—Barton, Harworth, Doncaster. [3985]

STRONG steel chassis, 6x9x2½, drilled four holes, 1.0, sockets, three control bores, fixing feet, anti-rust finish; 8/- each, post paid; s.a.e. for quotation other sizes.—Noller, Aldeburgh, Suffolk. [3911]

CONDENSERS (Telephone Man. Co.); Government controlled prices: 1mfd 450volt dc, 2/-; 2mfd 150volt dc, 2/3; 2mfd 350volt dc, 2/3; 4mfd 450volt dc, 3/-; 8mfd 200volt dc, 2/3; 8mfd 450volt dc, 4/-; 18mfd 450volt dc, 4/6; 32mfd 450volt dc, 5/9; 8x8mfd 450volt dc, 5/6; 8x16mfd 450volt dc, 6/3; 25mfd 250volt dc, 1/9; 25mfd 50volt dc, 2/6; 50mfd 120volt dc, 1/9; 50mfd, 50volt dc, 2/9; 5,000 valves in stock; terms, c.w.o.; please allow 6d. postage.—Scott's 14, Gardner St., Brighton.

ELECTRADIX OFFERS!

METERS. Special offer of new D.C. moving coil Milli-ammeters, 2½in. diam., reading 0-1 ma., 100 ohms resistance, bakelite case, 55/-. Metal Rectifiers, 0-1 ma., 10/6. Delivery from stock.

H.T. MOTOR GENERATORS. 28 volt D.C. input, 570 volt 160/200 ma. D.C. output; small and compact enclosed machines, General Electric, £5 10s. Double current Dynamos, ex R.A.F. 6 volts 5 amps and 600 volt 80 ma., ball bearings, weight, 17 lbs. 37/6.

TRANSFORMERS. 3 kW. Crypto 230 v. to 115 v., shrouded, £12. 3 kW. Metwick, 50 cy. 400 v. to 600 v., £9 10s. 1 kW. Powquip 50 cy. 250 v. to 50 v. 20 amps., £9. 500 watt Foster 50 cy. 440 v. to 110 v. 5 amps., £4 15s. 150 watt Foster 400 cy. 230 v. to 15 v. 10 amps., £2 15s. 5 watts H.T. test Transformers 110/220 v. to 1,000 v. 5 ma., 10/-.

TRANSFORMERS, FOR RE-WIND 3 kW. New type with stampings 4½ x 6 x 7½in., windings damaged by blitz. Can be taken apart to make a number of smaller units. Weight with damaged wire is 65 lbs. Limited number at 45/-, carriage extra.

MOVING COIL HEADPHONES P.M., less headbands. Here is a wonderful opportunity to secure highly sensitive headphones with coils energised by the famous ALNI magnets. These moving coil sound units have a 45-ohm, ½in. coil. They can also be used as miniature mikes, or as a miniature loudspeaker if matching transformer is used. Size 1½in. overall, in bakelite case with 3in. front flange. As new. Price each 12/6, or per pair 24/-.

Moving coil headphones with Brown type double steel headband and cord, 29/6 per pair.

MIKES. Tannoy Hand Mike for Announcers, Broadcasters and Recorders, multi-cell carbon type, weatherproof with switch in handle. For your sports meeting or dance hall, 21/-. Crystal and M.C. Mikes in stock.

CORDS, flexible, 1 yard long with R.A.F. plug, 1/3 each or 6 for 5/6; all post free.

G.P.O. Electric Counters 25/50 volts D.C. 500 ohm coil, counting to 9999, 5/6.

BELLS. Large "Tangent" A.C. 230/250 volt ironclad bells, 6in. gong, in new condition, 42/-.

INVISIBLE RAY CONTROL. The famous Raycraft Kit with selenium bridge, in bakelite case, 10,000 ohm Relay, megostat, etc.; with instruction booklet, 42/-.

SUPERSEDERS. H.T. Battery Superseders for Radio Receivers. 6 volts input, 110 v. 15 ma. output, 12 volts input, 230 v. 30 ma. output. The Army, the Navy and the Air Force use small Rotary Superseders, a 5½lb. midget type taking less space than your old H.T. Battery. Last for ever and cost little more than a few months run on H.T. Battery. Size is only 5½ x 3½ x 3½in., beautifully made, model finish, ball bearings, etc., and takes small current from your accu. Latest model and guaranteed 12 months. Price £3 15s.

BUTTON MICROPHONES. G.P.O. Sound Transmitter Units lin. dia. for transmission of speech, music, stethoscope, spotters, listeners, etc., 2/6. High-ratio Transformer for same, with instructions, 4/6.

MAGNETS. Midget ALNI perm. steel disc magnets, ½in. dia. with centre hole 3/16in. dia., of tremendous magnetic force; unlimited uses, 3/6 each. Horse-shoe permanent steel magnets, various sizes, from 3/- each.

Please include postage for mail orders.

ELECTRADIX RADIOS

214, Queenstown Road, Battersea, LONDON, S.W.8

Telephone: MACaulay 2159

G. A. RYALL, 36, Huron Rd., London, S.W.17. Mail order only, no c.o.d. under £1 please.

VOLUME controls with switch, ¼ meg Morganite, perfect job, long spindle, 4/9; twin screened microphone cable, Aerolite, 3yds, 2/9. **CONDENSERS**, tubular, 0.1 350v wkg. reliable make, 7/6 dozen, 0.002 450v wkg. moisture proof, 5/6 dozen.

ERIE ½ watt resistances, sizes 330, 450, 10,000, 22,000, 33,000, 220,000, 470,000, 10,000, meg insulated type except 33,000, 3/9 dozen. **CELESTION** 10in permanent magnet speakers, very powerful magnet system, really excellent job, 35/- ea.

METER switches, long spindle, 11-way, new, take 1in behind panel, 4/9 each. **SPECIAL** offer connecting wire as push back, stranded, cotton and waxed insulation, finished double cotton, blue, 12 yards, 1/6.

KNOBS, brown, thimble pattern, 4ml Mansbridge condensers, cast board mg. terminals and solder tags, 250v wkg. new high insulation, 4/6 each; Mansbridge 0.5x0.5 250v ac, 1/9 each; volume controls, 1½in base, spindle 2½in, 1 meg, high-class job, 3/- each; set 5 Clydon ceramic trimmers, on metal base, 30mm, 1/6.

YAXLEY type switches, 3 bank, 2 pole, 4 way, with middle screen, long spindle, 4 shorting bars, 4/9 each.

INPUT strips, 2in x ½in, with terminal screws, 2-way, 2/6 doz; anchor or mounting strips, 2-way, spaced for half and watt resistances, 5/6 doz; octal 8-pin plugs, with insulated terminal cap, complete with international octal chassis* type base, 1/3 ea, 3 for 3/-; valve holders, chassis type, our regular line in these available once again, 5- and 7-pin British 4, 5 and 6-pin UX American, international octal (for 6V6, etc.), all 4/9 dozen.

DIAL plates, oblong, 5¼x2½. Varley, 200-550, etc. transparent, 4/6; Buryndet 4-band dial 8x5½, sw on lower half of scale, 1/6 ea.

SPECIAL offer T.C.C. mica conds, double 0.0001x0.0001, 5 (10 condensers) for 1/3; Huxley 0.01 mica, 1/- ea. Yaxley type low loss switches, single-pole, double-throw, 2-bank, 2/9; single bank 2/5.

LOOK out for valves and circuit analyser: details later.—London Sound Labs. Ltd., an South Molton Lane, Bond St., London, W.1.

ELECTROLYTICS, 8x16mfd, 450v, 8/6 each; linecord, best 3-way, 0.3amp, 600, 3/- yd.—Clifton Lab., 28, Park Drive, Grimsby.

SUPREME RADIO, 746b, Romford Rd., Manor Park, London, E.12, and at Faircross, Manor Park, Essex. Head office, Romford Rd., Manor Park, Tel. III. 1260. Est. 15 years.

OUR motto, quick service, satisfaction guaranteed; 0.0005 2-gang condensers with trimmers, split vanes, fixing brackets, 12/6; 0.3amp line cord, 3-way 600mhs per ft, 2/- yd; 0.2 mains droppers, 1,000ohms, 2 sliders, fixing feet, 4/6; 0.03 ditto, 5/3; special line, 0.2 droppers with sliders, less fixing feet, 3/9; Eye replacement droppers, 3/6; few only midget coils, aerial and hf, mw, trf, high gain, with circuit, 8/6; ditto, good selectivity, less circuit, 7/6; mw dials, 3¼x4in, 1/9; 1 and m coils, American, 3/6; midget chassis, drilled, 5/6; midget chokes, 300ohms, 100mls, 6/6; heavy duty, 10/6; trimmers, 35-40pd, 9d. ea.; speakers, 3¼in, with tran. 30/-, less 25/-; 6in, with 27/6, less 22/6; 8in, with 26/6, less 21/-; metal speaker cabinets, 8in fitting, 17/6; v/cs, all values, with sw 5/3, less 4/6; wire wound v/cs, 2,000-10,000, 4/6; wire wound resistances, colour coded, 24 in pkt., assorted values, from 200-240,000ohms, 7/6; screen wire double 1/6, single 1/- yd.; valholders, 10/- doz; screen caps, octal or standard, 8/- doz; pilot holders, 3/- doz.; pilot bulbs, 6v 3a, 8/- doz.; spindle couplings, 3/- doz.; lf trans, 5-1, job line, 10/- doz.; slow motion drives, 1/-; rubber grum-dits, 3d. doz.; assorted midget valves, many types in stock; send s.a.e. all enquiries; no c.o.d.; 6d. extra all orders under £5. [4012]

H. HARRIS, Brouds, Bradfield, Berks. offers following at bargain prices: chromo folding mike stand, 38/-; Novotone compensator, 15/-; 300watt Vibrator, 110v dc to 110v ac, £6; Philips baretters, type 340, new, 5/- each; Tungen charger, 75v 6amp dc, £12; Edison phonograph, large, with shaver and 12 records (O.K. but no horn), £5; rotary interrupter, 24v dc, £2; Magnavox 10in speaker, 25/-; Rola 8in, 20/-; Ferranti 8in, 20/-; Majestic 10in, 20/-; Rola 10in energised 230v ac, £4; Webson 12in energised 250v ac, £3; Weston model 429 3in ac voltmeter, 0-7, £3; 3in D.C. amp meter, 0-6, £3; Wurliizer "Cardaptor" h.t. and l.t., from 6v, 35/-; C.A.V. h.t. accumulator, 60v, 10,000 ma, new, £3; Milnes 120v super unit, £3; new V.I.R. cable, 7/20, 5d yd; 3/20, 3d yd; 100v carbon lamps, new, 9d each; 210v 300w gasfilled, new, 3/6 each.—H. Harris, Strouds, Bradfield, Berks. Yattendon 254. [3649]

ELECTROLYTIC CONDENSERS

now available, but supplies limited. Our New List, 2½d. post paid, contains details. Examples: 8 mid. 450 v., 4/-; 8-8 mid., 5/4; 16-8 mid., 6/3; 25-25 mid., 1/9. **ROTHERMEL** Crystal Microphones, D.104 from stock, 95/-; Popular brand Moving Coil Microphones, £5.

WAVEBAND COILS are proving an enormous success; don't miss special price offers: Midget medium wave coils, 3/9 pair. Medium and Long wave, 7/6 pair. Medium, Long and Short wave, 11 6; all with wiring diagrams.

WAVEBAND I.F. Coils, 465 K/c., neat construction, 13 6 pair.

TRANSFORMERS for 6L6 Valves, 29 6. Matching Driver trans., 14/6.

CHOKES. Heavy duty chokes, 30 hen, 200 ohm, 120 ma., 17/6; 500-0-500 v. Transformers available in 6 v. or 4 v., reduced to 30/-.

SPEAKER FIELDS, 1" centre, any resistance, 8/6 each.

STEEL CABINETS with chassis 19" x 102 x 94", 63/-; 12" x 7" x 7", 39/-; undrilled chassis 18" x 94" x 34", 10/6; 8" x 64" x 2", 5/6; transmitter racks with 4 panels complete with frame, fender, chassis mounts, etc., price on application.

CELESTION 8" P.M. Speakers, ONLY 25/6 each; 2-gang .0005 Condensers with slow motion, 15/6; 2-gang short wave .000075, 15 6 each.

VOLUME CONTROLS with switch, every value, 5/9; carbon resistors, 1 watt, 8d. each, or 7/6 doz.

SWITCHES. "On-Off" Toggle switches, 2/9; DP Change-over or DP "On-Off", 5/6 each; **SERVISOL**, 5/- per tin.

"RADIO INSIDE OUT." The repair man's finest reference book, 4/9 copy. Set of 6 American Service Manuals, 75/-.

NOTE.—With the exception of Books, sufficient must be included to cover postage or carriage costs.

EXCLUSIVELY MAIL ORDER

WAVEBAND RADIO LTD.

63 Jermyn St., St. James's, London, S.W.1. Phone: REGent 3055/6.

FOR sale, qty. radio components, test gear, etc.; after 7 p.m. any evening.—**Wheeler**, 54, Granham Gdns, N.9. [4014

PRICE list 1d., unequalled range, example value.—**Vazley** 4-bank 6-way switches, 5/6.

—**Taylor**, Macaulay St., Huddersfield. [3595 **PARK RADIO OF MANOR PARK** have off priority a wide range of meters suitable for making up into multimeters or valve voltmeters; write for advice if you intend making up any test gear.

VALVES at B.O.T. list prices.—**Brimar**, **Cosor**, **Dario**, **Ever Ready**, **Ferranti**, **Hivac** Midgets, **Lissen**, **Marconi**, **Osram**, **Mazda**, **Mullard**, **Philips**, **Triotron** and **Tungaram**, **Brivaron** and **American**; all valves tested before despatch; we specialise in matched pairs of PX4s, 6V6s, etc.; no stock of 3Q5, 12A7, 50L6.

TUNGSTEN contacts for **Philips** (tubular type) converters, set of 9, 3/6.

METAL rectifiers, 1 to 5ma., 10/-; 5 to 10ma, 18 6; for converting dc meters to read ac.

WOLF electric drills.—Up to ½in drills, £8/8; ¾in drills, £10/10; ¾in drills, £15/10; 6in bench grinders, £11/17/6; heavy duty Sanders, £13/10; write for illustrated list, s.a.e.

STEP-DOWN transformers or up to 220-250 volts in, output tapped at 3, 4, 6, 7, 8, 9, 12, 13, 15, 21 volts at 2amps, transformer is housed in metal case and is suitable for working model trains, 35/6.

COMPLETE stocks of all radio and electrical gear carried; send for lists.

PARK RADIO OF MANOR PARK.—Sales: 676, Romford Rd., London (Manor Park), E.12. Ilford 2066, telephone or grams. Service and technical: 212, High St., N., East Ham, E.6. Grangewood 0213, phone or grams.

ELECTROLYTICS, 8mfd 450v, 3/6; 8mfd 350v, 2/3; 25mfd 25v, 1/11; **Gramplan** moving coil microphones, £3/18/6; matching transformer, 15/-; 8in p.m. speakers, 20/3.—**D. White**, 17, Upland Rd., London, S.E.22.

MAINS transformers, all types in stock; auto transformers, 1kw portable type or cast iron shrouded; we have a very large stock of transformers, and will be pleased to supply 1 or 1,000; send 1d. stamp for our list; liberal trade discounts; 24hr rewind service for all types of main transformers up to 1kva.—**Jagers Radio Products**, North St., Hornchurch Essex. Hornchurch 3856. [4031

MOVING coil hand microphones, p.m., energised by Alni magnets, 45 ohms, ½in coil, fitted with switch in handle; 12/6 each.

MOVING coil headphones, p.m., energised by Alni magnets, 45 ohms, ½in coil, ideal for mikes, miniature loudspeakers, etc. 1½in overall in bakelite cases with 3in front flange. 7/6 each, per pair with headband 16/6; throat microphones, fitted with elastic bands, phone, plug, etc. 7/6 each.

SYNCHRONOUS motors, **Sangamo**, 200-250 volts ac, 50c, self-starting, fitted reduction gears, ideal movements for time switches, industrial dark room, electric clocks, etc; rotor speed 200 rpm, final speeds available: 1 rev 12 mins 22/6, 1 rev 30 mins 25/-, 1 rev 60 mins 25/-; consumption 2½ watts, size 2½ x 2½ x 1½in; cash with order; registered post and packing 1/- extra.

ANNUAL Holidays.—Our postal dept. will be closed from Sept. 8 to 20. Callers only please between these dates.

TERMS: Cash with order.—**H. Franks**, Scientific Stores, 58, New Oxford St., W.C.1. Tel. Museum 9594. [3961

BATTERY charger kits, rectifiers, mikes, electrolytics, transformers, metal rectifier, 2v 0.5a type with transformer, makes ideal trickle charger for 2v cell, with circuit, 15/6, postage 7d.; metal rectifier, 12v 2.5a type, with transformer and ballast bulb for 2v to 12v charger, no ammeter or rheostat required, 47/6, postage 10d; also metal rectifier for 12v 2.5a charger, input volts 22v, 22/6, postage 7d; ditto 12v 4amp, 32/-; special charger kit for 6v car battery boosting, charges at 2amp, 37/6, post 10d; metal rectifier, 12v 3amp type, with transformer, for 12v charger, 52/6, post 1/-; metal rectifier, 12v 1.5a type, with transformer and ballast bulb for 2v to 12v charger, 37/6, postage 10d, or supplied with Junior lamp rectifier, 32/6, rectifier alone 8/6, post 6d.

HEAVY duty type kits, weight over 17lb, metal rectifier, 12v 4amp type, with transformer for 6v-12v starter, £4, or with 5amp rectifier, £4/10; transformer, metal rectifier and ballast bulb for 3 to 20 cells at lamp, ideal for small radio store, £5/10, guaranteed 1 year; transformer and metal rectifier for car battery boosting, 36v 5amp, tapped for 12v, 18v, 24v, £11, carriage 3/6, weighs over 30lb. Rectifiers of all ratings available for conversion of valve type chargers to metal rectification, half-wave and centre-tap types, most types from stock.—**Champion**, 43, Uplands Way, London, N.21. Lab. 4457. [4035

TRANSFORMERS

Best for all Purposes

RADIO INSTRUMENTS LTD
PURLEY WAY, CROYDON.
Telephone: THORnton Heath 3211

FOR THE RADIO SERVICE MAN, DEALER AND OWNER

The man who enrolls for an I.C.S. Radio Course learns radio thoroughly, completely, practically. When he earns his diploma, he will KNOW radio. We are not content merely to teach the principles of radio, we want to show our students how to apply that training in practical, every-day, radio service work. We train them to be successful!

Special terms for members of H.M. Forces and discharged members of H.M. Armed Forces.

INTERNATIONAL CORRESPONDENCE SCHOOLS

Dept. 38, International Buildings, Kingsway, London, W.O.2

Please explain fully about your instruction in this subject marked X.

Complete Radio Engineering
Radio Service Engineering
Elementary Radio Television

And the following Radio examinations:
British Institution of Radio Engineers
P.M.G. Certificate for Wireless Operators
City and Guilds Telecommunications
Wireless Operator & Wireless Mechanic, R.A.F.

Name.....Age.....
Address.....

Aladdin RADIO CORES

for all purposes

GREENFORD, MIDDx. WAXLOW 2300

WE LOOK FORWARD to the restoration of pre-war right to go ahead in our own way and improve the standard of reproduction.

VOIGT PATENTS LTD.

15, SILVERDALE LONDON, S.E.26

PHOTO-ELECTRIC CELLS

5e/Te on gold-alloy, super-sensitive to light, gas-filled, permanent, operate raly direct or with Valve Amplifier, perfect reproduction of Speech and Music from sound track of films; large tube 3½in. from glass top to valve pin base, 1in. diam., 38/-; same type, 2½in. long, 35/-; small tube 2in. from top to terminal base, ½in. diam., 30/-; miniature cell, glass top to cap base, 1in. overall, ½in. diam., thin flex leads, 28/-; all cells operate on 40-100 volts. Connections diagrams free.

PRECISION OPTICAL SYSTEM, producing fina line of light from any car headlight bulb, for scanning film sound track direct into Photo-cell, metal tube 2in. long, ½in. diam., ½in. focus, 52/-. Instructions free. Goods by return.

GEFA INSTRUMENTS, 38a, York Street, TWICKENHAM, MIDDx. POPostgrove 6597

RADIO and electrical engineers.—Ex-Govt. side cutters, 22/6 1/2 doz.; long-nosed insulated pliers, 22/6 1/2 doz., 42/- doz. prs., carriage paid, guaranteed brand new, mains transformers, 4v or 8v, heaters, 80mA, 28/6; 120 mA, 37/6; multi-output transformers standard size, 6/6; carriage paid orders £5; s.a.e. for list radio spares.—A.D.S. Co., 261-3-5, Lichfield Rd., Aston, Birmingham, 6. [3299]

CHARLES BRITAIN RADIO (K. H. Ede) offers new and used bargains this month. MAINS transformers, 350-0-350V, 4 or 6v heaters, shrouded type, with mains tap in top, used but perfect, £1 ea.; steel chassis, size 10 1/2 x 8 x 2 1/2 in, drilled 5 valves and hole for trans., 2/- ea.; asst'd resistances, stripped from Ekco chassis, all useful values, 3/6 doz.; asst'd mica condensers, new and used, various makes, 3/6 doz.; asst'd tubular conds., inc 0.1u, new and used, 4/6 doz.; mains energised spacers, ex Ekco with new cones and fields, 1,000 or 5,000ohms, 22/6 ea.

The following components are new and in perfect condition: All-wave aerial coils and oscillator coils covering all bands, long, medium and short, with circuit diagram, 14/- per set; tri coils, short and medium, with trims., 10/- pr.; P type coils, medium wave only, a, osc and hf, 2/- ea.; 2-gang condensers with trims., 2/2 ea.; 21 transformer, Litz wound iron cores with trims, and all cans, 12/6 pr. (465k/c); Amphenol valveholders, Int. octal or British octal, 7/6 doz. THIS month's special offer: Small moving coil mikes, can be used as tweeters, etc., 3/6 ea.; or slightly damaged, 2/- ea.; send for our new list; terms, cash or c.o.d. over £1.—Charles Britain Radio (temp. address), Eureka, Surrey Gardens, Egham, Surrey. [4023]

HENRY'S offer:—T.R.P. medium air long c.w. wave coils with reaction, 8/6 pr with circuit; single pole eleven way, two bank switches, 4/6; 8mfd 450v wkg, 4/-; 8mfd 350v wkg 2/3; 16/16mfd 350v wkg 10/-; line cord 0.3 three way 55ohms per ft 3/- per yd; also 0.2 115ohms per ft 3/- per yd; Rola 5in P.M. with transformer, 27/6; Goodman's 5in, less transformer, 21/6; Celestion 8in, less transformer, 21/-; Celestion amphenol valveholders, 4, 5 and 7 pin English, 4, 5, U.K. and Int. octal 9/- each, 7/6 doz.; medium and short wave coils, aerial and oscillator, 4/6 K.C. 12/6, with complete ac/dc circuit; l.f. trans. small cans 465 kc 7/6 each. HENRY'S, 5, Harrow Rd., Edgware Rd., London, W.2. [3658]

TELE-RADIO (1943), Ltd.—Everything for the amateur. Post-war octal based g.c.c. crystals, sub-standards, 10kc/s 45/-, 1,000kc/s, 70/-; transmitting crystals for the amateur band, ground to your own specified frequency, X cut, 3/7/6, AT and BT cut, 4/7/6; metal 6J5 and 6L6 valves, also 807's, standard racks, panels and chassis, high voltage transformers, chokes, condensers and rectifiers, ceramic formers, heavy duty wire-wound resistors, wire-wound potentiometers, precision resistors and condensers; Weston meters, 0-50 microamps, 90/-; 0-100 microamps, 70/-; 0-500 microamps, 65/-; 0-1 milliamp, 50/-; Westinghouse rectifiers, 0-1 milliamp, 10/-; without ray tubes, voltage regulators, Thyatron, Celestion and Vitavox speakers; all components brand new and first-class quality. Send stamped, addressed envelope for our list No. 1/W.W.—Tele-Radio (1943), Ltd., 177a Edgware Rd., London, W.2. Tel. Pad. 6116.

THE Simplex Four, complete constructional details of this most successful mid-band ac/dc receiver (total cost of construction 25), including theoretical and full scale layout wiring diagrams, with instructions, 4/6; midget high gain tri m wave coils, 7/6 pair; ditto midget m and l wave coils, iron cored, adjustable, 11/- pair; aerial and oscillator coils, all-wave, a, m, l, for use with if, 465kc/cs, matched pair with circuit, 15/-; Yaxley 3-way, 4-pole switch for above coils, 4/6; midget if transformer, 465kc/cs, 17/6 pair; standard size ditto, 15/- pair; midget 2-gang 0.0005mfd variable condenser, 13/6; Simplex midget chassis for the 4-wave midget, all component fixing holes, 11 x 4 1/2 x 2 1/2 in, 7/6; midget m wave dials, ivorine, 4 x 3 1/2 in, 1/6; midget smoothing chokes, 50-60ma, 6/-; medium chokes, 80ma, 25h, 8/-; 120ma 25h, 15/-; midget speaker trans., tapped output, 6/6; ditto, standard, 8/6; Rola P.P. tapped universal, 42U, 12/6; P.P. output for 6L6 valves, 1s to a load, 6,600ohms, tapped 7.5 and 15ohms, 21/-; P.P. driver transformer, split sec., heavy duty, 12/6; amplifier case, un-drilled chassis, with detachable perforated cover, height of chassis 2 1/2 in, overall 17 1/2 x 8 1/2 x 9 1/2 in, dark battleship grey, 45/-; miniature potentiometers, 1,000 and 2,000ohms, for zero control, etc., 4/6; comprehensive stocks of all components, lists monthly; 2/6 stamp with enquiries please; postage all orders.—O. Greenlick, 34, Bancroft Rd., Cambridge Heath Rd., London, E.1. Ste. 1334. [3024]

PREMIER RADIO

(MORRIS AND CO. (RADIO) LTD.)

ALL POST ORDERS TO:

JUBILEE WORKS, 167, LOWER CLAPTON ROAD, LONDON, E.8. (Amberst 4723.)

CALLERS TO:

169, FLEET STREET, E.C.4. (Central 2833.)

1945 LIST NOW AVAILABLE. HUNDREDS OF NEW LINES.

All enquiries must be accompanied by a 2d. stamp.

ELECTRIC CLOTHES PRESSING IRONS, 5 lb., pre-war quality, with lead, 35/6.
METERS, First grade army type Universal Test Meters, in shockproof bakelite cases, ranges 10, 100, 500 volts at 1,000 ohms per volt A/C and 1V/C, 1, 10, 100, 500 mA D/C, 0-10,000 ohms, £8 15s.

FIRST GRADE METERS, 3 1/2 in. diameter, 1 milliamp, 22 1/2s.; 500 microamps, 22 18s. 6d. 4 1/2 in. 1 milliamp, 23 5s.; 500 microamps, £3 12s. 6d. Westinghouse Meter Rectifier for either type, 10/-. Multiple subunits 10, 100, 500 mA, 10/-. Any value multiplier, 2/6 each. **SUPER QUALITY AMPLIFIERS**, 12 watts output high and low gain inputs with mixer, treble and bass controls, two DB 30-11,000 cycles, negative feedback, 2, 4, 8 and 16 ohms output, £14 14s. **AC/DC AMPLIFIERS**, 5 watt output, high gain, three-stage, feedback, 28 5s.

BATTERY CHARGERS for 2 v. batt. at 1 a., 25/-; for 2, 4 or 6 v. batt. at 1 a., 45/-; for 6 v. batt. at 1 a., 30/-; for 2, 6 or 12 v. batt. at 1 a., 49/6; for 6 v. or 12 v. batt. at 4 a., 24.

MAINS TRANSFORMERS, 300 + 300 v., 60 mA, three 4 v. 2-3 a., 63 v. 2-3 a., 250 + 350 100 mA, 8 v. 2 a., 6.3 v. 2-3 a., 250 v., 250 + 350 100 mA, three 4 v. 2-3 a. windings, 29/-; 350 + 350 150 mA, two 4 v. 2-3 a., two 2 v. 1 a. windings 39/-; 350 + 350 150 mA, 5 v. 2 a., 6.3 v. 2 a., 6.3 v. 2 a., 36/-; 500 + 500 250 mA, 8 v. 3 a., 6.3 v. 2 a., 6.3 v. 4 a., 65/-; 425 + 425 200 mA, 4 v. 2-3 a., 4 v. 2-3 a., 4 v. 2-3 a., 47/-; 350 + 350 150 mA, 4 v. 1-2 a., 4 v. 2-3 a., 4 v. 2-3 a., 36/-; 500 + 500 150 mA, four 4 v., 2-3 a. LT windings, 47/-.

1-VOLT BATTERY S.W. RECEIVER, with 2-volt valve, 4 coils, 12-170 m. bandspread tuning, 65/-, including tax.

STEEL CHASSIS, 10 x 8 x 3 1/2 in., 7/-; 16 x 8 in. 8/6; 20 x 8 in., 9/6; 12 x 8 in., 7/6.
SHORT-WAVE COILS, Int. octal sockets, 4-pin serial coils, 9-15, 12-26, 22-47, 41-94, or 76-170 m. 2/6 each; 150-350 or 250-550 m., 3/-; 490-1,000 or 1,000-2,000 m., 4/-; 6-pin H.F. Trans., 9-15, 12-26, 22-47, 41-94 or 76-170 m., 2/8. S.W. chokes, 10-100 m., 1/3; 6-200 m., 2/6.

SHORT-WAVE CONDENSERS, evenly ganged, 15 mmd., 2/11; 20 mmd., 3/8; 40 mmd., 3/3, 100 mmd., 5/11, 160 mmd., 4/8, 250 mmd., 5/8; shaft couplers, 7/4; flexible ditto, 1/6. Dual bandspread for use with 2-gang, 6/6.

MIDGET "P" TYPE COILS, 12-35, 16-47, 34-100 9/1-261, 250-750, 700-2,000, 200-557, available as H.F. trans., aerial, or osc. coils, 2/3 each. Y-trolley type wave-change switch, many types available; locators, 2/8 each; wafers, 1/6 each. Small 2-gang condensers: 0.0005, 15/-; Matched pairs iron-cored 465 K.C. I.F. Trans., 15/- pair; midget type, 21/- pair, 80 mmd. trimmers, 1/3; osc. paddler, 750 mmd., 1/9; B.F.O. coil, 2/3.

CONDENSERS, All small tubular type, 25 mf., 35 v.v., 50 mf., 12 v.v., 10 mf., 50 v.v., 1 mf., 500 v.v., or 20 mf., 50 v.v. 2/3 each. 2 mf., 350 v.v., 2/9, 4 mf., 450 v.v., 3/6, 8 mf., 450 v.v., 4/9, 16 mf., 450 v.v., 7/6, 20 mf., 450 v.v., 8/6, 16 + 8 450 v.v., 9/6, 16 mf., 150 v.v., 4/9, 50 mf., 50 v.v., 3/6.

CRYSTAL PICKUPS, Cosmocond, 22 11s. Rothermel super, 23 18s. 9d.

AMERICAN VALVES, 4525, 3525, 2525, 128K7, 128T7, 2529, 6V5, 6S6, 6Z4, 6X4, 6X7, 6K7, 15A, 1C5, 1B5, 1T5. Many others available.

SUPER GIANT PUSH-PULL INTER-VALVE TRANSFORMERS, 21/-, Midget type, 12/6.
MOVING COIL SPEAKERS, Rola 6 in. or 8 in. P.M., no trans., 25/-; Plessey 8 in. P.M. with trans., 29/6. Goodman's 3 1/2 in. P.M. with 3 or 16 ohm. voice coil, no trans., 8/4; 8 in., 1,200 ohm energised speakers, 35/-; Midget standard or P.P. trans. for any above, 10/6. Super quality giant Matchmaker output transformers, match any tube single or P.P. to any voice coil, 7-watt, 22/6; 15-watt, 30/-; 30-watt, 49/6; 60-watt, 59/6.

CHOKES 8H, 300 ohms, 40 mA, 4/6; 30 H, 400 ohms, 60 mA, 9/8; 30H, 100 mA, 400 ohms, 15/-; 30H, 185 ohms, 150 mA 25/-; 25H, 250 mA, 120 ohms, 39/6.

SUNDRIES, 2 mm. Systofax, 2 1/2 in. yd.; resin-cored solder, 6d. per coil or 4/6 per lb.; screened 2-pin plugs and sockets, 8d.; 2-pin, 4-pin, 8-pin, Octal socket, 6d.; ditto, amphenol type, 1/-; Valve screens 1/2; 6-volt vibrators 2-pin 12/6. 500T Indoor Aerial, 2/6.

SERVICEMEN—The following products are well designed and of high quality; volume controls, carbon type, all values, with or less switch, wire-wound resistors, 1 to 60 watts; dropper resistors, 0.2 and 0.5amp; line coils and razor resistors; terms and quotations on req.—Dagole, Ltd., 35, High St., Ruislip, Mdx. [3624]

CAR aerials, telescopic, nickel plated, 21/-; electric soldering irons (state voltage), 13/6; electric flat irons, 220/240v, w/flex, 27/6; trimmer tool kits, 14 tools in wallet, 30/-; Testoscope, fault tracing instr., ac/dc, 37/6; electric kettles, 200/250v, w/flex, 55/-; J. PULL and SONS (W.W.), 246, High St., Harlesden, N.W.10. [3624]

COTTON-COVERED copper instrument wire, 1/4lb reels, 18, 20, 22, 24 gauges, 1/6; 26, 28 gauges, 1/9; 30, 32g, 2/-; 34g 2/3; silk covered ditto, 2oz reels, 24, 26, 28g, 1/6; 30, 32, 34, 36g, 1/9; 42g, 2/-; 16g double silk, 1lb, 5/-; B.A. thread screws, 1 gross useful sizes, 2/6; ditto, nuts, 2/6 gross; assorted gross screws and nuts, 2/6; ditto, brass washers, 1/6 gross; fibre washers, 1/6 gr; assorted solder tags, 2/- gr; assorted small eyelets and rivets, 1/3 gr; rubber-covered stranded copper wire, 1d yard; heavier quality, 1 1/2d. yd; very heavy quality, 2 1/2d. yd; Ideal for aerials, earths, etc.; tinned copper connecting wire, 20ft coil, 6d.; ditto, rubber covered, 10ft 6d.; finest quality push-back wire, 12 yards, 2/3; single cotton-covered tinned copper wire, 25g, 12 yards, 9d.; 50 yds, 3/-; twin bell wire, 12 yds, 1/9; heavier quality, 12 yds, 2/3; flat rubber-covered ditto, 3d. yard; twin flat braided electric cable, 6d. yard; all postage extra.—Post Radio Supplies, 33, Bourne Gardens, London, E.4. [3593]

COUPLER PHONE RADIO, Station Rd., New London, or Preston.—New goods only of the highest quality; all orders attended to same day as received; note price reductions on many lines, and remember that all orders over 5/- are post free; electrolytics, 8x450v 8/9, 8x450, 12/6, 2x350 3/6, 25x25 and 50x12, 2/6, 25x50 3/-, 50x50 3/3; Rola, Plessey, Goodman's and Celestion speakers, p.m., less transf., 3 1/2 in 29/-, 5 in 21/-, 6 in 21/6, 8 in 27/6, 10 in 35/-; with transf., 6 1/2 in 27/-, 8 in 27/6, 10 in 42/6; Vitavox super quality, 12 in p.m., K12/10, £6/13; mains transformers, screened primary, 200-250v, 350-0-350, 100ma, with 4v or 6v l.t.s., 26/6; bobina one only, 15/6; 425-0-425, 200ma, 4v 8A, 4v 4a, 4v 4a or 6.3v 4a, 6.3v 4a, 5v 3a, 47/6; 20 h 200ma chokes, heavy duty, 21/-; speaker transformers, push pull universal types, 4watt 8/6, 8w 12/6, 15w 21/-, 40w 37/6; Midget pen, 5/-; dropper resistors, 800 0.35w, with feet and two sliders, 4/6; push-back wire (Henleys), 50ft 2/9, 100ft 4/9; Delatex 2mm sleeving, 21/- dozen; valveholders, 5, 7, 9 pin English, Mazda octal 4, 5, 6, 7 pin UX and Int. octal, all types 6d. each; resin-cored solder, 4/- lb.; 3-way cable, 6d. yd. 5-way 10d.; line cord, 60 1/2 foot, super quality two or three-way, 3/6 per yard; Centralab vol. controls, all sizes, less sw. 0/6, with sw. 4/3; 4 1/2 in. B.S. 1st grade 3-16 mA meters, 70/-; Midget 2-gangs, 0.0005, 13/6 trimmers, 11/6; R. and A. 8in energised speakers, 1,200 field; pen. transf., 32/6; carbon resistors, all values, 500 to 5meg, 1/4w 6d., 1w 9d.; 465K.C. iron-cored i.f. trans., Litz wound, screened, trimmers, 10/6 pair; s.a.e. for comprehensive list.

WANTED, EXCHANGE, ETC.

WTD. Avro all-wave mains oscillator, now cond.; state price.—Box 1561, 21/-, (4015)
WTD. crystal pick-up, B.T.H. preferred.—Scott, 12, Belgrave Place, Bath. [4007]
WTD. Taylor valve tester or similar.—Pars, 26, Kenilworth Cres., Enfield, Middx.
NEON transformers wanted, 6-10,000v.—Details to Vane, 23, Cres., Ilminster, Som.

WE offer cash for good modern communication and all-wave receivers.—A.C.B. Radio, 44, Widmore Rd., Bromley. [1541]

WTD. Voigt twin dia. speaker and corner horn, also Lowther radiogram, 10 watt output.—Clark, 3, Essex St., Walsall, [4010]
VOIGT twin diaphragm unit, any field resistance, with corner horn and bass chamber, wanted.—Full particulars, age and price to Box 1351. [3993]

WNTED, static and rotary converters, all ratios. Also small transformers, all ratios. H. H. HYWOOD, Elect. Eng., 18, Coram St., London, W.C.1. [3981]

WTD. Baldwin micro Henlog bridge, in good order; "W.W." Aug. 13th, '37, & Nov., '40; "Wireless Eng." April to Nov. (inc.), 1943.—Edwards, 71, Hill-la., South'pton.

WE buy for cash, new, used, radio, electrical equipment all types; especially wanted, radios, radiograms, test equipment, motors, chargers, recording gear, etc. Call, write or phone to University Radio, Ltd., 22, Lisle St., Leicester Square, W.C.2. Ger. 4447.

SEXTON'S of

138, Grays Inn Rd., London, W.C.1

for

SALES, SERVICE & SATISFACTION

ELECTRIC SMOOTHING IRONS, weight 5-5½ lbs., for AC or DC mains, strong bakelite handle and thumb rest. Fitted with heavy connector guard and rest. Sole plated specially designed for ironing under buttons, seams and pleats. Complete with two yards of best quality three-core flex and earthed connector. Beautifully finished in highly polished chrome and coloured pastel shades, Blue, Pink, Red, Green, Gold. Price 33/4, inc. of tax of 6/8. Post free.

AMERICAN RADIO VALVES. Types as under at controlled prices. 35Z4GT, 35Z5GT, 45Z5GT, 5Y3G, 1A5GT, 1C5GT, 1Q5GT, at 11/- each. 6J5GT, 6F5GT, 12J5GT, at 9/2 each. 12S17GT, 12SK7GT, 25L6GT, 6K7GT, 6L7GT, 6J7GT, 43G, 1A7GT, 6K6GT, 42G, 6V6G, at 12/10. 6D6, 6C6, at 11/- each. 6Q7GT, 75G, at 11/7 each. 6A7G, 6A8G, 6K8G, at 14/- each. 6U5Z6G5 G, Magic eye, 11/- each.

LOUDSPEAKERS. "Goodmans" Midget speaker, 3½" 2-3 ohms voice coil, 30/- each. "Rola" 5", 21/6 each. "Celestion" with transformer size 8" PM, 27/6 each. "Magnavox" 8" with multi-ratio trans. PM, 30/- each. "Celestion" 10" Mains energised, 2,000 ohms field coil, 35/- each. All post paid.

TUNING CONDENSERS. Twin gang .0005 Midget type, 12/- each. Three-gang ditto, 12/6 each.

TUNING COILS. Medium wave only. Aerial and H.F., at 3/9 per pair.

Write to-day for latest list of Radio and Electrical accessories. Enclose 1d. stamp and stamped addressed envelope.

TERMS: POSTAGE PAID. CASH WITH ORDER ONLY. We regret that owing to shortage of staff we are unable to despatch C.O.D. or send pro-forma invoices.

Telephone: TERMINUS 1304-4842.

MORE extracts from letters sent in by CANDLER students

1. "I have studied Lesson 1 according to Lesson. your instructions, and in spite of my lack of spare time and very short practice periods, I feel myself that I am progressing well."—Ref. 984. A. F.
2. "I am very satisfied with the first two Lessons. lessons and have improved considerably, despite the fact that these were only elementary lessons."—Ref. A. F. M.
3. "I have just completed lessons 1 to 3. Lessons. . . I can tell there is a marked difference by just learning the first three." . . . "My morse has improved considerably."—Ref. 1935. P. B.
4. "I have just finished lesson 4 . . . I Lessons. am getting on fine with my sending and receiving speeds. The other week I had my A.T.C. Morse Exam., and I passed 100 per cent."—

Ref. 1661. J. R. B.

These students are taking the JUNIOR Code Course. NEXT MONTH we will give you extracts from letters sent in by CANDLER students who are taking the ADVANCED Code Course.

WRITE NOW FOR THE FREE "BOOK OF FACTS." JUNIOR Scientific Code Course for beginners. Teaches all the necessary code fundamentals scientifically.

ADVANCED High-speed Telegraphing for operators who want to increase their w.p.m. speed and improve their technique.

TELEGRAPH Touch Type-writing for speedy recording of messages and for commercial uses.

Code Courses on Cash or Monthly Payment Terms.

THE CANDLER SYSTEM CO.
(Room 55W), 121 Kingsway, London, W.C.2
Candler System Co., Denver, Colorado, U.S.A. (345)

WTD. Avo valve tester, in good condition.—Write L. Smith, 21, Ash Rd., Aldershot **REPAIRS AND SERVICE**

BEST quality rewind in 24 hrs.; guaranteed; competitive.—Radiowinds, Brundall, Nk. **REWINDS** and conversions to mains and output transformers, fields, etc., from 4/6.

—N.L. Rewinds, 4, Brecknock Rd., N.7. [3915] **METROPOLITAN RADIO SERVICE CO.** for guaranteed repairs to British and American receivers of all types.—(Service Dept.), 1021, Finchley Rd., N.W.11. [3886]

REWINDS—24-hour service; best quality, guaranteed; low price.—Radiowinds, Brundall, Norfolk. [3606]

RADIO repairs quickly executed to all makes, English or American; lowest possible prices.—The Music Box, 89, London Rd., London, S.E.1. (Tel. Waterloo 4460 and 6766.)

MAINS transformers rewound and constructed to any specification; prompt delivery.—Brown, 3, Bede Burn Rd., Jarrow. [3460]

LOUDSPEAKER repairs, British, American, any make; moderate prices.—Sinclair Speakers, 12, Pembroke St., London, N.1. Terminus 4355. [3508]

ACCURATE radio rewinds, mains transformers, fields, op. transformer etc.—Southern Trade Services, 297-299, High St., Croydon. [3971]

TRIPLE cone and coil replacements to current model p.m. speakers only; write before sending speaker.—Bakers Belhurst Radio, 75, Sussex Rd., South Croydon. [3611]

ALL types of radio receivers serviced; Murphy and Pilot specialist; valves in stock; sound repairs for 13 years.—T. E. Feyer, P.I.P.E., 50, Vines St., Uxbridge. [3575]

MAINS transformers service, repairs, rewinds, or construction to specification of any type, competitive prices and prompt service.—Sturdy Electric Co., Ltd., Dipton, Newcastle-upon-Tyne. [3084]

SERVICE with a Smile.—Repairers of all types of British and American receivers; coil rewinds; American valves, spares, line cord.—F.R.L., Ltd., 22, Howland St., W.1. Museum 565. [1575]

24-HOUR service.—6 months' guarantee. **M** any transformer rewind, mains, outputs and i.f.s. etc.; all types of new equipment supplied to specification; business heading or service card for trade prices.—Majestic Winding Co., 180, Windham Rd., Bournemouth. [3592]

REWINDS, mains transformers, field coils, chokes, high-grade workmanship, 7-day delivery; new transformers constructed to customers' specification, singly or in quantities.—Metropolitan Radio Service Co., 1021, Finchley Rd., N.W.11. Speedwell 3006. [3719]

TRANSFORMER rewinds and replacement coils, machine layer wound on bakelite formers, interleaved, impregnated and clearly marked, rewinds £1, post paid, standard types to 70 watts; replacement coils, 15/6; larger types and additional secondaries pro rata; discount to trade; delivery by return post most types in common use; state model and iron size when ordering coils; cash with order or c.o.d.; fully guaranteed.—Radio Services, Field St. Works, Blackpool, R.T.R.A. Service members. Tel. 1774. [3328]

DEGALLIER'S, Ltd.—"Service with a guarantee." If you cannot get your receiver serviced let American specialists do the job; first-class workmanship only; specialising in Air-King, Belmont, Challenger, Detroit, deWald, Emerson, Ferguson, Garol, Hallcraft, Hammerlund, McMurdo, Medwest, Majestic, Pilot, Phico, Sparton, etc., also any British set. Remember, for 15 years we have handled as distributors American receivers; s.a.e. with all enquiries.—Degallier's, Ltd., 9, Westbourne Court, London, W.2.

MISCELLANEOUS

SPARKS' data sheets.—These data sheets provide complete constructional details, together with full-size prints, etc., of tested and guaranteed designs.

ELECTRIC guitar units (3rd edition), 5/-. **ELECTRONIC** one-string fiddle, 3/6; 6-8 watt ac/dc amplifier; phase inverter; push-pull output; neg. feed-back; portable for use with above or mike, p.m., etc., 3/6.

A.C. two-valver, med. wave coil details, 2/6; 5½ watt ac amplifier, 2/6.

SPARKS' DATA SHEETS (W.), 9, Pheobeth Rd., Brockley, London, S.E.4. [3622]

NO coupons for part-worn clothing.—Motor trousers, 15/11; black rubber coats, 32/-; paramatta police macs, 32/-; bus overcoats, 36/-; bus jackets, 26/-; bus suits, 37/6; conductress bus suits, 27/6; conductress overcoats, 30/-; black rubber leggings, 9/11; drivers' hats, 4/6; boiler suits, 10/11 and 12/11; bib and brace overalls, 5/11; R.A.F. helmets, 12/6; gannet gloves, 4/-; Sidcot suits, 35/-; crash helmets, good cond., 10/6; back packs, 10/6; haversacks, 4/11; packing, post ex.—Milletts, Cornhill, Lincoln. [3983]

*just because they
give no trouble—
don't forget*

DALY

ELECTROLYTICS

—they're serving you well!

DALY (CONDENSERS) LTD

Condenser Specialists for over 20 years
West Lodge Works, The Green, Ealing, WS
Telephone Ealing 4841

WARD ROTARY CONVERTERS

Petrol Electric Generating Plants, H.T. Generators, D.C. Motors, Frequency Changers, etc., up to 25 K.V.A.

CHAS. F. WARD
37, WHITE POST LANE, HACKNEY WICK, E.9
Phone: Amharst 1393

BATTERY CHARGERS & TRICKLE CHARGERS



ARMSTRONG

ARMSTRONG has always had the name for Quality.

When this war has been brought to a successful conclusion our new range of ARMSTRONG CHASSIS will prove that our reputation was built on a firm foundation.

ARMSTRONG WIRELESS & TELEVISION CO. LTD.
WALTERS ROAD, HOLLOWAY, LONDON, N.7
Phone: NORth 3213

M. WILSON LTD

Circuit No. 19.

MIDGET SHORT WAVE CONVERTER, 12-35, 34-100, 91-261 metres. Trigide hexode P.C. International Octal Valve. Can be fitted to any standard receiver. Battery, A.C. or A.C./D.C. Full specification on application. State type required.

GRAMPHONE AMPLIFIER CHASSIS.

Assembled on black crackle-finished chassis fitted with separate tone control. Volume control with on/off switch, sockets for microphone, gramophone and extension speaker. Hum free, good quality reproduction. A.C. only. Input 200/250 v. Size overall 8 1/2 x 7 1/2 in. Ready to play. Prices include valves and speaker.

4-Valve 4-Watt 10 Gns.
 4-Valve 6-Watt with PX4 output 12 Gns.
 Theoretical and practical blue prints of the above available separately, 3/6 per set.

BLUE PRINTS of the following circuits. 1 Theoretical and 3 Practical, 3/6 per set.

- No. 1.—A.C.T.R.F. 3 Valves Medium Wave only.
- No. 2.—A.C.T.R.F. 4 Valves. Long, Med. and Short.
- No. 3.—A.C.T.R.F. 4 Valves Short Wave only.
- No. 5.—A.O. Superhet 4 Valves L., M. and S.
- No. 6.—A.O/DC Superhet 4 Valves, L., M. and S.
- No. 7.—Battery T.R.F. 3 Valves, L., M. and S.
- No. 9.—Battery, T.R.F., 3 Valves Short Wave only.

8 NEW TROPICAL CIRCUITS.

No. 17.—Small Communication Type A.C. and A.C./D.C. Superheterodyne Receivers. Brief specification. 6 Wavebands, 5-2,000 metres. Radio Frequency stage. 7 Valves Int. Octals, including best Frequency Osc. and rectifier. 465 K/c. Overall measurements, 16in. x 8in. x 8in. in black crackle finish. Shortly available for export. Blue prints 5/- per set of 3.

No. 5A.—As above. Battery 4 Valve Superhet. 3 Wavebands, 16-50 metres, 200-557 metres, 700-2,000 metres. 1.4v. Valves. Blue prints, 3/6 set of 3. Priced List of Components sent with each set of Blue Prints.

307, HIGH HOLBORN,
 LONDON W.C.1. Phone: *HOLborn 4631*

YOU can become a first-class RADIO ENGINEER

We are specialists in Home-Study Tuition in Radio, Television and Mathematics. Post coupon now for free booklet and learn how you can qualify for well-paid employment or profitable spare-time work.

T. & C. RADIO COLLEGE
 North Road, Parkstone, Dorset
 (Please Note New Address)

(Post in unsealed envelope, 1d. stamp.)

Please send me free details of your Home-Study Mathematics and Radio Courses

NAME

ADDRESS

W.W.42

TIME recorders.—Write for particulars.—Gledhill-Brook Time Recorders, Ltd., 84, Empire Works, Huddersfield. [2419]
EXPERIENCED amateur with capital wishes to actively join with proprietor of an existing radio business.—Box 5494. [3600]
CHASSIS, brackets, clamps, shrouds, etc., made quickly accurately with professional finish in A.A. benders, used by large radio mfrs., invaluable to experimental engineers.—Full details free from A. A. Tools, 197a, Whiteacre Rd., Ashton-u-Lyne. [3770]
SITUATIONS VACANT.
 WIRE broadcasting.

OF interest to Class A Servicemen from Signal Corp.—Wanted, a working manager for radio relay service at branch in Clyde district, Scotland; knowledge of overhead line work and k/w amplifiers advantage; prospects for right man; opening up new territory and district managership.—Apply in own handwriting stating qualifications and experience, to F. Nuttall, L.M.&S. Relay Systems, Ltd., 48, Higher Enam, Blackburn. [4021]

A FIRM of scientific instrument makers, manufacturing electrical and mechanical precision instruments, have the following vacancies:—

(A) For a Chief Engineer, to take full control of an existing engineering department. This appointment will cover research, development engineering, design engineering, product engineering, production drawing office, inspection, test, quality control. The candidate should have good academic qualifications in the scientific and engineering field and preferably be acquainted with modern instrumentation as applied to Army and Naval Ordnance, aeronautics, fire control and navigation. Preference would be given to a candidate with an established record of personal achievement in this field of engineering and who is able to consult with Government research and production departments on a sound and constructive basis. Salary £1,500 to £2,000 per annum.

(B) For a Chief Research Engineer. This appointment will cover control of existing research laboratories and personnel, a small machine and assembly department, and a design and drawing office. The present personnel in the department is approximately twenty, and it is anticipated that this number will increase in the near future. Preference would be given to a candidate with good academic and scientific qualifications and some years' current experience in the control of a research establishment. Salary £1,250 to £1,500 per annum.

THE company is located on the outskirts of London and employs at the present time about 4,000 people.

BOTH the above appointments are eligible for participation in the company's pension scheme. WRITE Box 1847, c/o White's, Ltd., 72, Fleet St., London, E.C.4. [3979]

ELECTRICAL inspectors (Class A ex-Servicemen) required, with experience in radio, by firm of communication engineers in S.W. London.—Write, with full particulars, to Box 1127. [3960]

CHARGE hands required for radio and/or electrical instrument servicing class A Servicemen or men over 51; must be experienced, not afraid of work conversant with modern methods; good wages and permanency.—Box 3500. [3629]

LIVE radio service engineers wanted immediately, accustomed to fault finding, checking, testing, etc.; good wages; Slough district; permanent post for suitable men, over 51 or Class A ex-Servicemen; unless fully qualified do not write.—Box 3515. [3670]

FOREMAN wanted for small machine and assembly shop employed on electronic development and production; Class A ex-Serviceman; salary approximately £350.—Apply Box 4005, A.T.A. Advertising, Ltd., 69, New Oxford St., W.C.1. [4034]

REDIFFUSION, Ltd., will have vacancies for qualified radio engineers and draughtsmen, permanent and progressive positions; appointments will be made when present restrictions are relaxed.—Apply 11D, Lower Regent St., S.W.1. [3959]

ASSISTANT required in Central London to undertake full-time instruction work in tele-communications, principally broadcasting and radio-telephony; previous teaching experience not essential.—Write, stating age, experience, and salary required, to Box M.453, Willings 362, Gray's Inn Rd., W.C.1. [3644]

MANAGING director of a London electric instrument manufacturing company requires an assistant, principally for technical liaison between customers and suppliers; Class A ex-Serviceman with technical training, particularly in signals, preferred.—Write, giving details of education, age, experience, to Box 90, C. R. C., 29, Hertford St., W.1. [3995]

GALPINS

ELECTRICAL STORES,
408, HIGH ST., LEWISHAM,
LONDON, S.E.13.

TERMS: CASH WITH ORDER. No C.O.D.
 All Prices include Carriage or Postage.

ELECTRIC LIGHT CHECK METER, first-class condition electrically guaranteed, for A.C. mains, 200/250 volts 50 cy 1 phase 5 amp. load, each 12/6.

AUTO TRANSFORMERS, Step up or down, tapped 0-110-200-220-240: 1,000 watts. 4s.

POWER TRANSFORMER, 4kW, double wound, 400 volts and 220 volts to 110 volts, 50 cycle, single phase. Price 22/6.

AUTO TRANSFORMER, step up or step down, 500 watts, tapped 0-110-200-220-240 volts. 23/10s.

1 WATT WIRE END RESISTANCES, new and unused, price per doz., 6/-, our assortment.

MOVING COIL AMPMETER by famous maker, 2in. dia. flush mount, g. reading 0-10 amps. F.S.D., 20 mA, price 27/6.

METAL RECTIFIERS, large size, output 50 volts 1 amp. 3s/6.

SMALL MAINS TRANSFORMERS, input 230 volts, output 11 volts 1 amp., 11/-.

METAL RECTIFIERS large size, output 12 volts 1 amp. 17/6.

FIXED RESISTANCES, size 12in. by 1in., fireproof, resistance 5 ohms to carry 10 amps., 3/- each; set of 16 mounted in steel frame, only 25/-.

TRANSFORMER CORE for rewinding only, complete with clamps, size approx. 2 1/2 k.w., price 25/-.

SMALL M.L. ROTARY CONVERTER, in cast all. case size 14 x 4 1/2 x 4 1/2 in., permanent magnet field, converters need attention, not guaranteed, 30/-.

50 VOLT MOTOR, D.C., input 4 amps., 1/2 h.p., ball bearing, double ended shaft 1/2 in. dia., slow speed, only 500 r.p.m., shunt wound, condition as new, also make good slow speed generator. Price 50/-.

AUTO TRANSFORMERS, tapped 0-110-200-220-240v. 1 1/2 kW., 27/10s.; 2 kW., 31/0.

FOR DISPOSAL.
 10 K.V.A. High Tension Transformer Unit, 4 valves. Also combined diagnostic and superficial therapy apparatus, together with combined couch and screening stand. Tube stands and other accessories. Full particulars on application to above.

MOVING COIL METERS, all 2in. dia., flush mounting 0-5 M.A. 40/-; 0-20 M.A. 40/-; 0-25 M.A. 40/-; 0-50 M.A. 37/6; 0-150 M.A. 35/-; 0-300 M.A. 35/-.

MOVING COIL METERS, all flush mounting, 2in. 0-5 amp., 30/-; 2 1/2in. 0-10 amp., 25/-; 0-1 amp. 2 1/2in. 30/-; 0-30 volt 2 1/2in., 25/-; Weston galvo. 30-0-30, 50/-.

METAL RECTIFIERS, outputs 6v.-1 amp., 12/6; 6v.-2 amp., 25/6; 9v.-2 amp., 37/6; and 12v.-3 amp., 50/-.

ROTARY CONVERTERS, 210v. DC to 150v. AC at 500 watts, 11/0; ditto, 230 DC to 150 AC at 700 watts, 11/0; ditto, 480v. DC to 300 AV at 4 kW., 22s.

EPOCH super cinema speakers, 15in. cone, 20 watt output, 6v. field, no engraving, 66/10s.

HT TRANSFORMER, input 200/250v., output 3,000, 2,500-0-2,500-3,000 volts at 1,200 M.A., rating 7 kW., 220.

OOOLIDGE TUBE, filament transformers, 230v. input, 11 volts output, fitted HT insulator, insulation 100,000v. to earth, 4s.

LARGE HEAVY DUTY CHOKES, weight 24 lbs., wound heavy gauge wire, suitable for rewinding as auto transformer up to 1 kW., price 25/-, carr. paid.

LARGE FAXOLIN PANEL, size 14 x 7 1/2 in., fitted massive switch arcs, 12 large studs and contact blades, very smooth action, price 7/6 each.

BRAE FREQUENCY OSCILLATOR in case 21 x 11 x 9in., Lab. model, battery working, fitted 3in. dia. dual range voltmeter, reading 0-10-100 volts, complete with valves in working order, 11/0.

ELECTROLYTIC CONDENSERS, 2,000 MF, 25v. working, 10/- each.

BLOCK CONDENSERS, 2 MF, 1,500v. DC working, 7/6 each.

BELL TRANSFORMERS, output 3-5 and 8 volts, 6/- each.

LARGE OUTDOOR BELLS, 110v. DC working, 6in. dia. gong, 17/6 each.

VOLTMETER, 2in. dia., flush mounting, reading 0-250 volts AC only, 35/-.

MOTOR BLOWER, fitted 12v. DC motor, sorocco fan type, 2in. dia. inlet and outlet, very powerful, 45/-.

CLOSED half-day Thursday. Open all day Saturday.

TRANSFORMERS.

MAINS. Primaries 200/250v. A.O.

MAINS. Secondaries. 350/0/350v

TYPES.

V74. 75 ma., 4v. 2½a. and 4v. 4a. ct., 30/-.

V76. 75 ma., 5v. 2½a. and 6.3v. 4a. ct., 30/-.

X. 120 ma., 4v. 3a. and 4v. 6a. ct., 42/-.

Y. 120 ma., 5v. 3a. and 6.3v. 6a. ct., 42/-.

K450. 450/0/450v. 250 ma., 4/5v. 3a. and two 6.3v. 6a., 50/-.

The largest range of transformers are obtainable from our stocks. See List T55. (2½d.).

For amplifier enthusiasts, we have special sets of types, mains, chokes and outputs. 20 watt to 50 watts.

Complete amplifier kits, A20, £14. A35, £25.

These consist of entire amplifiers, ready to wire up.

Photostat prints of above cost 2/6 each.

Coming soon, a P.A. amplifier for £10.

SPEAKERS. P.M. 6½in., 25/9, 8in., 28/-, 5in. midget, 28/-, 12in. £6 15, M.F.E. 8in., 25/6.

ACCESSORIES. Our stocks of condensers, resistors, etc., are being built up for the Autumn Season, new lists "P" are expected to be ready Sept. 1st.

DEALERS. Write to our associate company, G.L. PRODUCTIONS, for generous trade terms.

RADIO INSTRUMENT CO.



Radio Products
294, BROADWAY,
BEXLEYHEATH, KENT

BERRY'S (SHORT WAVE) LTD.

for Quality

RADIO AND ELECTRONIC PRODUCTS

Including: O.R. Tubes, 14", 55/-; 21", £3 6s.; 41", £6 12s. P. Coils, 2/3 and 2/6. I.F.'s, 7/6 each. Crystal Pick-ups, 7/3 and 7/6; Crystal Molehead, 7/5/-; Mullhead 9-1 S.M. Dial with driving head, 3/5/-; S-1, 2/5/-; S.M. Drive escutcheon and glass, 8/6. Metal Cabinets, panels and chassis, 39/6 and 63/-; Speakers, 21", 27/-; 3", 30/-; also 5" to 12". Jacks and Jackplugs, 2/6 each. Vortexion 20 w. Amplifier for Mains or Battery, £19 13s. 6d. Ceramic trimmers, condensers, stand-offs, formers, wavebases, etc. Fuse-holders, single, 2/6; Twin, 3/6. Volume Controls, 4/3; with switch, 5/9. Polystyrene rod, tube or sheet. Send S.A.E. for complete list "W.W." to—

25 HIGH HOLBORN, LONDON, W.C.1

Telephones: Holborn 6231

RADIO BATTERY TESTER

Use "Quixo" method
of battery testing.

Reliable results. Guaranteed.

Send for interesting leaflet
R115 on battery testing.



RUNBAKEN · MANCHESTER 1

THE NORTHERN POLYTECHNIC, HOLLOWAY ROAD, N.7.

Principal: T.J. DRAKELEY, D.Sc., Ph.D.,
F.R.I.C., F.I.R.I.

Department of Radio and Musical
Instrument Technology.

Head of Department:

S. A. Hurren, M.C., F.Brit.I.R.E.

Full-time Day Courses in

RADIO TECHNOLOGY

in preparation for all
recognised qualifications in this subject.
Practical laboratory and workshop experience provided.

Prospectus free on application to Secretary
New Term begins September 24th

WANTED, London, operator technician, picture telegraphy; good knowledge of electronics; no previous experience necessary; salary £230 per annum; Class A ex-Serviceman or exempt.—Box 1352. [3994]

A S.E. London factory has vacancies for experienced engineers preferably having pre-war experience of the design of radio and television receivers and the application of radio to vehicles, excellent post-war prospects; appointment when present restrictions are withdrawn.—Write in confidence to Box 7189, A. K. Advg., 212a, Shaftesbury Ave., London, W.C.2 [3884]

RADIO valve engineer required, University trained, with at least 10 years' experience of valve development and manufacture, must possess initiative to follow a new type through to the shop and ensure economical manufacture; appointment when relevant restrictions are withdrawn.—Write in confidence to Box 7191, A.K. Advg., 212a, Shaftesbury Ave., London, W.C.2. [3884]

CATHODE ray tube engineer required, University trained with at least 10 years' experience of cathode ray tube development and manufacture, must possess initiative to follow a new type through to the shop and ensure economical manufacture; appointment will be made after relevant restrictions are withdrawn.—Write in confidence to Box 7194, A.K. Advg., 212a, Shaftesbury Ave., London, W.C.2. [3885]

DEVELOPMENT engineer required by established radio and communications component manufacturers; must have had at least 4 years' experience in the design and production of paper and mica dielectric capacitors; education up to Inter. B.Sc. standard; salary £350 or more, according to experience and ability. (Inserted by permission M.O.L. under Control of Engagement Order, 1945.)—Box 1131. [3966]

A SERVICE manager is required by a London company manufacturing a high-class valve amplified hearing aid. The position carries a salary of £500-£600 p.a., and offers considerable scope for a young man with knowledge of L.F. amplification, test equipment, and who is also a first-class organiser, correspondent and able to train and control staff.—Applications, giving age and detailed experience, should be made to Box 1130.

DEVELOPMENT engineer required by established radio and communications component manufacturers; must have had 4-5 years' experience in the design and production of radio receiving and low-power transmitting apparatus and associated test apparatus; education at least comparable to Inter. B.Sc. standard; salary £350 or more, according to experience and ability. (Inserted by permission of M.O.L. under Control of Engagement Order, 1945.)—Box 1132. [3967]

TELEPHONE RENTALS, Ltd., have vacancies for sound equipment engineers in the London area, and in some provincial areas; the main qualifications are some years' experience of radio or other branch of electronics; the possession of a reasonable background of electrical and radio theory, and a real interest in power amplification; Class A ex-Servicemen preferred.—Write or phone the Chief Engineer, Telephone Rentals, Ltd., Kent House, Knightsbridge, S.W.7 (Ken. 9201). [3967]

SITUATIONS WANTED

ARTIST-DESIGNER, specialised in modern cabinet design, seeks contact with radio manufacturer.—Write Box 1135. [3972]

COMMUNICATIONS engineer, experienced in radio, carrier and V.F.T., in Services, release about Dec., seeks position or partnership in U.K., Australia or N.Z.—Box 1353.

RADIO and electronic engineer, 52, design, research, development, servicing, shortly returning New Zealand, seeks connection with firm trading (or opening trade) in the Dominion; extensive practical advertising and managerial experience.—Box 1358. [4009]

CHIEF radio officer anticipates discharge from Merchant Navy in near future; City and Guilds finalist in radio-communication and electrical technology; completed student-ship practice course with well-known radio manufacturer; responsible for maintenance and organisation of telephony and telegraphy stations during sea career, aged 24 years; desires Technical situation.—Box 1129. [3964]

SUPERINTENDENT of test, controlling test and apparatus sections, latterly on Radar, for large radio manufacturer; seeks similar position; good prospects essential.—Box 1228.

PATENT NOTICES

THE proprietors of British Patent No. 537689, entitled Improvements in wave signalling systems, particularly applicable to facsimile telegraphy, and No. 537699, entitled Improvements in frequency modulation systems, offer same for license or otherwise to ensure their practical working in Great Britain.—Inquiries to Singer, Ehlert, Stern and Carlberg, Chrysler Building, New York City, 17, N.Y., U.S.A. [3627]

WANTED

Agent — Distributors

Pormeko Ltd. of Leicester intend to appoint agents for selling, distribution and servicing of Pormeko sound reproducing equipment in areas throughout the country. Applications are invited from established firms with staff for large wiring installations of factories and public buildings. A good trading reputation and wide connections and experience in this type of work are essential.

The equipment is designed for:—

INDUSTRY ('Music while you work,' Paging, Fire Alarm, etc.)	SCHOOLS THEATRES HOTELS SPORTS EVENTS, Etc
---	---

Full details to X.1 Department:

PARMEKO

AYLESTONE PARK, LEICESTER

WANTED

Well-known firm of Scientific Instrument Makers require for work of national importance American valves, type: 12SC7.

Write to: Box 1075, c/o "Wireless World."

SOUND SALES

TRANSFORMERS · QUALITY RADIO & AMPLIFIERS
WEST ST. FARNHAM, SURREY.

'SELECTEST'

is
Coming

... will interest every Electrical and Radio Engineer.

SALFORD ELECTRICAL INSTRUMENTS LTD.
PEEL WORKS · · · · · SALFORD · 3

LONDON CENTRAL RADIO STORES

NEW MAINS TRANSFORMERS. Superior Quality. 300-0-300v., 6.3v., 3 amp., 5v. 2a. Also 300-0-300v. 4v. 2a., 4v. 2a. Dim. 3 1/2 x 3. Weight, 4 1/2 lbs. Blue enamel finish. Price 24/6 each.

MALLOY VIBRATORS. 6 volt 4-pin. Unused. Slightly soiled but in perfect working order. 10/-.

MULTI-RANGE MOVING COIL TEST METERS. New. First-grade army type in bakelite case. Ranges: 10, 50, 100 and 500 volts at 1,000 ohms per volt A.C. and 1, 10, 100 and 500 mA at 0-10,000 ohms D.C. 28/15s.

WIREWOUND POTENTIOMETERS. 4,000 ohms. (Open type on porcelain formers, 9/16 spindle, 2 1/2 x 1 1/2 in.) 25,000 ohms. Tropical type enclosed in bakelite moulding, 1/2 in. spindle, 1 1/2 x 3/4 in. 4/6.

SPEAKERS. E. & A. 8in. mains energised with Pentode output transformer, 1,200 ohm field. 87/6. Celestion 10in. P.M. with transformer. 45/-. Celestion 6in. P.M. with transformer. 27/6.

SLIDING RESISTANCES. 1,100 ohms 0.4 amp. wirewound on twin porcelain formers. A first-class engineering job. 32/6.

D.C. MOVING COIL MILLIAMMETERS with 2in. clear reading dial, flush mounting, 0/1 mA. Full scale deflection. 47/6. 0-25 mA. 2in. dial. Flush mounting, bakelite case. Made by Ernest Turner Electrical Instruments Ltd., 50/- 0-6 mA. 2in. dial. Flush mounting, bakelite case. Extra scales for conversion to voltmeter and ohmmeter. Internal resistance, 260 ohms, 50/-.

MICROAMMETER. 0-500, 2in. dial. Flush mounting, bakelite case, 24/10s.

1 mfd. TUBULAR CONDENSERS, 5,000v. DC wkg. 5/6.

TWO-RANGE D.C. VOLTMETERS. Moving coil 0-300, 0-600v. Complete with shunt. 2in. clear reading dial. Flush mounting. Made by Ernest Turner Electrical Insts., Ltd. 23/17s. 6d.

TWIN CARBON POTENTIOMETERS, 0.5 megohm. 5/6.

MAINS TRANSFORMERS. Newly manufactured. 250-0-250v. 80 mA. 4v. 2a., 4v. 2a. 28/6. 300-0-300v. 75 mA. 6.3v. and 5v. 28/6.

4 mfd. CONDENSERS, 250v. D.C. wkg., size 2 1/2 x 2 x 2. 5/6.

MIDGET POTMETERS. Wirewound, 8 ohms. 4/6.

CONDENSERS. Metal cased. 0.1 mfd., 1,000v. 1/2 C.W. Insulated terminals. 2 1/2 x 2 1/2 in. 3/6.

TUBULAR CONDENSERS. 0.1 mfd., 350v. D.C.W., Bakelite with metal ends. 7ag terminals. 1/6.

YAXLEY TYPE METER SWITCH. Single pole. 11-way. 6/8.

"MUTER" PUSH-BUTTON UNITS. 8-way, with mains switch rated 125v. at 6.3 amp. and 250v. at 1 amp. 3/6.

EX-G.P.O. ELECTRO-MAGNETIC COUNTERS, 25-50v. D.C. Counting to 9,999. 6/-.

PLATINUM CONTACTS. Double spring, mounted on ebonite. 1/6.

MULLARD EA50 VALVES. 10/6.

CHASSIS 11 x 9 1/2 x 2 1/2 in. 3/6.

Closed Thursdays, 1 p.m.
Open all day Saturdays

23, LISLE STREET
LONDON GERard 2969 W.C.2.

COVENTRY RADIO

COMPONENT SPECIALISTS SINCE 1925

1925 TO 1945

THIS MONTH COMPLETES 20 YEARS OF SERVICE TO THE PUBLIC. WE HAVE ENDEAVOURED TO OFFER GOOD QUALITY COMPONENTS AT REASONABLE PRICES WITH REALLY PROMPT SERVICE. WE ARE NOW EXTENDING OUR RANGE OF GOODS AND WE HOPE TO STILL FURTHER IMPROVE OUR SERVICE. MAY WE SEND YOU OUR ANNIVERSARY LIST, PRICE 1d., READY MID-SEPTEMBER.

THE COVENTRY CO.
191, DUNSTABLE ROAD, LUTON.

THE proprietors of British Patent No. 505632, entitled Improvements in and relating to cathode-ray tubes, offer same for licence or otherwise to ensure its practical working in Great Britain.—Inquiries to Singer, Ehrlert, Stern and Carlberg, Chrysler Building, New York City, 17 N.Y. U.S.A. [3596]

TUITION
RADIO training.—P.M.G. exams. and I.F.E. Diploma; prospectus free. — Technical College, Hull. [0611]

PRE-EXAMINATION; C. & G. I.F.E. Brit.I.R.E., Radio and Tech. Elec., test papers supplied, marked and corrected; 5/- 6 problems; your own problems 1/- each; send Q. and A.s.; s.a.e.—Box 1134. [3970]

THE Tuitionary Board of the Institute of Practical Radio Engineers have available home study courses covering elementary, theoretical, mathematical, practical and laboratory tuition in radio and television engineering; the text in suitable coaching matter for I.P.R.E. Service-entry and progressive exams; tuitionary fees—at pre-war rates—are moderate.—The Syllabus of Instructional Text may be obtained post free from the Secretary, Bush House, Walton Avenue, Henley-on-Thames, Oxon. [1452]

FINANCIAL PARTNERSHIPS
RADIO, cycle, electrical retailer having licence, reopen when demobilised, Dec. Jan., desires partner, preferably knowledge household wiring; district preferred Yorkshire; own car desirable.—Write Box 1362. [4016]

OPPORTUNITY for young ex-Serviceman, with retail radio and electrical experience, to acquire interest (£200-£300) and directorship in progressive business, Newbury, Berks; genuine opening through death present partner.—E. J. Bach, 21, Oxford St., Newbury.

AGENCIES WANTED
MANUFACTURERS' contacts desired competent manufacturers offering radio and electrical parts for manufacturers (or wholesalers) requirement; sole agency preferred upon commission and part expenses basis; established connection with London office services shortly.—Box 1360. [4013]

RADIO manufacturer invites applications from established radio service companies and engineers of good standing & reputation to undertake installation & maintenance of their radio products in exclusive territories on contract basis.

THE areas in which coverage is required are: Cornwall, Devon, Dorset, Hampshire, Sussex and South and East Kent, Wales, west of a line from Swansea through Welshpool to Rhyl, Norfolk, Suffolk, Cambridge, Huntingdon and Lincoln, East Riding of Yorkshire, Westmorland, Cumberland and North Northumberland, Scotland, those parts lying south of a line from Edinburgh to Ayr, and north of a line from Helensburgh to Perth.

APPLICANTS should clearly define the exact area or areas in which they are interested, and should state if they are prepared to guarantee to maintain a one-day repair service; remuneration will be on the basis of a nominal retaining fee plus payment for each job completed.—Box 1156. [3976]

DESIGN and development. **WORK WANTED.**

WE have facilities particularly suited to this class of work; A.I.D. approved; enquiries to:—**GREEN ELECTRICAL INDUSTRIES, Ltd.,** 44-45, Tamworth Rd., Croydon. Tel. 7417-8.

CAPACITY available for mech. elec. radio, manufacturer, large or small, simple or intricate, repairs, modifications, tropicalisation, competitive.—Mec-Electric, Ltd, Bank Chambers, Chatham. [4005]

SHEET metal and engineering Co. in London area, have immediate capacity for all classes light sheet metal work; high standard of workmanship guaranteed.—Apply Box 3498.

WELDING capacity, 300 hrs./wk. available on precision controlled resistance welders, projection and spot, for light alloy and steel components, assemblies and sheets up to 24in wide, thickness 2 by 1/4 in.—Box No. 89, C.R.C., 29, Hertford St., W.1. [3975]

CAPACITY available for complete manufacture of all type of radio and electrical equipment; we do winding, coil and transformer winding, with vacuum impregnation, Ministry super tropical standards; A.I.D. approved. **GREEN ELECTRICAL INDUSTRIES, Ltd.,** 44-45, Tamworth Rd. Tel. Croydon 7417-8.

BOOKS, Etc.
COPIES "Wireless World," Feb., '41, to date inclusive; offers.—Box 1355. [3998]
BOUND volumes "Wireless Engineer," 1930, '31, '32, '33, '34, '35, '36; "W.W." 1829, 1930; offers.—Bush, 46, Wellesley Rd., W.

WEBB'S radio map of the world locates any station heard, size 40x30in, 4/6, post 6d.; on linen, 10/6, post free.—Webb's Radio, 14, Soho St., W.1. Gerrard 2089.



"THEY SAY THEY'LL RELEASE ME FOR A 3516." This chap is free now—thanks to Bull's who immediately sent (as usual) the right valve.
Courtesy "Radio-Craft," New York.

From our stock of 10,000 valves we can supply nearly all types required. Please order C.O.D. Under 10/- C.W.O. 2jd. stamp with enquiries B.O.T. prices.

MULLARD, MARCONI, OSRAM, MAZDA, COSSOR, BRIMAR, PHILLIPS, FERRANTI, EVERREADY, TUNGSRAM, HIVAC also **AMERICAN** midgets and accorns **VALVES AND ADAPTORS**

In the cases where we cannot supply the exact valve or equivalent, we can get your set going with a valve and adaptor, the additional cost being 4/6.

MODERN AIDS

AC/DC MULTI-METERS £8.17/6.
"TESTOSCOPE," the best pocket instrument for tracing faults. Enables 20 tests AC/DC, complete with leads, 37/6.

TRIMMER TOOL KITS. 14 tools in wallet, 30/-.

"ELCO," Electrical Light-weight Soldering Iron (state voltage), 13/6.

"FLIK-O-DISK," a novel calculator of Ohm's law problems, 6/6.

PYROBIT IRON, 22/-.

MOVING COIL METERS. 30 amps., charge, discharge, bakelite base, 19/6.

GAB AERIALS, telescopic, nickel-plated, 21/-.

FLAT IRONS, 200-240 v. 27/6.

RADIO LITERATURE

Television, 1/- Test Gear Construction, 1/6. Amplifier Manual, 2/-.

Equivalent Charts, our unique booklet, 1/7. Manual of Circuits, 2/-.

Short Wave Handbook, 2/-.

Handbook on American Midget Sets, 2/7.

Wireless Terms Explained, 3/-.

Manual of British and American Valves, 3/6.

Radio Inside Out, 4/6.

Radio Simplified, 4/6.

Basic Radio, 5/-.

Introducing Radio Servicing, 6/-.

Receiver Circuits Book, 6/-.

Various Service Sheets, 10/6 per doz.

Various Service Diagrams, 7/6 per doz.

Giant World Radio Map, 5/-.

COMPONENTS

RESISTORS, 1 wire, card of 50 assorted values, 27/6.

VARIEBLE WAFFLE DROPPER RESISTORS, 2 or 3 amps. 5/6.

Resistors in cages to permit fixing outside set, 3 amps., 7/4 ohms, 11/9.

DROPPERS ready to fit, 4 doz. assorted; Cossor, Ferranti, Decca, Maestro, Ferguson, Elco, 37/6.

EXPORT ORDERS INVITED

J. BULL & SONS, (Dept. W.W.)

246, HIGH STREET, HARLESDEN, N.W.10

ENGINEERING OPPORTUNITIES

This unique handbook shows the easy way to secure **A.M.I.Mech.E., A.M.Brit.I.R.E., A.M.I.E.E., City and Guilds, etc.**

WE GUARANTEE— "NO PASS—NO FEE."

Details are given of over 150 Diploma Courses in all branches of Civil, Mech., Elec., Motor, Aero., Radio, Television and Production Engineering, Training, Building, Govt. Employment, R.A.F. Maths., Matriculation, etc.

Think of the future and send for your copy at once—FREE.

B.I.E.T., 387, SHAKEPEARE HOUSE, 17, STRATFORD PLACE, LONDON, W.1.

LONDON COUNTY COUNCIL
NORWOOD TECHNICAL INSTITUTE,
 KNIGHT'S HILL, WEST NORWOOD, S.E.27
 Tel. : Gipsy Hill 2268
 Acting Principal :
 J. Dimmick, B.Sc., A.R.I.C., A.M.Brit.I.R.E.

New Session commences—Evening Students, 24th September, 1945
 Senior Day " 10th " " "

ENROLMENT :
 Evening Students—Commences 17th Sept., 1945.

DAY COURSES :
 Matriculation and Preliminary Professional.
 1st M.B.
 Intermediate Science and Pharmacy.
 Home Training School.
 Part-time day classes in Literary, Music and Women's Subjects.

EVENING COURSES :
 Science (to B.Sc. General).
 Matriculation and Preliminary Professional.
 Radio Engineering, Television, etc.
 Commercial.
 Languages.
 Literary and Music.
 Women's Department.

PROSPECTUS ON APPLICATION TO THE PRINCIPAL.

Varley

WIRE WOUND RESISTANCES
TRANSFORMERS
DELAY SWITCHES
POWER CHOKES

40 Years Reliable Service to the Industry

OLIVER PELL CONTROL LTD
 CAMBRIDGE ROW, WOOLWICH, S.E.18
 TELEPHONE : WOOLWICH 1422

WALTER SWITCHES
 ARE MADE FOR 

WALTER
INSTRUMENTS. LTD.

Earls Court Exhibition Buildings, Earls Court, London, S.W. 5
 FULHAM 6192



It isn't Isn't what !
 Isn't a watt !
 It's the c.g.s. unit of energy.

WHAT'S "ERG" ?

ERG is the trade mark identifying a line of products that will be available when we've finished the biggest job of all.

ERG RESISTORS LTD.
 1021a, FINCHLEY ROAD, LONDON, N.W.11
 PHONE : SPEEDWELL 6967



Superspeed
SPECIAL

CORED SOLDER
A.I.D. APPROVED

H. J. ENTHOVEN & SONS LTD.
 230 THORNTON ROAD, WEST CROYDON, SURREY
 THORNTON Heath 2462

FAN DISC LOCK WASHER
VIBRATION PROOF

Overlapping teeth cannot be flattened.
 Teeth grip and cannot shake loose.
 In steel or phosphor bronze. Sizes from 10 B.A. For all types of bolts and screws.

SEND FOR SAMPLES,
 PRICES & LITERATURE



FAN DISC LTD

NORTHWOOD ST., ST. PAUL'S, BIRMINGHAM 3

Even 24 hours' immersion in sea-water cannot affect impervious

Welwyn Resistors



Tested independently, a standard Welwyn Vitreous Resistor worked perfectly after 24 hours' immersion in sea-water. Sizes—1 w. to 300 w. High Stability Carbon Resistors— $\frac{1}{4}$ w. to 2 w.

New Trade catalogue available

WELWYN ELECTRICAL LABS. LTD
 Welwyn Garden City, Herts.
 Phone : WEL. GAR. 3816-8

Printed in England for the Publishers, LIFFE AND SONS LTD., Dorset House, Stamford Street, London, S.E.1, by THE CORNWALL PRESS LTD., Paris Garden, Stamford Street, London, S.E.1. "Wireless World" can be obtained abroad from the following—AUSTRALIA and NEW ZEALAND: Gordon & Gotch, Ltd. INDIA: A. H. Wheeler & Co. CANADA: Imperial News Co.; Gordon & Gotch, Ltd. SOUTH AFRICA: Central News Agency Ltd; William Dawson & Sons (S.A.), Ltd. UNITED STATES: The International News Co.

TO MEET THE ELECTRONIC AGE



A GREAT new force is now being unleashed to help solve many of Industry's toughest problems—Electronics is its name. Born out of Radio and fostered by the insatiable and exacting demands of War it is certain to exert a profound influence for good upon our future way of life. Indeed there's hardly an Industry or a process that, in the days to come, will not owe something to Electronics.

Take for example the surface hardening of a motor-car gear. The method, prior to 1939, would be to pack it in carbon and carefully heat it to the required temperature in a furnace. This would need several hours, costly supervision, and elaborate temperature control systems.

Today Electronics can do it better, quicker, cheaper *in a matter of seconds*. The operator merely places it within the heater coil and switches on the current. Twenty seconds for heating followed by a 9-second quench—and the job is done! Further, the heated area and penetration can be controlled within fractions of an inch. Because heating and quenching cycles are automatic, complete uniformity is achieved.

... As capacitor manufacturers we are naturally interested in all new Electronic applications, for in every such circuit, capacitors are essential components. If you have a capacitor problem, for radio, post-war television, or for a special electronic device, we offer you our co-operation.



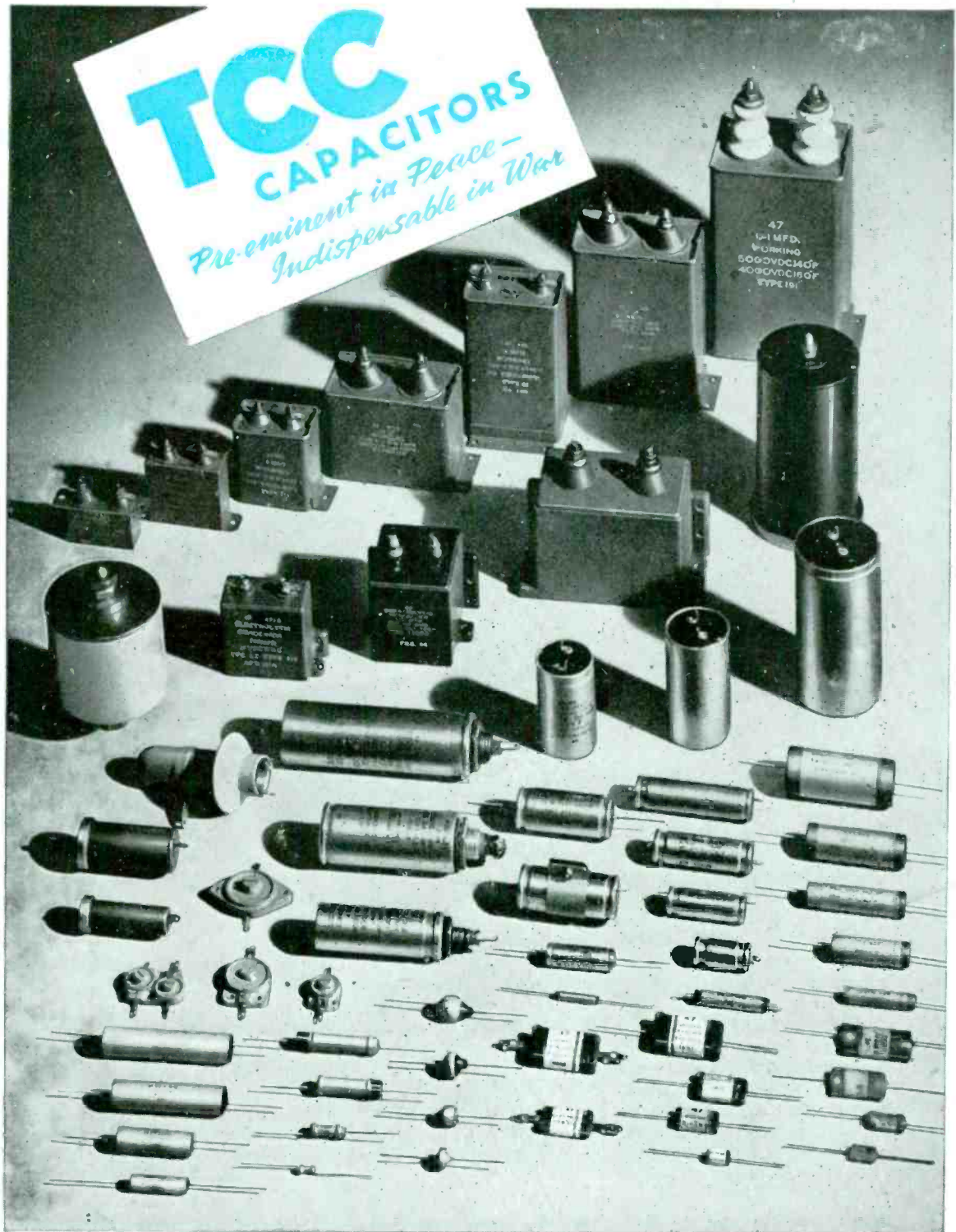

ADVERTISEMENT OF THE TELEGRAPH CONDENSER CO. LTD.