

Wireless World

RADIO • ELECTRONICS • ELECTRO-ACOUSTICS

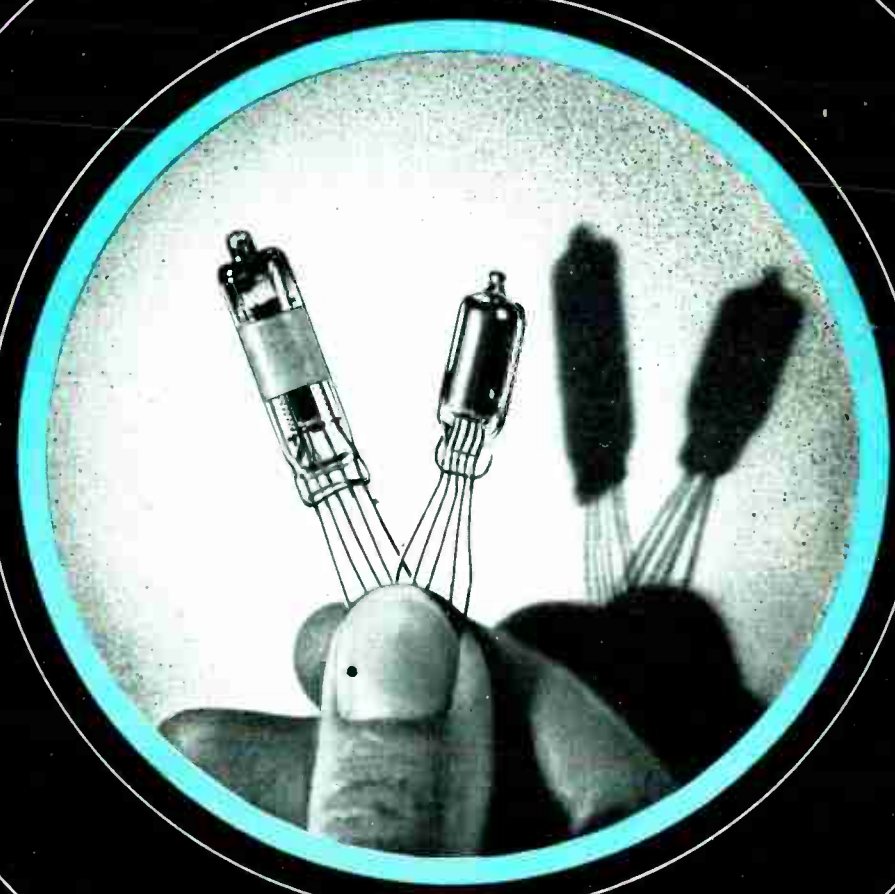

MAY 1944

1/6

Vol. L. No. 5

IN THIS
ISSUE :

DESIGN
FOR A

UNIVERSAL MEASURING INSTRUMENT

PRIMER ON RUBBER BONDING

NUMBER

4

IN SERIES

THIRD EXAMPLE

As originally planned -

... but upon submission to us we found stress-concentrations at metal corners and resulting from drilled holes projecting into rubber.

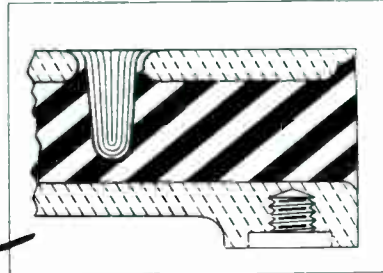
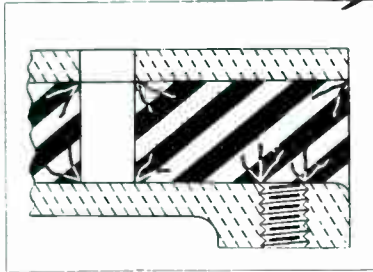

As modified -

... all sharp metal edges removed, also plain drilled holes altered to smooth cored holes, and tapped holes shortened to prevent cutting into rubber.

FOURTH EXAMPLE

As submitted to us -

... stress-concentrations at sharp corners; centre metal block difficult to locate accurately in mould.

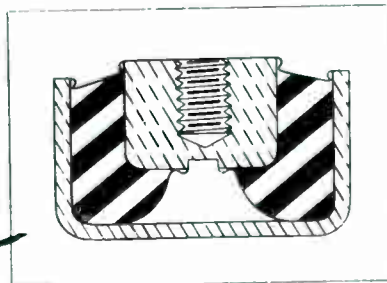
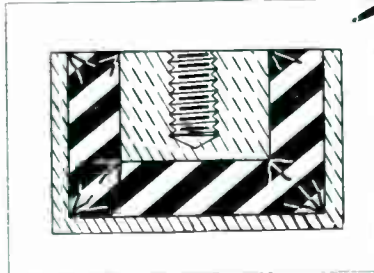

As modified -

... stress-reducing "beads" and radii added; also adequate means of locating metal part.

14.10.21



RUBBER BONDERS LTD.

ENGINEERS IN RUBBER BONDED TO METAL
FLEXILANT WORKS · DUNSTABLE · BEDS.

AVO

REC'D. TRADE MARK

MODEL 7
UNIVERSAL
AvoMeter

MODEL 40
UNIVERSAL
AvoMeter

THE AVO
TEST
BRIDGE

THE "AVO"
VALVE TESTER

THE
ALL WAVE
"AVO" OSCILLATOR

THE world-wide use of "AVO" Electrical Testing Instruments is striking testimony to their outstanding versatility, precision and reliability. In every sphere of electrical test work, on active service and in industry, they are maintaining the "AVO" reputation for dependable accuracy, which is often used as a standard by which other instruments are judged.

Orders can only be accepted which bear a Government Contract Number and Priority Rating.

THE AUTOMATIC COIL WINDER & ELECTRICAL EQUIPMENT CO., LTD.
WINDER HOUSE · DOUGLAS STREET · LONDON · S.W.1. TELEPHONE: VICTORIA 3404/7



WHY ERSIN MULTICORE

the Solder wire with 3 cores of non-corrosive ERSIN FLUX is preferred by the majority of firms manufacturing the best radio and electrical equipment under Government Contracts.



WHY THEY USE CORED SOLDER

Cored solder is in the form of a wire or tube containing one or more cores of flux. Its principal advantages over stick solder and a separate flux are:

- (a) It obviates need for separate fluxing
- (b) If the correct proportion of flux is contained in cored solder wire the correct amount is automatically applied to the joint when the solder wire is melted. This is important in wartime when unskilled labour is employed.

WHY THEY PREFER MULTICORE SOLDER. 3 Cores—Easier Melting

Multicore Solder wire contains 3 cores of flux to ensure flux continuity. In Multicore there is always sufficient proportion of flux to solder. If only two cores were filled with flux, satisfactory joints are obtained. In practice, the care with which Multicore Solder is made means that there are always 3 cores of flux evenly distributed over the cross section of the solder,

so making thinner solder walls than single cored solder, thus giving more rapid melting and speeding up soldering.

ERSIN FLUX

For soldering radio and electrical equipment non-corrosive flux should be employed. For this reason either pure resin is specified by Government Departments as the flux to be used, or the flux residue must be pure resin. Resin is a comparatively non-active flux and gives poor results on oxidised, dirty or "difficult" surfaces such as nickel. The flux in the cores of Multicore is "Ersin"—a pure, high-grade resin subjected to chemical process to increase its fluxing action without impairing its non-corrosive and protective properties. The activating agent added by this process is dissipated during the soldering operation and the flux residue is pure resin. Ersin Multicore Solder is approved by A.I.D., G.P.O., and other Ministries where resin cored solder is specified.

PRACTICAL SOLDERING TEST OF FLUXES

The illustration shows the result of a practical test made using nickel-plated spade tags and bare copper braid. The parts were heated in air to 250° C, and to identical specimens were applied 1/2" lengths of 14 S.W.G. 40/60 solder. To

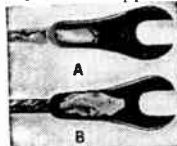

sample A, single cored solder with resin flux was applied. The solder fused only at point of contact without spreading. A dry joint resulted, having poor mechanical strength and high electrical resistance. To sample B, Ersin Multicore Solder was applied, and the solder spread evenly over both nickel and copper surfaces, giving a sound mechanical and electrical joint.

ECONOMY OF USING ERSIN MULTICORE SOLDER

The initial cost of Ersin Multicore Solder per lb. or per cwt. when compared with stick solder is greater. Ordinary solder involves only melting and casting, whereas high chemical skill is required for the manufacture of the Ersin flux and engineering skill for the Multicore Solder incorporating the 3 cores of Ersin Flux. However, for the majority of soldering processes in electrical and radio equipment Multicore Solder will

show a considerable saving in cost, both in material and labour time, as compared either with stick solder or single cored solder. Cored solder ensures that the solder and flux are put just where they are required, and by choice of suitable gauge, economy in use of material is obtained. The quick wetting of the Ersin flux as compared with resin flux in single core resin solder ensures that with the correct temperature and reasonably clean surface, immediate alloying will be obtained, and no portions of solder will drop off the job and be wasted. Even an unskilled worker, provided with irons of correct temperature, is able to use every inch of Multicore Solder without waste.

ALLOYS

Soft solders are made in various alloys of tin and lead, the tin content usually being specified first, i.e. 40/60 alloy means an alloy containing 40% tin and 60% lead. The need for conserving tin has led the Government to restrict the proportion of tin in solders of all kinds. Thus, the highest tin content permitted for Government contracts without a special licence is 45/55 alloy. The radio and electrical industry previously used large quantities of 60/40 alloy, and lowering of tin content has meant that the melting point of the solder has risen. The chart below gives approximate melting points and recommended bit temperatures.

ALLOY Tin Lead	Equivalent B.S. Grade	Solidus C.°	Liquidus C.°	Recommended bit Temperature C.°
45/55	M	183°	227°	267°
40/60	C	183°	238°	278°
30/70	D	183°	257°	297°
18.5/81.5	N	187°	277°	317°

VIRGIN METALS—ANTIMONY FREE

The wider use of zinc plated components in radio and electrical equipment has made it advantageous to use solder which is antimony free, and thus Multicore Solder is now made from virgin metals to B.S. Specification 219/1942 but without the antimony content.

IMPORTANCE OF CORRECT GAUGE

Ersin Multicore Solder Wire is made in gauges from 10 S.W.G. (.128"—3.251 m/ms) to 22 S.W.G. (.028"—.711 m/ms). The choice of a suitable gauge for the majority of the soldering undertaken by a manufacturer results in considerable saving. Many firms previously using 14 S.W.G. have found they can save approximately 33 1/3%, or even more by using 16 S.W.G. The table gives the approximate lengths per lb. in feet of Ersin Multicore Solder in a representative alloy, 40/60.

S.W.G.	10	13	14	16	18	22
Feet per lb.	23	44.5	58.9	92.1	163.5	481

CORRECT SOLDERING TECHNIQUE

Ersin Multicore Solder Wire should be applied simultaneously with the iron, to the component. By this means maximum efficiency will be obtained from the Ersin flux contained in the 3 cores of the Ersin Multicore Solder Wire. It should only be applied direct to the iron to tin it. The iron should not be used as a means of carrying the solder to the joints. When possible, the solder wire should be applied to the component and the bit placed on top, the solder should not be "pushed in" to the side of the bit.



Firms not yet using ERSIN Multicore Solder are invited to write for fuller technical information and samples.

MULTICORE SOLDERS LTD., Commonwealth House, New Oxford St., W.C.1. CHAN 5171/2.

F.W.S.CO.

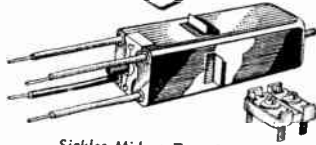

Sickles Midget Transformer and Trimmer.

WORLD'S LARGEST RADIO COIL MANUFACTURERS

- RADIO FREQUENCY INDUCTORS
- INTERMEDIATE FREQUENCY TRANSFORMERS
- RADIO FREQUENCY COIL CHOKES
- MICA COMPRESSION CONDENSERS
- AIR DIELECTRIC CONDENSERS
- MICA MOULDED CONDENSERS
- SICKLES SILVER CAP CONDENSERS
- GANGED PERMEABILITY TUNING COMMUNICATIONS EQUIPMENT
- F.M. EQUIPMENT PARTS
- U.H.F. RADIO EQUIPMENT
- SPECIAL ELECTRONIC EQUIPMENT



The F. W. SICKLES Co.
CHICOPEE, MASS., U.S.A.

RAYTHEON



RAYTHEON "FLAT" HEARING AID TUBES

THEY'RE tiny, but mighty when it comes to dependable hearing aid performance. And mighty popular, too, because of their long life and low battery drain. That's why RAYTHEON flat hearing aid tubes are standard equipment in leading electronic hearing aids. Through continuous growth over these past 5 years Raytheon has become the world's largest supplier of hearing aid tubes.

WORLD'S LARGEST EXCLUSIVE TUBE MANUFACTURERS

RAYTHEON

PRODUCTION CORPORATION
NEWTON, MASS., U.S.A.

P. R. MALLORY & CO. Inc.
MALLORY VIBRATORS

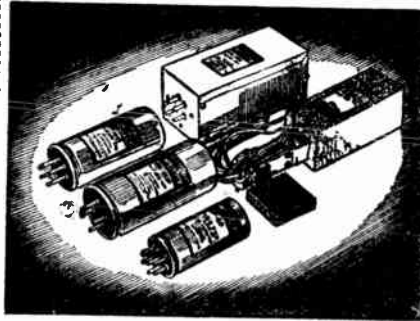

IDEAS WILL POP FOR YOU

IN the crucible that is war production, ideas pop into reality in bewildering numbers. Co-operative progress in techniques in chemical, metallurgical and electrical applications of materials, has contributed astounding gains to man's control over Nature's resources. Comparatively few can have more than a vague notion of industrial accomplishment for the war effort. But the discoveries that have mechanised warfare and conquered the air, that have developed transportation and supplies to marvellous wartime results, represent ideas that will pop into an amazing variety of commercial contributions to post-war living standards.

P. R. MALLORY & CO. INC.
INDIANAPOLIS, INDIANA,
U.S.A.

Radio and Electronics Division

- ALSO
- "MYKROY" CERAMIC INSULATING MATERIALS
 - "IDEAL" RECHARGEABLE CELLS AND CHARGERS
 - GENERAL ELECTRONIC VACUUM CONDENSERS

FOR THE FUTURE

These Manufacturers will help solve your post-war problems. Register your name now for full details which will be sent you when supply conditions again permit.

FRANK HEAVER LIMITED

Kingsley Road, BIDEFORD,
N. Devon

G.I.

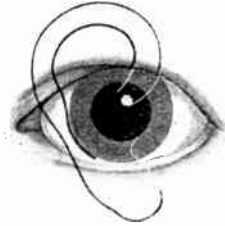

THE SEEING EAR

SYMBOLIC of modern electronic equipment—these human senses amplified and extended to limitless range . . . through fog and smoke . . . beyond the limits of normal sight and hearing . . . our fighting forces now SEE and HEAR at distances and under conditions that amaze the uninitiated. Such are the remarkable accomplishments of a war-inspired American Electronic Industry. Censorship shrouds the Seeing Ear in secrecy, but . . . in to-morrow's day of peacetime production G.I. will adapt its share of Seeing Ear developments to new products and to modernisation of its pre-war products. Many of these new ideas will have direct applications in our Record Changers—Variable Condensers—Push Button Tuners—and other products.

THE GENERAL INSTRUMENT CORPORATION
ELIZABETH, N.J., U.S.A.



TWO-WAY radio communication systems, like the plastic-cased beauty illustrated, are one of the new developments leading industrial designers are thinking of to speed the work of a busy post-war world. Applications of this compact, plastic-cased 'walkie-talkie' are almost unlimited. Naturally, this is only one of thousands of uses plastics will be put to after the war, but it will serve to remind you that post-war planning is being done . . . Kurz-Kasch designers, engineers, tool-makers and moulders . . . specialists for a generation in plastic planning and moulding will help you with your problems.



KURZ-KASCH INC.
Planners and Moulders for the Age of Plastics
DAYTON · OHIO · U.S.A.



Their hobby is radio too . . .

These are the leaders of science and communications. They are professionals in what has become a most vital element of modern civilization . . . radio communications and the science of electronics. Some of them wear the uniforms of top ranking military officers because we are engaged in war. Others remain civilians as doctors of science . . . the leaders of radio, electronic and electrical industries which are amazing the world through their achievements. Achievements which not only aid in war but which are creating the new era of industry to follow. They are the great men of today . . . they will be still greater tomorrow . . . and they are radio amateurs.

Eimac valves are leaders too. First choice of these leading engineers . . . first in the new developments in radio. They are first with radio amateurs too, which is no coincidence

Follow the leaders to

Eimac
RELIABLE FACTORY
VALVES

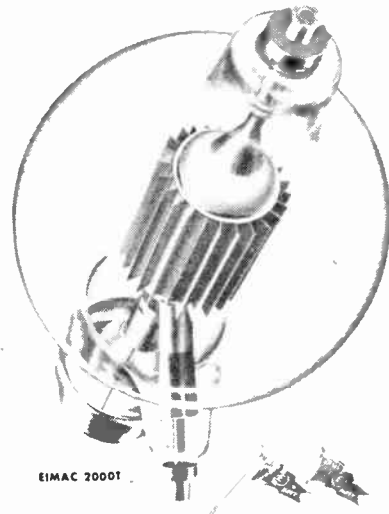

EIMAC 200D1

EITEL-McCULLOUGH, INC., 794 San Mateo Ave., SAN BRUNO, CALIF. • Plants located at San Bruno, California and Salt Lake City, Utah.
 Export Agents: **FRAZAR & HANSEN** • 301 Clay Street • San Francisco, California, U. S. A

As like as

PEAS IN A POD

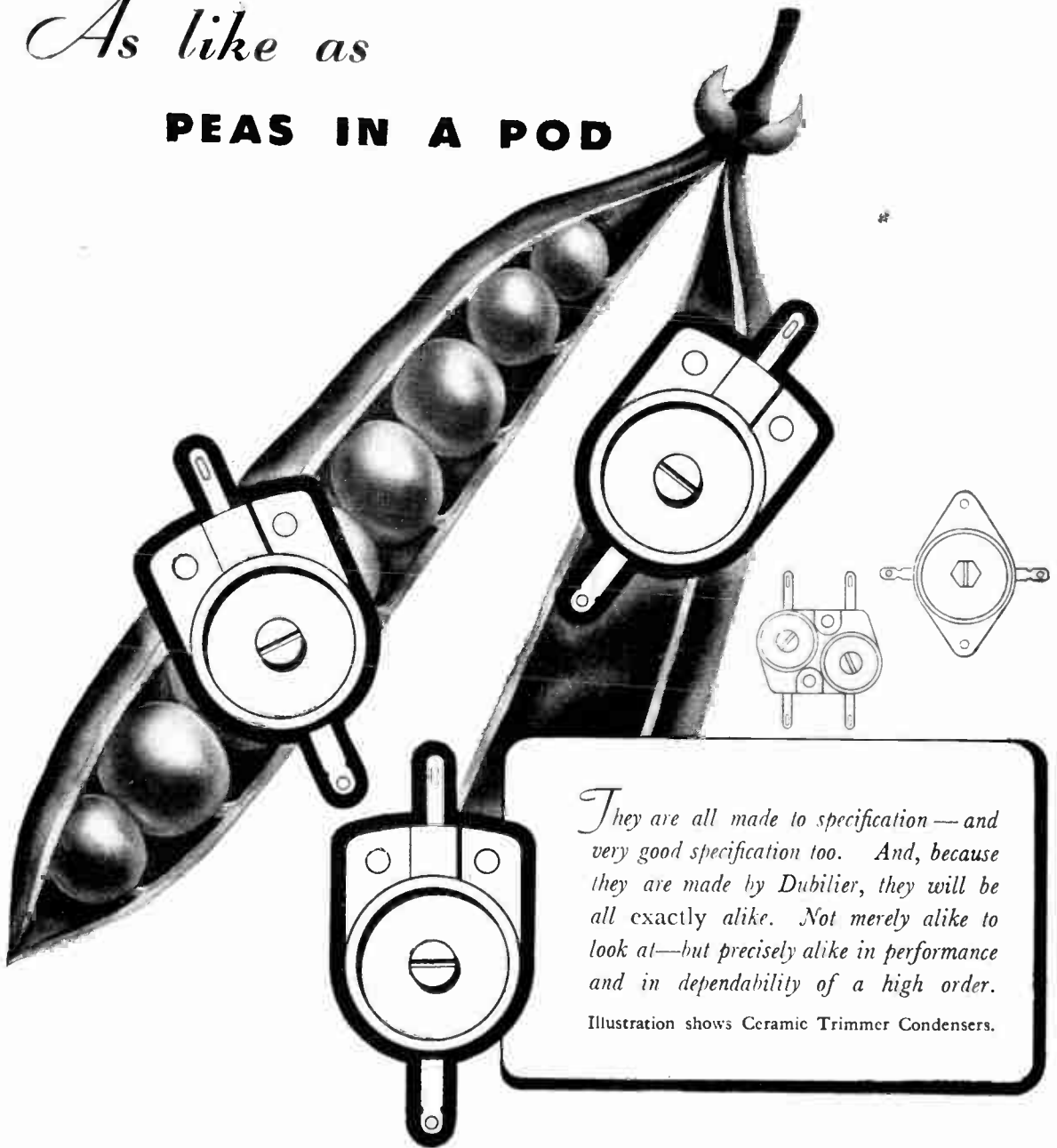

They are all made to specification—and very good specification too. And, because they are made by Dubilier, they will be all exactly alike. Not merely alike to look at—but precisely alike in performance and in dependability of a high order.

Illustration shows Ceramic Trimmer Condensers.

DUBILIER

CONDENSER CO. (1925) LTD.

CONSISTENTLY GOOD



C. R. Casson

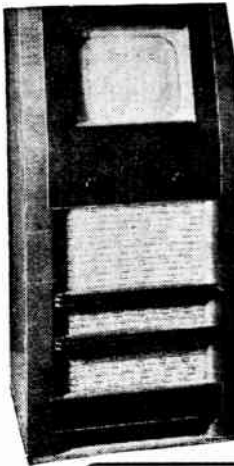

BAIRD TELEVISION RECEIVERS MODEL T 26

A New Purchase!

Every receiver is in perfect working order. Cabinet dimensions 3ft. 4in. high, 20in. wide, 17in. deep. Picture screen size 10in. by 8in. Pick-up sockets are fitted enabling it to be used as a Gramophone Amplifier. Extra loudspeaker sockets. 14 valves.

Simple to operate. Only two main controls, one for picture contrast and the other for sound broadcast.

PRICE
£32.10.0

Purchaser to make arrangements for collection.

MOTOR GENERATORS. TWO ONLY. A.C. motor 1.7 h.p., 440v., 1,500/1,446 R.P.M., 50 cycles, 2.7 amps. continuous rating. 3-Phase motors by Newton Bros. Direct coupled to generator 400/650v., 1 kw., 1.54 amps. continuous rating. Pillar type starter with Rotary Transformer by Electrical Apparatus Co., Ltd. **£33 10s.** each. Call and inspect.



MAINS TRANSFORMERS
A special line of newly manufactured British transformers. 300-0-300 v. at 80 m.a., 6.3 v. 3a., 5v. 2a size **37/6**
Post & pack, 1/3 extra.

MANSBRIDGE Type Metal-Cased CONDENSERS 350V. WORKING

2 mfd., 4 x 1 x 1 1/2 in.	2/6
2 mfd., 2 1/2 x 1 x 1 1/2 in.	2/6
.02 mfd., 4 1/2 x 1 1/2 x 1 1/2 in.	1/6
500-v. W.K.G. 2 mfd., 2 1/2 x 2 x 1 1/2 in.	5/6
2 mfd., 4 x 1 1/2 x 2 in.	4/6

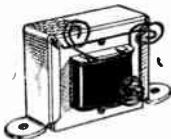

PENTODE OUTPUT TRANSFORMERS
Well-made and efficient. Suitable for Small Speakers. Size 1 1/2 x 1 1/2 x 1 1/2 ins. **7/-**

P.A. AMPLIFIERS

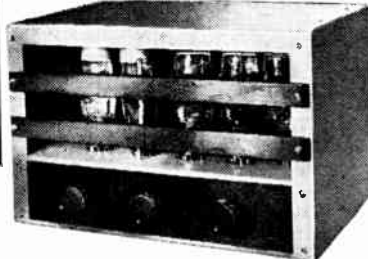

LIMITED QUANTITY ONLY

Output 15 watts, 6 valves, 200-250 A.C. Pre-Amplifier for microphone, gramophone and radio terminals. Multi-range output, 2.5 ohms to 15 ohms. Fitted two volume controls and tone control. In metal cabinet as illustrated. Price, Carr. paid **£18.10.0**

"MUTER" PUSH BUTTON UNITS

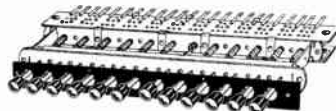

12-Button Unit. Complete with buttons and escutcheon, as illustrated, **8/6**. 8-Button Unit, with mains switch rated 125v. at 3 amp. and 250v. at 1 amp. Complete with knobs but no escutcheon **5/6**

Our goods being surplus to manufacturers' requirements cannot be repeated when stocks are sold.

See April 27 Advt. for RELAYS, etc.

★ No lists issued. As all goods are described as fully as possible we cannot reply to requests for further details.

LONDON CENTRAL RADIO

Miscellaneous Offers:

VITREOUS ENAMELLED RESISTORS. 10,000 ohms 10 watts. **3/6**.

WIRE WOUND POTENTIOMETERS. 50,000 ohms. Less switch. **5/6**.

LOUDSPEAKERS. Celestion 8in., with transformer, **29/6**. Goodmans P.M. without transformers: 6in., **21/-**; 8in., **30/-**; Post and pack., 1/6 each extra.

OAK SWITCHES. 2 1/2 in. spindle, complete with knob. 4-way, 2-bank with connecting block, **4/-**; 4-way, 2-bank, **3/3**.

EXTENSION SPEAKERS. Brand new, first-class P.M., in beautifully polished cabinets, **52/6**. In Rexine covered cabinets, **50/-**.

PLATINUM CONTACTS. Double Spring, mounted on ebonite, **1/6**.

CHASSIS drilled for 4 valves only. 10 1/2 x 7 1/2 x 3 in. (ends and sides). Grey finish, **5/-**.

CONDENSERS. First-class 0.1 mfd., oil-filled, 5,000 v., working, only **11/6** each.

TWIN SCREENED PICK-UP LEADS, fitted 2 plugs, 8ft. 6in. long, **2/9**.

ELECTRO-MAGNETIC COUNTERS. Ex-G.P.O. every one perfect, electro-magnetic, 500 ohm coil, counting to 9,999, operated from 25 v. 50 v. D.C., many industrial and domestic applications, **6/-**.

SCANNING AND DEFLECTOR COILS. Ex-television receivers, assembled complete in metal frame, **7/6**.

ELECTRIC SOLDERING IRONS. 200-250 v., 65/75 w., **12/6**.

2-GANG SUPERHET VARIABLE CONDENSERS, 0.005 mfd., with trimmers, **8/6**.

BRASS ROD. Screwed brass rod, 2 B.A., 4 B.A., and 6 B.A., 12in. lengths, useful for many purposes, **5/6** doz. lengths.

VALVE-HOLDERS, brand new, Mazda octal, 1/-; **VALVE-HOLDERS.** Paxolin, 5-, 7-, and 9-pin, 7d. each, **8/-** doz.

REACTION CONDENSERS. Fine quality job, 0.0003 mfd., to clear at 2/3 each.

TUBULARS. Wire-end tubular condensers, 0.1 and 0.01 mfd., 350 v. working, **1/-**.

T.C.C. TUBULAR CONDENSERS, 0.1 mfd., 6,000 v. D.C. test, **5/9**; 0.04 mfd., 350 v., **2/-**.

T.C.C. CONDENSERS in metal cases, special offer, much reduced to clear, 4 x 4 mfd., 70 v. working, **2/6** each.

EX-GOVT. PLUGS AND JACKS, as previously advertised, **5/9**.

EX-G.P.O. PLUGS, 1/9. **METAL SCREENED ANODE VALVE-CAPS,** with short screened lead, **9d**.

RED BAKELITE ANODE CAPS, 1/-. **HEAVY METAL SCREENED CABLE.** Single, **1/-**. Twin, **1/6** per yd.

TRIMMERS. Postage stamp 40 PF., **6d**. Twin 40+40 PF., **1/-**.

FLEXIBLE DRIVES. Ideal for remote control in radiograms, etc., approx. 2ft. lengths, **4/3**.

VALVES. EA50, Mullards, to clear, **10/6** each.

CERAMIC VALVE-HOLDERS, brand new, low loss, 7-pin, **1/5** each.

GERrard
2969

LONDON CENTRAL RADIO STORES

GERrard
2969

23, LISLE ST.,

LONDON, W.C.2

M·O·R·S·E

COMPLETE PRACTICE UNIT

as supplied to many branches of H.M. Services

No. 1961. Complete Morse Practice Unit. Heavy commercial Key with nickel silver contacts and sensitive triple adjustment. High-tone Buzzer with silver contacts, mounted on bakelite base with cover. Battery Holder, complete with 4.5 Ever

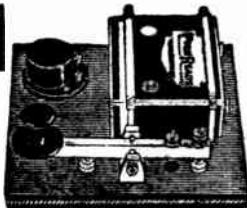

Ready battery. All metal parts heavily nickel plated, and the whole mtd. on polished Mahogany Base, 6 1/2 in. x 6 1/2 in. Price **29/6**

Send 1d. stamp for illustrated List
SIGNALLING EQUIPMENT LTD. (Dept. 8)
Merit House, Southgate Road, Potters Bar. 'Phone: Potters Bar 3133

WALTER CONDENSERS ARE MADE FOR



WALTER INSTRUMENTS LTD.

Earls Court Exhibition Buildings, Earls Court, London, S.W. 5

FULHAM 6192



German war industry pounded again

The raid is on industrial Germany, many miles away. Timed to perfection, groups of bombers from different bases converge on the target. Radio and radio-devices play an all-important part in these missions. Yet, despite priority requirements, good supplies of Mazda Valves are being made available to the listening public. Ask your Dealer for details of types available.

MAZDA

RADIO VALVES

THE EDISON SWAN ELECTRIC CO. LTD.,  155, CHARING CROSS RD., LONDON, W.C.2.
(R.M. 16)

WHAT IS MEASUREMENT?

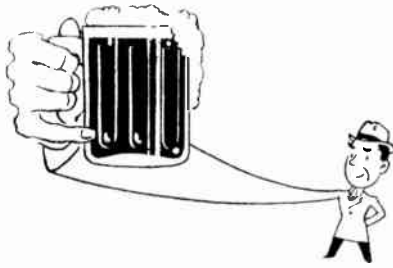

You can see a "pint." You can measure it quite easily (yes, we know what you would rather do with it). You can't see volts, not even if there are "a lot of 'em"—but you can measure them.

FOR ACCURATE MEASUREMENT USE ACCURATE INSTRUMENTS



M.I.P. Instruments have earned a world-wide reputation for precise and accurate performance. When installing electrical instruments, remember that it always pays to have the best. Specify M.I.P. They represent the recognised standard in dependability and long service.

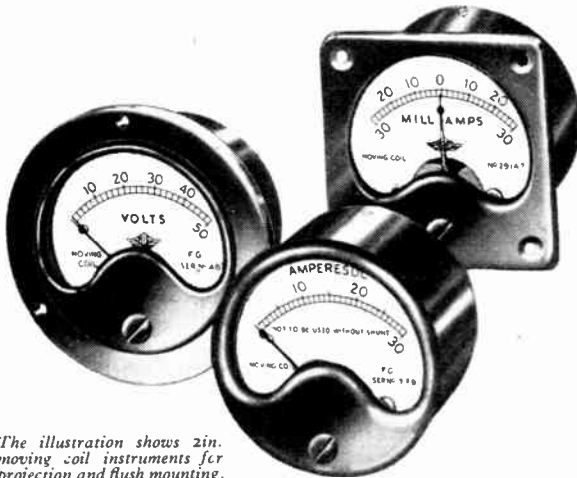

The illustration shows zinc moving coil instruments for projection and flush mounting.

MEASURING INSTRUMENTS (PULLIN) LTD.,
Electrin Works, Winchester Street, Acton, W.3

M.R. SUPPLIES

have the following first-class and brand new **ELECTRICAL AND INDUSTRIAL EQUIPMENT** in stock and available for collection or immediate delivery. All prices nett cash. Early application advised.

MOBILE AMPLIFIERS (by prominent maker) for 6 12 volt operation. Output full 10-watts. Inputs for microphone and pick-up with fade-over controls. Outputs for 7.5 and 15 ohms speakers. Sturdily built in fine solid oak carrying cabinet 19in. by 15in. by 11in., weight 5lb 10s. A highly efficient circuit employing five Osram valves and Vibrator. Supplied with all valves, Hand Microphone, 20 feet of heavy cable with microphone plug, all plugs and fuses, ready for use, price **£30** ex this address. (We have 15 only and advise an early call.)

G.E.C. CURRENT-FED MICROPHONES. Require no amplifier work directly from 12-volt accumulator. Supplied with appropriate transformer for matching to 15-ohms speaker. The trouble-free system for instant and concise announcements, as used by police, on board ship and for A.R.P., etc. Complete **£9 17 6**. Last few.

ROTHERMEL-BRUSH PIEZO-CRYSTAL MICROPHONES. Again available for immediate delivery! The new bijou model in black bakelite, 2 1/2in. dia., with plated mounting base (tapped standard 1/4in. thread, fitted with 6ft. screened lead. Level response and high output and fully recommended. **42 -**. Suitable **TABLE STANDS**, chrom., extending. **25 -**. **FLOOR STANDS**, chrom., portable, ext. to 5ft. 6in., with "easy-mount" adaptor, **45 6**.

MINIATURE PIEZO-CRYSTAL MICROPHONES (Rothermel-Brush). Only 1 1/2in. dia., and capable of very fine performance. In aluminium housing with short lead but no front grille. Ideal for deaf-aid, guitar or piano repeater and laboratory use, **29 6**.

G.E.C. PROJECTOR P.A. SPEAKERS with P.M. M Coil 15-ohms Projector Unit and 42in. round All-metal Horn, handling 10-watts. (Unit has built-in multi-line transformer). Complete **£10 5 -** (carr. 7 6). Also a few **10-watt CABINET SPEAKERS** with 10-inch P.M. Unit fitted all-matching trans. Massive polished oak cabinet measures 16in. by 15in. by 9in. **£6 10 -**. (We cannot despatch these.)

CENTRALAB "T" PAD FADERS for Sound Projection (or other) control. For 500, 200 and 50 ohms lines (3 models) controlling three channels. (Pre-war list price 41). Limited number at only **42 6** each. Diagram with each.

ROTHERMEL PIEZO-CRYSTAL PICK-UPS. Further small delivery now to hand. Black bakelite (Senior) model, **78 9**.

SLIDING RESISTANCES. 100-watts, fully enclosed, 6 1/2in. long. Following range now in stock: 100-ohms 1 amp, 200-ohms 0.7 amp, and 400-ohms 0.5 amp, any one **25 -**. Also a few 450-watt, 6,000-ohms 0.25 amp., **65 -**.

TOGGLE PRESSES (S.T.T.). Double-acting, precise tool suitable for all small pressing operations in many trades. Pressure 1 1/2 tons, weight 150 lbs. Delivery from stock against Government number only, **£30** nett, ex this address.

TRANSFORMER BOBBINS, solving the re-wind problem. Standard for most commercial receivers. Prim. tapped 200 240 v. Secs.: 350-0-350 v. 75 ma., 4v., 4v., 4v., 3a., core opening 1 1/2in. sq., and 1 1/2in. through, **18 6**. Also with 0.5v., 4a. and 5v., 3a., same price.

"PYROBIT" ELECTRIC SOLDERING IRONS, 230 250 v. "Instrument" model for small work. Only 9 1/2in. long, with efficient radiation for hand comfort, with pencil bit, **21 -**. Extra adjustable angle bit, if required, **4 6**.

"PYROBIT" NEON TESTERS, with screwdriver, 100 750 v. A.C. D.C. **9 6**.

LONDEX RELAYS, 230 v. A.C. coil and 3-pole C.T.O. 6-amp. H.T. switching, **42 6**. Also with 6v. D.C. coil and 2-pole break 3-amp., **7 6**.

GOODMAN 3-inch P.M. M COIL MICROPHONE SPEAKER UNITS. High efficiency model with weighty alnico magnet, imp. 12-ohms, **30 -**.

Please include sufficient for packing/postage.

M.R. SUPPLIES, 68, New Oxford Street, London, W.C.1
(Telephone: MUSeum 2958)

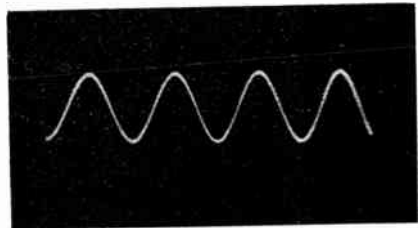

B.S.R. STANDARD SINE WAVE SOURCES TYPE LO.800A. OSCILLATOR

—an actual oscillogram of output voltage is illustrated—gives good waveform even below 10 c.p.s. This necessitates a minimum "pull-in" between the two H.F. oscillators. Superlative design results in an almost perfect waveform from the lowest to highest frequencies. The output voltage is constant to within a few per cent. over the frequency range. This Model is chosen as a Standard by most Departments. Stable, reliable. Indispensable to all serious workers.

Output up to 5 watts. Three range output voltmeter incorporated—0-250, 0-50, 0-10. Four output impedances, 5000, 1000, 600 and 15 ohms. Frequency ranges (3 models), 0-15000, 0-25000 and 0-50000 c.p.s.



BIRMINGHAM SOUND REPRODUCERS LTD.,
Clarendon Works, Old Hill, Staffs.
Cradley Heath 6212/3. Grams: Electronic, Old Hill



ELECTRO-MEDICAL
EQUIPMENT

DRAWING OFFICE
EQUIPMENT

H.F. ELECTRIC
FURNACES

SPECTROGRAPH
ANALYSIS EQUIPMENT

Interference created by above is suppressed by H.F. mains filters and screened rooms.
We supply screened rooms of any dimensions and H.F. mains filters 15 and 300 amperes maximum loadings.

AERIAL SYSTEMS
DESIGNED & INSTALLED

An Engineer with many years' experience in the work is available for consultation and practical assistance on all aspects of the subject of suppression on land or sea, either at the source of interference or at the receiver.

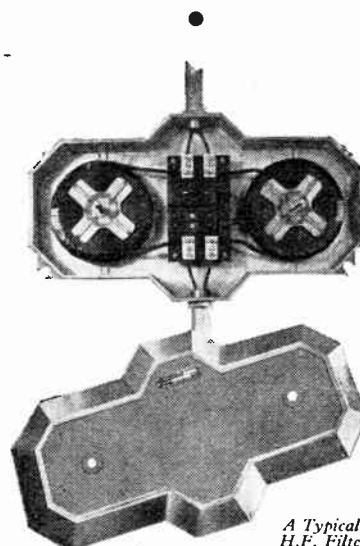

A Typical H.F. Filter

BELLING & LEE LTD
CAMBRIDGE ARTERIAL ROAD, ENFIELD, MIDDX

GA



GOODMANS
New **T 2-12"**
LOUDSPEAKER

for the **SERVICES***
 and all **PUBLIC ADDRESS PURPOSES**
 including **FACTORIES, WORKSHOPS,**
CANTEENS, ETC.

Goodmans **INDUSTRIES, LTD.**
LOUDSPEAKER & TELEPHONE ENGINEERS **WEMBLEY, MDX.**

TAYLOR VALVE TESTER



MODEL 45A

This new and improved Taylor Valve tester measures the Mutual Conductance of all types of amplifying valves and also checks the emission of Diodes and Rectifying valves. Two ranges of Mutual Conductance measurement are available being 3 mA/V full scale and 15 mA/V respectively. Anode and Screen Volts can be adjusted to suit the valve under test and a variable supply of Grid Volts is also available. A switch gives a choice of 17 different filament Volts covering from 1.1 Volts to 117 Volts. Sixteen valve holders are provided to cover all the popular British, American and Continental types. Separate tests are available for checking Continuity, Element Shorts and Heater to Cathode Leakage. The three selector switches ensure that the correct voltage is applied to every pin of the valve under test. A comprehensive book of instructions is issued with each instrument, complete with a valve chart giving settings for over 2,000 valves of all makes. The instrument is operated from A.C. Mains and a mains adjustment is provided covering from 200-250 Volts at 40-100 cycles.

Model 45A/S
 Price £15 . 15 0

Taylor
 electrical instruments

Please write for technical brochure.

Send your enquiries to
TAYLOR ELECTRICAL INSTRUMENTS LTD.,
 419-424 Montrose Avenue, Slough, Bucks.
 Telephone: Slough 21381 (4 lines) Groms: "Taylins, Slough"

When they have finished their vital war service



DAGENITE AND **PERTRIX**

—the dependable **BATTERIES** will again be available to all

FOR RADIO, CARS, MOTOR CYCLES, COMMERCIAL VEHICLES, AIRCRAFT, ETC.

Sales Concessionaires: **HOLSUN BATTERIES LTD.**
 137 Victoria Street, London, S.W.1.

D10b

◆ LINAGLOW LIMITED ◆

“LIBERTY SIX”

SIX-VALVE SUPERHET CONSTRUCTORS KIT

ALL-WAVE 16-50m., 200-560m., 1,000-2,000m.

Brief Specification: Frequency changer with two valves, separate oscillator, Six Tuned Circuit, 465 KC. Iron cored I.F.s. Separate tone and volume, 5-watt output, 8" P.M. speaker with baffle and output transformer, supplied with all valves, chassis, Practical and Theoretical wiring diagram and Parts Lists, Nuts, Bolts and Wire, ready to assemble, 200/250 volts A/C.

Carriage paid **£16 . 16 . 0** Including Purchase Tax

RADIO CHASSIS, 18-gauge steel, cellulosed grey, fitted 4 octal valve holders, grommets, with 20 colour coded resistors. Dimensions: 11 x 7 1/2 x 1 1/2, 15/- . Also similar but fitted mains socket and three 4-pin valveholders, grommets, drilled ready to take transformers, chokes, etc. Dimensions: 14 x 10 1/2 x 1 1/2, 17/6.

VALVE HOLDERS—AMPHENOL TYPE. International or Mazda Octal, chassis mounting, 1/-.

TUBULAR STEEL FRAMES. Cadmium plated for radio chassis mounting and many other purposes, drilled ready for use—18in. high x 14in. wide, very useful for aerial frame in Radio Laboratory, 7/6 the pair.

SUPERIOR QUALITY KNOBS, ex television, suitable for radio. For 1/2in. spindles with grub screw. 1 1/2in., 1/8; 1in., 1/3; 3/4in., 9d.

TUBULAR PAPER CONDENSERS. 350-500 v., D.C. working, .0001, .0003 mfd., 4/- doz.; .001, .004 mfd., 6/- doz.; .01 mfd., 7/- doz.; .05 mfd., 9/- doz.; .1 mfd., 12/- doz.; .23, .5 mfd., 15/- doz.; or assorted parcel of 50 for 27/6. Minimum orders, 1 doz. any type.

SILVER MICA CONDENSERS. Flat wire-end. Assorted values, 17/6 per 100.

UNIVERSAL RAZOR RESISTANCE. Suitable for practically every type of electric Razor, drops voltage from 200/250 to 100/110 v. Supplied in safety metal cage with asbestos lining. Specification: 1,500 ohms with adjustable slider, 10/6.

VOLUME CONTROLS. 1,000, 5,000, 10,000, 20,000, 25,000, 50,000, 100,000-ohm; 1/2, 1, 1 and 2 megohm, without switch, 4/8 each. As above, with switch, 6/9. **WIRE WOUND**, best American, New ex television, 2,000 and 10,000 ohms, 5/- each.

WIRE END CARBON RESISTORS. New, ex television chassis, 1/2, 1 and 2-watt. Assorted parcel of 100, 35/-.

CABINET STAYS SELF-LOCKING, best Bronze finish, 5/- each.

3-gang .0003 VARIABLE CONDENSERS, with geared slow-motion ball drive, pointer and dial frame. Ceramic insulation, 14/6.

12in. AUDITORIUM P.M. LOUDSPEAKER CHASSIS. Ticonal magnet, 10 ohms, 12/15 watts. Exceptionally sturdy construction, 27.15.6 each.

6 ASSORTED VOLUME AND TONE CONTROLS, with and without switch, 19/6.

P.A. AMPLIFIERS

Suitable for Factory Installation

— Immediate Delivery —

30-WATT P.A. AMPLIFIER. A high quality Amplifier, using finest components and Red "E" Valves. Circuit: High Resistance input feed through two separate input sockets or through pre-amplifier socket into two series connected valves with tone and volume control followed by twin valve acting as Amplifier and Phase Inverter, feeding into two High Wattage Output Pentodes connected in negative feed back. Class A B Circuit: 200/240 volts A.C. Chassis, finished in dark grey. 16-gauge steel. Brand new pre-war manufacture. Amplifier is fitted with Multi-Ratio output Transformer to take from one to forty-four 5,000 ohm speakers, also 15 ohm speakers and 600 ohm line. Separate Standby Switch. Amplifier with valves suitable for gram. microphone and radio inputs. Price **£35 10 0**

PORTABLE P.A. AMPLIFIER. Specification: 4-valve Amplifier Unit in metal case, microphone, one speaker, all cables, contained all in one cabinet and collapsible type tripod floor stand, AC/DC 200/250 v. 5 watt maximum, suitable for hall averaging 600 people. Input jack provided, transverse current carbon type microphone, separate volume controls for microphone and gramophone input. Variable tone control. **29 Gns.**

PORTABLE P.A. AMPLIFIER. Specification: 5-valve Amplifier Unit, 2 speakers, microphone, all cables, all in one cabinet and collapsible type tripod floor stand, AC/DC 200/250 v., 8/10 watts, suitable for hall averaging 800 people. Input jack provided, ribbon type microphone chromium plated, separate volume controls for microphone, gramophone input. Variable tone control. **39 Gns.**

MICROPHONES. De Luxe Piezo Crystal microphones in chromium case. Specification: 60 D.B. below 1 volt. Frequency response 30/8,000 C.P.S. **6 Gns.**

As above—Standard model in bakelite case **3 Gns.**

2-tier Stands for above, 25/-.

HIGH FIDELITY MOVING COIL MICROPHONE. 25 ohm impedance, frequency response level 50-8,000 cycles. 78 DB below 1 v. **£5 15 0**

SCREENED INTERLACED FLEXIBLE MICROPHONE CABLE. Single. Special Offer, 9d. per yd. Twin 1/3 per yd. Super quality Twin, rubber insulated, 1/9 per yard.

LINE CORDS. 2-way 260 ohms, 8/6; 480 ohms, 11/-; 600 ohms, 12/9; 3-way heavy duty .3 amp., 380 ohms, 13/6; 480 ohms, 17/6; 600 ohms, 11/-.

3 1/2in. **GOODMAN P.M. LOUDSPEAKER.** Extra heavy magnet for Midgets and communication sets, 30/-.

MULLARD & MAZDA CATHODE RAY TUBES

7 in. **£3 10 0** 9 in. **£4 18 0**

HOLDER, for above, complete with mounting base, scanning and focusing unit with coil **47/6**

HIGH VOLTAGE TRANSFORMER, for above, 200/250 v., 4,000 v., 2 v. 2 amp. **47/6**

Line Scanning Output Transformer **12/6**

0.1 T.C.C. 4,000 v.w. Condensers for above. Brand new **8/6**

REPTIFRAYS FOR ABOVE, U4 at 11/-; U21 at 12/3

Flywood Frame and Rubber Mount for Cathode Ray Tube, also suitable for loudspeaker baffle, 7in. hole **7/6**

LOUDSPEAKER TRANSFORMERS. Push-Pull output tapped Primary and Secondary, 120 m.a., ratios 10:1, 5:1 and 3.5:1, 15/-; Multi-Ratio and Push-Pull transformer, ratios 30:1, 45:1, 60:1, 90:1 and P.P. class B, 75 m.a., 12/6. Heavy duty multi-ratio transformer, ratios 24:1, 41:1, 45:1, 68:1, 82:1, 116:1, 1.80 m.a., 15/6. Class "B" and Q.P.F., 75 m.a., 12/6.

MAINS TRANSFORMERS. 200/250, 350-0-350, 6.3 v. 3 amp., 5 v. 2 amp., 120 m.a. shrouded, 42/6; 300-0-300, 4 v. 6 amp., 4 v. 2 amp., 150 m.a., 42/-; 325-0-325, 4 v. 6 amp., 4 v. 2 amp., 2 v. 1.5 amp., 150 m.a., 45/-.

AUTO TRANSFORMERS. Step up or down 110/220/240 v., 100-watt, 35/-.

LOUDSPEAKERS. P.M. 3-ohm voice coil without transformer, 5in., 21/-; 8in., 25/6; 10in., 28/6. 10in. Mains Energised M.C. Speaker, 2,000 ohms field, 2.5 ohm speech coil, 32/6.

UNIVERSAL RESISTOR. Suitable for practically every type of American and British AC/DC Receiver. Supplied in safety cage with asbestos lining. Specification: 750 ohms, .3 amp., with four sliders for adjustable tapping, 12/6.

VALVES

AMERICAN TYPES AT B.O.T. CONTROLLED RETAIL PRICES. FOR REPLACEMENT PURPOSES ONLY.

12E, 12F5, 12SF5, 9/8; 1A5, 10S, 5Y3, 2X26, 35Z4, 11/-; 8Q7, 12Q7, 11/7; 6F6, 6K7, 12J7, 35L6, 12/10; 6A8, 6B8, 6E8, 6SA7, 12SA7, 14/-; 70L7, 8S, 15/2.

Also British Valves at Manufacturers' List Prices. AC/ME, 10/6; U4, U6, U7, 11/-; H141DD, TDD4, 11/7; AC/VP2, C14, EF39, KTW61, Pen 45, SP41, SP42, T41, VP41, 12/10; D1 Diode 1in. Peanut Valve with valve holder, 12/10; ECH5, FC13, X63, 14/-; AC6Fane EL35, Pen 46* U21, 18/2.

* Post Office Permit necessary.

All prices include Purchase Tax. Add 3d. per valve postage.

L.V. SMOOTHING CHOKES. Finest quality, 20, 40 and 60 henrys, 150 m.a., 16/9 each.

SWITCHES. D.P. 4-point push-pull, 9d.

FLAT FLEX. 9-way, 14/36, 18/20-ft. lengths, suitable for amplifiers, extension speakers, remote control and many other purposes. Finest quality pre-war manufacture, 7/8 per coil.

LOUDSPEAKER FRETS. Coppered brass, 8 1/2 x 7in., 3.6, 14 1/2 x 9 1/2in., 8/9.

SILK-COVERED BAFFLE BOARDS. 12 x 9in., 1/2in. ply 6 1/2in. hole, 4/6.

50-OHM CENTRE-TAPPED RESISTOR, tapped at 25 ohm for pilot lamps, 2/-.

ALUMINIUM VALVE CAPS. Special price 6d.

HUMDINGERS. 25,000 and 50,000 ohms, 6d. each.

◆ **CALLERS to Show Rooms,**
61 HIGHGATE HIGH ST., N.6.
 Phone: MOUntview 9432.

LINAGLOW LIMITED
 HOURS OF BUSINESS 9 a.m. to 5.30 p.m.
 Saturday, 9.30 a.m. to 12.30 p.m.

◆ **POST ORDERS to Dept. M.O.16**
3 HAMPSTEAD LANE, N.6.
CASH WITH ORDER ONLY.



Clear as a
Crystal

AND HERE IS THE REASON . .

. . . the answer has been found in Bullers Low Loss Ceramics to the problem of Dielectric Loss in High Frequency circuits.

Years of Laboratory research and development have brought these materials to a high degree of efficiency. To-day they are in constant use for transmission and reception, and play a vital part in maintaining communications under all conditions.



Made in
Three
Principal
Materials

FREQUELEX

An Insulating material of Low Dielectric Loss, for Coil Formers, Aerial Insulators, Valve Holders, etc.

PERMALEX

A High Permittivity Material. For the construction of Condensers of the smallest possible dimensions.

TEMPLEX

A Condenser material of medium permittivity. For the construction of Condensers having a constant capacity at all temperatures.

BULLERS, LTD.
THE HALL,
OATLANDS DRIVE,
WEYBRIDGE, SURREY
Telephone :
Walton-on-Thames 2451
Manchester Office :
196 Deansgate, Manchester.

Bullers

LOW LOSS CERAMICS



Listen to this...

The Egyptian Pungi—a simple enough instrument to look at, but in the hands of an expert produces really "hot" music — here, Benny Goodman's wailing listeners into a frenzy — here, Benny Goodman's counterpart looks as if he is trying!

AND ON THE FACTORY FRONT

trust
TRIX
Quality SOUND Equipment

AVAILABLE FOR PRIORITY ORDERS. SEND FOR DETAILS.

The **TRIX ELECTRICAL CO., LTD.** New Address :
1-5, MAPLE PLACE, TOTTENHAM CT. RD., LONDON, W.1.
Tel : MUSEum 5817. 'Grams & Cables : TRIXADIO, WESDO, LONDON.

Instrument Cases

If you are on Priority Work, IMHOF's Engineering Division can place a well-equipped modern plant and a wide experience at your disposal for the building of high-grade Instrument Cases, Chassis, etc., in metal.

IMHOF'S

CONTRACTORS TO THE ADMIRALTY,
AIR MINISTRY, M.O.S and G.P.O.

ALFRED IMHOF, LTD., 112-116, NEW OXFORD STREET, LONDON, W.C.1. MUSEUM 5941



ADVERTISEMENT OF THE TELEGRAPH CONDENSER CO. LTD.

REDIFFUSION WAVEMETER

605A

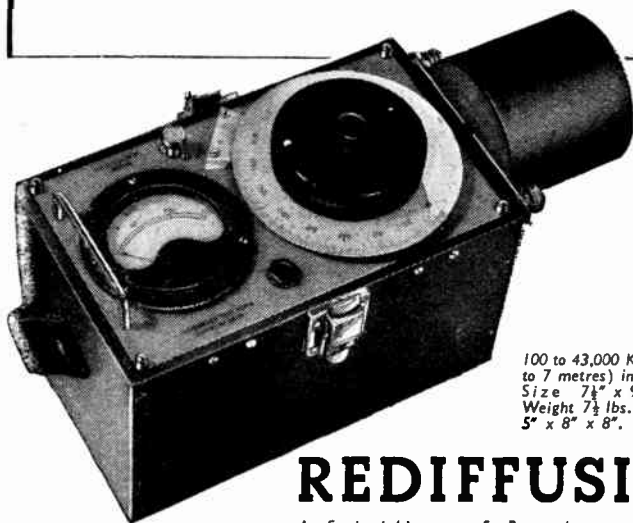

The compact, precise check on every ship and shore radio station. Used by very many senior inspectors and officers for setting and maintaining accurate frequency calibration.

Write for details :

100 to 43,000 K.C. (3,000 to 7 metres) in 8 ranges.
Size $7\frac{1}{2}'' \times 9\frac{1}{2}'' \times 6\frac{1}{2}''$.
Weight $7\frac{1}{2}$ lbs. Coil box $5'' \times 8'' \times 8''$.

REDIFFUSION LTD *REDIFON*

A Subsidiary of Broadcast Relay Service Limited

Designers and manufacturers of Radio Communication and Industrial Electronic Equipment

VICTORIA STATION HOUSE • VICTORIA STREET • LONDON • S.W.1 (PHONE VICTORIA 8831)

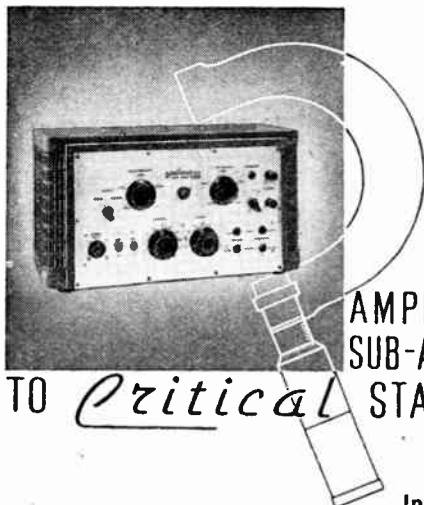

AUDIO
AMPLIFIERS &
SUB-ASSEMBLIES
TO *Critical* STANDARDS

In addition to Standard Amplifiers the activities of Acoustical include Special Amplifiers for Industrial Applications, Microphones, Transformers, Coil Winding, Sheet Metal Work, Stampings, Switch Assemblies, etc.



ACOUSTICAL
MANUFACTURING Co. Ltd.
HUNTINGDON • TEL: 361

INSTRUMENT RECTIFIERS

The following Westinghouse copper-oxide type rectifiers are available for output voltages of up to 500 millivolts at the current values listed :—

Four Westectors type WX.1 for a full-scale deflection of 100 microamps.

Four Westectors type W.1 for a full-scale deflection of 500 microamps.

1mA instrument rectifier for a full-scale deflection of 1mA.

5mA instrument rectifier for a full-scale deflection of 5mA.

10mA instrument rectifier for a full-scale deflection of 10mA.

M.3 instrument rectifier for a full-scale deflection of 10-50mA.

M.9 instrument rectifier for a full-scale deflection of 10-100mA.

General instructions regarding the use of rectifiers in A.C. measuring instruments are given in descriptive pamphlet No. 118 (price 3d.).



WESTINGHOUSE



for reliability and efficiency

WESTINGHOUSE BRAKE & SIGNAL CO., LTD.,
Pew Hill House, Chippenham, Wilts.



Over to you - OVER!

Intensive research and experiment by scientists and technical experts in collaboration with the service departments, have resulted in important developments in design and technique. To-day the output of Osram Valves is devoted to the war effort. But Osram Valves for maintenance of existing equipments are available. Consult your usual supplier.

One day — perhaps soon — the progress and developments that have been made will be of the greatest interest and benefit to all. Then it will be, over to you — over!



Osram Valves

MADE IN ENGLAND

Advt. of The General Electric Co. Ltd., Magnet House, Kingsway, London, W.C.2

B.I. CONDENSERS



for arduous conditions

B.I. Tropical Type Paper Condensers in Moulded Tubes, (U.K. Patent No. 506024 and application pending) are designed to operate continuously in extremely arduous conditions of temperature and humidity.

BRITISH INSULATED CABLES LTD.
Head Office: **PRESCOT-LANCS.** Tel. No: **PRESCOT 6571**



For nearly five years you have—with increasing difficulty, we agree—been able to obtain for your customers at least some R·S Sound Equipment. But all this time the demands made upon us in other directions have gradually increased until we must now “turn over the page” and start a new chapter—“Vital Work Only.” This will possibly be the last time we shall be able to tell you that there are a few models still available from the R·S range, so if you would like to know about them a penny stamp will bring you our latest list. Please don't think that this is “good-bye” — or even “au revoir.” We shall still say “Hello” each month and give you the latest “gen” on quality Sound Equipment as and when we are able.



LOUDSPEAKERS AMPLIFIERS MICROPHONES
R. S. Amplifiers, Ltd., 3-4, Highfield Road, Shepperton, Middx
Tel.: Walton-on-Thames 1019

CELESTION



LOUDSPEAKERS

As in the past, so in the future, the highest possible quality of reproduction will emanate from Loudspeakers bearing the name **CELESTION**

The Foremost Name in Sound Reproduction.
(At present supplied against Priority Orders only.)

CELESTION LTD.
Acoustical Engineers.
KINGSTON-UPON-THAMES, SURREY.
Telephone: Kingston 3656-7-8

HIVAC

THE SCIENTIFIC VALVE

BRITISH MADE



Specialists in

MIDGET VALVES

HIVAC LIMITED
Greenhill Crescent,
Harrow on the Hill, Middx.
Telephone: Harrow 0895.



SILVERED MICA CONDENSERS



*Overshadow
all others in
quality and
performance*

Incessant progress in methods of manufacture and research linked with the most thorough mechanical and electrical inspection, are reasons for the outstanding superiority of U.I.C. Silvered Mica Condensers. Available in all standardized sizes. Suitable for tropical and arctic conditions. Type approved.

UNITED INSULATOR CO. LTD
12-22, LAYSTALL ST LONDON, E.C.1

Tel: TERminus 7383 (5 lines)
Grams: Calanel. Smith, London



THE PIONEERS OF LOW LOSS CERAMICS



THE BENEVOLENT GENIE

But will he go back ?

A Genie is a nice thing to have about the place. When you're in a jam you rub the ring or the lamp, or what-have-you, and the benevolent genie pops up and solves your problem. We like to regard ourselves as a sort of Good Genie to Industry. We like to be called in to solve problems of design or production and — like all good genii — we'll tackle most tasks with a good heart. During the past few years we have served many industries in many ways; aircraft, motor, shipping, and others. We have solved or simplified production and assembly problems for them, but you don't find us making aircraft or motor vehicles or ships. Accessories we make and accessories we are — and intend to remain. So if you want to make the best use of us, you have to trust us. The Simmonds Genie is the servant of Industry. If you call on us to help with a problem we'll help if we can — and then go back in our bottle. A *good* genie in fact.

Finding
NEW and BETTER
ways

THE SIMMONDS NUT · PINNACLE NUT · SPIRE NUT · SIMMONDS INSTRUMENTS & CONTROLS · SIMMONDS ELECTRONIC PRODUCTS · FRAM OIL & ENGINE CLEANER

Simmonds Aerocessories Limited, Great West Road, London. A Company of the Simmonds Group

S I M M O N D S

LONDON · MELBOURNE · MONTREAL · PARIS · NEW YORK · LOS ANGELES

Wireless World

Radio • Electronics • Electro-Acoustics

34th YEAR OF PUBLICATION

MAY 1944

Proprietors :
ILIFFE & SONS LTD.

Managing Editor :
HUGH S. POCOCK,
M.I.E.E.

Editor :
H. F. SMITH.

Editorial, Advertising
and Publishing Offices :

DORSET HOUSE,
STAMFORD STREET,
LONDON, S.E.1.

Telephone :
Waterloo 3333 (35 lines).

Telegrams :
"Ethaworld, Sedist, London."

△

PUBLISHED
MONTHLY

Price : 1/6

(Publication date 25th
of preceding month)

Subscription Rate :
Home and Abroad
20/- per annum.

MONTHLY COMMENTARY	129
UNIVERSAL MEASURING INSTRUMENT By G. A. Hay, B.Sc.	130
B.B.C. MOBILE RECORDING EQUIPMENT	133
BOOK REVIEWS	136
RADIO HEATING EQUIPMENT—II By L. L. Langton, A.M.I.E.E.	137
EQUATORIAL RADIO GIRDLE	140
UNBIASED. By Free Grid	142
WORLD OF WIRELESS	143
WIRELESS AND WEATHER By T. W. Bennington	146
OPTIMUM LOAD, R_n or $2R_n$? By K. R. Sturley, Ph.D., B.Sc., A.M.I.E.E.	150
LETTERS TO THE EDITOR	152
POTENTIAL DIVIDER DESIGN By Patrick F. Cundy, A.M.I.E.E.	154
OUTWORKING	156
RANDOM RADIATIONS. By "Diallist"	158
RECENT INVENTIONS	160

Branch Offices :

COVENTRY :
8-10, Corporation Street.
Telephone : Coventry 5210.

Telegrams :
"Autocar, Coventry."

BIRMINGHAM :
Guildhall Buildings,
Navigation Street, 2.

Telephone :
Midland 2971 (5 lines).

Telegrams :
"Autopress, Birmingham."

MANCHESTER :
260, Deansgate, 3.

Telephone :
Blackfriars 4412 (4 lines).

Telegrams :
"Iliffe, Manchester."

GLASGOW :
26B, Renfield Street, C.2.

Telephone : Central 4857.
Telegrams : "Iliffe, Glasgow."

△

As many of the circuits and apparatus described in these pages are covered by patents, readers are advised, before making use of them, to satisfy themselves that they would not be infringing patents.

Miniature I.F. Transformers

DESIGNED FOR MAXIMUM
GAIN AND SELECTIVITY IN
THE SMALLEST DIMENSIONS

The coils are contained in enclosed pot-type iron dust cores, tuning adjustments being obtained by means of adjustable iron dust centre cores.

Fixed tuning condensers are contained inside the screening can.

The following frequencies are preferred standards but others are available for particular applications :—

M.400 - - 460 Kc/s. M.405 - - 1.6 Mc/s.
M.411 - - 2.1 Mc/s. M.415 - - 4.86 Mc/s.
M.418 - - 9.72 Mc/s.

Wartime restrictions prevent our accepting orders other than those covered by priority numbers.

The illustration shows the actual size of the Unit which is provided with one hole fixing, the terminal wires being fed through insulated bushings which, in turn, prevent movement of the transformer when mounted in position.

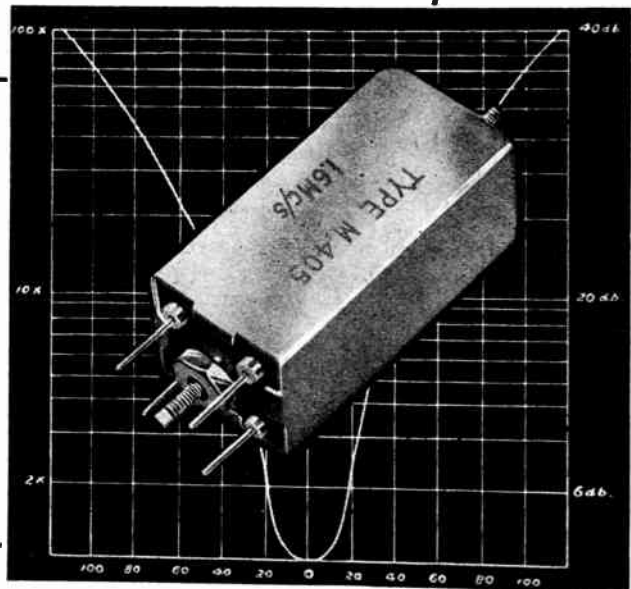

WRIGHT & WEAIRE LTD.

HIGH ROAD, TOTTENHAM, N.17.

Telephone : TOTtenham 3847-8-9.



X-Rays

There are no fanfares for him; no news-reels show him in action; he wields no weapons more lethal than a slide-rule. But he is instrumental in placing a great invisible power in the hands of others.

He—and his colleagues of the research and development laboratories—have made it possible to see deep into the heart of the metal of vital things like aero engines and gun barrels, to make sure that no hidden flaws exist; they have

given to doctors and surgeons an ally of ever-increasing power and scope for diagnosis and cure; to them belongs much of the credit for the part which mass radiography will play in the final elimination of the scourge of tuberculosis.

He and his colleagues have contributed greatly to Philips leadership in the field of X-rays. Their knowledge and experience are of vital importance to the nation today.

PHILIPS



RADIO ★ LAMPS

AND ALLIED ELECTRICAL PRODUCTS

PHILIPS LAMPS LTD., CENTURY HOUSE, SHAFTESBURY AVENUE, W.C.2 (28D)

Wireless World

Radio • Electronics • Electro-Acoustics

Vol. L. No. 5

MAY 1944

Price 1s. 6d.

Monthly Commentary

World-wide Communication Networks

ON another page in this issue we discuss the technical implications of an American plan, briefly reported in the lay Press, for setting up a wireless "trunk line" around the earth at the equator. According to the scheme, traffic originating in the centres of population would be transmitted by feeder services to the nearest "trunk" station on or near the equator, relayed round the equatorial channel to the appropriate points, and then passed to its destination through other subsidiary channels.

The plan for an equatorial radio girdle aims, in brief, at keeping short-wave signals out of the Polar regions, where conditions are inimical to their propagation. Why special measures are necessary to achieve that object may not be at once obvious. The familiar Mercator map tends to obscure the fact that, in an unexpectedly large number of cases, a signal following the normal (shortest) path between widely separated points on the earth's surface will pass through the so-called "auroral zones." In these zones, which surround the poles, the signal is so liable to be subjected to disturbances that the maintenance of an uninterrupted communication service becomes impossible. These effects are well known, and the principle of using relay stations for certain long-distance links is already accepted, although the idea of a radio channel following the equator seems to be novel.

We think that this and other possible extensions of the relay principle are worthy of careful consideration in this country, as, indeed, is anything that promises to improve wireless communication between units of the British Commonwealth of Nations. The Empire is particularly well placed for taking advantage of the favourable conditions existing in the equatorial regions, and a glance at the map shows a continuous chain of possible sites for stations extending right round the world. The matter is of importance, not only in the light of possibly improved and cheapened Empire communications, but also for the distribution of broadcasting on the grand scale. Great advances have been made in that direction since *Wireless World* first pleaded for the establishment of Empire

broadcasting, but there is undoubtedly still room for improvement.

Apart from questions of wave propagation, there are other technical problems of radio relaying which do not seem to be completely solved. Developments in this direction may well represent one of the more important advances of the post-war years. Not the least significant application of relaying technique may be to the distribution of television on a wider basis than has hitherto been practised—or even seriously envisaged.

Pooled Research.—Fears have been expressed that, if proposals recently made by the Brit. I.R.E. for the establishment of a centralised institute for wireless research come to fruition, the effect might be to curb inventiveness and to bring about an undesirable uniformity in design. That depends, we think, to a very large extent on what kind of work would be undertaken by the co-operative organisation. Research may be divided into three categories: (a) fundamental problems, (b) development, and (c) production methods. If we accept the idea of pooled research it would generally be agreed that the first-mentioned subject was its proper sphere; equally, that the last was not, as each manufacturer has his own production methods. But opinions would differ widely as to whether problems relating to the transition-stage between the fundamental idea and the practical embodiment were proper subjects for a co-operative organisation. Indeed, in matters like this, involving questions of degree, it is difficult to come to a conclusion, but we suggest as a rough-and-ready line of demarcation that when a subject approaches the "patentable" stage it might well pass out of the hands of the centralised research body. But, after all, that definition of scope perhaps adds little to the original proposal, which described the function of the suggested Research Institute as "the pursuit of basic research that has hitherto suffered restriction owing to its high cost, absence of obvious or immediate practical applications or the poor prospect of early financial returns."

UNIVERSAL MEASURING INSTRUMENT

1—General Design Considerations

By G. A. HAY, B.Sc.

IN the measurement of any electrical quantity the superiority of the null method, in which a balance is shown by zero reading on a suitable indicator, is due to the fact that a direct comparison is available with an existing standard of any desired accuracy. In such cases the accuracy of measurement is limited only by the accuracy of the standard and the precision with which the comparison can be made. The former can be made as high as desired, while the latter depends entirely on the choice of a suitable null indicator.

The requirements of a good null indicator are (1) high voltage sensitivity, (2) low power consumption, (3) low inertia, (4) robustness, (5) inherent stability and independence of external vibration, noise, etc. The cathode-ray tuning indicator or "magic eye" excels in most of these respects, and has the added advantage of cheapness and general availability. Although its input impedance to DC and AF is practically infinite, even the short grid base type is rather lacking in sensitivity, this being about 50mV for an easily visible change in shadow angle. Usually an extra valve used as an amplifier is necessary to overcome this^{1,2},

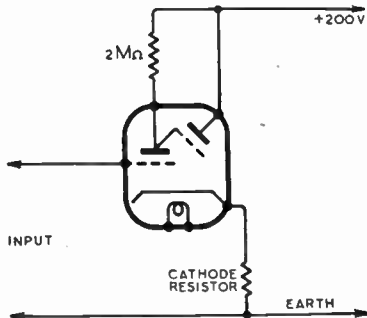

Fig. 1. Bridge detector for AC and DC.

but if a resistor is included in the cathode circuit, positive feedback is produced and an increase in sensitivity is obtained with a consequent decrease in stability^{3,4}. Normally the sensitivity can be

The instrument to be described in this article is designed for the measurement of DC and AC voltage and insulation resistance.

increased to about 5mV with complete stability, thus rendering the use of a separate amplifier unnecessary. If the cathode resistor is by-passed by a condenser, positive feedback is obtained only for DC, and consequent blurring of the shadow due to the presence of stray AC components in the input is avoided.

The indicator described can be used as a bridge detector for either AC or DC (or both) as shown in Fig. 1. On DC it is most useful in bridges with high resistance arms, and in such cases the galvanometer key must be arranged to short-circuit instead of open-circuiting the input. It finds its widest application in AC bridges, however, when it will give a visible indication of an input of 2mV peak at any frequency in the audio range. At higher frequencies the inter-electrode capacitance shunts the anode load of the triode section and reduces the gain materially. In using the indicator for bridge work one must also bear in mind that one side is earthy. This might interfere with the working of the bridge in measuring high impedances. In the absence of any other precautions neither side of the source can be at earth potential. If this state of affairs is not desired then a screened input transformer can be used. This can be quite effectively improvised out of a good quality AF transformer used to step down from the mains with shielding added between the windings⁶.

By including a filter in the grid circuit, and by-passing the cathode resistor, the valve can be used as a null indicator for DC, in the comparison of two DC voltages

(Fig. 2). A PD of 100V is maintained across the potentiometer, which is calibrated so that any voltage V between zero and 100V negative can be tapped off. The unknown voltage is connected as shown, the grid being positive, and zero input to the "magic eye" indicates equality between the unknown and V . The resistor in the filter circuit also serves to

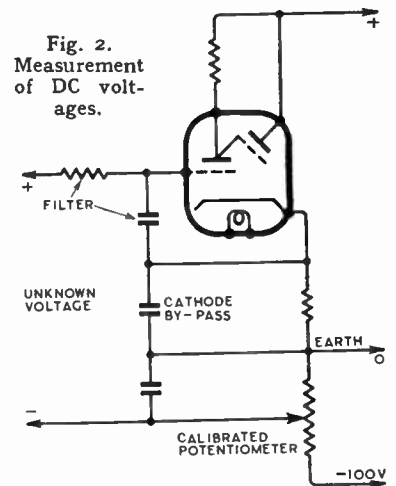

limit the flow of grid current if the grid is allowed to run excessively positive. If we require an accuracy of comparison of ± 1 per cent., the lowest voltage measurable will be $5 \times 100\text{mV}$ or 0.5V, which is quite adequate for normal work. The highest voltage is limited only by the maximum rating of the grid, usually stated to be 250V. It is essential in the above measurements to have a DC path between grid and earth, and in the rare cases where this is not already provided a resistance of high value must be shunted across.

The method of measuring the standard voltage V is rather important. It is possible, of course, to measure V directly with a voltmeter. This scheme has the disadvantage in the finished instrument of acting as a variable load on the power supply according to the position of the slider. Alter-

natively we can use the voltmeter to indicate the presence of exactly 100V across the potentiometer, and calibrate the latter. This is better, but it now seems wasteful to include a voltmeter in the instrument solely for this purpose. An external voltmeter would, in all probability, be in use somewhere else when it was wanted here. Perhaps the best all-round method is that using a neon stabiliser to ensure constant voltage⁵. We can either stabilise the whole power supply—rather a complicated and (as will be explained later) unnecessary business², or we can use a 120V neon tube and drop the voltage to 100 for the potentiometer only. This course was made very attractive by the discovery that a neon tube of the Cossor S.130 type would stabilise a voltage to an accuracy of ± 0.5 per cent. for all normal current and temperature changes.

Still using the tube as an indicator for DC voltages, high resistances can be measured by a method similar to that of the DC bridge. In Fig. 3 it will be seen that the unknown X is compared with the standard resistance R, the other two bridge arms containing sources of EMF which are assumed to have negligible resistance compared with the other arms. In use e_2 is adjusted so

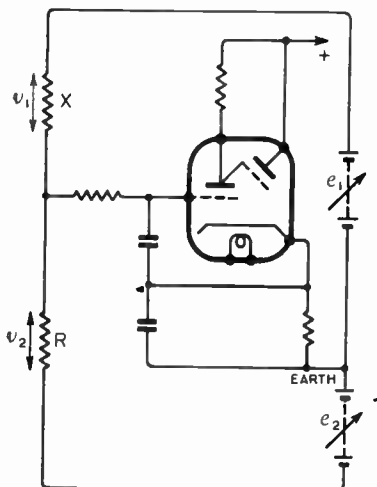

Fig. 3. Principle of the megohm meter.

that the input voltage to the "magic eye" is zero, then $v_1 = e_1$, and $v_2 = e_2$. Now the currents through the two resistances are equal, as none flows through the

"magic eye," hence $v_1/X = v_2/R$, therefore $e_1/X = e_2/R$ and $X = \frac{e_1}{e_2} \cdot R$ or $X = \frac{e_2}{e_1} \cdot X$. If e_1 is 100V, and e_2 a known variable voltage up to 100 (as used in Fig. 2), $X = \frac{100R}{e_2}$ and R can be any value higher than X. If now X and R are interchanged in the circuit, $X = \frac{e_2 R}{100}$ and R can be any value

lower than X. Hence any resistance between zero and infinity can be measured. The accuracy of measurement will naturally depend on the value of R chosen; by giving R a suitable value any desired part of the resistance range can be spread out. As in all bridge methods the accuracy of comparison is greatest when the unknown is equal to the standard.

This method has the advantage over orthodox bridge methods that the voltage applied to the unknown is constant. In using this circuit for the measurement of condenser leakage, the adjustment becomes rather troublesome when the product of insulation resistance in megohms and capacitance in microfarads exceeds⁶ about 50. There is no ambiguity, but the setting drifts for a considerable time, due to the very slow charge of the condenser. This, of course, occurs with any valve-operated megohmmeter of similar design.

When measuring AC voltages with the "magic eye" indicator, a separate rectifier must be used, as although the triode section can be used as an anode bend detector⁴, the characteristics do not admit of very precise measurements. This method is useful, however, where absolute measurements are not required, e.g. in the case of resonance experiments where only a voltage maximum is to be indicated. For frequencies lower than about 50 kc/s the anode load must be shunted by a condenser of about 0.01 μF , to prevent the

electron beam following the instantaneous value of anode current instead of indicating the mean value. At higher frequencies the inter-electrode capacitance of the valve is sufficient.

For measurement purposes at all frequencies, the rectifier *par excellence* is the diode, and this may be used as shown in Fig. 4, under slide-back conditions. The unknown voltage is connected to the input terminals, and the variable standard V applied as slide-back

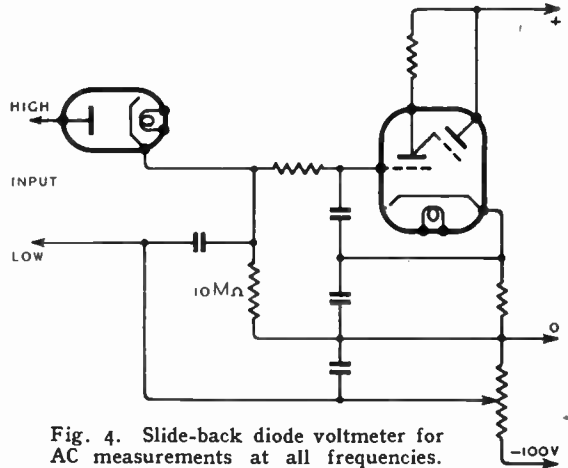

Fig. 4. Slide-back diode voltmeter for AC measurements at all frequencies.

to the diode, thus reducing the anode current to a predetermined value which is indicated by passing it through a high resistance and applying the resulting PD to the CR indicator. The operating conditions of the diode are important, as they affect materially the input impedance and ease of adjustment of the circuit. Fig. 5 shows a typical diode characteristic under various circuit conditions, with negative start of anode current due to initial velocity of electrons.

In Fig. 5 (a) we have the diode with no signal input, and the applied anode voltage zero, i.e. the load is returned to cathode. Anode current will flow, and the anode will take up a potential relative to the cathode as indicated by the load line OA intersecting the curve at B. If now an input of e volts peak is applied, current will flow through the diode on positive half-cycles, and by making the slide-back voltage nearly equal to e , the mean diode current is again brought back to the original value as shown in Fig. 5 (b). This in passing through the load resistance

Universal Measuring Instrument—develops a practically constant direct voltage which corresponds to zero on the CR indicator. If, however, the diode anode is given an initial negative bias (CD in Fig. 5 (a)), the anode current will be reduced nearly to zero, and an alternating input will now have the effect shown in Fig. 5 (c). It will be seen here that the current passed is much smaller, i.e. the input resistance is higher, but the sensitivity of adjustment is much lower due to the lower slope of the characteristic at C. There is also no definite indication of excessive slide-back voltage. On the other hand, the conditions of Fig. 5 (b) give rather lower input impedance, but much higher sensitivity of adjustment and quite definite indications. Incidentally the latter conditions also give larger deviations from theoretical readings at low voltages, but as these ranges must normally be calibrated in any case, this is no disadvantage. In general, the con-

dition shown in Fig. 5 (b) is best. The constants in the diode circuit must be chosen with care if a satisfactory performance is to be obtained. In the first place, the load resistance must be as high as possible in value, as a given diode current will then give maximum PD to operate the indicator. A convenient value is in the region of $10\text{ M}\Omega$. The by-pass condenser is chosen with two considerations in mind. It must be large compared with the diode inter-electrode capacitance, and also it must have a low reactance compared with $10\text{ M}\Omega$ at the lowest frequency desired. In practice the latter factor outweighs the former, and a reasonable figure is $0.01\ \mu\text{F}$. The usual precautions must be observed in ensuring a non-inductive capacitance at ultra-high frequencies.

To ensure accurate readings with the diode, it is important that the total resistance in the anode-cathode circuit be maintained substantially constant, as variation in resistance will alter the working point of the diode. This may be due to the slide-back potentiometer, or to variations in

short-circuiting. If larger errors can be tolerated, however, these remarks apply with less force. Incidentally, if the circuit being tested is discontinuous to DC, it will be necessary to use a condenser-resistance input unit to preserve a DC path from anode to cathode of the diode.

The accuracy of measurement on AC is limited mainly by the stability of the initial bias on the diode due to the initial electron velocity (OD in Fig. 5 (a)). This is determined for any given valve by the heater current, and it is advisable for accurate measurements either to stabilise this or adjust it to some predetermined value. Readings above 10V peak are little affected by this, but below 10V calibration is essential, and one must be prepared for greater errors. Above 10V peak the inherent accuracy is much better than that of a copper oxide rectifier voltmeter under the same working conditions.

(To be concluded.)

REFERENCES

- ¹ "High Sensitivity DC Amplifier," G. A. Hay, *Wireless World*, Jan. 1943.
- ² "A Diode Slide-back Peak Voltmeter," C. E. Cooper, *Electronic Engineering*, Sept. 1941.
- ³ "CR Tuning Indicators," G. A. Hay, *Wireless World*, March 1942.
- ⁴ "The Magic Eye as Resonance Indicator," J. M. A. Lenihan, *Electronic Engineering*, Sept. 1942.
- ⁵ "DC Voltage Tester," T. A. Ledward, *Wireless World*, July 1943.
- ⁶ "Transformer Screening," T. A. Ledward, *Wireless World*, Jan. 1944.

THE WIRELESS INDUSTRY

FORMERLY sold as a liquid, "Ardux" adhesive is now available in powder form with a storage life of six months. This chemical, which is a product of Aero Research, Ltd., Duxford, Cambs, is used for bonding cured plastic materials such as laminated sheet. It is used in the manufacture of transformer bobbins and for fixing inserts in panels.

The new address of H. J. Leak and Co., Ltd., is 470, Uxbridge Road, London, W.12.

We are informed by A.B. Metal Products, Ltd., Feltham, Middlesex, that H. S. Payman, B.Sc., A.Inst.P., A.M.I.E.E., formerly Deputy Director of Communications Production (I.S.C.C.), has joined the company as general manager.

Technical data on rubber-to-metal bonded joints and their applications is contained in a booklet "Elastomeric Engineering" which has just been issued by T. B. Andre Rubber Co., Ltd., Kingston By-pass, Surbiton, Surrey.

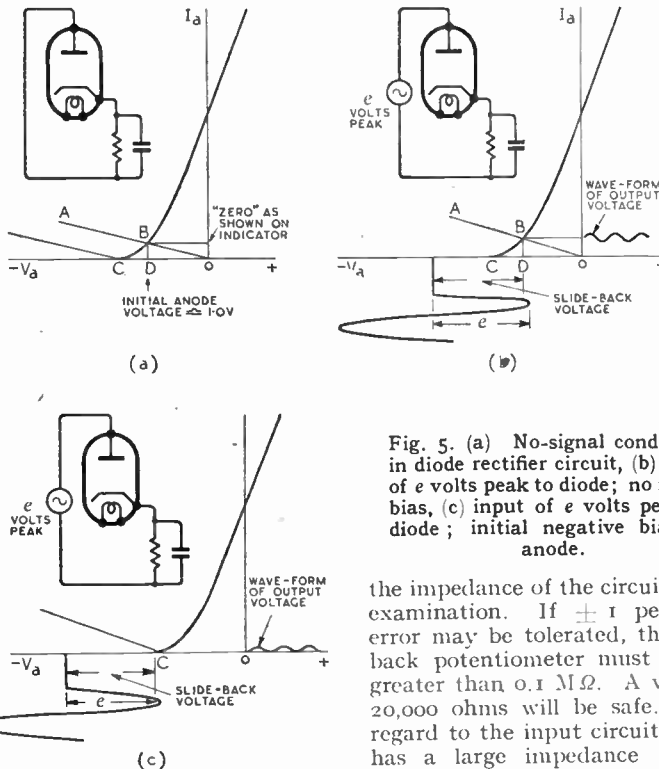

Fig. 5. (a) No-signal conditions in diode rectifier circuit, (b) input of e volts peak to diode; no initial bias, (c) input of e volts peak to diode; initial negative bias on anode.

the impedance of the circuit under examination. If ± 1 per cent. error may be tolerated, the slide-back potentiometer must not be greater than $0.1\text{ M}\Omega$. A value of 20,000 ohms will be safe. With regard to the input circuit, if this has a large impedance (greater than $0.1\text{ M}\Omega$), it is unwise to set the zero by short-circuiting the test leads; this should be done by leaving the unknown source connected and rendering its output zero by some method other than

condition shown in Fig. 5 (b) is best.

The constants in the diode circuit must be chosen with care if a satisfactory performance is to be obtained. In the first place,

B.B.C. MOBILE RECORDING EQUIPMENT

Technical Details of Some of the Machines Now in Use

TWO recent broadcasts of outstanding interest — the sound picture of a raid on Berlin and the recordings of partisan activities in Yugoslavia—have earned public recognition for the courage and enterprise of the B.B.C.'s recording engineers and observers. They have also stimulated the interest of the technically minded and through the courtesy of the B.B.C. we are now able to give some account of the various types of recording equipment in use.

In the main the B.B.C. relies on equipment designed and often built by its own Engineering Division, but it also keeps a watchful eye on the products of commercial companies and has experimented with examples of the leading British and American portable types. With most of these there has been a snag; the lightest are designed for mains

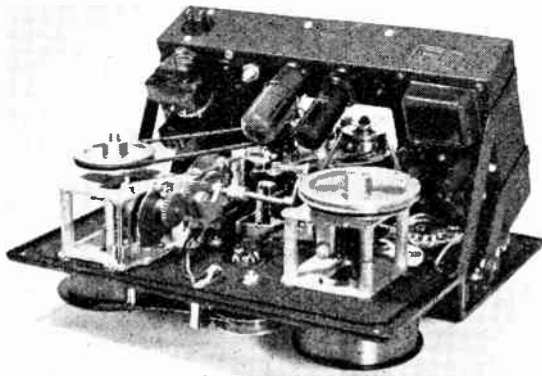

General Electric wire recorder, Model 50—chassis removed from case to show drive mechanism.

operation or, if designed for battery operation, require a heavy motor generator and battery. Greatest promise for the future is shown by a portable magnetic recorder using fine steel wire and capable of recording for 66 minutes at average quality or 33 minutes at high quality on a single spool about 4 inches in diameter and 1 inch thick. Two models are

General Electric wire recorder, Model 50.

available, a "ground" model with facilities for play-back, editing, etc., and a "flight" model which is purely a recorder and weighs 17 lb., to which must be added the battery weight of 53 lb. The obvious advantage of a magnetic recorder is that it does not require the horizontal set-up of the disc recorder and could be worked as a pack set on the march or in a parachute jump. A press button on the microphone starts the mechanism and switches on the amplifier when the observer has something to say.

The magnetic recorder has already won its spurs during the Salerno landings, but the question of supply limits its use at present to work which cannot be covered by other means. In

the meantime, the B.B.C.'s own standard portable and lightweight recorders continue the work of supplying the bulk of the sound material from the home and war fronts.

The B.B.C. lightweight recorder is a remarkably compact unit not much bigger than a portable gramophone and weighing about 37 lb. complete with self-con-

tained amplifier and batteries. The turntable is driven by a standard double-spring clockwork motor which also drives the tracking lead screw and quadrant arm. A piezo-electric cutter head is employed with adjustable spring pressure. The cut is lighter than usual in order that the torque required may be kept within the capacity of the motor.

The microphone is also of the piezo-electric type and is fitted with a substantial light alloy clip by which it can be attached to any convenient support, including the lapel of the commentator's coat.

The amplifier makes use of mid-gate valves with dry-cell HT and LT supply and is fitted with a two-position volume control switch giving a 20 db increase in sensitivity for picking up distant effect noises. A neon-type volume indicator gives useful guidance to the operator in judging the level of speech.

In order that the instrument may be used by observers working single-handed without the assistance of a trained engineer, a single knob control has been provided. This switches on the amplifier, starts the turntable and lowers the cutter gently on to the disc. A warning light appears 15 seconds before the end of the cut, giving the operator time to conclude what he is saying before the machine automatically switches itself off. Fifteen double-sided 10-inch discs with a playing time of 3 minutes per side are carried.

When compared side-by-side with the heavier standard mobile

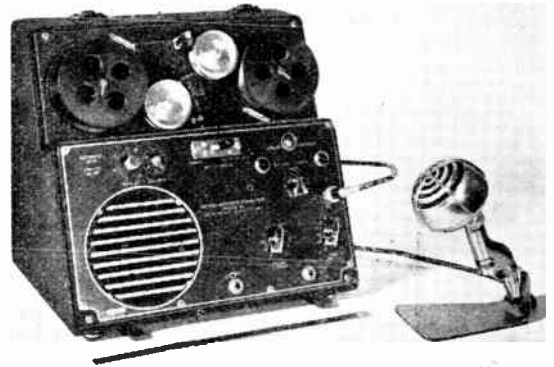

B.B.C. Mobile Recording Equipment—recorder the lightweight portable appears to be rather fragile, but it has more than justified itself in bringing home useful recordings of surprisingly good quality from situations which would have been inaccessible to the heavier equipment.

For most recording work in the field (as contrasted with studio work) the B.B.C. has, during the past four or five years, pinned its faith on its own design of battery-operated transportable disc-recording equipment. This type of work has increased considerably as a result of the war, and the

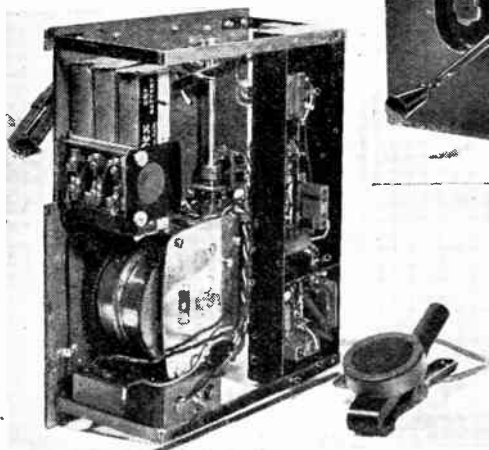

B.B.C. midget disc recorder, Mark I and (left) underside of chassis showing batteries, double-spring turntable motor and amplifier.

(Below) Standard Type C recording machine designed by the Engineering Division of the B.B.C.

enables the recording engineer to communicate with a distant pick-up point via the observer's moving coil microphone which is made to function temporarily as a loud speaker—a disconcerting experience for uninitiated commentators!

The recording machine is heavily built and beautifully finished from the engineering point of view. The 13in. turntable is driven through a friction roller by a 12-volt DC motor, the speed of which is controlled by a series field rheostat on the power supply unit. A series of holes in the periphery of the turntable are illuminated by an internal neon lamp which is energised by a stable stroboscope oscillator with a frequency ad-

justed for 78 r.p.m. In order that a preliminary adjustment of turntable speed can be made before the cutter is lowered a switch on the oscillator alters the speed of illumination to the equivalent of 80 r.p.m., which is the no-load turntable speed.

The massive traverse arm is carried on a machined tracking tube which encloses the lead

Type C equipment has risen to the occasion, performing with great reliability under the strenuous conditions of the blitz and in following the course of the 8th Army across the desert from Alamein to Tunis; it is regarded with affection by the hard-working staff whose efforts are judged by the quality of the discs they bring in.

The whole equipment is substantially built and with batteries, cable drums and other accessories may weigh up to 450 lb.; but it is by no means bulky and can be stowed on one side of the back seat in a standard saloon car of about 18 h.p. and still leave plenty of elbow room for the recording engineer. This is the way in which it is principally used in this country. There are three main units, the recording machine, the amplifier and the power supply unit. Auxiliary units include a mixer for as many as three microphone inputs, and a talk-back unit which

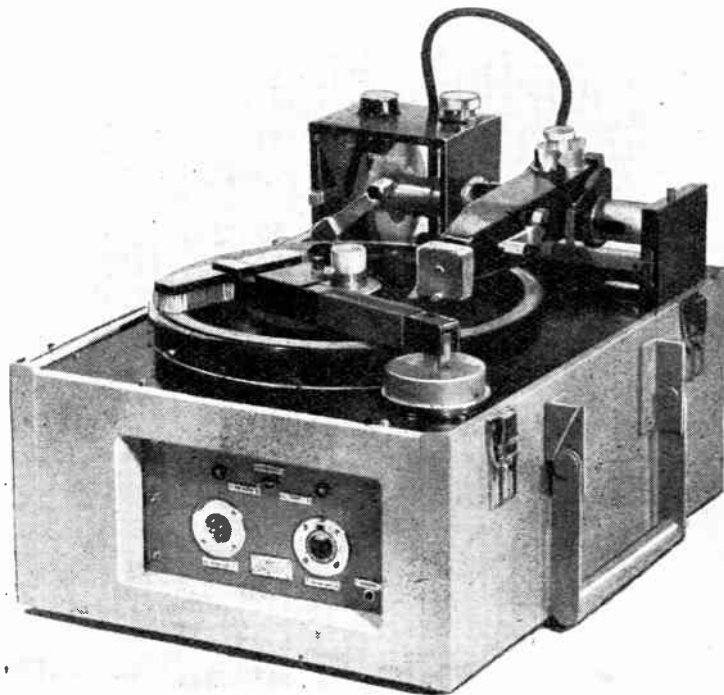

screw. An adjustment is provided by which the traverse arm may be rotated on the tracking tube to alter the cutter angle. The half-nut which drives the arm through a slot in the tube can be disengaged by pressing a catch lever. The lead screw is belt driven

arranged to take a microphone or pick-up or the output from the mixer unit. Volume control is effected by two ganged potentiometers, one in the coupling between the first two stages and the other in the negative feedback circuit. By this means a wide range of control is obtained with low distortion at high levels.

The output stage consists of two pentodes in push-pull with a paraphase resistance - capacity input. A tapping on the output trans-

ected from overload by circuit breakers and a delay relay is included in the output so that full HT is not applied to the valves until the cathodes are hot.

B.B.C. observers and engineers nowadays accompany the Armed forces the standard equipment is nearly all spheres of activity on land, by sea and in the air, and in many parts of the world. When working with the land forces the standard equipment is installed in a Humber vehicle of a type normally used by the Army as an ambulance; the chassis has optional two- or four-wheel drive and is capable of a true cross-country performance. The body has been specially adapted and is fitted with sleeping berths, cooking utensils, water tanks, etc., so that the crew can live as a self-contained unit. A collapsible tent provides sleeping accommodation in hot climates and serves as a light trap for night operation. There is ample luggage space on the roof and a hatch is provided over the spare seat, at the front for observation of aircraft when on the move. An extra dynamo has been fitted to the engine for charging the recorder batteries at a high rate. The unit construction of the

Interior and exterior views of the B.B.C. recording truck used at the battle fronts by B.B.C. War Correspondents. The tent provides sleeping accommodation for the crew and forms a convenient light trap for night operation.



from the turntable spindle through a friction clutch, the action of which can be observed through a Perspex window. An outer stop is provided for 12-inch records and a pilot lamp on the arm facilitates cutter changing.

Inside the channel - section traverse arm is mounted a pivoted balanced arm with the cutter head at one end and a counterbalance weight at the other. The masses are equally distributed about the pivots in both horizontal and vertical planes so that bodily movement of the machine produces no force which might alter the depth of cut. Cutting pressure is applied by a long leaf spring pressing on the balanced arm near the head.

The cutter head is of the moving iron type with grease damping and is of high sensitivity for use with an amplifier requiring a moderate HT supply. The effective frequency range of the cutter head is from 60 to 4,500 c/s.

In the amplifier unit the first two stages are voltage amplifiers using pentodes with negative feedback. The input circuit is

former is provided for the monitoring loudspeaker. The total harmonic distortion of the amplifier at normal recording level is not more than 1 per cent.

A peak programme level meter is incorporated with the amplifier and consists of a double diode rectifier and pentode amplifier.

High tension current for the amplifier is provided by a motor generator in the power supply unit. This is designed for a 12-volt input from nickel-iron batteries and delivers HT at 400 volts. The machine is fully pro-

Type C recorder also lends itself to installation in aircraft and ships, and recordings have been made in trawlers, M.T.B.s and submarines as well as in bombers. Difficulties are often experienced in suppressing engine noises, and special microphone installation has to be improvised in each individual case. The successes which have been achieved are the result of the happy relationship which exists between men and machines—sound basic design and resourceful adaptation.

BOOK REVIEWS

The Physics of Music, by Alexander Wood, M.A., D.Sc. Pp. 255; Figs. 110. Published by Methuen & Co., Ltd., 36, Essex Street, London, W.C.2. Price 21s.

THIS is primarily a book addressed to musicians to explain to them in simple terms the physical foundations of their art, but it is not therefore to be despised by physicists—still less by humbler enthusiasts for good quality of reproduction in broadcast and recorded music. For instance, there is a fund of interesting information on the instruments of the orchestra, their mechanism of tone production and control and an analysis of their characteristic harmonic content which gives an insight into the basis of pleasant and unpleasant tonal quality. Musical instrument makers apparently use the first six harmonics freely in various combinations to give acceptable variety of tone but avoid like the plague the seventh, ninth and higher odd harmonics which add dissonance and harshness—a clear pointer to amplifier designers. The application of modern acoustical knowledge to the improvement of wind instruments and investigations into the relative merits of old and new violins make interesting reading and the chapter on the ear and theories of hearing is an admirably lucid exposition.

The foundations of the book are laid in the pre-electrical era of classical acoustics with frequent historical anecdotes; the superstructure of modern knowledge draws freely on recent text books and scientific papers. Material has been chosen with discrimination and the view of the subject presented is well balanced. While the author is concerned mainly with traditional methods of music making, he does not deny the possibility of applying electrical methods to the production of new musical instruments, though in dealing with the possibilities of sustaining pianoforte tone (p. 95) he does not mention the existence of the Neo-Bechstein and Förster pianos developed by Nernst and Vierling.

Obvious errors such as "pressure amplitude in dynes" (p. 37) and at the bottom of p. 50 e for e^2 in the minor third are few, but it is more difficult to overlook the following passage on p. 20 dealing with beats between two sources sounding simultaneously. "One of the sources, however, is vibrating slightly faster than the other. The waves it send out begin to arrive earlier than those from the other source. Soon the faster source has gained half a vibration on the

other." It is only fair to say that this isolated example of loose expression is thrown into prominence by the clearness and accuracy of the rest of the text, but it is none the less unfortunate in the very first chapter on the nature of sound.

The publishers' note inside the paper cover speaks of an appendix which includes some of the more mathematical material, but this could not be found in the book itself. F. L. D.

Basic Radio, by C. L. Boltz. Pp. 272; 166 figs. Published by Thomas Nelson and Sons, Parkside Works, Edinburgh, 9. Price 5s.

THIS book is one in the publishers' series of "Aeroscience Manuals" and is an elementary text book covering the fundamentals of radio in the order prescribed in the syllabus for Air Training Cadets.

The book opens with chapters on the three effects of an electric current, sources of EMF, Ohm's law and the laws of electromagnetic induction. In the following chapters on condensers, alternating current and inductance, references are made to "Elementary Mathematics" by Professor Levy, another book in the same series. Chapter 10 introduces valves and in the subsequent chapters their use as oscillators, detectors and RF and AF amplifiers is discussed. It is pleasing to note that the author prefers the abbreviations RF and AF to the alternative HF and LF which are so misleading. Instead he uses HF, LF together with MF as three divisions of the radio frequency range, the system of the Admiralty Handbook. The book concludes with chapters on receivers, aerials and feeders. Each of the 17 chapters is complete with a useful set of examples; answers to them are given at the end of the book.

The diagrams have quite rightly been made particularly simple in order to stress the point they are designed to illustrate, but in some, for example Fig. 150 on p. 237, this process seems to have been carried too far, as some necessary details seem to be missing.

There is no mention in the book of transmitting circuits or superheterodyne receivers, and although the author admits in his preface the omission of the latter, one feels, in view of the extreme popularity of superhets, that some mention of their method of operation would have improved the book.

The style throughout is simple—at some points it could justifiably

be called "chatty"—and the book should prove a useful help to those who are approaching the subject for the first time. S. W. A.

Radio Questions and Answers; Vol. I.—Basic Radio, by E. M. Squire. Pp. 86, 82 figures. Published by Sir Isaac Pitman & Sons, Ltd., Parker Street, London, W.C.2. Price 5s.

THIS is the first of two volumes of the question-and-answer type with which we are becoming very familiar in these days. In this volume on the fundamentals of radio the questions are both descriptive and numerical in their nature.

The first chapter deals with direct current and its explanation in terms of the electron theory, numerical questions being concerned with Ohm's law, simple networks of resistance and power calculations. Magnets and electromagnets are next dealt with and the calculations are mainly on flux density. After a section on the construction and maintenance of primary and secondary cells the author goes on to deal with AC, the calculation of reactance and the voltage magnification of series-tuned circuits. In the latter section the author should certainly have been able to find a better phrase than "variably tunable circuits" (p. 45), and it is rather illogical to find inductance, capacitance and transformers defined and explained in Chap. V after calculations have been worked out on them in Chap. IV. Series and parallel connections of inductances and condensers are considered in Chap. V, and this chapter would have been improved if the author had adhered rigidly either to "capacity" or "capacitance" instead of using both indiscriminately, as he does. Chap. IV is on measuring instruments and the calculation of shunt and series resistance values; the final chapter introduces thermionic emission, diodes and other valve types. The calculation of mutual conductance, anode AC impedance and amplification factor are here duly treated, but there is an obvious misprint at the foot of page 80 where it is stated that the vacuum of a hard valve is equivalent to 10⁷ mms. of mercury!

There is considerable information in the book and those for whom it is intended, namely Service men training to be radio mechanics and radio operators, should find it useful. S. W. A.

GOODS FOR EXPORT

The fact that goods made of raw materials in short supply owing to war conditions are advertised in this journal should not be taken as an indication that they are necessarily available for export.

RADIO HEATING EQUIPMENT

II. Coupling "Work" to the RF Generator

THE previous article covered the major considerations in push-pull Class "C" oscillator design and enabled the optimum load to be found for a given pair of valves. With an assumed value of "Q" for the loaded tank circuit, a value of load inductive reactance (ωL) was derived to fulfil optimum conditions. It is now proposed to examine oscillator design more critically in its application to both eddy current and dielectric heating, also to discuss energy transfer from the tank circuit to the "work."

The power induced into "work" by eddy currents is proportional to the magnetic field at the surface of the "work" and this magnetic field is in turn proportional to the current in the "work" coil. A large circulating current in the tank coil is thus preferable for efficient heating, and it is advantageous to use low-impedance valves which, for a given power, operate at lower anode voltages and hence higher anode currents. This means that the value of $E_b - E_a$ min. is low, while the anode alternating current is high, and this calls for a low value of ωL in the tank circuit.

The frequency employed for eddy-current heating is comparatively low and usually of the order of a few hundred kilocycles, so that while ωL may be low the optimum value of inductance, although smaller than that required with a high impedance valve, will be sufficiently large to enable an efficient tank coil to be designed. There is, however, a factor which may weigh against the use of very low values of ωL , and that is the large capacity of the tank condenser needed to tune to the required frequency. Such condensers are expensive and, while the voltage across them may be comparatively low, there will be fairly large losses if the power factor of the condenser inclines to be poor. It is preferable to keep the tank circuit capacity down to such a value that an air or oil dielectric condenser may be used for tuning.

By

L. L. LANGTON

A.M.I.E.E.

Some commercial radio heaters use as the "work" coil part of the tank coil. Other types have the "work" coil coupled to the tank coil inductively. These methods are shown in Fig. 1.

A magnetically coupled "work" coil, Fig. 1(b), must be used where the tank circuit circulating current is not large. The system may be regarded as two transformers, having together an overall turns ratio which matches the impedance of the "work" to that of the tank circuit. The voltage step-down ratio of this combination is high, and hence there will be a large "work" coil current compared with that flowing in the tank circuit. It would appear at first sight that this method would be more efficient, but in fact the losses of the additional closed coupling circuit will reduce the power available for transfer to the "work."

The ideal conditions would occur when the whole tank coil formed the "work" coil, the "work" being such that the load it imposed reduced "Q" to 10. If this were done, it would greatly restrict the type of "work" which could be efficiently heated and, in any case, the diameter and length of an efficient tank coil would be such as to impose insuperable conditions upon its use as a "work" coil.

With a "work" coil forming part of the tank coil, there is a further disadvantage in that it does not enable impedance matching to be achieved with the same degree of flexibility as is possible by the inductively coupled method. In replacing an inductively coupled "work" coil by one of different turns, the overall change in impedance ratio of the combination is proportional to the square of the change in turns ratio, and so a fair degree of matching can be performed.

Alteration in the number of turns of a "work" coil which forms part of the tank coil does

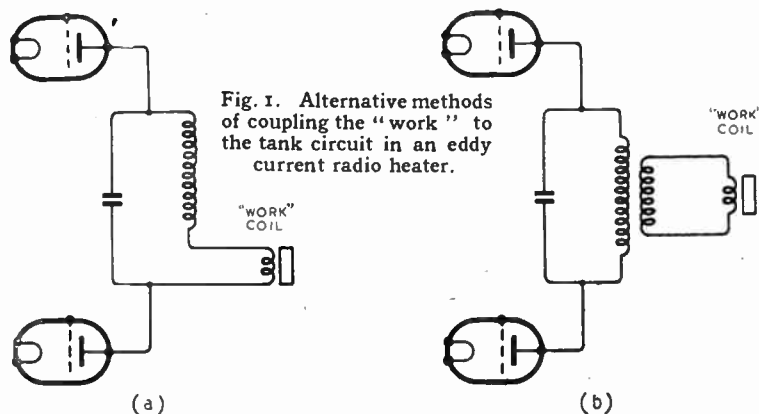

Fig. 1. Alternative methods of coupling the "work" to the tank circuit in an eddy current radio heater.

Using a "work" coil which is part of the tank circuit will enable a very much higher "Q" to be obtained for no-load conditions, in spite of the increase in tank coil resistance which this method entails. If, under load conditions, "Q" could be reduced to 10, this method would prove better but, in practice, it is not usually possible.

not vary the impedance ratio to the same extent, for the two coils do not form an auto transformer, because the inductive coupling between them is negligible.

In general, it may be taken that for powers up to about 3 to 5 kW, particularly when high-impedance valves are used, it is preferable to employ inductively coupled "work" coils. For higher powers,

the other method is generally considered advantageous, but it must be remembered that either method may be efficiently employed at any power to do a specific job, provided the whole apparatus has been designed for that purpose.

The flexibility of inductive coupling is to be preferred when the available power is insufficient to allow for considerable wastage through inefficient coupling and where the capital cost of the generator is of prime consideration. However, the comparatively exacting requirements of small power optimum efficiency heaters do not make for wide and easy industrial application, and, where this is wanted, the RF source should be of generous power.

It was pointed out in the previous article that non-magnetic conductors of low specific resistance do not form very suitable "work" for efficient RF heating, but when such heating must be done, the design of the "work" coil has to be such that the periphery of the "work" is situated in the region of maximum flux density. The author feels that there exists among many some doubt regarding the location of maximum flux density within an air-cored solenoid. This is doubtless due to the cursory manner in which many elementary text-books treat the subject.

Although magnetic flux does not flow in the manner of an electric current, it is often stated that the flux due to a coil carrying current arises at one end, pursues its journey in air to form the exterior field and concentrates at the other end to pass within the turns of the solenoid. The magnetomotive force H , due to the ampere-turns of the coil, will in media of unit permeability be equal to the flux density B , expressed in lines per square centimetre. This leads some to infer that the flux is distributed evenly over the cross-sectional area of the solenoid. Others suppose the flux to concentrate at the centre of the coil and there are books in which this is stated to be the case.

The location of the region of

maximum flux density is seen in Fig. 2, showing a section of a "work" coil.

The flux due to each turn is in such direction that within the solenoid the lines of force are of similar polarity and hence mutually repel. The greatest available flux density exists at the surface of the conductors, for the length and hence the

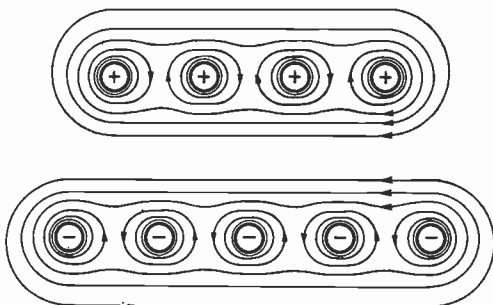

Fig. 2. Distribution of magnetic flux in and around a solenoid.

reluctance of the magnetic path surrounding the conductor is comparatively low. The path of flux remote from the turns of the coil has high magnetic reluctance, so that the flux density across a section of the coil becomes progressively less towards the centre. Along the axis of the coil the magnetomotive force due to an element of the winding is balanced by the force due to a diametrically opposite element, and it is possible that there may be no flux whatever at the centre of the coil.

When the surface of copper is to be heated, it will be seen that the coil must fit snugly to the "work" to enable reasonable energy transfer to take place. We shall see later that this will impose a limitation upon the minimum diameter of "work" which may be efficiently heated. It is sometimes very necessary, however, for small diameter "work" to be heated, and there exist some American illustrations showing how the "work" may be placed between two adjacent conductors of a "work" coil. The "work" may easily be heated in this manner, provided that abundant power is available, for the efficiency is very low.

Often the "work" coil must be made of tubing, so that water may be passed through the interior of the conductor for cooling

purposes. The power at which this becomes necessary could be, in some cases, below 1 kW. It is fortunate that experiments can be performed even before the generator is made to determine whether water cooling will become necessary. If the tank coil, coupling coil and "work" coil alone are wound, much evidence of practical utility may be gathered by a few simple measurements with a "Q" meter. It is not even necessary to have the tank circuit air or oil dielectric condenser, as it may be assumed that its power factor will be reasonably low, and for these experiments it can be replaced by normal receiver type tuning condensers.

There is one precaution to be observed during these measurements, and that is the necessity for simulating screening conditions which will exist in the finished equipment. If a metal side of the cabinet is in fairly close proximity to the tank coil, the "Q" of the circuit will be reduced. It is, of course, essential to minimise such losses by having adequate spacing between the tank coil and sides of the cabinet.

The "Q" of the tank circuit, with the "work" coil disconnected, is first measured and again with the "work" coil in circuit. The ratio of difference in "Q" to the first "Q" measurement will indicate for known valves the power which will be dissipated in the coupling and "work" coils. The diameter and length and hence heat dissipating properties of the coupling coil will incline to be greater than those of the "work" coil, so that on low-power heaters the necessity for water cooling may sometimes be obviated by using a "work" coil conductor of comparatively large cross-section and so making it the portion of the circuit having least resistance and power loss.

It is essential that no part of the tank circuit should contain a high resistance joint, for the heat generated at this point could in some cases be sufficient to melt the conductor, besides greatly reducing overall efficiency.

The optimum size and disposition of the coupling coil is best determined by "Q" measurements, and the coupling circuit should be so proportioned that, when specific "work" is placed in the "work" coil, the "Q" o

the circuit is reduced to 10 or to the minimum value exceeding 10 that can be achieved with such "work." By these few simple measurements the performance in heating specific "work" may be predicted with fair accuracy.

For "work" coils forming part of the tank coil, measurements can be made under no load conditions and then with "work" included. The necessity for water cooling the "work" coil is again determined by the amount of power that will be dissipated in it and the maximum temperature rise that can be tolerated. It is not usually necessary to water-cool the whole tank coil, for it may in practice be wound with a conductor of such large cross-section that its resistance will be sufficiently small for air cooling to dissipate the heat generated and enable the temperature rise to be kept fairly low. The limiting factors in reducing "work" coil resistance are the diameter, length and number of turns in the coil and the cross-section of the conductor which can be accommodated. It must also be remembered that the field due to the "work" coil increases for a given current with turns per inch. This, of course, calls for smaller conductors. As in problems found in most engineering applications, the solution is obtained by intelligent compromise.

Dielectric Heating

Some of the design requirements for dielectric heaters are different from those needed in eddy current heating (ECH). Here, it is the tank circuit voltage which must be high as the heating of the "work" is proportional to the voltage across it. High-impedance valves are therefore advantageous because for a given power the high-tension and anode alternating voltage will be greater than is the case with low-impedance valves. The manner in which energy is transferred to the "work" in the tank circuit is usually that shown in Fig. 3 (a).

The work is contained between parallel electrodes and so forms a condenser, the capacity of which is controlled by the physical dimensions and dielectric constant of the "work." The two series condensers are included for the purpose of insulating the "work"

electrodes from the DC high-tension voltage. Their capacity should be large compared with that of the "work", so that the RF voltage dropped across them shall be small. The arrangement shown in Fig. 3 (a) is somewhat inflexible as there are no means of adjusting the load imposed upon the oscillator. This difficulty may be overcome by the arrangement shown in Fig. 3 (b), where a variable inductance has been included in series with the "work."

It will be noted that the series capacity and inductance in the "work" circuit form an acceptor circuit. At resonance the impedance of this circuit will be a minimum and the current in it a maximum causing the potential across a reactive part of the circuit to be a maximum. The "work" circuit impedance is in parallel

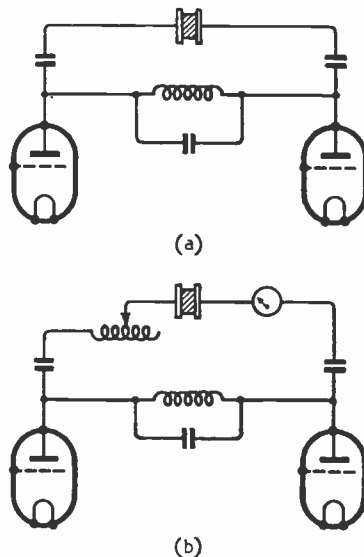

Fig. 3. Two methods of coupling "work" in a dielectric heater.

with and so reduces the dynamic resistance of the tank circuit. This reduction will cause the value of tank circuit "Q" to be reduced also. The series circuit is tuned to such a value that the tank circuit "Q" is reduced to 10, and so enables the oscillator to operate at maximum efficiency and also to transfer maximum power in the "work." The unloaded tank circuit "Q" should of course be as high as it is possible to obtain by good design.

Measurement of "Q" values,

loaded and unloaded, will indicate the performance to be expected from given valves, but it is not advisable in the case of dielectric heating (DH) to measure these "Q" values using the tank and "work" circuits alone, before the complete equipment is made. Losses imposed by a dielectric such as a valve holder included in the RF circuit will modify the "Q" values at the high frequency employed.

The variable inductance method of load adjustment is facilitated by the inclusion of a current meter in the "work" circuit. This will at a given reading indicate that the load is optimum. It is inadvisable to overload the oscillator as the output will not increase and there is a danger of serious damage to the valves. It is not usually necessary to tune the "work" circuit to exact resonance, for there would then be a very heavy shunt load on the tank circuit, which would reduce the "Q" value to well below 10 and serious overloading of the oscillator would result.

The tank condenser does not in the case of DH present much difficulty or expense, for the value of capacity required is quite small owing to the high frequency employed and the large L/C ratio required for optimum load conditions with high-impedance valves. It is usually possible to construct a satisfactory tank condenser by mounting two parallel copper or brass plates on supports made of very good dielectric material, such as quartz or Distrene.

Dielectric heating, because of its lower power requirements, may sometimes employ valves which are not much larger than those used in audio power amplifiers. With ECH and larger DH equipments, however, many will be exploring new fields, and it is intended later to review the peculiarities of valves and circuits of large power.

MINIATURE VALVES

THE cover illustration this month shows a pair of "Microtube" valves of the type used in American "personal portables" and hearing aids. The filament rating is 22.5 mA at 0.625 V and the normal anode voltage is 45. The valves are designed for wiring directly into the circuit and the dimensions are 0.4 inch diameter and 1½ inch long.

EQUATORIAL RADIO GIRDLE

Avoiding Zones of Ionosphere Disturbance

NEWS of an American plan for linking together the various countries and cities of the world by means of one radio network was given in the following report, taken from *The Daily Telegraph* of March 17th.

"Plans have been drawn up by American Government engineers for a world-wide system of radio communication. The principal feature is a 'trunk line' girdling the earth about 20 deg. north of the Equator, according to the *Wall Street Journal*.

"The plan is designed to overcome the technical difficulties involved in the present method of attempting to provide direct communication between all the principal cities of the world. It is also hinted that it is designed to satisfy the critics of the alleged British monopoly in communications in certain regions.

"Relay stations would be erected in the Canary Islands, Alexandria, Bombay, Hong Kong, Guam, Honolulu, Mexico City, and San Juan in Puerto Rico. The major cities north and south of the 'trunk line' would beam their transmitters to the nearest relay station.

"From there the messages would follow the round world route until they reached the relay point nearest their destination, whence they would be directed north or south to the major city from which they would be distributed."

Leaving aside the political and economic implications of this piece of news, such a plan possesses several technical advantages which are of considerable interest—advantages, be it said, which have been the subject of considerable study by others besides the American engineers responsible for this plan.

The accompanying world map on Mercator's projection aims to illustrate how the plan might be worked out. The world "girdle" is shown in heavy line, while the links connecting some of the world's principal cities to the "girdle" might be such as are shown in lighter lines. Thus, while the radio links comprising the "girdle" extend in an approximately east-west direction round the world, those connecting the population centres to the "girdle" run in an approximately north-south direction, and none of

the Great Circle paths between the stations pass through very high latitudes.

The most obvious advantage of such a network is the avoidance of the use of transmission paths which pass the zones of maximum auroral intensity. These auroral zones—zones where the auroræ are most frequently visible—are narrow belts which surround the earth's geomagnetic poles, and are shown on the map as full curved lines. Poor radio conditions nearly always exist in these zones—there is always high absorption of the radio energy, and the zones are affected by constant ionosphere disturbances. Such disturbances—which render short-wave communications poor or even impossible—often spread outwards from the auroral zones towards the equator, and the dotted lines on the map are intended to indicate roughly the boundaries of the areas in which they most frequently occur. Sometimes, however, they extend even further towards the equator than is indicated by the dotted line.

Main Advantages

It would seem that the principal intended function of the relay stations of the "girdle" would be to provide a link between any two centres which would be unaffected by ionosphere disturbances. Thus communication could be continuously maintained during the disturbances, for the transmission paths connecting the centres *via* the relay stations would, in most cases, pass clear of the disturbed zones.

Another advantage of the girdle would be that, since its stations would be located in low latitudes, they would be able to make use of higher frequencies than are usable by stations situated in higher latitudes. This is because the ionisation of the refracting layers is, presumably, higher in low than in high latitudes, because in low latitudes the sun's rays—which produce the ionisation—are stronger. Use of the highest radio frequencies would be an advantage since it would enable the stations to work in

relatively uncongested bands, and furthermore, on frequencies where the radio noise is low. The workable frequency band would also probably be much broader than in the case of high-latitude transmission paths.

When great differences of longitude exist between two radio stations communication often becomes impossible for many hours daily because of the great differences in the ionisation at the opposite ends of the path, due to the variation of daylight and darkness along the path. Under such conditions the relay stations of the "girdle" could provide a connecting link which should enable communication to be maintained throughout the 24 hours. Since there are eight stations more or less evenly spaced within the proposed world "girdle," there would be, on the average, 45 deg. of longitude between each station, representing a time difference of 3 hours. Communication between stations with such a small time difference as this could easily be maintained by changing the working frequency at suitable intervals, according to the local time of day at the centre of the path. Thus each relay station would work on the frequencies suitable for reception at the next station to it in either direction, and so the working frequencies would gradually change along the girdle so that a suitable one was always in use. For example, suppose that it is sunrise at longitude 10 deg. W. and that the station in the Canaries is receiving traffic from San Juan intended for Hong Kong. It would necessarily receive this on a low frequency, for the area to the westward of 10 deg. W. is in darkness. The Canaries would relay the traffic to Alexandria on a somewhat higher frequency, for it is full daylight at Alexandria. Alexandria in turn would relay to Bombay on a higher frequency still, while Bombay might relay on the same or a somewhat lower frequency. Thus the differences in time of day would be overcome and traffic could pass between any two centres throughout the 24 hours.

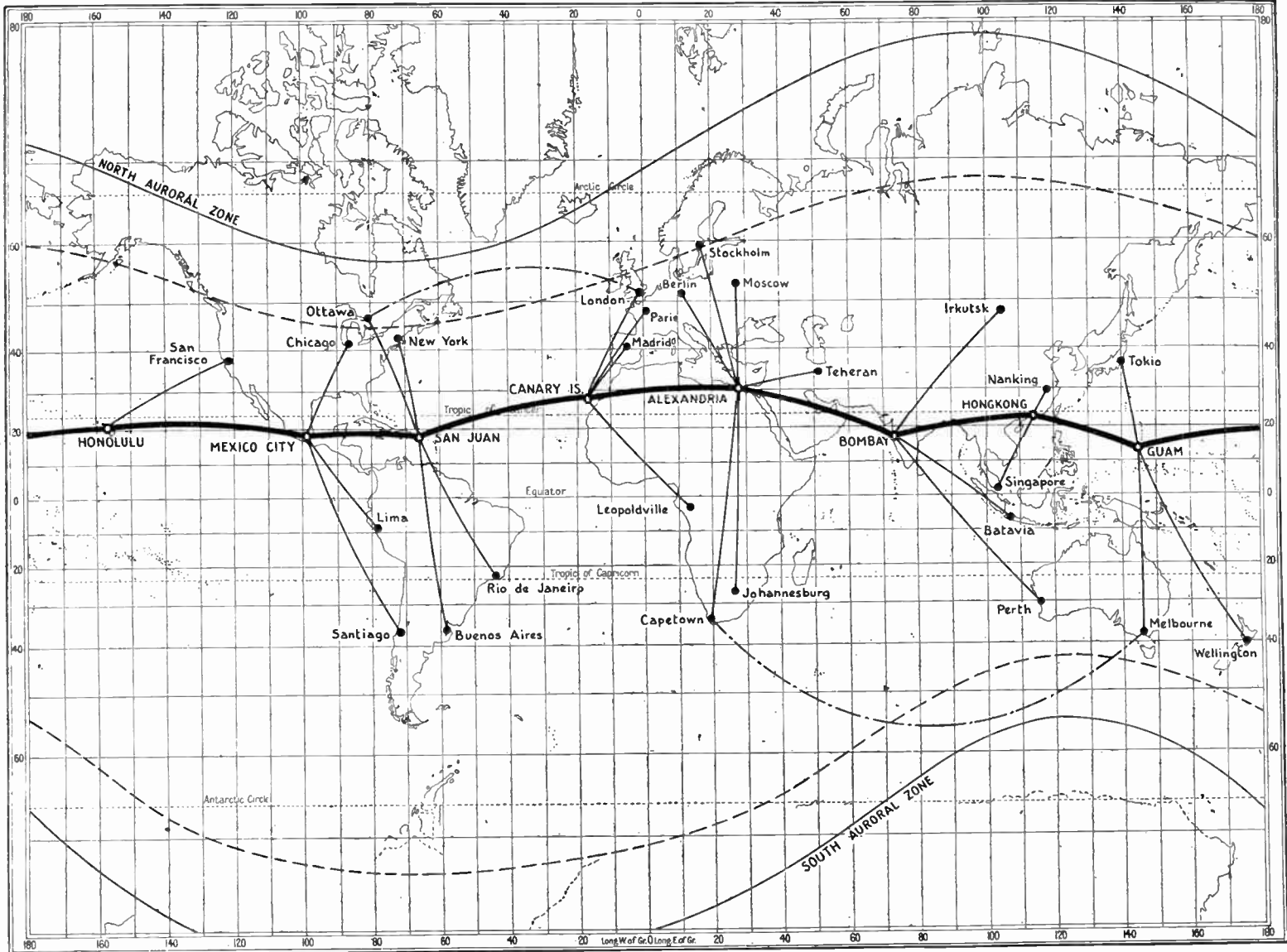

Drawn on a "Geographic" outline map.
Nucleus of a world communication system as it might be developed on the "equatorial girdle" principle. The dash-dot lines show how direct Great Circle signal paths encroach on disturbed zones.

UNBIASED By FREE GRID

Radio Racket

THE radio industry has reason to congratulate itself on being singularly free from the wretched rackets which infest other great industries, but there is always the inevitable black sheep to be found, even in the pages of Debrett, and I was not altogether surprised the other day to come across a case in which there was a sad falling-off from the high standard of integrity set by the industry as a whole. Whenever one comes across an unfortunate instance of this nature, however, in the case of the radio industry it nearly always possesses, as one might expect, the saving grace of ingenuity, and this case proved no exception to the rule.

I had been commissioned by Mrs. Free Grid's mother to endeavour to pick up a wireless set for one of her female relatives who had recently succeeded in persuading some misguided man into marrying her, and I was singularly fortunate in coming across a really first-class receiver of pre-war vintage in the shop of a radio dealer whom pressure of war-time shortage had, in common with other dealers, forced to add to his stock in trade a large number of re-conditioned second-hand sets.

"Brobdingnagian generators installed."

the set was not his property, but that of a private citizen, on whose behalf it was being sold on a commission basis, the citizen in question having purchased another set from the shop and requested him to put his set in the window and dispose of it for him in this manner.

The dealer heartily agreed with me that the price was indeed outrageous, but what, he asked me, could be done about it, as the customer had made it fairly clear that if his request were not complied with he would buy his new set from a competitor farther along the street? Subsequent enquiries confirmed my belief that the whole business was nothing but a racket. The law is apparently very elastic.

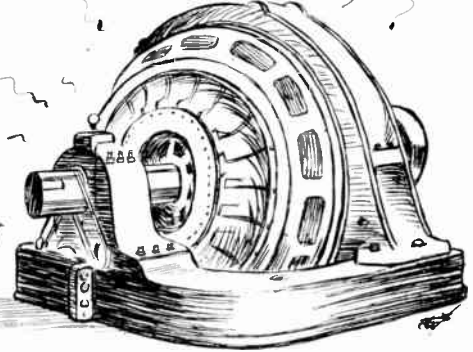

ago. This Spitzbergen business, however, is in quite a different category, and I am surprised that the Brains Trust should have so far belied its name as not to realise the enormous post-war radio possibilities of the subject under discussion, for the island is ideally situated for the world's first practical radio power link using highly directional ultra-short waves. Few people outside inner technical circles realise the enormous strides that have been made in directional USW technique during the war. I am, in fact, telling enemy technicians nothing which they do not already know by saying that when radio engineers direct ultra-short waves to a certain spot they obtain results far nearer the hundred per cent. mark of absolute obedience than does Mr. Bevin with his particular directees.

I am, of course, not going to deny that the overall losses with my proposed Spitzbergen system would be considerable, but does this matter when coal on this lonely island exists in the riotous abundance which the B.B.C. Brains Trust alleges? Enormous power stations can be built and Brobdingnagian generators installed, while the smoke nuisance won't worry anybody; the eskimos will probably enjoy it.

There is just one small snag, and that is the fact that the earth's surface is curved and ultra-short waves have a nasty habit of not following it but of shooting off into space like light waves. Technical minutiae of this kind, however, can be no concern of mine, but it is obvious that if half of what we hear about helicopter development be true, it will only be necessary for some of them to take up their stance at suitable intervals along the route to act as reflectors so that the transmitted energy can get across the four hundred miles of sea in some half-dozen zigs and zags 'twixt sea and sky.

Post-war Power Possibilities

THE recent statement by a member of the B.B.C. Brains Trust that the coal deposits of Spitzbergen were among the richest in the world was a great surprise to me. So, too, was the complete lack of imagination contained in the opinion expressed by another Brains Trustee that it was a pity that the uneconomic cost of transporting the coal to the European mainland would forever prevent this great source of potential energy being tapped.

It is, of course, this same parochial attitude of mind that is responsible for the present so-called coal shortage. Actually there is no shortage at all; there is just as much coal in North Wales and in other coalfields as there would have been had there been no war. The trouble is lack of transport facilities on the railways and lack of labour in the mines. Had the old and sound idea of burning the coal at the pithead been adopted in pre-war days there would have been no transport problem, and the labour so saved on the railways could have been directed to the pits.

Such matters, however, lie outside the scope of us radio engineers or they would have been settled long



"Commissioned by Mrs. Free Grid's mother."

The only fly in the ointment was the price, which was just about double the original figure at which the set sold when new. As most of you know, all second-hand articles must, by wartime regulations, be sold at a price not exceeding the original price, and I was just about to find a policeman when the dealer disclosed the ingenuity of the whole business by blandly explaining that

Angles on **BRIMAR PRESTIGE**



Brimar Valves often make all the difference to radio reception. They operate to very close limits with unfailing reliability.

BRIMAR **BVA** **VALVES**

STANDARD TELEPHONES AND CABLES LIMITED, FOOTSCRAY, SIDCUP, KENT.

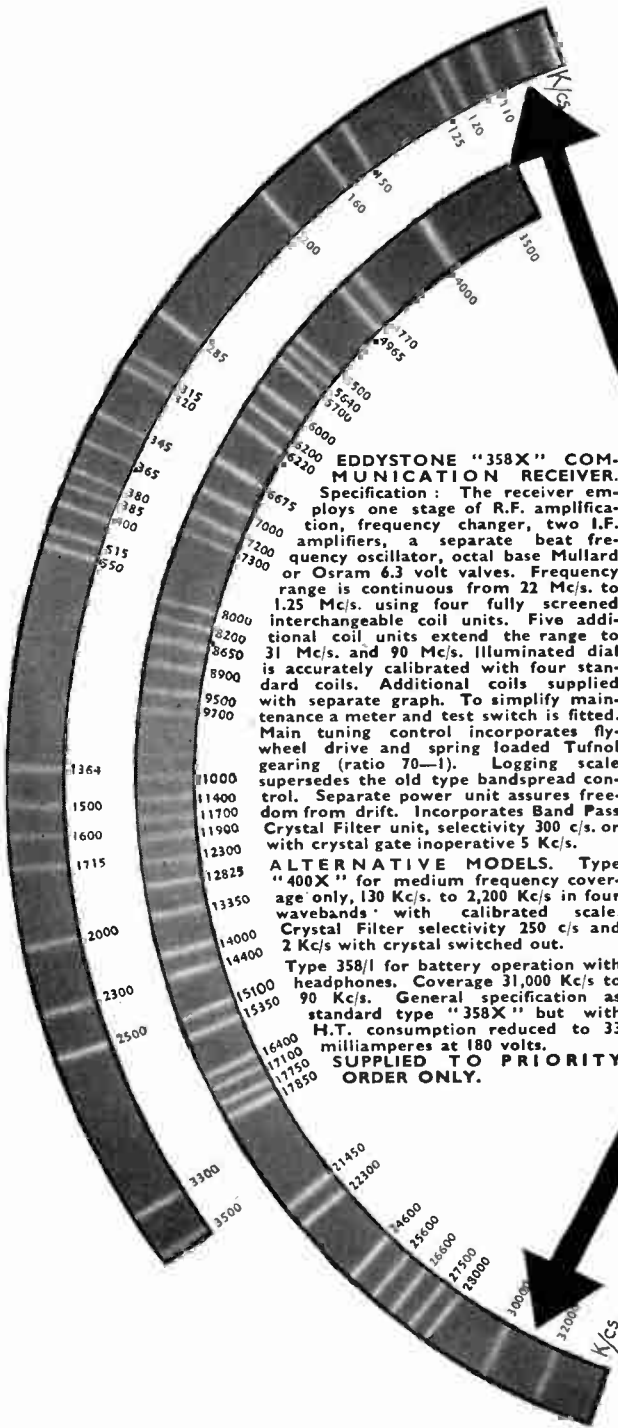

EDDYSTONE "358X" COMMUNICATION RECEIVER.
 Specification: The receiver employs one stage of R.F. amplification, frequency changer, two I.F. amplifiers, a separate beat frequency oscillator, octal base Mullard or Osram 6.3 volt valves. Frequency range is continuous from 22 Mc/s. to 1.25 Mc/s. using four fully screened interchangeable coil units. Five additional coil units extend the range to 31 Mc/s. and 90 Mc/s. Illuminated dial is accurately calibrated with four standard coils. Additional coils supplied with separate graph. To simplify maintenance a meter and test switch is fitted. Main tuning control incorporates fly-wheel drive and spring loaded Tufnol gearing (ratio 70-1). Logging scale supersedes the old type bandspread control. Separate power unit assures freedom from drift. Incorporates Band Pass Crystal Filter unit, selectivity 300 c/s. or with crystal gate inoperative 5 Kc/s.

ALTERNATIVE MODELS. Type "400X" for medium frequency coverage only, 130 Kc/s. to 2,200 Kc/s. in four wavebands with calibrated scale. Crystal Filter selectivity 250 c/s. and 2 Kc/s. with crystal switched out.

Type 358/1 for battery operation with headphones. Coverage 31,000 Kc/s. to 90 Kc/s. General specification as standard type "358X" but with H.T. consumption reduced to 33 milliamperes at 180 volts.

SUPPLIED TO PRIORITY ORDER ONLY.

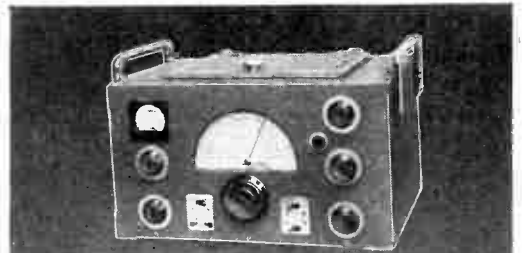

EDDYSTONE '358X' Communication Receiver

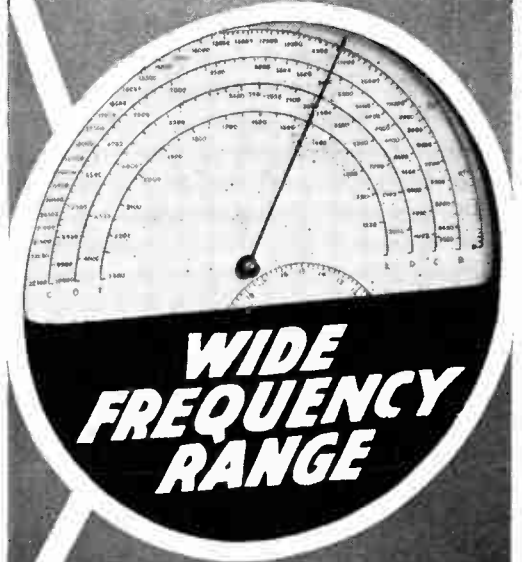

**WIDE
 FREQUENCY
 RANGE**

In these days of ever changing frequency allocation the Eddystone "358X" meets all emergencies with a coverage from 31Mc/s. to 90Kc/s.

WEBB'S RADIO
 THE SHORT-WAVE SPECIALISTS

The receiver may be inspected at
14, SOHO STREET, LONDON, W.1.
 Between 10 a.m. and 4 p.m. (Sats. 10 a.m. to 12 noon.)
 Telephone: GERrard 2089.

WORLD OF ——— WIRELESS

P.M.G. CERTIFICATES

IT was recently announced in *Wireless World* that the G.P.O. had agreed to the suggestion of the Radio Society of Great Britain that ex-Service men wishing to obtain amateur transmitting licences should be exempt from examination in radio theory and/or Morse, providing they can produce evidence that during the war they have served in an approved radio trade or category. This may have caused the rumour that wireless operators in the Armed Forces will, on application after demobilisation, be granted P.M.G. Certificates of Proficiency without further examination. There is, of course, no truth in this.

It is, however, proposed that wireless experience in the Armed Forces shall be deemed to be equivalent to Sea Service. This means that ex-operators from the Forces will be allowed to take a modified examination for the P.M.G.'s Second Class Certificate.

It should be made clear that the modified examination is not actually an easier test. It merely means that it is considered operating experience makes it unnecessary for the candidate to take certain tests. The written examination will not be modified and the Certificate will, in all respects, be the same as that issued to a candidate taking the full examination.

SPEECH-ON-LIGHT SYSTEM

THE German Army is said to be using a "speech-on-light" beam signalling system, which employs a modulated light beam as the transmitting medium for speech. The advantages claimed for this method, originally developed in about 1935, is that, unlike radio, it cannot readily be intercepted and it dispenses with line field telephone systems.

This German apparatus comprises a send-recv head, which contains a lamp, modulating device, transmitting lens (80 mm.), colour filters, receiving lens, photo-cell (Thalofide type) and its amplifier and built-in telescope (for aligning the instrument with distant terminal), the whole unit standing on a strong tripod. The separate send-recv AF amplifiers and batteries are housed in a box, which is placed on the ground near the tripod. The apparatus, complete with accessories, weighs about 5 lb.

The instrument can be operated on white, red, or infra-red light,

◆
WIRELESS OPERATORS of an R.A.F. squadron in the Mediterranean theatre of war have equipped the camp with a wired relay system over which transmissions from the unit's own "studio" are relayed. Some of the operators are shown in the "control room." Spare or discarded gear was used for the installation, which links each mess on the site.
◆



merely by turning a knob. By using the infra-red filter, the possibility of enemy interception is prevented and secret communication in darkness ensured. The average effective range, dependent on atmospheric conditions, is about five miles at which distance the practically parallel beam of light is about 90 ft. wide. Reception is by means of headphones.

U.S. TELEVISION PLANNERS

AT the first meeting of the American Television Broadcasters' Association a post-war planning committee was appointed. Its terms of reference are: "To study problems and potentialities of commercialised television not only in terms of telecasting, set manufacture and trade, but even more so as a huge employment opportunity."

CARIBBEAN CONFERENCE BROADCASTS

THE new station at Barbados—latest link in the Empire's telegraphic chain—established by Cable and Wireless to speed communications between the West Indies and the two powers which are co-operating in the Anglo-American Caribbean Commission, was used to transmit eye-witness accounts of the recent Anglo-American Caribbean Conference. The station, VPOIL, was equipped for telephony to meet possible war demands, and was thus able, at short notice, to comply with the Commission's request for this facility.

Three fifteen-minute talks were broadcast at the end of each day's

session; one for relaying in the B.B.C.'s Empire programmes; one for the National Broadcasting Company's American programme, and a third for the West Indies.

TECHNICIANS WANTED

TO meet a situation of "extreme urgency" in connection with the forthcoming military operations in Europe the Overseas Branch of the U.S. Office of War Information recently appealed to the broadcasting industry for the release for a period of six months of a number of qualified technicians. The immediate need was for transmitter and studio engineers and installation mechanics used to handling transmitters of from 250 watts to 50 kilowatts.

According to our Washington contemporary, *Broadcasting*, important installations in the Mediterranean theatre of operations are also being delayed by the lack of technicians.

B.B.C. DIRECTOR-GENERAL

AFTER only six months as Director-General of the B.B.C., Robert W. Foot is leaving to be the first full-time chairman of the Mining Association. He joined the B.B.C. in October, 1941, as general adviser on its wartime organisation. Three months later, on the resignation of Sir F. W. Ogilvie, Sir Cecil Graves and Robert Foot were appointed Joint Directors-General. In September last year Sir Cecil resigned and Robert Foot was appointed sole D.G.

W. J. Haley, who was appointed to the new post of B.B.C. Editor-

Wireless World

World of Wireless—

in-Chief last September, succeeds to the director-generalship. He served as a wireless operator at sea during the latter part of World War I.

Sir Noel Ashbridge continues as Deputy Director-General.

FLYING RADIO OFFICERS

THE Radio Officers' Union announces that an agreement with Associated Airways Joint Committee provides for a 50 per cent. increase in flying pay for radio officers and the institution of a new grade—that of Senior Radio Officer. The agreement allows for the immediate increase of £32 a year to all the radio officers concerned and an ultimate increase for certain radio officers who are appointed seniors, up to a maximum of just over £90 a year.

COMMEMORATION MEETING

A SPECIAL meeting of the Wireless Section of the Institution of Electrical Engineers has been arranged for May 3rd, to celebrate the Silver Jubilee of the Section. Six past chairmen of the Section will give short addresses reviewing wireless progress during the past 25 years. The speakers will be Col. Sir A. Stanley Angwin, Dr. W. H. Eccles, Prof. G. W. O. Howe, Admiral Sir Charles E. Kennedy-Purvis, H. Bishop and Dr. R. L. Smith-Rose. Historic apparatus will be on view and a gramophone recital dealing with historic events in the world of wireless will be given. If time permits films of Sir Oliver Lodge and Sir Ambrose Fleming will be shown. The meeting, which begins at 5.15, will be preceded at 4.30 by a reception and tea. A dinner will be given at the Waldorf Hotel at 7.30.

WHAT THEY SAY

IN the first World War our radio and sound production just about equalled one week's production in World War II. . . . Battles are won and lost on the strength of communications. Some of Rommel's earlier successes in Africa were due not so much to the numbers of his tanks as to the superiority of his communications. — Rear Admiral Stanford C. Hooper, U.S. Navy, writing in the "Proceedings of the I.R.E."

Found, while primrosing in Kent: strands of silver-coated radio dislocation paper. . . . Zoë Farmar, writing in "News Chronicle."

FM is of age and has come to stay. . . . It now stands on the threshold of as tremendous a development as did standard broadcasting in the 1920's.—F.C.C. Chairman, J. L. Fly, at the fifth annual meeting of F.M. Broadcasters, Inc.

B.B.C.'s S-W TRANSMITTERS

A BRIEF account of the engineering development of the B.B.C.'s European and Overseas Services during the war is given by Harold Bishop, chief engineer, in the recently published B.B.C. Year Book, 1944. He reveals that, whereas the B.B.C. had only eight short-wave transmitters in use before the war, in December, 1943, there were thirty-four in operation.

The Year Book, which is well illustrated, is a mine of information on the wartime activities of the B.B.C. It is obtainable, priced 2s. 10d., from the B.B.C. Publications Dept., The Grammar School, Scarle Road, Wembley, Middlesex.

INTERNATIONAL CONFERENCE

THE possibility of holding in England an early post-war international conference of radio institutions has been discussed by the British Institution of Radio Engineers with the Australian I.R.E. and the American I.R.E. It is learned that in view of the need for early post-war international discussions in the field of radio the Australian institution has intimated its support of the proposal.

OBITUARY

WE record, with regret, the death at the age of 65 of Commander John Ambrose Slee, C.B.E., R.N. (Retd.), technical consultant of the Marconi International Marine Communication Co., and formerly joint general manager of the Marconi Sounding Device Co. From 1908 until toward the end of the 1914-18 war he was in charge of all the Admiralty wireless stations and



The late Commander J. A. Slee.

visual signalling stations in the United Kingdom, and on the formation of the Wireless Telegraphy Board Commander Slee was appointed its chief. He retired from the Navy in 1919.

Commander Slee joined the M.I.M.C. in January, 1920, and represented the company at many

international radio telegraph conferences, including those in Washington in 1927, Madrid in 1932, and Cairo in 1938. He was a member of the I.F.E. and past chairman of the Wireless Section.

We also regretfully record the death of Capt. Oliver George Hutchinson, who was chiefly responsible for the financial structure of the Baird Television Companies both in this country and abroad. He was the first managing director of the Baird Television Development Company formed in 1927.

IN BRIEF

B.B.C. Income.—It is understood that the Government grant to the B.B.C. has been cut by one million pounds—from £10,000,000 to £9,000,000—in the Civil Estimates just out.

New York Viewers.—A recent survey of television receivers in the New York area, undertaken by the National Broadcasting Company, shows that only slightly over 80 per cent. of the 4,600 sets in the area are at present in working order. The survey further revealed that there was "a responsive television audience of 40,000 in the New York area."

Gramophone Bible.—The American Foundation for the Blind has recently completed a recording of the Bible. This "talking-book" comprises 160 discs, of the slow-speed (24 r.p.m.) type, and takes a little over 84 hours to reproduce.

R.C.A.—In the report accompanying the annual statement for 1943 of the Radio Corporation of America it is stated that the company's production for the Armed Forces of the U.S. and the United Nations showed an increase of more than 100 per cent. over 1942. The total gross income had increased by over \$97,000,000.

Anglo-American Relations.—At the request of Oliver Lyttelton, Minister of Production, Geoffrey Smith, Managing Editor of *Flight* and *Aircraft Production*, is proceeding to America in connection with the interchange of technical Press information.

MEETINGS

Institution of Electronics

North-West Branch.—At a meeting to be held at Reynolds Hall, College of Technology, Manchester, at 7 p.m., on May 19th, G. M. Tomlin and C. Wontner will lecture on "Selenium Photocells." Non-members may obtain tickets from L. F. Berry, 14, Heywood Avenue, Austerlands, Oldham.

Brit. I.R.E.

London Section.—At a meeting to be held at the Institution of Structural Engineers, 11, Upper Belgrave Street, London, S.W.1, at 6.30, on May 25th, Dr. Hilary Moss will give a paper on "The Electron Gun of the Cathode-Ray Tube; Part I—Limitations in its Performance."

Midlands Section.—A meeting will be held at the University of Birmingham (Latin Theatre) at 6.30 on May 17th;

subject and speaker not announced at the time of going to press.

North-Eastern Section.—"Theory of Rectification" is the subject of the paper to be given by A. H. Hoult at Neville Hall, Newcastle-on-Tyne, on May 24th at 6.30.

Institute of Physics

Electronics Group.—L. G. Grimmett will give a paper on "The Electro-

static Generator; its Development and Prospects," at a meeting to be held in the rooms of the Royal Society, Burlington House, London, W.1, at 5.30, on May 4th.

Institution of Electrical Engineers

Cambridge and District Wireless Group.—A discussion on "Training for the Radio Industry" will be opened

by C. R. Stoner and R. W. Wilson at a meeting to be held at the Cambridge-shire Technical School, Collier Road, Cambridge, on May 1st, at 5.30. "The Contribution of Cambridge to Radio Engineering" is the subject of the paper to be given by Dr. E. B. Moullin at a meeting to be held at 8.15 at the University Engineering Dept., Trumpington St., Cambridge, on May 11th.

NEWS IN ENGLISH FROM ABROAD

Country : Station	Mc/s	Metres	Daily Bulletins (BDST)	Country : Station	Mc/s	Metres	Daily Bulletins (BDST)
Algeria				Egypt			
Algiers	8.965	33.46	1700, 1800, 1900, 2000, 2200, 2300	Cairo	7.510	39.94	1945, 2200
	12.110	24.77	1800, 1900, 2000, 2200	French Equatorial Africa			
America				FZI (Brazzaville) ..	11.970	25.06	2045, 2245
WRUW (Boston) ..	6.040	49.67	0900	India			
WLWK (Cincinnati) ..	6.080	49.34	0700, 0800, 0900, 1000	VUD3 (Delhi) ..	7.290	41.15	0630, 1000, 1500, 1750
WKRD (New York) ..	6.100	49.18	0100, 0200, 0300, 0600, 0700, 0800	VUD4	11.790	25.45	0630
			0200, 0300, 0400, 0500, 0615	VUD3	11.870	25.27	0630, 1000, 1500
WOOC (Wayne) ..	6.120	49.03	1000, 1100	Iran			
			0800	EQB (Teheran) ..	6.155	48.74	2325
WBOS (Boston) ..	6.140	48.86	0810, 0910	Mozambique			
WCBX (Brentwood) ..	6.170	48.62	0000, 0100, 0200, 0300, 0400, 0500, 0600, 0900, 1000	CR7BE (Lourenco Marques) ..	9.830	30.52	2150
WGEO (Schenectady) ..	6.190	48.47	0300, 0400, 0500, 0600, 0800, 1000	Newfoundland			
WKTM (New York) ..	6.370	47.10	0700, 0800	VONH (St. John's) ..	5.970	50.25	0015
			0900, 1000†	Palestine			
WKLJ (New York) ..	7.565	39.66	1100, 2200	Jerusalem	11.750	25.53	1715
WLWO (Cincinnati) ..	7.575	39.61	1300	Portugal			
WKRD (New York) ..	7.820	38.36	1200	CSW6 (Lisbon) ..	11.040	27.17	2100
WGEO (Schenectady) ..	9.530	31.48	1300, 2100, 2200, 2300	Spain			
WCDA (New York) ..	9.590	31.28	1400, 1500	EAQ (Aranjuez) ..	9.860	30.43	2150†
WCRC (New York) ..	9.590	31.28	1630, 1730, 2000, 2145	Sweden			
WOOC (Wayne) ..	9.650	31.09	1400, 1500, 1600, 1700, 1800	SBU (Motala) ..	9.535	31.46	2320†
WNBI (New York) ..	9.670	31.02	1300, 1400	SBP	11.705	25.63	1800
WKRD (New York) ..	9.897	30.31	1200, 2200	Switzerland			
WCDA (New York) ..	11.145	26.92	1200, 2200	HER3 (Schwarzenburg) ..	6.345	47.28	2250
WLWO (Cincinnati) ..	11.710	25.62	1300, 1400	HER4	9.535	31.46	2250
WRUW (Boston) ..	11.730	25.57	1300, 1500, 1630, 1900	Syria			
WCRC (Brentwood) ..	11.830	25.36	1500, 1600, 1700, 1800, 1900, 2000, 2100, 2200, 2300	FNE (Beirut) ..	8.035	37.34	1835
WGEO (Schenectady) ..	11.847	25.32	1630, 1730, 2000, 2145	Turkey			
			1800	TAP (Ankara) ..	9.465	31.70	1900
WOOW (Wayne) ..	11.870	25.27	1300, 1400	U.S.S.R.			
WBOS (Boston) ..	11.870	25.27	1300, 1500, 1630, 1900	Moscow	5.890	50.93	0000
WRUS (Boston) ..	15.130	19.83	1400, 1500, 1600, 1700, 1800, 1900		7.300	41.10	0000, 0047, 1900, 2100, 2200, 2300
			1300, 1400		7.332	40.92	0000, 2100, 2200, 2300
WOOC (Wayne) ..	15.190	19.75	1300, 1500, 1630, 1900		9.545	31.43	1340, 1615
WBOS (Boston) ..	15.210	19.72	1500, 1600, 1700, 1800, 1900, 2000, 2100, 2200, 2300		10.445	28.72	1340
WLWK (Cincinnati) ..	15.250	19.67	1630, 1730, 2000, 2145		11.830	25.36	1700
			1800		11.940	25.13	0047, 0200
WCBX (Brentwood) ..	15.270	19.65	1300, 1400, 1800†		15.230	19.70	1340, 1615
WGEO (Schenectady) ..	15.330	19.57	1900		15.750	19.05	1340, 1420
WRUL (Boston) ..	15.350	19.54	1700, 1800	Vatican City			
WRUW (Boston) ..	17.750	16.90	1500, 1600, 1700, 1800, 1900, 2000	HVJ	5.970	50.25	2115
WLWO (Cincinnati) ..	17.800	16.85	1630, 1730	Algers		kc/s	Metres
						1,176	255
WCDA (New York) ..	17.830	16.83	1630, 1730	Athlone		565	531
Australia				Tunis		868	345.6
VLI4 (Sydney) ..	7.240	41.45	1615				0000, 0100, 0200, 2000, 2100, 2200, 2300
VLG (Melbourne) ..	9.580	31.32	1615				
Belgian Congo							
Leopoldville	15.167	19.78	1300				
Brazil							
PRL8 (Rio de Janeiro)	11.715	25.61	2130†				
China							
XGOY (Chungking) ..	9.635	31.14	1600, 1800, 2230				
Ecuador							
HCJB (Quito) ..	12.455	24.09	0100, 2130				

It should be noted that the times are BDST—two hours ahead of GMT. † Sundays excepted.

WIRELESS AND WEATHER

Exploration by Ultra-short-wave Reflections

By

T. W. BENNINGTON

SINCE the earliest days of short-wave experimentation there has always been an idea that propagation of the waves might, in some way, be affected by the weather. One recalls, for example, that the QSL cards used by amateur radio men nearly all contained a space for recording the barometric pressure, and, in some cases, the temperature, wind direction and weather conditions as well. Claims were made from time to time that variations in reception had been found to coincide with certain conditions of atmospheric pressure, with temperature, or with the geographical location of depressions and anticyclones.

It is not at all obvious, however, why, in the case of ordinary short-wave propagation, such a connection should have been so persistently sought for. So far as the ground wave is concerned, it would not appear likely that the atmosphere would have much effect upon its propagation—at least when compared with the effects of the ground itself. As to the sky wave, this was known to travel to its destination by refraction in the layers of the ionosphere, and that being so, such a small part of the trajectory would lie within the troposphere that it would seem unlikely that conditions in this part of the atmosphere would have much effect upon it.

It should here be remarked that the variation of weather conditions occurs only in the troposphere; i.e. in that part of the atmosphere stretching from the earth's surface up to a height of six miles or so above it. Above this region there would appear to exist more or less constant conditions of temperature and pressure at any particular height; at least, conditions do not change so as to give rise to the weather phenomena of the lower atmosphere.

But that there is something in this weather business is apparent when we come to consider the propagation of the ultra-short waves, for this has been found to vary appreciably with meteorological conditions.

Such waves travel from transmitter to receiver by a path which lies entirely within the troposphere, and rays which travel upwards at angles such as will take them above the troposphere never—under normal atmospheric conditions—return to earth at all. Above the upper boundary of the troposphere there is no medium capable of returning these waves, for their frequency is so high that they penetrate through the ionosphere entirely.

However, when there are certain irregularities present in the tropospheric air—such as are of considerable interest to the meteorologist—the upward-going energy may be returned. But before we go into this matter it may be well to consider a few points concerning ultra-short-wave propagation under normal atmospheric conditions.

Ultra-Short-Wave Propagation.—Waves of frequency higher than about 50 Mc/s, which take off at fairly large angles to the horizontal, do not—under normal ionospheric and atmospheric conditions—return to earth. Only waves which go out horizontally, and at small angles to the horizontal, are of use in effecting communication. This part of the radiated energy comprises the so-called ground wave, and this ground wave is made up of several components, only two of which we need consider here. The first of these is the surface wave; i.e. the energy which remains in contact with the ground itself throughout its journey. On the medium waves this surface wave is the most important component of the ground wave, and at any point within the service area of a station, and at the greatest height above the surface at which a receiving aerial would normally be situated, is strong enough to swamp any effects due to other components of the ground wave. But on ultra-short waves the

receiving aerial is usually several wavelengths above the earth's surface, and then the effect of the surface wave is negligibly small, for, at heights greater than 2 or 3 wavelengths it is so weak as not to contribute much to the received signal.

This brings us to the second component of the ground wave which we are to consider; namely, a wave which follows a direct path through the atmosphere between transmitting and receiving aeriels. On the ultra-short wavelengths this is responsible for the major part of the received signal, particularly at distances approaching the optical range, and beyond this. For, as we shall shortly see, this direct wave is enabled to reach a receiving aerial which is well below the line of sight.

Bending of the Direct Wave.—

If the direct wave travelled in a perfectly straight line—as it would do if it were travelling in a medium with constant electrical properties—it would soon be intercepted by the bulge in the earth's surface, and no energy would be receivable beyond this point.

But first there is the phenomenon of diffraction—by which a wave is enabled to bend slightly round an intervening object, like the bulge in the earth's surface. This does enable the wave to reach to distances below the line of sight, but it is only partly responsible for the field actually present at these distances, this being much greater and reaching to further distances than would be accounted for by the diffracted wave alone. The greater part of the field beyond the line of sight is due to the presence of a direct ray which has been subject to refraction in the troposphere.

When the tropospheric air is in what we may call its "normal" state, the temperature and the atmospheric pressure both decrease with increasing height, as also does the water vapour content of the air (the colder the air the less water vapour can it hold). From an electrical point of view the decrease in these quantities

results in a decrease of the dielectric constant of the troposphere with height. A decrease in dielectric constant means that the refractive index will decrease, and on waves of very high frequency, a small decrease in dielectric constant will result in the wave path no longer being in a straight line, but bending continuously from the regions of low refractive index to those where it is higher. Thus the wave will tend to be bent downwards again,

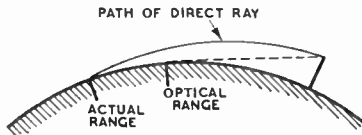

Fig. 1. Showing how the direct wave may be receivable beyond the optical range.

and we may regard the direct ray receivable at a place beyond the optical horizon as travelling in a curved path between transmitting and receiving aerials, as illustrated in Fig. 1. As will be seen from the diagram, it is this curvature in the path of the wave which enables it to reach to distances well beyond the optical horizon.

It will be appreciated that the rate of change of the temperature, pressure and water vapour content of the atmosphere with height will not be constant, but will undergo slow changes with time. The result is that the amount of bending of the direct ray will vary, and this will cause slow fading of the received signal. This fading, however, is usually of a tolerable nature.

Reflection From Atmospheric Discontinuities.—Under certain meteorological conditions there may arise a situation in the troposphere where the temperature no longer decreases with increasing height, but remains constant, or even shows a rise with height. Again, the water vapour content may, given certain air mass conditions, suddenly increase with increasing height instead of decreasing as in the "normal" atmosphere. When a wave of high frequency encounters such a "discontinuity" in the tropospheric air it no longer behaves in the way we have just discussed. A considerable part of the energy

in the wave is *reflected* at the boundary of, or just within, the air mass which gives rise to the discontinuity, and is sent travelling down towards the earth again. Waves travelling in all upward directions may be affected in this way, depending upon the location of the new air mass, and, under these conditions, the waves may return to earth so as to be receivable both within, and also beyond, the optical range. Fig. 2 should make this point clear. As the condition of the air where the discontinuity occurs may be changing fairly rapidly with time, and furthermore, as the new air mass may be moving fairly rapidly over the earth's surface, the downcoming reflections will affect the receiving aerial in random phase and intensity with respect to the directly received wave. Such a condition will give rise to deep and sometimes rapid fading of the received signal. Such fading has often been observed in reception of these frequencies, and is found to correlate with meteorological conditions. Although the reflected energy would appear to lead to an increase in the average field strength at the receiving location, it does not seem as if such reflections will be of much help in improving reception of ultra-short-wave stations, either within or beyond the optical range, because of the serious fading introduced into the received signal.

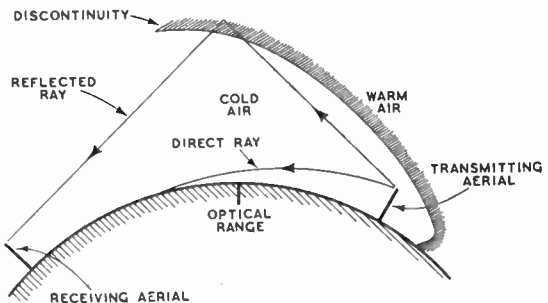

Fig. 2. Showing how the high angled rays may be returned from "discontinuities" in the atmosphere.

What may be of some importance, however, is the mere dependence of the reflected waves upon the meteorological conditions, for it would appear possible, because of this, that the reflections themselves might be of use in indicating that certain meteorological conditions existed. Thus the meteorologist would have a useful tool which would assist him in the analysis of the air

over large areas and at considerable heights above the surface. In order to understand how he might make use of this tool we had better examine some of the air mass conditions which might give rise to radio reflections of this kind.

Air Masses.—A mass of air which has been lying for a time over a certain area takes on some of the characteristics of the latitude of that area. It can, for example, become predominantly cold, hot, dry or moist, according to the conditions prevailing in the land or ocean over which it is lying. The two main types of air mass are the Polar and the Tropical—names which speak for themselves—and these are each subdivided into Continental and Maritime masses. Cold Polar air is usually dry, and warm Tropical air moist, whilst the Continental air mass is usually dryer than the Maritime air mass of the same order of temperature. There are numerous other classifications and characteristics which we need not bother about here.

When such air masses move—sooner or later they inevitably do—to different latitudes, they come into contact with other masses having different characteristics, and so give rise to changing weather conditions in the areas where the contact occurs. This will be apparent if one remembers only one or two of the scientific

facts involved: (1) That cold air is denser than warm air and so remains at lower levels; (2) that warm air can hold more water vapour—without it condensing out and causing clouds and rain—than can cold air, and (3) that when warm air is forced upwards it cools, and so cannot hold the water vapour it contains.

The temperate regions of the Northern Hemisphere are affected

Wireless and Weather—

mainly by Polar air masses, travelling in a south-westerly direction from the Arctic regions, and by air masses coming from sub-tropical regions which usually move in a north-easterly direction. When two such air masses come in contact there is a boundary region—which may be a few

pressure is plotted for places all around the bulge—after it has become well developed—it is found that the isobars run in a circular direction round the bulge, which thus becomes the centre of the depression. The whole system usually continues to move—generally in a north-easterly direction—and to develop, so that

pressure becomes equalised over the area, and the system disappears. That, at least, is the general picture of the life of a depression, and though it might not be complete enough to satisfy a meteorologist, is sufficiently accurate for our purposes.

Fronts and Occlusions.—If we could look at a section through a warm front we should get a picture like that of Fig. 4. Here we have the warm moist air mass overtaking the cold, dry air and flowing smoothly upwards over it. When warm air ascends in the atmosphere it becomes expanded, because of the reduction of atmospheric pressure, and this expansion causes the air to become colder. When cold the air can no longer hold the moisture which it contains, and this condenses out in the form of clouds and eventually—near the front—gives rise to heavy rain. Thus the warm front is responsible for certain weather conditions—rain, hail, sleet, snow—and various degrees and forms of cloudiness, which extend far in advance of the position of the front on the ground itself. And the important thing to notice is that for some hundreds of miles in advance of the front itself we have the situation where the air overhead may be at a higher temperature, and contain a greater amount of water vapour, than that immediately beneath it. So that at a certain height in the atmosphere we are likely to encounter a “discontinuity.” where the rate of change of water vapour content and of temperature with height alters abruptly.

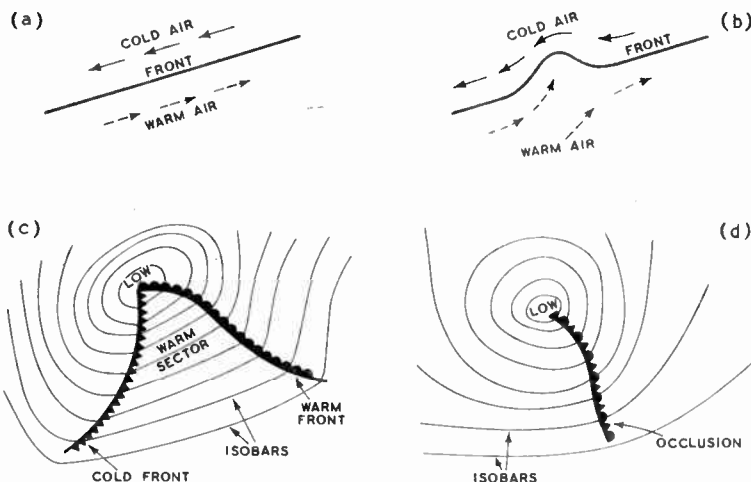

Fig. 3. Weather “fronts”: (a) The front in its initial stages; (b) formation of a “bulge” of warm air; (c) depression with cold and warm fronts; (d) an occluded depression.

miles wide—where the air undergoes rapid changes of temperature and humidity as one passes from one air mass into the other. This is called the front, and at first, since the two masses of air are usually moving steadily in opposite directions, the front may be pictured as a straight line representing the boundary between them, as in Fig. 3a. This arrangement does not, however, persist for very long, for a bulge of warm

after a time conditions are somewhat as in Fig. 3c. Here we have a well-developed depression, with warm front and cold front both moving in an easterly direction. The southern sector of the depression is the warm sector. But the cold front moves faster than the warm front, and gradually overtakes it, this happening at first near to the centre of the depression, and then gradually spreading farther away from it.

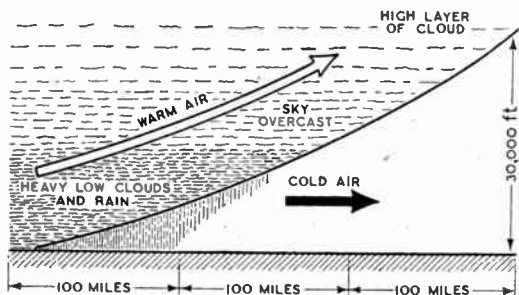

Fig. 4. Section through a warm front.

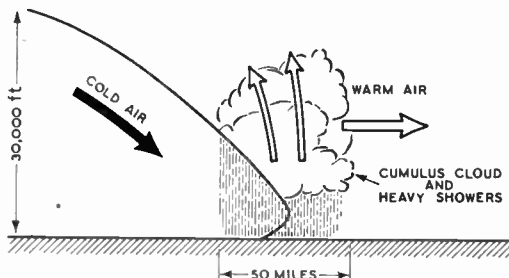

Fig. 5. Section through a cold front.

air is usually formed in the front, pointing towards the north, and in this the pressure falls (Fig. 3b). This is the beginning of a depression, for if the atmospheric

The fronts are then said to be “occluded” (Fig. 3d), and when the occlusion becomes more or less complete the depression gradually fills up, the atmospheric

Fig. 5 shows the conditions usually present in the cold front. Here we have a mass of cold air overtaking the warm air and pushing under it, so as to force the

warm air upwards. Warm air forced upwards in this way gives rise to large cumulus clouds, and to heavy rainstorms—perhaps to thunderstorms—near the front itself, and extending for several miles on either side of it. In this case a discontinuity in the atmosphere may exist for some hundreds of miles in the rear of the position of the front at the ground itself.

When the advancing cold front catches up with the warm front we may get the situation shown in Fig. 6. Here the cold air mass on the south-westerly side of the depression has made contact with the cold air on the south-easterly side, and the warm air is forced up above the ground altogether. The front at this point is occluded. In the region of the occlusion there is usually heavy rain, with a large amount of cumulus cloud in its rear, while in advance of it there are, for some hundreds of miles, certain distinctive types of cloud and weather conditions. On both sides of the occlusion conditions are such as to give rise to discontinuities with height, the warm moist air lying above the cold dry air in the atmosphere.

The pictures given here are, no doubt, somewhat idealised and over-simplified, and it would require a trained meteorologist to interpret all the conditions which might arise. Nevertheless, enough has been said to show that these fronts and occlusions are very significant in determining the weather conditions, and that their location and the analysis of the air in them are matters of importance to the meteorologist in the work of weather forecasting.

Conditions like those pictured in Figs 4, 5 and 6, would seem to be such as would give rise to the reflection, within the troposphere, of ultra-short radio waves. Furthermore, there is the possibility that reflections could occur, not only in the vertical, but in the horizontal plane as well, the reflections coming, as it were, from the "sides" of the air masses. So that, by observing the vertical and azimuthal angles from which the reflected energy was received

it would appear possible to locate the position of a front, and perhaps, by observing the change in these angles, to follow the motion of the air masses over the earth's surface.

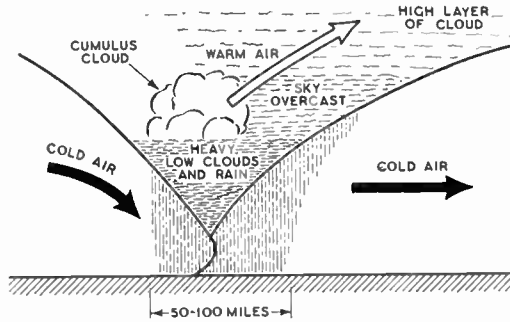

Fig. 6. Section through an occlusion.

Perhaps this may appear to be expecting too great a degree of precision in the observation of the reflections—a precision impossible of achievement because of their very nature. This may well be so—in this article we do but visualise the possibilities. However, judging from information recently published in America*, there does seem reason to think that this technique might become of some service to the meteorologist. Be that as it may, it appears highly probable that, in the post-war world, when the amateur is again permitted to resume his activities, he may have occasion to note down his weather observations with considerably more than his former interest.

* *Radio*, August, 1943, and *QST*, December, 1943.

SCATTERED RADIATION

A Theory Vindicated

WITHIN the skip zone of a short-wave station it is normally possible to obtain some sort of a signal, because of the fact that some of the energy in the radiated wave is "scattered," so that it can arrive at a receiving location which is unaffected by either the "ground" wave or the normal "sky" wave of the transmitter. Part of this scattered energy has been assumed to be due to energy which has been refracted by the F layer in the normal way, and then scattered by ionic clouds in the E layer as it passed through this region on its way down to the ground. But formerly there has been some doubt as to whether the energy was in fact scattered, not

within the E layer, but at the ground itself.

In a recent letter to *Nature*,* T. L. Eckersley, G. Millington and J. W. Cox give the results of some experiments which prove that this long-distance scatter is in fact produced by the ionic clouds in the E layer and not by any ground effects. If the energy were not scattered until it reached the ground there would be a slightly greater time delay in its arrival at the receiving station than if it had come from within the E. Using the measured vertical incidence virtual height against frequency data these experimenters calculated the time delays corresponding to both E layer and ground scatter for various frequencies. Close agreement between the time delays of the observed scatter and those calculated for the E layer clouds was obtained, the values calculated for the ground scatter being greater than those observed. Thus the scatter is shown to be due to the ionic clouds and the original theory (described by T. L. Eckersley) is entirely vindicated. The letter points out that it is not proved that ground scatter does not exist, but the experiments show that the cloud scatter is greatly predominant. As the frequency is increased the cloud scatter decreases in amplitude, so that eventually the ground scatter might predominate, but, as this would not occur until frequencies of about 30 Mc/s were reached, it is unimportant, because at those frequencies the F layer would not, in any case, be able to sustain the transmission.

* *Nature*, March 18th, 1944, p. 341.



Dr. Anton F. Philips, the co-founder and head of the Philips organisation, who has been in New York since the fall of Holland, recently celebrated his seventieth birthday. Although the Eindhoven factory, which at its peak employed 25,000 people, is now being used by the Nazis, Philips resources elsewhere are serving the United Nations' cause.

OPTIMUM LOAD, R_a or $2R_a$?

The Answer Depends on the Valve Operating Conditions

“MAXIMUM power output is obtained from a triode valve when the load resistance R_o in its anode circuit is equal to twice the valve slope resistance R_a .” Though this statement is generally accepted as true, a surprisingly large number of radio engineers seem unable to explain why. The most common suggestion put forward is that it is due to distortion, but distortion plays just the same role in the normal generator optimum load formula giving $R_o = R_a$.

The cause of the apparent anomaly resides in a difference of grid input and anode output conditions, and analysis shows

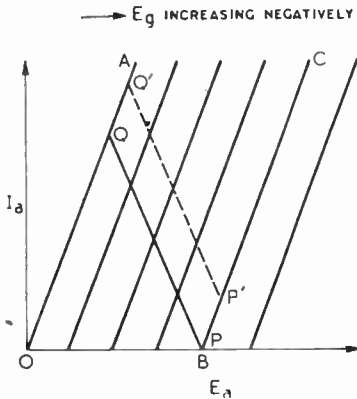

Fig. 1. Idealised linear valve characteristics with load line for maximum power from a limited input voltage.

that in certain circumstances the valve functions like the normal constant voltage generator and has an optimum load of R_a . This occurs when the input grid voltage is constant but the anode voltage is adjustable to any desired value. The valve is then exactly equivalent to a constant voltage generator of μE_g volts and internal resistance R_a supplying a load resistance R_o , and maximum power output is obtained when $R_o = R_a$. This condition is illustrated by the load line PQ drawn across the idealised linear $I_a E_a$ characteristic curves in Fig. 1. The grid voltage limits corresponding to the constant input voltage are indicated by the boundary line OA (for

By

K. R. STURLEY,

Ph.D., B.Sc., A.M.I.E.E.

From correspondence arising out of recent articles in this journal it would appear that there are two schools of thought regarding the loading of a triode valve for maximum power output. Equally weighty arguments have been adduced by both sides but the possibility of a deadlock seems to have been removed by this timely adjudication from an acknowledged authority.

which $I_g = 0$) and the line BC. The line PQ can be located anywhere between OA and BC, but clearly the most suitable position is when B and P coincide. If PQ is raised to P'Q' the AC output power is unchanged but the DC input power is increased, and P cannot be allowed to fall below B, otherwise cut-off distortion occurs. A practical example of this optimum condition ($R_o = R_a$) is provided by the direct-coupled anode load with fixed HT voltage in which R_o carries DC as well as AC anode current.

When the input voltage can be adjusted to make the most economical use of the available $I_a E_a$ characteristics, maximum power output occurs when

anode voltage, the load line MN must take up a position such that $NL = LM$, where L is the intersection of MN and the vertical line through an anode voltage equal to the constant anode voltage E_1 . The slope of OA is $\frac{1}{R_a}$, that of MN is $-\frac{1}{R_o}$ and the equation to MN is

$$I_a = -\frac{E_a}{R_o} + I_3 \dots \dots (1)$$

Replacing I_a by

$$I_1 = \frac{E_3 - E_1}{R_o} = \frac{E_1 - E_2}{R_o}$$

and E_a by E_1 we have

$$I_3 = \frac{2E_1 - E_2}{R_o} \dots \dots (2)$$

$$I_2 = \frac{E_3 - E_2}{R_o} = \frac{2(E_1 - E_2)}{R_o} = \frac{E_2}{R_a} \dots \dots (3)$$

$$\text{From (3), } E_2 = \frac{2E_1 R_a}{2R_a + R_o}$$

$$\text{and } I_2 = \frac{2E_1}{2R_a + R_o}$$

$$\text{AC power output, } P = \frac{1}{2}(E_1 - E_2)I_1$$

$$= \frac{1}{2}(E_1 - E_2)I_2 = \frac{1}{2} \frac{E_1^2 R_o}{(2R_a + R_o)^2} \dots \dots (4)$$

For maximum power output, $\frac{dP}{dR_o} = 0$, or $R_o = 2R_a$, which gives

$$P_{(opt)} = \frac{1}{16} \frac{E_1^2}{R_a} \dots \dots (5)$$

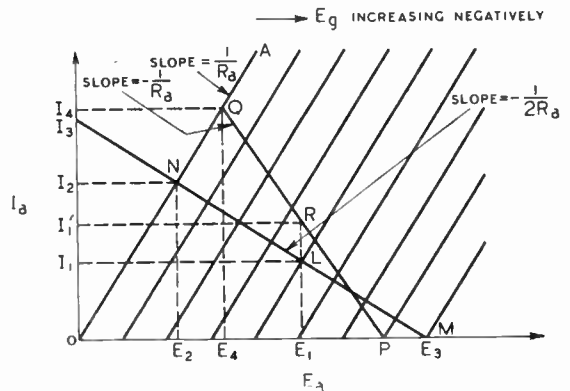

Fig. 2. Conditions of Fig. 1 compared with the case where the input voltage can be adjusted to make the best use of the available $I_a E_a$ characteristics.

$R_o = 2R_a$. Referring to the idealised $I_a E_a$ characteristics of Fig. 2, for zero distortion, fullest use of the characteristic and fixed

Now suppose we consider the case of $R_o = R_a$ for the same E_1 . The load line is represented by a line such as PQ and its position

s adjusted for $QR = RP$, where R is the intersection of PQ with the vertical line through E_1 . $OQ'P'$ is an isosceles triangle, so that $E_4 = \frac{2}{3} E_1$ (R bisects PQ), and

$$I_1 = 2I_1' = \frac{E_4}{R_a} = \frac{2E_1}{3R_a} \text{ or } I_1' = \frac{E_1}{3R_a}$$

AC power output ($R_o = R_a$)

$$P' = \frac{1}{2}(E_1 - E_4)I_1' = \frac{1}{18} \frac{E_1^2}{R_a} \dots (6)$$

which is less than that obtained when $R_o = 2R_a$ (expression 5). It is also less efficient from a DC to AC power conversion point of view because the DC power is

$$E_1 I_1' = \frac{E_1^2}{3R_a} \text{ compared with } \frac{E_1^2}{4R_a}$$

The higher anode circuit efficiency and power output for $R_o = 2R_a$ is achieved at the expense of increased input voltage as compared with that for $R_o = R_a$. However, there is usually little difficulty in obtaining the extra voltage from the previous stage.

The difference between the two load conditions is therefore seen to be a function of the grid input voltage. If the latter is the limiting factor and not the anode circuit conditions, then maximum power is obtained for $R_o = R_a$. When the input voltage is unlimited but anode voltage is fixed, $R_o = 2R_a$ gives maximum power output; in this instance E_g is a variable dependent on R_o . The result is modified if the $I_a E_a$ characteristics are not linear.

For $I_a = K \left(\frac{E_a}{\mu} - E_g \right)^2$, R_o (opt) = $1.6R_a^*$, but as a general rule $R_o = 2R_a$ gives more satisfactory results in practice and corresponds to about 5 per cent. total harmonic distortion. It is this fact which has probably led to the erroneous belief that an optimum load of $R_o = 2R_a$ is a result of distortion considerations.

* "Output Characteristics of Thermionic Amplifiers," by B. C. Brain. *Wireless Engineer*, March 1929, p. 119.

1944 HANDBOOK

WE have now received a copy of the Radio Amateurs' Handbook for 1944. This well-known annual publication of the American Radio Relay League was in pre-war days intended solely for the transmitting amateur; now its scope has been widened and it has become to a large extent a training manual for technicians and wireless operators.

With this purpose in view, sections dealing with fundamental principles and design have been revised and expanded. There is a new chapter on Carrier-current Communication; this subject is regarded as providing an interesting field to amateur transmitters debarred temporarily from using the ether. A chapter dealing with the organisation and activities of the War Emergency Radio Service of the American amateurs has been rewritten and expanded.

Among the many useful sections of the Handbook are valve data tables (which include 50 new types) and chapters on aerial systems and VHF equipment.

Copies of the Handbook can be ordered through the Radio Society of Great Britain, New Ruskin House, Little Russell Street, London, W.C.1, for delivery from America in about three months' time. The cost is 10s. 6d. For security reasons, the Handbook cannot be sent in this manner to Service or Government establishment addresses. We understand that copies will also be available direct from A. F. Bird, 66, Chandos Place, London, W.C.2; price 12s. 6d., postage 7d.

AIDING BRITISH EXPORTS

PLANS are now being completed by our publishers for the issue, as soon as possible after the war, of a new journal to foster British engineering export trade. *British Engineering Exporter* will circulate exclusively overseas, and there will be supplements in French, Russian, German and Chinese. Production will be on a lavish scale, with the most modern typography and free use of colour printing. The editorial content of the journal should achieve the highest standards, as its producers will have at their disposal all the resources of the Associated Liffe Press—the largest publishers of specialised journals in the world.

Executives of engineering firms and their publicity advisers can examine a "dummy" copy of *British Engineering Exporter* on application to W. H. Bowers, Dorset House, Stamford Street, London, S.E.1.

BOOK RECEIVED

The *British Journal Photographic Almanac*. The 1944 edition of this annual publication contains articles covering widely differing aspects of both the art and the scientific sides of photography. To meet wartime needs there is a detailed description of the various methods of photographic document copying. There is also a full review of new photographic apparatus. Henry Greenwood and Co., Ltd., 24, Wellington Street, Strand, London, W.C.2. Price 3s. 6d.

GALPINS

ELECTRICAL STORES
"FAIRVIEW,"
LONDON ROAD, WROTHAM,
KENT.

TERMS: Cash with Order. No C.O.D.
All prices include carriage or postage.

MOTOR-DRIVEN PUMP, for oil or water, motor 220v. D.C., 1 amp., 1,250 r.p.m., maker Keith Blackman. **£6 10s.**

MASSIVE GUNMETAL WINCH, complete with long handle, for use with $\frac{1}{2}$ in. dia. wire cable, weight 50 lbs., condition as new. **£3.**

ELECTRIC LIGHT CHECK METERS, well-known makers, first-class condition, electrically guaranteed, for A.C. mains, 200/250 volts 50 cy. 1 phase 5 amp. load, 11/- each; 10 amp. load, **13/6.**

SOLID BRASS LAMPS (wing type), one hole mounting, fitted double contact, S.B.C. holder, and 12 volt 16 watt bulb. **3/6** each, or **30/-** per doz.

TUNGSTEN CONTACTS, $\frac{1}{4}$ in. dia., a pair mounted on spring blades, also two high quality pure silver contacts, $\frac{1}{4}$ in. dia., also on spring blades, fit for heavy duty, new and unused. There is enough base to remove for other work. Set of four contacts, **5/-.**

ROTARY CONVERTER, D.C. to A.C. Input 22 volts D.C. (twenty-two). Output 100 volts at 140 M/A, 50 cycle, single phase, ball bearing, in first-class condition, no smoothing. **£3.**

RESISTANCE UNITS, fireproof, size 10×10 in. wound chrome nickel wire, resistance 2 ohms to carry 10 amps. **2s. 6d.** each.

TRANSFORMER, input 230 volts, output 2,000, 1,000-0-1,000, 2,000 v. at $\frac{1}{2}$ amp. **£9.**

3-PHASE TRANSFORMER, 410v. to 240v. at 2kW, size of core 14in. by 11in. by 5 square inch section. **£10.**

ROTARY CONVERTER, input 220 volts D.C.; output 18 volts at 28 amps. **£7 10s.**

TAPE MACHINE, fitted Klaxon 220v. D.C. motor geared drive, rheostat control, 18 ohm relay, complete with tape reel and tape. **£10.**

VOLTMETER, 9in. dia., switchboard type, for A.C. or D.C., range 0-700 volts, clear scale 100 to 700 volts, very even reading. **£3.**

AIR PRESSURE GAUGE by famous maker. 10in. dia., reading 0-4,000 lb. per square inch, as new, in case. **£7 10s.**

SWITCH FUSE in wrought iron case, 3-way, for 400 volts at 40 amp. **45/-.**

MOVING COIL METERS, a pair by a famous maker, one reading 0-70 v., the other 0-10 amp., 2in. dia., flush mounting, both 1,000 ohms per volt. **£5** the pair.

LARGE RECTIFIER, metal, not Westinghouse, size 4ins. by 5ins. long, output 60 v.-2 amp. **£3.**

METER MOVEMENT for recalibrating, moving coil, 6in. scale, 4 milliamp F.S.D. Price **35/-.**

METER MOVEMENT for recalibrating, moving coil, 4in. scale, deflection not known. Price **20/-.**

MOVING COIL ammeter reading 0-350 amps., 6in. dia., switch board type. Price **£3 10s.** DITTO reading 0-20 amps. **£2 10s.**

100 v. MOTOR BLOWER, $\frac{1}{2}$ h.p. motor, direct current, series wound, 4in. dia. inlet and outlet to Blower. Price **£5.**

100 v. D.C. MOTORS, series wound, ball bearing, totally enclosed, approx. $\frac{1}{3}$ h.p. **20/-.**

LARGE TRANSFORMER, weight 20 lbs., input 240 v., output 9 v.-20 amps. **40/-.**

Volume Expansion • Cathode-follower Output

New Contrast Expansion Unit

WITH reference to the contrast expansion circuit given in *Wireless World* for March, it may be of interest to know that a similar circuit has been made

it is not possible to take the 0.1MΩ potentiometer in the circuit shown in *W.W.* to maximum. Secondly, the circuit measured showed overloading above 22 volts input. Therefore the unit must be inserted at a suitable point in the main amplifier circuit such that the input never exceeds this voltage. Thirdly, it is evident from the measured results that the loss due to the unit is quite appreciable and sufficient stage gain must be available to take care of this.

It is hoped at some future date to make more complete measurements with delayed expansion. In the meantime the writer would thank M. O. Felix for a contrast circuit which causes less distortion of transients than any

Volume Expansion Problem

I HAVE followed the correspondence on volume expansion with considerable interest, hoping that a difficulty I have met in its application might be discussed and a remedy suggested.

The difficulty seems inherent in all types of expander using variable gain valves or valves used as variable impedances, and concerns the large voltage variations at the anode of the "expander" valve. For example, a variable gain valve with an anode load of, say, 20,000 ohms, whose anode current is caused to vary from ½ to 2 mA by the "control" DC, has a voltage variation of 30 volts at a frequency depending on the time-constant used, say 10 c/s. On this 30 volts swing at 10 c/s, the signal proper is superimposed. With RC couplings of normal value, a fair proportion of this swing is passed through the amplifier, and is perhaps responsible for the "objectionable flutter" noted by contributors some years ago.

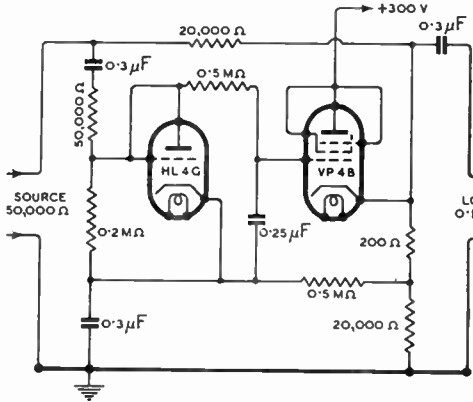

Contrast expansion unit.

up and works very satisfactorily.

The circuit tried was not quite identical with that proposed. A VP4B valve was used in place of the 6K7, and an HL4G strapped as diode was used to replace the 6H6. A sketch of the circuit is attached. A few measured results are given in the Table which may be of interest. Unfortunately time has not permitted of more complete measurements.

One or two minor points may be useful to anyone wishing to construct similar circuits. First, in order to avoid peak chopping it is essential to have 30,000-50,000Ω in series with the diode. Hence

other circuit the writer has tried, and which is very free from hum pick-up and noise due to contrast operation.

WILLIAM C. NEWMAN.
Dewsbury, Yorks.

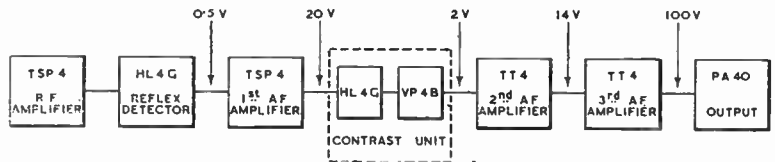

Position of W. C. Newman's contrast unit in amplifier.

The swing is, of course, cancelled out in the output transformer of a push-pull stage, which suggests using the actual "expander" valves in push-pull and taking the output from a transformer, but since RC couplings seem generally favoured for domestic "quality" amplifiers, the swing does its worst right through the amplifier to the output transformer — an anode-current meter in one output valve anode gives disconcerting evidence of this. To retain RC couplings a sharp cut-off filter suggested itself; it passed a 50-c/s signal, but virtually cut off at 20 c/s, the time-constant of the expander being about 1/10 second. Results were disappointing; anode current criteria were satisfied, but an

MEASURED RESULTS Anode Current of VP4B—No signal 5.5 mA.

Input Voltage	Output Voltage	Ratio Input to Output Voltage	Ia. VP4B
2.7 + 8.6db.	0.1 - 20db.	1 : 27	5.0mA
4.0 + 12.0	0.2 - 14	1 : 20	4.7
7.2 + 17.2	0.5 - 6	1 : 14.5	4.1
11.8 + 21.5	1.0 0	1 : 11.8	3.4
15.0 + 23.6	1.5 + 3.5	1 : 10	3.0
18.0 + 25.2	2.0 + 6.0	1 : 9	2.7
21.0 + 26.6	2.5 + 8.0	1 : 8.5	2.5

Figures in db. are relative to 1 volt.
All measurements made across 100,000 Ω load.

indefinable "something" was lacking although the reason for it is obscure. Or is phase-distortion important?

A satisfying solution to the difficulty is still sought. Perhaps one of your correspondents could help one who, convinced by practical trial of the merits of volume expansion, finds the gilt taken off the gingerbread by a difficulty which no doubt can be overcome by some electronic dodge which he has not the wit to devise.

A. A. TOMKINS.

Birmingham.

Post-war Amateur Transmission

AS an old transmitting amateur reading the signs of the times, I see looming ahead an ominous outlook in this sphere. Can any member of our fraternity ever forget the chaos and pandemonium experienced on Sunday mornings and week-ends in pre-war days? At times interference was so intense that anything in the way of serious experimenting was impossible for anyone!

In some directions we now find a marked tendency to commercialise the amateur movement. It is also suggested that a licence be granted to every qualified radio operator coming out of the Services, so that for every amateur transmitting before the war there may be 100 or even 1,000 after. Now, we do not complain, for the "more the merrier," but it seems fairly certain that, of necessity, the post-war amateur frequency bands will be restricted if anything, so what are the prospects for serious experimental work for anyone, old or new?

Are we making a rope to hang ourselves with? It will certainly be very interesting to watch events. "P. B. P."

Cathode-follower Output Stage

I WAS very interested in C. J. Mitchell's article in your April issue, as I have been experimenting along these lines for a couple of years.

When using transformer coupling from the preceding stage to the grid of the cathode follower, considerably less distortion is introduced by feeding into this transformer via another cathode follower. In this case a

primary inductance much lower than usual is satisfactory; if the primary winding of the transformer is wound in sections they may be placed in parallel to provide a useful increase in ratio, thus in part compensating for the loss of the valve's stage gain. On an oscilloscope and audibly the improvement in the extreme bass is most satisfying. Using an MH4 and Ferranti AF3 no harmonic distortion and only some five degrees of phase shift were detected at 50 c/s.

RC coupling may be used to the output stage provided the driver is an RF pentode, but adequate anode voltage is essential fully to load the output stage. In this connection it is preferable to use a separate self-bias resistance for the output stage between the high-potential end of the output transformer and the valve cathode, returning the grid to the junction of output transformer and resistance. The loss of output power in this resistance is very small even if no bypass condenser is fitted (though in this case the effective output impedance on the loudspeaker is increased) and the preceding valve is not so heavily loaded.

In using this type of output stage the impression most remarked upon by visitors who have heard mine is the impression of great reserve power, due presumably to the uncanny absence of harmonic distortion when "turning up the wick." In fact, very good results can be obtained using the "cheap and nasty" type of output transformer, but for sheer quality the results from a RC coupled push-pull outfit feeding a good transformer and speaker will, I think, prove a refreshing surprise to many.

D. BAKER.

Seaham Harbour, Co Durham.

MONOGRAPH ON PLASTICS

Plastics in the Radio Industry. By E. G. Couzens and W. G. Wearmouth. The second of the *Electronic Engineering* series of technical monographs. Chapters deal with the nature and types of plastics, their manufacture and manipulation, and their electrical properties. There are appendices giving information on cements and solvents for plastic materials; identification tests; also a lengthy bibliography. Pp. 57+III; 21 figures. Hulton Press, 43-44, Shoe Lane, London, E.C.4. Price 2s. 6d.

HOME SAFELY— THANKS TO RADIO



THE far reaching achievements of the electronics industry are being made available to the Armed Forces in ever increasing quantities.

Crowe is proud of its proven ability to produce precisely made electronic control mechanisms in large numbers.

★ Exclusively Represented by **Frank Heaver Ltd.,** Kingsley Road, Bideford, N. Devon.

CRONAME RADIO COMPONENTS

CROWE NAME PLATE AND MANUFACTURING CO. CHICAGO, ILL. U.S.A.

OF OUR ABILITIES AND FACILITIES WE GIVE GLADLY



PARAMOUNT above all else is the necessity of meeting urgent and immediate demands for the protection of cherished liberty.

Astatic's engineering and manufacturing facilities are therefore first at the disposal of Allied Governments.

Astatic will be ready to serve you again with high quality piezo-electric devices when the "All Clear" of Victory sounds.

Register your name with our Representative for your future benefit.



THE ASTATIC CORPORATION YOUNGSTOWN, OHIO, U.S.A. TORONTO, CANADA.

—Exclusively Represented by— **Frank Heaver Ltd.** Kingsley Road, Bideford, N. Devon

POTENTIAL DIVIDER DESIGN

A Simple Formula and a Useful Calculating Chart

A POTENTIOMETER in its simplest form consists of two resistances connected in series across a source of potential difference. A potential difference smaller than that of the original source can then be obtained from the junction of the two resistors and either terminal of the original supply. The magnitude of this smaller PD will not be constant, but will vary inversely as the current supplied.

In radio work two frequent problems are (1) to design a potentiometer such that the magnitude of the smaller PD shall not vary outside a stipulated range for a given change in the supplied current, and (2) to determine the value of the smaller PD available from a known potentiometer when supplying a known current. In the latter case a graph of PD against current supplied is useful.

A formula is given which greatly assists in solving all these problems and enables a graph to be drawn for a case when neither the supply PD nor the potentiometer resistance is known.

Nomenclature. — The nomenclature adopted in the subsequent paragraphs will be made clear from Fig. 1 in which V = supply

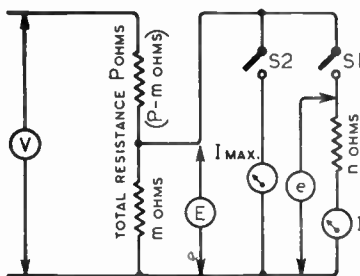

Fig. 1. Circuit diagram illustrating nomenclature used.

volts, E = no load volts with S1 and S2 open, e = "on load" volts with S1 closed, I = load current with S1 closed, n = equivalent resistance of load, I max. = short circuit current with S2 closed.

The Formula.—

$$I = I \text{ max.} - I \text{ max.} \times \frac{e}{E}$$

By

PATRICK F. CUNDY,

A.M.I.E.E.

Examples of Use.—(1) The screens of two valves consume together 5 milliamps and are to be fed with a potentiometer from the anode supply which is 300 volts. The required screen voltage is 80. On strong signals the AVC will reduce the screen current to a very low value, and it is necessary to limit the resulting increase in screen volts to 30 volts. What values of resistances are required?

The whole problem may be worked in terms of volts, kilohms (thousands of ohms) and milliamps, substituting the known values in the formula

$$5 = I \text{ max.} - I \text{ max.} \times \frac{80}{300 + 30}$$

$$\text{Rearranging } I \text{ max.} = \frac{5 \times 11}{3} = 18.33 \text{ mA.}$$

Therefore resistance of upper arm of potentiometer = $\frac{300}{18.33} = 16.5$ kilohms (approx.).

Under no load conditions this 16.5-kilohm resistance must drop 190 volts, and the lower half of the potentiometer must drop 110 volts.

Therefore lower arm of potentiometer = $\frac{110}{190} \times 16.5 = 9.5$ kilohms (approx.).

(2) A potentiometer consists of a 20 kilohm upper arm and a 30 kilohm lower arm. If it is supplied from 200 volts, what voltage will be available with a load of 2 mA?

$$I \text{ max.} = \frac{200}{20} = 10 \text{ mA.}$$

Open circuit voltage

$$= \frac{30}{20 + 30} \times 200 = 120.$$

Substitution of these values in the formula gives e = 96 volts.

(3) The regulation curve, or curve of output volts against output current is required for a

potentiometer the values of the resistances of which are not known and the supply voltage of which is not known.

Since the formula is that of a straight line between I and e, only two points on the curve need to be determined and then joined with a straight line.

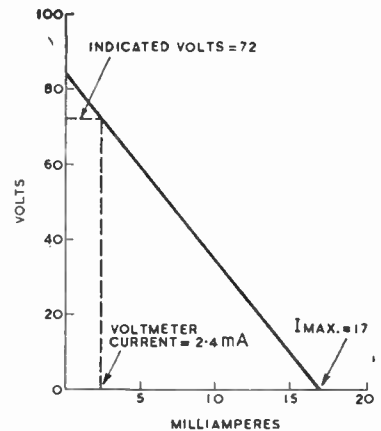

Fig. 2. Construction of regulation curve.

The easiest points to determine are I max. or value of I when e = 0, and E which is the value of e when I = 0. I max. is determined by shorting the potentiometer output with a suitable milliammeter. (A certain amount of judgment is necessary here: it is not always safe to do this.) E is measured directly with no load by a high-resistance voltmeter. If a low-resistance voltmeter only is available its loading effect can be corrected in the plotting.

An example with actual figures will make this clear. Suppose I max. is found to be 17 mA. and the no-load voltage, measured with a 0-150 voltmeter of 200 ohms per volt, was 72 volts. Scale a piece of graph paper 0-20 mA. horizontally and 0-100 volts vertically. Next determine the current taken by the voltmeter. (Note: a 200 ohms per volt meter takes 5 mA. for full-scale deflection, a 500 ohms per volt meter 2 mA., 1000 ohms per volt, 1 mA. and so on.) In

this case the current is $\frac{72}{150} \times 5 \text{ mA}$
 = 2.4 mA. The graph then
 appears as shown in Fig. 2. From
 this graph the value of output
 voltage at any value of current
 may be obtained.

Proof of Formula.—Off load

$$E = \frac{V \cdot m}{P} \dots \dots (1)$$

On load $n = \frac{c}{I} \dots \dots (2)$

On load, when $n = 0$, $I \text{ max.}$

$$= \frac{V}{P - m}$$
 Substitute for m
 from (1).

$$I_{\text{max}} = \frac{V}{P - \frac{PE}{V}} = \frac{V^2}{P(V - E)} \dots \dots (3)$$

On load, lower half of poten-
 tiometer becomes $\frac{mm}{n + m}$ ohms.

Total potentiometer resistance
 becomes

$$\frac{mm}{n + m} + (P - m) = \frac{Pn + Pm - m^2}{n + m}$$

ohms.

Therefore, $c = \frac{Vnm}{Pn + Pm - m^2}$

Substitute for value of m from (1)
 and for value of c from (2) and
 transpose.

$$n + \frac{PE}{V} - \frac{PE^2}{V^2} = \frac{E}{I}$$

Substitute for n from (2), put over
 least common denominator of
 V^2I and transpose.

$$PIEV - PE^2 = V^2E - V^2c.$$

Therefore $PIE(V - E)$
 $= V^2(E - c)$

$$I = \frac{V^2(E - c)}{PE(V - E)}$$

$$= \frac{V^2}{P(V - E)} \times \frac{c}{E}$$

Substitute for $\frac{V^2}{P(V - E)}$ from (3).

$$I = I \text{ max.} \cdot I \text{ max.} \times \frac{c}{E}$$

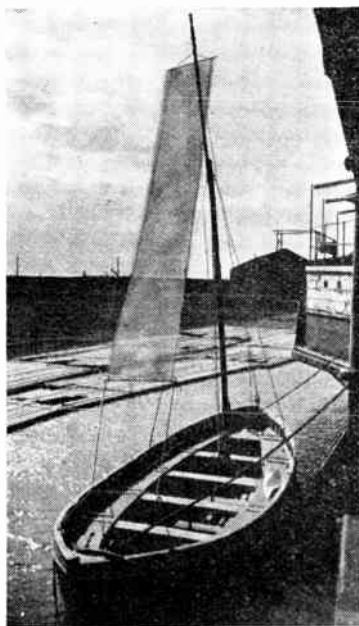

NETTING AERIAL.—This lifeboat
 aerial, of $\frac{3}{4}$ in. mesh wire netting,
 introduced by the Rees Mace Mfg.
 Company, is claimed to have a
 higher capacity than the normal
 wire aerial, and to increase the
 efficiency of radiation at the normal
 operating frequency of 500 kc s.
 When not in use it may be rolled
 up and stowed in a canvas bag.

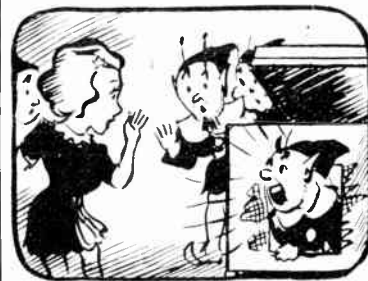

THE "FLUXITE QUINS" AT WORK.

"Thank goodness, our set works alright,
 Switch on—it's the Brains Trust to-night."
 "Any questions?" OO cried,
 Said a voice from inside,
 "Yes—Where's that new tin o' FLUXITE?"

See that FLUXITE is always by
 you — in the house — garage —
 workshop — wherever speedy
 soldering is needed. Used for
 over 30 years in Government
 works and by leading engineers
 and manufacturers. Of all Iron-
 mongers—in tins, 8d., 1/4 & 2/8.

Ask to see the FLUXITE
 SMALL-SPACE SOLDERING
 SET—compact but substantial—
 complete with full instructions,
 7/6.

TO CYCLISTS! Your wheels will
 NOT keep round and true unless the
 spokes are tied with fine wire at the cross-
 ings AND SOLDERED. This makes
 a much stronger wheel. It's simple—with
 FLUXITE—but IMPORTANT.

The FLUXITE GUN
 puts FLUXITE where
 you want it by a
 simple pressure.
 Price 1/6, or filled, 2/6.



ALL MECHANICS WILL HAVE
FLUXITE
IT SIMPLIFIES ALL SOLDERING

Write for Book on the ART OF "SOFT"
 SOLDERING and for Leaflets on CASE-
 HARDENING STEEL and TEMPERING
 TOOLS with FLUXITE. Price 1d. each

FLUXITE LTD.
 (Dept. W.W.), Bermondsey Street, S.E.1

Books issued in conjunction with "Wireless World"

	Net Price	By Post
FOUNDATIONS OF WIRELESS. Fourth Edition, by M. G. Scroggie, in preparation	7/6	7/10
TELEVISION RECEIVING EQUIPMENT, by W. T. Cocking	10/6	10/10
RADIO LABORATORY HANDBOOK, by M. G. Scroggie. Second Edition	12/6	12/11
WIRELESS SERVICING MANUAL, by W. T. Cocking. Sixth Edition	7/6	7/10
HANDBOOK OF TECHNICAL INSTRUCTION FOR WIRELESS TELEGRAPHISTS, by H. M. Dowsett and L. E. Q. Walker. Seventh Edition	30/-	30/7
WIRELESS DIRECTION FINDING, by R. Keen. Third Edition	30/-	30/7
RADIO DATA CHARTS. Third Edition, Revised by J. McG. Sowerby, B.A., Grad. I.E.E.	7/6	7/10
RADIO INTERFERENCE SUPPRESSION, by G. W. Ingram	5/-	5/4
LEARNING MORSE. 335th thousand	6d.	7½d.
INTRODUCTION TO VALVES, by F. E. Henderson	5/-	5/4
VALVE REPLACEMENT MANUAL, by A. G. Farnell and A. Woffenden	6/-	6/2

Obtainable from leading booksellers or by post from
 HILFFE & SONS LTD., Dorset House, Stamford Street, London, S.E.1.

OUTWORKING

Utilising Non-factory Labour for Assembly Work

CONSEQUENT upon the increasing call-up of men and women for the Forces there has been a growing demand for workers in industrial areas. In congested and highly industrialised areas where all the full-time and part-time available labour has been absorbed and demands for additional labour are still unsatisfied "outworking" has been found an invaluable expedient. This system, by which people whose age, domestic ties, or other obligations prevent them from working in factories are given the opportunity of contributing towards war production, has also provided a means of securing the services of persons living in outlying districts.

It was just over a year ago that the Ministry of Production introduced the scheme of outworking, which can be divided into two main categories:—

1. Individual work at home or in small groups.
2. Collective work in larger groups.

At the present time there are some six hundred outworking units in the London and South-Eastern Region alone, employing over 20,000 people. It is noteworthy that these 20,000 part-time voluntary employees work an equivalent of 1,380,000 man-hours per month, which is approximately equal to employing 6,000 full-time workers.

Although many manufacturers throughout the country have successfully employed outworkers, the radio industry (which because of its production of small parts appears to be the ideal industry for its application) has not attempted outworking on a large scale. Apparently the problem is not one of finding people willing to do outwork but to convince manufacturers of the advantages of outwork in districts where demands for additional labour cannot be met from the normal sources. There are, however, exceptions, as was proved to *Wireless World* during a recent tour of outworking radio production units in London and the Home Counties.

It will come as a surprise to

readers to learn that the much-talked-of laryngaphone, which has been employed so successfully with small pack transmitter-receivers by the Armed Forces during recent operations, is assembled exclusively by outworkers!

Sub-Assembly Section

In the country residence of a retired banker some 120 women are engaged in the assembly, testing and packing of this throat microphone and their output is several thousands a week. This country mansion has, in fact, become a sub-assembly section of the manufacturing company. The whole process in the assembly and testing of this piece of communication apparatus, from the winding of the bobbins—the rejects of which are below 0.25 per cent.—to the final test for armature adjustment (phasing) is undertaken on the premises. It should be added that an overseer from the manufacturers is employed at the house.

The photograph reproduced on this page shows some of the

workers employed in the erstwhile drawing room on a section of the miniature assembly line. The processes include the fixing of the magnets and pole pieces into the body, grinding of magnets, magnetising pole pieces, adjusting the armature, testing for flux density and subjecting the finished instrument to an artificial throat test at mean speech frequency.

Another outworking unit is functioning from what was originally a furniture shop in a London suburb. The supply of furniture having decreased to such a level that three floors of the four-storey building were empty the owner offered the space to a manufacturer of power supply apparatus with the result that an outworking unit was started with six girls and two factory instructors. This unit is producing, among other things, armature coils for the hand-driven generator used in the automatic SOS transmitter with which aircraft dinghies are equipped. In the first week's work the unit produced 100 coils; now, after fourteen months' work, the average weekly output of the



Outworkers assembling laryngaphones in the erstwhile drawing room of a country mansion.

floor, on which some one hundred part-time workers are employed, is 10,000 coils.

A second unit was started at another branch and in six months



National Fire Service and Civil Defence personnel. They do production work during duty periods when not engaged on essential fire service or C.D. tasks and receive an additional small remuneration.

The following example of the N.F.S. outworking scheme was recently quoted in the *Production and Engineering Bulletin* of the Ministry of Production. One contractor in the London region, engaged in the manufacture of radio equipment for tanks, first placed work with the N.F.S. just over a year ago. Two of the firemen at this station were keen radio amateurs and it was arranged that they should instruct and direct the other firemen. The job progressed so well that work was distributed to further stations at regular intervals and in rather less than twelve months the contractor reported that the output of his firm had in-

All laryngophones for the Services are assembled exclusively by outworkers.

the number of outworkers has grown from ten to five hundred. At this unit they are winding similar coils for another type of generator and the present output is about 7,000 a day.

When *Wireless World* published some time ago an article giving readers the procedure for carrying out the overhaul and adjustment of moving-coil meters some critics considered the article out of place, contending that the delicate operations entailed should be left to a specialist. Be this as it may, there is an outworking unit in North London where moving-coil meters are actually made by unskilled part-time workers. The assembly of the instrument, which includes the delicate task of soldering the hair spring to the pivot, is undertaken entirely by outworkers.

The outworking units so far referred to are staffed by housewives or other "non-directable" labour. There is, however, another class of outworking unit—that utilising the full-time

creased 300 per cent. and that 90 per cent. of this increase was due to the N.F.S.

At one station visited in the South London area ten or twelve firemen were working on an assembly job which was ideally suited to outworking. It was the assembly of a small unit necessitating the mounting of some two dozen component parts on a steel chassis and making 17 soldered joints. This unit is part of the radio equipment of our fighter aircraft. At this station, which is ahead of production schedule, the output per week is several hundred completed units.

At another N.F.S. station the staff are assembling and wiring the remote control unit employed with one of the heavier Army transmitter-receivers.

It will be seen from the foregoing that there is ample scope in the radio industry for outwork. There is no dearth of outworkers; the problem is to convince manufacturers that outworking is practicable.

The Improved VORTEXION 50 WATT AMPLIFIER CHASSIS



The new Vortexion 50 watt amplifier is the result of over seven years' development with valves of the 6L6 type. Every part of the circuit has been carefully developed, with the result that 50 watts is obtained after the output transformer at approximately 4% total distortion. Some idea of the efficiency of the output valves can be obtained from the fact that they draw only 60 ma. per pair no load, and 160 ma. full load anode current. Separate rectifiers are employed for anode and screen and a Westinghouse for bias.

The response curve is straight from 200 to 15,000 cycles in the standard model. The low frequency response has been purposely reduced to save damage to the speakers with which it may be used, due to excessive movement of the speech coil. Non-standard models should not be obtained unless used with special speakers loaded to three or four watts each.

A tone control is fitted, and the large eight-section output transformer is available to match, 15-60-125-250 ohms. These output lines can be matched using all sections of windings, and will deliver the full response to the loud speakers with extremely low overall harmonic distortion.

PRICE (with 807, etc., type valves) £18.10.0

Plus 25% War Increase

MANY HUNDREDS ALREADY IN USE

Supplied only against Government Contracts

VORTEXION LTD.

257, The Broadway, Wimbledon, S.W.19

Phone: LIBerty 2814

RANDOM RADIATIONS

—By "DIALLIST"—

Induction Motors

The letter from T. L. Franklin, printed in last month's issue of *Wireless World*, on the subject of non-interfering domestic electrical appliances and his stout advocacy of the induction motor for operating them cheered me immensely. For some reason manufacturers have fought shy of this very useful type of motor, though it has so much to recommend it; it is considerably cheaper to make than any kind of commutator type motor that I know; it has no "wipe" contacts to cause bother, and if it is respectably well designed and made it is as near trouble-free as makes no matter. Its great drawback for such things as vacuum cleaners is that normally its speed is limited to about half the frequency—that is with 50-cycle AC the maximum is 60 x .25, or 1,500 r.p.m. Vacuum cleaners and certain other devices need higher speeds than this; but surely there should be little or no difficulty about using gears. The induction motor causes no radio interference, whether radiated or mains-borne—except possibly that there may be some thing of a "kick-back" at the moment of starting with the bigger motors of this type owing to the rather heavy current that flows when switching on.

□ :) □

Hot and Cold

EVERYONE interested in electricity knows that metals in general have a lower resistance when cold than when hot, and that for this reason filaments of valves and lamps are most likely to break down immediately after being switched on. For a moment, until warming up brings the resistance of a filament to its normal working value, it has to carry much more than its rated current, and it may give way under the excessive load. The man in the street, by the way, doesn't always appreciate this. He is mystified that a household electric lamp or a flash-lamp bulb should apparently have "gone" when not in use. "It was perfectly all right last night, and it hasn't been used since; but it wouldn't light up when I switched on just now." He doesn't realise that the breakdown took place when he turned the switch or pressed the button. But I must admit I didn't know how great the difference in the resistance of the same filament when hot and cold could be until I made some simple tests. As only a rough

idea was needed, the following seems to be an easy and satisfactory method. Three 200-volt lamps were used, rated at 75 watts, 60 watts and 40 watts respectively. Assuming that these ratings are correct, the 75-watt bulb would pass 0.375 ampere of current when hot, and therefore have a resistance of 533 ohms. Similarly the resistance when hot of the 60-watt filament would be 666 ohms and that of the 40-watt filament 1,000 ohms.

Cold Facts

If a 2-volt cell were used to pass current through the filaments the leaking effect seemed likely to be insignificant. The current could be measured by means of a milliammeter and the next-door-to-cold resistance calculated. The 75-watt lamp was tested first. The milliammeter recorded 50 mA and this works out at 40 ohms! That seemed so incredible a figure that I fished out another milliammeter in case the first was out of order. It gave the same reading. And here are the figures for the three lamps.

Watts.	Filament resistance (ohms.)	
	Hot	Cold
75	533	40
60	666	52.6
40	1,000	80

You will see that in each instance the cold resistance was only about 8 per cent. of the hot. That there was practically no heating effect from the small current passed was shown by the fact that in these three instances the readings remained constant even when the lamp filament was in circuit for some minutes. All of these were lamps of well-known makes.



Evidence that broadcasting, the younger branch of wireless, has already grown up, is afforded by this photograph. C. G. Allen (left) receives from Leslie McMichael a silver salver to commemorate twenty-one years' service with McMichael Radio.

An Exception

Another lamp was also tried. This was a cheap affair of unknown make, bought at some place during my wartime journeyings where the local voltage was 230. It's curious, by the way, that, though the national standard mains voltage is 230, I have rarely been stationed at a place in either England or Scotland where it obtained! To return to the fourth lamp, which was rated at 230 V, 25 watts. The normal hot resistance of the filament would be 2,110 ohms. On the 8 per cent. basis we would have expected a resistance of about 170 ohms from the almost cold filament served by the 2-volt cell. The actual resistance, read as quickly as possible after switching on, turned out to be about 200 ohms, and it was seen that a definite warming-up effect was present even with the very small current that was passing. The needle of the milliammeter showed an appreciable and progressive drop in current, or increase in resistance. At the end of a couple of minutes the resistance had risen to 280 ohms, and it was still rising, though now very slowly. The results obtained in these tests were confirmed on the following day with an Avometer. I had expected a big difference between hot and cold filament resistance, but I had no idea that it would turn out to be as big as it is.

Quick Methods

Do you, by the way, use the quick method if, given the voltage and the watts, you have to find the working resistance? Heaps of people, I find, go a long way round to get the result. They divide the volts by the watts to obtain the current, and then divide the volts by the amps to get the resistance. The quickest way is to do it in one step. By Ohms Law $R = V/I$, but $I = W/V$; therefore $R = \frac{V}{W/V} = \frac{V \times V}{W} = \frac{V^2}{W}$. Square the volts, divide by the watts, and

there you are. Do you know the tip for squaring any two-figure number in your head? Suppose you want to find 23^2 : you know that $(x + y)(x - y) = x^2 - y^2$. In this case 23 is x . To make multiplication easy subtract 3 from 23, making 20, and add the 3 to 23, making 26. Then 3 is y and $20 \times 26 = (x - y)(x + y) = x^2 - y^2 = 23^2 - 3^2$. Anybody can multiply by 20 (or 30 or 40 or 70) in his head: $20 \times 26 = 520$, and $3^2 = 9$; $520 + 9 = 529$, and that is 23^2 . Similarly $70^2 = 80 \times 72 + 16 = 5776$. Just take from (or add to) one side enough to bring it to the nearest ten and add to (or subtract from) the other side the same amount. Multiply, and then add the square of the number that you have subtracted or added, as the case may be. Working on these simple lines, the filament resistance of a 220-V 30-watt lamp is $\frac{220^2}{30}$. To obtain 220^2 , square 22 and add two noughts. The calculation, in your head, becomes: $20 \times 24 = 480$; add 2^2 and you have 484. So the square of 220 is 48,400. Divide 48,400 by 3 and the answer is 16,133 ohms. And, talking of time-saving tips, there is a most useful one about sevenths. As a decimal $1/7$ is 0.142857—easy to remember, because 28 is double 14 and 57 is twice 28 plus 1. No need to work $2/7$ or $3/7$ or any other fraction up to $6/7$. To find $2/7$ start with the second highest figure and write down the rest in the same order: 0.285714. In the same way $3/7$ is 0.428571, $4/7$, 0.571428, $5/7$, 0.714285, and $6/7$ 0.857142. This tip may save a lot of time if you are working with π and calling it $22/7$; thus $6\pi = 18\frac{6}{7} = 18.857142$.

□ □ □

The Watte-Knowse Problem

ALL old hands would solve the problem I gave last month in a brace of shakes; but it probably puzzled the less experienced a bit. It was, if you remember, that of a moving-iron ammeter passing simultaneously a direct current of 3 amps and an alternating current of 5 amps. Mr. Watte-Knowse demanded and received his money back because it didn't read the 8 amps that he expected. The MI ammeter, like other measuring instruments, reads the root of mean squares, or RMS value. In this case it recorded $\sqrt{3^2 + 5^2} = \sqrt{34}$, or 5.831 amps. Any beginner who found—and perhaps still finds—it difficult will see why the total current does not come to 8 amps if he remembers that in the negative half-cycles of the AC component the two currents are in opposite directions and are, therefore, working, so to speak, against one another.

Forward

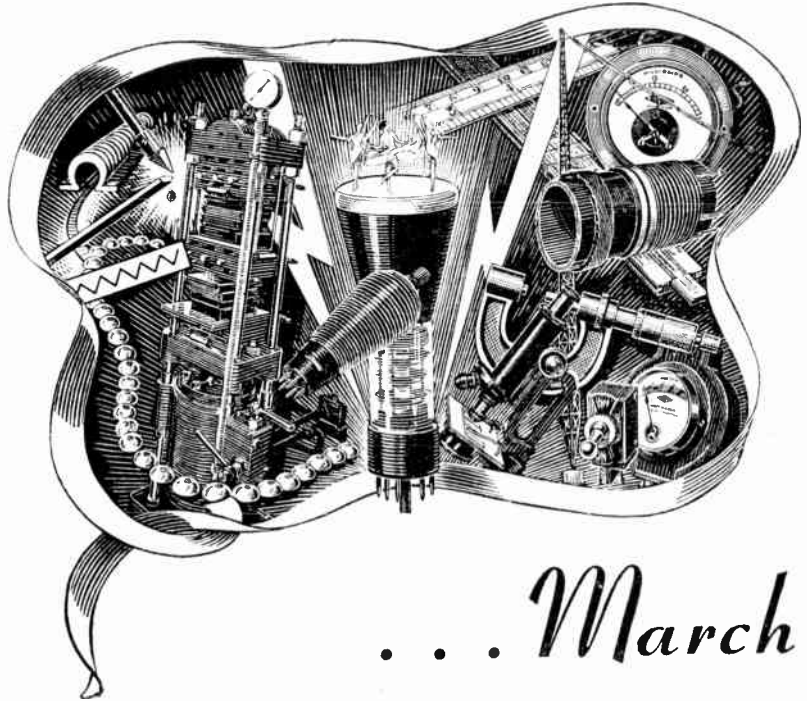

. . . March

THE science of Electronics moves apace in present time of War, but the future holds promise of great achievements. At present, we may only see "as in a glass" the fashion of things to come. In all phases and in all applications, BULGIN RADIO PRODUCTS will make their contribution; until then, we ask your kind indulgence. Please quote priority and Contract Nos.

"The Choice of Critics"



Registered Trade Mark

A. F. BULGIN & CO. LTD., BYE PASS RD., BARKING, ESSEX
 Radio and Electrical Component Manufacturers.
 TEL. 1 RIPPLEWAY 3474 (4 lines).

RECENT INVENTIONS

UHF GENERATOR

WHEN generating very high frequencies, the time taken by the electrons to move through the valve may amount to an appreciable fraction of each working cycle. The anode current will then tend to lag behind the anode voltage, and so prevent the valve from delivering the maximum power.

To offset this, the phase of the voltage fed back from the anode to the grid of the valve is advanced to the extent required to maintain the anode current and voltage in exact phase-opposition.

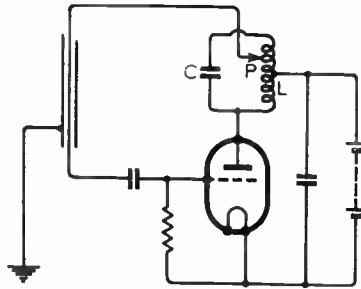

Phase-compensated oscillator.

As shown in the figure, the anode is connected to the HT supply through a parallel-tuned circuit LC, and feedback voltage is tapped off to the grid through a transmission line L, or concentric cable. The length of this line is adjusted to fall short of a full wavelength by the angle of phase-shift which it is desired to introduce. The tapping at P allows the amplitude of the grid voltage to be adjusted in accordance with the phasing of the feedback. To prevent reflection effects, the line L is terminated by a surge impedance (not shown).

Marconi's Wireless Telegraph Co., Ltd., and D. A. Bell. Application date August 30th, 1939. No. 556930.

SHORT-WAVE BEAM SIGNALLING

THE use of centimetre waves, say for radio-navigational purposes, is at present limited by the complexity and instability of the circuits required to handle them.

The inventors disclose a system in which the usual course-indicating A-N signals are applied by amplitude-modulation to two overlapping beams, which are simultaneously "swept," say, between 479 to 481 megacycles at a constant repetition frequency of 250 cycles per second. The outgoing signals are therefore modulated both in amplitude and frequency.

At the receiver the signals are mixed with local oscillations of 480 Mc/s, i.e., the mean carrier frequency, so that the output appears as a series of pulses occurring at those instants when the receiver is accurately in tune with one of the transmitted bands of frequencies.

The arrangement offsets the effect of "frequency drift" in the transmitter,

A Selection of the More Interesting Radio Developments

since the stability of the system as a whole depends upon that of the local heterodyne, which can be crystal-controlled. There are no "image" signals to confuse the operator, whilst high sensitivity is ensured by the use of simple resistance-capacity couplings in the amplifier.

Standard Telephones and Cables, Ltd.; C. W. Earp; and C. E. Strong. Application date May 22nd, 1942. No. 557563.

HIGH-STABILITY OSCILLATOR

A PENTODE of the beam power type is arranged to operate as a negative transconductance oscillator, so that an increase in grid potential produces a fall of anode current.

The anode is connected to the cathode through a rejector circuit (which includes the valve capacities in one of its sides) and to the control-grid through an acceptor circuit. Both circuits are tuned to the oscillating frequency so that they behave as pure resistances, the input and output voltages thus being kept in phase, instead of in phase opposition as is usual.

The series-tuned or acceptor circuit may be replaced by a piezo-electric crystal. Since all the circuit elements are resistive in operation no phase-shifts can occur, and the combination gives high frequency stability with maximum gain.

Standard Telephones and Cables, Ltd. (assignees of W. P. Mason). Convention date (U.S.A.) November 26th, 1941. No. 557148.

SHORT-WAVE AMPLIFIERS

IN a valve handling very high frequencies, the transit time of the electrons tends to set up an out-of-phase current which damps the input circuit by reducing its effective resistance. This can be offset by using a tube of the acorn type, which has, however, an inherently low mutual conductance, and therefore gives a poor overall amplification factor.

According to the invention, use is made of a valve of such a size that the transit time is greater than the period of the oscillations to be amplified, so as to ensure a high mutual conductance, and the damping due to transit time is neutralised by the provision of two auxiliary electrodes. These are connected to the

two ends of the output circuit and are so spaced apart in the stream that the electrons traverse them in less than half the working cycle.

The theory of operation assumes that the working current does not flow first through the valve and then through the external circuits, but that the two events occur simultaneously, those inside the valve being due to the action of "positive-image charges" induced by the moving electrons.

Philips Lamps, Ltd. (communicated by N. V. Philips' Gloeilampenfabrieken). Application date June 5th, 1941. No. 557005.

CUTTING OUT INTERFERENCE

AS shown in the figure, a frame aerial A is connected at an intermediate point P to the chassis S of the receiving set, the "free" end of the aerial winding being coupled through a small condenser C to a metal plate or counterpoise E1. By suitably adjusting the condenser C any undesired "pick-up" from the mains supply lines L can be made to divide at the point P, so as to give a "null" resultant on the grid of the input valve V.

One part of the current flows to earth E through the counterpoise E1, whilst the other part is passed to earth through the distributed capacity of the aerial windings, as indicated by the arrows. The switch across the condenser C, when closed, increases the "vertical effect" of the frame aerial,

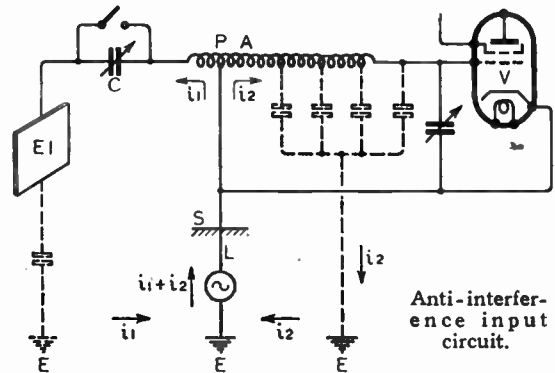

Anti-interference input circuit.

and so reduces what may be its undesirable directivity for broadcast reception, when the necessity for noise-suppression is not present.

Marconi's Wireless Telegraph Co., Ltd. (Assignees of L. E. Barton). Convention date (U.S.A.) March 25th, 1941. No. 557083.

The British abstracts published here are prepared with the permission of the Controller of H.M. Stationery Office, from specifications obtainable at the Patent Office, 25, Southampton Buildings, London, W.C.2, price 1/- each.

*Over twenty years of
experience and research
are behind the advanced
technique of today . . .*



MULLARD
THE MASTER VALVE
A Valve for Every Purpose

DOMESTIC · COMMERCIAL · INDUSTRIAL · SCIENTIFIC · MEDICAL · EXPERIMENTAL

THE MULLARD WIRELESS SERVICE CO. LTD., CENTURY HOUSE, SHAFTESBURY AVENUE, LONDON, W.C.2. (77 rev.)



"RIGHT ON TOP"

With this Raymart "Speed" Key which combines all that is best in British and American key design, you can, because of its extreme lightness of action and rigidity of construction, keep "right on top" of your transmitting. The key is fitted with heavy silver contacts.

The Wireless World test report confirms that it is "suitable for serious work."

Price
Post
Paid **8/6**

A good companion for morse practice, is the Raymart High Note Buzzer. Price 2/- (Postage 3d.). For further details see our advertisement on Page 10 of the March issue.

RAYMART
CRAFT A CREED

48, HOLLOWAY HEAD,
BIRMINGHAM, 1.
Telephone: Midland 3254

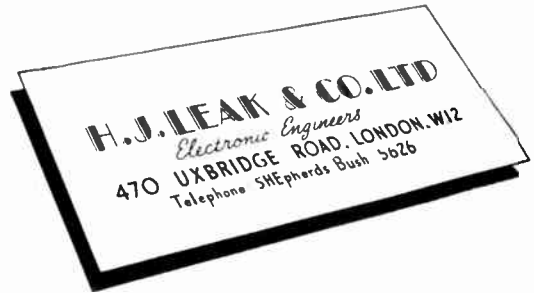

H. J. LEAK & CO. LTD
Electronic Engineers
470 UXBRIDGE ROAD, LONDON, W12
Telephone SHEpherds Bush 5626

E X P A N S I O N

Owing to the growth of our business, new premises at 470, Uxbridge Road, W.12, were already in the process of being fitted out when damage to our former premises made it necessary for us to move sooner than originally anticipated.

Unfortunately our stocks and records were lost, which temporarily held up manufacture, but thanks to the splendid co-operation of the Services Departments, our Suppliers and Main Contractors, we are now back in full production.

H. J. LEAK & CO. LTD.

Electronic Engineers
470 UXBRIDGE ROAD • LONDON • W.12
Telephone: SHEpherds Bush 5626

WHARFEDALE

MIDGET 3 1/2-inch UNIT

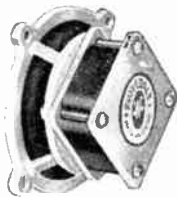

ALCOMAX MAGNET

Flux Density 8,000 lines.

Speech Coil 15 ohms or 2/3 ohms. The first Wharfedale Unit using the new ALCOMAX magnet steel which gives extremely high flux density with small size. Designed for use as Microphone or Midget Speaker. Very sensitive.

Supplies are available for
PRIORITY ORDERS ONLY

PRICE
28/6
(list)

WHARFEDALE WIRELESS WORKS

(SOLE PROPRIETOR: D. E. BRIGGS)

HUTCHINSON LANE • BRIGHOUSE • YORKS
PHONE: BRIGHOUSE 50

'GRAMS "WHARFEDALE"

I am the c.g.s. unit of energy—you'll find me in every radio circuit.

HULLO.
-I'M AN
ERG!

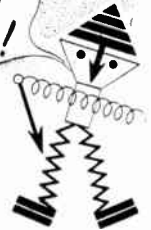

ERG

ERG is the trade mark that will identify our products of quality—small parts for big jobs.

ERG RESISTORS LTD.

1021a, FINCHLEY ROAD, LONDON, N.W.11
PHONE: SPEEDWELL 6967

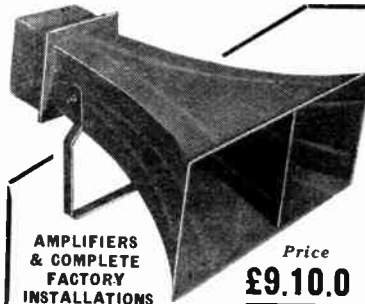

DIRECTIONAL HORN LOUDSPEAKERS

Designed and specially treated to avoid unwanted resonances.

Length 34", flare opening 28" x 12". 15 ohms, handles 10 watts.

AMPLIFIERS & COMPLETE FACTORY INSTALLATIONS

Price
£9.10.0

INDUSTRIAL AMPLIFIER & TELEPHONE CO.

Tower Works, Old Town, Clapham, S.W.4. Tel.: MACaulay 3200

CLASSIFIED ADVERTISEMENTS. Rate 6- for 2 lines or less and 3- for every additional line or part thereof, average lines 5-6 words. Each paragraph charged separately. Press Day; June issue, first post Monday, May 8th, one day earlier at branch offices. Box Numbers 2 words, plus 1- Deposit System; particulars on request. No responsibility accepted for errors.

Ode

Partridge

No. 31

“Rue—Mania”

A mania's an obsession,
To rue is to regret,
Methinks that many satellites
Will have "rue-mania" yet.

You pups of Axial parents
To stars your wagons hitched
But now the stars are falling
Methinks you'll soon be "ditched."

No more is Moscow fighting
A battle far away
From Axis buffer bound'ries,
They're right inside to-day.

You sought to steal from neighbours
To bring grist to your mill,
Forgetting there's another
That grinds more finely still.

N. Partridge

Transformer Manufacturers,
76-78, PETTY FRANCE, LONDON,
S.W.1. Telephone: ABBey 2244.

NEW RECEIVERS AND AMPLIFIERS

30 WATT ac amplifiers, precision built instruments, input and output channels to requirements, early deliveries. —Below.

150 WATT racks, comprising 5 amplifiers as above intercoupled, fitted for remote control for industrial installations; send for full details and illustrations; complete equipment, including speakers and microphones, etc., available.—Below.

18 WATT ac/dc amplifiers, mixing input channels, bass and treble controls, input and output transformers; 18gs.—Below.

DANCE and stage transportable equipment, comprising 18-watt amplifier as above, m/c mike, adj. stand, 2 speakers, cables; 36gs. —Broadcast & Acoustic Equipment Co., Ltd., Broadgate House, Tombland, Norwich. [2024

A C, DC 4-valve M.W. receiver; build the Wizard in an evening! Set of instructions, clear wiring diagram, component layout, theoretical circuit, parts list and prices, 5/- post free; uses British valves, obtainable from us; many equivalents; components sold separately, your queries answered free s.a.c.—Franklin Developments, Weldons, The Avenue, London, N.3. [2625

£24 /10 only.—New 7-valve "Wireless World" quality amplifier with tone control stage, 8watts push-pull triode output, price includes super quality triple cone, 12in permanent magnet speaker with large matched output transformer and all valves; as above but with 15watt tetraode output, £25/10; ideal for realistic reproduction for public address, limited number available.—Bakers Selhurst Radio, 75, Sussex Rd., S. Croydon. Tel. Croydon 4226 for demonstration. [2663

RECEIVERS, AMPLIFIERS—SECOND-HAND
SALE, G.E.C. radiogram, also H.M.V. 3-wave-band radiogram.—Box 3098. [2620

EDDYSTONE 358X communication receiver, complete set of coils A-I, power pack, all as new. Offers to Box 3094. [2607

HALLICRAFTERS Super Skyrider, late model, absolutely as new, prac. unused; offers. Box 3102. [2643

A MPLIFIER, 70 watt, ex-relay, super construction, valve switched h.t. meter, etc.; £50.—Evans, Brewood, Stafford. [2648

W W. Q amplifier and Straight Six Voigt speaker energising unit, corner horn, all perfect; offers.—"Hollies", May Lane, Hollywood, Birmingham. [2676

THREE radiograms, McMichael, Ekco, Marconi, also American Freid Eissman mid-get set, perfect, take £20 for Marconigram.—Ring Bays 0363. [2461

C OMMUNICATION receiver, 5 wavebands, separate speaker, £20; also quantity shortwave components, valves, etc.—Gascoine, 25, Nottingham Place, London, W.1. [2655

S COTT Imperial, 27-valve auto-radiogram, 3 all-wave, Garrard changer, crystal P.U., many features, one Tasman cabinet, cost 200gs.; £175.—A.C.S. Radio, 44, Widmore Rd., Bromley. [2636

T ANNOY amplifier, type 220, 25 watt, universal, little used; best offer secure.—Box 44, Young's Advertising Agency, 6, Melville St., Edinburgh. [2617

O WNER of Senior HRO, complete with 4 coils and power pack, wishes to exchange this receiver for a Hallicrafters SX.28 or a Hammarlund Super-Pro; cash adjustment either way.—Reply Mr. Bee, 25, The Granprians, Western Gate, London, W.6. [2630

A DVERTISER has several a.c. and a.c./d.c. amplifiers, 5watt, 8watt and 15watt, £8, £10 and £15 respectively; also Eddystone communication receiver, 3 short wave-band communication receivers, etc.; 2 a.c. and a.c./d.c. industrial radiograms, 20watt.—Box 3107. [2659

W W. Q.A. Super and Q.A. 12in speaker, £30; Ambassador 7-valve radio amplifier, £20; Baker 8watt Q.A., £18; Juvenile deluxe, £20; Collaro auto-changer Piezo, £30; 2 Baker P.M.12s, 70.-; all as brand new; pick-up and turntable, a.c.; £5; 4watt amplifier, faulty, .45.—Box 3106. [2659

S UPER-het, 4v (plus rect.), pentode output on steel chassis, complete with 5 valves, high quality set, £12/12; loudspeakers: Magnavox, 9in cone, with pen. transformer 2,500 ohm field, 32/6; Radio-Phone 3-gang 0.0005, complete, 11/6; drive and escutcheon, 2/6.—Box 3109. [2670

W anted
WE offer cash for good modern communication and all-wave receivers.—A.C.S. Radio, 44, Widmore Rd., Bromley. [1541

P RE-TIMED Q A (Aug., 1939) receiver unit only, less tone control stage preferred. H., 3, Hollybank, Otley Road, Leeds, 6.

M ODERN ac mains receiver or chassis wanted with push-pull triode output, about 8 watts, in good condition and with connections for pick-up; could offer almost new miniature camera in part exchange if necessary.—Write Box 3095. [2609

Advertisers and buyers are reminded that under Defence Regulations 1939, Statutory Rules and Orders 1940, Number 1689, a permit (T 99 G) must be obtained before sale or apparatus of certain electrical and wireless apparatus, particularly such valves and apparatus as are applicable to wireless transmission.



RI
Transformers

FAMOUS THROUGHOUT THE WORLD

Millions in Use since the inception of broadcasting in 1922

RADIO INSTRUMENTS LTD.
Purley Way, Croydon.

ARMSTRONG SERVICE

is almost back to normal!

We can now service receivers and return most of them in seven days.

One can never tell what the future holds but whilst this happy state of affairs lasts we can also undertake the repair and overhaul of receivers other than our own make including American types.

All enquiries should be addressed to

ARMSTRONG (Radio Service Dept.)
WALTERS ROAD, HOLLOWAY, LONDON, N.7
Phone: NORth 3213.

L.R.S. **STUART PUMPS**

As supplied to Govt. Depts. & County Councils

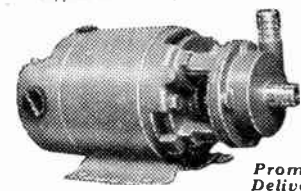

Prompt Delivery

These Centrifugal Pumps are ideal for Machine Tool Cooling and all pumping purposes—hot or cold water. Supplied complete with foot-valve, strainer and hose-union. Suitable rubber hose available from stock.

No. 10, 100 gals. per hour, Curr. 2 - extra, £5 2 6
No. 11, 280 gals. per hour, Curr. 2 - extra, £8 6 0
No. 12, 560 gals. per hour, Curr. 3 - extra, £7 12 0

Please send 2/d. stamp for specification.
State purpose for which pump is required.

The **STUART AUTOMATIC FLOAT SWITCH** is the best method of controlling water—Post paid level. Price complete with all fittings... £2 6 0

LONDON RADIO SUPPLY CO.
Estab. 1925
Ardingly Road, Balcombe, Sussex

LASKY'S RADIO 370, HARROW RD., PADDINGTON, W.9

(Opp. Padd. Hospital). Phone: Cunningham 1978

THIS MONTH'S SPECIAL OFFERS
24 assorted Condensers, consisting of 8 mfd. 500 v., 4 mfd. 200 v., 32 mfd. 350 v. (can type), 2 mfd. 500 v., 1 mfd. 500 v., .5 mfd. 250 v., .25 mfd. 350 v., .05 mfd. 500 v., .1 mfd. 350 v., .01 mfd. 500 v., etc., etc. All for £2. Post free. **SATISFACTION GUARANTEED.**

SPECIAL BARGAIN FORSET BUILDERS
Grey cellulosed steel radio chassis, including 27 mica condensers, 30 resistances, tubular condensers, 8 mfd. 500 v. condenser, 8 octal valve holders, volume control and screened coils, with trimmers, etc., etc. Size 8in. x 12in. x 1½in. Price £1 9s. 6d., plus postage.

Servisol at 5/- per tin, Systoflex, assorted, at 2/3, 2/6 and 3/- doz.

Volume Controls, ½, ¼ and 1 meg. less switch, at 2/9 each, with switch, 5/9 each. 2 and 3 amp. mains droppers, 4/9, 5/9 and 7/6 each. .3 amp. 3-way line cord, 70 ohms, per foot, best quality, at 5/9 yd.

Slow Motion Dial and Drive Escutcheon type, 2/6 each. Resistors, assorted, Kit of 48 ½, ¼ and 1 watt at 30/- lot.

Smoothing Chokes, Midget type, 650 ohms 60 mA., 6/6 each, larger type 180 ohms 160 mA., 15/6 each. Medium and long wave coils with reaction at 10/6 per pair. Universal Speaker Transformers, 7/6, class B and OPP. driver and output types, 9/6. Pentode S'Trans., 5/9 each. Solder, Resistances, tin copper wire, soldering irons, knobs, toggle switches, 2 and 3 gang condensers, etc.

SPEAKERS. Rola P.M., 5in., 19/6; 6½in., 21/6; 8in., 23/6 each. Godmans 3½in. P.M., 27/6; 10in., 39/6 each.

Celestion 10in. P.M., with Pentode Transformer, 45/6.

In stock over 5,000 new boxed English and U.S.A. mains and battery valves. Send 1d. for our lists of valves, mains transformers, etc.

Send us your requirement C.O.D., BUT CASH WITH ORDER PREFERRED.

YOU can become a first-class RADIO ENGINEER

We are specialists in Home-Study Tuition in Radio, Television and Mathematics. Post coupon now for free booklet and learn how you can qualify for well-paid employment or profitable spare-time work.

T. & C. RADIO COLLEGE 2 The Mall, Ealing, W.5

(Post in unsealed envelope, 1d. stamp.)

Please send me free details of your Home-Study Mathematics and Radio Courses.

NAME

ADDRESS

W.W.28

WE buy at your price, used radiograms, radios, amplifiers, converters, test meters, motors, pick-ups, all radio and electrical accessories, etc.; we call and pay spot cash.—Tel. Eust. 1966, or Ger. 4447. University Radio, Ltd., 238, Euston Rd., N.W.1 [2536]

LONDON CENTRAL RADIO STORES will pay good prices for receivers, radiograms, amplifiers, dynamos, converters, test equipment, electric gramophone motors, and all radio and electrical accessories.—London Central Radio Stores, 23, Lisie St., London, W.C.2. Gerrard 2969. [9836]

NEW LOUDSPEAKERS

NEW Broadcast P.M. loud-speakers, 3 models: 12in 12watt 15,500 lines, 1½in dia, voice coil; 12in 25watt 18,000 lines, 1½in dia, voice coil; 15in 40watt 18,000 lines, 2½in dia, voice coil; machined and precision built instruments. Ticonal magnets, detachable diaphragms, die-cast chassis, uniform response, superior standards in fidelity, sensitivity, accuracy, tonal quality, appearance and finish; prompt deliveries; specifications and illustrations upon request.—Broadcast & Acoustic Equipment Co., Ltd., Broadcast House, Tombland, Norwich. [2537]

£5/15 only.—Brand new Baker super quality 12in Auditorium permanent magnet speaker with triple cone, manufactured by Bakers Selhurst Radio, the pioneer manufacturer of moving coil speakers since 1925, wide frequency range, even response, ideal for quality reproduction, fitted with magnet having exceptionally high flux density in the air gap, suitable for public address equipment when quality reproduction is first consideration; send 2½d. stamp for leaflet giving details of above and constructional details of a new acoustic chamber designed to extend loud speaker frequency range; also constructional details of an infinite baffle cabinet; every music lover interested in realistic reproduction should write for leaflet.

£8/15 only.—Brand new Baker super power cinema permanent magnet speaker with 18in triple cone of new design, giving wide frequency response free from objectionable resonances; speech is clear and natural and music is reproduced with exceptional realism; fine engineering job, extremely sensitive, ideal for public address equipment when power handling capacity plus realistic reproduction is required.—Bakers Selhurst Radio, 75, Sussex Rd., South Croydon. Tel. Croydon 4226 for demonstration. [2664]

LOUDSPEAKERS SECONDHAND

SALE. Hartley Turner eng. spk., original cone but fitted new spider; £5.—Box 3096.

EPOCH 18in cinema speakers, 6 and 50-100-volt fields, handle 20 watts speaker, field rectifier less valve; offers, s.a.e.—Cinema, Bishop's Castle. [2650]

ROLA G.12, 190-250v, dc field, 15ohm speech coil, 6 test p.m.s. 19/6 each, £7/15 or offer; R.K. Senior, 200v dc field, 15 ohm speech coil, fitted latest white ribbed cone, £8.10 or offer.—D. Fraser, 13, Attadale Rd., Inverness. [2674]

Wanted

MAGNAVOX or Hartley Turner duode, 1,250 ohms.—Fairbank, 271, Grovehill, Beverley. [2645]

HARTLEY-TURNER Duode, 2,500 ohm field; also S.12 set, complete or parts.—Wright, Merrow, Grange Rd., Bearsden, Glasgow. [2673]

DYNAMOS, MOTORS, ETC.

E.D.C., 11volts d.c. input, output 500v d.c., 80m.a., with interference suppression, sprung mounted; £5/10.—Henry's, 5, Harrow Rd., Paddington, W.2. Pad. 2194. [2666]

ALL types of rotary converters, electric motors, battery chargers, petrol-electric generator sets, etc., in stock, new and second-hand; supplied against priority orders only.

WARD, 37, White Post Lane, Hackney Wick, E.9. Tel. Amherst 1393. [1988]

RELIABLE multi vibrator unit, input 50v dc, output 230v ac, 50 cycles, capable of delivering approx. 100w; shielded cabinet and full interference suppression, vibrator sprung mounted; 15gns.—Chapman, Grove Farm, Roydon, Diss. [2531]

ELECTRADIX dynamos and motors at bargain prices, dynamos, ht and lt G.E.C. double current, 6v and 600v, weight 17lb, 37/6, pkg. and carr. paid; supplied Eng. and Wales only; refund 5/- on returned cases; D.C. motors, 1/5th hp and ¼hp dc motors enclosed, silent, 220 to 250r, 1,500 revs, double-end ½in shaft, first grade make, guaranteed, 1/5th hp, £3/10 each; ¼hp, £4 each; all carr. paid Eng. and Wales; others in stock.—Electradix, 214, Queenstown Rd., Battered, London, S.W.8.

Wanted

WANTED, rotary converter, any size.—Hull, 221, City Rd., London, E.C.1. [2428]



Designed by engineers for engineers, the Solon Electric Soldering Iron gives neater, cleaner, more efficient work in less time. The heating element is right inside the bit, giving constant heat at the point—where you want it. All internal connections housed at end of handle—away from heat and easy to get at. Complete with 6ft. of Henley 3-core flexible. Made for the following standard voltages:—100/110, 200/220, 230/250. Supplies are, of course, only available for essential war work. Early ordering is advisable as the demand is heavy.

Made in England

Model shown is a standard 125 watt round pencil bit Solon. Other sizes and types available.



W. T. HENLEY'S TELEGRAPH WORKS CO. LTD.
Engineering Dept., Milton Court, Westcott, Dorking, Surrey

RECOMMENDED COMPONENTS!

NEW PRECISION DROPPER RESISTORS

.3 amp., 800 ohm, with fixing feet ... 5/9
.2 amp., 1000 ohm, with fixing feet ... 5/-
WIRE WOUND RESISTORS available from 25-2,000 ohm, 1 w., 1/-; 5 w., 1/6; 10 w., 1/9; 20 w., 3/-.

VOLUME CONTROLS, every value with switch, 5/9; less switch, 3/6.

4 v and 6 v. Standard mains replacement transformer Bobbins, 18/6.

TRIMMER TOOL KIT of box spanners and screw drivers, 30/-.

LOUDSPEAKERS. 3½" Godman P.M., 27/6. 8" Plessey P.M., 25/-.

Accumulators, cell'd 2 v., 60 a., 25/-, Eliminators, A.C., 25 ma., 75/-, Microphones, G.P.O. table mikes, 5/9. Bell Transformers, bakelite, 5/6. Carbon Resistors. Packets ½ gross, ½ w., good assortment, 24/-.

Universal O.P. Transformers, 7/6. G.P.P. Class "B" O.P. Transformers, 7/6. Min. Triode Pen Battery O.P. Trans., 5/9. Auto-Transformers, 75 w., 27/6.

Car Vibrators, 12 v., 12/6. Spade Terminals, Red and Black, 2/6 doz.; 3-core Line Cord, 2-foot, 60 ohm per foot. Solder, 1 lb. reels, 4/6.

SERVISOL, 8-oz. tin, 5/-.

New Razor Dropper Resistor, 1,600 ohm, in cage, 7/6. Line Cord resistor, .3a, 800 ohm, in cage, 10/-.

Wire-wound Barretters to replace CI and CIC, using existing valve base, 5/-.

Spindle Knobs, 8d.; 2 mfd. Mansbridge Condensers, 2/6.

TECHNICAL PUBLICATIONS. 66-page Radio Valve Manual, 3/9. Radio Circuits, 2/3. Amplifier and P.A. Manual, 2/3. Direct Disc Recording, 2/3. "Radio Inside Out," Complete Serviceman's Guide Book, 4/9. American Service Books. Vol. 1, Sparton/Emmerson, 12/6. Vol. 2, Crosley/Belmont, 12/6. Vol. 3, Crosley/Belmont, Part 2, 12/6. Set of 3 for 37/6, post paid.

EXCLUSIVELY MAIL ORDER

WAVEBAND RADIO LTD.

30 Queensgate, London, S.W.7

TEST EQUIPMENT

B.F. oscillator, a.c., £25; also power unit, various comp.—Wal. 3499. [2647]
BRAND new Avo meter, latest model 40; best offer secure.—Box 3093. [2605]
FURZEHILL universal multirange meter, perfect, as new; price £14.—Box 3103.
FOR sale, Avo 40, also Mullard test-board 7269, as new; offers.—Write O. Cripps, 168, Randolph Ave. W.9. [2624]
MULLARD test-board, complete with valve and test cards; £45 or nearest.—A. Haycock, 168, Kirkcaldy, Wakefield. [2623]
VARIOUS test instruments, mains transformers, valves, etc.—S.a.e. to Warburton View, Oldfield Rd., Altrincham. [2684]
AVO, model 40, almost new, £17/10; or will exchange for Taylormeter 83C.—Fewkes, 52, Fordwych Rd., N.W.2. [2627]
COSSOR ganging oscillator, model No. 3296. C and oscillograph, model No. 3295; offers.—Napiers, 127, Prestwick Rd., Ayr. [2649]
AVO universal 40, perfect condition, recently calibrated by makers; offers over 8gns.—Write Vereker, BM/OMRT, London, W.1. [2685]
TESTSCOPE, used everywhere by radio service engineers, makes 20 important tests; send for interesting leaflet "R.I."—Runbaken, Manchester, 1. [1074]
MULLARD Master valve test-board, type 7629, model 811, complete with large variety of test cards; offers.—Larr's. Radio Stockists, Whitehall St., Dundee. [2616]
WESTON analyser, model 1772, with carrying case, off perfect, new condition; best offer over £25.—Ralph, 16, Stakes Rd., Purbrook, Portsmouth, Hants. [2646]
AVOMETERS.—Model 7, £19/10; 40, £17/10; Uni., £8/10; D.C., £3/10; good stocks for immediate release to those holding Government priority contracts only, and H.M. Services. Callers only; no correspondence possible.—Judge, 676, Romford Road, Manor Park, E.12. Hford 2066. [2640]
METERS! We have over thirty assorted high-grade meters, Weston, Evershead, Pullin, Elliot, model 7.—Harris, 37, Edgeworth Crescent, N.W.4. Hendon 7153.
COLLINDER, Eta, Douglas, or similar power, interleaving paper, Presphan and leatheroid covered flexibles.—Radio Services, Field St. Works, Blackpool. [2671]

Wanted

HUNTS Capacitor Analyser; good price.—37, Edgeworth Cres., N.W.4. Hen. 7153.
AVOMETER, model 7.—Harris, 37, Edgeworth Crescent, N.W.4. Hendon 7153.
COLLINDER, Eta, Douglas, or similar power, interleaving paper, Presphan and leatheroid covered flexibles.—Radio Services, Field St. Works, Blackpool. [2671]
NEW MAINS EQUIPMENT
VORTEXION mains transformers, chokes, etc., are supplied to G.P.O., B.B.C., L.P.T.B.; why not you? Imitated but unequalled; orders can only be accepted against Government contracts.
VORTEXION, Ltd., 257, The Broadway, Wimbledon, London, S.W.19. Lib. 2814.

MORSE EQUIPMENT

MORSE practice equipment for classroom or individual tuition; keys, audio oscillators for both battery or main operation.—Webb's Radio, 14, Soho St., London, W.1. Tel. Gerrard 2089. [2291]
GRAMOPHONE AND SOUND EQUIPMENT
COILS for filters, tone controls, etc., all types of transformers for "W.W." circuits.—R. Clark-30, Langland Crescent, South Stanmore, Middx. [2570]

RECORDING engineer offers consulting service for disc-film-tape, etc.; advice, diagrams; tests and reports; general design and information all aspects of sound recording.—S.a.e. with enquiries BM/DWAD, London, W.C.1.
M.V. auto record changer, dc, in cabinet.
H.B.T.H. Universal gram. motor, old-type bar-magnet speaker, 15ohm coil, experiments—surplus, valves, condensers transformers, milliamperes, rectifiers, etc.—Box 3097. [2614]
CELESTION W.5 magnetic, fitted Everlast diamond needle, £6/15 or offer; Tel-funken T.1000, moving coil, £7/18 or offer; Rothermel de luxe, crystal, fitted Everlast diamond needle, £6/15 or offer.—D. Fraser, 13, Attadale Rd., Inverness. [2675]

Wanted

E.M.G. pick-up arm, less head. 8/Ldr. Grant, Courtney House, Hendon, N.W.4. [2606]
PICK-UP head for Philco radiogram, model CA638.—State price, etc., Box 3100. [2631]
CRYSTAL P.U., pref. B.T.H. Senior; also a.c. gram-motor, any voltage.—Box 3105.
TELEFUNKEN T.D.1001, or H.M.V. hyper-sensitive pick-up wanted.—Cundy, 68, Brownspring Drive, New Eltham, S.E.9. [2619]

PREMIER RADIO

Premier 1-Valve de Luxe Battery Model 8.W. Receiver, complete with 2-volt valve, 4 coils covering 12-170 metres. Built on steel chassis and panel, Bandspread tuning, 65/-, including tax.

PREMIER MICROPHONES

Transverse Current Mike. High-grade large output unit. Response 45-7,500 cycles. Low hiss level, 23/-.
 Premier Super-Moving Coil Mike. Permanent Magnet model requiring no energizing. Sensitivity 85db. Impedance 25 ohms. Excellent reproduction of speech and music, 45/5/-.
 Microphone Transformers, 10/6 each.
 Crystal Mike. Response is flat from 50-5,000 cycles with a slightly rising characteristic to 8,000 cycles. Output level is minus 60db. Price 39/6.
 Chromium Collapsible Type Microphone Stand, 52/6.

STEEL CHASSIS

Undrilled.
 10 x 8 x 2 1/2" price 7/- each.
 16 x 8 x 2 1/2" price 8/6 each.
 20 x 8 x 2 1/2" price 10/6 each.

I.F. TRANSFORMERS, IRON CORED
 450-470 kc., plain and with flying lead, 7/6 each.

NEW PREMIER S.W. COILS

4- and 6-pin types, now have total pin spacing and will fit International Octal valve holders.

4-PIN TYPE			6-PIN TYPE		
Type	Range	Price	Type	Range	Price
04A	9-18 m.	2/6	06	9-18 m.	2/6
04A	12-26 m.	2/6	06A	12-26 m.	2/6
04B	22-47 m.	2/6	06B	22-47 m.	2/6
04C	41-84 m.	2/6	06C	41-84 m.	2/6
04D	76-170 m.	2/6	06D	76-170 m.	2/6
04E	150-350 m.	3/-			
04F	255-550 m.	3/-			
04G	400-1,000 m.	4/-			
04H	1,000-2,000 m.	4/-			
New Premier 3-Band S.W. Coil, 11-25, 25-38, 38-86 m., 4/9.					
2 Push-Pull Switches to suit above, 9d. each.					
Bakelite Dielectric Reaction Condensers.					
001 mf. 1/3, 0003 mf. 2/6, 0005 mf. 2/9 each					
0003 mf. Differential 2/11 each					

H.F. CHOKES

S.W. H.F. Choke, 10-100 m. 1/3
 Binocular H.F. Choke 1/6
 Brass Shaft Compens. in. bore 7/4d. each
 Flexible Compens. 1/4 in. bore 1/6 each
 7-pin Ceramic Chassis mtg. English Sitting Valve Holders, 1/6 each.
 Amphenol Octal Chassis mounting Valve Holders. International type, 1/3 each; English type Octal 1/3 each.

RESISTANCES

Mains Resistances, 650 ohms, 3A Tapped. 350 x 180 x 60 x 60 ohms, 5/6 each.
 1,000 ohms, 2A Tapped. 900, 800, 700, 600, 500 ohms, 5/6 each.

SWITCHES

QMB, panel mounting, split knob type, 2 point on/off, 2/- each. Double pole on/off, 3/6 each.

VOLUME CONTROLS

Carbon type, 20,000 and 2 meg, 3/9 each.
 5,000 and 10,000, 4/6 each.
 Wire Wound Type, 10,000 ohms, 5/6 each.
 Valve Screens for International and U.S.A. types, 1/2 each.
 Resin-Cored Slider, 6d. per coil.
 Push-Back Connecting Wire, 2jd. per yard.
 Systoflex Sleeving, 3 mm., 2/6 per doz. yards.
 Screened Braided Cable, Single, 1/3 per yard. Twin, 1/6 per yard.

MOVING COIL SPEAKERS

Goodmans 3 1/2 in. P.M. Speaker, 15 ohms voice coil, 30/-.
 Eola 6 1/2 in. P.M. Speaker, 3 ohms voice coil, 25/-.
 Eola 5 in. P.M. Speaker, 3 ohms voice coil, 25/-.
 Above speakers are less output transformer.
 Pentode Output Transformers, 3 1/2 watts, price 10/6 each.
 Collection of Plessey 5 in. P.M. Speaker, 29/6.
 Celestion 10 in. P.M. Speaker, 49/6.
 The above speakers are fitted with output transformers.
 Morse.—The Premier Oscillator supplied complete with valve, on steel chassis, price 27/6. Practice key 3/3, TX key 5/10, Super key 11/6. 3-Hinged Chokes (as used in Oscillator), 10/-, High pitched Buzzer, adjustable note, 1/11 each.

Send for details of other Accessories available.
ALL ENQUIRIES MUST BE ACCOMPANIED BY A 2jd. STAMP.

PREMIER RADIO CO.

ALL POST ORDERS TO:
JUBILEE WORKS, 167, LOWER CLAPTON ROAD, LONDON, E.5. (Amberet 4793.)
CALLERS TO:
JUBILEE WORKS or 169, FLEET STREET, E.C.4. (Central 2833.)

RECORDING unit, complete with motor, weighted turntable, tracking gear and cutting head, any condition; price.—Slater, Acrewood, Burton, Wirral. [2672]

NEW COMPONENTS

ACORN valves, 954, 955, 957; Eddystone 4-pin coils, BB, Y, W, R; Eddystone 6-pin coils, 6GY, 6BB, 6LB, 6Y, 6BR, 6P; black Celestion amphenol international octal valve holders—Offers Box 3110. [2680]

COMPONENTS—SECOND-HAND, SURPLUS
CHARLES BRITAIN offers bargains in radio spares:—

SERVICE kits.—One 8mf 500v tubular, 6 assorted tubular condenser, 1,000v test, 6 assorted resistances, 11/6 per kit. Kit No. 2: Two 8mf 500v tubulars, one 60ma choke, one 0.3 mains dropper with var. tap, 6 assorted resistances, 30/6 per kit.

TUBULAR condensers, 1,000v test, 0.1 9/- doz, 0.05, 0.01 7/6 doz, 0.004, 0.002, 0.001, 5/6 doz; H.M.V. flat mica assorted values, 5/6 doz; silver mica, 3/6 doz.

MAINS droppers, 1,000ohm, 0.2amp, 2 var. taps, 4/6 each; Little Maestro type, 0.3amp, 5/6 each, or the two for 9/-.

WAVELENGTH switches, 2pt., 5-way, 4pt., 2-way, 3/9 each, Yaxley type.
VOLUME controls, long spindles, less switch, 5,000, 10,000, 25,000, 100,000, 1/4, 1/2, 1 and 2 meg, 3/4 each, or 2 for 6/-; 5,000, 1/4 and 1/2 meg, with switch, 5/6 each.

MAINs transformers, 350-0-350, 4-volt and 6-volt types, 100ma, 27/6 each.

DIALS, 7in. x 4 1/2 in. approx, 2-wave celluloid, 1/6 each; 3 waveband glass dials, 1/6.

VALVE holders, Octal and British, 7-pin, 7/6 doz; sleeving, grid caps, Oct. and standard, 1/- doz; sleeving, 3d. per yd. or 1 doz 2/6.

SPECIAL bargain offer: New 2-valve (M.W.) battery set chassis, complete and wired up for testing, less valves; 10/- each; terms, cash or c.o.d. over £1.—Charles Britain (temp. address), Eureka, Surrey Gardens, Effingham, Surrey. [2679]

LONDON CENTRAL RADIO STORES.—See our displayed advert., page 6 this issue.—London Central Radio Stores, 23, Lisle St., London, W.C.2. Ger. 2069. [2659]

FORMO Ceramic ribbed 2 x 1 1/2 in coil formers, with 2 1/2 x 1/2 x 1/2 in 5-hole base, without fittings, per doz, 5/-.—A.C.S. Radio, 44, Widmore Rd., Bromley. [2637]

ALL radio enthusiasts will find much to interest them; send 1d. stamp for latest list, or call at Berry's (Short Wave), Ltd., 25, High Holborn, W.C.1 (Tel. Holborn 6231).

APPROX. 4 doz electrolytics, 500v, working A 32 x 32 x 15md, 2 and 4md, Mansbridge, tubular 8mds, etc.; £10 the lot, or would separate; £20 offered for auto change.—Box 3108. [2669]

A QUANTITY of 2in and 1 1/2 in speech coils, A 15ohms, and other materials for Epoch Super and Domino diaphragms, also tools for assembling.—Weholi, 1, The Close, Kingsley Lane, Rayleigh, Essex. [2610]

EXPERIMENTER'S surplus stock of new and second-hand components, speakers, electrolytics, test equip., cath. ray tubes, etc.; 1d. stamp and s.a.e. for full list.—A. Trogelles, 13, Watstock Rd., Weston super-Mare. [2652]

HENRY'S offer T.C.C. 2mf, 1,000v. Radio, H 7/6; T.C.C. 1,000mf, 25v. wkg., 10/-; 3in wire-wound instrument rheostats, 500ohms, 8/6; small 3-gang 0.0005 with trim, 10/-; 5in Plessey P.M. with trans., 28/6; Goodman's 3 1/2 in, 27/6; trans. to match, 7/6; 0.2 line cord, 750 and 900 lengths, 2-way, 10/-; small mains trans., input 200-250 a.c., output 13 volts, cent. tap, 3amps, 12/6; short-wave h.f. chokes, 2/-; Centralia vol. controls, long spin, with switch, 6/-; 5,000, 10,000 and 1/2 meg., all above unused.—Henry's, 5, Harrow Rd., Paddington, W.2. Pad. 2194. [2665]

RADIOSALES offer all popular values resistances, 1/4w 4d., 1/2w 6d., 1w 9d.; most values tubulars, 0.0001 to 0.005 9d., 0.01 to 0.05 1/-, 0.1 (special) 6d.; Paxolin valveholders, octal, 7- and 9-pin 9d., 4- and 5-pin 6d.; volume controls, 5,000, 10,000, 25,000, 1/4m, 1/2m, 1m, without switch 3/-, with 4/-; neon tubes, 1s. 6d. each, s.a.e.—Radiosales, BOM/SAL/ES9, London, W.C.1. [2657]

RECTIFIERS, charger kits.—Metal rectifier, R 2v 1/2amp, with transformer, makes ideal trickle charger for 2v cell, 13/6, post 7d.; transformer, rectifier and ballast bulb for 2v to 12v 2.5a charger, 59/6, post 10d., rectifier alone 34/6, post 7d.; transformer, rectifier, ballast bulb for 2v to 12v 1/2amp charger, 38/6, post 10d.; rectifier alone, 12/3; transformer, rectifier, ballast bulb for 2v, 6v, 2amp charger, 42/6, post 10d.; instrument rectifiers for meters, bridge type, bakelite, good make, brand new goods, 1ma, 5ma 18/6, post 3d., 10ma, 50ma 15/6; Rothermel Bullet crystal microphones, black crackle finish, £3; also de luxe moving coil mikes, massive construction, plated, reproduction equal to a well-known £20 moving coil mike, £5/10.—Champion, 42, Howitt Rd., London, N.W.3. [2682]



Any Size

Low in cost
Require no attention
No lubrication
No adjustment
Cushion shock
Prolong life
Transmit power
No wear
Designed to eliminate vibration

You are certain to be interested in this unique constructed flexible bearing.

THE RUBBER AND METAL ARE ONE UNIT AFTER WELDING OR BONDING.

CLAYFLEX
FLEXIBLE BEARINGS

CLAYFLEX LTD.
TIDDINGTON RD. STRATFORD-ON-AVON
PHONE: STRATFORD-ON-AVON 3296/7
GRAMS: CLAYFLEX, STRATFORD-ON-AVON

RELAYS TYPE LF

WORK IN ANY POSITION



Specified by many Government Departments

Ask for leaflet SPN WW

LONDEX LTD
MANUFACTURERS OF RELAYS
100-102, ANERLEY ROAD, LONDON S-6 E 20
PHONE: 3128

THE AMBASSADOR P.A.143



FOR INDUSTRIAL EDUCATIONAL AND WELFARE NEEDS

's the best selling line in P.A. equipment. With built-in radio unit £26.10s. (subject) + 25/6 TAX. Industrial speakers (10") £3.12s. (subject)

Catalogue and terms on request.

R. N. FITTON LTD
HUTCHINSON LANE, BRIGHOUSE
Scottish Distributors: Tel.: 283
British Electrical & Manufacturing Co. Ltd.
133, West Campbell Street, Glasgow
Tel.: Central 3286

G. A. RYALL, 69, Wharfedale Gdns., Thornton Heath, Surrey.—Please note new temporary address; mail order only; no c.o.d. under 20/- please.

T.C.C. 0.1 non-inductive tubul. cond., in Pax. tubes, type 330, 350v wks., 7/6 doz.

SLOW motion (epicycle) drives, in well-finished brass, ratio 8-1, shaft 1/16in long, 1/16in dia., drilled to take pointer, 1/3 each.

PAXOLIN strip, 2 1/2in wide, 12in lengths, 3 1/6 and 100 25/-; short lengths cut group board size, 6 1/3; Wearite switches, ebonite with silver-plated contacts, for 2hi and band pass, with dial lights, 1/6 each.

TWO-WAY screened flexible, good quality, 1/3 yard, three yards 2/9; twin screened, high insulation and cotton outer cover 1/9 yard, 4 way 2/3 yard.

TEN-WAY cable, good conductors, 1/3 yard, three yards 2/9; ten-way cable, including three Samp conductors for low tension circuits, 2/- yard, three yards 4/9.

OPTAL 8 pin plugs with base, complete with insul. metal cap, 1/3 each, three for 2/9.

MORGANITE long spindle 10,000 vol. con. less switch, 3/9; 1meg with switch, 4/9; 50,000ohm Centralab with switch, 4/9.

5-PIN plug and sockets, no metal caps, suitable semi-permanent connections, 4 1/3.

TWIN tough rubber flexible cable, 1/3 yard, three yards 2/9.

DIAL plates, oblong, 5 1/2x2 1/2 approx., Burndepl, Varley, Vidor, with station names, 4 assorted for 1/6.

BURNDEPL portable set dials, 4 1/2x2 1/2 approx., 2 1/3; Burndepl 4-band, 8x5 3/8, s.w. on lower half dial, 1/6 each; Vidor 3-band, 6 1/2x5 3/8, 1/6 each.

COILS, iron core midget, Litz wound, medium wave tapped, no reaction, 2 3 each; push-back wire stranded, cotton covered, 3 colours, 12 yards, 2/3.

MICROPHONE cap-sules by Standard Telephone, 3/9 ea.; Centralab vr. less switch, long spindles, 5,000ohms, 1meg, 3/9 ea.

INPUT strips, 2in x 1/2in, 2-way, 2/6 dozen; with terminal screws, 3/3 dozen; anchor or mounting strips, 2/3 dozen, 5-way.

SPECIAL offer T.C.C. double mica cond. 0.0001-0.0001 five (ten condensers) for 1/3; Hunt's 0.01 mica cond., 1/- ea.; H chokes on ebonite bobbins, 5,000ohms, 1/3 ea.

ERIE colour coded resistances, 2-watt type, 680, 6,800, 140,000, 150,000, 220,000, 470,000, 820,000, 2 1/3; Erie 3-watt, 680, 18,000, 1/3 each.

YAXLEY type low loss switches, single pole dt., 2 bank, 2/9, single bank 2/3.

CLYDON and Plessey trimmers, 70mm, 2 1/6; 1,000 and 2,000mm, 2 1/6; low value oddments, 2 1/6. [2683]

IT would be an exaggeration to say we have everything in radio, but we have nearly every valve, resistance, condenser, etc.; pay us a visit, it will save you a lot of time.—Berry's (Musical), Ltd., 10, London Rd., Camberley, Surrey. [2522]

SOUTHERN RADIO'S wireless bargains.—Standard Telephone carbon microphone inserts, 4/- each; screws and nuts, assorted, gross of each (2 gross in all), 10/-; soldering tags, including spade ends, 6/- gross; 2mfd condensers, Post Office upright, paper type, used, but fully guaranteed, high working voltage, 2/6 each; Philco 3-point ear aeriols, excellent for short-wave and home aeriols, 7/6; limit tone arms, universal fitting, for sound boxes and pick-up heads, 10/-; Ace P.O. microphones, complete with transformer, ready for use with any receiver, 7/6; Erie resistances, brand new, wire ends, 1, 1/2, 1 and 2 watts, mostly low values but a very useful selection, 100 resistances for 30/-; Multicon mica master condensers, 28 capacities in one, from 0.0001, etc., etc., 4/- each; special offer of latest radio publications: "Radio Valve Manual," equivalent and alternative American and British types, with all necessary data, 3/6; "Radio Circuits," fully illustrated, receivers, test equipment, etc., etc., 2/-; "Services Signalling Manual," international code, Morse, etc., etc., 1/-; "Radio Manual," for mils, tables, colour code, etc., 1/-; crystals (Dr. Cecil), 6d.; with catwhisker, 9d.; complete crystal detectors, 2/6; Telsen reaction condensers, 0.0001, 1/9; Telsen large disc drives, complete boxed (type W184), 2/6; 25 yards push-back insulated wire, 5/-; insulated sleeving, assorted, yard lengths, 3/6 doz.; single screened wire, dozen yards 10/-; metal cased condensers, 0.1, 0.1, 0.1, 2/6; power rheostats, Cutler-Hammer, 200ohms, 4/6; push-button switches, 3-way 4/-, 8-way 6/- (complete with knobs); bakelite escutcheon plates for 8-way p.b. switches, 1/6; knobs for p.b. switches, 6d.; coil formers, ceramic and porcelain, 12 assorted sizes, 7/6; 20 assorted tubular condensers, up to 0.1, 15/-; 24 assorted mica condensers, 12/6; hundredmore bargains.—Southern Radio Supply Co., 46, Lisle St., London, W.C. Gerrard 6653.

HILL & CHURCHILL
BOOKSELLERS
SWANAGE DORSET

ENGLISH & AMERICAN BOOKS IN STOCK ON

RADIO AND TELECOMMUNICATION

CATALOGUE ON APPLICATION

SPEAKER REPAIRS
by Specialists
TRADE ONLY

Send trade card and id. stamp for current list published monthly.

We hold an export licence for Northern Ireland.

A.W.F. RADIO PRODUCTS
Borough Mills, Sharpe Street, Bradford, Yorks.
Tel.: 11928.

WARD ROTARY CONVERTERS

Petrol Electric Generating Plants, H.T. Generators, D.C. Motors, Frequency Changers, etc., up to 25 K.V.A.

CHAS. F. WARD
37, WHITE POST LANE, HACKNEY WICK, E.9
Phone: Amherst 1393

TESTOSCOPE



Makes 30 important tests AC/DC. Used everywhere by Electricians, Wiremen and Service Engineers. Interesting booklet "R14" on testing, free. From all Wholesalers or direct.

RUNBAKEN -- MANCHESTER -- I

REWINDS

MAINS & OUTPUT TRANSFORMERS, FIELD COILS, PICK-UP COILS, ARMATURES PROMPTLY EXECUTED

Philips and Ekco D.C. Converters bought, sold and exchanged. Valves, B.V.A. and American, good stock. Send stamped addressed envelope for price list.

A.D.S. Co. 261-3-5, Lichfield Road, ASTON, BIRMINGHAM, 6



W. BRYAN SAVAGE LTD.

Expert assistance in the solution of problems relating of

- TRANSFORMERS, CHOKES
- AMPLIFIERS
- POWER UNITS

and Specialised Equipment embodying

ELECTRONIC CONTROL

WESTMORELAND RD., N.W.9
COLINDALE 7131

VALVES

This is part of our current stock of valves and if all their equivalents were mentioned it would be found that we can supply either the exact valve or a suitable replacement for almost any type. Wherever possible please order C.O.D. Stamp with enquiries, please.

PRICES STRICTLY B.O.T. RETAIL

BATTERY - 21 OHM, 1P210, 5 10; P220, PM2A, 7 4; 210HT, 1 21; TD12A, 9 2; 2108PT, 210TA, 210VPT, 2154G, 220HT, 220 OT, HP210, K50M, KT2, KT4, PM12M, PM22A, SP2, SP210, VP210, VP2B, W21, Z21, Z22, 11 -; 210PG, P2, P2A, N24, 12 10.
A.C. TYPES - 201A, 6 9; 354V, AP HL, MH4, MH4, 9 2; AZ1, AZ2, DW2, HW1-350, HW1-350, M14, U10, 11 -; A7044, MH44, MH44, PNT, TD14, 11 7; 42MP Pen, AC VP1, AC Pen, AC2Pen, AC5Pen, KT41, KTZ6B, MKT4, MSPenB, MVSPen, MVSPenB, Pen4A, Pen4VA, SP4, VP4, VP4B, VTT4, 12 10; AC TH1, AC TP, P4, MK10, TH4, TX4, VHT4, HM10, 14 -; KT32, KT33C, PenB4, 14 8; MP Pen, 16 8; FM-5000, KT66, 18 3; PX25, P15 00, 24 4; Pen429, 30 5.

UNIVERSAL - 2013A, 9 2; CY1, U31, U31C, U31C, U320, 11 -; H103, TD113C, 11 7; 703, SP2, 902, 138PA, CL4, CL33, Pen30C, SP13, SP1320, VP13A, VP13C, 12 10; EBLL, GBLS4, PenDD4020, TR10C, 15 3.

MAZDA - H123, 5 10; H123DD, 9 2; Pen25, U15, U16, U17, U4020, VP23, 11 -; H141DD, H123DD, 11 7; Pen45, Pen33, SP41, TP23, TP26, VP41, VP133, 12 10; AC TPTTH41, TR233, 14 -; P225, PenDD4020, 15 3.

E TYPES - E44, 11 -; E45, E46, 11 7; CL4, CL33, EP8, EP9, EL3, EL33, 12 10; CCH35, EC12, EC13, EC135, EP5, EP6, EK2, EL2, 14 -; EBLL, EB131, 15 3; EL5, 16 8; EL25, 18 3.

AMERICAN - 024, 1A5, 1B5, 1H5, 2A6, 2A7, 2B7, 2F, 5U4, 5Y3, 5Z3, 5Z4, 6A3, 6A4, 6A5, 6A6, 6A7 conversion, 6C5, 6C6, 6D4, 6C8, 6E5, 6F6, 6E7, 6I6, 6G5, 6J7, 6K6, 6K7, 6K8, 6L6, 6L7, 6P5, 6Q7, 6R7, 6S47, 6SC7, 6SF7, 6V6, 6X5, 6Z5, 10, 1, 12A5, 12Q7, 17, 12SF5, 12Z5, 15, 19, 24, 25, 25A6, 25L6, 25Y5, conversion, 25Z4, 25Z5 conversion, 25V6, 32, 33, 34, 35, 37, 38, 42, 46, 47, 48, 50, 53, 57, 71A, 73, 76, 78, 80, 81, 82, 85, 89, 155A, (Ball) 155B.

VALVES & ADAPTORS

In the cases where we cannot supply the exact valve or equivalent, we can get your set going with a valve and adaptor, the additional cost being 4/6.

SPARES

KIT OF 12 TRIMMER TOOLS in American cloth folder, very handy, 30/- . Speakers, 5in, W, Trans., 32 6. LINE CORD, -3 amp, 3 core 60 ohm per ft., extremely good quality, 6/9 per yd. **CELLULOSE CEMENT** for speaker valve and most other repairs, 5/- tin. **SERVISOL**, more than a switch cleaner, 5/- tin. **MAINS TRANSFORMER**, 250-0-250 4 volt heaters, 2/9 3. **VOLUME CONTROLS** with switch, 7 6. **VALVE EQUIVALENTS CHARTS**, 17 post free. **BOOKLET ON AMERICAN MIDGETS**, 2/7.

J. BULL & SONS

(Dept. W.W.)

246, HIGH ST., HARLESDEN, N.W.10.

COULPHONE RADIO, New Longton, nr. Preston. New goods only: Tungram and B.V.A. valves; mains trans., 350v, 100 ma, 4v 6a, 4v 2.5a, or 6.5v 5; 3a, 33 6; mains trans, bobbin, windings as above, 17 6; p.m. speakers, legs trans., Rola 5in 21 6, 6 1/2in 22 6, 8in 24 -; Plessey 10in, powerful mag net, 35 -; Celestion, with pen. trans., 8in 30/-, 10in, heavy duty magnet, 45 -; 8in energised, 2,000 ohms field, pen. trans., 32 6; power-pen. output transf., 7 6; push-pull Universal, 15 6; Paraflex I.F. trans., 4; 1, 6 6; Bell trans., 6 6; line cord, pen. resistors, 800 ohm, 2 adj. taps, 5 6; push-back wire, 100ft, 5 6, 50ft 3 6; carbon resistors, 50 ohms to 5 meg, 1/4 doz., 1w 6d., 1w 9d.; switch cleaner, 2 6; bott.; cellulose cement, 4/- 1/2pt; cored solder, 4 6lb tin; cop. wire, 2 3 1/2lb; 1/4in shaft couplers, 6d.; lin bakelite knobs, 9d.; sleeving, 2um, 3d, yd; condensers, 50mfd 12v, 25mfd 25v, 2 -; 25mfd 50v, 2 9; 50mfd 50v, 3/3; tubular and silver mica, all sizes; valve holders, 1d. per pin; vol. controls, with sw. 5 9; less sw. 4 9; electro-micro. soldering irons, 60w, 12 6; smoothing iron elements, 450w, 2 3; fire spirals, 750w, 2 -; 1,000W 2 6; s.a.e. for stock list. [2653]

H.P. RADIO SERVICES, Ltd., offer following all new goods: Chassis comprising 7 screened coils, 27 mica cond., 30 resist., 4 paper cond., 1 vol. cont., etc., 50/-; basic parts for Oscilloscope, 7in or 9in Mazda cath. ray tube, high coil, mains trans. and 0.1 cond., shielded scanning coils and cradle for tube, £10; service man's or experimenter's service kit, as follows: Henley elec. soldering iron, soldering paste, solder, screwdrivers, pliers, test prods, switch cleaner, cabinet polish, sleeving, screened cable, connecting wire, insulated tape, adjustable 0.5amp voltage dropper, standard output transf., 42 watt resistors, 12 ass't. cond., grid clips, wandler plugs, spades, solder tags, screws, textbook, 'Radio Servicing' (4/6 edition), £4 inclus.; Rothermel crystal mike on table stand, 90/-; Meico m.c. mike, 5gns; telescopic stands, 39 6 10in Celestion m.c. spkrs, with trans., 45/-; 2volt 45amp glass accum., 11/-; valves, American GT and UX, British, etc., most types from stock; purchase by post with confidence; prompt despatch; orders £4 or over carr. paid.-H.P. Radio Services, Ltd., 55, Triode, L.F. Pen., Redfern, M.C. Speaker. Price 10 gns. Post 1/1, plus 3/6 packing (returnable). [2667]

ELECTRIC soldering irons, pencil bit, 12 6; resin cored solder, 1lb 4 6; 16g tinned copper wire, 1lb, 2 2mm sleeving, 2 9 doz yds; pushback wire, 1/9 doz yds; heavy twin mains flex, 7 6 doz yds; rubber-covered 3mm flex, 1 9 doz yds; 50mfd 12v electrolytics, 1 6; 10mfd 50v can type, 2 9; 0.2 amp 1,000 ohm droppers, adjustable, 4/-; 0.3 amp 750 ohm, adjustable, 5 6; American octal valve holders, 8d.; British 7-pin, 8d.; 0.1mfd 350v condensers, 6 6 doz; black set knobs, 7 -; solder tags, 2/- gross; "4" (4) 2-pin plugs, 5 amp, 1/-; 3-pin 5 amp, 1 3; 3-pin 15 amp plugs, 2 6; BC adaptors, 1/3; volume controls, long spindles, all usual values, 3 6; with switch, 4 6; top cap connectors, 1 -; doz; screened type, 8d. ea.; octal or standard; insulation tape, 1 1/2 lb 1/-; speaker cabinets, leatherette covered, smart job, 42in x 10in x 5in, 22 6; p.m. speakers, 8in, no trans., 22 6; 8in, with pentode trans., 30 -; midget smoothing chokes, 60ma, 7 6; Rothermel Senior crystal pick-ups, £3 18 9 (inc. par. tax); large stocks; American valves, etc.; orders above 10/- post free; mail order only. "A. H." Hazeljoin, Crofton Lane, Orpington. [2639]

Wanted

16x16 or 32-32, r.F. 150v wk2., elec., 230, (Chellaston Rd., Derby. [2629]
 PETER SCOTT dial for "W.W." a.c. Super.-140, Swanley Rd., Welling, Kent. [2661]
 CENTRE tapped filament transf., 230 4v 0 Taps.-Quirk, 4, Carris-brooke Rd., Birmingham, 17. [2662]
 CHASSIS, i.f.t.s and w.c. switch for "W.W." 3 band super. Kuckpatrick, 29, Glanrylan Ave., Swansea. [2628]
 "W.W." universal o.p. transformer, commercial built, cash or exchange acorns, microammeters, electrolytics, etc.-Box 3099.
 HAYNES output transformer OPP15, Haynes-mains T150, Haynes smoothing choke L15.-Flack, 10, Grove Pk. Rd., Chiswick, W.4. [2639]

VALVES

5000 valves, all types, including output rectifiers, etc.; also a few tax free ones left; s.a.e.-Davies, 28, Mount Vernon Crescent, Barmley. [2406]

COULPHONE RADIO, New Longton, nr. Preston.-Tunggram and B.V.A. valves, hundreds in stock; post and packing free; rectifiers 5Y3G, 5Z4G, 80, equiv. U12, U14, etc., 10 -; really prompt service; s.a.e. for list and enquiries. [2545]

AUSTERITY RADIO LIMITED

CONSTRUCTORS' KITS

3-v. T.R.F.

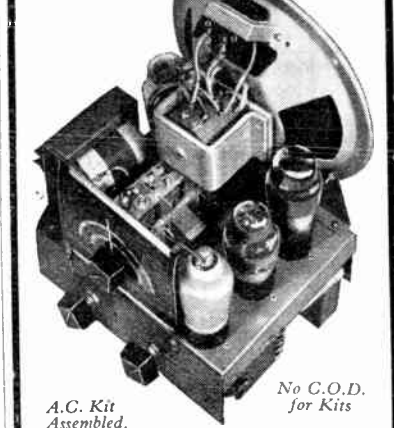

No C.O.D. for Kits
 A.C. Kit Assembled.

Delivery approximately One Month.
 New 140-wound coils are now supplied with these Kits which give good quality reception of B.B.C. programmes. Complete with chassis 8in. x 6 1/2in. x 2 1/2in. Valves, M.C. speaker and wiring diagram. (Roget, no cabinets.) 3 controls.
A.C. 3-V. (4-RETIFFER) KIT, V.M.H.F. Pen., Triode, L.F. Pen., Redfern, M.C. Speaker. Price 10 gns. Post 1/1, plus 3/6 packing (returnable).
BATTERY 3-V. KIT, V.M.H.F. Pen., Triode-Detector and Output Triode, P.M. Speaker. Price £7. Post 1/1, plus 3/6 packing (returnable).

3-GANG CONDENSERS, ceramic insulation, 0.0025, 8 6; also STANDARD .005 ceramic insul. 12 6.
SHORT-WAVE COILS, 3 bands covering 12-20 metres. Aerial and H.F. mounted on screened switch. Wired up to terminal output connections. All numbered, 1 1/2 spindle. Complete with circuit, 20 -.

A. & H.F. TRANSFORMERS with reaction colour coded, 10 6 a pair.
465 KCS. I.F. TRANSFORMERS, Iron-cored, unscreened, small, 15 - pair.

MAINS TRANSFORMERS, Universal, A.C. input, 230 v, output, 200-0-200, 6.3 v., 4 amp., 5 v., 2 amp., 4 v., 2 amp., 4 v., 3 amp., 80 ma. screened primary coil (used a good replacement transformer, especially for sets using mixed valves, 32 6 each. Standard Replacement, input 200-250 A.C., output 250-0-250, 80 ma. 4 v., 4 amp., 4 v., 2 amp. Screened primary, 30 - each. Standard, input 200-250 A.C., output 250-0-250, 150 ma., 6.3 v., 5 amp., 5 v., 2 amp., 35 - each.

MAINS VOLT DROPPING RESISTORS, 2 amp., 1,000 ohms, 2 variable sliders, 6 -; 3 amp., 750 ohms, 2 variable sliders, 7 -.

10-WATT WIRE-WOUND RESISTORS, 2,000, 1,000, 500 and 150 ohms, 2 6 each.
VOLUME CONTROLS, 10,000, 10,000 ohms, 1, 1 and 2 meg, with switch, 6 6 each. 5,000, 10,000, 25,000 and 50,000 ohms, less switch, 4 - each.

CHASSIS, Untidied steel, painted, new, 10 1/2 x 2 1/2in., 7 6 x 8 x 6 x 2 1/2in., 4 6 each.
OCTAL CABLE PLUG AND SOCKET, 2 -.

RESISTORS, All standard values, 1 and 1 watt, 6d.; 1 watt, 1 -.

TERMINAL STRIPS, 2d., 3d. and 6d. **SYSTO-FLEX**, Plain and striped, 4d. per yd. length.
CONDENSERS, High voltage mica, .01 mfd., 1 6. **VALVE HOLDERS**, 4, 5, 6, 7-pin Paycolite 6d., International octal, 9d. each.

★ Please add postage for enquiries and orders. C.O.D. orders accepted.

Postal Permit to export to Northern Ireland and Eire. (Owing to present circumstances, prices are subject to increase without notice.)

307, HIGH HOLBORN, LONDON W.C.1. Phone HOLborn 4631

Battery Charging CLIPS

Well made of steel, double ridged for strength. Teeth on three sides of lower jaw give firm grip and good contact. Opens 1 1/4".

Wingard
 Precision Engineers
 EUGENE WORKS, EDGWARE ROAD, HENDON, N.W.2



We could not but have a sneaking sympathy with the match-seller when we first saw this. We felt we had some affinity with him for, all too frequently, we must say, "Sorry, no transformers." Which is the position just at the moment especially in regard to the Small Power class up to 4 Kva. If you, too, have sometimes to say to your customers, "Sorry, no _____," you'll know how we feel. Naturally, we're doing our best to catch up.

GARDNERS RADIO LIMITED

*Manufacturers of
Very Good Transformers*

SOMERFORD · CHRISTCHURCH · HANTS



FOR THE
RADIO SERVICE
MAN, DEALER
AND OWNER

The man who enrolls for an I.C.S. Radio Course learns radio thoroughly, completely, practically. When he earns his diploma, he will KNOW radio. We are not content merely to teach the principles of radio, we want to show our students how to apply that training in practical, every-day, radio service work. We train them to be successful!

INTERNATIONAL CORRESPONDENCE SCHOOLS

Dept. 38, International Buildings,
Kingsway, London, W.C.2

Please explain fully about your Instruction in the subject marked X.

Complete Radio Engineering
Radio Service Engineering
Elementary Radio Television

And the following Radio examinations:

British Institution of Radio Engineers
P.M.G. Certificate for Wireless Operators
Provisional Certificate in Radio Telephony and
Telegraphy for Aircraft

City and Guilds Telecommunications
Wireless Operator & Wireless Mechanic, R.A.F.

Name..... Age.....
Address.....

OUR adaptors will help in replacing unobtainable valves; send 7d. for interesting booklet on valve replacements; trade enquiries invited.—V.E.S., Radio House, Ruislip. [1885]

VALVES.—We have over 5,000 new and boxed English and U.S.A. mains and battery valves in stock, including 6A7, 6A8, 252A, 75, 524, U50, 3525, 1D5, 35L6, 6F6, 6D13c, VP2, SP4, PX4, PENA4, 125Q7, TDD4, UUS, 6K7, 11726, 6Q7, 6K8, 6X5, 6B8, 1W4350, U12, 12A8, 12Q7, 68A7, 68K7, PEN36c, etc., etc.; send 1d. stamp for latest list.—Lasky's Radio, 370, Harrow Rd., Paddington, W.9 (opposite Paddington Hospital).

LARG'S offer choice of useful valves; listed prices; limited stocks; Mullard AZ1, AZ31, DW4/500, EBL1, EBL31, EL3, FC4, 1W4/500, PENA4, PENB4, PEN4DD, PM2BA, TDD4, VP4, VP4A, VP4B, EBC3, EBC33, ECH3, EC135, EF39, IC5GT, IH5G, 5Y3G, 5Z4G, 6A8G, 6P6G, 6QTG, 6L6G, 354V, Marconi D63, DH42, K733C, KJW63, M141, MHL4, X41, VMP4G, X65, Birmar 6A8G, 6F6G, 6K7G, 6K8G, 6Q7G, 6U7G, 9D2, 11D3, 1ZFSGT, 15D2, 25A6G, 2524G, 42, 78, 1ZSQ7GT, 25Z6GT, 352GT, Mazda AC/111, AC/11DD, AC/1ME, AC/2PEN, AC/TH1, AC/VP1, AC/VP2, DC/2PEN, HL2, HL21DD, HL22, HL23, HL41DD, HL42DD, HL1320, 42DD, PEN45, PEN45DD, PEN3520, PEN DD4020, QP25, QP230, S215V, SP41, SP42, SP210, SP215, SP1320, TP26, UUS, UU6, UU7, U4020, VP41, VP133, VP210, VP1322; sent carefully packed c.o.d.—Lark's, Radio Stockists, 18-24, Whitehall St., Dundee. [2615]

Wanted

NEW boxed valves wanted, any quantity. Dealers' and service men's complete stocks bought.—J. Bull and Sons, 246, High St., Harlesden, N.W.10. [2155]

REPAIR AND SERVICE

LOUDSPEAKER repairs, British, American, any make; moderate prices.—Sinclair Speakers, 170, Copenhagen St., London, N.1. Terminus 4355. [2415]

ALL types of radio receivers serviced; Murphy and Pilot specialist; valves in stock; sound repairs for 13 years.—T. E. Feyver, F.I.P.R.E., 50, Vine St., Uxbridge.

MIDWEST, McMurdo, Belmont, Crosley, Ferguson, etc., valves; the American experts.—Bennett's, 4, Humberstone Drive, Leicester. [2693]

"SERVICE with a Smile."—Repairers of all types of British and American receivers; coil rewinds; American valves, spares, line cords.—F.R.L. Ltd., 22, Howland St., W.1. Museum 5675. [1575]

MAINS transformers service, repairs, rewinds, or construction to specification of any type, competitive prices and prompt service.—Sturdy Electric Co., Ltd., Dipton, Newcastle-upon-Tyne. [9651]

MAINS transformers rewound, 48 hours service; state make and type of instrument from which removed, 17/6; output transformers, 4/6, post paid; c.w.o.—Express Radio Service, Southside St., Plymouth. [2654]

REWINDS mains transformers, field coils and chokes, high grade workmanship, seven to ten days' delivery; new transformers manufactured against Government contracts.—Metropolitan Radio Service, 1021, Finchley Rd., Golders Green, London, N.W.11. [2603]

DEGALLIER'S, Ltd.—Service with a guarantee. If you cannot get your receiver serviced, let American specialists do the job; first-class workmanship only; specialising in Air-King, Belmont, Challenger, Detroit, deWald, Emerson, Ferguson, Garod, Hallcraft, Hammerland, McMurdo, Midwest, Majestic, Pilot, Philco, Sparton, etc., also any British set. Remember, for 15 years we have handled as distributors American receivers; this is self-explanatory; s.a.e. with all enquiries. Technical advice on all radio and electronic problems: Due to large number of applications for technical advice received, technical queries answered 3/6 each; this does not apply to the supply of circuits.—Degallier's, Ltd., 9, Westbourne Court, W.2.

MISCELLANEOUS

PHOTO-ELECTRIC cells, 90 volts, 21/ each.—Universal Electrical Co., 221, City Rd., London, E.C.1. [2429]

TIME recorders.—Write for particulars.—Gledhill-Brook Time Recorders, Ltd., 84, Empire Works, Huddersfield. [2419]

NEWLY formed limited company wish to contact manufacturers interested in the production of modern hearing aids.—Box 3111.

ELECTRICAL and radio apparatus for sale at cheap prices, shop closing down; send s.a.e. for particulars.—R. H. Bury, 58, Whitworth Rd., Rochdale, Lancs. [2608]

RUBBER stamps made up to your special requirements, and design, typical example, stamp showing name, address and profession; 9/6 post free.—V.E.S., Radio House, Ruislip. [1884]

"UNIVERSAL CIRCUITS"

by R. S. Roberts, M.Brit.I.R.E., A.M.I.R.E.

Three folders and a thirty-six page booklet, presenting the main principles of radio circuit operation in a concise and convenient form for the pocket.

- I. The Transmitter.
- II. The T.R.F. Receiver.
- III. The Superheterodyne Receiver.

By means of hinged flaps, the charts give a large number of recognised alternatives for each stage. To assist the student in memorising and understanding these, a logical five-colour scheme has been adopted throughout.

"Grid Leak" says: "The Charts and Notes are really intended for students and teachers of radio, but are extremely useful to every radio engineer."

Price complete 6 3 post free, from

The Bookstall
NORTHERN POLYTECHNIC
HOLLOWAY, LONDON, N.7

WELWYN

VITREOUS ENAMELLED
and HIGH STABILITY
CARBON RESISTORS

NEW CATALOGUE

Shortly available to
the Trade.

WELWYN ELECTRICAL
LABORATORIES LTD.

Welwyn Garden City,
Herts.

SALFORD Selenium PHOTO-ELECTRIC CELLS

ENLIGHTENMENT
ON LIGHT

● A Range of Standard sizes available — mounted or unmounted. Special sizes to order.

Please address enquiries to:
SALFORD ELECTRICAL INSTRUMENTS LTD.
PEEL WORKS, SALFORD, 1

Telephone: 51. Address: 518 (14 lines). Telegrams and Cables: "SALFELSEC, MANCHESTER"
PROPRIETORS: THE GENERAL ELECTRIC CO. LTD., OF ENGLAND

The **“PYROBIT”** New

SOLDERING IRON

for Precision Instrument Work

Can be operated like a pencil

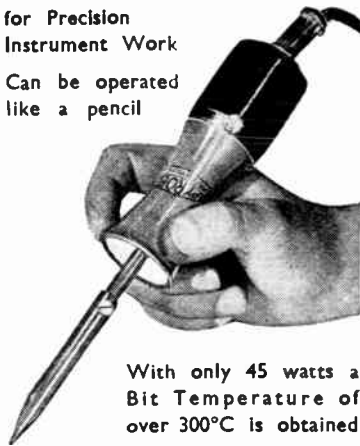

With only 45 watts a Bit Temperature of over 300°C is obtained

For all Voltages from 6—250 volts.

The ACRU ELECTRIC TOOL MFG. CO. LTD.
 123 HYDE ROAD
ARDWICK, MANCHESTER, 12
 Telephone: ARDwick 4284



TRANSFORMERS

Full specifications and new descriptive literature on all types sent on application (Enclose Stamp). All models now in production.

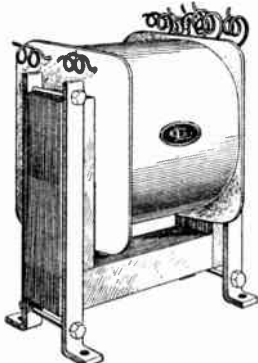

Type GT 350/0/350 v. 120 m.a. 4 v. 2 a. and 4 v. 2 a. and 4 v. 2 a. and 4 v. 4 a. CT	35/-
GX 350/0/350 v. 120 m.a. 4 v. 2 1/2 a. and 4 v. 6 a. CT	37/6
GY 350/0/350 v. 120 m.a. 5 v. 2 1/2 a. and 6.3 v. 6 a. CT	37/6
GW 425/0/425 v. 120 m.a. 4 v. 2 1/2 a. and 4 v. 2 1/2 a. and 4 v. 6 a. CT	45/-
GZ 500/0/500 v. 150 m.a. 4 v. 3 a. and 4 v. 7 a. CT	45/-
GAZ 500/0/500 v. 150 m.a. 5 v. 3 a. and 6.3 v. 6 a. CT	45/-

THE RADIO INSTRUMENT CO.
 294, BROADWAY, BEXLEYHEATH, KENT.
 Phone: Bexleyheath 3021.

CLASSIS transformer shrouds, clips and many other fittings quickly made on A.A. benders; accurate and inexpensive.—Details from A.A. Tools, 1977, Whiteacre Rd., Ashton-under-Lyne, 1977. [2677]

ACTIVE participation and controlling interest required in small but modern and progressive precision engineering and radio development concern, approximately 20 mile radius of London; finance and excellent post-war contacts immediately available for the right type of business.—Apply Box 3101.

RADIO and electricians can make 240 average solder joints with Ersin multicore 3-core flux filled solder wire for 6d.; supplied in automatic feeding carton; every handy man should have a quantity of this high grade cored solder wire; sent post free; all orders executed in strict rotation.—Larg's, The Service Engineers' Suppliers, Whitehall St., Dundee. [2678]

TECHNICAL TRAINING

A.M.I.E.E., City and Guilds, etc., on "No pass—no fee" terms; over 95% successes. For full details of modern courses in all branches of electrical technology send for our 112-page handbook, free and post free.—B.I.E.T. (Dept. 388A), 17, Stratford Place, London, W.1. [2432]

GREAT possibilities exist for technically qualified engineers, key men in wartime and afterwards. Through the home-study courses of The T.I.G.B. take a recognised engineering qualification, such as A.M.I.Mech.E., A.M.I.E.E., A.F.R.A.C.S., A.M.I.Chem.E., C and G., etc. in which examinations the T.I.G.B. students have passed 25 FIRST PLACES and hundreds of passes. Write today for "The Engineer's Guide to Success"—free—containing the world's widest choice of engineering courses covering all branches, including aeronautical, mechanical, electrical, wireless, chemical, etc.

THE TECHNOLOGICAL INSTITUTE OF GREAT BRITAIN. 82, Temple Bar House, London, E.C.4. [1403]

TUITION

LEARN Morse code the Candler way.—See advertisement on page 32. [1292]

RADIO training.—P.M.G. exams and I.F.E. Diploma; prospectus free.—Technical College, Hull. [0611]

PERSONAL radio tuition wanted, congenial, N.W.; good remuneration.—37, Edgeworth Cres., N.W.4. Hendon 7153. [2634]

RADIO Engineering.—Television and Wire less Telegraphy, comprehensive postal courses of instruction. Apply British School of Telegraphy, Ltd., 179, Clapham Rd., London, S.W.9 (Estd. 1906). Also instruction at school in wireless for H.M. Merchant Navy and R.A.F. [9249]

"ENGINEERING Opportunities," free 112-page guide to training for A.M.I.Mech.E., A.M.I.E.E., and all branches of engineering and building; full of advice for expert or novice; write for free copy, and make your peacetime future secure.—B.I.E.T. (Dept. 387B), 17, Stratford Place, London, W.1. [2626]

A POSTAL training in electrical engineering—power or radio; individual correspondence tuition by highly qualified engineers with wide teaching and technical experience. Elementary or advanced courses. Preparation for recognised examinations. Pre-service training specially arranged.—G. B., 18, Springfield Mount, Kingsbury, N.W.9. [1731]

THE Tuitionary Board of the Institute of Practical Radio Engineers have available home study courses covering elementary, theoretical, mathematical, practical and laboratory tuition in radio and television engineering; the text is suitable coaching matter for I.P.R.E., Service-entry and progressive exams; tuitionary fees—at pre-war rates—are moderate.—The Syllabus of Instructional Text may be obtained post free from the Secretary, Bush House, Walton Avenue, Henley-on-Thames, Oxon. [1462]

COACHING for P.M.G. examinations; 150 typical 1st and 2nd class technical questions, price by post 5/.—The North Eastern School of Wireless, 69, Osborne Rd., Newcastle-upon-Tyne, 2. [2081]

PATENT NOTICES

RADIO electric patents.—Well-known London radio component manufacturers are open to consider patents or designs for post-war period.—Write Progress, c/o Alfred Bates and Son, Ltd., 130, Fleet St., London, E.C.4.

BOOKS, INSTRUCTIONS, ETC.

WEBB'S radio map of the world locates any station heard, size 40x30in., 4/6, post 6d., on linen, 10/6, post free.—Webb's Radio, 14, Soho St., London, W.1. Tel. Gerard 2089. [9947]

Wanted

WANTED, "True Road to Radio," by Ferranti, good condition.—Box 3104. [2656]

ELECTRADIX OFFERS

CRYSTAL SETS, MARK III type. A two-circuit receiver with tapped inductance, vario-meter, tuning condenser, perikon and galena detectors, in field case 11in. x 10in. x 8in., Government model, 85/-.

THE WALL NUT. A superior set for shelter, table or wall, new model in polished hardwood case, tapped A.T.I. and variable condenser tuning, 42/-.

VICTORY Pocket type crystal receiver in bakelite box, 35/-.

AERIAL WIRE. 7/22 bare copper, 5/- per 100ft. Lead-in wire, 4d. per yard. Aerial insulators, 2d. each.



CONDENSERS. Ultra Short Wave variable air condensers. 16 m.mfd. Trolitul insulation ball-bearings. Surplus to a Govt. contract and new, 5/-.

SUNDRIES. H.M.V. Resistors, glass cased, wire ends, 1/2 watt, .01, 0.025, .05, 1/- per set of 3 or 2/6 per doz.

Multiple Connection Strips of soldering tags, telephone type moulded mounting, in 80, or 100 ways, at 3/6 and 4/- each.

G.P.O. Plugs, 2/- each. Mentor Battery Indicators, thermal type signal light, 2 1/2in. dial flush panel, 6 volt and 12 volt, 5/-.

Small Solenoids, "Gemi" 6 volts 1 1/2 amps., iron plunger, 6/6. Permanent magnets, horseshoe, all sizes, no discs. Stamp for illus. leaflet. Terminal covers, domino size, bakelite with two secure screws, 9d. each or 7/6 doz.

Electric Counters to 10,000 revs., G.P.O., 5/6.

RHEOSTATS. Aetna panel with 6v. bulb in knob, 0-1 ohm, and switch, 2/9. PITKIN Lab. circular 8in. base, glass front, 50 ohms 2 amps., 35/-.

Large heavy current enclosed grid with front panel 10-stud switch, 40 amps. for 220v. mains to 50 volts, 33in. x 16in. x 1 1/4in., £6 10s. Half-size 110 volt ditto, 16in. x 16in. x 1 1/4in., £4. Large sliders quoted for.

LIGHT RAY CELLS, Selenium Bridge, in bakelite case. Raycraft Model, 21/-.

Electro-cell, self-generating, light meter type, 35/-. Raycraft Ray Set, with relay, 42/-.

RELAYS. Telephone No. 6 twin bobbin polarised S.P. Change-over, 6 volts 25 m.a., 8/6. No. A "on-off" S.P., 2 volts, 5/-.

Less contact blades 1000 ohm coil C.T., 2/6. Enclosed 10,000 ohm tele-type, 22/6. For other Relays see special leaflet, 2d.

RECORDING OF MORSE SIGNALS. Ex G.P.O. Morse Inkers, record on paper tape, clockwork drive, fine workmanship; Siemens make in first class order, £12/10/-.

Special field H.Q. Morse Inker, Key and Indicator, £15.

CAMBRIDGE TOWNSEND BUZZERS are difficult to get. The highest note and smallest Buzzer made, used by Government on wave-meters, ample platinum contacts, 10/-.

Other Buzzers: Practice, bakelite-cased, 3/6. Square metal-cased buzzer, 7/6.

PETROL ELECTRIC PLANTS. 500 watt, direct coupled Stuart, 50 volts D.C., £45. Light-weight Engines, for direct coupling. Twin-cyl. petrol air-cooled Douglas, with fuel and oil tanks, governor, mag. ign., 2 1/2 H.P., £25.

MOTOR PUMPS. We can give immediate delivery of the famous Stuart Turner 12-volt D.C. motor pumps; 120 galls. per hour, 84/-.

Same type but for A.C. mains, 136/-. Pumps only; R type twin-piston rotary for 1/2 H.P. motor drive, £3 5/-.

Aquarium aerators, £5.

4-WING FAN BLADES for small motor blowers, 1/6. Motor Couplings, flexible, for 1/2 and 1 H.P. motors, 6/-.

See Pulleys for 1/2in. belt, 4in. and 4 1/2in. turned steel, 4/6 and 5/-. Water Tanks for storage or engines, Stuart steel 14in. x 5ft. high, 40/-.

G.P.O. LAB SWITCHES. D.P. reversing for model control, motors and test work, 7/6. Liquid Level Indicators with ball float, geared to watch-dial panel gauge for range of 9in. rise or fall, 7/6.

Please send stamped envelope for answer to enquiries and include postage for mail orders.

ELECTRADIX RADIOS

214, Queenstown Road, Battersea, London, S.W.8
 Telephone MACaulay 2159.

"ENGINEERING OPPORTUNITIES"



This unique handbook shows the easy way to secure A.M.I. Mech. E., A.M. Brit. I.R.E., A.M.I.E.E., City and Guilds, etc.

WE GUARANTEE— "NO PASS—NO FEE."

Details are given of over 150 Diploma Courses in all branches of Civil, Mech., Elec., Motor, Aero, Radio, Television and Production Engineering, Tracing, Building, Govt. Employment, R.A.F. Maths., Matriculation, etc.

Think of the future and send for your copy at once—FREE. B.I.E.T., 387, SHAKESPEARE HOUSE 17, STRATFORD PLACE, LONDON, W.1.

BATTERY CHARGERS & TRICKLE CHARGERS



Trouble-free Chargers fitted with selenium all-metal rectification. A few Agencies available. Thirty years experience behind every Runbaken product. Booklet R.15, giving useful information and describing 12 Models, on request.

RUNBAKEN-MANCHESTER

BERRY'S (SHORT-WAVE) LTD.

have a wide range of RADIO COMPONENTS & VALVES in stock.

Write: 'Phone HOLBORN 6231, or Call.

Send S.A.E. (1d. stamp) for LIST "W."

25, HIGH HOLBORN, LONDON, W.C.1

MORSE CODE TRAINING

There are Candler Morse Code Courses for Beginners and Operators.



SEND NOW FOR THIS FREE

"BOOK OF FACTS" It gives full details concerning the following Courses:—

JUNIOR Scientific Code Course for beginners. Teaches all the necessary code fundamentals scientifically.

ADVANCED High-speed Telegraphing for operators who want to increase their w.p.m. speed and improve their technique.

TELEGRAPH Touch Type-writing for those who wish to become expert in the use of the typewriter for recording messages and for general commercial uses.

Code Courses on Cash or Monthly Payment Terms.

IRREFUTABLE EVIDENCE of the value of the Candler System of Morse Code Training is given in the "24 extracts from students' letters," included with every "Book of Facts."

COUPON Please send me a Free Copy of Candler "Book of Facts."

NAME.....

ADDRESS.....

Post Coupon in 1d. unsealed envelope to London Manager

THE CANDLER SYSTEM CO. (Room 55W),

121 Kingsway, London, W.C.2

Candler System Co., Denver, Colorado, U.S.A. (544)

COVENTRY RADIO

COMPONENT SPECIALISTS SINCE 1925

MAY List of 1st Grade Components sent on receipt of 1d. stamped envelope. Coils, Xaxley and Toggle Switches, Knobs, Condensers, Transformers, Resistors, P.M. and Energised Speakers, Instrument Wires, Valves, etc.

Prompt Service. Satisfaction Guaranteed

COVENTRY COMPANY, 191, DUNSTABLE ROAD, LUTON

AMERICAN MIDGETS HANDBOOK

Describing with many circuit diagrams the peculiarities of small American (Midget) Radios. Especially written for service men, most likely faults and their remedies with hints on wartime substitutes for unobtainable parts are all given. The valve data section gives base and working characteristics of the 60 or so valves used in midgets.

Price 2/6

from booksellers or by post, 2/8.

V.E.S. (W),

Radio House, Melthorne Drive, Ruimsip, Mddx.



For high quality loud speakers when the good times come again.

The Courts, Silverdale, London

CLASSIFIED ADVERTISEMENTS

intended for the JUNE issue can be accepted up to First Post Monday, 1 MAY, 8th.

CABINETS

When Victory rings down the curtain on War, we shall again be able to provide you with cabinets of tasteful design.

F. W. EDWARDS, LIMITED.
18, NORMANS BUILDING'S CENTRAL ST. LONDON E.C1. Clerk 7460.

MELTON METALLURGICAL LABORATORIES LTD

Liquid Silver, Platinum and Gold for metallising CERAMIC, MICA, QUARTZ or GLASS.

Low melting-point **SOLDER** from 70°C.

Non-corrosive Liquid **FLUX** for all electrical purposes. A.I.D. Approved.

Agents for Australia: A. S. HARRISON & CO. PTY. LTD. 85, CLARENCE STREET, SYDNEY.

IPSWICH RD., TRADING ESTATE, SLOUGH, BUCKS. Phone: Slough 20992

BASICALLY BETTER

Air Insulated **LOW LOSS CABLES**

CO-AX

TRANSRADIO LTD.

16 THE HIGHWAY · BEACONSFIELD · 4 · BUCKS.

TYPICAL EXAMPLES		TYPE	C.4	A.2
IMPEDANCE OHMS			213	70
CAPACITY mmf./ft.			5	17
ATTENUATION 10Mc/s db/100ft.			0.4	0.2

Superspeed

CORED SOLDER

A.I.D. APPROVED

H. J. ENTHOVEN & SONS LTD.
230 THORNTON ROAD, WEST CROYDON, SURREY
THORNTON Heath 2462

Printed in England for the Publishers, LEEFE AND SONS LTD., Dorset House, Stamford Street, London, S.E.1, by THE CORNWALL PRESS LTD., Paris Garden, Stamford Street, London, S.E.1. "The Wireless World" can be obtained abroad from the following—AUSTRALIA and NEW ZEALAND: Gordon & Gotch, Ltd. INDIA: A. H. Wheeler & Co. CANADA: Imperial News Co.; GORDON & GOTCH, LTD. SOUTH AFRICA: Central News Agency, Ltd.; WILLIAM DAWSON & SONS (S.A.), LTD. UNITED STATES: The International News Co.



*T*owards the electronic world

*R*IGHT before our eyes a new world is being born—the world of Electronics. From the simple wireless valve has come a host of new applications—each more breathtaking and wonderful than the last.

Valves that are already revolutionising scores of industrial processes—that plumb new depths with mighty X-Rays—that magnify matter tens of thousands of times—that can probe the densest fog-bank—that, one day, will permit us to ‘see’ half across the globe. To-day—due to the exigencies of War—we can only glimpse the future. But never in the history of Science has the future appeared so bright.

As makers of Capacitors we are fully aware of the significance of these developments and our own responsibilities. To meet each new application of Electronics our Research engineers gladly offer their wide experience in Capacitor technique.



A. H. HUNT LTD.
LONDON, S.W. 18
ESTABLISHED 1901

Exide

BATTERIES

FOR RADIO

are playing their part in the great national effort. They are as indispensable to the purposes of war as to those of peace

THE CHLORIDE ELECTRICAL STORAGE COMPANY LIMITED
Grosvenor Gardens House, Grosvenor Gardens,
London, S.W.1

w.R. 8B/43