

# Wireless World

RADIO • ELECTRONICS • ELECTRO-ACOUSTICS



JULY 1943

1/3

Vol. XLIX. No. 7

FEEDBACK PITFALLS ♦ DC VOLTAGE TESTER

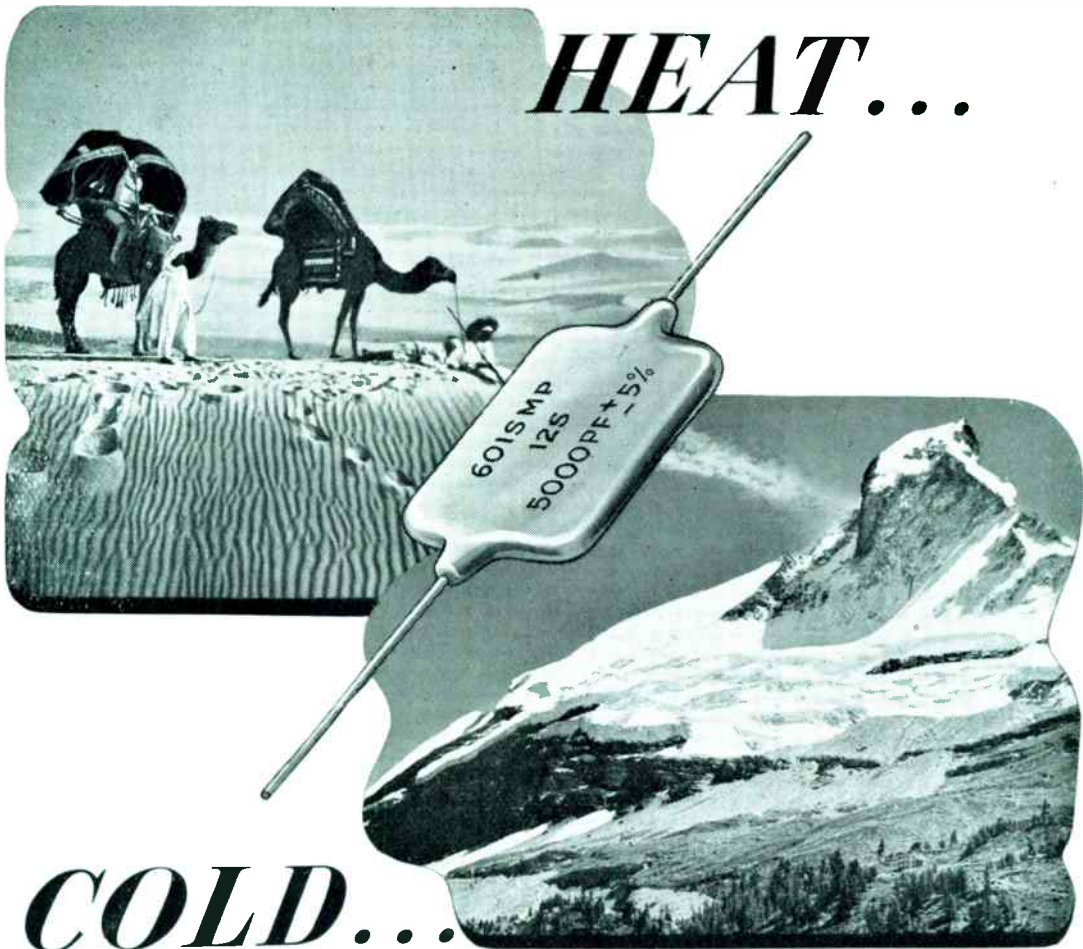

**HEAT...**

**COLD...**

*... In the heat of the desert or the  
jungles, the cold of winter or  
high altitudes,  
SILVERED MICA CONDENSERS  
have to do their job and main-  
tain their stability*



TYPE APPROVED

**UNITED INSULATOR CO LTD**

**12-20 LAYSTALL ST., LONDON, E.C.1**

Telephone : TERminus 7383

Telegrams : Calanel, Smith, London

*The Pioneers of Low-loss Ceramics*





**T**HE Model 7 Universal AvoMeter is the world's most widely used combination electrical measuring instrument. It provides 46 ranges of readings and is guaranteed accurate to B.S. first grade limits on D.C. and A.C. from 25 to 100 cycles. It is self-contained, compact and portable, simple to operate and almost impossible to damage electrically. It is protected by an automatic cut-out against damage through

severe overload, and is provided with automatic compensation for variations in ambient temperature.

The AvoMeter is one of a useful range of "Avo" electrical testing instruments which are maintaining on active service and in industry the "Avo" reputation for an unexcelled standard of accuracy and dependability—in fact, a standard by which other instruments are judged.

**ONE INSTRUMENT**

measures:—

Current, A.C. and D.C. (0 to 10 amps.)  
 Voltage, A.C. and D.C. (0 to 1,000 v.)  
 Resistance (up to 40 megohms)  
 Capacity (0 to 20 mfd.)  
 Audio-frequency Power Output (0 to 4 watts)  
 Decibels ( - 10 Db. to + 15 Db.)

*Some delay in delivery of Trade Orders is inevitable, but we shall continue to do our best to fulfil your requirements as promptly as possible.*

Sole Proprietors and Manufacturers:

**AUTOMATIC COIL WINDER & ELECTRICAL EQUIPMENT Co., Ltd., Winder House, Douglas St., London, S.W.1**

Telephone: VICtoria 3404/7

# NEVILLE'S

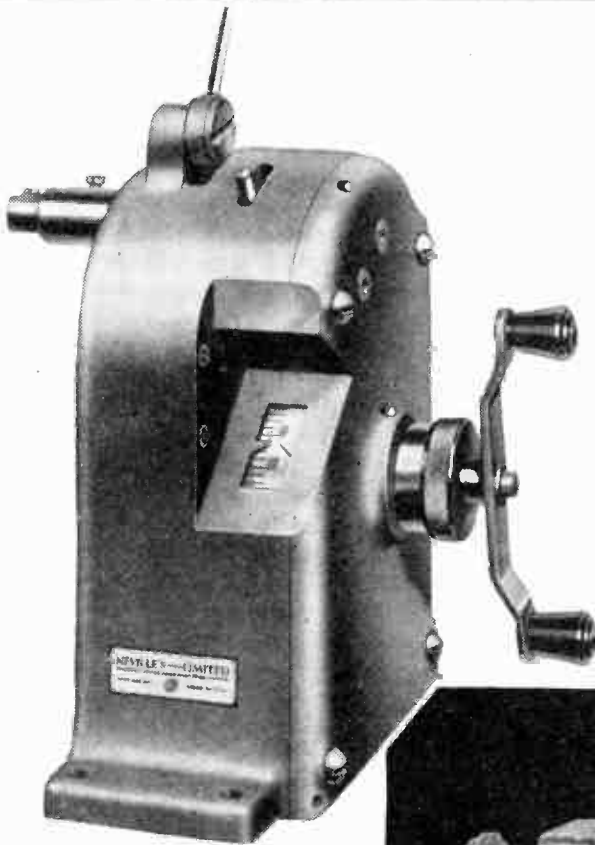

Hand Coil Winding Machine  
TYPE H-W

**Specialists in  
the design and  
manufacture of  
Coil Winding  
Machines**

**Contractors to  
the Admiralty and  
other Government  
Departments**

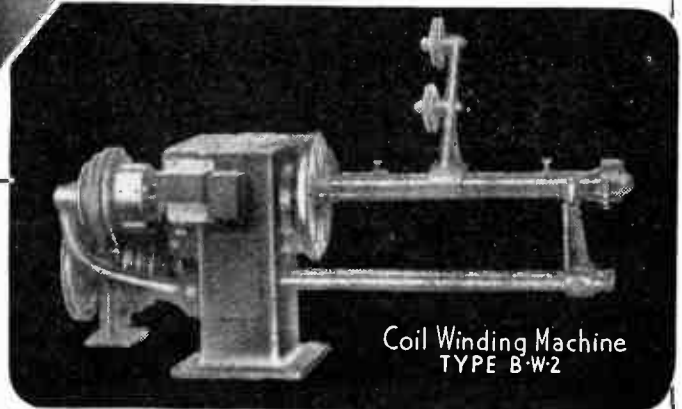

Coil Winding Machine  
TYPE B-W-2

**NEVILLE'S (LIVERPOOL) LIMITED**  
SIMMONDS TOWER · GREAT WEST ROAD · LONDON



A DIVISION OF THE SIMMONDS GROUP  
LONDON · MELBOURNE · PARIS · NEW YORK · LOS ANGELES



**“OUT OF RESISTANCE TO AGGRESSION  
SHALL COME  
LASTING BENEFIT TO MANKIND”**

\*

A great truth ; and equally true in other ways for it is from the function of a resistance in an electrical circuit that millions of complex instruments, upon which we are so dependent, derive their results. It is essential however, that the quality of the resistance in all cases shall be of the highest.

In a world where the use of electrical and radio devices has reached an unprecedented peak, the many and varied conditions in which resistances are required can be but inadequately imagined. Somebody must know about such things however, and who better than we whose care and privilege it is to develop and manufacture all kinds of dependable resistances to satisfy the most exacting modern operating demands.

What a wealth of technical excellence in resistances will be available to industry when better times arrive.

**DUBILIER**  
CONDENSER CO. (1925) LTD.



# WHY ERSIN MULTICORE

the Solder wire with 3 cores of non-corrosive ERSIN FLUX is preferred by the majority of firms manufacturing the best radio and electrical equipment under Government Contracts.



## WHY THEY USE CORED SOLDER

Cored solder is in the form of a wire or tube containing one or more cores of flux. Its principal advantages over stick solder and a separate flux are:

- (a) it obviates need for separate fluxing
- (b) if the correct proportion of flux is contained in cored solder wire the correct amount is automatically applied to the joint when the solder wire is melted.

This is important in wartime when unskilled labour is employed.

## WHY THEY PREFER MULTICORE SOLDER. 3 Cores—Easier Melting

Multicore Solder wire contains 3 cores of flux to ensure flux continuity. In Multicore there is always sufficient proportion of flux to solder.



If only two cores were filled with flux, satisfactory joints are obtained. In practice, the care with which Multicore Solder is made means that there are always 3 cores of flux evenly distributed over the cross section of the solder,

so making thinner solder walls than single cored solder, thus giving more rapid melting and speeding up soldering.

## ERSIN FLUX

For soldering radio and electrical equipment non-corrosive flux should be employed. For this reason either pure resin is specified by Government Departments as the flux to be used, or the flux residue must be pure resin. Resin is a comparatively non-active flux and gives poor results on oxidised, dirty or "difficult" surfaces such as nickel. The flux in the cores of Multicore is "Ersin"—a pure, high-grade resin subjected to chemical process to increase its fluxing action without impairing its non-corrosive and protective properties. The activating agent added by this process is dissipated during the soldering operation and the flux residue is pure resin. Ersin Multicore Solder is approved by A.I.D., G.P.O., and other Ministries where resin cored solder is specified.

## PRACTICAL SOLDERING TEST OF FLUXES

The illustration shows the result of a practical test made using nickel-plated spade tags and bare copper braid. The parts were heated in air to 250° C. and to identical specimens were applied 1/8" lengths of 14 S.W.G. 40/60 solder. To sample A, single cored solder with resin flux was applied. The solder fused only at point of contact without spreading. A dry joint resulted, having poor mechanical strength and high electrical resistance.

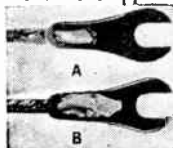

To sample B, Ersin Multicore Solder was applied, and the solder spread evenly over both nickel and copper surfaces, giving a sound mechanical and electrical joint.

## ECONOMY OF USING ERSIN MULTICORE SOLDER

The initial cost of Ersin Multicore Solder per lb. or per cwt. when compared with stick solder is greater. Ordinary solder involves only melting and casting, whereas high chemical skill is required for the manufacture of the Ersin flux and engineering skill for the Multicore Solder incorporating the 3 cores of Ersin Flux. However, for the majority of soldering processes in electrical and radio equipment Multicore Solder will

show a considerable saving in cost, both in material and labour time, as compared either with stick solder or single cored solder. Cored solder ensures that the solder and flux are put just where they are required, and by choice of suitable gauge, economy in use of material is obtained. The quick wetting of the Ersin flux as compared with resin flux in single core resin solder ensures that with the correct temperature and reasonably clean surface, immediate alloying will be obtained, and no portions of solder will drop off the job and be wasted. Even an unskilled worker, provided with irons of correct temperature, is able to use every inch of Multicore Solder without waste.

## ALLOYS

Soft solders are made in various alloys of tin and lead, the tin content usually being specified first, i.e. 40/60 alloy means an alloy containing 40% tin and 60% lead. The need for conserving tin has led the Government to restrict the proportion of tin in solders of all kinds. Thus, the highest tin content permitted for Government contracts without a special licence is 45/55 alloy. The radio and electrical industry previously used large quantities of 60/40 alloy, and lowering of tin content has meant that the melting point of the solder has risen. The chart below gives approximate melting points and recommended bit temperatures.

ALLOY Tin Lead	Equivalent B.S. Grade	Solidus C.°	Liquidus C.°	Recommended bit Temperature C.°
45/55	M	183°	227°	267°
40/60	C	183°	238°	278°
30/70	D	183°	257°	297°
18.5/81.5	N	187°	277°	317°

## VIRGIN METALS—ANTIMONY FREE

The wider use of zinc plated components in radio and electrical equipment has made it advantageous to use solder which is antimony free, and thus Multicore Solder is now made from virgin metals to B.S. Specification 219/1942 but without the antimony content.

## IMPORTANCE OF CORRECT GAUGE

Ersin Multicore Solder Wire is made in gauges from 10 S.W.G. (.128"—3.251 m/ms) to 22 S.W.G. (.028"—.711 m/ms). The choice of a suitable gauge for the majority of the soldering undertaken by a manufacturer results in considerable saving. Many firms previously using 14 S.W.G. have found they can save approximately 33 1/3%, or even more by using 16 S.W.G. The table gives the approximate lengths per lb. in feet of Ersin Multicore Solder in a representative alloy, 40/60.

S.W.G.	10	13	14	16	18	22
Feet per lb.	23	44.5	58.9	92.1	163.5	481

## CORRECT SOLDERING TECHNIQUE

Ersin Multicore Solder Wire should be applied simultaneously with the iron, to the component. By this means maximum efficiency will be obtained from the Ersin flux contained in the 3 cores of the Ersin Multicore Solder Wire. It should only be applied directly to the iron to tin it. The iron should not be used as a means of carrying the solder to the joints. When possible, the solder wire should be applied to the component and the bit placed on top, the solder should not be "pushed in" to the side of the bit.



ERSIN MULTICORE SOLDER WIRE is now restricted to firms on Government Contracts and other essential Home Civil requirements. Firms not yet using Multicore Solder are invited to write for fuller technical information and samples.

**MULTICORE SOLDERS LTD., BUSH HOUSE, W.C.2. 'Phone Temple Bar 5583/4**





**"Everything  
O.K. Sir!"**

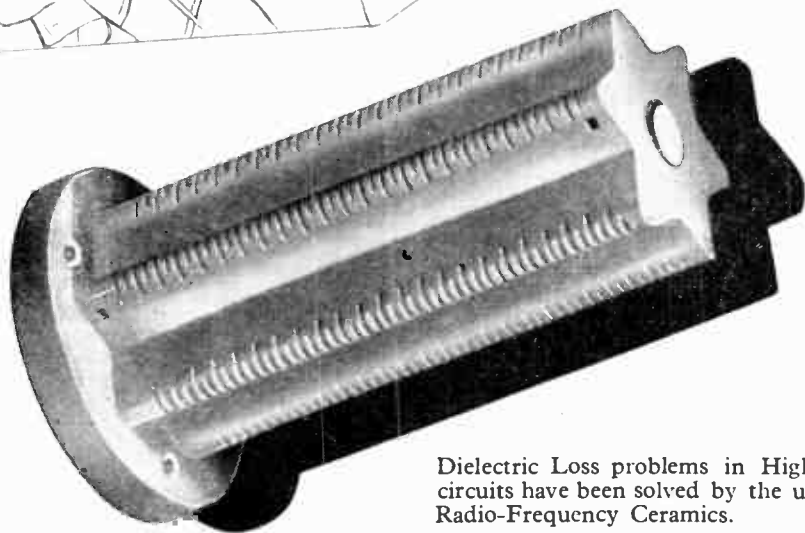

Dielectric Loss problems in High Frequency circuits have been solved by the use of Bullers Radio-Frequency Ceramics.

Many years of research and development in our Laboratories have brought these materials to a high degree of efficiency.

They are in constant use for transmission and reception and play an important part in maintaining communication under all conditions.

**Made in Three  
Principal Materials**

**FREQUELEX**

An insulating material of Low Dielectric loss. For Coil formers, Aerial Insulators, Valve Holders, etc.

**PERMALEX**

A High Permittivity Material. For the construction of Condensers of the smallest possible dimensions.

**TEMPLEX**

A Condenser material of medium permittivity. For the construction of Condensers having a constant capacity at all temperatures.



**BULLERS LTD.,**  
THE HALL, OATLANDS DRIVE,  
WEYBRIDGE, SURREY.  
Telephone : Walton-on-Thames 2451.  
Manchester Office : 196, Deansgate, Manchester.

**Bullers**

**LOW LOSS CERAMICS**

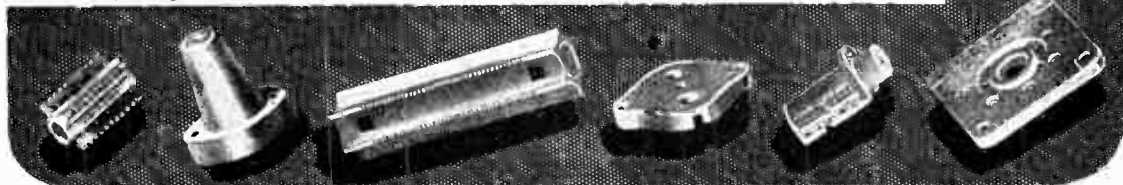

1 2 3 inches

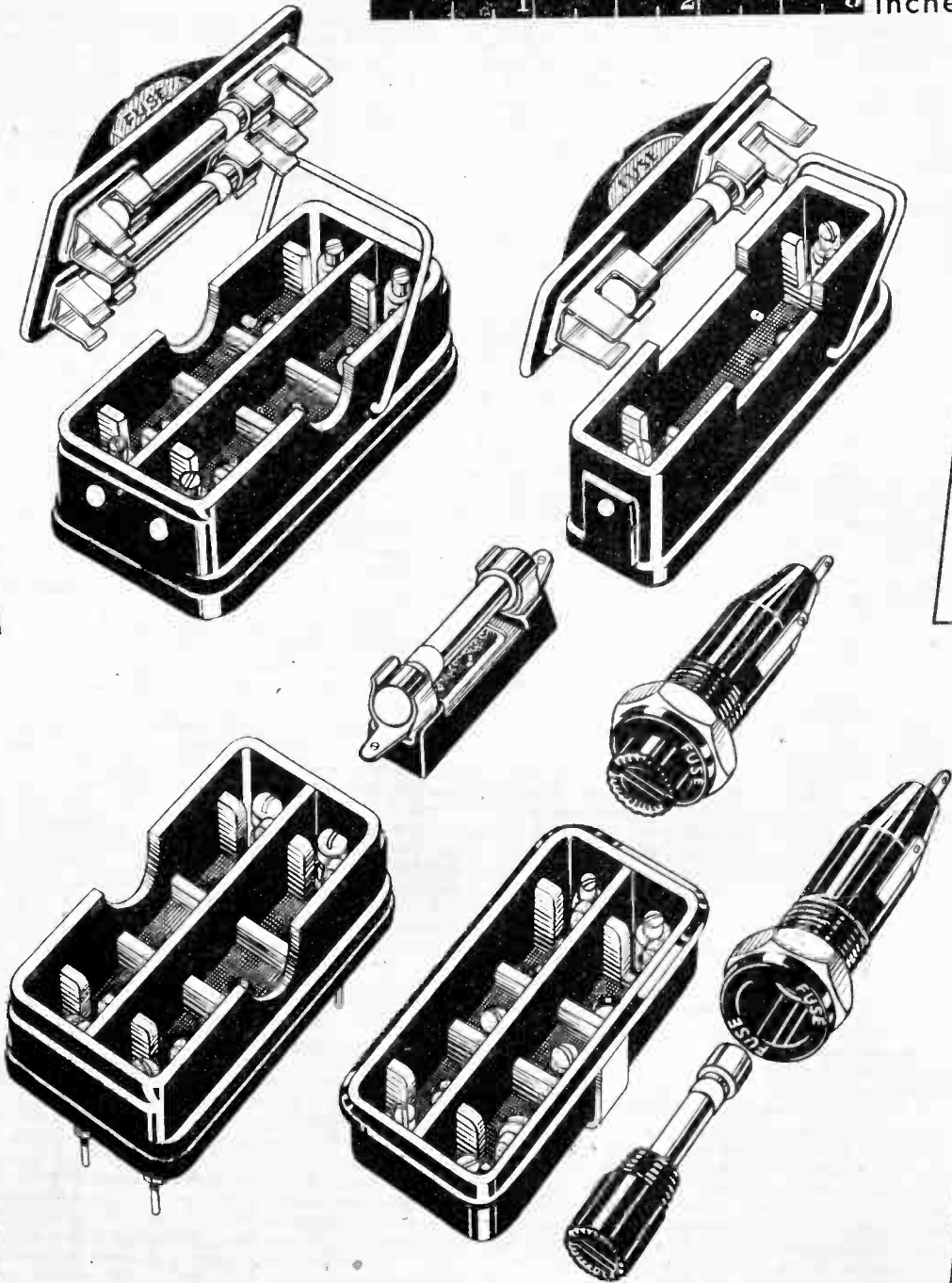

**BELLING & LEE LTD**  
CAMBRIDGE ARTERIAL ROAD, ENFIELD, MIDDX

8788

World Radio History



**Built to a rigid specification to withstand the storms and buffets of service communications—**

# EDDYSTONE

**"358X"**

COMMUNICATION RECEIVER

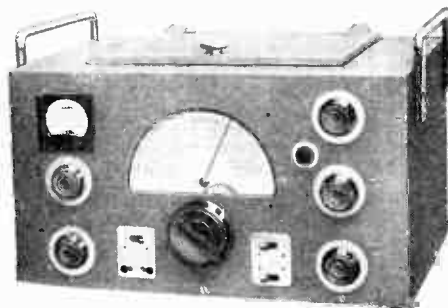

**—the mechanical construction of this receiver ensures a stability like the famous lighthouse.**

**SALIENT SPECIFICATION DETAILS**

**FREQUENCY RANGE**

31,000 Kc/s to 90 Kc/s.

**SENSITIVITY**

3 microvolts above 1,500 Kc/s.  
8 " " for lower frequencies (30% modulation for 50 milliwatts output).

**CRYSTAL FILTER**

Simmonds Band-Pass Filter, giving bandwidth of 300 c/s.

**ADJACENT SELECTIVITY**

2 Kc/s at 2.5 db down.

5 Kc/s at 3.5 db down.

With crystal—150 c/s at 40 db.

**IMAGE RATIOS**

At 20 Mc/s —33/1

" 12 " —100/1

" 9 " —210/1

" 4.5 " —400/1

" 3 " —500/1

Complete technical details available in 30 page Instructional Booklet on 358X including all circuit values.

Price 2/6 post free.

THE RECEIVER MAY BE INSPECTED AT

## WEBB'S RADIO

THE SHORT-WAVE SPECIALISTS

14, SOHO STREET, LONDON, W.1

Between 9 a.m. and 4 p.m. (Saturdays 10 a.m. to 12 noon).



Telephone : GERrard 2089

*Eliminates uncertainty*

LASSOLASTIC Adhesive IDENTIFICATION TAPE

TERMINALS

PIPELINES

CABLES

Lassolastic Tape provides thin filmic self-adhesive markers with designations coloured and spaced at regular intervals according to requirements. They offer no undesirable thickening or interference with flexibility at point of contact. They can be affixed without disconnection of ends.

Lassolastic is resistant to heat, water, oil and solvent, no tools required for application. Inscriptions cannot be erased and remain always legible.

HERTS PHARMACEUTICALS LTD., WELWYN GARDEN CITY, HERTS

## M.R. SUPPLIES

offer FROM STOCK the following brand new PUBLIC ADDRESS and ELECTRICAL MATERIAL of our usual dependable quality. All prices nett cash.

**MINIATURE P.M. MOVING COIL UNITS.** Only 3in. diameter, fitted weighty alnico magnet, imp. 12 ohms. For use as microphone or speaker and ideal for intercom. systems. Very efficient, 25/-.

**PIEZO-CRYSTAL MICROPHONES.** As we are now without supplies of the 72/6 model which we have frequently advertised we make a special offer of the original De Luxe (American) Rothermel D.104 Piezo-Crystal Microphone at 24/10/-. This is the well-known, expensively finished plated model with 6ft. screened lead, in makers' own boxes. Opportunity.

**ROTHERMEL-BRUSH MINIATURE MICROPHONES (Piezo-Crystal).** Only 1 1/2 in. dia. and capable of very high performance. In aluminium housing with short screened lead, but with no front grille. Although made for deaf-aids these instruments are suitable for all microphone duties and for cardiophone, etc. Useful in research depts., 27/6.

**G.E.C. MOVING COIL MICROPHONES.** Model 2283. Response level 50/9,500 c/s., sensitivity 50 db. In superior chromium housing with back terminals and mounting boss. Imp. 15 ohms. A few left at 25/18/6 each.

**MICROPHONE FLOOR STANDS.** Chrom. collapsible model ext. to 5ft. 6in. and folding to 2ft., to suit all microphones above (except deaf-aid type), 37/6.

**PUBLIC ADDRESS SPEAKERS.** Brand new latest model G.E.C., comprising 10-watt P.M. M/Coil Projector Unit, with 42in. Round Metal Horn, 21/0/5/- (carr. 7/6 each, per pass, train). Please see below for other bargains in P.A. Speakers offered to callers only. Instant delivery—all models.

**MEASURING INSTRUMENTS** by Weston, Ferranti, Elliott, etc. (We cannot select particular maker, but will do our best). Housing 2 1/2 in. square flange, flush panel mtg., requiring 2in. mtg. hole, black bakelite with back terminals. **M/COIL MILLIAMMETERS,** 0/150 milliamps, 32/6. Also in same size and style Thermo-couple **M/COIL AMMETERS,** 0/24 amps. These have the advantage of reading accurately on D.C. and any frequency of A.C., 37/6. (NOTE—These meters are ex-Govt., in excellent condition and lab. tested.)

**HEADPHONES.** Brand new Ericsson, 2,000 ohms, with adjustable headgear, maker boxed, 25/- pair. Also Single PHONES, as above but Secondhand, perfect, 3/8 each.

**RELAYS.** Compact enclosed model, with 4/12 v. D.C. coil and single-pole 6-amp. "make" switch with fuse holder, 6/6.

**INSPECTION LAMPS ("Gripper")** Approved shockproof type, fitted B.C. holder and strong gripping lugs for attaching anywhere. The wire cage is supplied with a movable eye-shade, 18/6.

**ELECTRIC SOLDERING IRONS.** Best industrial types from stock—trade quantity enquiries invited. S.T.C., all voltages, 75 watt with 4in. pointed bit, good all-purpose iron, 21/- (Spare elements, 230/250 v., 6/-). Same make, 150 watt, with massive flat bit, 32/6. Also ACRU bent model with interchangeable bit, 100 watt, 28/6. (Spare bits, our choice, 3/6 each.)

Please include sufficient for packing and post.

The following are offered to CALLERS ONLY:—

**G.E.C. SEMI-PROJECTOR P.A. SPEAKERS,** 10 watt, with enamelled wood horn, large size, high quality, 25.15/- **G.E.C. PROJECTOR SPEAKERS,** 10 watt Unit and 42in. Metal Horn, with fabric flare, 29/9/- **Same unit with 30in. dispersive Horn,** 28/17/6. **ROTARY CONVERTERS** (various).

**M.R. SUPPLIES, 68, New Oxford Street, London, W.C.1.**

(Telephone: MUScum 2958)

# ROLA

## LOUD SPEAKERS

THE WORLD'S FINEST REPRODUCERS

## TRANSFORMER LAMINATIONS

Core Widths  $\frac{3}{8}$ " to  $1\frac{1}{2}$ " (E's and I's.)

EIGHT STOCK SIZES

A Comprehensive Bulletin together with details of Associated Covers and Design with design data will be sent to manufacturers on request.

BRITISH ROLA LIMITED

MINERVA ROAD · PARK ROYAL · N.W.10 · WILLOWDEN 4322





# TCC CERAMIC TRIMMERS

*Pre-eminent in Peace -  
Indispensable in War*

ADVERTISEMENT OF THE TELEGRAPH CONDENSER CO., LTD.  
7705



MEASURING INSTRUMENTS



# RELIABILITY



IN THE AIR    ON THE LAND    ON THE SEA    UNDER THE SEA

*makes for confidence in*  
**Electrical Measuring Instruments**

In the operation of electrical installations, the human factor is an important one. Confidence in one's staff, however, is of no avail if there is the slightest doubt in the reliability of the apparatus being used. More and more are M.I.P. instruments being relied on to-day. In every branch of the Services and in industry they have been proved in the stern field of hard experience to be second to none—in other words—Reliable.

*The illustration shows 3" dia. Flush Type Instrument suitable for dashboard mounting on planes, power boats, launches, etc. Also available as Voltmeter.*

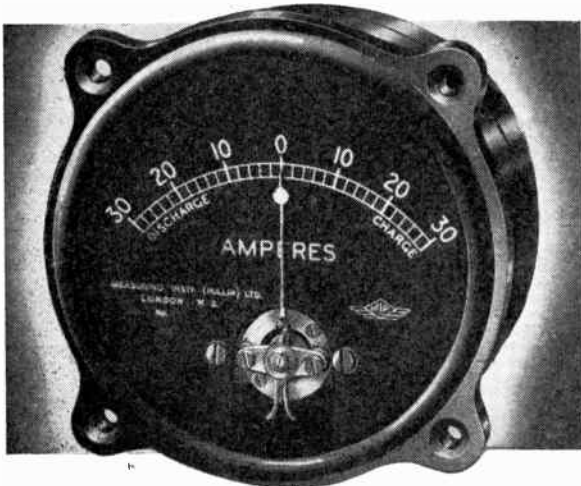

*Consult us without delay on your Measurement problems.*

**MEASURING INSTRUMENTS  
 (PULLIN) LTD.**

**ELECTRIN WORKS, WINCHESTER ST., ACTON, W.3**

*War-time installations show more conclusively than ever that*

**you can**

*Trust*

# TRIX

Quality  
**SOUND**  
 Equipment

30-watt Amplifier with Radio.

There are TRIX amplifiers from 5-500 watts. Send for details.

*To priority order only*

**TRIX ELECTRICAL CO. LTD., 65, Bolsover St., London, W.1.**  
 Phone: EUS 6471/2. Grams: Trizadio, Weado, London.

WRITE FOR CATALOGUE  
 W.O./330

# ADASTRA

**RADIO MASTS**

**POLES LTD** TYBURN RD ERDINGTON.  
 BIRMINGHAM. 24.

Enquiries should be accompanied by Government Priority Reference

# ◆ LINAGLOW LIMITED ◆

## SPECIAL OFFER of SERVICE KITS as follows

**No. 1.**—1 8×8 mfd. tubular can-type electrolytic condensers, 500 v.d.c.w., 25 assorted silver mica wire-end condensers, 25 assorted ½, ¼ and 1 watt carbon wire-end resistors, 25 assorted 1, 2- and 3-gang I.F. and aerial trimmers. **21 7 6** per kit.

**No. 2.**—3 8×8 mfd. tubular can-type electrolytic condensers, 500 v.d.c.w., 100 assorted silver mica wire-end condensers, 100 assorted ½, ¼ and 1 watt carbon wire-end resistors, 50 assorted 1, 2- and 3-gang I.F. and aerial trimmers, 50 assorted wire-end tubular paper condensers, 3 assorted volume and tone controls. **24 12 6** per kit.

**No. 3.**—6 8×8 mfd. tubular can-type electrolytic condensers, 500 v.d.c.w., 200 assorted silver mica wire-end condensers, 200 assorted ½, ¼ and 1 watt carbon wire-end resistors, 100 assorted 1, 2- and 3-gang I.F. and aerial trimmers, 100 assorted wire-end tubular paper condensers, 6 assorted volume and tone controls. **28 8 6** per kit.

**No. 4.**—**DE LUXE SERVICE ENGINEER'S KIT.** 15 8×8 mfd. tubular can-type electrolytic condensers, 500 v.d.c.w., 3 8 mfd. tubular can-type 500 v.d.c.w., 2 32 mfd. aluminium can-type, 350 v.d.c.w., 1 16 mfd. electrolytic condenser, 350 v.d.c.w., 3 32×32 tubular electrolytic condensers, 175 v.d.c.w., 1 50×50×2 block electrolytic condenser, 15/550 v.d.c.w., 1 50×50×12v. Mallory type condenser, 500 assorted silver mica wire-end condensers, 500 assorted ½, ¼ and 1 watt carbon wire-end resistors, 250 assorted 1, 2- and 3-gang I.F. and aerial trimmers, 100 assorted wire-end tubular paper condensers, 50 assorted wire-end wire wound resistors, 15 assorted volume and tone controls, with and without switch, 1 pentode output transformer, 1 multi-ratio output transformer, 1 push-pull output transformer, 3 rolls insulating tape, 6 assorted line cord replacement resistors. **29 10 0** per kit.

**VALVES.** Lease-Lead American types at B.O.T. controlled retail prices. For replacement only. 1A5, 1C5, 1H5, 1T5, 5Y3, 6A8, 6F5, 6F6, 6J5, 6J7, 6K7, 6Q7, 6SA7, 12A7, 12A8, 12F5, 12J7, 12K7, 12Q7, 12Z3, 12SA7, 12SJ7, 12SK7, 12SQ7, 25A6, 25A7, 25L6, 25Z6, 32L7, 35L6, 35Z4, 35Z5, 36, 47, 50L6, 70L7, 83.

Also British valves at manufacturers' list prices. AC/ME, AC/VP2, ACTP, CL4, ECH3, ELH3, EL35, EF39, FC13, KT33C, KTW61, TDD4, U06, U07, VP41, X63, X65.

**FIXED CARBON RESISTORS.** Wire ends, assorted and useful values. ½-watt, 24/-; ¼-watt, 30/-; 1-watt, 36/-; 2-watt, 55/- per 100. Minimum orders, 50 assorted. Assorted parcel for 83. Contains 25 ½-watt, 50 ¼-watt, 50 1-watt, 25 2-watt, 10 3-watt.

**ELECTROLYTIC CONDENSERS.** We have many types and sizes in stock. Send us your requirements.

**TUBULAR PAPER CONDENSERS, 350-500v.,** D.C. working. .00005, .0001, .0003, .0006 mfd., 4/- doz.; .001, .0015, .002, .003, .004, 6/- doz.; .01, .025, .03, .05 mfd., 7/- doz.; .08, .1 mfd., 12/- doz.; .15, .2, .25, .3 mfd., 15/6 doz.; .5 mfd., 18/- doz.; or assorted parcel of 50 for 27/6. Minimum orders, 1 doz. any type.

**SILVER MICA CONDENSERS.** Flat wire end. Assorted and useful values, 17/6 per 100 (not more than 5 alike).

**LOUDSPEAKER FRETS,** coppered brass, 8½in.×7in., 3/6; 10in.×16in., 10/6.

**I.F. AND AERIAL TRIMMERS.** 12 assorted and useful values for 2/6.

**HIGH FIDELITY M/C MICROPHONES, 20/25** ohm impedance, 60/4,500 cycles, ± 3 D.B. \$6 6 0 each. Folding Chrome Stand 3-tier for above, \$3 3 0 each.

**LOUDSPEAKERS.** Rola P.M., 3 ohm voice coil, without transformer, 5in., 21/-; 6½in., 22/6; 8in., 25/6; with Pentode Output Transformer, 5in., 27/6; 6½in., 29/6; 8in., 32/6. Celestion 8in. P.M., with transformer, 29/6. R.G.D. 10in. Energised Moving Coil, 250 or 500 ohm field, 2.5 ohm speech coil, corrugated cone, without transformer, 30/-; with heavy duty multi-ratio matching transformer, 42/-. Any of the above can be supplied with multi-ratio output transformer at 5/- extra per unit.

**ROLA 10in. P.M. 3 ohm speech coil,** corrugated cone, loudspeakers, without transformer, 27/-; with pentode output transformer, 35/-; with multi-ratio P/P output transformer, 39/6.

**LOUDSPEAKER TRANSFORMERS.** Philips Pentode 45 m.a., 5/6; Cossor output multi tap, 60 m.a., 10/6; Heavy Duty multi-ratio, 100 m.a., 12/6; Heavy Duty Pentode, 100 m.a., 16/6; Ex. Heavy Duty Pentode, 150 m.a., 12/6; Universal Output and Push-Pull, 100 m.a., 12/6; R.G.D. Push-Pull Output, 120 m.a., 12/6.

**MAINS TRANSFORMERS, 200/230/250, 300-0-300, 100 m.a., 6.3v., 3 amp., 5v., 2 amp., 35/-; 200/250, 350-0-350, 4v., 6 amp., 4v., 3 amp., 120 m.a., 37/6 each.**

**AUTO TRANSFORMERS.** Step up or down, 110/230v., 75 watt, 27/6; 110/210/220/240v., 100 watt, 32/6.

**ELECTRIC IRON [THERMOSTATS, 4-heat** control, very heavy quality, easily fitted, brand new, 3/6 each.

**EXTENSION LOUDSPEAKERS,** in attractive Walnut Veneered Cabinet, complete with 8in. P.M. Loudspeaker, 55/- each.

**BEDSIDE EXTENSION LEAD,** complete with B.C. adapter, lamp holder and torpedo switch, 9ft. flex, 10/6 each.

**AMERICAN AXLEYE, 6-way push-button** controls, well below pre-war price, 3/6 each.

**BRITISH-MADE CONVERTERS, 12v. input,** 230 v. output, 70 watt, in strong metal case, with heavy leads and smoothing unit, 27 15s. each.

**VOLUME CONTROLS, 5,000, 10,000, 25,000,** 50,000, 100,000 ohm; ½, ¼, 1 and 2 megohm, without switch, 4/9 each. As above, with switch, 6/9 each.

**WALNUT VENEERED LOUDSPEAKER** CABINETS. Modern design, fitted silk and haffe, suitable for 8in. speakers, 35/-.

**DE LUXE WALNUT VENEERED CABINET.** Suitable for American Midget sets. Overall dimensions, 14in.×7in.×6in., drilled three hole, 32/6 each.

**FLAT FLEX, 9-way, 14/30, 18/20ft. lengths,** suitable for amplifiers, extension speakers, remote control and many other purposes. Finest quality pre-war manufacture, 7/6 per coil.

## OUR NEW SHOW ROOMS

are now open. We strongly recommend you to pay us a personal visit as, due to paper restrictions, advertising on a large scale is impossible. We have a number of useful lines in stock—to mention a few—many types of pre-war I.F. and Aerial Transformers, Chrome Escutcheons, Bakelite Strips, Kaebs, Tuners and Meters, etc. All at very low prices.

## ◆ PLEASE NOTE ◆

◆ **CALLERS to Show Rooms,** 61 HIGHGATE HIGH ST., N.6

Phone: MOUntview 9432.

When ordering replacement parts for American or British Radios, please state Model No. and, if possible, forward faulty component with your order. 2½d. stamped addressed envelope must accompany all enquiries.

C.O.D. or CASH WITH ORDER.

## VOLTAGE DROPPING RESISTORS AND LINE CORD REPLACEMENTS

Suitable for every make of radio receiver, comprehensive ranges mentioned below.

950 ohm .2 amp. Chassis mounting, heavy duty on porcelain former, 3 adjustable tappings, 5/6 each; as above, 800 ohm .3 amp., 8/6 each.

.2 amp. 675 ohm, tapped 160, 100, 425 and 50 ohm, suitable for Ekco and other makes, 4/- each.

.2 amp. 840 ohm, tapped 100, 100, 475, 115 and 50 ohm, for Halcyon, etc., 4/-.

.2 amp. 945 ohm, tapped 100, 100, 445 and 100 ohm, for Halcyon, etc., 4/6.

.2 amp. 785 ohm, tapped 50, 50, 50, 50 and 535 ohm, for Fry, Lissen, etc., 4/8.

.2 amp. 510 ohm, tapped 60, 105, 85 and 260 ohm, for Cossor, etc., 4/6.

.2 amp. 660 ohm, tapped 150, 360, 120 and 30 ohm, for Pilot Major Maestro, etc., 4/8.

.3 amp. 647 ohm, tapped 80, 80, 347 ohm, for Ferranti, etc., 7/6.

.3 amp. 1,014 ohm, tapped 82, 82, 220 and 530 ohm, for Double Decca, 7/6.

.3 amp. 781 ohm, tapped 45, 45, 332, 166 and 193 ohm, for Ferguson, etc., 9/6.

.3 amp. 823 ohm, tapped 45, 45, 290, 166 and 277 ohm, for Ferguson, etc., 9/6.

.3 amp. 660 ohm, tapped 150, 260, 120 and 30 ohm, for Pilot Little Maestro, etc., 8/6.

**SPECIAL HEAVY DUTY RESISTORS, 5 watt, for b.a.s.,** etc., all values from 25 to 2,000 ohm, with copper clips, 1/9 each. Similar to above, but 10 watt, 2/3.

**SPECIAL 2.2 ohm Resistor, for converting dry battery sets** for use with 2-volt accumulator, 2/6.

50 ohm centre tapped Resistor, tapped at 25 ohm, for pilot lamps, 2/-.

**SPECIAL VOLTAGE DROPPING RESISTANCE, for** Electric Razors, 1,150 ohm, 2/6.

.3 amp. **LINE CORD RESISTOR, 360 ohm, 6/6; .3 amp.** **LINE CORD RESISTOR,** with slider, any resistance obtained up to 750 ohm, 7/6.

**SPECIAL MULTI-LINE CORD RESISTOR, 5 tappings 50** ohm, 1 tapping 750 ohm, with slider, .2 amp., 8/6.

**BARRETTER VALVES, TYPE C.1, .2 amp., 8/6 each.**

**BATTERY LEADS, 4-way, with Wander plugs,** best quality, 1/3 each.

**OSRAM TUBULAR PILOT BULBS, 6.2v., .3 amp.** MES or B.C., Round, 1/- each, including tax.

**HUMDINGERS, 30, 25,000 and 50,000 ohm,** 6d. each.

**INSULATING TAPE.** Best quality British and American manufacture, ½in., ¼-lb. reel, 9d.; ½in., ¼-lb. reel, 1/4; 2in., 1-lb. reel, 2/3.

**AMPHENOL OCTAL CHASSIS MOUNTING** VALVE HOLDERS, 1/3 each.

**L.F. CHOKES, 20 hys., 100 m.a., brand new,** 16/9.

**EVER-READY QUICK-START CAR BATTERY,** 6 volt, new, in metal container, with carrying handle, 12/6 each, plus tax.

**DPDT SWITCHES, panel mounting, P.O. type,** 2/6 each.

**4-POINT PUSH-PULL RADIO SWITCHES,** 1/3 each.

**I.F. TRANSFORMERS and AERIAL COILS.** Screened. Bargain offer, 6 assorted for 15/-.

**10-WATT WIRE WOUND BIAS RESISTORS,** 800 ohm, heavy wire ends. 2/- each.

**SCREENED INTERLACED FLEXIBLE MICROPHONE** CABLE. Pre-war quality, single, 1/3 per yard.

**SPECIAL OFFER.—C.A.V. 60 volt H.T.** Accumulators, type G.103, -5,000 m.a., at 1,000 hour rate, in strong carrying case, with handle, in used condition, as new, 25/- each.

◆ **POST ORDERS to Dept. M.O.5,** 3 HAMPSTEAD LANE, N.6.





Condensers are at work ...

TRADE **HUNTS** MARK  
The  
Home of Condensers

ADVT. OF A. H. HUNT LTD., LONDON, S.W.18. EST. 1901.

# WHARFEDALE FACTORY SPEAKERS

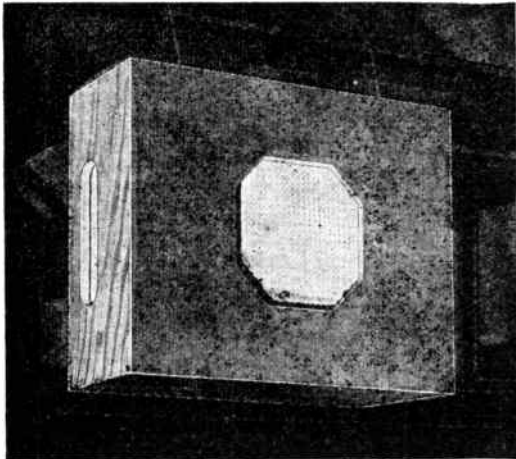

SIZE : 15½" by 12½" by 6½".

DELIVERY 3, to 4 WEEKS for PRIORITY ORDERS ONLY.

With 10" Bronze Unit	65/-	Transformer - - -	7/6 extra
With 10" Golden Unit	95/-	Truqual Volume Control	6/6 "
		Remote Volume Control	17/- "

**WHARFEDALE WIRELESS WORKS**

SOLE PROPRIETOR : D. E. BRIGGS

HUTCHINSON LANE, BRIGHOUSE, YORKS.

PHONE : BRIGHOUSE 50.

GRAMS : " WHARFDEL."

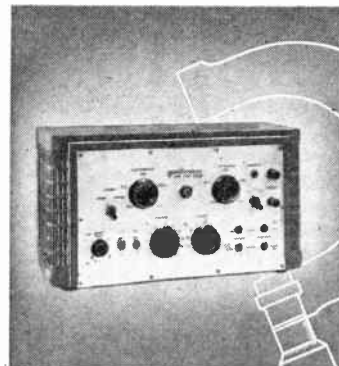

TO *critical* STANDARDS

AUDIO  
AMPLIFIERS &  
SUB-ASSEMBLIES

In addition to

Standard Amplifiers the activities of Acoustical include Special Amplifiers for Industrial Applications, Microphones, Transformers, Coil Winding, Sheet Metal Work, Stampings, Switch Assemblies, etc.



**ACOUSTICAL**  
MANUFACTURING Co. LTD.  
HUNTINGDON • TEL: 361





## Proving ground for the future of electronics

On the battlefields, electronics is meeting its extreme test. Failure here means death to men, defeat to armies. Conversely, experience here means vastly broadened knowledge, improved techniques, and progress so rapid as

to be impossible of description.

The collective brains of Eimac engineers are concentrated full tilt on the new knowledge which is coming out of this holocaust. And are consequently still setting the pace in vacuum tube de-

velopments. The fruits of their efforts are going directly to Uncle Sam and our Allies to play a vital role in the war.

When the fighting stops you'll find Eimac still the pre-eminent choice of engineers throughout the world.

*Army-Navy "E" awarded for high achievement in production for war.*

Follow the leaders to



**Eimac**  
VALVES

**EITEL-McCULLOUGH, INC.**  
SAN BRUNO - CALIFORNIA - U.S.A.  
Export Agent: FRAZAR & CO., LTD.  
201 Front Street, San Francisco, California, U.S.A.

# B.I. RADIO MATERIALS

We have had a long experience in the manufacture of all kinds of Cables and Wires, Static Condensers, Insulators and Ironwork, Telephone Cords and Copper Earthing Rods, for Radio use.



U.K. Regd. Trade Mark

**BRITISH INSULATED CABLES LTD.,**

*Cable Makers and Electrical Engineers*

Head Office: PRESCOT, LANCS. Tel. No.: PRESCOT 6571

## P. R. MALLORY & CO. INC. MALLORY



### Vibrators

ON the land, sea and in the air Mallory precision vibrators are giving faithful wartime service.

**P. R. MALLORY & CO. INC.**  
INDIANAPOLIS, INDIANA, U.S.A.  
RADIO AND ELECTRONICS DIVISION

Represented exclusively in Gc. Britain by

**FRANK HEAVER LTD.,** Kingsley Road, Bideford, N. Devon, Eng.

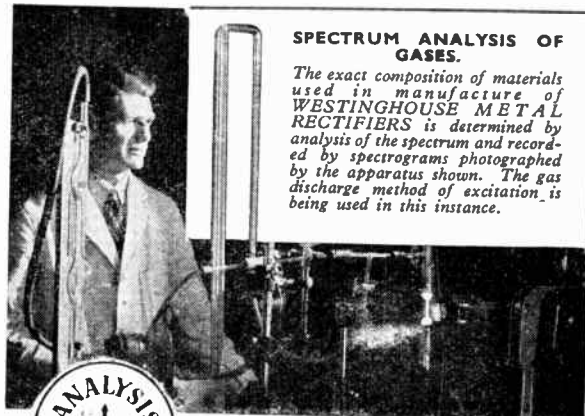

### SPECTRUM ANALYSIS OF GASES.

The exact composition of materials used in manufacture of WESTINGHOUSE METAL RECTIFIERS is determined by analysis of the spectrum and recorded by spectrograms photographed by the apparatus shown. The gas discharge method of excitation is being used in this instance.



In spite of greatly increased production we are unable to supply Westinghouse Rectifiers as freely as we would wish. We hope customers will understand and accept our assurance that the constant research now going on in our laboratories and designing departments is resulting in Rectifiers of remarkably advanced design, which will be available after the war.

*Westinghouse Rectifiers*

**WESTINGHOUSE BRAKE & SIGNAL CO., LTD.**  
PEW HILL HOUSE, CHIPPENHAM, WILTS.

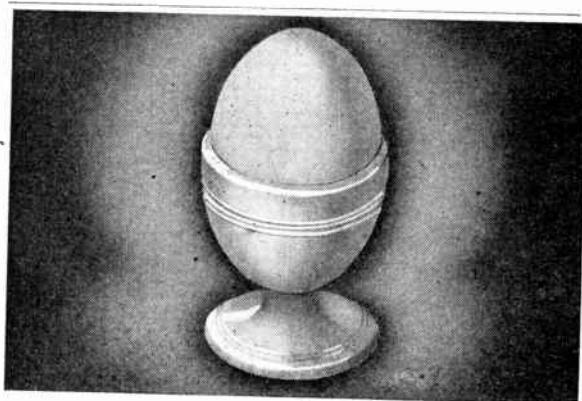

**Fitness for Purpose** ■■■ That the egg-cup is a "natural" for the egg (when you can get it!) is certain; and its fitness for purpose is undeniable. So it is with R • S Sound Equipment. Every component is chosen for its fitness for its purpose. Each piece of equipment is designed and built with but one object in view—fitness for purpose. The result is, of course, a range of Sound Equipment in which there is visible and audible testimony to its fitness for purpose. If you would like to know about the restricted range of "fitness for purpose" Sound Equipment we are still able to offer in limited quantities, a penny stamp will bring you our latest catalogue.

# R • S

*Amplifiers Limited*

3-4, Highfield Rd., Shepperton, Middlesex. Tel.: Walton-on-Thames 1019

W.W. 7/43



# Moving Coil Relays

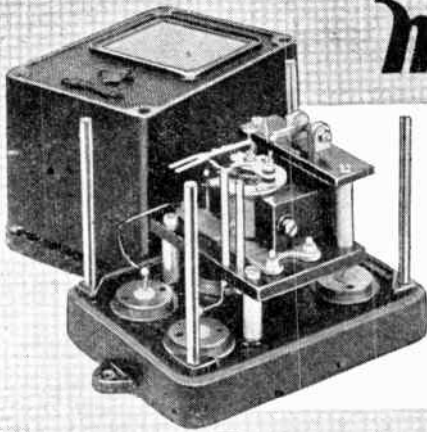

These FERRANTI instruments are built on lines similar to a high-grade moving coil milliammeter, with critically balanced double hair-spring controlled movement. Single-pole change-over contacts with moving contact arm fully insulated from moving coil and frame. It has a large permanent magnet. Permanent spring bias against one fixed contact with adjustable tension. Both contacts are adjustable. The Relay is totally enclosed in heavy cast-iron case with inspection window on top and is finished in black enamel. Connections are brought out to five large insulated terminals mounted underneath the case. Overall size, 5in. wide x 6½in. deep x 5½in. high. Contacts carry 40/50 m.a. approx. Moving coil resistance 50 ohms. .. Price **£6.10.0**

# Polarised Relays

Air Ministry type, high speed (V.F.) Relay. A modern instrument in cast alloy case, 2½in. dia. x 4½in. high. The Relay is mounted on high-grade Paxolin base, 2½in. x 2½in. x ½in. with 8 pins for connecting. It is polarised by a 3in. horseshoe magnet. Separate adjustments are provided for magnetic bias on armature. Large size operating coil with double windings 24 ohms and 13,500 ohms; alloy armature carries double contacts providing single-pole change-over switching with large adjustable fixed contacts. All contacts are of platinum and will carry 60-watts non-inductance load.



All contacts, windings and metal case are insulated from each other and brought out to pins on paxolin base. The actuating current is 8 volts at 0.6 m.a. Speed approx. 100 c.p.s. ... .. Price **£3.5.0**

## SCANNING & DEFLECTOR COILS

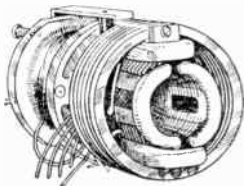

Assembled complete in metal frame, as illustrated.

**7/6**

Post. and pkg., 1/1 extra.

## EX-GOVT. PLUGS & JACKS

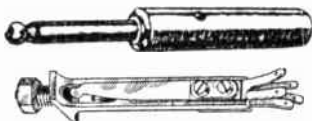

These Jacks have powerful phosphor-bronze springs ensuring a perfect contact. Overall length, including ½in. threaded shank, 3½in. Supplied complete with Plug. **5/6**

Price ... ..  
Post., etc., 3d. extra.

## ELECTRO-MAGNETIC COUNTERS

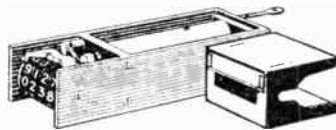

500 ohms coil. Counting up to 9,999. Operating from 25v. to 50v. D.C. Many industrial and domestic applications. (S.H., ex-G.P.O., all perfect.) Postage 9d. **5/6**

## TWIN ON-OFF SWITCHES

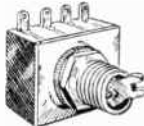

Carries 1.5 amp. at 250 v. Well made, with excellent snap action. Price **4/6**  
Post., etc., 3d. extra.

## ON-OFF TOGGLE SWITCHES



Finest quality. Turn movement. 1½in. spindle. Price **2/6**  
Post., etc., 3d. extra

## OAK VIBRATOR UNITS — Synchronous —

Input 6 volts. Output 250 volts 60 m.a. approx. These well-known units are fitted with 6-pin American bases ... .. **15/6**

Post., etc., 8d.



## HEAVY DUTY MAINS TRANSFORMERS

350 - 0 - 350 v., 120 m.a., 6.3 v. 5 amps., 4 v. 3 amps., 4 v. 1 amp. Input 100/250 v. Dimensions 5½ x 5½ x 4½in. Free wiring diagram. **32/6**

Post., etc., 2/-

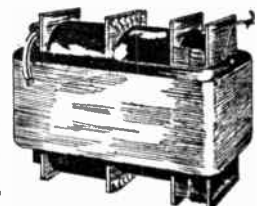

# LONDON CENTRAL RADIO STORES

See last month's advt. for other lines.

NO LISTS • NO PRO-FORMA INVOICES

**23, LISLE STREET, LONDON, W.C.2.**  
Phone—GERrard 2969



# RAYMART

CRAFT A CREED

The four phrases opposite appear in the "Wireless World" "test" report (May, 1942), reproduced below.

## "SPEED" KEY

- Is rigidly constructed.
- Extremely light in action.
- Fitted with heavy silver contacts.
- Suitable for serious work.

THERE are subtle differences between British and American practice in telegraphy. For instance, the typical American key has a cranked bar fitted with a small flat knob, and so is convenient for the method of manipulation where the operator's forearm rests on the bench, the key being mounted about 18in. from its edge. But that method is not generally approved by British instructors, and the view is sometimes expressed that the use of an American key encourages a style that does not fit in with our technique. It is freely admitted, however, that the design of the key confers rigidity and freedom from sideplay; it also makes for lightness. No objection can be urged against the British-made Raymart "Speed" key, a specimen of which has been submitted to us for test. The usual flat American knob has been replaced by a taller one of the British pattern, and there is no tendency to manipulate the key by methods other than those approved in this country. The key is rigidly constructed and is extremely light in action; being fitted with heavy silver contacts, it is suitable for serious work and can be recommended either for practice purposes or otherwise."

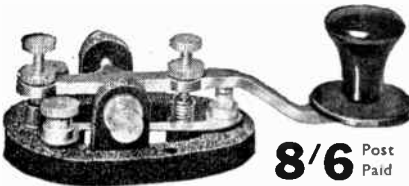

This Raymart "Speed" Key combines all that is best in British and American key design. It will give years of useful service.

8/6 Post Paid

# RAYMART

CRAFT A CREED

Send stamped, addressed envelope with all enquiries.

Telephone: MIDLAND 3254

48 HOLLOWAY HEAD, BIRMINGHAM, I

1916



1943

It's happening in Radio, too!

Between Verdun and Tunisia is a great advance in weapons and technique. But while paratroopers fight in the public eye, the radio war goes on "behind the scenes." The benefits of modern development will not be seen until domestic radio sets are built again. Masteradio are looking ahead to that happy time and invite you to register NOW without obligation for post-war priority, stating home or car radio interest. Write: Masteradio, Ltd., Watford, Herts.

# Masteradio

IS LOOKING AHEAD

★ One of a Series of Advertisements appearing in the National Press

MASTERADIO LIMITED • WATFORD • HERTS

Precisely!

for accurate testing it must be

# TAYLOR METERS

Write for complete details to:  
**TAYLOR ELECTRICAL INSTRUMENTS, Ltd., Montrose Av., Slough, Bucks**  
 Telephone: Slough 21381 (4 lines).

Greenwood

## BASICALLY BETTER...

Clear Imped. Chms.	Type	Att. db/100ft. 10M/c	Dielectric Constant
70	214	16.3	5.2
		0.11	1.27
			1.25

FROM THE COMPLETE RANGE MAY BE QUOTED:

Air Insulation... is the basic principle of

# CO-AX CABLES

LOW LOSS

Unequalled H.F. Properties

There is a CO-AX Cable for every H.F. Purpose

TRANSRADIO LTD. Inc. TELEQUIPMENT CO. 16 HIGHWAY-BEAONSFIELD

*Value proved by long service*

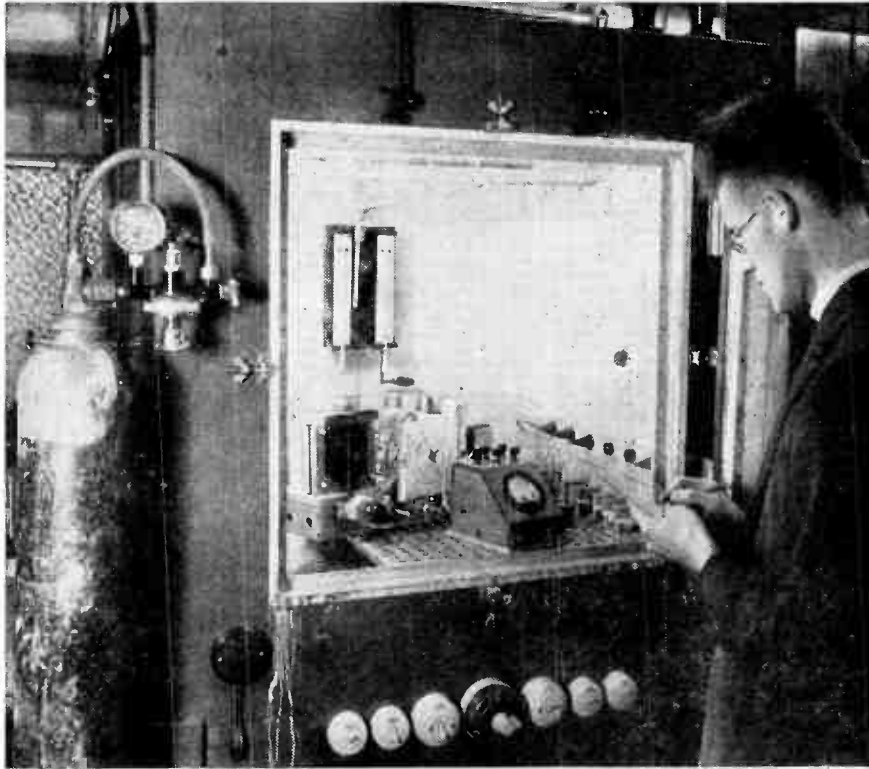

# Osram Valves

MADE IN  
ENGLAND

Ever since the advent of radio Osram Valves have been closely connected with all the progressive stages of development in radio science. Intensive research still goes on, and improvements in design and technique, to keep pace with the advancing times will ultimately be of benefit to all.

*Advt. of The General Electric Co. Ltd., Magnet House, Kingsway, London, W.C.2*



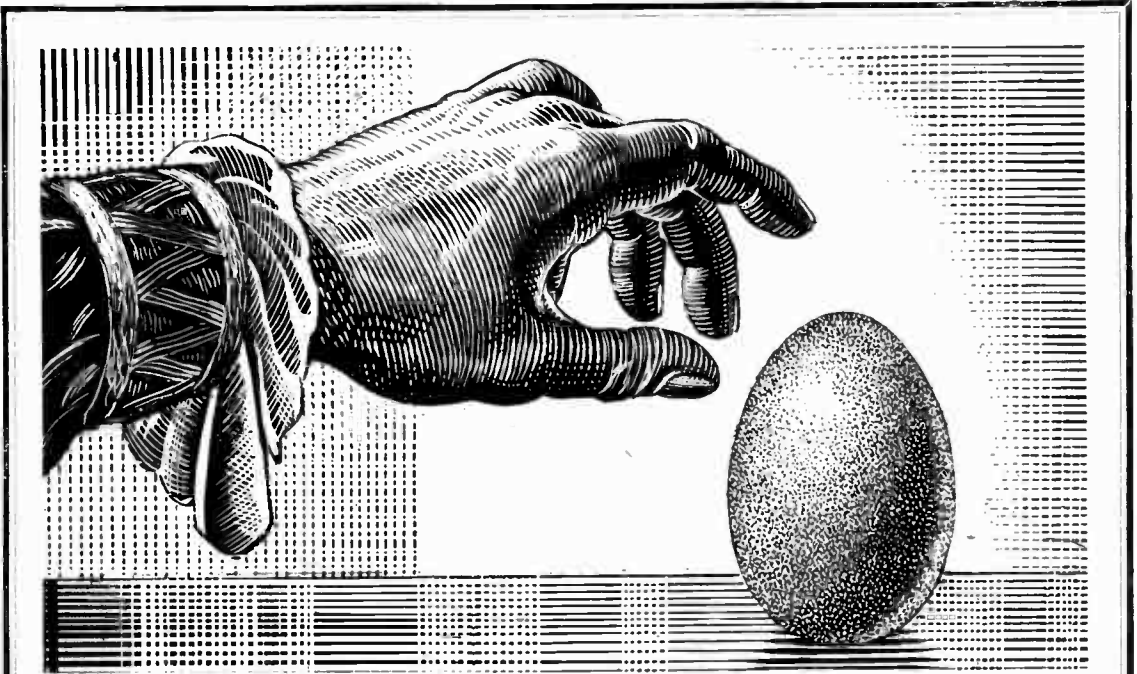

## Thus

THEY said it was impossible, but when Columbus deftly tapped the egg on the table it stood to attention like a good soldier.

Likewise it was long accepted as inevitable that engine oil in use must become progressively contaminated by acids and abrasives. But one day it occurred to an inventive mind to tackle the problem of surface wear from a new angle. The result was the Fram Oil and Engine Cleaner which purifies the oil while in circulation and trebles the life of the internal combustion engine.

Fram is therefore every inch an AEROCESSORY, revolutionary yet simple, economical yet conferring great benefit.

# S I M M O N D S

*In high service to*  
AERONAUTICAL, INDUSTRIAL & MARINE  
*Construction*

THE SIMMONDS NUT · PINNACLE NUT · SPIRE NUT · SIMMONDS INSTRUMENTS,  
CONTROLS AND ELECTRONIC PRODUCTS · FRAM OIL AND ENGINE CLEANER

SIMMONDS AEROCESSORIES LTD.,  
GREAT WEST ROAD, LONDON  
A COMPANY OF THE SIMMONDS GROUP

LONDON MELBOURNE MONTREAL PARIS NEW YORK

# Wireless World

Radio • Electronics • Electro-Acoustics

33rd YEAR OF PUBLICATION

## JULY 1943

Proprietors :  
ILIFFE & SONS LTD.

Managing Editor :  
HUGH S. POCOCK,  
M.I.E.E.

Editor :  
H. F. SMITH.

Editorial, Advertising  
and Publishing Offices :

DORSET HOUSE,  
STAMFORD STREET,  
LONDON, S.E.1.

Telephone :  
Waterloo 3333 (35 lines).

Telegrams :  
"Ethaworld, Sedist, London."

△

PUBLISHED  
MONTHLY

Price : 1/3

(Publication date 25th  
of preceding month)

Subscription Rate :  
Home and Abroad  
17/- per annum.

Branch Offices :

COVENTRY :  
8-10, Corporation Street.  
Telephone : Coventry 5210.  
Telegrams :  
"Autocar, Coventry."

BIRMINGHAM :  
Guildhall Buildings,  
Navigation Street, 2.  
Telephone :  
Midland 2971 (5 lines).  
Telegrams :  
"Autopress, Birmingham."

MANCHESTER :  
260, Deansgate, 3.  
Telephone :  
Blackfriars 4412 (4 lines).  
Telegrams :  
"Iliffe, Manchester."

GLASGOW :  
26B, Renfield Street, C.2.  
Tel-phon-e: Central 4857.  
Telegrams : "Iliffe, Glasgow."

△

As many of the circuits and  
apparatus described in these  
pages are covered by patents,  
readers are advised, before  
making use of them, to satisfy  
themselves that they would  
not be infringing patents.

EDITORIAL. Future of Broadcasting .. ..	191
TRACING THUNDERSTORMS. By J. S. Forrest, M.A., B.Sc., F.Inst.P. ..	192
RADIO DATA CHARTS.—No. 9: The Dynamic Resistance of a Parallel Tuned Circuit. By J. McG. Sowerby, B.A., Grad.I.E.E. ..	194
U.S. ARMY SETS .. .. .	196
NEGATIVE FEEDBACK. By J. T. Terry .. .. .	198
DC VOLTAGE TESTER. By T. A. Ledward, A.M.I.E.E. .. .. .	202
"WIRELESS WORLD" BRAINS TRUST .. .. .	205
WIRE BROADCASTING. .. .. .	207
ELECTRO-MAGNETIC FIELDS IN RADIO.—VI: Waves in Metals and the Ionosphere. By Martin Johnson, D.Sc. .. .. .	208
PICK-UP COUPLING TRANSFORMER. By John Brierley .. .. .	212
UNBIASED. By Free Grid .. .. .	214
WORLD OF WIRELESS .. .. .	215
RANDOM RADIATIONS. By "Diallist" .. .. .	218
LETTERS TO THE EDITOR .. .. .	219
NEWS IN ENGLISH FROM ABROAD .. .. .	220
RECENT INVENTIONS .. .. .	222

# Exclusive features

of the  
**'STRATOSIL'**

series of  
**SEALED  
VIBRATORS**

for use at all altitudes

★ Owing to wartime restrictions on supply of raw materials, it is not possible to supply Wearite Components for purposes other than those connected directly with the war effort.

- 1 All steel construction—even to the rivets—ensuring uniform expansion under extremes of temperature.
- 2 Reed driving coil—wound on a bakelite moulded bobbin to meet all climatic conditions.
- 3 Metal can, sponge rubber lined—Acoustically and electrically shielding the Vibrator.
- 4 Driving contact of non-tarnishable precious metal—ensuring starting under the lightest of pressures and voltages.
- 5 Contacts ground almost to optical limits.
- 6 Stack assembly. Mica and steel only are used.
- 7 International Octal base sealed by the WEARITE STRATOSIL process.

Embodying "Oak Manufacturing Co.'s" patents 460470, etc.

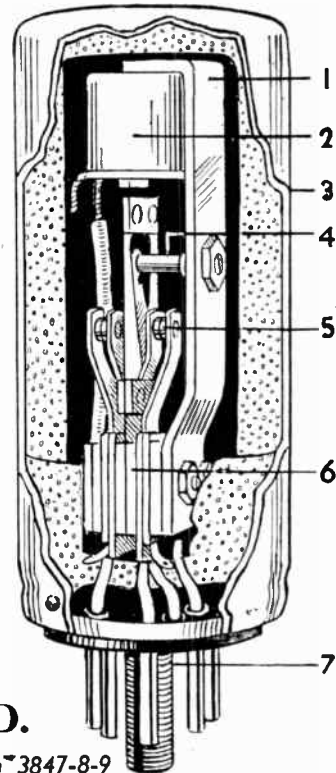

## WRIGHT & WEAIRE LTD.

HIGH ROAD, TOTTENHAM, N.17. Telephones : TOTtenham 3847-8-9



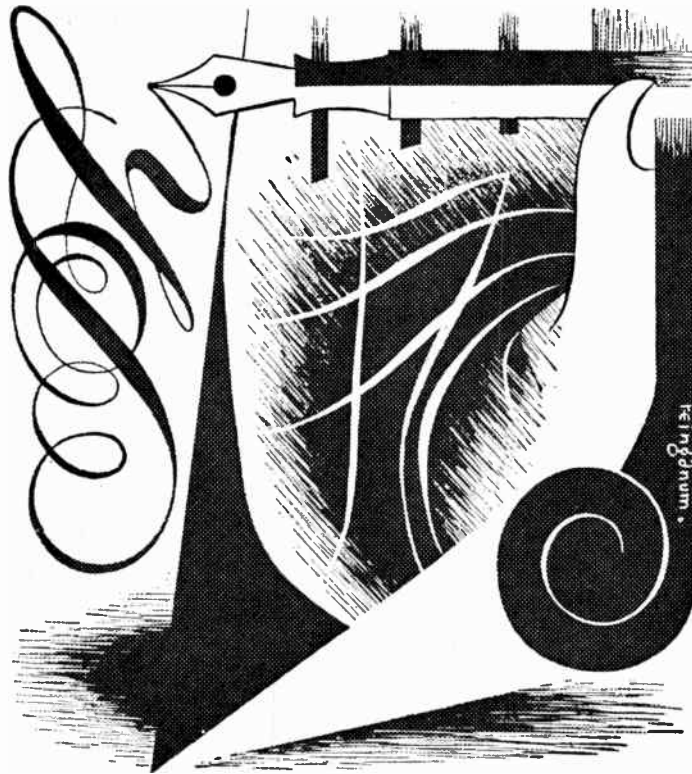

## CHARACTER

*The character of an organisation is accurately reflected in its products and its activities. To the experienced eye of the technician, the intrinsic quality of a Philips product is its own hall-mark; the non-technical public knows from long experience that the name of Philips is the sign manual of expert craftsmanship and unflinching service.*

# PHILIPS

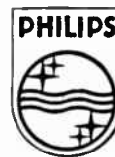

INCANDESCENT AND DISCHARGE LAMPS • FLUORESCENT LIGHTING • RADIO RECEIVERS AND TRANSMITTERS • COMMUNICATIONS EQUIPMENT • THERMIONIC VALVES AND OTHER DEVICES • X-RAY EQUIPMENT FOR ALL PURPOSES • ELECTRO-MEDICAL APPARATUS • ARC AND RESISTANCE WELDING PLANT AND ELECTRODES • MAGNETS AND MAGNETIC DEVICES • SOUND AMPLIFYING INSTALLATIONS

PHILIPS LAMPS LIMITED, CENTURY HOUSE, SHAPTESBURY AVENUE, LONDON, W.C.2 (126D)

# Wireless World

Radio • Electronics • Electro-Acoustics

Vol. XLIX. No. 7

JULY 1943

Price 1s. 3d.

## Future of Broadcasting

### *Preparing for Post-war Reconstruction*

**I**N our May issue we stressed the interdependence between the broadcasting section of the wireless industry and the B.B.C., pleading for a closer liaison between the two. Both will have to face vastly changed conditions after the war; the industry has at least made a preliminary move towards planning its future by appointing a Committee to study post-war problems, and it seems at least equally important that the B.B.C. should begin to prepare for the peace.

Before the war, broadcasting could still thrive, or at least survive, on its novelty value, and during the war its function in satisfying our hunger for news is by itself more than sufficient justification for its continued existence. But when peace returns it will have to offer new attractions if it is still to flourish. In a world where a member of almost every family has been in close contact with wireless communication during the war, the appeal of novelty will no longer operate. There will be other strong attractions; indeed, it has been said that the ordinary citizen will prefer the novelty of a stroll through lighted streets to listening to a broadcast programme. There is certainly some truth in that statement, although it will doubtless apply only to a passing phase of our post-war life. But if the habit of listening is interrupted, broadcasting as a feature of our national life will decline, and it will never be fully re-established unless the very best efforts that can be summoned up are put into the organisation of our post-war system.

### *Criticisms Cancel Out*

Criticism of the B.C.C., and planning for its reform, is surely one of the most vain and fruitless of our national activities. With unflinching regularity the subject comes up in Parliament, and with hardly any deviation the usual gambit is followed. Politicians of the Right accuse the Corporation of being too Leftish, those of the Left say it is too Rightish. The highbrows say it is too lowbrow, while the lowbrows are certain it is too highbrow. Those who plead for sweeping reforms of the whole system generally end by describing a "new" system with an extraordinary resemblance to the

B.B.C. we all know—but better, of course! Can one blame the average fair-minded citizen if, after listening to the arguments, he decides that there cannot be much wrong with the B.B.C.—but it might be a bit better, of course!

Most criticism of the B.B.C. is fruitless because it is generally confined to superficialities, and the fundamental issues involved in making the best use of what is still a new medium are ignored. Again, those whose suggestions for sweeping reforms in the organisation of broadcasting might otherwise be worthy of serious attention often come to grief through ignorance of the technical problems involved.

### *Spur of Competition*

There is a general feeling that some intangible factor is lacking in the B.B.C.; some fresh incentive or stimulus is needed. In our October issue last year we suggested that the stimulus of competition, at present entirely lacking, might best be introduced by setting up two separate B.B.C. Programme Boards, completely independent and each under a Director responsible only to Parliament. Each network would be responsible for providing a nationally distributed programme. Since then Sir Allan Powell, chairman of the B.B.C., has referred publicly to the possibility of internal post-war competition, and is reported as foreshadowing "friendly competition between Regions," but nothing approaching autonomy. That seems to be a rather useless form of competition, except to those listeners living in an overlapping transmitter service area. It would be small consolation to an Aberdonian to know that the London Regional programmes were exactly to his taste.

From some points of view it is a pity that the recent suggestion for setting up a Government Commission to examine the future of broadcasting has been negated. Sooner or later, this question will have to be examined, and it is desirable that decisions may be reached in time for putting into effect as soon as the war ends. If broadcasting retains its prestige and influence, it is capable of playing a great part in post-war reconstruction.



# TRACING THUNDERSTORMS

## A Use for Atmospherics

READERS of *Wireless World* who were actively interested in wireless about twenty years ago will remember the "experimenter's licence." In those days if one desired to construct a wireless receiving set it was necessary to convince the Postmaster-General that one was a *bona-fide* experimenter, and particulars had to be submitted of the investigations which it was proposed to make. Many of us chose as a subject of research "the elimination of atmospherics." This was a safe choice—no one was likely to have solved this problem over-night! As in many other problems, the solution came from an unexpected direction—short waves were found to be practically immune from atmospheric interference. Now, atmospherics have not only been conquered but are even being made to serve a useful purpose by providing evidence of the presence of thunderstorms.

It is well known that every visible lightning flash produces a strong atmospheric, and it is probable that every atmospheric originates in a lightning flash, although the latter statement is not so easy to prove. It has been found in practice, however, that atmospherics do give a reliable indication of thunderstorm activity particularly in the case of the relatively high field strength disturbances which are produced by storms within a few hundred

By J. S. FORREST,  
M.A., B.Sc., F.Inst.P.

miles of the receiver. A thunderstorm can therefore be located and its path traced by any radio method which will determine the source of the atmospherics.

Thunderstorms are uncontrollable and it may be asked why one should wish to trace their movements. Quite apart from the interest of such problems from a purely meteorological standpoint, there are certain other applications in which a knowledge of the outbreak and whereabouts of thunderstorms is of value. For example, thunderstorms are one of the hazards encountered by aviators, as not only are the electrical discharges dangerous in themselves, but the violent air currents in the storm are also a menace to aircraft. It should therefore be of considerable assistance to a pilot if he were given details of the position and direction of travel of a thunderstorm so that he could, if necessary, deviate from his course in such a way as to circumvent the storm. A further application is found in the operation of electric power supply systems. Lightning strokes to overhead power lines are responsible for a large number of breakdowns which may interrupt electricity supplies and cause extensive damage to electrical plant. If the operating engineers can

receive a few hours' warning of the outbreak of a thunderstorm in the area under their control, then it is often possible to take certain steps to safeguard the supply and minimise the damage; alternative lines may be put into service, while transformers which are not essential for the immediate load requirements may be switched out. Arrangements may also be made for repair gangs to stand by.

In order to find the position of the source of the atmospherics from a single receiving site, it is necessary to determine both the distance the atmospherics have travelled and their direction of arrival. Alternatively, if receiving instruments can be operated at two or three different sites it is sufficient to determine either the distance or the direction, as the position of the source can then be found by triangulation.

### Direction-finding Methods

The usual methods which have been employed for finding distance and direction may be very briefly summarised as follows:—

(a) The atmospherics are received on an aperiodic receiver and are recorded by a cathode-ray tube. The distance the atmospherics have travelled can then be deduced approximately from their amplitudes and wave-shapes.

(b) A "cathode-ray direction finder" tuned to a long wavelength is used to determine the direction of arrival of the atmospherics. This instrument consists in principle of two frame aerials at right angles, each connected through its own amplifier to the deflecting plates of a cathode-ray tube. The bearing of each atmospheric received is then shown directly on the screen of the tube.

(c) The direction of arrival may also be found by means of a "narrow-sector recorder" tuned to a long wave-length. This apparatus takes the form of two slowly-rotating frame aerials at right angles, the outputs of which are combined with that of a vertical aerial in such a way that

Photograph of Thunderstorm Recorder described in the text.

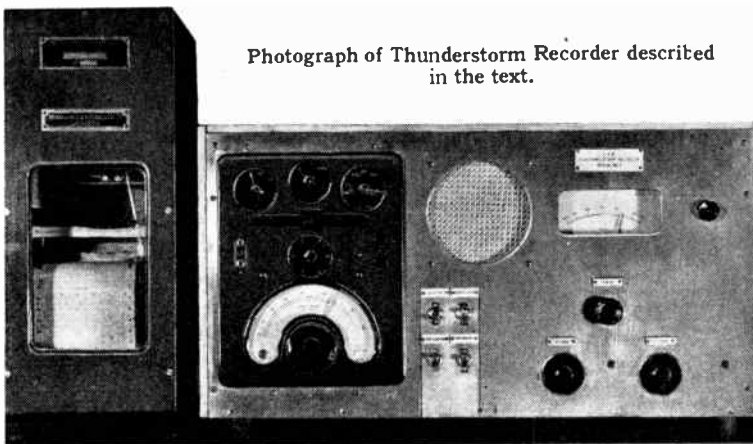

signals are accepted only in a narrow sector. The atmospherics, after amplification, are recorded by a pen-type recorder on a drum, rotating synchronously with the frame aeriels.

These methods all require complicated and specialised apparatus, but a much simpler method may be found to be adequate when it is not required to record thunderstorms at distances of more than a few hundred miles. This method has been used successfully in Britain in order to provide thunderstorm warnings for electric power system operators, and it may therefore be of interest to describe the apparatus in some detail.

The instrument consists essentially of a mains-driven radio receiver, a calibrated oscillator, and an output recorder. The receiver, a slightly modified standard chassis made by the Armstrong Manufacturing Company, is tuned to a frequency in the band 145-200 kc/s. The lower frequency end of the long-wave band is used, as the intensity of atmospheric disturbances increases as the frequency decreases. A straight circuit is employed with two radio-frequency stages, a diode detector, and two audio-frequency stages. The receiver has manual RF and AF gain controls; automatic gain control is not used. The output meter is an Evershed and Vignoles rectifier-type moving-coil pen-recorder giving full-scale deflection with 10 mA. The

that the receiver gain can be checked regularly and maintained at a constant value. The receiver

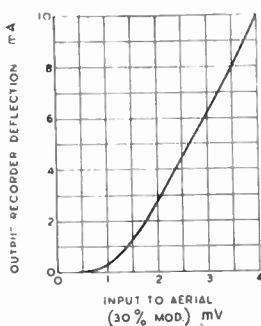

Courtesy, Royal Meteorological Society.  
Fig. 1. Sensitivity characteristic of receiver.

is comparatively insensitive, and it is normally adjusted to give full-scale deflection on the output meter when a 4-mV signal, modulated at 400 c/s to a depth of 30 per cent, is applied to the aerial terminal. The relation, at the normally used gain control settings, between the output recorder deflection and the input voltage on the aerial terminal is shown in Fig. 1 and the shape of this characteristic is also kept constant. The band width of the receiver is approximately 10 kc/s. The exact frequency to which the receiver is tuned is not important, but care is taken to see that radio stations operating near the receiver frequency do not give an appreciable indication on the recorder. A loud speaker is provided

interference from the electrical plant, and if such interference is present a mains filter and screened aerial system must be used to suppress the interference below the level which will affect the recorder. If necessary, interference can be eliminated by using a battery-driven receiver installed at a site some distance from any source of interference. The modulated oscillator, made by the Automatic Coil Winder and Electrical Equipment Company, was designed to maintain constancy of output and modulation depth, but provision is made to check its characteristics occasionally by means of a valve voltmeter and oscillograph. The components of the receiver are liberally rated, and the receiver operates twenty-four hours a day for at least three months without trouble; one equipment has been in operation for over a year without breakdown or valve replacement.

A typical thunderstorm record is reproduced in Fig. 2; this shows the severe summer thunderstorm of August 29th, 1942. The lines drawn on the chart by the recording pen when each atmospheric is received can be clearly seen; the length of the line is very approximately proportional to the signal strength of the atmospheric. It will be noted that between 7 p.m. and 10 p.m. full scale deflections were recorded; the storm was only a few miles distant at this time, and lightning

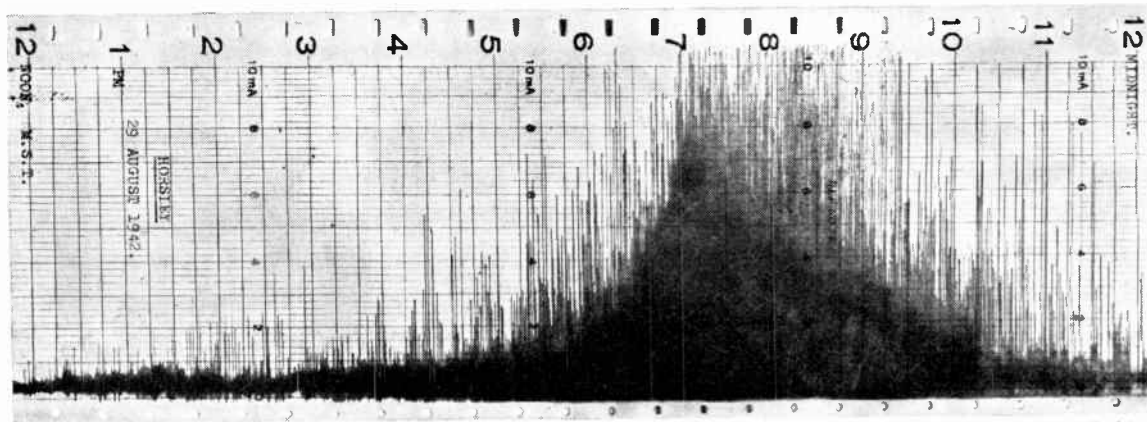

Fig. 2. Thunderstorm record—August 29, 1942.

Courtesy, Royal Meteorological Society.

chart is driven by a synchronous motor and has a speed of one inch per hour. The modulated oscillator is built into the equipment so

for monitoring purposes. An ordinary outdoor aerial, having a length of about 60 feet, is used. The instrument is affected by

was visible at the recording site. By correlating many records similar to the one shown in Fig. 2 with the known locations of the



**Tracing Thunderstorms—**

thunderstorms it has been found that there is a fairly definite relation between the deflections recorded on the charts and the storm distance. Fig. 3 is a typical curve showing storm distance in terms of the output recorder deflections; once such a calibration curve has been drawn it can be used to estimate the distance of any storm. It must be emphasised that the distance cannot be determined

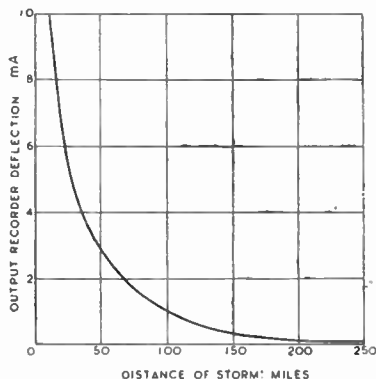

**Fig. 3. Relation between storm distance and output recorder deflection.**

from the deflection due to a single atmospheric as a considerable range of deflections has been found to occur for lightning flashes at the same distance. If, however, the maximum deflection of a group of atmospherics is used then the distance of the storm can be estimated with sufficient accuracy for most purposes. Further, the apparatus gives several hours' warning of the probable outbreak of a storm. In the case shown in Fig. 2, for example, the approach of the storm is clearly shown for some hours before its outbreak near the recording site.

By installing several instruments at different sites the movements of thunderstorms can be determined by triangulation if facilities for telephone communication between the sites are available. It should be mentioned, however, that in a small country like Britain the extent of the storm is often of the same order as its distance from the recording instruments, so that it may not be possible to plot the path of the storm as a whole. For many applications it is sufficient to utilise a single instrument to indicate the presence of storms within a certain distance of the recording site.

# RADIO DATA CHARTS—9

## The Dynamic Resistance of a Parallel Tuned Circuit

By J. McG. SOWERBY, B.A., Grad.I.E.E.

(By Permission of the Ministry of Supply)

IT is well known that a parallel tuned circuit behaves as a resistance at its resonant point. At other frequencies it behaves as an impedance with capacitive or inductive reactance predominating, depending on whether the incoming frequency is higher or lower than the resonant frequency. The maximum impedance is presented to the incoming signal at the resonant frequency, and it is at this point that the gain of a valve stage (say) is normally calculated. Hence it becomes important to know the dynamic resistance ( $R_d$ ), and it is the purpose of this chart to calculate it in terms of known quantities—the inductance, the tuning capacity, and the resistance of the coil. However, before coming to the chart it may be helpful to go over the mathematics on which it is based.

Consider the circuit of Fig. 1, which represents a parallel tuned circuit with resistance in the coil arm only—this being the commonest practical case.

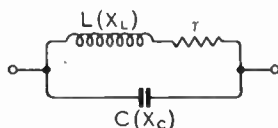

**Fig. 1. Parallel tuned circuit with resistance in the inductive arm.**

Using the symbols shown in the figure, let us calculate the impedance of the circuit. The inductance may be represented by  $(r + jX_L)$  and the capacity by  $(-jX_C)$ , where  $X_L$  and  $X_C$  are the inductive and capacitive reactances respectively. Since the two are in parallel the circuit impedance,  $Z$ , is given by

$$Z = \frac{-(r + jX_L)jX_C}{r + jX_L - jX_C}$$

But at resonance  $X_L = X_C = X$  (say).

$$\text{Hence } Z = \frac{X^2 - jrX}{r}$$

The absolute value of the

circuit impedance may be written

$$|Z| = \sqrt{\frac{X^4}{r^2} + X^2}$$

In any practical tuned circuit it is clear that the reactance  $X$  will always be large compared with the resistance  $r$ . For this reason we can safely ignore the  $X^2$  term in comparison with the other; and so we are left with

$$|Z| = \sqrt{X^4/r^2} = X^2/r = R_d.$$

$R_d$  is, of course, almost purely resistive, and is usually called the dynamic resistance.

Now since  $X_L = X_C = X$ , then obviously we may write any of the following with equal truth:

$$R_d = X_L^2/r \dots \dots (a)$$

$$R_d = X_C^2/r \dots \dots (b)$$

$$R_d = \frac{X_L X_C}{r} \dots \dots (c)$$

It is versions (a) and (c) which are of most use in practice, but both may be put into a more immediately useful form still. What is known more often than the resistance  $r$  is the  $Q$  of the coil and this is  $X_L/r$ . Hence (a) becomes

$$R_d = QX_L.$$

But since  $X_L = 2\pi fL$

$$R_d = 2\pi fQL \dots \dots (1)$$

Since  $X_L = 2\pi fL$  and  $X_C = 1/2\pi fC$

$$(c) \text{ may be written } R_d = \frac{2\pi fL}{2\pi fC} \cdot \frac{1}{r}$$

and so

$$R_d = \frac{L}{Cr} \dots \dots (2)$$

Broadly speaking (1) would be used when the  $Q$  of the coil is known, and (2) when  $r$  has been found either by measurement or calculation, say, from the abacs designed for the purpose in "Radio, Data Charts." The present chart is therefore designed to cover both formulae and is used as shown in the two keys.

Normally it will be found that  $R_d$  will change over a band of frequencies and so usually it is calculated at three points in the waveband—at either end and in the middle. Note too that the

(Concluded on page 196)

ABAC No. 9  
(Third Series)

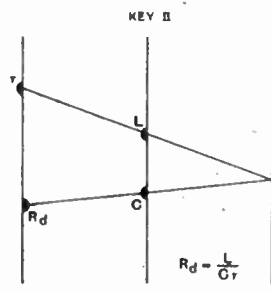
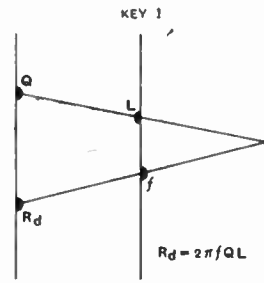
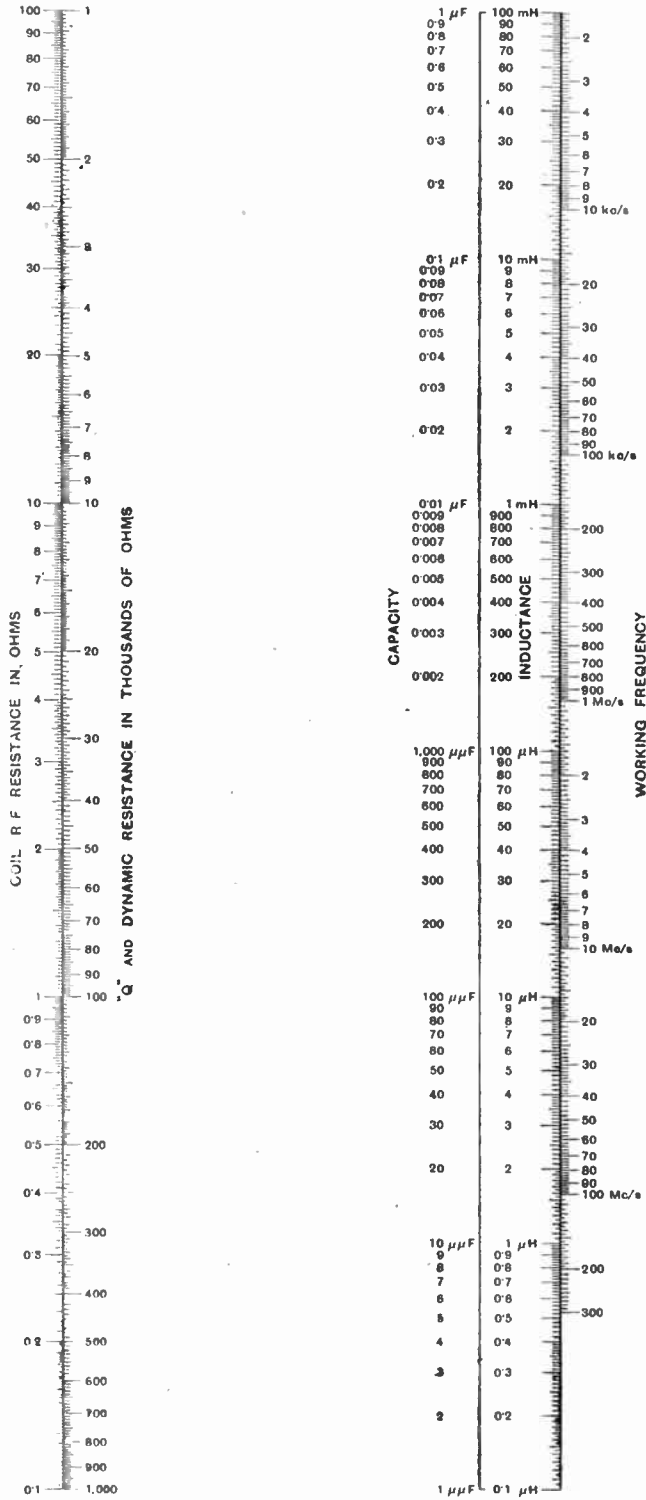

DYNAMIC RESISTANCE OF A PARALLEL TUNED CIRCUIT

Wireless World  
COPYRIGHT

**Radio Data Charts—9—**

RF resistance  $r$  will not remain constant throughout the wave-band and that dielectric losses will have the effect of increasing  $r$ , especially as the tuned frequency rises.

In the long-wave band the dynamic resistance may be as high as 0.5 megohms under favourable conditions, in the medium-wave band 100,000 ohms, while at 20 metres a dynamic resistance of 20,000 ohms would be difficult of attainment.

**Example 1. (Key I).**

A coil whose  $Q$  is 90 at 1 Mc/s has an inductance of 159.2  $\mu$ H. Calculation shows the dynamic resistance to be 90,000 ohms, and this is the value given by the chart.

**Example 2. (Key II).**

In the medium-wave band a coil of 160  $\mu$ H (RF resistance 8 ohms) is tuned by a condenser of 400  $\mu$ F. What is the dynamic resistance? The chart gives the answer as 50,000 ohms, and this is the calculated value.

## U.S. ARMY SETS

### Portable Transmitter - Receivers

**T**HE United States Signal Corps, like our own Royal Signals, is responsible for the Army's communication system and, in addition, for ground communications of the U.S. Army Air Force. To maintain the lines of communication many different types of transmitters and receivers are required.

Few facts having been published in this country about the sets used by the Corps, it is proposed to give some details about some of the pack sets—or "walkie-talkies" as they have been aptly styled—at present in use.

One of the most interesting of the transmitter-receivers used by the U.S. Army is type 511. Although originally designed for cavalry, this set is now being extensively used by the infantry for communication between company and battalion. Circuit details of this set, which is fixed tuned on six frequencies, are not available, but some of the salient features in design may be given.

"Miniature" technique is employed in the design of this nine-valve set, which is housed in a metal case measuring approximately 6×6×8in., mounted on a heavy 3ft. 6in. spike. Although intended for insertion in the cavalryman's stirrup bucket, the spike is useful for inserting in the ground.

Access to the valves, etc., is gained by sliding the base plate down the spike. This reveals a second plate, which, when withdrawn, comes away with

the screening cans of all the valves. Incidentally, rubber cushioning is provided in each valve screen.

The joints of the case are rubber-faced to render them waterproof except under most unfair treatment: the set can be passed



The send-receive switch on the "handie-talkie" is on the side of the 14in. case.

through water without suffering damage, but would be damaged if left submerged.

When extended, the 6ft. telescopic aerial, fitted to the top of the case, switches on the set. The send-receive switch is fitted at the base of the aerial where it is accessible and easily depressed. A multiple cable from the set is connected by means of a 9-way plug to a case measuring approximately 10×9×2in. carried on the operator's chest. This case contains the combined HT/LT battery, spare oscillator coil and the combined microphone-loudspeaker.

This interesting set, weighing 16 lb. complete, has an appreciable range and has been used with considerable success in North Africa and Guadalcanal.

Photographs have recently appeared in the lay press of another U.S. Army set, which has been styled the "handie-talkie." This transmitter-receiver, used by our Allies for communication between platoon and company, is about 14in. long. As can be seen from the photograph on this page



Marine Raiders, America's toughest fighting men, using one of the latest "walkie-talkies."



it is used like the hand-piece of a modern desk telephone.

Miniature technique is also employed in the construction of this 7-valve set, which weighs approximately 5 lb. Very few details are available however, regarding the circuit. Like the set already described it is switched on by extending the short telescopic aerial.

The original "walkie-talkie" pack set is a two-valve combined transmitter-receiver of considerably larger size and weight. The whole outfit complete with two telephone hand sets, telescopic rod aerial, spare valves and batteries is carried in a canvas haversack on the back of the operator, and weighs approximately 27 lb.

This set, although now obsolete, is still used in considerable quantities in the U.S. Army.



The set is housed in an aluminum alloy case. A plug on the bottom of the case is inserted directly into a socket on the top of the battery. Among the accessories is a break-in box, which connects to the battery plug of the set; this provides means for connecting separate batteries to the set if the standard block battery is unobtainable, and also enables meters to be connected to the various circuits for reading the anode voltages and current consumption of the microphone, relay and anodes. The approximate current readings are :

Receiver anode	.. 21 mA
Transmitter anode	.. 45 mA
(modulated)	.. 45 mA

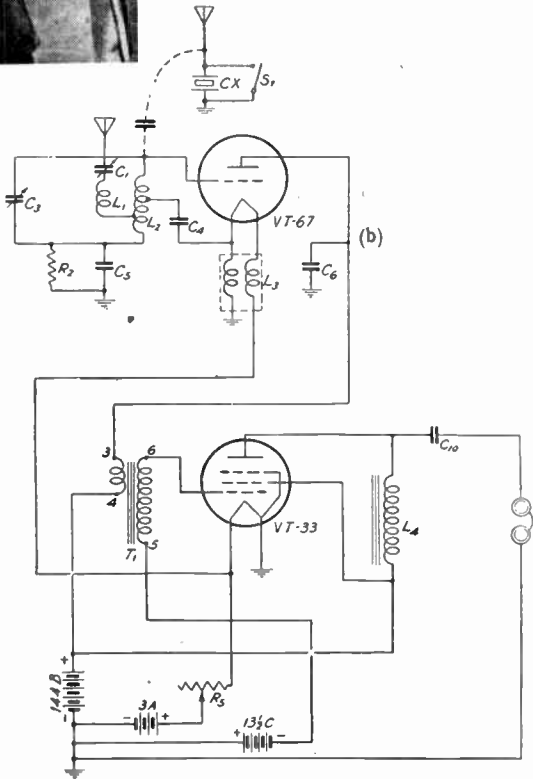
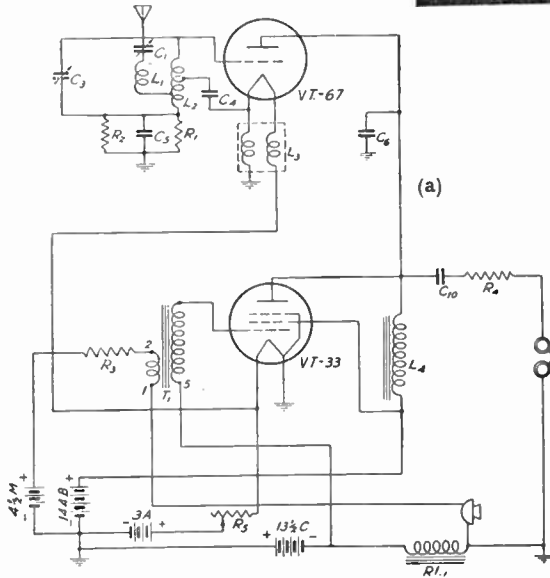

Reproductions from the U.S. Army instructional manual of the basic circuit diagram of the original "walkie-talkie" when functioning (a) as a transmitter and (b) as a receiver. The set, with separate microphone and headphones, is seen worn by a sergeant of the U.S. Signal Corps in the upper illustration.

When used as a transmitter one valve functions as the oscillator in a modified type of crystal-controlled Hartley circuit; the anode being maintained at RF earth potential. The second valve functions as the amplifier of the Heising (constant current) modulation system. For reception these valves operate, respectively, as super-regenerative detector and AF amplifier.

The set has a frequency range of from 52.80 to 65.80 Mc/s using one oscillator coil. There is a separation of 400 kc/s between the 33 available frequencies.

Power for the set is provided by a block battery, which, when continuously operated, has a life of approximately 20 hours. When used intermittently the effective life of the battery is, of course, two or three times as long.

Transmitter anode	.. 35 mA
(unmodulated)	.. 35 mA
Microphone	.. 35-60 mA
Relay	.. 18 mA

The controls and components mounted on the front panel of the set, comprise tuning calibration switch, calibration adjuster, filament resistance and switch filament voltmeter, and microphone and headphone socket.

# NEGATIVE FEEDBACK

## Some Pitfalls in Applying It to Quality Amplifiers

By J. T. TERRY

THE behaviour of a valve circuit is radically affected by feeding back part of the output voltage into the input circuit. This has been done for some considerable time past, with and without intention. De Forest

of the now purely negative  $m\beta$ . In these circumstances, it follows that  $1/1 - m\beta = 1/1 + |m\beta|$ , a factor less than 1 by which both  $D$  and  $m$  are reduced.

Now there is no point in comparing an indifferent amplifier with a better one unless both have the same gain; other things being equal, this could only be realised by suitably increasing the load or number of

The difficulty lies in the varied sources of the distortion term  $D$  which it is rather rash, if expedient, to assume independent of the output voltage proper. This could at best be maintained about one of its parts, e.g. mains hum, possibly about valve noise, certainly not about distortions arising in the grid circuit (grid current), in the mutual characteristic (bottom bend curvature) or in the anode circuit (non-linear behaviour of anode resistance  $R_A$  and load impedance  $Z_L$ , the latter also varying in general with

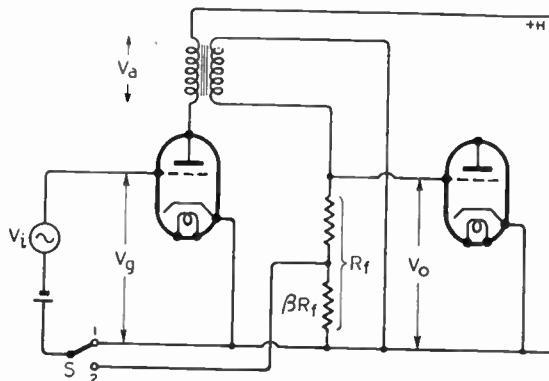

Fig. 1. Transformer-coupled voltage amplifier with provision for feedback.

was not long in applying positive feedback to his three electrode "audion" valve to obtain a detector of high sensitivity, or an oscillator. Negative feedback was also used even in the infancy of radio (multi-stage amplifiers of the First World War embodied this feature), but it was Nyquist's work which ten years ago paved the way to a deeper understanding and hence more widespread application of all forms of feedback<sup>1</sup>.

Since then it is usually held that the performance (especially the frequency/gain characteristic) of an audio amplifier is enhanced by the provision of negative feedback. This belief is based on the usual analysis<sup>2</sup> of negative feedback which assumes that in the absence of feedback the output voltage contains a distortion term  $D$  which is independent of the gain  $m$ . It is then easily shown that with a fraction  $\beta$  of the output voltage  $V_o$  fed back in any phase whatever, both gain and distortion are modified in the ratio  $1/1 - m\beta$ . In general, of course,  $m\beta$  is a complex term and a function of frequency. The feedback is said to be purely negative if  $m\beta = -|m\beta|$ , where  $|m\beta|$  is the magnitude (positive)

stages of the amplifier containing negative feedback. In other words, the comparison must be on the basis of a given output for a given input, i.e., on the basis of a given amplification factor. Doubt may then arise as to whether negative feedback is of any use; for the necessary addition of extra loading or stages tends to add equally to both the amplification and the distortion. The argument is admittedly somewhat academic, as any telephone engineer may proudly point to his amplifier racks containing dozens of valves, an achievement unthinkable without the bounties of negative

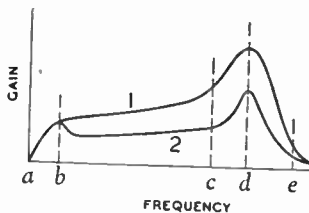

Fig. 2. Frequency/gain characteristics of circuit of Fig. 1, corresponding to switch positions (1) and (2).

feedback. Nevertheless, this does not solve the problem and it still awaits a general solution.

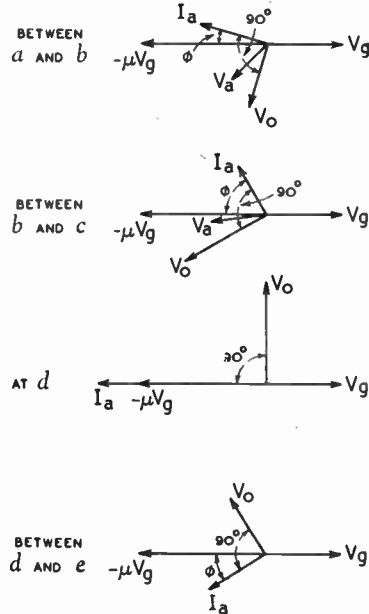

Fig. 3. Vector relations between grid voltage  $V_g$ , transformer primary voltage  $V_a$ , secondary voltage  $V_o$  and anode current  $I_a$ , in the amplifier of Fig. 1 without feedback and at the frequencies indicated in Fig. 2.

frequency). Only one factor has been cleared up so far, i.e., irregularities arising from changes in the amplification factor of individual valves, due to arbitrary reasons<sup>3</sup>. J. Peters has shown that the greatest improvement obtains when the stage or stages over which feedback is applied has a gain equal to  $\epsilon$  ( $= 2.718$  approx.).

While this is only a partial answer to the general problem, it is not proposed to attack it in a formal manner here. Nevertheless, it may be of interest to investigate the physical background and to warn the negative feedback enthusiast against some of the more frequently encountered pitfalls.

For a start, it is necessary that the feedback should be truly negative.<sup>4</sup> This does not mean pure negative feedback necessarily, but that the feedback voltage  $\beta V_o$  should contain a

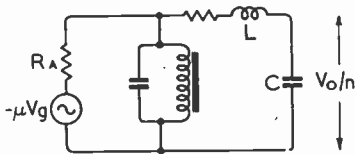

Fig. 4. Simplified equivalent circuit of valve and transformer at frequencies above (c) in Fig. 2.

component 180 degrees out of phase with the applied input voltage  $V_i$ . This postulate is not quite as trivial as it may first appear, as the following example will demonstrate.

Consider a stage of voltage amplification with transformer coupling (Fig. 1). The switch S is arranged to apply feedback from the secondary of the transformer when in position 2. In position 1 no feedback is applied, and providing the resistance  $R_f$  of the potential divider is adequately high, a frequency/gain characteristic as sketched in the top curve of Fig. 2 is likely to result. It reveals a poor low-frequency response below  $b$ , a resonant peak at  $d$  then a falling off rapidly towards  $e$ .

Obviously this characteristic is associated with serious frequency distortion and the cure would seem to lie in applying negative feedback rather than redesigning the transformer. Suppose then that the switch (Fig. 1) is thrown into position 2. Assuming that the feedback potentiometer has been suitably connected (otherwise self-oscillation is probable) the result will be disappointing, as is shown in the lower curve of Fig. 2. The gain is generally lower than before, but instead of a flatter characteristic it will be adorned by an additional "bump" at  $b$ ,

the obnoxious one at  $d$  still being present.

The simple truth is that neither below  $b$  nor at  $d$  does negative feedback obtain. This is explained by the vector diagrams of Fig. 3; they are based on the fact that the coupling transformer is in effect a complicated network of mutual inductance, leakage reactance  $L$ , shunting capacitances on primary and secondary (C), etc. This is more fully treated elsewhere<sup>5</sup>, and roughly indicated here by Fig. 4. Hence, while the secondary voltage  $V_o$  is always very nearly 90 degrees out of phase with the primary current  $I_a$ , the phase angle between the anode circuit EMF  $-\mu V_g$  and  $I_a$  varies from a slight to a large lagging angle as the frequency increases from  $a$  to and beyond  $b$ , since the effective load in this region is mainly the primary inductive reactance which increases with frequency. But at some point between  $b$  and  $d$  the transformer primary becomes effectively bypassed by the series combination consisting of L and C. The angle  $\phi$  thus decreases again, becoming

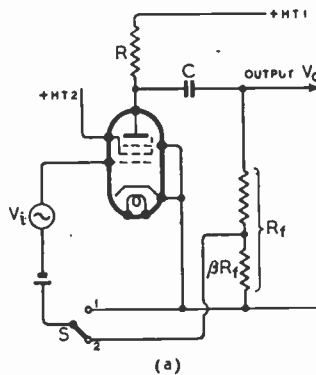

Fig. 5. (a) Circuit of resistance capacity coupled pentode amplifier with provision for negative voltage feedback. (b) Dynamic characteristic of pentode with resistance load.

zero at  $d$  where L resonates with C. Hence the output voltage is in quadrature with  $V_g$  at this frequency and feeding back a fraction of the former in the way

shown would not provide negative feedback. Hence the hump at  $d$  is, if anything, increased relatively. Beyond  $d$  the load is likely to be capacitive on account

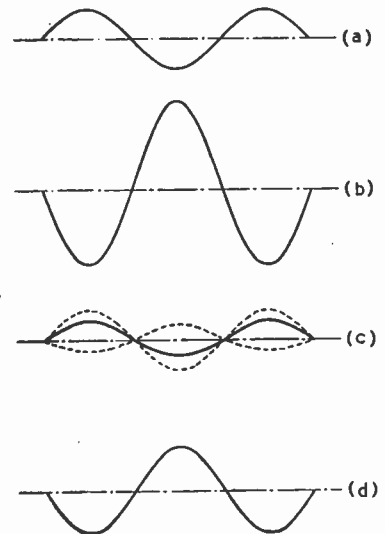

Fig. 6. Waveforms of "instantaneous" voltages in the amplifier of Fig. 5 (a) with, for the sake of clarity,  $m = 3$  and  $\beta = 1/3$ . (a) Sine wave input voltage. (b) Output voltage without negative feedback. (c) Effective input voltage (full line) made up of the original sine wave input and a fraction  $\beta \frac{I}{I + \text{Im}\beta I}$  of the distorted waveform (b). (d) Output voltage with negative feedback (where  $m = 3$  for the positive half cycles falling to 2.5 for the negative). It should be noted that curves (c) and (d) are approximations only, and an "infinite series" method would be necessary to arrive at the true waveform.

of the primary shunt capacity and a small amount of negative feedback may obtain once more.

Again, at the low frequency end below  $b$  the anode load is small but inductive, hence  $I_a$  is nearly in phase with  $-\mu V_g$  and  $V_o$  very nearly in quadrature with it; so feedback would not be negative with the connections shown. As shown by the fall of the characteristic, it does become so above  $b$ . Incidentally, this is a resonance-like effect although no capacity is present; it might be put to good use in special circuit work where a low frequency "resonance" is desired without a bulky condenser.



The basic cure for the resonant rise in the frequency characteristic is not to use feedback, but to eliminate it by some known stratagem, such as a resistance shunt on the secondary. This would also modify the phase-frequency characteristic suitably and allow of negative feedback at any frequency above  $b$ .

Thus, it seems axiomatic that feedback can correct frequency distortion in voltage amplifiers if, and only if, the distortion is not due to series-resonance.

Now, the conventional analysis

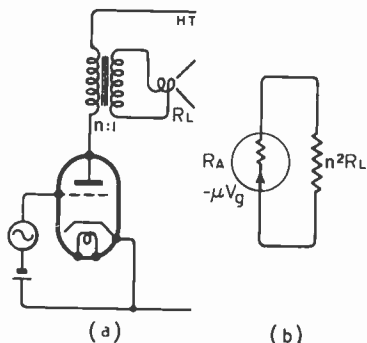

Fig. 7. Triode output stage with [ loudspeaker load. (b) Equivalent circuit.

referred to is formally correct; hence the reason for possible failures in practice must be sought in the underlying physical assumptions. What tends to be overlooked is the question of how the distortion term  $D$  arises in the first place, and by what mechanism, if any, negative feedback may reduce it. As a simple example, consider the circuit of a resistance-capacity coupled amplifier with pentode valve, as shown in Fig. 5 (a) switch  $S$  being in position 1. As is well known, the mutual or  $V_g/I_a$  characteristic of a pentode with load approximates less to a straight line than that of a corresponding triode circuit; in fact, as  $V_g$  gets less negative, the characteristic tends to flatten out. Thus, what happens when an operating point such as  $M$  in Fig. 5 (b) is chosen and a pure sine voltage  $V_i$  is applied to the input terminals of the circuit of Fig. 5 (a) is roughly as shown in Fig. 6 (b): the output voltage suffers amplitude distortion, its negative half cycles being flatter than the positive. This state of affairs

is termed "second harmonic distortion" as the output voltage is here practically equivalent to the sum of two sine voltages, one having the frequency of the input

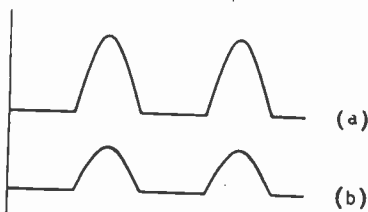

Fig. 8. Output voltages with operating point  $N$  in Fig. 5 (b) and sine-wave input. (a) Without negative feedback. (b) With negative feedback. Amplitude reduced, but waveform practically unchanged.

voltage, and a smaller one of twice that frequency.

Suppose now that we apply negative feedback in the circuit of Fig. 5 (a) by moving the switch  $S$  from position 1 to position 2. Assuming the blocking condenser  $C$  to have negligible reactance compared with the resistance of the feedback potentiometer  $R_f$ , the feedback will be purely negative, i.e., the actual grid-cathode voltage (alternating component) will be the sum of the input voltage Fig. 6 (a) and a fraction  $\beta$  of the voltage drawn in Fig. 6 (b): this resultant is drawn in Fig. 6 (c) and differs from the original input of Fig. 6 (a) both in amplitude and form. In particular, the positive half cycles are larger than the negative. On working it out you will see that this is exactly what is required to make the output voltage

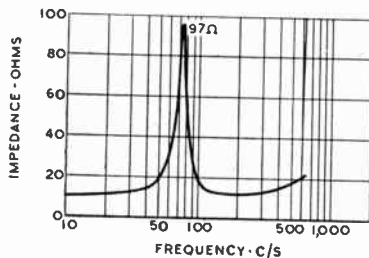

Fig. 9. Typical moving-coil loudspeaker impedance curve in the vicinity of the bass resonance.

less distorted. This is indicated in Fig. 6 (d), showing an improvement over Fig. 6 (b) at the cost of reduced gain.

The above explanation may be generalised in the statement that for negative feedback to reduce amplitude distortion, the distortion must be present at the input terminals of the feedback network (which in Fig. 5 (a) are identical with the amplifier output terminals) and that both the amplifying and the feedback paths must be able to pass the correcting voltage freely.

As an example of distortion occurring at a point beyond the input terminals of the feedback network, consider an output stage,

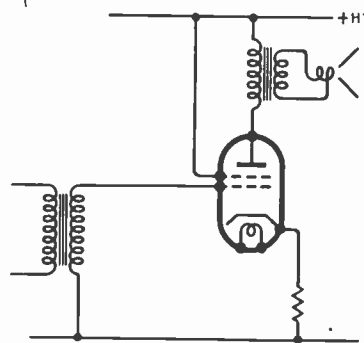

Fig. 10. Beam tetrode output stage with negative current feedback obtained by omitting the cathode by-pass condenser.

such as in Fig. 7 (a). It is conceivable that the loudspeaker impedance is non-linear, i.e., that it draws a distorted current in spite of sinusoidal voltages both on the primary and secondary sides of the output transformer. For simplicity, let us assume the latter to be perfect and the valve of zero internal resistance. It then requires no further argument to show that in Fig. 7 (a) the feedback (or, more precisely, its negative component) cannot combat this type of distortion.

Let us revert to Fig. 5 (a) for an illustration of the third postulate for successful negative feedback. Suppose the grid bias be chosen too large, shifting the operating point to cut-off, say, at  $N$  of Fig. 5 (b). The output voltage will then have the rectified appearance of Fig. 8 (a) and on applying negative feedback, this is changed to Fig. 8 (b) with its smaller magnitude but practically identical waveform. This is due to the inability of the amplification path to amplify the negative half cycles of the input voltage, even though the

fed-back voltage does not affect them.

Assuming, however, that your amplifier satisfies the conditions already postulated, there is another case worthy of careful attention. It concerns the power output stage and frequency distortion. Briefly, the loudspeaker, being a complex electro-mechanical system, is subject to some form of resonance at several frequencies; most serious perhaps is the lowest one, usually around 100 c/s. The electrical impedance of the loudspeaker is then almost purely resistive, rising to several times its normal value, i.e., from 10 to about 100 ohms in the case illustrated in Fig. 9. The upshot of this is that at the resonant frequency, the output power tends to rise many times, due to an undesired improvement in the transfer efficiency of electrical into mechanical power.

Now, when a triode is used, the load is matched to the valve; hence an increase in the normal load value will decrease the power available in the load and the "low-frequency boom" will be less serious than might be feared. In other words, a comparatively low anode resistance damps the loudspeaker resonance electrically.

high that there can be no question of matching the speaker. At resonance, speaker power will tend to rise with the resistance, producing very serious frequency distortion.

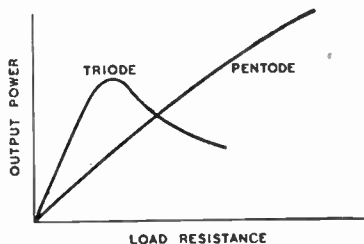

Fig. 12. Output power for given input voltage and variable load resistance; triode and pentode respectively.

The analysis of the above is as follows and may help in understanding the problem better; for a Class A operated valve and its equivalent circuit (Figs. 7 (a) and (b)) we may write down, neglecting loudspeaker reactance,

$$P = \frac{(\mu V_g)^2}{n^2 R_L} \cdot \left( \frac{n^2 R_L}{R_A + n^2 R_L} \right)^2$$

$$= \frac{(\mu V_g)^2}{n^2 R_L} \cdot \frac{1}{(1 + R_A/n^2 R_L)^2}$$

where  $\mu$  = valve amplification factor.

$R_A$  = valve slope resistance.

$R_L$  = AC resistance of voice coil.

$n$  = output transformer ratio.

$P$  = electrical power supplied to speaker.

At the resonant frequency, the speaker resistance rises to 10  $R_L$ , say, hence the electrical power in it,  $P$  (res.), rises to—

$$\frac{(\mu V_g)^2}{10 n^2 R_L} \cdot \frac{1}{(1 + R_A/10 n^2 R_L)^2}$$

For the desired damping effect to occur, i.e.  $P$  to fall as  $R_L$  rises, examination of the last equation indicates that  $R_A$  must be small compared with  $n^2 R_L$ . Indeed, if  $R_A$  were zero,  $P$  (res.) would be equal to  $P/10$ , or  $P$  would vary inversely with  $R_L$ , i.e., damping would be ideal. Conversely, if  $R_A$  is very large compared with the effective load resistance,

$$P = \frac{(\mu V_g)^2}{R_A^2} \cdot n^2 R_L \text{ and } P \text{ (res.)}$$

$$= 10 P, \text{ i.e., } P \text{ would vary directly with } R_L \text{ and resonant "boom" would be increased still further!}$$

This is roughly illustrated by the graph of Fig. 12.

Negative feedback is thus called for. There are two basic ways of applying it, either as current or as voltage feedback. The former is readily achieved by leaving off the by-pass condenser across the self-bias resistor in the cathode lead (Fig. 10): while this reduces amplitude distortion, it will actually increase the frequency distortion, for this step has the effect of increasing the anode resistance by the factor  $(1 + |m\beta|)$ .

On the other hand, voltage feedback decreases  $R_A$  by the factor  $1/(1 + |m\beta|)$  and will thus look after both forms of distortion in pentode power stages. The outline of a suitable circuit is shown in Fig. 11; it forms the basis of handling pentodes in push-pull circuits. Note that the feedback potentiometer should have a high value compared with the reflected speaker resistance  $n^2 R_L$ .

Thus you will see that in applying negative feedback to a circuit, it is necessary not only to make sure that the feedback is truly negative, and does not affect the operating point, but also that it can achieve your requirements in principle.

REFERENCES

1. "Regeneration Theory," by H. Nyquist: *Bell System Technical Journal*, Jan., 1932.
2. "Radio Engineering," 2nd edition, by F. E. Terman, or "Communication Engineering," 2nd Edition, by W. L. Everitt: p. 463, etc.
3. "Reducing Variations in Amplification by Means of Negative Feedback," by J. Peters: *Hochfrequenztechnik u. Electroakustik*: p. 46, Feb., 1942 (in German).
4. "Feedback," by E. K. Sandeman. *Wireless Engineer*, Aug., 1940.
5. "Communication Engineering," 2nd Edition, by W. L. Everitt, p. 454, etc.

BIRTHDAY HONOURS

IN the long list of recipients of honours on the occasion of the King's Birthday appear those of L. H. Bedford, chief research engineer at Cossor's, and P. I. Dee, F.R.S., principal scientific officer of the M.A.P. Telecommunications Research Establishment, who become Officers of the Order of the British Empire.

R. N. Holmes, radio officer, R.A.F. Ferry Command, and H. Oliver, first radio officer, Merchant Navy, become M.B.E.s.

Among the recipients of the British Empire Medal are C. E. Miles, foreman of the electric assembly and wiring shop at Cinema-Television works, and A. B. Stockwell, chief of Cossor's test section.

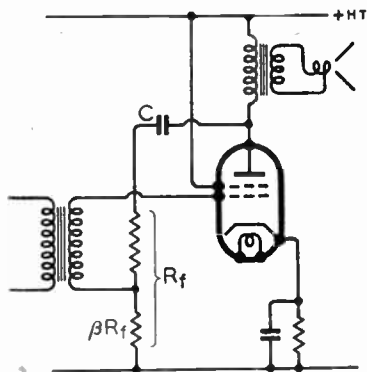

Fig. 11. Tetrode output stage with negative feedback correctly applied as voltage feedback through C and  $R_f$ .

On the other hand, power pentodes or beam tetrodes have the advantage of greater efficiency and sensitivity over triodes; but they tend to give greater distortion, partly due to the curvature in the mutual characteristic (see Fig. 5 (b)) which produces amplitude distortion, and partly due to their high internal resistance, the latter being normally so

# DC VOLTAGE TESTER

## A Wide-range Instrument with High Input Resistance

THE accurate measurement of voltages across different sections of high-resistance circuits or networks involves the use of an instrument that does not take current from the circuit, as this would alter the value of the quantity it is intended to measure. The measurement of the anode voltage or grid voltage of a valve is a case in point. When, as is usually the case, high resistances are incorporated in the valve circuit, voltage measurements are often made by indirect means. For instance, if the anode current is measured and then multiplied by the ohmic value of the resistance in the anode circuit, the result subtracted from the applied voltage will give the anode voltage. This is, however, a cumbersome and lengthy process when a number of tests have to be made.

An electrostatic voltmeter is the most speedy and direct means of making such a test, but such an instrument is expensive and delicate and not suitable for very low voltages. A suitable type of valve voltmeter\* can, of course, be

\* "DC Valve Voltmeter"; *Wireless World*, January, 1942.

By

T. A. LEDWARD,  
A.M.I.E.E.

used, but one of the most suitable devices would seem to be the potentiometer voltage balance, and this is the device that has been used in the apparatus to be described.

The design adopted was based on the following requirements:

- (1) Adequate accuracy for the purpose in view.
- (2) Convenience and speed in testing.
- (3) Reasonable cost.
- (4) Simplicity of construction and adjustment.
- (5) Immunity to damage by accidental overloads.

The effective input resistance on balance is equal to the insulation resistance of the apparatus.

It is necessary for the con-

struction of the instrument that means should be available for accurately measuring resistance values and that a reasonably accurate voltmeter should be available for the initial calibration. The cost of material and components is quite reasonable. The main features that enable

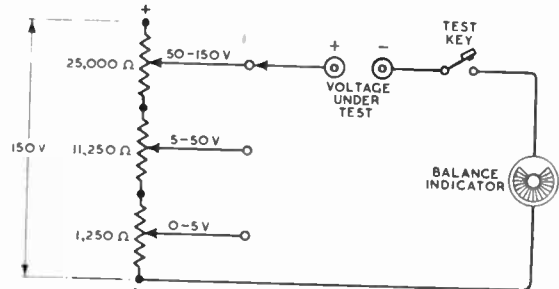
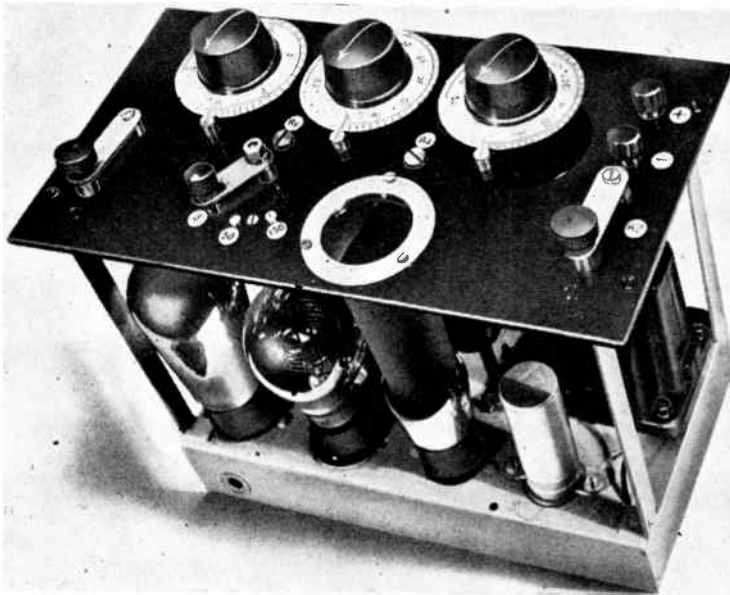

Fig. 1. Operating principle of the voltage tester.

simplicity to be attained are the use of a neon tube as a voltage stabiliser and a cathode ray (magic eye) tuning indicator for indication of balance. There is no delicate instrument to be damaged by accidental overload. The accuracy is at least as high as would normally be obtained by more indirect methods and is certainly sufficient for ordinary requirements.

Fig. 1 shows the schematic arrangement of the potentiometer assembly. It will be seen that three potentiometers, of 1,250  $\Omega$ , 11,250  $\Omega$ , and 25,000  $\Omega$  respectively, are connected in series across a 150-volt supply. Each potentiometer provides a voltage range in proportion to its resistance, so that the values stated will give voltage ranges of 0-5, 5-50 and 50-150. It is not easy to obtain potentiometers having these exact values of resistance and the best procedure is to obtain three potentiometers of approximately 25,000  $\Omega$  each and to connect across two of them fixed shunt resistances, which can be adjusted to give the values required between the potentiometer end terminals. For instance, for the 11,250  $\Omega$  5-50 volt range, a potentiometer having a resistance of 25,000  $\Omega$  can be shunted with



The complete voltage tester; power supply equipment is embodied in the assembly.



a fixed resistance of  $20,454 \Omega$ .

In the instrument described, three potentiometers of  $25,000 \Omega$  each have been used, appropriate shunts being provided as shown in the complete circuit diagram of Fig. 2, which also shows details of the power supply. If the unshunted potentiometer has a value differing from  $25,000 \Omega$ , the other two must have shunts adjusted to give appropriate ratios.

The 5-watt neon lamp N and  $15,000 \Omega$  fixed resistance  $R_1$  provide stabilisation for the potentiometer voltage, which is adjusted to exactly  $150 \text{ V}$  by means of the  $10,000 \Omega$  variable resistance  $R_p$ . If the neon lamp is changed,  $R_p$  may need re-adjustment. The resistance in the cap of the neon lamp should be removed.

### Avoiding Grid Current

The cathode-ray tuning indicator M, used here as a balance indicator, has a  $4 \text{ M}\Omega$  resistance connected across grid and cathode, and the slightest trace of grid current or leakage through this resistance would upset the accuracy of the balance indication. It is therefore necessary to provide grid bias to neutralise such an effect. This is done by means of the  $400 \Omega$  variable resistance  $R_g$ . The key  $K_1$  is used to check the

Resistances  $R_3$  and  $R_4$  are not critical in value and may be ordinary carbon resistances.  $R_6$  and  $R_7$  may also be carbon. These two latter resistances are not essential to the operation, but are advisable as protective resistances under certain conditions of test. All other resistances, including the potentiometers A, B and C, should be wire-wound. The capacitance values of condensers  $C_1$  and  $C_2$  are not critical, but the insulation resistance values must be high, as any leakage will impair the accuracy of tests. These two condensers and the screen provided on the power transformer primary are necessary for eliminating traces of superimposed AC which, under certain conditions of testing, would otherwise cause the outline of the cathode-ray image to appear blurred so that the DC balance would not be so distinct. For the same reason and also to prevent DC leakage to earth, both the test gear (including the chassis) and the apparatus under test should be insulated from earth. The transformer screen is connected as shown to the switch arm. Insulation between transformer windings and between windings and screen should be of high quality. These details are very important if

the appropriate range is selected by means of the three-way switch S. Initial adjustments are made as follows:—

- (1) Adjust  $R_g$  until on tapping  $K_1$  no deflection is observed on M.
- (2) Apply exactly  $150 \text{ volts}$  across the test terminals, set switch S to  $150\text{V}$  range and turn dial C to full scale reading.
- (3) Adjust  $R_p$  until on tapping  $K_2$  no deflection is observed on M.
- (4) Various known values of voltage may then be applied to the test terminals and A, B and C scales calibrated in turn. These scales will be approximately evenly divided.  $R_p$  should not, of course, be altered once it has been set as previously stated.

### Measurement Procedure

The apparatus is now ready for use and requires no further adjustments unless the neon lamp or cathode-ray indicator is changed. If the neon lamp is changed  $R_p$  may require readjustment. If the indicator tube is changed  $R_g$  may require readjustment.

To measure a voltage, apply the unknown voltage to the test terminals, taking care that polarity is correct, and set switch S to the appropriate voltage range. Then adjust dial A, B or C as

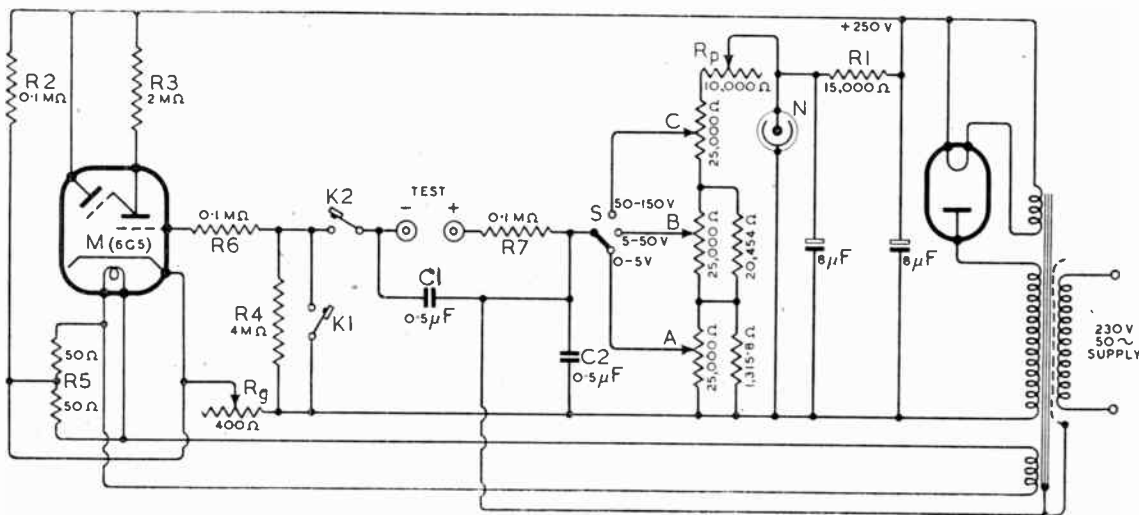

Fig. 2. Complete circuit diagram, with values of components.

correct adjustment of  $R_g$ . On tapping  $K_1$ , no disturbance of the image should be visible on the indicator M. The  $100,000 \Omega$  resistance  $R_2$  allows sufficient current to flow through  $R_g$  to provide the necessary bias voltage.

satisfactory operation is to be obtained under all conditions. If desired, the whole apparatus may be housed in a metal case, which may be earthed.

Three voltage ranges are provided, 0-5, 5-50 and 50-150, and

required until on tapping  $K_2$  no deflection is observed on M. Read volts directly on A, B or C, whichever range is in use. If the polarity is wrong, no harm will be done to the instrument, but it will be impossible to obtain a

**DC Voltage Tester—**

balance. Similarly, the instrument will not be harmed if an attempt be made to test a high voltage with the switch on the 5-volt range. It should be remembered, however, that a voltage, equal to the instrument setting, exists across the test terminals. Owing to the high internal resistance, this voltage falls rapidly on the application of any load, and the terminals may be safely short-circuited, but care should be taken when testing grid voltages that a high voltage of reverse polarity is not applied to the grids, as valves may be damaged by such treatment.

Incidentally, in testing grid voltages it is sometimes an advantage to insert a resistance of, say, 1 megohm at the end of the test lead nearest the grid, where the mere touching of the grid with a long test lead might perhaps start oscillation, or otherwise affect the working conditions. The insertion of this resistance will not affect the accuracy of the reading.

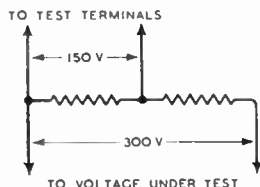

Fig. 3. Input potentiometer for doubling the 150-volt range.

Measurements up to 5 volts can be made to within 0.1 volt or even less; up to 50 volts to within 0.25 volt, and up to 150 volts to within 0.5 volt. Higher voltages than 150 may be measured by the addition of a high-resistance potential divider, but the effective input resistance will then, of course, be considerably reduced. A useful potential divider to give a range of 300 volts can be made by connecting two 2-megohm resistances in series across the voltage to be measured and measuring the voltage across one of them. The dial reading should then be multiplied by 2. (see Fig. 3.) The effective resistance of the test apparatus under these conditions will, of course, be 4 megohms. The resistances need not be exactly 2 megohms, but they must be of equal value. Any resistance inserted in the test lead

**Wireless World**

must, of course, be removed if the potential divider is in use.

A practical layout for the panel is shown in Fig. 4. The volt dials are discs of aluminium covered

characteristics, and some specimens may not be quite so good as the above.

If the neon lamp is removed from its socket after the apparatus

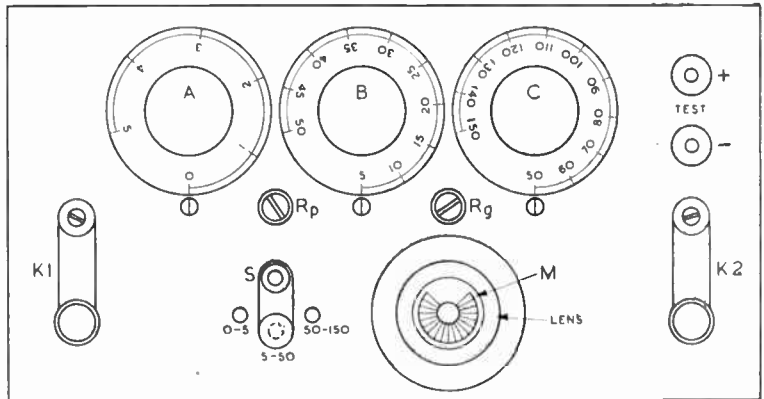

Fig. 4. Layout of the panel; component references correspond to Fig. 2.

with white paper, marked out in Indian ink and varnished. The discs are screwed to the underside of the bakelite knobs.  $R_p$  and  $R_g$  are arranged to be adjusted by means of a screwdriver. If knobs were provided for these two adjustments there would be a danger that they might be inadvertently altered after being correctly set.

Tests have been made to determine the variation of accuracy when the mains input voltage varies. It was found that when adjusted for a mains voltage of 230, the calibration remained accurate to within  $\pm 1\%$  when the input voltage was varied from 215 to 245 V.

Neon lamps of the same rating do not all have exactly the same

has been calibrated, it should always be replaced the same way round. That is to say, it is sensitive to polarity and the operating voltage may be slightly higher or lower if it is reversed.

Another point is that for the greatest accuracy the apparatus should be switched on a few minutes before preliminary adjustments and calibration and also before using it on subsequent occasions.

**"DESIGNING SUPERHETS"****Errata**

IN equation (1), page 164 of the last issue the terms  $B_x$ ,  $C_x$  and  $D_x$  should read  $B_x$ ,  $C_x$  and  $D_x$  and a few lines lower, the line beginning  $x = 4$ , should end  $\therefore D = \frac{1}{12} (f_i - \Delta f)$ .

**Books issued in conjunction with "Wireless World"**

	Net Price	By Post
FOUNDATIONS OF WIRELESS, by A. L. M. Sowerby. Third Edition, revised by M. G. Scroggie	6/-	6/4
TELEVISION RECEIVING EQUIPMENT, by W. T. Cocking	10/6	10/10
RADIO LABORATORY HANDBOOK, by M. G. Scroggie. Second Edition	12/6	12/11
WIRELESS SERVICING MANUAL, by W. T. Cocking. Sixth Edition	7/6	7/10
HANDBOOK OF TECHNICAL INSTRUCTION FOR WIRELESS TELEGRAPHISTS, by H. M. Dowsett and L. E. Q. Walker. Seventh Edition	27/6	28/1
WIRELESS DIRECTION FINDING, by R. Keen. Third Edition	30/-	30/7
RADIO INTERFERENCE SUPPRESSION, by G. W. Ingram	5/-	5/4
LEARNING MORSE. 335th thousand	6d.	7½d.
INTRODUCTION TO VALVES, by F. E. Henderson	4/6	4/10
VALVE REPLACEMENT MANUAL, by A. C. Farnell and A. Woffenden	6/-	6/2

Obtainable from leading booksellers or by post from

ILIFFE & SONS LTD., Dorset House, Stamford Street, London, S.E.1

## Wireless World Brains Trust

### Wire or Wireless? International Valve Standardisation

**Question No. 12.**—Though I have followed with an open mind the arguments of those who advocate wired broadcasting in place of radio, it seems to me they have failed to make out a case for such a revolutionary change.

The main argument against radio broadcasting is that it is subject to serious interference. That, so far as our pre-war service was concerned, is an exaggeration. A large majority of the population could receive two transmissions sensibly free of interference, and in any case, much of the interference was avoidable.

Another argument against radio is that it fails to give enough channels. I suggest that by an evolutionary process of gradually bringing into use such developments as FM or even AM ultra-short wave radio, we could have all the channels we want without any revolutionary change in methods of distribution. At the same time, the interference trouble could be greatly reduced.

But do we really want any more channels? The B.B.C. has always been hard put to it to provide two alternative programmes. I question whether it is within the capabilities of any organisation to provide continuously six programmes worthy of the potentialities of broadcasting, which is inherently the wrong medium for distributing trite trivialities or for serving small sectional interests.

My question, then, is: Is wired broadcasting wanted, and would it be in the public interest to adopt it as the main means of distribution?

“RADIOPHARE.”

*This question has been passed to P. P. ECKERSLEY, former Chief Engineer of the B.B.C., who is a staunch advocate of wire broadcasting and has written widely on the subject, notably in his book “The Power Behind the Microphone.” Here he states his case for distribution by wire.*

“RADIOPHARE” casts, from his open mind, a beam of illumination upon prejudices that

I believe to be quite widely held.

The fact that a “large majority of the population could receive two transmissions sensibly free from interference” during peacetime (much of the interference being avoidable) hardly seems a good argument against a system, by the use of which all the population could receive any number of transmissions completely free from interference at any time.

The questioner goes on to state that if we want more channels (which wire broadcasting supplies) we could use, instead, FM or AM ultra-short wave radio and avoid all interference.

But the questioner doubts if we want more channels and states that the interference with the existing system is negligible. So what? I feel “Radiophare” should make up his (open) mind as to what he does want. So far as I can gather he just does *not* want wire broadcasting; anything else, but not that. I wonder why?

I have been thinking about this problem for about twenty years. First, I have certain ideas about an ideal service of broadcasting, secondly, a conception of the means to put this ideal service into practice. Argument can develop on the issues:—

(a) As to whether these ideas are sound. (b) As to whether the means to implement them, assuming they are sound, are the best available.

To my mind an ideal service would be based on the following facilities:—

(1) That the listener should have a wide choice of programme material.

Just as I can read any number of different books with different themes, hear contrasting views on politics, religion, sociology, choose my newspaper, select my friends and my food, so, in a so-called “democratic” broadcasting service, I should be allowed to indulge a like freedom of selection. If the B.B.C. is “hard put

to it” to give the public a wide choice of programmes, I suggest they give me the job of showing them how to do it. It would be much easier than mixing up the indigestible hotch-potch served up to us at present.

(2) That the listener should hear the programme he selects clearly and without distracting noises.

If the gramophone companies sold records with the same crackles and bangs and noises printed on them as we get to-day when we listen to anything other than a very local station, I doubt if they would long continue in the business. The quality of reproduction on a gramophone record is much better than we get on the average radio receiver.

(3) That the receiver should be simple and cheap and judged mostly on its merits as a means to reproduce the programmes clearly and nothing else.

As a means to implement my ideals, set out above, I have chosen wire broadcasting. If a better means exists I would be its champion.

The sole difference between wire and wireless broadcasting is that in the former you “bury your ether” and connect your receiver to a source of supply which contains no energy other than that representing the intelligence broadcast; in the latter your aerial is coupled with extraneous sources of energy which can produce interference. True, with ultra-short wave radio this interference is minimised, but there is still a limited amount.

The chief objection I have to an open, contrasted with a closed, ether, is that based on the logical use of technical facility. It is essential to use radio for mobile services (aeroplanes, ships, trains, etc., etc.). The number of channels that will be required for these important services, particularly aircraft, is enormous. Why use them for broadcasting when another solution is available?



There is no other fundamental difference between wire and wireless broadcasting than that, in one, the system is "contained" within definable boundaries; the other scatters the waves anywhere and everywhere, producing mutual interference and being transmitted in an interference-ridden medium.

Of course, if my ideas about an ideal service are not accepted, then there is no need to make any changes. I am not devoted to wire broadcasting because of any passion for a particular technique; I just think it is the proper method to bring about a more exciting, amusing and stimulating broadcasting service. If some people do not want more programmes they could be perfectly satisfied with a wire broadcasting system; they need not listen to more than two out of the six or more programmes provided. We could arrange, if necessary, to supply a little interference with two of the less exciting programmes just to indulge the nostalgia of those who feel like "Radiophare"!

**Question No. 13.**—What can be done to bring about a practical scheme of valve standardisation, both in Great Britain and overseas?

F. LANGFORD-SMITH.

*The writer of this question, F. LANGFORD-SMITH, of the Amalgamated Wireless Valve Company, of Australia, has had experience of the valve problem not only in that country, but also in England and U.S.A. He adds, "May I be allowed to open the discussion by attempting to answer my own question? The excuse for this somewhat irregular procedure is the present delay in the mails between Australia and England." His proposals are printed below.*

AS a first step, the obviously desirable course is to form some representative body in England under the chairmanship of the most able engineer who can be found (he should also have detailed knowledge of the commercial aspect) to enquire into all the circumstances, to consult with an equivalent body in U.S.A., and make recommendations to be put into effect, either voluntarily by the industry as a whole, or,

alternatively, under Government control.

In general, valves can be grouped into two categories, which we may conveniently call Equipment and Replacement types.

**Replacement Types.** Small-quantity replacement types may then be allocated for manufacture, each type by a single factory selected for the most economical production, until the demand ceases. This will eliminate wasteful competition or the splitting up of production between several factories on a type, which is no longer being used in new sets.

In many cases it should be possible to use one valve to meet the replacement demand for several "types" marketed by different manufacturers but having substantially similar characteristics and basing, thus reducing the number of different types to be manufactured. The Committee could also draw up a plan for the discontinuance of production of old types which have reached their limit of usefulness.

**Equipment Types.** The major task facing the Committee would be the selection of a list of types to which receiving set manufacturers would be restricted for ordinary models. It is in the final selection of these types that consultation with a similar American body would be so important. In the past it has happened that English manufacturers have tried to assure their replacement market by using types which were not available from foreign competitors, but this policy has been most unsuccessful in practice, and in many areas has restricted the sale of the sets owing to uncertainty or difficulties (real or imaginary) associated with the purchase of replacement valves. A number of English manufacturers have, therefore, taken up the manufacture of standard American ("International") octal types so that it might be said that the ice has been broken as a first step towards the adoption of a standard international range of types. Perhaps all readers are not aware of the fact that standard American types were also manufactured before the war in many European countries, in Canada, Australia, and even Japan, so that a considerable measure of international standardisation has

already been achieved in this way.

Unfortunately, however, the American range is far too large, so that the problem of selecting a standard international range for equipment purposes has still to be determined. My remarks concerning the American series should not be taken as meaning that the range to be used in England should necessarily be a selection from the American range at present manufactured, since it should be possible to obtain American co-operation with give and take on both sides.

In reality, the position is not so difficult as some may imagine, since American and English manufacturers in many respects have been approaching one another for some years past. For example, the very low slope of many of the older American valves was in distinct contrast to the very high slope of some earlier English valves, and the medium slope of most types in current use to-day. American design has so much changed that valves having slopes quite comparable with those of English valves are widely used to-day, so that this question of slope or stage gain is no longer one of conflict between the two countries. The basic point for early decision is the type of socket to be used, whether the "International" octal or the "Lock-in" type or some other. If agreement can be reached, as it should be reached, there should be no doubt regarding the final attainment of an agreement on the valve types to be included in the Equipment range.

Having decided upon the Equipment range, it would be necessary to ensure that receiver manufacturers restricted their models, or at least all models other than those for very special purposes, to this new range.

If such a standardisation scheme is put into operation, the writer is convinced that it will enable the English valve manufacturers to compete both in their home country and in the export market with valves of American origin, the reduction in unit cost of production being used to bring about a general reduction in selling price. Moreover, the eventual reduction of types required to be stocked by retailers will undoubtedly assist those engaged in their distribution and sale.

# Final Test



**T**HE finished valve is finally subjected to extremely rigid tests to ensure the high quality and long life associated with Brimar products.

**BRIMAR**  
**BVA**  
**VALVES**

STANDARD TELEPHONES AND CABLES LIMITED, FOOTSCRAY, SIDCUP, KENT.

# "to Insulate"

Practically all waxes are used to "separate or isolate," but the degree of insulation provided by the different types of waxes varies enormously.

There is obviously no higher degree of insulation required than that of electrical components and apparatus in intense electrical fields, especially in the extremes of conditions to which they are subjected to-day.

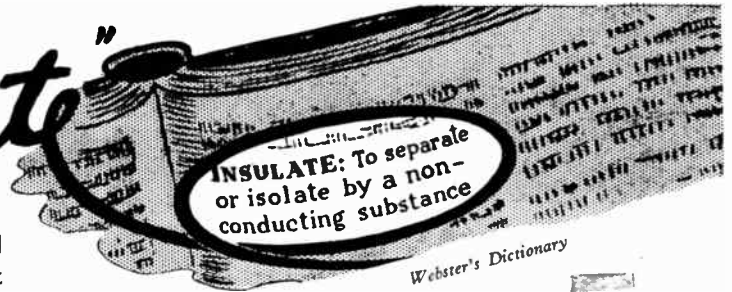

*We specialise in the supply of*  
**WAXES** *for all*  
**purposes—under all conditions**

Our technical advice is at your disposal.

If you have any problem of

**IMPREGNATING—DIPPING—FILLING**  
 we, as consultants to the Industry, shall be glad to offer you a solution.

**CLAUD CAMPBELL & CO. LTD.**

4, LLOYDS AVENUE—LONDON—E.C.3

Telephone Nos. :—ROYAL 5403/4/5.

## The glory of the future..



... when the tank gives pride of place to the "family 'bus" and engines of war to the instruments of peace, Goodmans will be able, once more, to give the connoisseur Loudspeakers that open up new possibilities in high fidelity reproduction.



# GOODMANS

Makers of

**HIGH GRADE LOUDSPEAKERS**

*Priority Orders only can be accepted*

GOODMANS INDUSTRIES, LTD., LANCELOT ROAD, WEMBLEY, MIDDLESEX



# WIRE BROADCASTING

## Sir Robert Watson-Watt's "Pipe Dreams"

WHEN Sir Robert Watson-Watt, the pioneer of radio-location, addressed the Radio Industries Club last month on "The Distribution of Broadcasting after the War," he stressed the fact that he spoke "as a member of the radio family" and not in his official capacity. His talk followed an address delivered by him before the British Association in March, in which he demanded for the broadcast listener "four freedoms": freedom from interference, freedom from distortion, freedom of choice, and freedom from distraction. Sir Robert, who had previously criticised our present technical methods of broadcast distribution and advocates a wire system as opposed to radiation for some at least of the programmes, contends that the "four freedoms" should guide the policy of distribution.

In the Radio Industries Club talk he developed this theme of "piped" broadcasting; in his own words he indulged in "pipe dreams," and urged that after the war there would be a heaven-sent opportunity of making a fresh start. Broadcasting is, in his view, a medium that should "be used seriously, but never heavily," and, to realise its full potentialities as a source of public enlightenment, some six channels should be available to every listener. He suggested that two of these should provide two kinds of good music, one news and topical talks, and another educational matter.

### Advantages of "Canalisation"

Sir Robert, in advocating "canalisation" as opposed to "haphazard broadcasting" enumerated the various forms of interference to which radiated transmissions are liable; they included side-band splash, atmospheric, man-made electrical interference, and such incidents of propagation as the Luxembourg effect. As a listener the speaker demanded freedom from measurable interference from all these sources, which in his opinion, are controllable.

When dealing with the question



of freedom from distortion, Sir Robert stated that "the man at the transmitting end was less responsible for distortion than some would have us believe." The set designer was, in his opinion, not entirely blameless, moreover, the allocation of frequencies played a big part in the realisation of this freedom. "Ought we," he said, "to stay in the medium-wave band, or in any open broadcast band?"

He urged that the system he advocates would not bring about standardisation or an end of technical advances in receiver design; there would still be plenty of scope for developing different types.

He stressed that the arguments concerning the merits and demerits of "space" and wire broadcasting had got to be settled, and in favour of the latter he claimed a higher degree of freedom in each case.

Although the speaker did not enlarge on the technical details of the system he favours, it is assumed that he has in mind a "wired wireless" or "carrier" technique, distribution being carried out over the electric mains and telephone lines—or possibly both. He said that most communities of over 1,500 could be served by wire, but that radiated transmissions would be needed in isolated or mainly agricultural

districts, and, of course, for foreign broadcasting. This question of broadcasting to other countries he regarded as a strong supporting argument for retaining radiated transmission as an auxiliary or parallel service.

### Opposition Views

In the discussion which followed, Sir Louis Sterling suggested that Sir Robert exaggerated the seriousness of interference and other handicaps from which radiated broadcasting allegedly suffers. As to the question of freedom, before the war millions of people in this country preferred the commercially sponsored programmes from Continental stations; Sir Louis himself wanted real freedom to hear what he liked and implied that such freedom would be denied him under a system where broadcasting is predominantly by wire. Still on the subject of listeners' freedom, he suggested that a good example of the possible evils of "canalised" broadcasting is to be found in the enemy-dominated countries of Europe. If those countries had had a wired system before their occupation, the vast majority of their population would now hear nothing but Nazi propaganda.

Sir Louis thought that, if the whole country were "piped up," technical development would be slowed down, as there would be a relatively small demand for receivers for radiated broadcasts. More important still, as there can be no export market without a big domestic market, our foreign trade in sets would disappear.

Sir Robert replied that the whole of the available programmes of the world were, in fact, chosen by a handful of men, so that the only real guarantee for freedom of choice was an increase in the total programme material. He was convinced that the technical problems of the "piped" system offered a very wide field for technical and industrial enterprise. So long as he was assured a system satisfying his four freedoms he had no desire "to deny to others bad reception of radiated programmes."

# Electromagnetic Fields in Radio—VI.

## WAVES IN METALS AND THE IONOSPHERE

By

MARTIN JOHNSON

D.Sc.

WE have discussed the bending of radio waves when they enter dielectric materials and their polarisation when they are reflected at the surface separating two dielectrics; we have still to consider what happens when they enter conducting material. Two instances of the latter are of practical importance for radio technicians, first, the wires and aerials and wave-guides representing the metallic termination of lines of force for the electric field, and, second, the ionosphere or regions of the earth's upper atmosphere which contain free electrons liberated by solar agencies, and which therefore control radio transmission over long distances.

We found that the behaviour of radio waves towards any material could be decided by inserting into Maxwell's equations of the electromagnetic field the variables  $k$  (dielectric constant),  $\mu$  (magnetic permeability), and  $\sigma$  (electrical conductivity). For empty space, in the simplest units,  $k = 1$ ,  $\mu = 1$ , and  $\sigma = 0$ , and for air these are still good approximations.  $\mu$  does not increase much except for iron and other magnetic materials, but in the previous article we considered the effect upon speed and bending of waves when  $k$  rose to 30, 50, or even 80 in an insulator.  $\sigma$  was considered to be not far from zero for such substances, but the effect of a growing  $\sigma$  must now be taken into account if metals and the ionosphere are to be compared with non-conductors and their behaviour explained.

**Electrical Grading of Materials for Waves of Different Frequencies.**—We mentioned that a dielectric could show "dispersion," the refractive index and dielectric constant varying for different frequencies, and the mechanism of orientation of molecules gave reason for this becoming important for very short waves. It is useful therefore to classify materials not solely according to their  $k$  and  $\sigma$  as measured with DC, but to include the frequency for which their proper-

ties will hold or fail. Engineers specialising in constructional materials for RF have tried various ways of specifying the useful ranges between insulating and metallic extremes; the ratio of "conduction current" over "displacement current" is commonly used and corresponds to the principle of interpreting Maxwell's equations which we outlined previously. The following useful quantitative criterion may now be found in one of the most recent and thorough treatises on electromagnetic theory\*:

$$(i) \sigma^2 \ll k^2 \omega^2$$

For such material, displacement current is large compared with any conduction. The inclusion of  $\omega$ , the angular frequency, shows that this relationship may occur either (a) if the material has highly insulating properties, or (b) even in moderate conductors when the electromagnetic field has sufficiently high frequency, for example, in sea water through which U.H.F. is passing.

$$(ii) \sigma^2 \gg k^2 \omega^2$$

The conduction current in this case greatly predominates. Metals where  $\sigma$  is of the order of  $10^7$  mhos/metre, will obviously belong here. Not much is known about the dielectric constants of metals, but it is clear that the displacement current would only equal the conduction current at frequencies greater than  $10^{17}$  c/s, a region well known in the general electromagnetic spectrum but which concerns atomic behaviour and is far removed from the wave bands of radio.

Manipulation of these and related expressions in the treatment of "attenuation" shows that wave amplitudes are damped out more readily as frequency, permeability, or conductivity increase. They also indicate that whereas in an ideal dielectric the

electric and magnetic vectors oscillate in phase as in a vacuum, in a conductor the magnetic vector lags behind the electric. We utilise this later.

(iii) Many materials of practical importance cannot be regarded as exclusively dielectrics or conductors, and cannot be treated as conforming to either of the above two extreme conditions. Alloys and semi-conductors we have discussed elsewhere, and there are also electrolytes. Many cases can be treated by retaining in principle the  $k$  of the dielectric but adding to it in practice a term involving both conductivity and frequency. The compound expression enables us to pick out the conditions under which conducting or insulating properties predominate.

Analysis of the speed of radio waves and their attenuation in these wider circumstances becomes complicated in comparison with our simple discussion of dielectrics, and we propose here to deal with one or two practical consequences only.

### "Skin Effect" in Metals—

We needed on a previous occasion to take account of the fact that some fraction of the wave energy becomes transformed into heat when absorbed in a dielectric: when the quantity  $\sigma$  allows metallic conduction currents to be fairly large, this also results in a loss of radiant energy into heat, which would cease if  $\sigma$  were either zero or infinite. Similarity of the electromagnetic mechanism throughout the whole spectrum is recalled by the fact that the radiation from a fire or the sun, of shorter wavelength than radio, can heat a metal in which it is absorbed. The heating accompanying propagation of radio waves in metal is, of course, decided by  $i^2R$ , the watts dissipated, as if  $i$  were DC instead of RF current; but the location of  $R$  is not so simple as in DC. Radio experimenters are familiar with the bundle of thin strands often used to carry RF in the metallic parts of a circuit, and will appreciate that since the

\*"Electromagnetic Theory," by J. A. Stratton published by McGraw Hill.

"skin effect" confines the current to layers not far below the metal surface it would be wasteful to make conductors of any but the thinnest cross-section.

This means also that the measured resistance of even a thick wire or rod is high, because only the outer skin has any share in carrying the current. There are several different ways of approaching the explanation of this "skin effect." The clue for the present treatment is perhaps our statement above, that the penetration of waves into a conductor shows phase lag of the magnetic behind the electric vector; for such lag we already associate with the passage of any AC through an inductive circuit.

Consider a cylindrical wire or rod (Fig. 1) and take two zones  $x$  and  $y$  of equal cross-section. For DC the currents carried by the two are equal. But analysis shows that the inductance for the path  $x$  is greater than for the path  $y$  so the reactance  $\omega L$  rises at high frequencies and the current is left to flow almost entirely in the path  $y$  which presents the lower impedance. The lag of  $i_x$  behind  $i_y$  may be associated with an aspect of the subject which we discussed in a quite different connection in an earlier article: treatment by the method of the Poynting vector showed that whereas for a perfect conductor the lines of force are orientated perpendicular to the metal surface, they become bent as energy is absorbed through the imperfect conductivity of an actual aerial. The flow of energy travels in the surrounding dielectric and leakage into the conductor takes time. Actually the velocity of the waves is so much slower than in a vacuum that the fields have fallen to near zero before much penetration is achieved.

If  $d$  be the depth into a metal at which the electric intensity has fallen to  $1/\epsilon$  or 0.37 of its surface magnitude, the phase being there 180 deg. behind,  $d = \sqrt{2/\omega\mu\sigma}$ . For instance, with a copper bar of large cross-section,

Frequency	$d$ (cm).
60	0.85
$10^3$	0.21
$10^6$	0.007

The confinement to a thin surface skin becomes very marked at the highest frequencies, and it may be noticed that an increased

magnetic permeability  $\mu$  has the same effect as increased conductivity  $\sigma$ : materials of high  $\mu$  like iron tend, however, to possess lower  $\sigma$ , and copper shows extreme examples of "skin effect" by reason of its  $\sigma$  rather than its  $\mu$ . The amplitude of waves is not just an inverse function of depth penetration, the simplest expression involving  $\epsilon^{-mx}$  where  $m = \sqrt{2\pi\omega\mu\sigma}$  for an attenuation at any depth  $x$  below the surface, and in general Bessel functions are needed for the calculation. All of these expressions show the dependence upon frequency  $\omega$ .

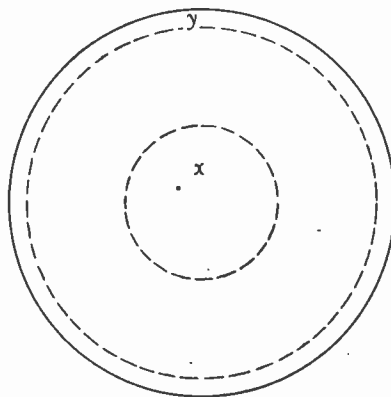

**Cause of Bending and Reflection in the Ionosphere.**—The ionosphere and its effects on radio transmission have been discussed by T. W. Bennington in the April, 1943, issue of *Wireless World*, and we here add some links with the account of electromagnetic mechanisms which we have been evolving in the present series of articles. For instance we described the phenomenon of total reflection when the track of a ray is turned back at the entrance to a transparent material of smaller refractive index. Entry into the upper atmosphere from a transmitter on the earth is a more complete transition, not from one insulator to another but from insulating air to a region whose rarefied oxygen and nitrogen have absorbed ultra-violet solar radiation and been dissociated into atoms, some of the atoms being ionised or deprived of an outer electron. The conductivity is much smaller than that of a metal: the number of free electrons per cubic centimetre,  $N_e$ , is of the order of  $10^5$ , whereas in a typical metal it may be  $10^{22}$ .

This  $N_e$  increases from almost zero near the ground to its maximum in some region of the "E" or "F" layers which has been most strongly ionised, but in which recombination between electrons and positive ions is not too rapid. The presence of these free electrons enables this atmosphere to reflect and refract radio waves, and for some purposes it acts as if it had a refractive index

$$\text{given by } \sqrt{1 - \frac{AN_e}{\omega^2 \pm B}}$$

The constants A and B involve properties of the medium and of the electron, but B involves also the earth's magnetic field. The expression shows that in addition to depending on  $N_e$ , the material is "dispersive" in the sense used in our articles, its behaviour to the waves depending on the angular frequency  $\omega$ . The ambiguity of sign

Fig. 1. Cross-section of wire in which zones  $x$  and  $y$  are of the same area. For DC  $x$  and  $y$  carry the same amount of current, but for AC of increasing frequency  $y$  carries an increasing proportion of the total current, since  $x$  offers the greater inductive impedance.

+ or - for constant B suggests at once that there are two possible refractive indices and a split into two modes of propagation. The form of expression also shows that "refractive index" is a wider term than the simple one which we described for optical phenomena; in fact zero and infinite and imaginary indices have significance in the case of radio waves in the ionosphere.

We saw, in the simpler case of light waves passing from one transparent dielectric to another, that refractive index controls the bending of the track because it represents a change in velocity: but we insisted that "wave velocity" not "group velocity" is there implied and is not limited to "c." Actually the wave velocity of radio entering the ionosphere may greatly exceed "c." but this velocity is not in the direction in which a Poynting vector carries energy; so there is no contravention of the principle that "c" is the maximum rate at which energy can be transmitted.

The phenomenon of "critical



angle," discussed earlier, becomes important: at a given frequency vertical or nearly vertical incidence transmits a beam right through a layer whose  $N_e$  is sufficient to produce sharper bending as incidence becomes more oblique, until at some layer the increasing  $N_e$  returns the beam down to earth again. The gradual alteration of refractive index and gradual increase of obliquity of incidence turns our simple diagram of the previous article into the curved trajectory illustrated in T. W. Bennington's article on the ionosphere.

**Polarisation in the Ionosphere.**—We have seen that as a conductor the rarefied gas of the ionosphere possesses far fewer free electrons than a metal, and that their distribution is not constant: in consequence a metal totally absorbs in a very short distance any fraction not reflected from its sharp boundary, whereas the ionosphere returns radio to the earth or transmits it outward according to frequency and in most cases by a gradual bending in material of continuously varying refractive index.

But there is another peculiarity of propagation in the ionosphere: it takes place in the presence of the earth's magnetic field. The

complexity of the effects, as it had long been known that certain crystals can split a light ray into two components, polarised in planes perpendicular to each other and travelling with different speeds: the material is "birefringent," possessing two refractive indices, one for the "ordinary" and one for the "extraordinary" ray which therefore bend differently and are differently absorbed. The analogy with radio seems at first sight more complete than it actually is, for recombination of the two plane-polarised rays of light from the crystal can produce "circularly or elliptically polarised light," and "elliptically polarised radio" does certainly return to us after refraction in the ionosphere. The literature of radio fading and direction-finding and ionospheric propagation can become very confusing unless this optical analogy is utilised for what it is worth but not pressed too far. The clue to the difference between the light and radio lies in the term involving the earth's magnetic field in the expression which we quoted for refractive index of the ionosphere, and which is absent from crystal optics.

The first crucial observation was due to Appleton and his

somewhat as the birefringent crystal, but the expression for the refraction shows that each of the two waves into which a plane-polarised system must split can itself be represented by an equation of elliptic polarisation.

"Intensity fading," as well as "directional errors," are due to interference between the various portions of single- and multiple-reflected components. Accounts of this process are generally known as the "magneto-ionic" theory, but are difficult to follow unless the reader has some conception of "circular" and "elliptic" polarisation. We add here, therefore, a treatment to bring this into line with the simplified ideas of vibrations and waves on which the earlier portions of the subject were shown to depend.

**Circular and Elliptic Polarisation.**—Early in these articles we related any mechanical or electrical wave motion to vibrations taking place to and fro and up and down along the diameters of a circle. The properties of these simple harmonic vibrations were derivable from a uniform motion round the circle itself. For understanding the various polarisations of light or of radio, vibrations in straight

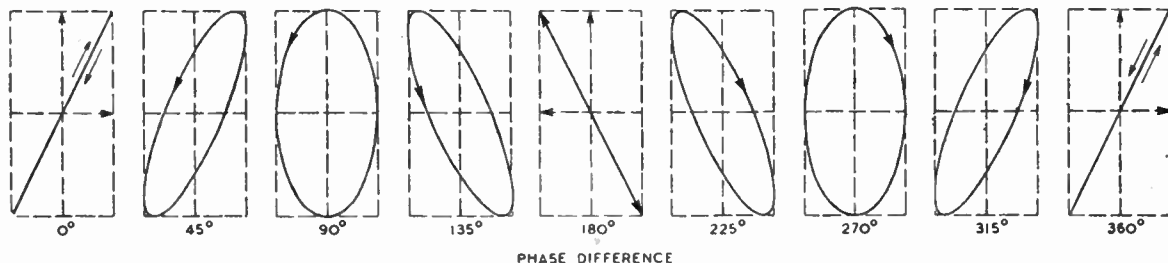

Fig. 2. Model of plane and elliptic polarisation. The resultant vector in each case is compounded out of the vertical and horizontal vibrations, but its shape depends on the phase lag between the components. If the amplitudes of the components are equal, the resultant for phase lag 90 deg. and 270 deg. becomes a circle; but the intermediate cases remain elliptic, with straight lines for phase lags of 0 deg., 180 deg., 360 deg., etc., which reverse the sequence from anticlockwise to clockwise.

consequence is a splitting of the entering radiation into two polarised components, bending differently and absorbed to very different extents: in fact the downward returning waves may consist solely of one or the other or a mixture. The final state of polarisation can be found by analysing reception with a CR tube.

Here again the optical analogy was very useful for disentangling

collaborators, to whom this remarkable clarification of radio transmission is due. They found that radio signals reflected down from the ionosphere showed "left-handed elliptic polarisation" in the northern hemisphere, but under similar conditions in Australia showed "right-handed elliptic polarisation." So the ionosphere, in conjunction with the earth's magnetic field, acts

lines can be compounded into movement in circular or elliptic paths, and clockwise and anticlockwise circular motions can combine into linear oscillation. For the simplest case imagine a pendulum swinging in its arc in a fixed plane, and give to it periodic impulses in a plane perpendicular to that of the original arc. If the period of the disturbing impulses agrees accur-

ately with the period of the original swing, the shape of the resulting compound motion may be linear, circular, or elliptic, entirely according to the phase difference between the swings and the applied impulses. Apply the latter at the instants when the original vibration is passing through its dead centre: the resultant is a diagonal linear motion either "North East-South West" or "North West-South East" according as the phase difference is 0 deg. or 180 deg. But if the crosswise impulse is applied when the original vibration is at its maximum extent and turning point, the result is a rotatory path, anticlockwise or clockwise according as the phase difference is 90 deg. or 270 degrees. The path is circular or elliptic according as the amplitudes of the two vibrations are equal or unequal; but in either case, for intermediate phase differences, the path is an ellipse which opens out and then collapses on to the two diagonal lines. These facts may be verified in a few minutes by swinging a weight on a string and applying the crosswise impulses by hand.

Translated into optics these simple mechanical models afford a picture of the orientation of electromagnetic vectors which is imposed upon ordinary light when a crystal splits a ray into plane polarised components: subsequent recombination of the latter produces elliptic or circular or plane polarisation, according to the thickness of the crystal and therefore the distance of path controlling the amount of phase difference between the components. The optics of transparent insulators and crystals and metals becomes thus intelligible, with useful practical consequences. The notions can also be applied to radio; for the experiments of Appleton and his collaborators of the Radio Research Board have shown that long distance transmission, direction finding, radio navigation, and the ionospheric effects upon "fading" can also become intelligible if we recognise that an ionised atmosphere in a magnetic field can resolve a plane-polarised beam into two elliptic motions. Even the very different absorption of the two shows the strongly "dispersive" properties to which we

have repeatedly drawn attention, since resonance may occur between the frequency in the radio wave and the frequency with which electrons can gyrate in the earth's magnetic field, and such resonance absorbs energy. Terms expressive of this are included in the constants which for simplicity we merely labelled by letters in the "refractive index" of the ionosphere.

It is fitting that we end this last of a series of articles concerning the electromagnetic field by so striking an instance of the way mechanical and optical models contribute to understanding radio, for the first clue to the existence of radio was the identification of wave motion with the solution of Maxwell's equations which summarise the connections between magnetism and electricity. Electromagnetic radiation, whether known as light or heat or X-rays or radio or cosmic rays, will continue to present us with puzzles as to its real status in nature when correlated with atomic phenomena, and in some aspects nowadays it seems to have properties not all explain-

able in terms of waves: but there is no doubt that *some* of the behaviour of radiation appears as wave properties, and it is through understanding these that the utilisation of radio has become possible.

### BOOKS RECEIVED

**Accumulator Charging.**—Eighth Edition. By W. S. Ibbetson, B.Sc., A.M.I.E.E. After introductory chapters dealing with the elements of electricity and measurement of power, the book goes on to describe accumulator construction, operation and maintenance in considerable detail. The latter half of the book deals with the charging from various sources of different types of cells. Accumulators of the alkaline type, as well as the more common lead-acid cells, are treated. Pp. 168+XIII; 42 diagrams and illustrations. Sir Isaac Pitman and Sons, Limited, Parker Street, Kingsway, London, W.C.2. Price 6s. net.

**Airwomen's Work.**—By Leonard Taylor. A description of the various kinds of work undertaken by the Women's Auxiliary Air Force, written for those who expect to join that service. There are sections on morse, electricity and wireless. Pp. 54, with many illustrations. Sir Isaac Pitman and Sons, Ltd. Price 1s. 6d.

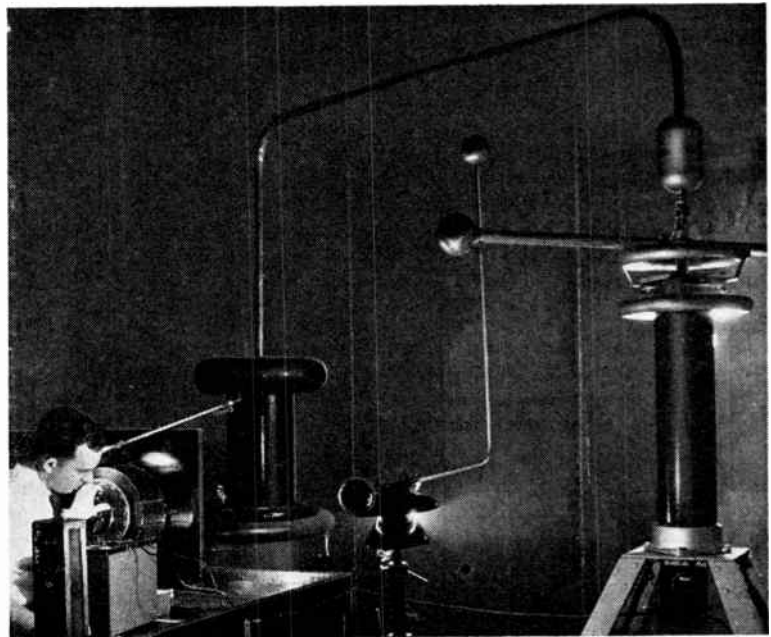

**REDUCING POWER-LINE INTERFERENCE.**—As pointed out in an article in our May issue, interference from power-lines during damp weather may be reduced by ensuring a uniform potential distribution over the insulators. This photograph, taken in the American Westinghouse laboratory where interference problems of this kind are investigated, shows the testing of an insulator that has been treated with a semi-conducting glaze in order to stabilise its insulation resistance at a relatively low value.

# PICK-UP COUPLING TRANSFORMER

## Practical Design for Use with Moving Coil Pick-ups

By JOHN BRIERLEY

SINCE the description in the July 1942 issue of this journal of a moving coil pick-up, there have been many inquiries by readers regarding a coupling transformer—particularly from those requiring data for the construction of a suitable component.

Before giving the constructional details it would be better perhaps to examine the considerations on which the design is based. The turns ratio is the first matter to be settled and this is determined by the values of the input and output impedances. The input impedance is that of the pick-up coil which can be taken as about 1.7 ohms, but the output impedance, in cases where the secondary is connected direct to the valve grid, is not quite so definite. Experience indicates that a safe maximum is about 50,000 ohms; with careful design this value can be considerably exceeded, but as the output impedance increases as the square of the turns ratio and hence of the voltage output for a given input, such a course should be adopted only in exceptional cases and it must not be forgotten that to accommodate the increased

then the value of 43,000 ohms, the ratio becomes

$$\sqrt{43000/1.7} = 160 : 1 \text{ (approx.)}$$

The considerations which determine the winding particulars are equally definite: for a good bass response it is essential that the inductance of the primary should be such that its reactance is at least twice that of the coil at the lowest frequency which it is required to reproduce. Taking this frequency as 25 c/s, then an inductance of not less than 20 mH is required. At the same time it is essential that the DC resistance of the windings should be as low as possible. It will be realised that these two requirements are directly opposed and that for a given core and winding area, one can be gained only at the expense of the other. It will suffice for our present requirements if the primary resistance is not more than 0.1 ohm and the secondary 2,000 ohms, though by using a nickel-iron alloy core of only moderate dimensions it will be possible to effect considerable reductions in these values

primary and secondary and this can be made to suit our requirements by sectionalising the windings; as for a given response the need for this is less the smaller the transformer, here again a nickel-iron alloy core by enabling us to reduce the size of the transformer, simplifies the construction to a very acceptable extent.

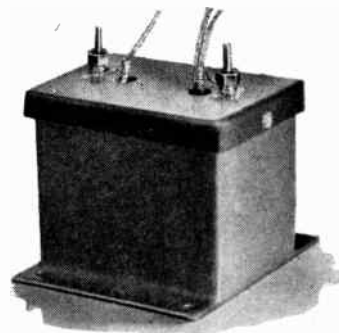

Finished transformer in its screening box with braided screened input and output leads.

Turning now to the practical design, employing nickel-iron alloy laminations such as No. 70—T "Mumetal" laminations of the Telegraph Construction and Maintenance Co., Ltd., built up to a core thickness of half an inch, the requisite primary inductance is obtained with 50 turns; the secondary will therefore need 8,000 turns. For the primary No. 20 SWG enamelled wire is used and No. 40 SWG enamelled for the secondary.

Two bobbins are used with two secondary sections and one primary section on each—Fig. 1(a) shows the arrangement. The dimensions of the bobbins and the position of the wire holes which are drilled before winding are shown in Fig. 2. Both bobbins are exactly similar and the holes are on one end-cheek only but on two opposite sides of the square centre hole. The two holes on one side take the inner and outer ends of the primary section and the four holes on the opposite side take the ends of the two secondary sections.

Before commencing the winding the bobbins should be checked to

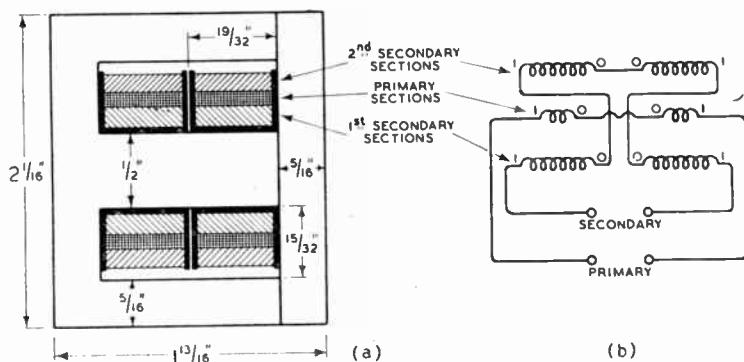

Fig. 1. (a) Section of transformer showing arrangement of windings and dimensions of core. (b) Method of joining up inside and outside wires of the six winding sections.

number of secondary turns in the available space an even finer gauge of wire must be used which increases the difficulty of construction when only improvised winding gear is available. Taking

and at the same time still have an adequate inductance.

The efficiency of the transformer at the higher frequencies depends to a great extent on the degree of coupling between the



ensure that the core can be inserted properly and a block of wood cut to fit exactly the centre hole; end pieces should also be

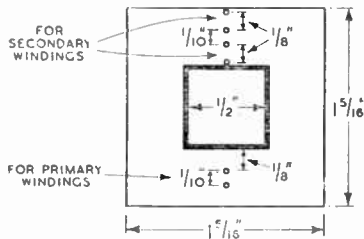

Fig. 2. Dimensions of one of the pair of bobbins, showing positions of leading out holes for the ends of the windings.

cut to prevent the end- cheeks being forced out by the windings and slots to expose the wire holes should be cut in one of these. The winding is started by soldering on to the beginning of the No. 40 SWG wire about 8 inches of No. 30 SWG DSC as a lead out wire, leaving about 2 inches exposed. Another length of about 12 inches of the No. 30 gauge DSC is soldered on after winding on the 2,000 turns leaving about 6 inches exposed. One layer of thin varnished paper is then put on and the primary section of 25 turns of No. 20 SWG enamelled wound on in two layers followed by another layer of varnished paper. The 6in. lead out wire of the end of the first secondary section is then threaded through the hole for the start of the second secondary section, the No. 40 SWG soldered to it and the

core—that is, with the leads coming from the exposed end- cheeks—the 33 pairs of laminations being inserted from alternate ends. The two outer ends of the second secondary sections on each bobbin are joined together and also the outer ends of the two primary sections, as the winding direction of the bobbins when assembled in this manner is opposite. Fig. 1(b) shows the wiring arrangement. The resistance of the primary is 0.08 ohm, and that of the secondary 950 ohms; 1 oz. of No. 20 SWG enamelled and 2 1/2 oz. of No. 40 SWG enamelled are required for the windings.

When a transformer is used at low signal levels and followed by several stages of amplification including bass boost as in a gramophone pre-amplifier, there is almost always difficulty in so placing it that it does not pick up hum due to stray fluctuating magnetic fields. It is therefore desirable in most cases to screen the transformer in a thick copper or iron case, though a high-permeability alloy case is better than either. The following figures show the reduction in hum pick-up at 50 c/s when the transformer, which was connected to a 4-stage battery amplifier, was housed in cases of various materials, and placed at a distance of 30 inches from a 100-watt mains transformer.

1/2 in. Copper	3/8 in. Cast Iron	1/8 in. Mumetal
5 db.	22 db.	42 db.

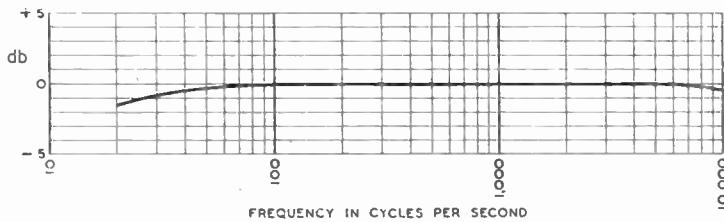

Fig. 3. Frequency response curve of transformer with artificial loads of 1.5 and 50,000 ohms across primary and secondary respectively.

bobbin completed by winding on the second secondary section of 2,000 turns complete with lead out wire. The second bobbin is wound in an exactly similar manner and it is essential that both bobbins and all of the windings on both bobbins should be wound in the same direction. The bobbins can now be mounted back to back on the

It is interesting to note though that in practice a thin copper case is often sufficient when the signal voltage across the secondary is not much less than 0.1 volt, though care must then be exercised in placing it as far as possible from possible sources of hum and in orientating it by a process of trial and error to the position of minimum hum.

**OF OUR  
ABILITIES  
AND  
FACILITIES  
WE GIVE  
GLADLY**



PARAMOUNT above all else is the necessity of meeting urgent and immediate demands for the protection of cherished liberty.

Astatic's engineering and manufacturing facilities are therefore first at the disposal of Allied Governments.

Astatic will be ready to serve you again with high quality piezo-electric devices when the "All Clear" of Victory sounds.

Register your name with our Representative for your future benefit.



THE ASTATIC CORPORATION  
YOUNGSTOWN, OHIO, U.S.A.  
TORONTO, CANADA.

Exclusively Represented by  
Frank Heaver Ltd. Kingsley Road, Bideford, N. Devon

**G.I.**  
**VICTORY  
PRODUCTION**

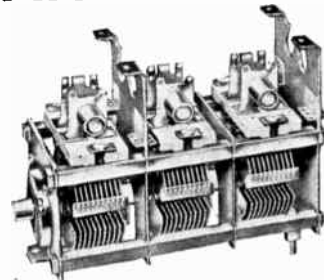

WHEN the mission of complete victory is accomplished, General Instrument will help "Win the Peace" by making the best use of still greater knowledge and experience in the manufacture of variable condensers and drives.

THE GENERAL INSTRUMENT CORPORATION  
ELIZABETH, N.J., U.S.A.

Exclusively Represented by  
Frank Heaver Ltd. Kingsley Road, Bideford, N. Devon

## Mahomet to the Mountain

**D**URING the palmy days of peace I never bothered myself overmuch about the nature of the B.B.C.'s programmes, but made it my business to see that adequate and efficient technical arrangements existed for conveying those programmes to our homes, and to that end I criticised receiver manufacturers and the B.B.C. engineering department alike.

Nowadays my concern is not so much to get programmes into your homes as to get propaganda into the homes of the enemy, and here again I do not regard it as my duty to join the controversy as to what form our propaganda should take,



On the home ground.

but I do consider it my business to see that adequate technical means are provided to get the propaganda into enemy loudspeakers. According to information which reaches me from the continent far too few people are hearing propaganda, and I have long thought that we should adopt a bolder technical policy in order to remedy this defect.

Apparently I am not alone in my views, for this subject has been well "plugged" in the House of Commons by the honourable and gallant member for Rochester, but, whereas he wants propaganda transmitters built all round the perimeter of Europe, my own ideas on the subject are far different. To start with, the building of these proposed transmitters would take time, and I doubt very much if they would be very effective when built; for it must be remembered that the wily Adolf saw to it years ago that the *οἱ πολλοί* of the Fatherland were for the most part provided only with primitive medium-wave Volksempfänger, and the proposed perimeter transmitters would be largely defeated by distance unless they were of prodigious power.

My proposal is simply to take

## By FREE GRID

Mahomet to the mountain by clearing out the bomb racks from a few of our egg droppers and installing therein a low-powered transmitter. By flying over selected German cities at stratospheric height well out of range of "flak," these radio bombers would literally be able to force their programmes on to the Volksempfänger, the very unselectiveness of which making this all the easier to accomplish. Nor would it be absolutely necessary for the studio to be in the plane. This could still be in London, one of the ordinary B.B.C. SW transmitters being used to link it up with a short-wave receiver in the tail of the plane, the propaganda programmes being then rebroadcast by the MW transmitter.

I need hardly add that there would be little object in Adolf copying the idea, since anybody over here who desires to do so is already able to listen direct to all the Axis propaganda they want. If any of you, apart from political obstructionists, can see any technical snags in the idea, let me know.

## Ignorance in High Places

**I**T is astounding what a tremendous amount of muddled thinking exists even among those who have had the advantage of being life-long readers of *Wireless World*. This fact was strikingly brought home to me the other day when talking to an electrical engineer of some eminence who is associated with the Central Electricity Board and is therefore in a position to speak with some authority.

Our talk had turned on the war, and I had remarked on what a tremendous saving in money and effort there would have been had the advice of myself and other men

of vision been taken years ago and all coal burned at the pithead, the latent energy dug out of the earth being swiftly distributed electrically instead of at the shambling gait of the average coal train.

Instead of hanging his head in shame on behalf of himself and of the whole electrical industry as I had expected, he rounded on me and rated me soundly for supporting what he called a popular superstition regarding the supposed economy of burning all coal at the pithead. He then went into a mass of statistics to prove that I was wrong, which is, of course, impossible. He stated that, apart from the high initial outlay, the operating costs of the pithead idea would, owing to transmission losses and other factors, exceed that of the present archaic system.

Frankly speaking, I was appalled at his ignorance of elementary economics. A little knowledge is a dangerous thing, and, as I pointed out to him, there is no subject of which this is more true than economics. As I told him, in the statistics which he had given me he had not mentioned one word about the costliest item of all which must be debited to the account of the present system, namely, the public health services.

Any good medical work will tell you of the health havoc wrought each year by the soot and smoke belched forth from our countless domestic chimneys. Apart from specific diseases, the screening of the sun's ultra-violet rays by this veil of the products of combustion is responsible for a large amount of "off-colour" health, resulting, of course, in much swallowing of noxious medicines which cost money and man-hours to produce.



London's Annual Sootfall.  
Ministry of Health  
Illustration.

# WORLD OF WIRELESS

## U.S. SETS FOR US

WHEN once again asked whether he was in a position to announce the date utility receivers would be available, Mr. Dalton, President of the Board of Trade, stated he had decided that "after the sets in process of manufacture have been completed, any new domestic sets made here shall be of simple standard designs." Discussions on this are understood to be proceeding with the trade. No sets of this type could, however, be available until next year.

He also announced that arrangements have been made to import receivers from the United States for early delivery.

It would appear from this and other statements that the much-talked-of utility set is still in the embryonic stage.

## RADIO OFFICERS' GALLANTRY

WHEN presiding at the General Meeting of the Marconi International Marine Communication Company, Admiral H. W. Grant, C.B., referred to the devotion to duty of the company's radio officers. He stated that since the beginning of the war and up to March 31st of this year, the following 21 decorations for gallantry have been awarded: O.B.E.s, 2; D.S.C.s, 2; M.B.E.s, 15; Silver Medal of the Royal Humane Society, 2. Three of the 21 have been awarded also Lloyd's War Medal. In addition, 45 radio officers have been officially commended for gallant conduct, 16 of them posthumously.

## VOICE OF BELGIUM

WE thank readers who have informed us of the reception of the experimental transmissions from the new 50-kW station at Leopoldville, which is now working on a regular eight-hour daily schedule.

The transmissions, broadcast in the two national languages of Belgium, are radiated on 25.70 metres from 0545 to 0730 and 2115 to 2330, and on 16.88 metres from 1215 to 1400 and 1830 to 2115 (BDST).

In addition to the programmes emanating from the capital of the Belgian Congo, transmissions from London and New York are rebroadcast daily.

## SIGNAL STRENGTH CODES

IN a recent issue of *Radio Times* reference was made to the code B.B.C. engineers encourage oversea listeners to use when reporting short-wave transmissions. It is a three-figure code, the first figure referring to the strength of signal, the second to the degree of fading, and the third to the over-all merit of usefulness of the signal to the listener.



Col. Sir A. Stanley Angwin, D.S.O., M.C., T.D., B.Sc. (Eng.), nominee for the I.E.E. presidency. He succeeded to the post of G.P.O. Engineer-in-Chief in June, 1939, and has been a member of the Government Television Committee since its inception. Sir Stanley was created a Knight Bachelor in June, 1941.

For each figure a reading of from 0 to 5 is used, those limits respectively representing minimum and maximum. The perfect signal, therefore, would be reported "505."

This code has not been internationally adopted and should not, therefore, be confused with the QSA and QRK codes. These employ the numerals 1 to 5 for strength and readability of signals, the highest figure being used for the best signal.

## AUTOMATIC SOS SETS

PORTABLE automatic SOS transmitters are now being dropped in buoyant bags from patrolling aircraft of Coastal Command to shipwrecked seamen.

Few details of the apparatus are disclosed except that it is about the size of a domestic coffee mill and transmits a continuous SOS signal so long as the handle is turned.

It was recently instrumental in locating, after five days, a lifeboat with 19 survivors which, owing to bad visibility, had been lost by the patrolling aircraft.

## B.B.C. SHORT WAVES

FIVE new frequencies have recently been introduced by the B.B.C. in its short-wave oversea services. They are:

GVU	11.78 Mc/s	25.47 metres
—	15.42	19.45
—	11.93	25.15
GRP	17.87	16.79
GVV	11.73	25.58

The frequency of GRN has been



When the guns cease firing Crowe will resume its leadership in design and production of decorative parts for the radio industry throughout the world.

Exclusively Represented in Great Britain by

**FRANK HEAVER LTD.**  
Kingsley Road, Bideford, N. Devon.



**CROWE NAME PLATE AND MANUFACTURING CO.**  
CHICAGO, ILL. U.S.A.

## RAYTHEON



MADE IN U.S.A.

THE knowledge and proven skill of Raytheon engineers obtained through years of advanced scientific research and gruelling laboratory tests are responsible for the high recognition of Raytheon tubes in the fulfilment of the most important tube requirements of the war.

You will benefit by the additional experience gained through wartime research when complete victory is won.

L.T.4 MIDGET.

**WORLD'S LARGEST EXCLUSIVE TUBE MANUFACTURERS**

**RAYTHEON PRODUCTION CORPORATION**  
NEWTON, MASS., U.S.A.

Exclusively Represented by

**Frank Heaver Ltd.** Kingsley Road, Bideford, N. Devon



changed from 6.19 Mc/s, as given in our list of short-wave stations in the May issue, to 6.20 Mc/s.

Some of these frequencies are used for the General Oversea Service introduced by the B.B.C. some time ago. It is intended for the Forces and "Britons in exile" in the Far East, Near East and North and West Africa. This service now occupies 12½ hours a day and is designed to provide an alternative service from 1200 to 0045 (BDST) in the areas served.

We give below the current schedule of short-wave transmissions of news in English in various B.B.C. services (times are BDST):

0000	31.25, 42.46.
0045	
0306	25.53, 25.68, 30.53, 31.32.
0445	25.68, 30.53, 30.96, 31.32, 41.96, 42.13,
0630	42.46, 48.43, 49.10.
0815	
0930	19.82, 25.53, 25.68, 30.53, 31.55, 42.13.
1300	16.64, 16.79, 16.84, 19.82.
1500	16.64, 16.79, 16.84, 19.42, 19.82, 25.53,
	30.53, 30.96, 31.25, 31.55, 31.75, 31.88,
	41.32, 41.75, 41.96, 42.43, 48.54, 49.10,
	49.59.
1700	16.64, 16.79, 16.84, 19.42, 19.60, 24.02,
	25.68, 31.55.
1800	16.59, 16.64, 16.84, 19.66, 25.53.
2000	19.66, 19.82, 25.15, 25.29, 25.47, 25.53,
	31.75.
2245	19.66, 25.29, 25.53, 31.25, 31.55, 41.75,
	41.96, 42.46, 48.78, 49.42, 49.92.
2345*	25.53, 25.68, 30.53, 31.32.

\* Sundays excepted.

### AUSTRALIAN LICENCES

IT is learned from Australia that during the first five months of the operation of the new Broadcasting Act, which came into force last July, over 23,000 supplementary receiving licences for sets in excess of one in a house have been issued. It will be recalled that in our February issue we referred to the new Act which necessitates the purchase of a licence for each set in use. The standard licence fee is £1 or 14s. a year, according to the area in which the set is situated; the fee for additional sets being half this standard rate.

The total number of licences in force at the end of November was 1,335,336, of which 1,367 were issued for car radio receivers.

### MUSIC WHILE YOU WORK

IT was announced in the House of Commons at the end of May that agreement had been reached between the Government and the Performing Right Society and Phonographic Performance, Ltd., whereby, for the duration of war, the diffusion of broadcast and other programmes of music and gramophone records in factories engaged on essential work—and in the associated canteens and hostels—will be free of charge to the individual managements. The necessary fee will be covered by composite annual payments by the Government of



CHECKING INSULATORS on a 125-foot tower of one of the radio beacons which are being erected along the route of the trans-Canadian air line to Alaska.

£25,000 and £7,500 respectively to the two concerns.

The agreement is to continue as long as the Emergency Powers (Defence) Act remains in force, but after one year, from May 6th, 1943 (the date from which the agreement is effective), either side may terminate it by giving one month's notice.

The agreement does not apply to entertainments to which the general public are admitted. Nor does it cover performances by living performers unless they are drawn from the workers in the factories themselves. In both these cases individual licences are still required.

### NAVIGATION PRIZE

THE Royal Society of Arts has again offered a prize of £50, under the Thomas Gray Memorial Trust, for an invention which, in the opinion of the judges, is considered to be "an advancement in the science or practice of navigation," proposed or invented by a person of British or Allied nationality in the period January 1st, 1938, to December 31st, 1943. Competitors must forward their proofs of claim between October 1st and December 31st, 1943, to the Acting Secretary, Royal Society of Arts, John Adam Street, Adelphi, London, W.C.2.

A second prize of £50 will be awarded to any member of the British Merchant Navy for any deed brought to their notice which, in the opinion of the judges to be appointed by the Council, is of out-

standing professional merit. The period to be covered by the offer will be the year ending September 30th, 1943.

### ANTI-INTERFERENCE

THE question "who should pay for the installation of anti-interference apparatus?" has been discussed at some length in Switzerland. The result has been an agreement between the Swiss Postal Administration and the Association Suisse des Electriciens providing that the expense of rendering new high-voltage equipment interference-free should be divided between the owner of the apparatus and the listeners in the immediate vicinity who will benefit by the suppression. In exceptional cases (for factories, etc.) the Postal Administration undertakes to meet one-third of the expense.

It is now compulsory for all new high-voltage equipment to be rendered interference-free unless the expense of so doing would be excessive. Manufacturers are now required to deliver only such products as are marked with the A.S.E. anti-interference mark.

According to the *U.I.R. Bulletin*, the obligation to make existing high-voltage apparatus interference-free is to be enforced only when "receivers in the neighbourhood are disturbed to an intolerable degree."

### IN BRIEF

**Australian Transmissions.**—Short-wave listeners will have noticed the use of several new call signs and wavelengths for the transmissions from Australia. They are:—

VL16 Sydney	9.590 Mc/s	31.28 metres
VL12	11.870	25.27
VL17	11.880	25.25
VL13	15.315	19.59
VLG4 Melbourne	11.835	25.35

The station VL12 is used for transmissions to the British Isles from 0855 to 0925 BDST.

Reports of the reception of these transmissions will be welcomed by the Australian Broadcasting Commission, which, if addressed care of *Wireless World*, will be forwarded.

**New Pacific Station.**—A new 50-kW international short-wave broadcasting station is being erected near San Francisco. It will operate on the following frequencies, which will be shared with stations WBOS and WKID: 6.06, 7.23, 9.57, 11.87, 15.29, 17.76 and 21.61 Mc/s.

**I.E.E. Councillors.**—Col. Sir A. Stanley Angwin, D.S.O., Engineer-in-Chief, G.P.O., has been nominated president of the I.E.E. for the 1943-44 session. Among those nominated to fill the vacancies occurring on the Council at the end of September next are Dr. E. B. Moullin, M.A., Oxford University, who stands as a vice-president, and Brig. F. T. Chapman, C.B.E., D.Sc., Deputy Director of Military Training, J. S. Forrest, M.A., B.Sc., of the Research Staff of the Central Electricity

Board, and E. C. S. Megaw, M.B.E., B.Sc., G.E.C. Research Laboratory, who are nominated Ordinary Members of the Council.

**Car Radio.**—When asked in the House of Commons if he would now permit the installation of radio receivers in private motor cars, Capt. Crookshank, the P.M.G., replied: "No, Sir, not as at present advised." He was then asked whether this decision was due to security reasons or lack of equipment, to which he replied: "Both, and others!"

**I.E.E. Wireless Section.**—The Committee of the Wireless Section of the Institution of Electrical Engineers has nominated the following to fill the vacancies which will occur on the Com-

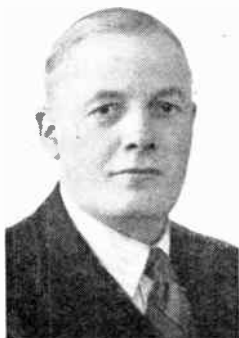

T. E. Goldup, director of Mullard Radio Valve Co., and also of Radio Transmission Equipment, who has been nominated chairman of the I.E.E. Wireless Section for the 1943/44 Session.

mittee on September 30th:—Chairman, T. E. Goldup (Mullard); vice-chairman, Prof. Willis Jackson (Manchester University); Ordinary Members, Capt. C. F. Booth (Post Office Engineering Dept.); H. L. Kirke (B.B.C.); O. S. Puckle (Cossor); T. Wadsworth (B.T.H.), and Dr. R. C. G. Williams (Murphy).

**Salvage.**—The Directorate of Salvage and Recovery (Ministry of Supply) asks us to request readers not to offer for salvage any foreign technical works, etc., as these may contain information which can be advantageously utilised by the Ministry of Economic Warfare. They particularly ask for any copies of technical reference books, technical dictionaries, maps, trade catalogues, etc., referring to countries in Europe, to be forwarded to Room 629, Ministry of Economic Warfare, Lansdowne House, Berkeley Square, London, W.1. They would also be glad to receive details of similar books which can only be lent.

**Radio Black-out.**—During air-raid alerts on the west coast of America a radio silence is now observed.

**Central Broadcasting Library.**—It has been suggested by the International Broadcasting Union (I.B.U.) that a Central Broadcasting Library should be established at its headquarters in Geneva.

**Hearing-aid Batteries.**—Customs and Excise inform us that the following goods are now exempted from Purchase Tax:—Batteries of not less than 30 volts and not more than 90 volts specially designed for high-tension supply for hearing-aid appliances and using cells not larger than 40 millimetres overall in length and 13.5 millimetres in diameter.

**I.E.E. Premiums.**—The Council of the Institution of Electrical Engineers has made the following award of premiums for papers read before the Wireless Section during the 1942-43 Session:—Duddell Premium (£20) to Dr. R. L. Smith-Rose and Miss A. C. Stickland—"A Study of Propagation over the Ultra-Short-Wave Radio Link between Guernsey and England on Wavelengths of 5 and 8 Metres"; Ambrose Fleming Premium (£10) to G. Parr and W. Grey Walter—"Amplifying and Recording Technique in Electro-Biology, with special reference to the Electrical Activity of the Human Brain"; Extra Premium (£5) to Prof. Willis Jackson—"The University Education and Industrial Training of Telecommunication Engineers."

**British Wireless Dinner Club.**—About 150 members attended the 21st anniversary dinner of the British Wireless Dinner Club in London on June 4th, which was presided over by Air Comdre. Blandy, C.B., D.S.O., founder of the club. Vice-Admiral Lord Louis Mountbatten, G.C.V.O., D.S.O., was the guest of honour. A presentation was made to Capt. Chas. F. Trippe, who has acted as honorary secretary since the formation of the club.

**Brit. I.R.E.**—The following awards to the most successful candidates in the two Graduateship examinations held during 1942 have been approved by the General Council of the British Institution of Radio Engineers:—President's Prize (Bronze Medal and cash, total value £15) to L. W. Blick, London, N.11, who also receives the Mountbatten Medal, awarded annually to the best candidate from the Services; the L.R.C. Prize (text-books to the value of £5), awarded annually to the candidate taking second place, goes to J. Pollard, B.Sc., Liskeard, Cornwall.

**Radio Industries Club.**—Capt. H. de A. Donisthorpe has been re-elected chairman of the club for the 1943-44 Session.

**Institution of Electronics.**—A joint meeting of the N.W. England Section of the Institution of Electronics and the Manchester and District Branch of the Institute of Physics, will be held at the Reynolds Hall, College of Technology, Manchester, on July 6th at 7 p.m. Dr. A. Sommer will be the speaker and his subject is "Photoelectric Cells" (with special reference to the Vacuum and Gas-filled Types). Tickets are obtainable from Leslie F. Berry, 14, Heywood Avenue, Austerlands, Oldham.

**Japanese Stations.**—A recent article in a German journal reviewing the expansion of broadcasting in the Far East claimed that Japan now operates more than fifty stations with a total power of over 400 kW. Many of these are, of course, in the occupied countries.

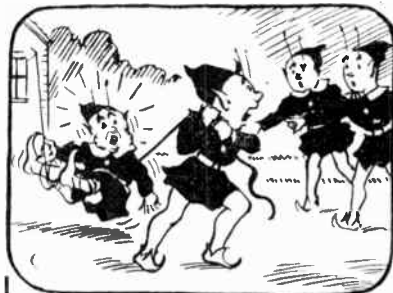

THE "FLUXITE QUINS" AT WORK

"We'll soon get this aerial fixed tight  
In two ticks—with the help of FLUXITE;  
My word, what a weight!  
Come on! Help us, mate!  
Or we shan't get this job done to-night."

See that FLUXITE is always by you — in the house — garage — workshop — wherever speedy soldering is needed. Used for over 30 years in Government works and by leading engineers and manufacturers. Of all Ironmongers—in tins, 8d., 1/4 and 2/8.

Ask to see the FLUXITE SMALL-SPACE SOLDERING SET—compact but substantial—complete with full instructions, 7/6.

TO CYCLISTS! Your wheels will NOT keep round and true unless the spokes are tied with fine wire at the crossings AND SOLDERED. This makes a much stronger wheel. It's simple—with FLUXITE—but IMPORTANT.

The FLUXITE GUN puts FLUXITE where you want it by a simple pressure. Price 1/6, or filled, 2/6.



ALL MECHANICS WILL HAVE  
**FLUXITE**  
IT SIMPLIFIES ALL SOLDERING

Write for Book on the ART OF "SOFT" SOLDERING and for Leaflets on CASE-HARDENING STEEL and TEMPERING TOOLS with FLUXITE. Price 1d. each.

**FLUXITE LTD.**  
(Dept. W.W.), Bermondsey Street, S.E.1

# RANDOM RADIATIONS

By "DIALLIST"

## Why 132 Kilovolts?

TALKING the other evening to an engineer who has been responsible for carrying out some biggish electrical installations in various parts of the country, I put a question that I have put to others without obtaining a satisfactory answer. "Why," I asked, "was 132 kV chosen for the grid scheme instead of, say, 125 or 150 or some other rounder figure?" He smiled. "I've asked heaps of people the same thing," he said, and no one that I have approached yet has been able to tell me. There must, I suppose, be some excellent reason for the choice, though for the life of me I can't fathom it. One suggestion was that 132 is eleven times twelve, and we Britons have a liking for thinking in dozens. Were there anything in that (as I am sure there is not), 144—the gross—would surely have been a likelier figure. Were many rival figures offered by experts for the grid line voltage when the scheme was in its infancy, and was 132 the average that would suit our national spirit of compromise so well? Or is there some deep mathematical reason for maintaining 132 kV in long power lines, the voltage of which will eventually be transformed down to 460 and 230? Perhaps some reader will answer a question that has long puzzled me, and no doubt many others as well. And while he is about it, can he tell me why the household voltage from the Scottish section of the grid (or a considerable part of it, at any rate) should be 250, instead of the 230, which one fondly believed was eventually to be the standard for the whole of the United Kingdom?

□ □ □

## Implosions

IN the days before the war that now seem so far away I had often heard and read of the unpleasant results of implosions (to implode is to burst inwards instead of outwards) of cathode-ray tubes. Since then my job has been concerned to a large extent with CRTs of all sorts and sizes. I have known a good few broken, but, so far—and here I touch wood firmly—I have never seen or heard an implosion. Possibly that is because most of the breakages that have come my way have been caused by the splitting off of one of the "horns" that contain the leads to the X and Y plates. When one of these is broken off, the entrance of air is to a large extent controlled by the comparatively

small hole in the glass that is opened to it; there is not the same wild rush that there would be if the screen or the body of the tube were splintered. That would probably cause the father and mother of a bang. I am told that in that case the "electron gun" assembly has a way of shooting out *en bloc* like a shell from the other sort of gun. The biggest implosion that I have come across during the war was that of a transmitting valve, of which the glass envelope, more than an eighth-inch thick, was cut through by an arc-over. There was not much noise, and there cannot have been any high-velocity flying fragments, for the damage done was *nil*, save to the valve itself. Even its push-pull partner was uninjured. Curiously enough, the glass of the bulb was cut off near the base in an absolutely straight line, just as if someone had taken a diamond to it. Has anybody had first-hand experience of an implosion of a biggish CRT?

□ □ □

## Off the Map

IT may seem hard to believe that in this country of ours there are places more than forty miles from the nearest "inhabited locality," to borrow a phrase from the Russian communiqués, that has any pretensions to being called even a townlet. But there are, right enough, and in the past few months I have visited a good few of them. Here is a typical instance. The camp is connected by six miles of the worst road you ever saw with a tiny village which boasts but a single general shop. The village is umpteen miles from the railway, the sole connecting link being a once-a-day bus service, liable to suspension if the weather is bad enough (as often it is) to cause the road to be blocked or washed away. Normally, the morning papers arrive at about 7 p.m. on week-days; the Sunday papers do not get there at all. If it was not for the broadcast receiver, the soldiery would get scanty news of the war. As it is, they are able—provided that their batteries are not down—to tune in all the news bulletins and to keep *au fait* with events. I have yet to find a place where a three-valve battery set would not give respectable loud-speaker reproduction of the news—and that, you will admit, says a great deal for the efficiency of our wartime broadcasting service. In some places HTBs have been a bit of a problem. I struck one only a week before this was written, where the only radio set was out of action

because its HTB had given out and the post had not yet brought a replacement. But, on the whole, the HTB problem is less of a headache than it was, and these out-of-the-way spots do not now so often find themselves cut off from the rest of the world for want of one. You have to visit such places to realise what a boon broadcasting can be. These notes are being written at one of them, and I am sure that if I put the question to those around me in the mess there would be no two opinions. I have even developed a lurking sympathy with those who indulge in non-stop wireless reception and do not much care what is coming in so long as some kind of cheerful noise is issuing from the loud speaker.

□ □ □

## Post-war Planning

HAVE you ever thought of the vast demand that there will be for wireless receivers as soon as the war is over? Those expert in the subject used, I believe, to calculate the average life of a wireless set as four years. With ten million receiving licences in force the annual needs of the people of these islands would thus have been 2,500,000 sets a year in the ordinary way. But of the sets now in service probably a great many more than nine million are over four years old, and before we are back to normal supplies the figure is certain to be over ten million. The potential demand is thus colossal, and I do hope that the industry is making plans to meet it. What we must not do is to find ourselves able to supply only a small proportion of the sets required. The plans must be ready in advance; it will be too late if we do not start thinking about them until Adolf Hitler signs on the dotted line.

□ □ □

## Television: An Opportunity

WHAT a chance we shall have when the war is well and truly won to scrap all the messes and muddles of the past and to see that television development here gets a flying start. I say "start" because I don't honestly think that it ever did get a proper start before the war. There was so much badgering by the lay press of the authorities to get a television service going that we probably led off before we were really ready to do so from either the technical or the programme point of view. The lay papers kept up their loud-voiced demands for an immediate service on



the ground that the public would fall over itself to buy television receivers as soon as regular programmes were transmitted. But events proved that the public's view of the situation was quite different. There was no rush to buy; the public had an idea that any apparatus produced would be out of date before it could say knife. They were not even reassured by the Government's undertaking to make no change in the system for some considerable time — three years, wasn't it? That undertaking, though it probably had to be given, was a mistake, for it committed us to a limited degree of definition, which was out of date almost as soon as it was adopted. The United States and the Continent plumped for a greater number of lines as soon as they got any kind of service going. Is there any reason why, when the war is over, we should remain wedded to a system that is behind the times?

**A Fresh Start**

Why shouldn't we make an entirely fresh start in television? The number of television sets in private ownership is comparatively small, and the Government cannot be accused of a breach of faith if it brings the standards up to date, for the guaranteed no-change period has long since run its course. I maintain that there should be international definition standards,

adopted by every civilised nation as the result of a conference held as soon as possible after peace is signed. Wartime research and experience are bound to have profound effects on the development of television and the standards adopted after the suggested conference may be surprisingly in advance of those of pre-war days. Do not let us handicap television by binding ourselves to hangersover from the past.

□ □ □

**Wartime Soldering**

**B**EFORE the war you could obtain solders as "soft" as you liked, that is, containing a large proportion of tin. But now that the Japanese occupy some of the world's greatest centres of tin production, tin has become a very precious munition of war and no very soft solder is allowed to be made. This makes wireless soldering in wartime rather difficult, especially if you use an electric iron; many of these are not designed to work at the higher temperatures needed by the harder kinds of solder now available. With a non-electric iron you can tackle most jobs, so long as you heat it until the surrounding flame shows a distinct greeny-blue tinge. But most of us prefer the electric iron on account of its cleanness and its simplicity. One way out of the difficulty is to obtain a fresh heater element (if you can get it!) designed for a higher temperature.

**LETTERS TO THE EDITOR**

**Gramophone Record Wear**

**R**EFERRING to comments in your June issue by G. E. Horn and R. H. Thrussell on needle armature pick-ups, I note they state that "drag across the turntable causes wear on the outer side of the groove. . . ."

Surely the wear takes place on the inner side of the groove as it would appear from the accompanying diagram of forces acting.

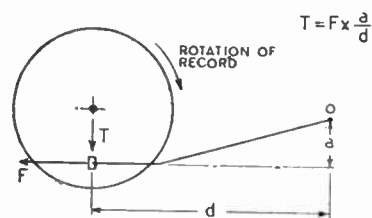

The frictional force (F) due to the rotating record and needle pressure has a turning moment about the centre of rotation of the

pick-up carrying arm. In order that the needle shall stay in the groove, therefore, there must be a side thrust (T) acting away from the record centre, and this is obviously supplied by the inner face of the record groove.

That the natural tendency is to move "centre-wards" unless restrained by the groove is evidenced by the action of a pick-up placed on the smooth initial portion of one of the older type records having no "lead in" towards the first groove.

If the pick-up arm hinges freely it will automatically start to move centre-wards without assistance from the operator.

R. BOORMAN.

Gillingham, Kent.

**Simpler Valves**

**A**LL that "Diallist" says about multiple valves in your June issue is true, but he seems to have missed the main reason

**The Improved  
VORTEXION  
50 WATT  
AMPLIFIER CHASSIS**

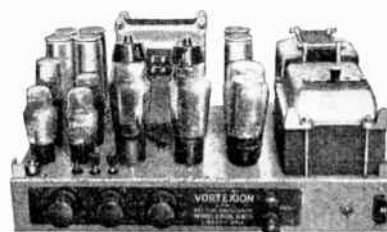

The new Vortexion 50 watt amplifier is the result of over seven years' development with valves of the 6L6 type. Every part of the circuit has been carefully developed, with the result that 50 watts is obtained after the output transformer at approximately 4% total distortion. Some idea of the efficiency of the output valves can be obtained from the fact that they draw only 60 ma. per pair no load, and 160 ma. full load anode current. Separate rectifiers are employed for anode and screen and a Westinghouse for bias.

The response curve is straight from 200 to 15,000 cycles. In the standard model the low frequency response has been purposely reduced to save damage to the speakers with which it may be used, due to excessive movement of the speech coil. Non-standard models should not be obtained unless used with special speakers loaded to three or four watts each.

A tone control is fitted, and the large eight-section output transformer is available in three types: 2-8-15-30 ohms; 4-15-30-60 ohms or 15-60-125-250 ohms. These output lines can be matched using all sections of windings and will deliver the full response to the loud speakers with extremely low overall harmonic distortion.

**PRICE** (with 807 etc. type valves) **£18.10.0**  
Plus 25% War Increase  
**MANY HUNDREDS ALREADY IN USE**  
Supplied only against Government Contracts

**VORTEXION LTD.**  
257, The Broadway, Wimbledon, S.W.19  
Phone: LIBerty 2814

**Letters to the Editor—**  
for the adoption of the "toad" valve (as a service-man I knew called it, with venom). It was first and foremost a matter of production cost.

At one time the British manufacturer, under a ridiculous and stultifying royalty system, was paying royalties on a valve-holder basis at a rate exceeding the cost of the valve he placed in the holder.

It was therefore to his benefit to reduce the number of valve-holders to a minimum, making up for sensitivity and volume by using complex valves, the unfortunate purchaser being left to carry the expense of replacements.

Fortunately, I see every prospect of "Diallist's" hopes being realised. Wartime experience is teaching us the real advantages of simplicity.

A. A. TURNEY.

Devonport.

**"Stereoscopic and Colour Television"**

REFERRING to D. A. Bell's letter in your March issue, I think it should be stressed that the anaglyphic method of television has been publicly demonstrated by Mr. Baird, who also described the use of Polaroid in *Electronic Engineering* for February, 1942.

The principles of stereoscopy

and its use in photography and cinematography are, of course, well known. Baird was, however, the first to achieve stereoscopic television. His system of direct viewing colour stereoscopic television differs from the photographic hand stereoscope in that the viewer need not have eye-pieces in front of his eyes. Also, the images are not side by side, but superimposed on the same screen.

The action of the converging lens, as used in Baird's discless system, may be made clearer by considering first the centre points of the two adjacent images. Each of the first two lenses collects light from the centre point, which

**NEWS IN ENGLISH FROM ABROAD**

**REGULAR SHORT-WAVE TRANSMISSIONS**

Country : Station	Mc/s	Metres	Daily Bulletins (BDST)	Country : Station	Mc/s	Metres	Daily Bulletins (BDST)
<b>America</b>				<b>Egypt</b>			
WRUW (Boston) ..	6.040	49.67	0900	Cairo .. ..	5.785	51.85	1225, 1840
WLVO (Cincinnati) ..	6.080	49.34	0700, 0800, 0900, 1000		7.510	39.94	1225, 1840
WBOS (Hull) ..	6.140	48.86	1000, 1100	<b>French Equatorial Africa</b>			
WCRC (Brentwood) ..	6.170	48.62	0700	FZI (Brazzaville) ..	11.970	25.06	2145
WGEA (Schenectady) ..	6.190	48.47	0700	<b>India</b>			
WBS .. ..	7.355	40.79	0700, 0800, 0900, 1000	VUD3 (Delhi) ..	7.290	41.15	0900, 1400, 1650
WDJ .. ..	7.565	39.66	0200, 0300, 0400, 0600, 0800, 0900, 1000	VUD4 .. ..	9.590	31.28	0900, 1400, 1650
				VUD3 .. ..	15.290	19.62	0900, 1400
WJP .. ..	8.810	34.05	0200, 0300, 0400	<b>Mozambique</b>			
WGEA (Schenectady) ..	9.530	31.48	2200, 2300	CR7BE (Lourenco Marques) .. ..	9.830	30.52	1255, 1812, 2015
WCBX (Brentwood) ..	9.650	31.09	0600, 0700	<b>Newfoundland</b>			
WNBI (Bound Brook) ..	9.670	31.02	0100	VONH (St. John's) ..	5.970	50.25	0015, 2345
WRUW (Boston) ..	9.700	30.93	0000, 2200	<b>Switzerland</b>			
WDL .. ..	9.750	30.77	1100, 1400	HER3 (Schwarzenburg) ..	6.165	48.66	2250
WKRX .. ..	9.897	30.32	0000, 1100, 1200	HER5 (Schwarzenburg) ..	11.865	25.28	2250
WRX .. ..	9.905	30.28	0700, 0900, 1000	<b>Spain</b>			
WLWO (Cincinnati) ..	11.710	25.62	0200, 2300	EAQ (Aranjuez) ..	9.860	30.43	1915
WRUL (Boston) ..	11.790	25.45	0000, 2200	<b>Sweden</b>			
WCDA (New York) ..	11.830	25.36	0000, 1200, 1300, 1400, 1630‡, 1830, 2200	SBU (Motala) ..	9.535	31.46	2320‡
				<b>Syria</b>			
WGEA (Schenectady) ..	11.847	25.33	1400, 1500, 1600, 1700, 1800, 1900, 2000	Beirut .. ..	8.035	37.34	1920
WBOS (Hull) ..	11.870	25.27	1300, 2000, 2200, 2300‡	<b>Turkey</b>			
WKRD .. ..	13.442	22.32	1300, 1400, 1500, 1600, 1700, 1800, 1900, 2000, 2100, 2200	TAP (Ankara) ..	9.465	31.70	1900
				<b>U.S.S.R.</b>			
WDO .. ..	14.470	20.73	1500, 1800, 1900, 2100	Moscow .. ..	6.980	42.98	0000, 0035, 1340, 1800
WBOS (Hull) ..	15.210	19.72	1500, 1800		7.300	41.10	0000, 1900, 2100, 2200, 2300
WLWO (Cincinnati) ..	15.250	19.67	1900, 2000, 2100		7.360	40.76	0000
WCBX (Brentwood) ..	15.270	19.65	1630‡, 1830, 2200		7.560	39.68	0000
WGEA (Schenectady) ..	15.330	19.57	1500, 1800		10.415	28.72	1340
WRUL (Boston) ..	15.350	19.54	1200, 1300, 1400, 1500, 1600		11.830	25.36	1700
					12.190	24.61	0200
WCW (New York) ..	15.850	18.93	2000		15.110	19.85	0035, 0515
WLWO (Cincinnati) ..	17.800	16.85	1500, 1600, 1700, 1800		15.230	19.70	0515, 1340
WCRC (Brentwood) ..	17.830	16.83	1200, 1300, 1400, 1630‡, 1830, 2200	<b>Vatican City</b>			
				HVJ .. ..	5.970	50.25	2015
<b>Australia</b>				<b>MEDIUM-WAVE TRANSMISSIONS</b>			
VLG3 (Melbourne) ..	11.710	25.62	0855	<b>Ireland</b>	<b>kc/s</b>	<b>Metres</b>	
VLI2 (Sydney) ..	11.872	25.27	0855	Radio Eireann ..	565	531	1440‡, 1945, 2310
VLG9 (Melbourne) ..	11.900	25.21	1615				
<b>Brazil</b>							
PRL8 (Rio de Janeiro)	11.715	25.61	2130‡				
<b>China</b>							
XGOY (Chungking) ..	11.900	25.21	1500, 1700, 1815, 2230				

It should be noted that the times are BDST—two hours ahead of GMT.

‡ Sundays excepted.

is on its axis and projects it in a parallel beam, so that two parallel beams enter the converging lens and are brought to a single point at its focus; a similar action takes place for every point in the picture. The apparatus when demonstrated to the writer gave what appeared to be practically perfect register of the superimposed images. N. W. M.

#### WASTE PAPER SALVAGE *The Industry's Part*

TO ensure more effective collection and disposal of waste paper, the radio industry is co-operating with the electrical industry in organising schemes for furthering this vital aim. The Electrical Industry Waste Paper Recovery Committee, in whose hands this matter has been placed, has already received support from many important wireless firms. An appeal for a further effort to increase both economy in the use of paper and the collection of waste is now made by the Committee. It is pointed out that the appointment of a paper "warden" in individual establishments has been proved to bring about good results.

Information on the work of the Committee can be obtained from the Secretary, 2, Savoy Hill, W.C.2.

#### WIRELESS HOWLERS

THE correspondent who sends us the following collection of "howlers" vouches for their authenticity and ascribes their authorship to "some of the less nimble-witted soldiery." They are in the form of answers to examination questions.

"A right angled triangle is the opposite of a left angled triangle."

"The side opposite the right side is called the hippopotamus."

"An Ampere is the current per square second."

"Electrolyte is waves with a speed of 186,000 miles an hour."

"Centi- means hundredth of; it is used in the centimental system."

"Resistance is measured in O.H.M.S."

"The electron gun is fired by pressing a button. It is used in the Navy."

"A dull emitter valve emits dulley."

"The way to charge accumulators is to pay 6d., but this depends on the garage."

#### GOODS FOR EXPORT

The fact that goods made of raw materials in short supply owing to war conditions are advertised in this journal should not be taken as an indication that they are necessarily available for export.

## COMMUNICATIONS DEPEND...

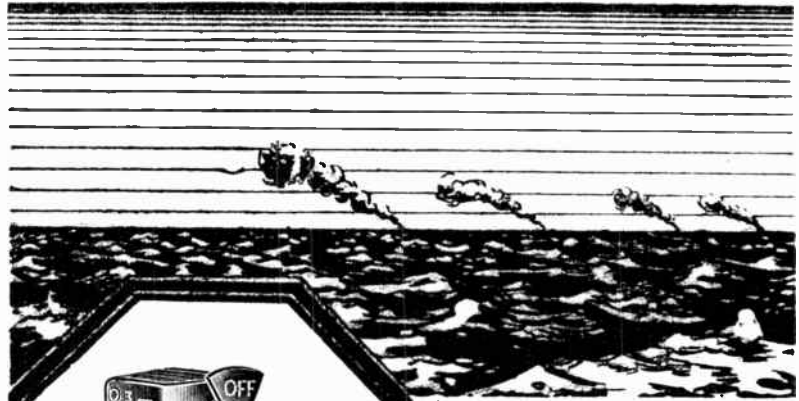

## ON SMALL PARTS...

IN countless instances quite intricate pieces of apparatus are wholly dependent on the proved reputation and reliability of their component parts.

All products from the House of Bulgin are pre-eminent for superior design and workmanship and every article bearing our Trade Mark has to pass exacting and exhaustive tests during the course of its production.

We ask the kind indulgence of the Trade on delivery until peaceful conditions return.

*The Choice of Critics*

### BULGIN FOR SWITCHES

The best Radio and small Electrical Switches in the world. Every one is the finest of its class, and the best for any job. Snap-action, low and constant contact resistance, reliable performance for tens of thousands of operations: all these are permanent characteristics.

**"The Choice of Critics"**

# BULGIN

REGISTERED • TRADE • MARK

A. F. BULGIN & CO. LTD., BYE PASS RD., BARKING,

TEL. : RIPPLEWAY 3474 (4 lines).

ESSEX



# RECENT INVENTIONS

## RADIO GUIDEWAYS

THE directional characteristic of a vertical dipole is a figure of eight curve in the plane of the two limbs. If an earthed horizontal screen is interposed between the two parts of the dipole, the response curve takes the form of four lobes extending symmetrically above and below the plane of the screen. The angle at which the periphery of each lobe cuts across the earthed screen varies from a minimum where the screen is infinitely large to a maximum when the screen is infinitely small (in the latter case the curve again becomes a figure of eight, which cuts across the horizontal plane at 90 deg.).

This fact is utilised to produce a radio guide wave of sharp discrimination by inserting a suitable size of screen between the two halves of a dipole aerial, and connecting first one and then the other to the screen, preferably in the well-known A-N keying sequence. The result is an overlapping beam course in which the centre zone is marked by a steady sustained note, with distinctive A or N signals on each flank.

*Aga Baltic Radio Akt. Convention date (Sweden) April 10th, 1940. No. 549958.*

## SUPPRESSING STRAY CURRENTS

TROUBLE may arise from the presence of the so-called "standing" current in a cathode-ray tube, that is, the current which persists even when the modulating voltage on the grid is at cut-off value and the electron-beam proper is wholly suppressed. This undesired current is due to electrons from the heater filament which pass down or away from the cathode and so find their way to the anode.

The leakage is stopped, according to the invention, by mounting a guarding ring below the heating-filament and surrounding the wires which pass from the stub to support the modulating electrode of the tube. The guard-ring is preferably gapped to prevent damage by eddy-currents during the "gettering" process, and carries a permanent negative bias.

*Cinema-Television, Ltd., and K. A. R. Samson. Application date July 15th, 1941. No. 550,655.*

## AIRCRAFT WIRELESS

THE rotating propellers of an aircraft tend to modulate or distort the field pattern of radiant energy passing through them, and thus may interfere with the transmission or reception of directional or other signals by the craft. The disturbance is most noticeable on short waves and when the propeller blades are of metal and of the same dimensions as adjacent dipoles.

In order to minimise this undesirable effect, a tunable circuit is interposed, preferably between the propeller and the nearby aerial system, and is coupled either magnetically or electrostatically to the propeller in order to alter the resonance of the blades relatively to the radiation.

*Standard Telephones and Cables, Ltd. (Assignees of A. Alford). Convention date (U.S.A.) October 11th, 1939. No. 550716.*

## A Selection of the More Interesting Radio Developments

### WIRELESS RECEIVERS

THE circuit shown is designed to give constant gain as well as uniform regeneration over a wide band of frequencies. The first result is secured by the use of permeability tuning, and the second by employing one valve as an amplifier and a separate valve to provide feedback, instead of making the same valve serve both purposes.

The anode circuit of the first valve V1 includes an inductance L which is shunted by a condenser C1 in parallel with two series condensers C2, C3, the cathode of the second valve V2 being connected through a resistance R to a point between the two last-numbered condensers. The main circuit is tuned by sliding a powdered iron core S relatively to the coil L, these two elements being designed to preserve a constant ratio of inductance to resistance over the frequency range.

The grid-cathode circuit of the valve

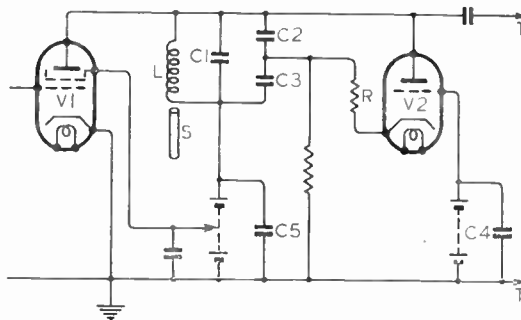

Constant gain amplifier.

V2 is completed through condensers C4, C5, C3 and the resistance R, whilst the anode circuit of the same valve includes the condenser C2. Condensers C2 and C3 therefore couple the main resonant circuit of V1 to the grid of V2 and also provide a feedback coupling for the valve V2 to regenerate the signal energy. The output is taken from T.

*Johnson Laboratories, Inc. (Assignees of W. A. Schaper). Convention date (U.S.A.) June 10th, 1940. No. 551045.*

### A PENTODE PROBLEM

THE first duty of the suppressor grid in a pentode valve is to prevent the flow of secondary electrons between the anode and the screening grid. In

The British abstracts published here are prepared with the permission of the Controller of H.M. Stationery Office, from specifications obtainable at the Patent Office, 25, Southampton Buildings, London, W.C.2, price 1/- each.

order to give the pentode a favourable working characteristic, it is, however, desirable to wind the suppressor grid with an open-pitched spiral. But this clearly reduces its efficiency as a suppressor.

The inventors propose to overcome the difficulty by coating both the anode and the screen grid with a highly emissive material such as caesium oxide. This rather surprising solution is based on the discovery that although the total emission is heavier than from the ordinary metal, say nickel or molybdenum, of which the anode and screening grid are usually made, the content of fast-moving secondary electrons is smaller. The braking action of an open-pitched grid is sufficient to prevent the passage of the comparatively slow electrons, even though it will fail to stop those travelling at high speed.

*Philips Lamps, Ltd. (communicated by N. V. Philips' Gloeilampenfabrieken). Application date August 23rd, 1941. No. 550728.*

### VARIABLE CONDENSERS

TWO hollow tapered parts of ceramic material fit snugly one inside the other. The outer part is fixed, whilst the inner can rotate in contact with it about a coaxial shaft which prevents relative axial movement. The inner surface of one and the outer surface of the other are coated with a metallic layer, which extends only over a part of the available surface so that relative rotation alters the effective capacity of the system.

The shape and relative extent of the metallic coating can be chosen to give any desired law of variation with angular setting. The two hollow shells may also be made of materials with different dielectric constants. Preferably, the metallic layers consist of a silver deposit cemented in place by a firing-on process.

*United Insulated Co., Ltd.; T. J. Rehfsch; and T. R. Amschwand. Application date June 11th, 1941. No. 550777.*

### VACUUM CONDENSERS

THE electrode plates of a radio-frequency condenser of the vacuum type are usually made of nickel. When subjected to high voltages pure nickel produces secondary electrons by cold emission, and this eventually gives rise to a point-discharge which, in effect, destroys the condenser.

According to the invention the plates are made of a material having a high "work function," such as oxidised nickel, which is found to be remarkably free from spurious emission of the kind mentioned.

*Standard Telephones and Cables, Ltd., and W. T. Gibson. Application date August 29th, 1941. No. 551638.*

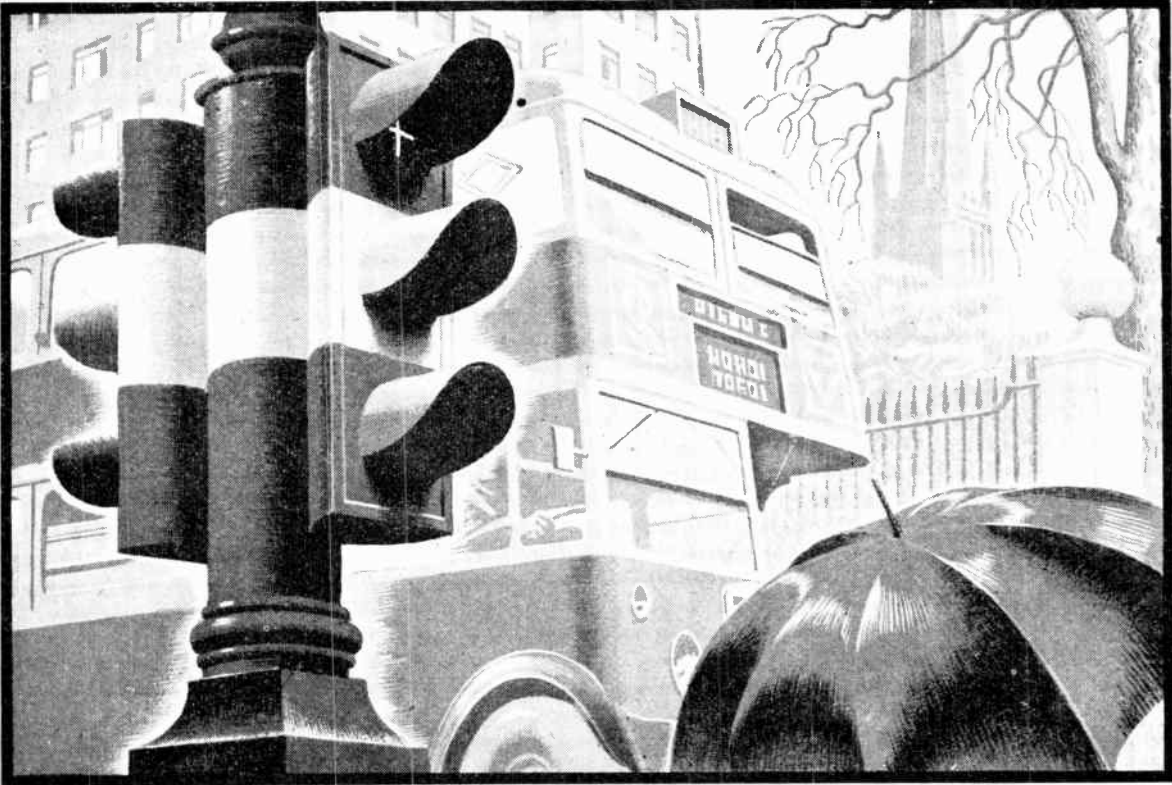

## Valves and Vehicles

The connection between valves and vehicles is frequently a very direct one — the contact pad in the road surface which controls the operation of traffic lights.

The equipment consists of electron tubes and relays, so arranged that when the contact pad is depressed a current impulse is released into the relay circuit and initiates the light sequence. The apparatus automatically resets itself after a time interval, or after the cessation

of further impulses. Sometimes, however, even the mechanical connection is eliminated. Then a "proximity" link is used, consisting of a particular arrangement of valves and circuit design which is sensitive to the proximity of vehicles. In other words, it can "feel" the approach of traffic.

This is yet another example of the indispensable services rendered to the community by the ubiquitous Thermionic Valve.

# MULLARD

THE MASTER VALVE

*A Valve for Every Purpose*

DOMESTIC · COMMERCIAL · INDUSTRIAL · SCIENTIFIC · MEDICAL · EXPERIMENTAL

THE MULLARD WIRELESS SERVICE CO. LTD., CENTURY HOUSE, SHAFTESBURY AVENUE, LONDON, W.C.2. (55A)

# Deny Yourself...

## AND YOUR RECORDS NO LONGER OF THE BENEFITS OF "IM" LONG-PLAYING NEEDLES

If the unavoidable acute shortage of IM Point-masters has caused you to delay conferring the benefits of IM—the world's Master Needle—on your records you need deny them, or yourself, no longer. The formation in every good record shop of a branch of

**THE "IM" NEEDLE CLINIC** will, at a modest charge, ensure

an adequate supply of new points for your used IM's whenever you need them. If for any reason your dealer cannot repoint for you then send your IM's by post to: The IM Needle Clinic, 112, New Oxford Street, London, W.C.1, with your name and address on the envelope flap, enclosing stamps or P.O. to the required amount plus 3d. return postage and packing.

### National Repointing Prices

10—6d., 20—11d., 30—1/3j, 40—1/8, 50—2/-, and 4d. each 10 over 50. Mail Order customers should add 3d. on all quantities to cover return postage and packing.



### LONG-PLAYING NEEDLES

NO RECORD WEAR • NO SURFACE HISS • NO PICK-UP CHATTER • NO NEEDLE SCRATCH  
 PERFECT TONE • SUIT AUTOGRAMS • ONE BOX OF 10 PLAYS—WITH REPOINTING—1,000 RECORDINGS.

Per "Top-hat" of TEN 2 - (Tax 1/4d.)

Alfred Imhof, Ltd., 112-116, New Oxford Street, London, W.C.1. MUSEum 5944

**WHAT DO YOU WANT IN A MICROPHONE?**

- Excellent Transient Response ?
- Good Frequency Response ?
- Steep Wave Front ?
- High Voltage Output ?
- No Pronounced Resonancy ?

All these, and every advantage for which you can ask is an integral part of the MEICO Moving Coil Microphone. Its new type cylindrical construction, plus the use of Alnico steel, places it definitely in the High Fidelity class. Full details and prices gladly sent on request.



**MEICO**  
 358-360, Station Road, Harrow, Mx.  
 Phone: HARrow 1064-5.

**HIVAC**  
 THE SCIENTIFIC VALVE  
 BRITISH MADE

*Specialists in*  
**MIDGET VALVES**

HIVAC LIMITED  
 Greenhill Crescent,  
 Harrow on the Hill, Middx.

Telephone: Harrow 0895.

*The Voice of the Services*

**SIGNALLING EQUIPMENT LTD.**

**Specialists in Morse Equipment**  
 Makers of Small Transformers, Heavy Duty Resistances, Plugs and Sockets, Fuse Holders, Electric Bells, Buzzers, and Switches. Also Plastic Mouldings, Coil Windings, Light Pressings, Turned Parts, and other components and accessories for the Wireless and Electrical Trades

**Merit House, Southgate Road, Potters Bar**  
 Phone: Potters Bar 3133. Telegrams & Cables: Sel, Potters Bar

**ERG** ON ALL GOVERNMENT LISTS

**Resistors**

MANUFACTURED BY  
**ERG RESISTORS LIMITED**  
 1021a, FINCHLEY ROAD, LONDON, N.W.11



**CLASSIFIED ADVERTISEMENTS.** Rate 6/- for 2 lines or less and 3/- for every additional line or part thereof, average lines 5-8 words. Each paragraph charged separately. *Free Day*: August issue, first post Monday, July 12th one day earlier at branch offices. Box Numbers: 5 words, plus 1/- Deposit System: particulars on request. No responsibility accepted for errors.

## FACT

In the near future our Business will be transferred to larger premises in Petty France, Westminster, S.W.1. All customers will be notified in due course.

## FICTION

Because the name of Dr. N. Partridge has long been pre-eminent in connection with special transformers, individually designed and produced, there are some who have the notion that **PARTRIDGE TRANSFORMERS** are manufactured only in small numbers. This idea is very much out of date.

If you are interested in large quantities—so are we.

*N. Partridge*

Transformer Manufacturers

Kings Buildings, Dean Stanley Street, LONDON, S.W.1. 'Phone: VICTORIA 5035

# ARMSTRONG SERVICE

OUR Service Department is still at your service.

Despite the many changes caused by over three years of war, and the difficulties in material and valve supplies, we have managed to maintain a very large proportion of Armstrong Chassis in good working order.

### IN ADDITION

to practically all Armstrong Chassis, including very old models, we can now undertake the repair and overhaul of many other makes of receivers, including American types.

**ARMSTRONG MANUFACTURING CO.**  
WALTERS ROAD, HOLLOWAY, LONDON, N.7  
'Phone: NORth 3213

**NEW RECEIVERS AND AMPLIFIERS**  
HIGH fidelity ac/dc amplifiers, 18 watts, H.U.D.O. mixing input channels, bass and treble controls, input and output transformers, octal base valves, complete chassis; 18gns.—Below.

**DANCE** and stage transportable amplifying equipment, comprising amplifier as above, m/c microphone, adj. stand, 2 auditorium speakers, cables; 36gns.—Broadcast and Acoustic Equipment Co., Ltd., Broadcast House, Pomblard, Norwich.

**£22 World**—New 7-valve "Wireless World" Quality amplifier, with tone control stage, 8 watts push-pull triode output, price includes Super Quality triple cone 12in permanent magnet speaker with large matched output transformer and all valves; as above but with 15-watt tetrode output, £24; ideal for quality reproduction; limited number available.—Bakers Selhurst Radio, 75, Sussex Rd., S. Croydon. (1698)

**RECEIVERS, AMPLIFIERS—SECOND-HAND**  
R.M.E. 69, DB.20, 1.s. to match, first-class 3 cond.; £50.—G&K, Chilcote, Coalport, Salop. (1826)

**TROPHY B, 1939**, per. con.; no dealers; best offer.—Reynolds, 39, Wood Ave., Uplands, Purfleet. (1824)

**5-VALVE** superhet mains radio, portable. American Sky Chief; £15.—Tem. 3628 (day only). (1825)

**NATIONAL NC44** communication receiver. ac/dc. as new; stamp particulars.—Box 2890, *Wireless World*. (1832)

**R.M.E. 69 A.C.** model, Xtal speaker, excellent condition; best offer above £40.—Cole, 49, Hill St., London W.1. (1774)

**BULGIN T.C. 23** all-wave 7-valve universal chassis and Wharfedale de luxe Gold speaker in cabinet.—Offers to D. King, Stalham Hall, Norfolk. (1831)

**A.C.** communication 8v plus rect. superhet, 12-160 mtrs., built-in spkr., phone jacks, coils switched, AVC BFO; £35.—Box 2892, *c/o Wireless World*. (1836)

**HALLICRAFTER** 26-valve dual diversity communication receiver, with 18in speaker, in fine American walnut cabinet.—Box 2882, *c/o Wireless World*. (1786)

**COMPLETE** 15-watt ac amplifier, tetrodes, push-pull; superhet tuner built in; large energised speaker; little used; £18, or near offer.—Box 2887, *c/o Wireless World*. (1818)

**LISTS** now available under following sections: Receivers, amplifiers, battery chargers, meters, valves, resistances, speakers, components, transformers, scientific instruments, batteries, switch gear; stamp, please, and state sections required.—Harris, Strouds, Bradfield, Berks. (1801)

**H.M.V.** special amplifying equipment, type H. 600, comprising playing desk in bureau cabinet, power amplifier (uses 3 transmitting valves and weighs 2cwt), 30in. moving coil speaker in cabinet (weighs over 1cwt.), with connecting leads and 2 spare transmitting valves in first-class condition, suit dance hall or works, cost £250, accept £95; H.M.V. type 201 moving coil microphone on chrome stand, £7 extra.—Harris, Strouds, Bradfield, Berks.

### Wanted

**COMMUNICATION** receiver, W.W. preferred. —Catchlove, R.A.F. Hosp., Ely. 1805

**12-VOLT** car radio, state make and price.—MacGorry and Co., Campbelltown. (1777)

**MURPHY A40RG** gram; faulty no objection. 8, St. Margaret's Ct., Cannon Pl., Brighton.

**HAMMARLUND** Rx, £29/10; Hallcrafters speaker, £5; together, £34. Box 2891, *Wireless World*. (1834)

**HALLICRAFTERS** Sky Champion or Buddy, or similar receiver, a.c., wanted.—Box 2888, *c/o Wireless World*. (1820)

**WE** Offer Cash for Good Modern Communication and All-Wave Receivers.—A.C.S. Radio, 44, Widmore Rd., Bromley. (1541)

**NATIONAL HRO** communications receiver, 230-volt a.c., must be late model and in good condition.—Box 101, Parris, 121, Kingsway, London, W.C.2. (1813)

**LONDON CENTRAL RADIO STORES** will pay good prices for receivers, radiograms, amplifiers, dynamos, converters, test equipment, electric gramophone motors, and all radio and electrical accessories.—London Central Radio Stores, 23, Lisle St., London, W.C.2. Gerrard 2969. (9836)

### NEW LOUDSPEAKERS

**£3/15** only.—Brand new Super Quality triple cone permanent magnet speaker, made by Bakers Selhurst Radio, the pioneer manufacturers of moving-coil speakers since 1925; wide frequency range, even response, ideal for quality reproduction; limited number available under list price; send 2½d. stamp for leaflet describing above and giving constructional details of infinite baffle cabinet; every music lover interested in realistic reproduction should write for leaflet now.—Bakers Selhurst Radio, 75, Sussex Rd., S. Croydon.

Advertisers and buyers are reminded that under Defence Regulations 1939, Statutory Rules and Orders 1940, Number 1689, a permit (T 99 G) must be obtained before sale or purchase of certain electrical and wireless apparatus, particularly such valves and apparatus as are applicable to wireless transmission.

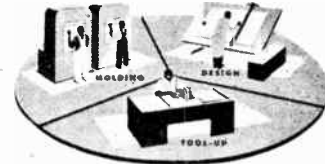

**WHEN** you think of plastic mouldings for post-war products we suggest you consult the Kurz-Kasch "Plastic Round Table"—a group of specialists in design, materials, tool-up and moulding. Kurz-Kasch can give you complete service under one roof, one responsibility.

Register your name with our representative now. He will forward you information of our products as soon as they become available.

## KURZ-KASCH INC.

Moulders of Plastics,

DAYTON . OHIO  
U.S.A.

Exclusively Represented by—

Frank Heaver Ltd. Kingsley Road, Bideford, N. Devon

## L.R.S

## STUART PUMPS

As supplied to Govt. Dep'ts. & County Councils.

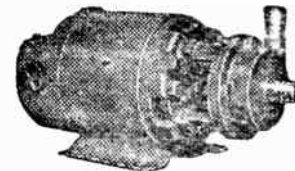

These Centrifugal Pumps are ideal for Machine Tool Cooling and all pumping purposes—hot or cold water. Supplied complete with foot-valve, strainer and hose union. Suitable rubber hose available from stock.

No. 10. 100 gals. per hour. Carr. 2/- extra £5 2 8  
No. 11. 280 gals. per hour. Carr. 2/- extra £8 6 0  
No. 12. 860 gals. per hour. Carr. 3/- extra £7 12 0  
Please send 2½d. stamp for specification.

**The STUART AUTOMATIC FLOAT SWITCH** is the best method of controlling water. Post Paid level. Price complete with all fittings .. £2 6 0

## LONDON RADIO SUPPLY CO.

Est. 1926

Ardingly Road, Balcombe, Sussex.

# VALVES

(RETAILERS NOT SUPPLIED)

Mullard numbers generally quoted, but we may send E.V.A. equivalents. Prices quoted are current retail. PM12, 11/-; PM12M, 11/-; SP2, 11/-; VPS, 11/-; VP22, 11/-; FOS, 12/10; FOS2, 12/10; PM12L, 5/10; PM22L, 5/10; PM2A, 7/4; PM22A, 11/-; PM22D, 11/-; TDD2, 9/2; also Marconi Osram F2, 18/3; L2, 7/4.

4-VOLT A.C. MAINS TYPES  
ACTP, TH4A, TH4B, FCA, 14/-; VP4, SP4, VP4B, SP4B, W42, AC5Pen, 12/10; TDD4, MHD4, 11/7; H4E, 35/4V, H4, 9/2; FM24A, FW4/500, 18/3; Pen B4, 14/8; Pen 4DD, 15/3; Pen 42B, 20/6; also Cosor MSPen, MVSPen, MSPenB, MVSPenB, 12/10.

A.U./D.C. TYPES  
C1, C1C, 10/6; FC13, FC13C, TH21C, TH30C, 15/2; UG6, 11/5; VP19C, SP19C, 6D2, 6D2, 12/10; HL13C, 2D13C, 2D13A, 9/2; TDD13C, 11/7; CL39, 12/10; CBL1, 12/3; VP133, KT1, KT36, 12/10; also Cosor VP13A, SP13A, 12/10; VP20 & SP20, equivalent, 15/3.

MAKDA OCTALS  
TH41, 14/-; VP41, 12/10; SP41, 12/10; DD41, 15/-; UG6, 11/5; HL41DD, 11/7; HL42DD, 11/7; Pen 4A, 12/10; Pen 4DD, 15/3; UG7, 11/7; TH233, 14/-; HL13SD, 11/7; VP133, KT1, KT36, 12/10; M123, 5/10; Q225, 15/8; VP23, 11/-.

MULLARD E TYPES  
EB4, 12/10; EBC3, 11/7; EBC33, 11/7; EBF2, 16/3; EBL1, 16/3; EBL31, 16/3; ECH2, 14/-; BOH3, 14/-; ECH33, 14/-; ECH35, 14/-; BPS, 14/-; BPS, 14/-; EFS, 12/10; BFO, 12/10; BFB9, 12/10; BKS, 14/-; BKS, 15/3; EL2, 14/-; EL32, 14/-; ELA, 12/10; EL33, 12/10; AZ1, 11/-; EM4, 11/-; CBL1, 12/3.

AMERICAN VALVES  
O1A, 11/-; O2A, 15/3; 1B4, 15/-; 1B5, 15/-; 165, 15/-; 175, 15/-; 2A6, 14/-; 2A7, 15/-; 2B7, 15/-; 5Y3, 5Y4, 5Z4, 14/6; 6A6, 18/3; 6AG6, 12/10; 6A7, 14/-; 6A8, 14/-; 6B6, 13/-; 6B7, 14/-; 6B8, 15/3; 6C6, 12/10; 6C8, 17/6; 6D6, 12/10; 6P5, 9/8; 6F6, 12/10; 6F8, 18/2; 6H6, 6/10; 6T7, 19/10; 6J8, 19/10; 6K3, 14/-; 6K5, 15/-; 6K7, 19/10; 6L7, 12/10; 6M6, 18/3; 6Q7, 11/7; 6R7, 11/7; 6SA7, 14/-; 6C07, 18/3; 6K27, 12/10; 6T06, 14/-; 6V6, 12/10; 6X5, 11/-; 6E3, 18/3; 6E5, 18/3; 15, 18/-; 19, 18/-; 24, 19/-; 25A6, 12/10; 25L6, 12/10; 25G6, 11/-; 27, 9/2; 29, 14/-; 30, 12/1; 31, 12/1; 32, 15/-; 33, 14/-; 34, 15/-; 35, 13/-; 36, 12/10; 37, 15/-; 38, 17/7; 39, 18/6; 42, 12/10; 46, 15/-; 49, 18/6; 50, 25/-; 52, 23/-; 53, 16/6; 55, 13/6; 56, 19/-; 57, 14/-; 58, 18/-; 59, 18/6; 71A, 14/6; 75, 14/6; 77, 19/10; 78, 12/10; 79, 18/3; 80, 14/6; 81, 21/-; 85, 12/1; 89, 18/6.

## SPARES

ELECTROLYTIC CONDENSERS, T.C.C., 570 volt, 32 and 32 and 16mf., separate leads, 24/-. ROLA F.M. SPEAKERS, 4 inch, fits most midgets, 17/6. 8 inch, 24/-. CEMENT for valve and speaker cone repairs, 5/- tin. SERVO MOTOR—more than a switch cleaner, 5/- 1-pit tin. MAINS DROPPERS, 3 or 2 amp. working, adjustable to suit any receiver or as line cord replacement, total ohms 900. FLUX CORED SOLDER, 1/- per coil or 5/6 lb. TINNED COPPER WIRE, 22 gauge, 1/6 reel. SLEEVING, 3/6 doz. yds. VALVE HOLDERS, all types PaX., 1/- each.  
COMPLETE LIST OF SPARES, 14. POST FREE. When making enquiries, enclose stamp for reply, also ask us to send the items if in stock C.O.D. (pay the Postman).  
POSTAGE MUST BE ADDED ON ORDERS UNDER 23

**J. B. BULL & SONS**  
246, HIGH ST., HARLESDEN, N.W.10



## W. BRYAN SAVAGE LTD.

Expert assistance in the solution of problems relating to

- TRANSFORMERS, CHOKES
  - AMPLIFIERS
  - POWER UNITS
- and Specialised Equipment embodying
- ELECTRONIC CONTROL**

WESTMORELAND RD., N.W.9.  
COLINDALE 7131

**GOODMAN'S** infinite baffle speaker.—Catch love, R.A.F. Hosp., Ely. [1806]

**SECONDHAND LOUDSPEAKERS**  
THREE public address F.I. type L.S.7 speakers, 40in straight all-metal exponential air column, with latest type L.S.7 permanent-magneto screw-on units, guaranteed in sound condition at 11gns each; carriage paid.—Watson, 24, Low St., Banff. [1782]

**REQUIRED**, good 12in. speaker.—Woodhall, Green Park Hotel, Aston Clinton, Bucks.  
**HARTLEY TURNER** Duode speaker.—Wright, 17, Hilleide Ave., Cheshunt.  
2 speakers, Rola G12, Sound Sales, or sim., p.m. type, also record player.—Tiffany, 9, Marlboro' St., Bath. [1809]

**NEW MAINS EQUIPMENT**  
**VORTEXION** mains transformers, chokes, etc., are supplied to G.P.O., B.B.C., L.P.T.B.; why not you? Imitated but un-equalled; orders can only be accepted against Government contracts.  
**VORTEXION, Ltd.**, 257, The Broadway, Wembley, London, S.W.19. Tel. Lib. 2814. [9942]

**MORSE EQUIPMENT**  
FULL range of transmitting keys, practice sets and equipment for Morse training.—Webb's Radio, 14, Soho St., London, W.1. Tel. Gerrard 2089. [9553]

**TEST EQUIPMENT**  
**MULLARD** test board, type 7629, as new, with quantity cards; £40.—Armitage, White Cross, Guiseley, nr. Leeds. [1807]  
**TESTSCOPE**, used everywhere by radio test service engineers, makes 20 important tests; send for interesting leaflet "R1".—Runkaben, Manchester, 1. [1074]

**Wanted**  
**RCA** Junior Voltohmyst, new or second-hand, wanted.—Randall, 379, Derby Rd., Lenton, Nottingham. [1788]  
**COLAR** capacity Analyser and resistance C bridge, universal model for AC or DC; several instruments are required, first-class condition imperative.—Offers to Box 2883, c/o Wireless World. [1789]

**GRAMOPHONE EQUIPMENT**  
**Wanted**  
**HYPERSENSITIVE** pick-up and arm, Marconi or H.M.V., must be in perfect condition; good price paid. Gordon, 83, The Hill, London, S.W.19. [1817]

**COMPONENTS SECOND-HAND, SURPLUS**  
**ENERGISED** speakers, h.t. metal rectifiers, small fixed tubular condenser, 1/2-watt resistance.—R. C. Wallis, Pinner 2839. [1778]

**RADIO** components for sale.—Some of these are unobtainable to-day.—Send requirements to A. Allen, Shutford, nr. Banbury.  
**OFFERS** wanted, both guaranteed brand new, model 40 Universal Avometer, Hallcrafters SX23 matching speaker, in original carton. Wanted, Hallcrafters PM12C speaker, as used on SX17; also HRO 6-volt power pack.—Box 2885, Wireless World. [1811]

**TRANSFORMERS**—Philips, 120-245v prim. T 300+300v, 4v+4v ct; ditto, but 6.3v ct+4v, 15/-; vibrator converters, Philips, dc to ac, 200-240v, complete with smoothing but require attention, 10/-; valves, slightly used, guaranteed, EBL1, 9/-; EK3, 9/-; EL3, 8/-; Pen A4, 8/-; AZ1, 7/-.—Rowe, 6, Beaufort Terrace, Beaufort, Mon. [1815]

**THE RADIO INSTRUMENT SERVICE** components, see displayed advertisement in this issue. Now available: volume controls, all sizes, w/s 4/9, 1/s 3/6; ganged controls, 6/9; speaker bobbin replacements, 2/9; toggle switches on/off, 2/11; D.P., 3/6; 4 waveband Yaxley 6 bank, 8/6; 5,000-ohm pots for bridges, 5/6; Dubilier 1w resistors, 3,000, 5,000, 10,000, 9d. each; 500-ohm 2-watt, 9d. each; bias, 15mf, 9v, 4v, 25mfd, 10d.; 25/25, 1/6; mica condensers, all rap, 6/- doz.; silver mica, 3/6 doz, assort.; Rothermel crystal p-pads, 23/18/9; crystal cutters, 23/12/6; speakers, large range, 5in to 10in, full particulars send for new list (2d).—The Radio Instrument Service Co., 116, Littleheath Rd., Bexleyheath.

**LASKY'S RADIO**, 370, Harrow Rd., Paddington, W.9, offer for sale the following condensers: 0.15mfd 2,000v at 1/6 each, 0.02mfd 2,000v at 1/- each, 0.23mfd 2,000v at 1/6 each, 0.05mfd 2,000v at 1/- each, 0.002mfd 2,000v at 1/- each; 2mfd cond., 700v, at 2/6 each; 50mfd 12v tubular, 16/- doz, 25mfd 25v tubular, 18/- doz; 0.1mfd 350v tubular, 6/- doz; 10mfd 25v tubular, 1/6 each; speakers, speaker output transformers from 6/-; 6in Rola speakers, less transformers, at 17/6, plus postage; 8in Rola speakers, less transformers, at 21/-, plus postage; 5in Rola speakers, less transformer, 17/6, plus postage; 8in Rola speakers, with transformers, 27/6; 10in Rola speaker, less trans., 31/6, plus postage; terms cash with order or c.o.d. Send us your requirements. [1737]

# The little more — how much it is...

In every Gardner Product the presence of 'the little more' is clearly discernible. And amply proven by the performance! In the Gardner range of Quality Transformers the 'plus' feature is particularly prominent in the group of Small Power Transformers up to 4 kVA. So when next you have a specification which calls for 'the little more,' Gardners will be happy to cooperate in seeing that you get it.

We regret that at present Small Power Transformers are available for highest priority orders only.



**GARDNERS RADIO LIMITED**  
SOMERFORD · CHRISTCHURCH · HANTS

# MORSE CODE TRAINING

If you wish to become a proficient W/T Operator, or, if you are already an Operator and desire to increase your present sending and receiving speeds as well as to improve your technique, then apply for a copy of the Candler "Book of Facts."

Numerous students trained by the Candler system are now W/T Operators in the ARMY, NAVY, AIR FORCE and MERCHANT SERVICE, whilst many others are doing W/T work of national importance. Full details of the following Courses are given in the Candler "Book of Facts."

**THE JUNIOR Scientific Code Course** for beginners teaches all the necessary code fundamentals scientifically.

**THE ADVANCED and High-Speed Telegraphing Course**, for operators who want to increase their w.p.m. speed and improve their technique.

**THE TELEGRAPH Touch-Typewriting Course.** Fill in the Coupon and learn more about this highly efficient Candler method of Morse Code training in your own home.

Code Courses on Cash or Monthly Payment terms.

## COUPON

Please send me a Free Copy of Candler "Book of Facts."

NAME .....

ADDRESS .....

Post Coupon in 1d. unsealed envelope to: —  
**THE CANDLER SYSTEM CO. (Room 55W),**  
121 Kingsway, London, W.C.2  
Candler System Co., Denver, Colorado, U.S.A. (743)



**E.H. WILSON**

**A.C. & BATTERY  
CONSTRUCTORS' KITS**

**3-v.**

**T.R.F.**

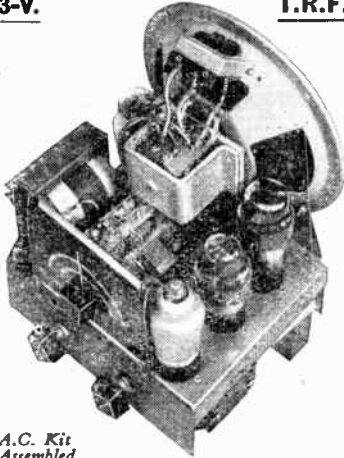

**A.C. Kit  
Assembled.**

When assembled these Kits give excellent reproduction on Medium and Long Waves. Supplied complete with chassis 8in. x 6 1/2in. x 2 1/2in., Valves, M.C. Speaker, and wiring diagram. (Regret, no cabinets.) 3 controls. **A.C. 3-V. (+ RECTIFIER) KIT.** V.M.H.F. Pen., Triode, L.F. Pen., Rectifier, 6in. or 7in. M.C. Speaker. Price **29 9s.** Post 1/1, plus 3/6 packing (returnable).

**BATTERY 3-V. KIT.** V.M.H.F. Pen., Triode Detector and Output Tetrode, 6in. or 7in. P.M. Speaker. Price **26 10s.** Post 1/1, plus 3/6 packing (returnable).

**KINDLY NOTE.** We cannot undertake the assembly of these Kits. Many readers have asked us to do so, but present conditions make it impossible. Awfully sorry!

Orders executed in rotation. Delivery approx. one month. No C.O.D.

**● CALL FOR DEMONSTRATION ●**

**WESTECTORS,** Type W6, 5/-.  
**VALVE HOLDERS,** English and American, 4-, 5-, 6- and 7-pin, 6d. each. International Octal, 9d.

**AERIAL AND H.F. COILS,** with reaction. Long and Med. Circuit, 8/6 per pair.

**OCTAL CABLE** Plugs and Sockets, 2/- each. **SCREENED** Valve Top Cap Connectors, English or Octal, 1/- each.

**NEW STEEL CHASSIS,** Painted, 10 x 8 x 2 1/2, 7/6; and 8 x 6 x 2 1/2, 4/6 each.

**10 WATT WIRE WOUND RESISTORS.** 2,000, 500, 150 ohm, 2/6 each.

**MAINS VOLT DROPPING RESISTORS,** 2-amp. 1,000 ohms, with two variable tappings 4/6 each. Also .3 amp. 750 ohms, one variable tapping, 6/- each.

**MICA CONDENSERS,** .001 2,200 v. test, 1/6; .0001, 1/-; .01, 1/6.

**TWIN PADDERS,** Ceramic, 300-600 mmfd., 1/6.

**YAXLEY** type 3-bank, 2-pole, 4-way, with screening shield. Complete, new, 7/6.  
**YAXLEY** type 2-bank, 2-pole, 2-way (shorting switch), 5/6.

Licence to export to Northern Ireland and Irish Free State. Please add postage for enquiries and mail orders.

**51-52, CHANCERY LANE  
LONDON, W.C.2. Telephone HOLborn 4621**

**LONDON CENTRAL RADIO STORES** offer the finest radio and electrical bargains.

**ELECTRIC** soldering irons, 200-250v, 75 watts; 12/6; post 8d.  
**6** **PUSH-BUTTON** mechanism only unit, complete with buttons; 4/6; post 9d.  
**T.C.C.** condensers, 0.1mf 5,000v, dc wkg.; 9/6 each; post 8d.

**S** **CREENED** cable, fine quality, heavy duty, 15 strand, 30 gauge, 5mm rubber covering, with two layers of Empire tape, 1/9 yd. **R** **UBBER** covd. flex. wire, tinned copper, approx. 17 strands, 9ft lengths; 3d. yd. **P** **HILCO** bleeder resistances, in metal cans, 100, 150, 250ohms; all 10v; 2/6; post 3d. **T** **UBULAR** condensers, 0.5mf, 500v working; 2/6; post, etc., 4d.

**M** **ULLARD** EAO50 diodes, 60mm x 12mm overall, 6.3v heater at 15a; 10/6; post 3d. **P** **OTENTIOMETERS,** carbon: 700.000ohms, less switch, 3/6; 100.000ohms, with 2-pole m and b switch, 4/6; post 6d.

**LONDON CENTRAL RADIO STORES, 23, Lisle St., London, W.C.2. Gerrard 2969.**

**COULPHONE RADIO, New Longton, nr. Preston.**—Brand new goods only; mains transfs., 350-350 120ma, 4v 6a, 4v 2.5a, 28/6; p.m. speakers with transfl., 8in. Celestion, 24/6; 5in. Rola, 24/6; Tungstram valves; cored solder, 4/6 lb. Barretter resistors, 6/-; line cord replacement resistors, 800 ohm, 2 adjust. taps, 6/9; electrolytics, 50mf, 50-volt, 3/3; Eric 1-watt resistors, all values, 9d. each; pushback wire, 100ft. coil, 6/-; switch cleaner, 2/3 bottle; heavy pentode transformers, 7/6. S.a.e. for stock list. [1787

**BATTERY** charging.—Charger kits, transformer, rectifier and ballast bulb for 2v, 6v, 2amp charger, 42/6, postage 9d.; ditto for 2v to 12v 2.5amps, 59/6; transformer and rectifier for 2v 0.5amp charger, amazingly efficient little charger at a modest price, 14/6, post 7d.; metal rectifiers, 6v 0.5amp, 6/3; 12v 0.5amp, 11/9, post 4d.; 6v 2.5amp, 15/9; 12v 3amp, 34/6, post 7d.; instructions supplied; instrument rectifiers for meters, bridge type, good make, new, 5ma, 10ma, 15/6; 1ma, 18/6; 50ma, 12/6, post 3d.; Rothermel Bullet crystal microphones, black crackle finish, quality equal to £5/5 model, £3, post 10d.; also a few only D.104 type, £4/15; miniature deaf aid crystal mikes, 42/6, post 6d.; few only Rothermel bakelite crystal pickups, 78/6; milliammeter, 1ma, full scale, 65/-;—Champion, 42, Howitt Rd., London, N.W.5.

**SOUTHERN RADIOS** Wireless Bargains: 6/- gross assorted screws, 6/-, 6/- gross soldering tags, including spade ends, 6/-, 7/6. Philco 3-point car aerials. Make excellent short-wave and home aerials. Complete with fixing bolts, etc., 7/6. 10/- limit tone arms. Universal fixing for all types of sound box and pick-up heads, 10/-, 7/-, Ace "P.O." microphones, complete with transformer. Ready for use with any receiver, 7/-, 30/-, Eric resistances, 100 assorted resistances, 1/4, 1/2, 1 and 2 watt. Sizes from 0.8 ohm upwards. Brand new, with wire ends, 100 for 30/-, 65/-, special assorted parcel for Servicemen, 100 Eric resistances, assorted sizes, from 0.8 ohms upward, 1/4, 1/2, 1 and 2 watt; 24 assorted tubular condensers, 0.01, 0.05, 0.1, etc., up to 6 mfd. 50 volt; 6 reaction cond. condensers; 12 lengths sleeving; 75ft. push-back wire; soldering tags, screws and wire. All brand new, 65/-, 1/6, powerful circular magnets, 1 1/4in. diameter by 3/16in. thick, 1/6 each, 15/- per dozen. Tungstram H.R. 210 valves. General purpose battery type, 4/9; crystals (Dr. Cecil), 6d. each, 5/6 per dozen; with cats-whisker, 9d. each, 8/- dozen; complete crystal detectors, 2/6; 75ft. covered wire for aerials, etc., 2/6; 25 yds. push-back wire, 5/-; crystals cups, 6d. each, 5/- dozen; Telsen reaction condensers (0.0001), 1/9 each, 18/- dozen; Telsen large disc drives, complete with escutcheon, knob, etc. type W184, 3/- each, 30/- dozen; insulated sleeving, assorted yard lengths, 4/- per dozen; single screened wire, 12 yds., 10/-; M.E.S. holders (miniature screw bulb holders), metal, 7 1/2d. each, 6/- per dozen. Many other bargains for callers.—Southern Radio Supply Co., 46, Lisle St., London, W.C. Gerrard 6653. [1599

**Wanted**

**FERRANTI** AF7c or cs, AF5c or cs, sound condition.—Box 2884, c/o *Wireless World*. **VIBRATOR** unit to give 20-25 ma at 120-150 volts.—Details and price to Redlands, Colebrook, Crediton, [1822

**W** **W.** O.P. transformer and mains transformer for P.P. qual. amplifier.—Oliver, Wellesbourne, Allestey, Coventry. [1829

**DYNAMOS, MOTORS, ETC.**

**A** **L** **L** types of rotary converters, electric motors, battery chargers, petrol-electric generator sets, etc., in stock, new and second-hand.

**W** **A** **R** **D.** 37, White Post Lane, Hackney Wick, E.9. Tel. Amherst 1393. [0518

**EXCEPTIONAL BARGAINS!**

**LABORATORY GEAR.** Mirror Galvos. Sullivan Marine Reflecting vertical M.C. suspen., £9 10s. Tinsley Ballistic ditto, £4 10s. Mahog. Stand Scales for Spot use, £2 10s. Wheatstone Bridges and 142M Resistance boxes quoted for. A number of ex-W.D. Wheatstone Bridges, less coils, cheap. Circuit testing G.P.O. Vertical Galvos., 35/-, Mag. Ringer and A.C. Bell, 25/-. We can still supply Siemens High-Speed Relays, Meggers, A.C. Panel Voltmeters, Relays and Alternators, 10,000 ohm Relays, etc.

**WAVEMETERS AND RADIOGONOMETERS.** We have some ex-W.D. Wavemeters, Buzzer and Heterodyne, less calibration chart, 45/- and 70/-. Radio Direction-Finders in mahog. cases, 90/-.

**RELAYS.** Telephone No. 6 twin bobbin polarised 8-P Change-over, 6 volts, 25 m.a., 8/6. No. A "on-off" 8-P, 2 volts, 5/-, Less contact blades 1,000 ohms coil C.T., 2/6. Relay enclosed 10,000 ohm tele-type, 22/6.

**MORSE KEYS.** Type B.1. A strong Key, 5/-, Bakelite base, type M, 6/6. American type, Brit. made "Speed" key, 8/6. A first-class type P.F., plated fittings, well balanced, 9/6. The best Key available is the IV., 12/6.

**BUZZERS.** Bakelite, 3/6.

Neat brass-cased Buzzer, 5/6.

Heavy type Bakelite Buzzer, 5/6.

Townsend Micro Buzzer, as illustrated, 10/-.

Perfect Morse Home Training with a practice Recording Inker, spring drive needs no battery, marks direct on tape with dead key. For novice or expert, Government type £3 10s.



**MAGNETS.** Massive horse-shoe permanent steel magnets. Various sizes, 3/6 and 4/6 each. Winder midget 2 oza. Disc P.M. Magnets as last advert., 2/6 each.

**A.C./D.C. MAINS MAGNETS,** 2-pole, 110 volts or 220 volts, 5/6. Small 12-volt solenoids with 2in. x 1/4in. plunger, 6/6.

**CONDENSERS.** Solo High-grade Variable .0005 mfd. in original carton, logarithmic vance, 4/6. Fixed Condensers, 2 mfd. smoothers, G.P.O., 2/6. Dubilier and T.C.C., .25 mfd., cased, 2/-, H.T. Mica, .25 mfd. for 4,000 volts, 10/-, Large 1 mfd., metal-cased, 2,000 volts, 10/6, 1 mfd. oil-filled case, B.I., 6,000 volt condensers, 35/-, 2 mfd., 4,000 volts, 45/-.

**PLUGS AND SOCKETS.** Radio 2-pin socket and plug 9d. pair. Sockets mounted on panel, 4/6 doz. pairs. 5 pair socket strip panel and one plug, 2/-, Model 5-pin plugs with panel socket and cords, compact type, 4/6 pair. 14-way plug and socket with cord, 7/6. 4-way flex cord, 5ft., 2/3.

**MORE RADIO SUNDRIES.** Headphones, 12/6. Headbands, Steel, double Brown's type, 2/6. Single receivers, 4/6. Crystal Catwhisker Detectors, 2/6. Spare Crystal, 1/- tin. Perikon permanent, 2/6. Carborundum, 7/6. Inter-valve Transformers, Ericsson type, 5/-, Telsen, Telexor Dials, 4 control, 5/-, 1 control, 2/6. Slow motion Dials, 4/6. Panels, cut square and finished, some drillings, 1/4in. thick, 6 1/2in. x 1 3/4in. aluminium, 3/-, Bakelite ditto 6 1/2in. x 7 1/2in., 2/6.

**HANDCOMS.** Government all-metal Field Handcoms, Micro-telephones or Transceivers, for portable or fixed telephones. The famous No. 16 Handcom used in so many field sets. Sturdily built with mike finger switch, as new but no cord, 12/6. Limited number available. Similar Handcom, less switch and no cord, 7/6. A Home Guard can make a complete pocket telephone with these, a mike, transformer, buzzer and a torch battery.

**LIGHT RAY CELLS.** Selenium Bridge, in Bakelite case. Raycraft Model, 21/-. Electro cell, self-generating, light meter type, 35/-, Raycraft Ray Set, with relay, 42/-.

Please add postage for all mail orders. Send stamped envelope for replies to all enquiries.

NOTE NEW ADDRESS. CALL AND SEE US.

**ELECTRADIX RADIOS,  
214, Queenstown Road, Battersea, London, S.W.8  
Telephone: Macaulay 2159**



**RADIO INSTRUMENT SERVICE CO.**

**MANUFACTURERS & DISTRIBUTORS OF COMPONENTS TO THE RADIO SERVICING INDUSTRY**

**MAINS TRANSFORMERS.**

We are now accepting orders for CHOKES, MAINS TRANSFORMERS and the OP12 OUTPUT TRANSFORMER. DELAYED Delivery on some types is inevitable, the new factory is steadily showing a larger output, but very heavy contracts of priority work have yet to be met. New machinery coming into use daily, will eventually enable us to effect delivery of all types with the minimum of delay. TO THOSE AWAITING DELIVERY of recent orders, OUR APOLOGIES . . . everything is being done to meet your requirements in as short a time as possible. ALL ORDERS ARE TAKEN IN STRICT ROTATION. PLEASE QUOTE CONTRACT NUMBERS WHERE AVAILABLE, naturally these are attended to before home receiver replacements. Type. Primaries. Common./210/230/250v. 50/60 c/a.

- A 350-0-350v. 80/100ma., 4v. 2a. and 4v. 4a. CT. . . . . 25/-
- B 350-0-350v. 80/100ma., 5v. 2a. and 6.3v. 4a. OT. . . . . 25/-
- S 350-0-350v. 80ma., 4v. 2a. and 4v. 2a. 4v. 4a. OT. . . . . 25/-
- T 350-0-350v. 80/100ma., 4v. 2a. and 4v. 2a. and 4v. 2a. and 4v. 4a. CT. . . . . 32/6
- X 350-0-350v. 120ma., 4v. 2a. and 4v. 7a. CT. 35/-
- Y 350-0-350v. 120ma., 5v. 2a. and 6.3v. 5a. CT. 35/-
- Z 500-0-500v. 120ma., 4v. 2a. and 4v. 7a. CT. 39/6

Postage on 100ma. range 1/2. 120ma. 1/6. Dimensions: Type A, B, S, 1 1/2in. x 4in. x 3 1/2in. T, X, Y, 1 1/2in. x 4in. x 4 1/2in. Type Z, 1 1/2in. x 4in. x 4 1/2in.

**OP12 OUTPUT TRANSFORMER. 39/6.** Post Free. Produced for amplifiers, PA, and industrial installations where large outputs and multiple speakers are required. Primary 180ma.

Primary and secondary tapped to match Power, Pentode, and Push-pull, enabling a choice of three ratios.

- SMOOTHING CHOKES.**
- OH1, 60/90ma., 8.6. OH2, 120ma. . . . . 17/6
- MAINS FILTER CHOKES.**
- (Air cored HP), 1a. . . . . 2/9

See Classified Advertisement, page 28

**RADIO INSTRUMENT SERVICE CO.**

(G. Lavington)  
**116, Littleheath Road, Bexleyheath,**  
Works: Bexleyheath and Welling

**PLAN YOUR FUTURE NOW**

Big developments in radio and television have been forecast. There will be splendid opportunities for technically trained men to secure well-paid positions. Hundreds of our students now doing important work owe their progress solely to our training. Our specialised method of Home-Study tuition is a proved success. Now is the time to prepare yourself for well-paid employment or profitable spare-time work. Post coupon for free details of our Home-Study Courses in Radio Reception, Transmission, Servicing, Radio Calculations, Television and Mathematics.

**YOU MUST KNOW MATHS.**  
If you wish to make progress in any type of technical work, you must know maths. Our method of tuition makes maths. really interesting and easy to understand.

**T. & C. RADIO COLLEGE**  
**2, THE MALL, EALING, W.5**

★ Please note new address ★

(Post in unsealed envelope, 1d. stamp.)

Please send me free details of your Home-Study Mathematics and Radio Courses.

NAME .....

ADDRESS .....

W.W.19 .....

**1000-watt rotary converter,** Crompton Parkinson, 230v. dc to 230v. ac, 50 cycles; £25.—Harris, Strouds, Bradfield, Berks [1800]

**CRYPTO commutating rectifier,** input 200-250v. ac, output 15v. 5a. dc, with switchboard; £15/10.—Harris, Strouds, Bradfield, Berks. [1800a]

**HUNDREDS in stock,** dynamos, rotary converters, ac and dc motors, electric light plants and accessories; lists available, stamp, please.—Harris, Strouds, Bradfield, Berks.

**I.T. dynamos for charging.** Lucas-Rotax, L 6-12v 8 amps dc, 3rd brush, weight 11lb, size 8in x 4 1/2in, unused ex W.D., cost £10, to clear 17/6 each; ht and lt G.E.O. double-current 6v and 600v, 17lb ditto, 27/6; all carr. paid England and Wales.—Electradix, 214, Queenstown Rd., Battersea, S.W.8. [1748]

**VALVES**

**IF you cannot obtain that wireless valve,** try Dowsett and Co., Ltd., 48, Grove Rd., Eastbourne. Stamp reply. [1779]

**5000 valves,** all types, outputs, rectifiers, etc., s.a.e.—Davies, 28, Mount Vernon Crescent, Barnsley. [1649]

**VALVES! valves!**—Napier has a huge selection of British and American valves suitable for mains or battery radios; a stamped addressed envelope brings you our comprehensive list.—Napier, 127, Prestwick Rd., Ayr.

**WE have a large stock of new and boxed valves,** all guaranteed, at retail prices, plus tax; also U.S.A. lease-lend types for replacement; send us your requirements.—Lasky's Radio, 370, Harrow Rd., Paddington, W.9. [1738]

**NEW American valves,** about 150; types 6H6, 12A5, 56, 1A6, 15, 30, 31, 32, 33, 71a, 1A4, 46, 6D7, 2B7, 19, at 6/- each; types 6V6, 6X5 at list price; or would consider offer for total quantity.—Metropolitan Radio Service, 1021, Finchley Rd., N.W.11, Speedwell 3000. [1830]

**1000 valves in stock;** U15, U16, U17, AC/SPEN, PEN45, PEN45DD, TH4B, VP4A, PEN383, TP1340, AC/TP, QP22B, TP26, 35, 45, 80, 35Z4GT, 6Q6GT, 117Z6GT, 6K7G, 6L7G, KTW6, 117, 5Y3, 6C6G, 6D6G, 6V6G, 6F6G; send s.a.e. for valve and wireless parts lists, 2d.—Ransom, 9 and 34, Bond St., Brighton. [1697]

**RADIO valves in stock**—D63, 6.9, inc. tax: 6F5G, MH4, 6C5G, HL13C, 354V, 2D13A, 9/2 each, inc. tax; VP2B, AZ1, 80, 5V4G, 5Y3G, 117, inc. tax; 2P, D14, TD13C, 6Q7G, 75, 6L7G, AC/HL/DD, DL63, 11/7 each, inc. tax; 25A6, 42, 5P4, VP4, MSPEN, 78, EL3, 6J7G, 6F6G, 12/10 each, inc. tax; QP21, EBL1, TH21C, 15/3 each, inc. tax; X63, EFS, ECH35, TH4B, 6A8G, FC130, ECH3, EL2, 14/- each, inc. tax; please send cash with order, as these valves are now in stock; include sufficient to cover postage; enquiries for other types welcomed.—Radio Department, Arding and Hobbs, Clapham Junction, London, S.W.11. [1785]

**ENGLISH and American valves.**—1A5, 1A7, 1C5, 1H5, 1T5, 6A5, 6A7, 6F5, 6F7, 6E5, 6T5, 6F6, 6K6, 6K7, 6K8, 6Q7, 6W5, 6Y5, 6J7, 6F6, 6C5, 5Z4, etc., 12A8, 12B8, 12F5, 12J7, 12K7, 12Q7, 12S47, 12BF5, 12SJ7, 12SK7, 12SQ7, 12T3, 25A6, 25A7, 25B8, 25L6, 25Z6, 32L7, 35L6, 35Z4, 35Z5, 45Z5, 50L8, 70L7, 41, 45, 43, 46, 47, 57, 58, 59, 79; L/L valves are for replacement only; English valves include HL2, 823, VP21, W21, MKT4, MX40, MH4, ML4, H30, PX25, MU14, U31, U50, etc.; normal retail prices plus tax; enquiries s.a.e. please; c.o.d. or c.w.o.—Dale Electric Co., 13, Tretawn Gdns., London, N.W.7. [1827]

**Wanted**

**WANTED, IT5 valve.**—Evans, The Vicarage, Box, Wilts. [1795]

**WANTED,** one 12J5 valve.—Tilley, 122, Broomfield Rd., Chelmsford. [1797]

**VALVES wanted,** any quantity from one upwards; also test equipment, service sheets and spares.—J. Bull, 246, High St., Harlesden, N.W.10. [9732]

**REPAIRS AND SERVICE**

**MIDWEST,** etc., the American experts.—Bennett's, 4, Humberstone Drive, Leicester. **INSTRUMENTS** of all types repaired and calibrated; work guaranteed.—McKissock, 9, Bruce St., Dunfermline. [1681]

**TRANSFORMERS,** motor rewinds, repairs of all descriptions to the wireless trade.—Marshall, 137, Windmill Lane, Nottingham. **METROPOLITAN RADIO SERVICE Co.** guarantee repairs to American and British receivers.—1021, Finchley Rd., N.W.11, Spe. 3000. [9641]

**MAINS transformers service,** repairs, rewinds, or construction to specification of any type, competitive prices and prompt service.—Sturdy Electric Co., Ltd., Dipton, Newcastle-upon-Tyne. [9651]

**MARTIN'S HAVE IT**

**IN STOCK:**

- 2-GANG .005 CONDENSERS,** Slow Motion Drive. Brand New. Boxed. 9/- each.
- STANDARD 3-GANG .0005.** New. 7/- each.
- VOLUME CONTROLS** and Tone Controls, nearly all values, with switch. 6/8 each. Without switch, 4/6 each.
- REACTION CONDENSERS,** .0003. 2/- each.
- VALVE HOLDERS,** American Type, Octal or British Standard 7-pin. 6d. each.
- YAXLEY SWITCHES,** 5-way, 1 bank. 2/8 each.
- YAXLEY SWITCHES,** 3-way, 1 bank. 2/6 each.
- VIBRATORS,** American Crosley, fitted 6-pin, American bases, input 6 Volts. 14/- each.
- 8 M.F.D. TUBULAR,** 500-volt working. 10/- each.
- REPLACEMENT VALVES** for American Midgets. Nearly all types in stock. Controlled Prices.

**MARTIN'S (Edmonton) LTD.**  
**3-4 THE BROADWAY, EDMONTON, N.9.**  
Phone: TOttenham 4188

**WARD ROTARY CONVERTERS**

Petrol Electric Generating Plants, H.T. Generators, D.C. Motors, Frequency Changers, etc., up to 25 K.V.A.

**CHAS. F. WARD**  
**37, WHITE POST LANE, HACKNEY WICK, E.9**  
Phone: Amherst 1393

**TESTOSCOPES**



Makes 20 important tests AC/DC. Used everywhere by Electricians, Wiremen and Service Engineers. Interesting booklet "R14" on testing, free. From all Wholesalers or direct.

**RUNBAKEN -- MANCHESTER -- I**

**GECALLOY RADIO CORES**



**MAIN ADVANTAGES**

- Greater magnification.
- Higher selectivity.
- Small size.
- Reduced costs.
- Robust construction.
- Simple adjustment.
- Non-rusting.

**Salford Electrical Instruments Ltd.**  
PEEL WORKS, SILK STREET, SALFORD, 3  
Telephone: 9Lackfriers 688 (6 lines)  
Proprietors: The General Electric Co. Ltd., England

# GALPINS

## ELECTRICAL STORES

"FAIRVIEW,"  
LONDON ROAD, WROTHAM,  
KENT.

TERMS: Cash with Order. No C.O.D.

Regret Orders from Eire and Northern Ireland cannot be accepted.

**ELECTRIC LIGHT CHECK METERS**, well-known makers, first-class condition, electrically guaranteed, for A.C. mains, 200/250 volts 50 cy. 1 phase 5 amp. load, 10/- each; 10 amp. load, 12/6, carriage 1/-.

**1 KW. FIRE ELEMENTS**, mounted on fireproof porcelain, for 220 volts, as new, easily mounted. Price 6/6, post free.

**1 KW. TRANSFORMER**, input 100 volts at 100 cycles, single phase, output 10,500 volts, centre tapped to earth. Price **£4 10s.**, carriage forward.

**ROTARY CONVERTER**, D.C. to D.C., input 48 volts, output 2,500 volts at 1 kW, condition as new and in perfect order. Price **£10**, carriage paid.

**WATT WIRE END RESISTANCES**, new and unused, assorted sizes (four assortment), 6/- per doz., post free.

**SOLID BRASS LAMPS** (wing type), one hole mounting, fitted double contact, S.B.C. holder, and 12 volt 16 watt bulb. Price 3/6 each, post free, or 30/- per doz., carriage paid.

**HEADPHONES**, 120 ohm, secondhand, complete with headband and cords, in perfect working order. Price 7/6 per pair, post free.

**INSTRUMENT METAL RECTIFIERS**, by famous makers, 10 mA full load, connect your D.C. meter to A.C. working. Price 15/- each, post free.

**TUNGSTEN CONTACTS**, 1/4 in. dia., a pair mounted on spring blades, also two high quality pure silver contacts 1/4 in. dia., also on spring blades, fit for heavy duty, new and unused. There is enough base to remove for other work. Price, the set of four contacts, 5/-, post free.

**220 VOLT DYNAMO**, 9 amp. output, by Lancaster Dynamo Co., shunt wound, speed 1,500 R.P.M., condition as new. Price **£10**, carriage paid.

**AMP METERS**, description as above, range 0-1 1/2 amps. Price 25/-, post free.

**KLAXON MOTORS**, 220v. D.C., 1/10th h.p., shunt wound, ball bearing, fitted reduction gear giving speed of 700 r.p.m., high grade job, condition as new. Price 50/-, carriage paid.

**D.C. MOTOR**, shunt wound, condition as new, high grade, ball bearing, 1/4 h.p., can be supplied in 110 or 220 volts as ordered. Price either voltage, 40/-, carriage paid.

**AUTO-TRANSFORMER**, 2,000 watts, tapped 0-110-200-220-240 volts, as new. Price **£9**, carriage paid.

**VOLTMETERS**, 2 1/2 in. dia., panel mounting moving coil, modern type, by famous maker range 0-120v. and 0-8v., F.S.D. 5 m.a. State which reading required. Price 32/6, post free.

**AMP METERS**, description as above. Ranges 0-1/2, 0-1 and 0-20 amps., F.S.D. 15 m.a. State which reading required. Price 25/- each, post free.

**ZENITH VITREOUS RESISTANCES**, size 5in. by 1in., 5,000 ohms, to carry 100 and 150 m.a. Two sizes. Price 4/- each, post free.

**DUBILIER RESISTORS**, new lead and wire ends 2 watt, 30,000 ohm, 1/6 each or 15/- per doz., post free. Ditto, 1 watt, 5,000 ohm, 3/6 per doz., post free.

**RESISTANCE MATS**, size 8in. by 6in., set of four. 80, 80, 150 and 690 ohms, carry 1/2 to 1 amp. Price, set of four, 5/-, post free.

**MOVING COIL MOVEMENTS**, needing slight repair, modern type, famous makers, deflection 5 to 10 m.a. Price 15/-, post free.

**RIGHT ANGLE DRIVE**, mounted in gunmetal box, all ball bearing, 1/2 in. dia. shafts, as new. 12/- each, carriage paid.

**KLAXON MOTORS**, as above, with right angle drive, but need slight repair, mostly fields open circuit, not guaranteed, laminated fields, 20/- each, carriage paid.

**ACCURATE** radio rewinds, mains transformers, fields, o.p. transformers, etc., and all loudspeaker repairs.—Southern Trade Services, 297-299, High St., Croydon. [1715]

**ALL** types of radio receivers serviced, Murphy and Pilot specialist valves in stock, sound repairs for 13 years.—T. E. Peyver, F.I.P.R.E., 50, Vine St., Uxbridge, Middx.

**"SERVICE with a Smile."**—Repairers of all types of British and American receivers; coil rewinds; American valves, spares, line cords.—F.R.I. Ltd, 22, Howland St., W.1. Museum 5675. [1575]

**DEGALLIER'S** Ltd., service with a guarantee.—If you cannot get your receiver serviced, let American specialists do the job; first-class workmanship only specialising in Hammarland Challenger, Philco, Scott, Air King, Majestic, de Wald, Hallicrafters, etc.; also all British sets; s.a. envelope with all enquiries.—Degallier's, Ltd., 9, Westbourne Court, London, W.2. [1833]

### MISCELLANEOUS

**WOODEN BOXES**—Large quantities available, suitable for packing war supplies.—Call or write, D.C. Ltd, 59, Belvedere Rd., S.E.1. Waterloo 5541. [1810]

**REPUTABLE** firm of toy manufacturers and electrical engineers seek ideas for electrical and mechanical toys for post-war programme; generous terms.—Apply Box 2869, c/o Wireless World. [1719]

**BOMB**, blast, fireproof safes to protect your valuables, books, etc.; prices from £3/10 to £21, according to size; over 2,000 sold; write for leaflet, id.—W. Crebboni, Ltd, 13, Orange St., London, W.C.2. [1784]

**ADVERTISER** wishes to contact a few of the most eminent engineers in the country, or men who have held the highest appointments in prominent engineering concerns, to criticize manuscripts of a practical and technical nature dealing with civil, mechanical, electrical, aeronautical, automobile and radio engineering. Interesting work, non-repetitive, could be carried out leisurely in spare time. A high fee is offered.—Write in strictest confidence, stating position, salary, etc., to Box 2889, c/o Wireless World. [1821]

### SITUATIONS VACANT

**MORSE** instructor (resident) required, one holding First Class P.M.G. and having sea operating experience desirable, but not essential.—Write, giving full particulars, salary required, etc. Principal, Wireless College, Colwyn Bay. [1776]

### SITUATIONS WANTED

**YOUNG** man, 19 years old, exempt, seeks practical experience of radio; N.W. London area; at present studying technical side. 13, Castle Rd., Northolt, Greenford, Middx. [1816]

**COMMUNICATIONS** engineer, 10 years' experience design, development and production, seeks administrative post, familiar with requirements of Government departments.—Box 2886, c/o Wireless World. [1812]

### TECHNICAL TRAINING

**A.M.I.E.E.**, City and Guilds, etc., on "No pass—no fee" terms. Over 95% successes. For full details of modern courses in all branches of electrical technology send for our 112-page handbook—free and post free.—B.I.E.T. (Dept. 388A), 17, Stratford Place, London, W.1. [1793]

**GREAT** possibilities exist for technically qualified engineers, key men in wartime and afterwards. Through the home-study courses of The T.I.G.B. take a recognised engineering qualification, such as A.M.I.Mech.E., A.M.I.E.E., A.F.R.Ae.S., A.M.I.Chem.E., C. and G., etc., in which examinations the T.I.G.B. students have gained 25 FIRST PLACES and hundreds of passes. Write today for "The Engineer's Guide to Success"—free—containing the world's widest choice of engineering courses covering all branches, including aeronautical, mechanical, electrical, wireless, chemical, etc.

**THE TECHNOLOGICAL INSTITUTE OF GREAT BRITAIN**, 82, Temple Bar House, London, E.C.4. [1403]

### TUITION

**THE** Tuitionary Board of the Institute of Practical Radio Engineers have available home study courses covering elementary, theoretical, mathematical, practical, and laboratory tuition in radio and television engineering; the text is suitable coaching matter for I.P.R.E. Service-entry and progressive exams; tuitionary fees—at pre-war rates—are moderate.—The Syllabus of Instructional Text may be obtained post free from the Secretary, Bush House, Walton Avenue, Henley-on-Thames, Oxon. [1462]

# PREMIER RADIO

**I.F. TRANSFORMERS, IRON CORED** 450-473 kc., plain and with flying lead, 5/6 each. Premier 1-valve de Luxe Battery Model S.W. Receiver, complete with 2-volt valve, 4 coils covering 12-170 metres. Built on steel chassis and panel, 55/-, including tax.

### PREMIER MICROPHONES

**Transverse Current Mike.** High-grade large output unit. Response 45-7,500 cycles. Low hiss level, 23/-.

**Premier Super-Moving Coil Mike.** Permanent Magnet model requiring no energising. Sensitivity 56db. Impedance 15 ohms. Excellent reproduction of speech and music. £5/5/-.

**Microphone Transformers**, 10/6 each. **Chromium Collapsible Type Microphone Stand**, 52/6.

### NEW PREMIER S.W. COILS

4- and 6-pin types, now have octal pin spacing and will fit International Octal valve holders.

4-PIN TYPE		6-PIN TYPE	
Type	Price	Type	Price
04	9-15 m. 2/6	06	9-15 m. 2/6
04A	12-25 m. 2/6	06A	12-25 m. 2/6
04B	22-47 m. 2/6	06B	22-47 m. 2/6
04C	41-94 m. 2/6	06C	41-94 m. 2/6
04D	76-170 m. 2/6	06D	76-170 m. 2/6
04E	150-350 m. 3/-	CHASSIS MOUNTING OCTAL HOLDERS	
04F	265-550 m. 3/-		
04G	490-1,000 m. 4/-	New Premier 3-Band S.W. Coil, 11-25, 25-38, 38-86 m. 4/9.	
04H	1,000-2,000 m. 4/-		

**Rotary Wave Change Switch**, to suit above, 1/6. **Bakelite Dielectric Reaction Condensers**, 0001 mf. 1/3 0003 mf. 2/6 0005 mf. 2/9 each 0003 mf. Differentiated. 2/11 each 2-3 gang 0005 mf. Condensers, with trimmers ..... 5/6 each

### H.F. CHOKES

**S.W. H.F. Choke**, 10-100 m. .... 10/4. **Binocular H.F. Choke**, 100-1,000 m. .... 1/- **Binocular H.F. Choke**, 100-1,000 m. .... 1/6

### SHORT WAVE CONDENSERS

**Tritium Insulation.** Certified superior to ceramic. All-brass construction. Easily ganged. 15 mmfd. .. 2/11 100 mmfd. .. 3/11 25 mmfd. .. 3/3 160 mmfd. .. 4/8 40 mmfd. .. 3/3 250 mmfd. .. 5/8 **Brass Shaft Condensers**, 1/2 in. bore .. 7/1d. each **7-pin Ceramic Chassis Mfg. English Fitting Valve Holders**, 1/6 each.

### RESISTANCES

**Main Resistances**, 650 ohms .3A Tapped. 360 x 180 x 60 x 40 ohms, 5/6 each. 1,000 ohms, 2A Tapped. 900, 600, 700, 600, 500 ohms, 5/6 each.

1 ohm ± 1%, suitable for Bridges, 5/-.  
1 watt all values, 5d. each.  
1 watt all values, 7d. each.  
4 watt from 50 to 2,500 ohms, 1/- each.  
8 watt from 100 to 2,500 ohms, 1/6 each.  
15 watt from 100 to 10,000 ohms, 2/- each.  
25 watt from 100 to 20,000 ohms, 2/9 each.  
**Valve Screens for International and U.S.A. types**, 1/2 each.  
**Resin-Cored Solder**, 71d. per coil.  
**Synthetic Slicing**, 2 mm., 2/6 per doz. yards.  
**Screwed Braided Cable**, 3/8, 1/2 per yard; Twirl, 1/6 per yard. Maximum lengths 6 yards approx.

### "LEARNING MORSE?"

Then purchase one of the new practice oscillators. Supplied complete with valve, on steel chassis, 27/6. Practice key, 3/3. TX key, 5/9. Super model on wooden base, 11/6. **Brown's Headphones**, 19/6 pair. **3-Henry Chokes**, 10/-.  
**Good Quality Buzzer**, 3/-.

### MOVING COIL SPEAKERS

**Celestion 8 in. P.M. Speaker**, 25/-.  
Above speaker is complete with output transformer.  
**Rola 5 in. P.M. Speaker**, 3 ohms voice coil, 21/-.  
**Rola 6 1/2 in. P.M. Speaker**, 3 ohms voice coil, 25/-.  
**Rola 8 in. P.M. Speaker**, 3 ohms voice coil, 25/-.

Send for details of Valves, and other Accessories available

ALL ENQUIRIES MUST BE ACCOMPANIED BY A 2 1/2d. STAMP.

# PREMIER RADIO CO.

### ALL POST ORDERS TO:

**JUBILEE WORKS, 167, LOWER CLAPTON ROAD, LONDON, E.5.** (Amherst 4723.)

### CALLERS TO:

**JUBILEE WORKS** or **169, FLEET STREET, E.C.4.** (Central 2883.)



# LASKY'S RADIO

for  
**Valves, Speakers, Condensers and Components.**  
**OUR SPECIAL OFFER FOR THIS MONTH!**

## 24 Assorted Condensers & Electrolytics

consisting of 16 + 32 + 32 mfd 470v., 1 mfd 350v., 50 mfd 15v., 25 mfd 2,000v., 3 mfd 700v. block, 2 mfd 400v. caps., 16 mfd 2,000v., 10 mfd 250v., etc. etc.

All for **22.0.0** (Post 6d.) or C.O.D. **22.1.6**

U.S.A. Octal Base Valve Holders, 8d. each	7/8 doz.
Wander Plug, assorted, 3d. each	2/6
Assorted Volume Controls, less Switch	2/9 each
Ditto, with Switch	4/9
2 mfd 700v. Block Paper Condensers	2/6
.15 mfd 2,000v. Tubular Condensers	1/6
.02 mfd 2,000v. ditto	1/6
.23 mfd 2,000v. ditto	1/6
.05 mfd 2,000v. ditto	1/-
.002 mfd 2,000v. ditto	1/-
50 mfd 12v. ditto	16/- doz.
25 mfd 35v. ditto	18/-
1 mfd 350v. ditto	6/-
10 mfd 25v. ditto	1/8 each
2 mfd 400v. Can Electrolytics	4/3
Toggle Switches	3/6

## VALVES! VALVES! VALVES!

We have a large selection of English and U.S.A. valves in stock as per example:

1A5, 5Z4, 5Z4, 6A5, 6P6, 6K6, 6K7, 6E6, 1C5, 6Q7, 12A5, 12Q7, 12B7, 2E5, 2E2, 6B8, 32L7, 35L6, 35Z4, 35Z5, 50L6, 70L7, 11Z8, 80, 0X5, 12B8, 12F8, 6J7, etc., etc. All at B.O.T. Fixed Retail Prices Plus Tax.

English AC, AC/DC & Battery Valves as follows: U80, H14, H115, MVSFBN, VP4, SP4, FC4, MU14, X66, MU13, U13, 6CH5, DW4/500, EBL1, FC2, U15, X63, ETV41, KTS9, WD40, TDD4, etc., etc.

Speakers, Speaker Transformers, Volume Controls, with and without switch. Rola P.M. Speakers in stock: 5", 6", 8", 10", with or without Transformer.

Send us your requirements.  
**LASKY'S RADIO,**  
370, Harrow Road, Paddington, W.9.  
Telephone: Cunningham 1979.  
**CASH WITH ORDER OR C.O.D.**

# MATRICULATION

*brings Success & Security*

Whatever your age, you can now study for the all-important Matriculation Examination at home on "NO PASS—NO FEE" terms. "MATRIC" is the accepted passport to all careers, and opens up opportunities which would otherwise be completely closed to you. Ensure the success and security of you and yours through post-war difficulties by writing for our valuable "Guide to Matriculation" immediately—FREE.

**B.T.I. (Dept. 114)**  
356, Oxford Street, London, W.1.

## VALVES AND COMPONENTS.

KT2, KT61, KT65, UU5, U14, U10, U50, X63, X65, DH63, EF38, TDD4, AGCP1, 2P, and hundreds of other types. List Prices plus Purchase Tax and Postage.

120 in a Meins Transformers, 4 or 6.3 volt, 25/8; Speaker Transformers, 7/6, 9/6; I.F. Transformers, 5/3, 3/6; Coloured Push Back, 2d. yard. Large Stocks of Components. Enquiries, stamped envelope.

**THE COVENTRY COMPANY,**  
191, DUNSTABLE ROAD, LUTON.

## "SYSTEMATIC RADIO SERVICING"

A method for organising the repair-shop, devised and employed by J. Bull. Also a catalogue of many Radio Service Aids including "History of Faults," "Job Cards," which almost repair the sets, "Valve Base Data Cards," and perhaps most important, a Rectifier which will replace any of the popular Universal valves such as 12Z3, 25Z5, ID5, U30, 40SUA, etc. Price 1/7 3/4.

**V.E.S.,**  
(W) Radio House, Melthorne Drive, Ruislip, Mdx.

## L EARN Morse code the Candler way. See advertisement on page 28.

**R**ADIO training—P.M.G. exams. and I.R.E. Diploma; prospectus free.—Technical College, Hull. [1298]

**R**ADIO Engineering.—Television and Wireless Telegraphy, comprehensive postal courses of instruction. Apply British School of Telegraphy, Ltd., 179, Clapham Rd., London, S.W.9 (Estd. 1906). Also instruction at school in wireless for H.M. Merchant Navy and R.A.F. [9849]

"**E**NGINEERING Opportunities."—Free 112-page guide to training for A.M.I.Mech.E., A.M.I.E.E., and all branches of engineering and building; full of advice for expert or novice; write for free copy, and make your peacetime future secure.—B.I.E.T. (Dept. 387B), 17, Stratford Place, London, W.1.

**A** POSTAL training in electrical engineering—power or radio; individual correspondence tuition by highly qualified engineers with wide teaching and technical experience. Elementary or advanced courses. Preparation for recognized examinations. Pre-service training specially arranged.—G. B., 18, Springfield Mount, Kingsbury, N.W.9. [1731]

## PATENT NOTICES

**T**HE proprietors of British Patent No. 475750, dated July 20, 1936, relating to improvements in electric wave signalling, are desirous of entering into arrangements by way of a licence or otherwise on reasonable terms for the purpose of exploiting the above patent and ensuring its practical working in Great Britain.—Enquiries to Singer, Ehlerst, Stern and Carlberg, Chrysler Bldg., New York City, N.Y., U.S.A. [1781]

**T**HE proprietors of British Patent No. 504934, dated November 1, 1937, relating to improvements in closures for evacuated envelopes and method of manufacturing the same, are desirous of entering into arrangements by way of a licence or otherwise on reasonable terms for the purpose of exploiting the above patent and ensuring its practical working in Great Britain.—Enquiries to Singer, Ehlerst, Stern and Carlberg, Chrysler Bldg., New York City, N.Y., U.S.A. [1780]

## BUSINESSES FOR SALE OR WANTED

**R**ADIO and electrical business required for immediate purchase, busy neighbourhood; stock and equipment at a value.—Full details to Box 2381, c/o Wireless World.

## BOOKS, INSTRUCTIONS, ETC.

**R**ADIO Trouble-shooters Handbook, as new, 710pp. 42/6.—BR83622, c/o BM/T.L.A., Monomark House, London, W.C.1. [1775]

**W**EBB'S radio map of the world locates any station heard, size 40x30in. 4/6, post 6d.; on linen, 10/6, post free.—Webb's Radio, 14, Soho St., London, W.1. Tel. Gerard 2039. [9947]

## VALVES AND COMPONENTS

Philco Valves, 1A4E and 1B4B, 9/-; Type 15, 11/-; Tungram Valves, 6K7G, 12B8, 6B8G, 6J6G, TR29, 13/6; DDT13, DDT18, 11/2, SP220, 6/10; Glass Rectifiers, British 4-pin and side-contact, 9/-; Philco I.F. Transformers, 250 Kcs. 3/6, 125 Kcs. 3/-; 451 and 465 Kcs., 10/-; with trimmers, 12/-; Philco 2-band (Long and Medium band) Coils, Aerial, RP or 125 Kcs. oscillator, 6/- ea.; with trimmers, 8/-; Oscillator for 461 or 465 Kcs., 8/- ea.; with trimmers, 10/-; Philco 3-band Oscillator Coils (Long, Medium and Short) with trimmers, 12/6 ea. Screening caps. 2/- extra.

Philco Dipole Aerial Transformers, for Long, Medium and Short waves, in screened can with switch and instructions, 10/-; Philco 1,200-volt test Moulded Fixed Condensers, .0001, .00028, .0003 and .002, 9d. ea. .01, 1/-, .015, 1/3, .02, 1/6, .05 and .09, 1/9, .1 and .15, 2/-; Fixed Condensers, various good makes, .0001 to .008, tag or terminal connections, 4/- doz., wire ended, 6/- doz. Resistors, 1-watt, 4/- doz. 1-watt, 6/6 doz., our assortment

**PARCELS OF ASSORTED COMPONENTS.** Fixed and variable condensers, resistors, coils, transformers, valveholders, insulators, wire, switches, trimmers, etc. Marvellous value. Satisfaction guaranteed.

Terms—cash with order, postage extra. Please send stamp with all enquiries.

**E. H. ROBINS TRADING CO. LTD.,**  
44, Kyle Crescent South, Whitchurch, Glam.

## SPEAKER REPAIRS by Specialists

Any make, British or American Best Service Moderate Charges

**TRADE ONLY**  
Also Components for Service Men at keenest prices. List Id.

**A. W. F. RADIO PRODUCTS** Phone: 11632  
99, Duckworth Lane, Bradford

## AMERICAN RADIO VALVES

International Majestic Radio Corporation, Ltd., were appointed Official Distributors by the Board of Trade of these valves under the Lease-Lend scheme.

The allocations so far made are now almost exhausted, but we have certain types still available.

Receiver owners still requiring valves, who give a definite guarantee that such are required for Maintenance-Replace-ment will be supplied. All prices are controlled by Government Order.

## TO AVOID DISAPPOINTMENT

Please observe the following suggestions strictly.

- (1) Apply for List enclosing S.A.E.
- (2) Do not in any circumstances order or enclose payment until you have obtained our list.
- (3) Order only such lines as are indicated by our list; no other types have been issued to us.
- (4) As stocks are so very limited, we advise application at once, and all goods are offered subject to their being in stock on receipt of any order.

## INTERNATIONAL MAJESTIC RADIO CORPORATION LTD.,

6, Angel House, Pentonville Rd., London, N.1

## AFTER THE WAR!

The advance in Radio Technique after the war will offer unlimited opportunities of high pay and secure posts for those Radio Engineers who have had the foresight to become technically qualified. How you can do this quickly and easily in your spare time is fully explained in our unique handbook.

Full details are given of A.M.I.E.E., A.M.Brit.I.R.E., City & Guilds Exams., and particulars of up-to-date courses in Wireless Engineering, Radio Servicing, Short Waves, Television, Mathematics, etc., etc.

**We Guarantee "NO PASS—NO FEE"**  
Prepare for to-morrow's opportunities and post-war competition by sending for your copy of this very informative 112-page guide NOW—FREE.

## BRITISH INSTITUTE OF ENGINEERING TECHNOLOGY (Dept. 388)

17, Stratford Place, London, W.1.



For high quality loud speakers when the good times come again.

The Courts, Silverdale, London, E.B.28. Phone: SYD 6666.

## ROLA SPEAKERS AND TRANSFORMERS AVAILABLE

- 8Z-6.5 P.M.M. 42U.
- 6Z-7.5 P.M.M.
- 5Z-7.5 P.M.M.

**BROOKS & BOHM LTD.,**  
90 Victoria St., London, S.W.1. VIC. 9550



*Electronic Engineering Services, Ltd.*

24 STANLEY ROAD HEATON MOOR  
STOCKPORT  
TELEPHONE HEATONMOOR 3107

FOR  
**AMERICAN EQUIPMENT**

WE WELCOME ENQUIRIES FOR ANY OF THE FOLLOWING. REASONABLY QUICK DELIVERY AGAINST GOOD PRIORITY.

**STATIONARY TRANSMITTERS :** A WIDE RANGE IS AVAILABLE, BOTH A.M. & F.M., ALSO CAR & AIRBORNE TRANSMITTER-RECEIVERS.

**INSTRUMENTS :** TRANSIENT ANALYSERS, DIRECT-INKING OSCILLOGRAPHS.

**COMPONENTS :** GANGED R.F. SWITCHES, SPECIFICATION TRANSFORMERS, SENSITIVE TYPE RELAYS, MIDGET VALVES & PARTS.

**GENERAL :** THROUGH OUR AMERICAN ORGANISATION WE CAN HELP IN LOCATING SOURCES OF SUPPLY FOR SPECIAL REQUIREMENTS UNOBTAINABLE IN THIS COUNTRY.



Postwar industry will be making wider use of industrial electronic technique developed during recent years. In this work Rogers Radio Tubes—the tubes which opened the way to all-mains wireless—have played and will play a recognised part. Rogers with an established reputation for quality, produce all standard types of radio receiving tubes, power tubes for radio transmission, audio frequency amplification and industrial electronic applications generally. At present engaged solely on official work, they look forward to future co-operation over a wide field of industry.

**ROGERS RADIO TUBES LTD.**

**TORONTO (ONTARIO) CANADA**

A subsidiary of BROADCAST RELAY SERVICE LIMITED,  
VICTORIA STATION HOUSE, VICTORIA ST, LONDON, S.W.1.

# CELESTION

**VALVEHOLDERS**

Manufactured under "Amphenol" Licence

Preferred by radio engineers because of their Strength, Efficiency and Uniform Contact

Supplied against Priority orders only. Send for List of English and American types.

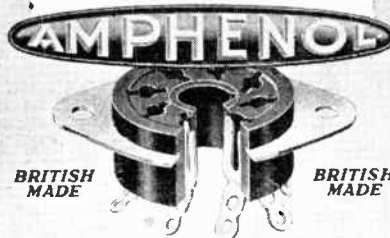

**CELESTION LTD.**

(Engineers).

**KINGSTON-UPON-THAMES, SURREY.**

Telephone: KINGSTON 5656-7-8.

On National Service WITH . . .

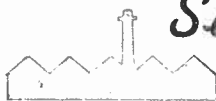

**ROYAL ORDNANCE FACTORIES** ★



**AIRCRAFT WORKS** ★



**ASSEMBLY PLANTS** ★



**SCIENTIFIC INSTRUMENT MAKERS** ★

. . . IN FACT, wherever a high-grade light lubricating and penetrating oil is required,

**'THREE-IN-ONE' OIL**



is 'on the job.' 301 uses in Factory, Workshop and Office.

Enquiries to Sole Manufacturers :

A. S. BOYLE CO. LTD., Chenies Street, London, W.C.1

or Trade Distributors :

ROLLINS & SONS (Ldn.) LTD., 107 Fleet St., London, E.C.4

## A 65-watt SOLOON for general use



This 65-watt Industrial type SOLOON Electric Soldering Iron is fitted with an oval tapered bit—a shape which is suitable for most general work. For specialised work the pencil bit model is recommended, whilst bigger jobs call for the 125-watt or 240-watt models. Supplies of these various models are only available for essential war work, of course, and due to heavy demands it is necessary to order well in advance to avoid disappointment in delivery.

Details of this and other models sent on request.



**MADE FOR USUAL STANDARD VOLTAGES**

**W. T. HENLEY'S TELEGRAPH WORKS CO. LTD.**  
Engineering Dept., Milton Court, Westcott, Dorking, Surrey



**F.W.S.CO.**  
TRADE MARK  
1933

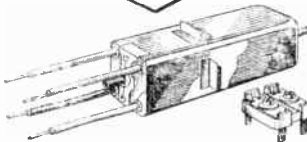

Sickles Midget Transformer and Trimmer.

OUR greatly increased manufacturing facilities in the War effort, coupled with our added production knowledge, will materially benefit you 'when Victory is won.' Quality has always been the dominant consideration in the design—in the choice of materials and in the method of manufacture of our products; and we look forward with confidence to the day when we shall once again continue our relationship with the Radio Industry of Great Britain with greater cordiality than ever before.

**I.F. TRANSFORMERS  
AERIAL AND OSCILLATOR COILS  
TRIMMER AND PADDER CONDENSERS  
'SILVERCAP' CONDENSERS  
COIL FORMS, etc.**

Register your name with our Representative for your future benefit.

**The F. W. SICKLES Co.**  
CHICOPEE, MASS., U.S.A.

★

Exclusively Represented by  
**Frank Heaver Ltd.** Kingsley Road, Bideford, N. Devon

## SEXTON'S for SALES, SERVICE, SATISFACTION

**ELECTRIC SMOOTHING IRONS**, super quality, for 200/250 volts AC/DC mains, 5-5½ lbs. weight, strong wooden handle, with thumb rest, heavily plated body, guard and rest, ground and polished sole plate, complete with heavy 6ft. three-core flex, at 32/6 each. Limited quantity available.

**ELECTRIC KETTLES**, 230/250 volts, 2½ pint size, sprayed gold with heavy three-core flex, suitable for AC/DC mains, 75/- each. Limited quantity available.

**ELECTRIC SOLDERING GUNS**, 200 250 volts, for AC/DC mains, with long flex and 2-pin plug, at 14/6 each. Superior quality at 17/6 each.

**AMERICAN LEASE-LEND RADIO VALVES**. We carry an excellent range of most popular types, sold subject for immediate replacement only at Board of Trade controlled prices, as per the Radio Valve (Maximum Price) Order, S.R. & O., No. 1934 of 1942.

**"BRIVARON,"** British Made Valves, equivalent to American type 80, being a 5-volt rectifier, and U.12 English 4-volt rectifier at 13/7 each.

**LINE CORDS**. 2-way, best quality, 350 ohms, at 7/6 each. 450 ohms, at 9/6 each.

**EXTENSION LOUD SPEAKERS**. "Rola," 3 ohm voice coil size, 5in., at 20/6 each. Size 6½in. at 22/6 each. Size 8in., at 24/- each. Size 10in., at 26/- each. Less trans. Send 1d. stamp and S.A.E. for latest list of all electrical appliances, fittings, and accessories, radio valves, components, etc., which we can offer to you at competitive prices.

**TERMS:** Cash with order only. Owing to shortage of staff we regret we are unable to despatch orders C.O.D. or send *pro forma* invoices. All prices include Purchase Tax where applicable.

**J. E. SEXTON & CO. LTD.**  
164, Grays Inn Road, London, W.C.1  
Tel.: Terminus 1304 and 4842.

## "ENGINEERING OPPORTUNITIES"



This unique handbook shows the easy way to secure A.M.I.Mech.E., A.M.Brit.I.R.E., A.M.I.E.E., etc.

**WE GUARANTEE—  
"NO PASS—NO FEE."**

Details are given of over 150 Diploma Courses in all branches of Civil, Mech., Elec., Motor, Aero, Radio-Television and Production Engineering, Tracing, Building, Govt. Employment, R.A.F. Maths., Matric., etc.

Think of the future and send for your copy at once—FREE.

**B.I.E.T., 387, SHAKESPEARE HOUSE  
17, STRATFORD PLAGE, LONDON, W.1**

## HILL AND CHURCHILL BOOKSELLERS SWANAGE DORSET

•

ENGLISH & AMERICAN  
BOOKS IN STOCK ON  
RADIO AND  
TELECOMMUNICATION

•

CATALOGUE ON APPLICATION

## LONDEX for RELAYS

for A.C. and D.C.  
**TWO STEP RELAY LF/FS**  
(Heavy Silver Contacts)



First Impulse "ON." Second impulse "OFF."

Also Aerial Change-over Relays.

Ask for leaflet 88A/WW

**LONDEX LTD**  
MANUFACTURERS OF RELAYS  
207, ABERLEY ROAD, LONDON, S.E.20. PHONE: SYDENHAM 6130/1

# INVENTORS



## The SIMMONDS GROUP

LONDON  
MELBOURNE  
PARIS-NEW YORK  
LOS ANGELES

The world-wide Simmonds Organisation has established new methods and new products in many industries with great success. Simmonds Development Corporation seeks new ideas and inventions of brilliance and ingenuity to be developed by the technical resources and marketing knowledge of the Simmonds Group.

**ALL COMMUNICATIONS MUST BE IN WRITING IN FIRST INSTANCE TO—**

SIMMONDS DEVELOPMENT CORPORATION LTD. 2-3 NORFOLK ST. W.C.2

Printed in England for the Publishers, LIFFE AND SONS LTD., Dorset House, Stamford Street, London, S.E.1, by THE CORNWALL PRESS LTD., Paris Garden, Stamford Street, London, S.E.1. "The Wireless World" can be obtained abroad from the following: AUSTRALIA and NEW ZEALAND: Gordon & Gotch, Ltd. INDIA: A. H. Wheeler & Co. CANADA: Imperial News Co.; Gordon & Gotch, Ltd. SOUTH AFRICA: Central News Agency, Ltd.; Wm. Dawson & Sons (S.A.), Ltd. UNITED STATES: The International News Co.



# *It was just a coil of wire . . .*

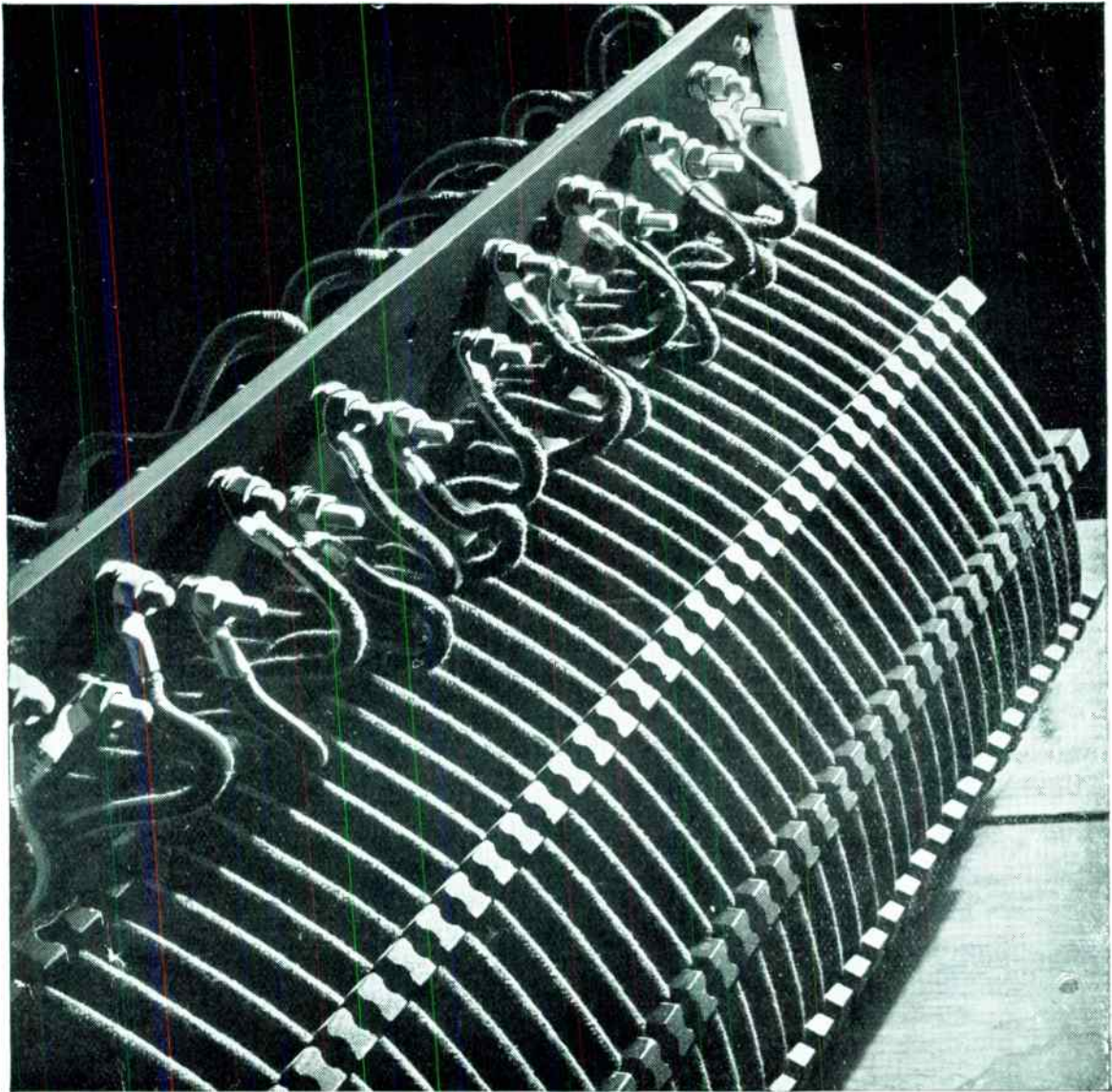

*. . . now it is an inductance coil which has to meet the stern demands of a communication system that goes on day and night. One more example of Rediffusion products used in Rediffusion communication equipment.*

# **REDIFFUSION** LIMITED

*A subsidiary of*  
**BROADCAST RELAY  
SERVICE LIMITED**

**DESIGNERS AND MANUFACTURERS OF COMMUNICATION EQUIPMENT**  
VICTORIA STATION HOUSE • VICTORIA STREET • LONDON • S.W.1 (PHONE VICTORIA 8831)



## SYMBOLS OF PRECISION

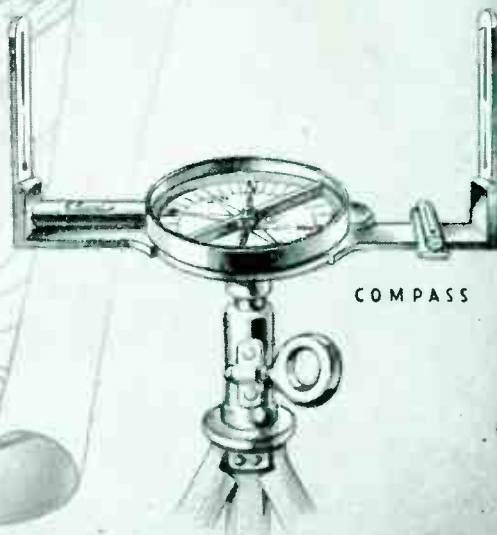

COMPASS



# MAZDA

RADIO  
VALVES

THE EDISON SWAN ELECTRIC CO. LTD.



155, CHARING CROSS RD., LONDON, W.C.2

*For full particulars write to Technical Service Department*