

Wireless World

RADIO • ELECTRONICS • ELECTRO-ACOUSTICS



APRIL 1943

1/3

Vol. XLIX. No. 4

RADIO WAVES IN THE IONOSPHERE

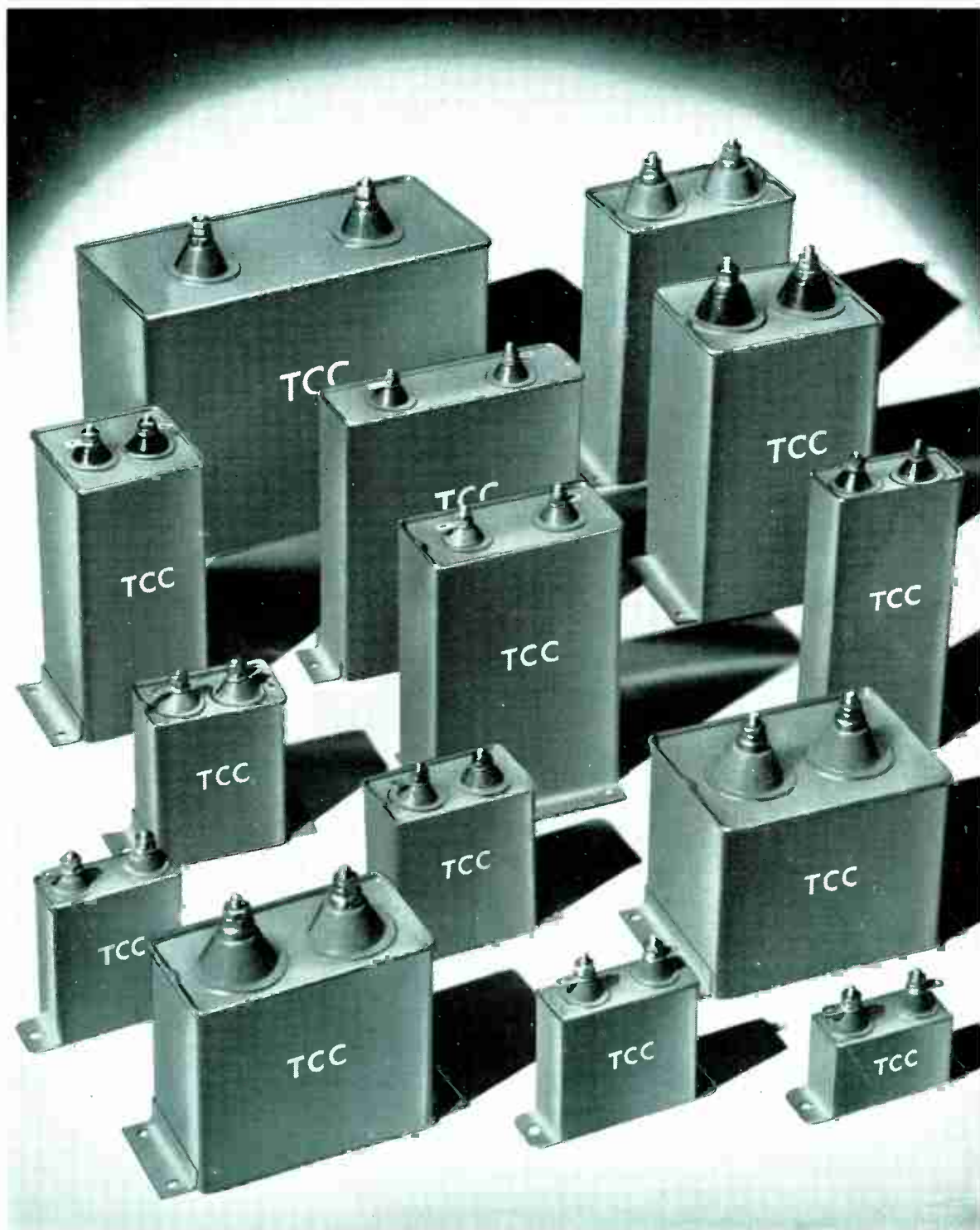

PRE-EMINENT IN PEACE – INDISPENSABLE IN WAR

ADVERTISEMENT OF THE TELEGRAPH CONDENSER CO. LTD.

G.P. 7702



46-range Model 7
Universal AvoMeter

The Model 7 Universal AvoMeter (illustrated) is a compact combination electrical measuring instrument of B.S. 1st Grade accuracy. Its 46 ranges cover A.C. and D.C. amperes and volts, resistance, capacity, audio-frequency power output and decibels. No external shunts or series resistances. Protected by automatic cut-out against damage through overload.

Some delay in delivery of Trade Orders is inevitable, but we shall continue to do our best to fulfil your requirements as promptly as possible.

Sole Proprietors and Manufacturers:

AUTOMATIC COIL WINDER & ELECTRICAL EQUIPMENT Co., Ltd., Winder House, Douglas St., London, S.W.1

Telephone: VICtoria 3404/7

The world-wide use of "AVO" Instruments is striking testimony to their outstanding versatility, precision and reliability. In every sphere of electrical test work—laboratory, shop or out on a job—they are appreciated for their dependable accuracy, which is often used as a standard by which other instruments are judged. There is an 'AVO' Instrument for every essential electrical test.



The Dawn of better days

Whatever new worlds may be planned, Radio will be more popular and more progressive than ever when the last gun has fired and the last bomb has dropped.

We can confidently promise to resume our service to the trade with efficiency at least equal to pre-war days and with more zealous optimism.

TRADE **HUNTS** MARK

The Home of Condensers

Established 1901

Advt. of A. H. HUNT, LTD., London, S.W.18.

Miniature ^{BRUSH} ~~Crystal~~ Earphones

TYPE DJE

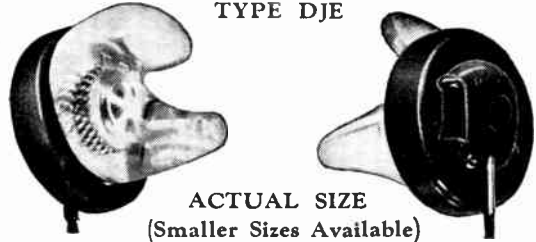

ACTUAL SIZE
(Smaller Sizes Available)

PHENOMENAL POWER SENSITIVITY

- 1 dyne per sq. cm. per 1 micro volt amp.

WEIGHS ONLY 7 GRAMMES

- Range of standard detachable mouldings

FITS INTO EAR CANAL

- Eliminates interfering sounds

EXCEPTIONALLY SMALL SIZE

- Inconspicuous and easy to wear

IDEAL FOR PORTABLE RADIO SETS

Sole Manufacturers

THE BRUSH DEVELOPMENT COMPANY
CLEVELAND, OHIO

PROMPT DELIVERIES AGAINST GOOD PRIORITIES

write for details to

ELECTRONIC ENGINEERING SERVICES LTD.

SOLE BRITISH DISTRIBUTORS



24, STANLEY ROAD, HEATON MOOR
STOCKPORT

TELEPHONE: HEATONMOOR 3107

Engraving

Imhof's Engineering Division is fully equipped for all types of the highest quality engraving on both Metals and Insulating Material. At the present time, however, only Priority Orders may be accepted.

CONTRACTORS TO THE ADMIRALTY
AIR MINISTRY, MoS and G.P.O.

Wide-World

IMHOF'S

ALFRED IMHOF, LTD., 112-116, NEW OXFORD ST., LONDON, W.C.1. MUSEUM 5944



T H E R E I S N O S U B S T I T U T E
F O R
E N G I N E E R I N G E X P E R I E N C E

*

And this is obviously a matter of extent, intensity and time.

Take Electrical condensers for instance—simple in conception maybe—but demanding infinite experience and skill, to satisfy the exacting operating conditions of modern requirements. The fulfilment of these has meant the whole time occupation of highly skilled specialists, working at high pressure, in this way to earn, along with their countrymen in other spheres, the right of survival.

What a wealth of experience and technical excellence will be available to all, when happier times arrive ; and nowhere more than in Dubilier Condensers.

DUBILIER
CONDENSER CO. (1925) LTD.



WEBB'S *Radio*

Specialists in RADIO COMMUNICATION

The recognised house where OFFICIAL requisitions for all radio apparatus and accessories can be supplied from STOCK.

METERS FROM STOCK

All ranges of

TAYLOR 425 (3½ in. scale) including 0/50, 0/100, 0/250 microamps., 0 1.5 milliamps.

TAYLOR 305 or 301 (2½ in. scale) 0/2, 0/3, 0/4, 0/6 milliamps.

As an indication of our comprehensive stock, note these various valveholders :—

VALVEHOLDERS

British 4 and 5 Pin Ceramic	1/3
.. 7 Pin Paxolin	1/-
.. 5 .. Eddystone DL9	1/9
.. Acorn	2/-
.. Octal Paxolin	1/-
.. Side Contact	6d.
U.S.A. 4, 5 and 7 Pin Ceramic	2/-
International Octal Ceramic	2/-
.. Paxolin	4d.
.. Moulded Bakelite	1/-
Baseboard, low-loss on pillars, skeleton construction, British 4, 5 and 7 Pin, all each	1/-

SUNDRIES

Push Back Wire, 12 yards	1/-
.. " " " 60 "	4/6
Volume Controls, all values	4/6
Wire Wound Potentiometers, 400, 1,500, and low values, 1 to 30 ohms, all	6/6

Additional charge of 1/- for postage and packing on orders below 10/-.

ALL **EDDYSTONE**
components generally available,
though OFFICIAL requirements must take priority.

14 Soho Street, Oxford Street, London, W.1

Telephone: Gerrard 2089

Open 9 a.m. to 5 p.m. Saturdays, 9 a.m. to 12 noon



Transformers to **TROPICAL** specification

from 10 VA-10kVA



Every precaution, including vacuum impregnation, special materials and exceptional care in manufacture, is taken to ensure that Woden Transformers made to tropical specification will give reliable service under the most arduous conditions.

WODEN Transformer Co.
THORNLEY STREET · WOLVERHAMPTON
TEL: WOLVERHAMPTON 22829

MAKERS OF TRANSFORMERS, POWER PACKS, & SPECIAL RECEIVING & TRANSMITTING APPARATUS

**IDENTIFICATION
LABELS** FOR CABLES
& PIPELINES
(M.A.P. APPROVED) A.I.D. APPROVAL N° 2583/42

TRANSMITTER

Indelibly printed on white or coloured fabric for use in conjunction with transparent adhesive tape.

• Guaranteed 2/3 day delivery service.

P. P. PAYNE & SONS LTD
HAYDN ROAD NOTTINGHAM Phone: 64335
BUSH HOUSE LONDON Phone: TEMple Bar 6356

SYMBOLS OF PRECISION

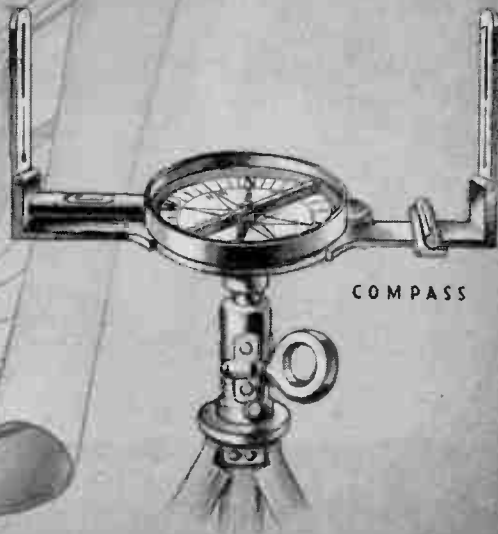

COMPASS



MAZDA

RADIO
VALVES

THE EDISON SWAN ELECTRIC CO. LTD.  155, CHARING CROSS RD., LONDON, W.C.2

For full particulars write to Technical Service Department

**SILVERED CERAMIC
FIXED CONDENSERS**
PEARL TYPE
0.5pF to 5pF.

Max. Dimensions 7 x 9mm
Test Voltage 1500V D.C.
Loss Factor 20 x 10⁻⁴

Mechanical and electrical
stability whatever the
climatic conditions.
Type approved.

MULTUM IN PARVO

UNITED INSULATOR CO LTD *The Pioneers of Low-Loss Ceramics*
12-20 LAYSTALL STREET, LONDON, E.C.1.
Phone: TERminus 7383 Grams: Colanel, Smith, London.

Wartime installations show more conclusively than ever that
you can
Trust
TRIX
Quality
SOUND
Equipment
To priority order only

30 watt Amplifier
Model T633

There are TRIX Amplifiers from 5-500 watts
Send for details

TRIX ELECTRICAL CO LTD., 65, Bolsover St., London, W.1.
Phone: EUS 5471/2. Grams: Trizadio, Weado, London.

HIVAC
THE SCIENTIFIC
VALVE
BRITISH MADE

Specialists in
MIDGET VALVES
HIVAC LIMITED
Greenhill Crescent.
Harrow on the Hill, Middx.
Telephone: Harrow 0895.

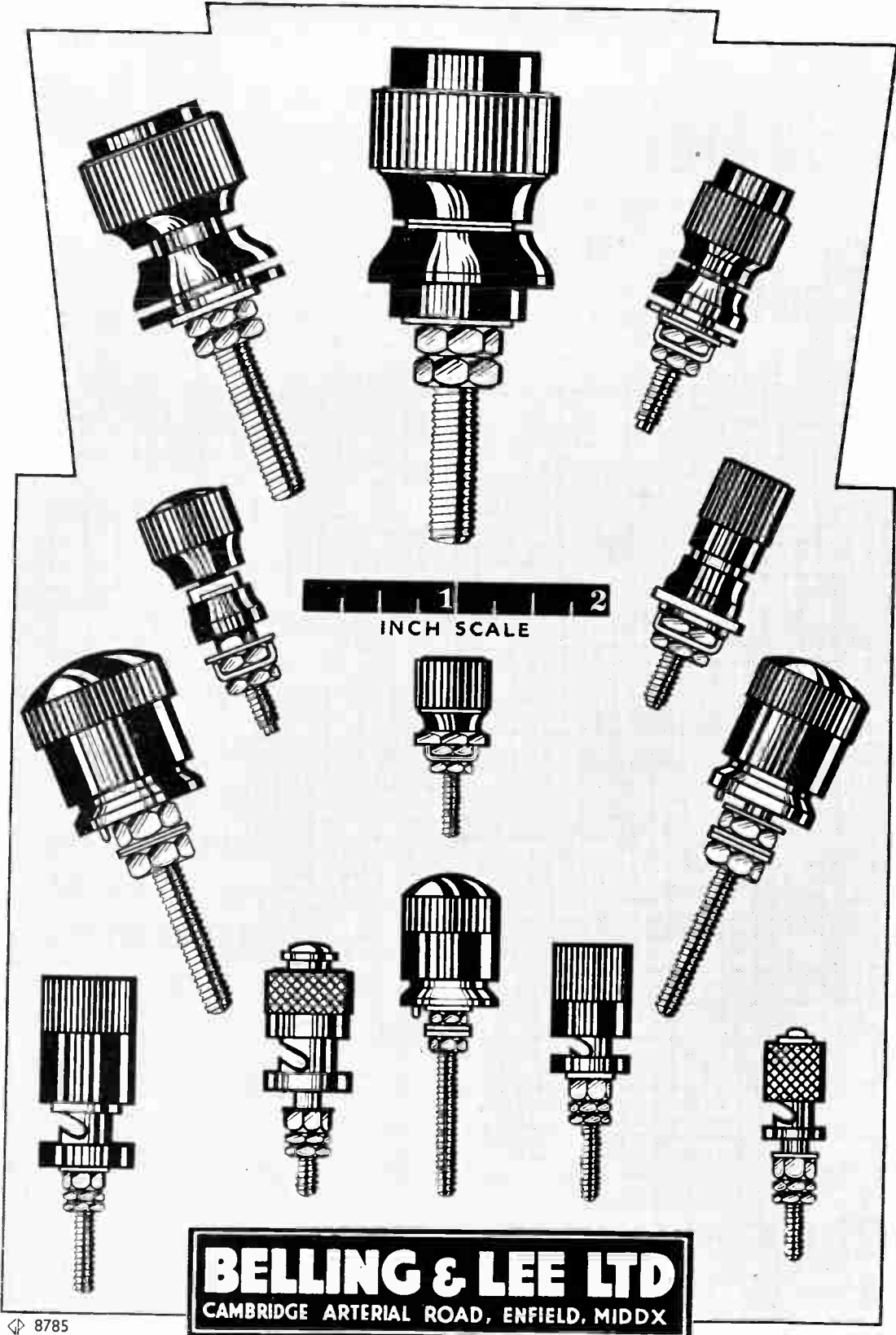

◆ 8785

BELLING & LEE LTD
CAMBRIDGE ARTERIAL ROAD, ENFIELD, MIDDX

TAYLOR
MODEL
400
MOVING COIL METER

A new robust Taylormeter with a scale length of 4 ins. Self-contained D.C. Ranges from 0-20 μ A to 100 amps. and 0.5 Millivolts to 1,000 Volts. Also available as Rectifier and Thermal type meters in a large number of ranges. Illuminated dials and mirror scale optional.

MODEL 500
is similar in appearance to Model 400, but has a scale length of 5 ins.

We manufacture a complete range of Moving Coil Meters—your enquiries are invited.

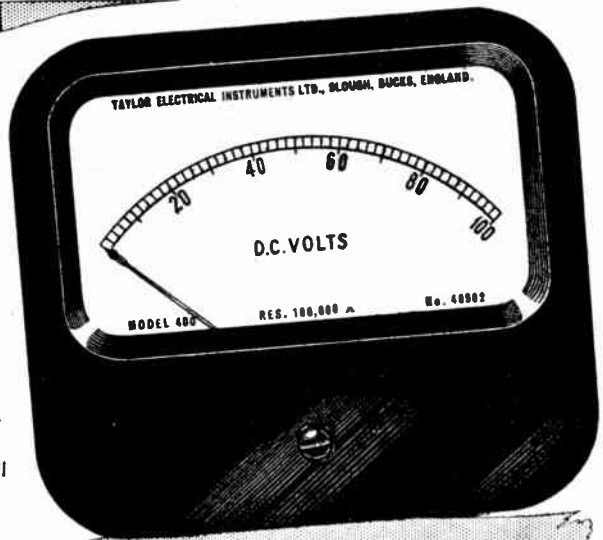

TAYLOR METERS

TAYLOR ELECTRICAL INSTRUMENTS LTD., MONTROSE AVENUE, SLOUGH, BUCKS.
Slough 21381 (4 lines)

P. R. MALLORY & CO. Inc.
MALLORY



Vibrators are always dependable

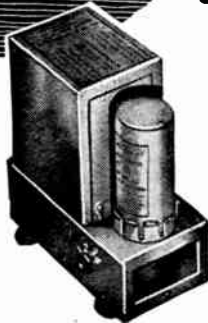

Along every front Mallory has pioneered in Vibrator design to ensure safety, dependability and long service.

Mallory offers synchronous and non-synchronous Vibrators for 6, 12 and 32 volt input, also a complete range of "STRATOSPHERE" Vibrators plus the world famous Mallory "VIBRAPACK" (Regd. Trade Mark).

★ Vibrapack is a registered trade mark, the property of the P. R. Mallory & Co. Inc., Indianapolis, U.S.A. Units which do not bear this trade mark are not of genuine Mallory manufacture.

Mallory engineers are at your disposal.

P. R. MALLORY & CO. INC.
INDIANAPOLIS, INDIANA, U.S.A.

Represented exclusively in Gt. Britain by

FRANK HEAVER LTD., Kingsley Road, Bideford, N. Devon, Eng.

TUNGSRAM VALVES

Our production of Radio Valves is both large and continuous. So, too, is the demand for them for urgent purposes. Some are available for domestic use, but the range is necessarily limited. You may be assured of our willing help whenever possible.

Announcement of

BRITISH TUNGSRAM RADIO WORKS LTD., WEST RD., TOTTENHAM, N.17

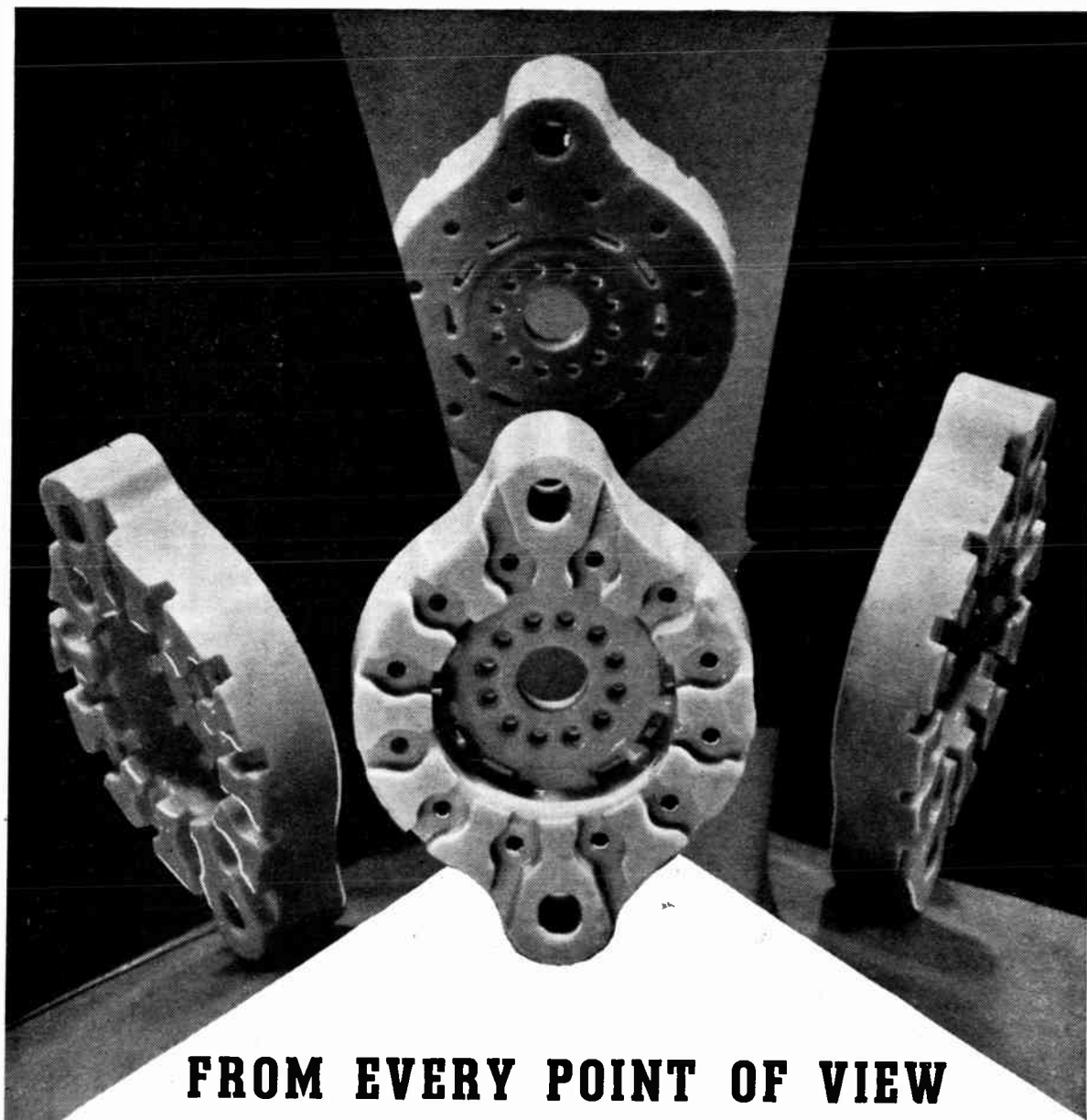

FROM EVERY POINT OF VIEW

"Frequentite" is the most suitable insulating material for all high frequency applications. Ten years ago we introduced the first British-made low loss ceramic, and consultation with us before finalising the design of new components is a wise precaution.



STEATITE & PORCELAIN PRODUCTS LTD.

Head Office: Stourport-on-Severn, Worcester.

Telephone: Stourport 111.

Telegrams: Steatain, Stourport.

SP19

The glory of the future..



... when the tank gives pride of place to the "family 'bus" and engines of war to the instruments of peace, Goodmans will be able, once more, to give the connoisseur Loudspeakers that open up new possibilities in high fidelity reproduction.



GOODMANS

Makers of
HIGH GRADE LOUDSPEAKERS

Priority Orders only can be accepted

GOODMANS INDUSTRIES, LTD., LANCELOT ROAD, WEMBLEY, MIDDLESEX

SPECTRUM ANALYSIS OF GASES

The exact composition of materials used in manufacture of WESTINGHOUSE METAL RECTIFIERS is determined by analysis of the spectrum, and recorded by spectrograms photographed by the apparatus shown. The gas discharge method of excitation is being used in this instance.

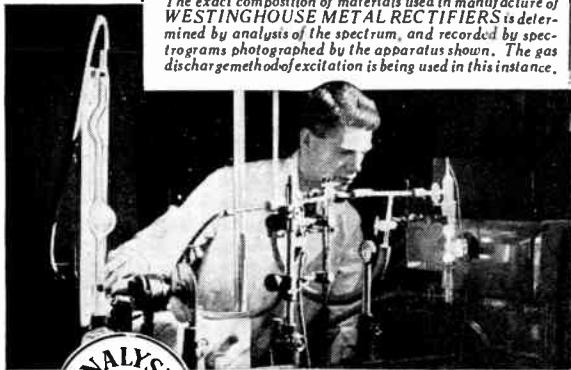

Behind the non-stop production of Westinghouse Rectifiers, our technical staff are ceaselessly at work.

We sincerely regret that very limited supplies only are available, but we know that our customers will understand. Today's intensive research, however, will release remarkable features of design when Westinghouse Rectifiers are again freely available to industry.

Westinghouse Rectifiers

WESTINGHOUSE BRAKE & SIGNAL CO., LTD.
PEW HILL HOUSE, CHIPPENHAM, WILTS.

OKERIN

AND
DIELECTRIC MATERIALS

Cable, Condenser, Coil, Transformer and Resistance
Impregnating, dipping, sealing, filling and finishing.

A.I.D. and C.I.E.M.E. TYPE AP-
PROVED WAXES to meet both
ARCTIC and TROPICAL conditions.

TELEPHONE : WEST DRAYTON 2189

**ASTOR BOISSELIER
& LAWRENCE LTD**

MIDDLESEX OIL & CHEMICAL WORKS

WEST DRAYTON, MIDDLESEX

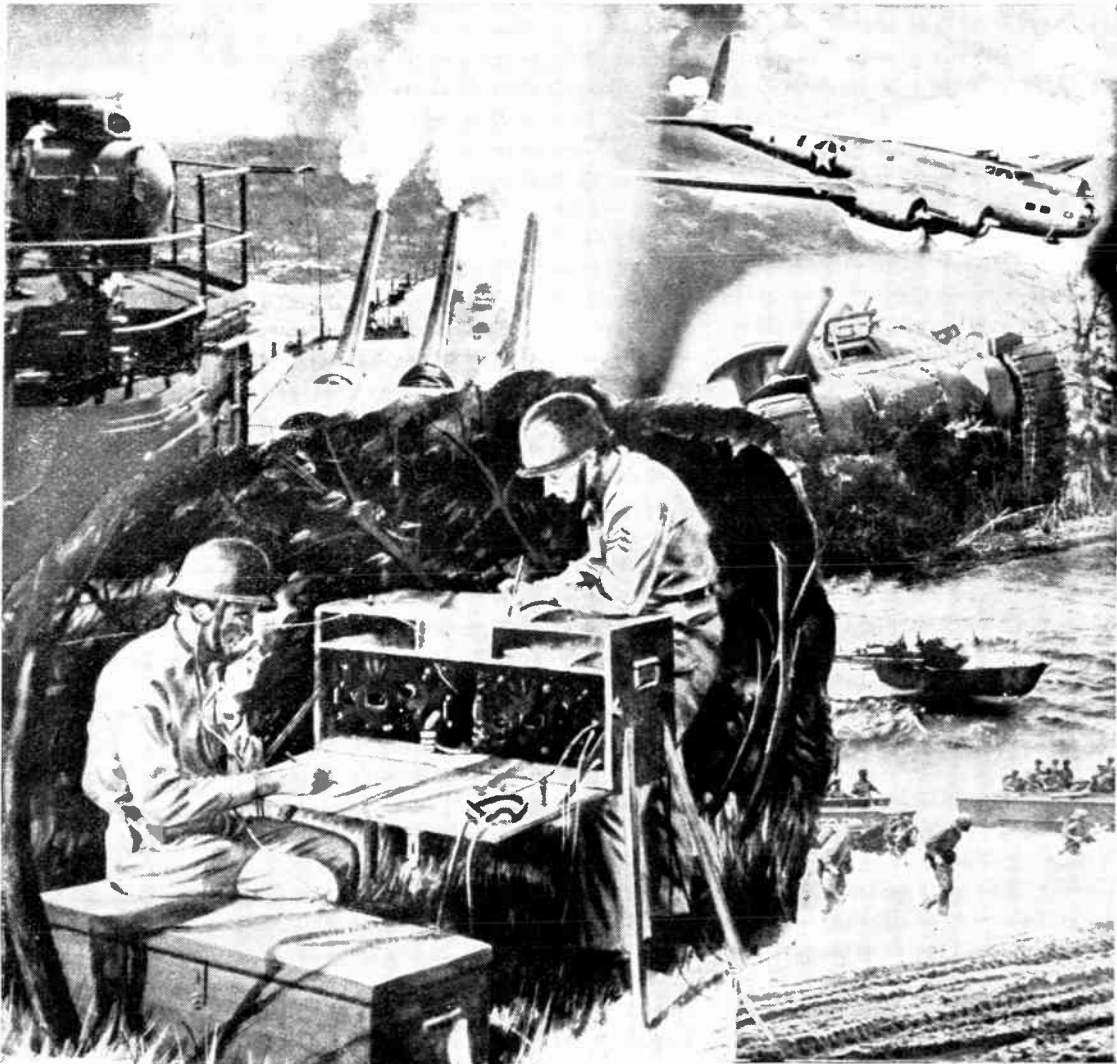

Proving ground for the future of electronics

On the battlefields, electronics is meeting its extreme test. Failure here means death to men, defeat to armies. Conversely, experience here means vastly broadened knowledge, improved techniques, and progress so rapid as

to be impossible of description.

The collective brains of Eimac engineers are concentrated full tilt on the new knowledge which is coming out of this holocaust. And are consequently still setting the pace in vacuum tube de-

velopments. The fruits of their efforts are going directly to Uncle Sam and our Allies to play a vital role in the war.

When the fighting stops you'll find Eimac still the pre-eminent choice of engineers throughout the world.

Army-Navy "E" awarded for high achievement in production for war.

Follow the leaders to



Eimac
VALVES

EITEL-McCULLOUGH, INC.
SAN BRUNO · CALIFORNIA · U.S.A.
Export Agent: FRAZAR & CO., LTD.
201 Front Street, San Francisco, California, U.S.A.

B.I.

CONDENSERS

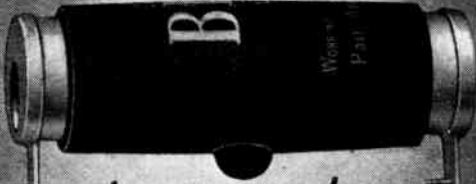

for arduous conditions

B.I. Tropical Type Paper Condensers in Moulded Tubes, (U.K. Patent No. 506024 and application pending) are designed to operate continuously in extremely arduous conditions of temperature and humidity.

BRITISH INSULATED CABLES LTD.
 Head Office: PRESCOT-LANCS. Tel. No: PRESCOT 6571



WRITE FOR CATALOGUE
W.O./330

ADASTRA

RADIO MASTS

POLES LTD TYBURN RD ERDINGTON. BIRMINGHAM. 24.

Enquiries should be accompanied by Government Priority Reference



FOR THE RADIO SERVICEMAN DEALER AND OWNER

The man who enrolls for an I.C.S. Radio Course learns radio thoroughly, completely, practically. When he earns his Diploma, he will KNOW radio. We are not content merely to teach the principles of radio, we want to show our students how to apply that training in practical, every-day radio service work. We train them to be *successful!*

Special terms for members of H.M. Forces.

.....You may use this Coupon.....

INTERNATIONAL CORRESPONDENCE SCHOOLS Ltd.
 DEPT. 38, INTERNATIONAL BUILDINGS, KINGSWAY, LONDON, W.C.2

Please explain fully about your instruction in the subject marked X
 Complete Radio Engineering. Radio Service Engineers.
 Elementary Radio. Television.

And the following Radio Examinations :-
 British Institution of Radio Engineers.
 P.M.G. Certificate for Wireless Operators.
 Provisional Certificate in Radio Telephony and Telegraphy for Aircraft.
 City and Guilds Telecommunications.
 Wireless Operator and Wireless Mechanic, R.A.F.

Name..... Age.....

Address.....

ROLA

LOUD SPEAKERS
 THE WORLD'S FINEST REPRODUCERS

TRANSFORMER LAMINATIONS
 Core Widths $\frac{3}{8}$ " to 1" (E's and I's.)
 EIGHT STOCK SIZES

A Comprehensive Bulletin together with details of Associated Covers and Clamps with design data will be sent to manufacturers on request.

BRITISH ROLA LIMITED
 MINERVA ROAD - PARK ROYAL - N.W.10 - WILLODEN 4322

● FOR RADIO

LONDON CENTRAL RADIO STORES

● BARGAINS ●

CLARKE'S ATLAS A.C. to D.C. CONVERTERS

Type R.M. 80/150

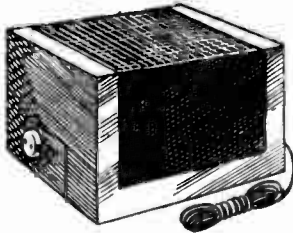

Input: 230v. A.C. 50~ Output: 80, 100, 120, 150, m.a. at 230v. D.C.
Incorporating Westinghouse Metal Rectifier. In strong steel case, well ventilated. Price **5 Gns.**
Post and packing 3/6 extra.

PHILIPS SCANNING & DEFLECTOR COILS

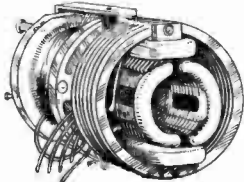

Assembled complete in metal frame, as illustrated **7/6**
Post. & pkg. 1/1 extra.

ELECTRIC SOLDERING IRONS
200/250 v. 75 watts. Post., etc., **12/6**
8d. extra



OAK VIBRATOR UNITS

— Synchronous —

These well-known Units are fitted with 6-pin American bases. Input 6 volts. **15/6**
Post. & pkg. 8d. extra.

CONDENSERS with Bakelite Insulated Terminals

2.5 + 2.5 + 1 mfd. 250v., D.C. wkg. ... **6/6**
2 mfd. 400v., D.C. wkg. ... **7/6**
4 mfd. 250v., D.C. wkg. ... **9/6**
Post. & pkg. 6d. extra.

EX-GOVT. PLUGS & JACKS



These Jacks have powerful phosphor-bronze springs ensuring a perfect contact. Overall length, including 1/4 in. threaded shank, 3 1/4 in. Supplied complete with Plug. **5/6**
Price ...
Post., etc., 3d. extra.

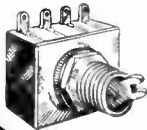

TWIN ON-OFF SWITCHES

Carries 1.5 amp. at 250v. Well made, with excellent snap action. Price **4/6**
Post., etc., 3d. extra.

VITREOUS ENAMELLED RESISTORS



10,000 ohms, 10w. Size 2 1/2 x 1/2 in. dia. Post 3d. **3/6**

EX-GOVT. CONDENSERS

0.5 mfd. 2,000v. D.C. working. Size 4 1/4 x 9 x 1/4 in. Made by Muirhead & Co. Post and packing, 9d. ... **3/6**

EX-GOVT. POTENTIOMETERS

Wire-wound. In bakelite case, 5,000 ohms. 2 in. dia. x 1 in. Without knob. Post, etc., 6d. ... **5/6**

T.C.C.

ELECTROLYTIC CONDENSERS

4 + 4 mfd. 70v. D.C. working. Reversible. Size 1 1/4 x 2 1/4 in. Post and packing, 3d. ... **5/-**

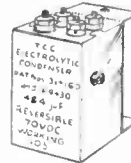

CHASSIS Drilled for 9 valves, also rectangular hole 6 1/2 x 2 1/4 in. Size 16 1/2 x 9 1/2 x 2 in. **3/6**
Also 11 1/2 x 9 1/2 x 2 1/4 in. and 11 1/2 x 7 x 2 1/4 in. **3/6**
12 x 9 x 3 in., drilled for 10v. transformer, etc. **5/6**
Post., etc., 10d. extra.

VOLTAGE DROPPING RESISTANCES

On asbestos formers. 1,000 ohms, 0.2 amp. Size 2 1/4 x 2 1/4 overall. Post., etc., 6d. ... **7/6**

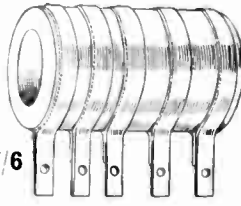

YAXLEY Type WAVE-CHANGE SWITCHES

4-way, 3-bank, with shielded oscillator section. Length from stop plate approx. 5 in., spindle 2 in. ... **5/6**

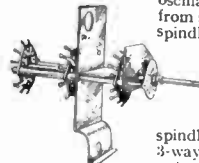

5-way, 6-bank, with 3 screened sections, adaptable to many uses. Length from stop plate approx. 6 1/4 in., spindle 2 in. ... **6/6**
3-way, 3 double banks, without shields, 2 in. spindle. Length 6 1/4 in. **5/6**. Post., etc., 9d. each.

SPEAKERS

ROLA 5 in. P.M., less transformer ... **22/6**
Post. and pkg. 1/6 extra.

CELESTION 8 in. P.M. Pentode Output. New **25/6**
Post., etc., on above, 2/- ex.

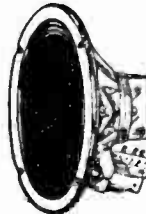

ON-OFF TOGGLE SWITCHES

Finest quality. Turn movement. 1 1/4 in. spindle. Post., etc., 3d. extra ... **2/6**



NO LISTS
NO PRO-FORMA INVOICES

SUPREMUS

H.T. BATTERY ELIMINATORS

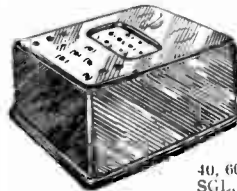

Model **E25A** for **200-250v. A.C.** 40-100~

Tappings 40, 60, 80, S.G.H., 100, S.G.L., 125v. These well-known H.T. Mains

Supply Units are fitted in handsome bakelite cases. Here is an opportunity for battery set owners, who have A.C. mains current available, to be independent of the battery situation. Owing to post and rail conditions these are available **TO CALLERS 70/- ONLY.** Price ...

TUNING CONDENSERS

3-gang, 0.0005 mfd., without trimmers, designed for motor drive. With large diameter driving disc and reduction gear, adaptable for slow motion manual drive. **12/6**
Post. & manual pkg 2/6 extra.

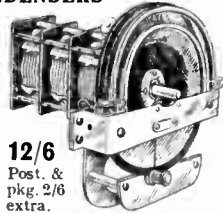

OAK SWITCHES

2 1/2 in. spindle, complete with knob. 4-way, 2-bank with connecting block, **4/6**.
4-way, 2-bk., **3/9**.
Post., etc., 6d.



PHILIPS High Voltage CONDENSERS
0.1 mfd. 5,000v. D.C. working. With porcelain insulated terminals. Size 2 1/4 high x 3 1/4 x 2 in. Post., etc., 9d. ... **10/6**

PHILIPS CONCENTRIC SPIRAL VANE VARIABLE CONDENSERS

3-Gang 0.0005 mfd. without trimmers. As used in Philips well-known Push-Button receivers. Price **4/6** Post. & pkg. 9d. extra.

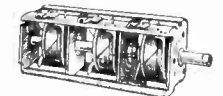

PHILIPS WET ELECTROLYTICS
50 mfd. 310v. working ... **9/6**
Post. & pkg. 9d. extra.

PHILIPS TRIMMER CONDENSERS

Non-drift air dielectric, 60 mfd., suitable for S.W. work. Price **1/3** Plus post., 3d. extra.



YAXLEY PATTERN SWITCHES

5-way, single-bank, with on-off mains switch, carrying 1 amp. at 250v., 2 in. spindle with knob ... **5/6**
3-way single-bank, 1 in. spindle with knob ... **2/9**
Post., etc., 6d. extra.

LONDON CENTRAL RADIO STORES, 23, LISLE ST. GERrard 2969 LONDON, W.C.2

M.R. SUPPLIES

Make **INSTANT DELIVERY FROM STOCK** of the following brand-new **ELECTRICAL AND INDUSTRIAL EQUIPMENT** of our usual dependable quality. All prices net cash.

G.E.C. MOVING COIL MICROPHONES. Very efficient model with response level 50-9,500 c/s. Sensitivity—50 db. In superior chromium-plated housing with back terminals and mounting boss. Imped. 15 ohms. Limited quantity at **25/6**. Fine opportunity.

ROTHMEL-BRUSH PIEZO-CRYSTAL MICROPHONES. Continuation of our very popular offer of these specially housed D.104 Microphones. Fitted knuckle-joint for angle adjustment. Response level to about 8,000 c/s. Sensitivity—60db. With 6ft. screened lead, **72/6**. Also special miniature model, only 1 1/4 in. dia., light-weight. Made for deaf-aid, but suitable for all purposes, having a fine frequency response. In aluminium housing with short screened lead, but no front grille, **27/6**.

MICROPHONE FLOOR STANDS, to suit 72/6 crystal microphone. Collapsible, 6ft. 8in. to 2ft., chromium-plated, **37/6**.

G.E.C. PUBLIC ADDRESS SPEAKERS. Latest models delivered immediately from our stock. 10-watt **PROJECTOR TYPE**, comprising P.M. Unit with built-in line transformer for multi-matching (details enclosed) and spun metal horn, 42in. long with tilting mounting bracket on cast neck, finished two coats industrial grey. With "B" Unit, **£10 5 0** (fully recommended). With "A" Unit (higher flux density), **£11 5 0**. Carriage on each speaker anywhere U.K., **7/6**. Also **INDUSTRIAL MODEL** in 9in. metal drum with front and rear grille and built-in multi-trans., handling 5 watts, **45/-**.

MEASURING INSTRUMENTS, by Weston, Ferranti, Elliott, etc. (We cannot undertake to select particular maker.) Housing 2 1/2 in. square flange, flush panel mtg., requiring 2in. hole, black bakelite, back terminals.

M Coil MILLIAMMETERS, 0/150 m.a. only left, **32/6**. **THERMO-COUPLE AMMETERS,** same style, for any frequency and D.C., 0/2.5 amp. and 0/3.5 amp. (two models), either, **39/6**. These meters are secondhand, ex. Govt., in good condition and lab. tested. Many important buyers—all fully satisfied.

HEADPHONES. New, maker-boxed Ericsson, with adjustable headband, 2,000 ohms, **25/-** pair.

SLIDING RESISTANCES. 100 watts. Fully enclosed, with fine smooth action. In following range: 4 ohms 5 amps., 10 ohms 3 amps., 50 ohms 1.5 amp., 200 ohms 0.7 amp., and 400 ohms 0.5 amp. Any one, **21/-**.

INDUSTRIAL ELECTRIC SOLDERING IRONS. Best makes from stock. S.T.C., all voltages, 75 watt, with 4in. pointed bit, good all-purpose iron, **21/-**. Same make 100 watt, with massive flat bit, **32/6**. Also ACRU, bent model, with interchangeable bit, **29/6** (100 watt). Discount for quantities.

TOGGLE PRESSES (by S.T.C.), double-acting, accurate, exerting 1 1/2 tons pressure. Height 52in., weight 130 lb. Further small supply available for immediate delivery from our stock. Inspection invited. **£30** nett. We have a large demand for this excellent tool.

RESIN-CORED SOLDER. Highest tin content. 40 per cent. tin, on 1 lb. reels **4/6** per reel.

Please include sufficient for packing and post.

The following items are offered to callers only:—

ROTARY CONVERTERS, for mobile work. Brand new and guaranteed. Input, 24 v. D.C., output 230 v. 50 c., 250-watts, **£16**. Very limited supply.

STEEL AMPLIFIER COVERS (G.E.C.), 15in. x 9in. x 7in. Black crackle finish, **7/6**. Also same style, 15in. x 10in. x 9in., **9/6**. **HEAVY-BASED FLOOR STANDS** (extending) to suit G.E.C. M/Coil Microphones (above), **47/6** and **52/6**.

M.R. SUPPLIES, 68, New Oxford Street, London, W.C.1.
(Phone: MUSEUM 2958)



*A Beacon light
in the P.A. field*

Beckoning to every operator and user of Sound Amplification is the inherent quality embodied in R-5 Equipment—equipment that keeps abreast, and is often ahead, of every modern development. At present we cannot supply all demands but if you would like to know about the range we are doing our best to make available, we will gladly send you our latest catalogue on request. Please enclose 1d. stamp.



Amplifiers Limited

3-4, Highfield Rd., Shepperton, Middlesex. Tel.: Walton-on-Thames 1019

WW. 4/48

WHARFEDALE

MIDGET 3 1/2-inch UNIT

ALCOMAX MAGNET

Flux Density 8,000 lines.

Speech Coil 15 ohms or 2/3 ohms. The first Wharfedale Unit using the new **ALCOMAX** magnet steel which gives extremely high flux density with small size. Designed for use as Microphone or Midget Speaker. Very sensitive.

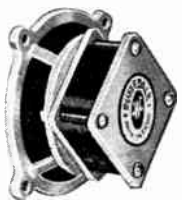

PRICE

Supplies are available for **PRIORITY ORDERS ONLY** **28/6** (list)

WHARFEDALE WIRELESS WORKS

(SOLE PROPRIETOR: D. E. BRIGGS)

HUTCHINSON LANE • BRIGHOUSE • YORKS

PHONE: BRIGHOUSE 50

GRAMS: "WHARFDEL"

Improve your Keying!

Correct spacing and high sending speeds are more quickly obtained by those operators who exercise sound judgment when purchasing their KEYS.

Scientific weight distribution, rigidity of construction, extreme lightness in action, heavy silver contacts and a high grade spring for accurate gap adjustment; these are the most important features, and, they are all to be found in the **Raymart "Speed" Key**. It combines all that is best in British and American key design.

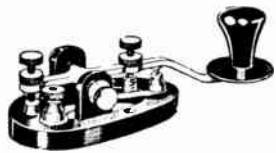

This British-made Key is definitely the finest value ever offered to the public. Choose the **Raymart "Speed" Key**. It will give you full satisfaction and years of useful service.

Price **8/6** Post Paid.

SPECIAL NOTE:

WIRE-WOUND POTS. Refer to our advertisement on page 18 of the January issue, and then note that we only have a small number of 20,000 ohm (4/- each) and 5,000 ohm (3/- each) types still available. These are 5-watt American C.T.S. wire-wound Volume Controls.

RAYMART
CRAFT A CREED

Please add postage on all orders valued 5/- or less.

Send stamped, addressed envelope with all enquiries.

Telephone: MIDLAND 3254

48 HOLLOWAY HEAD, BIRMINGHAM, I

FLEXIBLE TORSIONAL REMOTE CONTROL

— a study in End-Fittings

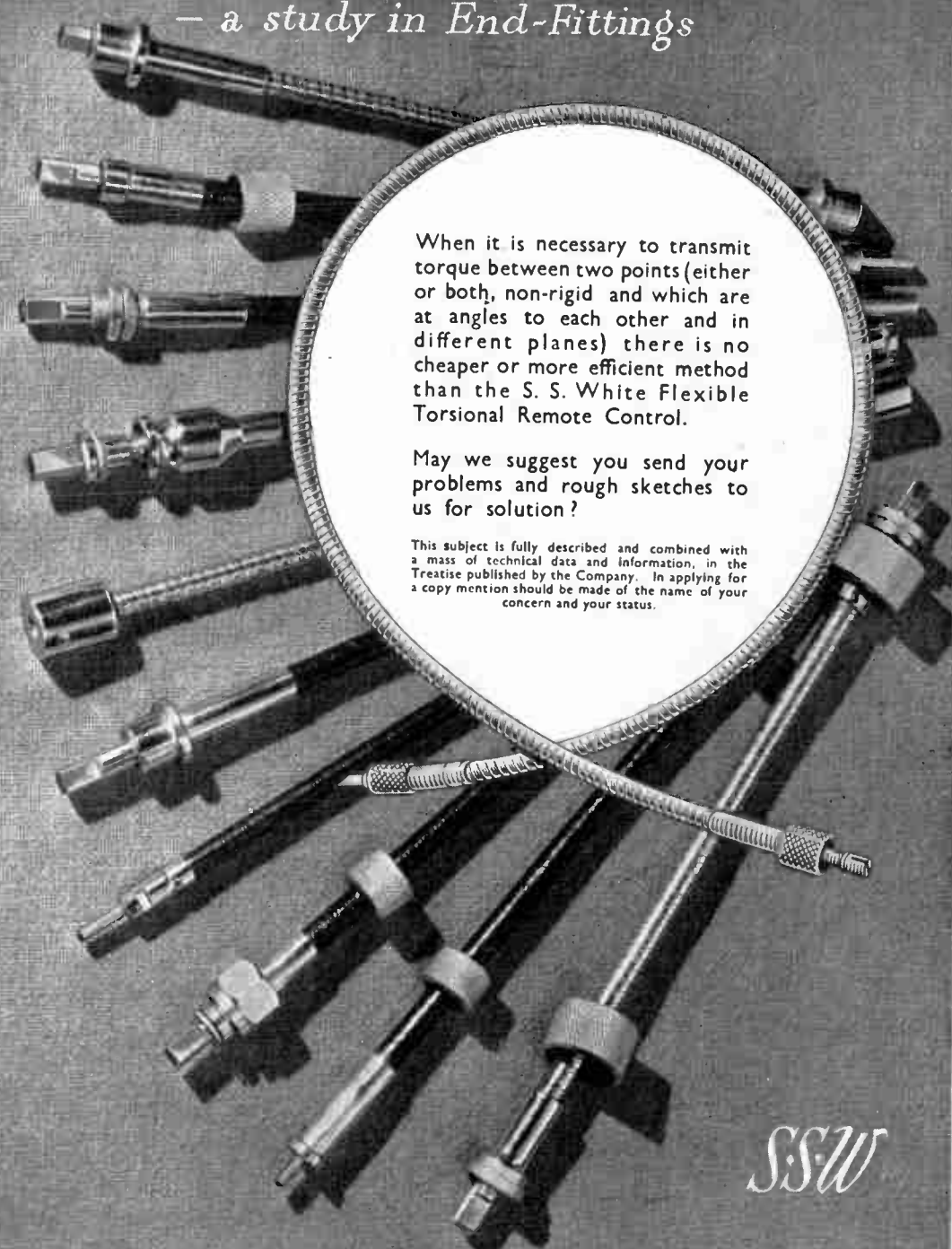

When it is necessary to transmit torque between two points (either or both, non-rigid and which are at angles to each other and in different planes) there is no cheaper or more efficient method than the S. S. White Flexible Torsional Remote Control.

May we suggest you send your problems and rough sketches to us for solution?

This subject is fully described and combined with a mass of technical data and information, in the Treatise published by the Company. In applying for a copy mention should be made of the name of your concern and your status.



THE S. S. WHITE COMPANY · BRITANNIA WORKS · ST. PANCRAS WAY · CAMDEN TOWN · LONDON N.W.1.

Cable Address: WHICODENTA, WESDO, PHONE, LONDON

Telephone: EUSTON 4758-4759

W.J.12

MAINS TRANSFORMERS.
 210/230/250 volts, 50 cycles. 350-0-350 v., 70 m.a. 6.3 v., 1.5 amp. 4 v., 2.4 amp., 25/- each. 200/250 v., 350-0-350 75 m.a., 5 v., 2 amp., 6.3 v., 3 amp., 28/- 200/250 v. 350-0-350 120 m.a., 5 v., 2 amp., 6.3 v., 3 amp., 37/6. 210/250 v., 6.3 v., 5 amp., 5 v., 2 amp., 350-0-350 75 m.a. Chassis mounting. Shrouded, 39/6 ea. 200/250 v., 4 v. 3 amp., 4 v. 6 amp., 350-0-350, 120 m.a., 39/6 each.

LOUDSPEAKER TRANSFORMERS. SPECIAL OFFER.
 Philco Pentode, 4/6; Heavy Duty Pentode, 7/-; Multi Ratio, 8/-; Heavy Duty Multi Ratio, 10/6.

ELECTRIC SOLDERING IRONS.
 60-watt, with Flex, 200/250 volts, A.C./D.C., Chrome-Plated, best quality, 12/6, tax free.

H. H. LINTON & CO. LTD.

CHROME-PLATED ELECTRIC BELLS with Transformer, A.C. 200/250 volts, supplied with instructions for fitting, 15/6, tax free. **WORTH DOUBLE.** Do away with that old "Leclanche" cell or dry battery and fit a reliable door bell.

ELECTRIC APPLIANCE LEADS. 6 ft. long, with connector one end for kettle, iron, radio, toaster, etc. Light adaptor or 2-pin plug other end, 5/9 each.

C.O.D. or Cash with Order. Carriage Paid
 Please Note—Callers to Showrooms,
2, HIGHGATE HIGH STREET, N.6
 Phone: Mountview 9431.
 Post Orders to Dept. L. O. 11, 2, Highgate High Street, N.6. 2jd. stamped addressed envelope must accompany all enquiries.

ROLA P.M. LOUDSPEAKERS.
 With Transformer, 5in., 22/6; 6½in., 25/6; 8in., 29/6.
 Without Transformer, 5in., 17/9; 6½in., 19/9; 8in., 24/- Only a few left.

CELESTION, 8in., P.M., with Transformer, 25/6.
 New 10in. **MAINS ENERGISED SPEAKER,** 1,200 ohms, without transformer, 32/6.

FIRE BARS WITH ELEMENT.
 Flat Type, 200/250 volt, 750 w., 3/9 each.
ROUND TYPE BAR.
 With Spiral, 200/250 volt, 750 w., 3/9 each.
BOWL FIRE ELEMENTS.
 Edison screw, 600 watt, 5/6 each.

SUNDRIES.
 4-way Battery Leads, with wander plugs, best quality, 1/3 each.
 Immersion Kettle Elements, 230/250 v., 1,000 watt, 22/6 each.
 Iron Connectors, 1/6 each; 2-pin 5 amp. plugs, 12/- doz.; Insulating Tape (best quality American), 3/- per lb.

A 65-watt SOLON for general use



This 65-watt Industrial type SOLON Electric Soldering Iron is fitted with an oval tapered bit—a shape which is suitable for most general work. For specialised work the pencil bit model is recommended, whilst bigger jobs call for the 125-watt or 240-watt models.

Supplies of these various models are only available for essential work, of course, and due to heavy demands it is necessary to order well in advance to avoid disappointment in delivery.

Details of this and other models sent on request.

SOLON Electric SOLDERING IRON

MADE FOR USUAL STANDARD VOLTAGES

W. T. HENLEY'S TELEGRAPH WORKS CO. LTD.
 Engineering Dept., Milton Court, Westcott, Dorking, Surrey

F.W.S.CO.

I.F. TRANSFORMERS of all types
AERIAL & OSCILLATOR COILS
TRIMMER & PADDER CONDENSERS
"SILVERCAP" CONDENSERS
COIL FORMS, etc.

Our increased manufacturing facilities, our added knowledge in the production of equipment for the Allied forces, will benefit you in due course.

We are making many specialised and intricate parts for the war effort, and we are happy to assist in winning that final unconditional surrender of the enemy forces.

Sickles transformers, coils, trimmers and many new parts will be ready for you again as soon as conditions permit.

Register your name with our Representative now. He will forward you information on our products as soon as they become available.

The F.W. SICKLES Co.
CHICOPEE, MASS., U.S.A.

Exclusively Represented by
Frank Heaver Ltd. Kingsley Road, Bideford, N. Devon

LASKY'S RADIO for Valves, Speakers, Condensers and Components.

Our Special Offer for this month.

24 ASSORTED CONDENSERS AND ELECTROLYTICS
 consisting of .1 mfd., .50 mfd., 12 v., 2 mfd., 400 v. cans, 16 mfd., 500 v. cans, .05, 8 mfd., etc., etc., all for 2/-, plus 6d. postage.

ROLA P.M. SPEAKERS
 8", less transformer ... 21/-, plus postage.
 6½" " " ... 17/6 " "
 5" " " ... 17/- " "

SPEAKER OUTPUT TRANSFORMERS
 Best quality ... 6/- each.

MAINS TRANSFORMERS
 4 v. 350/0/350, from 18/6 each, plus postage.
 6.3 v. " " 25/- " "

VOLUME CONTROLS
 Less switch, assorted, at 2/9 each.

We have a large stock of English and U.S.A. valves for replacement in stock. Send us your requirements.

A few examples of our Lease-Lend U.S.A. types in stock. 5Y3, 5Z4, 80, 6A8, 6F6, 6K7, 6Q7, 6SA7, 12A7, 12B8, 12Q7, 12SA7, 12SJ7, 25B8, 25L6, 25Z6, 32L7, 35L6, 35Z4, 35Z5, 70L7, 117Z6.

TERMS: Cash with order or C.O.D.

LASKY'S RADIO,
 370, Harrow Road, Paddington, W.9.
 Telephone: Cunningham 1979.

M.O.R.S.E. COMPLETE PRACTICE UNIT



as supplied to many branches of H.M. Services No. 1261. Complete Morse Practice Unit. Heavy commercial Key with nickel silver contacts and sensitive triple adjustment. High-tone Buzzer with silver contacts, mounted on bakelite base with cover. Battery Holder, complete with 4.5 Ever Ready battery. All metal parts heavily nickel plated, and the whole mtd. on polished Mahogany Base, 8½in. x 6½in. Post paid. **29/6**

Send Id. stamp for Illustrated List including particulars of the **S.E.L. Daylight-Signalling Lamp**
SIGNALLING EQUIPMENT LTD. (Dept. 8),
 Merit House, Southgate Road, Potters Bar. Phone: Potters Bar 3133

ERG Trade Mark



Resistors
 ON ALL GOVERNMENT LISTS

ERG RESISTORS LIMITED
 1021a, FINCHLEY ROAD, LONDON, N.W.11

NEVILLE'S

Model LW
Coil Winding Machine

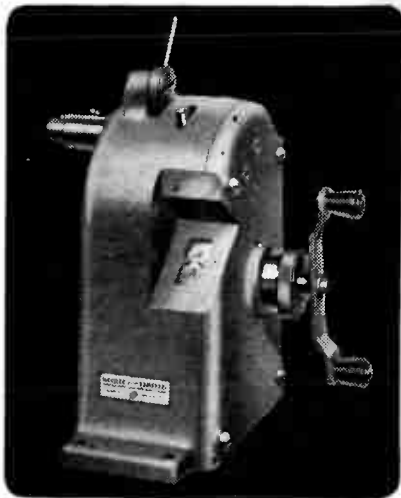
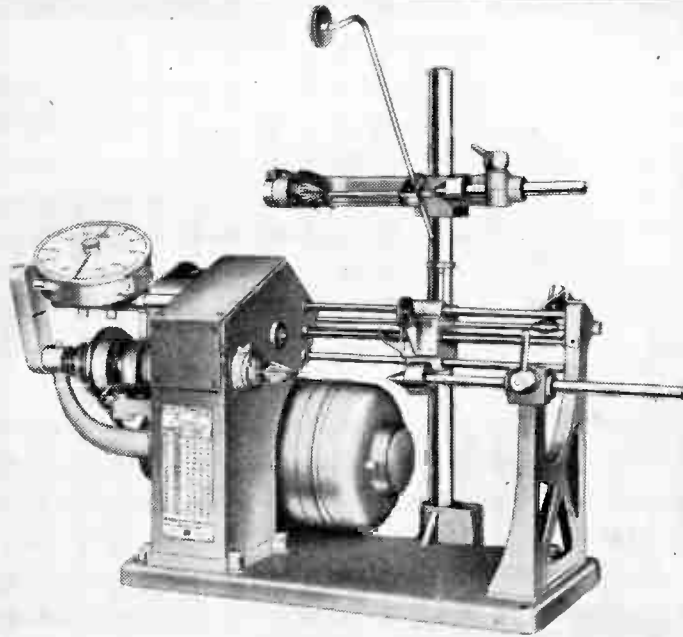

Model HW
Hand Coil Winding Machine

SPECIALISTS
in the design and manufacture of
COIL WINDING MACHINES
TAPING MACHINES
WIRE COVERING MACHINES
ARMATURE AND STATOR
COIL WINDERS

NEVILLE'S (LIVERPOOL) LIMITED

SIMMONDS TOWER · GREAT WEST ROAD · LONDON



A DIVISION OF THE SIMMONDS GROUP
LONDON · MELBOURNE · PARIS · NEW YORK · LOS ANGELES

BASICALLY BETTER...



FROM THE COMPLETE RANGE
MAY BE QUOTED:

Char. Imped. Ohms.	Type	A.3	C.4
Capacity mmf./ft.		70	214
Atten. db/100ft. 10Mc.		16.3	5.2
Dielectric Constant.		0.11	1.25

Air Insulation....
is the basic principle of
CO-AX LOW LOSS CABLES
Unequalled H.F. Properties
There is a CO-AX Cable for every H.F. Purpose

TRANSRADIO LTD. Inc. TELEQUIPMENT CO. 16 HIGHWAY-BEACONSFIELD

"THIS IS WHERE I COME IN" says Mark Cable



CONSULT US ON
CABLE BINDING
SYSTEMS WHEN
PLANNING

SAVE TIME WITH
Hellermann
CABLE MARKERS

HELLERMANN ELECTRIC LIMITED
GOODTRIC WORKS, OXFORD. Oxford 2403

BRIMAIN

POWER UNITS (Regd.)

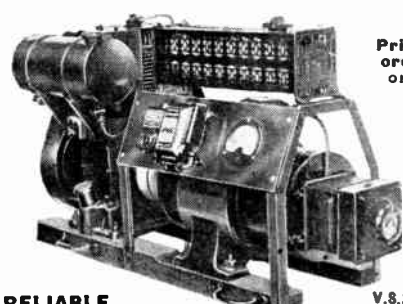

Priority orders only.

V.8.3
220 A.C.
1.25 K.V.A.

AS RELIABLE AS THE MAINS

The V.8.3 is a compact, sturdily built Petrol Electric Generator, produced specially for 16mm. film projection where constant voltage must be maintained and light load surge eliminated. The output of 1.25 K.V.A. is amply sufficient for standard 16mm. projectors. Fitted with handles and spring bolts, the V.8.3 is instantly detachable and can be removed in a matter of seconds from the light van in which it would travel for mobile work.

UNITS BUILT TO SPECIAL REQUIREMENTS
Designers and constructors of
MOBILE CINEMAS for indoor and outdoor displays

BRITISH FILMS LIMITED
Head Office: 199 PICCADILLY, LONDON. Regent 2828
Works: 260 HIGH ROAD, BALHAM, LONDON. Battersea 8506

MELTON METALLURGICAL LABORATORIES LTD

LIQUID SILVER

for metallising CERAMIC, MICA, QUARTZ or GLASS.

Low melting-point SOLDER from 70°C. or to specification. Non-corrosive Liquid FLUX for all electrical or Radio purposes.

Pre-War deliveries. Overseas enquiries invited.

IPSWICH RD., TRADING ESTATE,
SLOUGH, BUCKS. Phone: Slough 20992

Just to remind you!



Although more than ordinarily active on our job of manufacturing Transformers and Chokes of every type and size, we still keep well in mind our friends of pre-war years, both Trade and Public.

When the enemy has his final "break down," or is "burnt out," we shall be able to resume our normal peace-time business of providing you with products which do not.

ALL POWER TRANSFORMERS LTD.
8a, GLADSTONE ROAD, WIMBLEDON, S.W.19.
Phone: LiBerty 3303

◆ LINAGLOW LIMITED ◆

VOLUME CONTROLS. 5,000, 10,000, 25,000 50,000, 100,000 ohm; $\frac{1}{2}$, $\frac{1}{4}$, 1 and 2 megohm without switch, 4/9 each. As above, with switch, 6/9 each.

R.G.D. LIGHTNING ARRESTERS. Heavy Porcelain Case, can be used with any set or aerial. Safeguard your radio and house from damage by lightning, 1/6 each.

9-WAY 14/36 FLAT FLEX, 18/20ft. lengths, suitable for amplifiers, extension speakers, remote control and many other purposes. Finest quality pre-war manufacture. 7/6 per coil.

B.C. PILOT BULBS, 6 volt 3 amp. 15 mm. 1/- each, including tax.

INSULATING TAPE. Best quality British and American manufacture. $\frac{1}{2}$ in., $\frac{1}{4}$ lb. reel, 9d.; $\frac{1}{2}$ in., $\frac{1}{4}$ lb. reel, 1/4; $\frac{1}{2}$ in., 1 lb. reel, 2/3.

AMPHENOL OCTAL CHASSIS MOUNTING VALVE HOLDERS, 1/3 each. 7-pin chassis mounting valve holders, 6d. each.

WALNUT VENEERED LOUDSPEAKER CABINETS. Modern design fitted silk and baffle, pre-war quality, suitable for 8in. or 10in. speakers, 35/-.

HUMDIGERS. 30, 50, 25,000 and 50,000 ohm, 6d. each.

EXTENSION LOUDSPEAKERS IN ATTRACTIVE WALNUT VENEERED CASE. Fitted with 8in. Rola P.M. Speaker. A few only, 3 gns. each.

LOUDSPEAKERS. Rola P.M. 3 ohm voice coil with pentode output transformer, 5in., 23/6; 6 $\frac{1}{2}$ in., 25/6; 8in., 30/-. Without transformer, 5in., 18/6; 6 $\frac{1}{2}$ in., 22/6; 8in., 25/6. Celestion 8in. P.M. with transformer, 27/6. R.G.D. 10in. energised moving coil, 1,200 ohm field, 2.5 ohm speech coil, corrugated cone, without transformer, 30/- each. With heavy duty multi-ratio matching transformer, 42/-. Any of the above can be supplied with multi-ratio output transformers, add 5/- per unit.

BATTERY LEADS, 4-way, with Wander plugs, best quality, 1/3 each.

MAINS TRANSFORMERS, 210/230/250 volts, 50 cycles. 350-0-350 v., 70 m.a. 6.3 v., 1.5 amp. 4 v., 2.4 amp., 24/6 each. 200/250 v., 350-0-350 75 m.a. 5 v., 2 amp., 6.3 v., 3 amp., 27/6; 200/250 v. 350-0-350 120 m.a., 5 v., 2 amp., 6.3 v., 3 amp., 37/-. 210/250 v., 0.3 v., 5 amp., 5 v., 2 amp., 350-0-350 75 m.a. Chassis mounting. Shrouded, 39/- each. 200/250 v., 4 v. 3 amp., 4 v. 6 amp., 350-0-350, 120 m.a., 39/- each.

LOUDSPEAKER TRANSFORMERS. Philips' Pentode, 4/6; Heavy duty Pentode, 7/6; Multi-Ratio, 8/6; Heavy Duty Multi-Ratio, 12/6; Universal, 10/6.

DE LUXE WALNUT VENEERED CABINET. Suitable for American Midget sets, overall dimensions, 14in. x 7in. x 6in., drilled three hole, 32/6 each.

YAXLEY WAVE-CHANGE SWITCHES. 1-bank 4-way, long spindle, pre-war American, 3/6 each.

.0003 VARIABLE CONDENSERS WITH TRIMMERS. 3-gang, completely screened. Ideal for short-wave work, 3 or 6 hole chassis mounting, 6/6 each.

.0005 2-gang ALUMINIUM SPLIT VANE VARIABLE CONDENSERS. Long spindle, ball-bearing drive, 5/6.

Special Purchase

of the entire stock of a well-known accumulator hire service, due to premises being taken over by Government Department. We offer, in used condition, as new

C.A.V. 60 volt H.T. ACCUMULATORS

Type G.103, 5,000 m.a. at 1,000 hour rate in strong carrying case, with handle. Pre-war price over 70/- each. Unrepeatable bargain. Secure one of these and overcome your battery difficulties **25/-**

VOLTAGE DROPPING RESISTORS & LINE CORD REPLACEMENTS

Suitable for every make of radio receiver, comprehensive ranges mentioned below.

- 950 ohm .2 amp. Chassis mounting, heavy duty on porcelain former, 2 adjustable tappings, 8/6 each; as above, 800 ohm .3 amp., 8/6 each.
- .2 amp. 675 ohm, tapped 100, 100, 425 and 50 ohms, suitable for Ekco and other makes, 4/- each.
- .2 amp. 840 ohm, tapped 100, 100, 475, 115 and 50 ohms, for Ekco, etc., 4/-.
- .2 amp. 945 ohm, tapped 100, 100, 545 and 100 ohms, for Halcyon, etc., 4/6.
- .2 amp. 785 ohm, tapped 50, 50, 50, 50 and 535 ohms, for Fye, Lisson, etc., 4/6.
- .2 amp. 810 ohm, tapped 60, 105, 85 and 260 ohms, for Cossor, etc., 4/6.
- .2 amp. 660 ohm, tapped 150, 360, 120 and 30 ohms, for Pilot Major Maestro, etc., 4/9.
- .3 amp. 547 ohm, tapped 80, 80, 387 ohms, for Ferranti, etc., 7/6.
- .3 amp. 1,014 ohm, tapped 82, 82, 320 and 530 ohms, for Double Decca, 7/6.
- .3 amp. 781 ohm, tapped 45, 45, 332, 166 and 193, for Ferguson, etc., 9/6.
- .3 amp. 823 ohm, tapped 45, 45, 290, 166 and 277 ohm, for Ferguson, etc., 9/6.
- .3 amp. 660 ohm, tapped 150, 360, 120 and 30 ohms, for Pilot Little Maestro, etc., 8/6.
- SPECIAL HEAVY DUTY RESISTORS,** 5-watt, for bias, etc., all values from 25 to 2,000 ohm, with copper clips, 1/9 each. Similar to above, but 10-watt, 2/3.
- SPECIAL 2.3 ohm Resistor,** for converting dry battery sets for use with 2-volt accumulator, 2/6.
- 50 ohm centre-tapped Resistor, tapped at 25 ohm, for pilot lamps, 2/-.
- SPECIAL VOLTAGE DROPPING RESISTANCE,** for Electric Razors, 1,150 ohm, 2/6.
- .3 amp. **LINE CORD RESISTOR,** 360 ohm, 6/6; .3 amp. **LINE CORD RESISTOR,** with slider, any resistance obtained up to 750 ohm, 7/6.
- SPECIAL MULTI-LINE CORD RESISTOR,** 5 tappings 50 ohm, 1 tapping 750 ohm, with slider, .2 amp., 8/6.
- 2-way LINE CORD REPLACEMENT,** for Midget Receivers, 800 ohm, 6/-; 7/6; 600 ohm, 12/-; 15/-.
- BARRETTER VALVES, TYPE C.1.** .2 amp., 8/6 each.

.0003 VARIABLE CONDENSERS, 3-gang, ceramic insulation, with trimmers, copper braided connecting strips, ball and gear drive, 12/6 each.

.0003 VARIABLE CONDENSERS, 2- and 3-gang, ceramic insulation, with trimmers, ball drive, 7/6 and 9/6 each.

GLAR BULBS. 2.5, 15/9 per 100, inc. tax.

OSRAM PILOT BULBS, 6.2 volt, 3 amp. MES Tubular, 1/- each, including tax.

LISSEN R.C. Intervalve Coupling Units, 1/6.

SILVER MICA CONDENSERS. Flat Wire End—Assorted and Useful Values, 17/6 per 100 (not more than 5 alike).

I.F. AND AERIAL TRIMMERS. 12 Assorted and Useful Values for 2/6.

L.F. CHOKES. 20 hys. 100 m.a., brand new, 16/9; 40 hys. 100 m.a., brand new, 21/-.

LOUDSPEAKER FRETs, coppered brass, 8 $\frac{1}{2}$ in. x 7in., 3/6; 10in. x 16in., 10/6 each.

EVER-READY CAR STARTER BATTERIES, 6 volt, new, in metal container, with carrying handle, 12/6 each, plus tax.

TELSEN Illuminated Disc Drive, will fit any variable condenser, modern silver oxidised escutcheon, 1/9 each.

RADIO CABINETS, walnut veneered, attractive design, dim. 19in. x 12in. x 10in. Dial aperture 5in. x 7in., drilled for tuning, tone and volume controls, 39/6 each.

RADIO CABINETS, walnut veneered, suitable for extension loudspeaker, dim. 8in. x 7in. x 7in. Bargain, 10/6 each.

FIXED WIRE WOUND RESISTORS. Wire Ends. 4-watt (500, 1,000, 3,000, 4,000 and 5,000 ohm only), 110/-; 10-watt (800 ohm only), 150/- per 100. Minimum orders 12 of any value.

FIXED CARBON RESISTORS. Wire Ends. Assorted and Useful Values. $\frac{1}{2}$ -watt, 24/-; $\frac{1}{4}$ -watt, 30/-; 1-watt, 36/-; 2-watt, 55/- per 100. Minimum orders 50 assorted. Assorted parcel for 83. Contains 25 $\frac{1}{2}$ -watt, 50 $\frac{1}{4}$ -watt, 50 1-watt, 25 2-watt, 10 3-watt.

HEAVY DUTY WIRE WOUND RESISTORS. Copper Ends. 15-watt, 17,500/47,500 ohm, 3/6 each; 25-watt, 250/70,000 ohm, 5/6 each; 50-watt, 17,500/35,000 ohm, 7/- each.

TAPPED WIRE WOUND RESISTANCES. Special Offer. 25-watt, 375 ohms, tapped 125 and 250, 6/6 each.

GLASS RADIO FUSES. Spring clip, bakelite, base, 1.5 amp., 1/- each.

PHILIPS EXTENSION LOUDSPEAKER SWITCH, mounted on metal bracket, 1/6 each.

TUBULAR PAPER CONDENSERS, 350-500 v. D.C. working. .0005, .0001, .0003, .0006 mfd., 4/- doz.; .001, .0015, .002, .003, .004, 6/- doz.; .01, .025, .03, .05 mfd., 7/- doz.; .08, .1 mfd., 12/- doz.; .15, .2, .25, 3 mfd., 15/6 doz.; .5 mfd., 18/- doz.; or Assorted Parcel of 50 for 27/6. Minimum orders, 1 doz. any type.

10-WATT 4-VALVE P.A. AMPLIFIER

pre-war manufacture, exceptionally well built, finest quality components. 100/250 volt A.C. Amplifier in portable carrying case with space for gramophone motor, 10" Rola Energised Loudspeaker, with output transformer and long circular rubber connecting cable and plug in separate carrying case. Worth 30 guineas. Bargain,

£19. 10. 0

PLEASE NOTE

● CALLERS to Show Rooms, 61 HIGHGATE HIGH ST., N.6
Phone: Mountview 9432.

All orders C.O.D. or Cash with Order, carriage paid. 2½d. stamped addressed envelope must accompany all enquiries.

● POST ORDERS to Dept. M.O.9, 3 HAMPSTEAD LANE, N.6.



on ne passe pas

THOUGH Custom may cry Halt, the order of the day is Forward. In modern industry, men and women of imagination, undeterred by the doubts of the timid, are pressing on towards new ideas and methods.

Of this dynamic spirit Simmonds Aerocessories is at once the symbol and the servant. The Simmonds Organization is geared to the achievement of maximum output without loss in quality; the Simmonds products in all fields are fulfilling a high vocation in conserving the Nation's time, material and man-power. Let Simmonds be your ally in the great advance.

S I M M O N D S

The Creative Impulse in
AERONAUTICAL, INDUSTRIAL & MARINE
Construction

THE SIMMONDS NUT · PINNACLE NUT · SPIRE NUT · SIMMONDS GAUGES,
INSTRUMENTS AND CONTROLS · FRAM OIL & ENGINE CLEANER

SIMMONDS AEROCESSORIES LTD.,
GREAT WEST ROAD, LONDON
A COMPANY OF THE SIMMONDS GROUP

LONDON, MELBOURNE, PARIS, NEW YORK.

Wireless World

Radio • Electronics • Electro-Acoustics

33rd YEAR OF PUBLICATION

APRIL 1943

Proprietors :
ILIFFE & SONS LTD.

Managing Editor :
HUGH S. POCKOCK,
M.I.E.E.

Editor :
H. F. SMITH.

Editorial, Advertising
and Publishing Offices:

DORSET HOUSE,
STAMFORD STREET,
LONDON, S.E.1.

Telephone :
Waterloo 3333 (35 lines).

Telegrams :
"Ethaworld, Sedist, London."



PUBLISHED
MONTHLY

Price: 1/3

(Publication date 25th
of preceding month)

Subscription Rate
Home and Abroad
17/- per annum.

EDITORIAL. Wavebands and Frequency Bands ..	95
RADIO WAVES IN THE IONOSPHERE. By T. W. Bennington	96
PICK-UP ACCESSORIES. By John Brierley	100
SIMPLE TEST OSCILLATOR. By A. G. Chambers (G5NO)	104
RADIO DATA CHARTS.—No. 6: Length of Capacity- loaded Quarter-wavelength Transmission Line. By J. McG. Sowerby, B.A., Grad.I.E.E. ..	106
WORLD OF WIRELESS	108
FREQUENCY MODULATION.—IV: Pre-emphasis, De-emphasis, and the Double-tuned Discriminator. By Christopher Tibbs, Grad.I.E.E.	111
ELECTROMAGNETIC FIELDS IN RADIO.—III : Wave Transmission in Space. By Martin Johnson, D.Sc.	115
POST-WAR RADIO	119
LETTERS TO THE EDITOR	120
UNBIASED. By Free Grid	122
RANDOM RADIATIONS. By "Diallist"	123
RECENT INVENTIONS	126

Branch Offices :

COVENTRY :
8-10, Corporation Street.
Telephone: Coventry 5210.
Telegrams :
"Autocar, Coventry."

BIRMINGHAM :
Guildhall Buildings,
Navigation Street, 2.
Telephone:
Midland 2971 (5 lines).
Telegrams :
"Autopress, Birmingham."

MANCHESTER :
260, Deansgate, 3.
Telephone:
Blackfriars 4412 (4 lines).
Telegrams :
"Iliffe, Manchester."

GLASGOW :
26B, Renfield Street, C.2.
Telephone: Central 4857.
Telegrams: "Iliffe, Glasgow."



*As many of the circuits and
apparatus described in these
pages are covered by patents,
readers are advised before
making use of them, to satisfy
themselves that they would
not be infringing patents.*

"HYPERLOY"

TRANSFORMERS AND CHOKES

A range of high-performance, space-saving
Components designed to meet the most exacting
requirements of modern Electronic and Com-
munications equipments.

- Small in size
- Weighing only 2 ozs.
- Meeting the most rigid Tropical Specification
- Easily mounted in any position
- Manufactured in a variety of windings to meet many diverse applications

WRIGHT & WEAIRE LTD.
HIGH ROAD, TOTTENHAM, N.17

Telephone: TOTtenham 3847-8-9



TIMING TIME

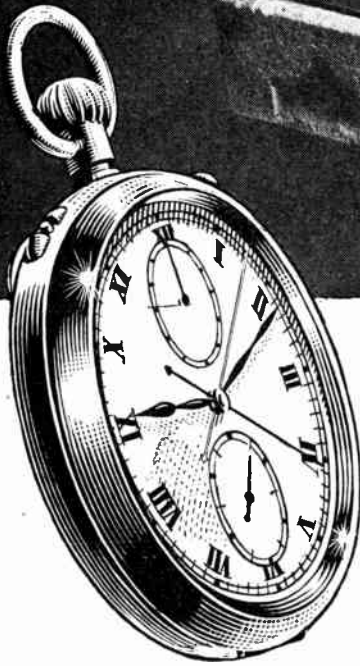
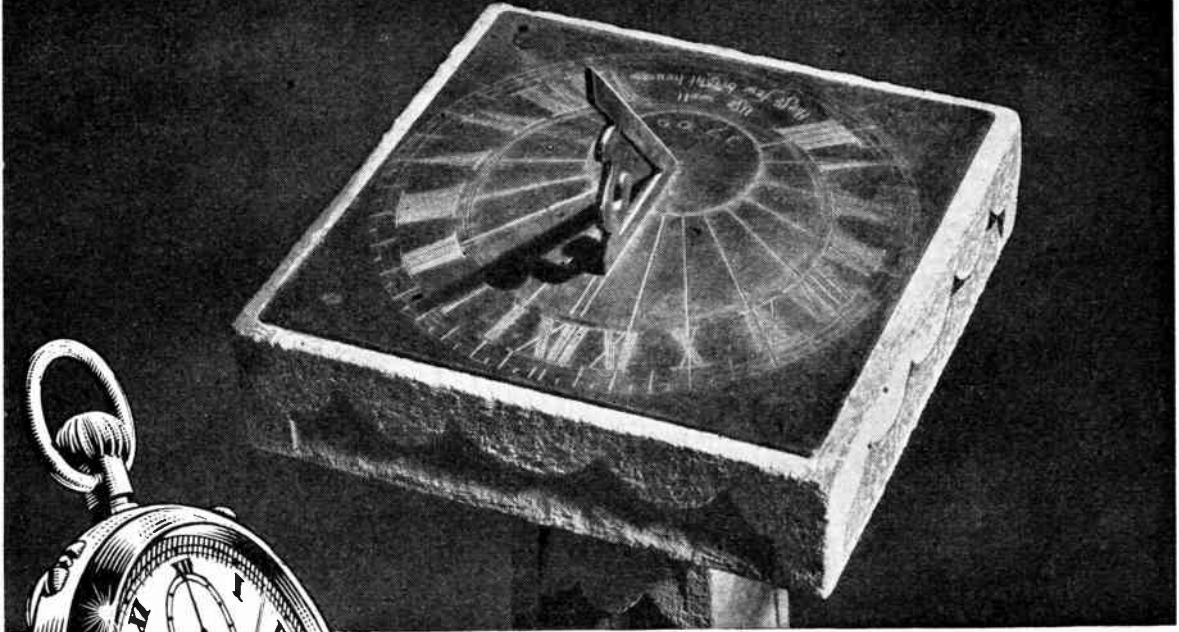

The accurate timing of watches and clocks is normally a lengthy procedure and involves keeping the instrument under observation for a considerable period.

The development of the Thermionic Valve and Cathode Ray Tube have made possible the design of special apparatus by means of which any timepiece can be regulated with great precision in a matter of minutes.

This is yet another example of the important part which the valve plays in solving specialised problems of control which arise in almost every industry.

{
 COMMERCIAL
 INDUSTRIAL
 SCIENTIFIC
 MEDICAL
 EXPERIMENTAL
 DOMESTIC
 }

MULLARD

THE MASTER VALVE

A Valve for Every Purpose

THE MULLARD WIRELESS SERVICE CO. LTD., CENTURY HOUSE, SHAFTESBURY AVE., LONDON, W.C.2 (47)

Wireless World

Radio • Electronics • Electro-Acoustics

Vol. XLIX. No. 4

APRIL 1943

Price 1s. 3d.

Wavebands and Frequency Bands

Universal Method of Classification

WRITING in last December's issue on the confusion that exists on the nomenclature of radio-frequency bands, we expressed the hope that a universally acceptable classification, applicable to both frequencies and wavelengths, might be devised. As was then stated, the International Radio Communications Conference (C.C.I.R.) had produced, before the war, a system of grouping that seemed to satisfy many of the requirements; in fact, so far as wavebands were concerned, it was entirely satisfactory. But the designations assigned to the corresponding frequency bands seemed to leave much to be desired, and moreover there was no easily memorised correspondence between the two. For example, the term "intermediate," one of those proposed, already has a specialised and generally understood application to frequencies in another sphere, while the relative significance of "ultra" and "super" is by no means obvious.

In the matter of frequency classification, the "power of ten" system, first suggested by B. C. Fleming-Williams in *Wireless Engineer* and reprinted in our December issue, seemed to offer many advantages, but the wavelength equivalents were not easily memorised, and the grouping differed from that of the C.C.I.R. system.

Many of our correspondents have made useful contributions, and taking all their suggestions into account, we feel confident in putting forward a system that seems to be free of all the usual objections. This is set out in the accompanying table,

where the alternatives in columns (4) and (7) are included as a matter of interest. As will be seen, the waveband classification is essentially that of the C.C.I.R., and so starts with the great advantage of a measure of international acceptance; indeed, it is noticed that such expressions as "centimetre waves" are already occurring quite often in the technical literature of various countries.

To our contributor "Diallist" goes the credit for combining the C.C.I.R. waveband classification (unchanged) with frequency-band numbering on the "powers of ten" principle proposed by Fleming-Williams. But, instead of using simple powers of ten of the frequency equivalents (in cycles per second), it is proposed that powers of ten multiplied by three (in kilocycles per second) should be employed. This modification is practically as easy to memorise as the key originally proposed. We are also indebted to "Diallist" for suggesting the frequency-band names in column 3; these avoid the confusing "intermediate" and "super" of the C.C.I.R. classification. The alternative waveband names in column 7 are merely the "reciprocals" of frequency band names in column 3. The alternative nomenclature of column 4, put forward by L. M. Rampal in a letter printed in this issue, has much to recommend it from a purely rational point of view, but, much as one may incline towards it, the present generation of wireless men is unlikely ever to look upon frequencies between 3 and 30 Mc/s as "medium."

Band No.	f in kc/s	Frequency Band Names		λ in metres	Waveband Names	
		Preferred	Alternative		Preferred	Alternative
1	Below 3×10^1 (30 kc/s)	Very low	Very low	Above 10,000	Myriametre	Very long
2	$3 \times 10^1 - 3 \times 10^2$ (30—300 kc/s)	Low	Low	10,000—1,000	Kilometre	Long
3	$3 \times 10^2 - 3 \times 10^3$ (300—3,000 kc/s)	Medium	Medium low	1,000—100	Hectometre	Medium
4	$3 \times 10^3 - 3 \times 10^4$ (3—30 Mc/s)	Medium high	Medium	100—10	Decametre	Medium Short
5	$3 \times 10^4 - 3 \times 10^5$ (30—300 Mc/s)	High	Medium High	10—1	Metre	Short
6	$3 \times 10^5 - 3 \times 10^6$ (300—3,000 Mc/s)	Very High	High	1—0.1	Decimetre	Very Short
7	$3 \times 10^6 - 3 \times 10^7$ (3,000—30,000 Mc/s)	Ultra High	Very High	0.1—0.01	Centimetre	Ultra Short
(1)	(2)	(3)	(4)	(5)	(6)	(7)

RADIO WAVES IN THE IONOSPHERE

Simplified Explanation of Their Behaviour

AMONG the less easily understood of the phenomena with which the radio man has to deal are those concerning the behaviour of a radio wave after its radiation into space. The textbook chapters on this subject are usually very involved, and nearly always depend on an extensive use of mathematics. Not all radio men, however—nor perhaps the majority of them—are capable of absorbing mathematical statements, at least without a great deal of trouble, and this type of person is therefore apt to “shy off,” and take the wave propagation chapters as read. If the physical phenomena involved could be explained in simple descriptive language, and without the use of mathematics, the subject could be interpreted to people to whom it might otherwise remain something of a mystery.

This article is an attempt to deal with some short-wave phenomena in this simple way. But, naturally, it cannot hope to explain matters in that comprehensive fashion necessary for a complete understanding. Furthermore, the reader will have to accept, without questioning, certain fundamental facts and principles. If he will do this it should be possible for him to form a pretty clear and useful picture of what happens to the radio wave during its journey to the ionosphere and back, and perhaps this knowledge will whet his appetite for a deeper study of the matter.

Start of the Journey—Let us start off with the concept of a wave which has just been radiated from a transmitting aerial and is commencing the journey which will—in our case—take it up to the ionosphere and back. We can visualise it as consisting of an electric field (brought into being by the electric charge in the transmitting aerial) and a magnetic field (produced by the current in the aerial). In any part of the wave-front these two fields are acting at right angles to each other, while the direction of travel of the wave is at right angles to both of them, the velocity being—as near as makes no matter—300,000,000 metres per

By T. W. BENNINGTON

second. At any point in space the amplitude of the electric and magnetic fields will vary with time, increasing and decreasing according to the wave-frequency (initially according to the frequency of the electrical oscillation fed to the transmitting aerial). The velocity of the wave remaining constant, there will be a certain definite distance between any two maxima of the fields, this again depending on the wave frequency. The three quantities of wavelength, velocity and frequency are therefore inter-connected according to the well-known law; $\lambda = \frac{300,000,000}{f}$. The direction in which the electric field is acting—and at first this direction remains constant—is said to be the direction of “polarisation” of the wave. Thus, if the electric field acts in a direction parallel to the earth’s surface the wave is “horizontally” polarised. We can now go on to see how the behaviour of the wave will vary according to the nature of the medium through which it is passing.

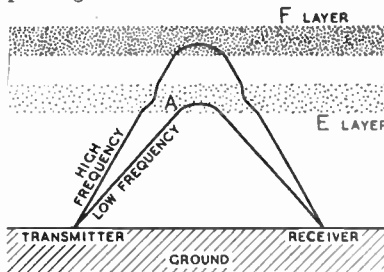

Fig. 1. Showing how the wave may reach its destination by either of the principal ionosphere layers, according to its frequency.

The wave—so long as it maintains its original velocity—travels outward from the transmitting aerial in a straight line. We will neglect that part of the radiated energy which starts its journey in a direction parallel to the earth’s surface, and consider only that part radiated in upward directions from the aerial. For our purpose we can consider the energy going in any one single upward direction—as shown by

either of the lines in Fig. 1—and we may look upon it as a single “ray” of radio energy. But we would do well to remember that, for all practical purposes, there is never one single ray going upwards, even when we narrow our radiated wave into the narrowest “beam,” but a great many such rays travelling side by side. Radio waves are, of course, propagated through the all-pervading ether, but their behaviour may be profoundly modified by the nature of any material media in their path.

Wave Velocity.—Now the speed at which the wave travels is inversely proportional to the current set up by the oscillating electric field. Since a current is, in reality, a movement of electrons, and in an insulator it is impossible—or at least extremely difficult—to produce any such movement of electrons. Ordinary air is—as far as we need consider—an electric insulator; therefore, when the wave travels through it the electric field does not set up any current.

If, then, the wave does not set up any current at all, why does it travel at only 300,000,000 metres per second? One would have expected its velocity to be infinitely great. Well, although the field in ordinary air does not set up any actual current, its own rate of change is equivalent to a current because it consumes part of the energy in the wave, and it is, in fact, called the “displacement current.” It is this displacement current which limits the speed at which the wave travels to the figure just given.

Travelling onward in a straight line at this speed, then, our wave very soon reaches the ionosphere. The air in the ionosphere is in a different condition to that in which the wave has so far been travelling, for, due to the action of certain rays from the sun, numbers of electrons have been liberated from their parent atoms, and now exist as “free electrons.” The air in the ionosphere is therefore not an insulator, but, since its electrons are capable of independent movement, an electrical conductor. The electric

field of the radio wave does set these free electrons into motion, and they, in motion, constitute an oscillating electric current, which, of course, affects the future behaviour of the wave. Unlike the displacement current—which “leads” on the electric field by 90° —the electronic current does not reach its cyclic maxima and minima until 90° after those of the field which produced it. It is therefore in phase opposition to the displacement current, and thus tends to cancel it out.

The effective current set up by the oscillating electric field is therefore reduced, being now equal to the displacement current less the current due to the oscillating elec-

tronic current. The upper part will therefore travel faster, causing the wave to bend away from the region where the electrons are most dense towards that where there is a smaller electron population.

Eventually the wave has been so turned round that it is travelling back towards the ionosphere boundary again, and, emerging, it continues on in a straight line through the ordinary air until the earth's surface is reached.

Group Velocity.—Now we must turn for a moment to a phenomenon which is certainly not one of the easiest to explain in a few

relationships between the various frequencies comprising it will occur at greater time intervals.

This may be a bit difficult to grasp, but let the reader imagine the pulse to consist of a group of waves of varying amplitude with the peak amplitude in the centre of the group. What happens is that, because of the frequency discrimination as to wave speed, the various frequencies that go to make up this complex wave have their phase relationships one to another altered in such a way that the peak amplitude occurs later than before. This means that the wave group as a whole is travelling slower than it did in ordinary air. Furthermore the greater the wave velocity—which implies that the frequency discrimination is greater—the smaller is the group velocity. The group velocity, moreover, is *never* greater than that of light. So that the greater the electron density the slower is the signal as a whole propagated. In fact, with a certain critical concentration of free electrons the group velocity becomes zero, and the wave-group going vertically upwards is completely stopped. This occurs when the electronic current is of such magnitude as to cancel completely the displacement current.

So far as our pulse signal is concerned; then—and this is usually sent vertically up towards the sky—we can regard it as ascending to the ionosphere with the velocity of light, and after reaching it proceeding onwards more slowly. As the density of the free electrons, and hence of the current set up, gets greater, it proceeds at ever decreasing speed. Then, with a certain critical density of electrons, it is completely “reflected,” and commences to travel downwards again; gathering speed as it gets into regions where the electronic density is smaller. Emerging from the ionosphere again it continues on with the velocity of light until the ground is again reached. We thus have it sent back to us in the form of an ionospheric echo.

Variation of Electronic Effects with Frequency.—Now we come to a very important point. The impetus given to the electrons by the wave will vary according to the rate at which the electric field is changing. The velocity attained by the electrons will be determined by the time during which the field

Fig. 2. Ionosphere characteristics: heights from which waves of various frequencies are returned under typical daytime conditions in winter.

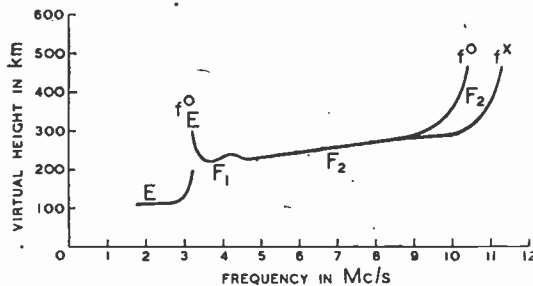

trons, and the velocity of the wave—therefore increases. As the strength of the electronic current increases—and it will continue to increase as the wave goes farther into the ionosphere, where the density of the free electrons gets greater—so will the effective current set up become smaller, and the wave speed become increasingly greater.

Now the same law will be applicable here as applies in optics. When a wave passes from one medium into another in which its speed is greater, the direction of the path of the wave changes—it is refracted or bent away from the normal to the boundary of the new medium. Thus the wave no longer continues onwards in a straight line, but swerves off so as to travel in a direction at a smaller angle to the lower boundary of the ionosphere, as at A in Fig. 1. Furthermore, this “bending” process is progressive, for the farther the wave goes into the ionosphere the greater becomes the strength of the electronic current, the greater becomes the wave speed and the more does it bend away from the direction of its original course. Perhaps the best way to picture this is to regard the upper part of the wave-front as being in a region where the electron density is greater than it is in the

simple words. It has been said that when the wave enters the ionosphere the wave velocity increases, due to the effect of the electronic current, and becomes greater than that of light. But, apart from what has just been said, we are not really concerned with the wave velocity, but with a quantity known as the “group” velocity. For this is what determines the speed of the “signal” in the ionosphere, as distinct from the speed of individual waves.

Take, for example, the sort of signal which is used in ionosphere measurement work. This is known as a “pulse,” and consists of a very short, sharp burst of energy, somewhat like the dot in the morse code, but much shorter, lasting only a few thousandths of a second. Nevertheless in this time several complete waves are emitted from the aerial, comprising what we may call a “group” or “train” of waves. Such a signal—and indeed all practical signals—is, in fact, made up of a large number of different frequencies, and, as we shall see later, the wave speed in the ionosphere varies according to frequency. Now if the various frequencies comprising the pulse signal are travelling at different speeds it means that the signal as a whole is retarded, because the phase

Radio Waves in the Ionosphere—

continues to act in a certain direction. Therefore the amplitude and average velocity of the vibrating electrons will be greater the lower the frequency of the wave. Consequently the magnitude of their effect upon the wave—in altering its velocity and direction of travel—will be the greater the lower the frequency. It varies, in fact, inversely as the square of the frequency or directly as the square of the wavelength. From this we gather that a wave of high frequency will penetrate further into an ionised layer before the electron density is sufficient to ensure reflection than will a low frequency wave. Also that there is an upper limit to the frequencies which can be reflected, depending on the maximum electron density existing within the ionised layer.

The foregoing may be taken as the basis upon which ionosphere measurement work is conducted. The pulse signals are sent, as has been said, vertically or nearly vertically upwards, and the echoed signal is picked up at a location near to the transmitter, the receiver also being actuated by energy from the pulse picked up directly at the moment it is sent off. The interval between the directly received signal and the echo, as shown on the oscillograph, is measured, and, assuming that the echoed signal has travelled with the velocity of light, the virtual height of its reflection is thus easily calculated, or, more conveniently, read off directly from a suitably calibrated instrument. Fig. 2 shows the sort of curve which is obtained when the heights are plotted for the whole range of frequencies on which echoes can be obtained at a certain time of day. Although we do not propose to discuss all its details, a few points about it may be considered, as throwing some light on the behaviour of the wave.

Virtual Height.—First, however, we had better say something about the quantity known as "virtual" height. In Fig. 3 we have illustrated the case for a pulse signal sent up somewhat more obliquely than is usual for measurement work, in order to show the difference between the virtual and true heights. The pulse signal, on entering the ionosphere, deviates away from its original course in the manner shown by the curve

B C D, and during this part of the trajectory it travels at a speed less than that of light.

If it has continued with its original velocity, and had followed the path B E D, it would have arrived at F at exactly the same moment as it does in fact arrive there after following the curved path B C D. If, therefore, we take the delay between reception of the signal and its echo and multiply this by the velocity of light, then dividing the answer by 2, will give the height h' , and not the top of the actual trajectory; h' is the virtual height, and this will always be greater than the true height—or at least never less—and the difference between the two will depend on the electronic gradient in the layer. We are, however, unable to determine what this is, since we are unable to assess the precise way in which the signal is retarded in the layer, i.e., how this retardation varies with height. We know, however, that the further the wave penetrates into the layer the greater will be the difference between the virtual and the actual height, because the wave will be travelling longer in regions where the electronic density

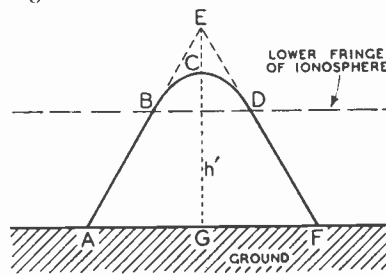

Fig. 3. Showing the difference between virtual and true height.

is such as to cause retardation of the signal. We may thus assume that on the "curls" of the curve in Fig. 2—these imply deep penetration of a layer—the difference between the two quantities will be at a maximum, but that on the straight parts of the curve it may not be so great.

The Critical Frequencies.—We may now examine some of the principal features of the curve in Fig. 2.

It will have been gathered from Fig. 1 that the electron density in the E layer is considerably less than that in the F layer, for the wave of high frequency goes right through the E, though it is sent back from the F. It should be mentioned that

during the day there are two F layers, the F₁ lying underneath the F₂. During the winter day, when the curve of Fig. 2 was taken, there is little difference in the height at which these two layers lie.

At first, on the lowest frequencies, no echoes at all are obtained because the radiated energy is all absorbed in the lower ionosphere. At about 1.7 Mc/s echoes are obtained from a height of 110 km., and this continues up to about 2.8 Mc/s, when the height recorded starts rapidly to increase. The pulses over this band of frequencies are being reflected from the lower part of the E layer, as is shown by the height. The upward curl at the right-hand end of the curve is occasioned by the penetration of the wave into the E as the frequency is raised, until at 3.2 Mc/s the pulses penetrate the E altogether and go up to the F₁; 3.2 Mc/s is thus the critical frequency of the E, i.e. the highest frequency returned by it at vertical incidence.

As the frequency is further increased—the pulses now coming down from the F₁ layer—the height at first apparently decreases with increasing frequency. The upward curl at the left of the F₁ curve is, however, only occasioned by excessive retardation in the E, at frequencies near its critical frequency. At about 4.2 Mc/s there is a decided kink in the curve, which shows where the pulses penetrate the F₁ and start to come down from the F₂, the uppermost layer of the ionosphere. The kink is due to retardation in the F₁. Continuing to increase the wave frequency results in the wave beginning to penetrate further into the F₂, and the height recorded gets slowly greater. Then, at about 9 Mc/s—following the upper or left-hand branch—the penetration (and retardation) in the F₂ rapidly increases, until at 10.4 Mc/s the wave penetrates the layer altogether. This is the critical frequency of the F₂ and the highest frequency—if we neglect the lower or right-hand branch of the curve—returned from the ionosphere at vertical incidence.

Effect of Earth's Magnetic Field.—Now we come to another rather difficult matter—that is, the forking of the curve which is seen to commence at 8.6 Mc/s. It is due to the action of the earth's magnetic field. When the wave is

travelling in ordinary air, and is not setting up any electronic motion, the magnetic field has no effect upon it. But as soon as the wave sets up movements in the ionosphere, it begins to be affected by the field. For the field exercises a force upon the moving electrons, producing a twisting effect upon the paths in which they vibrate, and, because of its dependence upon the nature of the electronic motion, the wave itself is affected.

As might be gathered, the electrons will initially vibrate in paths determined by the direction in which the electric strain lines of the curve are acting. The electronic motion, when affected by the field, causes the polarisation of the wave to change in a complicated manner which we had better, in this article, ignore. But we can perhaps explain the forking of the curve in this way. Suppose in the case of our exploring wave, sent vertically up, that when it enters the ionosphere the electric field is acting so that the electrons are set vibrating in a direction exactly parallel to that of the earth's magnetic field. The field, in such a case, will have no effect upon them, and consequently its effect will not be apparent in the behaviour of the wave itself. The pulse signal will ascend until the magnitude of the electronic current is sufficient to cause complete reflection, and then it will commence to descend.

Suppose, now, that the electric field is acting so as to set the electrons vibrating in a direction *transverse* to that of the magnetic field. The field will now have the maximum effect upon them—its twisting effect upon their paths will be at its greatest. And this twisting effect is equivalent to an increase in the strength of the electronic current itself, so that the wave is more affected than before. Its wave velocity is increased by a greater amount, it is deviated more from its original path, and it is completely reflected with a lesser density of electrons than before. It therefore is reflected lower down in the ionosphere than is the wave we first considered. In practical cases—when the wave enters the ionosphere with the direction of its electric field at an angle to that of the earth's field—the wave is resolved by the ionosphere into two separate components, each behaving differently and according to the general cases stated above. They

become differently polarised, travel with different velocities, follow different paths and require different electronic densities to ensure their reflection. That behaving according to the first case is called the "ordinary" wave (f^o), and its performance is represented by the upper or left-hand fork of our curve. That behaving according to the second case is the "extraordinary" wave (f^a), and its behaviour is recorded in the lower or right-hand fork. As will be seen—after a frequency is reached such that the ordinary wave has penetrated the layer—echoes of the extraordinary are still received, because it requires less electrons to reflect it than does the other. As the frequency is further increased its behaviour follows closely that of the ordinary ray at lower frequencies, until it, too, penetrates the ionosphere layer. The difference in the critical frequencies of the ordinary and extraordinary rays is thus a measure of the strength of the earth's magnetic field, and will therefore vary somewhat at different locations on the earth's surface.

In practice—for the purpose of finding the frequencies suitable for

practical short-wave communication—it is the ordinary ray critical frequency which is almost always used, this being regarded as the highest frequency from which the working frequency for oblique incidence may be calculated.

At oblique incidence—such as is necessary in communicating over a distance—the ionosphere will return higher frequencies than it will at vertical incidence. We have been speaking, mainly, of the behaviour of the wave when it is sent up more or less vertically, so as to make a very small angle to the normal to the ionosphere boundary.

When our wave strikes the ionosphere at a large angle to the normal—as it must do in practical communication over great distances—then its behaviour is somewhat altered.

In general it conforms to Snell's law of refraction—but there are considerable complexities because of the ionosphere curvature, the electronic gradient and the presence of the earth's field. However, we had better not start to discuss these now; we can perhaps talk about obliquely incident waves in a later article.

FOR THE MIDDLE EAST

Choosing a Broadcast Receiver

A CORRESPONDENT serving with the R.A.F. in the Middle East stresses the fact that most domestic broadcast receivers fail to survive the conditions prevailing in that theatre of war, and in other respects are unsuitable for members of the Forces serving there.

The need for robustness is self-evident, so far as sets for those engaged in the more active operations are concerned. It is less obvious that receivers as used at home are not designed to stand up to the prevailing climatic conditions—particularly high temperatures. Electrolytic condensers tend to dry up quickly, while wax or pitch-like substances used for impregnation or insulations will melt. Components such as resistors should be more conservatively rated than usual.

With regard to frequency coverage, short waves between 13-50 metres are by far the most useful, though the medium-wave band provides plenty of signals. Long waves are almost useless.

Local power supplies are generally AC, in most cases 110 volts 60 c/s, though some are 230 volts 50 c/s. From the point of view of most Service men, the best type of set is one that derives its power supply from a

6-volt accumulator installed in a vehicle. HT is, of course, generated by a vibrator. HT batteries, when obtainable, are dear, and much of their useful life has been expended through delays in transport.

The form of power supply that our contributor advocates is, incidentally, included in some of the British-built sets specially designed for overseas markets. One could wish that the number of such "export" sets was greater, as it is known that the better types are capable of withstanding the most trying climatic conditions. We hear of a G.E.C. "Overseas 6," owned by a senior R. Signals officer, that has survived, without any repairs and with no protection other than that afforded by its original packing case, many rigorous months of campaigning on the battle-fronts of the Middle East.

OUR COVER

AN adaptation of the back-cloth in one of the B.B.C.'s overseas studios is reproduced as our cover illustration this month. The radiations on the map, which is based on Pletts' zenithal azimuthal projection published by *Wireless World*, show the zones served by the various transmissions.

PICK-UP ACCESSORIES

Design and Construction of a Low-pass Filter and Feeder Unit

IN previous articles reference has been made to what is undoubtedly a most disturbing fault in the reproduction of gramophone records, namely a characteristic "fizziness," and various aspects of pick-up design have been discussed with a view to its reduction or elimination. It is a fact, however, that its complete elimination under average conditions is not possible, owing mainly to variations in the groove shape of records and the use of unsatisfactory needle points.

By **JOHN BRIERLEY**

the low-pass filter which is to be described in this article, the attenuation is no greater than 2 db. at 7,200 c/s, but is 40 db. at 8,200 c/s. It should perhaps be emphasised that as the filter cuts off only those frequencies which are above the useful recorded range, it has no effect whatever on the balance of tone, and it is therefore still necessary to compensate fully in the amplifier for the rising treble as

the inductance of the 0.3 H coil is 10 per cent. too low, and the inductance of the 0.53 H coil 10 per cent. too high, there may well be an attenuation of 5 db. at 6,000 c/s, as the sharpness of cut-off is dependent on the various cells of which the filter is composed being accurately matched. It is rather unfortunate, but it seems that coils such as are likely to be made in the amateur's workshop may not be sufficiently accurate for the best results, even though the exact number of turns specified are wound on, so particulars will be given later for checking their accuracy in as simple a manner as possible. But so that the correction required need be small or even un-

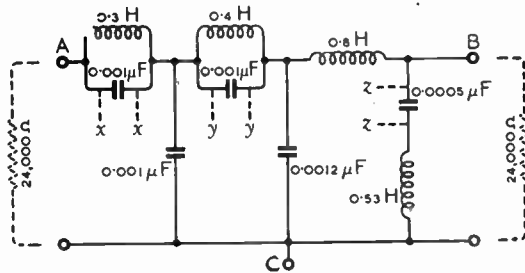

Fig. 1. Circuit diagram of low-pass filter. Test condensers for adjustment are connected at x, y and z.

It has been pointed out that the improvement in quality to be expected from the reduction in size and inertia of the moving parts and the removal of the top resonance above the recorded range is not easily realised in practice owing to the extended high-frequency response giving greater prominence to buzz and scratch, and it was mentioned that when using such pick-ups so great an improvement could be effected by the use of a low-pass filter cutting off all frequencies above about 8,000 c/s that it should be considered a *sine qua non*.

Optimum Cut-off

There is no certainty as to what is the extent of the recorded range. It is certain that it has increased to some extent in recent years, and it is not impossible that it may increase still further in the future; but it can be shown experimentally that in reproducing modern records a cut-off below 7,000 c/s results in a noticeable loss in quality, but the extension of the frequency range above 8,000 c/s results in no discernible improvement in quality, but, on the contrary, in an increase in buzz and scratch. Therefore, in

well as the falling bass of the recording characteristic.

The design of a suitable filter requires little comment; for constant impedance termination the end half-cells are m-derived with $m=0.6$; an intermediate m-derived cell, for which $m=0.4$ approx., gives a sharp cut-off, whilst a prototype ($m=1$) half-cell provides all the attenuation required at the higher frequencies. Fig. 1 shows the circuit diagram of the complete filter, and Fig. 2 gives all the details required for winding the coils. There are, however, several points regarding the latter which should be carefully noted. It is absolutely essential that these should be very accurately wound; if, for instance,

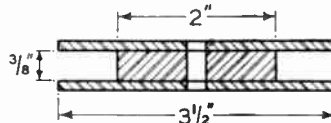

Fig. 2. Section of coil former for all inductances in filter. Winding data are as follows: 0.3H, 2100 turns; 0.4H, 2400 turns; 0.53H, 2700 turns; 0.8H, 3200 turns. No. 36 SWG enamelled copper wire is used throughout, and 1 1/2 lb. is sufficient.

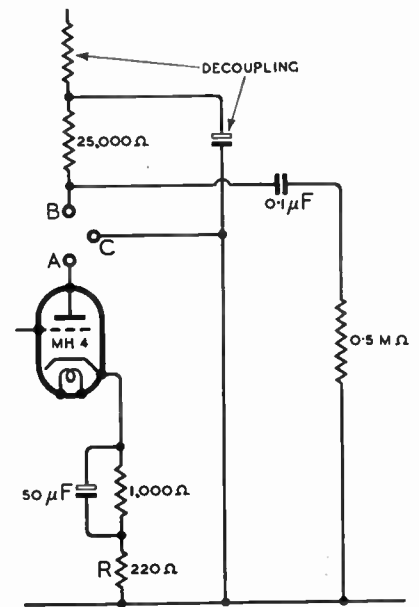

Fig. 3. A, B and C correspond to Fig. 1 and indicate the point of insertion of the filter in the amplifier.

necessary, the turns should be wound on as evenly as possible; a little difficulty may be experienced in satisfying this requirement unless care is exercised in setting up the coil former. It will be found, for instance, that if the former does not rotate truly upon its axis the winding will pile up on one side; this effect is likely to be most

noticeable in winding the two larger coils, and if it is noticed in the early stages of the winding process the winding should be taken off, the fault rectified and the winding started again, as, once it starts, it quickly builds up and gets completely out of control.

It will be noticed from Fig. 1 that the terminating resistance is

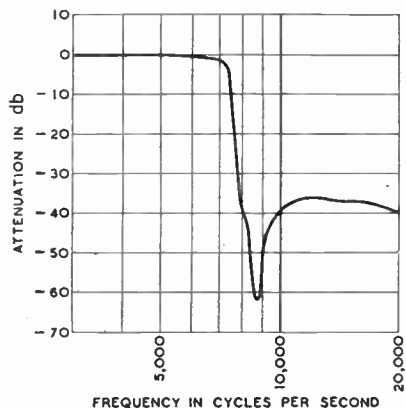

Fig. 4. Frequency characteristic of low-pass filter in region of cut-off.

given as 24,000 ohms. approx. This is a very convenient and suitable value, as if a higher resistance is selected the coils become increasingly large, and there is a greater tendency for them to pick up hum, whereas if a lower value is selected the valve load resistance has to be reduced to a lower value than is advisable for linear amplification at reasonable signal levels—and it is advisable to have as high a signal level as possible at the point where the filter is connected so that any hum picked up is not amplified more than is necessary. The exact values for the terminating resistance, cut-off frequency and the value of "m" in the m-derived cells were juggled with in order to obtain convenient values for the condensers.

Fig. 3 shows the method of connecting the filter in the amplifier.

Fig. 5. Recommended layout and spacing of inductances in the filter.

One end of the filter is terminated by the AC resistance of the valve, and the other end by the load resistance (including the following grid leak in parallel). For the sake of example a medium impedance triode is shown; its normal AC resistance is assumed to be 15,000 ohms under working conditions, so that a certain amount of negative feedback is applied by means of the un-bypassed cathode resistance R to raise it to an effective value (Ro) of 24,000 ohms.

As $R_a + R(1 + \mu) = R_o$, R works out at about 220Ω when $R_a = 15,000\Omega$, $\mu = 40$, and $R_o = 24,000\Omega$. The normal gain is given by $\mu R_L / R_a + R_L$ where R_L is the load resistance and R_a the valve AC resistance, which for a valve of this type would be about 25. But with feedback the gain is reduced as if $R_a = R_a + R(1 + \mu)$, so the gain of Fig. 3 is given by $\mu R_L / R_a + R_L + R(1 + \mu) = 20$ approx.

The measured attenuation of the filter is shown in Fig. 4. Perhaps the method of measuring it is not without interest. A 12-watt output stage will give 350V across a 10,000-ohm load. If this is made equivalent to 0 db., then an attenuation of 60 db. will read as 0.35V—a value easily measured. But it must be noted that this is equivalent to one millionth of the full output or roughly 1/80 mW, and the hum output of a reasonably quiet amplifier will give this reading. In addition there is hum and noise output from the source (beat oscillator), a certain amount of hum picked up by the filter and other incidental background noise which brings the total "noise output" to nearly 4 volts, that is about -40 db. Obviously accurate measurement of anything approaching this attenuation is impossible. This difficulty

is easily overcome by introducing between the valve anodes and the output meter a high-pass filter cutting at about 5,000 c/s; the hum and noise output is then reduced to too low a value to be measured, and by maintaining a constant input at selected frequencies, the performance of the filter can be measured as accurately as desired.

With regard to the mounting of the coils, probably the most compact arrangement is shown in Fig. 5, and it should be noted that they should not be enclosed in a metal box if it can be avoided, as this can cause considerable losses, resulting in reduced attenuation over 8,000 c/s and some attenuation between 5,000 and 7,500 c/s, the exact amount depending on the size and type of screening employed. Experience indicates that if connected into a part of the circuit where the maximum signal level is not less than 0.2 volt no screening is necessary, though it is probably better to build the filter as a separate unit and connect it to the amplifier by about a yard of twin screened flex, so that it may be conveniently positioned away from mains transformers and smoothing chokes.

Coil Adjustment

There now remains only the final checking of the inductance of the 0.3 H, 0.4 H, and 0.53 H coils—the 0.8 H need not be checked. For this, a gliding frequency record (HMV 4037), 0.0015μF and 0.001μF condensers (one each), and an output meter are required, though the latter can easily be dispensed with. The procedure is to shunt in turn each of the condensers tuning the three coils concerned by an extra capacity, so that the resonant frequency is

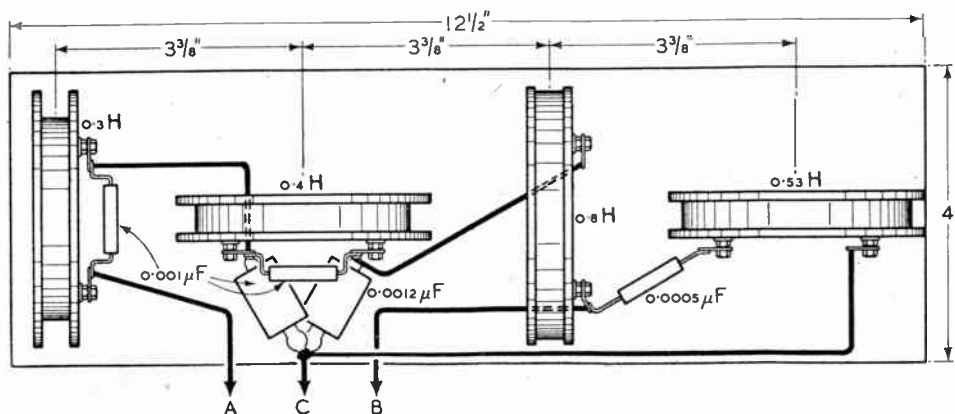

between 5,000 and 6,000 c/s. With the filter connected in circuit and with the additional condenser connected for the particular coil being checked, the pick-up should be placed in the first groove and the time noted on the seconds hand of a watch; after nearly 10 seconds from the beginning of the cut, the pointer of the meter will have moved from zero to about half scale, and then at between 18 and 21 seconds (depending on the coil under test) the pointer will drop to zero (or nearly so) before moving up again. This "zero" reading will be quite sharp, and the number of seconds from the start of the cut at which it occurs should be carefully noted. In the table the value of the additional capacity, the resonant frequency and the time from the beginning of the cut for each of the three coils are given. This method

by ear. It should be observed that with the start of the note (8,500 c/s) which will be radiated by the pick-up is $2\frac{1}{2}$ seconds from the start of the cut, a fact which is helpful in confirming the exact time of the start. If the "zero" is found to occur sooner than it should, then the inductance is too low, and perhaps 50 to 100 turns will have to be added, whereas

Fig. 6. Two methods of compensating for restriction of bass in a record.

if it is too high the "zero" will occur too late, and then some turns will have to be removed.

It was mentioned earlier in this article that bass lifting and treble cutting circuits to compensate for the recording characteristic have still to be provided, and it seems that some remarks on this subject would be helpful.

The two best-known methods of obtaining bass lift are shown in Fig. 6; with (a) the amplification of V varies according to the

coupling impedance which is made low and constant down to about 250 c/s by C and R, but rises continuously below this frequency

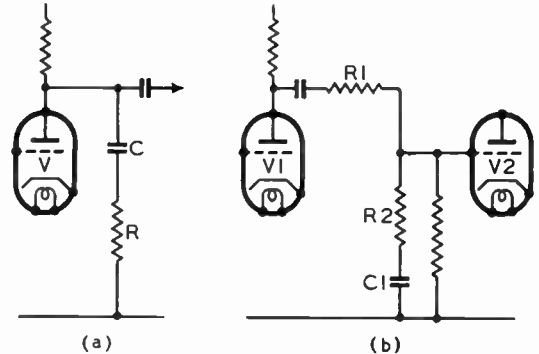

Coil	Additional capacity (μF)	Resonant frequency (c/s)	Time from beginning of cut on HMV. DB4037
0.3H	0.0015 across xx	5,750	18 sec.
0.4H	0.001 across yy	5,500	21 sec.
0.53H	0.001 across zz	5,600	20 sec.

has been found very simple and capable of giving quite good results. If no meter is available the "zero" referred to can easily be detected

owing to the action of C; (b) shows a potentiometer method, the bottom limb of which is constant in value for medium and high frequencies but rises at low frequencies. There are two points which should be remembered about their use: (a) cannot handle inputs of more than about 0.2 V, and (b) should not be used at low signal levels, as the following valve will introduce hum; this is due to the fact that the input of V_2 is not shunted by the AC resistance of V_1 as R_1 is in series. Quite often a pentode is recommended for use in circuit (a), and though it is capable of giving

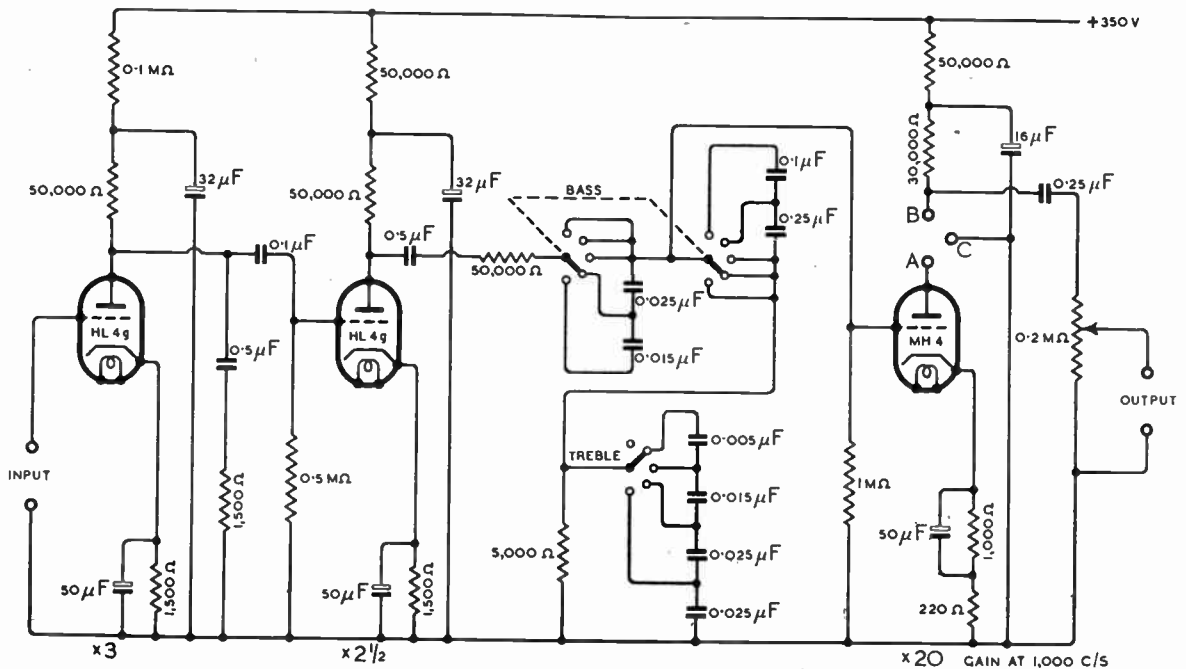

Fig. 7. Circuit diagram of complete gramophone feeder unit.

better results than a triode, its comparatively high anode current necessitates the use of a high voltage HT supply, and even then it is difficult to arrange adequate decoupling.

Bearing these facts in mind, the circuit of a gramophone feeder-unit which is generally suitable for use in conjunction with pick-ups similar to the design the writer described recently (*Wireless World*, July 1942) is given in Fig. 7. The first stage provides bass compensation, the second tone control and the third is an amplifier with provision for connecting the low-pass filter just described. In the tone control stage provision is made for bass lifting or cutting in steps of 7 db. at 50 c/s, but no provision is made for treble lift as this is seldom required for gramophone work. The opportunity is taken, therefore, of providing four treble cut switch positions other than normal, in steps of 3 db. at 8,000 c/s. The decoupling especially of the early stages is greater than usual, but it must be remembered that the total gain at very low frequencies can be in the region of 10,000. No difficulties from hum will be experienced, but the heater supply must be accurately centre-tapped.

BOOK REVIEW

High Frequency Thermionic Tubes.

By A. F. Harvey, B.Sc., D.Phil. Pp. 222 + XIII; 99 figures. Chapman and Hall, Ltd., 11, Henrietta St., London, W.C.2. Price 18s.

History has produced some strange reversals in the trend of valve design. We all became accustomed to the giant valve, as higher power was developed in long-wave and medium-wave transmission. Then came the miniature circuits of very small inductance and capacity for very short waves and the "acorn" valves, and the latest ultra-short-wave generators do not look like valves at all. It is perhaps a defect of Dr. Harvey's book that we get so many pictures of valves that a startling exterior makes the change in principle of internal design seem even more revolutionary than it actually is.

After all, a cathode-ray tube is only a valve, and the transition to recent velocity-modulation devices is already half made when this commonplace of the television set is understood. So the present book need not be put aside as unreadable by anyone. It starts, rightly, by summarising rectifier, amplifier, and oscillator principles, and showing why conventional tubes become inefficient when high frequency reverses electrical condi-

tions before the transit time of an electron's path between electrodes has been completed.

A large part of the book is taken up with the circulation of an electron stream in a magnetic field, the physical basis of Magnetron oscillators. It is a merit that methods of measurement are throughout emphasised in detail: for instance, the impedance of a Magnetron is neither simple to picture nor to estimate. Even with the author's wealth of detail, some questions are raised rather than answered: double and multiple frequencies are not assigned to very clear origins, but that could be said of all published treatments. The account of closed resonators is too brief: but the reader must recognise that inadequate scraps from papers already out of date are all that he can expect until Dr. Harvey produces his post-war edition. As a gallant attempt to satisfy for the time being the appetite of the valve user, the book will be widely appreciated.

M. J.

"VALVE REPLACEMENT MANUAL"

Second Edition Now Available

RADIO maintenance men have been quick to appreciate the value of this manual (reviewed in our issue of January, 1942), and it is not surprising that the first edition was quickly sold out. In view of the importance of this publication to those engaged in the work of servicing broadcasting receivers under

present conditions arrangements were made for a second edition to be published from the Technical Dept. of *The Wireless & Electrical Trader*. In addition to a mass of information on possible valve substitutes and, where necessary, valve base alterations, there is an up-to-date list of American receiving valves with their base connections and operating data, notes on barretters, pilot lamps and line cords—in fact, an answer to most of the questions confronting the harassed service man.

The price is 6s., or 6s. 2d. postage paid, from The Trader Publishing Co., Ltd., Dorset House, Stamford Street, London, S.E.1.

THE WIRELESS INDUSTRY

We have received from E. Siegrist, Ltd., Berners Street, London, W.1, a technical leaflet giving dimensions and mechanical properties of latex sleeves for binding and marking insulated wires.

A recent article in *Electrical Review* by Richard Arbib gives useful information on "Wartime Soldering," including advice on the choice of types of soldering iron, methods of stripping insulation and the use of jigs in soldering. Reprints of this article are available on application to Multicore Solders, Ltd., Bush House, Aldwych, London, W.C.2.

The firm of Lockwood and Company, of Lowlands Road, Harrow, best known to readers as makers of wireless receiver cabinets, are now undertaking the making of radio and other parts in plastic materials. Thermo-plastics are moulded to shape, and the materials handled include Perspex, Bakelite, Delaron, Paxolin and Polystyrene.

THE COX - BOTH ELECTRO - CARDIOGRAPH (pronounced to rhyme with "Goth"). A view of the panel of this instrument, which is the first to produce a cardiogram without an intermediate photographic process, is shown here. In this portable, three-valve, dry-battery-operated instrument, which is manufactured by Stanley Cox, Ltd., the heart action voltage is collected by electrodes in the normal manner.

This voltage is amplified and fed to a moving-coil device suspended in a permanent-magnet field. Attached to this coil is a diamond point that records the movement on a carbon-surfaced glass disc, which is revolved at a constant speed by a spring motor. A light is projected through the glass disc into a microscope, having an accurately adjusted magnification factor, which enables the 1/40th standard size trace to be observed as a standard size cardiogram, whilst actually being recorded. A photographic method is also available for purposes of making permanent records for filing, despatch, etc.

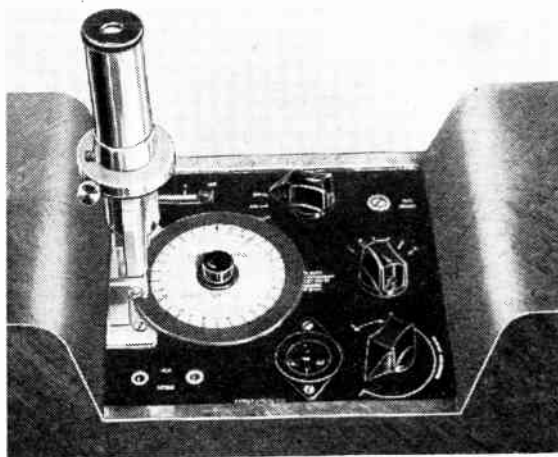

SIMPLE TEST OSCILLATOR

Practical Uses of the Transित्रon

By

A. G. CHAMBERS (G5NO)

In last month's issue the principles of the Transित्रon oscillator were explained. The present article gives practical information on the use of the circuit for a modulated test oscillator

A TEST oscillator is an instrument that every seriously minded radio man, amateur or professional, should have. While the oscillator to be described in this article is not intended to replace a well-designed signal generator, it has many uses, and only costs a fraction of the price. It cannot be used for absolute sensitivity measurements, although it will give the owner a fair idea of the performance of any receiver.

As explained in an article by the present writer in last month's issue, the Transित्रon oscillator can be used with advantage as a test oscillator, making use of the grid amplitude control as an attenuator. Several experiments have been carried out since the last article was written, and in the first circuit that was tried rather a novel form of modulation was incorporated. The idea was not original as it had been suggested by Brunetti in his paper on the Transित्रon in 1934. He did not mention, however, that over-modulation is unavoidable. For a simple oscillator this is not so important, and the circuit, for what it is worth, is shown in Fig. 1. It will be noticed that both the RF and AF oscillatory circuits are in series, one modulating the other. If R , the inherent dynamic resistance in both circuits, is made equal to the negative resistance of the valve, oscillation takes place in both circuits, and hence the lower frequency modulates the higher. In both coils the "Q" must be

fairly high; this is more important in the case of the L_2 circuit, in which the production of oscillations is more difficult than in the other; also, the screen and anode voltages are fairly critical. Oscillation in the L_1 circuit will take place over wide limits, but often L_2 will not oscillate until L_1 is first short-circuited. This can, however, be overcome by altering the anode potential. A number of different coils were placed in both circuits, and, with the resistances and voltages shown, both circuits "kicked off" every time.

It should be noted that no iron is shown in the L_2 circuit, although the frequency is in the order of 800 cycles. An iron-cored choke, of course, may be used, but, due to hysteresis, a pure sine wave is not possible. The resistance R_3 is used to bias off the oscillator and may be used in place of an attenuator, as explained in the previous article. A Type 58 valve is recommended, as this valve has a linear negative characteristic, and hence excellent control of amplitude is obtained. Of the English valves the Osram

VMP4 and its equivalents are suggested, although these have not so far been tried.

The circuit of Fig. 2 is slightly more elaborate, but overcomes the difficulty of over-modulation experienced with the arrangement of Fig. 1. The valve V_1 , with its associated circuit, L_1 , C_1 , acts as the RF oscillator. R_5 is the automatic bias resistance, supplying approximately 45 volts bias. R_3 is a 1-megohm potentiometer placed in parallel to control the amplitude of oscillation; R_2 and R_4 are placed in series to give better control. It will be noticed that the usual by-pass condenser across R_5 has been omitted, for the following reason. RF voltage is developed across the bias resistance R_5 . When the grid is connected to the cathode end of R_3 , since it is in phase with the cathode, a certain amount of feedback takes place, and the amplitude of oscillation is increased. As the grid is taken nearer to earth, less and less feedback is possible, and, at the same time, bias is being applied which is reducing amplitude. With this method an extremely fine control is possible. With a by-pass condenser in circuit only a 2:1 ratio of amplitude control is possible.

AF Modulation

The valve V_2 is the modulator; in this case a Mullard EF50 was used as another 58 could not be procured. The same Transित्रon circuit was used, giving a pure output at about 1,000 cycles. This is transformed down through a 1:3 transformer to the RF circuit (a 3:1 audio transformer reversed was used for this purpose). The reason the step-down transformer and associated network R_8 , R_9 , was incorporated was to stop over-modulation, as the output from the EF50 was too great. By using another 58 valve in place of the EF50, and taking its grid through a decoupling network to the centre point of R_3 , constant modulation could be obtained, and the writer hopes to do this as soon as another 58 can be obtained.

With the present network, approximately 30 per cent. modulation is obtained at maximum out-

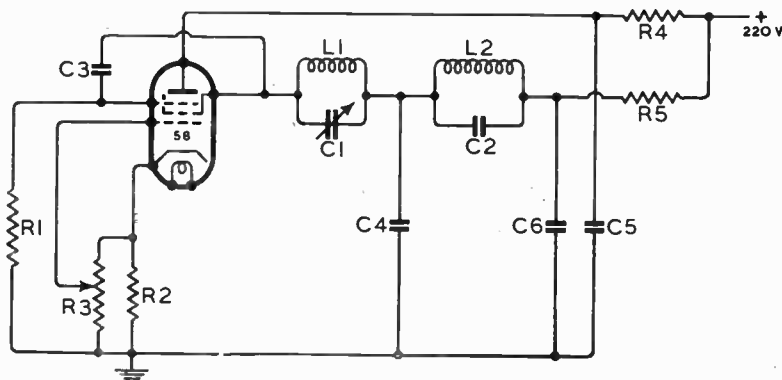
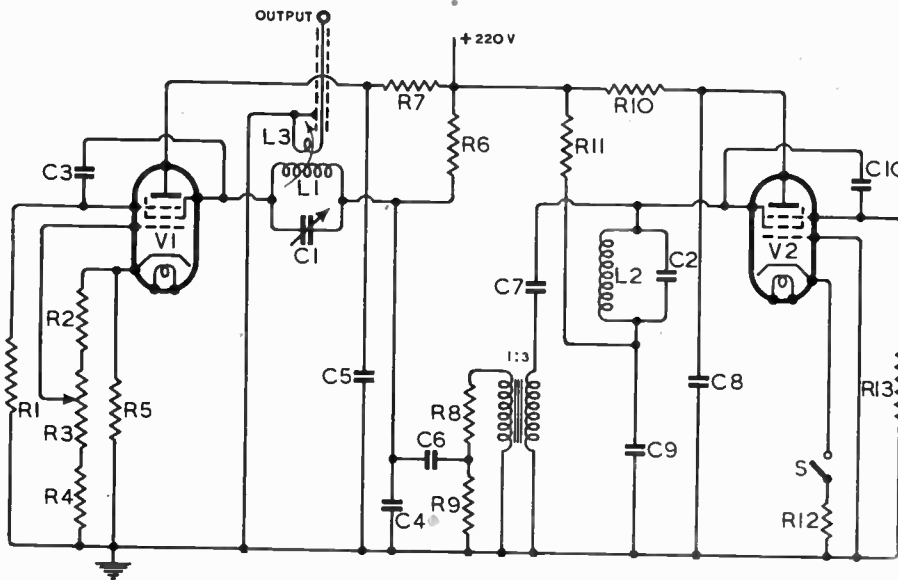

Fig. 1. Original Transित्रon oscillator circuit. Values of components: R_1 , 100,000 Ω ; R_2 , 2,000 Ω ; R_3 , 0.5M Ω ; R_4 , 7,500 Ω ; R_5 , 25,000 Ω ; C_1 , 0.0005 μ F; C_2 , 0.03 μ F; C_3 , 0.01 μ F; C_4 , 10 μ F; C_5 , 1 μ F; C_6 , 1 μ F.

put, the 100 per cent. mark being reached when maximum bias is applied to V1. This is not a good

frequency increases the coupling is decreased to keep the ratio correct. It is preferable to house the oscil-

being approximately 400 cycles; for more accurate work a tuning fork could be used, though it is



Values of Components

- R1, 100,000 Ω
- R2, 200,000 Ω
- R3, 1M Ω
- R4, 100,000 Ω
- R5, 13,000 Ω
- R6, 7,500 Ω
- R7, 25,000 Ω
- R8, 20,000 Ω
- R9, 50,000 Ω
- R10, 30,000 Ω
- R11, 30,000 Ω
- R12, 150 Ω
- R13, 100,000 Ω
- C1, 0.0005 μF
- C2, 0.03 μF
- C3, 0.005 μF
- C4, 0.03 μF
- C5, 0.5 μF
- C6, 0.1 μF
- C7, 0.01 μF
- C8, 1.0 μF
- C9, 1.0 μF
- C10, 0.1 μF

Fig. 2. Modified Transistron oscillator circuit. All resistances may be half-watt, except R3, which should be 2-watt.

point, as it is a little misleading when using the oscillator to line up a receiver. It is recommended that those building this instrument should include precautions against over-modulation as described.

Coil data has not been included in this article, as any coil can be pressed into service or wound to the desired frequency with the aid of a *Wireless World* Abac. The writer had some old honeycomb coils, which were used for the medium and long waves. IF coils obtained from the junk box were used for the intermediate frequencies, and short-wave coils were also retrieved from the same place.

The approximate output at a megacycle is just over a volt, which is ample for most purposes and corresponds to the output of a commercial generator at this frequency. It is necessary to find the optimum coupling for L3 for each band. For this coupling coil about six turns was found to be correct for the medium and long waves. Naturally, as the

lator in a screening box, although, due to the attenuator system, this is not essential, as the total radiation is cut down when the bias is increased. With the usual type of test oscillator the attenuator, of course, is in the output only, and unless the instrument is carefully screened, direct radiation takes place and the attenuator is rendered useless.

The figures for the Type 58 valve, which, as a matter of interest, are given in the table, were obtained from the American A.R.R.L. Handbook. The 2½-volt filament presents a little difficulty, but, as the voltage is so low, it is a simple matter to wind on about ten or so turns on to any transformer over the top of the outside winding to obtain this voltage. Most transformers have space enough for about one layer of 20-gauge enamelled wire.

Calibration of frequency is best carried out with the aid of a good all-wave receiver, whose frequencies are known to be correct. Failing this, with the modulation switched off (switch S) the oscillator can be made to beat with a few known stations; interpolation will do the rest.

Calibration of the audio-frequency side can best be checked against a piano, middle G sharp

unlikely that any high degree of precision will be required on the audio-frequency side of an oscillator of this type.

Automatic amplitude control may be added, as a refinement, and, for those who are interested, this is shown as a separate circuit (Fig. 3).

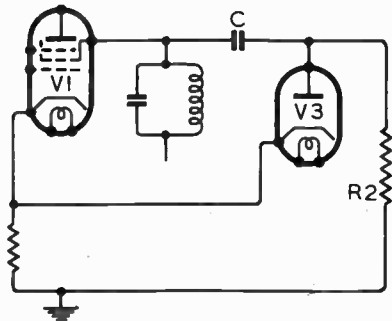

Fig. 3. Circuit for automatic amplitude control. R2, 0.5MΩ; C, 0.1 μF.

The output from V1, the oscillator, is taken through C to a diode V3, which can be any triode with its grid strapped to anode. This small voltage is rectified and taken back to the auto-bias circuit. Hence any small variations in amplitude alters the bias by an equally small amount, thus keeping the signal constant.

TABLE CHARACTERISTICS OF TYPE 58 VALVE

Triple-grid Variable-mu		As a Mixer
Vf, 2.5V	If, 1.0A	Ea, 250V
Ea, 250V	Is, 2mA	Eg, -10V
Es, 100V	Ia, 8.2mA	Es, 100V
Ra, 800,000 Ω	G, 1.6mA/V	Osc. peak volts
μ, 1280		7.0

RADIO DATA CHARTS—6

Length of Capacity-loaded Quarter-wavelength Transmission Line

IN No. 5 of this series it was shown how a transmission line could be used as a resonant circuit by making its physical length one-quarter of the desired resonant wavelength. Such a circuit is tuned to a fixed frequency, and corresponds to a pre-set tuned circuit. It is often required to cover a band of frequencies as in the tuning circuits of a receiver where a variable condenser is the usual device employed. This method may be carried over into transmission line technique by loading the resonant line with a small variable condenser. The effect of this is to increase the apparent electrical length of the line so that the physical length of line required to resonate to a given wavelength is less than a quarter of that wavelength. It should be noted that this loading will affect the value of the "Q" of the line given by the last abac, which is based on the assumption that the end capacity is zero; but if a "high-Q" resonant line is required for a wavelength for which the quarter-wavelength unloaded line is inconveniently long a capacity-loaded line may be substituted, and the line will be shortened according to the size of loading condenser used. In order to keep the "Q" high it is desirable to use small air dielectric condensers with a minimum of solid insulating material which should be polystyrene or of the low-loss ceramic type.

The equation for the sending-end impedance of a transmission line was given last month in connection with the "Q" of the quarter-wavelength line, and is

$$Z = Z_0 \frac{Z_r \cos \beta l + jZ_0 \sin \beta l}{Z_0 \cos \beta l + jZ_r \sin \beta l} \quad (1)$$

where Z = sending-end impedance
 Z_r = terminating impedance
 Z_0 = characteristic impedance

l = length of line

β = phase-shift constant.

In the case of the quarter-wavelength shorted line $Z_r = 0$, and the impedance becomes

$$Z = Z_0 j \frac{Z_0 \sin \beta l}{Z_0 \cos \beta l} = jZ_0 \tan \beta l \quad (2)$$

By

J. McG. SOWERBY,

B.A., Grad.I.E.E.

(By Permission of the Ministry of Supply)

If this is now connected in parallel with a condenser of capacity C at the sending end as shown in Fig. 1, then the impedance of the combination must be infinity at some frequency if the line is to behave as a parallel-tuned circuit at that frequency. Thus we may state:—

$$\frac{-j/\omega C \cdot jZ_0 \tan \beta l}{-j/\omega C + jZ_0 \tan \beta l} = \infty \quad (3)$$

where C = capacity of condenser. For this to be true the denominator must be equal to zero. Hence

$$j/\omega C = jZ_0 \tan \beta l$$

or

$$\tan \beta l = \frac{1}{\omega C Z_0} \quad (4)$$

If the transmission velocity is that of light, as it is very nearly at high frequency, then we may put $\beta = 2\pi/\lambda$. Making the same assumption we may also substitute $\lambda/2\pi v C Z_0$ for $1/\omega C$ and (4) becomes

$$\tan \frac{2\pi l}{\lambda} = \frac{\lambda}{2\pi v C Z_0} \quad (5)$$

where v = velocity of light.

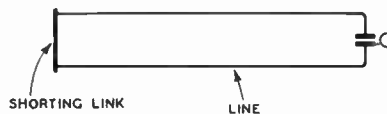

Fig. 1. Transmission line loaded by a parallel-connected condenser.

In the great majority of cases what we want to know is the length of the line required to resonate at a given wavelength when the capacity of the loading condenser and the characteristic impedance of the line are known. Hence (5) is conveniently rearranged thus:—

$$l = \frac{\lambda}{2\pi} \tan^{-1} \frac{\lambda}{2\pi v C Z_0} \quad (6)$$

This is the relation on which the abac is based.

It should be noted that the principal assumption is that the velocity of transmission of the signal down the line is the same as

the velocity of propagation of radio waves in free space, and this was shown earlier in this series to be very nearly true at high frequencies. It will be noticed that the symbol for the wavelength in equation (6) appears both within and without the \tan^{-1} sign, and this means that in the construction of an abac for this equation it is necessary to employ a "trick." As far as the user is concerned this consists of using a point found on the reference scale on the first journey across the abac in a subsequent operation. The reference scale then is only included so that a point on it may be held without having to make pencil marks on the chart; it is, in fact, simply a bookmark.

The key indicates the mode of operation of the abac, and a worked example follows.

Example: A line of characteristic impedance 75 ohms is available, and also a variable condenser with a minimum capacity of 2.2 μF and a maximum capacity of 14.5 μF . If the shortest wavelength required is one metre, what will be the longest tunable wavelength with this set-up?

The shortest wavelength will obviously be obtained when the condenser is at a minimum, so that the first step is to find the actual physical length of line required for one metre when $C = 2.2 \mu\text{F}$. Lay the ruler on 75 on the impedance scale, and 2.2 on the capacity scale. A point of intersection is found on the reference scale. Note this point carefully. Join this point to one metre on the wavelength scale and note the point of intersection on the centre scale. From this point on the centre scale draw a tangent to the curve and project to the wavelength scale. Connect to the point on the reference scale and the ruler cuts the length scale giving the answer to the problem. The length is 20.2 cms.

Now for the second step—to find the longest wavelength to which this line can be tuned by the condenser. Under these conditions $C = 14.5 \mu\text{F}$, the length (Concluded at foot of col. 1, page 108)

ABAC No. 6
[Third Series]

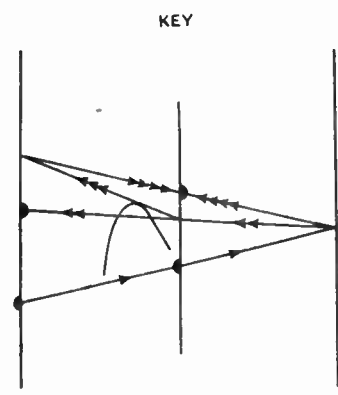
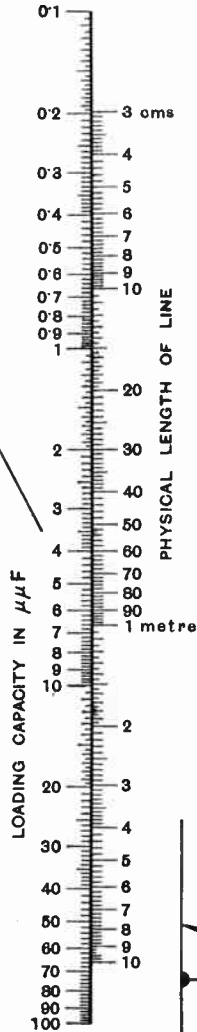
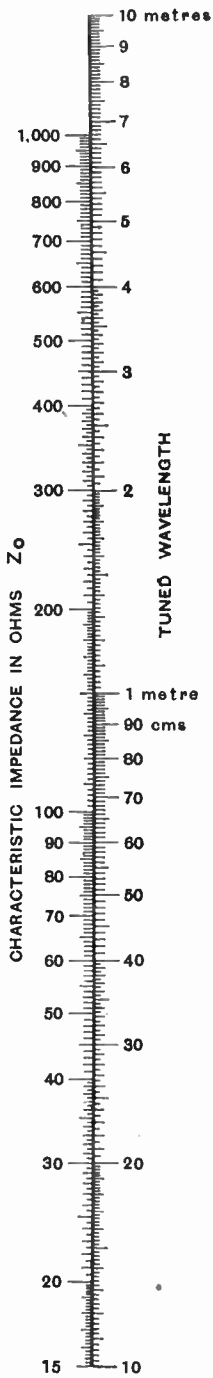

LENGTH OF CAPACITY-LOADED QUARTER-WAVELENGTH TRANSMISSION LINE

Wireless World
COPYRIGHT

WORLD OF WIRELESS

RADIO SERVICING CERTIFICATE

DETAILS for the formation of the Radio Trades Examination Board, the sole function of which is to conduct a Radio Servicing Certificate Examination and award certificates to successful entrants, have been completed. The Radio Manufacturers' Association, the Scottish Radio Retailers' Association, the Radio and Television Retailers' Association, and the British Institution of Radio Engineers will subscribe to the incorporation of the Board, the registered office of which will be 9, Bedford Square, London, W.C.1. G. D. Clifford, general secretary of the Brit. I.R.E., has been appointed secretary to the Board.

A Technical Committee has been appointed to examine the syllabus and regulations of the examinations which will be held in May and November of each year in principal Universities or technical institutes throughout the country. For this purpose the country is being zoned and local examiners for the practical examination will be appointed in due course. It is proposed to hold the first of these examinations next November.

Meanwhile, the Radio Servicing Certificate Examination held in the past by the Brit. I.R.E. and the S.R.R.A. will be held for the last time in May. This examination will be superseded by that to be held by the Radio Trades Examination Board.

Details of the syllabus and regulations of the examinations will be issued shortly.

CANADA'S D.G. RESIGNS

MAJOR W. E. GLADSTONE MURRAY, director general of broadcasting in the Canadian Broadcasting Corporation, has resigned to

become "a public relations counsel in the general field of industry." It will be recalled that last year he was transferred from his post as general manager of the Corporation, which he had held from 1936, and appointed director general. The Rev. Dr. J. S. Thomson was appointed in his place.

Prior to going to Canada in 1936, Major Murray had been with the B.B.C. for fourteen years. During part of this time he was Sir John Reith's deputy.

In 1933 he was lent by the B.B.C. to Canada to advise on the general organisation of broadcasting there. He is a native of Western Canada and was a Rhodes Scholar from Quebec.

LORD GAINFORD

WE read with regret the death at the age of 83 of Lord Gainford, who since the early days of broadcasting has been associated with it.

He was the first chairman of the board of directors of the British Broadcasting Company, a post which he held from 1922 until 1926, when the British Broadcasting Corporation was constituted under Royal Charter. With this change the place of the board of directors was taken by a board of governors nominated by the Government, over which Lord Clarendon presided as chairman with Lord Gainford as vice-chairman. He held that position until 1932.

Lord Gainford held many Government posts; among them that of Postmaster General in 1916. In 1935 he was elected president of the Radio Manufacturers' Association.

"PRO RATA" LICENCE FEES?

WHEN asked in the House of Commons if he had considered a number of communications from wireless licence holders expressing their intention to withhold part of their fee and what action he proposed to take, Capt. Crookshank, the P.M.G., said he understood that the persons in question based their intention on dissatisfaction with the aspect of the B.B.C. programme policy. Licences would not, however, be issued unless the whole of the fee was paid.

BDST

ALTHOUGH Double Summer Time does not come into operation until a few days after this issue of *Wireless World* is published the times of transmission schedules are given in BDST—two hours ahead of GMT—unless otherwise stated. For the schedule of G.P.O. morse transmissions GMT is adhered to for ease of reference for oversea listeners for whom the bulletins are intended.

RADIO OFFICERS' PAY

NEW rates of pay for radio officers in the Merchant Navy came into force in February. The lowest monthly rate is £12 7s. 6d. for radio officers with less than six months' experience as a radio officer at sea, plus £1 per month for those possessing a second-class or higher P.M.G. certificate. This proficiency pay increases with each year's service up to three.

Radio officers with three years' experience and over at sea who possess first- or second-class certificates receive from £20 7s. 6d. to £26 15s. per month according to the tonnage and class of vessel they serve in. Radio officers-in-charge will receive an extra £1 or £2 per month.

Officers with ten years' continuous service with the same employer may receive seniority pay of £24 per year.

On and after April 1st all applicants holding the P.M.G. "Special" certificate first entering the marine wireless service will be known as assistant radio officers. Their commencing rate of pay will be £8 per month, which will increase to £12.

War risk money is additional to all these rates.

EDISON MEDALIST

IN announcing the award of the Edison Medal for 1942 to Dr. Edwin H. Armstrong, professor of electrical engineering at Columbia University, the American Institute of Electrical Engineers states, "probably no one man has contributed as many fundamental radio inventions which so closely touch on our everyday life as Dr. Armstrong."

The award, which was made at the Institute's national technical meeting in New York at the end of January, is for his "distinguished contributions to the art of electrical communication, notably the super-regenerative circuit, the superheterodyne and frequency modulation."

BROADCAST ADVERTISING

A GUIDING principle for the acceptance of advertising matter to be included in the programmes broadcast by the Canadian Broadcasting Corporation has been outlined by Dr. J. S. Thomson, the recently appointed general manager of C.B.C.

The principle is that "all advertising matter and commercial announcements shall be of such a character that they can be freely introduced into a mixed company of adults and children as a subject of ordinary conversation."

"The distinctive character of radio," Dr. Thomson stated, "has determined the adoption of this ruling. Radio is principally a medium of communication directed

RADIO DATA CHARTS—6

(Concluded from page 106)

is 20.2 cms and the impedance is 75 ohms as before. Lay the ruler on the appropriate values for Z_0 and C ; this gives the point to be noted on the reference scale. Join this to 20.2 on the length scale and a point of intersection is found on the wavelength scale (this is not the answer). From this draw a tangent to the curve to cut the centre scale, and join the point so found to the noted point on the reference scale. The ruler now intersects the wavelength scale at the required result—1.76 metres.

into the Canadian home: the family circle is the normal listening group. We have therefore to maintain canons of good taste that are in line with the finest standards of home life."

Although Government controlled, in that its Governors are Government appointed, the C.B.C. includes in its programmes a small percentage of sponsored material.

OFFICIAL NEWS IN MORSE

SEVERAL changes have been made in the schedule of transmissions of official news in morse from the G.P.O. stations since the last published details. The call signs, including a new one—GIM, and wavelengths employed for these transmissions, which, although intended for oversea listeners, can be heard in this country, are:—

GIA: 15.27 m.	GIM: 23.13 m.
GAD: 15.40 m.	GIH: 28.17 m.
GBL: 20.47 m.	GAY: 33.67 m.
GID: 22.13 m.	GBR: 18.750 m.

The times (GMT) of these transmissions and the transmitters radiating them are:—

0030: GBR, GIA, GID, GIH.
1302: GBR, GAD, GIA, GID.
1602: GBR, GAD, GIA, GID.
1930: GBR, GAY, GBL, GIM.
2330: GBR, GAY, GIH.

RADIO TECHNIQUE AND MEDICINE

SOME idea of the possibilities of collaboration between wireless and medicine was suggested when a paper on "Amplifying and Recording Technique in Electro-Biology" was recently read before the Wireless Section of the Institution of Electrical Engineers by G. Parr and W. Grey Walter. One of the authors pointed out that electricity and physiology share a common ancestor in Galvani. The paper was written with special reference to the electrical activity of the human brain (as investigated by means of electro-encephalography). The potentials produced by the brain are often extremely small, and the problems in designing amplifiers of the high gain required are considerable.

B.B.C. SHORT-WAVE SERVICES

A NUMBER of new transmissions in the B.B.C. European Service with consequent time and wavelength changes will be introduced on March 28th. Particulars are not available at the time of going to press, so that the details in the schedule of B.B.C. short-wave transmissions of news in English as given below will be altered or supplemented.

Some of the transmissions are radiated on a number of wavelengths in the same waveband. Times are BDST.

0045 49, 31	1300 25, 19
0300 49, 31	1500 25, 19
0445 49, 31	1700 31, 25, 19, 16
0630 49, 41	1800 31, 25, 19, 16
0815 41, 31	2000 25, 19
1000 41, 31, 25	2145 31, 25, 19
1100 49, 41, 31	2345 49, 41, 31, 25*

* Sundays excepted.

UTILITY SETS

THE stories regarding the production of a two-valve utility receiver costing £7, which recently appeared in the lay Press, have brought forth a statement from the Radio Manufacturers' Association to the effect that they are entirely without foundation. Utility sets are not likely to appear whilst there are still 100,000 receivers in the hands of manufacturers awaiting components to complete them.

The importance of completing these sets is realised by the President of the Board of Trade, who has intimated that component manufacturers have been informed that components for the completion of these receivers and also those for the maintenance of civilian sets must be given priority equal to that of normal requirements of the Services. This does not, of course, place such components as high in the priority schedule as those for special productions for the Government and the Services.

IN BRIEF

Sir Edward Appleton, M.A., D.Sc., F.R.S., will lecture on "Radio Exploration of the Ionosphere" at the next meeting of the Wireless Section of the Institution of Electrical Engineers at 5.30 on Wednesday, April 7th.

"Picture by Wireless."—With the opening of the new radio-picture service between Cape Town and London, Cable and Wireless now has direct links with seven cities for this photo-facsimile service. They are: Melbourne, Moscow, New York, San Francisco, Cairo, Buenos-Aires, and Cape Town. It is understood that new equipment is also to be installed at Montreal and Bombay.

French Set Manufacture.—It is stated in the monthly bulletin of the U.I.R. that a decree of October 1st, 1942, prohibited the manufacture of civilian wireless sets in France. Orders on hand were permitted to be delivered up to the end of the year.



MULE-BACK RADIO. An unusual mounting for a transmitter-receiver seen in N. Africa, where Arab muleteers have been recruited to assist our Forces.

WOMEN TECHNICIANS

IN an endeavour to make the best possible use of the technical capabilities of the women and girls of this country the Minister of Labour and National Service has started a Women's Technical Service Register.

Those who have taken the School Certificate Examination, the Leaving Certificate of the Scottish Education Department or any higher examination in mathematics, physics, chemistry or general science, can apply for enrolment on the Register.

Among the posts open to women technicians is that of laboratory assistant in radio and other branches of research. Training for the post may be given by the future employer, or in a Government Training Centre or Technical College.

Application for enrolment on the Register should be made to the Ministry of Labour and National Service, Appointments Office, at the address nearest to the applicant's residence, marking the envelope W.T.S.R. The London office is at Sardinia House, Kingsway, W.C.2.

Middle-East Director.—The appointment of Edward G. D. Living to the newly created post of B.B.C. Middle-East Director, with headquarters at Cairo, was recently announced. Since joining the B.B.C. he has held many posts, among them North Regional Director from 1928-1937. He recently undertook an extensive tour of investigation in the Middle East.

Hearing Aid Pioneers.—Awarded every seven years for any work which "typifies the beneficence and wisdom of the Almighty," the Royal Institution Actonian Prize of 100 gns. has been awarded jointly to Dr. Alexander and Mrs. Ewing for their pioneer investigation work on hearing aids, and the detection, measurement and assessment of deafness.

New Wireless Group.—At the informal opening meeting of the I.E.E. North-Western Centre Wireless Group, which was held on March 12th in the Engineers' Club, Albert Square, Manchester, Capt. C. F. Booth opened a discussion on "Quartz Crystal Applications."

G.E.C.—Following the recent death of Lord Hirst, Dr. A. H. Railing, who was vice-chairman of the G.E.C., has been appointed chairman, and Leslie Gamage, a son-in-law of Lord Hirst, vice-chairman. They have both been appointed

The World of Wireless—

joint managing directors. The appointment is also announced of T. Dyke and N. A. Enticknap as (temporary) joint secretaries.

The Radio Industries Club.—Owing to the present-day difficulties in catering for large luncheon meetings, the Committee of the Radio Industries Club have reluctantly decided that for the time being they cannot increase the membership of the Club. The Committee propose, however, to establish a waiting list of applicants from which any vacancies that may arise in future will be filled.

U.S.-China Link.—The first direct inter-continental radio-telephone link across the Pacific between San Francisco and Chungking is to be opened shortly.

A Discussion on "Metal Rectifiers and their Applications to Radio and to Measurements" will be opened by S. A. Stevens, B.Sc.(Eng.), at an informal meeting of the Wireless Section of the Institution of Electrical Engineers on Tuesday, April 20th, at 5.30.

Radio's Lingua Franca.—The need for a common language for use by radio operators of all aircraft in the post-war years was stressed by Air Chief Marshal Sir Arthur Longmore when addressing a meeting of the Royal Empire Society recently.

Obituary.—The death was announced on March 2nd of the distinguished physicist, Rollo Appleyard, O.B.E., M.I.E.E., at the age of 76. It will be recalled that in 1939 he wrote "The History of the Institute of Electrical Engineers, 1871-1931."

Brit.I.R.E.—At the next meeting of the British Institution of Radio Engineers at 6.30 on Thursday, April 29th, J. C. Pocock, A.M.I.E.E., will give a paper on "The Functions and Properties of Acousto-Electric Transducers."

Scophony.—It was recently announced in New York that the Scophony Corporation of America has been formed to control the American rights in patents on the "supersonic" method of television transmission and reception developed by Scophony in England.

U.I.R.—The headquarters of the Union Internationale de Radiodiffusion was recently transferred from 52 to 37, Quai Wilson, Geneva.

Institute of Physics.—The next meeting of the Electronics Group of the Institute of Physics has been arranged for Tuesday, April 6th, at 6 o'clock, in the lecture theatre of the Royal Institution, Albemarle Street, London, W.1, when Dr. J. H. Fremlin, of Standard Telephones and Cables, will deliver a paper on "Physics and the Static Characteristics of Hard Vacuum Valves."

Institution of Electronics.—A lecture meeting of the recently formed North-Western Section of the Institution of Electronics will be held in Manchester at 6.30 on Friday, April 30th, at the Reynolds Hall, Manchester College of Technology. The subject of the paper to be delivered by S. Rodda, B.Sc., F.Inst.P., will be "Beam Tetrodes." Application for tickets should be made to the Hon. Sec., L. F. Berry, 14, Heywood Avenue, Austerlands, Oldham.

NEWS IN ENGLISH FROM ABROAD**REGULAR SHORT-WAVE TRANSMISSIONS**

Country : Station	Mc/s	Metres	Daily Bulletins (BDST)	Country : Station	Mc/s	Metres	Daily Bulletins (BDST)
America				China			
WRUW (Boston) ..	6.040	49.67	0900	NGOY (Chungking)	11.900	25.21	1500, 1700, 1815, 2230
WLWO (Mason) ..	6.080	49.34	0700, 0800, 0900, 1000, 1100	French Equatorial Africa			
WBOS (Hull) ..	6.140	48.86	1000, 1100	FZI (Brazzaville) ..	11.970	25.06	2145
WCRC (Brentwood)	6.170	48.62	0700	India			
WGEA (Schenectady)	6.190	48.47	0700	VUD3 (Delhi) ..	7.290	41.15	0900, 1400, 1650
WBS	7.355	40.79	0700, 0800, 0900, 1000	VUD4	9.590	31.28	0900, 1400, 1650
WDJ	7.565	39.66	0200, 0300, 0400, 0600, 0800, 0900, 1000	VUD3	15.290	19.62	1400
WJP	8.810	34.05	0200, 0300, 0400	Spain			
WGEO (Schenectady)	9.530	31.48	2200, 2300	EAQ (Aranjuez) ..	9.860	30.43	1915
WCBX (Brentwood)	9.650	31.09	0600, 0700	Sweden			
WNBI (Bound Brook)	9.670	31.02	0100	SBU (Motala) ..	9.535	31.46	2320†
WRUW (Boston) ..	9.700	30.93	0000, 2200	Syria			
WDL	9.750	30.77	1100	Beirut	8.035	37.34	1920
WHL5	9.897	30.32	0000, 1100, 1200	Turkey			
WRX	9.905	30.28	0700, 0900, 1000	TAP (Ankara) ..	9.465	31.70	1900
WLWO (Mason) ..	11.710	25.62	2000, 2100, 2200, 2300	U.S.S.R.			
WRUL (Boston) ..	11.790	25.45	0000, 2200	Moscow	5.890	50.93	0000
WCDA (New York)	11.830	25.36	0000, 1200, 1300, 1400, 1630†, 1830, 2200		6.980	42.98	0000, 0047, 1800
WGEA (Schenectady)	11.847	25.33	1400, 1500, 1600, 1700, 1800, 1900, 2000		7.300	41.10	0000, 1900, 2100, 2200, 2300
WBOS (Hull) ..	11.870	25.27	1300, 2000, 2200, 2300†		7.360	40.76	0000
WHL6	13.442	22.32	1300, 1400, 1500, 1600, 1700, 1800, 1900, 2000, 2100, 2200		7.560	39.68	0000
WDO	14.470	20.73	1500, 1800, 1900, 2100		9.860	30.43	0047, 0200, 1340
WBOS (Hull) ..	15.210	19.72	1500, 1800		11.830	25.36	1700
WCBX (Brentwood)	15.270	19.65	1630†, 1830, 2200		12.190	24.61	0047, 0200
WGEO (Schenectady)	15.330	19.57	1500, 1800		15.230	19.70	0047, 1340
WRUL (Boston) ..	15.350	19.54	1200, 1300, 1400, 1500, 1600		8.050	37.27	2130
WCW (New York) ..	15.850	18.92	2000	Kuibyshev	11.700	25.64	0700, 1500, 1545
WLWO (Mason) ..	17.800	16.85	1600, 1700, 1800		13.010	23.06	0700, 1500, 1545
WCRC (Brentwood)	17.830	16.83	1200, 1300, 1400, 1630†, 1830, 2200	Vatican City			
Australia				HVJ	5.970	50.25	2015
VLQ5 (Sydney) ..	9.680	30.99	0755	MEDIUM-WAVE TRANSMISSIONS			
VLG3 (Melbourne) ..	11.710	25.62	0755	Ireland			
Brazil				Radio Eireann ..	kc/s	Metres	
PRL8 (Rio de Janeiro)	11.720	25.60	2230	565	531	1440†, 1945, 2310	

It should be noted that the times are BDST—two hours ahead of GMT. Owing to the change from BST to BDST the times of some of the transmissions may be altered. The times of the transmission of news in English in the B.B.C. Short-wave Service are given on the previous page.

† Sundays excepted.

Exhausting

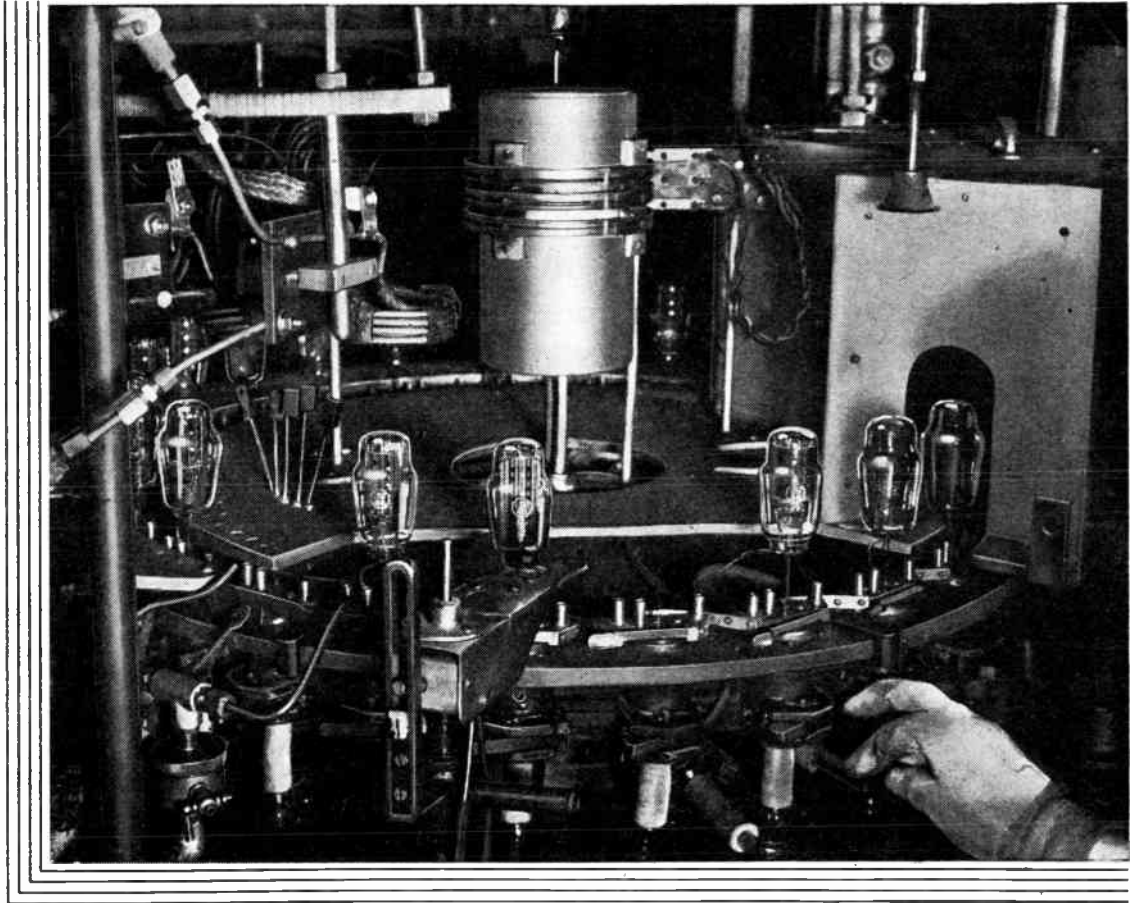

SUCCESSFUL valve manufacture demands a very high degree of vacuum.

Our illustration shows a fully-automatic rotary pump station on which all necessary operations are carried out up to and including the sealing of the vacuum.

BRIMAR
BVA
VALVES

STANDARD TELEPHONES AND CABLES LIMITED, FOOTSCRAY, SIDCUP, KENT.

Rotary Cutting, Filing, Grinding and Polishing - *Economy and Accuracy*



Use **MORRISFLEX** Flexible Shaft Equipment, and **REX** Rotary Files and Cutters for cutting, filing, grinding and polishing components of aluminum, Elektron, non-ferrous alloys and ferrous metals. For metal buffing and cleaning we supply **MORREX** Rotary Wire Brushes, and **MORRISFLEX** Rotary Polishing Mops and Felts, also Felt Cones. **MORRISFLEX** Rotary Rasps are ideal for woodworking, and attachments for **MORRISFLEX** machines include Sanders and Grinders.

MORRISFLEX machines are available in overhead suspension, bench and floor types. Their use ensures speed with accuracy, and a high degree of finish. Write for Lists.

B. O. MORRIS LTD.
SHIRLEY,
BIRMINGHAM.

Shirley 1237.

*Grams :
Morrisflex, Birmingham.



MORRISFLEX

FLEXIBLE SHAFT EQUIPMENT

MOULDED TODAY ARE THE DESTINIES OF TOMORROW . . .

Upon the shape of events to-day, and every day, depend the fortunes of the future. Through to-day's endeavour in research and industry already are discerned new and greater benefits for the coming era.

The name Marconi, since the earliest days of Radio, stands foremost in the field of communication; and Marconi Instruments Ltd., in the specialised work of instrument production, maintain this pride of place.

Over the horizon we see a golden age for scientist and technician. As always to the fore—but in who knows what new guise?—will be the name Marconi;—accuracy and reliability, then as now, the standard by which we judge ourselves.

Meanwhile, we concentrate on the business of to-day and endeavour to meet fully all requirements.

COMMUNICATION TESTING EQUIPMENT • INDUSTRIAL, MEDICAL AND LABORATORY APPARATUS

MARCONI INSTRUMENTS LIMITED

ST. ALBANS • HERTS • Phone 4323

Frequency Modulation—IV.

PRE-EMPHASIS, DE-EMPHASIS, AND THE DOUBLE-TUNED DISCRIMINATOR

IN the preceding instalment the improvement in signal-to-noise ratio resulting from the use of wide-band frequency modulation was discussed. It was shown that while an amplitude modulation system reproduces noise at the same amplitude over the whole audio band, an FM system has a triangular noise spectrum. From Fig. 1 it will be seen that this results in a progressive increase in the amplitude at which the noise is reproduced, from the lower to the higher audio frequencies. This noise distribution is far from satisfactory, resulting as it does in the smothering of the higher audio frequencies while the lower still possess quite a reasonable signal-to-noise ratio.

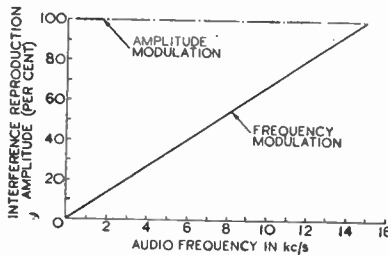

Fig. 1. Percentage amplitude at which noise is reproduced over the audio band with FM and AM transmission.

This state of affairs is further aggravated by the fact that most programme material results in the greatest modulation depths in the band below 1,000 cycles, while above this the average modulation depth steadily decreases. It is, however, the presence of the relatively small percentage of energy contained in the upper audio frequencies which results in a high standard of reproduction fidelity. Unfortunately, as the audio band of an FM receiver is extended the noise rises as the square of the increase—not proportionately as is the case for amplitude modulation. An increase in noise on a square law is a very high price to pay for any increase in fidelity, and it is obvious that some means must be found of eliminating the noise

The reduction in noise level which is produced by pre-emphasis is discussed and the total improvement due to FM is shown to be over 30db. The discriminator is introduced with an investigation into the functioning of the double-tuned type of circuit.

By

CHRISTOPHER TIBBS,
Grad.I.E.E.

while retaining a good high-frequency response.

Pre-emphasis

This is the term applied to the accentuation or emphasising, before transmission, or the higher audio frequencies. At the receiver the complementary de-emphasis or restoration to normal is effected by a special filter. This filter usually takes the form of a simple resistance and condenser network connected across the discriminator output and directly preceding the audio amplifier. A typical arrangement was shown in the circuit of Fig. 8 in the second article in this series.

The de-emphasis filter attenuates the interference as well as the higher audio frequency components, with the result that while the programme material is merely reduced to its original form, a considerable reduction is made in the level at which the interference is reproduced. Although this method of improving the noise level

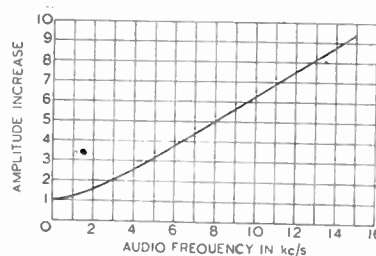

Fig. 2. American R.M.A. Television Transmission Standard (M9-218) for the pre-emphasis of high frequencies.

is not an inherent property of an FM transmission, it is an essential part of most wide-band systems.

The American R.M.A. have drawn up a Television Transmission Standard (M9—218) for the pre-emphasis of a sound channel; this standard is shown in Fig. 2. It will be noted that the upper audio frequencies are accentuated many times; 15,000 cycles, the generally accepted audio limit is boosted to almost ten times its original amplitude.

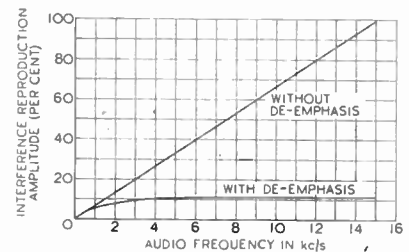

Fig. 3. Noise distribution over the audio band, with and without de-emphasis in a FM receiver.

The prime object of pre-emphasis is to make it possible to attenuate the noise in the receiver to the greatest possible extent. It will be noted from Fig. 3 that a de-emphasis filter in accordance with the R.M.A. standard attenuates the noise, so that above 5,000 to 6,000 cycles it is reproduced at a constant level. Any improvement in the receiver response is therefore accompanied by a proportionate increase in the noise and not, as previously, by an increase equal to the square of the response improvement.

With normal programme material the lower audio frequencies have by far the larger amplitude and therefore produce the greatest modulation depth, while the upper frequencies have relatively small amplitudes and result in shallow modulation. The second object of pre-emphasis is to produce as far as possible an even distribution of modulation depth over the whole audio band. Expressed in another way pre-emphasis should result in equal chances of 100 per cent.

Frequency Modulation—IV.—modulation occurring at any frequency over the audio band. The R.M.A. standard represents a reasonable approximation to these conditions. Tests which have been carried out by R.C.A.¹ confirm this point.

The reduction in noise amplitude which is produced by de-emphasis is equal to the ratio of the ordinates of the two curves in Fig. 3. For instance the improvement at 10 kc/s is some 600 per cent. It would be possible to produce an even greater reduction in noise level by employing more pre-emphasis. However, any further increase in the amount of pre-emphasis would result in the upper audio frequencies being boosted to such an extent that over-modulation would occur in that region before it took place elsewhere. This would force a reduction to be made in the general modulation depth at all frequencies. The loss at the transmitter from this cause would be greater than the reduction in noise due to the added receiver de-emphasis. The standard chosen is in fact a happy compromise between noise reduction and loss due to a reduced modulation depth of the lower audio frequencies.

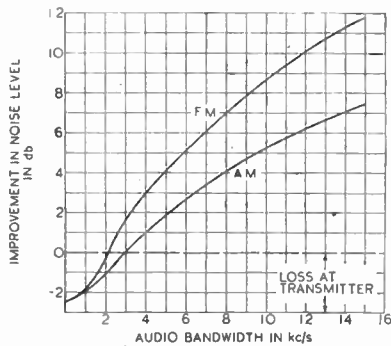

Fig. 4. Diagram showing improvement with FM and AM resulting from pre-emphasis for any given bandwidth. At very narrow bandwidths pre-emphasis actually causes a loss.

The improvement in noise level effected by de-emphasis is equal to the ratio of the areas under the two curves in Fig. 3. For a receiver having a response up to 15 kc/s, this reduction in noise is of the order of 5 times (14db.). Against this must be set the loss resulting from the reduction in modulation which is necessary in order to avoid over-modulation of the pre-emphasised higher audio

frequencies. This reduction has been found by Crosby¹ to average around 2.5 db., although with certain types of programme material such as guitar, harmonica and piano solos the reduction may be as high as 4.5 db. To obtain

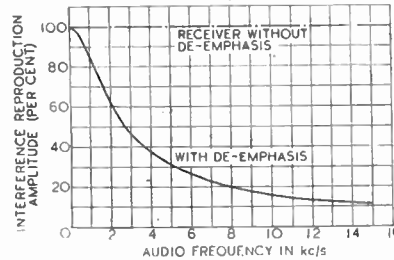

Fig. 5. Noise distribution in a AM receiver with and without de-emphasis.

the overall gain due to pre-emphasis the average reduction in modulation depth must be subtracted from the improvement in noise level. This gives a round figure of 11.5 db. as the overall improvement produced by pre-emphasis of a wide-band frequency modulation system handling a peak audio signal of 15 kc/s.

The improvement produced by pre-emphasis (in accordance with the American R.M.A. standard) for any bandwidth of either a frequency-modulated or an amplitude-modulated transmission is shown in Fig. 4. These two curves were produced by comparing the area under the noise spectrum curves (Figs. 3 and 5) with and without pre-emphasis, for both frequency and amplitude modulation, with varying bandwidths. It will be noted that these curves show the improvement effected by pre-

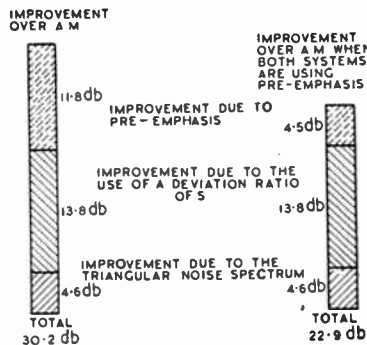

Fig. 6. The total improvement in signal to noise ratio which FM shows over AM is some 30 db. This figure assumes that the maximum audio frequency is 15 kc/s in each case and that the FM station has a deviation of 75 kc/s.

emphasis as considerably greater for FM than for AM. It should also be noted that with very narrow bandwidths pre-emphasis actually results in a loss. This point is of considerable interest should the idea ever be entertained of using pre-emphasis on the medium-wave broadcast band. If a medium-wave broadcast receiver bandwidth is assumed to be 9 kc/s (i.e., 4.5 kc/s either side of the carrier) then, from Fig. 4 it is seen that pre-emphasis would only result in an improvement of 1.5 db. This would be inaudible to the human ear and would not justify the increased receiver cost.

Overall Improvement

The total improvement in signal to noise ratio which is produced by

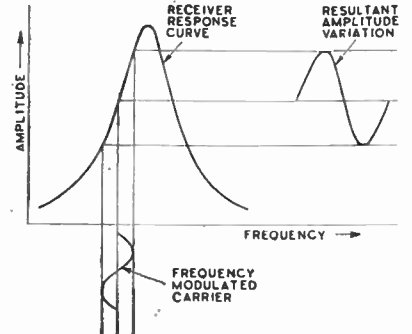

Fig. 7. The sloping side of the receiver response curve can be used to convert carrier frequency changes into variations of amplitude.

wide band FM is apparent from Fig. 6. This diagram is built up from figures for comparable amplitude and frequency modulation transmissions. It is assumed that both systems have to pass a maximum audio frequency of 15 kc/s and that the deviation of the FM system is ± 75 kc/s. Under these conditions the overall noise level improvement is some 1,000 times (30 db.). If pre-emphasis is used on the AM system as well, the total improvement resulting from FM will be some 23 db.

It should be noted that the improvement of 30 db. will only be achieved when the interference is less than 10 per cent. of the signal. If the noise rises to some 25 per cent. of the signal the improvement will fall to 800 times (29 db.), while if the noise is 50 per cent. of the signal the improvement will fall to 500 times (27 db.). At noise levels above 50 per cent.

of the signal the improvement falls away very rapidly as the improvement threshold is approached.

If, as is sometimes done, the reduced power drawn by the transmitter is included, this will approximately double the transmission efficiency and bring the total improvement up to some 2,000 times (*i.e.*, 33 db.). This improvement would actually be achieved if a high-fidelity transmitter working on the USW band (such as the pre-war Alexandra Palace sound channel), were to be changed from amplitude to wide-band frequency modulation. To attempt to compare the results obtained on a wide-band FM station with those on the broadcast band, is liable to be misleading. The type of interference most common to the medium-wave band is non-existent on the USW band and vice versa. On the broadcast band the sidebands are drastically limited while on the USW band they are transmitted in full. It can however be stated that the combination of high-fidelity transmission, with the interference freedom due to FM, produces results which are incomparably better than those obtained on the medium-wave broadcast band.

The Discriminator

A very large measure of the success attained by wide-band FM can be attributed to the high efficiency with which it is possible to convert changes in carrier frequency into audio voltages. As late as 1932 a paper² was published in which it was deduced that a receiver designed for FM would have less than one-tenth the power output of a similar AM receiver. This conclusion resulted from the fact that this author and others of the same period based their calculations on the only method then available for the demodulation

of FM transmissions. They used the sloping side of a receiver response curve to convert changes in frequency into amplitude changes. As will be seen from Fig. 7 this

an FM transmission, this method is never employed if it can be avoided. It is possible to use only the substantially linear section of the skirt as a frequency-to-

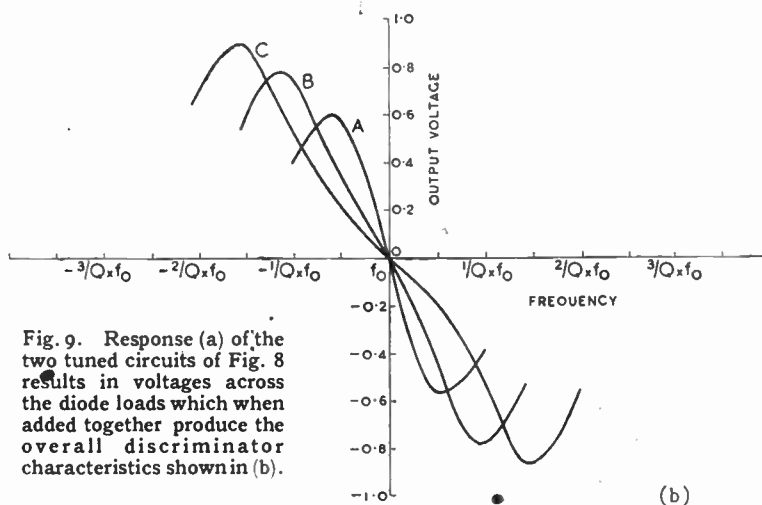
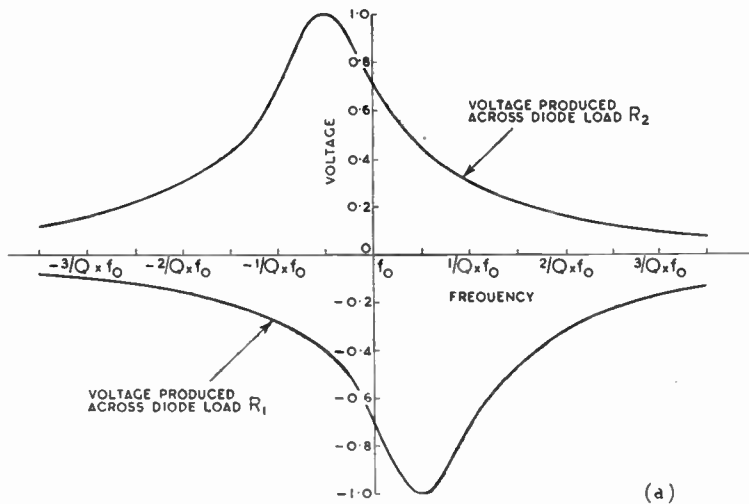

Fig. 9. Response (a) of the two tuned circuits of Fig. 8 results in voltages across the diode loads which when added together produce the overall discriminator characteristics shown in (b).

may be done by tuning the FM carrier to about midway up one skirt of the response curve. The resulting changes in the carrier

amplitude can be demodulated with any normal detector circuit.

While in an emergency it is possible to use an amplitude modulation receiver for the reception of

amplitude converter. Less than 50 per cent. of the peak amplitude is suitable for this purpose. A further loss results from the amplification of the carrier some way down the skirt, instead of on the top of the response curve. Under these conditions it is not difficult to understand how the power output from an FM receiver was found to be one-tenth of that from a comparable amplitude modulation receiver.

Armstrong's original paper introducing his system of wide band FM contained the following observation: "The most difficult operation in the receiving system is the

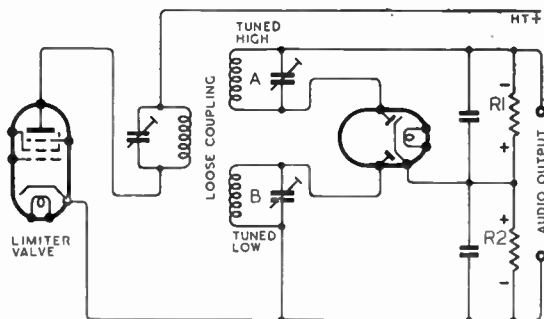

Fig. 8. Discriminator stage of the double tuned circuit type.

translation of the changes in the frequency of the received signal into a current which is a reproduction of the original modulating current." Although the discriminator is still the most important stage in an FM receiver, it can no longer be described as the "most difficult."

The discriminator circuits in use to-day fall into two main classes. First those depending on two tuned circuits, one resonant beyond the upper and the other below the lower deviation limit. The second arrangement depends for its functioning on the phase shifts which occur with varying frequency between the primary and secondary windings of a tuned transformer. Of these two types the latter is by far the most popular and can almost be regarded as the standard discriminator circuit. It will be treated in detail in the next article.

A typical circuit of the first type of discriminator is shown in Fig. 8. It was first described in a paper by Travis³. There is a wide variety of

Fig. 10. Alternative arrangements of the double tuned circuit type of discriminator. The upper one is used in a Motorola mobile communication receiver.

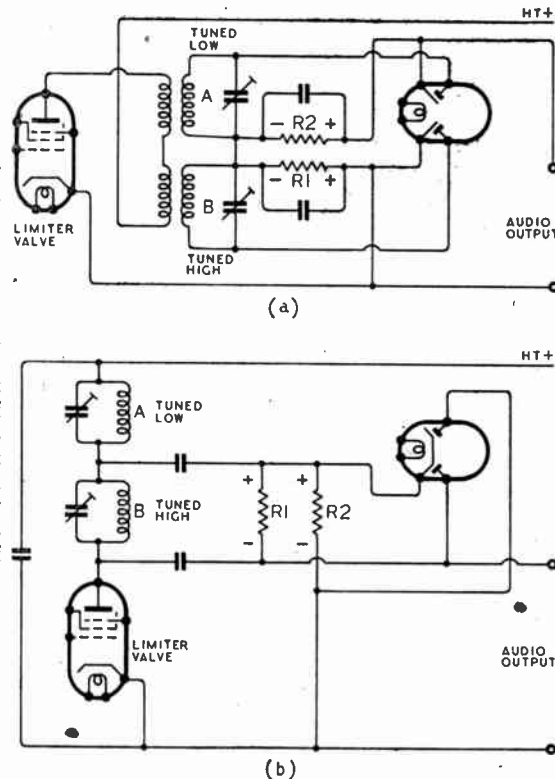

ways in which it can be arranged, but the basic functioning of all is the same. The discriminator shown in Fig. 8 consists of a transformer with two loosely coupled secondaries, one tuned to a frequency above the upper and the other below the lower deviation frequency limit.

As the carrier frequency is moved over the receiver band the voltages shown in Fig. 9(a) are produced across the two diode loads. It will be noted that while that produced across R_2 is positive, that across R_1 is negative. The output from the discriminator will therefore be

the difference, or algebraic sum of these two voltages. The optimum characteristic for this type of discriminator is shown in curve A in Fig. 9(b). This curve is linear over quite a considerable part of its range. This linear characteristic will only be obtained when the two tuned circuits are separated by a frequency equal to $1/Q \times f_0$, where $Q = \omega L/R$ and is the same value for both circuits, and f_0 is the mid-frequency between those to which the two circuits are tuned.

The effect of increasing the frequency separation above the optimum value is shown by curves

strictly linear over the working portion of its characteristic, which must be at least equal to the maximum peak-to-peak deviation (i.e., 150 kc/s.). Referring to curve A it will be noted that the characteristic is only linear over a frequency range of $0.5/Q \times f_0$. In the example under consideration this frequency band has already been fixed as 150 kc/s. The optimum peak separation has, however, been shown to be $1/Q \times f_0$. As this is double the frequency covered by the linear part of the characteristic, then for the example given the optimum peak spacing must be 300 kc/s. Under these conditions the Q of the two tuned circuits will be:

$$Q = \frac{1}{\text{frequency separation}} \times f_0 \\ = \frac{1}{0.3 \text{ mc/s}} \times 5 \text{ mc/s} \\ = 17 \text{ (approx.)}$$

The only real objection to the double-tuned circuit type of discriminator is its relatively low efficiency; at best its output is only about one-third that of the phase-difference type of discriminator. In the next article curves will be given which show that the Q figure for a corresponding phase-difference discriminator is 25. In comparing the two circuits the loss resulting from the loose coupling between the primary and secondary windings should be added to the unfavourable Q ratio of 17 to 25. In addition a far smaller portion of the double-tuned discriminator characteristic is linear.

Two alternative circuit arrangements are shown in Fig. 10. The first is a circuit which has been used in a Motorola communication receiver, while the second is an attempt to eliminate the losses which loose transformer coupling introduces. Many other arrangements of the basic circuit are possible⁴, and some unrecognisable circuits turn out to be variations of the double-tuned discriminator.

Bibliography

- 1 "The Service Range of Frequency Modulation," by M. G. Crosby. *R.C.A. Review*, January, 1940.
- 2 "The Reception of Frequency-modulated Radio Signals," by V. J. Andrew. *Proc. I.R.E.*, May, 1932.
- 3 "Automatic Frequency Control," by C. Travis. *Proc. I.R.E.*, October, 1935.
- 4 "The Development of an FM Receiver," by K. E. Thomas. *R.C.A. Review*, October, 1941.

Electromagnetic Fields in Radio—III.

WAVE TRANSMISSION IN SPACE

By

MARTIN JOHNSON,

D.Sc.

IN the previous two articles we have traced the interaction of electric and magnetic fields from experiments on electron beams in a C R tube to the laws of Faraday and Maxwell, and have finally reached the equations which sum up the way in which magnetic and electric phenomena mutually generate each other under certain conditions of relative motion. The conventions of vector treatment were explained in detail, so that a physical picture was attached to the statement concerning electric intensity E and magnetic intensity H and " c " the ratio between units of measurement, which we wrote

$$\text{curl } E = \frac{1}{c} \frac{\partial H}{\partial t}, \quad \text{curl } H = \frac{1}{c} \frac{\partial E}{\partial t}$$

The discussion so far applies only to empty space and will be found a sufficient basis for understanding the speed, energy and polarisation of radio waves, for example in properties of aerials or directional radio. A further step will be to extend the terms in the equations to cover transmission through material instead of empty space for application to dielectric loss, bending of waves and the effects of the ionised Heaviside layer in the upper atmosphere.

To begin with, a junction must be made between whatever we understand by oscillation and wave

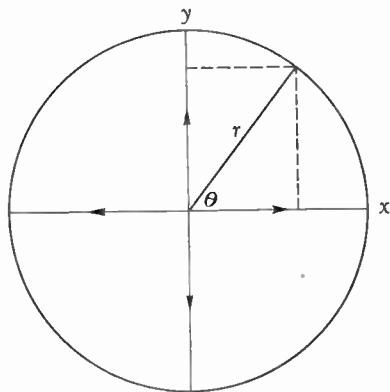

Fig. 1. Angular motion and oscillations.

motion and by the electromagnetic laws. Why do Maxwell's equations imply that E and H oscillate?

Oscillations and Waves. Anyone with the slightest acquaintance with

the mechanism of the piston and crank in locomotive or pump or internal combustion engine, recognises that circular motion at constant speed (Fig. 1) "generates" a vibratory motion along vertical and horizontal diameters. The definition of sine and cosine for the angle θ , made by any radius relative to its initial orientation, ensures that all properties of the vibrations bear simple calculable relationship to the "generating" motion round the circle. If in accord with the vector treatment of the previous article the vertical and horizontal oscillations are written $y = r \sin \theta$ and $x = r \cos \theta$, these will have a phase difference or angular separation of 90 deg. or $\pi/2$. If the angular velocity or rate of sweeping round of the radius is ω or θ/t , where t is the time elapsed since the radius was horizontal in its sweep, the vertical vibration becomes $y = r \sin \omega t$. If T is the time required for the completion of an entire cycle, n the frequency of rotation is the same as the frequency of oscillation along the diameters, and $n = 1/T$. If the vertical and horizontal displacements in the above equations are plotted against the angle θ , Fig. 2 (a), the property of a $\pi/2$ phase difference is seen pictorially, and radio workers will recognise that it is equivalent to the relation between EMF and current in certain AC circuits.

If (a) in Fig. 2 is merely the picture of the equation governing any oscillation, derived from the motion along the diameters of a circle, (b) and (c) are of the same form but may be given physical meaning to represent the way the medium oscillates when waves of any kind pass through. For mechanical waves the "thing" whose amplitude of vibration is given by the ordinates of the diagram will be a particle, solid or fluid. But for radio waves in empty space the amplitude is of H or E vector and the medium need have no material

properties—in spite of the old-fashioned name of "aether" which falsely suggested material. Fig. 2 (c) is an instantaneous "snap" of how displacement varies along a wavelength, while (b) shows how displacement at any single point goes through a cycle of changes as time progresses; but the form of

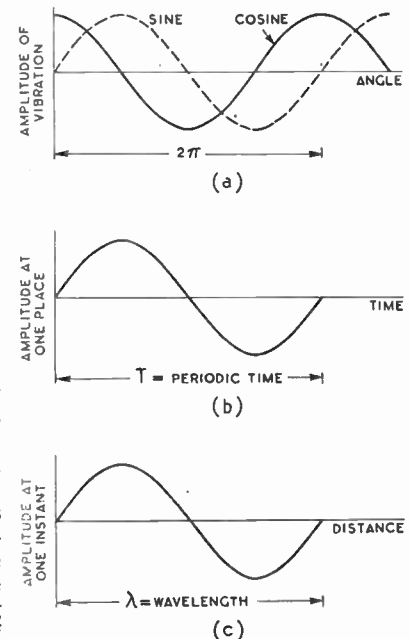

Fig. 2. Time and space diagrams of wave motion.

the two is identical. The transverse nature means that displacement is across not along the axis of propagation, somewhat as a cork bobs up and down when a water wave passes, though circular motion is there also. But the longitudinal waves of compression in sound have no counterpart in radio, the transverse character of E when an aerial picks up or when a photo-cathode absorbs light, being essential.

The Wave Equation. From the sine and cosine picture of waves which we have derived from a circular diagram of oscillation, the meaning we have given to T (periodic time), n (frequency), and λ (wavelength) can be combined so as to see why the E and H of Maxwell's equations must move in

Electromagnetic Fields

wave form. If a wave disturbance, mechanical, acoustical or electrical, moves forward with velocity v , then a linear description $v = \lambda/T$ corresponds to an angular description $\omega = 2\pi/T$. Also velocity, frequency and wavelength are always connected by $v = n\lambda$. If now the amplitude in Fig. 2, (b) and (c), refers to any vector V , and its dependence upon time or distance were expressed by saying it is some function $f(t)$ or $f(x)$, then the form of the function according to our diagram and our definitions will be

$$f(t) = r \sin \frac{2\pi}{T}(t) \text{ or } f(x) = r \sin \frac{2\pi}{\lambda}(x)$$

according as the picture is of time variation or the "instantaneous snap." Similar expressions, only with cosines, provide the quarter-period out-of-phase curve.

Since progress along the x direction occurs as distance alters by vt , forward or backward travel of a wave is merely a shift of the pattern expressed as

$V = f(x - vt)$ and $V = f(x + vt)$
If we write down the rates of change of these functions, representing by f' and f'' the first and second "partial derivatives" obtained by differentiating as explained in the previous articles,

$$\frac{d^2V}{dx^2} = f''(x - vt)$$

$$\text{and } \frac{d^2V}{dt^2} = v^2 f''(x - vt)$$

by arguments in the calculus which we cannot pause to elaborate here. The point of importance which can be seen even without the steps of proof, is that when these two differentiations for time and for distance are compared,

$$\frac{1}{v^2} \frac{d^2V}{dt^2} = \frac{d^2V}{dx^2}$$

This is therefore the summarised expression of the properties of any vector which oscillates and can thereby take part in wave propagation. It is the standard equation of wave motion in one dimension carrying physical properties with velocity v , and merely mathematical extension is needed to include the three dimensions of space.

We now need to show that Maxwell's equations of electromagnetism possess this form, and we shall have reached, by the same route as the pioneers, the conviction that waves and therefore

radio are an inevitable accompaniment of electromagnetism.

Why Waves are Implied in the Laws of Electromagnetism.

Turn to look for wave properties in Maxwell's equations: notice to begin with that the "curl" expressions quoted at the beginning of this article and explained previously connect a rate of change of E in time with a change of H in space, and vice-versa. It is suggestive that our "wave equation" connects an x differentiation with a t differentiation, though of a single variable V . In these two Maxwell relations, ignore as before all plus and minus signs and take a case of $\frac{\partial}{\partial y} = \frac{\partial}{\partial z} = 0$ in all operators, so that the system reduces to motion in a single x direction. This will turn out to suit plane instead of spherical waves. The equations then become,

$$\frac{1}{c} \frac{\partial E_y}{\partial t} = \frac{\partial H_z}{\partial x} \quad \frac{1}{c} \frac{\partial H_z}{\partial t} = \frac{\partial E_y}{\partial x}$$

The vector E is now confined to (or "polarised in") the xy plane, and H in the xz plane. Each of these is now differentiated according to our rule for obtaining rate of

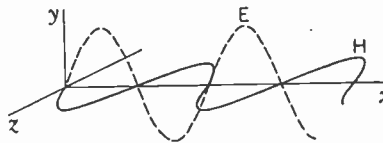

Fig. 3. Electric and magnetic vibrations mutually perpendicular, with velocity and energy flow in the third direction.

change, in the one case a change with respect to time and in the other with respect to distance. By combining the two results, H is caused to drop out of the expression, i.e. to be eliminated, leaving only

$$\frac{1}{c^2} \frac{\partial^2 E_y}{\partial t^2} = \frac{\partial^2 E_y}{\partial x^2}$$

Performing the same operation, only with distance and time derivatives interchanged, results in eliminating E instead.

$$\frac{1}{c^2} \frac{\partial^2 H_z}{\partial t^2} = \frac{\partial^2 H_z}{\partial x^2}$$

Text-books will perform these operations with greater generality in three dimensions, obtaining "curl of curl" until

$$\nabla^2 E = \frac{1}{c^2} \frac{\partial^2 E}{\partial t^2}, \text{ etc.,}$$

but the physical meaning is complete in the one-dimensional form above.

We are now in a position to notice that these last expressions are actually identical with the wave equation which we had derived for any vector V , provided that "c" has become the velocity "v" with which the wave travels. We have once again reached the conclusion that electromagnetic fields move with a speed equal to the ratio between electrostatic and electromagnetic units: but this time we have arrived there by showing that the laws of electromagnetism contain implicitly a form equivalent to the way of describing any kind of wave motion. The complete information can be pictured (Fig. 3), where the perpendicularity of the magnetic field H in the z direction and the electric field E in the y direction is contrasted with the direction of travel of the wave, x . That a radio wave consists of an H oscillating at right angles to an E , and both transverse to the direction of propagation, is completely deducible from Maxwell's equations.

Energy Transmitted in Radio Wave.

The most intriguing question next arising is this: we have said that the electric and magnetic vectors E and H undergo harmonic oscillation transverse to the axis of the wave pattern. How then is energy carried forward by a train of waves? For the setting in motion of electrons in a receiving circuit must imply that some energy is carried; and though under modern conditions of amplification the power in the wave itself may be extremely small compared with receiver output, and the magnitude of primary flow from incoming RF impulses very minute, some transfer of energy from wave to intercepting device is a necessary requirement.

The answer is in Poynting's theorem—the link between the geometry of waves and their power properties. Poynting was one of the first utilisers and extenders of the Maxwell electrodynamics. Without detail of proof we can here suggest a little of how the understanding of radio fields passes this crucial stage by connecting together the force felt in a field (starting point of our first article), the work done and energy expended and the notion that a product of two vectors may give rise to another vector perpendicular to them both (explained in the second article).

Appreciation of Poynting's argument can suitably start from con-

sidering any region in space and the rate at which energy is entering it, giving rate of increase therein of electric and magnetic field energy density together with rate at which work is done on any charges within the region. Force upon any charge can be written in terms of the fields and velocities as in our initial derivation of the electromagnetic laws, and the rates of working are calculable. The final result is that at any point there is a stream of energy crossing unit area, equal to $\frac{c}{4\pi} \mathbf{E} \times \mathbf{H}$ units per cm.² per sec.

Our vector theory stated that such "cross product" is itself a vector perpendicular to both \mathbf{E} and \mathbf{H} , and this is therefore the direction in which energy flows. Our diagram (Fig. 3) of a plane wave in empty space shows that the Poynting energy flux coincides with the direction of forward motion of the wave pattern. The earlier discussion of vector products shows also that this Poynting vector must have a maximum when \mathbf{E} and \mathbf{H} are mutually perpendicular and would vanish if they coincided in direction—another side-light on the necessary orientation of the electric and magnetic field vectors in an energy-carrying radio wave.

But if empty space propagation of energy is so simple, it is often hard to imagine what is going on in the "material" portions of a radio circuit, and here the Poynting vector becomes particularly helpful; we select a few examples.

(a) The connecting wires of our circuits may be considered as long cylinders of circular cross-section.

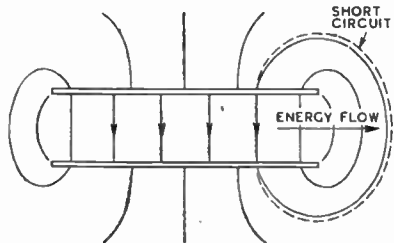

Fig. 4. Poynting flux during transient condenser discharge.

If a steady current i is being carried and e is potential drop per unit length and R resistance per unit length, we know there is energy dissipation ie or i^2R . But the Poynting conception is useful in picturing the mechanism even in the steady non-oscillatory state. For e will also be the intensity outside and

parallel to the wire, while magnetic lines will be circles coaxial with the wire. Hence on the Poynting principle the energy flux $\frac{c}{4\pi} \mathbf{E} \times \mathbf{H}$ must

be perpendicular to \mathbf{E} and to \mathbf{H} and directed inwards from the surrounding dielectric into the wire surface. It can be shown that this energy amounts to i^2R per unit length per second, thus accounting quantitatively for the heating of the wire. This is independent of the current direction, by analysis of the Poynting vector, and occurs whether the dielectric is space or material. Emphasis that the non-conducting surroundings are the seat of energy transmission serves to bring radio both inside and outside the "wireless set" under the same common notion. For example the concentric feeder used in modern short-wave gear is no longer an abnormality, the power being transmitted in the hollow space and the Poynting vector behaving as in the single lead. This makes intelligible the "waveguides" of modern UHF technique.

(b) Imagine the discharge path for a radio condenser (Fig. 4) to be represented, for simplicity, by the dotted line which coincides with some line of electric intensity outside the plates, which are seen in vertical section. The interior field \mathbf{E} is vertical from plate to plate. The magnetic field \mathbf{H} is front to back. So the Poynting vector gives the flow of energy as parallel to the plates from left to right. This is therefore directed towards the connecting wire, as in the example (a), the energy moving from dielectric towards conductor again.

(c) We have applied the Poynting vector to a steady current and to a transient discharge: the other condition of flow interesting to radio is of course the oscillatory, whence the Poynting method was first derived. Consider a plane wave propagated parallel to a conducting surface, Fig. 5 (a). The \mathbf{E} lines of force are as shown, the \mathbf{H} lines are parallel to the surface, back to front of picture or front to back according as \mathbf{E} is up or down, the two possibilities alternating, of course, with each phase reversal. The Poynting vector gives the energy flux as in the direction of the long arrow, independent of the reversals. This would mean that there is no energy flux component into the surface and no dissipation



**VARIABLE CONDENSERS
—DRIVES—
AUTOMATIC TUNERS**

WE are designing and building even better equipment with our enlarged and extended facilities and these improvements will be available for your use when the present struggle is over.

For the time being domestic receiver design and production has ceased but your radio receiver manufacturers will be ready to equip their sets with General Instrument variable condensers, automatic tuners and other G.I. devices as soon as conditions permit.

Always remember General Instruments
**VARIABLE CONDENSERS — DRIVES —
AUTOMATIC TUNERS**

Register your name with our Representative now. He will forward you information on our products as soon as they become available.

THE GENERAL INSTRUMENT CORPORATION
ELIZABETH, N.J., U.S.A.

Exclusively Represented by
Frank Hoaver Ltd. Kingsley Road,
Bideford, N. Devon

**OF OUR ABILITIES
AND FACILITIES
WE GIVE GLADLY**

PARAMOUNT above all else is the necessity of meeting urgent and immediate demands for the protection of cherished liberty.

Astatic's engineering and manufacturing facilities are first, therefore at the disposal of Allied Governments.

Astatic will be ready to serve you again with high quality piezo-electric devices when the 'All-Clear' of Victory sounds.

Register your name with our Representative for your future benefit.



THE ASTATIC CORPORATION
YOUNGSTOWN, OHIO, U.S.A.
TORONTO, CANADA.

Exclusively Represented by
Frank Hoaver Ltd. Kingsley Road,
Bideford, N. Devon

Electromagnetic Fields—

into the conductor; but this is only the ideal case of infinite conductivity. Finite conductivity, causing loss into the surface, means the Poynting vector has some component *towards* the surface, and this can be represented by the E lines curving as shown in Fig. 5 (b). This happens, for instance, where a radio wave is transmitted over sea or land.

Light Waves and Radio Waves.

It must finally be recognised that when energy travels with the Poynting vector and meets a non-transparent object, the absorption or reflection of energy may involve

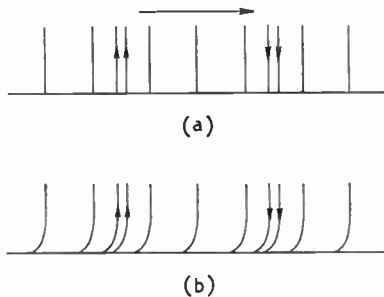

Fig. 5. Propagation of wave along conducting surface. (a) zero resistance. (b) finite resistance.

a transfer of momentum from beam to object. In other words, radiation exerts a mechanical pressure. We here have a striking instance of electrical theory unifying widely separated regions of common experience: the Maxwell-Poynting theory means nothing unless ordinary visible light and radio waves represent precisely the same travel of electric and magnetic fields but with vastly differing wavelength, visible radiation being just that wave-band between 3 and 7×10^{-6} cm, to which our eyes happen to be sensitive. The mechanical pressure exerted by radiation ought to occur in all wavelengths. But it is only with "light" that a beam can conveniently be so concentrated upon so small an absorber or reflector that this can be delicately suspended enough to detect the pressure. In the laboratory the phenomenon which thus convincingly demonstrates the Poynting idea is hard to disentangle from the minute drifts due to warmed air, etc., but at the surface of the sun or a hot star it must act as a "mighty rushing wind" and is probably responsible for the explosive eruptions which signal to us a "new star" in the sky.

The insistent question pursues us, what in empty space is the momentum of the radio wave? There is a force on a current in a magnetic field due to the action of the field on the magnetic field of the current itself. In empty space there is no material on which the force is to act, so it reacts on the field and we have to ascribe momentum to the latter. It even becomes necessary to recognise that electro-magnetic energy travelling as radio with velocity "c" possesses mass or inertia. We then begin to see why no material particle can acquire 100 per cent. of this speed, since it would thereby acquire infinite mass. Actually the electrons shot out of radioactive substances show speeds up to more than 90 per cent. of "c," and their increase of mass with velocity becomes detectable. We here trespass upon an electro-magnetic view of the universe to which radio and its fields is a clue in the far wider tale.

Polarisation. Application of the Poynting vector theory has been

based on the notion that E has a unique direction in space: we have considered plane polarised waves. Actually some degree of polarisation happens to be more common in radio waves than in the shorter electromagnetics of visible light, where crystal filtering or reflection at a definite angle is generally needed to confine E (and the H which always follows it perpendicularly) to a fixed direction. In radio the form of the apparatus acting as source is apt to impose polarisation, being generally a dipole or combination of dipoles, made up of some linear distribution of alternate positive and negative charge. But polarisation of radio waves can occur, as in the case of light, by certain kinds of reflection and by the action of an external magnetic field. It may be possible later to say something about the application of this notion to reflection of radio from the Heaviside layer in the upper atmosphere, and to the influence of the earth's magnetic field.

RED CROSS FUND**Wireless Industry's Contributions**

ALL branches, including radio, of the electrical industry are supporting the Electrical Industries Red Cross Fund, details of which have appeared in earlier issues of this journal. The fund is now well under way and the total is growing to a very considerable figure — about £12,000 at the time of going to press. In this total are included not only donations but covenanted subscriptions, which offer special advantages both to the subscriber and to the Red Cross. Full details can be obtained from the joint Secretaries of the Fund, c/o The E.D.A., 2, Savoy Hill, London, W.C.2. Contributions should be sent direct to the Electrical Industries Red Cross Fund, St. James's Palace, London, S.W.1.

Among those wireless firms, or firms with wireless interests, whose names appear in the latest lists are the following:—

COVENANTED SUBSCRIPTIONS

	£	s.
Standard Telephones & Cables, Ltd., London	500	0
Automatic Telephones & Electric Co., Ltd., Liverpool	400	0
W. T. Henleys Telegraph Works, Ltd., Dorking	250	0
Ultra Electric Co., Ltd., London	200	0
Oliver Pell Control, Ltd., London	50	0
J. H. Tucker & Co., Ltd., Birmingham	10	10
R. Cadisch & Sons, London	10	10

DONATIONS

	£	s.
B. T.-H. Co., Ltd., Rugby	500	0
Metropolitan-Vickers, Ltd., Manchester	500	0
Ericsson Telephones, Ltd., London	250	0

	£	s.
Ever Ready Co., Ltd., London	250	0
Bakelite, Ltd., Brackley	105	0
British Industrial Plastics, Ltd., Oldbury	100	0
Edison Swan Elec. Co., Ltd., London	100	0
Wharfedale Wireless Works, Brighouse	5	5
British Institute of Engineering Technology, London	5	5
Ripaults, Ltd., Enfield	2	2
Aerialite, Ltd., Stalybridge	1	1

BOOKS RECEIVED

Practical Morse. By John Clarricoats. Written for the prospective wireless operator, this booklet contains information on learning the code, on signalling procedure and on practice equipment. The uses of both buzzer and valve oscillators as "signal generators" are treated; oscillators of the simplest kind for a single pair of headphones, as well as more ambitious types for multi-headphone operation, are described. Both battery and mains-fed models are dealt with, and a method of producing artificial interference is discussed. Pp. 38+X; 13 figures. Sir Isaac Pitman and Sons, Ltd., Parker Street, Kingsway, London, W.C.2. Price 1s. 3d. net.

British Journal Photographic Almanac. We have received a copy of the 1943 edition of this useful book. As usual, it is a mine of technical information relating to photography, and contains many articles, some of which are of specialist interest. A chosen selection of the year's photographs is also included as a supplement. Publishers: Henry Greenwood and Co., Ltd., 24, Wellington Street, W.C.2. Price 3s. 6d.

POST-WAR RADIO

What Engineers are Thinking

THE Cossor Branch of the Association of Scientific Workers recently called a meeting to discuss "Post-War Radio." It was attended by research and development engineers from the Cossor, Peto-Scott and Invicta laboratories, and, although it was a purely local affair, many of the points discussed and individual opinions expressed were of general interest.

UHF Broadcasting. One of the main topics discussed was UHF broadcasting. It was the general opinion that this was a very necessary post-war development, and also that the development of frequency modulation broadcasting in the United States should be studied most carefully. The importance of the American development was not so much the use of frequency modulation, but the extension of broadcasting to a new frequency band on which it was possible to provide the public with a large number of alternative programmes. UHF broadcasting in Britain could only be really successful if it provided the public with a considerable number of alternative and varied programmes, and it was felt by the meeting that this would never be done by the B.B.C. The Corporation should retain its monopoly on the lower frequencies, but it would be disastrous if this monopoly were allowed to prevent a real expansion of UHF broadcasting. A wide band in the short-wave region should be thrown open to approved undertakings of all kinds, not only to provide entertainment but also educational programmes. Local broadcasting could then play as important a part in the life of this country as it does in U.S.A. The B.B.C. would continue on the medium waves as a Government service, and no one who did not wish to need listen to the stations on the UHF band. Every centre of population over 100,000 could afford at least one local station, particularly if relayed and recorded programmes were fairly extensively used. All large educational authorities, such as Universities and County Councils should either have their own stations or share a station. Large

industrial concerns should be allowed their own stations, with only reasonable restrictions as to advertising.

Television. It was assumed that the television service would be resumed after the war, and that it would be extended to provincial centres; this should be a nationally run service, covering all the main provincial centres. It was unnecessary, however, and might even be undesirable, to run the television programmes for more than a few hours each day; the frequencies allocated to television should be used to provide sound programmes during much of the time when no television programme was being broadcast.

The Radio Industry. The industry would be fully employed in replacing obsolete broadcast receivers for two or three years after the war. Healthy expansion of the industry for a longer period would necessitate the new development of UHF broadcasting. This development, if rightly used, could also be of the utmost benefit to the community, and would enable radio to take its right place in the educational programme of the country.

The radio industry should be able to employ all radio engineers, whether now in the Services, in Government employ or in industry, as long as reasonable standards of technical competence were insisted upon. Strong opinions were expressed on the necessity for legislation to compel all radio dealers to employ at least one man holding a certificate of technical competence in radio service work. This insistence on technically qualified retailers had already been tried by one manufacturer with success. The legislation covering retail chemists should be taken as an example for the radio retail trade.

Position of Technical Staffs. A very great amount of research and development would be necessary in the post-war period to bring apparatus up to date, and also in peacetime applications of wartime developments. Research and development had not been financed as lavishly in this country in the past as in some other coun-

RAYTHEON

SINCE the curtailment of Civilian radio production, RAYTHEON engineers and scientists are devoting all their energies to designing and building special tubes for to-day's important electronic developments. This new challenge for special tubes of intricate design to meet rapidly expanding use of electronic devices is being met by our engineers in the same manner with which we, in the past, produced tubes for Civilian use. Raytheon is supplying replacement tubes under Lease-Lend arrangements, and you will benefit by the priceless electronic experience now being gained when final victory is won.

WORLD'S LARGEST EXCLUSIVE TUBE MANUFACTURERS

Register your name with our Representative now for your future benefit.

**RAYTHEON
PRODUCTION CORPORATION
NEWTON, MASS., U.S.A.**

Exclusively Represented by—
Frank Heaver Ltd. Kingsley Road,
Bideford, N. Devon

CROWE

RADIO COMPONENTS

ESCUTCHEONS
TUNING CONTROLS
DIALS—REMOTE CONTROLS
POINTERS, ETC.

FOR BOTH HOME AND
COMMUNICATION EQUIPMENT

THE Crowe organisation is known to radio manufacturers throughout the world for dependable service and excellent quality of its many products.

Now devoted exclusively to production for Victory, with some items assisting directly in your Country's great efforts, we look forward to the time when our expanded facilities will be available for continuing our pleasant relationship with the British Radio manufacturing industry.

Register your name now with our British Representative for details as soon as available of Crowe Products.

**CROWE NAME PLATE &
MANUFACTURING CO.**

3701 RAVENSWOOD AVENUE
CHICAGO, ILL., U.S.A.

Exclusively Represented in Great Britain by
Frank Heaver Ltd. Kingsley Road,
Bideford, N. Devon

Post-war Radio—

tries, even in relation to the size of our population; this was a matter of great national importance, for the future of this country must depend to a great extent on the technical level of industry. It was therefore important for industry and for the Government to pay greater attention in the post-war world to technical education, research and development.

More engineers and scientists should be employed on the administrative side in industry and in Government. The percentage of administrative personnel who were technically educated was less in Britain than in certain other countries.

Development of Backward Countries. Several speakers discussed the development of broadcasting and radio communications in colonial countries. It was felt that even the smaller countries would wish to have their own radio industries, but that for a long time to come such countries would be dependent on the large industrial countries for technical assistance.

With a better ordered world economy the possible demand for broadcast receivers was immense, as not 10 per cent. of the world's population now ever had an opportunity to listen to a broadcast programme. Some fear was expressed, however, as to our ability to compete in overseas markets.

New Radio Applications. Another point discussed was future developments in communications. Civil uses for the "walkie-talkie" were possible, and communication systems using a highly directional beam on very high frequencies would be of value to many large industrial undertakings. Facsimile was a field with very great long-term possibilities, and would in the end supplement, and even replace to a limited extent, the telegraph service, postal service and the newspaper. On the whole, it was considered that technical developments offered ample scope for the radio industry in peacetime, but that it would require a great deal of careful planning and organisation to put these possibilities into practice.

D. A. B.

Another field that is becoming available, in an ever increasing degree, to the fully qualified Radio Officer, is as an Aircraft Radio Officer, and here the remuneration and conditions of service are more commensurate with the higher degree of qualifications advocated by Mr. Moore.

Doubtless a more comprehensive scheme is necessary, if not immediately, certainly in the not distant future. Such a scheme inevitably must cover all branches of the profession. It will probably be news to many readers that any person first going to sea in a wireless capacity on and after April 1st next will do so as an Assistant Radio Officer with appropriate rates of pay. On the Marine side, therefore, a man with a "Special" (or the proposed 3rd class) certificate would enter the profession as an Assistant Radio Officer. It is suggested that such a scheme as that envisaged would require the holder of the inferior certificate to complete, say, two years' service at sea before qualifying to sit for a 2nd class certificate and similarly for a 1st class certificate. A further certificate of a yet higher standard, corresponding somewhat to that of Extra Master, or Extra Chief Engineer, could perhaps be instituted. Such a certificate which would cover not only marine work of an advanced character but shore and aircraft requirements should be recognised by all industries and authorities associated with the wireless profession. Some such scheme on the foregoing brief outline could be made to serve the best interests not only of the Radio Officers concerned but also the Marine employers, shore employers, and the general public alike.

D. H. LAMB,

Organising Secretary, Radio Officers' Union.

Letters to the Editor

Radio Officers' Training • Frequency Classification

Qualifications of Radio Officers

MR. MOORE'S interesting article in the January issue of *Wireless World*, and the subsequent editorial and letters in the following month's issue, raise many important questions and call for somewhat critical comment. At the outset, it should be borne in mind that the questions set in the examinations for the P.M.G. Certificate are by no means so stereotyped as Mr. Moore would have us believe and are constantly being revised to meet the ever-varying requirements associated with marine wireless developments. Any standard, particularly in the technical sphere, in advance of that now in force would not materially assist the Marine Radio Officer. After all, the first and foremost requirement of any Radio Officer is the ability to receive and send morse.

On the other hand, there is much

to be said for a system of examinations whereby superior certificates could only be obtained progressively and subject to a definite intervening period of sea service. Mr. Moore is unfortunate, however, in comparing the 1st class P.M.G. Certificate with that of Extra Master, or Extra Chief Engineer, without explaining that the two latter certificates are not actual sea requirements.

Some of the arguments advanced for higher examination standards are sound but what should not be forgotten is the possibility, or probability, of the financial benefit that would, or would not, thereby accrue. Granted that sound theoretical knowledge, coupled with the practical experience which can only be obtained by years of actual service at sea, would be of considerable benefit to the individual, what hopes has he of obtaining a position commensurate with his financial outlay and mental effort?

"Practical Training"

I AM in agreement with your correspondent Mr. Webb who says that the morse examination standard should be raised. Surely it is of the utmost importance that the sea-going wireless operator—or any other kind of wireless operator—should be proficient in the art of telegraphy.

I think that the present standard of technical training set out in the P.M.G. syllabus is quite sufficient, if not excessive, but the amount of practical training is not sufficient.

What do I mean by practical training? I mean the ability of the trainee to handle traffic with the minimum of delay; the ability to correct faults; the ability to handle the receiver and transmitter intelligently; the ability to sense and correct the recurring faults and idiosyncrasies of his apparatus.

The wireless operator's job is an immensely practical one and it is not necessary—as some of your correspondents seem to think—for the good wireless operator to have his head crammed with electrical formulæ and technical knowledge, rather is it more important that he should have good practical operating ability plus—to put it rather crudely—electrical horse sense.

In my opinion, the duties of a wireless operator are 85 per cent. practical and 15 per cent. technical.

Y. ADALIAN.

Civilian Radio Instructor.

Classification of Frequencies

MAY I suggest the following modification of the list given by "Diallist" in your February issue?

"Diallist's" List	My Modification
Very Low	Very Low
Low	Low
Medium	Medium Low
Medium High	Medium
High	Medium High
Very High	High
Ultra High	Very High

Whatever disadvantage there may be in certain respects in shifting the "medium" position seems more than counterbalanced by its position in the actual middle of the terminology, the similarity of the high and low sides of the terminology and the avoidance of the term "ultra."

L. M. RAMPAL.

London, S.W.14.

Last-century Theory

ACCORDING to your Brains Trust, Maxwell's equations are still valid because they embrace "a very large number of natural laws." Bertrand Russell says that "they have continuously grown in importance as well as in certainty," although he admits that "Maxwell's arguments in their favour were so shaky that the correctness of his results must almost be ascribed to intuition."

It would indeed be foolish to deny that they "still tell the truth" as far as we can test it.

At the same time, a good deal of nibbling has been going on. For instance, the background of an electromagnetic ether has proved

illusory, and has been replaced by an "empty" space with certain transcendental properties. The displacement current—a vital link in Maxwell's argument—has also, it seems, been promoted to esoteric rank.

There remain the equations. These were derived with the aid of a calculus which is founded upon Newtonian—or Euclidean—space, homogeneous in nature and independent of time. The surface and volume integrals which Maxwell uses in his formulæ are accordingly innocent of those very "spatial distortions" which he was seeking to evaluate. Does not this innocence reveal a flaw in his mathematical argument?

If one accepts the view that fields of force—gravitational and electromagnetic—manifest themselves by modifying the properties of space, it hardly seems logical to put one's full trust in a calculus which ignores such effects.

J. J. H.

Transitron Oscillators

THE description of the Transitron oscillator in the March *Wireless World* must be of great interest to all who have tried to solve the problems of the local oscillator in multi-waveband superhets.

If it were not for the capacitative coupling between the 1st and 2nd grids it would appear possible to use the valve as a frequency changer by applying the signal frequency to the first grid. It should not be impossible to develop a valve in which these two grids are screened from each other.

RICHARD MORT.

London, S.W.1.

Electron Multipliers

AS far as I have observed, no compact designation has yet been found for the secondary emitting electrodes of multiplier valves. These are variously referred to as "auxiliary cathodes," "multiplying electrodes," etc.; all rather bulky expressions. May I suggest the introduction of a new term: either "SECTRODE" or "IMPACTODE"? D. LOMAN.

Southall, Mddx.

WASTE PAPER

By economies such as cutting the size and thickness of forms, envelopes, etc., and by printing on both sides, paper consumption by Cable and Wireless has been reduced by 95 tons annually. The company has also salvaged nearly 1,000 tons of waste paper since the beginning of the war.



THE "FLUXITE QUINS" AT WORK

"I'd just like to meet the young kite
Who fixed this without FLUXITE
We should all be in bed,
But we're working instead
In a blue, blind, blank, blustering night!"

See that FLUXITE is always by you—in the house—garage—workshop—wherever speedy soldering is needed. Used for over 30 years in Government works and by leading engineers and manufacturers. Of all Ironmongers—in tins, 8d., 1/4 and 2/8.

Ask to see the FLUXITE SMALL-SPACE SOLDERING SET—compact but substantial—complete with full instructions, 7/6.

TO CYCLISTS! Your wheels will NOT keep round and true unless the spokes are tied with fine wire at the crossings AND SOLDERED. This makes a much stronger wheel. It's simple—with FLUXITE—but IMPORTANT.

The FLUXITE GUN puts FLUXITE where you want it by a simple pressure. Price 1/6, or filled, 2/6.



ALL MECHANICS WILL HAVE

FLUXITE
IT SIMPLIFIES ALL SOLDERING

Write for Book on the ART OF "SOFT" SOLDERING and for Leaflets on CASE-HARDENING STEEL and TEMPERING TOOLS with FLUXITE. Price 1d. each.

FLUXITE LTD.
(Dept. W.W.), Bermondsey Street, S.E.1

UNBIASED

Receivers of the Future

By
FREE GRID

IT seems to be fashionable nowadays to talk about what we all want after the war in the economic and political spheres, and, therefore, I don't see why we shouldn't discuss what we want in the post-war realm of radio. Whether we get it or not is another matter. As a start, I have been collating views on the question of broadcast reception by discussing the matter in hotels and hostels ranging from the Ritz to Rowton House in order to get a true cross-section of the nation's opinion.



"From the Ritz to Rowton House."

Most people want high fidelity, although they are by no means agreed as to how it should be obtained, but there are three strong favourites: controlled contrast compression and expansions at transmitter and receiver respectively, double-channel transmission and reproduction (or, in other words, our old friend binaural listening), and lastly FM. The latter necessarily entails a large number of UHF, and, therefore, short-range stations. Comparatively few want television as an accompaniment to all programmes although there is a strong demand for a vision accompaniment to be provided for the main evening broadcasts, and for the vision to be nation-wide; not, as a Manchester man put it to me, merely for the idle rich living in the south of England.

My own ideas are, I fear, rather unorthodox and likely to rouse the wrath of "Diallist," whose knob policy always seems to me to be "the more, the merrier." Briefly, I want push buttons—whole rows of them and not merely one or two. Being a pianist, I like push buttons—or, in other words, keys—on my piano, and don't expect to have to "tune in" every note like a wretched violinist, and I want the same thing on my wireless set.

My next demand will be one more likely to meet with approval from the

strongly conservative quarter I have mentioned, and that is a worthwhile SW section to all sets, because my views are that the real alternative and "competitive" programmes to those of the B.B.C. for which the Editor was pleading a little while back (Opus XLVIII, Oct., 1942) are those provided by the stations of the U.S.A. It is useless our ever hoping to understand European programmes owing to the language difficulty. In the U.S.A. they speak the same tongue—nominally so at any rate—and we are all getting used to the peculiar nature of American humour by listening to the special programmes for U.S. troops over here.

The most important thing of all, however, is that each post-war set should be provided with a built-in steel-tape recorder and a reliable time switch so that we can pick out the items we want from the published programmes and "bottle" them for consumption when we feel in the mood to listen to them instead of having, as at present, to listen to a lot of nonsense from the Brains Trust when we feel more like a little plain common sense from Mrs. Buggins. Apart from this there are plenty of occasions, even in the case of a programme repeated or "diagonalised" by the B.B.C. on a subsequent day, when we are compelled to miss an item we particularly want to hear owing to its clashing with a "date."

Swords into Ploughshares

NO doubt many of you have been wondering what effect the intense regardless-of-expense research work brought about by the war is likely to have on our daily lives. We have read a lot in the newspapers about marvellous passenger planes which will get us from here to New York in five hours by the simple expedient of rising to super-stratospheric heights and waiting for the earth to roll away under them. Getting back will be rather more difficult, as Adolf has found out in Russia, but, in any case, such things do not interest us wireless men who want to know what new applications of wireless principles there will be.

It is a little difficult to give you any precise information without running the risk of breaking one of the many Defence Regulations which hedge us about nowadays, but I think I can pass on to you one small

item which was revealed to me recently while staying the night with a scientist whose name, unknown to the public before the war and not too well known even now, will become a household word when the full story of the war is told.

It so happened that as I was dressing I had the misfortune to tread on a piece of orange peel thrown down, no doubt, by some careless child, and in my effort to recover my balance my collar stud slipped from my grasp, and, as is the way of collar studs all the world over, vanished from mortal sight. After grovelling ineffectively for some time under various pieces of furniture, I rang the bell and a maid-servant tottered into the room (over eighty years old, Mr. Bevin!) and was so startled by my wild and dishevelled appearance that she cried loudly for help, and my host came in at the double with a mystified look on his face.

After apologies and explanations had been duly made and given, the learned scientist whose guest I was left me for a few minutes and returned with a queer-looking contraption about which I am not permitted to give you any technical information. I can only say that at first I took it for some new-fangled kind of valve analyser and that, after adjusting a few small knobs, my host was able to inform me that my stud was three inches to the north-west of a heavy old-fashioned wardrobe in the room.



"Wild and dishevelled appearance."

With the assistance of the 80-year-old maid we quickly moved the wardrobe and the stud was successfully "located"—or perhaps it would be better to say found—in the exact position indicated. My host refused to make any comment except to say that these devices, made up in suitable foolproof and portable form, will probably be available at all good radio dealers after the war, although I strongly doubt that myself, as the big collar-stud combines are sufficiently influential to be able to bring strong pressure to bear on the post-war Government to force them to veto the whole business.

RANDOM RADIATIONS

By "DIALLIST"

A Useful Book on Maths

FROM time to time readers of *Wireless World* ask me to recommend books on maths, electricity and similar subjects, and I am always glad to be of use in that way when I can. Here's a book dealing with—I will not say the higher, but the rather less elementary, maths that we need in ordinary radio work; it is one that I have found useful for my own Army students. The title is "A Manual of Practical Mathematics," and it is by the late Frank Castle, who did so much good work in teaching the subject. The publishers are Macmillan and Co., and the edition you want is that of 1940. This book has quite a long history. It appeared first in 1903, and after being reprinted four times, it was published with additions in 1911 and with more additions in 1916. Six further reprints followed; then, five years after Castle's death, a revised and enlarged edition came out in 1934 and has since been four times reprinted. The book begins with a kind of revision of elementary algebra and proceeds by reasonably easy stages via Trig, Logs, Indices, Vectors and Progressions to the Differential and Integral Calculus. The arguments and explanations are clear, and one feature that I like very much is that each chapter contains a considerable number of examples worked out in full. If you want to avoid the expense of a new copy, no doubt you could get hold of one second-hand from any of the shops that deal in used educational books.

Trig Tables

My mention of Trig just now reminds me of that excellent set of tables and formulæ published by the Ford Motor Company, of Dagenham. I saw it announced in *Wireless World* and sent for a copy, thereby obtaining as good an eighteen-penn'orth as ever I had. This little book, which is of convenient pocket size, contains in its 56 pages complete tables of trig ratios for every minute of angle. As the ratios are six-figure, it is just what you want when you have accurate calculations to make. For instance, in ordinary tables, giving the ratios at 6-minute or 10-minute intervals, you would find the remark "Difference columns cease to be useful" against tangents from 80 to 90 degrees, and, of course, against cotangents from 0-10 degrees, or a bit farther. And where the differences are given they are not always so hot, either. Now, if I want to get $\sin 21^{\circ}8'$ from an ordinary

4-figure table with the ratios at 10-minute intervals, I find that $\sin 21^{\circ}$ is 0.3584 and the difference for 8 minutes is $22=0.3606$. My Ford tables show that $\sin 21^{\circ}8'$ is 0.360540. Not only do you get much more accurate data, but you read straight off from the tables without having to fiddle with differences. Have you ever, when getting a bit tired, subtracted a difference, instead of adding it, or vice-versa? I know I have! The tables actually occupy 48 pages; the remaining eight are devoted to trigonometrical formulæ and all the things you are likely to want to know about π .

□ □ □

Frequency Modulation

IT is good to see that *Wireless World* is giving frequency modulation so much attention. Ever since I read Major Armstrong's original description of FM I have had a growing conviction that the future of broadcasting is very closely bound up with this system. Looking ten years ahead, I see the broadcasting arrangements of the world organised on lines very different from those that we know now. Each country will probably retain one or two medium-wave or long-wave stations with amplitude modulation for serving out-of-the-way areas; it will also most likely maintain some AM short-wave stations for overseas broadcasting. But the main service within the boundaries will be provided by chains of moderately powered FM stations. So far as one can see, the advantage would be enormous: splendid quality of reproduction with complete or almost complete freedom from interference. FM has had a lengthy trial in the United States, and I gather that the results have been most satisfactory.

□ □ □

Tone Control

REFERRING to my recent remarks about the queer modern habit of keeping the tone control in its most woomphy position when music is being reproduced by the loudspeaker, a Bradford correspondent suggests that "pentode shrillness" and the spurious top introduced by these valves in output circuits of the less-well-designed kind have something to do with it. I couldn't agree with him more—if there was any top worth talking about, whether spurious or otherwise, in the sort of set that I have in mind. There is not, as you can hear when speech comes through. It is completely muffled, and you can't produce shrillness sufficient to make it "edgy" if you jam the tone con-

The Improved VORTEXION 50 WATT AMPLIFIER CHASSIS

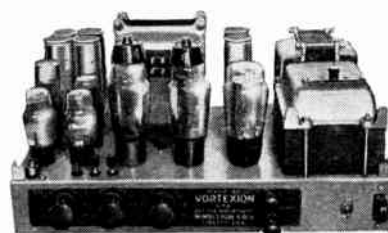

The new Vortexion 50 watt amplifier is the result of over seven years' development with valves of the 6L6 type. Every part of the circuit has been carefully developed, with the result that 50 watts is obtained after the output transformer at approximately 4% total distortion. Some idea of the efficiency of the output valves can be obtained from the fact that they draw only 60 ma. per pair no load, and 160 ma. full load anode current. Separate rectifiers are employed for anode and screen and a Westinghouse for bias.

The response curve is straight from 200 to 15,000 cycles. In the standard model the low frequency response has been purposely reduced to save damage to the speakers with which it may be used, due to excessive movement of the speech coil. Non-standard models should not be obtained unless used with special speakers loaded to three or four watts each.

A tone control is fitted, and the large eight-section output transformer is available in three types: 2-8-15-30 ohms; 4-15-30-60 ohms or 15-60-125-250 ohms. These output lines can be matched using all sections of windings and will deliver the full response to the loud speakers with extremely low overall harmonic distortion.

PRICE (with 807 etc. type valves) £18.10.0

Plus 25% War Increase

MANY HUNDREDS ALREADY IN USE

Supplied only against Government Contracts

VORTEXION LTD.

257, The Broadway, Wimbledon, S.W.19

'Phone: UBerty 2814

Random Radiations—

trol hard over against its fully clock-wise stop. There are, I grant you, sets in which misused pentode output is guilty of horrible crimes. The original upper audio frequencies are pretty well removed by sideband cutting in SF and IF stages, and a shrill, uncorrected pentode is used in the output to supply a top quite unlike that which has been suppressed earlier. Such sets are loathsome things on both speech and music, and no juggling with the tone control avails much. Pentode output can be good enough if you take a deal of trouble over the circuits and do not cheesepare over components; but the pentode output valve offers the designers of the cheaper sets such a money-saving means of providing largish volume combined with poor quality of reproduction that I for one sometimes regret that it was ever invented.

□ □ □

More Spares

REALLY good news for all wireless folk is that the Government has at last awakened to the urgency of the demand for components, not only to keep existing receiving sets in action but also to enable the many thousands which are lying in a partly finished condition on manufacturers' shelves to be completed. The demands of the Services have hitherto been so enormous that they absorbed almost the entire output of most firms of component makers and still remained only partly satisfied. Things are a little easier now and manufacturers have been directed to do all they can to meet the needs of the public. You do not realise how big the requirements of the Services are in the way of wireless bits and pieces unless you are intimately concerned with them. Then you do! I have, for instance, various kinds of apparatus whose total valve strength is not very much below the 500 mark,

whilst condensers and resistors run into thousands. Anyhow, the man in the street is likely to be better off in future when he blows up a valve or an electrolytic or a transformer. And the easing of the component situation should mean better supplies of new sets. They are badly needed, for there must be thousands of receivers now that are quite past repair and must be replaced. There are huge numbers of other sets, too, which ought to have been scrapped long ago. They are something of a menace when supplies of spare parts are short, for they simply eat components; as soon as one faulty part is replaced another goes wrong. To keep them going is uneconomical in every sense of the word.

□ □ □

Hire Purchase

IN peacetime a pretty considerable proportion of the wireless receivers and radiograms sold during the year was disposed of by the hire-purchase method. A recent regulation has made illegal the sale on H.P. of many price-controlled goods, radio sets amongst them. When I first saw the announcement in the lay papers I expected a terrific outcry in their correspondence columns from Constant Reader, Paterfamilias, Fed Up, Lover of Fairplay, and other members of the itching-pen fraternity. However, there were no letters and no outcry. The reason, I suppose, is that there are now so few new receiving sets available for sale that practically all transactions are done for cash. H.P. flourishes best when industry has large quantities of comparatively high-priced goods to dispose of to a public whose pockets are not too well lined. The position now is that a big section of the public has its pockets comfortably lined and that the wireless trade has few of its wares to offer. It is a little difficult at first to see what the purpose of the H.P. Order is. I imagine, though, that it must be part of the

general anti-squander-bug policy, to which the powers-that-be have given a good deal of publicity of late. Possibly, whoever was responsible for including wireless sets in the list did not realise that the demand for them on a cash basis far exceeded the supply.

□ □ □

Trap for the Unwary

WE get a good few radio breakdowns in the remote part of Caledonia where I have now been for some months. In fact, it is a regular trap for the unwary. A newcomer to the camp comes along bringing a small mains set with him, plugs it in, switches on, and for a time enjoys what entertainment is going. But only for a time, unless he has been warned or is of the prudent kind. If he is not, something gives out pretty soon and the set ceases to work as it should, or perhaps it closes down altogether. You see, we have one of those queer mains voltages in which Britain abounds. Our AC is 250 volts, 50 cycles, and the imprudent either fail to verify this, or, if they do, forget to alter the tapping point on their mains transformers. One fellow, who came from a Buckinghamshire district where the mains voltage is 200, proved conclusively, if rather expensively, that his particular brand of set was not built for a 25 per cent. overload on heaters and anodes, to say nothing of condensers and resistances. The curious thing about our local voltage is that we are definitely on the grid system—in fact, we tap into a pretty big grid line. In my ignorance I had thought that one of the aims and objects of those who sponsored this system was to standardise voltages at 230 and frequencies at 50 cycles all over the country. It is about time that something was done to bring them into line. I have been stationed in seven places since the war began, one of which had no electric light. In the other six no fewer than four different bulbs were needed for my bedside reading lamp: 110 volts, 200 volts, 230 volts and now 250 volts.

□ □ □

Television in the U.S.A.

WHATEVER is happening in this country, television is not standing still in the United States. A recently received bulletin from the American G.E.C. shows that transmission services for the public are being continued, though ours have perforce had to remain closed down since September, 1939. I do not think we need worry much about the effects of the quiescent period here. The technical aspect of television will take care of itself. Personally I have always thought that by far the most difficult problems were those presented by its

Books issued in conjunction with "Wireless World"

	Net Price	By Post
FOUNDATIONS OF WIRELESS, by A. L. M. Sowerby. Third Edition revised by M. G. Scroggie	6/-	6/4
RADIO LABORATORY HANDBOOK, by M. G. Scroggie. Second Edition	12/6	12/11
WIRELESS SERVICING MANUAL, by W. T. Cocking. Sixth Edition	7/6	7/10
HANDBOOK OF TECHNICAL INSTRUCTION FOR WIRELESS TELEGRAPHISTS, by H. M. Dowsett and L. E. O. Walker. Seventh Edition	27/6	28/1
WIRELESS DIRECTION FINDING, by R. Keen. Third Edition	30/-	30/6
RADIO INTERFERENCE SUPPRESSION, by G. W. Ingram	5/-	5/4
LEARNING MORSE. 335th thousand	6d.	7½d.
INTRODUCTION TO VALVES, by F. E. Henderson	4/6	4/10
VALVE REPLACEMENT MANUAL, by A. C. Farnell and A. Woffenden	6/-	6/3

Obtainable from leading booksellers or by post from

ILIFFE & SONS LTD., Dorset House, Stamford Street, London, S.E.1

entertainment side. What I mean is this. By the autumn of 1939 we had reached a stage where (1) images really worth looking at could be reproduced in the viewing screen; (2) reproduction could take place in almost any house within a wide range of London which had AC lighting supplies; (3) reproducing apparatus of attractive design was available at prices not much higher than those of the ordinary radio sets of a few years before; (4) a regular service of television broadcasts had been conducted for some little time. Yet the public was slow to spend its money on television sets. Why? Well, I am sure that the reason was that television, having solved the basic problems of transmitting and receiving images accompanied by sound, had not discovered the kind of images that should be its material if it was to be a success. It is no use sending out films to a public which can get better and longer pictures by walking a few yards to the picture theatre and paying a small charge for a seat. Cabaret palls in time; plays are terribly expensive to put on, owing to the number of rehearsals needed and to their short studio life. The public certainly does want to see races (both horse and dog), prize fights, football matches and other sporting events. It likes also to see striking current events reproduced on the screen. But these things are not always available, and, anyway, they do not always happen at suitable times. The Americans, still able to keep their television services going, are experimenting hard to try to discover the ideal material for television, and when the war is over we shall reap the benefits of their work and experience. That is why I feel that we stand to gain rather than lose from the closing down of our own television service.

ABSTRACTS AND REFERENCES

ALTHOUGH the receipt of journals from overseas is being seriously delayed, every effort is being made to maintain the Abstracts and References section of *Wireless Engineer* at its pre-war standard. The March issue of our sister journal includes about 300 abstracts from, and references to, articles on wireless and allied subjects which have recently appeared in the world's technical journals. Some of the abstracts occupy as much as a page.

Among the original articles in the March issue is one which deals with the difficulties of "standardising" the grading of electrical standards for the communication industry.

GOODS FOR EXPORT

The fact that goods made of raw materials in short supply owing to war conditions are advertised in this journal should not be taken as an indication that they are necessarily available for export

COMMUNICATIONS DEPEND...

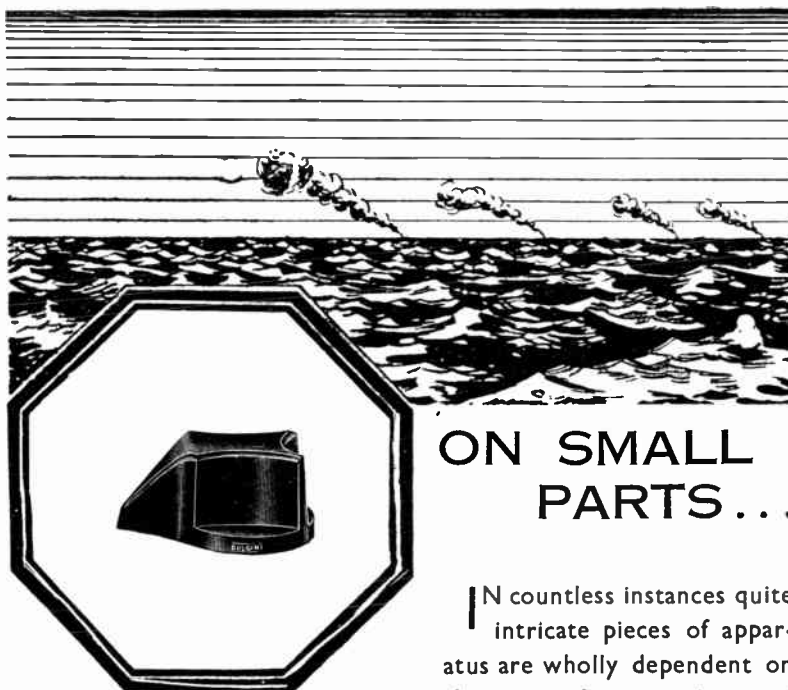

*The Choice
of Critics*

BULGIN FOR KNOBS

The largest and most extensive range in the world. Over fifty models from which to choose. All sizes and shapes, for different classes of work or operation. Nearly every type has brass-insert, steel grub-screws are fitted, well sunk. For 0.25in. dia. shafts and other sizes. Finely moulded and highly polished. The highest class instruments use Bulgin Knobs exclusively.

ON SMALL PARTS...

IN countless instances quite intricate pieces of apparatus are wholly dependent on the proved reputation and reliability of their component parts.

All products from the House of Bulgin are pre-eminent for superior design and workmanship and every article bearing our Trade Mark has to pass exacting and exhaustive tests during the course of its production.

We ask the kind indulgence of the Trade on delivery until peaceful conditions return.

"The Choice of Critics"

BULGIN

REGISTERED • TRADE • MARK

A. F. BULGIN & CO. LTD., BY-PASS RD., BARKING,
TEL.: RIPPLEWAY 3474 (4 lines). ESSEX.

RESONATOR VALVES

THE valve electrodes are enclosed in an evacuated metal casing which forms a high-Q circuit of the resonant-cavity type. This construction is said to be better adapted to handle high power than the ordinary type of velocity-modulation valve, in which the resonant electrodes are mounted inside the bulb.

As shown, the resonant metal casing is a hollow toroid with a circumferential gap in the inner wall, the usual control electrodes being mounted inside the inner wall of the toroid. Other alternative arrangements are described, the particular one illustrated being distinguished by the fact that only one glass seal is necessary. The indirectly heated cathode K

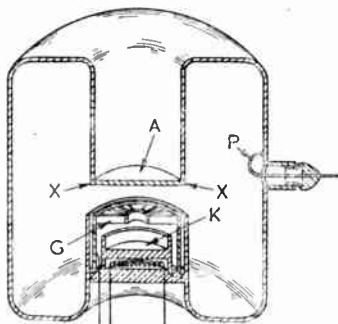

Resonator valve construction.

and the grid G are both mounted on the glass seal, and co-operate with an anode A which forms part of the resonant casing. The grid is capacity-coupled by its close proximity to the outer casing.

The anode A may be replaced by a metallic cylinder which fits inside the upper hollow space and is held in place by a glass seal around the periphery XX. The output is drawn off from the resonant cavity by a probe P.

Standard Telephones and Cables, Ltd. (Assignees of C. V. Litton). Convention date (U.S.A.) May 11th, 1930. No. 548,119.

WIDE-BAND AMPLIFIERS

IT is possible to produce a multistage high-frequency amplifier with a wide bandpass characteristic by "staggering" the tuning of the interstage couplings up and down the desired frequency band. This, however, involves a considerable sacrifice in overall gain, a limitation which is avoided, according to the invention, by using non-amplifying couplings, such as resistance-capacity networks with appropriate time-constants, between certain of the valves. This results in a high gain characteristic even at low signal-level, whilst preserving the desired bandpass response.

The circuit is also stated to have a high signal-to-noise ratio. In this connection, an analysis is made of the usual sources of noise in such amplifiers, including that due to random or thermal agitation of the electrons in the cathode of the valve, in associated circuit resistances, and in the fortuitous distribution of the electron discharge stream between the various electrodes, particularly the screening grid, inside the valve,

A Selection of the More Interesting Radio Developments

and it is shown that the level of noise increases with the band-width accepted by the usual type of amplifier.

Standard Telephones and Cables, Ltd., and P. K. Chatterjee. Application date April 11th, 1941. No. 548,547.

FRAME AERIALS

PERMEABILITY-TUNING offers an economical alternative to the variable condenser, but when applied to a portable receiver, with a small self-contained frame-aerial, certain difficulties arise. The obvious arrangement is to arrange the tuning solenoid, with a powdered-iron core, in series with the frame windings. A certain conflict then arises between the requirements (a) that the aerial should pick up as much signal energy as possible, and (b) that the whole circuit, including the aerial and solenoid, should be tunable over the required band of wavelengths. In practice (b) requires that the inductance of the frame-aerial should be less than 20 per cent. of the total circuit inductance when the powdered-iron core is removed. These and other factors involved in the problem are examined in detail, and various circuit arrangements are suggested (1) to overcome the difficulties already mentioned and (2) to ensure a constant-coupling coefficient over the whole tuning range.

Marconi's Wireless Telegraph Co., Ltd. (Communicated by Radio Corporation of America). Application date April 1st, 1941 No. 548,218.

TRANSMISSION LINES

THE characteristic impedance of a two-wire transmission line carrying short-wave signals is modified, say, for matching the line to a given load, by loading a given section with one or more auxiliary wires arranged as festoons. For instance, the auxiliary wire may be bonded to the transmission line at two or more points, several feet apart, and may be allowed to sag for, say, 12 inches between these points. This reduces the impedance of the loaded section to a degree which depends upon the cross-section of the loading wire and by the amount by which the loops or festoons are allowed to sag. Preferably, the depth of sag should not appreciably exceed the spacing between the two primary wires forming the transmission line.

E. W. Hayes. Application date August 18th, 1941. No. 549132.

The British abstracts published here are prepared with the permission of the Controller of H.M. Stationery Office, from specifications obtainable at the Patent Office, 25, Southampton Buildings, London, W.C.2, price 1/- each.

ALTERNATIVE AERIALS

IT is convenient for long-distance reception to be able to use an outside aerial as an alternative to the usual small frame aerial of a portable set. One can do this, say, by using the frame as a tuned input to which the outside aerial can be coupled, either by connecting it directly or through a small condenser to a tap on the frame windings. Alternatively, the two aerials can be inductively coupled through one or two auxiliary turns wound parallel with those of the frame aerial. It is said that none of these expedients proves satisfactory in practice.

The inventors prefer to use a high-impedance coupling such as a three-inch coil of approximately 2 millihenrys, which is included in series with the outside aerial and is mounted close to the windings of a frame aerial measuring 14 in. by 8 in. The coupling coil is short-circuited for reception on the frame.

Philco Radio and Television Corporation (Assignees of W. H. Newbold). Convention date (U.S.A.) May 1st, 1940. No. 548,633

CONSTANT AERIAL COUPLING

THE aerial circuit shown is designed to give constant coupling. In other words, it feeds the input valve with a voltage which is directly proportional to the strength of signals coming in either at the high- or low-frequency end of the tuning range.

The receiving frame aerial comprises two sets of windings L, L₁, which are coupled inductively. The circuit L, C is preset to a frequency at the lower end of the tuning range. Winding L₁ is shunted by a relatively small condenser C₁ in series with a coil L₂ having an adjustable powdered-iron core M which provides the main tuning control of the set. The effective tuning range is preferably determined by the difference in the reactances of the circuits L, C and L₁, L₂, C₁. The windings L and L₁ of the aerial are accordingly wound in opposition; this is stated to give a relatively higher overall gain. The provision of the preset circuit L, C is intended to

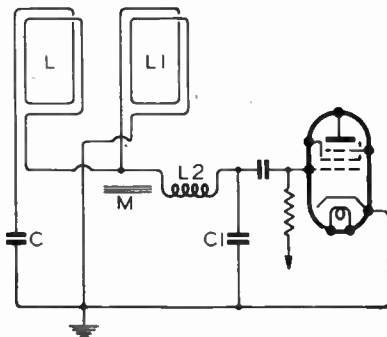

Constant coupling aerial circuit.

offset the variation in the inductance/resistance ratio which naturally occurs as the tuning core M is moved in and out of the coil L₂.

Johnson Laboratories, Inc. (Assignees of W. A. Schaper). Convention date (U.S.A.) February 19th, 1940. No. 548695.

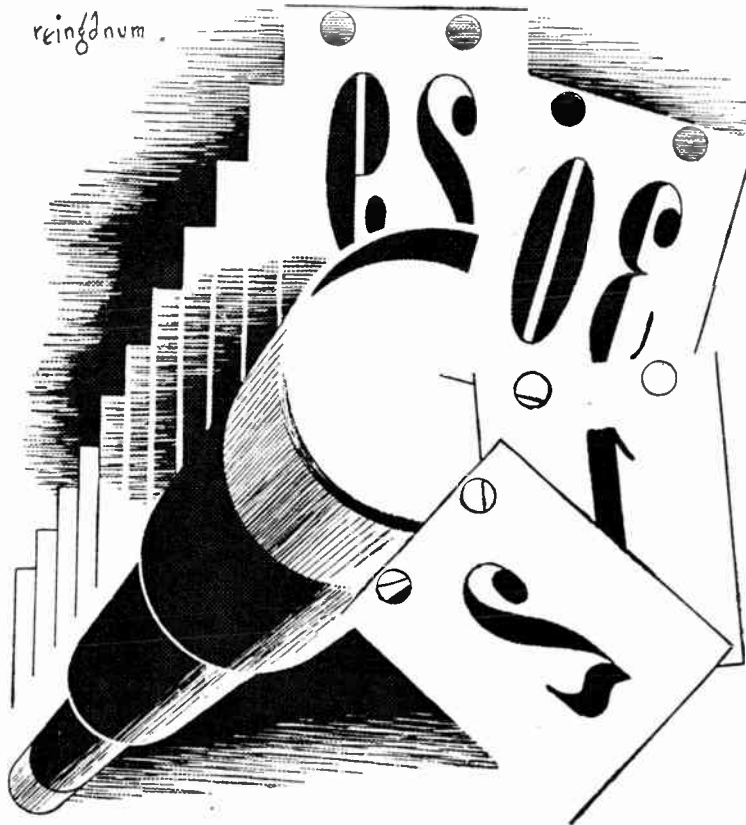

FORESIGHT

The march of Science, its tempo quickened by the needs of war, goes inexorably on . . . making some things obsolete and foreshadowing new developments in the utilisation of electricity. The House of Philips, as always during its fifty years of progress, is ever looking ahead to the needs of tomorrow.

PHILIPS



INCANDESCENT AND DISCHARGE LAMPS · FLUORESCENT LIGHTING · RADIO RECEIVERS AND TRANSMITTERS · COMMUNICATIONS EQUIPMENT · THERMIONIC VALVES AND OTHER DEVICES · X-RAY EQUIPMENT FOR ALL PURPOSES · ELECTRO-MEDICAL APPARATUS · ARC AND RESISTANCE WELDING PLANT AND ELECTRODES · MAGNETS AND MAGNETIC DEVICES · SOUND AMPLIFYING INSTALLATIONS

PHILIPS LAMPS LIMITED, CENTURY HOUSE SHAFTESBURY AVENUE, LONDON, W.C.2 (124F)

CLASSIFIED ADVERTISEMENTS. Rate 6/- for 2 lines or less and 3/- for every additional line or part thereof, average lines 5-8 words. Each paragraph charged separately. Press Day: May issue, first post Friday, April 9th, one day earlier at branch offices. Box Numbers: 5 words, plus 1-. Deposit System: particulars on request. No responsibility accepted for errors.

Ode

Partridge

No. 22

ANY OFFERS?

I told mein people "Russia's done,"
I promised dat ve would not fail,
But Stalingrad ve haf not von
And Rostov? Ach, mein troops turn tail.

Der Caucasus vas all but mine,
Der Ukraine still is in mein grasp.
On paper it looks very fine,
But how long for? meinsel I ask.

Der Russians, dey are savage, blind,
Dey do not know der rules of var.
For ven I've killed them all, I find
Dey still get up and fight some more.

How can der kultured Herrenfolk
Rest on der laurels dey haf von,
Ven folks like Stalin, whom I broke,
Insist on making me to run?

Mein intuition, always right,
Advices me I must not sob
Nor chew my carpet every night.
Hi, someone! vill you take mein job?

N. Partridge

Kings Buildings, Dean Stanley Street,
LONDON, S.W.1. Vic. 5035.

ARMSTRONG SERVICE

After three years of war and despite the changed conditions we have succeeded in keeping our Service Department in operation.

Many difficulties have arisen owing to material and valve shortage but on the whole we have managed to maintain a very large proportion of Armstrong Chassis in good working order.

We can still undertake the repair and overhaul of practically all Armstrong Chassis including very old models.

ARMSTRONG MANUFACTURING CO.
WALTERS ROAD, HOLLOWAY, LONDON, N.7
Phone: NORth 3213

NEW RECEIVERS AND AMPLIFIERS

HIGH Fidelity A.C./D.C. Amplifiers, 18 watts, U.D.O. mixing input channels, bass and treble controls, input and output transformers, Octal base valves, complete chassis, 18gns.—Below.

D.A.N.C.P. and Stage Transportable Amplifying Equipment, comprising amplifier as above, M/C microphone, adj. stand, 2 auditorium speakers, cables; 36gns.—Broadcast and Acoustic Equipment Co. Ltd., Broadcast House, Tombland, Norwich. [1640

£22/10 Only.—New 7-valve "Wireless World" Quality Amplifier, with tone control stage, 8 watts push-pull triode output; price includes Super Quality triple cone 12in. permanent magnet speaker with large matched output transformer and all valves; as above but with 15-watt tetrode output, £24; ideal for quality reproduction; limited number available.—Bakers Selhurst Radio, 75, Sussex Rd., S. Croydon. [1643

RECEIVERS, AMPLIFIERS—SECOND-HAND
PYE Television Receiver, unused; £16.—S./Sgt. Johnson, R.C.A.F. Station, Digby, Lincoln. [1618

W.W. Q.A. Super, complete valves, £10; wanted, Earl P.M. speaker.—Box 2847, c/o *Wireless World*. [1638

HAYNES 2RF Quality Radiogram, 13 watts, perfect, no cabinet; W.W. new Monodial radiogram, walnut cabinet; offers.—Box 2845, c/o *Wireless World*. [1633

PHILCO 116 RX, Mystery Control impounded by Post Office (would be transferred to buyer); £60. Collected.—Carleton, Cemetery Rd., Shelton, Stoke on-Trent. [1604

EXCHANGE Sound Sales Superhet Feeder Unit for 1939 W.W. pretuned unit; Murphy 5-valve portable superhet, no batteries, £9.—Elliott, 10, College Close, Harrow Weald. [1645

20-25 w. A.C. Amplifier, complete with t./table, pick-up, M.C. microphone, 4 projector type speakers (28in. flares), suitable canteen or works; £85.—M., 10, Burkes Parade, Beaconsfield, Bucks. [1628

HARTLEY TURNER M.A.7 Receiver and Power Pack Chassis; I.T. speaker and 18in. box baffle; cost £45, accept £30; Voigt H.C. horn with bass chamber and Hartley Turner Duode speaker, £15.—Moreton, "Pilgrims Way," Elm Drive, Leatherhead, Surrey.

PHILIPS 6-valve All-wave Radiogram, with matching unit and 3-stage P.A. amplifier, 2-451's output stage; added to special order feeding upwards of 20 speakers. Four Philips 8in. P.M. extension speakers in walnut cabinets.—Tenders to be submitted to E. W. Sellings, Millmead House, Guildford, by March 31st, 1943. [1600

Wanted
WANTED, A.C. communication receiver.—Box 2846, c/o *Wireless World*. [1635

TROPHY 6 or Sky Buddy Wanted.—R. W. Gould, 58, Beechwood Rise, Watford. [1608

TABLE Model R.G.D., with remote control. Emmott, "Santa Ana," Hillbrow, Liss. Hants. [1594

WANTED, W.W. 2RF Set and Amp., W.W. Quality Amp. for sale.—Read, 110, Mottingham Rd., S.E.9. [1610

WE Offer Cash for Good Modern Communication and All-wave Receivers.—A.C.S. Radio, 44, Widmore Rd., Bromley. [1541

NATIONAL "IRO," "IOXA," "One-Ten" Hallcrafters, "SX24," "SX25," Eddystone 358; good price.—Box 2841, *Wireless World*. [1614

NATIONAL H.R.O. Communications Receiver Required, 230 volts A.C.; must be late model, in good condition; state lowest cash price.—Box 285a, 75-79, Farringdon St., London, E.C.4. [1557

WANTED, Scott Phantom, MacMurdo 15-17, Masterpiece 6, or similar; exchange Hallcrafters S.X.16 or Howard 460; cash adjustment if necessary.—41, Fearville Place, Leeds. [1621

LONDON CENTRAL RADIO STORES Will Pay Good Prices for Receivers, Radiograms, Amplifiers, Dynamos, Converters, Test Equipment, Electric Gramophone Motors, and all Radio and Electrical Accessories.—London Central Radio Stores, 23, Lisle St., London, W.O.2. Gerrard 2969. [9836

NEW LOUDSPEAKERS

£3/15 Only.—Brand new Super Quality triple cone permanent magnet speaker, made by Bakers Selhurst Radio, the pioneer manufacturers of moving-coil speakers since 1925; wide frequency range, even response, ideal for quality reproduction. Limited number available under list price. Send 2½d. stamp for leaflet describing above and giving constructional details of infinite baffle cabinet. Every music lover interested in realistic reproduction should write for leaflet now.—Bakers Selhurst Radio, 75, Sussex Rd., S. Croydon.

Advertisers and buyers are reminded that under Defence Regulations 1939, Statutory Rules and Orders 1940, Number 1689, a permit (T 99 G) must be obtained before sale or purchase of certain electrical and wireless apparatus, particularly such valves and apparatus as are applicable to wireless transmission.



KURZ-KASCH RADIO KNOBS—DIALS INSTRUMENT KNOBS

NOT only are modern plastics materially helping to win the war, but they will also help in designing those better post-war days.

We patiently await the time when we shall once again be able to help equip your radio receivers and instruments with those well designed and good looking mouldings and, no doubt, with other items resulting from plant expansion and new developments.

Register your name with our Representative now. He will forward you information on our products as soon as they become available.

KURZ-KASCH INC.
Moulders of Plastics,
DAYTON, OHIO, U.S.A.
—Exclusively Represented by—
Frank Heaver Ltd. Kingsley Road,
Bideford, N. Devon

L.R.S. STUART PUMPS

As supplied to Govt. Depts. & County Councils.

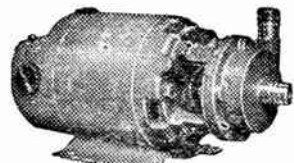

These Centrifugal Pumps are ideal for Machine Tool Cooling and all pumping purposes—hot or cold water. Supplied complete with foot-valve, strainer and hose union. Suitable rubber hose available from stock.

- No. 10. 100 gals. per hour. Carr. 2/- extra £5 2 6
 - No. 11. 280 gals. per hour. Carr. 2/- extra £6 6 0
 - No. 12. 560 gals. per hour. Carr. 3/- extra £7 12 0
- Please send 2½d. stamp for specification.

The **STUART AUTOMATIC FLOAT SWITCH** is the best method of controlling water. Post Paid level. Price complete with all fittings. £2 6 0

LONDON RADIO SUPPLY CO.
Est. 1925
Ardingly Road, Balcombe, Sussex.

ELECTRADIX BARGAINS

BUZZERS. Neat brass cased Buzzer, 4/8. Heavy type, Bakelite cased, 5/8. 1/3 Buzzers, multiple windings, no contacts, 5/-. **Townsend** Micro Buzzer (as illus.), 10/-.

Perfect Morse. Home training with a practice Recording Inker, spring drive, needs no battery, marks direct on tape with dead key. For novice or expert. Govt. type, £3 10/-.



HANDCOMS. Government all-metal Field Handcoms, Micro-telephones or Transceivers, for portable or fixed telephones. The famous No.16 Handcom used in so many field sets. Sturdily built with milic finger switch. As new, but no cord, 12/6. Limited number available. Similar Handcom, less switch and no cord, 7/6. A Home Guard can make a complete pocket telephone with these, a mike, transformer, buzzer and a torch battery.



CABINETS. Suitable for test set apparatus, mike amplifier, oscillator, portables, etc. 9in. x 9in. x 6 1/2in. with double doors. A very fine ex W.D. job, in mahogany, canvas covered. Chassis, panel 4 transformers, a 5-tap switch and rheostat is included. All-in price, 45/-.

VEE PULLEYS for 1/2in. belt, turned steel, 4in. and 4 1/2in. outside bore, 4/6 each.

COUPLINGS. For motor or dynamo to 1/2 h.p., 6/-.

WATER TANKS for engines, storage, etc., 1/2 kW. galv. iron, 5ft. high, 14in. dia., with pipe unions, 35/-.

TANKS. Small oil or soda tanks, 6 1/2in. x 3in. x 1 1/2in., 1/6, post 6d. Welded steel high press containers for liquid gas or refrigerant, pint size, 8 1/2in. x 2 1/2in., new. Make good model boiler. 3/6, post 6d.

MAGNETS. The Wonder Midget 2-oz. Permanent Magnet Discs of Alni Steel. Tremendous magnetic force and only 1.3/16in. dia. x 1/4in. thick, with soft centre for drilling. One leaps off the table to meet another. Uses: Any magnetic duty, metal separation, magnetic chucks and lifters. Cut-out core, polariser, solenoid cores, head-phone re-magnetisers, etc., 2/6 each, or 4/6 pair. A.C./D.C. Mains Magnets, 2 wound poles, 110 or 220 volts, 7 lb. lift. 5/6. Small 12-volt solenoids, 2in. x 1/2in. plunger, 6/6.



TURNABLES. Ball-bearing, for table sets, etc., bakelite body, 4 1/2in. dia., 2/- each.



CHARGERS. We have some specially large Westinghouse 230-volt Rectifier (chargers for 15 amps. and 32 amps. at 8 volts for priority delivery from stock.

Switches and Plug Sockets on Ebonite Panel Mahogany Case



WE CAN STILL SUPPLY Wheatstone Bridges, Sullivan and Tinsley Mirror Galvos, Scales and Stands; Siemens High-speed Relays, Radiogrameters, Wavemeters, Meggers, A.C. Panel Voltmeters, Rotaries and Alternators, 10,000 Ohm Relays, etc.

LAB. GEAR. Mirror Galvos. Sullivan Marine Reflecting vertical A.C. suspen., £9/10/-; Tinsley Ballistic ditto, £4/10/-; Mahog. Stand Scales for Spot use, £2/10/-; Wheatstone Bridges and 142M

Resistance boxes quoted for. A number of ex. W.D. Wheatstone Bridges, less coil, cheap. Circuit testing (r.p.o. Vertical Galvos. 35/-). Mag. Ringer and A.C. Bell, 25/-.

DIMMERS or RHEOSTATS with "off" 0 to 1 ohm and will carry up to 3 amps., for regulation on 6 to 12 volts, dimming or bank circuit battery charge model control, etc. One hole fixing with panels with bracket for other fixing. Hollow knob has socket for min. bulb, glowing when circuit alive. New U.S.A. Atena make, in carton, 2/6. Worth 5/-. Large 40 amp. ironclad grid Rheos with heavy 10 stud switch to drop 220 volts to 45 volts. Size 3 1/2in. x 1 1/2in. x 1 1/2in., £5 10/-; 110-volt ditto, 16in. x 1 1/2in. x 1 1/2in., £2 10/-.



Please add postage for all mail orders. Send stamped envelopes for replies to all enquiries.

ELECTRADIX RADIOS

19, Broughton Street, Battersea, London, S.W.3

*Telephone: Maccusay 2159

SECONDHAND LOUDSPEAKERS

H.M.V. Extension Loudspeakers, P.M. unit in high grade pol. cabinet; £2/19/6, carriage 1/-.—Napiers, 127, Prestwick Rd., Ayr. **HARTLEY TURNER** Permanent Magnet Speaker, 2.5 ohms, speech, box baffle, £5/10; ditto, duode, 2.500 ohms field, £6; Sound Sales output transformer, 25/-; Sound Sales Trichannel amplifier, complete with tweeter, bass speaker, £27; large M.C. cinema tweeter, £3/10; Hardwicke, 29, Warwick Ave., Crosby, Lancs. [1634]

Wanted
GOODMAN'S 12in. P.M. Auditorium Speaker, good price paid.—D. Roe, T.R.E., Malvern. [1616]

NEW MAINS EQUIPMENT
VORTEXION Mains Transformers, chokes, etc., are supplied to G.P.O., B.B.C., L.P.T.B.; why not you? Imitated but unequalled Orders can only be accepted against Government contracts.

VORTEXION, Ltd., 257, The Broadway, Wimbledon, London, S.W.19. Phone: [9942] Lib. 2814.

MORSE EQUIPMENT
FULL Range of Transmitting Keys, practice sets and equipment for Morse training.—Webb's Radio, 14, Soho St., London, W.1. Phone: Gerrard 2089. [9553]

TEST EQUIPMENT
RADIOMETER'S Valve Tester, type UVT; offers.—R. P., 29, King's Rd., Cowplain, Hants. [1622]

WESTON Super Analyser, new condition, complete in case, with all accessories; offers.—Box 2843, c/o Wireless World. [1624]
TESTOSCOPES, used everywhere by radio service engineers, makes 20 important tests. Send for interesting leaflet "R1."—Runbaken, Manchester, 1. [1074]

SIGNAL Generators, Western All-wave Model E.692, complete with leads and calibration charts, just back from complete overhaul and complete with new batteries, £11/10; Wearite All-wave Battery Model, in good order, but no batteries. £6; similar model but in need of small repairs, £2/10.—J. Bull, 4, Melthorpe Drive, Rushlip, Middx. [1630]

GRAMOPHONE EQUIPMENT

Wanted
A.C. Electric Gramophone Motor and Pick-up Required.—Box 2848, Wireless World.

WANTED, auto. changing unit, 10in. to 12in. records, any condition.—Harris, 96, High St., Markyate, Herts. [1626]

H.M.V. Record Player, or similar Adagram; good condition essential; light pick-up.—Box 2856, c/o Wireless World. [1588]

WANTED, 50 C/S. Simpson Turntables, 189376.—Fill details and prices to BM/FAM3, W.C.1. [1611]

COMPONENTS—SECOND-HAND, SURPLUS
LONDON CENTRAL RADIO STORES Offer the Finest Radio and Electrical Bargains. **PUSH-BUTTON** Mechanism only Unit. **G** complete with buttons. Post, etc., 9d. extra; 4/6.

SIDE Contact Valve Holders, 8 contacts. Post, etc., 3d. extra; 1/6 each.

T.C.C. Condensers, 0.1 mfd. 5,000 v., D.C. wkg. Post, etc., 8d. extra; 9/6 each.

SCREENED Cable, fine quality, heavy duty, 15 strand, 30 gauge, 5mm. rubber covering, with two layers of Empire tape, 1/9 per yard.

RUBBER Covered Flexible Wire, tinned copper, approx. 17 strands, 9ft. lengths, 3d. per yard.

PHILCO Bleeder Resistances, in metal cans. 100, 150, 250 ohms. All 10 watts. Post, etc., 3d. extra. 2/6 each.

TUBULAR Condensers, 0.5 mfd., 500 v. working. 2/6; post, etc., 4d.

MULLARD EA50 Diodes, 60mm. x 12mm. overall, 6.5 v. heater at 15 amps. Post and pkg. 13d. extra. 10/6 each.

PHILIPS Potentiometers. Carbon: 700,000 ohms, less switch; 3/6; 100,000 ohms, with 2-pole M. & B. Switch. 4/6. Wire-wound: 450 ohms and 10,000 ohms, 6/6. Post and pkg. 6d. extra.

LONDON CENTRAL RADIO STORES, 23, Lisle St., London, W.C.2. Gerrard 2969.

FERRANTI A.F.5; B.1; B.T.H. Minor speaker; "Kinva" filters V2a (tunable) and A3; offers—144, Makepiece Ave., Higgate, N.6.

COULPHONE Radio, New Longton, Dr. Preston.—Brand new goods only; mains transformer, 350-350, 120ma., 6.3v. 3a., 5v. 3a., 28/6; P.M. speakers with trans. 8in. Celestion, 24/6; 5in. Rola, 21/-; Tungstram Valves; Cored Solder, 4/6 lb.; Barretter Resistors, 6/-; Line Cord Replacement Resistors, 800 ohm, 2 adjust. taps, 6/9; electrolytics, 50mfd, 50-volt, 3/3; Erie 1-watt resistors, all values, 9d. each; pushback wire, 100ft. coil, 6/-; switch cleaner, 2/3; bottle; power-pentode transformers, 6/9; S.A.E. for stock list. [1409]

GALPINS

ELECTRICAL STORES
"FAIRVIEW,"
LONDON ROAD, WROTHAM,
KENT.

Please Note Change of Address!

This Business is now transferred permanently to the above address, where all Mail Orders will receive strict personal attention.

TERMS: Cash with Order. No C.O.D.

Regret Orders from Eire and Northern Ireland cannot be accepted.

ELECTRIC LIGHT CHECK METERS, well-known makers, first-class condition, electrically guaranteed, for A.C. mains, 200/250 volts 50 cy. 1 phase 5 amp. load, 10/- each; 10 amp. load, 12/6, carriage 1/-.

1 KW. FIRE ELEMENTS, mounted on fireproof porcelain, for 220 volts, as new, easily mounted. Price 6/6, post free.

POWER PACKS, for smoothing, etc., consisting of two 300 ohm chokes and 2 M.F. condensers. Price 7/6, post free.

LOUD RINGING BELLS, working on 110 volts D.C., 8in. dia. gong (bell metal), plated; waterproof, new. 32/6 each, post free.

1 KW TRANSFORMER, input 100 volts at 100 cycles, single phase, output 10,500 volts, centre tapped to earth. Price £4 10s., carriage forward.

HEAVY DUTY CABLE, V.I.R., and braided, in first-class condition, size 37/13, lengths 30 to 40 yards. Price by the length, 5/- per yard, carriage forward, or 7/- per yard for short lengths, carriage paid.

200 AMP. SWITCH FUSE, three-way, ironclad, unused, 400 volt, size overall 30in. x 12in. x 12in., maker E. N. Bray, Ltd. Price £6, carriage forward.

ROTARY CONVERTER, D.C. to D.C. Input 12 volts; output 1,100 volts at 30 M/A, ex R.A.F., can also be used as double output generator. Price 50/-, carriage paid.

HEAVY DUTY KNIFE SWITCHES, D.P., D.T., quick break, 100 amp., in first-class condition. Price 20/-, carriage paid.

X-RAY TRANSFORMER, in oil-filled tank, medium size, input 120 volts, 50 cycles, 1 ph., output 45,000 volts at 2kW, intermittent rating, in perfect order. Price £20, carriage paid.

ROTARY CONVERTER, D.C. to D.C., input 48 volts, output 2,500 volts at 1 kW, condition as new and in perfect order. Price £10, carriage paid.

1/2 WATT WIRE END RESISTANCES, new and unused, assorted sizes (our assortment), 6/- per doz., post free.

150,000 VOLT X-RAY TRANSFORMER, large size, weight 12 cwt., input 120 volt, 50 cycle, single phase; output 150,000 volts at 10 kVA, intermittent rating, mounted in steel tank, oil filled, in good working order. Price £45, carriage paid.

DYNAMO, output 20 volt, 15 amp., shunt wound, interpole, slow speed, ball bearing, condition as new. Price £3 10s., carriage paid.

SOLID BRASS LAMPS (wing type), one hole mounting, fitted double contact, S.B.C. holder, and 12 volt 16 watt bulb. Price 3/6 each, post free, or 30/- per doz., carriage paid.

HEADPHONES, 120 ohm, secondhand, complete with headband and cords, in perfect working order. Price 7/6 per pair, post free.

INSTRUMENT METAL RECTIFIERS, by famous makers, 10 M/A, full load, connect your D.C. meter to A.C. working. Price 15/- each, post free.

TUNGSTEN CONTACTS, 1/2in. dia., a pair mounted on spring blades, also two high quality pure silver contacts 1/2in. dia., also on spring blades, fit for heavy duty, new and unused. There is enough base to remove for other work. Price the set of four contacts, 5/-, post free.

220 VOLT DYNAMO, 0 amp. output, by Lancaster Dynamo Co., shunt wound, speed 1,500 R.P.M., condition as new. Price £10, carriage paid.

POST OFFICE RELAYS, small type, high resistance, twin blade, very low milliamps operation, as new. Price 7/6 each, post free.

SEXTON'S for SERVICE

AMERICAN LEASE-LEND RADIO VALVES.

Types and prices as under at Board of Trade Controlled Prices, inclusive of Purchase Tax.
 1A5GT, 1C5GT, 1T5GT, 5Y3GT, 2526GT, 3524GT, 3525GT at 11/- each. 1H5GT, 6F5GT, 12F5GT at 9/2 each. 6A8GT, 12A8GT, 12SA7GT, 6SA7GT, at 14/- each. 6F6GT, 12Q7GT, 12S7GT, 6S7GT, 25A8GT, 25L8GT, 35L8GT, 50L8GT, 6J7GT, 6K7GT, 36, 47, at 12/10 each. 32L7GT, 70L7GT, 83 at 15/3 each. 6Q7GT, 12Q7GT, 12S7GT, at 11/7 each. Postage 4d. These valves are sold only for immediate replacements in actual Purchaser's radio and not for resale or use in new receivers. Non Lease-Lend American Valves at standard prices incl. of tax.
 Types 42 at 10/8. 6A7 at 11/7. 6D6 at 10/5. 6B8 at 15/3. 31 at 9/2. 6U5/6G5 at 10/5. Brivaron British made Valves, types equivalent to American 80 and English U12 at 13/7. Postage 4d.

EXTENSION LOUDSPEAKERS

"Rola" 3 ohms voice coil, less Trans. Size 5in. at 17/9 each. 6in. at 19/8 each. 8in. at 24/- each. "Coloson," Model CT104 with Universal Trans., 8in. Chassis, 3 watts at 36/- each. Model CT108, with Universal Trans., 8in. Chassis 5 watts, at 48/- each.

Six-way Push Button Units at 4/- each. Postage 6d. Four-way Battery Leads, with 4 Clix plugs, at 1/3 each. Postage 5d. Barretters, 3 amp. replacements for Phillips C1 at 8/6. Postage 4d. Push Back Connecting Wire, 100ft. coils, at 4/6. Postage 4d.

ELECTRIC FIRES, Parabolic type, 750 watts, at 31/3 each. Postage 1/-.

ELECTRIC FANS, for 110 volt A.C. mains only, at 37/6 each. Postage 1/-.

ELECTRIC IRONS, super quality, 5-5 1/2 lbs. weight, strong bolt through handle, heavily-plated body, unplated bottom, connector guard and rest, complete with heavy 3-wire flex and 3-pin 5 a. plug, 31/3. Smaller model, 3-3 1/2 lbs., 2-pin, 5a. plug and flex, 27/6. Postage 1/- each.

TERMS: Cash with order only, owing to shortage of staff we regret that super invoices to despatch orders C.O.D. or send pro-forma invoices. All prices above include purchase tax where applicable. SEND 1d. stamp and S.A.E. for latest list of all Valves, Radio components, Electrical Fittings and Accessories, etc.

J. E. SEXTON & CO. LTD.
 164, Gray's Inn Road, London, W.C.1
 Telephone: TER. 1304, 4842.

YOU MUST KNOW "MATHS"

If you wish to understand radio, or any other technical subject thoroughly, you must know mathematics.

Our method of Home Study tuition is an outstanding success. Hundreds of students owe their progress and increased earnings solely to our training.

Trained men get good jobs. Even if you are now in the Forces, or on work of National importance, you should think of your future. There will be splendid opportunities for men who have studied radio or mathematics, and now is the time to start learning.

Post coupon for free details of our Home-Study Courses in Mathematics, Radio Calculations, Radio Reception and Transmission, and Television.

T. & C. RADIO COLLEGE
 2, THE MALL, EALING, W.5

★ Please note new address ★

(Post in unsealed envelope, 1d. stamp.)

Please send me free details of your Home-Study Mathematics and Radio Courses.

NAME.....

ADDRESS.....

W.W.16.....

G. A. RYALL, "Arnehurst," Marsh Lane, Taplow, Bucks, offers radio components.
ERIE Resistors, 1/2-watt type, 27,000, 33,000, 1 1/2 meg., 3/- doz., new goods; Erie resistors, 2-watt type, 150, 820, 3,900, 75,000, 140,000, 220,000, 560,000, three for 1/6, new goods, as used in well-known sets; 3-watt type, 700, 1,500, 3,300, 6,800, 8,200, two for 1/6.

SLOW Motion (Epicyclic) Drives fit 1/4in. shafts, long 1/4in. spindles, well made in brass, with ball bearings ratio 3-1; 1/3 each.

PAXOLIN Strip, 2 1/2in. wide, as used for group boards, etc., three 12in. lengths for 1/6; 4 1/2 ft. for 150 lengths.

GROUP Boards, undrilled; six for 1/3.

TURNABLES, as used for rotating portables, ball bearing, 1/6 each, soiled; post 9d. extra on single items.

THIMBLE Top Caps; 36 for 1/3.

T.C.C. 0.1 Tubular Non-inductive Condensers, 350v. working, in Pax tubes and waxed; 6/6 doz. 75/- gross.

INSULATING Tape, 2oz. reels; eight for 1/3.

SWITCHES, Wearite, long type, silver plated contacts, ebonite barrel, will switch band pass, HF, and dial lights; 1/3 each.

CONE Units, heavy circular, less reeds, bobbins, mostly O.K., two 1/6, postage 9d.; Yaxley switch screens, 3 1/2 x 3 1/2, with fixing flange, 4 for 1/3.

K.B. Wave Traps, iron core, 1/3 each, 12/6 doz.

DIAL Plates, 3 band, 6 x 5 scale, 4 x 2 1/2. Whit. ground, 2 1/3; dial plates, ex-Berners, 4 band, in green, red, blue, orange, transparent, brass stiffened edges, 1/6 each, dial and scale 6 1/2 x 4; 9-pin V. holders, 4d. each.

SPECIAL Offer Clearing Line Speakers, damaged cones, otherwise O.K., resistances 750 ohm., 325, carry 120 m.a., 600, 7,500 ohm.; 5/9 each, pots only 3/9.

SPECIAL Note.—We now confine our business to Mail Order.—G. A. Ryall, "Arnehurst," Marsh Lane, Taplow, Bucks. [1617]

RESIN-CORED Solder, 5/6 per 1lb. reel; solder tags, 4/6 gross; 22 S.W.G. tinned copper wire, 2/6 reel (1/2lb.); c.w.o.—J. Wm. Charge, 34, Wimborne Drive, Pinner, Middx.

H.C. Voigt Horn, with bass chamber, £10; also practically new valve tester (Avo) and unused oscillator (Avo)—R. G. Neville, 51, Culverley Rd., S.E.6. Hit. 3096. [1625]

METAL Rectifiers for Battery Charging, 12v. 3 amp., 34/6, post 7d.; instrument rectifiers for meters, bridge type, bakelite moulded, best make, 15/6, post 3d.; transformer and rectifier for 2v. 0.5 amp. trickle charger, 13/6, post 7d.; 8 mid. cardboard electrolytics, 450v. working, surge proof, very good make, 6/6, post 3d.; Rothermel "Bullet" crystal mikes for stand mounting, black crackle finish, very good response, £3, post 8d.; miniature crystal mike for deaf aids, etc., lapel type, 42/6; few only, Rothermel Bakelite crystal pick-ups, latest type, 67/6.—Champion, 42, Howitt Rd., London, N.W.3. [1646]

CAMBRIDGE Pattern "T" 50 mA microammeter, £16/5; Mullard cathode ray tube, A41-B4, £6/15; output valve, DO 60, £3/10; Standard Telephones output meter, £1; Universal elec gram motors, Garrard £25/5. B.T.-II. £3/10; Elliswan pick-up, £1/10; B.T.-II. and Marconi mains energised loud speakers, 1,000 and 3,000 ohms field, 16 ohms speech coil, handling capacity 6w., £3; B.T.-II. mains trans., 630-0-630, 100 m.A.; 3 1/2-0-3 1/2, 6 amps; 3 1/2-0-3 1/2, 6 amps, 200-250v. input, £3/10; Dubilier, 6 mid, 750v. paper condensers, 15/-. Parties, other interesting material sent on request.—T. G. R. Dows-tt, 48, Grove Rd., Eastbourne. [1589]

SUPPLIES for the Radio Engineer and Serviceman.—Valves, 1,000s English and American types in stock. Please order c.o.d. Replacements for U12, U14, UU5, APV4, DW2, DW3, IW3, IW4, A11D, S11A, 442BU, R2, R3, R4, PV4, U50, 524G, 5Y3, 5Y4, ACPEN, MKT4, MP/PEN, Pen4VA, A70B, N41, 7A2, ACY, APP4A, M.P.A., etc., all at 14/6. Speakers, Bin. P.M., Rola, no trans., 25/-; 5in. Rola P.M., no trans., 23/6. Vol. controls, B.P. and D.P. switches, long spindle, 5/3 ea., 55/- per doz.; ass. valves, less switch, 3/6 and 2/9. Barretter resist., 5/-. Bias electrolytics, 25/25 1/8, 50/12 1/8, 50/50 2/6. Tubular wire end condensers, 0.001 to 0.0006, 5/- doz.; 0.01, 0.02, 0.03, 5/6 doz.; 0.04, 0.05, 5/9 doz.; 0.1 6/6 doz.; 0.25 9/- doz.; 0.5 12/6 doz. Mains trans., 4 volt, 350-0-350 25/-, 6.3 volt, 350-0-350 27/6 ea. Universal O.P. trans., inc. P.P., 6/- ea. Multicores solder, 1lb. reels, 4/- lb. Many more lines in stock; enquiries receive prompt attention. S.a.e., please. C.w.o. or C.o.d.—Provincial Radio & Electrical Supplies, 66, Queen's Rd., Nuneaton. [1598]

HILL AND CHURCHILL

BOOKSELLERS

SWANAGE DORSET

ENGLISH & AMERICAN BOOKS IN STOCK ON RADIO AND TELECOMMUNICATION

CATALOGUE ON APPLICATION



W. BRYAN SAVAGE LTD.

Expert assistance in the solution of problems relating to

- TRANSFORMERS, CHOKES
 - AMPLIFIERS
 - POWER UNITS
- and Specialised Equipment embodying

ELECTRONIC CONTROL

WESTMORELAND RD., N.W.9.
 COLINDALE 7131

WARD ROTARY CONVERTERS

Petrol Electric Generating Plants, H.T. Generators, D.C. Motors, Frequency Changers, etc., up to 25 K.V.A.

CHAS. F. WARD
 37, WHITE POST LANE, HACKNEY WICK, E.9
 Phone: Amherst 1393

GECALLOY
N.F. ALLOY POWDER
 THE LATEST DEVELOPMENT IN MAGNETIC POWDER METALLURGY

MAIN ADVANTAGES:

1. Higher Permeability.
2. Higher Particle Specific Resistance.
3. Low Eddy Current Loss.
4. Non-Rusting.

Salford Electrical Instruments Ltd.
 PEEL WORKS, SILK STREET, SALFORD, 3
 Telephone: B1A (4 lines 6688 16 lines)
 Proprietors: The General Electric Co. Ltd., England

PREMIER RADIO

Premier 1-Valve de Luxe Battery Model S.W. Receiver, complete with 2-volt valve, 4 coils covering 12-170 metres. Built on steel chassis and panel, 55/-, including tax.

PREMIER MICROPHONES

Transverse Current Mike. High-grade large output unit. Response 45-7,500 cycles. Low hiss level, 23/-.

Premier Super-Moving Coil Mike. Permanent Magnet model requiring no ohmings. Sensitivity 56db. Impedance 15 ohms. Excellent reproduction of speech and music, 25/5-.

Microphone Transformers, 10/6 each.
Chromium Collapsible Type Microphone Stand, 52/6.

NEW PREMIER S.W. COILS

4- and 6-pin types now have octal pin spacing and will fit International Octal valve holders.

4-PIN TYPE			6-PIN TYPE		
Type	Range	Price	Type	Range	Price
04	9-15 m.	2/6	06	9-15 m.	2/6
04A	12-26 m.	2/6	06A	12-26 m.	2/6
04B	22-47 m.	2/6	06B	22-47 m.	2/6
04C	41-94 m.	2/6	06C	41-94 m.	2/6
04D	76-170 m.	2/6	06D	76-170 m.	2/6
04E	150-350 m.	3/-			
04F	255-550 m.	3/-			
04G	490-1,000 m.	4/-			
04H	1,000-2,000 m.	4/-			

New Premier 3-Band S.W. Coil, 11-25, 25-38, 38-90 m., 4/9.

Rotary Wave Change Switch, to suit above, 1/6.
Premier 2-Gang S.W. Condenser, 2 x 00016 mfd., with integral slow motion, complete with pointer, knob and scale, 10/6.

Bakelite Dielectric Reaction Condensers, 0003 mf., 2/6 0003 mf., 2/9 each 0003 mf. Differential 2/11 each

H.F. CHOKES

S.W. H.F. Choke, 10-100 m. 10/6.
Standard H.F. Choke 1/-
Binocular H.F. Choke 1/6

SHORT WAVE CONDENSERS

Trolitul Insulation. Certified superior to ceramic. All-brass construction. Easily ganged.
15 m.mfd. 2/4 100 m.mfd. 3/-
25 m.mfd. 2/2 150 m.mfd. 3/7
40 m.mfd. 2/6 250 m.mfd. 4/-
Brass Shaft Condensers, 1/2 in. bore 7/6 each
Flexible Compens., 1/2 in. bore 11/6 each
7-pin Ceramic Chassis mtg. English fitting Valve Holders, 1/6 each.

"LEARNING MORSE" ?

Then purchase one of the new practice Oscillators. Supplied complete with valve, on steel chassis, 27/8. Practice key, 3/3. TX key, 5/9. Super model on wooden base, 11/6.
Brown's Headphones, 19/6 pair.
3-Heary Choke, 10/-.
Good Quality Buzzer, 3/-.

ELECTROLYTIC CONDENSERS

Tubular wire end type, 25 mf. 25v., 1/6 each; 50 mf., 50v., 3/- each.

RESISTANCES

Mains Resistances, 660 ohms .3A Tapped. *360 x 180 x 60 x 60 ohms, 5/6 each.
1,000 ohms .2A Tapped. 900, 800, 700, 600, 500 ohms, 4/6 each.
Valve Screens for International and U.S.A. types, 1/2 each.
Push-Back Connecting Wire, 2d. per yard.
Resin-Cored Solder, 7 1/2 d. per lb.
Synstoflex Sleeving, 2 mm., 2/6 per doz. yards.
Waterproof Covered Cable, 3-way, 1/8 per yard; 5-way, 1/6 per yard.
Screened Braid Cable, Single, 1/3 per yard; Twin, 1/6 per yard. Maximum lengths 6 yards approx.

MOVING COIL SPEAKERS

Celestion 8 in. P.M. Speaker, 25/-.
Above speaker is complete with output transformer.
Eola 5in. P.M. Speaker, 3 ohms voice coil, 21/-.
Eola 6in. P.M. Speaker, 3 ohms voice coil, 25/-.
Eola 8in. P.M. Speaker, 3 ohms voice coil, 25/-.

ALL ENQUIRIES MUST BE ACCOMPANIED BY A 21d. STAMP.

PREMIER RADIO CO.

ALL POST ORDERS TO:

JUBILEE WORKS, 167, LOWER CLAPTON ROAD, LONDON, E.6. (Amherst 4723.)

CALLERS TO:

JUBILEE WORKS or 169, FLEET STREET, E.C.4. (Central 2833.)

SOUTHERN RADIOS Wireless Bargains:

6/- gross assorted screws, 6/- 6/- gross soldering tags, including spade ends, 6/- 7/6. Philco 3-point car aerials. Make excellent short-wave and home aerials. Complete with fixing bolts, etc., 7/6. 10/- limit tone arms. Universal fixing for all types of sound box and pick-up heads, 10/- 7/-, Ace "P.O." microphones, complete with transformer. Ready for use with any receiver, 7/- 30/-, Erie resistances, 100 assorted resistances, 1/4, 1/2, 1 and 2 watt. Sizes from 0.8 ohm upwards. Brand new, with wire ends, 100 for 30/- 65/-, special assorted parcel for Servicemen. 100 Erie resistances, assorted sizes, from 0.8 ohms upward, 1/4, 1/2, 1 and 2 watt; 24 assorted tubular condensers, 0.01, 0.05, 0.1, etc., up to 6 mfd. 50 volt; 6 reaction condensers; 12 lengths sleeving; 75ft. push-back wire; soldering tags, screws and wire. All brand new, 65/- 1/6, powerful circular magnets, 1 1/2 in. diameter by 3/8 in. thick, 1/6 each, 15/- per dozen. Tungram H.R. 210 valves. General purpose battery type, 4/9; crystals (Dr. Cecil), 6d. each, 5/6 per dozen; with cats-whisker, 9d. each, 8/- dozen; complete crystal detectors, 2/6; 75ft. covered wire for aerials, etc., 2/6; 25 yds. push-back wire, 5/-; crystals cups, 6d. each, 5/- dozen; Telsen reaction condensers (0.0001), 1/9 each, 18/- dozen; Telsen large disc drives, complete with escutcheon, knob, etc. type W184, 3/- each, 30/- dozen; insulated sleeving, assorted yard lengths, 4/- per dozen; single screened wire, 12 yds., 10/-; M.E.S. holders (miniature screw bulb holders), metal, 7/6d. each, 6/- per dozen. Many other bargains for callers.—Southern Radio Supply Co., 46, Lisle St., London, W.C. Gerrard 6653. [1599]

GERRARD A.C. 10in. and 12in. Record Changer, RCI, with pick-up, little used, new condition, offers; Radioheart tuning pack, less dial, 3 bands, H.F. stage, 465 kcs., £2/15; 3 Bulgin 5-wave coils, aerial, H.F. and osc., with trimmers, padders, switch assembly and data, £3/10; polar dial horizontal micro. drive, 10/-; McMichael battery SG3, with valves, no cabinet, £3/10; Brown A. phones, 120 meg., good condition, 17/6; 1,500 meg. working, needs adjustment, 12/6. —Palmer, Beam Ends, Tregaron Av., Cosham, Portsmouth. [1619]

WANTED

headphones, in good condition.—Box 370, Gordon House, 75-79, Farringdon St., E.C.4.

DYNAMOS, MOTORS, ETC.

ALL Types of Rotary Converters, electric motors, battery chargers, petrol-electric generator sets, etc., in stock, new and second-hand.

WARD, 37, White Post Lane, Hackney Wick, E.8. Tel.: Amherst 1393. [0518]

L.T. Dynamors for Charging or Windmill, 3rd Lucas-Rotax, 6-12 volts 8 amps. D.C., 3rd brush, weight 11lb., size 8in. x 4 1/2 in., unused ex W.D., cost £10, to clear 17/- each, carr. paid; H.T. and L.T. G.E.C. double-end 6 volts and 600 volts, 17lb. ditto, 27/6 carr. paid.—Electradix, 19, Broughton St., London, S.W.8. [9993]

VALVES

VALVES.—Thousands in stock; send requirements s.a.e.—Davies, 28, Mount Vernon Cres., Barnsley. [1073]

578 Watts, Greenaway, Cedar Ave., Christchurch, Hants. [1603]

1,000 list 1d. UT5 11/-; TH2321, 14/-; AC/HUDD, 11/7; SF41, 12/10; 8D2, 12/10; EBL1, 15/3; Tungram TX21, 14/-; 6K7G, 12/10; 6L7G, 12/10; AZ1, 11/-; DSB, 21/4; DH63, 11/7. Post 6d.—Ransom, 34, Bond St., Brighton. [1602]

UNIVERSAL Valves for Receiver Replacement Only, 50L6, 12J7, 12K7, 12SK7, 25L6, 12/10 each; 35Z5, 25Z6, 35Z4, 1A5, 1T5, 11/- each; also 70L7, 12SQ7, 12Q7, 11T5, 6A8, etc., etc., at controlled prices. All "GT" types. British and other American valves always in stock. S.A.E., please.—The Dale Electric Company, 13, Tretawn Gardens, London, N.W.7. [1636]

VALVES.—Large stock British and American types: F.C.4, F.C.13, V.P.4, S.P.4, V.P.4B, V.P.2, S.P.2, V.P.2B, V.P.13C, 354V, TDD4, TDD13C, P.M.24A, P.M.24M, PENA4, PEN36C, P.M.22A, PEN4DD, 2D13A, E.C.H.3, E.F.9, E.B.C.3, EBL1, EI33, CBL1, E.B.34, A.Z.1, 6A8G, 6K7G, 6Q7G, 45Z5, 12B9G, 12SK7. Send s.a.e. for printed list.—Napiers, 127, Prestwick Rd., Ayr. [1597]

Wanted

ONE Edison Valve, catalogue No. 68530, or one Phillips Valve No. 357 for battery charger.—Egertons, Northgate, Ipswich. [1639]
VALVES Wanted, any quantity from one upwards; also test equipment, service sheets and spares.—J. Bull, 246, High St., Harlesden, N.W.10. [9732]

● VALVES ●

BRITISH VALVES

Mullard numbers generally quoted, but we may send B.V.A. equivalents. Prices quoted are current retail, plus Purchase Tax. PM2 11/-, PM12M 11/-, SP2 11/-, VP2 11/-, VP2B 11/-, FC2, 12/10, FC2A 12/10, PM1HL 5/10, PM2HL 5/10, PM2DX 5/10, PM2A 7/4, PM22A 11/-, PM22D 11/-, TDD2A 9/2; also Marconi/Osram P2 12/3, LP2 7/4.

4-VOLT, A.C. MAINS TYPES

ACTP 14/-, TH4A 14/-, TH4B 14/-, FC4 14/-, 2D4A 7/4, PM24M 12/10, ACSPEN 12/10, PEN A4 12/10, PEN4VA 12/10, VP4 12/10, VP4B 12/10, SP4 12/10, SP4B 12/10, W42 12/10, TDD4 11/7, MHD4 11/7, H42 9/2, 354Y 9/2, HL4 9/2, PM24A 18/3, FW4/500 18/3, PEN4DD 15/3; also Cossor MSPEN, MVS PEN, MSPENB, MVS PENB 12/10.

A.C./D.C. TYPES

FC13 and FC13C 14/-, TH21C and TH30C 14/-, ISD2 14/-, VP13C, SPI3C, 9D2, 8D2 12/10, HL13C, 2D13C, 2D13A 9/2, TDD13C 11/7, CL33 12/10, CL4 12/10, "PEN 26" 12/10, KTW61, KTW63, K761, K763, 12/10, also Cossor VP13A and SP13A 12/10.

MAZDA OCTALS

ACTHIA 14/-, TH41 14/-, VP41 12/10, SP41 12/10, DD41 11/-, UUG 11/-, HL4IDD 11/7, H42DD 11/7, PEN4S 12/10, PEN4SDD 15/3, UUT 11/-, TH233 14/-, HL133DD 11/7, VP133 12/10, PEN2S 11/-, HL23 5/10, QP2S 15/3.

MULLARD E TYPES

EB4 12/10, EBC3 11/7, EBC33 11/7, EBF2 15/3, EBL1 15/3, EBL31 15/3, ECH2 14/-, ECH3 14/-, ECH33 14/-, ECH35 14/-, EFS 14/-, EF8 12/10, EF9 12/10, EF38 12/10, EF39 12/10, EFM1 18/3, EK2 14/-, EK3 15/3, EL2 14/-, EL32 14/-, EL3 12/10, EL33 12/10, EZ2 12/10, EM1 11/-, EM1 11/-, EM3 11/-, EM4 11/-, EF6 14/-, CBL1 15/3, CBL31 15/3, CL4 12/10

AMERICAN TYPES

For complete list and prices, see our last month's display. See also next month for revised list.

LEASE LEND American valves as used in midget sets, etc. We have fair stocks of most types, but can only send these for immediate replacement in broken-down receivers. Stocks include 12U7 12/10, 35Z4 11/-, 50L6 12/10, 70L7 15/3, etc. etc.

BARRETTERS

Replacements for Phillips C.I. and C.I.C. and American 150A and 150B, all at 10/-. A few assorted other resistance tubes also in stock.

RECTIFIERS

Non-B.V.A. replacement types all at 14/6 each. Replacements for American 80, SY3, SZ4, SY4; Marconi/Osram U10, U12, MOUNT, U50; Mullard IW2, IW3, DW2, DW3; Cossor 442BU, 431IU, Brimar R1, R2, R3; Phillips 1821 Mazda U03, U04, etc., etc.

SPECIAL NOTE.—The above valves represent only a small proportion of our stocks. Please mention the other types you are requiring and we will send them if in stock.

TO SAVE TIME ORDER VALVES C.O.D.

● SPARES ●

ROLA P.M. speakers, dustproof pattern, 4 inch, ideal for most midgets, 17/6; 8 inch, with O.P. transformer, 27/6. ■■■■■

CELLULOSE cement, ideal for speaker and valve base repairs, 5/- 1/2-pint tin.

Flux cored solder, 5/6 lb. Tinned copper connecting wire 2/3 lb. Sleeving, 3/6 doz. yds.

Terms: Cash with order or C.O.D. (pay the postman). We prefer C.O.D. Please give full address, including county.

J. BULL & SONS

246, HIGH ST., HARLESDEN, N.W.10

LONDEX for RELAYS

for A.C. and D.C.

TWO STEP RELAY LF/F8 (Heavy Silver Contacts)



First Impulse
"ON." Second
Impulse "OFF."

Also Aerial
Change-over
Relays.

Ask for
leaflet 88A/WW

LONDEX LTD

MANUFACTURERS OF RELAYS

ANERLEY 207 ANERLEY ROAD LONDON S.E.20

MATRICULATION

brings Success & Security

Whatever your age, you can now study for the all-important Matriculation Examination at home on "NO PASS—NO FEE" terms. "MATRIC" is the accepted passport to all careers, and opens up opportunities which would otherwise be completely closed to you. Ensure the future success and security of you and yours by writing for our valuable "Guide to Matriculation" immediately—FREE.

B.T.I. (Dept. 114)
356, Oxford Street, London, W.1.

VALVES

FREE OF TAX

2-Volt British Type, det. and L.F., 3/6; Power, 4/6; Tungram super-power, SP220, 8/-; American Philco, VMHF pentode, 1A4E, 6/-; Screen-grid, 1B4E, 6/-; Output Pentode, 2101, 9/-; Heptode, 1A6E, 14/-; 4-Volt Mains, AC/HP, 5-pin H.F. Pentode, 6/-; Barretters, 4-pin and side contact, 9/-; magic-eye Tungram, VME4, 8/6; AC/DC. Tungram, etc., DDT13, DDT13a, VP2118, etc., 9/6; TH29 and TX21, 11/6; American Types 1A4, 1B4, 24, 35/51, 56, 27, 1F4, 26, 1F5G, 6/- each. 6-pin Barretter, 9/-; Resistors, 1/2 watt, 3/6 doz., 1 watt, 5/6 doz., 2 watt, 1/- each. Condensers, Miva, 4/6 doz., 1 wire-end, 6/- doz.; Philco, high voltage test, 1/- each. Volume Controls, 2/6 each. Speaker Transformers, 5/- each. Philco Spares. I.F., Aerial and R.F. Transformers, at pre-war price. Parcels, assorted components, 10/-, worth many times this. No lists, please send stamp with enquiries. Terms: Cash with order, postage extra.

E. H. ROBINS TRADING CO. LTD.
44, Kyle Crescent South, Whitechurch, Glam.

KESSLERS (London) Ltd

For TURNING and MACHINING of
PLASTIC MATERIAL
SIGNAL LAMP CAPS
SCREW CUTTING IN BAK.FABRIC

Aldon House, 201-3, Church St., London, N.16
Tel.: Clissold 6247



For high quality
loud speakers when
the good time's
come again.

The Courts, Silverdale, London, S.E.26
Phone: SYD 6866

REPAIRS AND SERVICE

L.T.P. Repair All Mains Transformers and Chokes. Prompt delivery.

LONDON TRANSFORMER PRODUCTS, Ltd., Willesden, N.W.10. Wil. 6486 (3 lines). (1952)

MIDWEST, etc. we are the American experts.—Bennett's, 4, Humberstone Drive, Leicester. (1620)

TRANSFORMERS, motor rewinds, repairs of all descriptions to the wireless trade.—Marshall, 137, Windmill Lane, Nottingham.

ACCURATE Radio Rewinds, mains transformers, Fields O.P. transformers, etc., and all loudspeaker repairs.—Southern Trade Services, 75a, George St., Croydon. (1039)

MAINS Transformers Service, repairs, rewinds, or construction to specification of any type, competitive prices and prompt service.—Sturdy Electric Co., Ltd., Dipton, Newcastle-upon-Tyne. (9651)

METROPOLITAN RADIO SERVICE Co. Guarantee Repairs to American and British Receivers.—1,021, Finchley Rd., N.W.11. Sne. 3000. (9641)

"SERVICE with a Smile."—Repairers of all types of British and American receivers; coil rewinds; American valves, spares, fine cords.—F.R.L., Ltd., 22, Howland St., W.1. Museum 5675. (1575)

A.L. Types of Radio Receivers Serviced; Murphy and Pilot specialist; valves in stock. "Sound repairs for thirteen years."—T. E. Feyver, F.I.P.R.E., 50, Vine St., Uxbridge, Middx. Ux. 308. (1587)

DEGALLIER'S, Ltd.—"Service with a Guarantee." If you have an English or American receiver that needs servicing, let American specialists do the job; any set handled from a T.R.F. Midget to a 30-valve Scott; first-class workmanship only; when forwarding, chassis and valves needed only. Send S.A.E. with all enquiries.—Degallier's, Ltd., 9, Westbourne Court, London, W.2. (1468)

MISCELLANEOUS

RUBBER Stamps of all Descriptions Supplied. Send 1d. for fuller details.—V. E. S., 4, Melthorne Drive, Ruislip, Middx.

POST-WAR Planning.—Radio amateurs: Enquiries invited now—American keys, communications receivers, crystals, field strength meters, impedance meters, oscillators. Radio service men: Direct reading valve volt meters, signal tracers, oscilloscopes. P.A. engineers: Volume indicators, switching systems, microphones and record players, audio oscillators. Get your name and address on our files for your specific requirements when available. All communications answered.—Box 2839, c/o Wireless World. (1605)

PATENT NOTICES

MORSE System Economising in Transmitter. Energy and Size. Patentee wishes to contact firm to exploit above.—Box 2844, c/o Wireless World. (1629)

THE Proprietors of British Patents Nos. 516110, dated May 17, 1938 (Convention date May 28, 1937); No. 516111, dated May 17, 1938 (Convention date Feb. 8, 1938); No. 516167, dated May 17, 1938 (Convention date Feb. 8, 1938); No. 516168, dated May 17, 1938; all relating to Improvements in Electron Discharge Tubes; and No. 516169, dated May 17, 1938 (Convention date May 28, 1937), relating to Improvements in Bases or Caps for Electron Discharge Tubes; are desirous of entering into arrangements by way of a licence or otherwise on reasonable terms for the purpose of exploiting the above patents and ensuring their practical working in Great Britain.—Enquiries to Singer, Ehlert, Stern and Carlberg, Chrysler Bldg., New York City, N.Y., U.S.A. (1561)

PATENT AGENTS

BUREAU.—Consultants and registered agents for British, foreign and Colonial patents, design and trade mark registrations, investigations and searches.—Thanet House, 231, Strand, W.C.2. Central 7330. (1609)

TUITION

THE BRITISH NATIONAL RADIO SCHOOL (Correspondence). Specialists in individual coaching of aspirants for the more responsible positions in the radio profession ashore. Principal, Mr. J. Sykes, A.M.I.E.E., 16, Wallisote Rd., Bristol, 9.

RADIO Engineering—Television and Wireless Telegraphy, comprehensive postal courses of instruction. Apply British School of Telegraphy, Ltd., 179, Clapham Rd., London, S.W.9 (Est'd. 1906). Also instruction at school in wireless for H.M. Merchant Navy and R.A.F. (9249)

POSTAL Training in Electrical Engineering—power or radio; individual correspondence tuition by highly qualified engineers with wide teaching and technical experience. Elementary or advanced courses. Preparation for recognised examinations. Pre-service training specially arranged.—G. B., 18, Springfield Mount, Kingsbury N.W.9. (1647)



MOVING COIL MICROPHONES

are skilfully designed to ensure a high standard of efficiency, durably made to give lasting satisfaction. . . . are to be depended upon in the biggest job—in the front line of communications.

MICRAMATIC ELECTRICAL INSTRUMENTS CO.
360, STATION RD., HARROW, Middx.
Telephones: HARrow 1064/5. Telegraphic Address: MEICO, HARROW

Appointment Vacant

Director of research and development, to take complete charge of these departments, required by a London firm of Electrical Engineers manufacturing radio frequency, acoustic and electrical instruments. First class qualifications in Physics or Electrical Engineering essential, coupled with wide industrial experience. Write, stating full particulars, to Box 2821, Wireless World.

Repairs & Service

REWINDS. Transformers—Mains, 25/-, O.P., 6/-. Fields, Pick-ups, Coils, Chokes.

VALVES. We may have those you want. S.A.E. to: 261/3/5, Lichfield Road, Aston, Birmingham, 6.

A.D.S. Co.



BATTERY & TRICKLE CHARGERS

for all purposes
"QUICK-CHARGE" CHARGERS
well known for reliability
Thousands already in use.
Send for interesting booklet "B.15"

Rubakken
MANCHESTER-1

"SYSTEMATIC RADIO SERVICING"

A method for organising the repair-shop, devised and employed by J. Bull. Also a catalogue of many Radio Service Aids including "History of Faults," "Job Cards," which almost repair the sets, "Valve Base Data Cards," and perhaps most important, a Rectifier which will replace any of the popular Universal valves such as 12Z3, 25Z5, 1D5, U30, 405UA, etc. Price 1/7 p.f.

V.E.S.,
(W) Radio House, Melthorne Drive, Ruislip, Mdx.

Engineering firm requires the following work: Press Tools, fly press work, process drilling, mechanical and radio assembly, coil winding.

C. B. ENGINEERING CO.
X.L. Works, Robin Hood Gate, Kingston Vale, S.W.19.
Phone: Kingston 3587.

PITMAN'S for Radio Books

SHORT WAVE RADIO

By J. H. Reyner, B.Sc., A.C.G.I., etc. This book gives an account of the tremendous progress which has been made in the field of short-wave radio-telegraphy during the last few years, and shows how many of the problems formerly regarded as insuperable have been overcome. Third Edition. 10s. 6d. net.

EXPERIMENTAL RADIO ENGINEERING

By E. T. A. Rapson, A.C.G.I., D.I.C., etc. This book sets out a number of experiments and methods of measurement suitable for a three or four years' course in radio engineering at a technical college. A few of them require rather specialised apparatus, but the majority may be carried out with standard laboratory equipment. 8s. 6d. net.

WIRELESS TELEGRAPHY [322] Notes for Students

Compiled by W. E. Crook. A book which has been used as a textbook for an operator's course with satisfactory results. Dealing as it does with fundamental radio theory, the book is equally applicable to any kind of wireless operating. 7s. 6d. net.

RADIO RECEIVER SERVICING AND MAINTENANCE

By E. J. G. Lewis. A practical manual specially written to give the radio dealer and service man up-to-date and reliable information on the technical details of their work. The index is combined with a handy fault-finding summary. 8s. 6d. net.

39, PARKER STREET
KINGSWAY, LONDON, W.C.2

MORSE CODE TRAINING!

Hundreds of Candler trained W/T Operators are now serving in the Army, Navy, Air Force and Mercantile Marine of Great Britain and her Allies.

There are Candler Morse Code Courses for Beginners and Operators.



SEND NOW
FOR THIS
FREE
"BOOK OF FACTS"
It gives full details concerning the following Courses:—

JUNIOR Scientific Code Course for beginners. Teaches all the necessary code fundamentals scientifically.
ADVANCED High-speed Telegraphing for operators who want to increase their w.p.m. speed and improve their technique.
TELEGRAPH Touch Type-writing for those who want to become expert in the use of the typewriter for recording messages.

Terms: Cash or Monthly Payments.

COUPON

Please send me a Free Copy of Candler "Book of Facts."

NAME

ADDRESS

Post Coupon in 1d. unsealed envelope to London Manager

THE CANDLER SYSTEM CO. (Room 55W),
121 Kingsway, London, W.C.2

Candler System Co., Denver, Colorado, U.S.A. (432)

LEARN Morse Code the Candler Way. See advertisement on this page. [1292]
RADIO Training.—P.M.G. exams. and I.E.E. Diploma; prospectus free. — Technical College, Hull [0611]
THE Tuitionary Board of the Institute of Practical Radio Engineers Have Available Home Study Courses Covering Elementary, theoretical, mathematical, practical, and laboratory tuition in radio and television engineering; the text is suitable coaching matter for I.P.R.E., Service-entry and progressive exams; tuitionary fees—at pre-war rates—are moderate.—The Syllabus of Instructional Text may be obtained post free from the Secretary, Bush House, Walton Avenue, Henley-on-Thames, Oxon. [1462]

TECHNICAL TRAINING
GREAT Possibilities Exist for Technically Qualified Engineers, key men in war-time and afterwards. Through the home-study courses of The T.I.G.B. take a recognised engineering qualification, such as A.M.I.Mech.E., A.M.I.E.E., A.F.R.Ae.S., A.M.I.Chem.E., C and G., etc., in which examinations the T.I.G.B. students have gained 25 FIRST PLACES and Hundreds of Passes. Write today for "The Engineer's Guide to Success"—Free—containing the world's widest choice of engineering courses covering all branches, including Aeronautical, Mechanical, Electrical, Wireless, Chemical, etc.

THE TECHNOLOGICAL INSTITUTE OF GREAT BRITAIN, 82, Temple Bar House, London, E.C.4. [1403]

BUSINESSES FOR SALE OR WANTED
LIMITED Company in Working Order for Disposal; incorp. 1939; profits since inception negligible; main objects builders' merchant's, wireless and electrical equipment, wholesale and retail. Price for quick sale £300.—Box 2837, c/o Wireless World. [1596]

SITUATIONS VACANT
OVERSEAS Employment.—Applications are invited for the following overseas vacancies:
GROUND Radio Operators (age not over 45).—Candidates must hold 1st or 2nd class P.M.G. Wireless Operating Certificate and have practical operating experience. They must be prepared to go anywhere.

TRAINED Coxswains able to handle motor launches and maintain the engines and fit for service in the Tropics. Salary: £4/5 per week basic plus overseas pay of £2 per week plus a Station allowance which varies between £100 and £335 a year according to cost of living and climate. Separation and children's allowances are paid in addition. Free passages out and home; medical attention provided under insurance scheme; full wages during sickness overseas.

Written applications (no interviews), giving full particulars of age, registration numbers, training, experience, and name of present employers, should be sent to The Secretary, Overseas Manpower Committee (Ref. 299 C), Ministry of Labour and National Service, Hanway House, Red Lion Square London, W.C.1.

HEAD Foreman Required to Take Complete Charge of Machine Shop, comprising about 70 operators. Must be fully conversant with modern practice.—Write, stating full particulars and salary required, to Box 2838, c/o Wireless World. [1601]

PRODUCTION Manager required for valve deaf aids, scheduled occupation, sound knowledge L.F. amplification, control small production staff, purchasing, stock-keeping; excellent post-war prospects.—Write, age, experience, salary, Box 2840, Wireless World.

INSTRUCTOR Wanted for the Training of Students in Wireless Engineering and Servicing. Qualified up to Final City and Guilds standard and with practical experience. Salary up to £500 per annum, according to qualifications.—Application, with testimonials and full particulars, to The Secretary, Elliot Macintosh Wireless Colleges, Windsor St. Dundee, Scotland. [1595]

SITUATION WANTED
YOUNG Engineer, free in three months. exempt, honours degree in electrical (and mechanical) engineering, grad. I.E.E., A. (Amer.) I.R.E., seeks post with radio firm, first class practical and theoretical radio knowledge, experience in design and transmitting, capable of handling labour.—Box 2842, c/o Wireless World. [1623]

BOOKS, INSTRUCTIONS, ETC.
WANTED, aligning instructions for Hallcrafters Ultra-Skyrider S-10.—Johnson and Co., 4, Dorset St, Sevenoaks. [1593]

WANTED, back numbers of "Wireless World," "Radio News," "Radio," and "Radiocraft." State price.—Write "Weldona," The Avenue, Finchley, N.3. [1615]

WEBB'S Radio Map of the World Locates any Station Heard. Size 40x30in., 4/6, post 6d.; on linen, 10/6, post 6d.—Webb's Radio, 14, Boho St., London, W.1. Phone: Gerrard 2088. [9947]



WAR-TIME 'ECONOMY' CONSTRUCTORS' KITS

A.C. STRAIGHT THREE, V.M. H.F. Pen., Triode L.F. Pen., M.C. Speaker, £8.8.0, plus 1/1 post and 3/6 packing (returnable).
BATTERY THREE, V.M. H.F. Pen., triode detector and output tetrode, P.M. Speaker, £6.0.0, plus 1/1 post and 3/6 packing (returnable).

● CALL FOR DEMONSTRATION ●
Delivery approx. one month

NOW IN STOCK

STANDARD 3-GANG .0005 CONDENSER, with trimmers, new, boxed, 7/6.

2-GANG CONDENSER, .0005, with trimmers, 7/6.

MIDGET 2-GANG .0005, S.M. drive and dial, 10/-.

A. & H.F. COILS, dual range, reaction, coloured wires, circuit, 8/6 per pair.

DUAL RANGE COILS, small, simple, with reaction, circuit, 5/- each.

PHILLIPS DUAL RANGE AERIAL COILS, screened, no reaction, circuit, 1/6 each.

DUAL RANGE H.F. TRANSFORMER, no reaction, screened, 5/- each.

H.F. CHOKES, high induction, low capacity, boxed, new, 4/6 each.

ALL-WAVE H.F. CHOKES, shielded, 4/6.

NEW STEEL CHASSIS, undrilled, painted grey, 10x8x2 1/2, 7/6; 8x6, 4/6.

VOLUME CONTROLS (no switch), 50,000 ohm, 4/-.

OCTAL PLUGS AND SOCKETS, 2/- each.
SCREENED VALVE CAPS, ENGLISH AND OCTAL, 1/- each.

GROUP BOARDS, to mount 3, 2 fixing brackets, 9d. each.

10-WATT WIRE WOUND RESISTORS, 2,000, 500, 150 ohms, 2/6 each.

RESISTORS, 1/2-watt, 4d.; 1/4-watt, 6d.; 1 watt, 1/-.

LINE GORD REPLACEMENT RESISTORS, 750 ohm with variable tapping, 5/6; 800 ohm, 50 tapped, 3/6.

PARALLEL FEED SCREENED L.F. TRANSFORMER, small, 6/-.

SET OF 4 S.W. COILS on low-loss formers, 5/91 metres, 6/6.

PAXOLIN PANELS, A, A1, E, 6d. each; L.S. or P.U., 6d. each.

VALVE HOLDERS, English, or UX 4, 5, 6, 7, Octal, 6d. each.

TERMINAL STRIPS, 3d. to 1/-; solder tags, 3d. doz.; Systoflex, coloured, 4d. per yard.

3-WAVE BAND GLASS DIALS, black or silver background, 1/6.

CERAMIC TRIMMERS, twin 380/600, 1/6.

MICA CONDENSERS, .001, 2,200v. test, 1/6; .0001, 1/-; .01, 1/6.

SPECIAL LOW-LOSS COIL FORMERS, 1in. x 2in., 1/- each.

FILAMENT CHOKES, double wound, S.W., etc., 1/6.

WAVE-CHANGE SWITCHES, 3-pole, 3-way. Can be altered to 4-way, 3/6.

FREQUENTITE VALVE HOLDERS, 7-pin only, 1/6.

AERIAL SERIES CONDENSER, 2/6. Licence to export to Northern Ireland and Irish Free State. Please add postage for enquiries and mail orders.

51-52 CHANCERY LANE.

LONDON: W.C.2. Telephone HOLBORN 4531.

AUDIO AMPLIFIERS and SUB-ASSEMBLIES

Standard Amplifiers • Special Amplifiers for Industrial Applications • Transformers and Coil Winding • Sheet Metal Work and Stampings • Switch Assemblies • Microphones, etc.

One of our range of Standard Amplifiers available for work of National Importance.

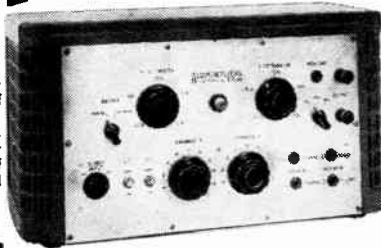

ACOUSTICAL
MANUFACTURING COMPANY LTD
HUNTINGDON TEL: 361

"Veni, vidi, vici"

Although we at Gardners have no Caesarian ambitions in the usual sense of the word, if our range of quality transformers could only speak, it could say with truth, "I came, I saw, I conquered." We believe that prior to its advent, quality as applicable to this important component was an abstract virtue rather than concrete. And nowhere in that range is the "conquering spirit" in greater evidence than in the Small Power Transformers up to 4 kva. So when next you need this type of transformer and you have a specification in which the will to win is underlined, ask us to help you conquer.

We regret that at present Small Power Transformers are available for highest priority orders only.



GARDNERS RADIO LIMITED
SOMERFORD · CHRISTCHURCH · HANTS

AMBITIOUS ENGINEERS



Whatever your age or experience — you must read this highly informative guide to the best paid Engineering posts. The Handbook contains particulars of:

- A.M.I.C.E.
- A.M.I.Mech.E.
- A.M.I.E.E., A.M.I.A.E., A.M.Brit.I.R.E.
- and other important Engineering Examinations, and outlines courses in all branches of **Civil, Mechanical, Electrical, Automobile, Radio and Aeronautical Engineering, Govt. Employment, Draughtsmanship, Building Matriculation, "R.A.F. Maths," etc.**

WE GUARANTEE 'NO PASS-NO FEE'

If you are earning less than £10 a week you cannot afford to miss reading "Engineering Opportunities"; it tells you everything you want to know to secure your future, and describes many chances you are now missing. Write for your copy of this enlightening guide to permanent well-paid posts NOW—FREE.

BRITISH INSTITUTE OF ENGINEERING TECHNOLOGY, 387a, Shakespeare House, 17, Stratford Place, London, W.1.

RADIO SERVICE SUPPLIES

MAINS TRANSFORMERS.	
Primaries tapped 200/230/250v.	
Type A. 350-0-350v. 80/100ma., 4v. 2a. and 4v. 4a. CT.	22/6
B. 350-0-350v. 80/100ma., 5v. 2a. and 6.3v. 4a. CT.	22/6
S. 350-0-350v. 80 ma., 4v. 2a. and 4v. 2a. and 4v. 4a. CT.	25/6
X. 350-0-350v. 120ma., 4v. 2.5a., and 4v. 7a. CT.	30/-
Z. 500-0-500v. 120ma., 4v. 2.5a. and 4v. 7a. CT.	35/-
(Postage on Types A, B, S, 9d.; X and Z, 1/-)	
AUTO TRANSFORMERS.	
60 watts, 100-150/200-250v., step up or down ..	22/6
SPEAKER TRANSFORMERS.	
Standard size stampings and fixings. (45ma.) Pentode ratio only, 5/6. Power/Pent./P.P. 7/6 (60ma.), 8/6.	
LARGE OUTPUT TRANSFORMERS. For Amplifiers, Primaries CT. 12/15 watts	30/-
BOBBINS ONLY.	
Wound bobbins to fit standard Rola, or Goodmans, etc., speaker transformers. Wound for Pentode	2/6
SPEAKERS.	
Goodmans 8in. P.M., with transformers	25/-
Goodmans 6in. P.M., less transformers	17/-
Goodmans 10in. P.M., with CT transformers	35/-
Rola 8in. P.M., less trans., Ideal Inter. comm. unit	16/6
Energised Speakers, 8in., 2,000 ohm. fields with trans.	24/6
P.A. Types energised 10in. 1,000 fields, with trans.	30/-
(Postage on larger sizes 9d. each.)	
SUNDRIES.	
Bias Condensers, 25mfd., 25v., 1/6; Bias Resistors, up to 2,000 ohms, 5-watt, 1/9; 10-watt, 2/3. Tuning Colls, M.W. and L.W., on formers, 2in. x 1in., 1/3 each, Volume Controls, less sw., 3/-. With switch, 4/9, popular sizes.	
SERVICE COMPONENTS OF EVERY DESCRIPTION IN STOCK. —Resistors, Condensers, Sleeveing, Wires, etc. Valve Holders, Mica Condensers, etc. Large stocks of valves of all types. All enquiries must be accompanied by 3d. stamps for lists. Prices quoted nett cash, add estimated postage where not stated.	
Terms—Cash with order or C.O.D.	
MAIL ORDERS ONLY.	
RADIO INSTRUMENT SERVICE CO.	
116, Littleheath Rd., Bexleyheath, Kent. Brixth 2814	

INVENTORS

The world-wide Simmonds Organisation has established new methods and new products in many industries with great success. Simmonds Development Corporation seeks new ideas and inventions of brilliance and ingenuity to be developed by the technical resources and marketing knowledge of the Simmonds Group.

The SIMMONDS GROUP

LONDON
MELBOURNE
PARIS-NEW YORK
LOS ANGELES

SIMMONDS DEVELOPMENT CORPORATION LTD · BUSH HOUSE · W.C.2

Printed in England for the Publishers, LIFFE AND SONS LTD., Dorset House, Stamford Street, London, S.E.1, by THE CORNWALL PRESS LTD., Paris Garden, Stamford Street, London, S.E.1. "The Wireless World" can be obtained abroad from the following: AUSTRALIA and NEW ZEALAND: Gordon & Gotch, Ltd. INDIA: A. H. Wheeler & Co. CANADA: Imperial News Co.; GORDON & GOTCH, LTD. SOUTH AFRICA: Central News Agency, Ltd.; Wm. Dawson & Sons (S.A.), Ltd. UNITED STATES: The International News Co.

WHY ERSIN MULTICORE

the Solder wire with 3 cores of non-corrosive ERSIN FLUX is preferred by the majority of firms manufacturing the best radio and electrical equipment under Government Contracts.



WHY THEY USE CORED SOLDER

Cored solder is in the form of a wire or tube containing one or more cores of flux. Its principal advantages over stick solder and a separate flux are :

- (a) it obviates need for separate fluxing
- (b) if the correct proportion of flux is contained in cored solder wire the correct amount is automatically applied to the joint when the solder wire is melted.

This is important in wartime when unskilled labour is employed.

WHY THEY PREFER MULTICORE SOLDER. 3 Cores—Easier Melting

Multicore Solder wire contains 3 cores of flux to ensure flux continuity. In Multicore there is always sufficient proportion of flux to solder. If only two cores were filled with flux, satisfactory joints are obtained. In practice, the care with which Multicore Solder is made means that there are always 3 cores of flux evenly distributed over the cross section of the solder,



so making thinner solder walls than single cored solder, thus giving more rapid melting and speeding up soldering.

ERSIN FLUX

For soldering radio and electrical equipment non-corrosive flux should be employed. For this reason either pure resin is specified by Government Departments as the flux to be used, or the flux residue must be pure resin. Resin is a comparatively non-active flux and gives poor results on oxidised, dirty or "difficult" surfaces such as nickel. The flux in the cores of Multicore is "Ersin"—a pure, high-grade resin subjected to chemical process to increase its fluxing action without impairing its non-corrosive and protective properties. The activating agent added by this process is dissipated during the soldering operation and the flux residue is pure resin. Ersin Multicore Solder is approved by A.I.D., G.P.O., and other Ministries where resin cored solder is specified.

PRACTICAL SOLDERING TEST OF FLUXES

The illustration shows the result of a practical test made using nickel-plated spade tags and bare copper braid. The parts were heated in air to 250° C, and to identical specimens were applied ½" lengths of 14 S.W.G. 40/60 solder. To

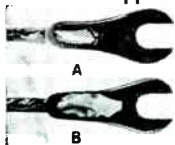

sample A, single cored solder with resin flux was applied. The solder fused only at point of contact without spreading. A dry joint resulted, having poor mechanical strength and high electrical resistance. To sample B, Ersin Multicore Solder was applied, and the solder spread evenly

over both nickel and copper surfaces, giving a sound mechanical and electrical joint.

ECONOMY OF USING ERSIN MULTICORE SOLDER

The initial cost of Ersin Multicore Solder per lb. or per cwt. when compared with stick solder is greater. Ordinary solder involves only melting and casting, whereas high chemical skill is required for the manufacture of the Ersin flux and engineering skill for the Multicore Solder incorporating the 3 cores of Ersin Flux. However, for the majority of soldering processes in electrical and radio equipment Multicore Solder will

show a considerable saving in cost, both in material and labour time, as compared either with stick solder or single cored solder. Cored solder ensures that the solder and flux are put just where they are required, and by choice of suitable gauge, economy in use of material is obtained. The quick wetting of the Ersin flux as compared with resin flux in single core resin solder ensures that with the correct temperature and reasonably clean surface, immediate alloying will be obtained, and no portions of solder will drop off the job and be wasted. Even an unskilled worker, provided with irons of correct temperature, is able to use every inch of Multicore Solder without waste.

ALLOYS

Soft solders are made in various alloys of tin and lead, the tin content usually being specified first, i.e. 40/60 alloy means an alloy containing 40% tin and 60% lead. The need for conserving tin has led the Government to restrict the proportion of tin in solders of all kinds. Thus, the highest tin content permitted for Government contracts without a special licence is 45/55 alloy. The radio and electrical industry previously used large quantities of 60/40 alloy, and lowering of tin content has meant that the melting point of the solder has risen. The chart below gives approximate melting points and recommended bit temperatures.

ALLOY Tin Lead	Equivalent B.S. Grade	Solidus C.°	Liquidus C.°	Recommended bit Temperature C.°
45/55	M	183°	227°	267°
40/60	C	183°	238°	278°
30/70	D	183°	257°	297°
18.5/81.5	N	187°	277°	317°

VIRGIN METALS — ANTIMONY FREE

The wider use of zinc plated components in radio and electrical equipment has made it advantageous to use solder which is antimony free, and thus Multicore Solder is now made from virgin metals to B.S. Specification 219/1942 but without the antimony content.

IMPORTANCE OF CORRECT GAUGE

Ersin Multicore Solder Wire is made in gauges from 10 S.W.G. (.128"—3.251 m/ms) to 22 S.W.G. (.028"—.711 m/ms). The choice of a suitable gauge for the majority of the soldering undertaken by a manufacturer results in considerable saving. Many firms previously using 14 S.W.G. have found they can save approximately 33 1/3%, or even more by using 16 S.W.G. The table gives the approximate lengths per lb. in feet of Ersin Multicore Solder in a representative alloy, 40/60.

S.W.G.	10	13	14	16	18	22
Feet per lb.	23	44.5	58.9	92.1	163.5	481

CORRECT SOLDERING TECHNIQUE

Ersin Multicore Solder Wire should be applied simultaneously with the iron, to the component. By this means maximum efficiency will be obtained from the Ersin flux contained in the 3 cores of the Ersin Multicore Solder Wire. It should only be applied direct to the iron to tin it. The iron should not be used as a means of carrying the solder to the joints. When possible, the solder wire should be applied to the component and the bit placed on top, the solder should not be "pushed in" to the side of the bit.



ERSIN MULTICORE SOLDER WIRE is now restricted to firms on Government Contracts and other essential Home Civil requirements. Firms not yet using Multicore Solder are invited to write for fuller technical information and samples.

MULTICORE SOLDERS LTD., BUSH HOUSE, W.C.2. 'Phone Temple Bar 5583/4



"Everything O.K. Sir !"

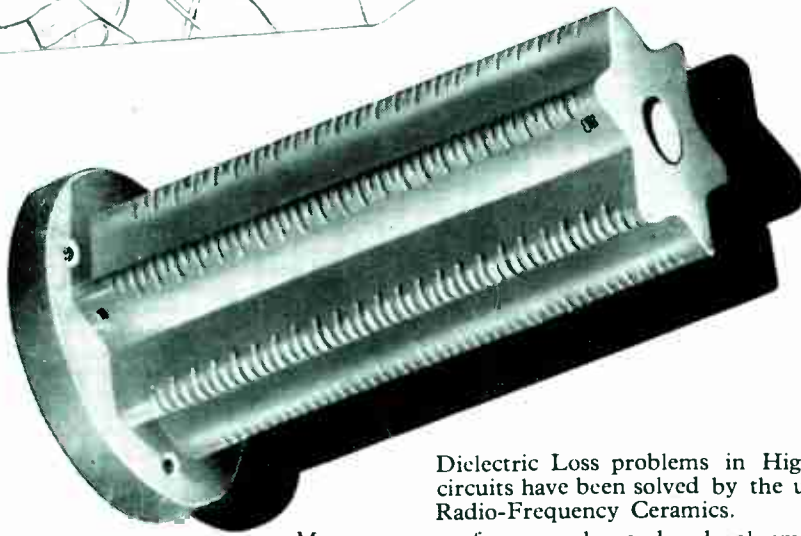

Dielectric Loss problems in High Frequency circuits have been solved by the use of Bullers Radio-Frequency Ceramics.

Many years of research and development in our Laboratories have brought these materials to a high degree of efficiency.

They are in constant use for transmission and reception and play an important part in maintaining communication under all conditions.

Made in Three Principal Materials

FREQUELEX

An insulating material of Low Dielectric loss. For Coil formers, Aerial Insulators, Valve Holders, etc.

PERMALEX

A High Permittivity Material. For the construction of Condensers of the smallest possible dimensions.

TEMPLEX

A Condenser material of medium permittivity. For the construction of Condensers having a constant capacity at all temperatures.



BULLERS LTD.,
THE HALL, OATLANDS DRIVE,
WEYBRIDGE, SURREY.

Telephone : Walton-on-Thames 2451.
Manchester Office : 196, Deansgate, Manchester.

Bullers

LOW LOSS CERAMICS

