

STEREOSCOPIC COLOUR TELEVISION

The
**Wireless
World**

MONTHLY
ONE SHILLING

*COVERING
EVERY WIRELESS INTEREST*

FEBRUARY 1942



WOMEN IN WIRELESS

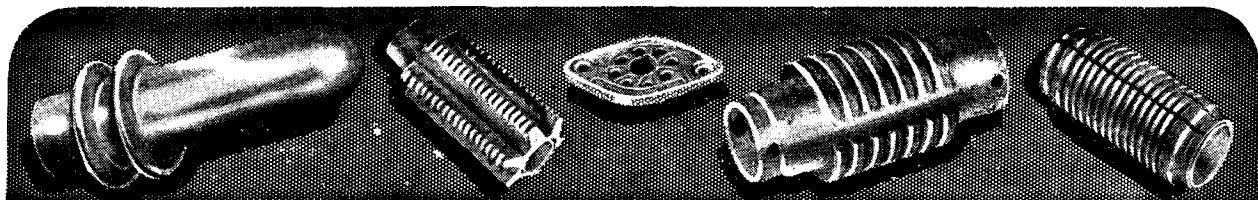

Clear as a Crystal

**AND HERE IS
THE REASON..**

.. the answer has been found in Bullers Low Loss Ceramics to the problem of Dielectric Loss in High Frequency circuits.

Years of laboratory research and development have brought these materials to a high degree of efficiency. To-day, they are in constant use for transmission and reception and play a vital part in maintaining communications under all conditions.

Made in Three Principal Materials.

FREQUELEX—An Insulating material of Low Dielectric Loss. For Coil Formers, Aerial Insulators, Valve Holders, etc.

PERMALEX—A High Permittivity Material. For the construction of Condensers of the smallest possible dimensions.

TEMPALEX—A condenser material of medium permittivity. For the construction of Condensers having a constant capacity at all temperatures.

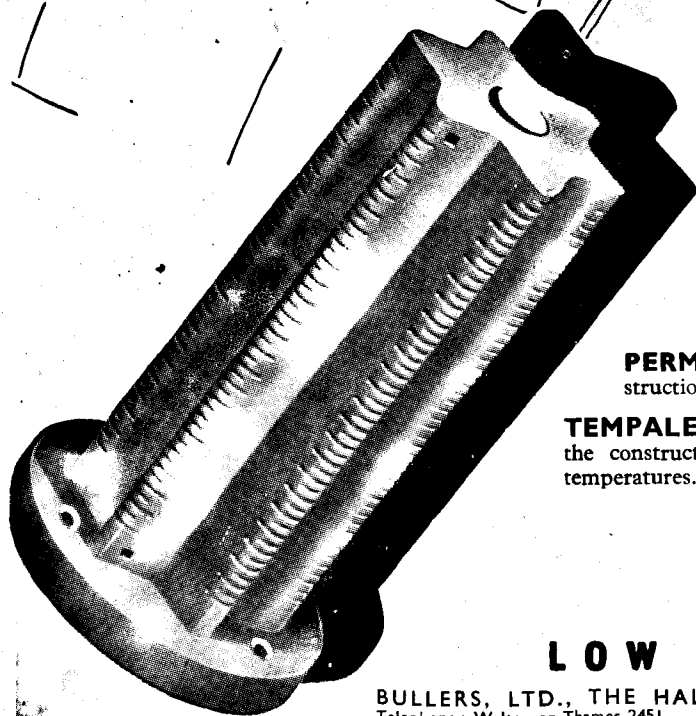

Bullers

LOW LOSS CERAMICS

BULLERS, LTD., THE HALL, OATLANDS DRIVE, WEYBRIDGE, SURREY
Telephone: Walton-on-Thames 2451 Manchester Office: 195 Deansgate, Manchester

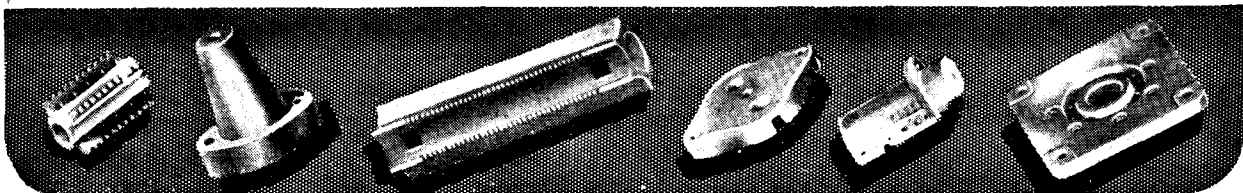

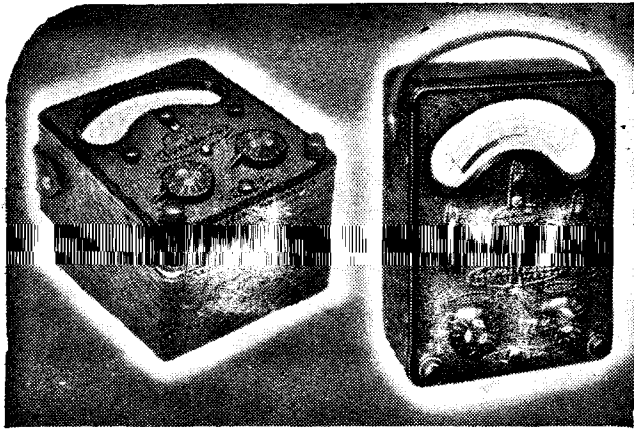

46-range Model 7
Universal Avometer

40-range Model 40
Universal Avometer

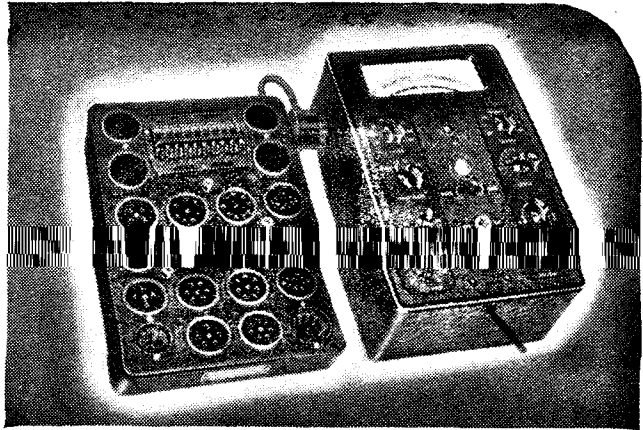

"Avo" Valve Tester with Universal Panel

PRECISION METERS

that Master every Testing Problem

The world-wide use of "AVO" Instruments is striking testimony to their outstanding versatility, precision and reliability. In every sphere of electrical test work—laboratory, shop or out on a job—they are appreciated for their dependable accuracy, which is often used as a standard by which other instruments are judged. There is an "AVO" Instrument for every essential electrical test.

Some delay in delivery of Trade Orders is inevitable but we shall continue to do our best to fulfil your requirements as promptly as possible.



ELECTRICAL MEASURING INSTRUMENTS

BRITISH MADE

● Write for fully descriptive literature dealing with any instrument in which you are interested, and for current prices.

Sole Proprietors and Manufacturers:—

THE AUTOMATIC COIL WINDER & ELECTRICAL EQUIPMENT Co., Ltd., Winder House, Douglas St., London, S.W.1

Phone: Victoria 3404-7.

All-Wave "Avo" Oscillator

"Avo" Test Bridge

Universal AvoMinor

D.C. AvoMinor

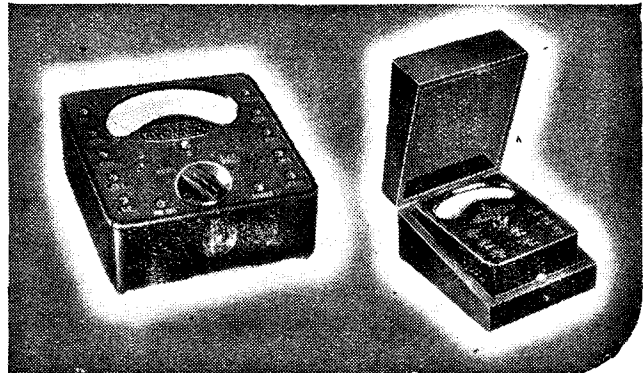
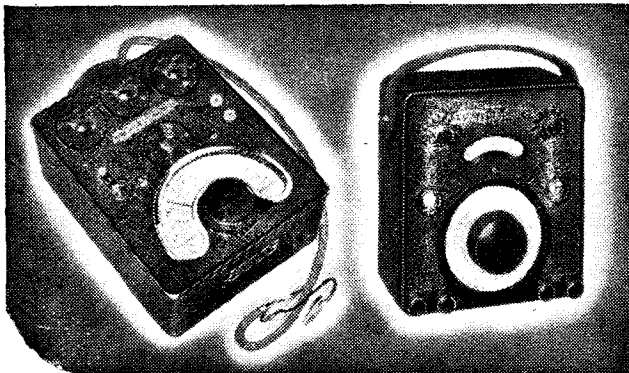

Solder THE MODERN AND SPEEDY WAY

USE ERSIN MULTICORE

THE SOLDER WIRE
WITH 3 CORES OF
NON-CORROSIVE
ERSIN FLUX



- Avoids Dry Joints
- Increases Electrical Efficiency of Joints
- Speedily makes Sound Joints on Dirty or Oxidised Surfaces
- Always Correct Proportions of Flux and Solder
- No Additional Flux Required
- Low Melting Point (190° C. for 60/40 alloys)
- Approved by Air Ministry & G.P.O.
- All-British and acknowledged by the Leading Manufacturers to be the finest Cored Solder in the World.

FREE Two informative publications on soldering have been issued by Multicore Solders Ltd. Executives are invited to send for copies and a free sample of Multicore Solder.

MULTICORE SOLDERS LTD., BUSH HOUSE, LONDON, W.C.2

Telephone: TEMple Bar 5583/4

The stars

look down . . .

. . . upon the sleeping villages and towns of England. Over the peaceful scene the moon mounts guard with watchful eye. Yet, at any given moment, should the necessity arise, the quietest country village can be in instant communication with the greatest city; can command its resources and enlist its help. Our products for many years have served in spreading human happiness and in forging links between men, and to-day we still proudly play our part in maintaining human fellowship.

DUBILIER
CONDENSER CO. (1925) LTD.



Eyes on America

Radio engineering and design in the States has always been of special interest to British Amateurs and at Webb's, American Receivers and components were always available from stock. Now that they can be supplied on priority order only, and there are no English stocks, we can only serve the ordinary amateur by bringing to his notice the latest available items and providing information that will enable him to assess developments there. We illustrate a Hallicrafter Portable Communication Receiver which we feel is indicative of the trend of American design.

WEBB'S RADIO

14 SOHO STREET, OXFORD STREET, LONDON, W.1

Telephone: GERrard 2089. Hours of Business: 9 a.m. to 4 p.m. Sats. 9 a.m. to 12 noon.

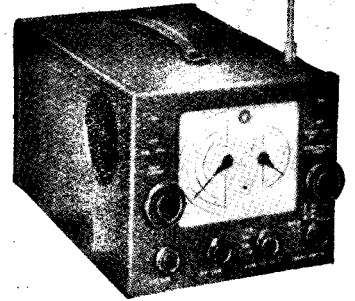

HALLICRAFTER MODEL S.29. SKY TRAVELLER: A truly portable communication type receiver covering from 542 kc. to 30.5 mc. in 4 bands. Operates from its own self-contained batteries or from 240 volt AC or DC mains. The Valve Line-up is: IT4 R.F., IR.5 Mixer, IP5-GT I.F. Amplifiers, IH5-GT 2nd Det., A.V.C. 1st. Audio, 3Q5-GT Output Amplifier, IG4-GT Beat Oscillator, IG4-GT Noise Limiter and 25Z5G Rectifier (9 valves in all). Electrical bandspread. Battery life prolonged through a self-contained charging unit. Self-contained collapsible antenna, which can be extended to nearly 3ft. An R.F. stage used on all bands. Dimensions: 7in. high x 8in. wide x 13in. deep. Weight including all batteries, 18 lbs. Price on application. This instrument is not available from English stock and can only be supplied against Priority Order.

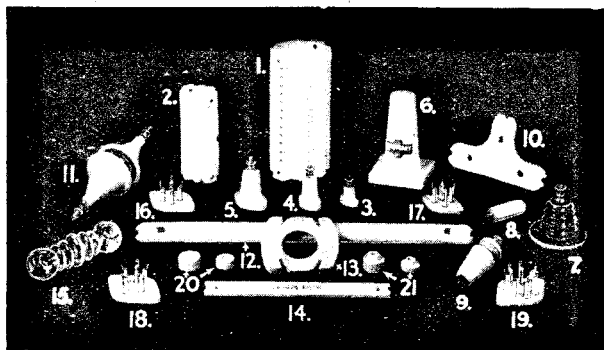

Here are the details of the 21 lines illustrated above:

12. **Type AX.**—12" glazed porcelain insulator with an exceptionally long leakage path and negligible capacity effect, used extensively for trans mitting or where aerial loss must be kept to a minimum.
13. **Type TB.**—Transposition Block, an extremely light ceramic block for transposed feed lines. These will not slip out and are suitable for continuous exposure as supplied to the Cunard White Star Liner "Queen Mary."
14. **Type FS.**—Highly-glazed feeder-spreader giving a 600 ohm line. Light in weight and free from appreciable loss when exposed to atmospheric influences.
15. **Type AG.**—Flint-glass aerial insulator, with an excellent high frequency characteristic and long leakage path.
- 16 & 17. **English Ceramic Valveholders** with silver-plated contacts, both four and five pin.
- 18 & 19. **Ceramic Sockets** with silver-plated contacts for American valves.
- 20 & 21. **Types FTL and FTS.**—Feed-through bushes in ceramic. Type FTL passing a 2BA screw; Type FTS a 4BA screw. Extremely useful for carrying high voltage or R.F. through metal panels.

RAYMART

CRAFT A CREED

INSULATORS AND CERAMIC GOODS

OUR ILLUSTRATION GIVES BUT A SMALL INDICATION OF THE WIDE VARIETY OF INSULATORS AND CERAMIC GOODS AVAILABLE FROM RAYMART WHO CARRY THE LARGEST RANGE OF THESE PRODUCTS IN THE COUNTRY.

1. **Type TFX.**—Coil Form, grooved and ribbed, 2½" dia., 5" of winding space with mounting holes and provision for link or inductive coupling.
2. **Type BTX.**—A similar coil form, 1½" dia. x 3½" long.
3. **Type ST.**—White glazed vitreous porcelain stand-off insulator, fitted with nickel-plated terminals; height excluding terminals ½".
4. **Type SS.**—Similar in all respects; height excluding terminals 1".
5. **Type SM.**—The largest of this type of stand-off insulators, 1½" excluding terminals.
6. **Type SX.**—Heavy stand-off insulator, 3½" high, four-hole fixing, no terminal supplied, but we have sockets specially made to fit.
7. **Types SG and SL.**—Standard beehive insulators; two versions are available—(a) Brown glazed (SG); (b) Unglazed (SL).
8. **Type SP.**—A special low-loss pillar insulator, produced primarily for ultra-high frequency use, the lowest loss insulator ever offered of this type. 1½" long x ½" dia. and internally threaded at both ends 2BA; supplied with screws and cork washers.
9. **Type FTI.**—Double-cone feed-through insulator for feeding H.T. or R.F. through baseboard of chassis, mounting coils, etc. Height above chassis 1½"; below chassis ½". Full insulation provided on chassis up to ½" thick. Supplied with two cork washers and 2BA all-thread with nuts.
10. **Type AT.**—Aerial T Piece, designed to facilitate erection of transposed or zeppelin type aerials.
11. **Type SCL.**—Lead-in insulator or H.F. bushing, provides maximum surface leakage path, highly glazed. Rubber ring washers ensure absolute weather-proof qualities. For especially exposed positions our Type DCL insulator is identical with the SCL, but has at one end an overlapping double cone, so ensuring that no moisture shall form a path on the insulator.

RAYMART
CRAFT A CREED

Government departments—Manufacturers—Servicemen, etc., are invited to send us their inquiries
48, HOLLOWAY HEAD, BIRMINGHAM, 1. Phone: MIDLAND 3254.

*Value proved
by long service*

Osram Valves

MADE IN
ENGLAND

for

BROADCAST RADIO

•

INDUSTRIAL APPLICATIONS

(INCLUDING P.A. SYSTEMS)

•

**ELECTRO MEDICAL
EQUIPMENT**

•

**THERMIONIC INSTRUMENTS
and TEST GEAR**

•

**VITAL COMMUNICATIONS
and WARNING SYSTEMS
ETC.**

THE GENERAL ELECTRIC CO. Ltd.

Magnet House, Kingsway, London, W.C.2

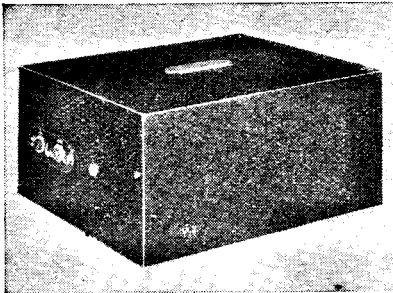

H.T. from L.T.
ACCUMULATORS

A **NEW SELF-CONTAINED RADIO POWER UNIT—THE**

Masteradio

VIBRATORPACK

MODEL 6AHTP for 6 Volts — MODEL 4AHTP for 4 Volts

1—Operates all types of Battery Sets from a "2 Valver" to a "Superhet" without the H.T. Battery replacement problem.

2—Designed for the most economical consumption. Constructed for Constant Output, Reliable Service and Maximum performance.

3—Completely enclosed in Metal Case—smaller than the H.T. Battery it Replaces — attractively finished in Brown Crystalline Enamel.

4—A product of the Leading British Manufacturers of Vibrator Operated Power Supply.

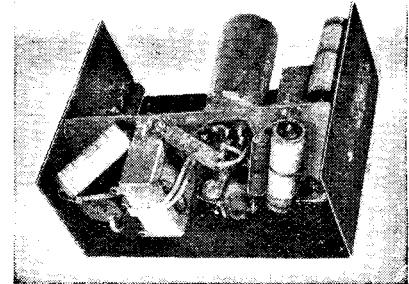

Full instructions for operation and maintenance provided with each unit.

Write for details

MASTERADIO LTD

Vibrant Works, Watford, HERTS.
Telephone : - - - - Watford 9885/9890
Telegrams : - - - - Mastiola, Watford

Continued

● **TENAPLAS** materials are specified on Government contracts because of their excellent dielectric properties, chemical inertness and resistance to water and acids. Full particulars of Tenaplas K and L products will be forwarded on request.

TENAPLAS LTD.
Head Office :
7, PARK LANE, LONDON, W.1.

TENAPLAS
Hand L PRODUCTS

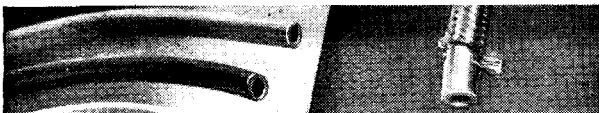

WHARFEDALE
FACTORY SPEAKER

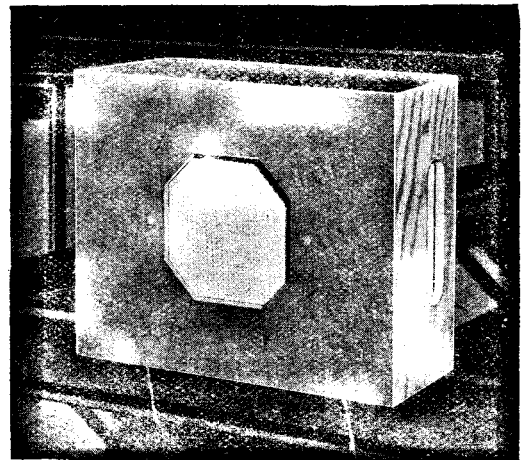

Available with or without Volume Control or Remote Control. REVERSIBLE. Fitted with 8" BRONZE UNIT for 4/5 Watts input, or 10" BRONZE UNIT for 5/6 Watts

WHARFEDALE WIRELESS WORKS

SOLE PROPRIETOR: D. E. BRIGGS
HUTCHINSON LANE • BRIGHOUSE • YORKS
PHONE: BRIGHOUSE 50 "GRAMS: "WHARFEDALE"

F R E Q U E N T I T E

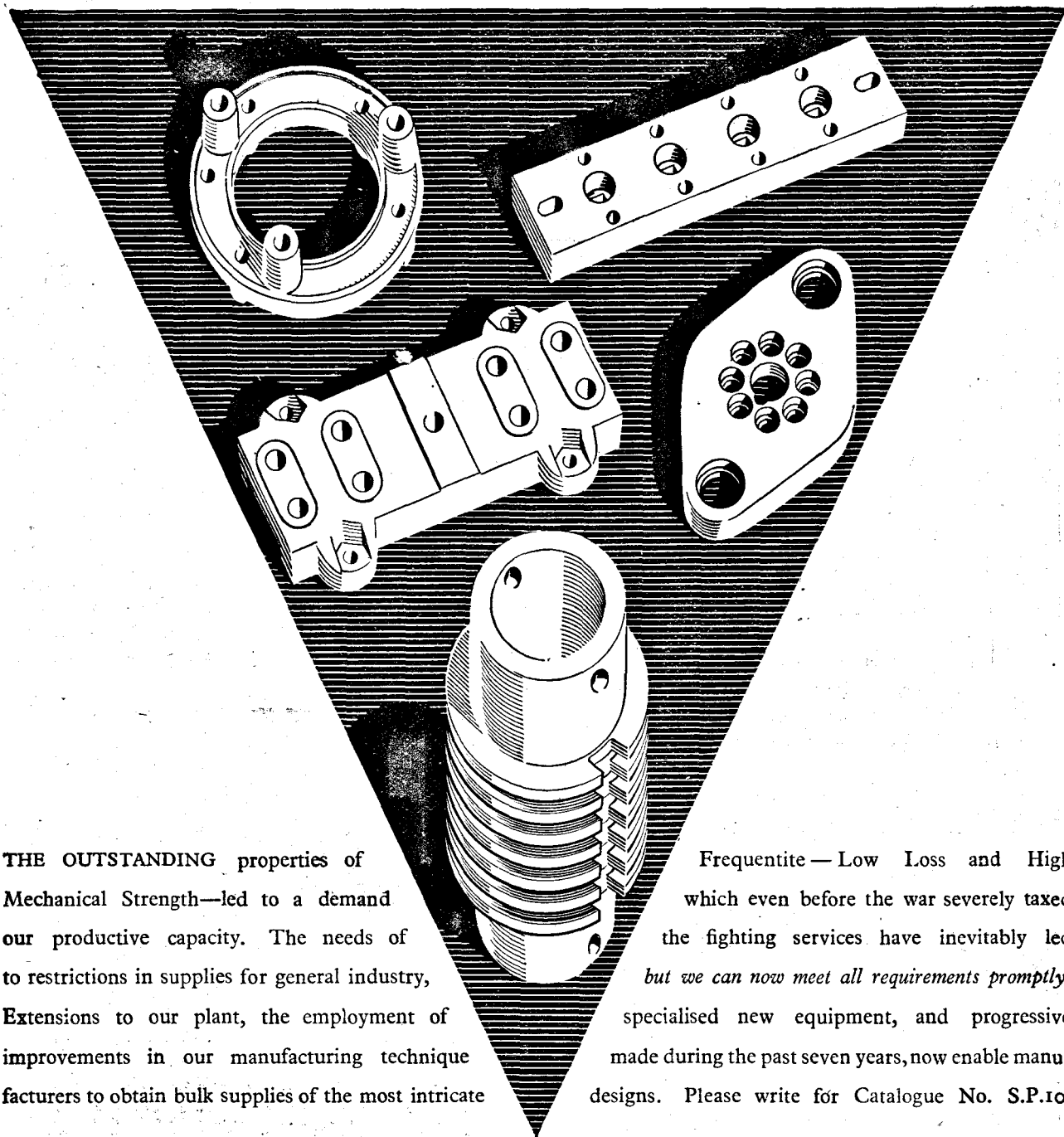

THE OUTSTANDING properties of Mechanical Strength—led to a demand our productive capacity. The needs of to restrictions in supplies for general industry, Extensions to our plant, the employment of improvements in our manufacturing technique facturers to obtain bulk supplies of the most intricate

Frequentite—Low Loss and High which even before the war severely taxed the fighting services have inevitably led *but we can now meet all requirements promptly.* specialised new equipment, and progressive made during the past seven years, now enable manu- designs. Please write for Catalogue No. S.P.10.

The Pioneer British-Made Low Loss Ceramic

STEATITE & PORCELAIN PRODUCTS LTD.

Head Office and Works :

STOURPORT - ON - SEVERN, WORCS.

Telephone: Stourport 111.

Telegrams: Steatint, Stourport.

SP.3



Links in the chain of Success

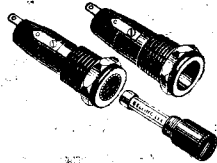

PANEL FUSEHOLDER. Where it is desirable to fit a fuse behind a panel, yet retain accessibility, this holder is indispensable; moulded in Bakelite, single hole fixing, bushed from panel, coin slot in carrier. Soldering spills are provided for easy connecting. With 1 amp. fuse or as required.

Other Belling-Lee Activities

Terminals up to 100 amps., plugs and sockets up to 10-way, fuses 60 m/a. up to 300 amps., fuseholders, valve-holders up to 12,000 volts, screened couplers, thermal cut-outs, interference suppressors, screened rooms and cabinets, anti-interference aerials, dipoles and speciality feeders.

BELLING & LEE LTD
CAMBRIDGE ARTERIAL ROAD, ENFIELD, MIDDX

G.P.2828

TRANSFORMERS

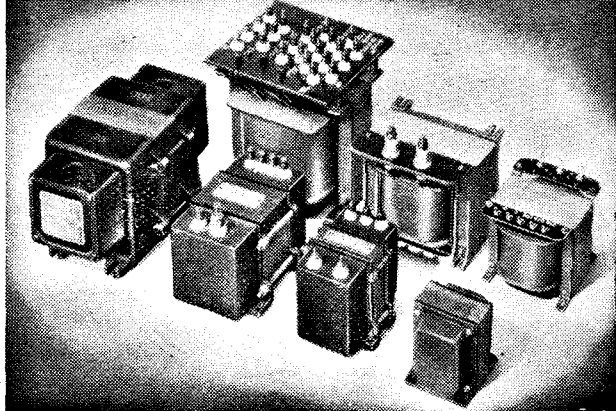

of every type for every purpose

Woden supply all types of transformers, including stripped, fully shrouded, and special types built to specification. Special impregnating and dehydrating processes safeguard reliability. Punctual delivery ensured on priority work.

WODEN TRANSFORMER CO.
Thornley St., Wolverhampton
Tel.: Wolverhampton 22829.
MAKERS OF TRANSFORMERS, POWER PACKS, AND SPECIAL RECEIVING AND TRANSMITTING APPARATUS.

M.R. SUPPLIES

present to-day's greatest opportunity in MICROPHONES and ELECTRO-TECHNICAL EQUIPMENT. All goods brand new, perfect and guaranteed. All prices nett.

NEW & EXCLUSIVE!

ROTHERMEL-BRUSH PIEZO-CRYSTAL MICROPHONES
(see illustration).

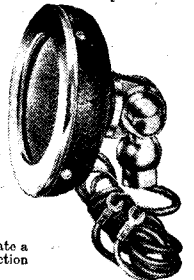

A model of really outstanding performance and appearance, incorporating the latest piezo-electric generating agent producing a level response to about 8,000 c/s. Output level—60 db. In handsome satin-black housing with chromium bezel and knuckle-joint for angle adjustment. Mounting thread is 1/8" (26). Complete with 6 ft. screened lead.
72/6 nett

We are already receiving many recent orders and anticipate a ready sale for the limited number available. Instruction leaflet sent with each.

G.E.C. MINIATURE MICROPHONES.—Transverse current model of precise instrument finish, approx. 1 1/2 in. square. Provided with clip for lapel use, 8 ft. lead and plug-connector. These remarkable little instruments are a revelation in performance. (List price 55/-). Very few now left at 39/6.

MICROPHONE/SPEAKER UNITS.—High efficiency model with excellent frequency response. Dia. 3 in., fitted weighty high-flux alnico magnet. Imped. 12-ohms. Perfect for intercom. systems, public address and as extension speaker. One of our most popular offers, 18/6.

HIGH-FIDELITY OUTPUT TRANSFORMERS.—Further supply available at time of going to press. Model "A," exact "W.W." spec, providing 11 ratios from 12/1 to 75/1 with C.T. for P.P. 42". Model "B," super-fidelity "W.W." report gives response level 20/20,000 c/s. Ratios, 18/1, 24/1, 36/1 and 72/1—all push-pull—and other ratios for straight outputs. Weight, 10 1/2 lbs. Finest Output Transformer extant, 59/6. (We regret unavoidable slight increases.)

HEAVY DUTY STEP-DOWN TRANSFORMERS.—Varied selection of high-class transformers available. Example—Prim. 220/240 v., secondary 25v., 10 amps. (Weight, 21 lbs.), 70/- (plus 2/6 pt. carr.). For low-voltage safety lighting, etc. List of others submitted on request.

HEAVY DUTY METAL RECTIFIERS.—D.C. delivery, 12/14 v. 6 amps., 35/-, also D.C. delivery 12/14 v. 10 amps. 47/6. These require A.C. input of about 16 v. **STEP-DOWN MAINS TRANSFORMERS** for above. Prim. 200/250 v., sec. tapped for 6 and 12 v. charging at 6 amps., 39/6.

ELECTRIC SOLDERING IRONS.—200/250 v. Domestic model with airtight element (guaranteed one year). Flat bit or pointed bit, 11/8.

SLIDING RHOOSTATS.—(100-watts capacity). Fully enclosed with bushed cable entry and laminated brush contact. Positive smooth action. Following range:—4-ohms 5-amps., 10-ohms 3-amps., 50-ohms 1.4 amp., 100-ohms 1-amp., 200-ohms 0.7-amp., 400-ohms 0.5-amp. Any one, 17/6.

BATTERY CHARGERS.—200/250 v. A.C. fitted metal rectifier. For charging 2, 6 and 12 volt batteries at 1.5 amp. Sturdily made in perforated metal cabinet arranged for table use or wall mounting. Excellent source of LT/DC supply for other purposes, 50/-.

M.R. SUPPLIES, 68, New Oxford St., London, W.C.1

Telephone: MUSeum 2958

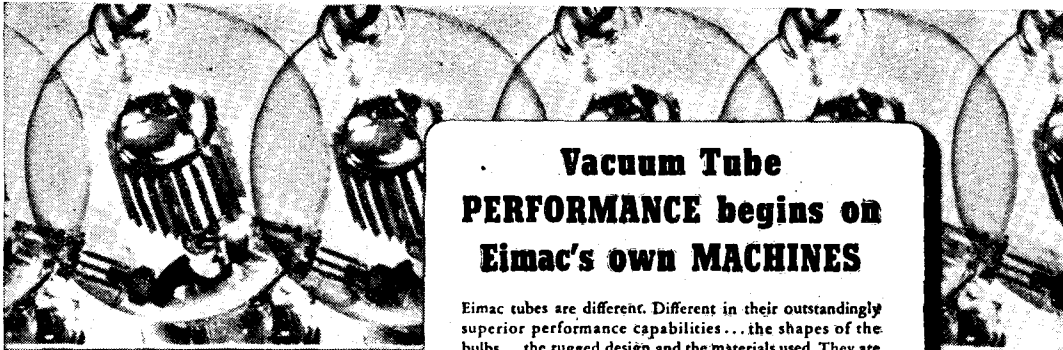

**Vacuum Tube
PERFORMANCE begins on
Eimac's own MACHINES**

Eimac tubes are different. Different in their outstandingly superior performance capabilities... the shapes of the bulbs... the rugged design and the materials used. They are the only tubes on the market which are unconditionally guaranteed against premature failures which result from gas released internally.

So exacting are the production requirements for Eimac tubes that the tools are specially made in the Eimac factory. The glass lathes... the vacuum pumps... there's many a "gadger" so unusual that procurement from a conventional tool maker is impossible.

Follow the leaders to

Eimac
TUBES

Eitel-McCullough, Inc.
San Bruno, Calif.

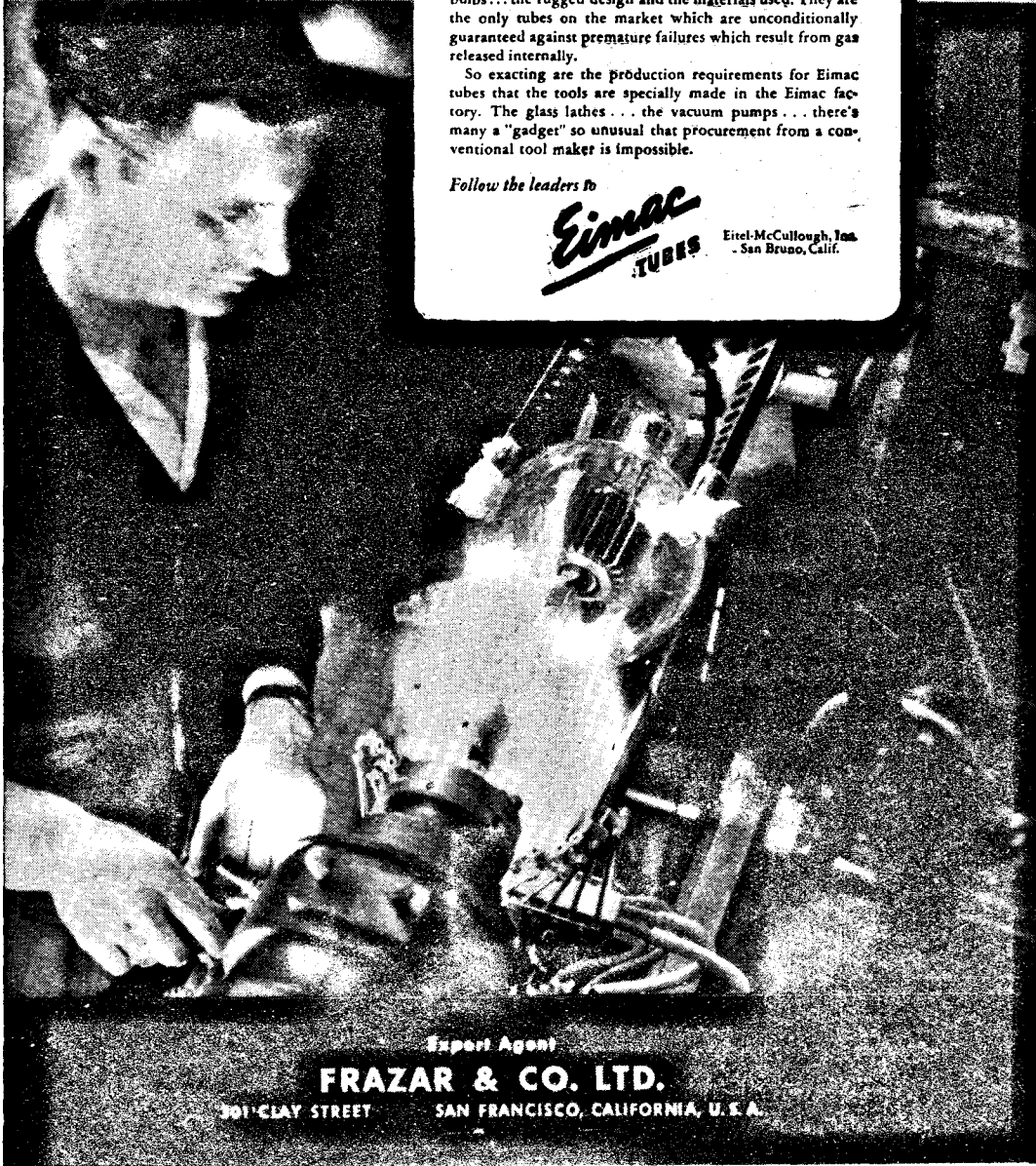

Expert Agent

FRAZAR & CO. LTD.

301 CLAY STREET

SAN FRANCISCO, CALIFORNIA, U. S. A.

BATTERY CHARGERS

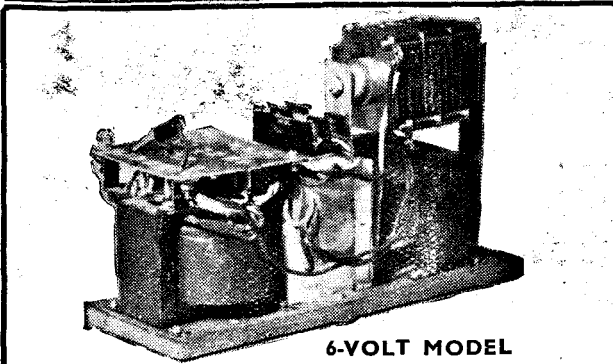

6-VOLT MODEL

A new delivery of these well-made Heavy Duty Battery Chargers is just to hand. Built of first class components with Metal Rectification and mounted on solid base board, as illustrated. Input 200/245 volts A.C. Output 1½ amps. at 6 v. **PRICE 35/- EACH**

● **SMALL TRICKLE CHARGERS** ●

These Chargers have metal rectification. Input 200-220v. A.C. Output 2v. ½ amp. Reliable and Shockproof. Price 17/6. Similar to above but in metal case for mounting. Price 19/6.

BAIRD TELEVISION RECEIVERS

MODEL T 26 — In Console Cabinets — BRAND NEW

Here is an excellent opportunity! Every receiver is in perfect working order. Cabinet dimensions 3 ft. 4 in. high, 20 in. wide, 17 in. deep. Picture screen size 10 in. by 8 in. Pick-up sockets are fitted enabling it to be used as a Gramophone Amplifier. Extra loudspeaker sockets. 14 valves.

Simple to operate. Only two main controls, one for picture contrast and the other for sound broadcast. The Vision Receiver is a straight set with 2 R.F. stages, diode detector and one V.F. stage with secondary emission valves.

Price **£38.10.0** Carriage extra

RADIO EQUIPMENT

MAINS TRANSFORMERS. Originally made for Television Power Packs where accuracy and robustness are essential. Weight 12lb., size 5½ in. x 4½ in. overall 350-0-350 v. 120 m.a. Tapped. 4 v. 2 a.; 4 v. 8 a.; 8 v. 3 a. 20 v. 1 a. Diagram free. Post and packing 1/6.
HEAVY DUTY MAINS TRANSFORMER. Input 240 v. A.C. One tapping at approx. 5,000 v. max. 20 m.a., and one for supplying filament of Mullard HVR 2 (6.3 v. at 65 amp.). Shrouded in metal box. Car. fwd. Also input 200-250 v. A.C. approx. 6,500 volts. Shrouded in metal box. Car. fwd.
ROLA ENERGISED SPEAKERS 10in. 300 ohms. Pentode output transformer to suit, 5/6
GOODMAN'S 8in. P.M. Speakers, brand new, boxed, complete with universal transformer. Each 22/6
B.I. CONDENSERS. 1 x 1 mid. 7,000 volts D.C. test with porcelain insulators 20/-

PLEASE NOTE

- **ALL COSSOR C.R. TELEVISION IS SOLD** ●
- You should order only from current advertisement, as many lines soon go out of stock ● No orders can be sent C.O.D. ● Orders cannot be accepted from Eire or Northern Ireland ● Postage must be included with all orders.

See also our Classified Advertisement on page 20.

LONDON CENTRAL RADIO STORES

23, LISLE STREET — LONDON, W.C.2

Phone: GERrard 2969.

38 RANGE UNIVERSAL TAYLOR-METER

This improved Taylor Model 90 instrument is soundly constructed and carefully adjusted to give accurate measurements over a very wide range. It is particularly suitable for all Radio and Electrical measurements:

TAYLOR MODEL 90
Sensitivity: 1,000 ohms per volt on all voltage ranges.

38 RANGES!

- (7) D.C. Volts from 0-0.25 to 1,000v.
 - (6) A.C. Volts from 0-2.5 to 1,000v.
 - (5) Output from 0-2.5 to 500v.
 - (5) D.C. Current from 0-1 mA. to 2.5 Amps.
 - (5) A.C. Current from 0-1 mA. to 2.5 Amps.
 - (3) Resistance from 1 ohm to 1 megohm with internal battery.
 - (1) 1,000 ohms to 10 megohms with external 60 volt battery.
 - (6) Decibels from -22 db. to +60 db.
- Meter. 5 Scales covering A.C. and D.C. Measurements and also Ohms and Decibels.

Scale Length Outer scale is 3½ ins. long. Further details on request.

BRITISH MADE. GUARANTEED 6 MONTHS.

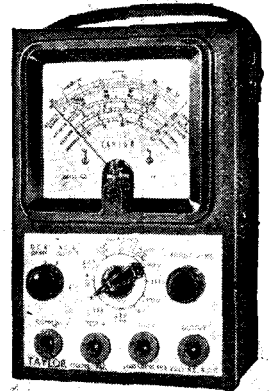

TAYLOR MODEL 90
£11-11-0

Supplied complete with leads and test prods internal battery and instruction book.
NOTE:—Control panel; all markings are engraved in white on black case.

TAYLOR ELECTRICAL INSTRUMENTS LTD.
148a, High Street, Slough, Bucks.
Telephone SLOUGH 21383.



and there **★**
is where you'll find

DELARON LAMINATED MATERIAL

On guard at many strategic points of Insulation stands "DELARON"—a High-grade Laminated Material in Fabric and Hard Paper Sheets which are supplied in Air Ministry and Ministry of Supply approved grades. Panels and strips gladly cut to order. Fulllest information, samples and prices on request.



5, Regent Parade, Brighton Road, Sutton, Surrey.
Tel.: Vigilant 4472.



...get a good job in the Army!

Interesting work — good conditions — *good pay* — they're all waiting for you if you have a knowledge of radio, or aptitude for training. The Royal Army Ordnance Corps wants men, and wants them urgently, for the installation, maintenance and repair of Radio and Radiolocation Equipment. There are good opportunities for promotion from the ranks. And there is this further advantage — if in civil life you are a radio expert, you can return to your job after the war with a first-hand knowledge of all the very latest developments in radio. (N.B. Even though you are unskilled, this is still your opportunity. You will be given a thorough training at a

Civilian Institute on full pay.) Britain's Radio defences must be kept in 100% working order. That's why you must volunteer TODAY. These are the vacancies:—

	<i>Pay and Allowances</i>	
	SINGLE	MARRIED
Ordnance Mechanical Engineers (Wireless)	£431 p.a.	£504 p.a.
Radio Maintenance Officers - -	£330 p.a.	£460 p.a.
Armament Artificers (Radio) - -	10/3 per day	
	plus clothing, rations, accommodation and family allowance)	
Radio Mechanics (commencing at)	3/9 per day	
	(plus clothing, rations, accommodation and family allowance)	

POST THIS COUPON AT ONCE

To the Assistant Director of Mechanical Maintenance, The War Office (MMI), Room 206, Golden Cross House, Duncannon Street, London, W.C.2.

Please send full details of Wireless Positions in the R.A.O.C

NAME

ADDRESS

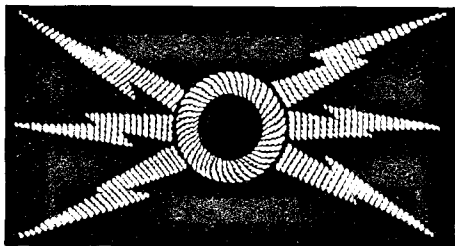



Mañana

MANUFACTURING methods which are "good enough" to-day will not get by to-morrow. The tempo of industry is accelerating. In this change of outlook and method the Simmonds Organization is playing a vital part. In the aeronautical world, in the motor industry, throughout engineering and in numberless other fields of industrial activity, Simmonds products have wrought revolutionary economies. Each represents the biggest advance to date in its particular field. Collectively they impinge upon the activities of practically every industrial undertaking in the country. The Simmonds Information Centre, established with the express purpose of assisting in the solution of all manner of problems involving the speeding-up of output and the reduction of costs, is constantly being consulted by the managements of concerns alive to the increasing demands upon production. The Simmonds Information Centre is at your service now.

S I M M O N D S

THE SIMMONDS "SIA" NUT
 SIMMONDS-CORSEY CONTROLS
 SIMMONDS CONTENTS GAUGES
 FOR AIRCRAFT.
 SIMMONDS POSITION INDICATORS
 SIMMONDS ELECTRIC TEMPERATURE
 AND PRESSURE GAUGES
 SIMMONDS AIRCRAFT FLOORING



SPIRE "SIA" NUTS
 FRAM OIL & ENGINE CLEANER
 SIMMONDS INDUSTRIAL AND
 MARINE CONTENTS GAUGES
 SIMMONDS JOINTING COMPOUND
 SIMMONDS CRYSTAL UNITS
 SIMMONDS-GOUDIME
 NAVIGATIONAL INSTRUMENTS

SIMMONDS AEROCESSORIES LTD

A COMPANY OF THE SIMMONDS GROUP
 LONDON · MELBOURNE · PARIS · NEW YORK

P.L.

ALL ENQUIRIES TO GREAT WEST ROAD, LONDON.

The Wireless World

32nd Year of Publication
 Covering Every Wireless Interest

FEBRUARY 1942

Proprietors :
 ILIFFE & SONS LTD.

Managing Editor :
 HUGH S. POCOCK.

Editor :
 H. F. SMITH.

Editorial, Advertising
 and Publishing Offices :
 DORSET HOUSE,
 STAMFORD STREET,
 LONDON, S.E.1.

Telephone:
 Waterloo 3333 (35 lines).

Telegrams:
 "Ethaworld, Sedist, London."



**PUBLISHED
 MONTHLY**

Price : One Shilling

(Publication date 20th
 of preceding month)

Subscription Rate
 Home and Abroad
 14/- per annum

EDITORIAL	25
CARRIER CURRENT COMMUNICATION. By J. S. Forrest, M.A., B.Sc., F.Inst.P.	26
THE INDUSTRY IN WARTIME	29
STEREOSCOPIC COLOUR TELEVISION	31
CONSTANT VOLTAGE SUPPLY. By T. A. Ledward, A.M.I.E.E.	33
UNBIASED. By Free Grid	36
THE WORLD OF WIRELESS	37
NEWS IN ENGLISH FROM ABROAD	39
IN-PHASE AMPLIFIER. By R. C. Whitehead	40
THE MIRRORPHONE	42
RANDOM RADIATIONS. By "Diallist"	44
LETTERS TO THE EDITOR	45
CURING INSTABILITY. By James Gibbons	48
RECENT INVENTIONS	50

Branch Offices :
 COVENTRY :
 8-10, Corporation Street.
 Telephone : Coventry 5210.
 Telegrams : "Autocar, Coventry."

BIRMINGHAM :
 Guildhall Buildings,
 Navigation Street, 2.
 Telephone :
 Midland 2971 (5 lines).
 Telegrams :
 "Autopress, Birmingham."

MANCHESTER :
 260, Deansgate, 3.
 Telephone :
 Blackfriars 4412 (4 lines).
 Telegrams :
 "Iliffe, Manchester."

GLASGOW :
 26B, Renfield Street, C.2.
 Telephone : Central 4857.
 Telegrams : "Iliffe, Glasgow."



As many of the circuits and
 apparatus described in these
 pages are covered by patents,
 readers are advised before
 making use of them, to satisfy
 themselves that they would
 not be infringing patents.

U.I.C.

CONDENSERS & COMPONENTS For Modern Radio Technique

- 1 CERAMIC PEARL TYPE CONDENSERS
- 2 CERAMIC COIL FORMERS
- 3 SILVERED MICA (Tropical Type) CONDENSERS
- 4 POT CONDENSERS
- 5 FIXED CERAMIC CONDENSERS
- 6 CERAMIC TRIMMER CONDENSERS

Full details and advice gladly given.

CONTRACTORS TO G.P.O. & GOVERNMENT DEPARTMENTS.
 ON A.I.D. APPROVED LIST.

UNITED INSULATOR CO. LTD.

12-20, LAYSTALL ST., LONDON, E.C.1

Phone : TERminus 7383.

Grams : "CALANEL, SMITH LONDON."

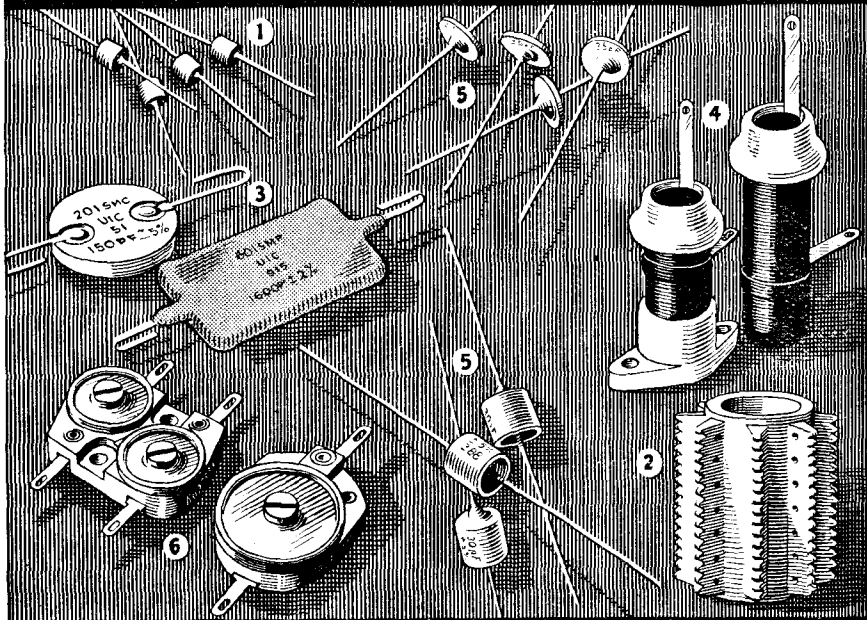

The Pioneers of Low Loss Ceramics



Threes and Fives

If the problems of to-day, and their solution, followed the simple sequence of a game of dominoes, life would be comparatively easy. But we move in a bustling world. A world of constant change and ever-quickenning tempo where . . . it isn't all 'threes and fives'. So,

in the unceasing search for new developments, and the restless urge for faster progress, Mullard technicians are overcoming many difficulties . . . and the results of their labours will be truly appreciated in the years which lie ahead.

MULLARD

THE MASTER VALVE

TRANSMITTING AND RECEIVING VALVES FOR COMMUNICATIONS · BROADCASTING
TELEVISION · SOUND AMPLIFICATION · ELECTRO-MEDICAL EQUIPMENT · INDUSTRIAL EQUIPMENT

THE MULLARD WIRELESS SERVICE CO., LTD., CENTURY HOUSE, SHAFTESBURY AVENUE, LONDON, W.C.2

The Wireless World

COVERING EVERY
WIRELESS INTEREST

ESTABLISHED
1911

Vol. XLVIII. No. 1076

FEBRUARY, 1942

Price One Shilling

Inter-Allied Broadcasting

A Plea for Reorganisation

NOW that the majority of decent freedom-loving folk throughout the world are united as active participants in the struggle against the aggressor nations, it seems opportune to consider whether the time has come for a drastic overhaul of the system of international short-wave broadcasting that has served us—sometimes well and sometimes not so well as it might have done—during the first two years or so of the war.

That circumstances have changed will at once be obvious. The need for convincing potential allies of the justice of our cause has largely disappeared. There remains, of course, the need for propaganda to the peoples of the enemy countries and occupied territories, but, apart from that, the main function of international broadcasting is now to cement friendship between the United Nations; to explain our various points of view to each other, and, above all, to pave the way for the kind of post-war co-operation that will lead the way to a New World Order so different from anything Hitler has to offer.

Improved B.B.C. Services

Few will deny that the B.B.C. Overseas Service has greatly improved during the past year, both with regard to programme content and technical organisation. But the sweeping changes that might have been expected on the entry of the United States and Japan into the war have not yet taken place, although it must be admitted that some details of programme make-up have been appropriately changed.

Of course, this matter of inter-allied broadcasting must be a two-way affair, and specially beneficial results are likely to result from exchanges between the two great English-speaking nations. There is almost unlimited scope for showing the real Britain

to the real America—and vice versa. Broadcasting, with its vast potentialities in the way of living actuality, has advantages over the cinema film and the written word that should be exploited with imagination, courage, and in the spirit of democracy.

Careful study of ionosphere conditions plays an important part in the organisation of long-range broadcasting services. That should be obvious, but the choice of wavelengths could sometimes be happier. Recently there have been indications that broadcasts from the United States to this country would have been better received during the early evening if transmitted on longer wavelengths.

Importance of Timing

There is also the question of time. The organiser of international broadcasting must keep a watchful eye on the world clock and arrange times of transmission so that the more important programmes are receivable at times when the majority of listeners are free to hear them. Many of the American broadcasts for Britain at present come to an end too early in the evening. Clashing of time between home news bulletins and those from overseas must also be taken into account and avoided wherever possible by co-operative planning.

Neither we nor our allies possess an unlimited number of channels nor of broadcasting stations. It is particularly difficult to make the fullest possible use of directional transmission in all the circumstances where it would help to ensure good coverage. All these factors stress the need for considering, on the broadest inter-allied basis, the possibility of reducing those services that are unproductive and strengthening those that give promise of helping to win the war—and the peace.

Carrier Current Communication

"Wired Wireless" Over High-voltage Power Lines

RECENT articles have dealt with wire broadcasting systems, and in particular with the distribution of programmes at carrier frequencies over the low-voltage electric supply mains. Carrier currents are often superimposed on high-voltage power transmission lines for communication purposes, and it is thought that a brief account of this subject will be of interest.

It is rather paradoxical that from some points of view a high-voltage power line is almost an ideal communication line. The desiderata for communication circuits are: low resistance, low capacitance, high insulation resistance; a high-voltage power line fulfils all these requirements. The resistance must be low in order that heavy currents can be carried without excessive losses; the capacitance is low as large conductor spacings must be used at high voltages, and similarly the high voltage necessitates a high level of insulation. In the operation of high-voltage power networks communication facilities are essential for many purposes, e.g., telephone communication is necessary for control and maintenance, while communication channels are also required for the remote indication of switch positions and meter readings, and for the remote control of switching and generating stations. In addition, for certain types of automatic line protection it is necessary to transmit some form of signal from one end of the line to the other in order to ensure that, if a breakdown occurs, the faulty section of line will

By J. S. FORREST, M.A.,
B.Sc., F.Inst.P.

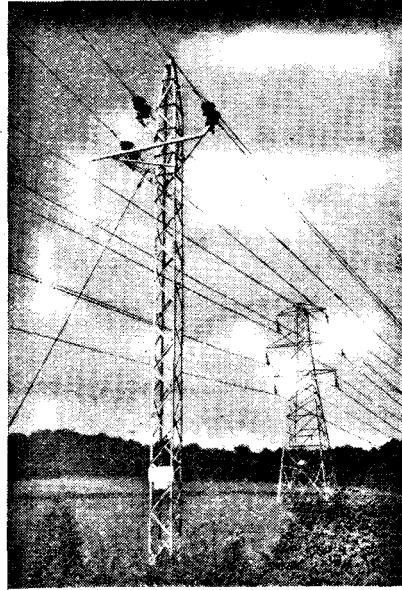

Carrier currents for communication and control purposes can be superimposed on high-voltage power lines. The photo shows 33- and 132-kilovolt lines.

be automatically isolated by the controlling circuit-breakers with a minimum of disturbance to the remainder of the system. It is natural, therefore, that power companies should utilise high-voltage lines for communi-

cation purposes by superimposing the communication signals at carrier frequencies on the power line. Carrier frequencies in the range of 50-150 kc/s are suitable for this purpose, so that a power line is potentially an eleven-channel communication circuit

long lines, however, say over 50 miles, carrier currents provide very economical and reliable communication channels, and a carrier current installation should be regarded as an essential accessory to a modern power transmission line.

The basic principles underlying the application of carrier currents to high-voltage lines are shown in Fig. 1. The carrier current apparatus (HF) is similar to that employed in ordinary telephone practice and is coupled to the power line (L) by high-voltage coupling condensers (C). The power transformers (T) and switchgear (S) at the terminals of the line have an appreciable capacitance and a correspondingly low impedance at carrier frequencies, so it is necessary to connect high-impedance tuned circuits or wave traps (Z) in the power line to prevent excessive carrier current losses.

The coupling condensers (C in Fig. 1) usually have a capacitance of 100 μF . It is essential that the coupling condensers should have a high factor of safety as a breakdown would involve the interruption of the power supply as well as of the carrier current communication. The condensers must be designed to withstand continuously the full line-to-earth voltage of the power system in addition to voltage surges, which may amount to several times this value. Also, the condensers are installed outdoors and must withstand the application of these voltages under all weather conditions. The condensers are normally of the oil-immersed paper dielectric type, and are assembled in a porcelain weather shield. For high voltages several units are connected in series. A photograph of a condenser of this type on a 220-kV system was given on page 8 of the January issue of *The Wireless World*. For use on the 132-kV Grid system in this country three units are connected in series, and the complete condenser withstands a pressure test of 300 kV for one minute. High-voltage coupling condensers having porcelain dielectric have been made in Germany and the United States, but have not been so widely applied as the oil impregnated paper type.

The line trap (Z) consists of an air-cored inductance tuned to the carrier frequency by a mica dielectric con-

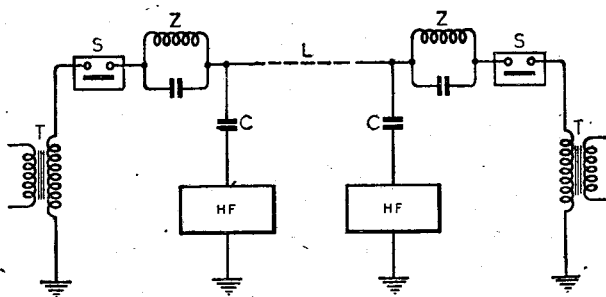

Fig. 1. How carrier currents are superimposed on a high-voltage line.

—assuming 10 kc/s spacing between channels. The cost of the high-voltage equipment necessary to couple the carrier apparatus to the line is high, so that carrier current communication is seldom used on very short lines. On

www.americanradiohistory.com

denser. The inductance must be designed to carry the full load current of the power line and must, in addition, withstand the stresses due to heavy short-circuit currents, say, 5,000 A, which may occur under fault conditions on the power system. The parallel tuning condenser must be provided with some form of surge protection, as high voltages are imposed on this condenser by steep-fronted travelling waves on the line. The line traps are usually suspended from the sub-station structure at the terminals of the high-voltage line, but a form of construction has been introduced in this country in which the line trap and coupling condenser are assembled in a single unit.¹ A complete line coupling unit of this type for a 132-kV system is shown in Fig. 2; the overall height is about 15ft. It should

Fig. 2. Carrier coupling unit for a 132,000-volt system. A, connection to sub-station; B, line trap; C, connection to line; D, 3-unit coupling condenser; E, pedestal housing filter and protective circuits.

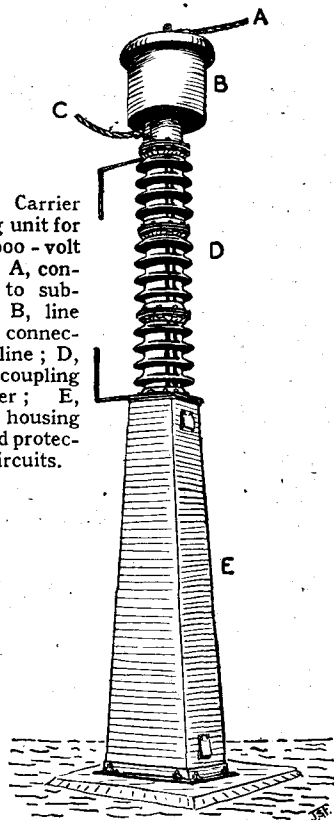

be noted that any intermediate switching or transforming stations in the line must be by-passed at carrier frequency by means of further high-voltage line-coupling equipments.

The system shown in Fig. 1 is for transmission between one conductor and earth, but as three-phase conductors are always available, the carrier equipment is often coupled to two

phases of the power line, as shown in Fig. 3. Such a system necessitates twice as many coupling condensers and wave traps but possesses the following advantages. The transmission efficiency is rather higher and interference from external sources is much reduced; it follows therefore that the radiation of the carrier frequency from the line is also reduced. Another advantage of the two-phase system is that communication can be maintained even if

Fig. 3. Carrier current coupling between two phases of a three-phase system.

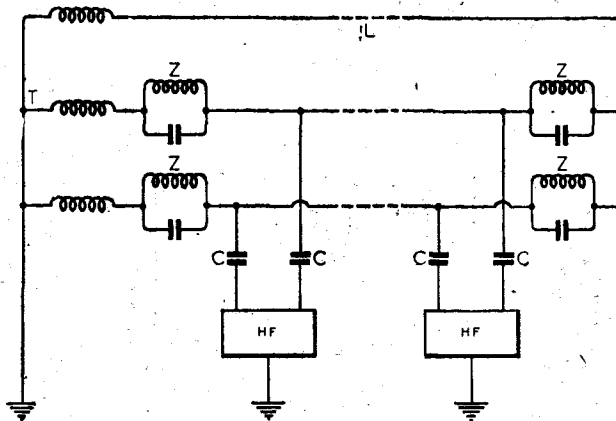

one of the phases to which the carrier equipment is coupled is broken. In the case of the single-phase system, if the phase transmitting the carrier is broken, communication is interrupted. The necessity for using twice the number of line coupling equipments in the two-phase system is not always a disadvantage, as coupling condensers may in any case be available on all three phases for other purposes, such as providing voltage supplies for metering and automatic protection equipment.

For the case in question the inductive reactance at carrier frequencies is large compared with the line resistance, and the leakage resistance is high compared with the capacitive reactance, so that the attenuation constant is given by

$$\alpha = \frac{R}{2Z_0} + \frac{GZ_0}{2}$$

where R is the line resistance per mile at carrier frequencies,

G the leakage conductance per mile

and $Z_0 = \frac{\sqrt{L}}{C}$ the characteristic impedance,

L being the line inductance and C the line capacitance.

The power loss is then 8.7α db./mile.

Considering, for example, two phases of a 132-kV line at 100 kc/s—the DC resistance is 0.5 ohm/loop mile, and the resistance at 100 kc/s is approximately twenty-five times this value, or 12 ohms/loop mile. The characteristic impedance is 750 ohms, so that neglecting leakage (G=0), the power loss is 0.07 db./mile. For

single-phase and earth transmission the characteristic impedance is 450 ohms and the resistance approximately 9 ohms/mile, giving a value of 0.09 db./mile for the power loss.

The power loss is therefore very low in the case of overhead high-

voltage lines, but serious difficulties are experienced if the line contains a section of underground cable. Cable sections are sometimes inserted in overhead lines at road crossings or at the line terminals where the line enters a built-up area. The characteristic impedance of the cable is approximately a tenth of that of the line, so that the attenuation is greater, but a more serious difficulty is that very high losses occur due to reflection at the junction of the cable and the line. For this reason carrier currents cannot be used on power lines containing several sections of underground cable.

Interference Problems

Another difficulty in the application of carrier current to power lines is due to the high noise level. The noise is caused by radio interference due to spark discharges on the power line insulators. Interference of this type occurs over a wide range of frequencies and is relatively intense in the frequency band employed in carrier current technique. Even in dry weather the interference is appreciable, and in humid weather or in fog the line noise may increase to one hundred times the dry weather value. In addition to line noise due to discharges on the insulators, momentary interference is caused by the operation of isolating and earthing switches and oil circuit-breakers on the power system owing to the occurrence of arcing at the switch contacts.

The carrier current apparatus does not differ essentially from that employed in low-voltage carrier current

¹ T. W. Ross and C. Ryder. *J.I.E.E.*, 1938, Vol. 83, p. 228.

Carrier Current Communication— practice. The essential requirement is that an adequate signal/noise ratio is obtained at the receiver under all conditions. The transmitter power and

usually provided in the anode circuit of each valve in order to give an indication of valve failure, while means are incorporated for the approximate measurement of the mutual conduct-

being applied to the amplifier, and a demodulator and speech amplifier are added to the receiver. Modulators and demodulators of the metal rectifier type are used in accordance with normal telephone practice. As only one frequency is available, the telephone channel is one-way or Simplex, i.e., the operator must change over manually from send to receive as in radio telephone practice. Another method is to effect the change-over automatically by means of voice-operated circuits which put the carrier on the line and block the receiver when transmitting, and *vice versa*. The number of facilities available on single carrier frequency apparatus can be increased still further by making use of modulated frequencies outside the speech frequency band. The useful audio frequency band is, say, 50-2,500 cycles, while satisfactory telephony can take place within a band of 200-2,200 cycles, so that, by using filter circuits several additional audio frequency signals can be transmitted below and above the speech frequencies. Such signals may be used for the remote indication of meter readings and other purposes. Carrier equipments with two or more carrier frequencies are in common use, and for Duplex or two-way telephony different carrier frequencies are used for the "Go" and "Return" circuits. Installations having two or more carrier frequencies, however, have the disadvantage of requiring more complicated carrier equipment and filter circuits. In addition, line traps must have a high impedance at all the carrier frequencies used. It is for this reason that there is a tendency to obtain as many facilities as possible with a single carrier frequency.

On the European continent carrier current communication is widely ap-

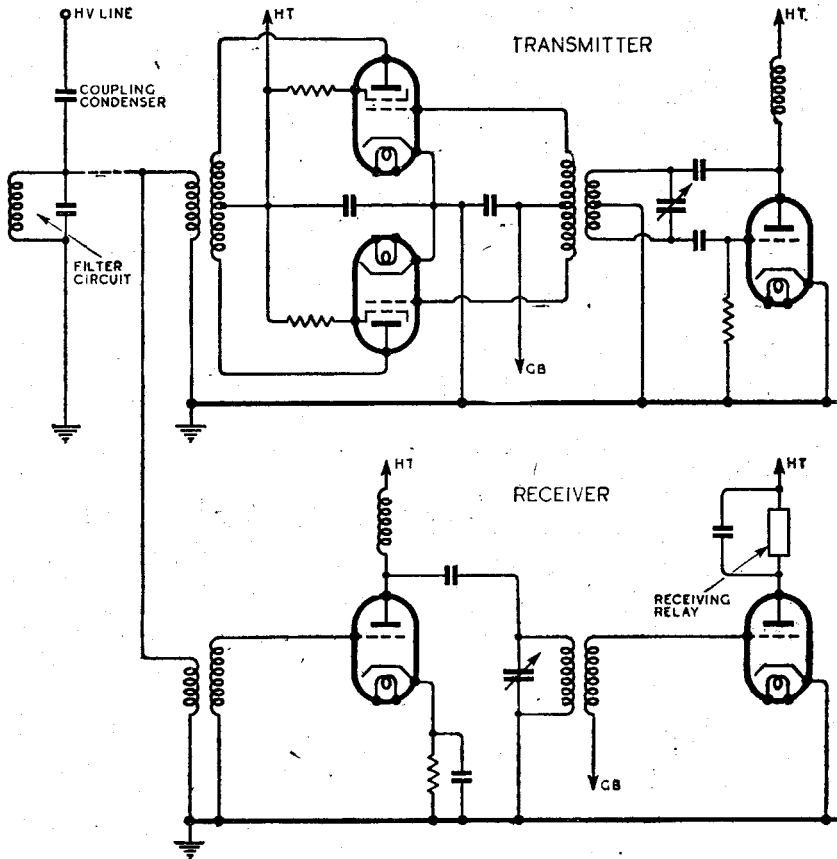

Fig. 4. Schematic diagram of a simple form of "wired wireless" transmitter and receiver.

the receiver sensitivity are fixed on this basis from a consideration of the line noise and the attenuation in the line and coupling equipments. The simplest type of installation is the single-frequency transmitter and receiver used for the transmission of unmodulated signals in connection with automatic protective gear, as mentioned in the first part of this article. A schematic diagram of an equipment of this type is shown in Fig. 4. The transmitter consists of a Hartley master oscillator and a push-pull amplifier having an output of about 10 W; receiving-type valves are used. The receiver consists of one or two amplifying valves and a heavily biased output valve which operates the signalling relay in its anode circuit when the carrier signal is received. Apparatus of this type is kept in continuous operation, and reliability and speed of operation are the main requirements. Alarm relays are

ance of the valves in order that regular tests may be made to ensure that their characteristics are satisfactory.

It is possible to increase considerably the utility of this equipment without interfering with its primary protective function by using it for point-to-point telephone communication. For this purpose the oscillator output is modulated by speech before

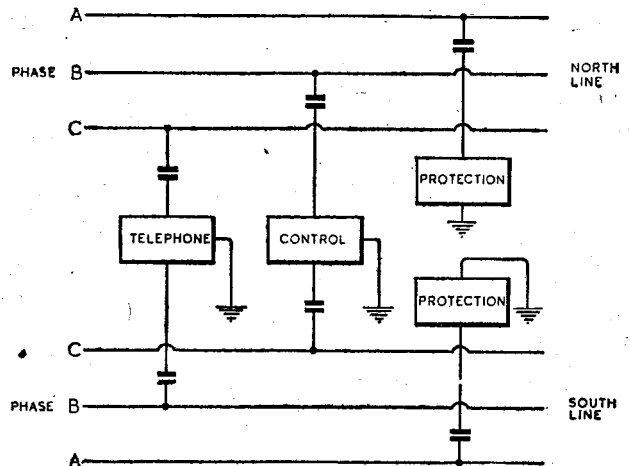

Fig. 5. Arrangement of carrier equipments on the Boulder Dam-Los Angeles lines.

plied to high voltage power systems at voltages up to 220 kV, e.g., on the French 220-kV network interconnecting the water power stations in the South and the steam stations in the Paris region. In Eire a carrier current telephone is installed on the 110 kV line between the Shannon water power station at Ardnacrusha and Dublin—a distance of 110 miles. Automatic exchanges are installed at each end of the line. There are many carrier current installations in the United States, but the most noteworthy is that of the 287 kV line between Boulder Dam and Los Angeles—a distance of 270 miles.² The installation is a very comprehensive one employing eight carrier frequencies for supervisory control, telephone communication and automatic protection. Single side-band suppressed car-

rier transmission is used for telephony. The line has two three-phase circuits, and the carrier sets are connected as shown in Fig. 5, the telephone and supervisory equipments each using two phases, while the protective equipments are connected between a single phase and earth. In the latter case it is only necessary to transmit signals when there is no breakdown on the line section in question, so that the single phase and earth system is satisfactory. Instructions can also be transmitted to maintenance men patrolling the line in cars equipped with radio receivers. The transmitters have an output of from 50-400 W, and the total power loss is about 30 db.

In Great Britain there have been fewer applications of carrier current to power lines, due mainly to the fact that, owing to the small size of the country, long transmission lines are

not common. The first application was made in 1931 to the 132-kV line between Rannoch and Abernethy—a distance of 60 miles.³ This installation is used for telephone and control purposes, separate carrier frequencies being used for each direction, the carrier and both sidebands being transmitted. More recent installations in Great Britain have been carried out primarily for line protection, although a subsidiary telephone channel is sometimes provided, as described in the previous section.

In conclusion, the above survey of a specialised branch of communication technique has necessarily been brief, but it should suffice to give an indication of the potentialities of carrier current superposition on power supply networks.

² J. D. Laughlin, *A.I.E.E. Trans.*, 1939, Vol. 58, p. 147.

³ A. S. Valentine and E. M. Bergstrom, *J.I.E.E.*, 1935, Vol. 76, p. 125.

The Industry in Wartime

Annual Report of the Radio Manufacturers' Association

THE year 1941 was notable, so far as the industry was concerned, for vastly increased demands on the part of the Fighting Services for wireless apparatus in various forms. This expansion was such that, as is all too well known by the man in the street, difficulties arose regarding the supply of valves and certain components for civilian use.

It was announced at a meeting of the Radio Manufacturers' Association in August that negotiations were in train to co-ordinate, through the Ministry of Aircraft Production, the requirements of all three Services for specified components and materials in short supply. The scheme of co-ordination centred round the formation of an Inter-Service (Communications) Components Committee, on which the three Supply Ministries and the Post Office were represented, under the chairmanship of Air Commodore Leedham (Director of Radio Production, Ministry of Aircraft Production).

The component requirements of the Services will in the future be co-ordinated and arrangements made by this committee to direct the orders to the manufacturers with available capacity to produce them by the specified dates. It is within the purview of the committee to establish additional capacity for production where the existing facilities are found to be inadequate.

Throughout 1940 the policy of the Government was to develop exports from the United Kingdom to the "inexpansible maximum." In support of that policy it will be remembered that the R.M.A. formed the Radio Manufacturers' War Export Group, the aim of which for its first year's work (1940) was to achieve an export of some 120,000 receivers and main-

tain export in components and accessories amounting to some £360,000. The results actually achieved, as already reported, were: sets and radio-gramophones, 67,823, valued at £438,119, and components and accessories valued at £280,122.

The R.M.A. Report for 1941 states that because of the valve position, the export programme for the year author-

Trainee fault-finders and repairers at the South West Essex Training College. To create a reserve of trained personnel for future needs of the industry, a scheme providing 16 weeks of free training, fostered jointly by the Ministry of Labour, the Board of Education and the Radio Manufacturers' Association, has been introduced for boys and girls who have reached the School Certificate standard in physics and mathematics, or general science and mathematics.



ised by the Board of Trade amounted to some 75,000 sets. It was clear, therefore, that the original plans "aiming at a large expansion of export business, must be abandoned." The fact, however, is noteworthy that the actual export of both sets and components up to the end of October, 1941, exceeded those of the previous year which, "considering all the difficulties, must be considered as satisfactory."

Production Problems

The problem of civilian production, whether for the home market or for export, has been considered by the Council of the R.M.A. as one problem. So far as the home market is concerned it was considered that a minimum of a quarter of a million sets would be needed during 1941 to avoid serious interference with the reception of the home broadcast service. Production of receivers both for the home and export markets was, however, controlled throughout the year by the availability of essential components, particularly valves, and all plans were overridden by that factor. The report states "The rapid expansion of the Services' demands for radio equipment taxed severely the resources of the industry in many directions. In the case of valves it was apparent in the latter part of 1940 that supplies for civilian purposes would soon be most difficult to obtain. Further large increases in Government requirements of valves were notified at the beginning of 1941, and it then became clear that valves for civilian purposes would have to be drastically curtailed."

The original plan for the production of receivers for export alone involved the use of over a million and a quarter valves.

"It was beyond question," continues the Report, "that the requirements of the Services must come first; and capacity being found to be insufficient to meet all needs, a decision had to be made by the Government as to the extent to which civilian production was essential, and the relative importance of the maintenance of existing receivers and the production of new receivers, both for home and export markets."

Early in the year the Inter-Service Valve Production Committee—an organisation of the Services Departments set up to plan the production of valves for Government needs—and the Board of Trade went into the question of the supply of valves "for the completion of sets in an advanced stage of progress in manufacturers' works and for the continuance of the

production of sets for export." At that time any immediate release of valves for civilian purposes could only have been made at the expense of Service needs, "a course which none of the negotiating parties, Government or industry, could contemplate for a moment." It was not until July that the Board of Trade announced the existence of a surplus of valves available for civilian purposes, and a plan of allocation was evolved.

The outcome of the negotiations regarding valves has left quite a considerable quantity of receivers, probably some 250,000, "in progress" still to be completed and equipped with valves during 1942. Negotiations are in progress to plan the programme of receiver production for 1942, based on the principle that this 250,000 "progress" receivers should be completed before expending labour and material on new sets.

It is reported that the R.M.A. Battery Committee has had protracted discussions with the Board of Trade regarding the present shortage of HT batteries required for the maintenance of civilian receiving sets. The various causes of this shortage have been defined to the Board and recommendations made for remedying them.

Seeking Substitutes

The work of the R.M.A. Technical Advisory Committee has, as would be expected, tended to become increasingly centred in the war effort. At the request of the Aluminium Controller, M.A.P., the Committee considered the possibility of using tinfoil instead of aluminium foil in the manufacture of paper dielectric condensers, and to furnish the Controller with an estimate of the amount of aluminium that would be saved by instituting such a change. No details of the outcome of the investigations are, however, disclosed in the Report.

The unsatisfactory behaviour in tropical climates of variable condenser vanes made of zinc, as a substitute for aluminium, was also considered by the Technical Advisory Committee. It is learned from the Report that, after a very thorough examination, the Committee reported that whilst there is no entirely suitable substitute for aluminium in the manufacture of condenser vanes for use in tropical climates, there seems to be no reason why sheet zinc should not be relatively satisfactory if rolled to the required thickness and tolerance, if suitably finished to guard against deterioration, and provided that precautions are taken to ensure that no material treated with lin-

seed oil is enclosed in the same space as the zinc.

Brass of a soft drawing quality has also been found reasonably satisfactory if rolled to the necessary limits of thickness and flatness. The use of steel was not recommended for condenser vanes because of the impossibility of maintaining tolerances with this metal, the general risk of microphonic troubles which it introduces, and the excessive wear and tear on existing types of tools that its use would involve.

Consideration has been given during the year to the possibility of standardising existing bases and sockets for cathode-ray tubes and valves, and negotiations are progressing. It is pointed out, however, that there are many difficulties to be faced, but it is hoped that some advance may be possible.

Radiating Receivers

The Ministry of War Transport issued a memorandum in September defining the permissible radiation from broadcast receivers installed in foreign-going merchant vessels as not exceeding 0.1 microvolt per metre at one nautical mile distance, and stated that all receiving sets which do not comply with this condition must be dispensed with. The practical effect of this Order would be such as to place an embargo on the use of all normal domestic superheterodynes on board foreign-going merchant vessels, as it is stated that it is impossible for set manufacturers to give any undertaking that their sets comply with this standard of radiation. It is learned that the R.M.A. is in communication with the Ministry to obtain further information regarding the Order and its probable effects on the radio industry.

Reference is made in the Report to the R.M.A.'s representations to the Ministry of Labour regarding reservation ages of wireless engineers and mechanics, dry battery makers, PA engineers and clerical and office staffs. It is stated that these representations were almost entirely successful.

Post-war problems were also considered during the year under review. The great expansion in production of radio equipment and components for the Services will create for the industry a most serious problem when the war is over. It is pointed out that this problem will arise in three main forms: (a) Disposal of surplus Government stocks; (b) Absorption into the industry of skilled wireless personnel on their demobilisation; (c) Development of transmission systems, both sound and vision.

Standard Telephones and Cables Limited

announce the

BRIMAR 1 D 6

produced to meet the demand for a Universal American U.X. Base Rectifier. It is suitable as a direct replacement for types 25 Z 5, 25 Y 5 and 25 R E.* Supplies are limited and allocations are shortly being delivered to all B.V.A. Wholesalers.

LIST PRICE 9/-

PLUS PURCHASE TAX 2/-

★ NOTE:—Of “Half Wave” construction the Brimar 1 D 6 cannot be used where “Voltage-doubling” is employed.

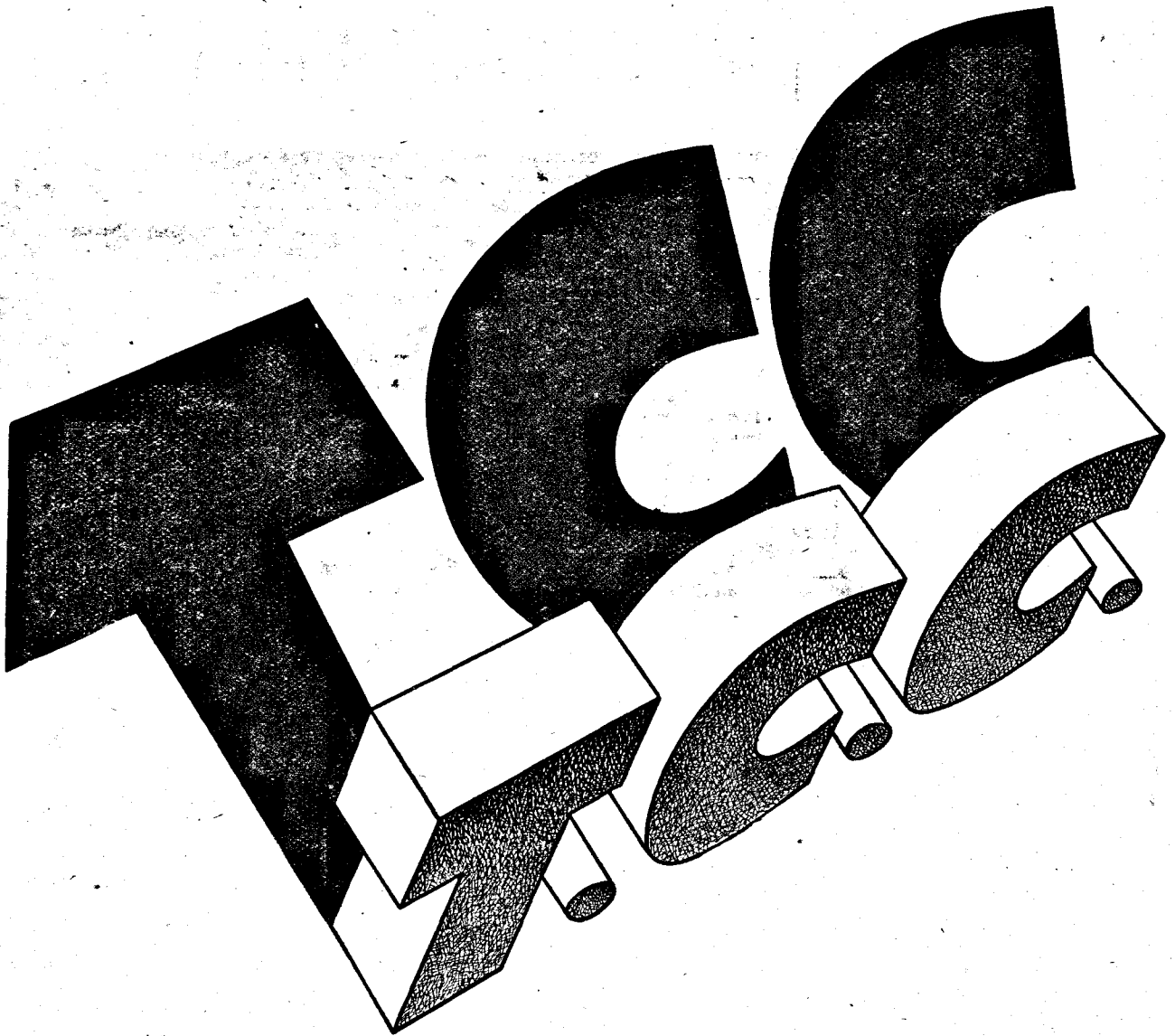

**PRE-EMINENT IN PEACE
INDISPENSABLE IN WAR**

**ADVERTISEMENT OF THE TELEGRAPH CONDENSER CO., LTD.
G.P. 525**

Stereoscopic Colour Television

Baird Gives Practical Demonstration for Individual Viewers

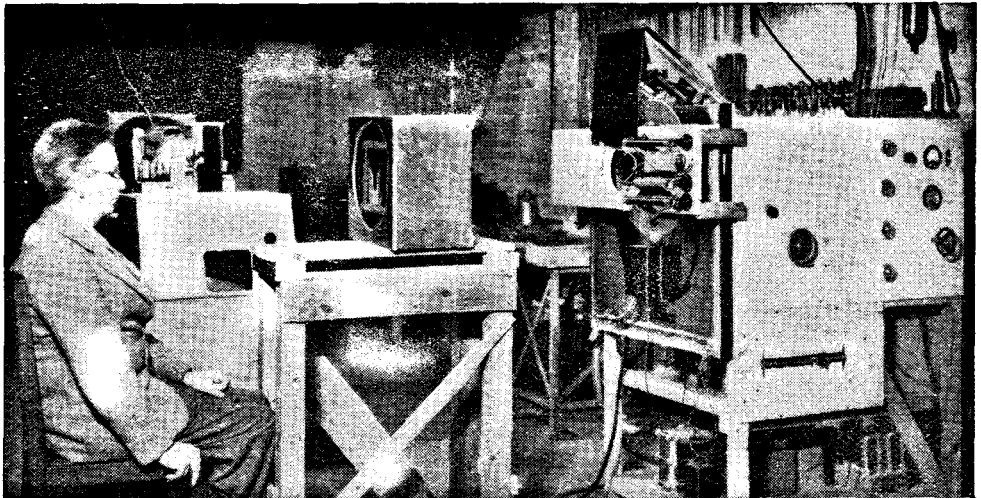

ALTHOUGH much more work remains to be done before colour television in depth can be made available to theatre audiences, Mr. J. L. Baird has recently demonstrated the fact that a practical solution of the problem has been found for the individual viewer.

As in some of Mr. Baird's earlier 30-line demonstrations, it is necessary for the viewer to sit directly in front of an image-forming lens, and in this latest development, although the picture quality is vastly superior, the tolerance in the matter of movement of the head is smaller since the left eye must not know what the right eye is seeing, and vice versa. That is not to say that any special skill or endurance is called for in finding and holding the viewpoint which makes the picture "come to life," and one can readily accede to the inventor's suggestion that the system might be usefully employed in a "seeing telephone" system. The addition of colour and a third dimension would be

of inestimable value in demonstrating samples, processes and a host of other subjects to which two-dimensional vision cannot do full justice.

A projection-type cathode-ray tube is used for scanning, the image of the spot being focused on the object by a lens. Complete 100-line frames are repeated 150 times per second, successive frames being scanned through green, red and blue filters, and interlaced five times to give a 500-line picture. In a previous Baird demonstration of colour television, designed for broadcasting, a 600-line picture with 50 frames per second was used, there being only two filters, red and blue-green; but for the present purpose of demonstrating the optical practicability of stereoscopic images,

Mr. Baird checks the alignment of his stereoscopic colour television receiver.

no attempt has been made to restrict the side-band frequencies

The original scanning beam after passing through one of the colour filters and the projecting lens is divided by pairs of parallel mirrors into two subsidiary beams spaced by a distance equal to the average separation of the human eyes. A revolving shutter with a special contour to correct geometrical scanning errors allows first one and then the other beam to scan the object in succession. Light reflected from object is picked up by sensitive photo-cells and the resulting current is made to modulate the transmitter.

At the receiving end the image formed on the screen of a cathode-ray tube is passed through synchronised

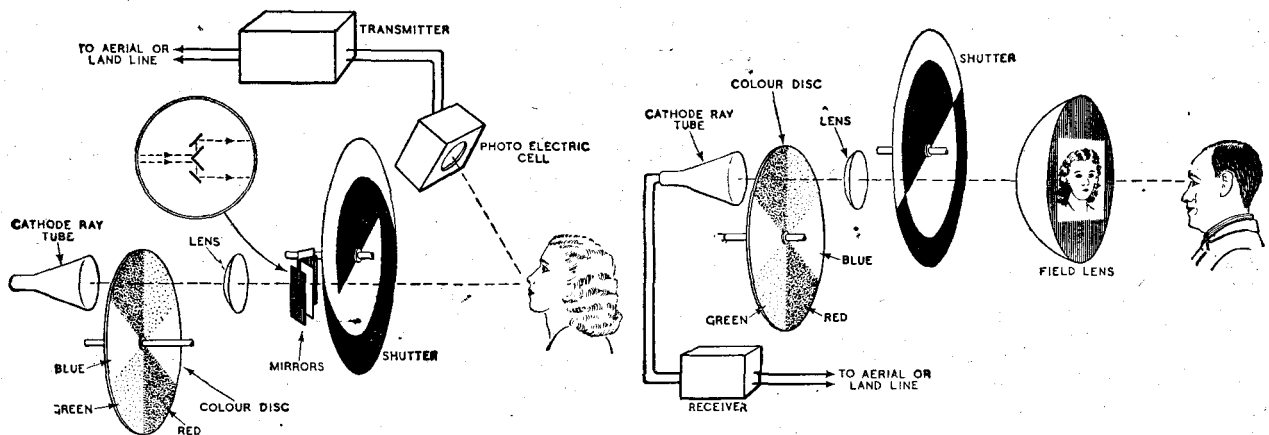

Schematic diagrams showing the principle of operation of the transmitter (left) and receiver (right).

Stereoscopic Colour Television—

colour filters and a revolving shutter which ensures that the alternating left- and right-hand images are reformed by the field lens in line with the appropriate eye of the viewer.

If the colour reproduction lacked the ability in this early experiment to differentiate the subtler shades, it dealt faithfully with the bolder colours. The stereoscopic effects were an unqualified success, and when the person being televised reached towards the "camera," his arm at the receiving end seemed to project out of the lens towards the viewer.

Mr. Baird is to be congratulated upon the success of this new step towards the ultimate ideal of complete illusion in television, and recognition

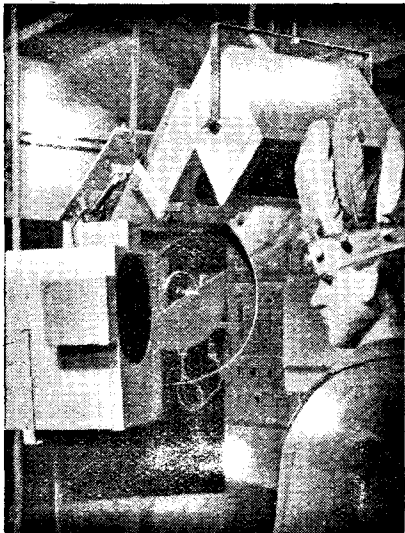

Dummy figure with coloured head-dress used in experimental transmissions. The revolving shutter used to give alternate exposure to the dual scanning beams will be seen in the centre of the photograph.

should be given to his perseverance and detachment in keeping this particular line of research alive in wartime Britain.

Emergency Output Transformers

IN these days of limitations of supplies we are often content to adopt expedients, in order to keep our sets in working order, which in more normal times would cause the technical purist to shudder and pass into merciful oblivion. Thus, if the transformer which couples the output valve to the loudspeaker were to break down in peacetime, we should probably take the opportunity to fit

a better one, if possible, than the loud-speaker manufacturer fitted initially. In these days, however, we should be lucky if we got a replacement of any sort.

However, there is no need to despair if a disused mains transformer or even a so-called bell-ringing transformer is available. The mains transformer will, if we are lucky, probably possess two separate filament windings, and these can be pressed into service as the secondary winding for connecting to the speech coil, the mains winding being used as the primary.

We have got quite a range of ratios available for a rough attempt at matching, as we can use one filament winding alone or can use the two in series or parallel. In the latter case, however, be careful to get the two windings connected in the same "sense," or they will cancel out. If a bell transformer is available, we have a tapped secondary labelled 3, 5 and 8 volts, the latter being the full winding. The three- and five-volt tappings will give us other ratios.

Book Review

A Text-Book of Electricity and Magnetism. By G. R. Noakes, M.A., A.Inst.P. Pp. 513+x. Published by Macmillan & Co., Ltd., St. Martin's St., London, W.C.2. Price 8s. 6d.

As the author points out in his preface, this book is designed primarily for those taking the Higher School Certificate and University Scholarship examinations. Its usefulness, however, is by no means confined to such students, for it forms a valuable reference book to all in any way connected with electrical matters.

The value of the book lies largely in the stress which is laid upon fundamental matters and in the clarity of the treatment. Mathematics are freely used, up to and including calculus; a large part of the material can be understood, however, even if less perfectly, if the mathematics are skipped.

A valuable feature of the book is the clarity and precision with which the author defines his terms. In one case, however, his precision deserts him, for it is not always easy to find out which convention he is using for the direction of current flow. Since the old convention of a current flow from positive to negative in the external circuit breaks down with electronic devices, it has long seemed to the reviewer that no case can be made out for its further retention.

After dealing thoroughly with the



TELEPHONIC COMMUNICATION between company and battalion headquarters is maintained during manoeuvres by this pack transmitter-receiver which employs a collapsible vertical aerial. This photograph was taken during exercises recently when "enemy" airborne troops landed and occupied a South Wales town.

fundamentals of electricity and magnetism, the author goes on to discuss alternating current and resonance phenomena. These are equally well treated, but it should be noted that Figs. 172 and 173 on pages 257 and 258 are reversed.

Among the chapters that follow are those dealing with Magnetic Materials, Thermo-Electricity, Electron Tubes, Atomic Physics, and Radioactivity. These are much less complete, but necessarily so, as many of the subjects call for a book to themselves. The chapter on Electron Tubes is very sketchy, especially the part dealing with the cathode-ray tube. Incidentally, Fig. 253, showing scanning in a television receiver, is incorrect, since it shows the frame scan as starting at the bottom of the picture and going towards the top. In modern television the scan stroke invariably starts at the top. The illustration shows the principle of scanning correctly, but does not agree with modern practice.

The book contains numerous questions for students, and where a numerical answer is required it will be found at the end. Log. tables are included, and there is an index.

The book can confidently be recommended to all seriously interested in the subject.

W. T. C.

Constant Voltage Supply

Circuit Combining Partial Stabilisation of AC Input with Full Stabilisation of DC Output.

By T. A. LEDWARD,
A.M.I.E.E.

A DIRECT-CURRENT test supply of some hundreds of volts and tens of milliamperes is often required, and various means of ensuring constancy of voltage have been devised. Where, as is usual, the basic apparatus comprises a rectifier and smoothing unit, stabilisation is usually applied to the DC output circuit, but in some cases it is applied to the AC input.

If the AC input only is stabilised, the DC output volts will be stable at a fixed load, but will fall with increasing load in accordance with the normal regulation curve of the rectifier and smoothing unit. On the other hand, if stabilisation is applied to the DC output only, the output voltage can be made the same at all loads, but the voltages applied to the valves, including the rectifying and stabilising valves, will vary within the extreme limits of mains voltage variation. This is clearly undesirable in the case of heater voltages if the mains voltage variation is fairly large.

A combination of AC and DC stabilisation will remove the above disadvantages, but this becomes rather an expensive matter if the usual apparatus is adopted. The present writer, feeling the need for a stabilised supply for his own work, evolved the apparatus to be described, the main attributes of which are DC stabilisation within fine limits, following partial AC stabilisation of a much coarser variety. The DC stabilisation has then to operate over a much more

at present used by the writer, it was decided, in order that the apparatus should be generally useful, to aim at covering a range of AC input voltage of 200 to 260 with a normal voltage of 230.

The DC stabilising arrangement forms the most important part of the apparatus, and will be dealt with first. It will, if required, give stabilisation over the whole range of 200 to 260 volts AC input on full load, but without partial AC stabilisation the valves would be overrun at the higher voltage.

The principal item in the DC control circuit is a neon tube, so, before explaining the complete circuit arrangement, it will be useful to consider exactly how a neon tube behaves under changes of current and voltage.

Simple Neon Stabiliser

The simplest form of constant voltage circuit employing a neon tube is shown in Fig. 1 (a). The output voltage E_2 is equal to the input voltage E_1 , minus the voltage drop in R . The latter drop is equal to IR , where I is the input current. Suppose there is no load connected across E_2 , then as E_1 is raised E_2 will rise and will be equal to E_1 until E_1 reaches a value

lamp with the resistance removed from the cap are shown in Fig. 1 (b). If E_1 be increased, E_2 will remain at approximately 150 volts, while the current in N will increase so that its value at any instant will cause a voltage drop in R sufficient to compensate for the rise in E_1 . R must, therefore, be of such a value that the maximum rise of E_1 will not cause an excessive current to flow through N . If a load be connected across E_2 , the current through N will decrease by the amount of the load current, so that the total current, and therefore the voltage drop in R , will remain the same, and E_2 will be constant. This is shown in Fig. 1 (c).

These conditions are approximate, and this simple apparatus has certain limitations, the principal ones being a fixed output voltage and a very small current rating, the latter being limited by the rating of the neon tube. This circuit can, however, be combined with a thermionic valve in such a way as to control a much higher current and voltage.

Fig. 2 shows how the current rating may be increased. A negative bias is applied to the valve V by means of battery B , sufficient to reduce the anode current to zero with 150 volts on the anode. This negative bias is, however, only fully operative when

Fig. 1. The neon tube as a stabiliser, with curves showing its operation. (b) Voltage stabilisation with varying input. (c) Voltage stabilisation with varying load.

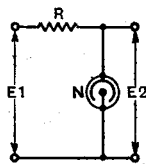

(a)

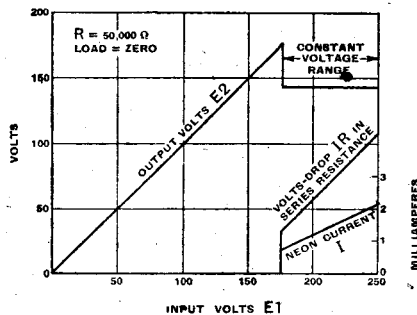

(b)

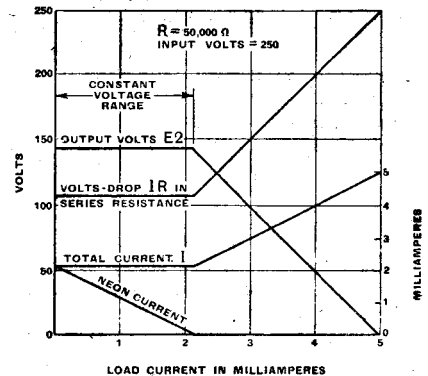

(c)

restricted range, while the AC stabilisation, being only partial, can be satisfactorily carried out with relative simplicity.

Although there is comparatively little voltage variation on the supply

of approximately 170 volts, when the neon tube will glow, and E_2 will fall to 150 volts. The drop in R will then be 20 volts. Round figures are used here for simplicity. Curves illustrating an actual test of an "Osglim"

the current through N is zero. Assume that N is passing current, then the voltage drop in R due to this current opposes the bias due to B , thus reducing the negative potential on the valve V , and, when suitable con-

ditions obtain, causing a flow of anode current. The flow of anode current will cause a voltage drop in R. (The drop in R due to the current through N will, in this case, be negligible.)

Now, if E_2 is to remain constant while E_1 varies, then the change of voltage-drop in R must at all times equal the change of E_1 . The current through V must, therefore, change while the anode voltage remains constant. The change of anode current is, of course, brought about by a change of grid potential, and this necessitates a change of current through N and R_1 . To increase the anode current, the voltage drop in R_1 must increase, and, if the voltage across N were to remain constant or were to rise, then the total voltage across N and R_1 in series would have to increase. From this reasoning it would appear that if E_1 were increased a small increase in E_2 would be inevitable, as E_2 is equal to the algebraic sum of the voltages across N,

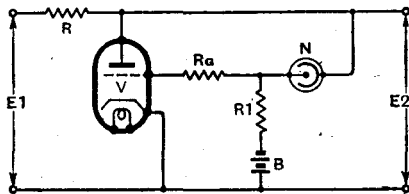

Fig. 2. Obtaining a greater stabilised output by using a neon tube to control a valve.

R_1 and B. But this conclusion assumes that the voltage across N remains constant, or rises. If, however, the voltage across N can be arranged to fall when the current through N increases, then the total voltage across N and R_1 can remain constant. That is what happens with suitable circuit conditions, and it is, in fact, possible to obtain a decrease of E_2 when E_1 is increased.

The diagram of Fig. 3 will serve to illustrate the action. In this diagram, which is self-explanatory, E_R , E_{R1} , E_N and E_B are the voltages across R, R_1 , N and B of Fig. 2. The slope of the curves and general proportions are exaggerated for the sake of clarity. In an actual test, the neon volts were found to fall from 149 to 148.5 for an increase of current from 5.4 to 8.5 mA. The series resistance was 0.25 MΩ.

If the grid battery be replaced by automatic bias (see Fig. 4), the voltage E_B (Fig. 3) will not longer be constant, but will follow the variations of AC input. This does not detract in any way from the correct working of the apparatus. In practice, the

neon current assumes a value which produces a stable condition in the circuit, and this stable condition can be

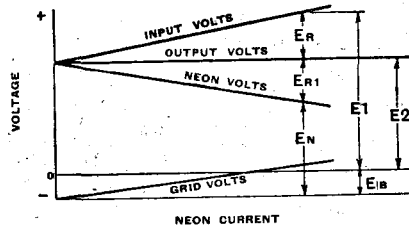

Fig. 3. Illustrating the operation of the stabilising circuit of Fig. 2.

made to correspond to either a level output characteristic or to one which slightly rises or falls. The resistance R_g is required for stability and to prevent a comparatively large current passing through N via the grid in the event of the grid becoming positive.

The voltage output from the circuit of Fig. 2 would be approximately 140 volts—allowing 10 volts for grid bias—but this may be increased to any desired value (limited, of course, by the available voltage at E_1). All that is needed is a potentiometer connected across E_2 with N connected to a tapping. This is shown at R_p in Fig. 4, which is a diagram of the complete circuit, including the usual rectifier and smoothing circuit. The partial AC stabilisation has also been added. The grid battery of Fig. 2 has been replaced by automatic bias obtained by means of a small half-wave metal rectifier M connected as shown. The smoothing of this grid-bias circuit must be effective, as any ripple

be termed the "surplus" current at any time—the total DC current for any particular AC input voltage being constant, irrespective of external load—it is clear that if the control is to be effective from no load to full load, the valve must be capable of carrying at least the full output current. It is also clear that if, when the input voltage is low and there is no external load, the valve carries a current equal to normal full load, then when the input voltage is high the valve must take a current, under no-load conditions, which is higher than normal full load. Another point with regard to suitable valves is the effect of the negative bias voltage on the operation of the neon tube. The negative bias voltage is included in the voltage applied to the neon lamp circuit, but not in the output voltage, so that a high negative bias voltage will limit the effective range of the stabiliser circuit.

Choice of Valve

Heavy-current, steep-slope valves are, therefore, indicated, and the "Harries" tetrode type has been found to be the most satisfactory. For the present purpose these tetrodes may be connected as triodes or in the manner shown in the diagram (Fig. 4), which is rather better.

Two such valves (Hivac AC/Z) are shown in parallel in Fig. 4, and, with the component values shown, this circuit gives a sensibly constant output voltage of 200 from no load to 60 mA when the AC input is varied from 190 to 270 volts. This easily covers the

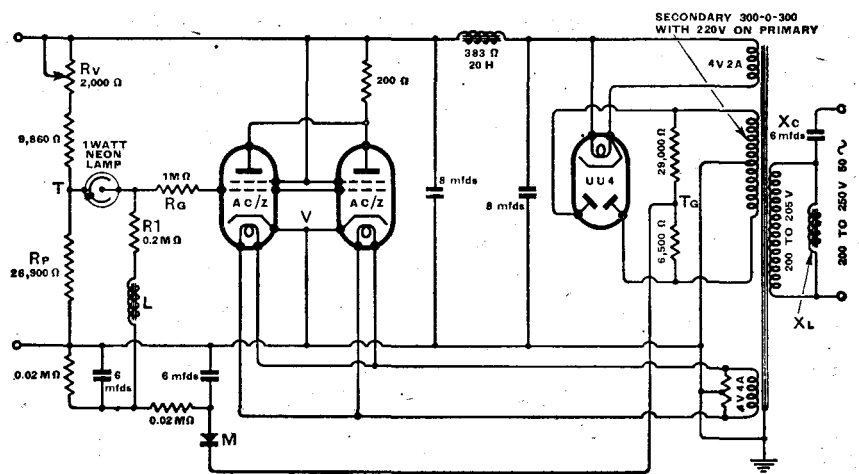

Fig. 4. Complete power supply unit, with both AC and DC stabilisation.

would be superimposed on the output voltage.

As the valve V carries what might

range of 200 to 260 volts originally aimed at. Alternative valves of the tetrode type are the Osram KT 41 or

Constant Voltage Supply—

the Cossor 42 OT. These valves have not been tried in this circuit, but should be quite satisfactory without alteration of component values. Another valve that should give good results, but would require some alterations in resistance values, is the Brimar PA1, a high-slope output triode. It is suggested that if this latter valve be tried, the potentiometer tap T on the neon potentiometer R_p should be variable.

means is $\pm 2\frac{1}{2}$ per cent. If a large voltage adjustment is required, the tapping T on the potentiometer should be variable.

Turning now to the partial stabilisation of the AC input, the reduced voltage-change is effected by connecting a condenser X_c (Fig. 4) in series with a choke XL and connecting the transformer primary across the choke. As XL has an iron core that is operated near saturation point, its reactance

In Fig. 6 vector triangles have been drawn for three different input voltages in order to indicate more clearly what happens in a circuit of this kind. It would be of little use to give details of the choke as this must be made to suit the particular transformer employed. Incidentally, it should be possible to design the transformer itself to have the necessary variable impedance characteristic and so dispense with the choke. The

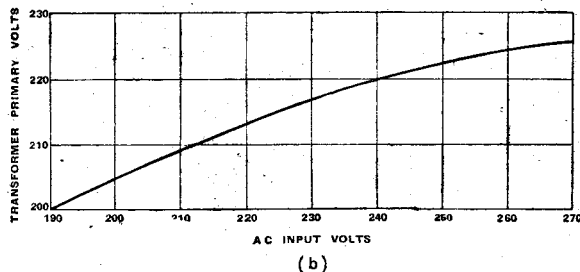
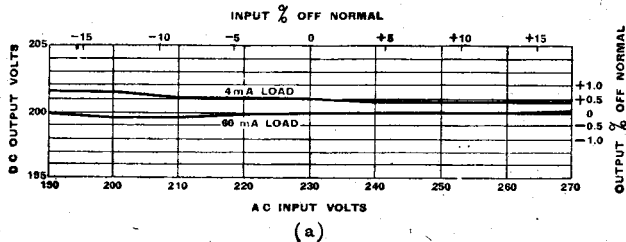

Fig. 5. Curves showing performance for DC and AC stabilisation.

Also, the tap TG on the AC potentiometer for grid-bias rectifier supply should be variable. These two taps could then be adjusted on test to give best results. R_r might also need some adjustment.

The neon tube is of the 1-watt indicator type, and the resistance has been removed from the cap. It will be noticed that there is no special series resistance in this circuit to take the place of R in Fig. 2, as the resistance of the smoothing choke is sufficient for the purpose. With a mains input variation of 200 to 260 volts, the transformer input only varies from 205 to 225 volts owing to the partial AC stabilisation. It will thus be seen that the valve filaments are never overrun.

varies considerably with variation of current. As the choke is in parallel with the transformer primary, the two can be considered as a single inductive impedance varying with current value and in series with the condenser X_c. The whole forms a series resonant circuit which, if the supply frequency be fixed, will resonate at a particular current value.

The actual resonance condition is not required for the present purpose, but with a resonant circuit of this kind it is possible to obtain across either the choke or condenser separately a voltage that is higher than the applied voltage across the two in series. Thus, with 200 volts input, the voltage applied to the transformer primary is 205 in the present case. If the input voltage be increased, thereby increasing the current through the choke and reducing its impedance, the output voltage across the choke will obviously not increase at the same rate as the input voltage, a point being reached where the output voltage becomes less than the input—see Fig. 5 (b).

addition of the choke, however, allows the main equipment to be of standard form.

Choice of Components

Most of the components in the apparatus described may vary in value within fairly wide limits without much affecting the satisfactory performance, and the changing of valves and neon tubes for new ones of the same type will not usually necessitate adjustments in other parts of the circuit. There is one resistance assembly, however, that must not be subject to appreciable resistance variations due to changes of temperature, etc., and that is the potentiometer assembly which provides a voltage tap for the neon tube. This must be wire-wound and of good quality.

A precaution should be noted with regard to valve connections: a short bridge-wire should join the two screen grids, from which a single wire should be taken to the positive supply. The reason for this may seem rather obscure, but it entirely prevents self-oscillation at ultra-high frequency which can occur with certain other arrangements of connections. If such oscillation is permitted it will interfere with the stability of the output voltage.

It is an advantage, although not essential, to screen the neon tube. This has been done in the present apparatus by means of a coating of "Aquadag" (colloidal graphite) applied to the glass bulb and connected to the negative output terminal, which is earthed.

Avoiding Parasitic Oscillations

The choke L prevents oscillations in the neon circuit which are otherwise liable to occur and would appear as a ripple on the output voltage.

The curves in Fig. 5 (a) show the performance with 4 mA and 60 mA loads. It will be noticed that a slight fall of output occurs with rise of input volts on light load. Both curves were taken with the voltage adjustment set for 200 volts on full load. Fig. 5 (b) shows the control exercised by the partial AC stabilisation. The tests were made after the apparatus had been left in circuit for half an hour, although a few minutes warming-up suffices for ordinary use.

The 2,000Ω variable resistance R_v allows an exact setting of the output voltage under any conditions. The total adjustment provided by this

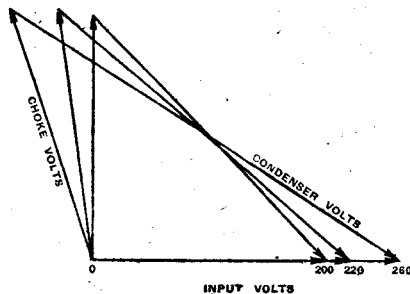

Fig. 6. Vector triangles to illustrate operation of the AC stabiliser.

UNBIASED

By FREE GRID

1066 and All That

I HAD rather a shock a few days ago when I was invited by a member of *The Wireless World* editorial staff to accompany him to a meeting of the I.E.E. Wireless Section. I was very greatly irritated by the behaviour of my companion, who, during the discussion period, was fidgetting uncomfortably in his seat and betraying every symptom of uneasiness, so much so that I began to wonder whether I had not, at last, hit on the real reason why it is that editors and their puppets invariably use the archaic "we" when referring to themselves in their respective journals.

It was not until we got outside after the show was over that I learned the cause of my companion's extraordinary behaviour. It appeared that he had been irritated because he had wanted to take down, there and then, certain observations made during the discussion period without waiting for the official report. Thinking that he must have inadvertently left his portable steel-wire recorder in the taxi in which we had arrived, I expressed my sympathy, only to be told that he possessed no such article, and that what was annoying him was that he had no knowledge of shorthand.

For a moment I could only stare stupidly at him, as I could scarcely credit that any member of the staff of a wireless journal which, apart from "covering every wireless interest," counts electrical recording as being also among its lawful prey, should rely on so archaic a method of recording the human voice as shorthand.

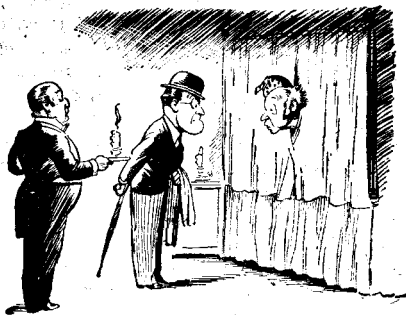

Bedtime story.

In fact, the whole affair made such a very deep impression on my mind that I began to wonder dimly whether the Editor of the *Wireless World* himself still arrived at the office each morning in his own horseless carriage

and was gently wafted upstairs in an old hand-cranked lift to a quiet and peaceful office which knew not women with their ceaseless chatter and their noisy typewriters, but was served by staid middle-aged clerks who plied their quill pens gently under the flickering light of the gas jets, breaking off from time to time as they were summoned to the Editor's presence by a restful tinkling from the row of old Victorian pull-bells over their heads.

Probably, I mused, in this haven of old-world peace, the raucous voice of the loud-speaker was never heard, but the news bulletins (bringing tardy tidings of the relief of Mafeking) came in on the morse inker to the gentle accompaniment of the de-coherer tapping softly on the coherer while the imperious and shrill-voiced summons of the telephone never disturbed the peaceful drowsiness of a summer afternoon, its place being taken by the gentle warbling of the speaking-tube.

I was so lost in my musings that I nearly got run over by a very horseless carriage in the Strand, which had the effect of bringing me back to harsh reality, and I jumped hastily into a taxi with the determination that, late as the hour was, I was going to see the Editor in person about the matter, even if it meant rousing him from his old four-poster and interviewing him in nightcap and nightshirt by the light of a guttering candle.

Morse Mucked-up

IT is astonishing what a large number of morse-learning books there are now upon the market, under various fancy titles such as "Telegraphy without Tears." Although I have carefully studied all of them I must confess that, much as it goes against the grain to admit it after my recent difference of opinion with the Editor, in which I found it necessary to return my *Wireless World* tie to him, none of them makes me regret the sixpence I spent on the original edition of the *Wireless World* morse booklet.

Yet when all is said and done, even the *Wireless World* book is far from perfect, as in spite of the fact that at the outset it warns me to memorise rhythmic sounds rather than graphical symbols, it tells me later on that the letter A is represented by $\bullet\text{---}$, the letter B by $\text{---}\bullet\bullet\bullet$, and so on. Now

this just isn't true in any system of telegraphy, nowadays. It disappeared, in the case of wireless communication, about the year 1902, when we threw our coherers and morse inkers overboard and started to use headphones and a magnetic detector.

There seems to be as much muddying thinking about this matter as there is about economics, judging from the recent unseemly wrangle in the columns of *Wireless World* between the Editor and one of his correspondents about "immutable economic laws." A man who ought to know better has tried to tell me that the writing down of the morse code as a series of dots and dashes on paper is analagous to a musical score, which a skilled musician can "read" as easily and quickly as we more earthly folk can read the betting news. It is nothing of the kind, of course, as you

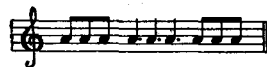

Try this on your piano.

can easily prove by asking a skilled wireless operator to read a message written down in dots and dashes and watching the hopelessly halting hash he makes of it.

To my mind the only way of teaching morse to the budding wireless operator is to eschew all mention of dots and dashes and let him learn the rhythmic sounds straight away. In the case of the lone learner with nobody to help him, this obviously means gramophone records, but unfortunately gramophone records are clumsy things and cannot be included in a sixpenny booklet.

Therefore, we must find some system of representing rhythmic sounds by means of printers' ink, and we do not need to look very far, for what else is a musical score than a method of representing rhythmic sounds by means of printers' ink. It may be argued that only a very small percentage of people understand even the simplest musical score. This is so, of course, but still fewer people know anything about dots and dashes. Therefore, as they have got to learn one or the other, they might as well learn the simple musical score method which, once they have learned it, will always conjure up rhythmic sounds in their minds, which is more than can be said for dots and dashes. To my mind, the dot-and-dash system is just morse mucked-up. No doubt, however, the *Wireless World* booklet will serve as an efficient stopgap until I can find time to produce something better myself.

THE WORLD OF WIRELESS

STANDARDISING AMATEUR GEAR

U.S. National Defence Plan

STANDARDISATION of ultra-high-frequency radio equipment for amateur civil defence radio networks, is proposed by the American Radio Relay League.

It is planned to make the separate units of 112-Mc/s emergency stations, as constructed by individual amateurs, universally interchangeable through use of a standard system of plug and socket cable connection and the adoption of standard voltages and currents.

Because of the probable failure of power supplies, it is essential that the apparatus should be self-contained. Since, however, there is a shortage of dry batteries because of military requirements, a widely available vibrator-type of power supply equipment, delivering approximately 30 watts from a 6-volt accumulator, has been selected as the source of power.

PRICE REGULATIONS

THE continued shortage of new receivers has encouraged a certain class of undesirable retailer to increase the price of sets. Whilst *The Wireless World* is frequently receiving complaints from indignant purchasers, few of them seem to realise that machinery has been set up by the Government to deal with such cases, but that only when the cases are notified can they be investigated.

The Price Regulation Committee in each area, the address of which should be available at Town Halls and Borough Offices, are very anxious to be informed of such irregularities, and readers will be doing the industry and the general public a service by doing so. The address of the Price Regulation Committee for the London area is Belgravia Chambers, 72, Victoria Street, S.W.1.

AERIAL DESIGN

IN a paper on "Aerial Characteristics," read before the Institution of Electrical Engineers on January 7th, Mr. N. Wells made a valuable contribution to the study of aerial design for broadcasting on medium and long waves. Starting from basic physical formulæ for radiation from vertical antennæ, the author considered the modifications introduced by current retardation and showed the basic principles in the design of anti-fading aerials of the straight vertical and folded-top types.

FUEL ECONOMY

Broadcasting Stations and Receivers

SIR ALLAN POWELL, chairman of the Board of Governors of the B.B.C., when asked recently if the Corporation intended acting upon the recommendation of the Government Select Committee that the B.B.C. should close down at 10 p.m., thereby saving the fuel required for the transmitters and for the millions of receivers, pointed out that if that were done the enemy would very soon take the opportunity to use the unoccupied wavelengths for propaganda purposes.

The question of the fuel consumed by receivers has been the subject of correspondence in *The Times*, where one writer stated that they used 1,000,000 units a year, equivalent to a million tons of coal, which, according to the 1938 figures, represents a fourteenth of the coal used by the generating stations. This figure, however, appears to be very wide of the mark. On the assumption that 7,000,000 of the 9,000,000-odd receivers are mains-operated, that each one consumes 50 watts and that it is used for four hours a day, the total current consumption is 511,000,000 units a year. Even this figure is considerable, for it is probably 3 per cent. of the electricity generated.

NEW YEAR HONOURS

Services of the Wireless Fraternity Rewarded

AMONG the many members of the wireless fraternity who received honours in the New Year list was Sir Frank E. Smith, Controller of Telecommunications Equipment, who was awarded the Grand Cross of the Order of the Bath for services to the Ministry of Aircraft Production and Ministry of Supply. Mr. A. P. Rowe, Superintendent, Telecommunication Experimental Establishment of the Ministry of Aircraft Production was created a Commander of the Order of the British Empire. Air Commodore H. Leedham, who is Director of Radio Production in the Ministry of Aircraft Production and chairman of the Inter-Service (Communications) Components Committee, was made a Companion of the Order of the Bath.

Among the many appointments and awards for "outstanding zeal, patience and cheerfulness, and for setting an example of wholehearted devotion to duty, without which the high tradition of the Royal Navy could not have been upheld," was the Distinguished Service Medal to P.O. Telegraphist L. H. Flanagan and A.P.O. Telegraphist R. E. R. Richards. Telegraphist Lt. S. H. Hewison, R.N.,



WOMAN'S INVASION of the hitherto predominantly masculine field of wireless continues, and an A.T.S. Wireless Training Battalion has been formed in the Southern Command. Here the girls are seen at morse practice with the help of a Creed Teacher, while our cover illustration shows them doing practical work with a field set.

The World of Wireless—

was made a Member of the Order of the British Empire.

Two First Radio Officers in the Merchant Navy, W. S. Cardwell and J. Clarkson, were made M.B.E.s. A civilian wireless operator in the R.A.F. Coastal Command, C. F. Wheeler, was awarded the British Empire Medal.

Five Chief P.O. Telegraphists were awarded the British Empire Medal.

Two B.B.C. officials were honoured. Val Gielgud, Director of Features and Drama, and Miss M. H. Wace (Mrs. O. Wilson), Empire Talks Director, were created Officers of the Order of the British Empire.

**VACATION APPRENTICESHIP
SCHEME****Practical Experience for Students**

FOR some years a scheme has been working whereby students at the Imperial College of Science and Technology have been enabled during the long summer vacation to obtain practical experience with manufacturers.

There is a large number of students studying electrical communication at the College, many enjoying State Bursaries, and some will be desirous of obtaining the practical experience that this scheme affords. During this year's summer vacation more than 300 students will be available for varying periods of from 6 to 8 weeks. This number constitutes a record. Although there are more than a dozen firms in the wireless industry co-operating in the scheme, the organiser, Mr. J. Newby, wants to extend this list, and asks us to draw manufacturers' attention to the scheme. He will gladly give information to interested manufacturers if they will communicate with him at the Imperial College, Prince Consort Road, London, S.W.7.

Last year's 181 students worked for a total of 981 weeks with 124 firms and received a total payment of £1,466.

WCRC ON THE AIR

THE new 50-kW short-wave station of the Columbia Broadcasting System, WCRC, which has been erected at Brentwood, Long Island, New York, is scheduled to begin a regular service on January 25th. The station has been granted permission to operate on the following frequencies: 6.06, 6.12, 6.17, 9.65, 11.83, 15.27, 17.83, 21.52 and 21.57 Mc/s. It will operate in conjunction with WCBX, which was recently moved from Wayne to Brentwood. Eight of the thirteen aerial arrays will be directed towards Latin America.

**"AUTOMATIC" AIRCRAFT
NAVIGATION****Dual Direction Finders.**

ACCORDING to a report in *Flying* (U.S.A.) it would appear that the Civil Aeronautics Administration of America is using a dual automatic direction finder, of which the possibilities were foreshadowed by J. A. McGillivray in *Wireless World* for January 26th, 1938. The apparatus is installed on board a twin-engined "laboratory plane" which has just been put into commission by the C.A.A. with the object of keeping its inspectors abreast of technical developments.

The automatic navigator comprises two interconnected direction finders, with their pointers operating on the same azimuth scale. Different stations are tuned in on the two sets; if, to take a very simple example, the stations chosen are at the aerodromes of departure and destination, all the pilot has to do is to manoeuvre his aircraft so as to keep the pointers in a straight line.

BRITISH SPONSORED PROGRAMMES?

MR. W. E. GLADSTONE MURRAY, general manager of the Canadian Broadcasting Corporation, is reported as having told the Washington, D.C., journal, *Broadcasting*, on his return from England, that the British Government has under consideration the erection after the war of a number of commercial broadcasting stations in the Crown Colonies.

The proposed stations, which would operate on the medium and short wavebands, would not be connected with the B.B.C., but would be under official Government control. Mr. Murray stated that the stations would operate individually, and in networks between various colonies.

U.S. RADIOLOCATION

A NEW radio device to locate ships and aircraft hidden from the human eye has been announced by the U.S. Navy Department. According to *Broadcasting* it is thought to be similar to our radiolocators. Skilled personnel to maintain the "Radars," as the apparatus is called, must have had experience in the design, construction and operation of UHF transmitting and receiving equipment, or experience with television and cathode-ray equipment. Accepted applicants will be enlisted in the Naval Reserve.

Mr. R. A. Watson Watt, whose name is so closely linked with radiolocation, has, incidentally, been on a visit to the U.S.A. during the past month.

VALVE PRODUCTION**Statement by Board of Trade**

THE President of the Board of Trade appreciates the importance of keeping the maximum number of wireless sets in commission, subject to the overriding claims of the Services, and hopes to ensure that a sufficient supply of suitable valves will be available. The present production of most types of British valves should shortly be sufficient to meet the home maintenance demand, and the possibility of importing any necessary balance of valves of American types is under consideration."

This statement was made in reply to a question recently raised in the House of Commons asking whether the President of the Board of Trade was aware that a number of radio sets in the country were unusable owing to the shortage of valves.

RADIO OFFICERS REWARDED

FIRST RADIO OFFICER F. W. T. MCGOWAN, of a merchant vessel which was set on fire and later sunk as a result of enemy action, has been awarded the George Medal. After transmitting the distress call he was trapped in his cabin with three others, but forced his way out and returned three times to release the others, two of whom were seriously injured.

Another first radio officer to be honoured is B. H. Smith, who is created an M.B.E. His ship was torpedoed and so badly damaged that she had to be abandoned, but before doing so he sent out signals on the emergency transmitter.

In the latest list of awards of Lloyd's War Medal for Bravery at Sea is the name of Chief Radio Officer N. W. Campbell.

TELEVISION IN FRANCE

ACCORDING to French newspapers which have recently reached London, television in France is by no means dead.

A demonstration recently given at Lyons to the press, by M. Henri de France, President of Radio-Industrie, showed a new system of large-screen television followed by reproduction on a convex home screen about 14 by 12 inches. Definition was 567 lines.

It is proposed to recondition the Eiffel Tower television station and to build two other stations, one at Lyons and the other at Marseilles. Two to three years are indicated as the time which will elapse before television will become general in France. Individual receiving sets will, the writer says, cost 12,000 francs each, which at pre-war exchange would represent a little over £68.

**FROM ALL
QUARTERS**

FM Link

A FUNDAMENTAL application of frequency modulation has been introduced by the National Broadcasting Company. As an additional safety factor against interruption in the transmission due to line failures, the key stations of the two N.B.C. networks WFAF and WJZ, have been equipped with FM receivers. These will be kept tuned to the N.B.C.'s experimental FM station W2XWG, in the Empire State Building, which would be employed to transmit the programme if the lines broke down.

R.M.A. Council

THE number of members on the Council of the Radio Manufacturers' Association has this year been increased from 12 to 18. This number includes 12 set and/or valve manufacturers and six component and/or accessory makers. After its election at the annual general meeting on December 12th, the Council elected Mr. M. M. Macqueen (G.E.C.) as chairman and Mr. E. J. Power (Murphy) as vice-chairman. The Rt. Hon. Lord Hirst of Witton was unanimously re-elected president of the Association.

Marconi-Ekco

AT the annual general meeting of E. K. Cole, Mr. W. S. Verrells, the chairman, announced that the company had sold the whole of its share interest in Marconi-Ekco Instruments. The accounts for E. K. Cole for the eighteen months to September 30th shows a net profit of £70,076.

B.B.C. News

THE transmission of news in English in the B.B.C.'s European and World Services are tabulated below. Times are given in BST.

0200:	49.10,	31.32,	30.53,	25.53.
0300:	49.10,	31.32,	30.53,	25.53.
0530:	49.10,	31.32,	25.53.	
0715:	49.10,	42.46,	31.55,	31.25, 25.53, 19.60.
0900:	49.50*,	41.49*,	42.46,	40.98*, 31.55, 30.96*, 25.53, 25.29*, 19.82, 19.66, 19.60, 16.86, 16.84.
1200:	31.86,	25.53,	19.82,	16.84, 16.77, 16.64, 13.97.
1400:	25.53,	19.82,	16.84,	16.77, 16.64, 13.97.
1700:	19.82,	19.66,	16.84,	16.77.
1900:	49.10,	45.54,	31.86,	19.82, 19.66, 16.84.
2145:	49.10,	31.25,	25.68,	25.53, 19.82.
2315:	49.10,	31.32,	30.53,	25.53.
2300:	49.69*,	41.96*,	41.49*,	
2345:	49.10,	31.32,	30.53,	25.53.

Wavelengths marked with an asterisk are used in the European Service only.

New Stokowski Recordings

It is reported from America that for Leopold Stokowski's latest gramophone recording session, when one hundred recordings were made in ten days, a new technique was employed. All the music was first recorded on film sound-tracks and then "dubbed" on to discs. This method enabled Stokowski, in the re-recording process, to manipulate the dynamic range to suit his wishes.

FM Receivers

A TOTAL of more than 120,000 frequency-modulation receivers are now in use in American homes, according to a report recently issued by FM Broadcasters Inc. At the beginning of 1941 there was approximately only 15,000 FM sets in use. It is estimated that manufacturers were turning out 1,500 receivers a day at the outbreak of the war in the Pacific.

I.E.E.

FREQUENCY modulation will be the subject discussed at the informal meeting of the I.E.E. Wireless Section on Tuesday, January 27th, at 5.0, when Mr. D. A. Bell will open the discussion. For the second half of the 1941-42 session, which begins in February, the Council has decided to alter the time of meetings to 6 o'clock. The first meeting of the Wireless Section in February will be held on Wednesday, 4th, when Mr. O. S. Puckle will give his paper on time bases.

Brit. I.R.E.

DESCRIBING the radio profession as the practice of the youngest branch of engineering, Mr. Leslie McMichael, recently elected vice-president of the British Institution of Radio Engineers, stated that "the necessity for the existence of a professional body devoted solely to radio and allied engineering cannot be disputed in this age of specialisation."

Transmitting valves is the subject of the paper to be given by Mr. L. Grinstead at the meeting of the Brit. I.R.E. at 21, Tothill Street, Westminster, S.W.1, on Saturday, February 7th, at 3 p.m. The next Midlands Section meeting will be held on February 27th at the James Watt Memorial Institute, Birmingham, when Mr. G. Bernard Baker will read a paper on thermionic frequency control.

Obituary

WE regret to record the death at the age of 63 of the Right Hon. H. B. Lees-Smith, who was Postmaster-General from 1929-1931 in the second Labour Government.

NEWS IN ENGLISH FROM ABROAD

REGULAR SHORT-WAVE TRANSMISSIONS

Country : Station	Mc/s	Metres	Daily Bulletins (BST)	Country : Station	Mc/s	Metres	Daily Bulletins (BST)
America				India			
WNBI (Bound Brook)	15.130	19.83	2.15, 3.0†, 4.0†, 6.0†.	VUD4 (Delhi)	9.590	31.28	9.0 a.m., 1.30, 4.50, 6.15.
WRCA (Bound Brook)	17.780	16.87	2.15, 3.0†, 4.0†, 6.0†.	VUD3	11.830	25.36	1.30.
WGEO (Schenectady)	9.530	31.48	9.45 a.m., 9.0†, 10.55†.	VUD3	15.290	19.62	9.0 a.m.
WGEA (Schenectady)	15.330	19.57	7.45§†, 9.55§†.	Sweden			
WGEA	9.55	31.41	9.45 a.m.	SBO (Motala)	6.065	49.46	10.20.
WBOS (Hull)	11.870	25.27	2.0, 3.0, 5.0, 9.0, 12.0 midt.	Turkey			
WCAB (Philadelphia)	6.060	49.50	2.55 a.m., 6.0 a.m.	TAP (Ankara)	9.465	31.70	8.15.
WCBX (Wayne)	11.830	25.36	7.30†, 8.15†, 8.45§†, 11.30.	TAQ	15.195	19.74	1.15.
WCBX	15.270	19.65	2.0, 5.0§†.	U.S.S.R. (Moscow)			
WRUL (Boston)	9.70	30.93	12.15 a.m.†.	31-metre band	—	—	7.0, 8.0, 9.0, 10.15.
WRUL	11.730	25.58	12.15 a.m.†.	Vatican City			
WRUL	11.790	25.45	9.30†, 11.15§†.	HVJ	6.190	48.47	8.15.
WRUL	15.350	19.54	5.0*, 9.30†, 11.15§†.	MEDIUM-WAVE TRANSMISSIONS			
WRUL	17.750	16.90	5.0*.	Ireland			
WLWO (Cincinnati) ..	15.250	19.67	5.0†, 8.0†.	Radio Eireann	565	531	1.40†, 6.45†, 6.50†, 10.0.
Australia				kc/s Metres			
VLR7 (Lyndhurst) ..	11.840	25.34	5.20.				
Egypt							
SUX (Cairo)	7.865	38.14	6.50, 10.10.				
French Equatorial Africa							
FZI (Brazzaville)	11.970	25.06	8.45.				

It should be noted that the times are BST—one hour ahead of GMT—and are p.m. unless otherwise stated. The times of the transmission of news in English in the B.B.C. Short-wave Service are given at the top of the page.

The American stations are now transmitting bulletins in addition to those tabulated as and when the necessity arises.

* Saturdays only. § Saturdays excepted. † Sundays only. ‡ Sundays excepted.

In-phase Amplifier

By R. C. WHITEHEAD

Designing a Non-phase-reversing Stage

THE ordinary resistance-capacity amplifying stage has an output voltage which is 180 degrees out of phase with respect to the input voltage. In the design of vision-frequency amplifiers, pulse-generators, multi-valve oscillators, etc., it is sometimes found that, while sufficient gain can be obtained with a given

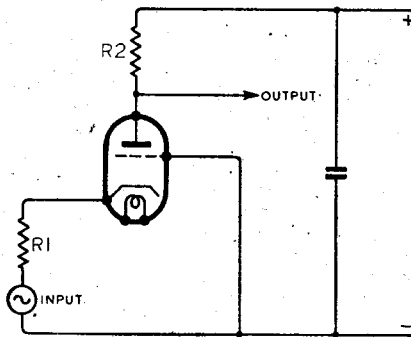

Fig. 1. Basic circuit arrangement: normal connections to grid and cathode are reversed.

number of valves, this combination produces the wrong number of phase reversals. To avoid adding a valve, the gain of which is not required, one of the stages can be made into a non-phase-reversing stage.

Fig. 1 shows the fundamental circuit of a non-phase-reversing stage. Instead of the cathode being connected to earth and the input being applied between grid and earth, the grid is earthed and the input is applied between cathode and earth.

In Fig. 2 is shown the circuit of a practical non-phase-reversing stage. Because the input and output voltages are in phase, and because the grid acts as an earthed screen between input and output, a triode valve can generally be used in cases where otherwise it would be necessary to use a pentode.

The condenser C1 and the resistance R3 have been introduced in order to avoid passing the DC component of anode current through the source resistance R1. If R1 is high in value and a wide frequency band is to be covered, then C1 and R3 cause design difficulties, and they should not be included unless absolutely necessary. If R3 is made high then the voltage available for operation of the valve is

reduced. If R3 is made low, then C1 must have a low reactance at the lowest working frequency, and if this frequency is in the neighbourhood of 50 cycles, then, as both sides of C1 are at high signal potential, the stray capacity between it and earth will influence the design and performance at very high frequencies (e.g., 3 megacycles).

Design Considerations

Since the cathode has been taken up above earth potential (as regards DC), so also must the grid be taken up above earth potential by the same amount, less the amount of grid bias required for normal operation. This is most conveniently done by connecting the lower end of the grid leak to a tapping on R3. The grid condenser C2 and the grid leak R4 can have normal values.

In this circuit the anode decoupling condenser C3 is shown connected to the cathode. The alternating component of anode current does not therefore pass through the source resistance R1, and negative feedback and consequent reduction of gain are avoided.

When selecting a condenser for the C3 position an electrolytic type should only be chosen if the normal leakage current will not upset the performance of the circuit.

Examination of Fig. 2 reveals that both R3 and R5 are effectively in parallel with R1. Normally R5 should be equal to R3.

Fig. 2. Circuit diagram of a practical non-phase-reversing amplifier.

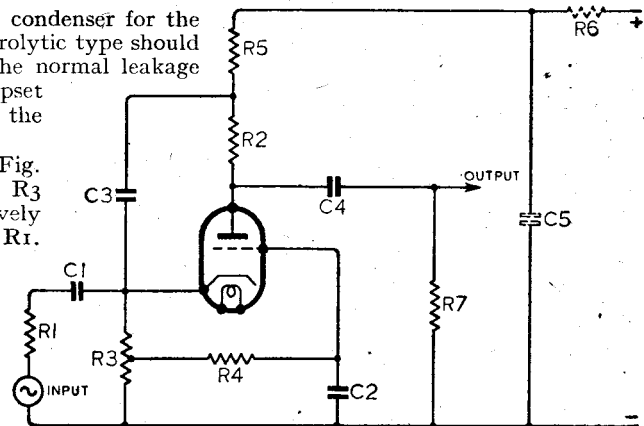

The load resistance R2 and the decoupling resistance R5 should be made as high as is consistent with other requirements in order that the capacity of C3 may be kept to a minimum, because the stray capacity of C3 to earth is effectively across R1.

Supposing that the HT supply voltage contains some residual hum, and for the moment ignore the components shown dotted in Fig. 2. In an ordinary amplifier the decoupling circuit acts also as a smoothing circuit.

However, in the circuit of Fig. 2 this is not so. If the reactance of C3 at the hum frequency is small compared with R1 plus R5, then the hum volts present in the HT system are only reduced in the proportion $R1/(R1 + R5)$ and these hum volts are applied to the cathode or input of the stage and are thereby subject to its full amplification. The remedy is to ensure that the hum voltage is small at the top end of R5. This is done by adding C5 and R6.

Variations in HT voltage occurring at very low frequencies (a few cycles per second) may also find their way to the cathode and these are not entirely removed by C5 and R6. If these are troublesome they may be reduced by reducing C3 or C2. Reduction of the former will increase the bass response, reduction of the latter will decrease the bass response.

The grid leak of the succeeding stage (R7) should have a value which is high

compared with R1 multiplied by the stage gain.

If the cathode-earth volts exceed about 30, the valve should normally have its own heater winding. A compromise may, however, be effected by connecting a common heater winding to a potentiometer across the HT supply, and arranging for the potential of the heaters to be midway between the extreme values of cathode-earth potentials of the various valves.

The input capacity of the stage com-

"Journal of the Institution of Electrical Engineers," September 1939. Description of Series Amplifier in the Standard Telephones transmitter.

prises the following:—(a) Cathode-heater capacity. (b) Cathode-grid capacity. (c) C₁ and C₃ stray capacities to earth. (d) Stray wiring capacities.*

It will be seen that the input capacity of this stage is higher than that of a normal stage.

Finally a successful design can be best achieved by arranging the circuit as follows. These notes apply particularly when covering a very wide frequency band. (a) Insert the non-phase-reversing stage at a point where the output impedance R₁ and the output voltage of the previous stage are both low. (b) Avoid the use of C₁ if possible. This can be done if the previous stage is a cathode-follower. (c) Make R₂ as high as possible without encountering loss at the highest operating frequency. (d) Make R₃ and R₅ as high as possible without allowing the valve to be overloaded. (e) Make C₁ and C₃ as low as possible without encountering loss at the lowest operating frequency.

* Examples of "strays" are as follows: (a) For AC2/HL class of valve, about 18 μF. (b) For same valve, 8.5 μF. (c) A 1 μF metal-cased upright condenser having a base area of 2 square inches had stray capacity to earth of 22 μF when stood directly on a metal panel and 4 μF when stood up on ¼-inch insulators. (d) Allow about 10 μF.

"Foundations of Wireless"

Third Revised Edition

THIS well-known *vade mecum* of the wireless student has just made its appearance in completely revised form; the revision has been carried out by M. G. Scroggie. Certain portions of it, more especially the part dealing with the all-important subject of detection, have been largely rewritten, and two entirely new chapters have been added. The first of these deals with the question of wave propagation and of aerial design, including specialised types such as dipoles, DF and anti-interference aerials, to mention three among many.

The second new chapter forms a very necessary corollary of the first, and treats of transmission lines of various types. In revising the book opportunity has been taken to substitute completely modern terminology where necessary.

One of the goals which the reviser aimed at when setting about his task was to make the book appeal to the very large number of men who are now entering, or waiting to enter, the wireless branches of the three Services, although the book has not thereby lost one iota of its usefulness to the ordinary stay-at-home wireless man,

who desires to get a sound grasp of fundamental wireless principles. Simple algebraic formulæ are freely used, but these need frighten nobody, the book being definitely in the non-mathematical class. As its name suggests, it commences from the beginning and assumes no previous knowledge of wireless, nor indeed of electricity and magnetism.

This book, which is issued from the offices of *Wireless World*, can be obtained through any bookseller at a cost of 6s., or 6s. 6d. by post direct from our publishers, Iliffe & Sons Ltd., Dorset House, Stamford Street, London, S.E.1.

Sentiment and the War

IN spite of the strenuous efforts which have undoubtedly been made, there is plenty of evidence available to show that many people have not yet done as much about waste-paper salvaging as they could do. Even we, in this office, in spite of the large contribution already made, feel somewhat guilty when we survey the well-stocked shelves of the *Wireless World* Library, and we are now setting about the by-no-means enviable task of thinning it out in the best Mr. Middleton style. There are, we fear, many old books, periodicals, and newspapers dealing with wireless matters, some dating back to the last century, which we have hitherto kept solely for sentimental reasons, and these will undoubtedly have to go. We are probably not the only ones who have been hoarding a lot of old literature, wireless and otherwise, for purely sentimental reasons, and we hope that these few words will catch the eye of our fellow-sinners in this respect. So, to work.

Rendering a Service

WERE it not for such a service as that rendered by the Radio Research Board in compiling the Abstracts and References section of *The Wireless Engineer* month by month, the wireless engineer might well feel cut off so far as the advances in wireless are concerned, for the majority of journals from overseas are now going to the Government libraries. In the January issue of our sister journal, which is published on the first of the month, some 350 articles recently appearing in the world's technical Press are abstracted or referred to.

Articles on transit time phenomena in electronic tubes and recent developments in air-cored inductances, together with a three-page summary of recently accepted wireless patent specifications, are also included in this issue. *The Wireless Engineer* is obtainable to order through newsagents, or direct from our publishers at Dorset House, Stamford Street, London, S.E.1, at 2s. 8d., including postage.

GALPINS

ELECTRICAL STORES

21, WILLIAM ST., SLOUGH, BUCKS.

Phone: SLOUGH 20855 TERMS: Cash with Order

MOTOR-DRIVEN ALTERNATOR, direct coupled, motor, 110 or 220 v. D.C. input, complete with starter; alternator output 220 volts, 50 cycle, single phase, 178 watts, fitted governor; mounted on teak beams and fitted handles for carrying, condition as new, wear nil, size overall 40in. by 9in. by 11in. Price £16, carriage forward.

DYNAMO, 110 volts, 60 amps., shunt wound, interpole, ball bearing, speed 1,750 r.p.m. continuous rating. Price £15, carriage forward.

EX G.P.O. MORSE INKER AND TAPE RECORDER, complete with actuating relay and tape reel, mounted on mahogany base, clockwork model, in good clean condition and perfect working order. Price £15, carriage paid.

CAR DYNAMOS, small round type, output 6 volts at 10 amps., in perfect working order. Price 17/6, carr. paid.

SHEET EBONITE, size 12in. by 11in. by 1/32in., best quality. Price 4/- per doz., post free.

ELECTRIC LIGHT CHECK METERS, well-known makers, first-class condition, electrically guaranteed, for A.C. Mains 200/250 volts 50 cy. 1 phase 5 amp. load, 10/- each: 10 amp. load, 12/6; carriage 1/-.

D.C. ELECTRIC LIGHT CHECK METERS, 200/250 volts, 5 and 10 amps., in new condition and electrically perfect; 7/6, post 1/-.

AUTO. CHARGING CUT-OUT AND VOLTAGE REGULATOR, ex-R.A.F., suit any dynamo up to 20v. at 15 amps., fully adjustable, with wiring instructions, complete in metal case, 3/6, post 9d.

X-RAY TRANSFORMER, 110/220 v. A.C. input; output 45,000 volts at 7 milliamps, as new, small portable type. £12/10/-, carriage forward.

X-RAY TRANSFORMER, 110/220 v. A.C. input; output 90,000 volts at 60 milliamps, latest type safety model, complete with high tension leads. Price £25, carriage forward.

ROTARY CONVERTOR, vertical type, 220 v. D.C. input; output 150 volts at 150 watts, complete with transformer for 110 to 240 volts, complete with starter, stand good overload. Price £26/10/-, carriage forward.

REPULSION INDUCTION MOTOR, maker "Century," 1 h.p., speed 940 r.p.m., complete with starter, condition as new. Price £18, carriage forward.

ELECTROSTATIC VOLTMETER, 8in. dia. reading 0-6,000 volts, in new condition. £7/10/-.

AUTO TRANSFORMER, 1,500 watts, tappings 0-110-200-220 and 240 volts for step-up or step-down. Price £5, carriage paid.

CRYPTO A.C. MOTOR, ½ h.p., speed 3,000 r.p.m., note short shaft, in perfect working order. Price 45/-, carriage paid.

110 V. BULBS 150 C.P., Ediswan screw fitting, half watt gas-filled, 2/6 each, post free, or 22/6 per doz., post free.

FRACTIONAL H.P. D.C. MOTORS, for 110 volt and 220 volt D.C. mains, only from 1/20th to ½ h.p., state size and voltage required. Price 10/- each, carriage 1/-.

LARGE TRANSFORMERS for rewinding, rating unknown, size 1 kW. auto. Price 17/6, carriage paid.

LARGE TRANSFORMERS for rewinding, size 2 kW. auto., rating unknown. Price 30/-, carriage forward.

WOUND RESISTANCES, mounted on enamelled iron, overall size 12in. by 1½in., resistance 6 ohms, wound with 18 gauge chrome nickel wire, new and unused. Price 2/6 each, post free, or 25/- per doz.

HIGH-VOLTAGE CONDENSERS, size 4in. by 4in. by 10in. 1 mf. 4,000 v. working. Price 15/-, carriage paid.

LARGE A.C. MOTOR for rewinding, size 2 to 3 h.p., induction type, in good mechanical condition, ring oiler bearings. Price 50/-, carriage forward.

LARGE HOT-AIR ENGINE, 5½in. dia. piston, in good mechanical condition, no heating. Price £3, carriage forward.

HIGH FREQUENCY TRANSFORMERS, 75 v. A.C. input at 300 cycles; output 5,000-5,000 v. at 500 watts. Price 45/-, carriage forward.

10 K.W. AUTO TRANSFORMER in case, 110 v. to 220 v. or vice-versa, in new condition. Price £15, carriage forward.

MOVING COIL MOVEMENTS, 2½in. dia., complete with pointer, full scale deflection approx. 5 milliamps, for recalibrating into multi-range meters. Price 15/- each, post free.

MOVING COIL MOVEMENTS as above but slight repairs needed. Price 7/6 each, post free.

AIR PRESSURE GAUGE, 9 in. dia., scale 0-4,000 lbs. per square inch, in gunmetal. Price £4 each.

The Mirrophone

Compact Magnetic Recorder and Play-back Unit

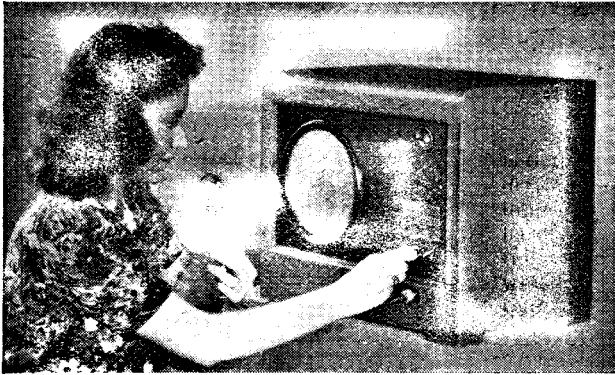

As most readers will know, there are three main methods of recording sound: mechanically on wax, photographically on film, and magnetically on steel wire or tape. The last, though widely used by the B.B.C. and other organisations, has not achieved the wide popularity of the other methods, in spite of the advantage that it offers, as compared with most other systems, of immediate play-back. Unlike the film or the commercial wax recording, the steel tape requires no processing and retains its impressions almost indefinitely.

Thanks mainly to this feature of immediate play-back, a suitably designed magnetic recorder would appear to have especial advantages for certain specialised uses, and it is not surprising to learn that a compact unit, combining provision for recording and immediate play-back has recently been produced in the United States by Western Electric. The Mirrophone, as it is called, employs the normal principles of magnetic recording, and uses a steel tape, which, as compared with a wire, can easily be prevented from twisting, and permits of transverse recording.

Housed in a small cabinet is the recording-reproducing unit, an amplifier and a loud speaker. Associated with this unit there is a high-fidelity crystal microphone. The thin narrow tape on which the recordings are made is mounted on drums which rotate to draw the tape between the poles of the recording magnet. To allow the tape to repeat without rewinding, its ends are welded together to form an endless belt. The material of the tape is a special magnetic alloy recently developed by the Bell Telephone Laboratories.

In reproduction the recording magnet serves as the pick-up device.

speaker is supplied by a two-stage amplifier, which develops exceptionally high gain. An acoustic chamber encloses the back of the speaker. Its field coil also serves as a smoothing choke for the amplifier anode current supply.

Alternating current from any 110- to 120-volt lighting circuit operates the Mirrophone. A volume con-

Below is shown the magnet assembly of the Mirrophone. The upper magnet is used for polarising the tape and the lower one for recording and reproduction. The right-hand picture shows the position of the magnets in the chassis; also the drums by means of which the tape is passed between the pole-pieces of the magnets. The tape is endless, so rewinding is not required.

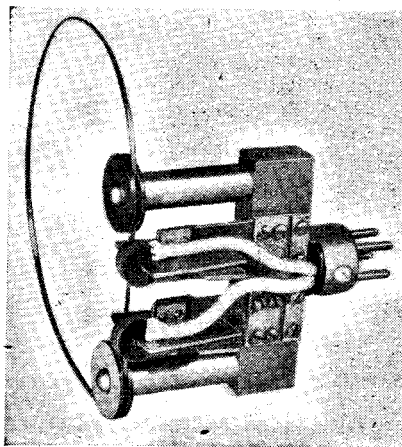

An accompanying illustration shows the recording and polarising magnets; a short loop of tape illustrates the method of threading. These magnets are a removable unit with plug connections. The dynamic loud

speaker regulates the intensity of the recording or the reproducing currents; and an electronic volume indicator shows when the level is correct for recording. To indicate the length of the recording there is a moving pointer which makes one complete revolution per minute and can be reset at any time.

A record once made can be reproduced as often as desired and kept indefinitely or until the switch is again thrown to the recording position. Doing so automatically clears the tape as it passes the polarising magnet and

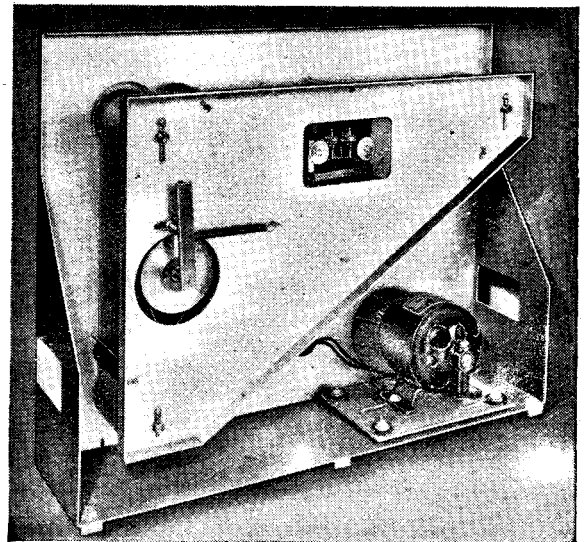

prepares it for a new record. The switch also has a stand-by position which leaves the tape running but disconnects the erasing, recording and reproducing units. An output jack permits connection to an external loud speaker or another recording machine when permanent records are wanted.

Best quality recordings are obtained when the speaker is close to the microphone, but the results are entirely satisfactory from greater distances. Group conversation can be picked up when the speakers are several feet away. Intelligible recordings have been made in large auditoriums with the sound source many feet from the microphone. On the other hand, whispered words can be reproduced

loud enough to be heard by all present in a large auditorium with the sound source many feet from the microphone.

In the Mirrophone, instructors in voice training have an effective new tool. Public-speaking classes and music schools should find it helpful in developing good diction and correcting faulty technique in the rendition of vocal and instrumental music, for it has the great advantage of permitting a student to hear his own efforts as others hear them and to listen critically to the faults which his teacher wishes to correct. An experimental model in use at the Juilliard School of Music in New York City is shown in an accompanying photograph.

As a lecture demonstration for talks and at expositions and conferences it has the advantage of being able to reproduce recorded speech immediately and of preparing itself automatically for a new record. The Mirrophone is also an effective aid in teaching the correct pronunciation of foreign languages. Large commercial organisations and retail establishments can use it to train their personnel in correct diction for contacts both face to face and over the telephone. For the first time those interested in cultivating the voice and studying instrumental music have in the Mirrophone the opportunity of critically reviewing and surveying their own performances without any appreciable time-lag; at last they can share in a privilege long enjoyed by those who follow the literary and graphic arts.

The Wireless Industry

THE introduction of a rectifier (type 1D6) on American UX base as a direct replacement for types 25Z5, 25Y5, etc., is announced by Standard Telephones and Cables, Ltd. Allocations are shortly being made to BVA wholesalers.

We have received from British Insulated Cables, Ltd., Prescot, Lancs, a leaflet on B.I. Flux Solder, which is in the form of wire with a core of activated resin. Stocks are available in 13 or 16 SWG with 50/50 or 60/40 tin-lead alloy.

The emergency catalogue just issued by Gardners Radio, Ltd., Somerford, Christchurch, Hants, indicates that in spite of rationalisation in some directions, the firm is still able to supply most of the transformers and other replacement components required for receiver servicing and to undertake rewinding and repairs to standard types of mains transformers and loudspeakers.

Hammans Industries, Ltd., have sent us copies of their engineering bulletin (H101) in which the physical and electrical properties of aluminium and other non-ferrous metals are compared with those of laminated synthetic materials. Also a leaflet dealing with the nameplates and dials made by their associated firm the Universal Engraving Co., Ltd.

Rimington, Van Wyck, Ltd., suppliers of high-quality gramophone recordings, of 42/3, Cranbourn Street, London, W.C.2, issue each month "Rimington's Review," in which the latest records are described. The price of the publication is 4d.; the December number deals with the firm's own issue of recordings of French pianoforte music played by Phyllis Sellick.

BOOKS ON WIRELESS

issued in conjunction with "The Wireless World"

	Net Price	By Post
"FOUNDATIONS OF WIRELESS," by A. L. M. Sowerby, M.Sc. Third Edition revised by M. G. Scroggie, B.Sc., A.M.I.E.E.	6/-	6/6
"RADIO LABORATORY HANDBOOK," by M. G. Scroggie, B.Sc., A.M.I.E.E. Second Edition Revised and Enlarged	10/6	11/1
"WIRELESS SERVICING MANUAL," by W. T. Cocking, A.M.I.E.E. Sixth Edition Revised and Enlarged	6/-	6/6
"HANDBOOK OF TECHNICAL INSTRUCTION FOR WIRELESS TELEGRAPHISTS," by H. M. Dowsett, M.I.E.E., F.Inst.P., M.Inst.R.E. and L. E. Q. Walker, A.R.C.S. Seventh Edition in preparation	25/-	25/9
"WIRELESS DIRECTION FINDING," by R. Keen, B.Eng. Hons. Sheffield, A.M.I.E.E. Third Edition	25/-	25/9
"RADIO DATA CHARTS," by R. T. Beatty, M.A., B.E., D.Sc. Second Edition	5/-	5/5
"TELEVISION RECEIVING EQUIPMENT," by W. T. Cocking, A.M.I.E.E.	8/6	9/-
"RADIO INTERFERENCE SUPPRESSION," by Gordon W. Ingram, B.Sc.	5/-	5/4
"LEARNING MORSE," Ninth Edition	6d.	7½d.
"RADIO DESIGNER'S HANDBOOK," Edited by F. Langford Smith, B.Sc., B.E.	8/6	9/1
"THE WIRELESS WORLD" GREAT CIRCLE PROJECTION MAP	2/-	2/3
B.V.A. LIST OF EQUIVALENT AND PREFERRED ALTERNATIVE VALVES	1/-	1/1

Obtainable from Leading Booksellers and Railway Bookstalls or by post (remittance with order) from

ILIFFE & SONS LTD., Dorset House, Stamford Street, London, S.E.1



R • S.
=
P • A

When P.A. Equipment and amplifiers are the object of consideration the name R.S. automatically comes to mind, for R.S. not only equals P.A. but it stands for Reliability, Quality and Appearance as well.



R • S

Amplifiers Limited

3-4, Highfield Rd., Shepperton, Middlesex
Telephone: Walton-on-Thames 1019

RANDOM RADIATIONS

By "DIALLIST"

Television "In the Round"

YOU'VE probably been thinking about the possibilities of the new development in television, of which something has appeared in the papers. I mean, of course, Mr. Baird's demonstrations of three-dimensional images on the viewing screen. So far, I've not seen any technical account of the method used, but from what I can gather it consists at the transmitter end in scanning the image by split beams subtending angles about the same as those at the human right and left-eyes respectively. Then at the receiver the images are projected alternately. It's not quite so simple as that, for red, blue and green filters are used, and the picture appears in colour. It is still in the experimental stages, of course, and so far the picture can be seen as a stereoscopic picture by one viewer only at a time, and he must be seated bang opposite the receiver. Still, it is a good step forward, and I don't doubt that developments will follow. I'm not saying that we'll have full colour television perfected by the end of the war; but I wouldn't be a bit surprised if it came along pretty soon after the service gets going again.

Sound, Too

A recent article in *The Wireless World* showed what has been done in the matter of reproducing sound by loudspeakers in such a way that it gives a true "two-eared" impression. Just as we see things in the round because we use two eyes some inches apart in the process, so speech, music and other sound don't seem quite natural unless the "two-eared" effect can be reproduced to some extent. Our ears are, I suppose, direction finders of a kind! There must be a slight phase difference in the sound waves that strike their drums unless we are directly facing the source of the sound, so that the two paths from it to the brain, *via* air, ears and nerves are exactly equal. Anyhow, very definite progress has been made in the matter of stereophonic reproduction, and I'm sure that there will be much bigger developments in the future. The movie people have taken it up, as you know; they have plenty of money to spend on research and

they're egged on by that spirit of competition which is so excellent a spur.

In Continuation

Think what it will mean when we are able to receive television with the images appearing solid instead of flat and the accompanying sounds coming through as if the microphone were binaural like our noble selves. When that has happened we shall look with astonishment at the flat images that we are used to now, and listen to the one-eared sounds with which we are satisfied at present with astonishment that anyone could ever have found them sufficiently real to be worth bothering about. Such is our make-up that we accept new developments in reproduction, no matter how far from the real thing they may be, and enjoy their results thoroughly until a further step is made. Then we wonder that we could ever have been entertained by the old methods. When I was very young, people used to revel in the music of the phonograph, with its cylindrical records and its little tin horn.

Much was lacking in its performance; but we hadn't missed it because we didn't realise that it ought to have been there.

Stepping Stones

Then came electrical recording—1925, wasn't it?—and the radiogram. Heavens! Could we ever have listened with any pleasure to the mechanically made record mechanically reproduced? Try the combination now, if you can rake up an old record and an old gramophone and you'll be surprised. And whilst you are about it, turn up any old wireless book that is on your shelves and look at the circuits and the valves of the four- and five-valve receivers in whose performances people once took such delight. High-impedance triodes throughout, all (even the output) of the general-purpose type. Yet enthusiasts used to write to the papers boasting that their sets gave such volume that "every word and every note of music could be heard to perfection (!) at 100 yards or more." And grid bias! No negative bias on the AF grids in the early days; what bias there was you'll find

on the RF side of the set, and it was *positive*, its job being to hold down unruly, unstabilised stages that were prone to burst into oscillation at the slightest provocation.

Unintentional Broadcasting

REFERRING to my recent note on the music that could be heard—coming apparently from its aerial masts—when passing near one of our high-powered B.B.C. stations, a reader sends me some interesting particulars. He's soldiering now, like me, but at one time he was on the staff at Droitwich. There they didn't get music from the masts, but they got it "very loud and clear" in both the feeder huts. The explanation accepted was that it was due to movements of the air heated up in the immediate neighbourhood of the feeder lines. He asks how the necessary rectification could take place if the masts were responsible. I think it could at any electrically bad joints—under bolt-heads and so on—as the masts swayed slightly in the wind. Do you remember an article in *Wireless World* some years ago on Parasitic Rectification? It gave instances of trouble caused in houses near high-powered stations by rectification between the joints in gutter spouting, lead roofs and other metal bits and pieces. Re-radiation gave rise to some mysterious cases of local interference, which were subsequently cured by bonding together the offending joints, thus short-circuiting the rectifying contacts.

Saying It with Sparks

This kind reader sends me also an account of a very funny incident that occurred at the station. During a thunderstorm a local lightning flash caused the horn gaps on the masts to flash over. The transmitter went on working, but, once struck, the arcs persisted for some time. While they lasted a terrific burst of music was broadcast from them to an astonished countryside. One labourer rushed in, all of a dither, crying that the middle of the field was full of flames and music! A singing arc with a vengeance.

GOODS FOR EXPORT

The fact that goods made of raw materials in short supply owing to war conditions are advertised in this journal should not be taken as an indication that they are necessarily available for export.

LETTERS to the EDITOR

The Editor Does Not Necessarily Endorse the Opinions of His Correspondents

Scale Distortion

BEING, I believe, the originator of the term "scale distortion," I feel I must be involved in A. S. Evans' criticism of it in the January issue. I am not prepared to answer for all the "many articles" to which he refers, but if my own are included among them they must have been misinterpreted.

Mr. Evans' argument is that, as the effect described as scale distortion occurs when listening to the original performance at varying distances, (1) it is not peculiar to loudspeaker reproduction, and (2) is not distortion, and (3) that the real distortion is due to the falling bass of the loudspeaker, knowledge of which has hitherto been confined to himself and P. G. A. H. Voigt.

(1) I am sorry if I have made the impression of holding that scale distortion is something to do only with reproduced sound. Actually I agree entirely with Mr. Evans that it exists equally in direct listening to a performance or speech; but I was writing in a journal devoted more to loudspeaker reproduction than to concert-going. Moreover, listening at really abnormal levels is in practice confined almost entirely to loudspeaker reproduction.

(2) "The farther from the orchestra, generally speaking, the worse the distortion, but does one worry about it, or complain . . . ? No!" This I disagree with, and so would Mr. Evans if he paid for a seat in the dress circle and was given an equally well-upholstered one in the foyer. If he were so unfortunate he might be quite glad of some sort of tone correction for making the best of a bad situation. The variations in loudness in different positions within a normal concert hall are found by actual measurement (see *The Wireless World*, March 10th, 1938, p. 210) to be far less than those due to typical volume control settings. For various reasons (such as a desire not to disturb other people) an orchestral programme is often turned down to much less than the original loudness in any part of the hall, and sometimes studio speech is magnified. The fact I have tried to bring out is that in such cases one does not get a perfectly proportioned reduction or enlargement; the actual

balance of tone is affected, chiefly in the bass, which is deficient in the former but excessive in the latter (so a "compensated" volume control does not help, for the same setting may give an enlargement of one programme and a reduction of another, depending on adjustments at the broadcasting end). If the unpleasant effect of reproduction at a different level is due purely to insufficient loudspeaker bass, how does Mr. Evans account for the growing boominess of quiet speech when it is magnified?

If one is obliged by circumstances to listen to an orchestra at much less loudness than one would hear it in the most expensive seats, is it better to hear it, as it were, at a great distance in the open air, with a false balance of tone, or is it better to attempt to create an illusion of the real thing by restoring at least the balance of tone heard at the best distance?

(3) I feel sure that P. G. A. H. Voigt would disclaim any monopoly in realising the general badness of loudspeakers in the bass or of striving hard to improve them. Loudspeaker characteristic curves have been published in *The Wireless World* and elsewhere for many years, and far more has been written about their faulty bass response and methods of counteracting it than on scale distortion. If I have not emphasised that unbalanced reproduction is obtained if the loudspeaker is deficient in bass, it is because it is surely self-evident.

And now a counter-attack. When he says, "To give full orchestral volume a baffle-mounted loudspeaker must be fed with something like 600 watts," Mr. Evans may be quite correct, but he is running a great risk of being misunderstood to mean *loudness* where he says *volume*. Actual measurement showed (see again the article referred to above) that a 1½-watt output was enough to reproduce the same loudness in a living room as was being heard in the stalls of the now lamented Queen's Hall during the playing of very loud music indeed. At the same time, I called attention to the imperfection which would remain even if all recognised reproducer distortion could be eliminated. The listener is very sensitive to the subtle

The "Fluxite Quins" at work



"O!s soldering our aerial? Oh crumbs!"
He'll be through, sure as fate, my old chums.
With a tin of FLUXITE
There's no holding that sprite—
Look out! Duck your heads! Here he comes!

See that FLUXITE is always by you—in the house—garage—workshop—wherever speedy soldering is needed. Used for 30 years in Government works and by leading engineers and manufacturers. Of Ironmongers—in tins, 4d., 8d., 1/4 and 2/8.

Ask to see the FLUXITE SMALL-SPACE SOLDERING SET—compact but substantial—complete with full instructions, 7/6.

Write for Free Book on the art of "soft" soldering and ask for Leaflet on CASE-HARDENING STEEL and TEMPERING TOOLS with FLUXITE.

TO CYCLISTS! Your wheels will NOT keep round and true unless the spokes are tied with fine wire at the crossings AND SOLDERED. This makes a much stronger wheel. It's simple—with FLUXITE—but IMPORTANT.

THE FLUXITE GUN

is always ready to put Fluxite on the soldering job instantly. A little pressure places the right quantity on the right spot and one charging lasts for ages. Price 1/6, or filled 2/6.

FLUXITE LTD.
(Dept. W.W.),
BERMONDSEY
STREET, S.E.1.

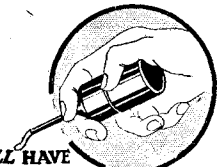

ALL MECHANICS WILL HAVE

FLUXITE

IT SIMPLIFIES ALL SOLDERING

Letters to the Editor—

effects of sound *distribution* (e.g., "Acoustics of Cinema Auditoria," Mason and Moir, *Proc. I.E.E. (Pt. III), Sept., 1941*). If Mr. Evans insists on renting a full-size concert hall and a 600-watt amplifier and loudspeakers to match, he must be warned that the orchestra must play in an entirely "dead" studio, for it wouldn't do to have the reverberation of *two* concert halls superimposed. And then there would still be the need for multiple-channel technique *à la* Disney to give a semblance of source distribution. "CATHODE RAY."

IN the days immediately preceding the war you were good enough, on occasions, to give me space to join, with "Cathode Ray," and many others, in the perennial controversy on scale distortion. Now, in your January issue, this controversy has been revived in the article, "Scale Distortion," by A. S. Evans. I should like, if I may, to return to this subject.

The article in question was really divided into two parts. In the first Mr. Evans showed to his own satisfaction that scale distortion is, in effect, a fallacy, whilst in the second he discussed frequency distortion in loud speakers, and its correction. In my view the first part of the article was unsound; it was based on wrong premises and reached completely wrong conclusions. With the second part I was in full agreement—but the question of frequency distortion in loud speakers has but little bearing on the subject of the article. There is not any disagreement, so far as I am aware, with the view that loud speakers in general (and, maybe, baffle-mounted speakers in particular) do introduce frequency distortion to an extent which is detectable if real high-quality reproduction is required. Nor, again, so far as I am aware, is there disagreement with the view that frequency distortion in one link of a reproducing system may (and, indeed, should) be corrected by an inverse distortion deliberately introduced elsewhere in the system. But what has this got to do with scale distortion?

Scale distortion, so called, is the result of the ear's frequency characteristic being dependent upon sound intensity. Thus, if a programme which one would hear in the original at one level is reproduced at another, then its "balance" will be changed, and scale distortion will be occurring. It is true that if, in addition to being reproduced at the wrong level, it is

also being subjected to frequency distortion, then it will sound even worse than it would if scale distortion alone were occurring. This, though true, is irrelevant.

It may be conceded that scale distortion occurs as one moves from one part of a concert hall to another, but to say, as Mr. Evans says, that "the balance is automatically corrected by that very peculiarity of the ear over which we have worried unduly" is completely incorrect.

The balance is not corrected; it is overlooked, by the uncritical, in just the same manner as the inaccurate reproduction of the vast majority of radio equipments is overlooked by their owners. If Mr. Evans' statement is true, why do many of us prefer a particular distance from the orchestra in a given concert hall? The reason is that in that position we get what we consider (and all this is essentially a subjective decision) to be the best "balance."

An ideal reproducing system will reproduce the sound of the orchestra (free from frequency distortion, of course) at that level at which it would be heard if the particular listener were in *his* favourite seat in the concert hall. It follows that there is no *one* correct reproducing level—it is always that level at which the individual would most like to hear the original. This suggests a very large range of variation, but, in practice, this is not so since a good concert hall is inherently one in which the sound intensity does not vary very greatly from one position to another.

It is, in general, a risky thing to endeavour to analyse matters of art in terms of scientific precision. So it is in this case. It is not true that the only factor in scale distortion is the variation of the ear's frequency characteristic with intensity. There is, in addition, the question of the formation of subjective harmonics (i.e., harmonics formed in the ear itself as a result of its non-linear mechanism) which depend upon intensity. Most important of all, there are the subjective or artistic factors.

The charm of a sunset, the majesty of the snow-clad Alps, the perfection of a Beethoven symphony; these things are not definable in terms of colours, of shapes, or of frequency characteristics. Scale, size or loudness—these are inherent factors. A miserable, puny, undersized reproduction of a great symphony is no more capable of exciting the deepest emotions than is a vest-pocket photograph of the Matterhorn.

Finally, may I say that Mr. Evans'

figure of the 600 watts required to produce "full orchestral volume" may very easily mislead. It may be true that the acoustic output of an orchestra is 600 watts, but it is of more general interest that an amplifier rated at some 10 to 20 watts is fully capable, with a baffle-mounted speaker in an ordinary room, of producing at the listener's ear an intensity equal to that which would exist at his ear in the concert hall.

Batley, Yorks. J. R. HUGHES.

Wire versus Wireless

AS one who has devoted considerable thought and time to convincing people of the advantages of wired broadcasting, I was very pleased to see that in your Editorial last month no attempt was made to confound Mr. Eckersley on technical grounds. Instead, the argument offered was merely a clever exposition of the elementary objection always raised against wired wireless before the matter has been the subject of serious thought or experience. It so happens that the idea, at first sight, appears to be in opposition to the independence of thought and action upon which we, as a nation, pride ourselves. The objection is usually stated as "having to have what they give you instead of what you want."

The significance of this *cliché* lies surely in the personality behind the word "they." If by "they" we mean a democratic authority working for the best possible use of such entertainment and enlightenment as can be conveyed to man through the ear alone, "what they give" immediately becomes synonymous with "what you want," and the objection breaks down.

The use of the expression, "Properly applied international broadcasting" in your Editorial suggests that you are prepared to believe that some such authority as I have assumed may come into being in the post-war world. For those, however, who are not prepared to accept this assumption, and consider free listening as a necessary brake on dictatorial tendencies of the governments of the future, I would point out that the taxing of all receivers out of existence, except a standard low-range, pre-tuned model, would give all the advantages of the wired system to any government so inclined.

It might be argued that the war has brought in foreign listening to stay. There are no grounds for this belief; world news will once again resume its third place to local gossip and sports

results. News bulletins in foreign languages will disappear because, while it is of interest to-day to tune in Lisbon and check up statements made by our own news service, no one will wish to tune in, say, Breslau, to hear the result of the Wigan by-election or the latest purchaser of some eminent footballer.

The part which international broadcasting has to play in the post-war world is, therefore, based on this reasoning, rather limited. It is obvious that this small part will be played more efficiently if one central authority is responsible, which automatically presupposes the use of the very best receiving equipment, to say nothing of recording the material for dissemination at a suitable time.

F. ALWYN.

Rotherham, Yorks.

Technical Training

IN your January issue W. M. Dalton makes a number of curious and almost incredible assertions on the subject of training of radio engineers. I do not know exactly what he means by "three years' simple electrical engineering," but obviously his students do not spend much time in the classroom; all the electricity needed by a radio engineer can be taught in forty hours, at the outside, to people with matriculation physics and mathematics. No one with qualifications less than this will ever learn much about radio. "Three years' thermionics" is equally absurd. My students acquire all that is necessary in six hours, or less.

Your correspondent goes on to suggest that the nine-year course he outlines should be supplemented by acoustics, astronomy, chemistry, heat, mathematics, and optics, to a standard higher than that of the B.Sc. (London). Mathematics is useful to the really expert student, and acoustics to the loud-speaker specialist, but advanced astronomy, chemistry, heat, and optics have no connection whatever with radio.

These and other points, as, for example, his statement that "the radio man could eat the electrical engineer's subject and then carry on with his own," lead one to suppose that Mr. Dalton's letter is to be taken as a jest. If it is seriously intended, then he presents a misleading and wholly ridiculous picture of the knowledge needed by a radio engineer.

SUBALTERN.

I THINK Mr. W. M. Dalton (in his letter in your January issue) has omitted a vital step in the training of

radio engineers: between the three years' simple electrical engineering and "at least three years on thermionics" there should be at least ten years on atomic physics, to include quantum theory, relativity, wave-mechanics and whatever new developments in fundamental physics there may be in the next ten to fifteen years, without which the student cannot possibly understand the emission of an electron from a complex surface.

Seriously, though, a trained engineer is not an encyclopædia, but a man who has some knowledge and knows how to use it, and knows where and how to look for further information. With all due respect to the regular contributors to *The Wireless World* (whom your correspondent suggests as suitable teachers for his extensive syllabus), I should hesitate to ask any one of them to hold forth on all of the following subjects: theory of electrical machines (e.g., the use of inter-poles), atomic physics of the type outlined above, optics of the standard required for the design of wide-aperture lenses, astro-physics and meteorology as required for investigation of propagation conditions, filter theory, mathematical treatment of radiation from aerials, high-efficiency modulation systems for broadcasting stations, and the design of oscillators of extremely high frequency stability. If there is no teacher who can cover the whole field envisaged by Mr. Dalton, is it reasonable to expect the student to learn it all during his "training" period?

A training course should be devoted to the study of fundamental principles, not specific pieces of apparatus; but departure from this ideal is forced in practice by the need for the student to acquire the practical technique of some particular sub-section of radio by the age at which he requires to earn a living. I suggest that the only hope for a practicable scheme of part-time training is a three-year course in mathematics and the relevant sections of physics, followed by a two-year course of radio in which the time is divided equally between general radio theory and a specialised course in one section of radio technique. (Possible subjects for specialisation might be: acoustics and AF amplifiers, aerials and propagation, high-power RF amplifiers and modulators, etc.) Having got a footing in the industry on the strength of his one specialisation, the engineer may then (if he has the time and inclination) study other branches of the art.

D. A. BELL.

London, N.21.

VORTEXION
50w. AMPLIFIER CHASSIS

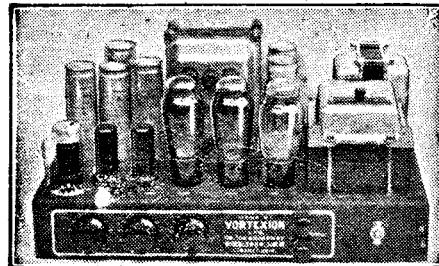

A pair of matched 6L6's with 10 per cent. negative feed-back is fitted in the output stage, and the separate HT supplies to the anode and screen have better than 4 per cent. regulation, while a separate rectifier provides bias.

The 6L6's are driven by a 6F6 triode connected through a driver transformer incorporating feed-back. This is preceded by a 6N7 electronic mixing for pick-up and microphone. The additional 6F6 operating as first stage on microphone only is suitable for any microphone. A tone control is fitted and the large eight-section output transformer is available in three types:—2.8-15-30 ohms; 4-15-30-60 ohms or 15-60-125-250 ohms. These output lines can be matched using all sections of windings and will deliver the full response (40-18,000 c/s) to the loud speakers with extremely low overall harmonic distortion.

- CHASSIS with valves and plugs £17 10 0
- Moving Coil Microphones £5 5 0
- Chromium Microphone Stands from £1 5 0

Many hundreds already in use

15w. AC & 12-VOLT DC AMPLIFIER

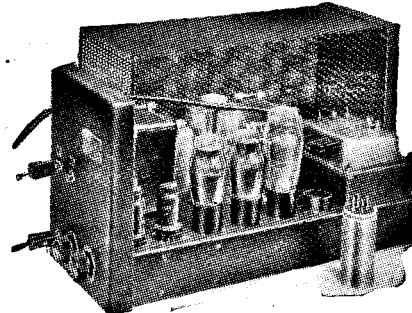

IYP: CP20

This small Portable Amplifier operating either from AC mains or 12-volt battery, was tested by "THE WIRELESS WORLD," October 1st, 1937, and has proved so popular that at Customers' demand it remains unaltered except that the output has been increased to 17.2 watts and the battery consumption lowered to 6 amperes. Read what "The Wireless World" said:—

"During tests an output of 14.7 watts was obtained without any trace of distortion so that the rating of 15 watts is quite justified. The measured response shows an upper limit of 15,000 c/s and a lower of 30 c/s. Its performance is exceptionally good. Another outstanding feature is its exceptionally low hum level when AO operated even without an earth connection. In order to obtain the maximum undistorted output, an input to the microphone jack of 0.057 volt was required. The two independent volume controls enable one to adjust the gain of the amplifier for the same power output from both sources, as well as superimpose one on the other or fade out one and bring the other up to full volume. The secondary of the output transformer is tapped for loud speakers of line impedances of 4, 7.5 and 15 ohms." Prices

- AC and 12-volt CHASSIS with valves, etc. £12 12 0
- AC only CHASSIS with valves, etc. £8 18 6

Gazette Case for either chassis, 12/6 extra.

Plus 20% War Increase.

Orders can only be accepted against Government Contracts.

Vortexion Ltd., 257, The Broadway, Wimbledon, S.W.19. Phone: LIBerty 2814

Curing Instability

By JAMES GIBBONS

Causes of Unwanted Oscillation in Broadcast Receivers

AMONG the many faults which a wireless receiver can develop, and one of the hardest to locate, is that of instability. Like many other defects, it may be just perceptible, or immediately obvious, and ranges from hardly audible "motor-boating" at full volume to a violent succession of whistles as the tuning condenser is rotated. Again, the cause of such instability may be a change of circuit conditions in either the AF, RF, or IF circuits. It is widely known that this effect is always caused by unwanted reaction, and is the result of spurious coupling between two or more circuits in cascade, or to self-oscillation of any particular stage.

Whistles in superhets need not be regarded with grave concern in every case. All receivers of the low-IF type (100-130 kc/s) and particularly those without any signal-frequency amplification have self-generated whistles on the LW band at least, usually on that part of the band which coincides with a wavelength equal to the 2nd harmonic of the intermediate frequency. (Assuming an IF of 117 kc/s, the second harmonic would be 234 kc/s, equivalent to a wavelength of about 1,277 metres.) This is, of course, due to a beat effect between the output of the second detector and a received signal. It is one of those self-generated whistles which have to be considered when the receiver is designed, because very little can be done about it afterwards.

Typical Causes

The cause of instability in a wireless receiver may be fairly simple, such as wrong operating voltages on IF or FC valves, or more elusive, perhaps being due to SG by-pass condensers having become open-circuited, or to the screening of coils, or leads, become disconnected from, or developed high resistance contact to, earth. Metallised valves, too, develop queer tricks. The connection between the metal coating and the cathode sometimes works a little loose, and often provokes acute instability. Anything, therefore, which tends to reduce the efficiency of inter-circuit screening, and decoupling, or introduces unwanted coupling by high-resistance contacts, must be suspected when normal stability is affected.

A systematic check of all the possible causes, starting with the simplest, is the best procedure. First of all it should be noted what type of instability has developed. Is it present all the time, or only on the weaker stations? Does it occur only at certain positions of the wave scale? Does the set seem lively, etc.? A careful test will often give a clue to the whereabouts of the trouble; for instance, unstable conditions which show up only at certain positions on the tuning scale are quite often caused by poor contact to the different rotor sections of the gang tuning condenser. If this is suspected, and, for that matter, at any time a set is being given a "surface" overhaul, these contacts should be removed, and their surfaces cleaned with petrol and fine glass paper. On replacing, the contact tension should be increased, and a smear of vaseline applied to the bearing surfaces. It is also advisable to examine carefully the continuity of the earth wire, and earthing device. There are many commercial superhets that are not at all happy when worked without an earth, while nearly all high-gain TRF sets develop self-oscillation at the high-frequency end of the MW band without its stabilising influence.

Visual Indications

Keen visual observation has always been a necessary asset to rapid fault-tracing in radio receivers. Quick perception will often reveal in a fraction of the time faults which could only be found in a general way by much tiresome routine testing. It is therefore good practice to make a careful examination for obvious defects. Be always on the look-out for traces of electrolyte round the bases of tubular electrolytic condensers. This sometimes dries and makes detection difficult, but it always impairs good contact, and increases the apparent power factor of the condenser, causing reduced general performance, abnormal hum level and reduced HT voltage in the case of reservoir condensers, and low volume, thin reproduction, and instability in the case of smoothing condensers. Press all coil cans, valve screens, etc., firmly down on their bases, giving them at the same time a screwing motion to make sure of a good biting contact. Be sus-

picious of all earthing tags, making sure of their electrical connection to the chassis; remember that high-resistance contact to earth of screening and decoupling components has been productive of more cases of instability than any other single cause. Check carefully all soldered connections to valve-holders and decoupling components. It takes very little time to re-solder many joints, while a poor one which goes undetected is probably the most difficult of all faults.

Many rough, but informative, tests can be made before the chassis is removed from the cabinet. If the main smoothing condenser is suspected of being open-circuited, a substitute can be tried between the HT side of the output transformer and chassis, or between the SG of an output pentode and chassis. Sometimes, too, stability can be restored by touching the metal coating of one of the valves. The implication here is obvious, and that particular valve and stage should be checked without delay. SG decoupling condensers can likewise be temporarily connected between the appropriate contact on the valve-holder and chassis, if the mechanical design and layout will allow. If not, remove the chassis right at the start and work in comfort. Always rearrange as before any inter-circuit wiring disturbed during tests. This is important, as neglect to do it may provoke further instability, and even AF circuits are sometimes quite critical.

Stray Couplings

Volume control wiring should always be treated with respect. The controlling potentiometer in many sets is used as, or part of, the signal diode load resistance; it is therefore in circuit with the high-gain end of the IF amplifier and second detector. Any careless derangement of its attendant wiring may cause unwanted self-

generated whistles by reaction between nearby leads carrying RF currents. The writer knows of at least one commercial superhet which was cured of a nasty whistle on Luxembourg by altering the run of wiring to the volume control, thereby eliminating acute 2nd-IF harmonic feedback. It is so often the small things which make the big differences.

Open-circuited secondaries are another certain cause of greatly reduced performance, together with lively "chirps" all over the scale. A voltage and current test will, however, always give a clue to this defect, as it removes the bias from the succeeding valve, which then shows reduced anode volts and high anode current.

A flat, unchanging howl and/or "motor-boating" are manifestations of instability which are peculiar to AF circuits. Again the most likely causes are O-C anode de-coupling components, or cathode resistor by-pass condensers, and/or a partially O-C smoothing condenser. This latter component, if its capacity has become low, can cause most puzzling faults, ranging from an 80 per cent. reduction in general performance, or perhaps whistles on all but the strongest signals, to barely perceptible "motor-boating." Further, there is never any rise in hum level, as might be expected. As a potential destroyer of performance this component is nothing if not versatile, as many service-men will ruefully testify. Accordingly, it should be checked at an early stage.

Finally, the writer would like to repeat an axiom that is well known wherever successful radio servicing is performed. It is this: "Never take anything for granted, test it and be sure, or surprised."

"Wireless World" Index

THE index to Volume 47, January to December, 1941, of *Wireless World* is in course of preparation and will be published shortly at 7½d., post free, or, with cloth binding case, 4s. 5d., post free. Arrangements can be made for readers' copies to be bound with an index in the publishers' case at a cost of 10s., plus 9d. for the return postage.

Aircraft Identification

TWENTY-SIX leading types of aircraft are included in the revised edition of the identification chart of British aircraft issued by our associated journal *Flight*. Grouped according to type, the perspective illustrations present a general air aspect of each aircraft. Copies of the chart may be obtained from Dorset House, Stamford Street, London, S.E.1, price 1s. 3d. each, plus 6d. postage on single copies, or 7d. up to three copies.

COMMUNICATIONS DEPEND....

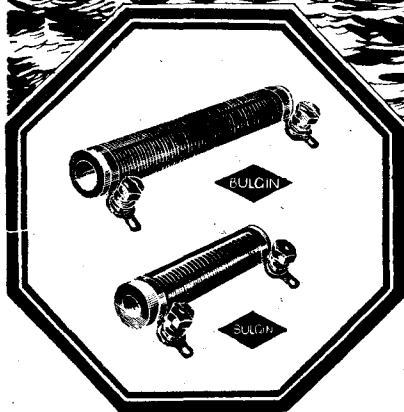
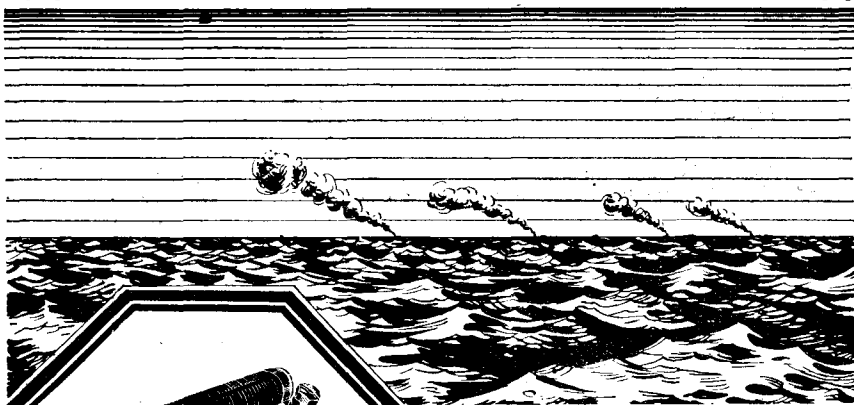

ON SMALL PARTS....

IN countless instances quite intricate pieces of apparatus are wholly dependent on the proved reputation and reliability of their component parts.

All products from the House of Bulgin are pre-eminent for superior design and workmanship, and every article bearing our Trade Mark has to pass exacting and exhaustive tests during the course of its production.

We ask the kind indulgence of the Trade on delivery until peaceful conditions return

*The Choice
of Critics*

BULGIN FOR RESISTORS

The largest and most comprehensive range of Resistors. Values from 0.10 to 150,000Ω in wire-wound types, ratings from 2 to 100W. Solenoidal-wound and double-spiral models available. Special accuracies of $\pm 1\%$ to order, at special prices. Only the finest materials are used throughout.

ALWAYS DEPEND ON



REGISTERED • TRADE • MARK

A. F. BULGIN & CO. LTD., BY-PASS RD., BARKING, ESSEX.
TEL.: RIPPLEWAY 3474 (4 lines).

RECENT INVENTIONS

A Selection of the More Interesting Radio Developments

A RADIO INCLINOMETER

A HORIZONTAL aerial, subjected to a vertically polarised field, is connected to a counterpoise so that there is no signal pick-up. The counterpoise may be an aeroplane in flight, and the point of zero pick-up is determined empirically. Under these circumstances, any change in the fore-and-aft trim of the aeroplane will be indicated on a zero-centre indicator.

In order to remove any doubt as to whether the variation in level is in the upward or downward direction, the horizontal aerial is coupled through a reversing switch to the output from a second aerial which is arranged vertically. The combined signals are then fed to a receiver, and a reversing switch, synchronised with the first switch, is connected between the receiver and a pair of rectifiers feeding the indicator. The initial setting of the aerial to give zero pick-up is approximately horizontal when the aerial is connected to the electrical centre of the counterpoise. If it is not practicable to connect it to the electric centre, then it may be connected at any other convenient point, provided it is given a corresponding slight "tilt" upwards or downwards.

Marconi's Wireless Telegraph Co., Ltd., and J. Stewart. Application date, November 3rd, 1939. No. 536259.

PHOTO-SENSITIVE RELAYS

RELATES to relays of the kind which give a visual or audible indication either when light falls on a photo-electric cell or when the normal illumination increases in intensity. One drawback of the usual arrangement is that no positive indication is given should the supply current fail, and so render the device ineffective.

According to the invention, a photo-electric cell in the grid circuit of a thermionic amplifier is arranged so that any increase of the normal incident light causes an increase in anode current. Two relays are included in the anode circuit, one of which responds when the current rises and the other when the current falls below a predetermined value. During normal conditions the second relay is energised, but the alarm circuit is open and ready to be operated should the photo-electric cell be stimulated by extra light. In the latter event, the first relay responds and is locked to give a continuous warning, even when the exciting stimulus has ceased. Should the supply current to the device fail or be cut off, the second relay is de-energised, but its alarm is activated to draw attention to the failure.

Baird Television and L. C. Bentley. Application date, January 5th, 1940. No. 537832.

DIRECTION-FINDERS

A RADIO compass indicates the bearing of a ship or aeroplane with respect to a radio transmitter, and it is possible to utilise a self-orientating aerial system which will show continuously the radio bearings of the craft as it changes course. The object of the invention is to combine a radio-compass reading with that given by a magnetic compass so that an indication of the craft's true bearing (with reference to a meridian) can be constantly shown at various observation points on the craft in the same way as an ordinary repeater compass.

This is done by applying voltages derived from the radio compass to one pair of the deflecting plates of a cathode-ray tube, and voltages derived from the earth compass to the other pair of deflecting plates. At the same time a rotary arm sweeps over a potentiometer, which takes the form of a double figure-of-eight and applies to both pairs of deflecting plates voltages which are proportional to the instantaneous angular position of both bearing indicators. The cathode-ray tube will then show two traces simultaneously, one corresponding to the radio bearing and the other to the

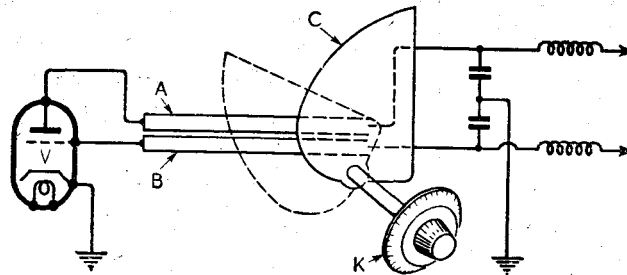

Rotary Lecher-wire tuning.

magnetic compass bearing. By applying a further potentiometer control, the arrangement can be used to give a point position of the craft on a chart.

Marconi's Wireless Telegraph Co., Ltd. (assignees of D. G. C. Luck). Convention date (U.S.A.), January 31st, 1939. No. 537089.

PREVENTING FADING

FADING is usually localised, and it is known that it can be largely offset by feeding a single receiver with the combined effective pick-up from a number of separate aerials distributed over a fairly limited area. This method of diversity reception is not, however, a practical proposition to the ordinary broadcast listener.

As a more convenient alternative it is proposed to make use of, say, two aerials which are in close proximity to each

other and to the receiver, but possess different directional characteristics. When fading sets in on the aerial to which the set is for the moment coupled, a switch is automatically brought into operation and changes that aerial for the alternative one. Fading may be general, or it may be selective in the sense that the carrier is attenuated more than the sidebands. The latter type produces the same kind of distortion as over-modulation. In either case a voltage derived from the AVC circuit is applied to control the condition of a pair of gas-filled discharge tubes which are inter-coupled to form a "flip-flop" relay between the receiver and one or other of the alternative aerials.

Marconi's Wireless Telegraph Co. (assignees of H. O. Peterson). Convention date (U.S.A.), March 15th, 1939. No. 537937.

LECHER-WIRE CIRCUITS

THE usual way of tuning a pair of Lecher wires is to slide a short-circuiting bar or condenser along the length to fix the voltage node. The object of the invention is to replace this method by one in which tuning control can be effected by means of a rotating dial or knob.

The arrangement is shown as applied to the tuning of a receiving set for centimetre waves. The grid and anode of the valve V are coupled by a quarter-wave Lecher circuit consisting of two strips A, B set parallel to each other with their wide surfaces in the same plane. The tuning element is a thin metallic disc C, of the contour shown, and mounted eccentrically on the spindle of a rotary control knob K. The disc moves close to and parallel with the plane of the deeper strips, so that the series capacities between the disc

and the strips form a low impedance shunt, the position of which is determined by the leading edge of the disc. The rotation of the disc increases or decreases the effective electrical length of the Lecher circuit, and therefore its tuning by an amount which is linearly related to the angular rotation of the control knob K.

Marconi's Wireless Telegraph Co., Ltd. (Assignees of J. R. Schick). Convention date (U.S.A.) March 22nd, 1939. No. 538921.

The British abstracts published here are prepared with the permission of the Controller of H.M. Stationery Office, from specifications obtainable at the Patent Office, 25 Southampton Buildings, London, W.C.2, price 1/- each.



When the iron is hot . . .

We are striking *now*, to forge the weapons of victory at ever-increasing speed! Weapons as modern as the methods now used to make them. The slow, deliberate art of the armourer and blacksmith has given place to the speed of the electric arc welder. In other ways, too, electrical development has revolutionised our methods;

for our armies, our ships, our hospitals and our factories, it has provided the boon of X-rays; the many uses of the sound amplifier; the efficiency of modern lighting; the wonders of radio communication . . . and much more besides. It is an inspiring story of electrical achievement in which the name of PHILIPS is outstanding.

PHILIPS



LAMPS • RADIO • X-RAY AND ELECTRO-MEDICAL EQUIPMENT • DISCHARGE LIGHTING
SOUND AMPLIFYING INSTALLATIONS • ARC WELDING EQUIPMENT AND ELECTRODES

PHILIPS LAMPS LTD., CENTURY HOUSE, SHAFTESBURY AVENUE, W.C.2

CLASSIFIED ADVERTISEMENTS. The charge is 6/- for each paragraph of 2 lines or less, and 3/- for every additional line or part thereof, average 7 words to a line. Each paragraph is charged separately.
 ADVERTISEMENTS for the March issue are accepted up to First Post on Tuesday, February 10th, at the Head Offices of Dorset House, Stamford Street, London S.E.1, or one day earlier at provincial Offices.

THE PROPRIETORS retain the rights to refuse or withdraw advertisements at their discretion. They are not responsible for clerical or printers' errors although every care is taken to avoid mistakes. Cheques and postal orders should be made payable to Iliffe & Sons Ltd. and crossed. Notes are legal tender and cannot be traced if lost in transit.

ADVERTISERS may have letters, other than circulars, addressed to numbers at this office. The words Box 000, c/o "WIRELESS WORLD" must be paid for and a further 1/- added for registration and forwarding replies.
 DEPOSIT SYSTEM. Full particulars upon application to the Deposit Dept., "Wireless World," Dorset House, Stamford Street, London, S.E.1.

Ode
Partridge
No. 13
TO HITLER

When evening's twilight gathers round
 You'll find your dupes flat on the ground
 All frozen in the Russian snow.
 Oh Adolf, what an awful blow!

You boasted that ere Christmas came
 You'd be in Moscow. What a shame!
 Joe Stalin really is unkind
 To make you change your mystic mind.

You said you'd soon get Leningrad,
 Its outlook, true, was very bad
 But once again he's changed your plans
 And put 'em in the "also rans."

Then there's the Ukraine and Crimea,
 Strange how your schemes slip out of gear,
 From top to low—and now reverse
 But cheerio it'll soon be worse.

N. Partridge
 B.Sc., A.M.I.E.E.
 Makers of Transformers and Chokes
 King's Bldgs., Dean Stanley St.,
 LONDON, S.W.1. 'phone: VICTORIA 5035

NEW RECEIVERS AND AMPLIFIERS
WIRELESS WORLD 2 R.F. Receiver, including tone control stage, quality amplifier, Garrard gramophone unit, Piezo P.U., Magnavox energised speaker complete in cabinet; £25.—Box 2625, c/o The Wireless World. [9884]

100 Car Radios, new, latest model, two waveband, 200/2,000 metres, complete with speaker and all accessories, less valves. Containing a quantity of useful components. A very good investment at 45/- each, carriage paid, immediate delivery.—H. H. Linton and Co., Ltd., 2, Highgate High St., N.6. Mountview 9431-2. [9867]

£19/10 Only—"Wireless World" 2R.F. receiver, with push-pull quality amplifier chassis, 10 valves, including tone control stage, 3 watts triode output, ideal for quality reproduction from radio and gramophone, limited number; reduced price includes all valves.—Bakers Selhurst Radio, 75, Sussex Rd., South Croydon. [9809]

RECEIVERS & AMPLIFIERS, SECOND-HAND, ETC.
H.R.O. Receiver, perfect; best cash offer secured. Box 2621, c/o The Wireless World. [8970]

Wanted
HALLICRAFTER Sky Champion or Similar Receiver.—Box 2624, c/o The Wireless World. [9879]

NATIONAL Standard HRO or SX28, SX25, "list price paid," required to help war effort.—Wire, 14, Common Rd., Evesham. [9878]

COMMUNICATION Receiver, H.R.O. National or R.M.E.; reasonable price.—Green, Haydonway House, Coughton, nr. Redditch. [9841]

NEW or Used Receivers, Amplifiers, Meters, Converters, Radio & Electrical Accessories. Very high prices paid for really clean apparatus.—Phone: Gerrard 4447. [9696]

LONDON CENTRAL RADIO STORES Will Pay good prices for Receivers, Radiograms, Amplifiers, Dynamos, Converters, Test Equipment, Electric Gramophone Motors, and all Radio and Electrical Accessories.—London Central Radio Stores, 25, Lisle St., London, W.C.2. Gerrard 2969. [9836]

NEW MAINS EQUIPMENT
VORTEXION Mains Transformers, chokes, etc., are supplied to G.P.O., B.B.C., L.P.T.B.; why not you? Limited, but unequalled.
VORTEXION, Ltd., 257, The Broadway, Wimbledon, London, S.W.19. 'Phone: Lib. 2814. [9571]

NEW LOUDSPEAKERS
BAKERS Brand New Surplus Speaker Bargains.
EVERY Music Lover Interested in Realistic Reproduction should write for free descriptive leaflet now.
£6/10; usual price £10.—Brand new permanent magnet, infinite baffle speaker, complete with beautifully finished cabinet in polished walnut.
£3; usual price £5.—Brand new super quality triple cone speaker, permanent magnet model; exceptional bargain; limited number.
SECURE One of These Exceptional Bargains Now.
BAKERS Triple Cone Conversions Will Immensely Improve Reproduction of Your Present Speaker. ("For a few shillings you have converted a speaker scheduled for the scrap heap into one worth pounds.—W. E. Darby, Grad.L.E.E.") Write for details.
BAKERS SELHURST RADIO, 75, Sussex Rd., Sth. Croydon. [9810]

Wanted
ROLA G12, Magnavox 66, or similar size, 3 or R 15 high speech, PM or energised.—Bland, 6, Hart Close, Rugby. [9891]

GRAMOPHONE MOTORS
Wanted
A.C. Gramomotor or unit, Telefunken pick-up.—Box 2620, c/o The Wireless World. [9865]

GRAMOPHONE EQUIPMENT
Wanted
HIGH Fidelity A.C. Gramophone, two or three units.—15, Fairfield Park Rd., Cheltenham. [9885]

VARLEY Auto-Arm for Pickup; details, price.—Parker, 49, Buckingham Ave., Welling, Kent. [9877]

GARRARD Electric Gramophone Motor and Turntable, type 201A preferred; must be perfect; deposit system.—79, Allesley Old Rd., Coventry. [9875]

WANTED, Telefunken sapphire needle pick-up, in perfect condition, purchase guaranteed at reasonable price.—L. Gregory, 51, Higher Rd., Urmston, Manchester. [9881]

CABINETS
WE Regret that, owing to all our employees having joined H.M. Forces, we are unable to accept orders for cabinets except to callers. Limited stock only. We have a large stock of radio components.—H. L. Smith and Co., Ltd., 289, Edgware Rd., London, W.2. Tel.: Pad. 5891. [9682]

ARMSTRONG

EXCELLENT COIL PACKS COVERING 4 WAVE-BANDS—STILL AVAILABLE

We are pleased to say we are now up-to-date with deliveries and thank you for your patience.

Originally designed for use with our export chassis Model EXP48, which was so favourably reviewed in the October, 1940, issue of *Wireless World*. The Test Report said: "no difficulty was experienced in picking up American stations." This assembly is ideal for constructing a modern receiver using English or Octal valves, for constructing a battery receiver or tuning unit to work with an amplifier. The short-wave performance with the EXP48 coils is extremely high.

Specification. EXP48 coil and switch assembly covering 13-45, 43-160, 200-550, 1,000-2,000 m. Mounted on cadmium plated sub-chassis with 4 position Yaxley type rotary switch. Medium and long wave adjustable paddlers and fixed paddlers on the short wave ranges. Each coil fitted with individual trimmer and the whole assembly wired up. **Factory Blue Print** giving 7-valve EXP48 circuit and values of components **FREE** with assembly. **Price 35/-**. Heavy Steel Chassis for use with above, 12in. x 8in. x 3in. deep, drilled and cadmium plated. **Price 10/6**. 465 kc. High "Q" I.F. Transformers, Leitz wire wound and fitted with iron cores, in aluminium cans, incorporating trimmers with ceramic insulation. For use with the above. **Price 18/6 per pair.**

Glass Tuning Scales, 4 wave-bands, calibrated in station names and metres. For use with the above. **Price 3/6**.
 A complete chassis, incorporating the above components, will be gladly demonstrated at our Showrooms and any technical advice given.
Deliveries should not exceed 7 to 10 days.
All components advertised in November issue, including Aluminium Screens, are still available.

ARMSTRONG MANUFACTURING CO.
WALTERS ROAD, HOLLOWAY, LONDON, N.7
 'Phone: NORTH 3213

Subservience to Quality

At GARDNERS everything takes second place to the high manufacturing standards that have been set. In no GARDNER product, however, is this subservience to an ideal more exemplified than in our range of Small Power Transformers and Chokes. These high-lights of modern Transformer engineering are designed and built especially for those occasions when the specification says "best"—and means it. If, then, you use or are contemplating using Small Power Transformers up to 4 kva., you can with confidence ask for the best—and get it. Please remember, however, that delivery can only be made on orders quoting priority numbers.

QUALITY MAINS TRANSFORMERS

GARDNERS RADIO, LIMITED
 SOMERFORD • CHRISTCHURCH • HANTS

HUNT'S MICA CONDENSERS

For Sale IN 10-GROSS LOTS

All capacities up to .007 mfd. Wire ends and Tag ends.
 Price **32/6 per Gross.**
 .008, .01, .015 mfd.
 Price **96/- per Gross.**

These well-known British Condensers are brand new.
ALL ORDERS & ENQUIRIES TO

LONDON CENTRAL RADIO STORES
 23 Lisle Street, London, W.C.2
 Telephone: GERRARD 2069



Another 65-watt SOLON

This 65-watt industrial type SOLON is fitted with an oval tapered bit—a popular shape for all general work. Pencil bit types and heavier models are also available.

Details of this and other models sent on request.



MADE FOR USUAL STANDARD VOLTAGES

Due to the heavy demands, it is necessary to order well in advance to avoid disappointment in delivery.

W. T. HENLEY'S TELEGRAPH WORKS CO. LTD.
Engineering Dept., Milton Court,
WESTCOTT, DORKING, SURREY.

CODE COURSES

For Beginners and Operators



The Candler System of Code training is just what one needs for entering or advancing in Army, Navy, Air Force, Amateur Radio work, or the Commercial side of telegraphy.

JUNIOR AND ADVANCED COURSES on Cash or Monthly Payment terms.

There's no royal road to learning—but there IS a quick, sure way to genuine CODE skill. Thousands upon thousands of Candler Trained Operators have proved the value of this truly remarkable system of Code instruction.

J. Clarricoats, Sec., Radio Society of Great Britain—says: "I regard the Candler System as being the most important system of its kind and already large numbers of Members of the Radio Society of Great Britain have intimated to me that they are studying the course of instruction with a view to preparing themselves for service in one branch or another of H.M. Forces."

In the "BOOK OF FACTS," which will be sent FREE on request, you will see that full information is given concerning the subjects covered by Courses for beginners and also for operators.

COUPON

Please send me a Free Copy of Candler "Book of Facts."
NAME.....
ADDRESS.....

Post Coupon in ld. unsealed envelope to London Manager
CANDLER SYSTEM CO. (Room 55W), 121,
Kingsway, London, W.C.2
Candler System Co., Denver, Colorado, U.S.A.

242

MORSE EQUIPMENT

FULL Range of Transmitting Keys, practice sets and equipment for Morse training.—Webb's Radio, 14, Soho St., London, W.1. Phone: Gerrard 2089. 19553

TEST EQUIPMENT

ONE Model 3295 Cossor Oscilloscope, unused and as new; offers wanted.—Box 2622, c/o The Wireless World. 19871

TRIPLETT Model Condenser Tester, new condition, £15; Supreme Signal Generator, £10; AVO Oscillator Model, £4.—Harris and Gillow, 80 Wardour St., W.1. 19868

Wanted

CONDENSER, analyser and tester; state maker, condition, price.—Hall, 4, Cowick Hill, Exeter. 19876

VALVES Wanted

VALVES Wanted, any quantity from one upwards; also test equipment, service sheets and spares.—J. Bull, 4, Melthorne Drive, Ruislip. 19732

DYNAMOS, MOTORS, ETC.

ALL Types of Rotary Converters, electric motors, battery chargers, petrol-electric generator sets, etc., in stock, new and second-hand.

WARD, 57, White Post Lane, Hackney Wick, E.9. Tel.: Amherst 1393. 10518

ROTARY Converters, 230 D.C. in, 230 A.C. out, 1,000 watts, £25; Crypto ditto, 400 watts, £15; several others from 40 watts up; Dynamos, all sizes up to 5kw.; Motors up to 5hp., A.C. and D.C.—Harris, Strouds, Bradford, Berks. 19869

COMPONENTS—SECONDHAND, SURPLUS, ETC. SOUTHERN RADIO'S Wireless Bargains.

7/6—Assorted components contained in attractive permanent box. 9 assorted valve-holders, 2 volume controls, 12 assorted condensers, 6 resistances, choke wire, plugs, circuits, etc.; 7/6, postage 7d. Ormond loud-speaker units, balanced armature types, small Bakelite, 3/6; unshrouded, 2/6; largest 4-pole type, 6/6. Ace P.O. microphones, ready for use on any receiver, 6/6. Westcoaters, W.2, 2/16. Telsens radio magazines, complete with 4 circuits, 9d., post free. Wireless crystals, 6d. each, 5/- per dozen. Permanent magnet speakers, 8in., complete with multi-ratio transformer, 20/-. Many other bargains for callers. All goods guaranteed. Please add extra for postage.

SOUTHERN RADIO SUPPLY Co., 46, Lisle St., London, W.C. Gerrard 0653. 19847

F. H. WILSON (former Manager of Radio Clearance, Ltd.), 52, Chancery Lane, London, W.C.2. Telephone: Holborn 4631.

B.I. Tubular Condensers, N.I., 0.0001, 0.0002, 0.0003, 0.0005, 0.001, 0.005, 5d. each.

T.C.C.C. Tubular Condensers, 0.01, 5d. each; 0.1, 7d. each.

T.C.C. Tubular Electrolytics, 25 mfd. 25v., 1/6 each. 50 mfd. 12v., 1/6 each. 25 mfd. 50v., 1/9 each. 50 mfd. 25v., 1/9 each. 2 mfd. 200v., 1/6 each. 2 mfd. 300v., 1/9 each.

MICA Condensers, 0.0065 mfd., 6d. each.

VARIABLE Condensers.—Single Gang, 0.0005, 1/11 each. Three Gang, 0.0005, 3/11 each.

SPECIAL.—All-Wave 2-Gang 0.0005 Variable Condensers, Ceramic Insulation, 4/- each.

PHILIPS Dual Range Aerial Coils, no reaction, with circuit, 1/6 each. Also I.F. Transformers, 180 K.C., 1/6 each.

YAXLEY Type Switches, 2 Pole 4 Way, 4 Bank, 4/- each.

YAXLEY Type Switch Locator Units, 6d. each.

STRAIGHT Line Dials, 3 Waveband, 1/6 each.

VALVE Holders, Chassis type, 4 pin, 3d. each. 5 and 7 pin, 4d. and 6d. each.

PHILIPS P.M. Speakers.—New, 8in., suitable for Extension Speaker, 15/- each.

PHILIPS Speakers.—P.M. approx. 6in. Cone, with Transformers, 17/6 each.

LOUD-SPEAKER or 'Phone Cords, 4d. each.

BATTERY Leads, complete with plugs, 5 Way, 1/6 each.

SINGLE Screened Cable, 9d. yard.

CONNECTING Wire, 10ft. Coils, 4d. each.

ALL Orders and Enquiries Must Include Sufficient Postage.

F. H. WILSON (former Manager of Radio Clearance, Ltd.), 52, Chancery Lane, London, W.C.2. 19888

L.T. Metal Rectifier, 2v. 1/2 amp, 5/3, post 4d.; transformer for above with full instructions, 6/3; instrument type rectifiers for meters, 1 to 10 m.a., 9/6; High Fidelity Crystal pick-ups, famous maker, brown crackle finished arm and head, 29/6, post 7d.; Crystal mikes, headlamp shape, 52/6; metal rectifier, 12v. 1 amp., with special transformer, ballast bulb, and holder, charge one to six cells, 24/9, post 8d.; kit as above for 6v. 4 amps. only, 47/-; chargers, well-known make, 2v., 6v., 12v., 1 amp., 45/6; three only, 1 1/2 kw. transformers, s/hand, 230v.-110v., or vice-versa, 55/-—Champion, 42, Howitt Rd., London, N.W.3. 19890

COULPHONE Radio, New Longton, nr. Preston.—Brand new goods only; 8in. Plessey and Goodmans P.M. speakers, with transformer, 22/6; electrolytics, 500v. 8 mfd. 4/-, 8+8 mfd. 7/9, 50 mfd. 50 volt 3/3; Erie 1-watt resistors, all values, 8d. each; Tungram valves, state requirements; S.A.E. for stock list. 19838

PREMIER RADIO

DE LUXE S.W. KITS

Complete Kit, including all Valves, coils, wiring diagrams and lucid instructions for building and working. Each Kit supplied with a steel Chassis, Panel and plug-in coils to tune from 13 to 170 metres.

1-Valve Short-Wave Receiver or Adaptor Kit 24/6
2-Valve Short-Wave Receiver Kit 35/6
1-Valve Short-Wave Superhet Converter Kit 28/-
Utility Micro Dials, direct and 100-1 6/6

SHORT-WAVE CONDENSERS

Trolitul insulation. Certified superior to ceramic. All-brass construction. Easily ganged.

15 m.mfd.	2/4	100 m.mfd. ...	3/-
25 m.mfd.	2/6	160 m.mfd. ...	3/7
40 m.mfd.	2/6	250 m.mfd. ...	4/-

ELECTROLYTIC CONDENSERS

16+24 525 v. Can. Neg., small type, 7/6; ditto, 32+32 mfd. 350 volt peak, 7/6; 25 mfd. 25 volt, 50 mfd. 12 volt, 1/6; 50 mfd. 50 volt, 2/6; 15 mfd. 100 volt, 1/3; 8 mfd. 125 volt tubular, 1/6.

Rothermel Junior Model Crystal Pick-up, 31/10.
Rothermel Crystal Pick-up head, will fit any tone arm, 34/8.

Potentiometers, all res., 3/6; ditto, with Switch, 4/6.
Premier Replacement Valve, 4 volt A.C. Type, 5 pin, ACHL, ACL, ACP, ACSG, all 5/6 each.

PREMIER MICROPHONES

Transverse-Current Mike. High grade large output unit. Response 45-7,500 cycles. Low hiss level, 23/-.
Moving Coil Mike. Permanent magnet* model requiring no energising. Response 90-5,200 cycles. Output .25 volt average. Excellent reproduction of speech and music, 49/-.
Crystal Mike, Rothermel D.105, 63/-.

Please Note.—All Short-wave Kits include Purchase Tax.

NEW PREMIER S.W. A.C. RECEIVER

In response to many requests we have now produced an A.C. version of the popular Premier Short Wave SG3 Kit. Circuit: Pentode H.F. Stage, Pentode Detector, Pentode Output, and F.W. Rectifier. 200-250 v. A.C. Operation. Built-in Power Pack. Hum-free operation. For use with Phones or P.M. Speaker.

Complete Kit of Parts with drilled chassis, all components, Plug-in Coils covering 13-170 metres, 4 valves and full instructions £6. 14. 6 and circuits

Battery Version also available, Kit £4/15/4.

★ "The Wireless World" said they were "very much impressed..." ★
See full Test Report, pp. 492-3, December issue
Send for de ail:

LEARNING MORSE

Premier Morse Practise Key on Bakelite base and brass movement..... 3/3
General Purpose Morse Key 5/10
Bakelite Buzzers 2/6
Complete Valve Oscillator as described in "W.W." "Learning Morse" 27/6
Brown's Headphones..... pair 17/6

ALL ENQUIRIES MUST BE ACCOMPANIED BY 2½d. STAMP.
ALL ORDERS LESS THAN 5/- 6d. POST EXTRA.

MOVING COIL SPEAKERS

P.M. Models. Celestion 8" 25/-.
Energised Models. Plessey 8", 2,000 ohm field, 15/-.
All speakers are complete with output transformer.

PREMIER RADIO CO.

ALL POST ORDERS to:

JUBILEE WORKS, 167, LOWER CLAPTON ROAD, LONDON, E.5 (Amherst 4723).

CALLERS to:

Jubilee Works, or
169, Fleet St., E.C.4 (Central 2833), or
50, High St., Clapham, S.W.4. (Macaulay 2381.)

ELECTRADIX

THE CAMBRIDGE TOWNSEND BUZZER is the highest note and smallest Buzzer made, used by Government on wavers, and has ample platinum contacts. Ideal for key work, 10/-. Other Buzzers: Practice, bakelite-cased, 3/6. Square brass-cased Buzzer, 4/6. Heavy type bakelite-cased, 5/6. Few D111 Buzzers, multi windings, no contacts, 5/8.

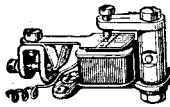

MORSE RECORDERS for home training, on Service Model gramophone recording, direct dot-dash on paper, with dead key fitted, £3/10/-. Standard G.P.O. Transmitting Morse Inkers, £10. A few Wheatstones and incomplete Teleprinter.

MICRO-MOTORS, A.C. Synchronous squirrel rotor. Self-starter with spur reduction gear from 2,000 to 58 revs., double shaft, 20 volts 60 cycles, pew. For tuning drive, remote control, model work, 8/-. New 1 h.p. A.C. Motors: Steel, 62/6. Higs, 82/6.

DYNAMOS BARGAINS. Lucas-Botax, 6/12 volts 81 amps. D.C. 3rd brush size 8in. x 4 1/2in., 11 lb., cost £10, unused, 15/-. G.R.G. Double-current Dynamo, 6 volts and 600 volts, ball-bearings, 17 lb. as new, 25/-. Charging Dynamos, 16 volts 15 amps, Leitner, 1,600 revs., 75/-.
PUMPS. We can supply from stock, with or without A.C. or D.C. Motors.

A.C./D.C. MAINS MAGNETS, 2 wound poles, 110 or 220 volts, 7 lb. lift, 5/6. Small 12-volt solenoids, 2in. x 1 1/2in. plunger, 6/6. Relays all types.

FRACTIONAL H.P. MOTORS, D.C. 13 volts enclosed 1/40 h.p., 2,500 revs., 15/-. 50 volts shunt, 1/20 h.p., K.B., 2,000 revs., 24/-. 60/70 volts shunt, 1/8 h.p., Crypto, 1,500 revs., 27/6. 110 volts shunt, 1/12 h.p., Croydon, 2,500 revs., 26/-. 110 volts shunt, 1/2 h.p., Maudslay special, 4,000 revs., 45/-. 220 volts shunt, 1/12 h.p., Croydon-Wilson, 2,400 revs., 30/-. 220 volts shunt, 1/3 h.p., Deico, 1,750 revs., 50/-. 240 volts shunt, 1/3 h.p., Century, 1,440 revs., 55/-. 220 volts shunt, 1/8 h.p., Keith B., 1,250 revs., geared to 80, 45/-.
TUNING COILS. Radiophone tuners, medium and long wave, with reaction 4 in. on one base, 3 1/2in. x 1 1/2in. dia., Plessey make, 1/3 each. Twin Trimmer Condensers on ceramic, .00012 to .00015 mf., 6d. Crystal Sets, B.B.C., 15/-.
* Kindly state wants; no lists available.
Add postage for all mail orders, and send stamped envelope for all replies.

ONLY ADDRESS
ELECTRADIX RADIOS
19, Broughton Street, Queenstown Road,
Battersea, London, S.W.8.
Telephone: MACaulay 2159.



FOR THE RADIO SERVICE MAN, DEALER AND OWNER

The man who enrolls for an I. C. S. Radio Course learns radio thoroughly, completely, practically. When he earns his diploma, he will KNOW radio. We are not content merely to teach the principles of radio, we want to show our students how to apply that training in practical, every-day, radio service work. We train them to be successful!

INTERNATIONAL CORRESPONDENCE SCHOOLS

Dep. 38, International Buildings, Kingsway, London, W.C.2.

Please explain fully about your instruction in the subject marked X.

Complete Radio Engineering

Radio Service Engineers

Elementary Radio Television

If you wish to pass a Radio examination, indicate it below.

Inst. of Wireless Technology

P.M.G. Certificate for Wireless Operators

Provisional Certificate in Radio Telephony and

Telegraphy for Aircraft

City and Guilds Telecommunications

Name..... Age.....

Address.....

(Use penny stamp on unsealed envelope)

LONDON CENTRAL RADIO STORES Offer Finest Bargains in Radio and Electrical Gear.

PHILIPS Speech Transformers for Pentode Output; 3/6 each.

MORSE Keys. Don't confuse these with inferior junk; it's a super job; 8/6 each.

VALVES are in Short Supply; stock of Mullard T.S.P. 4's and H.V.R. 2's to be cleared at 15/- each; first come, first served.

CONDENSERS.—Special offer of metal-cased paper condensers, 300v. working, all brand new and unused, 2 mfd. 2/-, 1 mfd. x 1 mfd. 1/9, 1 mfd. 1/9.

SINGLE R.A.F. Earphones, resistance 750 ohms D.C. approx., 4/- each; ex-Govt. low-resistance single earphones, 2/6 each; microphone buttons, well-known make, 2/- each; heavy duty double button carbon microphones, chromium-plated case, gold-plated electrodes, high output, good quality, with mounting clips and springs, complete with transformer, 23/6.

SHIELDED Wire with Rubber Covering, twin, single S 18, rubber insulated, tinned copper braiding; 1/3 per yard.

TELEVISION Diode Valves, unused Mullard EA50, 69 mm. x 12 mm. overall, 6.3v. heater at 15 amp.; 10/6 each.

WESTINGHOUSE Heavy Duty Rectifier Unit, 6-8v. D.C. output at 32 amps., input 200-250 A.C., 50 cycle, size 22in. x 15in. x 17in. approx.; price £30 each; three only.

PLUGS and Jacks, single circuit, new, 3/6 complete; plugs only, 2/- each.

RESISTORS, 10 watt, 100 ohm vitreous enamelled mains resistors, 1/3 each

EXBAIRD wax impregnated cardboard panels, 10 1/2in. x 6in., 1/3 doz., short-wave coil, 7.23 meters mounted on ceramic trimmer, 1/- each; a big range of volume controls, 1 ohm, 200 ohm, 600 ohm, 1,000 ohm, all values 2/6 each.

FLEXIBLE Drives, well made, shielded cable drives for remote control, ideal for radiogramophones, approx. 2ft. long; to clear, 4/- each.

MIDGET Volume Controls, 5,000 ohms, 3/6 each.

CONVERTERS, D.C. to A.C., 220v. D.C. input, 220v. A.C. output, 100 watts; £10/10.

ELECTRO-MAGNETIC Counters, resistance 500 ohms, from 1-12,999, size 4 1/2in. x 2in. x 1 1/2in., ex-G.P.O., invaluable for countless purposes, 9/6 each; a smaller type, 1,199, size 4 1/2in. x 1 1/2in. x 1 1/2in., 5/6.

VALVE Holders.—Belling Lee special H.F. 5-pin, chassis mounting in black bakelite; 1/- each, 10/6 doz.

PLESSEY Small Block Type Condensers, two tapings, 0.0005 and 0.1 mfd., 350v. test; 1/- each, 10/6 doz.

VARIABLE Condensers, well made heavy 3-gang superhet condensers, die cast frames in first class condition; 5/6 each.

SMALL Reversible A.C. Motors (as used for motor tuning), 25-30 volts A.C., built-in reduction gear spindle, speed about 60 r.p.m.; 12/6.

AUDAK Cutting Heads, heavy duty type, 3.5 ohm coil, a really high-class instrument; 17/6.

YAXLEY Type Switches, 2-way, 1/-; 2 bank 3-way, 2/-; 4-way, 4/-.
SCREENING Shields in Aluminium, 6 1/2in. x 5in. x 5 1/2in., brand new and unused; 2/6 pair.

OUTPUT Transformers, primary 300 ohms D.C., secondary 0.5 ohm D.C., brand new manufacturer's type, 5/6; also new chokes, 30 henry, 150 ohms, 5/- each.

PUSH-PULL Input Transformers, by well-known maker, nickel iron core in metal case, size 2in. x 1 1/2in. x 1 1/2in. high, ratio 6:1; 6/6.

B.I. Condensers, block type oil filled in metal cases with terminals, high quality components, 0.1 mfd., 1,000v. D.C. test, 2/6 each; and 0.25 mfd 1,000v. D.C. test, 2/6 each; also 0.0003 mfd. 400 volt working D.C., 6/- per doz.

RELAYS.—Small relays for operation on 2v. D.C. with 6-way make and break switches, brand new; 5/- each.

TRIMMERS.—Twin trimmers on ceramic base, brand new; to clear, 6d. each, 5/- doz.; also Bakelite Strip containing 5 Postage Stamp Trimmers, 2/6.

COIL Formers, cardboard and paxolin, assorted sizes, useful for experimenters; 1/6 doz.

CHASSIS.—Beautifully finished, highly polished, new cadmium-plated Chassis. Superbly made, 16 1/2in. x 13 1/2in. x 4in. Drilled for 6 valves, transformer, etc., 4/- each. Also heavy gauge metal Chassis, finished battleship grey, 12in. x 5 1/2in. x 2 1/2in., 1/3 each. All drilled for valves, etc.

ACCUMULATORS.—Ediswan 2v. 60 amp., brand new, in ebonite cases, size 8in. x 4 1/2in. x 2 1/2in.; callers only; 17/6 each.

TUBULAR Wire-end Condensers, brand new, first quality components, 0.0003 mfd., 8d.; 0.005 mfd., 9d.; 0.01 mfd., 10d.; 0.1 mfd., 1/- each.

SEE Also Display Advt. Page 10. Postage must be included. No C.O.D. orders.

LONDON CENTRAL RADIO STORES, 23, Lisle St., London, W.C.2. Phone: Gerrard 2969. [9889]

ENGINEERING OPPORTUNITIES

FREE
208 PAGES

This unique Handbook shows the easy way to secure A. M. I. C. E., A. M. I. Mech. E., A. M. I. E. E., A. M. I. A. E., A. M. I. Br. R. E. and similar qualifications. WE GUARANTEE—"NO PASS—NO FEE" Details are given of over 150 Diploma Courses in all branches of Civil, Mech., Elec., Motor, Aero., Radio and Production Engineering, Draughtsmanship, Trading, Inspection, Government Employment, BUILDING (great scope), MATRIC, R.A.F. MATHS., etc. Write for this enlightening Handbook to-day, FREE and post free. Men with Radio knowledge can obtain attractive posts in the Services.

BRITISH INSTITUTE OF ENGINEERING TECHNOLOGY, 387 Shakespeare House, 17, 18, 19 Stratford Place, London, W.1

LONDEX for RELAYS

For A.C. or D.C., silent and reliable

Synchronous Time Delay Relay PRL

2VA coil consumption, from 2-600 volts, tested to 2,000 volts. Unmounted and in cast iron casing. Also Time Lag Relays, High Sensitive Relays, Synchronous Process Timers, and Complete Control Plants.

Apply for leaflet SPN/ER.

LONDEX LTD.

Manufacturers of Relays
Anerley Works, 207 Anerley Road
LONDON, S.E.20
Phone: SYDENHAM 6268 & 6269.

"COSMOCORD" CRYSTAL PICK-UP

LICENSED BY BRUSH CRYSTAL CO., LTD., under Brit. Pat. Nos. 366,252 and 454,595

Retail Price
27/6
Plus Tax

Trade only supplied.

SOLE SELLING AGENTS:
SALE, TILNEY & Co., Ltd.,
3, LLOYD'S AVENUE, LONDON, E.C.3
Phone: ROYAL 4811.

WARD ROTARY CONVERTERS

Petrol Electric Generating Plants, H.T. Generators, D.C. Motors, Frequency Changers, etc., up to 25 K.V.A.

CHAS. F. WARD 37 WHITE POST LANE, Phone: Amherst 1393. HACKNEY WICK E.9.

ARDUX

WELDS PLASTICS

AERO RESEARCH LIMITED
PIONEERS OF SYNTHETIC ADHESIVES
DUXFORD CAMBRIDGE TELEPHONE SAWSTON 109

G. A. RYALL, "Arnhurst," Marsh Lane, Taplow, Bucks (late Ryall's Radio, London), offers radio components; post free.

T.C.C. 0.1 Tubular Non-inductive Condensers, 350v. wkg. rolled and waxed, 5/6 dozen; T.C.C. ditto in Paxolin tubes and waxed, 6/6 dozen; T.C.C. Midget cardboard, 25 mfd., at 25v., plus 10 mfd. 150v., 1/3 each.

PLESSEY Tuning Coils, in oval cans, oddments only, aerial, H.P., etc., no sets, 3 for 1/3; Ferranti screened coils, pairs, aerial and H.F. transformers with reaction, 2/6 pair, with coil connections.

CELESTION Loud-speakers, energised type, with and without transformers, m.c., mostly 8in. (a few 6in.) fields, 600, 920, 1,200, 2,000, 6,500, 7,000, mostly been damp, out centre, at 12/6 per box five, 17/6 per five, and 22/6 per five, according to condition; please give alternative if best not available; assorted boxes if required; carriage paid.

CELESTION M.c. Oval Loud-speakers, less transformers, speech coils, 30 ohms, handle 8 watts, fields 750 ohms, 70-100ma., been damp, out centre, cones intact, pole pieces rusty; 22/6 per box ten, carriage paid.

RESISTANCES, well known make, 1/4-watt, 1 meg., 1/3 dozen, 9/- gross; ditto, 1/2-watt, 800 ohms, 1/3 dozen, 10/- gross; 400 ohms, 1/2-watt, 1/3 dozen, 10/- gross; 30,000 1/2-watt, 1/3 dozen, 10/- gross; 300,000 1/4-watt, 1/3 dozen.

CLIX Chassis Valve Holders, 5-pin oblong, 7-pin lemon and round, 4-pin round, all 2/3 dozen; American, 7-pin, chassis, British make, 4/- dozen; insulating tape, 2oz. reels, 1/3 lb.

VOLUME Controls, U.S.A. make, 60,000 ohm, broad base, medium brass slotted spindle, less switch, 1/6 each; Sator midget 1 meg. and 400,000 ohm, 1/3 each; British make broad base, 1 meg. and 0.4, at 1/6 each; slightly soiled; Sator broad base, 10,000 ohm, 1/6 each; few only.

G.E.C. "Tuneon" Tuning Indicators, as used in the "AVC Five" neon type, 1/3 each; slow motion (epicyclic) drives, fit 1/4in. shafts, long 1/4in. spindles, well made in brass, with ball bearings, ratio 8-1, 1/3 each.

PAXOLIN Strip, 2 1/2in. wide, as used for group boards, etc., three 12in. lengths for 1/6; group boards, with tags, 12-way, two for 1/3; or drilled, less tags, four for 1/3.

AMERICAN 2v. Battery Valves, set three, American bases, 1A4VM/HFP, 1B4HFP, 2101 1/2-watt output pentode; 6/6 set three; suit Philco sets.

ERIE Resistors, 1/2-watt type, actual values, as used in many well known sets, 150, 200, 220, 270, 680, 3,300, 6,000, 7,500, 18,000, 25,000, 27,000, 33,000, 150,000, 330,000, 390,000, 1 1/2 meg., 3/- dozen; new goods; Erie resistors, 2 watt type, 800, 1,000, 1,500, 3,900, 7,500, 8,000, 8,200, 12,000, 30,000, 47,000, 56,000, 68,000, 120,000, three for 1/6, new goods; Erie resistors, 3-watt (note, many sizes in 2w. and 3w. are offered with a view to being used in parallel), 150, 300, 330, 390, 400, 680, 700, 1,500, 2,200, 3,300, 4,700, 6,800, 7,000, 12,000, two for 1/6, new goods.

KNOBS—Large black mottled, 2in., three 1/3.

CLIX Input Strips, A, and E. P.U. loudspeaker, etc., 2-, 3-, 4-, 6-way, 2/3 dozen.

LARGE Goldtone H.F. Mains Chokes, heavy duty, two for 1/6, may be slightly soiled; Ferranti wire wound resistors, nickel end caps, 4,000, 6,000, 8,000, 4 for 1/3.

CLYDON Type Trimmers on Ceramic Bases, 70 mm., 2/6 dozen; double trimmers on Paxolin, ex G.E.C., not joined, 2/6 dozen; single ditto, 1/6 dozen; ditto, not mounted, 1/2 dozen.

REX Type Switches, 4-bank, 2-pole, 4-way, 5 with shorting plates, 2/6 each; Rex type switch wafers, 3-way, 2-, 3-, 4-pole, 4 for 1/3.

VALVES—Europa AC/L 4v. 1 amp., makes good detector or L.F. amplifier, 3/3 each; Europa AC/HP 5-pin base, 3/3 each (metallising of the AC/HP may be rather soiled, but all O.K.); 6G5 Magic Eyes, 4/6 each; two only each customer.

WELL KNOWN Make Mica Condensers, 0.0028 and 0.003, 1/3 dozen; silver mica, 0.00045, 2/3 dozen; wave traps, ex K.B., iron core, 1/3; switches for band pass H.F. and dial lights, Wearite type, 1/3.

BATTERY Leads, 4-way, with plugs, two for 1/6; cable, 4-way single strand in one cover, 4 yards, 1/3; single connecting wire, white, 18 yards, 1/3.

PLESSEY 2-gang Screened Variable Condensers, with trimmers, straight type, 3/-; 2-gang unscreened, with ceramic insulation, 3/-; less trimmers, 3-gang, screened, with one trimmer only, 5/-; all straight, no superbend types; condenser drives, with 2-band scale, less watchion, similar Polar VP, 1/9.

INVERTED Type large capacity Mansbridge low-voltage for cathode by-pass, pair in one block, 1/6; small blocks, 0.5x0.5x0.25x0.25, 250v. wkg., 2 for 1/6.

SPECIAL Note—We now confine our business to Mail Order; prompt attention, in rotation. Our customers should note that when the present stocks are disposed of there is no likelihood of our being able to offer further surplus goods.—G. A. Ryall, "Arnhurst," Marsh Lane, Taplow, Bucks. (19880)

CRYPTO Rotary Converter, output 80 volts, 25 amps., £25; Baker's Auditorium Loudspeaker, £10; Ferranti Test Set, £8; Brown's Hand Microphone with Transformer, £8; Marconi Pick-up, old type, 30/-; Ferranti Transformers, Microscope, Reflex Camera, Duplicator; enquiries invited.—S. Vernon, Tarporley, Cheshire. (19866)

L.R.S. PROMPT DELIVERY

There is nothing better than the 'Stuart' Centrifugal Electric SHELTER PUMP

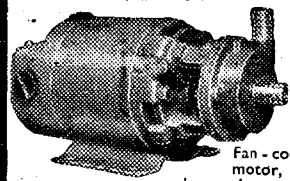

to keep your Shelter or Cellar dry. Ideal for many A.R.P. and general purposes

A sound job built for continuous running.

Fan-cooled ball-bearing motor, A.C. or D.C., any voltage. Low current consumption. Connections for rubber hose. All parts non-rusting. Please state exact mains voltage required.

These pumps (as supplied to Government Departments, County Councils etc.) may also be used for garden fountains.

FOUNTAIN JETS for above, 4/- extra
No. 10, 100 gals. per hour Carr. 2/- extra ... £5 2 6
No. 11, 280 gals. per hour " 2/- " ... £6 6 0
No. 12, 560 gals. per hour " 2/- " ... £7 12 0
Prices include foot valve and strainer, and hose union. Pump is ready for immediate use.

A Useful Accessory

The STUART AUTOMATIC FLOAT SWITCH, dependable and easy to install, is the best method of controlling water-level. Immediately water rises in the sump the Float Switch starts the motor pump. This guarantees no flooding. Price, complete with all fittings, £2.5.0.

Only a limited number in stock—
PHILIPS CYCLE DYNAMO LIGHTING SETS
36/- or with larger lamp 42/- Postage 7d.
BELLING BOILING RINGS 33/- Postage 1/-

Send 2d. stamp for illustrated price lists.

LONDON RADIO SUPPLY CO.

"WINDEN," ARDINGLY ROAD, BALCOMBE, SUSSEX.

The RAF wants YOU

Are you keen on radio? The R.A.F. urgently needs you for work of vital importance.

Even if you know nothing about radio, you can study at home in your spare time and qualify as a Radio Engineer. We have successfully trained hundreds of men for the R.A.F. and other vital war-time services. We can train you.

Do not miss this wonderful opportunity of qualifying for highly specialised and well-paid service. The work is intensely interesting and you gain experience which can be of tremendous value to you after the war.

Now, more than ever before, the outstanding merits of our tuition are being proved again and again. Students who previously knew nothing about radio have passed the R.A.F. Trade Test with "flying colours."

Waste no time, but post coupon now for free details of our Home-Study Courses for Radio Mechanics, Radio-Location, Mathematics, Servicing, Television and Transmission.

★ If you are not liable for service, there are excellent opportunities for you to earn good money in your spare time as a Service Engine r.

T. & C. RADIO COLLEGE

29, Market Place, READING

(Post in unsealed envelope, 1d. stamp)
Please send me free details of your Home-Study Radio Courses.
NAME.....
ADDRESS.....
WWW.....

10,000 Used B.V.A. Valves, all types, for sale as bases for remaking, 10/- per hundred.—Darley, 130, Park Rd. Crouch End, N.8. (19887)

Wanted: WE Buy New or Used Radios, amplifiers, meters, converters, radio and electrical accessories, etc.—Phone: Ger. 4447. (19603)

CONVERTER, 240 D.C. to 200/210 A.C., 50 cycles, 200 watts, suitable A.C. radio on D.C.—Sycamore, Northwood, Broadstairs. (19872)

WANTED—48 gauge enamelled copper wire, any quantity.—Radio Transmission Equipment, Ltd., Nightingale Works, Nightingale Lane, London, S.W.12. Telephone: Battersea 8521, Extension 14 (Buyer).

WANTED, Westinghouse metal rectifier, style I.T.-1, giving 200v. D.C. 100 m.-amps.; also step down trans., 240v. to 110v. 60w.—Jackson, Elphick and Co., Ltd., Birkenshaw, Larkhall, Lanarkshire. (19874)

REPAIRS AND SERVICE
L.T.P. Repair All Mains Transformers and Chokes. Prompt delivery.

LONDON TRANSFORMER PRODUCTS, Ltd., Willesden, N.W.10. Wil. 6486 (3 lines). (19552)

MAINS output transformers, chokes, etc., rewound. Davies, 50, Morley Av., Manchester, 14. (19700)

MIDWEST, etc.—We are the American experts.—Bennett's, 4, Humberstone Drive, Leicester. (19833)

TRANSFORMERS, pick-ups, motor windings, repairs of all descriptions to the wireless trade.—Marshall, 137, Windmill Lane, Nottingham. (19842)

"SERVICE with a Smile."—Repairers of all types of British and American receivers; coil rewinds; American valves, spares, line cords.—F.R.I., Ltd., 22, Howland St., W.1. Museum 5675. (18934)

METROPOLITAN RADIO SERVICE Co. Guarantee Repairs to American and British Receivers. Linecord resistances, condensers, and vol. controls. Trade supplied.—1,021, Finchley Rd., N.W.11. Spe. 3000. (19641)

MAINS Transformers Service, repairs, rewinds, or construction to specification of any type, competitive prices and prompt service.—Sturdy Electric Co., Ltd., Dipton, Newcastle-upon-Tyne. (19651)

SITUATIONS WANTED
CANADA, U.S.A., Eng., 7y. Fcty. Reach. TX & RX. Telev. U.F. Microwave. Polytech. pract. and theoret. qualif. C. & G. Exams, seeks managerial position.—Box 2626, c/o The Wireless World. (19886)

TECHNICAL TRAINING
GREAT Possibilities Exist for Technically Qualified Engineers, key men in wartime and afterwards. Through the home-study courses of The T.I.G.B. take a recognised engineering qualification such as A.M.I.Mech.E., A. M. I. E. E., A. F. R. Ae. S., A.M.I.Chem.E., C. and G., etc., in which examinations the T.I.G.B. students have gained 25 FIRST PLACES and Hundreds of Passes. Write to-day for "The Engineer's Guide to Success"—Free containing the world's widest choice of engineering courses covering all branches, including Aeronautical, Mechanical, Electrical, Wireless, Chemical, etc.

THE TECHNOLOGICAL INSTITUTE OF GREAT BRITAIN, 82, Temple Bar House, London, E.C.4. (19335)

TUITION
RADIO Training.—P.M.G. exams, and I.E.E. Diploma, prospectus free.—Technical College, Hull. (10611)

MORSE Code Training in Your Own Home; "Book of Facts" free.—Candler System Co. (W.G.), 121, Kingsway, London, W.C.2. (19744)

PRACTICAL Radio Postal Courses, coaching for I.P.R.E., R.A.F., A.I.D. exams; booklet free.—Secretary, I.P.R.E., Bush House, Walton Avenue, Henley-on-Thames. (19547)

RADIO Engineering.—Television and Wireless Telegraphy, comprehensive postal courses of instruction.—Apply British School of Telegraphy, Ltd., 179, Clapham Rd., London, S.W.9. (Estd. 1906). Also instruction at school in wireless for H.M. Merchant Navy and R.A.F. (19249)

BUSINESSES FOR SALE OR WANTED
The Wireless and Electrical Trader "is an essential part of the equipment of every Wireless Trader, its pages reflect the very latest turn of trade events, and it is read by all the leading dealers and manufacturers, for particulars of businesses offered or wanted. By subscription, to the trade only, 17/6 per annum, post free.—Send your trade card for specimen copy to Dorset House, Stamford St., London, S.E.1. (10614)

BOOKS, INSTRUCTIONS ETC.
WEBB'S Radio Map of the World Locates Any Station. Hard. Size 40x30in. 4/6, post 6d. On linen, 10/6, post 6d. Webb's Radio Globe, 12in. model, Radio prefixes, zones, etc., 27/6.—Webb's Radio, 14, Soho St., London, W.1. Phone: Gerrard 2089. (19554)

EVERY Radio Dealer Who is Not a Regular Reader of "The Wireless and Electrical Trader" should send his trade card at once for a specimen copy and full details of the "Trader" Services. "The Wireless and Electrical Trader" has the widest influence, and is read by all the leading manufacturers and traders. Trade only, 17/6 per annum, post free. Published at Dorset House, Stamford St., London, S.E.1. (10615)

CLASSIFIED ADVERTISEMENTS

intended for the MARCH ISSUE can be accepted up to Tuesday, February 10th.

CELESTION

CELESTION-AMPHENOL

valveholders are preferred by radio engineers because of their Strength, Efficiency, Uniform Contact and exceptional Insulation.

All standard British and American types are available.

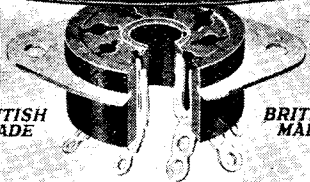

CELESTION LTD.

(Engineers).
KINGSTON-UPON-THAMES, SURREY.

Telephone: KINGston 5656-7-8.

Sixth Edition—Revised and Enlarged WIRELESS SERVICING MANUAL

By W. T. COCKING, A.M.I.E.E.

(of "The Wireless World")
6/- net By post 6/6

Iliffe & Sons Ltd., Dorset House, Stamford St., London, S.E.1

RADIO LABORATORY HANDBOOK

SECOND EDITION

By M. G. SCROGGIE, B.Sc., A.M.I.E.E.

401 pp. 219 illustrations and diagrams

PRICE 10/6 net. By post 11/1

Iliffe & Sons Ltd., Dorset House, Stamford Street, S.E.1

TRIX

SOUND
REPRODUCER

RELIABLE AMPLIFICATION
The TRIX ELECTRICAL COMPANY LTD.
65, Bolsover St. London, W.1. Euston 5471

for AMPLIFIERS, TRANSFORMERS
AND ALL PA. EQUIPMENT

ACOUSTICAL

MANUFACTURING COMPANY

ERMINE STREET HUNTINGDON. Telephone: HUNTINGDON 361

This space reserved for

W. BRYAN SAVAGE LTD.

FOR THAT INDOOR P.A. JOB

Use your VOIGT LOUDSPEAKER UNIT

with one of our 2 ft. mouth horns. It dismantles easily for transport and storage. (Stock very limited)

Price - \$4 - 16 - 3
(ex works)

UNIT WITH TWIN DIAPHRAGM
£15 - 15 - 0

(about 40 watts required for full excitation)
(Delivery delay about 3 months)

VOIGT PATENTS LIMITED

THE COURTS, SILVERDALE, SYDENHAM, S.E.26
Telephone: SY Denham 6866.

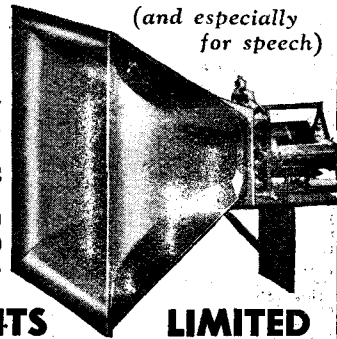

FOUNDATIONS of WIRELESS

By A. L. Sowerby, M.Sc. Third Edition, revised by
M. G. Scroggie, B.Sc., A.M.I.E.E.

Price 6/- net
By post 6/6

The aim of this book is to teach the wireless student the principles on which the design and operation of modern receivers are based. It covers the whole field from the simplest electrical phenomena to the construction of a modern set. All the vital points in receiver design are treated in full detail.

Issued in conjunction with "THE WIRELESS WORLD"
and published by the Proprietors

ILIFFE & SONS LTD.

DORSET HOUSE, STAMFORD STREET, LONDON, S.E.1

THE SIMMONDS GROUP

INVENTORS

We continually seek new inventions and products in all branches of industry for development and production by the manufacturing Companies of the Simmonds Group throughout the world.

SIMMONDS DEVELOPMENT CORPORATION LTD.
BUSH HOUSE, W.C.2.

Printed in England for the Publishers, ILIFFE AND SONS LTD., Dorset House, Stamford Street, London, S.E.1, by THE CORNWALL PRESS LTD., Paris Garden, Stamford Street, London, S.E.1. "The Wireless World" can be obtained abroad from the following: AUSTRALIA and NEW ZEALAND: Gordon & Gotch, Ltd. INDIA: A. H. Wheeler & Co. CANADA: Imperial News Co.; Gordon & Gotch, Ltd. SOUTH AFRICA: Central News Agency, Ltd.; Wm. Dawson & Sons (S.A.), Ltd. UNITED STATES: The International News Co.



UNIVERSAL
ENGRAVING CO. LTD. LONDON.

**NAMEPLATES
AND DIALS**
in
**GLASS, CELLULOID, METAL
OR LAMINATED MATERIAL**

IF YOU HAVE AN ENGRAVING PROBLEM, OR
IF YOU WISH FOR BETTER ENGRAVING OUR
ADVICE IS FREELY AT YOUR DISPOSAL.

Sole Representatives:



HAMMANS INDUSTRIES
LONDON

5 REGENT PARADE • BRIGHTON ROAD
SUTTON • SURREY • TEL: VIGILANT 4472

B.I.

RADIO MATERIALS

We have had a long experience in the
manufacture of all kinds of Cables and
Wires, Static Condensers, Insulators
and Iron Work, Telephone Cords and
Copper Earthing Rods, for Radio use.



U.K. Regd. Trade Mark.

BRITISH INSULATED CABLES LTD.
CABLE MAKERS AND ELECTRICAL ENGINEERS
Head Office:
PRESCOT, LANCS. Tel. No. PRESCOT 6571

ROLA

**LOUD
SPEAKERS**
THE WORLD'S FINEST REPRODUCERS

**TRANSFORMER
LAMINATIONS**

Core Widths $\frac{3}{16}$ " to $1\frac{1}{2}$ " (E's and I's.)
EIGHT STOCK SIZES

A Comprehensive Bulletin together with details of Associated Covers
and Clamps with design data will be sent to manufacturers on request.

BRITISH ROLA LIMITED
MINERVA ROAD • PARK ROYAL • N.W.10 • WILLODEN 4322

Special WAR-TIME EDITION

Our descriptive pamphlet No. IIB has been abridged. We have retained all the information necessary to the experimenter and the new edition is known as descriptive pamphlet No. IIB/I. Whether you ask for D.P.IIB, D.P.IIb/I, or D.P.IIB/I (the book was referred to as this by error in a recent advertisement) we can only send you D.P.IIb/I. It contains a good deal of technical information about meter rectifiers and test sets, and is still worth 3d.

COUPON

WESTINGHOUSE BRAKE & SIGNAL CO. LTD.,
Pew Hill House, Chippenham, Wilts.

enclose 3d. in stamps. Please send me D.P. IIB/I.

Name.....

Address.....



Exide BATTERIES

'Still keep going when the rest have stopped'

THE CHLORIDE ELECTRICAL STORAGE COMPANY LTD.

Grosvenor Gardens House, Grosvenor Gardens, London, S.W.1.

Telephone : VICTORIA 2299. Telegrams : Chloridic, Sowest, London