

DUAL-ACTION AVC SYSTEM

The **Wireless** **World**

MONTHLY  
ONE SHILLING

*COVERING  
EVERY WIRELESS INTEREST*

DECEMBER, 1939

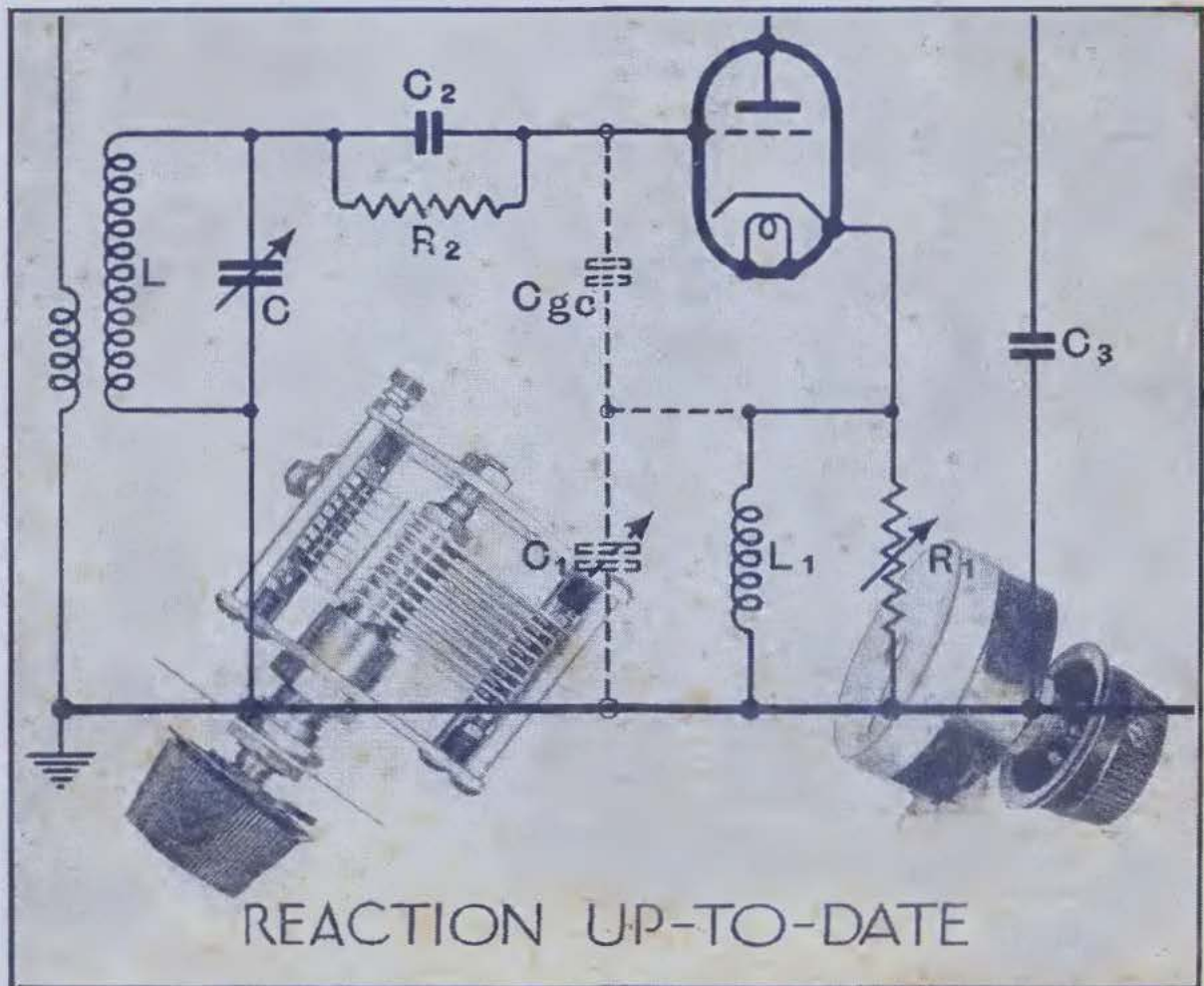

REACTION UP-TO-DATE

**NEW!**

# OSRAM VALVE TYPE Z62

*A new high gain screened Pentode of exceptional interest*



**TYPE  
Z62**

**CHARACTERISTICS**

Heater voltage	6.3 volts
Heater current (approx.)	0.45 amps.
Anode voltage	300 max.
Screen voltage	150 max.
Mutual conductance at Ea 300, Es 150, Eg-2	7.5 mA/volt
Input resistance at 40 Mc./ sec. (approx.)	4,000 ohms.

*Octal Base, Grid to Top Cap.*

**PRICE 12/6 EACH**

Experimenters and designers will welcome technical data on a new screened Pentode, the Osram Z62, which incorporates many outstanding features.

### POINTS OF THE OSRAM Z62

- 1 The normally long "pinch" is replaced by a shortened design to hold the electrode supports, and results in a great reduction of lead wire length and reduction in lead inductance. This improvement is of real value for short-wave applications.
- 2 A high mutual conductance of 7.5 mA/volt is achieved at the working point. This means more gain per stage with low impedance anode loading, such as in very short wave circuits or wide band amplifiers.
- 3 A high ratio of mutual conductance to total cathode current results in an improved signal to noise ratio.
- 4 Suitable as audio frequency amplifier with high stage gain and low attenuation at the highest audio frequencies.
- 5 Fitted with "international" octal base—no special socket required.

**WRITE FOR TECHNICAL LEAFLET WITH FULL DATA**



# PRECISION METERS

*that Master every Testing Problem*

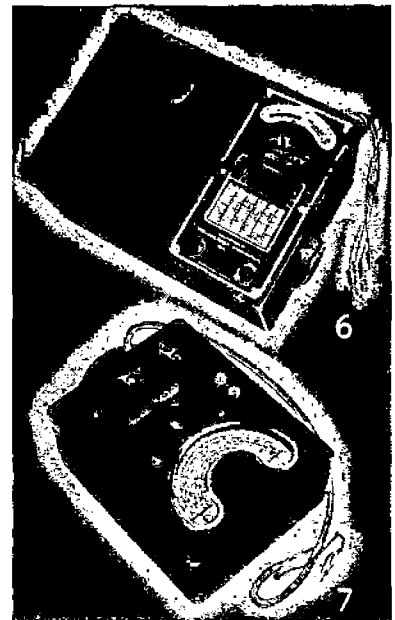
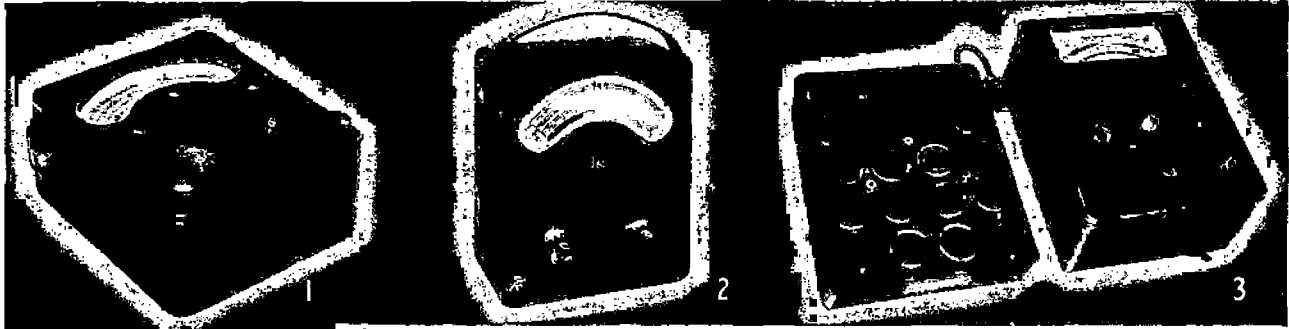

## ELECTRICAL MEASURING INSTRUMENTS

BRITISH MADE

**HIGH** accuracy, simplicity, exceptional versatility and proven reliability have won for "AVO" Instruments a world-wide reputation for supremacy wherever rapid precision test work is demanded. There is an "AVO" Instrument for every essential electrical test.

*Write for fully descriptive literature dealing with any instrument in which you are interested, and for current prices.*

1. 46-range Model 7 Universal AvoMeter.
2. 40-range Model 40 Universal AvoMeter.
3. "Avo" Valve Tester.
4. Universal AvoMinor.
5. "Avo" Test Bridge.
6. "Avo" Capacity Meter.
7. All-Wave "Avo" Oscillator.
8. D.C. AvoMinor.

*Other "Avo" Instruments:*

- 22-range D.C. AvoMeter.
- High Resistance AvoMinor.
- "Avo" Low Resistance Ohmmeter.
- The AvoDapter.
- 9-pin AvoCoupler.

*Sole Proprietor and Manufacturer:*

**THE AUTOMATIC COIL WINDER & ELECTRICAL EQUIPMENT CO., LTD.,** Winder House, Douglas St., London, S.W.1. Telephone: Victoria 3404/7.

# RADIOMART

G5NI (BHAM) LTD.

THE SHORT-WAVE SPECIALISTS

WE CARRY LARGE STOCKS OF ALL TYPES OF SHORT-WAVE AND COMMUNICATION EQUIPMENT, INCLUDING AMERICAN VALVES

RADIOMART SPECIAL OFFERS! Fully shrouded Transformers with America's largest manufacturer. While they last.

All 250 v. primary and fully impregnated.

T2871S—375/375 v. 150 m A., 6.5V2A, 2.5V1A, 5V3A. ....	15/6
T19610—350/350 v. 150 m A., 2.5V2A, 2.5V2A, 5V3A. ....	12/6
T7226—375/375 v. 120 m A., 6.5V1T, 4A, 5V3A. ....	10/6
T7320—350, 350 v. 100 m A., 6.5V1T, 3A, 5V3A. ....	9/6
T7307—350/350 v. 80 m A., 6.5V1T, 3A, 5V3A. ....	7/6
T7003—350, 350 v. 80 m A., 6.5V1A, 5V3A. ....	7/6
T6025—350, 350 v. 80 m A., 2.5V1A, 3V3A. ....	7/6
T49419—10V4A, Primary Tapped 110—250. ....	5/6
T1113AB—110, 230 v. 500 watt Auto Transformer. ....	29/6

The following chokes are intercoiled and impregnated.

T7007—250 m A., 135 ohms, 20-4 Hy., cadmium shrouded. ....	12/6
T7007A—150 m A., 250 ohms, 30-12 Hy., cadmium shrouded. ....	12/6
100 m A., 20 Hy., 500 ohms, unshrouded. ....	4/11
60 m A., 15 Hy., 250 ohms. ....	1/11

**HEAVY DUTY TRANSFORMER** for models, bells, etc., 6 v. 3 a., 2/3. 4 m.f., 1,500 v. test 500 v. wkg. oil filled condensers, 2/-.

**HEAVY DUTY Mains Transformer**, worth 45/-, 350-300, 150 m/A., 4 v. 2.5 a. (CT, 4 v. 6 a., CT, 12/6; 300 300 v., 80 m A., 4 v. 3 a., CT, 4 v. 2 a., CT, 6/6. Moving Coil Speaker Transformers power, pentode or push pull, 1 1/11. WB Heavy duty ditto, 2/11.

**GANG CONDENSERS** with Airplane Dial, 8 and 50-1. Cost 35/-. Few only. 4/11. Utility, 7/6. Microdials, 3/8.

**W.B. Sin. PERMANENT MAGNET SPEAKERS AT ONE-THIRD COST.** Extension Type (no Transformer), 8/11. Standard Type (with Transformer), 10/6. Energised 8", 1,200 ohms with Transformer, 6/11.

**PUSHBACK** Wire, 6 yds., 6d., heavy, 9d. Resin-coated Solder, 6ft., 6d.; Screened Flex, single, 6d. yd.; twin, 9d. yd. Assorted Solder Tags, 6d. packet. Humdimmers, 6d. each. Centralab pots, all sizes, 1/6; switched, 2/-; tubular fuses, 2d. Milliammeters, 25 m.a. upwards, 5/8.

**VALVES**: Reliable replacements for all types, British and American, showing saving of over 50 per cent.

**OUR NEW 66-PAGE MANUAL**, packed full of valuable information. Communication receivers, transmitters, etc., 7/d. post free.

**THE NEW RAYMART CATALOGUE** shows dozens of New Short-Wave Components and is yours for 1/d. post free.

*TRADE ENQUIRIES* solicited for all types of communication equipment receivers, etc.

**RADIOMART** 44, HOLLOWAY HEAD, BIRMINGHAM

G5NI (Birmingham) Ltd.

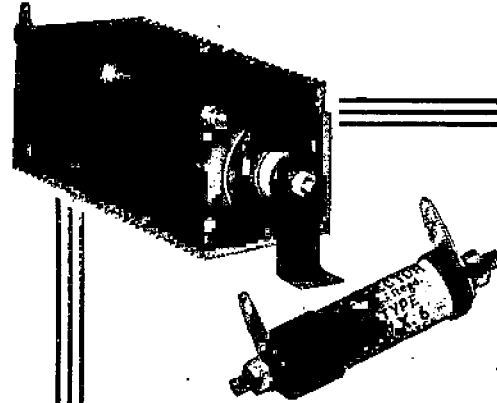

The range of reliable

*Westinghouse*  
METAL

**RECTIFIERS**

meets every possible requirement

Never need replacing and their use, either in battery or mains receivers, cuts down the power consumption of the set. Send 3d. to Dept. W.W. for a copy of "The All Metal Way."

WESTINGHOUSE BRAKE & SIGNAL Co. Ltd., Pew Hill House, Chippenham, Wilts.

*It's more than a diary!*

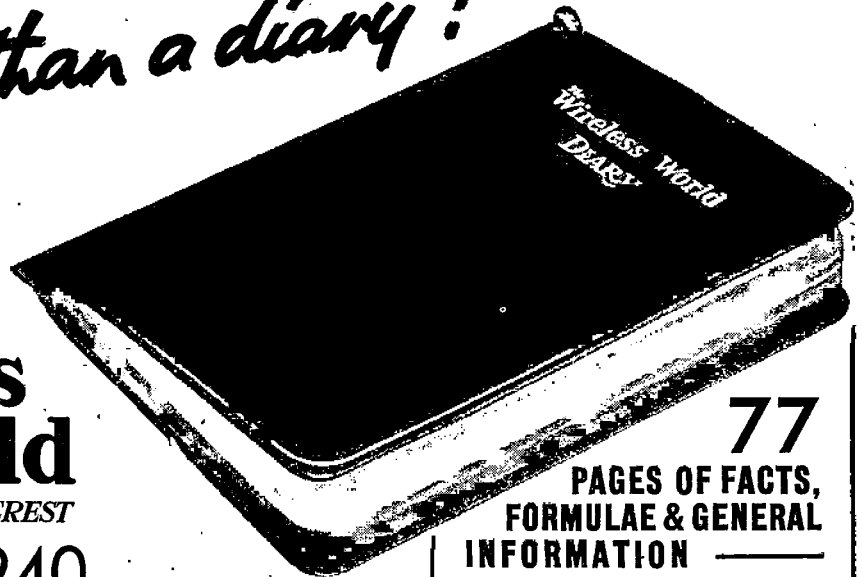

The  
**Wireless  
World**

COVERING  
EVERY WIRELESS INTEREST

**DIARY for 1940**

**NOW ON SALE**

**77**  
PAGES OF FACTS,  
FORMULAE & GENERAL  
INFORMATION

that is difficult to memorise  
but

**ESSENTIAL TO  
THE ENTHUSIAST!**

Size 3 1/2 by 4 1/2 inches, 192 pages.  
Bound leather cloth, back loop  
with pencil.

PRICE 1/6 net

By post 1/7

From bookstalls and stationers or  
direct from the Publishers.

ILIFFE & SONS LTD., DORSET HOUSE, STAMFORD STREET, LONDON, S.E.1

# Simmonds Speed Nuts

(PATENTS APPLIED FOR)

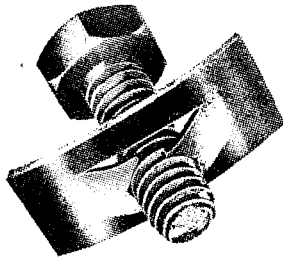

**IN YOUR ASSEMBLY  
LINES WILL RESTORE  
LOST PROFITS**

**S**IMMONDS Speed Nuts replace threaded nuts and lock washers, save handling time and eliminate unnecessary assembly operations. They are fitted with amazing speed and are extremely flexible in adaptation being particularly invaluable for 'blind' locations. A wide range of standard speed nuts is available from stock for all sizes of machine screws, sheet metal screws, rivets, and plastic studs. Special types are constantly being designed to suit individual applications and there is practically no assembly problem which cannot be solved by the use of Speed Nuts.

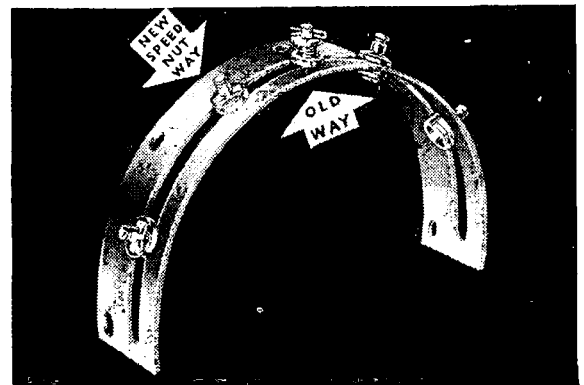

On this automatic selector bracket, each SPEED NUT eliminated a coil spring, a washer, a drilled hole and a cotter pin.

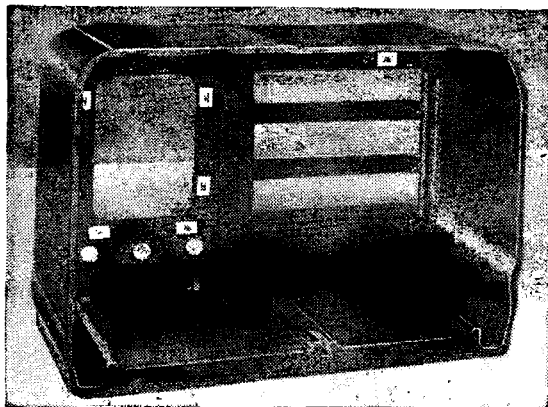

SPEED NUTS can be 'zipped' on to threaded or unthreaded metal and plastic studs.

★ Manufacturers and Designers of Radio Sets and Components are invited to investigate this efficient fastening method. Our development department will be pleased to collaborate and put forward the most effective designs to suit your needs.



Spring collar SPEED CLIP for plastic knobs.

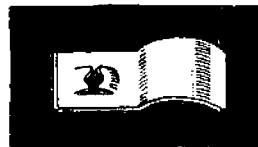

SPEED NUT with loop for holding wires inside radio sets.



SPEED FIX designed to hold contacts in automatic tuning mechanism.

**SIMMONDS AEROCESSORIES LTD**  
GREAT WEST ROAD, LONDON.

**'LABORATORY  
BUILT by  
HALLICRAFTERS'**

*YOU know  
what that means*

To say of any instrument that it is "Laboratory-built by Hallicrafters" places that instrument in a class beyond all need of help from fine words and high-sounding phrases. To be "Laboratory-built by Hallicrafters" is to achieve a standard of quality accepted by leading authorities the world over as pre-eminent. Here are two examples :

**S X 24**

One of the newest Hallicrafters Communications Receivers. Built-in Frequency Meter Tuning; Built-in Noise Limiter; Variable Selectivity; Frequency Stability; Battery Operation; Break-in Relay Operation; Crystal Filter; Four Band Positions; 9 Valves; Electrical Band Spread. Price for 110 to 250-volt, A.C., including valves and crystal, **£24.** (Speaker £4.12s.)

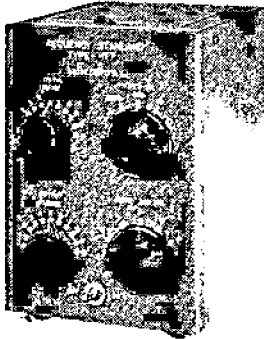

**HT7** This is the Hallicrafters Frequency Standard, an instrument of great accuracy for use in conjunction with any good communications receiver in checking transmitter frequency; checking receiving calibration; calibrating receivers and crystals, etc.; bandsetting receivers; locating signals for skeds, and setting ECO frequency. This is an instrument of particular interest to manufacturers and research workers. For 110-250 A.C., **£10.7s.**

Ask for new RECEIVERS CATALOGUE.

**WEBB'S** THE HOME OF THE  
**LONDON** SHORT WAVE ENTHUSIAST  
14 SOHO ST., OXFORD ST., W.1

(Open 9.30 a.m. to 6 p.m.)  
Telephone: Gerrard 2089

Emergency Branch: 58, Victoria Street, St. Albans, Herts.  
Phone: 4924

Birmingham Depot: -41, CARRS LANE

Phone: Mid 5669

**GALPINS ELECTRICAL STORES**

75, LEE HIGH RD., LEWISHAM, LONDON, S.E.13

Telephone: Lee Green 5240.

Terms: Cash with Order or C.O.D. Charges extra.

ALL GOODS SENT ON THREE DAYS' APPROVAL AGAINST CASH

MULTI CONTACT RELAYS, EX-G.P.O., as used in automatic exchange, condition as new, small size, suitable for automatic tuning for press button control; heavy platinum contacts; 2/6, post 3d.; 2 for 4/-, post 6d.; 3 for 6/-, post 6d.

ELECTROLYTIC CONDENSERS, 8 mf., 350 v.; 4 mf., 250 v.; 6 mf., 450 v.; 1/3 each, post 3d.; 8 x 8 mf., 450 v., 2/-; 8 16 mf., 450 v., 2/- and 8 2 mf., 450 v., 2/- each, post 3d.

AUTO TRANSFORMERS, 500 watt, 25; 750 watt, 32; 1000 watt, 37 6 1600 watt, 50/-; guaranteed 12 months.

HIGH VOLTAGE TRANSFORMERS for Television, Neon, etc. 200 240 v. 50 p. 1 ph. primary, 5,000 and 7,000 volts secondary, enclosed in petroleum jelly. Size: 5 1/2 in. x 4 1/2 in., 7 6 each, post 1/-. D.H.T., Skeleton type, 5/6, post 6d. All brand new.

EVERSHED EX-R.A.F. HAND-DRIVEN GENERATOR, in new condition, 800 volts 30 m/A. and 6 volts 2 1/2 amps. D.C. Useful as megger genies and all test work. 20/- each, post 1/6.

EX-G.P.O. GLASS TOP RELAYS, Type B. Useful as Keying Relays, 5/- each, post 6d. Also a few only that need points, which easily fitted, 2/6 each. P/F.

T.C.C. 20,000 MF. ELECTROLYTIC CONDENSERS, 50-volt working (brand new), 5/- each, post 6d.

STANDARD TELEPHONE BELL WIRE, all brand new, 150-yd. coils, twin 22 gauge, 4/-, post 9d.; 250-yd. coils, single 16 gauge, 4/-, post 1/6; 300-yd. coil, single 22 gauge, 3/-, post 6d.

C.A.V. SHUNT WOUND DYNAMOS, 25 volts 8 amps., 1,750 r.p.m., 32 6 C/F

G.E.C. SHUNT WOUND DYNAMOS, 50 volts 6 amps., 1,500 r.p.m., 30 - C/F.

CROMPTON SHUNT WOUND DYNAMO, 100 volts 4 amps., 1,750 r.p.m., 35/- C/F.

CROMPTON DYNAMO, 4-pole shunt wound, 1,750 r.p.m., 100 volts 10 amps., 70/- Ditto, 50/75 volts 15 amps., 75/- C carriage forward.

MACKIE MOTOR GENERATOR, 220 volts 3.35 amps. D.C. Input, 10 volts 30 amps. D.C. output, 37.8 C/F.

STANDARD TELEPHONE MAINS TRANSFORMERS, input 200/250 volts, output 250 0 250 volts 200 m/A., 3 x 4 volt windings and a 50-volt winding, 12 6 each.

MACKIE DOUBLE WOUND EX-R.A.F. GENERATORS, 1,200 volts 100 m/A. and 10 volts 4 amps., 3,000 r.p.m., 12/6 each. Carriage 1/6.

MURHEAD 1 MF. CONDENSERS, 1,000-volt working, 1/- each, post 6d.; or three for 2/6, post 1/6. Philips' 1 mf., 3,000-volt working, 5/6. T.C.C. 4 mf., 3,000-volt working, 9/6 each. Standard Telephone 1 mf., 400-volt working, 4d. each, or in lots of 100 for 12/6, post 1/6.

ERNEST TURNER & WESTON 2-in. DIAL MOVING COIL MILLIAMMETERS, B.S. first grade, 0 to 5 and 0 to 50, 17/6 each.

E.C.C. SHUNT WOUND DYNAMO, 100 volts 50 amps., 1,500 r.p.m., £6 10s. C/F.

**Don't ration your Radio!**

Treat your amplifier to one of our new range of

**FEEDER UNITS**

and listen to world opinion. We are now producing a range of these units, incorporating our popular R.F. tuners.

ACF 5 Feeder Unit, for A.C. operation. 5-valve, 5-band unit, covering 12 to 35 m., 30 to 80 m., 73 to 200 m., 200 to 550 m., 750 to 2,000 m. R.F. stage on all bands, triode heptode frequency changer, iron-cored 465 Kcs. I.F. stage, double diode triode as detector/A.V.C./first audio stage. 2-speed drive, full vision horizontal scale, calibrated in wavelengths and frequencies. Magic-eye tuning indicator. Gram input, if required. Total H.T. required: 50 mA. at 250 volts. Chassis size: 11 in. x 9 in. x 3 in. ... **£9:9:0**

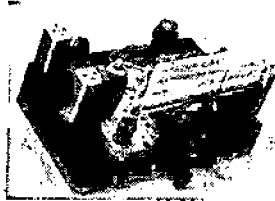

UF5. As above, but with .2 amp. "E" type valves (series or parallel heaters) ... **£9:9:0**

ACF 3 and UF 3. As above, but with coverage 16 to 50 m., 200 to 550 m., 750 to 2,000 m. Size: 9 in. x 9 in. x 3 in. ... **£8:8:0**

ACF 4 and UF 4. As above, but with coverage 12 to 35 m., 30 to 80 m., 200 to 550 m., 750 to 2,000 m. Size: 11 in. x 9 in. x 3 in. ... **£8:18:6**

Battery models of above can be supplied to order.

Owing to increased costs, we regret that all our previously advertised prices have been advanced by 5 per cent.

All our other products and services are still available—for particulars please refer to last month's advertisement.

Write for details to Edward Thomas, Facilities Dept.

**JOHN MCCLURE LTD. (66JM)**  
ERSKINE ROAD, LONDON, N.W.3.

PRImrose 5435-6.



# CATHODE RAY TUBE

TYPE 4096 A

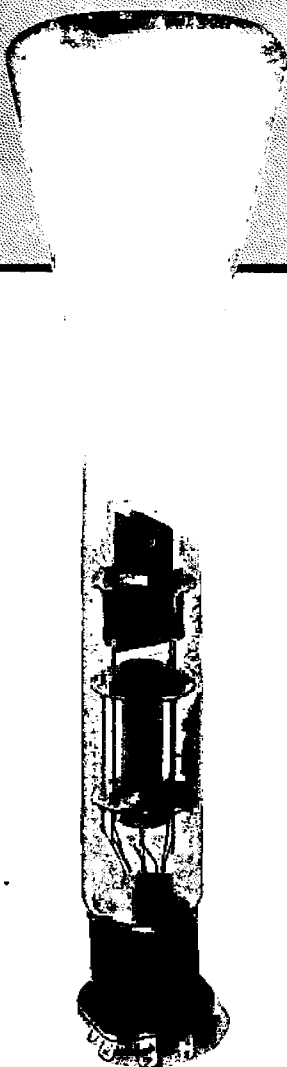

**T**HE 4096'A Cathode Ray Tube is a hard vacuum tube suitable for use with anode voltages from 800 to 2,000 volts and has a screen diameter of 3 inches. The screen provides a blue spot of high actinic value necessary for photographic purposes and, in addition, owing to its intense brilliance, is suitable for visual work.

Efficient electrostatic screening is ensured by the internal coating of the tube with aquadag while the connections to the "Y" plates are brought out to separate pins, thereby facilitating the use of balanced circuits and providing for improved focussing.

The cathode is indirectly heated and thus the heater may be supplied with raw A.C. This tube is fitted with an American type octal base.

**The popularity of this tube has now enabled us to offer it at the attractive price of**

**£2.10.0 NETT**

*Delivery in Great Britain or Northern Ireland.*

***Standard Telephones and Cables Limited***

**NORTH WOOLWICH**

**LONDON, E. 16**

Telephone : Albert Dock 1401.

**BRANCHES AND REPRESENTATIVES THROUGHOUT THE WORLD**

# Erie Products

SAME RANGE  
SAME QUALITY  
SAME PRICE!

Despite increasing costs you can still obtain the full range of Erie Products at pre-war prices. Every item is guaranteed to be of the same high standard of quality always associated with the name "ERIE."



Guaranteed to carry 50% overload with less than 4% maximum resistance change. They give uniformly superior results in all standard tests for load, temperature, voltage, humidity and noise—compact and safe—cannot short or earth even in the smallest installation spaces. The strong Ceramic Insulating Tube will withstand 3,000 volts A.C.

Every Erie Resistor is individually hand-tested.

CARBON RESISTORS		(10 ohms to 5 megohms)
RMA9.	1/2 watt ± 10% Insulated ...	3d. each
RMA8.	1 watt ± 10% Insulated ...	6d. each
RMA2.	2 watt ± 10% Non-Insulated ...	1/- each
RMA1.	3 watt ± 10% Non-Insulated ...	1/6 each
RMA0.	5 watt ± 10% Non-Insulated ...	2/6 each

Specified by "The Wireless World" for the Pre-set Quality Receiver described in Aug. 24th, 1939 issue; for the Magnetic Television Receiver and many others.

## For Dealers & Service Engineers

### ERIE RESISTOR KITS

For efficiency and economy you should have your resistor stock in metal box or cabinet form. No losses—No waste—Easy to find. We give you the metal box or cabinet. You pay only for the resistors, which are an assortment of the most used values. All these Resistors are RMA Colour Coded. Tolerance ± or — 10%.

- KIT I R 49. 49 One-Watt Resistors. 24/- In FREE Pressed-steel box.
  - KIT I R 96. 96 Half-Watt Resistors. 24/- In FREE Pressed-steel box.
  - KIT I R 100. 100 One-Watt Resistors. 50/- In FREE Strong board Cabinet, 8 partitioned drawers.
  - KIT I R 200. 200 Half-Watt Resistors. 50/- In FREE Strong board Cabinet, 8 partitioned drawers.
- Subject to usual Trade Discount.

### TONE AND VOLUME CONTROLS

ERIE Type "M" (with 2 1/2" duralumin spindle)  
The duralumin spindle can be grooved, split or drilled to any required specification and can be cut to any required length within two or three minutes, thus enabling you to save time and money often wasted in procuring special replacements.

- Less Switch ... 2/6 With Single-Pole Switch ... 3/-
- With Double-Pole Switch 3/6 Centre Tapped with Switch 4/6

Non-standard spindles 6d. per control extra.

### DUAL AND GANGED CONTROLS

(Including special replacements)  
Less Switch ... 4/6 With Single-Pole Switch... 5/-  
With Double-Pole Switch ... 5/6

The range of ERIE PRODUCTS includes :  
Volume Controls, Tone Controls, Vitreous Wire-wound Power Resistors, Ceramics-Midget Fixed Condensers, Silver Mica Condensers, Car Radio Suppressors, High Voltage Resistors.

Send to-day for full details.

## ERIE RESISTOR LTD.

CARLISLE ROAD, THE HYDE, HENDON, N.W.9.  
Telephone : Colindale 8011

# GOOD NEWS!

## McMURDO SILVER RADIO

*We are pleased to be able*

to announce that the McMurdo Silver 15/17 Receiver will continue to be available to those discriminating enthusiasts who insist on superlative performance from their set.

We have succeeded in obtaining the entire receiver and component stocks of the British McMurdo Silver Co. Ltd., and also the rights to manufacture the 15/17. When present stocks are exhausted our own production of these receivers will be in full swing, while present stocks last prices will remain unaltered.

*The following is a brief specification :*

12 valve (plus two rectifiers and tuning indicator) ; 6 wave bands ; Television sound, 9.5m. to 30m., 24m. to 65m., 60m. to 210m., 200m. to 560m., 800m. to 2,200m. R.F. stage on all except television band. Two stages of I.F. amplification with three position selectivity control. R.F. stage on all except television band. Low noise Converter. Separate electron-coupled triode oscillator. Two I.F. stages with three position selectivity control. Distortionless inter-station noise suppression. Variable pitch beat oscillator. Distortionless infinite impedance second detector. Negative feed-back splitter feeding a Class A output stage capable of delivery 14 watt, undistorted to the 12" Auditorium Speaker.

*We have recently supplied these*

receivers, housed in a special "Utility" cabinet, to the Allied Newspapers for use night and day at their new Listening Station. Could any set have a better recommendation? Remember, these receivers have a sensitivity of one microvolt even at 30Mc/s.

*May we send you full*

technical details and illustrations of the various models.

## ERSKINE LABORATORIES LIMITED

PROSPECT WORKS  
SCALBY : SCARBOROUGH



# PREMIER RADIO

## - AS USUAL!

### PREMIER 1940 HIGH FIDELITY AMPLIFIERS

Ideal for A.R.P. Alarm Systems.

A new Complete Range of 7 High Fidelity P.A. Amplifiers for A.C. or A.C./D.C. Mains operation.

	Kit of Parts Wired and with Valves.	Completely Tested
3-watt A.C. Amplifier	£2-6-6	£3-4-0
3-watt A.C./D.C. " "	£2-6-6	£3-4-0
6-watt A.C. " "	£6-2-6	£7-0-0
8-10-watt A.C./D.C. " "	£5-5-0	£6-2-6
15-watt A.C. " "	£6-14-0	£8-2-6

Black Crackle Steel Cabinet 15/- extra.

### PREMIER SHORT-WAVE KITS for OVERSEAS NEWS.

Incorporating the Premier 3-Band S.W. Coil, 11-86 Metres without coil changing. Each Kit is complete with all components, diagrams and 2-volt valves. 3-Band S.W. 1 Valve Kit, 14/9. 3-Band S.W. 2 valve Kit, 22/6.

### DE LUXE S.W. KITS

Complete to the last detail, including all Valves and coils, wiring diagrams and lucid instructions for building and working. Each Kit is supplied with a steel Chassis and Panel and uses plug-in coils to tune from 13 to 170 metres.

1 Valve Short-Wave Receiver or Adaptor Kit	20/-
1 Valve Short-Wave Superhet Converter Kit	23/-
1 Valve Short-Wave A.C. Superhet Converter Kit	26/3
2 Valve Short-Wave Receiver Kit	29/-
3 Valve Short-Wave Screen Grid and Pentode Kit	68/-

### REPLACEMENT VALVES FOR ALL SETS.

**EUROPA MAINS VALVES.** 4 v. A.C. Types A.C./H.L., A.C./L., A.C./S.G., A.C./V.M.S.G., A.C./H.P., A.C./V.H.P., A.C.P., all 5/3 each. A.C./H.P., A.C./V.H.P., 7 pin, 7/6. A.C./Pens, I.H., 7/6; A.C./P.X.4, 7/3; Oct. Freq. Changers, 8/6; Double Diode Triodes, 7/6; 3½-watt D.H. Triode, 7/6. 350 v. and 500 v. F.V.V. Rect., 5/6. 13 v. 2 amps. Gen. Purpose Triodes, 5/6; H.F. Pens. and Var.-Mu. H.F. Pen., Double Diode Triodes, Oct. Freq. Changers, 7/6 each. Full and Half-wave Rectifiers, 6/6 each.

### TRIAD U.S.A. VALVES.

We hold the largest stocks of U.S.A. tubes in this country and are sole British Distributors for TRIAD High-grade American Valves. All types in stock. Standard types, 5/6 each. All the new Metal-Class Octal Base tubes at 6/6 each. 210 and 250, 8/6 each.

### CLEARANCE LINE U.S.A. VALVES.

U.S.A. Types, 24, 30, 41, 39/44, 35/51, 55, 56, 57, 58, 71, 77, 78, 85, 2A5, 2A6, 2A7, 2B7, 6A7, 12Z3, 210, 250, all 2 for 3/-.

### U.S.A. MAINS TRANSFORMERS

at less than pre-war prices.

Input 110 v. + 220 v. A.C. Output 325-325 v. 120 mA. 5 v. 2 amps. C.T. 6.3 v. 2-3 amps.	7/6 EACH
Input 230 v. A.C. Output 325-325 v. 75 mA. 5 v. 2 amps. 6.3 v. 2-3 amps. C.T.	6/6 EACH
Input 200-250 v. A.C. Output 250-250 v. 60 mA. 4 v. 2 amps. 13 v. 1 amp.	3/6 EACH
Input 100-250 v. A.C. Output 300-300 v. 80 mA. 4 v. 5 amps. C.T. 4 v. 1 amp.	6/11 EACH

### PREMIER MAINS TRANSFORMERS

Screened primaries 200-250 volts. Fully guaranteed. Wire end types.  
S.P. 250. 250-250 v. 60 mA/A. 4 v. 1-2 a., 4 v. 2-3 a., 4 v. 3-4 a., all C.T., 11/6.  
S.P. 300. 300-300 v. 60 mA/A. 4 v. 1-2 a., 4 v. 2-3 a., 4 v. 3-4 a., all C.T., 11/6.  
S.P. 351. 350-350 v. 150 mA/A. 4 v. 1-2 a., 4 v. 2-3 a., 4 v. 4 a., all C.T., 14/6.  
S.P. 352. 350-350 v. 150 mA/A. 5 v. 2 a., 6-3 v. 2 a., 6-3 v. 2 a., all C.T., 15/-.  
The above can be supplied fitted with Panel and Terminals, at 1/6 extra.  
S.P. 500. 500-500 v. 150 mA/A., 16/6.  
S.P. 501. 500-500 v. 150 mA/A. 4 v. 2-3 a., 4 v. 2-3 a., 4 v. 2-3 a., 4 v. 3-5 a., all C.T., 23/-.  
S.P. 502. 500-500 v. 150 mA/A. 5 v. 3 a., 4 v. 2-3 a., 4 v. 2-3 a., 4 v. 3.5 a., all C.T., 27/6.  
S.P. 503. 500-500 v. 200 mA/A. 5 v. 3 a., 6-3 v. 3 a., 7.5 v. 3 a., or 2.5 v. 5 a., all C.T., 27/6.  
The above can be supplied fitted with Panels and Terminals, at 2/- extra. Details of complete range available. Special Transformers wound to order.  
**ELECTROLYTIC CONDENSERS.** Metal Can. 8 mfd. 320 volts 2 for 1/6. 8+8 mf. 475v. +10 mf. 50 v., 2 for 2/6. 8+8 mf. 450v. +8 mf. 250 v., 2 for 2/6.

### PREMIER 1940

### "5 v. 5" COMMUNICATIONS RECEIVER

A 5-valve Superhet, covering 12-2,000 metres in 5 wave bands.

- Beat Frequency Oscillator
- 2-Spread Band-Spread Control
- A.V.C. Switch
- Illuminated Band-Spread Dial
- Send-Receive Switch
- Iron-Cored IF's
- Phone Jack
- Over 4-Watts Output

Provision for single wire or Di-pole Aerial. International Octal Valves for 200-250 v. mains (A.C.). Built into Black Crackle Steel Case providing complete screening, 10½ in. Moving Coil Speaker in separate steel cabinet to match.

Receiver, Complete with all tubes and Speaker £9 9 0

### PREMIER BATTERY CHARGERS

for A.C. Mains.

Westinghouse Rectification complete and ready for use.

To Charge:

2 volts at ½ amp.	11/9
6 volts at ½ amp.	19/-
6 volts at 1 amp.	22/6
12 volts at 1 amp.	24/6
6 volts at 2 amps.	37/6

### Special Purchase of

### "AIR WARDEN"

5-VALVE MIDGET RECEIVERS  
for 200-250 v. A.C. Mains.

Completely self-contained in highly polished wood cabinet 12 x 9½ x 9 ins. with built-in Moving Coil Speaker.

Wave range 190-550 metres,  
Usual Price..£6-6-0.

**OUR PRICE 55/-**

The Ideal "Stand-by" Receiver.

### SHORT-WAVE CONDENSERS

Trolitul insulation. Certified superior to ceramic. All-brass construction. Easily ganged.

15 m.mfd. .... 1/9	100 m.mfd. ... 2/3
25 m.mfd. .... 2/-	160 m.mfd. ... 2/6
40 m.mfd. .... 2/-	250 m.mfd. ... 2/11

PREMIER S.W. H.F. Chokes, 10-100 metres, 9d. each. Pie-wound, 1/6 each. Screened, 1/6 each.  
**SHORT-WAVE COILS,** 4- and 6-pin types, 13-26, 22-47, 41-94, 78-170 metres, 2/- each, with circuit. Premier 3-band S.W. coil, 11-25, 19-43, 38-86 metres. Suitable any type circuit, 2/11.

UTILITY Micro Cursor Dials, Direct and 100 : 1 Ratios, 4/3.

PREMIER MORSE KEYS. Smooth action, 3/3.

YOU MUST HAVE OUR GIANT 1940 ILLUSTRATED CATALOGUE AND VALVE MANUAL ——— OVER 100 PAGES. PRICE **6d.**

# PREMIER RADIO CO.

ALL POST ORDERS to: JUBILEE WORKS, 167, LOWER CLAPTON ROAD, LONDON, E.5 (Amherst 4723).  
CALLERS to: Jubilee Works, or 169, Fleet Street, E.C.4 (Central 2833) or 50, High Street, Clapham S.W.4 (Macaulay 2381).

# Undistorted reproduction

Undistorted reproduction is an essential demand of the listener for whom the best alone is good enough. The man whose aim in radio is quality sets the same high standard in his other pursuits.

In reading, for instance. He wants information and entertainment that will bring him the most useful and agreeable news and opinions on a wide range of current affairs. Where better will he find it than in the pages of the BBC's weekly review "The Listener"?

*There* is the full undistorted reproduction of what experts in every walk of life have broadcast in the clear, good English that the microphone exacts from all who come to it.

Recorded in the permanence of print, there are the talks of our national leaders, to provide facts and opinions for the present and a valuable record for the future. There is advice on adjusting one's daily life to the conditions of today. There are descriptive articles dealing with affairs of the moment and comments on books, art, music and broadcasting. There are pictures that add still further to the interest of the printed word.

You will enjoy "The Listener." It is published every Thursday, price 3d. Ask your newsagent to deliver it for you.

## THE LISTENER

Every Thursday, 3d.

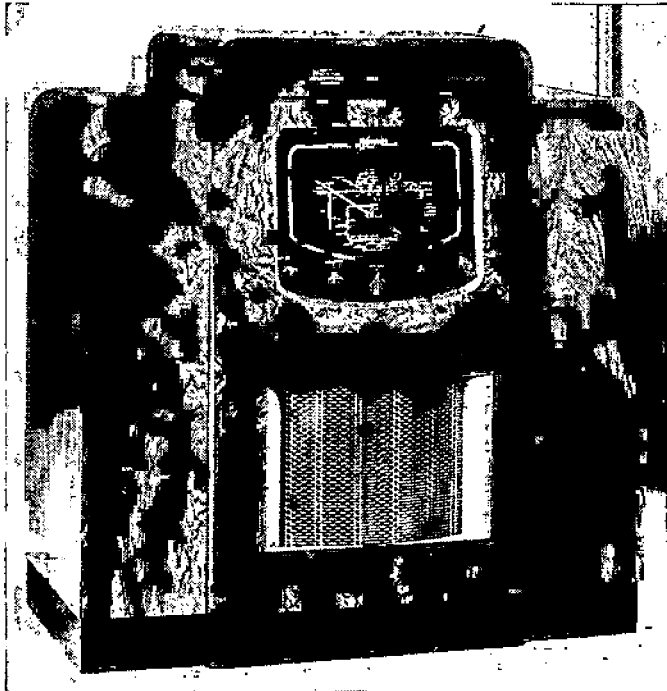

Chassis equipment sold separately if desired.

The New  
**A**MBASSADOR  
RADIOGRAM

For the man who likes Radio and Gramophone combined this new AMBASSADOR model is undoubtedly something for earnest consideration. An entirely new style of cabinet design, affording accommodation for storing up to 200 10" and 12" records, is a unique feature. A powerful six-valve three-band Superhet. receiver with R.F. stage covers from 12.5/52m., 175/550m. and 1,000/2,000m. MAZDA valves—Band spreading on short waves—and a host of other essential features are described in literature available free on request.

PRICE £24:5

Details from

**AMBASSADOR RADIO WORKS**  
HUTCHINSON LANE, BRIGHOUSE, YORKS.  
Tel. 283.

Wholesale Enquiries Invited.

**WHARFEDALE EXTENSION SPEAKERS DE LUXE**

The demand for Extension Speakers is to-day much greater than normal. Wharfedale are maintaining their unique service of supplying Speakers to match the set in preference to using a Universal Transformer.

Extension Speakers are available in the following types without extra charge—

- Type "32" for 1½ to 4 ohms.
- Type "64" for 4 to 6 ohms.
- Type "98" for 7 to 10 ohms.

With "TRUQUAL" Volume Control.

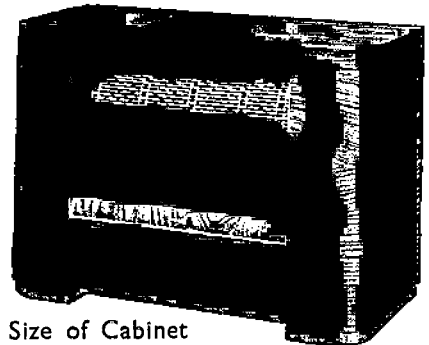

Size of Cabinet  
16" x 12" x 8"  
Walnut. (Mahogany or Oak 2/6 extra.)

The Cabinet illustrated is the Wharfedale DE LUXE model and is available with the 8" Bronze unit or with the 10" Golden unit—as supplied to and used by the B.B.C. Most Wharfedale Cabinet Models are available in Oak or Mahogany at an extra charge of 2/6.

**REVISED PRICES**

OCTOBER 1939

CABINET MODELS	Less Transformer	With Transformer	V.C. extra
Gem .. ..	23/-	28/-	4/-
Moderne .. ..	25/-	30/-	4/-
Meritor .. ..	28/6	35 3	with v.c.
Bijou .. ..	37/-	43/6	"
Coronet .. ..	46/-	54/6	"
Corner Cabinet .. ..	49 6	58/-	"
Bronzian .. ..	55/-	63/3	"
De Luxe, Bronze Unit	66/-	74/3	"
De Luxe, Golden Unit	88/-	103/-	"

**WHARFEDALE WIRELESS WORKS, Hutchinson Lane, BRIGHOUSE, YORKS.**

PHONE BRIG. 59



# The Wireless World

COVERING EVERY WIRELESS INTEREST

29th Year of Publication

Proprietors : ILIFFE & SONS LTD.

No. 1050

VOL. XLVI No. 2

Editor :  
HUGH S. POCOCK.

DECEMBER 1939

Editorial,  
Advertising and Publishing Offices :  
DORSET HOUSE, STAMFORD STREET,  
LONDON, S.E.1.

## Contents

Telephone : Waterloo 3333 (50 lines).  
Telegrams : "Ethaworld, Sedist, London."

COVENTRY : 8-10, Corporation Street.  
Telegrams : Telephone :  
"Autocar, Coventry." 5210 Coventry.

BIRMINGHAM :  
Guildhall Buildings, Navigation Street, 2.  
Telegrams : Telephone :  
"Autopress, Birmingham." 2971 Midland (5 lines).

MANCHESTER : 260, Deansgate, 3.  
Telegrams : Telephone :  
"Iliffe, Manchester." Blackfriars 4412 (4 lines).

GLASGOW : 26B, Renfield Street, C.2.  
Telegrams : Telephone :  
"Iliffe, Glasgow." Central 4857.

PUBLISHED MONTHLY.  
Price : One Shilling  
(Publication date 20th of preceding month).

Subscription Rates :  
Home and Abroad, 14/- per annum.

As many of the circuits and apparatus described in these pages are covered by patents, readers are advised, before making use of them, to satisfy themselves that they would not be infringing patents.

EDITORIAL COMMENT .. .. .	39
REACTION CIRCUITS .. .. .	40
PROBLEM CORNER .. .. .	43
"BUG" KEYS. By W. A. Roberts .. .. .	44
AERIALS—AND WHERE THE EARTH COMES IN By "Cathode Ray" .. .. .	47
BROADCASTING IN GERMANY .. .. .	50
AVC DEVELOPMENTS. By W. T. Cocking .. .. .	51
TEST REPORT : G.E.C. Model 4010 .. .. .	56
LETTERS TO THE EDITOR .. .. .	59
CURRENT TOPICS .. .. .	60
INDUCTION. By G. A. V. Sowter, B.Sc.(Eng.) Lond., A.M.I.E.E. .. .. .	63
EMERGENCY RECEIVER .. .. .	65
SHORT-WAVE RECEPTION. By "Ethacomber" .. .. .	66
UNBIASED. By Free Grid .. .. .	67
B.B.C. RECEIVING STATION. By H. V. Griffiths .. .. .	69
NEW IDEAS .. .. .	72
RANDOM RADIATIONS. By "Diallist" .. .. .	74
TEST REPORT : PHILIPS Type 855X .. .. .	76
SHORT-WAVE STATIONS OF THE WORLD .. .. .	78
RECENT INVENTIONS .. .. .	79

## TROPHY brings you the World's opinions and NEWS!

● THE SET YOU MUST CHOOSE FOR RELIABLE RECEPTION ON 7 TO 550 METRES

As installed at "Radio Royal," Europe's largest Press listening post.

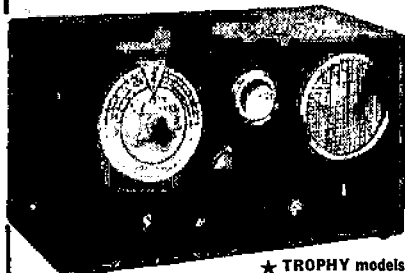

FOR War news—flashes and bulletins, entertaining programmes and to bring into your home every worth-while radio signal in the World—for all of these—the TROPHY 6 (illus. on left) is a wise investment. This A.C. 6-valve superhet employs electrical bandspreading and tuning refinements of the communication type of set. M/C speaker is built-in with provision for alternate use of 'phones . . . for performance and reasonable outlay, the TROPHY 6 is confidently recommended.

Fully Guaranteed **£10-19-6** Or on Easy Terms.

★ TROPHY models from £6-6-6 to £14. SEND NOW FOR LISTS

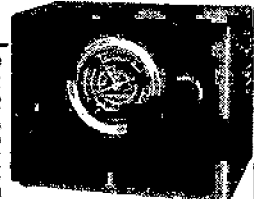

### New 2-Stage R.F. AMPLIFIER

Of special appeal to "The Wireless World" reader who appreciates the shortcomings of his existing receiver. This new PRESELECTOR—for use in front of any set—ensures increased range, volume, selectivity and sensitivity and appreciable image suppression. Spread tuning is provided with a continuous coverage of 7 to 550 metres. Uses two "E" type R.F. pentodes with built-in power-pack for all A.C. 200/250 v. 40-100 cycle supplies. Fully guaranteed. **£7-8-6**

PETO SCOTT CO. LTD., 77, (W.M.B.) City Road, London, E.C.1. Tel.: Old 9875.  
41, High Holborn, W.C.1. Tel.: Holborn 3248.

WEST END LONDON Demonstrations—call at R. E. M. LTD., 70, Wigmore St.





## Let's get on with the job!

**I**T does my heart good to hear of those people who are going ahead with their work in spite of things.

It's easy enough to be pessimistic. On the manufacturing side of radio we've got our troubles—lack of raw materials, transport and a hundred and one other headaches.

The Country's needs must come first and if that leaves the Industry a bit behind with some of its supplies then we've just got to find alternatives. We'll find them if or when the time comes I know, but meanwhile we can still go on turning out sets in the way we've always done—and, up to date, that's precisely what we at Murphy Radio are doing.

E. J. POWER

*Managing Director.*

# MURPHY RADIO

*All Murphy sets, exclusive of valves and batteries, guaranteed for a year.*

MURPHY RADIO LTD., WELWYN GARDEN CITY, HERTFORDSHIRE

# The Wireless World

COVERING EVERY  
WIRELESS INTEREST

ESTABLISHED  
1911

No. 1050. Vol. XLVI. No. 2

DECEMBER 1939

Price One Shilling

## Editorial Comment

### Putting Back the Clock

**I**T is not our purpose to comment here on the recent change-over from British Summer Time to G.M.T. That, so far as broadcasting is affected, resolves itself mainly into adjusting one's listening programme to meet the return to Standard Time. In its figurative sense, however, the expression "putting back the clock" now has implications in wireless circles that should not be ignored.

Not only has the war threatened to slow down progress in the design of broadcast apparatus; it has actually had a reactionary effect, turning our minds back to devices and circuit arrangements that were abandoned many years ago as crude and out of date. Wireless people are not complaining, of course. Indeed, it is pleasing to record that, as compared with many others, they have in general had little to complain about. Wireless has come into its own, and everyone who is doing his job well and conscientiously in any of its many branches has the comforting feeling that he is playing a useful part in the National effort.

We are all willing to face the present need for simplification in broadcasting at both the transmitting and receiving ends. None of those who understands the technical position has complained against the present single-programme Home Service with its various limitations. Equally, we are prepared if and when the need arises to receive this programme on apparatus that savours rather more of 1922 than 1939. But, if we are going to revive out-of-date devices, there is no harm in trying to improve them by applying the knowledge we have gained during the intervening years.

#### *-Emergency Receivers*

A surprisingly large number of readers have written to us for information on the almost-forgotten crystal set, a type of receiver that has obvious uses for stand-by purposes in times of emergency. Such a simple device would hardly seem to be susceptible to improvement, but it happens that a new type of copper-oxide detector, working on a low signal input and so capable of replac-

ing the erratic and unreliable crystal, has recently made an opportune appearance. The practical use of this new rectifier is described elsewhere in this issue.

Reaction as an aid to sensitivity and selectivity has played an important part in receiver technique, although most of us have thought for many years that it was best forgotten, except for one or two special applications. But now it seems possible that reaction may again be called upon in the design of simple sets for specialised wartime conditions. We therefore make no apology for publishing on another page an article in which the choice of reaction control circuits is examined in the light of modern knowledge. It will be realised that most of the classical systems were devised by more-or-less empirical means.

#### *Sets for Active Service*

*The Wireless World* has never been a party to advocating and encouraging the use of portable broadcast receivers in situations and conditions where such use seems to be entirely inappropriate and unnecessary—even ridiculous. But without going to the absurd length of suggesting that every front-line soldier needs a receiver to while away the hours of waiting, we do maintain that thought should be given to the needs of members of the fighting forces both overseas and at remote stations at home. Some of our readers, asking for suggestions as to suitable types of sets, point out that the typical portable, excellent as it may be for the purpose for which it was evolved, is far too heavy and bulky for most members of the Forces. Another aspect of the problem of devising a suitable receiver is brought up in our correspondence columns.

Here, it would seem, is another case for simplification and for "making do" with something that might be regarded as crude. A really effective set, compact and light enough to be practicable, is not easy to devise, and the suggestions of readers would be welcomed. Headphones and dry-battery valves would appear to be essential features of a "soldier's set."

# Reaction Circuits

WHICH IS THE BEST ARRANGEMENT?

*IT has been said that reaction comes nearer than anything else in radio to giving something for nothing. As economy is vital under wartime conditions, it is worth while examining the possibilities of reaction, particularly for short-wave work, in the light of modern knowledge. In the present article circuit arrangement receives most attention, but subsequent articles will deal with valve-operating conditions and similar related matters.*

**T**HE use of reaction has become much less general in recent years, and now the majority of receivers do not include it at all. This is largely because improvements in valves and circuit design have made it easy to get the required sensitivity without it. In spite of this, reaction still has its uses, especially in short-wave equipment.

Short-wave sets can be divided into four groups: (1) the small straight set; (2) the SW band of a broadcast set; (3) the small communication set; (4) the large communication set.

Sets of the second and fourth groups rarely make any deliberate use of reaction, but those in the first category rely on it very largely for their sensitivity and selectivity. The third group is a newcomer, and quite a small one up to the present. The sets in it are designed with the aim of approaching the performance of the large communication sets with a simpler circuit and fewer valves. Reaction is employed more to increase selectivity than sensitivity, and it is used in a moderate degree only; it is not pushed to the edge of oscillation as is essential in the case of the small straight sets of group 1.

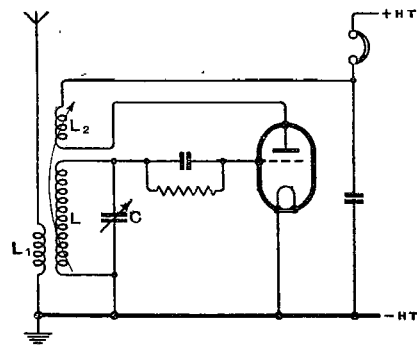

Fig. 1.—This diagram shows the classical swinging-coil reaction circuit.

retical analysis checked by controlled experiment. Because of this, general statements must be treated with caution.

Reaction is so old and so well known that it might be thought that little fresh could be said about it. This is far from being the case, however, for so much that has been said about it in the past has been based upon uncontrolled experiment and comparatively little upon theoretical

analysis. It has become accepted that one of the best methods of reaction control is by variation of screen voltage of a tetrode or pentode valve. This is now probably the commonest method of control in short-wave apparatus because it has much less effect on the tuning than many other possible arrangements. If anyone were to conclude from this that it is always the best arrangement, however, he would be sadly disappointed. It is easy to show theoretically that while it is very good in some circumstances it is very bad in others.

There are three main requirements of a good reacting system: variation in the setting of the reaction control should not affect tuning, the valve should go smoothly into oscillation, and there should be no backlash. All three are important when critical reaction is used, but when only a moderate degree is employed the attainment of smooth oscillation is less important. This is because the valve will never be intentionally worked close to the oscillation point. For the same reason the avoidance of backlash is less important; it is still very

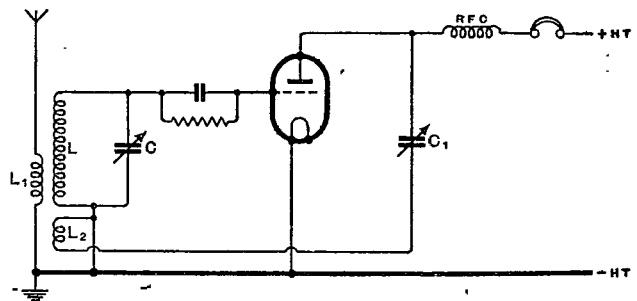

Fig. 2.—The common condenser-controlled or Reinartz reaction system. This is still probably the most widely used of any.

desirable, however. When backlash is present it is quite possible for a strong signal or a peak of interference to start the valve oscillating, and once started it will not stop until the reaction control is slackened off.

## Effect of Valve and Circuit

The variations of tuning experienced depend chiefly upon the circuit adopted, but the smoothness of oscillation and backlash depend upon the valve used and the voltages applied to it. The effects are not completely separate, and it would not be true to say that smoothness and backlash depend only on the valve and voltages; the circuit does have an effect, and one which it is sometimes hard to disentangle.

The classical reaction circuit shown in Fig. 1 was in common use in the very early days of broadcasting.

## Reaction Circuits—

The tuned circuit LC is coupled by  $L_1$  to the aerial, and reaction is obtained with the aid of  $L_2$ . Reaction is controlled by varying the physical distance between, or the angle between,  $L$  and  $L_2$ .

The great drawback to the arrangement is the considerable variation of tuning experienced with changes in the reaction coupling. Apart altogether from secondary electrical effects, the mechanical movement of the coils necessarily changes the circuit capacity and so alters the tuning.

To overcome this it became customary to adopt a fixed coupling between the coils with a capacity control of reaction. There are many possible variations of this scheme, but the commonest is that shown in Fig. 2, which is still in use today. Sometimes the reaction condenser  $C_1$  is placed on the earthy side of the coil  $L_2$ , and this is less likely to give hand-

capacity effects. Provided that the capacity between  $L$  and  $L_2$  themselves is small, however, this makes little difference, and so one can be guided by convenience.

This circuit is a considerable improvement, but is by no means perfect. At low operating frequencies when the anode-cathode valve capacity can be considered negligible,  $L_2$ ,  $C_1$ , and the valve resistance can be considered as a series-tuned circuit coupled to LC. Changing  $C_1$  alters the resonance frequency of this circuit and so alters the tuning of LC, since the two circuits are coupled together. Owing to the very high circuit resistance, however, this effect is small.

At high operating frequencies the anode-cathode capacity plays an important part. Ignoring the valve

resistance for the moment, it comes in series with  $C_1$  across  $L_2$ . The reaction circuit then becomes a tuned circuit of only moderate resistance, and although its resonance frequency may be widely different from that of LC, an alteration in the capacity is reflected into the circuit LC. The finite value of valve resistance modifies things somewhat, but the general effects remain.

At very high frequencies this circuit fails because it is very difficult to secure a sufficiently large mutual inductance between  $L$  and  $L_2$  to secure oscillation without making  $L_2$  so large that it resonates with the various circuit capacities at or below the resonance frequency of LC. With ordinary valves the upper-frequency limit for this circuit is usually about 60 Mc/s as an oscillator, and it is often difficult to make it work above 40 Mc/s. For reaction purposes the latter frequency should normally be taken as the upper limit.

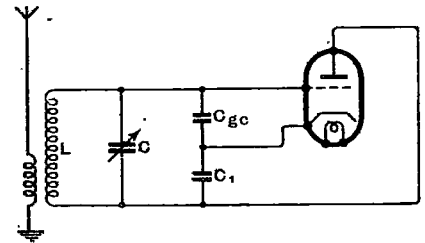

Fig. 5.—This is the basic circuit of the Colpitts oscillator when the valve inter-electrode capacities are used to provide the tapping point on the tuned circuit.

## For Ultra-short Waves

For high-frequency work generally it is more usual to employ some form of the Hartley or Colpitts circuits shown at (a) and (b) respectively in Fig. 3. These have many variations, especially in the method of controlling regeneration. Probably the most widely used is the Hartley modification of Fig. 4. A screen-grid or pentode valve is used and the cathode is tapped up the coil so that the valve oscillates with normal screen volts; regeneration is controlled by varying the screen voltage by  $R_1$ .

This arrangement can be made very satisfactory, but the Hartley oscillator is always more liable to trouble than the Colpitts. This is because it is impossible to prevent its being a Colpitts oscillator as well as a Hartley! If the important valve capacities are drawn in on Fig. 4 (dotted) it will be seen that the grid-cathode and screen-cathode capacities form the split condenser of the Colpitt's circuit. Provided a high impedance path to RF and low impedance to DC were maintained between cathode and earth, the circuit would still work with the tap on the coil removed. It would then actually be a Colpitts circuit.

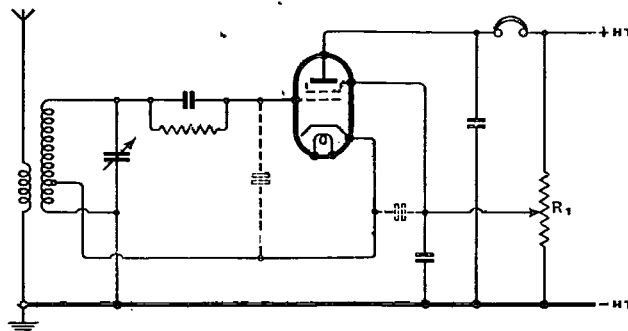

Fig. 4.—This modified form of the Hartley circuit is commonly used with an indirectly-heated valve. It permits one side of the tuning condenser to be earthed. Reaction is controlled by varying the screen voltage by means of  $R_1$ .

## Reaction Circuit—

Because it is really two circuits in one the Hartley circuit is sometimes troublesome; it may try to work in one mode at one end of the tuning range and in the other mode at the other end. Naturally all sorts of peculiar effects take place in the region where the change-over occurs. This particular trouble does not occur with the Colpitts oscillator, and it is often simpler because the coil does not need tapping. An analysis of its conditions is rather more easily carried out than in the case of some other circuits, and it is then easy to show that some of the usual arrangements of controlling regeneration in Colpitts receiver circuits are not the best that can be devised.

The basic circuit is shown in Fig. 5, where the detector arrangements, HT supply, and DC circuits have been omitted. It can be shown that the part to the right of LC behaves as a capacity  $C_{in}$  in parallel with a resistance  $R_{in}$ . The resistance

purposes it is usually arranged in the form shown in Fig. 6, where the grid-cathode capacity  $C_{gc}$  and the anode-cathode plus stray capacities  $C_1$  form the necessary capacity for the tuned circuit LC.

The grid condenser  $C_2$  is large enough in relation to these others to have a negligible effect.  $C_3$  is the reaction control.

Measured between the points AB the valve will behave as a capacity  $C_{in}$  in parallel with a negative resistance— $R_{in}$ . The equivalent circuit is thus of the form shown in Fig. 7 (a), and this can be still further reduced to Fig. 7(b), and it is clear that varying  $C_3$  changes both  $R'$  and  $C'$

Suppose that at 30 Mc/s (10 metres)  $R_{in}$  is  $-2,800$  ohms and  $C_{in}$  is  $3.9 \mu\mu\text{F}$ . These are also approximately the values of  $R'$  and  $C'$  when  $C_3$  is large for full regeneration. Now let us reduce  $C_3$ , say to  $3.9 \mu\mu\text{F}$ . Then  $R'$  becomes  $-11,850$  ohms and  $C'$  becomes  $2.16 \mu\mu\text{F}$ . When  $C_3$  becomes zero  $R'$  is infinite and  $C'$  is zero.

To vary  $R'$  from  $-2,800$  ohms to infinity involves a change of  $C'$  from  $3.9 \mu\mu\text{F}$  to zero. In practice, a change of resistance of  $11,850 - 2,800 = 9,050$  ohms involves a change of capacity of  $3.9 - 2.16 = 1.74 \mu\mu\text{F}$ . If the total tuning capacity is  $25 \mu\mu\text{F}$ , as it may well be; this means a change of 6.96 per cent., which will entail a change of resonance frequency of roughly 3.4 per cent. or about 1 Mc/s!

One method of overcoming the difficulty is to make  $C_3$  fixed and to control regeneration by a variable resistance shunted across C.

This means using a fixed value of negative resistance and a variable positive resistance in the tuned circuit instead of the more usual course of keeping the positive resistance fixed and varying the negative resistance. A

resistance shunted across C would be a perfect control, since it would cause no change of tuning. It is, however, very doubtful whether it would be satisfactory in practice, because of the difficulty of obtaining a suitable variable resistance. The internal capacity would have to be constant or negligible at all resistance values.

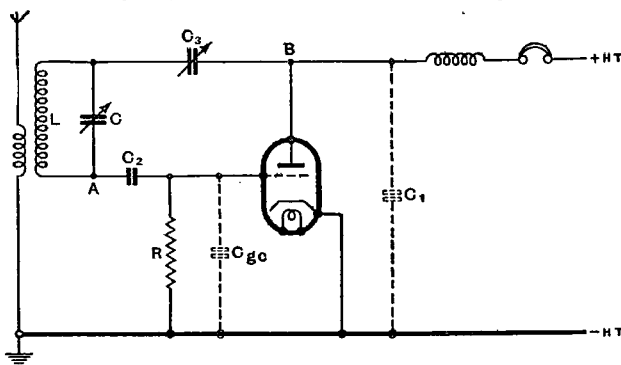
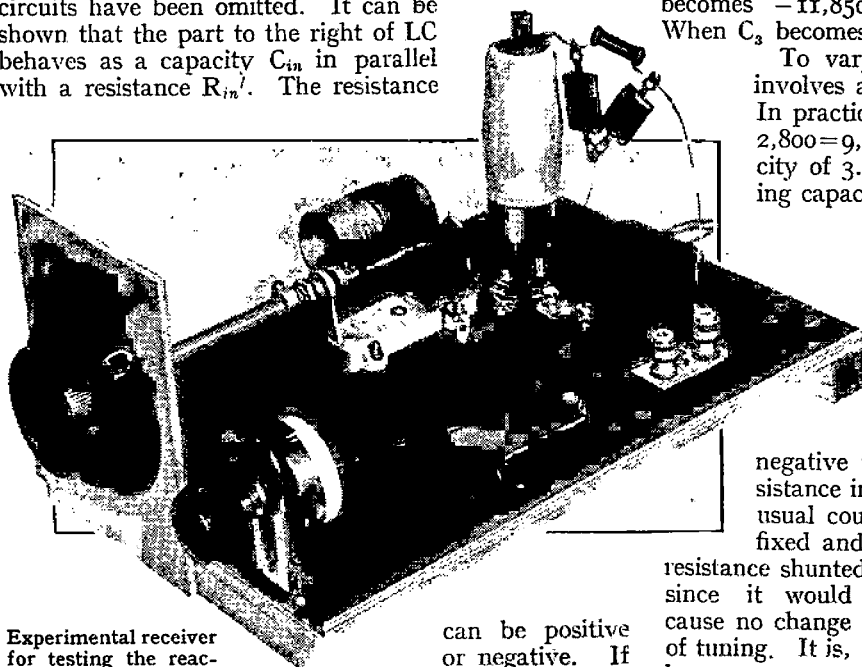

Fig. 6.—A commonly used Colpitts circuit in which regeneration is controlled by  $C_3$ .



Experimental receiver for testing the reaction circuits discussed.

can be positive or negative. If it is the latter regeneration occurs, and oscillation commences when the negative resistance is numerically less than the dynamic resistance of the circuit LC.

If we use this arrangement as a reacting system it is necessary to be able to vary  $R_{in}$  at will, and it is necessary that changes of  $R_{in}$  should affect the input capacity  $C_{in}$  as little as possible. The problem of design consists of choosing that form of control which most nearly meets this condition.

Now when this Colpitt's circuit is used for reacting

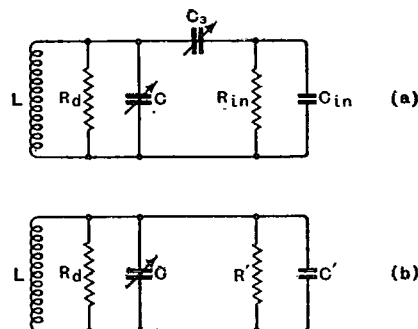

Fig. 7.—The equivalent circuit of Fig. 6 is shown at (a); it can be further reduced to (b), as explained in the text.



## Reaction Circuit—

If we make  $C_3$  fixed or omit it, we can control regeneration by varying  $C_1$  or  $C_{gc}$  by varying a resistance in parallel with  $C_1$ , or by altering the valve "constants" through changing the voltages applied to it. Let us redraw the circuit in the form of Fig. 8. Here  $C_2$  and  $R_2$  are the grid leak and condenser for grid detection and if  $C_2$  is large enough they play no direct part in regeneration.  $C_3$  is the anode circuit by-pass condenser, assumed to have negligible reactance at the operating frequency. The coil  $L_1$  in the cathode circuit is assumed to have such a large reactance that it can be ignored; its purpose is merely to provide a low-resistance direct-current path.

The essential factors governing the input impedance of the valve are  $C_{gc}$ ,  $C_1$ ,  $R$ , and  $g$ , where  $g$  is the mutual conductance of the valve and  $R = R_1 R_a / (R_1 + R_a)$ ; that is,  $R_1$  in parallel with the anode AC resistance of the valve. This ignores the grid-cathode resistance, which is likely to be fairly high when  $R_2$  is large.

The input capacity  $C_{in}$  and input resistance  $R_{in}$  depend on all four quantities, so that whichever is varied to change  $R_{in}$ , then  $C_{in}$  is necessarily altered also. There are, however, two limiting cases. When  $(1 + gR) / \omega^2 C_1$

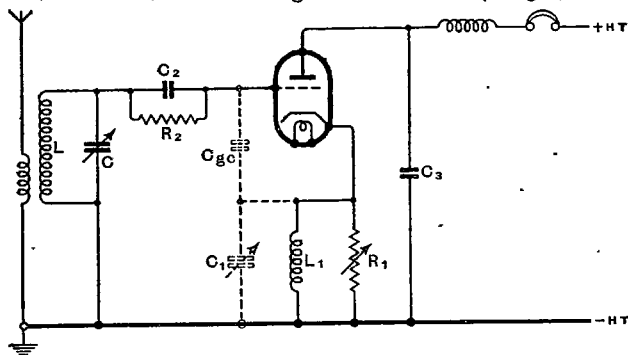

Fig. 8.—This version of the Colpitts circuit is particularly convenient since the tuning condenser can be earthed. Regeneration can be controlled by  $C_1$  or  $R_1$ ; it is shown in the text that  $C_1$  should be used at low frequencies and  $R_1$  at high frequencies.

$C_{gc} R^2 \ll (1 + C_1/C_{gc})$  and  $(1 + gR)^2 / \omega^2 C_{gc}^2 R^2 \ll (1 + C_1/C_{gc})^2$  then  $C_{in} \approx C_1 / (1 + C_1/C_{gc})$ . Obviously, neither  $C_1$  nor  $C_{gc}$  can be used as a reaction control; but if either  $R$  or  $g$  is varied  $C_{in}$  is nearly constant.

The above conditions are, in practice, most nearly met at high frequencies and we find that the correct reaction control is then  $R$  or  $g$ .  $R$  can be varied by using a variable resistance for  $R_1$ ;  $g$  can be altered by changing the anode (or grid) voltage of the valve. This will also alter  $R_a$  and hence  $R$ . This voltage control has for long been used as a regeneration control in SW equipment. Found originally by experiment, it has decided theoretical justification.

There is, however, another extreme condition, when  $(1 + gR) / \omega^2 C_1 C_{gc} R^2 \gg (1 + C_1/C_{gc})$  and  $(1 + gR)^2 / \omega^2 C_{gc}^2 R^2 \gg (1 + C_1/C_{gc})^2$ . The input capacity  $C_{in} \approx C_{gc} / (1 + gR)$ . Under these conditions  $C_{in}$  is no longer dependent on  $C_1$  or  $C_{gc}$ , but is greatly dependent on both  $g$  and  $R$ . When these conditions hold, therefore, it is definitely wrong to control regeneration by

varying  $R_1$  or the voltages applied to the valve. The correct thing to do is to vary  $C_1$  or  $C_{gc}$  and the former is usually the more convenient. These conditions are most nearly fulfilled at low and moderate radio frequencies.

In order to obtain the minimum change of input capacity reaction should be controlled by  $g$  or  $R$  at high frequencies and by  $C_1$  or  $C_{gc}$  at low or moderate frequencies. In practice, the former condition applies for general short-wave reception and the latter at frequencies below some 500 kc/s.

## Henry Farrad's Problem Corner

### No. 41.—Strange Behaviour of an AC/DC Receiver

An extract from Henry Farrad's correspondence, published to give readers an opportunity of testing their own powers of deduction:—

All Hallows School,  
Berkhamsted.

Dear Henry,

Some people I know have an AC/DC set, several years old—they are on DC mains—and the life of the rectifier was rather short, so when I was staying with them it struck me that a rectifier is rather a superfluity in a DC set and why buy a new one? So I proceeded to short-circuit the old one (anode to cathode). Another thing I had in mind was that these mains are only 200 volts, which doesn't give the set much of a chance. Cutting out the resistance of the rectifier shoves up the HT a bit, and as these sets are supposed to work on any mains up to 250 there seemed to be no likelihood that anything would be given more than its safe voltage. And the results seemed to be all the better for it.

So far so good. But recently I have had disturbing communications from the said friends. Apparently there was a good old boil-up inside, as a result of which a new electrolytic condenser had to be fitted. Not long after the same thing happened again. And then again. Naturally, my reputation as an engineering genius has slumped somewhat. I have advised a removal of the short-circuit as a precautionary measure, but I would feel much happier about it if I knew what was going on. As I say, the slight extra HT ought not to have such drastic effects. And a curious thing—it may be a coincidence—is that the trouble always seems to occur just after the set has been shifted, to a different room for example.

Can you rally round and help the old firm again, please?

Yours ever,

Tony.

*Why did Tony's attempt to "ginger up" the set fail?  
Henry Farrad's explanation is on page 55.*

### Collins Wireless Diary, 1940 Edition

IN addition to formulæ and other technical data, Collins Wireless Diary for the forthcoming year contains sections on such subjects as Direction Finding, Aerials and Earths, Valves, Faults and Remedies, etc. Bound in sand grain, with pencil, the diary costs 2s.; other bindings are available.

# “Bug” Keys

WHAT THEY ARE AND WHAT THEY DO

By W. A. ROBERTS (G2R0)

A NOTICEABLE feature on the 7 Mc/s and other amateur bands is the increase which has taken place in general morse operating speeds over the last few years. Time was when 15 w.p.m. was fast for the average British amateur; that speed was considered slow when our activities were stopped by the outbreak of war.

Much of this faster operating is due to the rapidly increasing popularity of bug keys. Operating a straight key at high speeds for a considerable period is apt to become very much like hard work. A bug key cuts out 50 per cent. or more of the hard work, and also makes high speeds easier to attain, because a single motion of the hand will produce any desired number of dots. For each dash, an individual motion must still be made. The letter V, for instance, can be sent by a bug with only two movements of the hand. A straight key would require four such movements.

The diagram accompanying this article shows the layout of a typical high-speed key, and helps to explain its action. The diagram shows the position of the key at rest—making no signal. For dots, the paddle is pressed to the right. The main shaft moves laterally on its pivot, against the restraining spring A, and hits the left-hand stop S2, in that way producing dots. Within limits, the number of dots made is proportional to the time for which the paddle is held over. The speed of the dots is dependent upon the position of the movable weight W, which determines the oscillation period of the shaft. When the paddle is released, the restraining spring returns the shaft to a central position and the far end of the shaft hits the back stop S3, so that the vibration is immediately eliminated.

Dashes are made on contacts C3

and C4. The dash arm is pivoted at the same point as the main shaft, but is independent of the main shaft. The screw carrying contact C3 is fastened to the dash arm, and passes through a clearance hole in the main shaft. Over the left-hand end of this screw, between an adjustable nut and the main shaft, is a spring B. When the paddle is moved to the left to make a dash, it carries the dash arm with it, against the restraining spring B. Any tendency for the main shaft to move is annulled by the right-hand stop S1. The meeting

of contacts C3 and C4 produces a dash. All the screws, with the exception of that carrying the dash contact C3, are adjustable. They pass through threaded pillars, as shown, which are fixed to the heavy metal base of the key. The tension on spring B is adjusted to suit individual requirements by moving the nut to a different point on the screw.

Now it may be said of bug operating that “When it is good it is very, very good, but when it is bad it is horrid!” It is easy to use a bug so as to produce morse of a kind, but it takes much more care and practice to produce signals of the “copper-plate” variety. Perhaps an operator who has used these keys, both commercially and on the amateur bands, for several years may be allowed to offer a few suggestions as to how to get the best out of a semi-automatic key. The comments are not laid down as hard-and-fast rules—for the style of operating a bug can be as nearly personal as the way you part your hair—but they are intended to give a general line on how to go about getting the best results.

Let me commence with a statement that is almost a truism, but which deserves reiteration. Don’t attempt to use a bug until you can send a good, solid and well-formed 25 w.p.m. on a straight key, and can receive it, too. A moment’s thought will show that if you can’t receive 25 p.w.m. then you can’t know if

*THIS article deals with the type of morse key that is manipulated by lateral movements instead of in the familiar up-and-down fashion. The use of the word “bug” was first derived from the nature of the device stamped on the base of the well-known “Vibroplex” keys. By common usage, however, it has come to apply to any similar type of key, whatever its manufacture. The word is used in the wider sense throughout this article.*

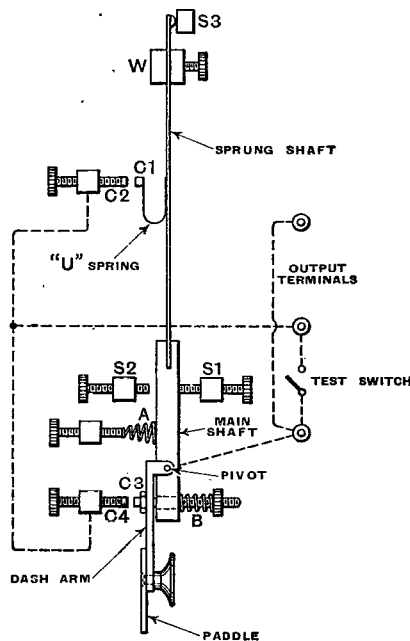

Diagram showing the mechanical arrangement of a bug key. The references are explained in the text. The dotted lines indicate the wiring between the contacts and the terminals of the key.

## Wireless World

### "Bug" Keys—

you are sending good signals at 25 p.w.m.—which is a common operating speed for bugs. Of course, there is another way of looking at it, too. If you race away on the air at 25 per, then the fellow at the other end is entitled to come back at the same speed—and then where are you, if you can't read it?

Suppose we are starting off with a new bug key. The very first thing to do is to put the adjustable weight right at the far end of the sprung shaft, so that the dots are made as slowly as possible. Moreover, the weight should stay there until one is completely competent to send perfectly formed signals at that speed. Many a bug operator has been more or less permanently spoiled by trying to send at a high speed right from the start. There is a great temptation to shift the weight further in on the shaft to get what sounds like a higher speed. The dots, certainly, will be made faster, but it is very interesting to notice that, with the beginner, the measured speed in w.p.m. almost invariably remains the same, and may even be less. The principal actual result is that the sending loses any balance it may have had, and becomes jerky.

With the weight at the far end of the shaft, the right-hand stopper  $S_1$  should be set so that the end of the sprung shaft just hits the stop at the back of the key sufficiently hard 'o kill the vibration. The vibrations should stop immediately, but the end of the shaft should not press hard against the stop, or the resilience of the movement will be lost.

With this point settled, the dots can be adjusted. First, the left-hand stop  $S_2$  should be set so that the near tip of the paddle can move a lateral distance of between  $1/16$  in. and  $1/8$  in. when it is pressed to the right. In this position, the very important adjustment of the actual dot contacts can be made. It is a common mistake to arrange the dot contacts so that a maximum number of dots can be made on a single movement of the paddle, before the signal slurs or misses. This is quite incorrect, and is the cause of the spluttery dots we hear so often. The adjustment should be made so that the signal slurs into a dash after making nine or ten dots. In this way, solid and definite dots are made, which are essential for pleasant morse. The setting of the coiled spring  $A$  is a matter for individual taste, like the spring on a straight key. The slower the speed the tighter the spring may be made. For extremely high speeds the spring will have to be very light.

### The Foundations of Good Sending

The dot contacts are now set, and attention can be turned to the dash side. There is little difficulty here. The spacing of the contacts,  $C_3$  and  $C_4$ , should be set so that the movement of the paddle is approximately the same as that required, in the opposite direction, to make dots. If the spacing is made greater than this, a familiar

fault is likely to occur on the signals—the space between the dots and the dashes in a letter will be exaggerated. The setting of the dash spring,  $B$ , is again a matter for personal taste. As in the case of the dot spring, it should be weakened for fast sending. At this point it may be remarked, in passing, that the adjustment of the key for a considerably higher speed is not just a matter of sliding the weight along the shaft. For perfect formation of characters at higher speeds, the spacing of each set of contacts must be reduced, both springs must be weakened, and the swing of the paddle on either side, must be decreased.

Having set up the key in the proper operating condition, the next thing is to be able to control it perfectly. Getting the right number of dots is one of the beginner's usual bugbears. The writer has found the following method of practice a very good one. Connect the key

to an audio oscillator, or to something which will give a note when keyed. Place the key so that it can be operated properly—that is, so that the whole length of the arm from

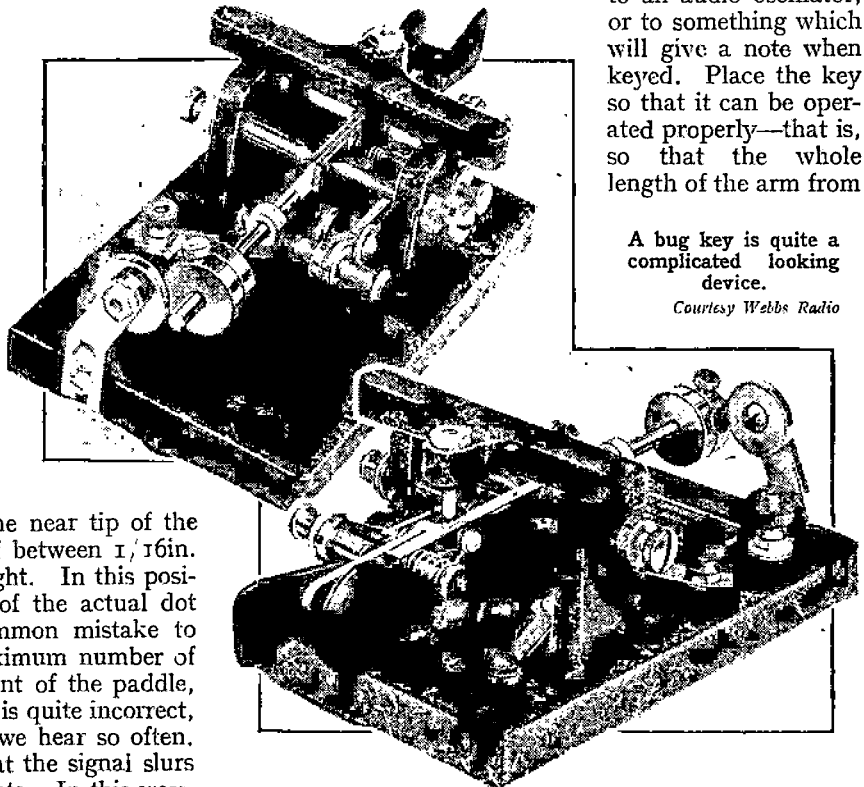

A bug key is quite a complicated looking device.

*Courtesy Webbs Radio*

the elbow is lying along the table. Then make single well-spaced dots, until you can send them rhythmically and almost indefinitely without making errors or splutters. Having conquered the one dot, go on to make a series of two dots, until you are 100 per cent. perfect at that. Proceed in this manner, through three, four and five, until you are making strings of six dots without error. Then begin again at one dot, just to make sure! When the making of dots is completely controllable you have overcome one of the greatest difficulties of bug operation.

The next point of attack is to obtain the proper co-ordination between dots and dashes. Lack of this co-ordination explains the "NST" or "NV" we often hear for "TEST," and the "ST" we sometimes hear

**"Bug" Keys—**

for "V." A sound starting plan is to send strings of Vs, trying to get the dash to follow smoothly and immediately after the dots. If, after long practice, you still find yourself sending "ST" instead of "V," then the remedy is to decrease the spacing between the dash contacts and/or the strength of the dash spring. Beware that you don't go too far, though, or your dots will be slurred into the dash. When the Vs sound satisfactory, constant repetition of the numbers, from one through nine to zero, is good practice in this connection. These numbers, incidentally, give you a chance to check that your dashes are all the same length and evenly spaced. Don't be afraid that you are making the dashes too long. Clipped, jerky dashes are a much more common fault than dashes which are too lengthy.

**Pitfalls to Avoid**

When all these points have been thoroughly practised and mastered, you can get down to sending plain text. Letters to watch are C, F, L, P, Q, X and Y, all of which may present difficulties in the co-ordination of dots and dashes. Individual practice on these letters, until you get them perfect, will mean that you will find the other letters easy.

When sending plain text, a point to watch is that you get ample spacing between letters and words. The ease and swing with which a bug operates often leads even experienced operators to run letters and words together. The result at the receiving end is confusion. It is much better to make the spacing too great rather than too small, particularly as the tendency is for the spacing to get shorter with continued operation. After all this practice, if it is faithfully carried out, you will be sending good, solid, well-formed and intelligible morse. The final thing is to put that "copper-plate" finish on it; this is the most difficult point of all and usually is achieved only after several months of regular use and practice.

A method which the writer has found of great value is to check one's sending against automatically keyed transmissions. One earpiece of a pair of telephones is connected, through the key, to an audio oscillator; the other is connected to a receiver, in the normal way. It is easy to tune the receiver so as to find an automatic station sending "Vs," or "ABCs" and its call-sign at around 20 to 25 w.p.m. In these transmissions, the same sequence of signals is repeated time after time, indefinitely. Having heard exactly what sequence the station is sending, the game is to try to key the oscillator exactly in synchronism with the automatic signal. It is difficult at first, but after a while you will get into the swing of it, and you will find it possible to check where your faults of spacing, and so forth, are occurring, and to correct them. After continued practice of this kind one gets the rhythm of automatic transmission, and can duplicate it in ordinary working. To a keen operator, the effortless operation of a fast bug, with the knowledge that it is making signals of a perfect "automatic" type, is a real delight—worth working for! If the advice given in this article is followed, the signals will give equal delight to the operator at the other end who is receiving them.

# Back to Pre-last-war Sets

## INTEREST IN CRYSTAL RECEIVERS

IT is not difficult to understand why so many readers have written to us for information on the construction of crystal sets. Unlike mains-fed or even battery-fed receivers, they will, in the words of Exide, "go on when the rest have stopped." There is no need to stress the advantages of such a set as a stand-by in times of emergency.

The crude type of crystal set as used in the early days of broadcasting became practically useless when the Regional system was put into operation in this country, and, in response to readers' requests some years ago, we described in detail the construction of a two-circuit crystal set that provided the necessary selectivity. Although enquirers may still be referred to that description, which appeared in *The Wireless World* for February 7th, 1936, it should be pointed out that the circuit arrangement can be simplified to meet the conditions prevailing with our present single-programme Home Service. Long-wave reception is no longer needed, and in many situations selectivity will be adequate with a single-circuit tuner.

In the accompanying diagram is given a circuit diagram of a single-wave-band crystal set suitable for present-day conditions, which comprises two tuned circuits coupled by means of a small variable condenser C3 of some 25 micro-microfarads maximum capacity. Ordinary broadcast-

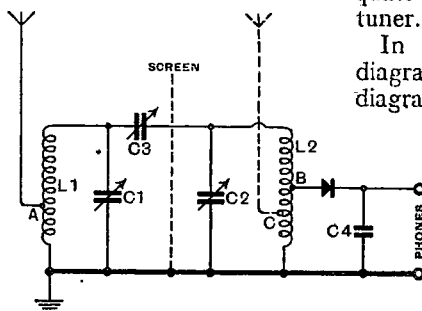

Wartime stand-by crystal set for single-band reception. Where high selectivity is not needed the input circuit may be eliminated, the aerial being connected as shown in dotted lines.

band coils can be adapted for use as L1 and L2, or, alternatively, these coils can be wound at home with 55 turns of No. 22 DCC wire on 3in. formers. L1 is tapped at point A at the 15th turn from the earthed end, while L2 is tapped at B, the centre point. C1 and C2 comprise a two-gang condenser, each section of 0.0005 mfd. capacity, preferably with an externally controllable trimmer. C4 may have a capacity of 0.001 mfd.

In cases where the extra selectivity conferred by a second tuned circuit is not necessary, the set may be greatly simplified by eliminating L1, C2, C3, and transferring the aerial connection to point C, a tapping made at the 15th turn from the earthed end of the coil L2. It is perhaps worth pointing out to relative newcomers to wireless that the initial adjustments—especially the crystal adjustment—of a two-circuit receiver are most easily made by temporarily reverting to single-circuit tuning in the manner just described.

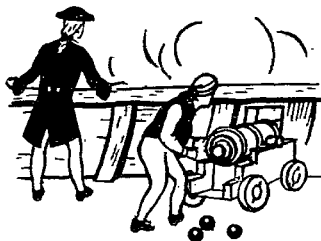
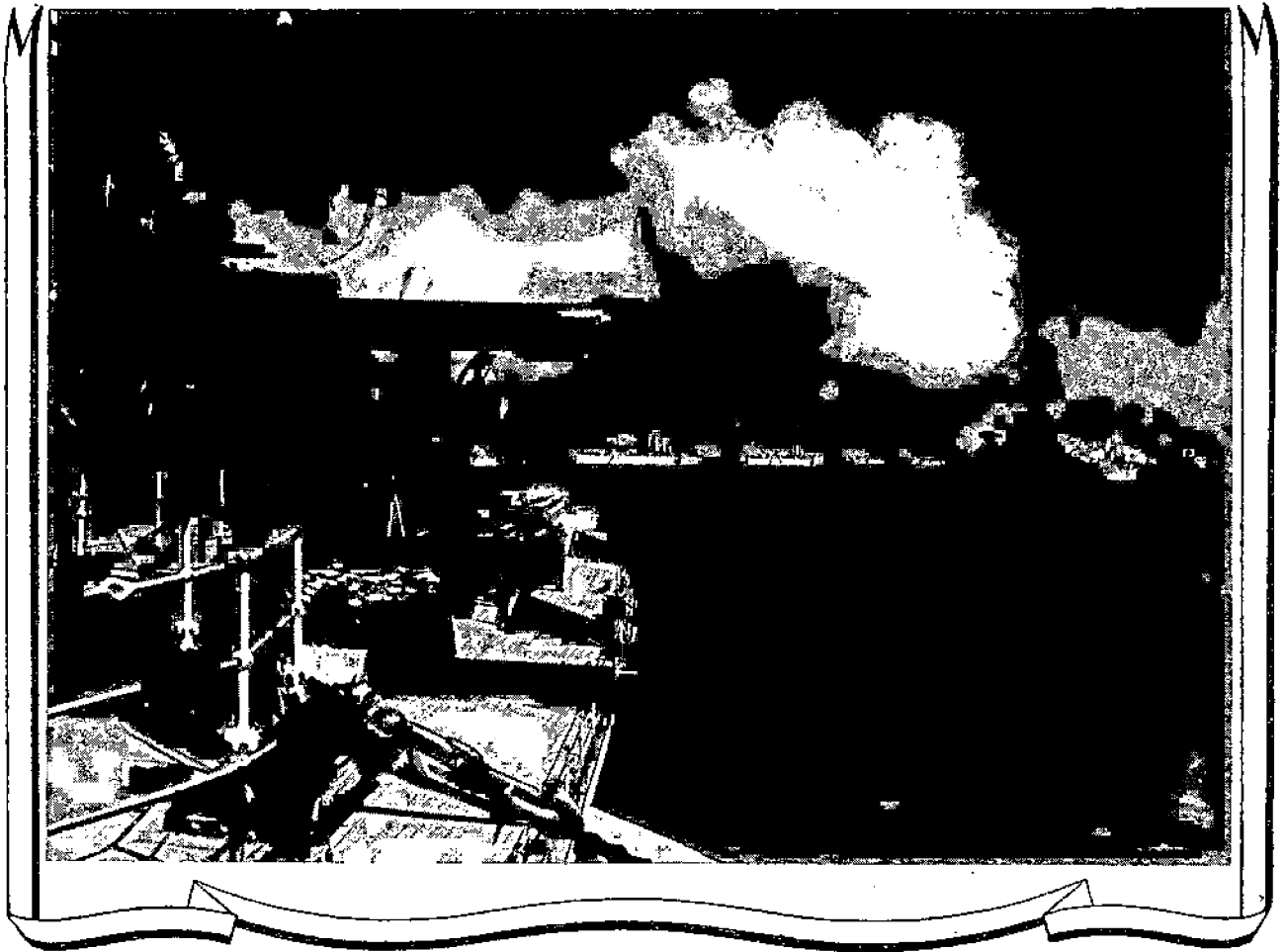

—AND STILL WE SAIL SUPREME

We've had our squalls and we've had our battles ; we've had our salvos and we've had our broadsides ; but in spite of all we've carried on. And now, in this greatest trial of all, we are still riding the troubled waters calmly, and still, if we may say so, doing our job just that little bit better than anyone else.

# DUBILIER



DUBILIER CONDENSER CO. (1925) LTD., DUCON WORKS, VICTORIA ROAD, NORTH ACTON, LONDON, W.3  
C. R. Casson 154



# Why not extend your Radio This Christmas?

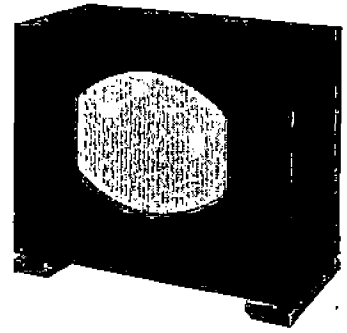

Stentorian Baby Cabinet £1 12 6.

Christmas this year will be essentially home entertainment with the radio playing a principal part. Stentorian Extension Speakers will enable you to enjoy the programmes in any part of the house—and even in your Air Raid Shelter! Instantly adjustable for any impedance value, an exceptionally high standard of performance is maintained throughout the entire range. At such moderate cost there could be no more pleasing and practical gift for your family.

... And if you have a "Long Arm" Remote Control as well, you can switch your set on and off without moving from the room in which you are listening.

ASK YOUR DEALER TO DEMONSTRATE!!



The perfect extra speaker for any set.

WHITELEY ELECTRICAL RADIO CO., LTD., MANSFIELD, NOTTS.

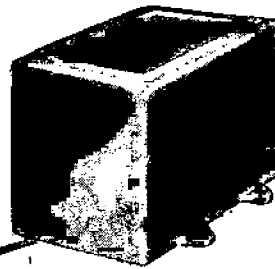

Long Arm Remote Control for distant extension switching 17/-.

### Chassis Models

Senior .. ..	£2 6 3
Junior .. ..	£1 15 9
Baby .. ..	£1 6 0
Midget .. ..	19 3

### Cabinet Models

Senior .. ..	£3 9 3
Junior .. ..	£2 14 6
Pendant .. ..	£2 14 6
Cadet .. ..	£2 3 6
Handy .. ..	£1 1 6

## A War-time necessity—a peace-time investment

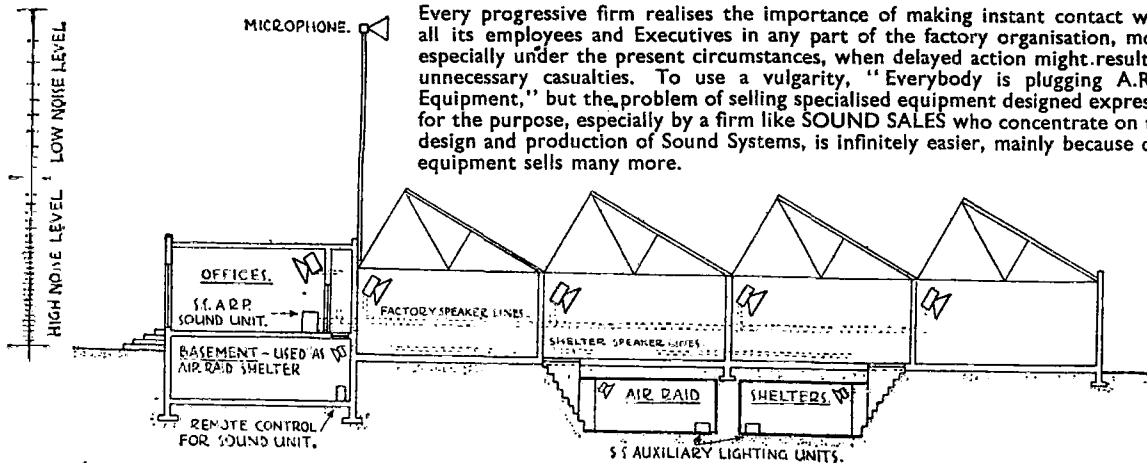

Every progressive firm realises the importance of making instant contact with all its employees and Executives in any part of the factory organisation, more especially under the present circumstances, when delayed action might result in unnecessary casualties. To use a vulgarity, "Everybody is plugging A.R.P. Equipment," but the problem of selling specialised equipment designed expressly for the purpose, especially by a firm like SOUND SALES who concentrate on the design and production of Sound Systems, is infinitely easier, mainly because one equipment sells many more.

The illustration above shows a suggested equipment which enables Air Raid Warnings to be instantly relayed, together with verbal instructions, irrespective of Factory noise level. Automatic or individual control is incorporated with remote control from Shelters, which should of course be equipped with SOUND SALES Auxiliary Lighting System.

In peace time the system is invaluable, and pays for itself in a very short time. Prices range from £20, and knowing the possibilities of such a system, we are almost tempted to invent a slogan which might well be—

**HAVE AN AIR-RAID IN COMFORT WITH SOUND SALES**

**SOUND SALES LTD.**  
WEST STREET • FARNHAM • SURREY

Telephone: Farnham 6461-2-3

Contractors to the Air Ministry, War Office, Admiralty, G.P.O., B.B.C., etc.

# Aerials

## AND WHERE THE EARTH COMES IN

By "CATHODE RAY"

IN past years an aerial was—and for most people still is—a piece of wire strung across the garden or equivalent space. To complete the installation an "earth" is also necessary, or at least desirable. And so it has remained year after year without change, except perhaps for the worse, when people found that modern sets could get plenty of stations with any old thing as an aerial, or even (apparently) nothing at all. Appearances are sometimes deceptive, however, for birds have ears, and portable sets have aerials. They are merely unobtrusive. And when the aerial and earth are disconnected from a mains-driven receiver, the local station still comes in because the mains wires act as an aerial.

The earth connection is more of a mystery, because it seems to play an important part in the normal receiver; yet obviously a car radio can't be anchored firmly to the

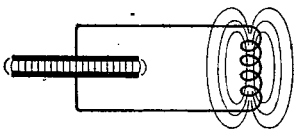

Fig. 1.—In a concentrated tuning circuit the inductive and capacitive fields (represented by imaginary lines) are practically confined to the immediate neighbourhood of the components.

ground. Neither can a portable. And more recently we have special television and short-wave aerials, in some of which the absence of an earth connection appears to be not merely carelessness or lack of opportunity, but part of the plan.

All this may be causing some confusion of thought, so perhaps a little sorting out of the subject of aerials and earths may be welcomed.

The relationship between an aerial and the tuned circuit to which it is coupled (in either transmitter or receiver) is very much the same as that between the sounding board of a musical instrument and the vibrating string. When a piano key is pressed it strikes a wire string, making it vibrate, or, to use radio language,

*oscillate*. These mechanical oscillations set up waves of sound in the surrounding air; but the amount of sound radiated directly in this way is very small, and, in order to increase it, the string is mounted on a sound board so as to set a much larger volume of air vibrating and increase the sound waves. The same thing is done with violins, where the strings are mounted on a body that can vibrate easily and has a large surface to "get a grip on" the air. In a drum, the oscillating part is itself given such a large surface that it is a good sound radiator. Musical instruments are used for broadcasting sound in the air, but they could be used for receiving it, too. If a certain note is played on a piano, the corresponding note in a second piano (with the damper lifted) would respond if within a reasonable distance. The sound board of the receiving piano would greatly increase the distance at which it could collect enough sound energy to give a perceptible response.

And so in radio an aerial is used at the transmitting end to radiate the oscillations generated in the oscillator circuit, and at the receiving end to enable the received tuned circuit to be affected by waves over the largest possible catchment area.

Any tuned circuit comprises two essentials—inductance and capacity. Current flowing through an inductance sets up a magnetic field in the space around it, and voltage across a capacity sets up an electric field in

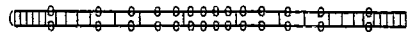

Fig. 2.—The same applies to a close-spaced parallel line, although this is a tuned circuit with inductance and capacity distributed over a long distance. The rings indicate lines of magnetic force around the wires, and the short lines represent the electric force between them.

the space between the two plates. Electric and magnetic fields in motion generate one another, so once

one of them gets started there is a rapid to-and-fro exchange of energy between the two; in other words, oscillation. One moment the energy is due to the current rushing through the inductance; the next moment this current has charged up the capacity, and the energy is due to the

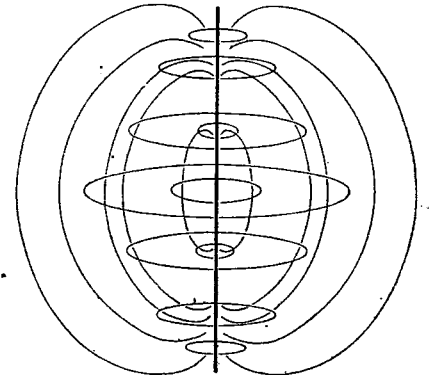

Fig. 3 . . . but when the tuned circuit is not only distributed but also opened out the field extends and waves are radiated or received easily.

voltage difference across it, which causes current to rush back through the inductance in the opposite direction, and so on as long as the oscillation lasts.

### Non-Radiating Systems

If the tuned circuit is in concentrated form—a close-wound, multi-turn coil and a condenser with plates separated only by a thin film of air, mica, etc.—then there is very little effect outside its immediate neighbourhood. Representing the field in the usual way by imaginary lines, they run closely around and in between the compact components (Fig. 1).

A long parallel or concentric cable is just as much a tuned circuit, but the inductance and capacity are distributed along its whole length, which may be miles. So long as the two wires or tubes are very close together, the fields are still closely around them (Fig. 2). The magnetic lines cannot enclose both wires at once, because the currents in them are flowing in opposite directions.

# Wireless World

## Aerials—

Note that the magnetic field, due to the current, is strongest at the centre, because, of course, there can be no current at the disconnected ends. The electric field can be strong there, however, because the voltage may be high. Tuned circuits of this type are often used for high-frequency (or short-wave) work.

## Conditions for Radiation

Now suppose that the wires are opened out so as to form a single long straight line (Fig. 3). The inductance and capacity are still distributed along its length, but the electric field lines have a long way to go to stretch between the points of greatest opposite voltage, and the magnetic lines can spread out without finding themselves neutralised by a wire carrying opposing current. In these circumstances the wire with an oscillating current in it acts as a sound board, radiating waves off into space. Like the diaphragm of a drum, the wire can be made to serve both as the tuned circuit and radiator combined; or, alternatively, like a piano sound board, it may be coupled to a separate and more concentrated oscillatory circuit, as in Fig. 4, which can be turned into a complete transmitter by adding a valve with power supply, reaction coil, etc.

On the other hand, if there is no means of setting up oscillations for the wire to radiate, but it is swept by waves radiated from elsewhere, its extent enables it to have oscillations generated in it by these oncoming waves over a long front. The circuits of the types shown in Figs. 1 and 2, on the contrary, make contact with so little of the waves that they pick up hardly anything of what is about; and that is a good reason for using them in places where they would be more likely to receive interference than desired signal.

That, very roughly, is a reminder of what an aerial is and what it does. How about the earth? Hitherto we have conveniently ignored its existence, supposing ourselves to be located somewhere in an empty universe. Anything in the neighbourhood of an aerial affects the waves being radiated or received, especially

if it is a conductor of electricity, because it acts more or less as another aerial. This second aerial, if of suitable size, receives and re-radiates

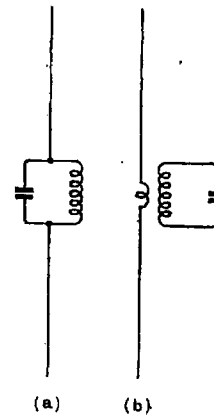

Fig. 4.—Two ways of coupling a radiating part and a concentrated part of a tuned circuit. If the aerial forms only a small part of the whole tuned circuit, it is not very effective either for transmitting or receiving.

Apply this idea to the familiar dipole television aerial, which is of the Fig. 3 type. It is a complete self-contained tuned circuit, and the way of controlling the tuning is to adjust the length. This would be awkward if it were needed to work at different wavelengths, but quite all right for one fixed wavelength.

## Dipole Principles

The aerial is correctly tuned when it is half a wavelength long. To convey the results to the receiver, a line can be used of the Fig. 2 type, which, as already explained, is negligible as an aerial, and therefore does not introduce complicating effects. And so signals are brought to the receiver. But now suppose another identical aerial (except for the draw-off line) is placed parallel to the first. It also has oscillations generated in it, and, as there is no essential difference between a receiving and a transmitting aerial, it re-radiates them. What the first one gets, then, is a combination of the waves from the distant transmitter and those from the nearly parallel aerial. The result depends on the

distance between the two parallel aerials. If the distance is a quarter of a wavelength (half an aerial length), and the transmitter is on the opposite side to the secondary aerial (Fig. 5), the latter receives the waves after they have travelled an extra quarter wavelength. The re-radiated wave is of the opposite polarity to that arriving; equivalent to half a wavelength, for that is the distance from a positive crest of a wave to a negative crest. The re-radiated wave arrives at the main aerial another quarter-wavelength behind. Quarter plus half plus quarter equals a whole wavelength, which means that the re-radiated wave comes into step with that from the transmitter, and the result is double-strength.

## Phase Relationships

The secondary aerial, in effect, reflects the wave, and gives an increased result from that direction, just as a lamp reflector increases light. If the transmitter is on the right, however, the re-radiated wave is *half* a wavelength out of step, cancelling the original wave and stopping reception from that direction.<sup>1</sup> Hence the value of the arrangement in improving desired reception and reducing pick-up from other and undesirable sources such as motor car ignition.

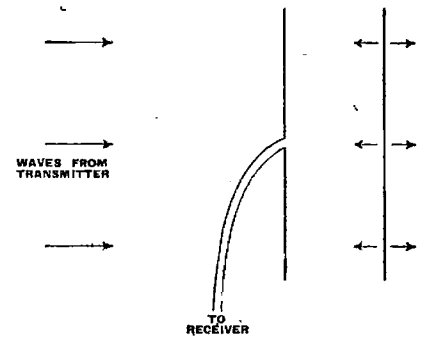

Fig. 5.—Showing how a conductor acts as a reflector.

That is interesting in itself, but the point to note at the moment is that a conducting wire acts as a reflector. Several conducting wires

<sup>1</sup> If you have been following this you may wonder why in Fig. 5 the real aerial doesn't cancel reception by the reflector, in which case it would have nothing to re-radiate. The answer is that the real aerial is loaded by the receiver and the power generated in it is consequently absorbed and not free for reflection.

## Aerials—

can be arranged as a more effective reflector. A large metal surface, like a gasometer, is a good reflector. The earth itself, assuming it to be a good conductor, is a very important reflector. One obvious thing it does is to stop waves going downwards through it for any distance. Unless they are lost in it, then, they must be reflected up again. The earth's surface can be imagined as a mirror. If a wire or rod radiating light (which is just ultra-ultra-short-wave radio), say, a red-hot poker, is suspended above a mirror-like floor,

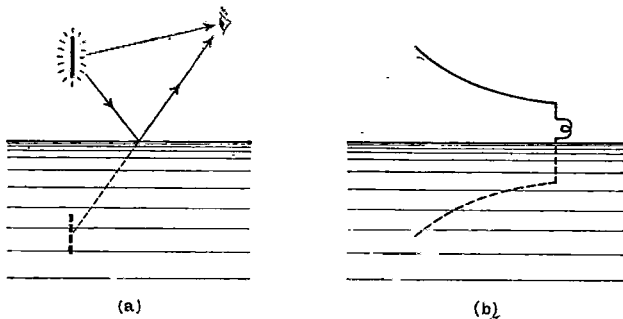

Fig. 6.—(a) A source of radiated light above a reflecting surface appears to be accompanied by an image below the surface. In a similar way the reflecting earth below an aerial is equivalent to a second aerial beneath, which can be combined into one by an earth connection (b).

what one sees is not only the actual poker but apparently another one beneath the floor. If the real poker is 3ft. above the floor, the imaginary one appears to be 3ft. below. Red light comes from both positions (Fig. 6 (a)). The illusion is due to light reflected from the surface of the floor. The more perfectly reflecting it is the more exact is the duplication of the radiator.

## Aerial Images

The same sort of principle holds good with an aerial. The effect of the earth, if it is assumed to be perfectly conducting, and therefore a perfect reflector, is the same as if an image aerial existed below the ground level. If the real aerial is high above the ground, it is a long way from its image, the effect of which is not so noticeable; but if it comes down to ground level and is connected to the earth, the image forms a sort of second half, doubling the real length (Fig. 6 (b)). If the

aerial were not connected to earth, the lower end would really be an end, and obviously there could be no current at that point because it would have nowhere to go. By joining it to earth, the lower end becomes really the middle, which is the point of maximum current, and therefore a very good place for inserting a coil to couple the aerial to the receiver or transmitter. This is altogether in addition to the advantage of connecting the receiver to earth to minimise risk of getting a shock from it should it accidentally come in contact with the mains, and of avoiding hum by connecting screens and things to a point of zero voltage. Generally, the same "E" connection serves all these purposes.

Nothing in this world is perfect, including the world itself, which is by no means a perfect conductor, especially when contact is made by the average amateur "earth." So the above description is rather of an ideal than an actuality. Therefore, for some purposes, especially very short

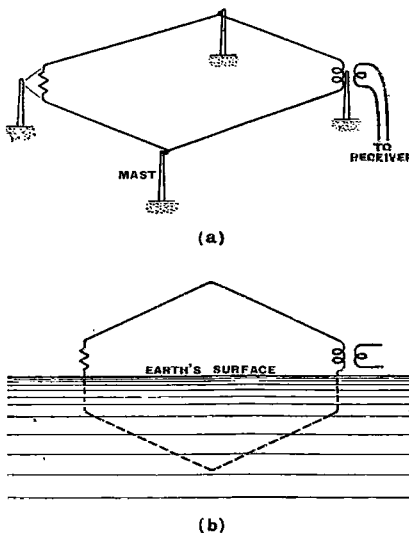

Fig. 7.—The rhombic aerial (a) is complete in itself, but the inverted V (b) requires an earth image to complete it.

waves, it may be better to look the gift horse in the mouth, and, dissatisfied, substitute an artificial earth in place of the one provided free by Nature. The shorter the

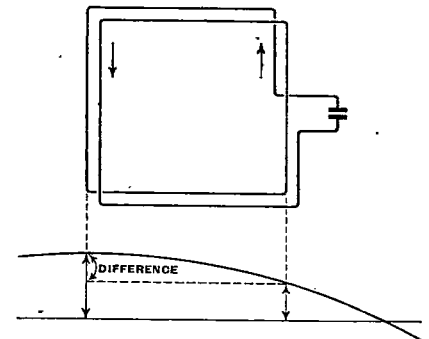

Fig. 8.—A frame aerial is formed when different parts of a coil are far enough apart to be at appreciably different parts of a wave.

wave the less the expense. Hence the elevated dipole, which is an aerial complete in itself. The rhombic aerials, used for Transatlantic short-wave work, are another example. The inverted V aerial, on the other hand, is really a rhombic turned up on its end, the lower half being formed by the earth image (Fig. 7).

## Frame Aerials

When an aerial is close to earth but not connected to it—as in a car—it can be looked on either as a slightly elevated aerial with its earth image below, or as an ordinary earthed aerial with a series condenser in the earth lead (formed by its capacity to ground).

The only sort not yet considered is the frame aerial, used in most portables. In connection with Figs. 1 and 2 I explained that when the "go" and "return" wires forming the inductive element are very close together, there is negligible radiation or pick-up because the two tend to cancel out. This is not so when the wires are opened out. One way of doing it is as in Fig. 3; another is as in Fig. 8. Here, although every wire carrying current upwards is matched by another downwards, they are too far apart to wipe one another's currents out. Or, in another way, if the upgoing wires are at the peak of a wave, the downgoing are far enough away to

## Aerials—

be at a different part of the wave, leaving a balance to drive current around. The exception is when the frame is broadside on to the station, because then the wave reaches all parts of the aerial simultaneously, and the voltages induced in the various parts cancel out. As you know, reception disappears in this position. And as there is a complete loop for current to flow around, there is no need for an earth con-

nection to provide a place for current to flow to as in the common or garden aerial.

All this is really only the beginning of the aerial story. One can persuade aerials to radiate or receive in almost any desired plan of distribution, around and upwards, to suit special geographic situations, or for avoiding certain types of fading. Perhaps we can go into that on some future occasion, as it deserves an article to itself.

will be known as Łódź I when it resumes transmissions on its former wavelength of 1,339 metres. The other stations which will operate from the Łódź headquarters are the 1.7-kW Cracow, the 2-kW Łódź II and the 7-kW Warsaw (originally Warsaw II), which will remain on their own wavelengths of 293.5, 224 and 216.8 metres respectively.

Although the long-wave Warsaw station was destroyed during the siege of the city, German broadcasts have been radiated on its wavelength. It is thought that these have originated from the old Deutschlandsender at Zeesen, near Berlin, which was still in working order, the new transmitter having been opened only a few months ago.

There is some mystery as to which German station is operating on Saarbrücken's wavelength of 240.2 metres, for it is doubtful if this station on the Western Front is still working.

With the annexation of the Polish stations and their wavelengths, German propaganda will now be well heard in the Balkans, for the Polish stations were always well received in south-east Europe. It is expected that the German Government will

## Broadcasting in Germany

NEWS FROM OUR FORMER BERLIN CORRESPONDENT

WRITING from a neutral country adjacent to Germany, our former Berlin correspondent has sent us some interesting details of broadcasting in Germany, which, with the acquisition of the Austrian, Czech and most of the former Polish stations and their wavelengths, is now the largest and highest-powered service in Europe.

On the subject of English-speaking announcers in Germany, our correspondent says: "I have been able to identify the voice of Eduard Roderich Dietze from the Cologne station. He was born in Glasgow of a German father and a Scottish mother, and has for some time been on the staff of the German Broadcasting Company. Dietze was the star English announcer for international relays from Germany, and has done considerable work for the N.B.C. of America. Prior to the war he was not heard from Cologne or Hamburg."

It will be remembered that it was announced at the outbreak of war that listening to foreign stations was forbidden and that those caught doing so would be imprisoned. It has further been reported that headphones and sets capable of receiving foreign stations had been confiscated. Regarding the latter report, our correspondent says: "Personally, I think that the official German statement that people can still buy short-wave sets and that the industry is hoping for an even bigger turnover this year is correct. It has, however, been stated in Germany that every dealer warns his purchasers of the danger of listening to foreign stations. I know, however, from personal experience that Germans do still listen to foreign stations."

The Ministry of Propaganda has appointed the former President of the Reich Chamber of Broadcasting and

Chief of the Radio Department in the Ministry of Propaganda as Chief of the new Polish group of stations, the headquarters of which is at Łódź. With this appointment was announced a general post of wavelengths. The 24-kW transmitter at Torun, which worked on 304.3 metres, is now known as Reichssender Danzig I; a second Danzig station is working on 230.2

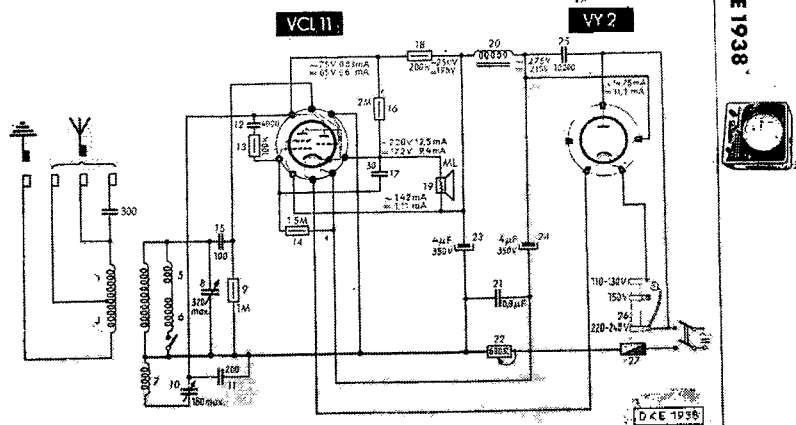

As can be seen from this reproduction of a German manufacturer's diagram, the "People's Set" is inherently unselective. But with skilful adjustment it is capable of receiving British broadcasts under moderately favourable conditions in its Fatherland. Although not shown, the aerial coupling is continuously variable.

metres. Kattowice, the 10-kW station in the south-west, is to be rebuilt and will operate on 249.2 metres. This wavelength has until now been used by Troppau (formerly Prague II).

The 120-kW long-wave station Warsaw I, which is situated at Raszyn, about 18 miles to the south-west of the city, is to be rebuilt and

very shortly notify the International Office of Telecommunications that the Reich is the rightful owner of the wavelengths belonging to Polish stations on territory which is now occupied by Germany.

All the former Polish stations in the hands of Germany may now be freely listened to by Germans.



# AVC Developments

## USING A SUBSIDIARY RF AUTOMATIC GAIN CONTROL

By W. T. COCKING

IT is well known that the amount of selectivity preceding the point at which the AVC voltage is tapped off affects the operation of a receiver. The relative merits of feeding the AVC diode from primary or secondary of the last IF transformer have often been discussed in the past. The effect of deriving a subsidiary AVC voltage from a point of quite low selectivity, however, is not one which has received much attention.

One of the difficulties associated with a sensitive superheterodyne is the elimination of undesirable effects caused by powerful local stations. The usual experience is that a receiver which includes an RF stage is more liable to give whistles on the medium waveband than one which does not include such a stage, but it is admitted to give a better signal-noise ratio, which is a thing to be desired.

If certain forms of whistles are to be avoided it is necessary to keep the signal applied to the frequency-changer below a certain level. When there is no RF stage this level is rarely exceeded even when a good aerial is used; it is exceeded only when the receiver is used exceptionally near a local station or when the receiver is tuned to this station, in which case it does not matter from the point of view of whistle production. Matters are quite different with an RF stage, however, for the signals applied to the frequency-changer are multiplied by the gain of this stage—some 10 to 50 times. This presupposes that no additional tuned circuit at signal-frequency is added with the RF stage; if such a circuit is added, matters are much better, but, even so, it is found that a larger signal is applied to the frequency-changer by the local station *when the receiver is not tuned to this station* with an RF stage than without.

### Is an RF Stage Wanted?

The writer's experience on the medium waveband has been that with a good outdoor aerial no RF stage is necessary for general reception. Nevertheless, it is found that when such receivers are in the hands of the public, complaints of background hiss are made, but very few of whistles. Similar receivers including an RF stage give rise to few complaints of hiss but relatively many of whistles. Clearly a large section of the

public does not yet trouble about good outdoor aerials.

In practice an RF stage is commonly used in the more expensive receivers, but no attempt is made to secure the full possible gain from it. The circuit constants are adjusted so that background hiss becomes small even with a fairly poor aerial, the tuned circuits and the accuracy of ganging are made as good as possible so as

to keep unwanted signals on the frequency-changer at the lowest level. In this connection ganging is very important. With the ordinary system ganged condensers with identical sections for both signal-frequency and oscillator tuning are used, and perfect ganging is then obtainable only at three points in the waveband. At all other points there are some errors, which increase in magnitude with the intermediate frequency, and in

a common case may reach several kilocycles.

Owing to the high selectivity of the IF amplifier the setting of the tuning control is always governed by the oscillator. Consequently, when the ganging is imperfect it is always the signal-frequency circuits which are mistuned. If they are mistuned from the wanted signal they are quite likely to be tuned to some other signal, and if this happens to be a local station a very strong signal may appear on the grid of the frequency-changer.

### Minimising Ganging Errors

In commercial production these ganging errors can be minimised by adjusting the split end-plates of the gang condenser. This is difficult for the amateur to do satisfactorily, and in any case the adjustment may vary during the life of the receiver. After a few years it may be no better than one lined up in the normal way.

If a superheterodyne with an RF stage and without AVC be used near a broadcast station it will usually be found much pleasanter to operate than a similar set with AVC. This assumes that the manual gain control operates on the RF stage, as will usually be the case. When tuning a set which is not fitted with AVC, the gain control is usually kept well below maximum and its setting increased for weak signals. Especially when tuning near a local station is its setting kept low, in order to avoid a sudden burst of volume. The result is

*IN order to secure a better signal/noise ratio and greater immunity from whistles and other ill-effects due to overloading, communication receivers are often provided with separate manually operated controls of RF and IF gain. This article shows how these advantages may be obtained by a purely automatic dual control that does not involve skilled operation.*

## AVC Developments—

that very large signals on the frequency-changer are unlikely to occur, except when trying to receive a weak signal close in wavelength to a very strong one.

With AVC conditions are just the reverse. The gain is always at maximum except when tuned to a signal. Quite large signal voltages are likely to be produced

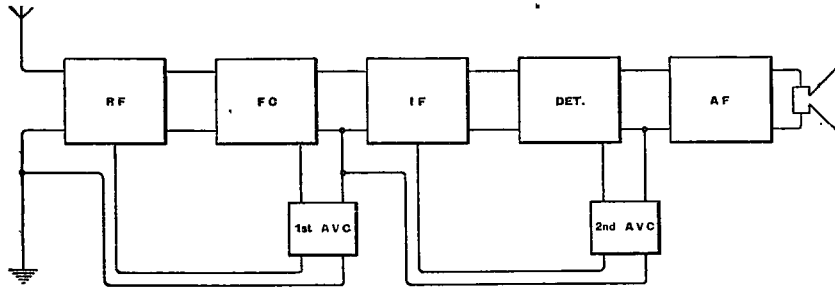

Fig. 1.—This diagram illustrates the principle of a subsidiary AVC system operating on the RF stage only. The normal AVC circuit operates on the IF stages.

at the frequency-changer during the tuning process, for the gain only drops to its correct value when the station has been tuned in. When tuned to a signal, of course, it makes no difference whether the gain control is manual or automatic, save that the signal levels throughout the receiver are likely to be a little higher with the latter.

If the receiver has independent manual RF and IF gain controls, matters are still better—for when it is found that signals on the frequency-changer are too strong the RF gain can be reduced, and the IF gain increased to maintain the overall gain constant. Such controls are out of place in a domestic broadcast set, for they need skilled operation, but they are to be found in many high-quality communication receivers. It is by no means impossible, however, and, in fact, not difficult, to devise automatic independent control of both RF and IF gain. This sounds as though it would be complicated and expensive, but actually it is not, although it is naturally more so than the conventional AVC system.

Dual control can be carried out by means of an auxiliary AVC system which derives its control voltage from a point immediately after the frequency-changer. The arrangement is sketched in Fig. 1; the second AVC system can be of any conventional type, but the control voltage which it develops is applied only to the IF stages. The first AVC system can also be of more or less normal type, but its output is applied to the RF stage, and possibly to the frequency-changer also, while its input is taken from the output of the frequency-changer, at which point the selectivity is

substantially that of the signal-frequency circuits alone.

Now what characteristics is such a circuit likely to have? In the first place it is clear that with weak signals very little AVC bias is likely to be developed by the first AVC system, for the signal voltage at the output of the frequency-changer will be still quite small. Even in the case of a moderate signal of the order of  $2,000 \mu\text{V}$  on the first valve, the frequency-changer output is not likely to exceed 1 volt, and the AVC bias produced may not exceed 0.5 volt. Thus we can say that the RF stage is substantially uncontrolled for weak signals, not because a deliberate delay is introduced, but because the AVC bias which is produced is too small to have much effect.

On weak signals we can say, roughly, that the first system has little effect. The RF stage works virtually at full gain, and the detector output is controlled by the second system acting on the IF amplifier.

As the signal increases, the first AVC system becomes more and more effective, and on really strong signals it reduces the RF gain to a low level. So far there would appear to be little difference between this and the conventional arrangement; the real difference, however, lies in the effect when a weak signal is being received a few channels away from a very strong signal.

Suppose we take the conventional system and tune in a weak signal and also feed into the aerial circuit the output of a signal generator operating at a frequency 20 kc's different. For clarity let us call the weak signal

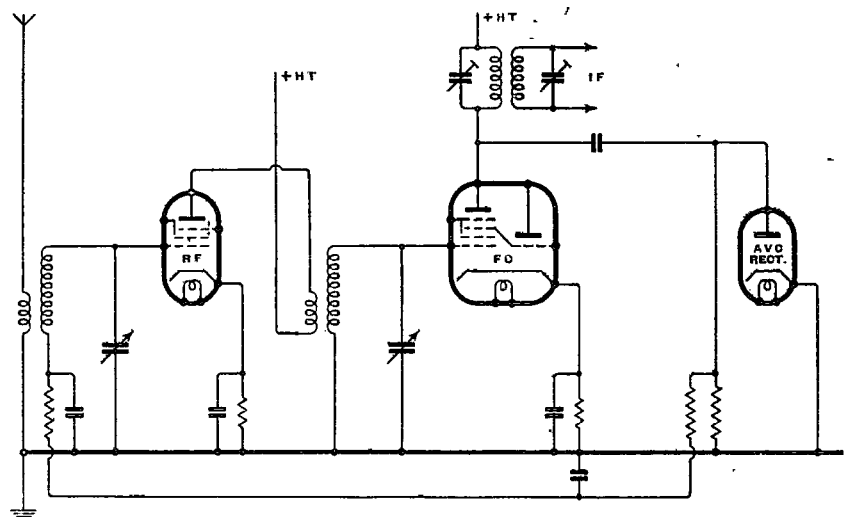

Fig. 2.—An obvious method of obtaining the RF stage AVC bias is shown here, but it is one which is unlikely to prove satisfactory.

W and refer to the signal generator output as S. We start with a small output from S. The AVC bias and receiver gain are determined by W. Now we increase S gradually. For a long time we find no change,

## AVC Developments—

for the selectivity of the IF amplifier is high enough to reduce S to negligible proportions at the detector and second AVC system. No change will occur, in fact, until S produces a strong enough signal on the frequency-changer to cause some overloading. This will occur long before there is any detectable signal from S at the detector, because the selectivity is obtained after the frequency-changer and the signal-frequency circuits do little to attenuate a signal 20 kc/s off-tune.

If the frequency relations are right, a whistle will

come by not controlling the frequency-changer from the AVC system. It is true that it would not occur in the form described, but it will occur as soon as S is strong enough to drive the RF valve into grid current. Before this happens, of course, the frequency-changer will be driven into grid-current and its input circuit heavily damped.

Now with the double AVC system of Fig. 1 matters are quite different. When S is weak it has little effect and conditions are as before. When S increases, at first little happens, but at length the first AVC system begins to develop appreciable voltage and biases back the RF stage to reduce its gain. The stronger S becomes, the greater is the AVC bias and the lower is the RF gain. Neither the RF stage nor the frequency-changer ever run into grid current.

## RF and IF Gain

As the RF gain falls as S increases, the output of the frequency-changer on the weak signal W falls. The detector input thus falls and also the AVC bias developed by the second AVC system; this in turn results in an increase of IF gain. The net result at the detector of increasing S is thus merely a slight decrease of W, and this result is achieved by an automatic decrease of RF and increase of IF gain.

One other advantage of the scheme comes in short-wave reception, for with weak to moderate signals the RF stage is kept working at full gain—a condition which leads to the maximum signal-noise ratio—while effective AVC action is retained in the IF amplifier. In spite of this, overloading of the RF stage or frequency-changer on strong signals is prevented.

We now have to consider practical ways of obtaining this desirable result. The second AVC system need not be considered, because it can be of any normal type. It is

with the first that we are concerned. The first thing that occurs to one is to use a diode fed from the anode of the frequency-changer in the manner shown in Fig. 2. This is not likely to work very well, however, and for two reasons.

There will be very little voltage at signal-frequency developed across the primary of the IF transformer, and the diode will actually operate on an intermediate frequency signal. Both strong and weak signals will produce intermediate frequencies of their original frequency difference. The ratio of the voltages produced across the transformer primary, however, will no longer be equal to that existing on the frequency-changer grid, but will be modified by the selectivity of the IF circuit. As a result the strong signal will not develop at this point as great a voltage as we want. The selectivity preceding the AVC source will not be merely that of the signal-frequency circuits, but that of these circuits multiplied by the effects of the first IF transformer.

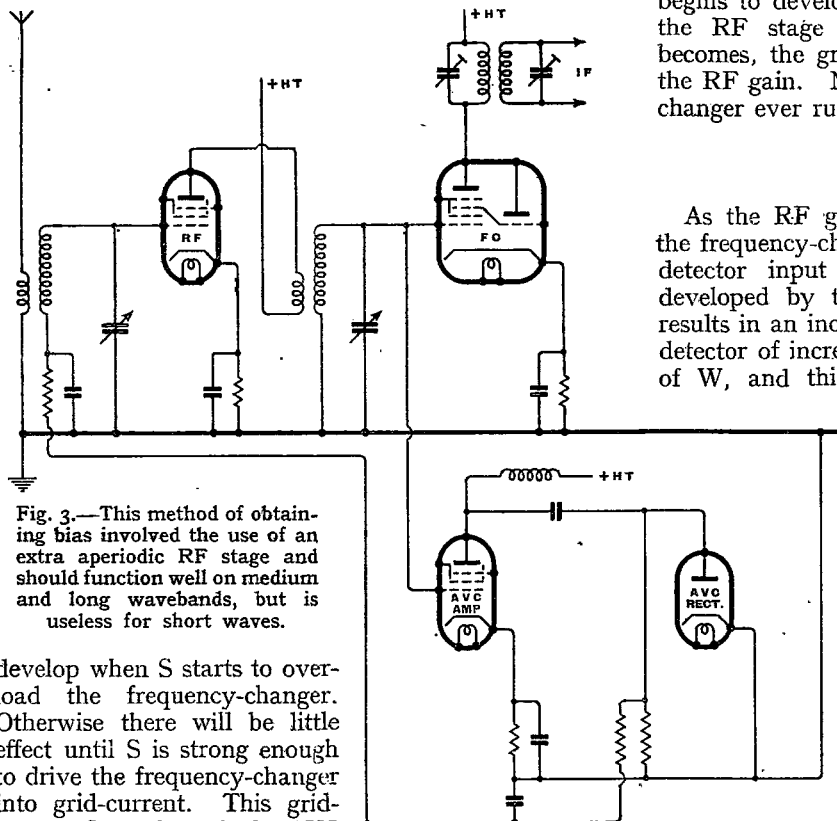

Fig. 3.—This method of obtaining bias involved the use of an extra aperiodic RF stage and should function well on medium and long wavebands, but is useless for short waves.

develop when S starts to overload the frequency-changer. Otherwise there will be little effect until S is strong enough to drive the frequency-changer into grid-current. This grid-current flows through the AVC network and develops a voltage in it which is applied as negative bias to the controlled valves. The grid circuit of the frequency-changer, in fact, acts just as a delayed diode AVC system.

The bias voltage produced by the frequency-changer biases back the RF stage and reduces its gain. It also biases the controlled IF stages and reduces their gain, and in extreme cases it may apply sufficient bias to the diode detector, if this produces the normal AVC voltage, to mute it. The receiver is then completely silent!

This extreme condition does not often arise, since it demands a very strong signal S. What does more often happen is that the wanted signal W disappears, or is greatly weakened, because of the great reduction of RF and IF gain by the bias produced by the frequency-changer. In the practical case this is always liable to occur when receiving a weak station on a channel near a strong one.

It may be objected that this trouble could be over-

## AVC Developments—

The characteristics of the system, therefore, will come between those we want and those of an ordinary arrangement.

The second reason why trouble may be experienced lies in the multiplicity of frequencies in the output of

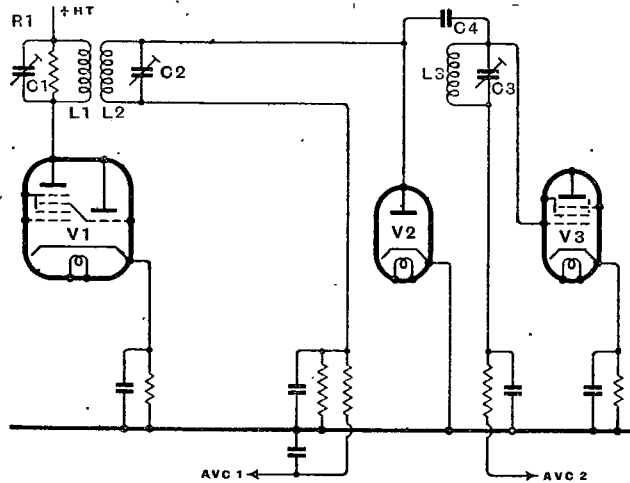

Fig. 4.—The method shown here can be used for any wavelength;  $L_1C_1$  and  $L_2C_2$  form a wide-band IF transformer. The IF valve is fed from  $L_3C_3$  which is coupled to  $L_2C_2$  by a small capacity  $C_4$ .

the frequency-changer. Among the components of the alternating anode current there is the oscillator frequency, which is by far the largest in amplitude. If the oscillator frequency is too near the signal frequency it will cause a considerable voltage to be developed across the IF transformer primary, and there will consequently be a large AVC bias voltage which bears no relation to the signal. This fact alone prevents the use of an aperiodic coupling between the frequency-changer and the AVC diode.

### For Normal Broadcast Bands

The signal voltage on the grid of the frequency-changer is not great enough to permit us to feed the diode from this point, but if reception were confined to the medium and long wavebands we could adopt a form of amplified AVC as shown in Fig. 3. Here an extra RF valve is used with its grid fed from the same point as the signal-grid of the triode-hexode, and its anode circuit coupled by an aperiodic circuit to the AVC diode. Provided that care be taken to avoid pick-up of the oscillator voltage on the grid of this extra RF stage, quite good results should be obtained. The circuit is more complex than one would like, however, and is unlikely to be of any use on short waves.

For good results on short waves it is essential to make use of the IF signal, unless an extra *tuned* RF stage is adopted, which is a complication that we need not consider. Now we have seen that we want no appreciable selectivity in the coupling to the AVC diode from the point of view of the desired operation of the circuit, and yet we want sufficient selectivity to prevent the

diode from being operated by the oscillator voltage. We require, therefore, a coupling of rather special characteristics.

In most cases an intermediate frequency of the order of 465 kc/s is used, so that the oscillator is always higher than the signal frequency by this amount. On short waves the oscillator frequency will be so much higher than the intermediate frequency that no trouble is likely to be experienced. It is on medium and long waves that we are most likely to find difficulty.

The medium waveband is some 500-1,500 kc/s, so that the oscillator tunes over the range 965-1,965 kc/s. The long waveband is some 150-300 kc/s, with the oscillator covering 615-765 kc/s. Clearly, any trouble from the oscillator will get worse as the wavelength increases. Our coupling must be designed so that it will not pass frequencies higher than 615 kc/s at any appreciable intensity.

On the other hand, we want the coupling to have as flat a response as possible so that the selectivity preceding the AVC diode does not differ appreciably from that of the signal-frequency circuits. In most cases it will probably suffice if this result is obtained over a range of  $\pm 25$  kc/s about the frequency of the wanted signal. Outside this range signal circuits will in most cases have sufficient selectivity to prevent excessive voltages from being developed. We can say, therefore, that the desired results are likely to be achieved if the coupling from the frequency-changer to the AVC diode has a band-width of 50 kc/s and gives negligible coupling at a frequency of 615 kc/s—that is, it must pass from 440 kc/s to 490 kc/s and cut-off outside that band.

The coupling between the frequency-changer and the

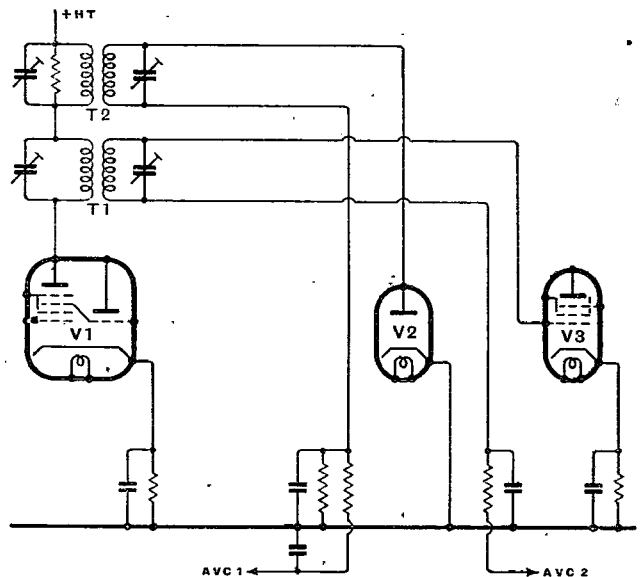

Fig. 5.—This diagram illustrates an alternative and rather better arrangement than that of Fig. 4.  $T_1$  and  $T_2$  are respectively narrow- and wide-band IF transformers.

first IF valve, however, must not pass such a wide band as this, or there will be a real danger of this latter

## AVC Developments—

valve becoming overloaded by a strong signal off-tune. Unless this coupling is reasonably selective we shall have done little more than transfer the overloading from one stage to the next.

Incidentally, we need not be too fussy about preventing the oscillator from developing a voltage on the anode of the frequency-changer on the long waveband, because signals on this band are normally a good deal stronger than on the others. The loss of sensitivity through any *small* AVC bias developed from the oscillator will consequently not be very important.

One form of coupling which might be adopted is shown in Fig. 4. Here  $V_1$  is the frequency-changer and  $V_2$  the AVC diode. They are coupled by an IF transformer comprising  $L_1C_1$  and  $L_2C_2$ ;  $L_1$  and  $L_2$  are very tightly coupled to give a wide band-width, and the circuits are damped to prevent a double-humped response from being received. The primary is damped by the shunt resistance  $R_1$ , and the secondary, by the diode; if the latter is not enough a resistance can be joined across  $L_2$ . The values needed must be found by experiment in most cases, although they can be calculated if the characteristics of the coils are known.

The IF valve  $V_3$  has a fairly sharply tuned circuit  $L_3C_3$  coupled to the secondary of the transformer by a small capacity  $C_4$ . The coupling should be below the optimum value giving maximum signal strength, otherwise the presence of  $L_3C_3$  will cause a serious trough in the response of the coupling between  $V_1$  and  $V_2$ .

All this means that there will be an appreciable drop in gain through adopting this system if normal IF coils are used. This is because of the band-width necessary in the  $V_1$ - $V_2$  coupling. The drop in gain can be overcome to some extent by using smaller trimming capacities and increasing the inductance of the coils. In the case of the first circuit, however,  $C_1$  should not be below some .50  $\mu\mu\text{F}$  if satisfactory operation of the frequency-changer is to be secured on short waves.

An alternative, and probably better, arrangement is shown in Fig. 5. Here two IF transformers with their primaries in series are connected in the anode circuit of the frequency-changer, which should be of a type having a high AC resistance and low output capacity if interaction between the trimmers is to be kept small. The transformer  $T_1$  is of conventional type and provides the coupling between the frequency-changer  $V_1$  and the IF valve  $V_3$ . The transformer  $V_2$  must be designed for a wide band-width, and couples the frequency-changer to the AVC diode  $V_2$ . This method of coupling is likely to give better gain than the system of Fig. 4.

## Chassis Assembly

### A NEW METHOD OF FASTENING FOR THE MANUFACTURER

IN the mechanical assembly of wireless receiver chassis there are many points where permanent methods of attachment such as riveting or spot welding cannot be applied. Tuning mechanisms and dials, for instance, have often to be removed to obtain access to components for

servicing or for replacing scales when new wavelength plans are put into operation.

The use of screws with conventional hexagon nuts or tapped holes in the metal itself add considerably to production costs, while if the tuning mechanism is of the mechanical push-button type, some additional method of locking to prevent loosening under vibration will have to be employed. Sealing with an adhesive paint is simple for the manufacturer, but a nightmare for the serviceman.

Most of these difficulties disappear if a self-locking nut is employed such as the Speed Nut made by Simmonds Aeroaccessories, Ltd., Great West Road, Brentford, Middlesex. This is a sheet-metal pressing which adjusts itself instantly to the thread of the screw and will engage easily when the fitting has to be made in cramped positions. The fact that a spring tension is automatically applied when the screw is tightened, also ensures that it will not work loose.

The device has wide possibilities for application in ordinary domestic wireless sets with a view to reducing costs, as well as in car radio and aircraft installations where vibration presents difficult problems.

## Henry Farrad's Solution

(See Page 43)

TONY has forgotten that the rectifier has, after all, a purpose in DC operation as well as in AC; namely, to protect the electrolytic condenser. All may be well, until the receiver is unplugged and reconnected. If it is reconnected the same way, all is still well. If it happens to be reversed, then the electrolytic condenser is connected to the mains in the wrong polarity, and it won't stand that very long. If the rectifier intervenes, HT current is cut off and the set merely refuses to work until the plug is reversed.

## Morse Code System

IN view of the present importance of Morse to many who have joined or are thinking of joining the wireless branches of one or other of the Services, special interest attaches to the Candler System of code instruction, which aims at developing speed and accuracy with a minimum of drudgery. The various courses of instruction offered by the Candler System Company are described in a booklet obtainable from the British Office of the Company, 121, Kingsway, London, W.C.2.

### BOOKS ON WIRELESS

Issued in conjunction with "The Wireless World."

- "FOUNDATIONS OF WIRELESS," by A. L. M. Sowerby. Second Edition. Price 4/6 net. By post, 4/11
- "RADIO LABORATORY HANDBOOK," by M. G. Scroggie. Price 8/6 net. By post, 9/-
- "WIRELESS SERVICING MANUAL," by W. T. Cocking. Fourth Edition. Price 5/- net. By post, 5/5
- "HANDBOOK OF TECHNICAL INSTRUCTION FOR WIRELESS TELEGRAPHISTS," by H. M. Dowsett. Sixth Edition. Price 21/- net. By post, 21/9
- "WIRELESS DIRECTION FINDING," by R. Keen. Third Edition. Price 25/- net. By post, 25/9
- "RADIO DATA CHARTS," by R. T. Beatty. Second Edition. Price 4/6 net. By post, 4/10
- "ELEMENTARY PRINCIPLES OF WIRELESS TELEGRAPHY AND TELEPHONY," by R. D. Bangay. Revised by O. F. Brown. Third Edition. Price 7/6 net. By post, 8/-
- "THE WIRELESS WORLD," DIARY FOR 1940. Price 1/6 net. By post, 1/7
- "LEARNING MORSE." Price 6d. net. By post, 7d.

Obtainable by post (remittance with order) from ILIFFE & SONS, LTD., Dorset House, Stamford Street, London, S.E.1, or from Leading Booksellers and Railway Bookstalls.

# G.E.C. Model 4010

AC SUPERHETERODYNE (EIGHT VALVES + RECTIFIER AND TUNING INDICATOR), FIVE WAVE RANGES, TWIN LOUD SPEAKERS, AND AN OUTPUT OF 12 WATTS. PRICE 29 GUINEAS

**T**HE fact that this receiver was designed primarily for the overseas market will ensure for it a favourable hearing from those in search of good short-wave performance, since for many years no set has had a chance of selling in the Dominions and Colonies unless it could compete in this respect with the best the world can offer.

It will also appeal strongly to the quality enthusiast, for the audio-frequency specification is one of the most comprehensive to be found in commercially produced table model receivers at the present time.

Push-button tuning has been omitted, but a slow-motion dial of

cedes the triode-hexode frequency changer. This is followed by two stages of IF amplification in which the variation of the initial cathode bias constitutes the sensitivity control of the receiver. Separate diodes are used for signal rectification and AVC bias. The latter is applied, together with a small delay voltage, to each of the first four stages. In the second IF stage the bias is reduced to maintain signal-handling capacity.

The AF amplification is generous and comprises two triode stages preceding a push-pull tetrode output stage. In the resistance coupling between the first and second stages a potentiometer is arranged to control bass by varying the effective coupling capacity. Separate control of

stage is brought about by a parallelfed auto-transformer following the DL63 second AF stage. The diodes in this valve are not used and are short-circuited to the cathode.

Twin loud speakers, with their speech coils connected in parallel, are employed to convert the 12 watts undistorted output into acoustic energy. A jack switch enables an external loud speaker to be used with or without the internal units.

The mains transformer, which is fitted with a shield for the primary, is tapped for mains voltages between 100 and 250 volts. Smoothing for the rectified HT current is carried out by chokes in both the positive and the negative leads.

**Performance.**—The out-

Complete circuit diagram of the G.E.C. Model 4010. Separate controls are provided for sensitivity and AF volume as well as for bass and treble tone control. AVC is applied to the first four stages in the receiver.

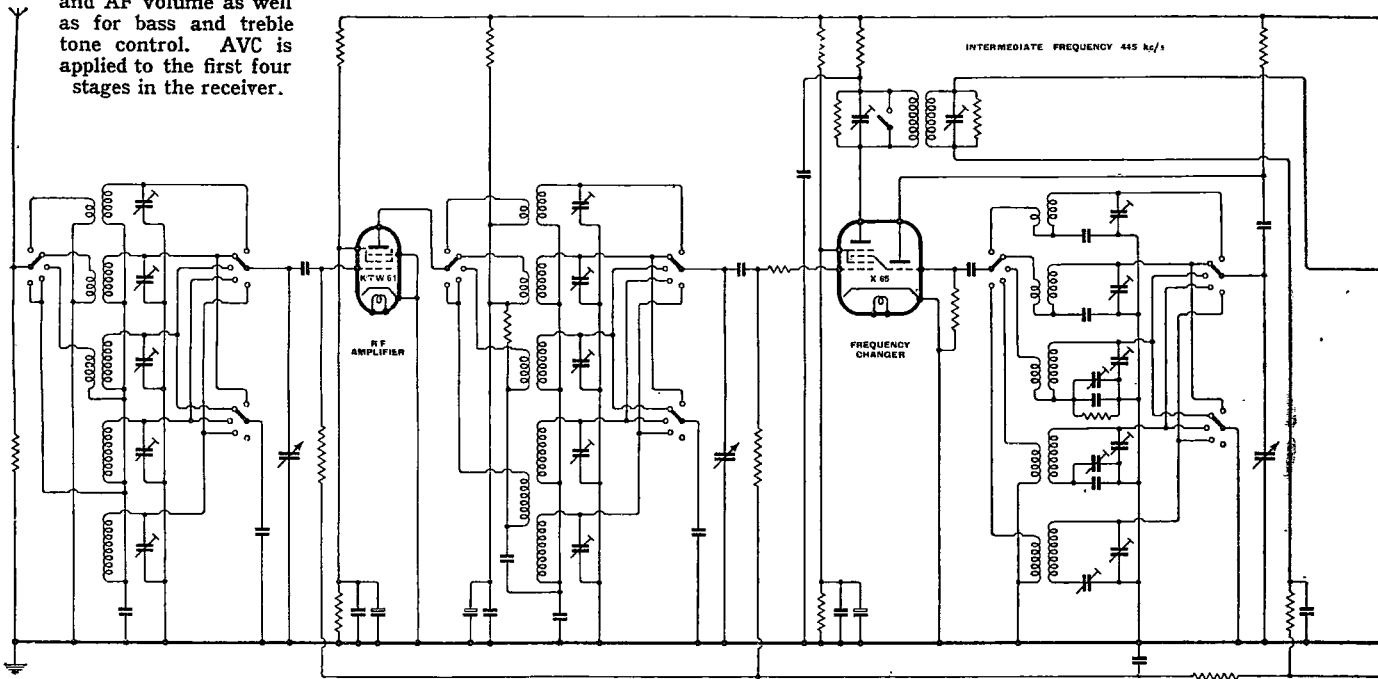

efficient design greatly increases the ease of tuning on short waves.

**Circuit.**—An RF amplifier, tuned on all five wave ranges pre-

the treble response is effected by a variable resistance-capacity shunt across the grid leak.

Phase reversal for the output

standing impression left after testing this set is one of unlimited power. There are two factors contributing to this, one is the exceptional

volume available from the twin loud speakers and the other is the unusually high overall magnification and the ability to make the most of the weakest distant stations.

These qualities are at once apparent when the set is first switched on. What is not quite so obvious is the extraordinarily effective AVC system. This does its work so efficiently that were it not for the cathode-ray tuning indicator the listener would be quite unaware of the severity of fading behind the rock-steady programmes from many of the short-wave stations.

Frequency drift in the oscillator circuits is negligible and the set is very stable from the point of view of microphonic feed-back. There is, therefore, no restriction on the use of the full power of the set other than considerations of volume in relation to the size of the room in which the set is used.

There are three ways of reducing volume—by the sensitivity control, by the AF volume control or by a combination of both. A little thought and experiment will indicate

initiative. The same might be said of the separate tone controls.

The tuning scales are calibrated in metres with frequencies indicated in parentheses. Since the set is designed for use in any part of the world, station names are only found on the short waves of world-wide range. On the

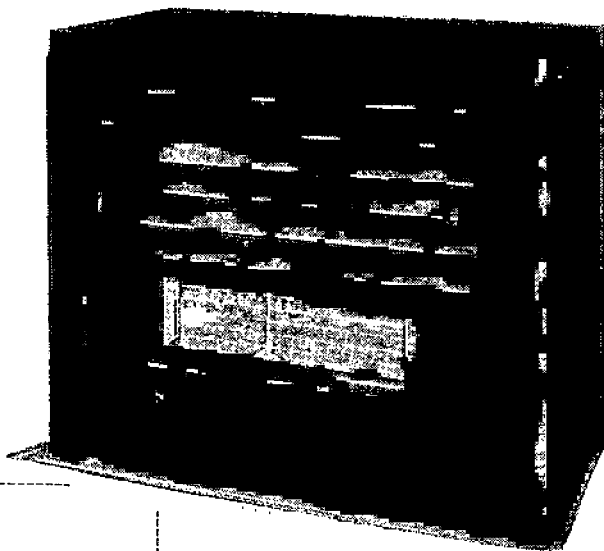

### WAVERANGES

(1)	11-25	metres
(2)	25-75	"
(3)	75-200	"
(4)	200-550	"
(5)	900-2,100	"

In this he is helped considerably by an ingenious device described as the "Rotavernier." At the base of the main tuning pointer is a small circular dial, calibrated with even divisions, which travels with the pointer and at the same time is rotated through a high gear ratio to

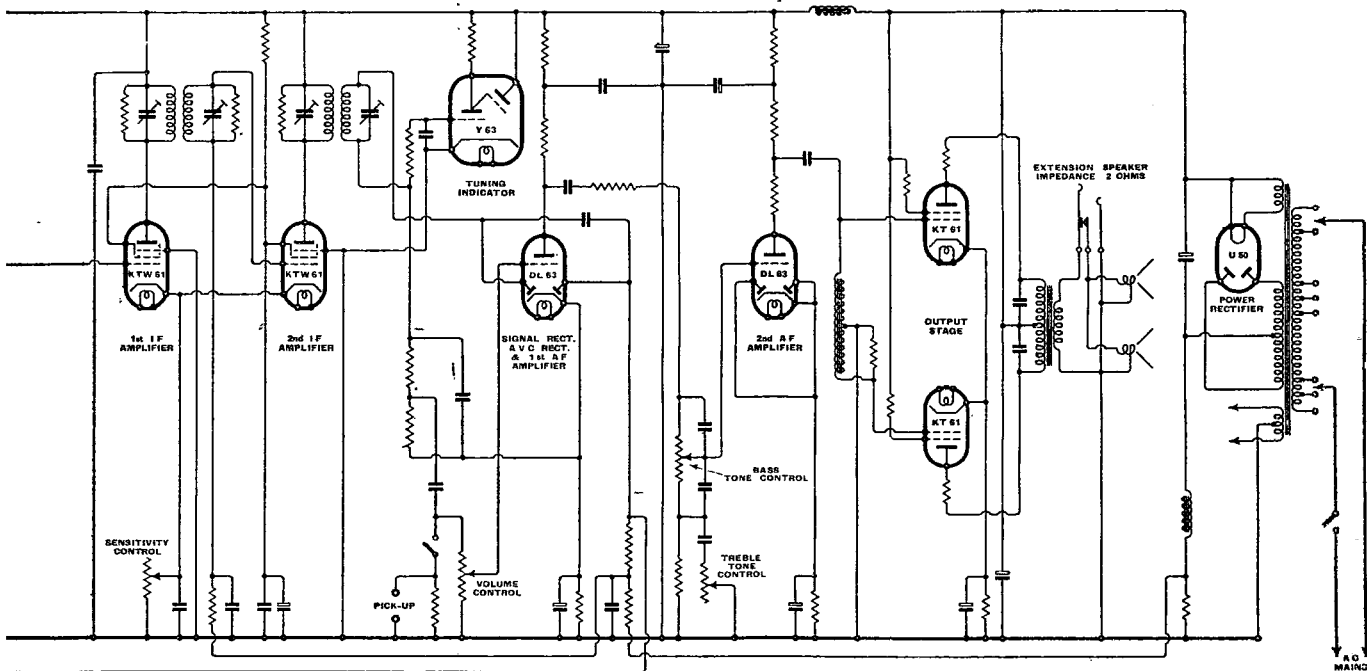

the best procedure in any given circumstances, and it is clear that the designers have given the listener credit for some intelligence and

medium- and long-wave ranges, which are of comparatively local interest, the reader must work out his own station calibrations.

give accurate readings. A station channel on 13 metres is equivalent to about two divisions on the subsidiary dial.



## G.E.C. Model 4010—

Sensitivity is very uniform throughout the range of the set, and the overlapping of the three short-wave bands. There is no serious second-channel interference—a few tunable whistles on short waves but no double tuning points.

Selectivity is good and only one channel would be lost on either side of a strong local station, yet the quality does not appear to suffer from any restriction of audio-frequency response. No doubt the necessary connection has been effected in the tone compensating stage.

### Constructional Details.—

The chassis design and layout is simple and straightforward, with no complicated mechanical tuning devices to get out of order. The firm's experience in catering for the export market is seen in the judicious use of Keramot and other insulators suitable for use under wide extremes of climate. Instead of the conventional silk covering for the loud-speaker fret there are overlapping louvres which effectively deflect dust without impeding the sound output.

The provision with each receiver of a waterproofed card giving a full circuit diagram and the electrical characteristics of every component is particularly commended.

**Summary.**—This is an imposing-looking set (it measures 24 by

FOR ULTRA HIGH FREQUENCIES

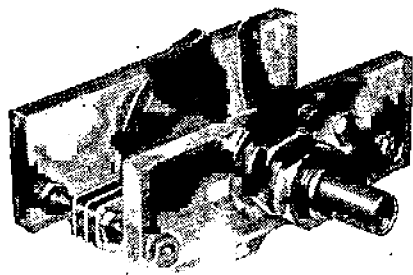

One of the new Type VCR variable condensers produced by Denco, Warwick Road, Clacton, Essex, for experimental work at ultra high frequencies. The end plates are of polystyrene dielectric material and the assembly is unusually rigid. The connection to the moving vanes is designed to minimise contact noises and the vanes are shaped to give a close approximation to a straight line frequency law. Maximum capacities range from 10 to 100 micro-mfd. and prices from 3/6 to 5/6.

19½ by 12 inches), the performance of which is in every way in keeping with its appearance. It is a set which might be singled out as a quality receiver for the local station or, alternatively, as a short-wave "special." The price is above the average for a table model, but the connoisseur will appreciate that it is primarily performance which he is buying.

**Makers.**—The General Electric Co., Ltd., Magnet House, Kingsway, London, W.C.2.

## Interference Suppression

New Belling-Lee Publication

NOW in its ninth edition, "The Suppression of Electrical Interference with Radio Reception" has been entirely rewritten. In accordance with modern conceptions of the nature of interference, distinction is drawn between the free radiated field of interference and the field of direct induction extending from the source to a distance of about half a wavelength.

Among the subjects dealt with in this comprehensive and practical manual are the nature and production of interference, the design of suppression filters, and suppression at the receiving end, including the use of screened aerial systems. The greater part of the book, however, deals with suppression at the source and all the more prolific trouble-makers, not excluding motor ignition systems and trolley buses, are discussed. The subjects are treated in such a way as to interest all those who are concerned with interference, whether professionally or merely as intelligent and therefore not entirely passive sufferers. The book, published by Belling and Lee, Ltd., Cambridge Arterial Road, Enfield, Middlesex, costs 3s. 6d.

## Varley Dry Accumulator

Type V-20

THIS new cell, which was introduced this year at Radiolympia, combines the good electrical characteristics of the free-acid lead accumulator with the cleanliness of a dry cell.

The electrolyte is absorbed in the porous electrodes which completely fill the cell. The negative pole is formed by a lead cylinder which is thickly coated inside with spongy lead. Next comes a porous insulating coating, and the positive element consists of lead peroxide tightly packed round a central lead cage.

One advantage of this form of con-

struction is that it gives a low internal resistance, and our measurements showed this to be less than 0.3 ohm. Another important point is that there

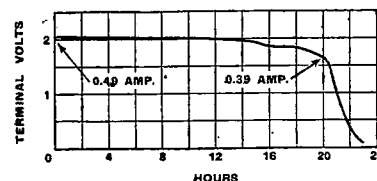

Discharge curve of the Varley V-20 dry accumulator through an external resistance of 4 ohms.

are no plates to buckle or disintegrate.

On the assumption that the cell will be used to supply a battery set with three or four valves, it was discharged through a fixed external resistance of 4 ohms at approximately half an amp.

At this rate the actual capacity is, for all practical purposes, 10 ampere-hours. The discharge curve shows no sudden initial drop of voltage and is remarkably level right up to the cut-off point.

The manufacturers are Varley Dry Accumulators, Ltd., By-pass Road, Barking, Essex, and the current price is 10s. 5d. Larger capacities are also in course of production.

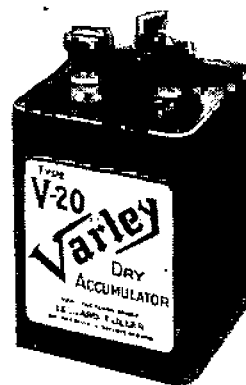

## For the New Year

The Wireless World Diary, 1940

A comprehensive list of short-wave stations is merely one of the valuable features of the new edition of *The Wireless World Diary*, now on sale. A considerable amount of new matter has been introduced into the data section, and some of the familiar features appear in revised form. Base connections of British valves and also of many American and Continental types are given. The circuit diagram section, always a much appreciated feature, has been considerably revised.

The new Diary, compiled by the staff of *The Wireless World*, is issued by our publishers, Iliffe and Sons Ltd., Dorset House, Stamford Street, London, S.E.1, at 1s. 6d., or by post 1s. 7d.

# Letters to the Editor

THE EDITOR DOES NOT NECESSARILY ENDORSE THE OPINIONS OF HIS CORRESPONDENTS

## Sets for Active Service

I WONDER if somebody can help a few of us out here to decide upon the best type of set to obtain for use in our rather specialised circumstances. We have for the past few weeks been at one of our bases "Somewhere in France," and our primary desire is to pick up programmes from the Homeland during the present period of enforced inactivity. We cannot quite make up our minds whether to rely on the ordinary medium-wave transmissions of the B.B.C. home service or whether to concentrate on the Empire SW transmissions. Probably a SW receiver would be the better proposition as it would enable us to have a shot at picking up long-distance transmissions. The set must be as light and portable as possible, as we are liable to be moved about at very short notice.

Incidentally, it may interest you to know that *The Wireless World* in its monthly form is quite well represented out here, and has been the means of my making the acquaintance of several other wireless enthusiasts.

On Service in France.

H. WEST.

## The New "Wireless World"

AS one who has been closely associated with the advertising side of *The Wireless World* from the days when it was produced bi-monthly, I have of course been seriously interested in its editorial value as related to the value it offered those whose advertisements I have had the pleasure of inserting.

Year after year the standard of editorial has been a high one, and now that war conditions have made it necessary to publish monthly, I am convinced that even under the present adverse trading conditions your publication has reached a greater advertising value than ever.

Congratulations to all who were responsible for producing one of the most interesting issues offered the public during the 28 years it has been in existence.

London, W.C.2.

H. FREEMAN,

Managing Director, Parr's Advertising, Ltd.

AS a member of a race which has the reputation of being "careful" in money matters, I should like to pay a tribute to the good value for money which we are receiving now that *The Wireless World* is published once a month. At first sight a whole shilling seems rather staggering, but we Scotsmen have not earned our reputation for financial discrimination for nothing, and we realise that it now costs us only threepence per week instead of sixpence to keep up to the minute in wireless matters.

"MAC."

## High-Frequency Medical Apparatus

THE notes of your contributor, "Ethacomber," concerning interference from short-wave diathermy must interest many of your readers. The proved success of this form of treatment will probably lead to a considerable increase in the demand for these instruments in

the days before us. Their servicing is already falling to the lot of the radio man.

As "Ethacomber" says, there is ample room for improvement in the design and control of the apparatus, and more light on the subject may lead to a definite waveband being allotted for short-wave diathermy.

Harpenden.

J. W. PELLANT,

W. Pellant and Sons, Ltd.

## Wireless Thrills

MAY I record an early wireless thrill? The set lived in the barn. The antenna was a six-wire flat-top about 200 feet long. This delicate little contraption was backed by an enormous tuning coil with knobs on. A pair of dubious headphones and a lump of authentic galena completed the picture.

A small boy—aged 14—sometimes heard weary signals from the mighty transmitter at Filene's, Boston (Mass.)—about twelve miles away.

One afternoon in (as I remember) November, 1916, a very frightened youngster definitely heard voices instead of Filene's scratchy spark. In order to preserve some reputation for veracity the kid kept quiet about it.

Years later I came across a description of early experiments carried out by the U.S. Navy at Boston Navy Yard. They modulated an arc transmitter by inserting a large number of carbon microphones in shunt between antenna inductance and earth. The microphones lasted about five minutes.

On Service

ex-W2ZZAT.

"Somewhere in England."

## Receiving U.S. High-Fidelity Broadcasts

NOW that more interest centres on short-wave reception, I should like you to know what kind of results I obtain.

It is now 13.45 BST, and I am listening to W8XNU relaying WSAI of the Crosley Corporation in Cincinnati at perfect entertainment level on the 26-Mc/s band. I use a ten-valve Philips 362A which is built internally like a communications receiver and takes me down to 5 metres. There are 4 or 5 American high-fidelity transmitters in the 11-metre band who use 80 to 100 watts only. Previously they have been heard from about 5-8 p.m., but not good enough to entertain. But now W8XNU seems to have come across much earlier and much stronger.

American police radios are sometimes picked up on 31 or 32 Mc/s.

I have under the roof a horizontal dipole cut to 26 Mc/s with a twisted downlead but no matching transformer. I should imagine that a horizontal dipole with a reflector and matching arrangements would produce even more interesting results.

I should like to hear from other readers regarding these high-frequency transmissions and how they set about receiving them.

J. A. YEARSLEY.

Southampton.

# Current Topics

RECENT EVENTS IN THE WORLD OF WIRELESS

## B.B.C. CHANGES

### A Former Governor's Criticism

IN a letter to *The Times* Mr. H. A. L. Fisher, one of the five Governors of the B.B.C., whose appointment was terminated with the change in the Corporation's Board, states that the announcement by Sir Samuel Hoare, which was recorded in our last month's issue, "lacks something in perspicuity."

"The truth is," says Mr. Fisher, "that, without any consultation with the Board of Governors, an Order in Council was prepared last year eliminating the Governors altogether in the event of war. It was only as a result of an energetic protest from the Governors, made when they were apprised of this arrangement . . . that the present arrangement was arrived at between the Board of Governors, on the one hand, and the Ministry of Information on the other."

"The present scheme is one which the Governors willingly accept as a temporary wartime measure, though it would not have occurred to them to suggest it, having regard to the general interests of the listening public."

## THE I.E.E.

MR. JOHNSTONE WRIGHT'S inaugural address as President of the Institution of Electrical Engineers for the 1939-40 session, which in normal circumstances would have been delivered at the opening meeting on October 26th, has been circularised to all members of the Institution. In his address Mr. Wright refers to the retirement of Mr. P. F. Rowell, the secretary, who has served the Institution for the past thirty-eight years. Mr. Wright says: "To most members Mr. Rowell and the Institution have become synonymous, and his unique and splendid contribution to its development will be of permanent value." The new secretary is Mr. W. K. Brasher.

"The History of the Institution of Electrical Engineers" is the title of a book just published by the Institution. It relates chiefly to the sixty years from 1871, when the Society of Telegraph Engineers was founded, to 1931, which marked the centenary of the discovery by Michael Faraday of the evolution of electricity from magnetism. The volume is available to the public, price 18s. 6d.

## TELEVISION SETS

### Advice to Owners

OWNERS of H.M.V. and Marconi-phone television sets have received through their dealers letters from the respective manufacturers, giving hints on the maintenance of the sets during the absence of television transmissions. No part of the set is likely to suffer appreciable damage in standing unused for some months, state the companies, but the tube will benefit from an occasional short warming. It is suggested that the set should be switched on and the brightness control turned up to normal level for about a quarter of an hour, once a fortnight. If this procedure is not possible, the set should be kept in a dry living-room, and when it is again brought into use the dealer should be advised, so that a qualified engineer is present when it is switched on. In this way any fault will be detected before serious damage can occur.

The companies have advised purchasers that the guarantee on receivers incorporating television only will be suspended as from September 1st, and that the unexpired portion of the twelve months' period will be effective at the resumption of the television service. Where televisions incorporate ordinary sound broadcast receivers, the guarantee on this portion of the set will continue, whilst that on the television equipment is suspended.

## THE CITY OF FLINT

ONE of the radio operators aboard the American steamship *City of Flint* during her adventurous voyage was a Britisher, Mr. J. G. McConochie, who joined the ship on September 1st, two days before war broke out. He is now in Scotland, having left the ship on its arrival in Tromsø with the German prize crew from the *Deutschland* aboard. Shortly after his arrival in England he broadcast his story of the ship's adventures to the U.S.A. over the N.B.C. network.

This typical American cargo steamer, built in 1918, is equipped with an R.C.A. 500-watt valve transmitter, which has a daylight range of 700 miles. It is, perhaps, interesting to note that she still carries her original 1½-kW QG transmitter, which, says the operator, would be a useful stand-by in the event of the main transmitter breaking down.

## SCANDINAVIAN WIRELESS

### Some Effects of the War

THE urgency of establishing contact with merchantmen not equipped with wireless led to an interesting Danish arrangement. Merchant vessels were ordered to carry ordinary broadcast receivers or to alter the existing installations so that broadcasting stations could be received, and the masters and radio officers were ordered to listen to the broadcast news bulletins. This means of communication is used to inform ships of minefield and drift-mine dangers, to give navigational restrictions, and also to send owners' private instructions to masters of vessels.

Incidentally, the Latvian Government has ordered all its ships used for foreign trading to be equipped with broadcast receivers not smaller than four-valve superhets capable of covering all frequencies between 150 and 4,000 kc/s.

Soon after the outbreak of war Norway put a ban on amateur activities. This example was soon followed by Finland and Sweden. The ban on Danish amateur activities was not introduced until October 1st.

## OPERATOR'S GALLANTRY

THE gallantry of the wireless operator of the steamship *Manaar*, which was sunk by an enemy submarine off the coast of Portugal on September 6th, was recalled by the announcement that Mr. J. G. M. Turner, of Banstead, Surrey, had been awarded the O.B.E. and the gold medal and certificate of the Liverpool Shipwreck and Humane Society. The story is that when Mr. Turner, unaware that the crew had been ordered to abandon the ship, came on deck to report that he could no longer transmit on power as he had been doing during the attack, he found that the crew had taken to the boats.

Whilst endeavouring to lower a boat for himself and two wounded Lascars, a heavy explosion on the opposite side of the vessel knocked him senseless, killed one of the Lascars and destroyed the lifeboat. On coming to, he went down the pilot ladder and swam to an empty boat, which was half submerged, and brought it alongside. He ascended the ladder, carried down the wounded Lascar and got him into the boat from which they were rescued.

# Wireless World

## BROADCAST TECHNICAL INSTRUCTION

A NEW series of weekly lectures in the Modern Radio Course, broadcast from WRUL, the short-wave station of the World Wide Broadcasting Foundation, began on Tuesday, November 14th. This series, which is given by Dr. C. Davis Belcher, will deal with the fundamentals of electrical engineering and radio circuits.

To ensure that the lectures can be received at suitable times and on satisfactory wavelengths in different parts of the world, recordings are re-broadcast on two different days. The initial broadcast is radiated on 11.73 and 15.13 Mc/s on Tuesdays at 3.0 a.m., G.M.T. The recordings are broadcast on 11.79 Mc/s at 9 p.m. on Fridays and again at midnight on Mondays on 6.04 Mc/s.

## CULLERCOATS

"RADIO fame has come to the little fishing community of Cullercoats." Thus a writer in *The Newcastle Evening Chronicle* sums up the recently broadcast recorded programme of life in this fishing village. To those, however, whose wireless memories go back beyond the days of "broadcasting," the village of Cullercoats achieved "radio fame" many years ago. It will be remembered that it was in this little village over thirty years ago that the Poulsen Company built and operated a transmitter which was taken over by the Post Office in 1912.

## ROYAL INSTITUTION LECTURES

TO meet the needs of students and others wishing to qualify themselves for future service in radio branches of the Defence Forces, the Royal Institution arranged a course of twelve lectures on modern wireless communication, which commenced on October 31st. Professor C. L. Fortescue gave four lectures on modern radio apparatus and installations, and Dr. R. L. Smith-Rose was scheduled to give four lectures on the transmission of radio waves over the ground and direction finding, the last two of which will be given on November 21st and 23rd.

The last four lectures of the series will be given by Dr. E. V. Appleton on the transmission of radio waves through the atmosphere, on December 6th, 8th, 13th and 15th. All lectures begin at 5.15 p.m.

Tickets, for which no charge is made, may be obtained from the general secretary, Royal Institution, 21, Albemarle Street, London, W.1.

## OVER 41,000 MORE LICENCES

AN increase of 41,323 in the number of licences issued during September was announced by the Post Office. The approximate total number in force at the end of the third quarter of the year was 9,085,050, as compared with 8,757,480 at the same time last year, an increase of 327,570 during the year.

It is surprising that the special circumstances which prevailed in September did not create a greater increase for the month, which was nearly 27,000 fewer than the increase during September last year.

The increase for the first nine months of the year was 176,150, as compared with 278,450 for the same period last year.

## COMMERCIAL BROADCASTING

FROM "Somewhere in France" the International Broadcasting Company has resumed commercial broadcasts in English. Radio-Normandie, although still working, has not been used for commercial programmes since the outbreak of the war.

The present station, which has not previously broadcast commercial programmes, is operating daily from 6 a.m. to 7 p.m. G.M.T. on 212.5 metres (1,412 kc/s).

Radio Saigon, a 12-kW short-wave station in French-Indo China, is introducing the transmission of commercial programmes in English for three-quarters of an hour a day, from 5 p.m. G.M.T. The wavelengths used are 25.46 and 49.05 metres. Programmes will be recorded in England and shipped by the regular mail service between Marseilles and Saigon.

## FROM ALL QUARTERS

### Receivers for R.A.F. Men

In order to take advantage of a manufacturer's offer to provide 1,000 receivers at less than cost price for the use of units of the Royal Air Force in lonely parts at home and overseas, the R.A.F. Comforts Fund is appealing for £5,000. Donations, which will be acknowledged, should be sent to the Officer in Charge, R.A.F. Comforts, Berkeley Square House, Berkeley Square, London, W.1.

### Informal Discussion

QUALITY enthusiasts may be interested to learn that Mr. P. G. A. H. Voigt is holding an "at home" at 53, Church Road, Upper Norwood, London, S.E.19, on Saturday, November 25th, at 6 p.m., to discuss among other things some of the problems of gramophone reproduction. As the number of visitors must necessarily be limited, readers are invited to make a previous appointment by telephone (Sydenham 6666).

### "The Marconi Review"

It has been decided to suspend publication of *The Marconi Review*, the internal technical journal of Marconi's Wireless Telegraph Company and its associates, during the war.

### L.R.S.

THE London Radio Supply Co. has changed its emergency address from "Denwyn," Oxenden Wood Road, Chelsfield, Kent, to "Windem," Ardingly Road, Balcombe, Sussex.

### Former Polish Stations

In addition to the Polish stations annexed by Germany, and to which reference is made elsewhere in this issue, two former Polish transmitters are now in the hands of the U.S.S.R. They are the 50-kW transmitters at Baranowice



MONITORING news bulletins in many languages from all over the world is a task the B.B.C. is undertaking on behalf of the Ministry of Information. Using ordinary commercial receivers—some of those seen here will be easily recognised—the operators keep a continuous watch throughout the twenty-four hours. Some of the bulletins are recorded, and these, together with shorthand notes, are transcribed, and the resulting information sent to various Government Departments.

# Wireless World

## Current Topics—

and Lwów which work on 576 and 377.4 metres respectively. With the ceding by Russia of former Polish territory, the 50-kW 559.7-metre Wilno station now belongs to Lithuania.

## News from America

At 7.45 p.m. G.M.T. the international short-wave station of the Columbia Broadcasting System, WCBX, transmits on 19.65 metres (15.27 Mc/s) a recording of the previous evening's reports from the C.B.S. commentators in the various European capitals. This is apparently for the benefit of those European listeners who find the nightly "round-up" too late for them.

## R.I.G.S.

In view of the present circumstances, it has been decided to suspend all activities of the Radio Industry Golfing Society until further notice.

## Rumania

EXPERIMENTAL transmissions in the 31- and 49-metre bands are being continued by the new Rumanian short-wave station. The new 20-kW medium-wave station at Kisenew, which has been named Bessarabia, has been trans-

mitting for short periods each day for the past month or so on 1,410 kc/s (212.6 metres).

## Baird Television

A RECEIVER and manager of Baird Television was appointed in the Chancery Division of the High Court of Justice on November 3rd, on a motion by two plaintiffs in a debenture-holders' action against the Company. The ground for the appointment was "inability to carry on business."

## Ediswan's Belfast Office

WE have been asked by the Edison Swan Electric Company to announce that, following the resignation of Mr. A. Scott from the managership of the Ediswan Belfast office, Mr. C. W. W. Torrance has been appointed in his place.

## Recognising German Aircraft

OUR associated journal, *Flight*, has produced a revised recognition chart of Nazi aircraft, reference to the first edition of which was made last month. On strong cardboard, holed and corded for hanging, the cost of the chart is 8d., post free, from the Flight Publishing Co., Dorset House, Stamford Street, London, S.E.1.

## R.C.A. and Farnsworth

THE Radio Corporation of America and the Farnsworth Television and Radio Corporation announce that they have entered into patent licence agreements whereby each party has acquired the right to use the inventions of the other in the fields of television and in other fields of their respective businesses. Neither corporation has acquired the right to grant sub-licences to a third party under the patents of the other corporation.

## Indian Licences

A RECORD increase for the time of the year in the number of licences issued in India was shown when the figures for August were issued. The 6,511 licences issued during the month brought the total to 79,580, which shows an increase of 21,716 during the past year.

## Index and Binding Case

WITH the change to monthly publication, Volume XLV of *The Wireless World*, which commenced on July 6th, ended with the issue of September 28th, 1939. The Index for this volume is now available from the Publishers, Dorset House, Stamford Street, London, S.E.1, price 4d. post free, or with binding case, price 3s. 1d. post free.

## NEWS IN ENGLISH FROM ABROAD: Regular Short-Wave Transmissions

Country : Station	Mc/s	Metres	Daily Bulletins (G.M.T.)	Country : Station	Mc/s	Metres	Daily Bulletins (G.M.T.)
<b>America</b>				<b>Russia</b>			
WNBI (Bound Brook)..	17.78	16.87	2.0, 3.0 a.m., 5.0.	RNE (Moscow) ..	12.00	25.00	9.30, 10.30, 12 midnight.
WRCA (Bound Brook)..	9.67	31.02	3.0 a.m., 5.0.	RW96 .. ..	6.03	49.75	8.0, 10.30, 12 midnight.
WCBX (Wayne) ..	6.17	48.62	6.55 a.m.		9.52	31.51	8.0, 10.30.
	9.65	31.09	4.0 a.m.		15.18	19.76	8.0 a.m.
	11.83	25.36	1.55 a.m.†, 9.55†, 10.50, 11.30.	RKI .. ..	7.51	39.89	9.30, 10.30.
	15.27	19.65	6.30.		15.04	19.95	12.0 midnight.
	21.56	13.91	1.0, 2.0†, 4.0.	RAL .. ..	9.60	31.25	8.0, 9.30, 10.30, 12.0 mid-night.
WGEO (Schenectady)..	9.53	31.48	9.55.				
WGEA (Schenectady)..	15.33	19.57	5.0 a.m., 9.55, 10.15†	RWG .. ..	7.36	40.76	9.30†, 10.30†.
	21.50	13.95	2.0.	— .. ..	8.06	37.22	8.0.
WPIT (Pittsburg) ..	11.87	25.26	3.0 a.m., 11.45.	— .. ..	11.64	25.77	11.0 a.m.
	15.21	19.72	5.0, 6.0.	— .. ..	11.90	25.21	9.30, 10.30†.
	21.53	13.93	1.0, 2.0.	<b>Germany</b>			
WCAB (Philadelphia) ..	6.06	49.50	11.30 (11.45 Wed., Thurs. and Sat.).	DJA (Zeeseen) ..	9.56	31.38	1.30, 4.30, 6.0, 7.15, 8.10, 9.10, 10.20, 11.15.
	9.59	31.28	1.55, 4.0, 6.55 a.m., 11.30 (11.45 Sun., Tues. and Fri.).	DXB .. ..	9.61	31.22	7.15, 9.15.
	15.27	19.65	5.15, 7.0, 11.0.	DJB .. ..	15.20	19.74	9.30 a.m.
WRUL (Boston) ..	6.04	49.67	11.0.	OLR5A (Podébrady) ..	15.23	19.70	7.50.
	11.73	25.58	4.0 a.m., 8.0.	SP48 (Warsaw) ..	6.14	48.86	7.45.
	11.79	25.45	8.30.	<b>Yugoslavia</b>			
<b>Italy</b>				YUA (Belgrade) ..	6.10	49.18	5.40, 9.0.
I2RO3 (Rome) ..	9.63	31.15	12.30 a.m., 6.18.	YUC .. ..	9.50	31.56	5.40, 9.0
I2RO4 .. ..	11.81	25.40	12.30 a.m., 11.0 a.m., 4.0, 6.18, 10.0.	<b>Japan</b>			
I2RO6 .. ..	15.30	19.61	12.30 a.m., 9.40 a.m., 4.0.	JZJ (Tokio) ..	11.80	25.42	12.30, 8.5.
I2RO8 .. ..	17.82	16.83	11.0 a.m.	JZK .. ..	15.16	19.79	12.30, 8.5.
I2RO9 .. ..	9.67	31.02	11.16.	<b>China</b>			
IRF .. ..	9.835	30.52	12.30 a.m.	XGOY (Chungking) ..	11.90	25.21	10.0.
<b>France</b>				<b>Spain</b>			
TPB6 (Paris-Mondial) ..	15.13	19.83	8.15 a.m.	FET1 (Valladolid) ..	7.07	42.43	7.45.
TPB11 .. ..	7.28	41.21	7.0.	<b>Australia</b>			
TPA2 .. ..	15.243	19.68	11.0 a.m.	VLR (Melbourne) ..	9.58	31.32	8.45 a.m. (9.20 a.m. Sun.), 12.30 (12.15 Sun.).
TPA4 .. ..	11.718	25.60	3.0 a.m.	VLR3 .. ..	11.88	25.25	2.20 a.m., 8.30, 10.30.
TPA4 .. ..	11.885	25.24	3.0 a.m., 8.15 a.m., 7.0.	<b>Finland</b>			
<b>Ireland</b>				OFD (Lahti) .. ..	9.50	31.58	9.20.
Athlone .. ..	9.59	31.27	6.45, 10.0 (10.5 Sun.)		15.19	19.75	9.20.
	17.84	16.82	6.45, 10.0 (10.5 Sun.)				

All times are p.m. unless otherwise stated. \* Saturdays only. † Sundays only.

# Induction

## A ONE-TIME RIVAL TO RADIO BECOMES ITS ALLY

By G. A. V. SOWTER, B.Sc. (Eng.) Lond., A.M.I.E.E.

**A** FEW months ago on lifting the domestic telephone receiver the writer was astonished to hear a voice announce that a well-known compère was about to present one of his "Discoveries." Curiosity getting the better of discretion, the reason for telephoning was forgotten and at least a minute of interested listening took place before it was appreciated that here, unintentionally, was what might be a demonstration of the proposed National Broadcasting Service by telephone wires. It was quickly remembered that a radio set was operating at that time in the house and the telephone earpiece was raised and lowered from the ear a few times to confirm that the broadcast programme was actually being reproduced by this earpiece.

It was evident that some unusual phenomenon was occurring and, in order to solve the mystery, domestic aid was vociferously solicited by requesting that the radio be turned off for a moment. This proved definitely that the programme was emanating from the writer's own set, but the loud speaker in use was incapable of being heard in the vicinity of the telephone, and consequently there must have been some electrical association between the loud speaker distribution system and the telephone wires.

Thoughts of common earth connection, or no earth connection, immediately arose and led to an early examination, but everything appeared to be in order in that respect. The next step was to examine the wireless set, and it was evident that the telephone only "picked up" the radio programme when the extension speakers were in operation. A little thought soon gave the following satisfactory explanation of the action: When the house was built there had been installed in every room one or more loud speaker points connected by a four-wire cable, of which only one wire was being employed for this service. The cable had been laid ring fashion, which meant that there was a loop of wire round the upper storey and a similar loop downstairs, as in sketch,

Fig. 1a, carrying the output low frequency current from the radio set. This current was of good strength since it was supplied from the secondary winding of a suitable step-down transformer for the low impedance external speakers.

Obviously an alternating magnetic field was being created by these loops carrying current and, as indicated in Fig. 1b, the small transformer in the housing of the G.P.O. telephone instrument, T, was being thereby influenced. This transformer consists of a short core of magnetic material suitably wound, and because the magnetic

circuit is not closed is quite susceptible to external fields. Although enormous improvements have been made in magnetic materials of recent years, the basic pattern of this transformer is still retained because the design is particularly suited to the operating conditions. To verify the fact that this transformer is easily influenced by magnetic fields a length of wire, actually No. 22 SWG, was joined to the radio set and arranged to carry the loud speaker current. When a loop of this wire was bent to form a *single turn* round that portion of a telephone similar to the G.P.O. equipment containing the transformer, the broadcast programme could be heard at good strength, while with three or four turns the audio output was increased very considerably. At the same time an experiment

was conducted where one and more turns were placed near the telephone earpiece, and here again the programme could be easily reproduced. Lest a number of readers be tempted to carry out these experiments without using a separate telephone, it should be pointed out that the Post Office have some arrangement\* on their system whereby a delay switch operates after a short period of listening, and introduces a noise tone which nullifies

artistic appreciation of the broadcasting.

However, to return to the aforementioned domestic induction display, it is obvious that the alternating magnetic flux picked up by the core of the telephone trans-

*THE experiments described in this article show that there is a right and a wrong way of wiring a house for extension loud speakers, but it is also explained that the wrong way can serve a useful purpose by functioning as an inductive deaf-aid system.*

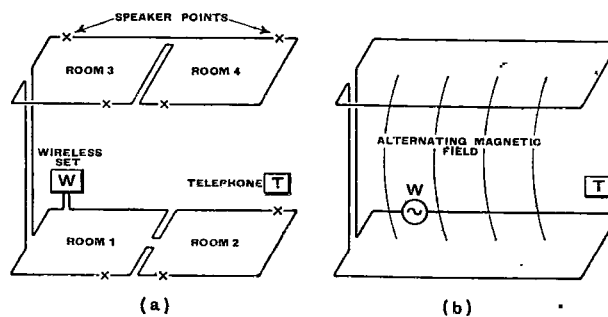

Fig. 1.—Layout of loud speaker extension wiring which by induction affected the telephone system is shown in (a), while in (b) is the equivalent circuit showing how the magnetic field is distributed.

## Induction—

former will generate voltages and currents and these will be converted into sound in the telephone earpiece. This effect, whilst of interest, was certainly not welcome for normal operation of the telephone, and was easily eliminated by utilising a pair of wires for external loud speaker distribution. As indicated in Fig. 2, this means that the magnetic field is annulled in a manner similar to that adopted for non-reactive windings in the construction of precision resistance boxes.

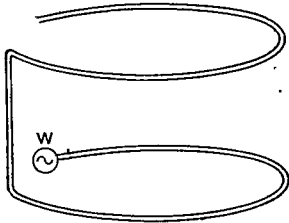

Fig. 2.—By using parallel or twisted twin wires no appreciable magnetic field is created.

Whilst the discovery of the magnetic field surrounding a conductor carrying current is due to Oersted, it was Faraday who first demonstrated the fact that when an intermittent current is passed through one coil of wire it will induce currents in a similar coil arranged as a closed circuit and which is suitably placed in the vicinity.

In 1882 Willoughby Smith, the well-known scientist, wrote a paper<sup>1</sup> on induction which in a modified form was read subsequently in 1883 before the Society of Telegraph Engineers and Electricians. (This society was the immediate forerunner of the present Institution of Electrical Engineers.) In this paper he refers to the work of Faraday, Henry, Felice and others, and describes some of his own experiments wherein he used two flat helices about 12in. in diameter arranged as in Fig. 3. When the current in coil P is interrupted, the telephone reproduces loudly a note corresponding in frequency with that of the tuning fork. He mentioned that this note was audible up to distances of 50 feet, and he employed as a volume control a plug type resistance-box R. In the following words he states . . . "I discovered an important fact, that the telephone was affected even when entirely disconnected from the circuit and several feet from the inducing spiral." This led him to construct a much larger flat helix—similar to the so-called "pancake coil," but 36in. in diameter, supported between two square sheets of cardboard fixed in a wooden frame as shown in Fig. 4. The winding consisted of 800 turns of 0.018in. diameter copper wire, silk covered, i.e., No.

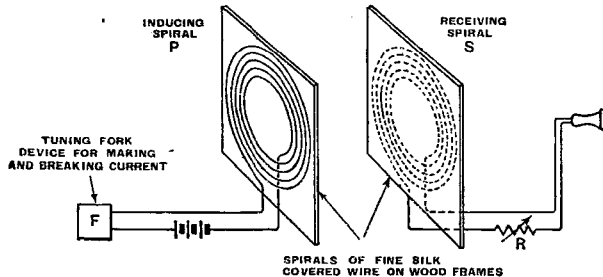

Fig. 3.—Circuit and layout of the apparatus used for the early induction experiments described in the text.

26 SWG, the length being 1,220 yards and the resistance 122 ohms (actually the ohm which existed in 1882). The amazing fact concerning this coil, to the writer's mind, lies in this extract from that ancient paper . . . "If such a spiral be placed in the centre of a large room, sounds such as speech or music affecting the transmitter can be distinctly heard in every part of the room by any person placing a disconnected telephone to his ear, provided, of course, that his hearing is not seriously defective, and that the telephone is held in a favourable position with regard to the inductive lines of force."

From the paper it would seem that the "transmitter" might refer to the tuning fork interruptor, which obviously was not seriously affected by sound. On the other hand, the striking fact exists that, without realising it, Willoughby Smith had invented the equivalent of our modern moving coil microphone. In his case he had used a coil 36in. in diameter and taken advantage of an appreciable amount of the earth's magnetic field as his source of unidirectional flux. To make this clear, assume that sound of some kind impinges on one portion of the cardboard diaphragm supporting the 36in. coil. This will cause some of the turns to move and cut the earth's flux, thereby causing currents to circulate in the coil which is closed through the transmitter. These varying currents will set up corresponding alternating flux variations which will affect the telephone as described. It is interesting to note that the coil resistance is not incomparable with that of a practical moving coil

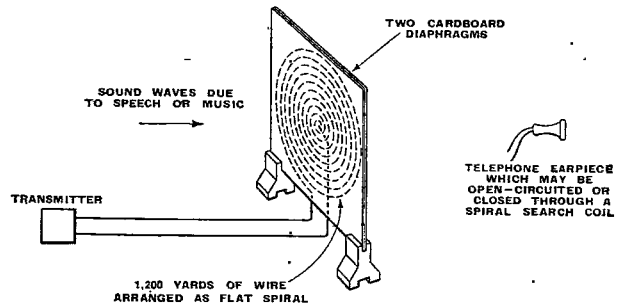

Fig. 4.—Large spiral of wire employed by Willoughby Smith in 1882 and which might be regarded as the first moving-coil microphone.

microphone, although, of course, the diaphragm is at least outside.

Unfortunately the inventor did not regard this discovery as important, and devoted the rest of his paper to other matters which included, nevertheless, sound reproduction by magnetostriction and shielding properties of different metals. The latter effect, which he termed "interception of inductive energy," was investigated over a wide range of frequencies, the highest of which was 2,000 reversals per minute. In the same paper he demonstrated the practicability of an inductive system of railway signalling which, in principle at any rate, is comparable with modern practice.

Now no doubt many readers will have carried out experiments at schools or technical colleges during the study of inductive effects, and Lenz's Law, but it is only quite recently that use has been made of induction in connection with deaf-aid apparatus.

<sup>1</sup> Published by Hayman Bros. & Lily, Hatton House, London, E.C.



## Induction—

There were brief mentions in *The Wireless World* some time ago<sup>2</sup> of inductive systems suitable for use in cinemas and theatres which consist basically of the installation of a loop conductor around the auditorium arranged to carry the low-frequency output current from an amplifier handling the speech or music associated with the film or microphone on the stage. A magnetic field is set up in a manner very similar to that already described, but being alternating in character follows exactly the variations of the audio frequency currents.

The normal deaf-aid equipment is really a self-contained battery-fed midget amplifier and it is possible to remove the microphone and substitute a suitable pick-up

<sup>2</sup> May 19th, 1938, page 446, and June 23rd, 1938, page 561.

device which may be termed an inductor. In its simplest form the latter consists merely of a coil of copper wire which may be incorporated in the amplifier container or employed as a separate unit. This is influenced by the alternating magnetic field specifically provided in the auditorium, and the output from the deaf-aid unit may be considerably better than when its own microphone is used in the normal manner in a theatre or cinema. A notable improvement in the signal/noise ratio is one advantage of this system.

The design of the best pick-up device is of extreme importance, and the writer has made a brief but specialised study of the problems involved with a view to suggesting an efficient unit. The experimental work carried out and details of the final design will be described in a future article.

## Emergency Receiver

NEW TYPE WESTECTOR IN PLACE OF A CRYSTAL

UNDER emergency conditions a simple receiver which will operate without any form of power supply would be exceedingly useful for the reception of certain essential programmes, such as news bulletins. Under such conditions headphone reception must suffice, bearing in mind that the main essentials are simplicity, reliability and independence of power mains or batteries.

A receiver using a crystal detector hardly meets these requirements, as the crystal cannot be described as reliable under strenuous conditions. The Westinghouse WX1 Westector, on the other hand, provides an entirely satisfactory detector under such conditions, as it is robust and permanent. It is similar to the well-known WX6 Westector used in multi-valve receivers, but is designed to work at the lowest possible signal voltages. In spite of this modification of design it must not, however, be compared too closely to a crystal detector. It still requires a bigger voltage than the crystal detector for efficient and good quality demodulation, but, of course, given this greater input voltage it has the advantage of giving correspondingly greater output.

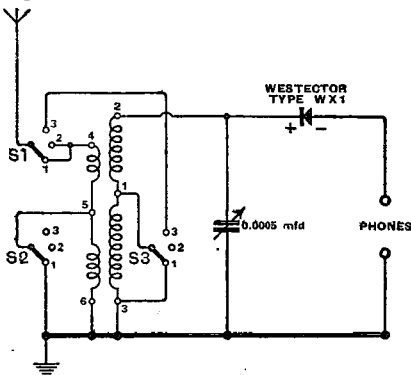

As this circuit diagram shows, the new low-input, low-capacity Westector is used in exactly the same way as a crystal detector. Numbering of terminals relates to the types of components specified in the List of Parts.

meet the requirements of an emergency receiver while at the same time being extremely inexpensive.

A list of suitable components is given in the accompany-

ing list. Construction is so simple that comment is unnecessary, but the linked wave-change switching should perhaps be explained. In switch positions 1 and 2 the coils are connected for medium- and long-range recep-

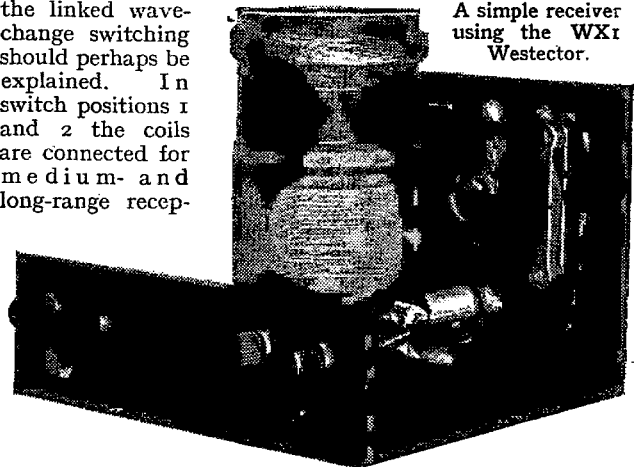

tion respectively, using the coupled aerial circuit in both cases. Increased signal strength on long waves (but lower selectivity) is obtained in position 3, in which the aerial is switched over to the junction point of the tuned secondary coil.

Under present conditions the set described may obviously be simplified by omission of provision for long-wave reception. In certain circumstances the connection of an 0.002-mfd. condenser across the phone terminals may improve reception.

### LIST OF PARTS

As used in the receiver illustrated.

- |                                       |   |
|---------------------------------------|---|
| 1 Westector.                          | Westinghouse, Type WX1.                   |
| 1 Coil, dual range.                   | Bulgin, Type C69.                         |
| 1 Variable Condenser, 0.0005 mfd.     | Bulgin low-loss midget, Type CV19.        |
| 1 Switch, 4-pole, 3-way (S1, S2, S3). | Bulgin midget rotary selector, Type S204. |
| 4 Terminals.                          | Bulgin, Type T2.                          |
| 2 Knobs.                              | Bulgin, Type K26.                         |
|                                       | 1 pr. Headphones, high resistance.        |

# Short-wave Reception

NEWS-GATHERING CONDITIONS IN PROSPECT AND RETROSPECT

**T**AKING the retrospective angle of these notes firstly—one can record with some satisfaction the appearance of the Yankee Network's new frequency-modulated station W1XOJ on 43.1 Mc/s during the recent period of peak conditions on the ultra-high frequencies. This period was undoubtedly connected with the appearance of a large sunspot, and lasted from approximately October 25th until November 3rd. However, U.S. reception on frequencies up to about 34 Mc/s is still continuing up to the time of writing but appears to be on the down-grade.

The best time for reception of W1XOJ was about 3 p.m., G.M.T., and at times reception was very strong, though frequently highly distorted. It must be realised that a special form of balanced detector circuit is necessary to convert frequency modulation to amplitude modulation before distortionless rectification can be obtained.\* Such a circuit was not available, but by sitting the "carrier" carefully on one edge of the IF resonance curve, at times good quality was obtainable. Subject to this limitation, I think I can say that fading distortion is more noticeable than on an equivalent amplitude-modulated signal, but the signal was exceptionally powerful; so much so that at times the receiver RF gain control was turned down to one-quarter of its full position. This transmitter is rated at 50 kW, with an excursion of 200 kc/s.

Another much weaker station was also heard on a somewhat higher frequency; this was probably W2XMN, Major Armstrong's station, at Alpine, New Jersey, a station rated at 40 kW, also with an excursion of 200 kc/s; W1XOJ is located at Paxton, Massachusetts.

In addition to these very interesting stations, many U.S. police transmitters have been heard on frequencies ranging from 30 to 35.5 Mc/s. It has been noted that most, if not all, of these stations now operate under four-letter calls, such as WGKC New Rochelle Police, or WGIE Newark N.J. Police.

## Police Wireless is Wonderful

Although the Metropolitan Police in London do not at present operate on the 30-35 Mc/s band it may be stated, nevertheless, that they do possess an excellent radio system, undoubtedly one of the most advanced and efficient of its kind in the world.

Many U.S. amateurs have been heard on 28 Mc/s between midday and 5 p.m., and special reference must be made to W2VH.

This station puts down a very high field in this country and uses a four-element horizontal beam made from  $1\frac{1}{2}$  in. diameter copper tube. The transmitter is as follows:—802 crystal oscillator, 6L6 doubler, 807 doubler, 35T driver (RF) followed by a pair of 254 Gammatrons in push-pull with 400 watts input modulated by a pair of 203Z's. A Thordarson amplifier is used with a crystal microphone.

On Thursday, November 2nd, an amateur on 28 Mc/s reported that some German amateurs were still active, presumably on 28 Mc/s—reference has been made to this disclosure in the daily Press, and it is suggested that these amateurs are operating under orders from the German Government, to test the reactions of the United States in a somewhat novel fashion.

Before passing on to the more orthodox waves one cannot help remarking on the utter silence which prevails below 4 metres. No car ignition is to be heard, even on a sensitive receiver, and up to the present, no diathermy either. Why no diathermy has been heard remains a mystery—the only solution one can think of at the moment is that the rather clumsy self-oscillatory circuits at present favoured by the medical profession do not work readily below about 5 metres. It should also be borne in mind that a self-oscillatory circuit is not nearly so efficient as a driven generator when it comes to delivering power to the load, even if the load is only human flesh and bone!

In view of the cessation of amateur activities it might perhaps be a gesture on the part of this journal if it could include in its pages a design for a simple driven (LC circuit) diathermy set, which would combine the essentials of flexibility of waverange with adequate output plus minimum radiated energy.

## Jamming Essential Services

Before very long, someone is going to sit on top of an essential Government service with a 50-cycle diathermy set and then the trouble will begin; let us hope the offender will not be one of the quenched-spark outfits which I saw advertised some while ago.

Since, as has already been recorded, U.S. signals on the ultra-high frequencies have been well received, it follows, of course, that general short-wave reception conditions have been good, at least until the end of the first week in November. Nevertheless, one still feels that Columbia would have done better to have reverted to 17.83 Mc/s for the WCBX daylight transmissions; although the 21.57-Mc/s signal has been heard regularly, the frequency is rather too high both for the beginning and end of its transmission period, i.e., 1300-1700 GMT. The news on 21.57 Mc/s (13.9m.) at 1 p.m. GMT, a very popular feature, has been very difficult to receive clearly on a number of occasions, and a far greater run of successes was scored on the old and lower frequency. Reception on 15.27 and 11.83 Mc/s later in the evening is generally much more successful for the average listener.

May I suggest that Columbia's regular English listeners drop a postcard to Mr. Ed. Morrow, Columbia Broadcasting System, Inc., 14, Langham Place, W.1, stating which of the two daylight frequencies, 21.57 or 17.83 Mc/s, they prefer for WCBX? This would be only a small return for the excellent service rendered by this station.

For almost two months now the short-wave ether has been surprisingly free from methodical and deliberate jamming, but one is sorry to record that recently several of the B.B.C.'s late night frequencies, namely GSW in the 7 Mc/s band, and GSA and GSL on 6 Mc/s have suffered seemingly deliberate interference. But both stations are so well received generally that it must be difficult to jam them successfully.

According to present indications, propagation conditions will have reverted completely to winter type by the time these notes are in print. That is to say, conditions favouring the very high frequencies will prevail during daylight hours, with a rapid and progressive change during the early evening towards conditions favouring the lower frequencies.

"ETHACOMBER."

\* See Chaffee, *Proc. I.R.E.*, May, 1939, page 323.

# Unbiased

By FREE GRID

## *Irritating Interlude*

THIS war is, I fear, interfering with my laboratory work very seriously indeed, as I am left entirely alone in the house, and have to keep interrupting my experimental work to get myself a meal and to answer the door. The trouble is that immediately the sirens sounded the knell of peace on September 3rd, Mrs. Free Grid and Faradia gave themselves over to an orgy of sandbag knitting and other activities designed to harass the enemy. They have now got well into their stride, and, of course, have blossomed out into uniform, although, quite frankly, I am at an entire loss to identify it, as it seems to be quite different from any of those which other women are wearing. Such are the horrors of war.

In the last war, I recollect, Mrs. Free Grid belonged to what I believe was called the League of Young Lady Helpers, whose function was, so far as I could see, to sit by the bedside of wounded soldiers and read uplift poetry to them. Mrs. Free Grid was, of course, very much younger then—scarcely out of the flapper stage, in fact—and some of the soldiers didn't mind it. Some of them no doubt felt that it was part of the treatment and swallowed it like a dose of medicine, as something which the M.O. had ordered for their benefit. In the majority of cases, however, it led to the soldiers begging to be allowed to go back to the front again, which was exactly the psychological effect which the Government desired to produce, and was the reason why they not only permitted it to go on, but actually encouraged it.

At the risk of being accused of "comforting the King's enemies," I must say that I can't help feeling a little sorry for the unfortunate Führer when he eventually finds—as he most certainly will do—Mrs. Free Grid and others of her kidney billeted on him as part of the army of occupation. I cannot help

thinking that had the Prime Minister sent Mrs. Free Grid over with his ultimatum, there would have been no war, except, of course, a purely local one in the Führer's study.

I suppose that, really, my sympathy with the Führer is misplaced, since it is obvious that the man is devoid of any vestige of decency, as he has not only upset all my own carefully planned experimental work, but, by deliberately timing his preliminary antics to coincide with the commencement of Radiolympia, he gravely inconvenienced the whole

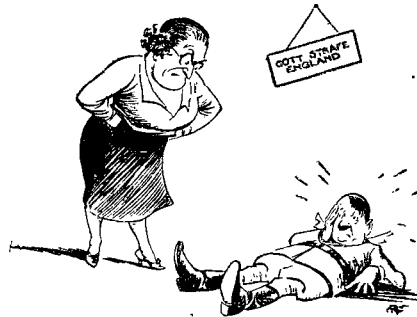

The unfortunate Führer.

of the radio industry. In connection with this I am now going to let you into a little secret war history. Secrets, especially international ones, are always welcomed with open arms by the great British public, judging by the success in the last war of such publications as "Peeps into Potsdam," and while I know that *Wireless World* readers are above these human failings, there may possibly be one or two new readers who have not yet acquired the correct attitude of aloofness from mundane matters which characterises the true scientist. It is for these weaker brethren that the next item is written, and I would therefore ask pukka *Wireless World* readers to pass it over with the contempt it deserves.

## *Causa Belli*

IT must have struck many as curious that the preliminary crisis which led to war coincided exactly

with the period of the greatest and best Radiolympia that has ever been staged. Actually, there was no coincidence about it at all. It was all deliberately and cold-bloodedly planned down to the last detail. Radiolympia was ruined as a deliberate act of retaliation, due to an unfortunate purchase which the Führer made through an agent at the previous year's show.

Apparently he was—as is now obvious—completely unacquainted with our habits and customs, and when the set referred to refused to work he did not realise that he had to fulfil the old-world ritual of sending it back two or three times before he got the actual working model. Consequently, he jumped to the conclusion that a dud set had been supplied with malice aforethought, with the result that he made deliberate plans to spoil this year's show. Unfortunately for him, he found that he had started something which he could not stop, as I cannot really believe that he intended his grievance against the British wireless manufacturers to carry him into war, although at times I must confess that my own feelings of exasperation have been such that it was a good job for the manufacturers that I did not possess totalitarian powers.

## *Future Plans*

THE extraordinary thing about the present situation is that I find myself forced into an alliance with the wireless manufacturers and the rest of the country against the common enemy. I did at first consider the question of declaring my neutrality, but in the end I decided to throw my influence and resources on to the side of the Allies, my resolution being due in no small measure to the fact that Mrs. Free Grid's mother is of indirect German descent, her ancestry being strongly evident in some of her habits of life, among which I may mention an inordinate devotion to the pleasures of the table. I am pleased to say that

Unbiased—

one of Mrs. Free Grid's sisters, who was on holiday in Germany at the commencement of the crisis, was unable to get out in time, and is now, I dare say, doing a compul-



A compulsory course of slimming.

sory course of slimming in an internment camp.

I have been wondering how best I might serve you during these troublous times in keeping you *au fait* with the latest wireless developments, and I have been making very elaborate plans with this end in view. It so happens that I received part of my education at a German university and consequently I am not only familiar with the language, but also with the German national habits and customs, and I hope later on to obtain for you some first-hand information by entering the country through a neutral state.

The only difficulty will be that of getting across the frontier. If I posed as a German I should be expected to produce some sort of explanation of where I had been, and I must therefore go, I suppose, as a distinguished neutral. I had thought of posing as a Dutchman, but the German frontier officials are a suspicious lot, and if it were found out that I could not speak Dutch, they would probably think it somewhat fishy. I shall probably adopt Swiss nationality, therefore. Even so, there will be a difficulty about getting a passport, but the Editor has a lot of low friends in high places, and I shall probably be able to wangle things a bit. Among other things which I wish to discuss with radio technicians in Germany is their extraordinary inability to detect, by means of DF, the whereabouts of the *Freiheitsender*. It would be mere child's play to our G.P.O. to unearth this transmitter,

after the great show which, as we all know, they put up in locating unlicensed receivers with their detector van, even in cases, so we were told, where the receiver consisted of a disused crystal set mouldering in a lumber room. This completely baffles the Germans.

## The Pipes of Pan

LIKE Gamelin and Gort, the Editor is still holding on to his advanced posts, but is all prepared to withdraw his forces to an impregnable Maginot line "somewhere in Somewhere," in the event of what is usually euphemistically referred to as "certain eventualities." I have been privileged to attend, as a spectator, a full dress rehearsal of this withdrawal of forces, and am at present sitting on a heap of dead leaves in a wood in a remote fastness of the country, writing these few notes. It is a typical dreary and misty



Evacuated!

November morning, and the rain is steadily dripping down my neck from the leafless branches of the tree against which I have my back.

I suppose that true country dwellers appreciate this sort of thing, and grow to like it, but for my part I find that the so-called peace of the countryside is greatly over-rated. I am, for instance, having great difficulty in preventing my manuscript being eaten by rats and stoats in the stilly watches of the night. The Editor, too, is finding things somewhat difficult. He has just passed me at top speed ardently pursuing his breakfast, which has again

beaten him by a short head, its absurd white tail just disappearing into its hole as he stretched out his hand to grasp it. No doubt perfection will come with practice, but I can't help thinking that the real countryman, unscientific and ignorant as he is concerning most things, must have more up-to-date methods of catching rabbits than this. Somehow or other a profound knowledge of wireless technique seems utterly useless when we get right down to life in the raw.

## Tailpiece

I HAVE always realised that *The Wireless World* is read by "all sorts and conditions of men," ranging from dukes to dustmen, but I must confess that I have never had this fact brought home to me so strikingly as was the case the other day when taking a morning stroll through the West End. I had just passed a couple of Westminster City scavengers sucking their clay pipes, and disputing hotly with each other concerning the inferences drawn by Scroggie from Buchmann and Meyer's scratch-spectrum analysis, when my progress was suddenly arrested by the imperious hand of a gorgeously beliveried chauffeur who flung his arm across my path as he stood by the open door of a truly magnificent-looking car drawn up by the kerbside. Emerging from the door of the neighbouring house was a lordly looking individual, monocled, bespatted and immaculately attired generally. Behind him tailed a footman carrying *The Wireless World*, which was duly handed into the car with the air of

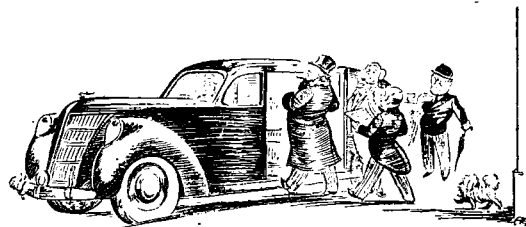

A pukka "Wireless World" reader.

reverence which, after all, is no more than its due. I raised my hat and stood in silence a moment before passing on my way.

# B.B.C. Receiving Station

## SOME RECENT DEVELOPMENTS

By H. V. GRIFFITHS

IN order to improve upon the 1938 figure for maximum accuracy of frequency measurement attainable at the B.B.C. Receiving Station, it became necessary to improve the quartz-crystal master oscillator, the two original oscillators having a stability not better than  $\pm 2$  to 3 parts in  $10^7$ , even when measured over short periods of a few hours. A new quartz oscillator, manufactured by the Research Laboratories of the G.P.O., has now been installed. The calculated stability of the generated frequency of 1,000 kc/s produced by this device is of the order of a few parts in  $10^{10}$  (one thousand million). A description of the design technique by means of which this very high degree of stability has been obtained, and of the precautions taken to maintain it, will perhaps be of interest.

A quartz plate of low temperature coefficient "A-T cut" is lightly but rigidly held by locating pins engaging recesses on the nodal line of vibration of the quartz. This mounting is assembled within a hollowed stainless steel block, together with a manometer tube. The mounting ring is internally cushioned to ensure improved freedom from damping, and the top of the recess in the steel block is closed by a transparent vitreous plate and by vacuum sealing, the compartment thus formed being partially exhausted of air.

### Maintaining Constant Temperature

The temperature control system comprises inner and outer ovens, the inner oven temperature being controlled by contact thermometers and relays, the outer oven by a simpler bi-metallic thermostat. Combined failure alarm and temperature-limiting circuits are fitted, enabling satisfactory operation to be maintained even when the normal temperature control circuits fail, with only a small change of quartz temperature (and, hence, of generated frequency). The anode reactance of the maintaining valve is also kept at

*THE functions of the B.B.C.'s Receiving Station in frequency measurement and diversity reception have already been described ("The Wireless World," January 13, 1938 and "World Radio," March 11, 1938). Various improvements and additions have since been made and equipment has been developed for other services. The Engineer-in-charge of the station describes these developments in the present article*

an approximately constant temperature by the outer oven.

In addition to these precautions—designed to reduce the effect of changes of ambient temperature and

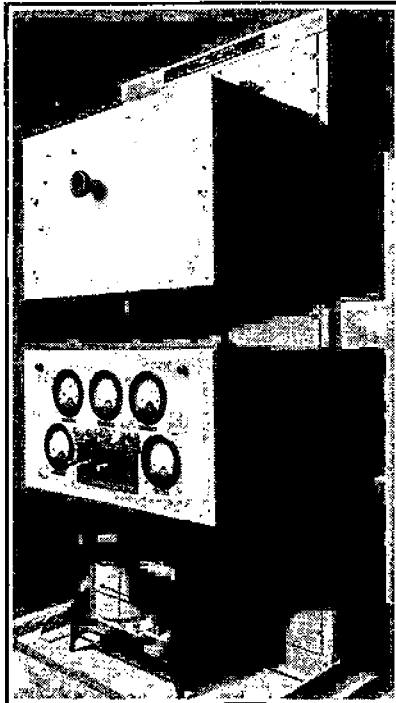

The 1,000-kc/s crystal frequency standard is housed in an underground chamber.

of barometric pressure to a minimum—it is necessary, despite the use of a maintaining-valve circuit of the most

stable type, to reduce fluctuation of supply voltages to the smallest possible limit. To this end, the heater current of the master-oscillator valve is stabilised by means of barretters, the required voltage being developed from a battery floated across a rectifier connected to the AC mains. The anode voltage for this valve has additional stabilisation, incorporating a "Stabilivolt" gas-discharge device, the stabilised 210 volts being thus developed from a 340-volt floating battery. The batteries mentioned are not used to supply any other equipment, the oven-heater current and the necessary supply voltages for buffer valve and relays being obtained from separate batteries. The whole of this apparatus will continue to operate with almost unimpaired constancy of frequency during a failure of the AC mains supply of several hours' duration.

### Amplifying the Output

The output frequency of 1 Mc/s. generated by the equipment described, is amplified by the buffer valve and passes via carefully balanced hybrid circuits to four separate screened outputs at an impedance of 75 ohms, whence it is carried by concentric cables to the multi-vibrators, etc., in the measurement room.

In view of the desirability of isolating this frequency standard from the effects of vibration, it has been installed in a specially constructed underground chamber and is mounted on a concrete bed, with additional precautions to prevent transmission of mechanical shock. This chamber is also being fitted with thermostatic control of temperature. The frequency standard equipment is rack-mounted, and is provided with test keys which enable the operation of relays, etc., to be checked. A simple scheme of viewing light and lenses enables the manometer, mounted adjacent to the quartz crystal inside the inner oven, to be inspected at will.

## Wireless World

### B.B.C. Receiving Station—

The remainder of the equipment of the measurement service has not substantially changed since the previous description was published, although minor improvements have been effected. The possibilities of

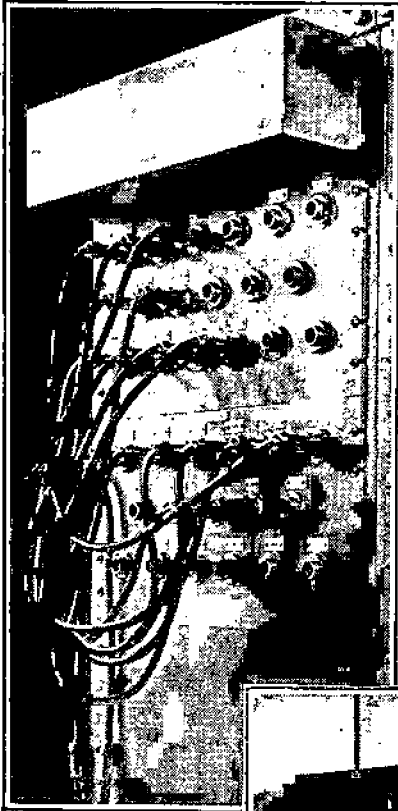

By means of this panel (above) different units of the elaborate aerial system may be connected to various receivers.

(Right) Direction finding apparatus is seen on the left; recording equipment is on the right.

using a scheme of interpolation—whereby decade-locked oscillators with a final quasi-optical system would be used for the actual measurement—have not been neglected.

Modifications to the four special diversity receivers, used for short-wave relaying, are well advanced. These modifications take the following form. The selectivity of the intermediate frequency circuits of the original receivers has been improved very considerably; a necessary change in order to cope with the increased interference experienced as the short-wave bands allotted to broadcasting become more congested.

This improvement has been obtained by modifying the receivers so that they are now "triple-detection"—i.e., amplification takes place at two intermediate frequencies. The first of these is approximately 1,000 kc/s, the relevant circuits being of conventional type. The second intermediate-frequency amplifier embodies twelve sections of band-pass filter circuits with a mid-band frequency of 100 kc/s. The overall attenuation at frequencies 10 kc/s or more off "mid-band" is of the order of 80 decibels, which is more than ample for good discrimination against transmissions operating on adjacent channels in the short-wave bands.

The AVC and output circuits have

being quasi-ganged tuning controls plus separate trimmers. The former control facilitates quick searching, the trimmers being used for final adjustments.

The original first frequency-changer valve circuits remain almost unaltered, but the separate beat oscillator has been considerably improved and is now both more stable and more flexible in order to meet optimum adjustment possible independently of the changing ratio of inductive to capacitive reactance over the tuning ranges.

### Linked AVC Circuits

Finality has not yet been reached in the matter of the AVC circuits and their linking for diversity reception. Experiments have necessarily been subordinated to the fact that at least two or three receivers must be kept ready for daily use. Further experiments are planned, which include the provision of a form of "volume-limiter," in an attempt to reduce further the objectionable sudden changes of output level associated with selective fading.

Other experiments are in hand with a view to avoiding the undesir-

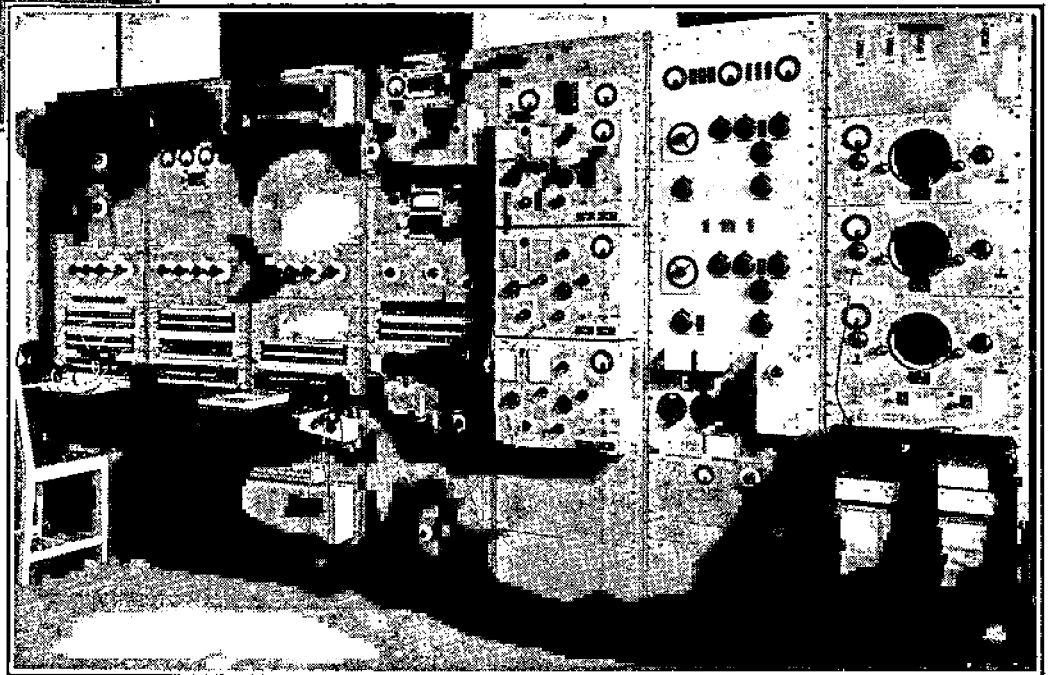

also been modified. In addition, an extra stage of radio-frequency amplification has been added, incorpor-

able phase-interference which is present on the combined output signal from two receivers momen-

## B.B.C. Receiving Station—

tarily carrying equivalent signal-voltages. Furthermore, the provision of a "locally supplied carrier" system is not ruled out, as by this means some of the advantages of single-side band transmission and reception may be obtainable.

There still remains much scope for improvement to reception quality during periods of severe selective fading, and, as in all engineering matters, it is frequently necessary to restrict enthusiasm for improvement in order to avoid curtailment of the proper daily work of the station.

Two more rhombic aerials have recently been erected, enabling improved "diversity" to be obtained on North American signals.

Experimental work in the direction of a simple form of vertical-angle "diversity" may further ameliorate the effect of selective fading. The logical point at which to attack this phenomenon would appear to be in the aerial circuits. Efforts to mask its presence later in the chain between aerial and output seem at best to act more as a palliative than a cure. In this respect, the "multiple-unit steerable antenna" system would appear to be of primary importance, but the cost involved would make this system a very difficult one to put into use, other than in a simplified form. The cost of land, aerials, and complex phasing equipment make the full "MUSA" a very expensive matter indeed.

In order to obtain data required for many purposes, field-strength measurement and continuous recording of fluctuations of field-strength associated with fading are undertaken at the station as required.

Field-strength contour measurements of B.B.C. medium-wave transmitters are not included, these being undertaken by the mobile units of the B.B.C. Research Department. The work at the Receiving Station is almost wholly concerned with the variations of field-strength of distant B.B.C. and foreign stations, and is frequently carried out simultaneously with similar measurements made at the Checking Centre of the International Broadcasting Union at Brussels and elsewhere.

## Our November Issue Heavy Demand

The demand for the November issue of *The Wireless World* proved to be heavier than was anticipated, with the result that some readers may have been unable to obtain copies. Our publishers state that they now expect to have a limited number of copies available (price 1.2 post free) for those who write for them to Dorset House, Stamford Street, London, S.E.1. It should be remembered that the November issue is the first in monthly form, and the first issue of a new volume.

A special non-screening hut, together with a vertical aerial which is unaffected by other objects in its vicinity, permits measurements to be made on either frame or vertical aerials. Co-axial cables enable the receivers to be situated remotely from the aerial (i.e., in the main building) if service exigencies make operation of the receiver in the hut undesirable. The receivers thus provided in the main building are of simple design embodying "straight" circuits, enabling receiver and recorder to be left running with only intermittent monitoring, once they have been lined up.

Originally, a very simple scheme of wall-mounted plugs and sockets enabled the more important receivers to be connected to the co-axial feeder or vertical aerial chosen. The need for something more comprehensive became apparent as the number of aerials and receivers increased.

An increase in the size of the station building, which became necessary at about the same time as the additional rhombic aerials were decided upon, made it essential to re-route the old co-axial cables. The opportunity was therefore taken to centralise all feeders from aerials, and also the internal feeders connecting to each receiver, on an apparatus bay in line with the diversity receivers.

The present panel-mounted plug-and-socket connection system is not only more comprehensive but more flexible, and allows for future expansion.

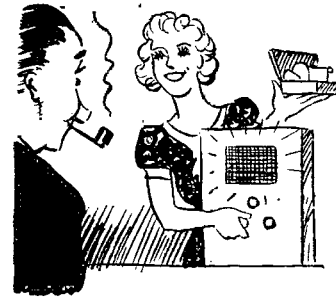

Moaned Smith "Our old super-het  
Is on its last legs, darling pet."

"Oh no" replied she "I've mended  
it, see

With FLUXITE'S cute soldering  
set."

See that FLUXITE is always by you—  
in the house—garage—workshop—  
wherever speedy soldering is needed.  
Used for 30 years in government  
works and by leading engineers and  
manufacturers. Of Ironmongers—in  
tins, 4d., 8d., 1/4 and 2/8.

Ask to see the FLUXITE SMALL-  
SPACE SOLDERING SET—compact  
but substantial—complete with full  
instructions, 7/6

Write for Free Book on the art of  
"soft" soldering and ask for Leaflet  
on CASE-HARDENING STEEL and  
TEMPERING TOOLS with FLUXITE.

TO CYCLISTS! Your wheels will  
NOT keep round and true, unless the  
spokes are tied with fine wire at the cross-  
ings AND SOLDERED. This makes  
a much stronger wheel. It's simple—with  
FLUXITE—but IMPORTANT.

## THE FLUXITE GUN

is always ready to put Fluxite on the  
soldering job instantly. A little pres-  
sure places the  
right quantity on  
the right spot and  
one charging lasts  
for ages. Price  
1/6, or filled 2/6.



ALL MECHANICS WILL HAVE

# FLUXITE

IT SIMPLIFIES ALL SOLDERING

FLUXITE LTD. (Dept. W.W.),  
DRAGON WORKS, BERMONDSEY,  
STREET, S.E.1.



# New Ideas

## RECENT ADVANCES IN WIRELESS TECHNIQUE

### Car Aerials

IN general, car aerials may be divided into two main classes, the vertical rod type and the horizontal type; the latter may be mounted on the roof of a car or underneath the chassis. From a technical point of view the main difference between the two is that the vertical type is a better signal collector, but, owing to its low capacity relative to the "earth," i.e., the car chassis, its coupling efficiency at the upper end of the wavelength scale is poor when the usual method of direct coupling is employed. The result of this is that any advantage gained in extra signal pick-up is nullified. To put it in another way, it may be said that this defect of the vertical rod aerial may be explained by the fact that, with direct coupling, the gain between aerial and the input of the first valve is equal to the product of the percentage coupling and the "Q" of the coupling network.

This difficulty has been overcome by the development in the laboratories of the Radio Corporation of America of a coupling network which is introduced between the aerial and the first valve. This coupling network consists of the fixed inductance L and the small variable condenser C shown in (a). C is ganged to the main tuning condenser assembly, and its purpose is to vary the inductive reactance of the coupling network. This arrangement results in a considerable improvement in the gain obtained at the upper part

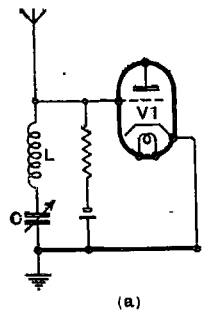

(a)

of the wavelength tuning scale. Some increased gain is also desirable at the lower end of the wavelength scale, and this can be brought about by adopting the modification shown in (b), which involves the use of another valve, V2, connected in "push-pull" with the original valve V1. In this circuit the

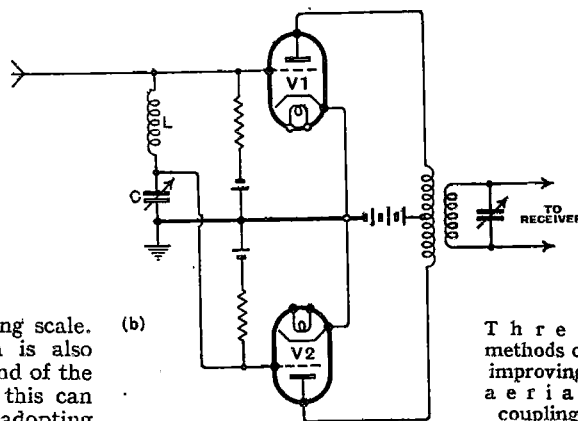

(b)

normally shunted by a condenser C shown in dotted lines. The value of C is normally made sufficiently large to prevent feedback, and if it is

inductance L is effective, as is also the case in the original circuit, in giving a large transference of energy at the top part of the wavelength scale. At the other end of the wavelength scale, however, the effect of the condenser C predominates in transferring energy to the receiver through the additional valve V2.

In (c) is shown a further improvement which does not call for an additional valve; in fact the only difference between this method and the original one is the provision of an additional variable condenser C1. By choosing a suitable ratio between the capacity of condenser C and that of C1 the maximum coupling may be made to occur at any desired part of the wavelength scale.

### Frequency Changer Problems

THE beneficial effect of negative feedback in AF amplifiers is nowadays a matter of common knowledge. As a result of research work carried out by R.C.A. engineers, it has been revealed that negative feedback can be made to perform the same good office in the case of a frequency changer as it does in the case of an AF amplifier.

This can most easily be explained by reference to the diagram, which shows an ordinary heptode frequency changer together with its associated circuit arrangement. The important part of the circuit from the point of view of the subject being dealt with is the cathode resistance R, which is

moved feedback will undoubtedly occur.

Were it not for the fact that considerable stray capacities are present,

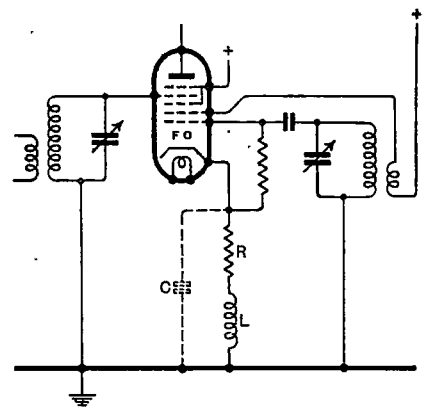

Negative feedback applied to a frequency changer.

it would not be necessary to do anything further than to remove the condenser C, since the resistance R will, of course, present the same impedance to all frequencies, which is what is desired when it is remembered that several different frequencies are present in the frequency changer, all of which must be dealt with equally if distortion is to be avoided. Unfortunately, stray capacities are present, and to balance their effect it is necessary to insert in circuit an inductance L.

The value of L depends upon that of R and C and upon the highest fre-

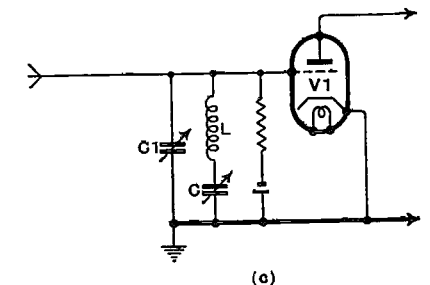

(c)

quency to be dealt with. If R equals the reactance of C at this uppermost frequency, and the reactance of L is chosen to be of half this value, then the desired result will have been achieved.

In addition to minimising distortion, this negative feedback has the result of decreasing the effect of the

## New Ideas—

frequency-changer on its associated circuits, thus lessening the likelihood of oscillator-frequency drift due to voltage variations. In addition, by increasing the output impedance to intermediate frequencies, the presence of the inductance L improves the selectivity. The signal/noise ratio is also increased.

## Anti-interference Reception

THE most popular scheme of defence against man-made interference is to raise the aerial as high as possible above ground—where it is usually outside the reach of local disturbance—and then either to screen the downlead, or balance it against inductive pick-up. In theory this should prevent any local noise from getting into the set, but in practice it doesn't always turn out to be quite so good.

An alternative plan which has been suggested is to let the interference get into the set along with the signals, and then so arrange matters that the interference is automatically excluded from the loud speaker. Artificial static usually consists of short "peaked" impulses, which can be made to trigger a relay and so put the speaker momentarily out of action. Such interruptions are too rapid to affect the apparent continuity of the signal proper, which is accordingly heard without any background of noise.

A new self-suppressing system for eliminating man-made interference

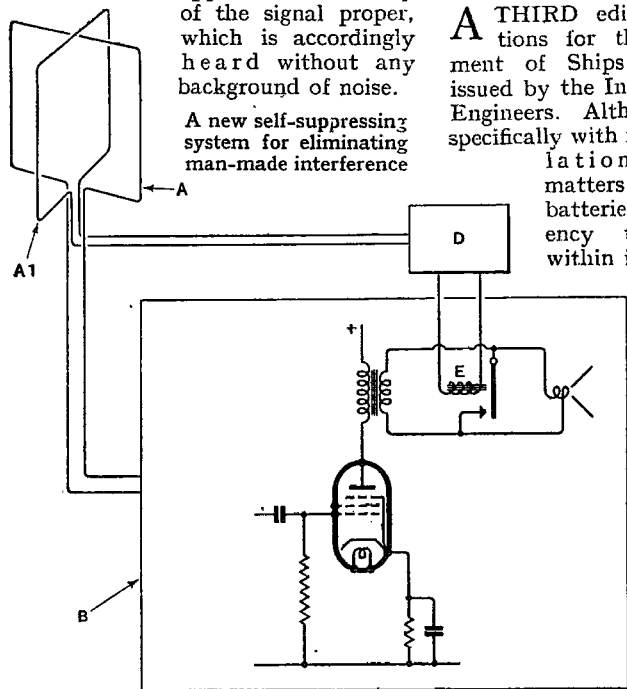

But this scheme, too, is subject to the limitation that the cut-out relay only comes into action for disturbing impulses which rise well above the normal level of signal-strength. The

latest development (Patent 506987) is designed to suppress less violent disturbances.

The desired signal is received on a frame aerial A and passes through the set B in the ordinary way. A second frame aerial A1 is rigidly clamped at right-angles to the first, so that although tuned to the same wavelength, being broadside-on, it will receive only a minimum of the desired signal-voltage. It will, however, pick up local interference without any noticeable directive discrimination, and feed it to a separate amplifier D, the gain of which can be made independent of the main receiver. The amplified disturbance is then applied, through a relay E, to short-circuit the speaker for any local noise above a given threshold value.

## Ferranti Patents

ARRANGEMENTS have been made by the British Licensing Pool whereby the Patents controlled by Ferranti within the scope of the A5 Licence are made available to licensees without payment of additional royalty.

## Ships' Electrical Equipment

### New I.E.E. Publication

A THIRD edition of the Regulations for the Electrical Equipment of Ships, has recently been issued by the Institution of Electrical Engineers. Although it does not deal specifically with marine wireless installations, several related matters such as secondary batteries as used for emergency transmitters, come within its scope.

The suppression of electrical interference with radio reception and direction-finding is treated in an appendix, in which it is laid down that the power supply to the radio room should be adequately suppressed, both at the source and at the cable termination in the radio room. Ignition

interference suppression in small motor-driven vessels is also treated.

Copies of the Regulations cost 2s. net (by post from the Institution at Savoy Place, London, W.C.2, 2s. 2d.).



## EVERYTHING FOR RADIO

Present conditions make Radio more vital than ever to Life; it has become a National necessity. You must keep your set in fighting trim for the Home Front. Modernisation and construction with Bulgin Products ensures satisfaction. (You can get all you want from our unparalleled range.)

## A.F. CHOKES

The Bulgin Range covers inductances of from 0.25 H. to 100 H., and includes current-carrying capacities of from 10 mA. to 0.75 A. Both skeleton and shielded types are available. All have generous cores and mono-metallic windings. Prices range from 6/- each.

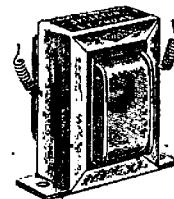

## FIXED CONDENSERS

From 10  $\mu$ F. to 4  $\mu$ F., the Bulgin Range of non-inductive paper-dielectric Condensers is complete. All are suitable for 400 V. peak working. (Other types are listed for voltages up to 5,000.)

For every condenser requirement; silvered-mica, metal-cased, electrolytic, air-dielectric. The Bulgin Range meets each and every requirement, but each model is the best of its type. Prices from 4½d. each.

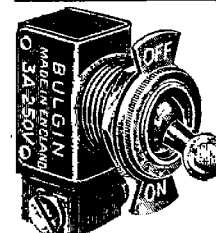

## SWITCHES

The famous Bulgin Toggle Switches constitute the largest range in the industry (illustrated). List No. S.89 Polished Nickel Plated finish, Max. 250 V. 3 A. Complete with on-off Plate. Note Large Terminals. 1/9 each. Bulgin for Switches.

## BULBS

The Bulgin range of Pilot Bulbs covers M.E.S. cap and M.B.C. lamps, tubular and round, in voltages 2-14, 0.06 to 0.5 A. Every replacement requirement is met. 9d. each. (Catalogue 162, page 13.)  
Fit your customers' torches and flash lamps with Bulgin Low-Consumption Bulbs, 2, 4 or 6 V., .06 A. Batteries last 3 to 5 times as long (or give 3 to 5 times the burning hours), and adequate light is obtained.



## RADIO SERVICE MANUAL

Servicing and Modernising Radio Receivers is easy with this New Manual, with its 280 pictorial and theoretical diagrams, and clear, concise, sectionalised text. Solves your problems. Price 1/- post free.

## SEND COUPON NOW

Please send me the NEW 128 pp. Catalogue No. 162, showing full range of Bulgin Products, for which I enclose 3d. stamps. I have not had this edition yet.

NAME.....

ADDRESS.....

W.W. 12.39. ....

Advert. of A. F. Bulgin & Co., Ltd., Abbey Road, Barking, Essex. Tel. R1Ppleway 3474 (3. lines).

# Random Radiations

## At It Again

WHEN I was first called up for service towards the end of August the major horrors of the war proved to be (a) that I had a small portable battery set but could obtain no HTB when the one in use ran down, and (b) that, though a small mains-operated communication receiver was available, there was no mains supply of AC from which to work it. Since then things have looked up. A detachment of Royal Engineers descended upon the hut wherein I and my fellows live and wired it for electric lighting. Then some days later they erected a line of poles and slung to these the cables bearing the longed-for "juice." It has been something more than a joy to get into touch with the world again through the short-wave stations. Whenever I have a spell off duty—even if it's one of only a few minutes—over goes the switch and in comes some interesting station. I find that my companions are just as keen as I am on hearing music and news (especially the latter) from far-away stations. One thing they never want

to miss is the German news bulletin in English, which gives us some of the most mirthful moments of the day.

## Really Funny

If you don't already listen to these, make a habit of doing so, for you'll find them full of unintentional and unconscious humour. Long ago, when propaganda by radio was almost in its infancy, I wrote that the Germans defeated their own objects in this kind of broadcasting by an astonishing misunderstanding of the people to whom they were speaking and whom they sought to convert to their way of thinking. Overstatements and gross misstatements have an effect that is precisely the opposite of that intended.



## The Fly in the Ointment

IN the very depths of the country as I am now, far from any main road, and farther still from electrical machines, I did think that I should be pretty free from interference. But the coming of the supply mains,

## By "DIALLIST"

which has been so great a boon in one way, has also been a curse in another. So long as we had no electric light and relied upon such batteries as we could get, there were no nasty noises. But, now that juice from the mains is ours, several of my companions have produced electric razors from the recesses of their valises. And as they go on duty at all sorts of odd hours of the day and night there seems always to be somebody shaving! At home my nearest user of an electric shaver was some distance away, and I thought him nuisance enough. But now I have them in the very same hut where my wireless set lives. Reader, have you ever heard the dreadful din that issues from the loud speaker of a short-wave set when one of these horrid instruments is switched on? If you have, you'll appreciate my oft-expressed view that it is a crime for manufacturers to unload such destroyers of the radio peace on the country at large. If you haven't, take the first opportunity of so doing, and I am willing to wager that you will agree with all that I say—and feel—on the subject.



## Not the Game

ONE of the queerest phenomena of the war's early days was the Great Dry Battery Famine. Radio HTBs were affected because so many jittery folk formed the quaint idea that mains supplies of current were to be cut off or tremendously restricted. Why they leapt to this quaint conclusion I don't know, but leap they did. And they decided that as they were to be deprived so soon (!) of the use of their mains sets, the only thing to do was (a) to buy a battery set and (b) to lay in enough HTBs to last for a year or two. Of course, they didn't know that HTBs of the dry kind aren't like canned foods: you can't just put them on the shelf and find them as good as ever the year after next. The dry HTB peters out in time, even if you don't use it at all. Result: all available dry HTBs were bought up by the hoarders, and the rest of us couldn't get replacements when ours ran out. But it wasn't only the hoarders who caused the HTB dearth.

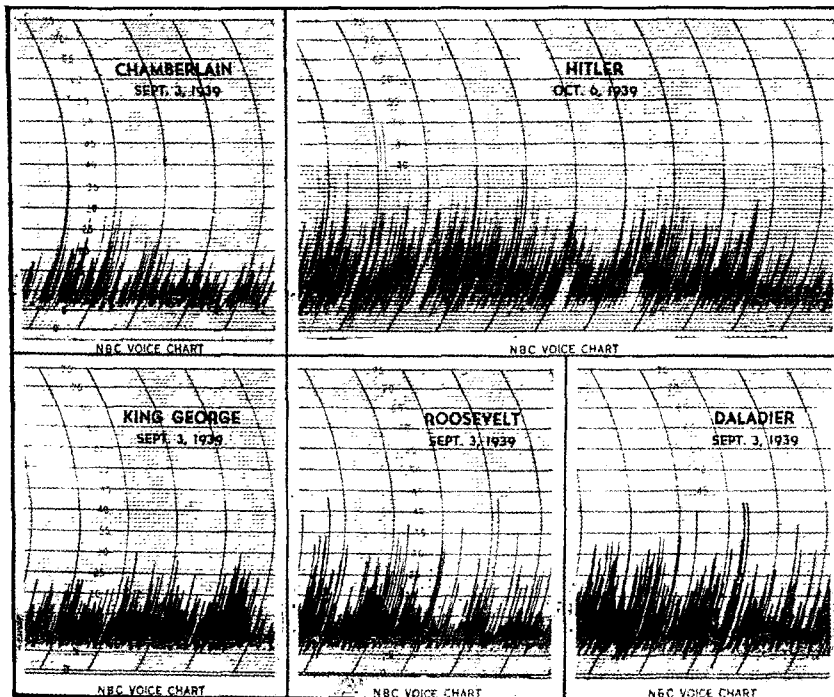

Record charts taken by the National Broadcasting Company of America of the reception of broadcast speeches by four of the world's leading figures on the day the war started and of Hitler's voice during his speech to the Reichstag.

## Black-outs

You see, everybody needed flash-lamps and torches when the black-out regulations were enforced, and the sales of these rocketed. Hoarding showed its ugly head again: those who already had torches and those who bought them for the first time tried to lay in all the refill batteries that they could, and that led to one very reprehensible piece of work on the part of certain dealers who ought to have known better. The little "pencil" torches that take up so small an amount of room in the pocket or the vanity bag use refills consisting of two cells of the same dimensions as those that go to make up standard HTBs. Thousands of such HTBs were broken up and turned into torch refills, the cells being sold at 2d. or even 3d. apiece. A 6s. 120-volt HTB contains eighty cells. Dispose of these at 2d. each, and the 6s. becomes 13s. 4d., which allows a pretty handsome profit. Some dealers pleaded that this was justified by the cost of breaking up the batteries. I've my own ideas on that point! Anyhow, I'm jolly well certain that you can't make out much of a case for collaring a whole pound by turning a 6s. battery into eighty threepenny cells. It was this breaking up of the HTBs to make highly profitable torch and flashlamp refills that made it so difficult for many wireless users to obtain replacements when they needed them.

## Experience Teaches—or Does It?

I'm sorry for those who bought torch refills made up of HTB cells, for I'm afraid that they wouldn't get very satisfactory results from them. Though the two kinds of cells may look exactly the same, they aren't; or, at any rate, they shouldn't be. The HTB cell is designed, particularly as regards its depolariser, to give a reasonably steady current and to have a good service life under a maximum load of some 10 milli-amperes. On the other hand, the torch battery is made to supply a current of 250 milliamps or thereabouts for short periods, with long intervals for recuperation in between. Subject a small HTB cell to this kind of work, and it doesn't last very long. I expect that lots of folk have learnt quite a bit about dry-cells in the hard school of experience in the days since peace was with us. Some, though, still won't be convinced, and probably they'll waste a good deal more money before they learn wisdom.

## Osram Z62

A New High-slope RF Pentode  
DESIGNED for use in ultra short wave or television receivers, this valve has an indirectly heated cathode rated at 0.45 amp., 6.3 volts. The electrodes are of small dimensions and the internal wiring has been kept short. As a consequence it is possible to obtain appreciable amplification up to 60 Mc/s, and at 40 Mc/s the input resistance is approximately 4,000 ohms.



The overall height of the Osram Z62 is just under 3½ inches.

The mutual conductance is 7.5 mA/volt with the maximum anode volts of 300, screen at 150 volts and grid bias at -2.0 volts.

The valve is mounted on a 7-pin Octal base and the price is 12s. 6d.

## The Wireless Industry

FOR the convenience of correspondents, the Automatic Coil Winder and Electrical Equipment Co., Ltd., Winder House, Douglas Street, London, S.W.1, may now be addressed as Acweero. Ltd.

Mr. J. C. Arrigoni, of Peto-Scott, Ltd., has changed his name by deed poll to J. C. Harland.

Whiteley Electrical Radio Co., Ltd., ask us to point out that the price of the W.B. Junior chassis loud speaker is £1 15s. 9d. and not £1 12s. 9d., as stated in their advertisement last month.

C. F. King, 53, Green Lane, Northwood, Middlesex, has been appointed sole representative in the U.K. for Ducati condensers and allied products.

Wingrove and Rogers, Ltd., 12, Dartmouth Street, London, S.W.1, announce that the following Polar products have been discontinued: Micro horizontal drive, V.P. horizontal drive and vertical C.K. drive.

When present stocks of the Mullard Master Test Board are exhausted the price will be increased. In the meantime deliveries will be made at the original price.

# VORTEXION

15w. AC & 12-VOLT DC AMPLIFIER

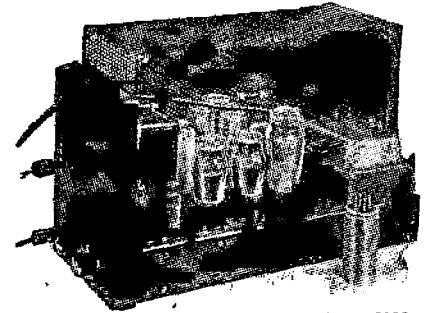

Type CP20

This small Portable Amplifier, operating either from AC mains or 12-volt battery, was tested by "THE WIRELESS WORLD" October 1st, 1937, and has proved so popular that at Customers' demand it remains unaltered except that the output has been increased to 17.2 watts and the battery consumption lowered to 6 amperes. Read what "The Wireless World" said—

"During tests an output of 14.7 watts was obtained without any trace of distortion so that the rating of 15 watts is quite justified. The measured response shows an upper limit of 18,000 c/s and a lower of 30 c/s. Its performance is exceptionally good. Another outstanding feature is its exceptionally low hum level when AC operated even without an earth connection. In order to obtain the maximum undistorted output, an input to the microphone jack of 0.937 volt was required. The two independent volume controls enable one to adjust the gain of the amplifier for the same power output from both sources as well as superimpose one on the other, or fade out one and bring the other up to full volume. The secondary of the output transformer is tapped for loudspeakers or line impedances of 4, 7.5 and 15 ohms."

AC and 12-volt CHASSIS with valves, etc.	£12 12 0
Or in Rexine Case with Collaro Motor, Piezo P.U. and Mike Transformer	£17 17 0
AC only CHASSIS with valves, etc.	£8 18 6
Or in Rexine Case with Collaro Motor, Piezo P.U. and Mike Transformer	£14 0 0

Gauze Case for either chassis 12 6 extra.

Many hundreds already in use for  
A.R.P. & GOVERNMENT purposes

## 50w AMPLIFIER CHASSIS

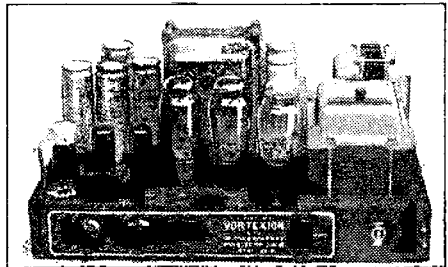

A pair of matched 6L6's with 10 per cent. negative feed-back is fitted in the output stage, and the separate HT supplies to the anode and screen have better than 4 per cent. regulation, while a separate rectifier provides bias.

The 6L6's are driven by a 6F6 triode connected through a driver transformer incorporating feedback. This is preceded by a 6X7 electronic mixing for pick-up and microphone. The additional 6F5 operating as first stage on microphone only is suitable for any microphones. A tone control is fitted, and the large eight-section output transformer is available in three types:—2.5-15-30 ohms; 4-15-30-60 ohms or 15-60-125-250 ohms. These output lines can be matched using all sections of windings and will deliver the full response (40-18,000 c/s) to the loudspeakers with extremely low overall harmonic distortion.

CHASSIS with valves and plugs	£17 10 0
Or complete in black leatherette cabinet with Collaro turntable, Piezo P.U. and shielded Mike Transformer	£22 10 0

Goodmans P.A. Speakers in stock.

Reslo Horns	£11 11 0
Reslo M.C. Microphones	£3 15 0
Amperite Ribbon Microphones from	£5 5 0

All P.A. and A.R.P. Warning Gear in stock.

Write for Illustrated Catalogue.

Vortexion Ltd., 182, The Broadway,  
Wimbledon, S.W.19. Phone: L1Berty 2814.

# Philips Type 855X

AC SUPERHET. (5 VALVES + RECTIFIER) MECHANICAL PUSH-BUTTON TUNING WITH AUTOMATIC WAVEBAND SWITCHING. PRICE £17

ALTHOUGH the short-wave circuits of this receiver show many points of technical interest, it is not primarily a "short-wave special." To describe it as such would be to underrate the many other good qualities which combine to make it the ideal "all-rounder." The design includes not only a new and ingenious push-button tuning circuit with automatic wave-range switching, but also a comprehensive system of negative feed-back and tone control which in conjunction with band-pass tuning and variable selectivity ensures the attainment of the best possible quality of reproduction under all conditions.

**Circuit.**—The valve used in the RF stage is the EF8, in which an extra grid is used to reduce the screen current and ensure a noise-free

pass filter and on these bands is resistance-capacity coupled to the frequency changer. On the short-wave range the coupling is tuned.

The IF amplifier is straightforward, but an unconventional valve arrangement has been adopted for the detector and AF stages. Signal and AVC rectification is carried out by diodes associated with the output valve. The rectified signal then passes to a pentode first AF amplifier, which is contained in the same bulb as the cathode ray tuning indicator, and finally through resistance-capacity coupling to the pentode output stage.

A centre-tapped third winding on the output transformer is the source of EMF for the negative feed-back circuits. A section of the winding applies feed-back voltages to the

through a resistance-capacity network to a tapping point near the top end. At this point, which corresponds to a setting which would be used for weak stations, and where quality is not so important, the feed-back cancels out and the AF circuits operate at full gain. On more powerful stations as the volume control is reduced the degree of feed-back is increased with a progressive reduction in harmonic distortion.

The tone control also makes use of the negative feed-back system. A proportion of the high-frequency output is by-passed through a condenser from the anode of the output valve to a tuned circuit in the cathode of the first AF amplifier. The feed-back thus introduced ensures a sharper cut-off for the tone control circuits, the upper frequency

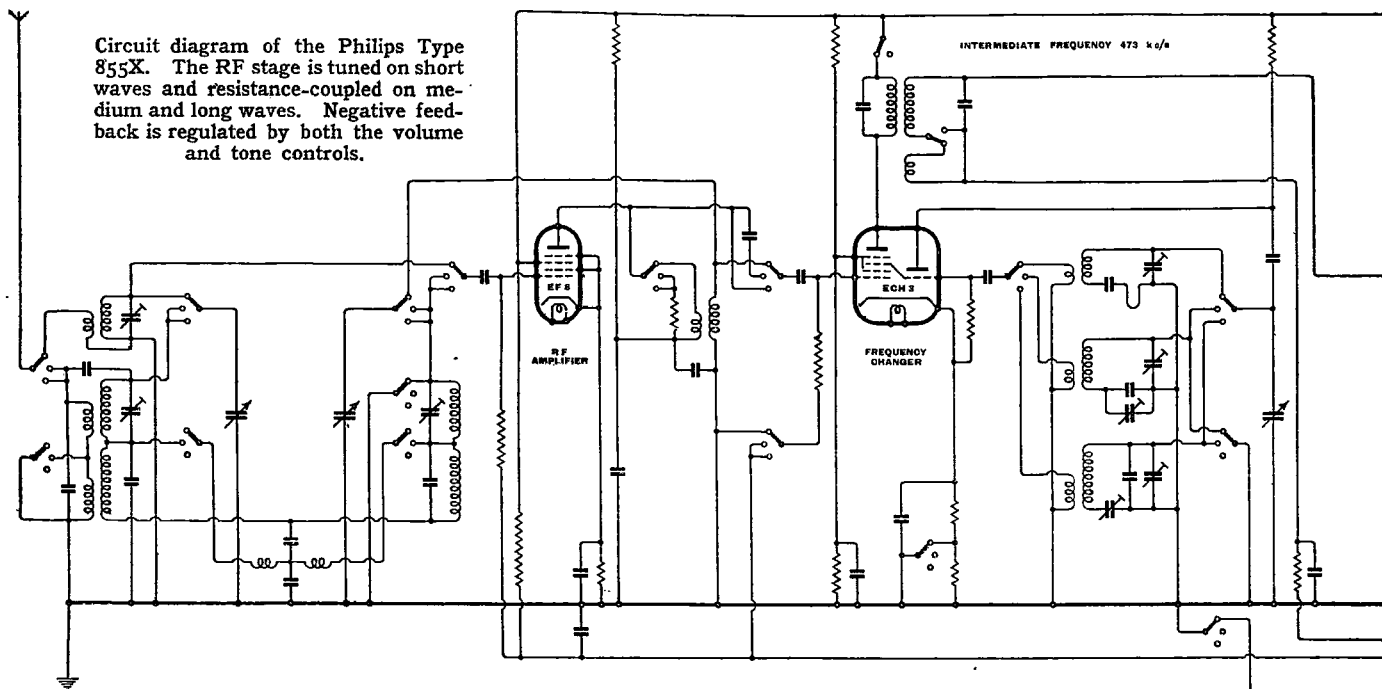

background. It is preceded on medium and long waves by a band-

lower end of the volume control potentiometer and in opposite phase

limit of which is controlled by the tone control potentiometer.

**Performance.**—The quality of reproduction provides ample proof of the soundness of the design in the AF circuits. It is well balanced and full bodied without any obvious "holes" or resonances in the frequency range; but more important still, it possesses the clarity which can only be attained when harmonic distortion has been reduced to a very low level. The tone control is one of the most effective we have so far tested. Its range is small, and excellent quality is obtained with the maximum top cut, yet the cut-off is so sharp that the worst types of interference are adequately dealt with when use is also made of the variable selectivity control. The loud speaker is fitted with a high-note diffuser, which effectively disperses the sound and removes the impression of a "point source."

On long waves adjacent station separation is easy, and on medium waves when using maximum selectivity less than one channel would be lost on either side of a "local" station. The sensitivity is ample, and the RF stage is undoubtedly contributing useful amplification even with aperiodic coupling.

On the short waves, with the RF

of tuning reaches the high standard set by the medium-wave range. There is very little second-channel interference even on 13 metres, and on this useful band the sensitivity is quite as high as on the 16- and 19-metre bands. The signal-to-noise ratio is exceptionally good, and is determined

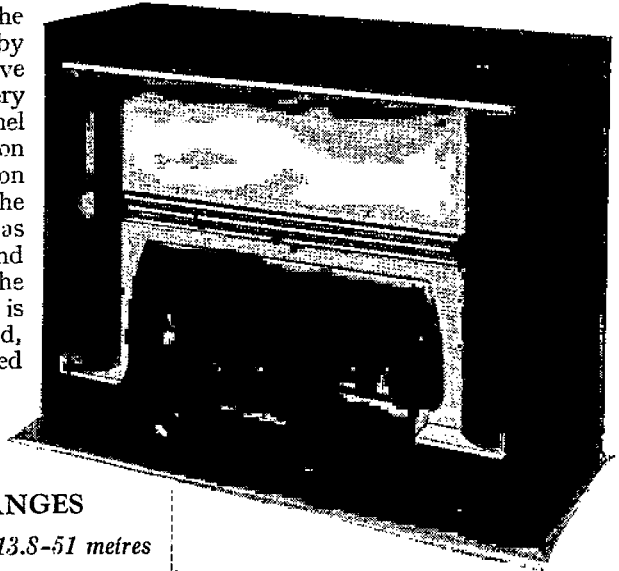

### WAVERANGES

Short . . . . .	13.8-51 metres
Medium . . . . .	175-535 metres
Long . . . . .	708-2,000 metres

solely by conditions external to the set. With the aerial removed and the volume control at maximum there is literally not a trace of valve hiss to be heard from the loud speaker.

tuning control is sufficiently high to remove the necessity for undue concentration. Location of individual stations is facilitated by an ingenious zig-zag degree scale with serrations which are approximately equal to the width of a station channel.

**Constructional Details.**—The tuning pointer consists of a cylindrical lens which projects a narrow line of light on the translucent scale. It is spring loaded to absorb the minor shocks inseparable from a mechanical tuning system.

The spiral-vaned tuning condensers have been modified to give a straight line frequency characteristic, and the mechanism associated with the operating keys permits three of the six station keys to be set up for medium or long waves. Once the adjustment has been made from the front of the set, each key selects the appropriate waveband on being depressed. The change-over to manual operation is effected by operating one of the separate waverange keys and engaging the manual drive by pushing in the tuning knob.

A safety plug is incorporated with the back panel of the set and a separate switch for changing from radio to gramophone is located near to the pick-up sockets on the back of the chassis.

**Makers.**—Philips Lamps, Ltd., Century House, Shaftesbury Avenue, London, W.C.2.

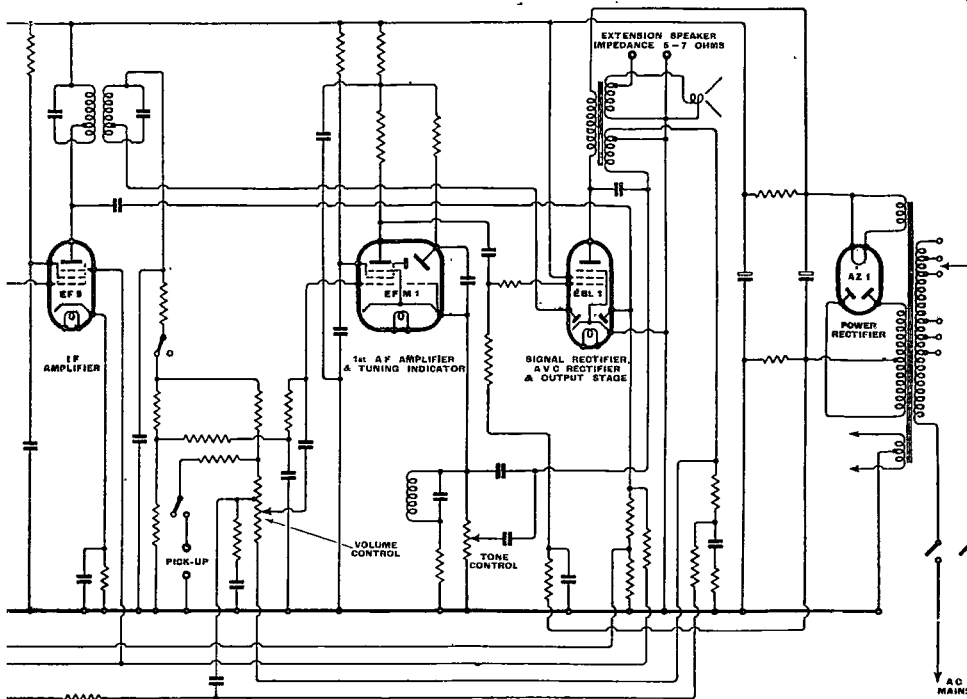

stage tuned, the performance as regards signal strength and stability

There is no band spread tuning on short waves, but the ratio of the

# Short-wave Stations of the World

Arranged in Order of Frequency and Wavelength

Station	Call Sign	Mc/s.	Metres	kW	Station	Call Sign	Mc/s.	Metres	kW
Moscow (U.S.S.R.)	RIA	5.85	51.24	15	Oslo (Norway)	LKQ	11.73	25.56	5
Moscow (U.S.S.R.)	RNE	6.00	50.00	20	Boston (U.S.A.)	WRUL	11.73	25.56	20
Zeesen (Germany)	DJC	6.02	49.83	5-40	Vatican City	HVJ	11.74	25.55	25
Moscow (U.S.S.R.)	RW96	6.03	49.75	100	Warsaw (Poland)	SP25	11.74	25.55	5
Vatican City	HVJ	6.03	49.75	25	British Oversea Service	GSD	11.75	25.53	10-50
Boston (U.S.A.)	WRUL	6.04	49.67	20	Rome (Italy)	I2R015	11.76	25.51	—
British Oversea Service	GSA	6.05	49.59	10-50	Zeesen (Germany)	DJD	11.77	25.49	5-40
Philadelphia (U.S.A.)	WCAB	6.06	49.50	10	Boston (U.S.A.)	WRUL	11.79	25.45	20
Motala (Sweden)	SPO	6.06	49.46	12	Zeesen (Germany)	DJO	11.80	25.42	5-40
Zeesen (Germany)	DJN	6.08	49.35	5-40	Tokio (Japan)	JZJ	11.80	25.42	50
Bound Brook (U.S.A.)	WNBI	6.10	49.18	25	Rome (Italy)	I2R04	11.81	25.40	100
Belgrade (Yugoslavia)	YUA	6.10	49.18	1	British Oversea Service	GSN	11.82	25.38	10-50
British Oversea Service	GSL	6.11	49.10	10-50	Wayne (U.S.A.)	WCBX	11.83	25.36	10
Wayne (U.S.A.)	WCBX	6.12	49.02	10	Lisbon (Portugal)	CSW5	11.84	25.34	10
Sinkiang (Manchukuo)	MYCY	6.12	49.02	—	Zeesen (Germany)	DJP	11.85	25.31	5-40
Pittsburgh (U.S.A.)	WPIT	6.14	48.86	28	Budapest (Hungary)	HAD	11.85	25.31	—
Winnipeg (Canada)	CJRO	6.15	48.78	2	British Oversea Service	GSE	11.86	25.29	10-50
Wayno (U.S.A.)	WCBX	6.17	48.62	10	Madras (India)	VUM2	11.87	25.28	10
Vatican City	HVJ	6.19	48.47	25	Pittsburgh (U.S.A.)	WPIT	11.87	25.26	24
Rome (Italy)	IAC	6.35	47.21	50	Melbourne (Australia)	VLR3	11.88	25.25	2
Radio-Nations (Switzerland)	HBQ	6.67	44.94	20	Radio-Mondial (France)	TPA11/12	11.88	25.24	12
Barcelona (Spain)	EAQ1	7.03	42.7	—	Chungking (China)	XGOY	11.90	25.21	35
Valladolid (Spain)	FET1	7.07	42.43	0.25	Moscow (U.S.S.R.)	RNE	12.00	25.00	20
Burgos (Spain)	EA1BO	7.07	42.43	—	Warsaw (Poland)	SPW	13.63	22.00	10
Lisbon (Portugal)	CSW8	7.26	41.32	10	Radio-Nations (Switzerland)	HPJ	14.54	20.64	20
Radio-Mondial (France)	TPB7, 11	7.28	41.21	25	Rome (Italy)	IQA	14.79	20.28	—
Moscow (U.S.S.R.)	RWG	7.36	40.76	15	Moscow (U.S.S.R.)	RKI	15.04	19.95	25
Moscow (U.S.S.R.)	RKI	7.51	39.89	25	Rome (Italy)	I2R012	15.10	19.87	—
Budapest (Hungary)	HAT4	9.12	32.88	5	Zeesen (Germany)	DJL	15.11	19.85	5-40
Radio-Nations (Switzerland)	HBL	9.34	32.1	20	Vatican City	HVJ	15.12	19.84	25
Ankara (Turkey)	TAP	9.46	31.70	20	Warsaw (Poland)	SP19	15.12	19.84	5
Lahti (Finland)	OFD	9.50	31.58	1	Radio-Mondial (France)	TPB6	15.13	19.83	25
Belgrade (Yugoslavia)	YUC	9.50	31.56	—	British Oversea Service	GSE	15.14	19.82	10-50
Melbourne (Australia)	VK3ME	9.51	31.55	5	Motala (Sweden)	SPT	15.15	19.80	12
British Oversea Service	GSB	9.51	31.55	10-50	Tokio (Japan)	JZK	15.16	19.79	50
Moscow (U.S.S.R.)	RW96	9.52	31.51	100	Oslo (Norway)	LKV	15.17	19.78	5
Warsaw (Poland)	SP31	9.52	31.49	5	Moscow (U.S.S.R.)	RW96	15.18	19.76	100
Schenectady (U.S.A.)	WGEO	9.53	31.48	100	British Oversea Service	GSO	15.18	19.76	10-50
Calcutta (India)	VUC2	9.53	31.48	10	Lahti (Finland)	OFD	15.19	19.75	1
Motala (Sweden)	SBU	9.53	31.46	12	Zeesen (Germany)	DJB	15.20	19.74	5-40
Vatican City	HVJ	9.55	31.41	25	Ankara (Turkey)	TAQ	15.20	19.74	20
Schenectady (U.S.A.)	WGEO	9.55	31.41	20-25	Pittsburgh (U.S.A.)	WPIT	15.21	19.72	18
Bombay (India)	DUB2	9.55	31.40	10	Lisbon (Portugal)	CSW4	15.21	19.72	10
Zeesen (Germany)	DJA	9.56	31.38	5-40	Huizen (Holland)	PCJ2	15.22	19.71	60
Millis (U.S.A.)	WBOS	9.57	31.35	10	Podebrady (Bohemia)	OLR5A	15.23	19.70	15-30
British Oversea Service	GSC	9.58	31.32	10-50	Rome (Italy)	I2R014	15.23	19.70	—
Melbourne (Australia)	VLR	9.58	31.32	2	Radio-Mondial (France)	TPA2	15.24	19.68	12
Sydney (Australia)	VK2ME	9.59	31.28	20	British Oversea Service	GSI	15.26	19.66	10-50
Huizen (Holland)	PCJ	9.59	31.28	60	Wayne (U.S.A.)	WCBX	15.27	19.65	10
Philadelphia (U.S.A.)	WCAB	9.59	31.28	10	Philadelphia (U.S.A.)	WCAB	15.27	19.65	10
Delhi (India)	VUD2	9.59	31.28	10	Schenectady (U.S.A.)	WGEO	15.27	19.65	20-25
Athlone (Ireland)	—	9.59	31.27	—	Zeesen (Germany)	DJQ	15.28	19.63	5-40
British Oversea Service	GRY	9.60	31.25	10-50	Delhi (India)	VUD4	15.29	19.62	10
Moscow (U.S.S.R.)	RAL	9.60	31.25	20	Buenos Aires (Argentina)	LRU	15.29	19.62	7
Cape Town (S. Africa)	ZRL	9.61	31.22	5	Rome (Italy)	I2R06	15.30	19.61	50
Oslo (Norway)	LLG	9.61	31.22	5	British Oversea Service	GSP	15.31	19.60	10-50
Zeesen (Germany)	PXB	9.61	31.22	5-40	Schenectady (U.S.A.)	WGEO	15.33	19.57	20-25
Budapest (Hungary)	HAD	9.62	31.17	—	DJE	DJE	15.34	19.56	5-40
Rome (Italy)	I2R03	9.63	31.15	25-100	Budapest (Hungary)	HAS3	15.37	19.52	5
Wayne (U.S.A.)	WCBX	9.65	31.09	10	Moscow (U.S.S.R.)	RAL	15.35	19.55	15
Lisbon (Portugal)	CS2WA	9.65	31.09	2	Oslo (Norway)	LKW	17.75	16.90	5
Vatican City	HVJ	9.66	31.06	25	Zeesen (Germany)	DJE	17.76	16.89	5-40
Buenos Aires (Argentina)	LRX	9.66	31.06	7	Huizen (Holland)	PHI	17.77	16.88	20
Rome (Italy)	I2R09	9.67	31.02	25	Bound Brook (U.S.A.)	WNBI	17.78	16.87	35
Zeesen (Germany)	DJX	9.67	31.02	5-40	Tokio (Japan)	JZL	17.78	16.87	50
Bound Brook (U.S.A.)	WRCA	9.67	31.02	35	British Oversea Service	GSG	17.79	16.86	10-50
British Oversea Service	GRX	9.69	30.96	10-50	British Oversea Service	GSV	17.81	16.84	10-50
Buenos Aires (Argentina)	LRA1	9.69	30.96	7	Rome (Italy)	I2R08	17.82	16.84	50
Lisbon (Portugal)	CSW7	9.74	30.80	10	Wayne (U.S.A.)	WCBX	17.83	16.83	10
Rome (Italy)	IRF	9.83	30.52	30	Athlone (Ireland)	—	17.84	16.82	—
Madrid (Spain)	EAQ	9.86	30.43	10	Radio-Mondial (France)	TPB3	17.85	16.81	25
Buenos Aires (Argentina)	LSX	10.35	28.99	12	Radio-Nations (Switzerland)	HBH	18.48	16.23	20
Lisbon (Portugal)	CSW6	11.04	27.17	10	Zeesen (Germany)	DJS	21.45	13.99	5-40
Radio-Nations (Switzerland)	HBO	11.40	26.31	20	British Oversea Service	GSH	21.47	13.97	10-50
Warsaw (Poland)	SPD	11.53	26.01	2	Schenectady (U.S.A.)	WGEO	20.50	13.95	20-25
Rome (Italy)	IQY	11.67	25.70	—	Rome (Italy)	I2R016	21.52	13.94	—
Motala (Sweden)	SBP	11.70	25.63	12	Philadelphia (U.S.A.)	WCAB	21.52	13.94	10
Moscow (U.S.S.R.)	IRA	11.71	25.62	15	British Oversea Service	GSJ	21.53	13.93	10-50
Radio-Mondial (France)	TPA4	11.72	25.60	12	Pittsburgh (U.S.A.)	WPIT	21.53	13.93	6
Winnipeg (Canada)	CJRX	11.72	25.60	2	British Oversea Service	GST	21.55	13.92	10-50
Huizen (Holland)	PHI	11.73	25.58	20	Wayne (U.S.A.)	WCBX	21.57	13.91	10



# Recent Inventions

Brief descriptions of the more interesting radio devices and developments disclosed in Patent Specifications will be included in these columns.

## VARIABLE SELECTIVITY CIRCUITS

WHEN press-button or other methods of automatic selection are used, without the further refinement of ATC, it is necessary to keep the IF circuits flatly tuned in order to prevent distortion, though, of course, a higher degree of selectivity is desirable when the set is to be tuned by hand.

The object of the invention is to meet both these requirements by automatically varying the circuit selectivity according to whether the listener uses push-button or manual control. For this purpose an auxiliary coil is automatically inserted in series with the secondary winding of the IF transformer, whenever a push-button selector is operated. This, of course, tightens the coupling, and so reduces the selectivity of the set below the level which it normally possesses when tuned by hand, with the loading coil out of circuit.

*E. K. Cople, Ltd., and H. A. Brooke.*  
Application date, February 12th, 1938.  
No. 510897.

## TELEVISION IMPROVEMENTS

IN the ordinary television receiver the picture produced by the impact of the stream of electrons on the fluorescent screen of the cathode-ray tube is momentary, and, apart from natural "afterglow," disappears as soon as the scanning stream has passed. By contrast it would be an advantage, particularly as a method of preventing flicker, if the picture could be made to persist until just before the same line is scanned in the next frame.

The Figure shows a cathode-ray tube designed to secure this effect. The

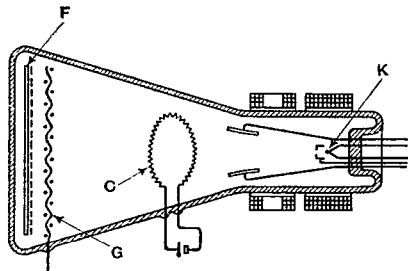

CR tube with auxiliary cathode.

ordinary scanning stream is projected from the gun K of the tube in the usual way, and passes through a positively charged grid G to reach the fluorescent screen F. An auxiliary cathode C, in the form of a loop, is arranged to "spray" the screen F with a diffused stream of electrons, after they have been accelerated by the grid G. The result is

that those parts of the screen F that emit fluorescent light under the action of the primary scanning beam are kept "active," because they emit more secondary electrons than they receive from the cathode C; whilst those parts that were originally dark remain so, because their potential is such that any secondary emission is less than the electrons received. The picture is thus kept alive until it is deliberately extinguished by a second concentrated stream of electrons.

*F. Ring.* Convention date (Germany), October 26th, 1936. No. 506911.

## PREVENTING ATMOSPHERIC DISCHARGES

THE presence of an electrically charged cloud is liable to set up voltages in a receiving aerial, particularly when the latter is of the vertical or pointed type. The resultant currents tend to flow intermittently at a frequency which increases with the potential difference between the cloud and earth, and so give rise to a disturbing note or whistle of rising pitch. This kind of atmospheric interference is to be distinguished from the ordinary type.

According to the invention, the type of disturbance in question is prevented by fitting the top of the aerial with a condenser, one plate of which is formed by the aerial wire, whilst the other plate consists of a plane or curved metal sheet which is separated from the aerial by insulating material. Alternatively, the top of the aerial may be fitted with an inverted metal cup. This cup should, of course, be insulated from the aerial wire.

*G. de Monge.* Application date September 1st, 1938. No. 509729.

## NEGATIVE FEEDBACK

THE ideal coupling circuit for applying negative feedback should possess an attenuation characteristic which increases with frequency, though the variation of phase angle with frequency should remain substantially constant; otherwise there is a risk of the negative feedback degenerating into positive feedback at certain frequencies, so creating conditions of instability.

To prevent this, the coupling circuit is made of elements whose resistance, owing to the so-called skin effect, increases to a marked degree with increase of frequency. A resistance made of magnetic material is one way of accomplishing this. Chokes and transformers made with a solid-iron core, or with a core built up of comparatively thick laminæ, which develop increasing losses at increasing frequencies, form another method. By combining such components with elements possessing constant resistance, it is possible to ensure that the

higher frequencies are suitably attenuated, without introducing undesirable phase shift at other parts of the frequency range.

*Telefunken Gesellschaft für drahtlose Telegraphie m.b.h.* Convention date (Germany) February 2nd, 1937. No. 510535.

## LECHER-WIRE COUPLINGS

THE Figure shows a Lecher-wire coupling say between the output circuit L of an ultra-short-wave valve and the

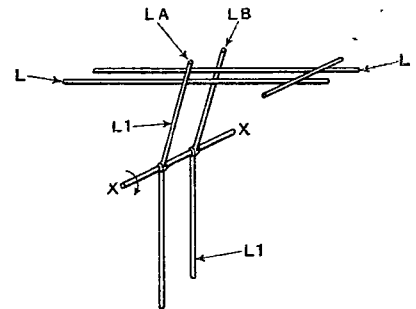

Preserving constant LC ratio with variable Lecher-wire couplings.

feed line L<sub>1</sub> of a transmitting or receiving aerial. When such a coupling is to be varied, e.g., for the purpose of impedance matching, it is usual to alter the relative position of the two Lecher-lines, but this, in turn, alters the relative proportion of inductance and capacity in the coupling, and so introduces undesirable phase changes in the currents concerned.

According to the invention, these difficulties are avoided by arranging the two "lines" at right-angles to each other, and fitting the feed line L<sub>1</sub> with a pivoted end-section, which is swivelled about an axis XX so that the end-members LA, LB can be moved relatively to the stationary-wave system which exists along the line L. This controls the amount of energy transferred, whilst keeping the capacity coefficient of coupling between the two circuits constant. Preferably the section of the line L over which the jointed members sweep is made circular instead of straight, so as to keep the effective length of the coupling links LA, LB constant in all positions.

*Telefunken Gesellschaft für drahtlose Telegraphie m.b.h.* Convention date (Germany), February 10th, 1938. No. 508297.

## SELECTIVITY CONTROL

BAND-PASS filters having an effective width which is regulated by varying the degree of coupling are subject to the defect that, owing to the dip in

## Recent Inventions—

the double-peaked resonance curve, the lower modulation frequencies of the received signal fall off with respect to the higher frequencies. This may, of course, be offset by increasing the damping of the circuits, but it must be done without altering the frequency, since otherwise a fresh tuning adjustment becomes necessary each time the band width is altered.

The Figure illustrates a simple and inexpensive method of securing the desired result, by moving an inductance coil over a core which is made partly of iron (which has a high specific resistance) and partly of low-resistance copper. As shown in the Figure, the coils L, L<sub>1</sub> form part of the filter circuit, the coil L<sub>1</sub> sliding over the composite core marked Fe and Cu. When the coil L<sub>1</sub> is tightly coupled to the coil L, the flux passes through the iron part of the core, and

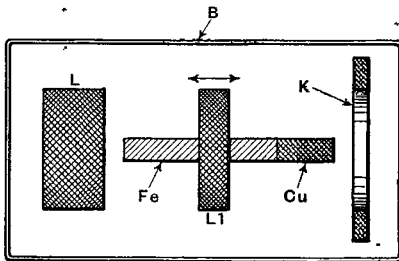

Method of tone compensation in band-pass circuits.

the resulting high loss provides the required damping. In the loosely coupled position, the coil L<sub>1</sub> is situated over the copper part of the core, and the losses are small. They may be further reduced by arranging an auxiliary copper ring K inside the screening box B, as shown.

*N. V. Philips Gloeilampenfabrieken, Convention date (Germany), June 7th, 1937. No. 510919.*

o o o o

## VOLUME COMPRESSION IN CAR RADIO

CAR receivers are usually operated at a high level of output so as to prevent the weaker sounds from falling below the prevailing level of noise. This, however, tends to overload the set at peak periods, and so causes distortion.

According to the invention, volume compression is applied to the low-frequency part of the set, whereby the weaker sounds are automatically strengthened, whilst those tending to overload the amplifiers are automatically cut down. Preferably the reduction in gain is only applied to signals which exceed a predetermined amplitude, leaving the bulk of the reproduction unaffected. The required method of gain control is ensured by using a back coupling which includes a lamp filament, or some other form of non-linear impedance.

*Pye, Ltd., and M. V. Callendar. Application dates February 2nd and June 22nd, 1938. No. 510301.*

## PUSH-BUTTON TUNING

RELATES to tuning arrangements of the kind in which each button is automatically locked as it is depressed, and remains in that position until another button is operated. It is usual in such arrangements to see that the circuits are first set to the proper waveband for the station selected. The main object of this invention is to eliminate the necessity of carrying out this extra operation.

According to the invention, the switch which controls the tuning motor is so interlocked with the waveband switch that the latter is automatically moved to the appropriate position whatever its initial setting may be. A special button, interlocked with the others is provided to operate the motor when required for gramophone reproduction. Another button is arranged to disconnect the motor when it is desired to tune the set by hand.

*Radio Gramophone Development Co., Ltd., and W. R. Parkinson. Application date, February 11th, 1938. No. 510895.*

o o o o

## AERIAL-MATCHING PROBLEMS

THE Figure shows a transmitter and receiver, both working on a common aerial and on frequencies which lie close together. Usually it is desirable that the feed line (which is usually of low impedance) should be matched to the transmitter (or receiver) at one end, and to the aerial at the other end. But when both transmitter and receiver are coupled to the same aerial, the feeders are in parallel, and the problem of matching each to the aerial presents some difficulty, particularly when the two operating wavelengths lie close together.

According to the invention the aerial A is coupled to the receiver R through a matching transformer S and a coaxial cable K, the inner lead of which is tapped to a double-tuned circuit C which has a low impedance for the incoming signals but a high impedance for the transmitter frequency. The coupling from the aerial to

Coupling receiver and transmitter to a common aerial.

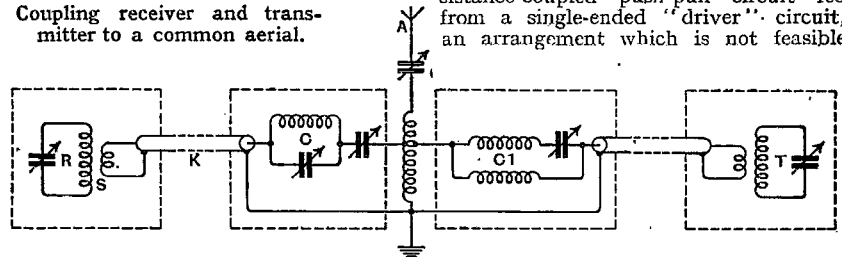

the transformer T is similarly arranged, except that it includes a double-tuned circuit C<sub>1</sub>, which presents a high impedance to the received signals, but a low impedance to the transmitter frequency. This arrangement prevents any undesirable interaction between the two working frequencies.

*The General Electric Co., Ltd.; N. R. Bligh; J. B. L. Foot; and R. F. Proctor. Application date, March 25th, 1938. No. 511079.*

The British abstracts published here are prepared with the permission of the Controller of H.M. Stationery Office, from specifications obtainable at the Patent Office, 25, Southampton Buildings, London, W.C.2, price 1/- each.

## ELECTRON OPTICS

THE "gun" of a cathode-ray tube is mounted approximately at the centre instead of at the end of the tube, the stream being directed initially towards a negatively biased electrode located at the end of the tube opposite to the fluorescent screen. As it leaves the gun, the stream is subject to a positive electric field, but as it progresses towards the negatively charged electrode, it reaches the equipotential surface which separates that field from the one due to the negatively charged electrode.

The equipotential surface acts as a mirror, and reflects the stream back towards the far end of the tube, where it presently comes under the influence of a third electrode which carries a positive bias of 20,000 volts. This focuses the stream on to a clear-cut spot on the fluorescent screen.

The arrangement allows the normal length of the CR tube to be reduced, and at the same time minimises spherical aberration.

*O. Klemperer and F. H. Nicoll. Application date, December 4th, 1937. No. 510699.*

o o o o

## MULTI-GRID VALVES

IN a valve comprising at least two grids, the spacing of the electrode system as a whole, and the biasing voltages applied to them, are so chosen that a virtual cathode is produced between the second grid and the anode, and the anode current is made to decrease as the voltage applied to the first grid becomes more positive. Such a valve has certain useful applications.

For instance it can be used in a resistance-coupled push-pull circuit fed from a single-ended "driver" circuit, an arrangement which is not feasible

with the standard type of valve. It can also be used as an oscillator valve with direct coupling between the anode and grid, since the anode and grid voltages are in phase with each other. If the positive grid is used as the output electrode, the valve operates with high mutual conductance.

*Marconi's Wireless Telegraph Co., Ltd., (assignees of B. J. Thompson). Convention date (U.S.A.) January 29th, 1937. No. 510265.*

# If you used an 8ft. baffle..

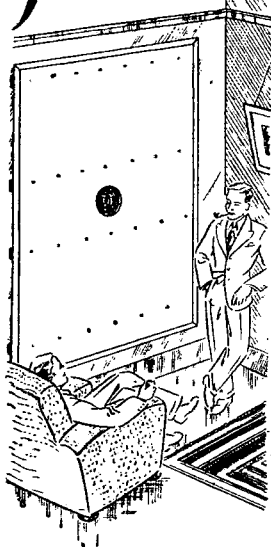

you could reproduce, with a suitable loudspeaker, low frequency notes down to 40 c.p.s. A baffle of such dimensions, however, is impracticable for domestic use. A practical solution is GOODMAN'S "Infinite Baffle" Loudspeaker, a scientific combination of unit and cabinet measuring only 18 ins. cube. Due to accurately predetermined air stiffness, not only is all radiation from the rear of the diaphragm absorbed, but correct loading is maintained at low frequencies. The interior of this cabinet is specially treated to eliminate reflection and formation of standing waves at the higher frequencies.

- (1) TRUE REPRODUCTION DOWN TO 40 C.P.S.
- (2) COMPLETE FREEDOM FROM FREQUENCY DOUBLING.
- (3) EXCEPTIONAL TRANSIENT & HIGH NOTE RESPONSE.
- (4) ABSENCE OF SPURIOUS RESONANCES.

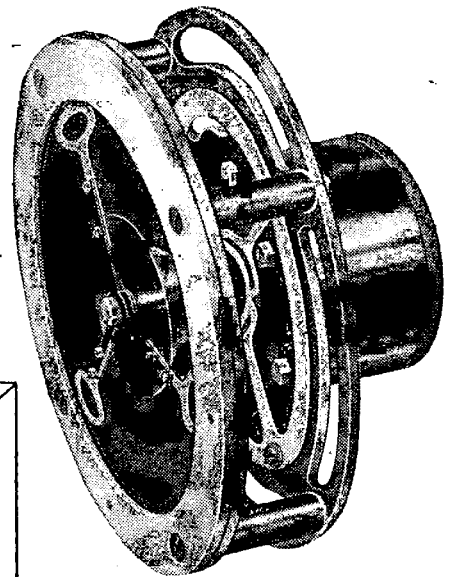
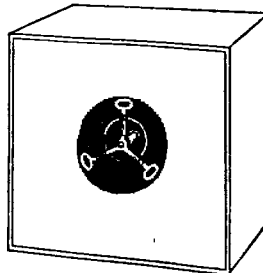

**SPECIFICATION :**  
Useful frequency range 30 c.p.s. to 12,000 c.p.s.  
Power Rating Capacity: 15 watts A.C. Peak.  
Speech Coil impedance: 2.5 ohms.  
Weight: 42 lbs.

Supplied fitted in plain loudspeaker case 18" x 18" x 18", finished grey. **£10**  
(Excluding Transformer)

High grade cabinets also available in various finishes.

## GOODMANS

### Infinite Baffle LOUDSPEAKER

GOODMANS INDUSTRIES, LTD., Lancelot Rd., Wembley, Middx. Phone: WEMley 4061 (5 lines)

**POST THIS COUPON** for details of the new "Infinite Baffle" Loudspeaker and for a copy of Goodman's 20-page technical booklet "The Attainment of an Ideal." Please enclose 1d. stamp.  
W.W. 1239. Attach this to your card or letterheading.



# International 'BAND SPREAD RADIO'

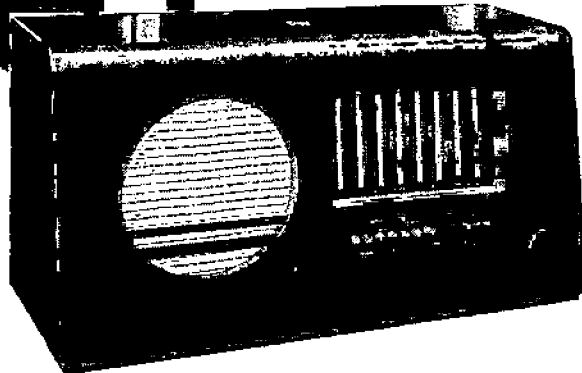

A new tuning method has been incorporated whereby you get on a simple scale effective tuning over a range, which, had it been spread out on one continuous band, would have required a scale 44 feet long.

You select your station—and it is there with the same accuracy as a close-by transmitter. Its ability to bring in short-wave stations by swinging from band to band on a press-button is as intriguing as it is effective and the standard of fidelity based on the development of selective inverse feed-back satisfies the most critical listener. Wavelengths: 13.7-14.2, 16.5-17.1, 19.4-20.1, 24.8-25.8, 30.6-31.9, 48-50, 180-560, 850-2,000 metres.

Cabinet finished in sapelè mahogany, 10" moving-coil speaker, 6 watts output valve, five valves (including rectifier).  
Dimensions: 25" x 13½" x 11¼"

Price **16½ gns.**

PYE LTD., RADIO WORKS, CAMBRIDGE

# CLASSIFIED ADVERTISEMENTS

**THE CHARGE** for advertisements in these columns is 12 words or less 3/6, 3d. for every additional word. Each paragraph is charged separately.

**ADVERTISEMENTS**, with remittance, should reach Dorset House, Stamford Street, S.E.1, not later than first post Friday, December 8th, for the January 1940 issue, or one day earlier at the Branch Offices, 8-10, Corporation Street, Coventry; Guildhall Buildings, Navigation Street, Birmingham, 2; 260, Deansgate, Manchester, 3; 26b, Renfield Street, Glasgow, C.2.

**SERIES DISCOUNTS** are allowed to trade advertisers on orders for consecutive insertions provided a contract is placed in advance, and in the absence of fresh instructions the entire copy is repeated from the previous issue. 3 insertions, 5 per cent.; 6 ins., 10 per cent.; 12 ins., 15 per cent.

Advertisements received too late for one issue, or crowded out, are published in the first following in which there is space. The Proprietors retain the right to refuse or withdraw advertisements at their discretion.

The Proprietors are not responsible for clerical or printers' errors, although every care is taken to avoid mistakes.

**BOX NO. ADVERTISERS** should include the words "Box 000 c/o 'The Wireless World'" which must be paid for. An additional 6d. is charged for registration and cost of forwarding replies.

## NEW RECEIVERS AND AMPLIFIERS

A.

A.

"**CHALLENGER RADIO CORPORATION**," the best firm for reliable, fully guaranteed ultra short-wave radio, have on view in London without exception the finest receivers ever made; for instance, a 5-valve T.R.F. Midget (2 bands) at 75/-; a mains/battery transportable (operating without alteration to A.C., D.C. or batteries), at £8, a 13-valve receiver, 5 bands, 5-2,100 metres, is only £16; any American valve for receivers 1925-40 for 5/6 each, only firsts such as Rathon Ken-rad, etc., supplied; they have a range like this right up to an 18-valve Challenger Twin Chassis De Luxe, valves and 12in. public address speaker (weight 23lb.), at £29/10; why not call and handle these receivers, at your leisure. No obligation to purchase; or handsome, profusely illustrated catalogues forwarded on receipt of 1/4d. stamp; sale list of 1939 receivers also available.

**CHALLENGER RADIO CORPORATION**, 31, Craven Terrace, London, W.2, Paddington 6492. Nearest point Marble Arch, down Bayswater Rd., turn 5th right. [8731]

**MCCARTHY PP9AW** 9-valve Chassis, 4wb, 15 watts output; £8/19/6.—Superadio, Dantzic St., Manchester. [8753]

**A.C.S.—RADIO**, now at 46, Widmore Rd., Bromley (Ravensbourne 0156). For all communication receivers and amateur radio needs; part exchanges, easy payments. [8738]

## RECEIVERS AND AMPLIFIERS CLEARANCE, SURPLUS, ETC.

**BANKRUPT Bargains**—Brand new 1938-9 models, makers' sealed cartons, with guarantees, at less 40% below listed prices; also portables and midjet radio; send 1/4d. stamp for lists.—Radio Bargains, Dept. A.W., 26f-3, Lichfield Rd., Aston, Birmingham. [8733]

## USED SETS FOR SALE

H.M.V.

**H.M.V.** 1936 5-valve Mains Set, hardly used, perfect condition.—Offers to 154, The High, S.W.16, Streatham 2792. [8760]

## MISCELLANEOUS

**A.C.S. RADIO**, 46, Widmore Rd., Bromley, offer bargains in reconditioned Scotts, McMurdo Silver, Challenger, and Communication receivers. [8739]

# ARMSTRONG

## WE ARE VERY HAPPY

because we can still supply our chassis at pre-war prices. In fairness to our "Wireless World" friends, however, we must point out that in the near future a slight increase will be inevitable owing to the rise in cost of essential materials. BUT—in accordance with our Fair Trading Policy only the bare increased expenditure we incur will be added.

We apologise for the delay in delivery of some models, particularly AW125 PP, but we feel sure you will appreciate the many difficulties the war has created. Everything possible is being done to give you the prompt service it has always been our pleasure to provide.

When sending your order it will help us greatly if you would allow as much time as possible for delivery.

Send for our illustrated Art Catalogue which fully describes our full range, including the following:

### MODEL SS10 — 10-V SUPERHET-STRAIGHT ALL-WAVE HIGH-FIDELITY R-G CHASSIS

Incorporating Two Independent Circuits, Superheterodyne and Straight, having R.F. Pre-amplifier and R.C. Coupled Push-Pull Triode Output capable of handling 8 watts.

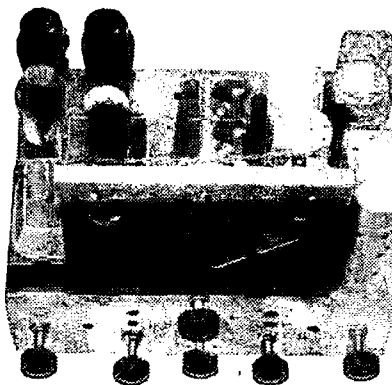

The circuit of the SS10 is unique. When used as a STRAIGHT receiver two HF stages are in operation with A.V.C. Diode Detector is used for distortionless detection together with Triode Push-Pull output. A turn of only one knob is necessary to switch from "Superhet" to "Straight." The Gramophone Amplifier has been specially studied and records can be reproduced with excellent quality. **12 gns.**

### MODEL AW38—8-V ALL-WAVE SUPERHET

This radiogram chassis has R.C. Coupled Push-Pull Output capable of handling 6 watts.

This being our Quality Year we have carefully studied the design of our more economically priced models and it's now possible for those requiring **8 gns.** quality with economy to satisfy their desire.

### Matched Push-Pull Speaker for above 1gn.

### MODEL AW125PP—12-V 5-BAND ALL-WAVE R-G CHASSIS (12-550 continuous, 1000-2000 m)

with R.F. Pre-Amplifier, 2 I.F. stages with Variable Selectivity. Manual R.F. gain control and 10 watts R.C. coupled Triode P.P. Output.

Readers need no introduction to this most popular model, so favourably reviewed by *The Wireless World* on Jan. 5th last. **17 gns.**

**7 DAYS' APPROVAL—12 MONTHS' GUARANTEE**

## ARMSTRONG MANUFACTURING CO.

WALTERS ROAD, HOLLOWAY, LONDON, N.7

(Adjoining Holloway Arcade.) 'Phone: NORTH 8213.

Letters addressed to Box Nos. are simply forwarded to the advertiser. No responsibility is accepted in connection with these advertisements.

**DEPOSIT SYSTEM.** Readers may deal with advertisers in safety through our Deposit System. Purchase money payable to Hiffe & Sons Ltd. should be deposited with "The Wireless World," when both parties are advised of its receipt.

The time allowed for decision is three days, counting from receipt of goods, after which period, if buyer decides not to retain goods, they must be returned to sender. If a sale is effected, buyer instructs us to remit amount to seller, but if not, seller instructs us to return amount to depositor. Carriage is paid by the buyer, but in the event of no sale, and subject to there being no different arrangement between buyer and seller, each pays carriage one way. The seller takes the risk of loss or damage in transit, for which we take no responsibility. For transactions up to £10 a deposit fee of 1/- is charged; over £10 and under £50, 2/6; over £50 and under £75, 6/-; over £75 and under £100, 7/6; over £100 one-half per cent. All correspondence must be sent to Dorset House, Stamford Street, London, S.E.1.

Cheques sent in payment for deposits or advertisements should be made payable to Hiffe & Sons Ltd. and crossed. Postal orders and notes are legal tender and cannot be traced if lost in transit. They must therefore be regarded as being despatched at sender's risk. Alternatively, they may be sent per registered post.

## PUBLIC ADDRESS

**PARTRIDGE P.A. Manual**, standard handbook on electro-acoustics, amplifiers, and audig circuits; price 2/6 (free to trade).

"**PARTRIDGE Amplifier Circuits**," describes many modern constructional amplifiers, 2w. to 45w. output, battery, A.C.-D.C., etc.; price 2/- (no free copies).

**PARTRIDGE, N., B.Sc., A.M.I.E.E.**, King's Buildings, Dean Stanley St., London, S.W.1. [0630]

V

**VORTEXION P.A. Equipment**

**IMITATED**, but unequalled.

**WE Invite You to a Demonstration.**

**A.C.-D.C. Dance Band Amplifier**, 10 watts output, complete in case, with moving coil microphone, speaker and cables, weight 22lb.; 12 gns.

**A.C.-20 15-20-watt Amplifier**, 38-18,000 cycles, independent mike and gram. inputs and controls, 0.037 volts required to full load, output for 4, 7.5, and 15 ohms speakers, or to specification, inaudible hum level, ready for use; 8½ gns. complete.

**C.P. 20 12-volt Battery and A.C. Mains Model**, as used by R.A.F., output as above; 12 gns.

**A.C.-20**, in portable case, with Collard motor, Piezo pick-up, etc., £14; C.P.20 ditto, £17/17.

**50-WATT Output 6L6s**, under 60-watt conditions, with negative feed back, separate rectifiers for anode screen and bias, with better than 4% regulation level response, 20-25,000 cycles, excellent driver, driver transformer, and output transformer matching 2-30 ohms impedance electronic mixing for mike and pick-up, with tone control, complete with valve and plugs; £17/10.

**COMPLETE in Case**, with turntable, B.T.H., Piezo pick-up and shielded microphone transformer; £22/10.

**80-WATT Model**, with negative feed back; £25, complete.

**120-WATT Model**, with negative feed back; £40, complete.

**250-VOLT 250 m.a.** Full Wave Speaker field supply unit; 25/-, with valve.

**ALL P.A. Accessories in Stock**; trade supplied.

**SEE Our Display Advertisement on Page 75.**

**VORTEXION, Ltd.**, 182, The Broadway, Wimbledon, S.W.19. 'Phone: Lib. 2814. [8241]

**AMPLIFIERS, speakers, microphones, turntables and converters for hire and repairs departments**—Easco, 18, Brixton Rd., S.W.9. 'Phone: Rel. 1693. [0643]

The Symbol of Service  
&  
Simplified Buying



Early '25 to late '39! Fifteen years of continuous Radio Service and despite the war we are still concentrating on supplying Quality apparatus on

**EASY TERMS**

In bad times, we need good things!

In these bad times we particularly need good radio—distance getting sets on all wave-bands with real Quality. We have always emphasized quality—it's so much cheaper in the long run.

**ARMSTRONG CHASSIS**

have an enviable reputation. You can't go wrong with one of these. Take Model SS10 for example at 12 Gns. Really good workmanship, reliable components, exceptional reproduction and 12 months' guarantee. (See their Advertisement page 16).

All orders are executed in rotation so SEND TO-DAY for illustrated literature of all models with particulars of our convenient terms.

In addition to the Armstrong range, we shall be glad to quote for all other high grade equipment, such as Sound Sales Amplifiers, Voigt Speakers, Haynes Radio, Avometers, and PORTABLE A.B.F. RECEIVERS.

Emergency address:—

**LONDON RADIO SUPPLY COMPANY**  
"Winden," Ardingly Road, Balcombe, Sussex

\*\*\*\*\*  
**WASTE AVOIDED!**

We cannot get a permanent magnet which is as effective as our Electro-magnet. Fortunately, the cost of a field rectifier can often be avoided.

The power pack of the normal 12W. amplifier can supply the excitation for a Voigt loud-speaker and also operate the output valve(s) at reduced wattage.

High efficiency enables the Voigt loudspeaker to give ample power for high quality domestic reproduction with only 2 watts input.

**PERFORMANCE with ECONOMY**

Consult us if in difficulty.

Home Constructors corner horn with bass chamber. Price readymade **£7.15**  
Twin diaphragm units from **£15**

Please write for literature.

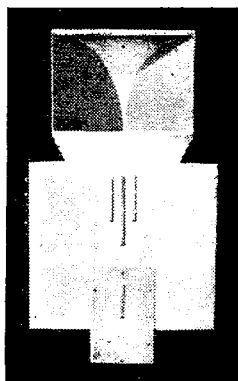

**VOIGT PATENTS LTD.**  
THE COURTS, SILVERDALE, LONDON, S.E.26

Telephone: SYDenham 6666  
Regd. Office: 22, Castle Street, London, E.C.1

\*\*\*\*\*

**NEW MAINS EQUIPMENT**

**V**ORTEXION Supply G.P.O., B.B.C., L.P.T.B. Why not you?

**A**LL Models Super Shrouded, primaries screened and tapped, 200-250v., filaments C.T.

**A**NY Model Fitted 5v. or 6.3v. Filaments if Required.

**500**-0-500 150 m.a., 4v. 4a., 2.5a., 4v. 2a., 4v. 2a., 4v. 2a., 35/-; 400 or 350v., same price.

**500**-0-500 120 m.a., 4v. 4a., 4v. 2.5a., 4v. 1-2a., 4v. 1-2a., 28/-; 400v. or 450v., same price.

**425**-0-425 150 m.a., 4v. 8-10a., 4v. 2.5a., 4v. 1a., 4v. 1a., 32/-.

**350**-0-350 120 m.a., 4v. 4a., 4v. 2.5a., 4v. 1-2a., 21/-; with extra 4v. 6a., 25/-.

**350**-0-350 75 m.a., 4v. 2-4a., 4v. 1-2a.; 18/-.

**250**-0-250 60 m.a., 4v. 2-4a., 4v. 1-2a.; 15/-.

**A**UTO Transformers, 100-120 to 200-240v., 80 watts, 11/-; 120 watts, 14/6; 200 watts, 21/-; 250 watts, 25/-; 300 watts, 28/-; 500 watts, 47/6.

**W**.W. Q.A. Output Transformer; 21/-.

**M**ICROPHONE Transformers, in heavy magnetic shielding; 12/6.

**C**HOKES.—30h., 60 m.a., 7/6; 7-13h., 120 m.a., 12/6; 30h., 150 m.a., 15/-; 25h., 150 m.a., 21/-.

**T**RANSFORMERS and Chokes to Any Specification.

**C**AR Battery Charger, 6 and 12v., 1½ to 2 amperes; 20/- complete.

**V**ORTEXION, Ltd., 132, The Broadway, Wimbledon, London, S.W.19. Telephone: Liberty 2814. [8715]

**SHORT-WAVE EQUIPMENT**

**'H.A.C.'** one-valve Short-wave Receiver, famous for over 5 years, now available in kit form; complete kit of precision components, accessories, full instructions, 12/6, post 6d., no soldering necessary; descriptive folder free on request.—Bacchus, 109, Hartington Rd., S.W.8 [8720]

**NEW LOUD-SPEAKERS**

**B**RAND New Speakers.

**S**AVE Pounds. 1½d. stamp for list of British and American P.A. speakers. Example: P.A. speaker with transformer, weight 2½lb., incorporating curved cone; 52/-.

**C**HALLENGER RADIO CORPORATION, 31, Craven Terrace, London W.2, Paddington [8733]

**B**AKERS' Brand New Surplus Speaker Bargains.

**£9** Only.—Usual price £16; brand new corner horn speakers in beautifully finished polished walnut corner horn cabinet, frequency range 30-12,000 cycles, amazingly realistic reproduction.

**£3/10**—Usual price £6; brand new Baker super power electro magnet speakers, as solely specified for the "Wireless World" Quality Four receiver.

**45/-**—Usual price £4 10; brand new Bakers' super power permanent magnet speakers, exceptional bargain.—Bakers Selhurst Radio, 75, Sussex Rd., South Croydon. [8725]

**LOUD-SPEAKERS**

SECOND-HAND, CLEARANCE,  
SURPLUS, ETC.

Wanted

**W**ANTED, Voigt unit, high voltage field.—Parson, 4, Lower Rd., Beeston, Notts. [8755]

**W**ANTED, Hartley-Turner Duode speaker, perfect.—Price to A. Anderson, 42, Gala St., Glasgow. [8750]

**LOUD-SPEAKER CONVERSIONS**

**B**AKERS' Triple Cone Conversions Will Immensely Improve Reproduction of Your Present Speaker. No matter what type or make you possess, British or American, you can considerably improve frequency response and quality of reproduction by having a triple cone fitted. Enables you to bring your speaker right up to date and obtain really realistic reproduction at the cost of a few shillings; free descriptive leaflet from the pioneer manufacturers of moving coil speakers since 1925.—Bakers Selhurst Radio, 75, Sussex Rd., South Croydon. [8724]

**THIS WONDER EDDYSTONE ALL-WAVE ALL-WORLD RECEIVER SENT YOU ON 7 DAYS TRIAL**

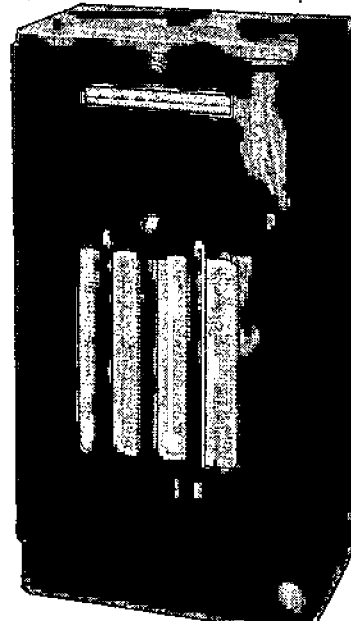

Yes, the headline means exactly what it says—we will send you this Wonder "Eddystone" All-World All-Wave Receiver, carriage paid to your address for you to subject it to 7-days Home Trial, and should you then find it not up to your fullest expectations you are at liberty to promptly return it—when we will cheerfully refund your money IN FULL.

This is an exceptional offer—but we make it because we want YOU to see for yourself what words cannot fully convey—the outstanding capabilities of this Set that makes everyone we show it to wish to obtain it.

It is a 7-valve Mains Receiver that will give you *intriguingly interesting* World-Wide reception—something EXTRA—news from all countries of World-wide events, official and unofficial impressions, American Amateurs, etc. It has 4-wave bands (13-33 metres, 31-85 metres, 200-555 metres and 900-2,100 metres), special chassis and coil unit construction, automatic volume control, special intermediate frequency stage, H.F. amplifier, "Magic Eye" for accurate tuning, separate oscillator valve to eliminate frequency drift, tone control, power pentode valve giving 5-watts undistorted output, 12 in. moving-coil loudspeaker, gramophone pick-up and external speaker terminals. In truly magnificent Oak or Walnut Cabinet, for A.C. mains. 25 Gns.

This is a *super set*, fitting for your requirements. Send the coupon below NOW for full descriptive literature.

**STRATTON & Co. Ltd.**  
EDDYSTONE WORKS, BROMSGROVE ST., BIRMINGHAM

POST THIS COUPON  
To STRATTON & Co. Ltd., EDDYSTONE WORKS,  
BROMSGROVE ST., BIRMINGHAM  
Please send me full descriptive details of the ERA 7 Receiver offered on 7 Days' Trial.  
Name.....  
Address.....

# ELECTRADIX

**WAR EQUIPMENT FOR SIGNAL SECTIONS**  
**SERVICE TYPE SIGNALERS' DOUBLE HEADPHONES**, with tough cords, and leather headbands for steel helmet wear, 120 ohms, by S.T. Co. 3/6. Large stock, immediate delivery. 5-line and 20-line Exchanges for field.

**MORSE KEYS**, Practice, Field, Pilots, etc. **Buzzers**, small type, with cover, 1/6. **Power Buzzers**, with screw contact and adjustable spring armature, 2/6. **Heavy Buzzer** in Bakelite case, 3/6. **Biemens Morse Transmitters**, with key and brass-cased Power Buzzers, 17/6. **Magneto Exploders**, Field Telegraph Sets and Helios.

**SIGNAL LAMPS** by Lucas and Aldis, hooded for night and day use, telescope sights, key and discs; for tripod or hand use. **Heliographs**, Mark V, with spare mirrors in leather case, with mahogany tripod.

**MORSE RECORDING**, G.P.O. type inkers, on mahogany base with tape reel under, in first-class order, 2/6. **Lightweight French Army Field Morse Inkers**, fold up into wood case, 27/10/-.

**Super Model Army G.P.O. Field H.Q. Morse Inker**, brand new, entirely enclosed and fitted every refinement, current indicator, key, tape container, etc., 28. **Mahogany Tape Container**, G.P.O., desk top with brass reel, 3/6. **Power coil**, 4/0, for 3/6 only. **Morse Paper Reels**, 3d.

**HEADPHONE CORDS**, 6 foot, fitted 2-pin plugs and 2-hole socket, 2/-.

**Crystal sets**, houndir 6/6. **B.M. Table 7/6**.

**LEARNER'S MORSE PRACTICE SET**, Sound Type No. 10, with Key and Buzzer on base, 3/-. **Visual Type No. 2A** with Key and Lamp on base. No. 3A Duplex with Key and Buzzer and Lamp for sound and visual, line plug in on base, 7/-.

**WARTIME ELECTRIC SUPPLY**. An Independent Emergency or Stand-by Set may be of great value to you. Can be transported on any car that can carry 3 cwt. All these sets that we are offering are in first-class order and straight from reserve Govt. Stores, kept unused as stand-by. Being a pre-crisis reserve they are an opportunity for a low price purchase that might not otherwise have occurred and certainly cannot be repeated. The H.B. Kilowatt Set is worth £40, but our price is only £18, and with engine and dynamo carry the full Electradix guarantee.

**A.R.P. PETROL ELECTRIC GENERATING SETS FOR LIGHTING AND CHARGING FOR £18 ONLY**. A 500 watt, single cyl., 2-stroke, water-cooled, self-cleaning 2-pin engine with mag. ign. coupled to 50/70 volts, 10 amps. shunt dynamo, 1,000 r.p.m., £16. No increase in price, these are 240 sets ready for immediate delivery.

**FOR £12**. A 150 watt engine and dynamo on similar lines but coupled to 25/30 volts, 6 amps. dynamo. Half Kilowatt and other sizes; all ready for immediate delivery.

**SIGNAL BELLS—FIRE ALARM BELLS**. Waterproof mains, Battery or Hand magneto Buzzers; Morse Practice Sets. Morse Keys. Recorder gear, previous adverts.

**CHARGERS. YOU MUST KEEP YOUR BATTERY PREPARED!!!** Battery Charging on A.C. Mains. The A.C. NIN-DAY will keep your battery fit without attention. Model N/A6, 100/250 volts A.C. and D.C. 6/8 volts 1 amp., 15/-. Model N/B6, 100/250 volts to D.C. 6/8 volts 1 amp., 25/-. Model N/C6, 100/250 volts to D.C. 6/8 volts 1 amp., 35/-. Model N/D12, 100/250 volts to 12 volts 1 amp., 39/-. Ditto, 12 volts 2 amps., with 6-volt tap, 55/-. 5 amp., 24/10/-.

And many others.

**SHELTER CHARGERS**, with automatic switchgear.

**A.R.P. ACCUMULATORS** for stand-by H.T. at 6d. per volt; 3 amp. hours. In 24 volt unit crates, glass cells, 12/- each. Can be parallel charged off 12 volts.

**ELECTRIC IMMERSION HEATERS**. Save coal. Armoured bath or tank type with flex. 1,000 watts 230 volts, 25/-. **FURRY Dug-outs** or ill-ventilated shelters must be kept fresh.

**A.R.P. SHELTER Ventilation and Air Conditioning**. Compact unit, drive off A.C. or D.C. mains, 80 watts; 5in. Blower, 20 cub. ft. fresh air per min. 25/- in a bag.

**WET WEATHER ELECTRIC PUMPS**, for A.C. or D.C. 12 v. to 230 v. Centrifugal all-bronze pump, throws 120 gals. per hour, 72/6. Type B pumps, Twin piston type for draining shelters, dug-outs, etc., 26/17/6. Auto. float switch, 45/-. **RAID SIGNAL PHONES**. Complete sets with 5-line or 20-line exchanges.

**PORTABLE WARDEN'S PHONES**, etc. **State warts HEADPHONES**. Wireless type, with aluminium headbands, 3/6. 4,000 ohms, 4/6, 8/6 and 8/6.

**LISTENING MIKES**, steel clad Electradix, indestructible; are ears outside your dug-out.

**ELECTRADIX BARGAIN**. Home Recording with the all-gear **FEIGH Electric Recorder**, Ball Bearing centre gear box and traverse rod. Is the lowest priced electric home recorder that will fit any grammo. The set with Tracking Gear, Pick-up and tone arm only, 21/6.

**ACOUSTIC RECORDERS**. Cost is low. **New MIVOCHE** acoustic sets, complete outfits in carton de luxe, 16/-. No. 2 Mivoche, 10 G. Junior, 5/6.

**ELECTRIC SOLDERING IRONS**. Heavy workshop type, 125 watts, 220/250 volts, 6/8.

**BELLS**. G.P.O. type trembler Circuit Desk Bell, with movement in gong, 1/6. Wall Bells, trembler, 2/6. Ditto, large size, 7/6. Large metal 12-volt single stroke Bells, 10/-.

**A.C. MAINS MOTORS**. Enclosed, self-start on load. A.C. repulsion, 1/10 h.p., with pulley. Type 36, 1,500 revs., 13/6. Ditto, 1/10 h.p., G.E.C. 3,500 revs., 27/6. Induction 1/10 h.p., 2,500 revs., 35/-. 1/2 h.p., 1,425 revs., 55/-. **D.C. MAINS MOTORS**. 1/40 h.p., 110 v., or 220 v., K.B. series, 1,750 revs., 15/-. Ditto, 1/40 h.p., G.E.C., 230 v. series, 2,000 revs., 16/-. Ditto, 1/12 h.p. Croxford 110 and 230 v. shunt, 30/.

**DIX-MIPANTA VEST POCKET TESTER**. A versatile moving-iron multi-range meter for service on A.C. or D.C. **THREE** ranges of volts: 0-7.5, 0-100, 0-800. Used for MILLIAMPS, reads 120 m.a. in black bakelite case, 2 1/2 in. x 2 1/2 in., with pair of test leads and plugs. 19/6

**5/- EMERGENCY PARCELS** of useful stand-by electrical and radio repair material and apparatus, 7 lbs. for 5/-. Post Free.

Don't forget to send for latest Bargain List "W"

**ELECTRADIX RADIOS**

21, UPPER THAMES STREET, LONDON, E.C.4

Telephone: Central 4611

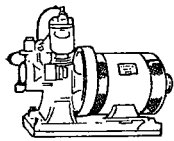

## TRANSMITTING APPARATUS

**G5NI** for Communication Receivers, American and British valves, short-wave equipment; largest stocks in the country; National Agents. -44, Holloway Head, Birmingham. [0531

## CABINETS

**A CABINET** for Every Radio Purpose. **CONVERT** Your Set into a Radiogram at Minimum Cost; surplus cabinets from noted makers under cost of manufacture (undrilled); 30/- upwards; motors at wholesale prices. **"FIT-A-GRAM"** Cabinet, 31x17x15, 21/-.

**UNDRILLED** Table Console and Loud-speaker Cabinets from 3/6.

**INSPECTION** Invited; photos loaned to country customers.

**H. L. SMITH and Co., Ltd.**, 289, Edgware Rd., W.2. Tel.: Pad. 5891. [0-165

## DYNAMOS, MOTORS, ETC.

**ALL** Types of Rotary Converters, electric motors, battery chargers, petrol-electric generator sets, etc., in stock, new and second-hand.

**A.C.-D.C. Conversion Units** for Operating D.C. Receivers from A.C. Mains, 100 watts output, £2/10/-; 150 watts output, £3/10.

**WARD**, 46, Farringdon St., London, E.C.4. Tel.: Holborn 9703. [0518

**A.C. and D.C. Motors** from 19/6; new and second-hand, guaranteed; also repairs department. Enso, 1-3, Brixton Rd., S.W.9. Phone: Reliance 1694. [0644

## Wanted

**WANTED**, propeller for Lucas wind dynamo, or complete unit if reasonable.—26, Fabian St., Swansea. [8761

## METERS, ETC.

**FERRANTI A.C.-D.C. Tester**, £3/10/6; 0/1 m.a., 20/-, or 31/- with ohms-watts-decibel scales; large-scale multimeters and kits (see last month's advert.); list, 1/4d. stamp.—L. A. MacLachlan and Co., Strathyre. [8758

## TEST EQUIPMENT

**D.C. Avometer**, almost new; 32/5.—J. C. Jack, Strathaven Rd., Lesmahagow. [8766

**BEEDE** Moving Coil, 0-1 m/a., 3/4 in., 100 ohms internal, 1,000 ohm sp. shunts; 29/6.—Superadio, Dantzic St., Manchester. [8754

## Wanted

**FERRANTI A.C.-D.C. Circuit Tester**, state price.—Frost, 14, Purser Rd., Northampton. [8765

**WANTED**, Universal Avometer, D.C. Avometer or similar; cheap.—48 Frampton Rd., Gloucester. [8756

**SERVICEMAN** Requires All-wave Test Oscillator, multirange meter.—Box 1168, c/o *The Wireless World*. [8759

**REQUIRED** Immediately, laboratory test instruments and sub-standard meters.—Write, giving full particulars and prices, Box 1132, c/o *The Wireless World*. [8746

## VALVES

**ALL** Types of American Tubes in Stock of Impex and Arcturus makes at competitive prices.

**WE** Can Also Supply a Full Range of Guaranteed Replacement Valves for Any British non-ing. American or Continental type at an appreciably lower price.

**SEND** for Lists of These, and also electrolytic condensers, line cords, resistances, etc.

**CHAS. F. WARD**, 46, Farringdon St., London, E.C.4. Tel.: Holborn 9703. [0452

**METROPOLITAN RADIO SERVICE**—American valves, in all types, trade supplied.—1021 Finchley Rd., N.W.11. Speedwell 3000. [0456

## COMPONENTS

SECOND-HAND, CLEARANCE, SURPLUS, ETC.

**OLIVER'S** Aluminium Chassis, 18 s.w.g., 16in. x 10in. x 3 1/2in.; 7/6; any dimensions to order; quotations free.

**DUBILIER** 1-watt Resistances, all values, 3/6 dozen; Centralab volume controls, with switch, each 2/-.

**SPEAKER** Transformers, mains or battery pentode; each 3/6; list free.—Olivers, 676, Christchurch Rd., Boscombe, Hants. [8757

# NEW VALVE TESTER

ACCURATELY CHECKS ALL ENGLISH, CONTINENTAL AND AMERICAN VALVES

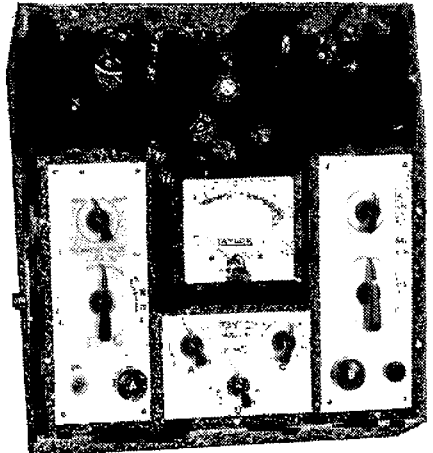

This British-made, new and comprehensive Valve Tester accurately checks the mutual conductance of all English, American and Continental valves from 0.25 milliamperes per volt and up to 24 MA/volt. It provides for over 1,000 readings and has 17 valve holders of 15 different types ranging from the midjet valve holder for testing Deaf-Aid Valves, to the latest Mullard side contact and the American octal, octal and bantam bases. It is THE ONLY TESTER OF ITS KIND and is fully guaranteed. Portable Model £12.17s. Bench Model £12.12s. **11 1/2 Gns.**

Our range of precision-made instruments includes: MULTI-RANGE AND SINGLE RANGE METERS, SIGNAL GENERATORS, OSCILLOSCOPES, ETC.

Send for details to: **TAYLOR ELECTRICAL INSTRUMENTS LTD.**, 45, FOUBERTS PLAGE, REGENT STREET, LONDON, W.1

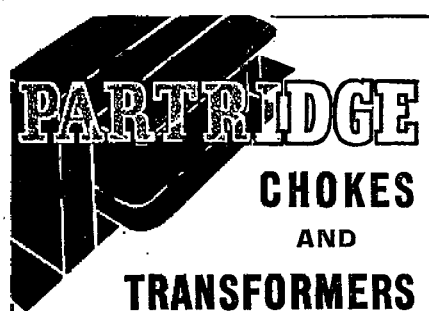

It was to be expected that, as the leading manufacturers of high grade transformers, we should be asked to handle certain work relating to w.r. requirements.

But it has not been forgotten that the trade and the private user provided the demand that made possible the popularity of Partridge Transformers.

Our policy is, therefore, to study the needs of old customers and to endeavour to maintain pre-war standards of quality and service. Although Government work must be given priority, the Partridge Organization is still primarily for you.





COMPONENTS—SECOND-HAND  
CLEARANCE; SURPLUS, ETC.

**R.** RADIO CLEARANCE, Ltd.  
63, High Holborn, W.C.1. Phone: Holborn 4631.

**FILAMENT** Transformers, input 200-250 volts, output 4 volts 4 amps., 4 volts 6 amps.; 4/11 each.

**MAINS** Transformers, American windings, input 200-250 volts, tapped, output 350-0-350 volts, 100 m.a., 5 volt, 2 amp., 6.3 volt., 5 amp.; 8/6 each.

**G.E.C.** Mains Transformers, American windings, 350-0-350 volt, 65 m.a., 5 volt, 2 amp., 6.3 volt, 2.5 amp., suitable for replacements in G.E.C. models; 5/6 each; auto transformers, 100-230 volt, 6.5 each;

**24 MFD.** Can Type Electrolytics, 450 volts working; 1/6 each.

**T.C.C.** 8 Mfd. Can Wet Type Electrolytic, 450 volts working; 1/3 each.

**PRESS** Button Units with 6 Press Buttons, ready for wiring into set, with circuit; 6/11 each.

**BULGIN** 20 Ohms, wire-wound pots; 1/- each.

**STRANDED** Push Back Wire; 1d. yard, 12 yds. 10d.

**CHASSIS** Mounting Valve Holders, American, 4, 5, 6 and 7-pin, 4d. each; Octal 6d. each; Local 10d. each; 7-pin English type, 3d. each.

**ROTHERMEL** Piezo Crystal Speakers, 7-pin, cone, list 55/-, our price 10/6 each; 10in. cone, ditto, 12/6.

**CRYSTAL** Pick-up, high grade American bronze finish, complete with arm; 2/- each.

**POLAR** N.S.F. 1 Watt Resistances; 4d. each 3/9 dozen; all sizes up to 2 meg.

**WEARITE** Mains Transformers, made to strict electrical standards, wire end type, all windings centre tapped, screened primaries, tapped inputs 200-250 volts, screw adjustment.

**TYPE R.C.2** 350-0-350 Volts 120 m.a., 4 volts 2.5 amp., 4 volt 5 amp.; 12/6 each.

**TYPE R.C.4** 500 0 500 Volts 150 m.a., 4 volt 2 amp., 4 volt 2 amp, 4 volt 2.5 amp., 4 volt 5 amp.; 2/1 each.

**TYPE R.C.2** Drop-through Type, capped.

**TYPE R.C.4** Upright Mounting Type, fully shrouded

**PHILCO** Mains Transformers, American windings, 350-350 volts 65 m.a., 6 volt 3 amp., 5 volt 2 amp., 5/- each; ditto but 80 m.a., 6/6 each; ditto but 90 m.a., 7/6 each.

**AMERICAN** C.T.S. Volume Controls, finest made, divided spindles, length 2 1/2 in., with switch 2,000, 5,000, 10,000, 25,000, 50,000, 100,000; 2/11 each; less switch, 50,000, 100,000, 500,000, 1/9 each; wire-wound 5 watt (less switch), 10,000, 25,000 ohms, 2/- each.

**BRADLEY** Wire Wound Volume Control, with switch, 600,000 ohms; 1/- each.

**WEARITE** Chokes, screened; 1/6 each.

**PLESSEY** Dry Electrolytics, can type, 12 mfd x6 mfd, 500 volts working, 1/6 each; 12 mfd x16 mfd, 350 volts working, 1/6 each; 12 mfd x8 mfd, 500 volts working, 1/6 each; 16 mfd x8 mfd, 475 volts working, 1/6 each; 6 mfd x6 mfd, 500 volts working, 1/6 each; 12 mfd x50 volts working, 1/6 each; 8 mfd x8 mfd x8 mfd, 500 volts working, 2/11 each; 16 mfd x8 mfd, 500 volts working, 2/11 each; 16 mfd, 450 volts working, 1/3 each; 16 mfd x16 mfd, 350 volts working, 1/6 each.

**B.1** Cardboard Electrolytics, wire end type, 550 volts working, 8 mfd., 1/9 each; 8 mfd x8 mfd, 4 lead type, 2/9 each; 8 mfd. Midget tubular, wire end 550 volt working, 2/- each; bias wire-end type, 50 mfd 12 volt, 1/3 each; 50 mfd, 50 volt., 1/6 each.

**TUBULAR** Wire-end Non inductive Paper, all sizes up to 0.1, 5d. each; 4/9 doz.

**METAL** Case 1 Hole Fixing Electrolytic Condensers, 550 volt working, 8 mfd.; 2/6 each.

**STANDARD** Telephone Headphones, resistance 2,000 ohms and 4,000 ohms; 6/11 pair

**VOLUME** Controls, 1,000 and 5,000 ohms with switch, 1/3 each; G005 3-gang tuning condenser units, with trimmers, 2/11 each.

**PLESSEY** P.M. 8in. Moving Coil Speakers, with pen-trans., 11/6 each; less pen-trans., 9/6 each

**PLESSEY** Energised Speakers, 1,500 ohm field, 8in. cone, with trans., 7/11 each; 10in. cone, 2,500 and 1,000 ohm field, with trans., 12/6 each; 6in. cone, 2,500 and 1,500 ohm field, 5/11 each.

**RUBBER** Grommets, 4d. per dozen.

**S.P.D.T.** Twist Switches, 1/1 each.

**RAYTHEON** First-grade Valves, largest stockists, all types in stock including glass series, glass octal series, metal series, bantam series, single-ended metal series, and resistance tubes; all at most competitive prices; send for valve lists.

**ALL** Orders Must Include Sufficient Postage to Cover.

**A** Hours of business: 9 a.m.-8 p.m. Saturdays 9 a.m.-1 p.m.

**RADIO CLEARANCE, Ltd.** 63, High Holborn, London, W.C.1. Telephone: Holborn 4631. [8737

LEONARD HEYS

for ALBA, PILOT, FERGUSON, and other first-class RADIO RECEIVERS.

LEONARD HEYS

for REMINGTON - RAND, PACKARD, CASCO, RABALDO, and SHAVEMASTER Electrical Dry Shavers.

LEONARD HEYS

for the BEST lines in Electrical FIRES - IRONS - TOASTERS - HAIR DRYERS - VACUUMS - SUNLAMPS - KETTLES.

LEONARD HEYS

for SMITHS - HAMMOND - TEMCO - GEC and FERRANTI Electric Clocks.

LEONARD HEYS

for WIRES and CABLES for RAYTHEON American Valves for TUNGSRAM and HIVAC Valves for PROPRIETARY MAKES of COMPONENTS and for every imaginable Radio Accessory.

Send TRADE CARD for our lists.

Leonard Heys  
(WHOLESALE ONLY)

Faraday House, 36, Henry Street,  
BLACKPOOL, Lancs.

COMPONENTS—SECOND-HAND  
CLEARANCE, SURPLUS, ETC.

**R**YALL'S RADIO, 280, High Holborn, London, W.C.1, offer new goods, post free.

**ELLIPTICAL** Speakers, Celestion, suitable Ekco replacements, 750 and 1,250 ohms, less transformers, speech 25 ohms, new, handle 8 watts, carry up to 120 m.a.; 3/9 each to clear.

**SPEAKERS**, pairs, brand new, elliptical cone speakers, made by first class firm, quality of reproduction outstanding, push-pull pentode transformer, fields 325 ohm for smoothing choke, 8,600 as bleeder, circuit available, handle 10-15w.; 12/9 pair.

**HEAVY** Duty Mains H.F. Chokes, Goltone, 75w. high inductance type, 1/6; 180w. low inductance type, 1/-.

**MAINS** Transformers, drop through chassis type, top cover with mains adjustment, input 200-250v., outputs 350-350, 80 m.a. 4v. 2 1/2a., 4v. 4-5 amp., heavy jobs, 6/9 each.

**B.1** 0.05 Non-inductive Tubulars, 350r. wkg., new stock, 1,3 doz, 9 - gross; Cornel-Dublier mica, sizes 001, 002, 005, 1/3 dozen.

**EPICYCLIC** Drives, Polar ex Ferranti, and Plessey, long or medium spindles, ratio 10-1; two for 1/3 or 3/9 dozen.

**PLESSEY** Fully Screened 2-gang Condensers, short spindles, with top trimmers, 2/9; Plessey mid-gate 2-gangs semi screened, 2/9; both 0005 straight type.

**PLESSEY** 3-gang Straight Type Condensers, top trimmers, fully screened, brand new, 2/9; Coscor 3 gangs ditto, 1/9, or 12/- dozen.

**FERRANTI** Air Core Type Tuning Coils, transformer wound, can be used as band pass, tuned grid with reaction, chassis type; three for 2/6, with coil connections.

**I.F.** Cores, Air, size 1 1/4 x 1 1/2 x 4in. high, complete with double trimmers, 4/9 dozen; Erie 60 ohm 1/2 watt resistance, 1/3 dozen; NSF 1 watt 1/4 meg., 1/3 dozen; 600 ohm wire wound 3 watt resistance, four for 1/3.

**THRIMBLE** Top Caps, 24 for 1/3; clip on bulb holders, 12 for 1/3; Volume controls, 1/2 meg. with switch, Morganic Stackpole, ex K.B., 1/9; Murphy type 1/2 meg. with D.P. switch, 1/9.

**BRITISH** Type Magic Eye Valves, 4v. 1/2a. heater, octal base, 3/3; American wafar type 4 and 7 pin valve holders, 2/3 dozen; British 5 and 7 pin VIX, 2/6 dozen.

**MAGNAVOX** 7in. Cone Speakers (8in. overall), ribbed pattern, ideal replacement speakers, 2,000 ohms pentode transformers; 7/- new.

**SATOR** 1meg. Pots with Switch, 1/3 each, 7/9 dozen; 10,000 ohm broad base tone control type, less switch, 1/3 each, 6/9 dozen

**ELECTROLYTICS**, B1, 20x20 mfd. at 350v., 25x25v., 1/3; size 3 n.x2 1/2 in., B.1 2x2x2, 400v., peak, 1/3 each, 9/- dozen; 25x25v., 1/3; Plessey 30x8x2, 300v. wkg., 1/6 each, 12/- dozen.

**SATOR** 1,500v. Test Tubular Condensers, assorted, equal numbers, 0.0002-3.5, 0.001, 0.05, 0.05, 0.002-3, mica; all at 50 for 2/6

**ASSORTED** Resistances, 50 for 2/6; 1-watt carbon, U.S.A. make, reasonable assortment given, sizes approx. 450-12,000-17-60-70-90-120 thousand ohms.

**PUSH** Back Wire, 18g., 50 yards, 3/6; Systodex 1 1/2 mm., 1/2 gross; 5/-; twin screened 2x14-36, British made, 12 yards, 2/6; minimum quantities.

**REX** Type Switches, 4B, 2P, 4w., with shorting plate on 5 switches; 2/6 each, length 7in., spindle 2in.; ditto, 3w. 4P, 3B., 1/6; 3w. 3P, 3B., with shorting plate, 1/6; 3w. 2P, 4B., 1/6; any combinations of this item supplied; screens, 3in. x 1/2 in. x 3in. x 1/2 in., 5 for 1/3.

**TRIMMERS** on Porcelain Plessey, double and single, 50-100-200-160 ohm. approx.; 50 for 2/6; special price quantities.

**PLESSEY** 6,500 ohm. 8in. Speakers, with pentode transformer, 6/6; U.S.A. valve screens (goat), complete, 3 for 1/4.

**SCREENED** Leads about 4 yards, 3-way, two only screened, 1/3; extra heavy for car sets, with spades, 1/3, 2 1/4 yards.

**HAMMERLUND** 30mm. Midget Trimmers on Pazo-lin, 1/9 dozen; ultra type brown knobs, octangle, plain arrow, L.B. 1/9 dozen, 8/6 gross assorted, 10/6 gross plain or arrow.

**SMALL** Iron Core Coils, made by Varley, aerial and oscillator, 465 k/c, 2/6 pair, with coil connections for straight type gang.

**SPECIAL** Offer, 2v. valves, similar to Triotron, HD2, SD2, YD2, ZD2, UD2, all 2/- each, new; also type 46 U.S.A., 3/6, A.C. Class B.

**WEARITE** 110 kc. I.F.'s with Top Trimmers, 1/6 each; screened pass air core superhet coils, ex Halcyon, setted chassis type, 4/9 set five; 110 kc. with coil details. [8894

CLIX  
FLEXIPIN Self-Adjusting PLUGS

If your radio CRACKLES when you touch the plug which connects your set to the wall socket, it is because the plug-pins are not making proper contact with the socket-tubes.

The CLIX plug has been specially designed to eliminate this trouble and its self-centering, expanding pins will fit and make perfect contact in any make of BSS Socket.

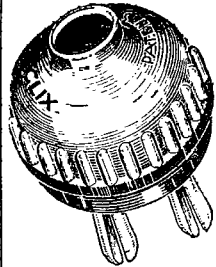

CLIX  
5 amp 2-pin  
"M" type  
plug as used  
by all the  
leading radio  
manufacturers  
Costs 4 1/2  
only 4 1/2

A full range of 2 and 3 pin BSS types in 2, 5 and 15 ampere sizes is available from all good Radio and Electrical Dealers.

If in difficulty write to the makers:—

British Mechanical Productions Ltd.

1, Church Road, Leatherhead, Surrey.

FIT "CLIX" and CUT THE CRACKLE



# Better Results with SOLON Electric SOLDERING

- NO DIRT—**  
Heating element clamped inside bit. No flame, hence no dirt.
- CONSTANT HEAT—**  
Switch on—ready in 4 minutes. Heat maintained while current is on.
- PERMANENT RESULTS—**  
Perfect jobs always—no dirt or corrosion with Solon resin-cored solder.

**ECONOMICAL IN USE—**  
15 hours' continuous use requires only 1 unit of electricity.

**WEARING PARTS REPLACEABLE—**  
These can be supplied and fitted without trouble.

Supplied complete with resin-cored solder, flex and lamp adaptor 9/4.  
Solon resin-cored solder 6d. per reel.

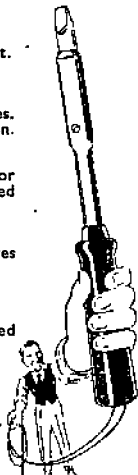

It's Easier with a



W.T. HENLEY'S TELEGRAPH WORKS Co., Ltd. (Dept. 4/E)  
MILTON COURT, WESTCOTT, DORKING, SURREY

## WARD WE MANUFACTURE:

**ROTARY CONVERTERS** DC/AC for operating P.A. amplifiers, Radio Receivers, etc.

**DC/DC ROTARY TRANSFORMERS, SMALL ALTERNATORS, SMALL D/C MOTORS, H.T. GENERATORS, MAINS TRANSFORMERS** up to 10 kva. **PETROL ELECTRIC** generator sets up to 50 k.v.a.

**BATTERY CHARGERS** for private and industrial use.

We can also handle general small engineering work.

Full details of any of the above upon request

**CHAS. F. WARD**  
46, FARRINGTON ST., LONDON, E.C.4  
Telephone: Holborn 9703.

## AMPLIFIERS !!

for A.R.P. Shelters, Regimental Institutes, Canteens, Factories, etc.

We have some SPECIAL BARGAIN OFFERS of first-class makes, all new and perfect and we have supplied over 100 large firms since the start of the war. Example:—

**GRAMPIAN** Universal AC/DC. Output 10-watts. Complete equipment with Senior M/Coil mike, floor stand, speaker, etc. £15.15.0

**GRAMPIAN** Universal AC/DC. Output 12-watts. Complete equipment with gramophone playing desk, Senior M/Coil mike, floor stand, speaker, etc. Ideal for Institutes, etc. 28 guinea model £15.13.6

Please send your enquiries to us—we can save you pounds.

Also last few **CROSBY MOBILE SUPERHET CHASSIS**. Operating entirely from 6-volt battery, 6-valve circuit tuning 15 to 555 metres in three bands. Output 3-watts. Current only 2-amps. New, slightly soiled, £5.10.0 with valves and speaker.

Get our latest Supplementary Bargain List.

**M. R. SUPPLIES, 68, NEW OXFORD STREET, LONDON, W.C.1. Museum 2968.**

### COMPONENTS—SECOND-HAND CLEARANCE, SURPLUS, ETC.

#### PREMIER RADIO.

PLEASE See Our Displayed Advertisement on page 7. [0488]

#### SOUTHERN RADIO'S Bargains.

ALL Articles Fully Guaranteed. Postage extra.

**5/-**—Parcel of useful components, comprising condensers, resistances, volume controls, coils, wire circuits, etc., etc value 25/- 5/- per parcel.

**10/-**—Parcel of useful components, comprising 100 articles, including electrolytics, valve holders, etc., etc., value 55/- 10/- per parcel.

**21/-**—Small traders' parcel of components, comprising at least 150 articles, including 24 assorted tubular condensers, 24 valve holders, 36 resistances, 12 Mainsbridge type condensers, 6 electrolytics, etc., etc., value 85/- 21/- per parcel.

**5/-**—Twelve Mainsbridge type condensers, 1-2.4 mfd.; 5/- per dozen.

**7/6**—24 assorted tubular condensers, up to 2 mfd. 7/6 for 24; Telsen 3-range meters (volts and milliamps), 4/-; Morse tappers, 2/11.

**BZZZERS**, 1/6; crystal detectors, 2/-; crystal sets, 5/6; crystals, 6d.

**2/6**—Ormond loud speaker units, 2/6; A.C. eliminators, with trickle charger, 37/6.

IN Spite of Increased Costs of Production, whilst our present stock lasts no increase will be made in prices. It is, however, advisable to buy now. Thousands of bargains for callers.

**SOUTHERN RADIO**, 46, Lisle St., London, W.C. Gerrard 6653. [8904]

**KEN-RAD**, Arcburns, reduced prices. Volume controls, condensers.—Wood, 33, Kingsal Rd., Catford, S.E.6. [8765]

**VAUXHALL**—Polar 4-gang straight .0005 mid. condensers, 13/6; Clix valveholders, class 5, 5-pin 5d., 7-pin 6d.; resistors, one watt, 4d.

**VAUXHALL**—Collaro A.C. gramophone motors, boxed 29/-; flat sheet aluminium, 12x12in., 3/-, 18x18in. 5/6.

**VAUXHALL**—Rola G12 P.M. speakers, 63/6; G12 energised, 55/-; brand new, with input transformer.

**VAUXHALL**—Rola 8in. P.M. speakers, 14/9; 10in. energised 25/0, 19/9; all complete input transformer.

**VAUXHALL**—Iron-cored coils on base, with switch, terminals, circuit, 2-gang 12/6, 3-gang 19/6.

**VAUXHALL**—Three-band 2-gang coils for mains superhet, switch, terminals, 18/-; volume controls, 2/-; with switch 3/-.

**VAUXHALL**—T.C.C. aluminium containers, 8 mfd. 500 v., 3/-; T.C.C. cardboard containers, 8 mfd. 600 v., 2/-; 8 plus 8 mfd., 3/6.

**VAUXHALL**—Electrolytic condensers, 50 mfd. 50 v., 1/9; 50 mfd. 12 v., 1/6; 0.1 mfd., 3d.; tubulars.

**VAUXHALL UTILITIES**, 162a, Strand, London, W.C.2.—Write for free list. [8728]

**MAINS RADIO DEVELOPMENT COMPANY** Carry on Their Super Service Under Management of Proprietor's Wife: list 232 contains many fine bargains; send stamp; note new address.

**ERIE** Unused 1-watt Resistors, all sizes; 4d. each, 3/6 dozen; 2-watt, 7d.

**CENTRALAB** Latest Potentiometers, long spindle, all sizes; 2/5, with switch 2/6.

**CLIX** Latest Chassis Valve-holders, English, 5- and 7-pin, 4d.; all American sizes, 6d.; standard sleeving, 1 1/2d. yard.

**DUBILIER** Unused Mini Condensers, midget tags, 0.00005 to 0.0005 mfd.; 3d. each, 2/3 dozen.

**T.C.C.** New Tubular Wire-end Condensers, 350v. working, 0.0001 to 0.05 mfd., eight useful sizes in each parcel; 12 condensers 2/-, 25 for 3/6.

**N.S.F.** Wire-end Resistors, unused, eighteen useful marked and colour-coded sizes in each parcel of 50 resistors for 2/6.

**TUBULAR** Condensers, new, 400v. w. wire ends, non-inductive, best make, all sizes 0.0001 to 0.1 mfd. 4d., 0.25 and 0.5 mfd. 8d.

**T.C.C. Metal Can**, one-hole dry 8 mfd. electrolytics, 500v. w., 2/6; Dubilier 4-mfd. electrolytics, 250v. w., 10d.

**MAINS RADIO DEVELOPMENT Co.**, 52a, Church Crescent, Muswell Hill, London, N.10. Tudor 4046. [8709]

# TAYLOR PRECISION INSTRUMENTS VALVE TESTER

Taylor Model 45 Valve Tester is a superb instrument for the service engineer and research worker. Accurately checks mutual conductance of all English, American and Continental valves (from as low as 0.25 milliamps per volt and up to 24MA/volt) as well as filament continuity, electrode shorts and cathode leakage. Seventeen holders. **£12 1 6** British Made. MODEL 45

# SIGNAL GENERATOR

This precision-built All-wave Signal Generator offers an unusually wide range. It has a frequency range from 100kc. to 46m.c. (6.5 to 3000 metres). Operates entirely from A.C. mains. Perfect workmanship throughout. British Made. **£10 10 0** MODEL 60

# UNIVERSAL METERS

For quick and accurate measurements of A.C. and D.C. Volts and Amps, Ohms, Capacity, Inductance and Decibels. Hand calibrated. Strongly constructed and well balanced. MODEL 80A (2000 ohms per volt A.C. & D.C.) **£11 11 0**

Full stocks carried by **WEBB'S RADIO**, Attractive Easy Terms. Ask for further details from:—

# WEBB'S LONDON

14 SOHO ST., OXFORD ST., W.1

(Open 9.30 a.m. to 6.0 p.m.). Telephone: Gerrard 2089  
Emergency Branch: 58, Victoria Street, St. Albans  
Birmingham Depot:—41, Carrs Lane.

# LEARNING MORSE

An easy method of mastering the international signal code

Everyone interested in acquiring skill in the use of Morse should obtain this little handbook, which not only explains the code itself, but also enables the beginner to make rapid progress.

**PRICE 6d. NET**  
By post 7d.

Published from the Offices of  
**"THE WIRELESS WORLD"**  
DORSET HOUSE, STAMFORD ST., LONDON, S.E.1

**COLLINS**  
**WIRELESS**  
**DIARY**  
1940

144 pages of specially written matter  
for all engaged in the Wireless  
Industry

Leaf 5: 3      Three Days to Page  
From 13 to 7.6 each

From all Booksellers & Stationers

LONDON      **COLLINS**      GLASGOW  
CLEAR-TYPE PRESS

**COMPONENTS—SECOND-HAND  
CLEARANCE, SURPLUS, ETC.**

**COULPHONE RADIO**, Ormskirk.—Collaro A.G. motors, 12in. turntable, 24/-; Dubilier 1 watt resistors, 3/3 per dozen; 14<sup>th</sup> ed. stamp catalogues. [8764]

**5/-** Only.—Bargain parcel comprising speaker cabinet, drilled steel chassis, condensers, resistances, and many other useful components, worth 35/-, limited number; postage 1/-.—Bakers Selhurst Radio, 75, Sussex Rd., South Croydon. [8723]

**CLEARANCE**.—30,000 assorted resistances, 250 ohm, 400 ohm, 50,000 ohm, 75 ohm, 500 ohm, 150 ohm, 1 meg., 5 meg., 2,000-3,000 condensers, 0.00085, 0.00001, 0.00005, 0.005 tubular, 0.001 mica; others invited.—G. F. and H. Burton, Bernard St., Walsall. [8743]

**Wanted**

**WANTED**, Colvern Ferrucat coils, G.1, 2, 3.—C. F. Gibbs, 93, Pennygate, Spalding. [8748]

**GOODMAN'S "Infinite Baffle" Speaker**, Telefunken 1001 pick-up, powerful gramophone motor.—Box 1144, c/o *The Wireless World*. [8747]

**"WIRELESS WORLD"** Paraphase Quality Amplifier, with radio unit, Sound Sales, 4-12 watts preferred.—Write 15, Cecil Rd., Erdington, Birmingham. [8749]

**MISCELLANEOUS**

**CARDS**, memos., billheads; 1,000, 5/9; samples.—"B," Tices, 11, Oaklands Grove, London, W.12. [8741]

**A.R.P. Emergency Electric Lighting**; engine electric sets, 500 watts, £16; 150 watts, £12; details on request; wardens' exchanges; telephones, wire, cables, etc., for shelters; motor pumps, 72/6; exhaust fans, 25/-.—Leslie Dixon Co., 218, Upper Thames St., London, E.C.4. [8740]

**EVERY Radio Dealer Who is Not a Regular Reader** of "The Wireless and Electrical Trader" should send his trade card at once for a specimen copy and full details of the "Trader" Services. "The Wireless and Electrical Trader" has the widest influence, the largest weekly circulation, and is read by all the leading manufacturers and traders. Trade only. 15/- per annum, post free.—Published at Dorset House, Stamford St., London, S.E.1. [0615]

**REPAIRS AND SERVICE**

**L.S. Repair and Rewinding Service**.—Prompt service, see below.

**REPAIRS to Moving Coil Speakers** a Speciality, new cone assemblies fitted, speech coils and fields wound or altered, mains transformers, chokes and eliminator repairs; prices quoted.

**SPEAKER Transformers Class "B"** L.F. transformers and pick-ups rewound at 4/- each. Post free. Discount trade. Estimates free. Guaranteed satisfaction.—L.S. Repair Works, 5, Balham Grove, London, S.W.12. 'Phone: Battersea 1321. [0394]

**GUARANTEED Repairs**, any transformers, choke, motor armature, converter, dynamo, etc.; keenest prices, immediate quotation, prompt, dependable service.—See below.

**L.T.P. (LONDON TRANSFORMER PRODUCTS, Ltd.)**, Willesden, N.W.10. Willesden 6486 (3 lines). [6892]

**MAINS Transformer Service**, repairs, rewinds, or construction to specification of any type, competitive prices and prompt service.—Sturdy Electric Co., Dipton, Newcastle-on-Tyne. [0516]

**METROPOLITAN RADIO SERVICE**.—Guaranteed repairs to American and British receivers; American valves, service parts and rewinds; trade supplied.—1021, Finchley Rd., N.W.1. Speedwell 3000. [0435]

**CHALLENGER RADIO CORPORATION**.—Repairers of British and American receivers to the trade; lowest prices with good workmanship; "service with a guarantee"; also speakers, transformers, coils, etc., rewound.—Challenger Radio Corporation, 31, Craven Terrace, Lancaster Gate, London, W.2. Paddington 6492. [8732]

**SITUATIONS VACANT**

**RADIO Engineer Wanted** for Permanent Position, must have practical experience modern receivers and high power amplifiers, City and Guilds or equal certificate; salary £3/5 per week or higher according to qualifications and experience.—Apply by letter, with references, age, experience, to The Swindon Radio Relay Exchange, Ltd., 14, Victoria Rd., Swindon, Wilts. [8752]

# TRIX

## SOUND EQUIPMENT

is in constantly increasing demand for public address installations where Reliability and Quality are the prime considerations. Equipments recently supplied cover 4 watts to 400 watts speech output. Let us send you our latest lists showing 28 different amplifier models in addition to Microphones, Speakers and all Public Addressories.

★ A.C. and A.C./D.C. Amplifiers, 12 volt Battery Models, 2 way Loudspeaking Systems. Rack type equipments, etc., for Factory speech and music installations, A.R.P., Hospitals, Dance-Bands, etc., etc.

**THE TRIX ELECTRICAL Co., Ltd.**  
65, BOLSOVER STREET, Gt. Portland Street,  
London, W.1. 'Phone: Euston 5471/2.

## Dits and Dahs!!

THIS IS THE LANGUAGE OF THE AIR THAT EVERY RADIO AMATEUR, PILOT, SHIP'S OPERATOR, ETC. MUST BE ABLE TO READ AND SEND. IT IS EASILY AND QUICKLY LEARNED BY THOSE WHO TAKE UP A **CANDLER CODE COURSE**



In the "Book of Facts," which will be sent free on request, you will see that full information is given concerning the subjects covered by Courses for Beginners and also for Operators who desire to greatly increase their w.p.m. speeds.

**THE CANDLER SYSTEM** not only teaches you the right way to send, but the right way to read code sound just as easily as you read print by sight.

**JUNIOR Scientific Code Course** for beginners. Teaches all the necessary code fundamentals scientifically. **ADVANCED High-Speed Telegraphing** for operators who want to increase their w.p.m. speed and improve their technique.

**TELEGRAPH TOUCH-TYPEWRITING** for those who want to become expert in the use of the typewriter for recording messages.

Either Course is supplied for Cash or on Monthly Payment terms.

**COUPON**

Please send me Free and without obligation a copy of the Candler "Book of Facts."

NAME.....  
ADDRESS.....  
Post coupon in 3d. unsealed envelope to London Manager  
(Room 55W) 121, KINGSWAY, LONDON, W.C.2  
**CANDLER SYSTEM CO.**  
Candler System Co., Ashville, North Carolina, U.S.A.

## ALL-POWER

**MAINS EQUIPMENT SPECIALISTS**

To Manufacturers: We are equipped and qualified to handle quantity orders for Chokes and Transformers of every type—Power, Output, Intervalve and Line.

Enquiries Invited — Quotations by return.

To Experimenting Amateurs: We are still catering for your special requirements. Write Dept. "E.A." for quotation.

For Efficiency, Reliability and Speedy Delivery get in touch with

**ALL-POWER TRANSFORMERS LTD.,**  
Contractors to H.M. Govt. and the Services,  
8a, Gladstone Road, Wimbledon, S.W.19  
LIBerty 3303

## ENGINEERS! ARE YOU EARNING LESS THAN £10 PER WEEK?

If so, you cannot afford to carry on without reading our 258-page Handbook. The book explains clearly and definitely many ways of carving out a successful career. Among other things it explains the Services of our unique Appointments Department; outlines Home-Study Courses in all branches of Civil, Mechanical, Electrical, Motor, Aero, Wireless, "Talkie" Engineering, Building, Govt. Employment, etc., and gives details of B.Sc., A.M.I.C.E., A.M.I.E.E., A.M.I.Mech.E., A.M.I.A.E., A.M.I.W.T., A.M.I.R.E., G.P.O., MATRIC., and all Exams. We Guarantee — "NO PASS—NO FEE." whether you be an old hand or a budding apprentice get this book to-day. FREE and POST FREE.

**BRITISH INSTITUTE OF ENGINEERING TECHNOLOGY**  
867, Shakespeare House, 17/19, Stratford Place, London, W.1.

268 PAGES **Free!**

SITUATIONS VACANT

AIR MINISTRY.

CIVILIAN Wireless Instructors Required.

VACANCIES Exist for Civilian Wireless Instructors at the Electrical and Wireless School, Royal Air Force. The commencing rate of pay is £4 a week inclusive, which may be increased to £4 5s. a week after a short period of satisfactory service. Candidates must be capable of lecturing and must have a sound knowledge of electrical principles and their application to Radio and low-power electrical engineering. Applications should be addressed to the Under Secretary of State, Air Ministry, Savoy Hill House (S.5.d.), London, W.C.2, giving full particulars as to previous experience, age, etc. Candidates will be required to appear before a Selection Board at the School, for interview and test. The test will include the giving of a lecture on any subject which may be chosen by the candidates, involving the principles of modern radio. Lecturing sequence and style are most important. [0571]

DESIGNER Draughtsman Required by Large Company Specialising in Development of Aircraft Radio Apparatus, capable of initiating design of chassis, mechanism's, switches and similar component parts.—Write Box 1124, c/o *The Wireless World*. [8745]

RADIO Testers Required to Undertake Test Work on Communication Receivers and Low-powered Transmitters, must have factory experience on similar or broadcast apparatus (Coventry district).—Write giving age, experience and salary expected, to Box 1169, c/o *The Wireless World*. [8751]

VACANCIES Exist for Civilian Wireless Instructors at the Electrical and Wireless School, Royal Air Force. The commencing rate of pay is £4 a week inclusive, which may be increased to £4 5s. a week after a short period of satisfactory service. Candidates must be capable of lecturing and must have a sound knowledge of electrical principles and their application to Radio and low-power electrical engineering. Applications should be addressed to the Under Secretary of State, Air Ministry, Savoy Hill House (S.5.d.), London, W.C.2, giving full particulars as to previous experience, age, etc. Candidates will be required to appear before a Selection Board at the School, for interview and test. The test will include the giving of a lecture on any subject which may be chosen by the candidates, involving the principles of modern radio. Lecturing sequence and style are most important. [0616]

THE BEST WAY to LEARN MORSE

"MASTERS" INSTRUCTIONAL RECORDS Prepared by an ex-R.A.F.V.R. Signal Instructor, these records contain messages at a speed from 2 to 15 words a minute. Details on Request.

Price 3/6 each or Complete Set of Three 9/-.  
C. E. MASTERS,  
Forest Way, Pound Hill, Crawley, Sussex.



Mains Transformers as specified for *The Wireless World* High Quality Communication Receiver Type WW51-45/-.

**W. BRYAN SAVAGE LTD.**  
Weshmoreland Rd., London, N.W.9. Phone: Colindale 7131

THE INSTITUTE OF WIRELESS TECHNOLOGY

(Founded in 1925. Incorporated)  
**PROFESSIONAL MEMBERSHIP**  
The advantages of professional membership are open to all qualified wireless engineers. Full information, with syllabus, may be obtained from the Assistant Secretary, Institute of Wireless Technology, 25, Firs Drive, Palmers Green, London, N.13. Phone: PALMERS GREEN 2413

LESLIE L. HIND, for 15 years in charge of the illustrating department of "The Wireless World" and "Wireless Engineer," owing to the present war seeks employment as **COMMERCIAL ARTIST or DRAUGHTSMAN.**  
Write Box No. 8742, c/o "The Wireless World," Dorset House, Stamford Street, S.E.1.

SITUATIONS WANTED

RADIO Engineer (31), former service manager at manufacturers, experienced all makes of receivers, technical correspondence, control staff, clean driving licence, engaged in radio industry since 1925, desires change, preferably London area.—Box 1180, c/o *The Wireless World*. [8762]

TECHNICAL TRAINING

BEST Wartime Training in Engineering is Home Study with the T.I.G.B., free from black-out and travel difficulties; trained men are urgently required for well-paid technical posts in all branches and in the Services.—Write to-day for "The Engineer's Guide to Success"—free—containing world's widest choice of engineering courses—over 200—covering all branches. **THE TECHNOLOGICAL INSTITUTE OF GREAT BRITAIN**, 82, Temple Bar House, Fleet St., E.C.4. (Founded 1917. 20,000 Successes.) [8722]

PATENT AND TRADE MARK AGENTS

GEE and Co. (H. T. P. Gee, Mem. R.S.G.B., etc.), 51-52, Chancery Lane, London, W.C.2. Holborn 4547-8. Handbook free. [0001]

PATENTS

THE IMPERIAL PATENT SERVICE.—Address during the war: 49, Great Thrift, Petts Wood, Kent. Phone: Orpington 3993. Practical Hints on Patents free on request. Preliminary consultation in London free by appointment. [0481]

TUITION

RADIO Training.—P.M.G. exams, and I.E.E. Diploma; prospectus free.—Technical College, Hull. [0611]  
PRACTICAL Postal Courses, radio television; test equipment design; I.P.R.E. and I.W.T. exams.—Write I.P.E., 3, Shirley Rd., London, W.4. [8838]

BUSINESS & PROPERTY FOR SALE, TO BE LET, OR WANTED

"THE Wireless and Electrical Trader" is an essential part of the equipment of every Wireless Trader; its pages reflect the very latest turn of trade events, and it is read by all the leading dealers and manufacturers, for particulars of business offered or wanted. By subscription to the trade only, 15/- per annum, post free.—Send your trade card for specimen copy to Dorset House, Stamford St., London, S.E.1. [0614]

F.I. for P.A.

Write for details of the new  
**A.R.P. VOICE ALARM SYSTEM**  
FILM INDUSTRIES LTD.,  
60, PADDINGTON STREET, LONDON, W.1  
Telephone - - - - - Welbeck 2385/6

INDEX TO ADVERTISEMENTS

	PAGE		PAGE		PAGE
All Power Transformers .....	21	Film Industries .....	22	Pifco, Ltd. ....	Inside Back Cover
Ambassador Radio-Works .....	9	Fluxite, Ltd. ....	Edit. p. 71	Player's Cigarettes .....	Inside Back Cover
Armstrong Manufacturing Co. ....	16	Galpin's Electrical Stores .....	4	Premier Radio .....	7
Automatic Coil Winder Co., Ltd. ....	1	General Electric Co., Ltd. ....	Inside Front Cover	Pye, Ltd. ....	15
Birmingham Radiomart G5N1 .....	2	Goodmans Industries, Ltd. ....	15	Savage, W. Bryan, Ltd. ....	22
British Institute of Engineering Technology .....	21	Henley, W. T., Telegraph Works Co., Ltd. ....	20	Sinmonds Aerocessories, Ltd. ....	5
British Insulated Cables, Ltd. ....	Inside Back Cover	Heys, Leonard .....	19	Sound Sales, Ltd. ....	14
British Mechanical Productions, Ltd. ....	19	Institute of Wireless Technology .....	22	Standard Telephones & Cable, Ltd. ....	2
British Thomson-Houston Co., Ltd. ....	Inside Back Cover	"Listener" .....	8	Stratton & Co., Ltd. ....	17
Bulgin, A. F., & Co., Ltd. ....	Edit. p. 73	London Radio Supply Co. ....	17	Taylor Electrical Instruments, Ltd. ....	18
Candler System .....	21	Marconiphone Co., Ltd. ....	10	Trix Electrical Co., Ltd. (The) .....	21
Collins .....	21	Masters, C. E. ....	22	Voigt Patents, Ltd. ....	17
Cossor, A. C., Ltd. ....	Back Cover	McClure, Ltd. ....	4	Vortexion, Ltd. ....	Edit. p. 75
Dubilier Condenser Co. (1925), Ltd. ....	13	M.R. Supplies .....	20	Ward, G. F. ....	20
Electradix Radios .....	18	Murphy Radio, Ltd. ....	12	Webbs Radio .....	4 & 20
Erle Resistor, Ltd. ....	6	Partridge, N. ....	18	Westinghouse Brake & Signal Co., Ltd. ....	2
Lrskine Laboratories, Ltd. ....	6	Peto-Scott Co., Ltd. ....	11	Wharfedale Wireless Works .....	9
				Whiteley Electrical Radio .....	14

Printed in England for the Publishers, ILIFFE AND SONS LTD., Dorset House, Stamford Street, London, S.E.1, by THE CORNWALL PRESS LTD., Paris Garden, Stamford Street, London, S.E.1. "The Wireless World" can be obtained abroad from the following: FRANCE: W. H. Smith & Son, 248, Rue Rivoli, Paris; Hachette et Cie, Rue Réaumur, Paris, and branches; Messageries Dawson, 4, Rue de Faubourg Poissoniere, Paris. BELGIUM: W. H. Smith & Son, 74-75, Boulevard Adolphe Max, Brussels. AUSTRIA: Gordon & Gotch, Ltd., Melbourne (Victoria), Sydney (N.S.W.), Brisbane (Queensland), Adelaide (S.A.), Perth (W.A.), and Launceston (Tasmania). NEW ZEALAND: Gordon & Gotch, Ltd., Wellington, Auckland, Christchurch and Dunedin. INDIA: A. H. Wheeler & Co., Bombay, Allahabad and Calcutta. CANADA: Imperial News Co., Toronto, Winnipeg and Vancouver; Benjamin News Co., Montreal; Gordon & Gotch, Ltd., Toronto. SOUTH AFRICA: Central News Agency, Ltd.; Wm. Dawson & Sons (S.A.), Ltd., Cape Town. UNITED STATES: The International News Co., New York.





SHERLOCK HOLMES says...

"If it's electric test it with a PIFCO"

Don't waste time over testing electrical appliances. The Pifco Rotameter will do it for you, swiftly, surely, and with the minimum of trouble. Whether you're an amateur or an expert, it will enable you to trace faults immediately in radio sets, bells, or anything electrical. It is made from the finest of materials; designed for durability and absolute precision.

**EIGHT RANGES:**  
 0-5 volts      0-10mA  
 0-20 volts    0-50mA  
 0-100 volts   0-250mA  
 0-400 volts

Resist/valve test  
 Plug-in test for valves.

Complete in velvet-lined case with testing leads.

Your regular dealer can supply you, or write:

**PIFCO LTD.**  
 Watling St., Manchester.  
 London Address:  
 58, City Road, E.C.1



42/-

**PIFCO ALL-IN-ONE A.C./D.C. RADIOMETER**  
 The only instrument of its kind in the world for making both A.C. and D.C. tests.  
**RANGES:** 0-6 volts, 0-240 volts, 0-30 mA.  
 Filament and Resistance Test, and socket for plug-in test for valves. 8,000 ohms resistance. Complete with two 15-inch flex cables. Fitted with PIFCO DRY CELL.....



12/6

**ROTAMETERS and RADIOMETERS**  
 PIFCO ON THE SPOT WILL TRACE YOUR TROUBLES LIKE A SHOT

*Memo*

Don't forget  
 Player's  
 Please

PLAYER'S NAVY CUT CIGARETTES

MEDIUM or MILD  
 10 for 7s 20 for 11s 3d

NCC 495 A.

# B.I. CONDENSERS

FOR RADIO & GENERAL USE

**B.I. CONDENSERS** for Radio Receivers, Battery Eliminators, Smoothing Circuits, etc., are made in several different types to suit the various uses for which Condensers are required in connection with Wireless circuits.

These Condensers are the result of 36 years' experience in the manufacture of all kinds of Condensers from the smallest sizes up to those weighing more than 2 tons.

In addition to the Standard Types, B.I. Condensers can be supplied in special forms to suit manufacturers' requirements.

The illustration shows Type 212 recommended for use with eliminators.



**BRITISH INSULATED CABLES LTD.**  
 Cable Makers and Electrical Engineers  
**PRESCOT, LANCS.**  
 Telephone No.: PRESCOT 6571.



**PUBLIC ADDRESS EQUIPMENT**

for

**A.R.P.**

in Workshops, Factories and all Industrial or Municipal Undertakings

Send your enquiries to

**SOUND REPRODUCER SALES—**

**BTH RUGBY**

THE BRITISH THOMSON-HOUSTON COMPANY LIMITED, RUGBY, ENGLAND





# LIFT THE CENSORSHIP of worn-out valves ON WAR-TIME LISTENING!

A SELECTION OF POPULAR TYPES IN GENERAL USE

Type	Plns	Bulb	Purpose	Slope m.A/V.	Price
<b>2-VOLT BATTERY-OPERATED VALVES</b>					
210 V.P.A.	7	Met	Variable-mu H.F. Pentode ...	1.1	9/-
210 S.P.T.	4	Met	H.F. Pentode ...	1.3	9/-
do.	7	Clear/Met	H.F. Pentode ...	1.3	9/-
220 I.P.T.	7	Met	Detector Pentode (Ind. Heated) ...	1.0	9/-
220 T.H.	7	Met	Triode Heptode ...	—	10/6
210 D.D.T.	5	Met	Double Diode Triode ...	1.1	7/6
210 H.L.	4	Clear/Met	Triode Detector or H.F. ...	1.1	4/9
220 H.P.T.	4 or 5	Clear	Economy Output Pentode ...	2.5	9/-
220 O.T.	5	Clear	Output Tetrode ...	2.5	9/-

<b>INDIRECTLY HEATED MAINS VALVES (4-volt 1.0 amp. Series)</b>					
M.S./Pen.	5	Clear/Met	H.F. Pentode (Anode to Top Terminal)	3.5	10/6
M.S./Pen.	7	Clear/Met	H.F. Pentode (Anode to Top Terminal)	3.5	10/6
M.V.S./Pen.	5 or 7	Met	Variable-mu H.F. Pentode (Anode to Top Terminal)	3.0	10/6
M.S./Pen.B.	7	Clear/Met	H.F. Pentode (Control Grid to Top Terminal)	3.5	10/6
M.V.S./Pen.B.	7	Met	Variable-mu H.F. Pentode (Control Grid to Top Terminal)	3.0	10/6
41 M.P.G.	7	Met	Pentagrid ...	—	11/6
41 S.T.H.	7	Met	Triode Hexode ...	—	11/6
4 T.H.A.	7	Clear/Met	Triode Hexode ...	—	11/6
D.D.T.	7	Met	Double Diode Triode (A.V.C.) ...	2.4	9/6
41 M.P.	5	Clear	Normal Power Output ...	7.5	7/6
42 O.T.	7	Clear	(2 amps. heater) Output Tetrode ...	7.0	10/6
41 M.E.	8 contacts	Clear	"Magic Eye" Tuning Indicator ...	—	8/6

<b>(.2 amp. Series)</b>					
202 V.P.	7	Met	Variable-mu H.F. Pentode (Anode to Top Terminal)	3.2	10/6
202 V.P.B.	7	Met	Variable-mu H.F. Pentode (Control Grid to Top Terminal)	3.2	10/6
202 S.P.B.	7	Met	H.F. Pentode (Control Grid to Top Terminal)	3.6	10/6
202 S.T.H.	7	Met	Triode Hexode ...	—	11/6
202 D.D.T.	7	Met	Double Diode Triode (A.V.C.) ...	2.4	9/6
402 Pen.JA.	7	Clear	Output Pentode ...	8.0	10/6
402 O.T.	7	Clear	Output Tetrode ...	7.0	10/6

<b>DIRECTLY HEATED MAINS VALVES</b>					
2 X.P.	4	Clear	(2 volts, 2 amps. Fil.) Output Triode ...	7.0	9/6
4 X.P.	4	Clear	(4 volts, 1 amp. Fil.) Output Triode ...	7.0	9/6

<b>STANDARD RECTIFIERS</b>							
Type	Filament Volts R.M.S.	Filament Amps. R.M.S.	A.C. Volts per anode R.M.S.	Max. D.C. Volts developed	Max. D.C. Output m.a.	Type of Rectification	Price
442 B.U.	4.0	2.5	350	350	120	Full Wave	9/-
43 I.U. (Indirectly Heated)	4.0	2.5	350	360	120	Full Wave	9/-
40 S.U.A. (Indirectly Heated)	Heater 40	Heater .2	250	210	75	Half Wave	9/-

Prices are subject to alteration without notice.

AS TODAY'S chief channel of news and entertainment, no radio receiver should be prevented from giving of its best by obsolete or worn-out valves.

## GET THE MOST OUT OF YOUR PRESENT SET

If your receiver's performance has fallen off—fewer stations, less volume, inferior tone, slight distortion—it can be given new life at the small cost of a new set of Cossor Valves. Products of the pioneers in radio valve development, Cossor Valves are up-to-date in design and are subjected to severe testing at every stage of manufacture—ask your local stockist for a full list, including American types. To get more stations, better tone, improved volume—change to Cossor Valves... the name guarantees absolute reliability.

A. C. COSSOR LTD.  
HIGHBURY GROVE,  
LONDON - N.5.



# COSSOR VALVES