

The

Wireless World

6^D

*THE
PRACTICAL
RADIO & TELEVISION JOURNAL*

Thursday, April 6th, 1939

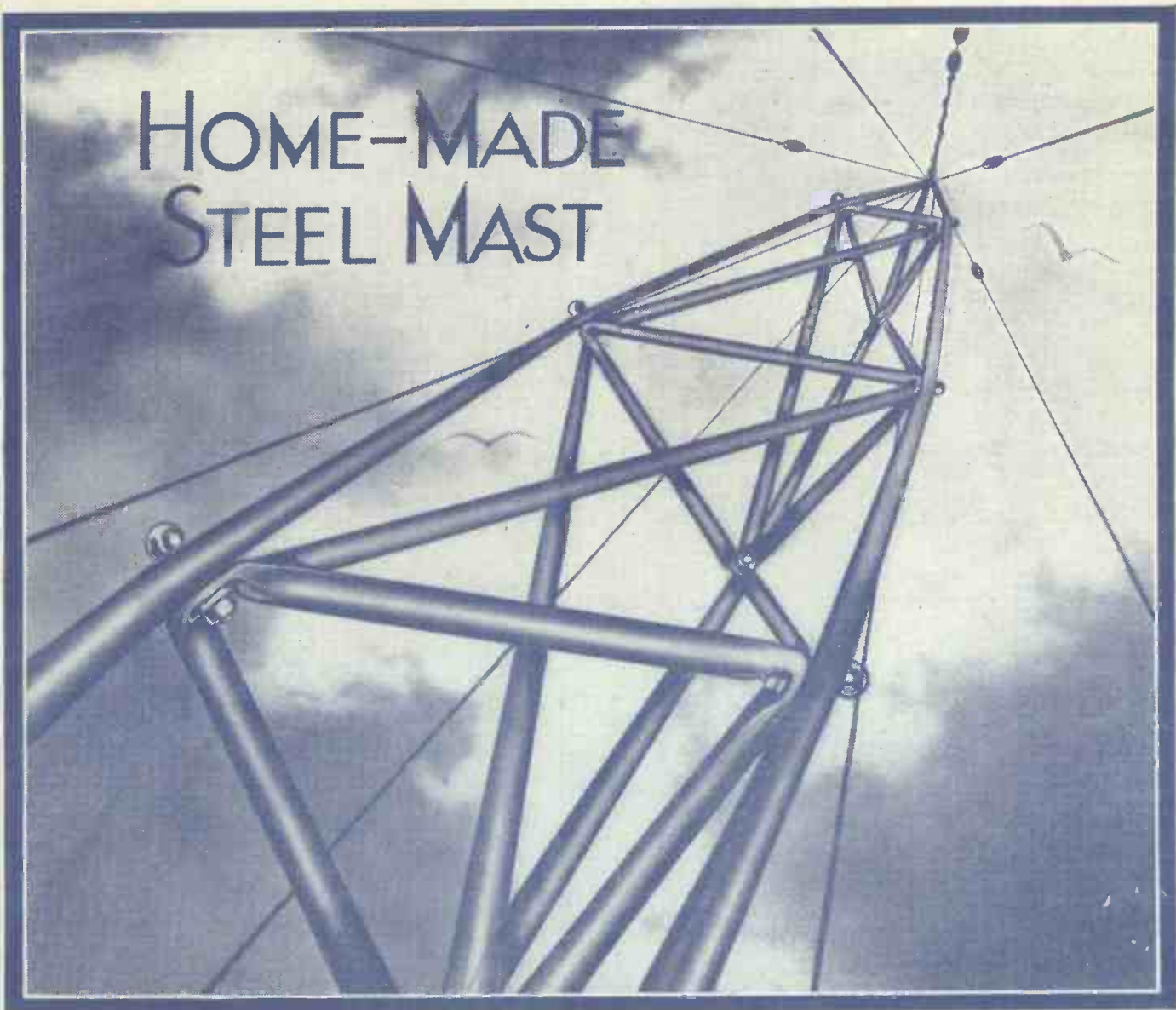

NEW VOICES — 100% SUCCESSFUL!

All models of the latest **S.S. SPECIAL SCHOOL BROADCASTING EQUIPMENT** were recently submitted by us for examination by the Central Council for School Broadcasting.

The entire group passed **100% SATISFACTORY**, thus substantiating our slogan—**"AN EDUCATION IN RADIO."**

May we send you our latest Special Booklet dealing solely with School Radio Equipment?

SOUND SALES LTD.

MARLBOROUGH RD., UPPER HOLLOWAY, LONDON, N.19

Telephone: ARCHway 1661-2-3

Contractors to the Air Ministry, G.P.O., etc.

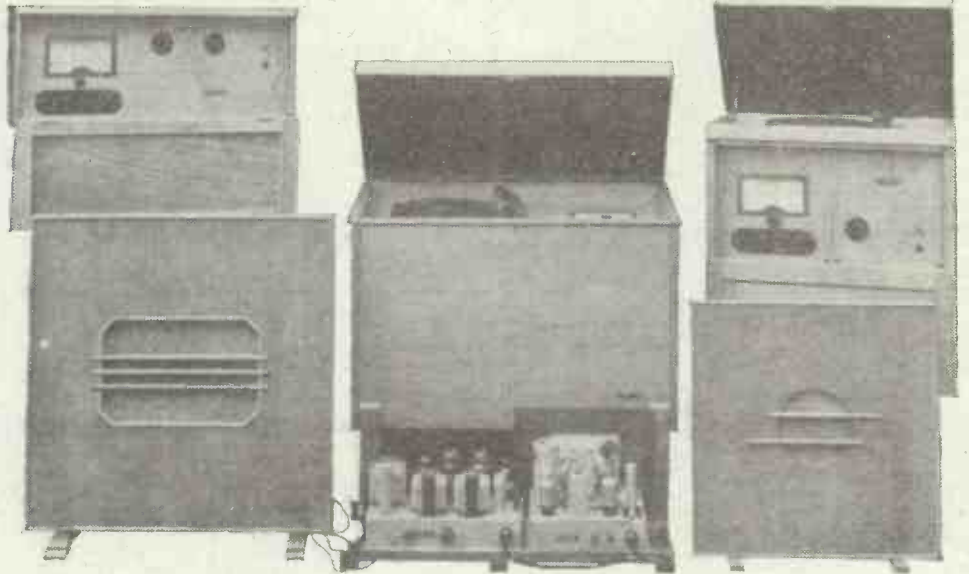

Specified for the
"WIRELESS WORLD"
**STAND-BY
THREE**

GOODMANS
Type B/605/12000 PERMANENT MAGNET
LOUDSPEAKER

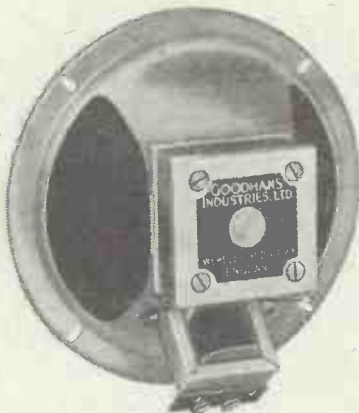

Complete with transformer to give 12,000 ohms load.
PRICE 21/-

Those interested in technical data and fundamental principles of Loudspeaker design are invited to send for a 20-page Brochure entitled "The Attainment of an Ideal."

The technical treatise fully describes many problems encountered and solved in the quest of High Fidelity reproduction.

SEND FOR THIS FREE TECHNICAL BROCHURE

To GOODMANS INDUSTRIES LTD., Lancelot Rd., Wembley, Mdx.
Phone: Wembley 4001-5

Please send me a copy of "The Attainment of an Ideal." I enclose 1/4 stamp.

NAME.....
ADDRESS.....
W.W.64



The new 'SKY BUDDY' communication receiver

Now with 10 Metre Band Electrical Band Spread

This NEW 'SKY BUDDY' has sensitivity, image ratio, signal-to-noise ratio and all-round performance that excels many receivers sold at twice its price. It's complete with all the essential controls for communications reception, built-in speaker, full coverage from 10 metres to 550 metres—a far greater value than ever before.

LEADING FEATURES:

6 tubes with 8-tube performance; Complete coverage 10 metres to 550 metres; Built-in speaker; Beat frequency oscillator.

Price: 110v. 10 250v. A.C. MODEL

£ 10

(Hire Purchase facilities available.)



The cheapest efficient COMMUNICATION TYPE RECEIVER

This new 'Sky Buddy' is the smallest Hallicrafter receiver manufactured, and one of the range of instruments which extends up to the £162 Dual Diversity Model. Webb's new Catalogue, which includes full descriptions of all the communication receivers available, will be forwarded upon receipt of 2d. in stamps.

WEBB'S LONDON

**THE HOME OF THE SHORT-WAVE ENTHUSIAST
14 SOHO ST., OXFORD ST., W.1**

Telephone: Gerrard 2089.

Birmingham Depot:—41, Carrs Lane. Phone: Mid 5669

Mention of "The Wireless World," when writing to advertisers, will ensure prompt attention.

The Wireless World

THE
PRACTICAL RADIO
JOURNAL
29th Year of Publication

No. 1023.

THURSDAY, APRIL 6TH, 1939.

VOL. XLIV. No. 14.

Proprietors : ILIFFE & SONS LTD.

Editor :
HUGH S. POCOCK.

Editorial,
Advertising and Publishing Offices :
DORSET HOUSE, STAMFORD STREET,
LONDON, S.E.1.

Telephone : Waterloo 3333 (50 lines).
Telegrams : "Ethaworld, Sedist, London."

COVENTRY : 8-10, Corporation Street.
Telegrams : "Autocar, Coventry." Telephone : 5210 Coventry.

BIRMINGHAM :
Guildhall Buildings, Navigation Street, 2.
Telegrams : "Autopress, Birmingham." Telephone : 2971 Midland (5 lines).

MANCHESTER : 260, Deansgate, 3.
Telegrams : "Iliffe, Manchester." Telephone : Blackfriars 4412 (4 lines).

GLASGOW : 26B, Renfield Street, C.2.
Telegrams : "Iliffe, Glasgow." Telephone : Central 4857.

PUBLISHED WEEKLY. ENTERED AS SECOND CLASS MATTER AT NEW YORK, N.Y.

Subscription Rates :
Home and Canada, £1 10s. 4d.; other countries, £1 12s. 6d. per annum.

As many of the circuits and apparatus described in these pages are covered by patents, readers are advised, before making use of them, to satisfy themselves that they would not be infringing patents.

CONTENTS

	Page
Editorial Comment	313
Stand-by Three. Constructional Details	314
Steel Aerial Mast	317
The Television IF Amplifier	319
Wired Wireless Broadcasting	323
Random Radiations	324
Bass. The Reproduction of the Lower Tones	325
News of the Week	327
The Modern Receiver Stage by Stage. VI.—IF Amplifiers	329
Letters to the Editor	331
Television Programmes	331
Unbiased	332
Overcoming Harmonic Radiation	333
H.M.V. Model 1102 Test Report	334
Directory of Wireless Clubs	336
Recent Inventions	337
Principal Broadcasting Stations	338

EDITORIAL COMMENT

Broadcasting by Telephone

Necessity for Assurances

THE announcement last week of the Government's decision to renew the licences of the broadcast relay companies by a further term of ten years was coupled with a statement that the Post Office will also participate in the relay business by means of the wires now connecting telephone subscribers.

Some time ago, it will be remembered, the Post Office made known their intention to enter this field and proposed to start with a relay service for Southampton. That project was abandoned, at least for the time being, because of the strong opposition which it called forth from the radio industry, which quite naturally feared that a competitive means of receiving broadcasting run under the auspices and with the resources of the Post Office would be the kind of competition which the private enterprise of the radio firms could not hope to survive.

So here the matter ended for a time, but now A.R.P. has been called to the aid of the Post Office to provide the excuse apparently for obtaining authority for a policy which a democratic Parliament would probably not have sanctioned in normal times.

The nature of the new proposals suggests, however, that there has been some recognition of the devastating effect which a national Post Office relay system would have upon the radio industry, for the proposal is now to supply programmes by "wired wireless" on the telephone wire and for the reception to be carried out on the listener's own receiving set which he will tune to the programme he selects ;

he will also be able to tune in other programmes received through the medium of his aerial as at present.

Now, if the legitimate activities of the radio industry are not to be unfairly hampered and if the listener is to continue to have a free choice of programmes it is essential that an assurance should be forthcoming from the Post Office that they will not at any time compete with the radio industry by themselves supplying receivers or other reproducing apparatus to their subscribers or listeners. Such an assurance is vitally necessary if the goodwill of the radio industry, both manufacturers' and local dealers', is to be retained, and it should contribute a great deal towards helping in the A.R.P. aim which the Post Office have made the justification for their present autocratic action.

There is another important assurance which is required from the Post Office. This is that their adoption of a relay service should not result in a lessening of their zeal in fighting the problem of electrical interference. It is easy to appreciate that with a relay system of this kind, less prone to interference than ordinary reception, the Post Office may be tempted to make this fact an argument to persuade listeners to adopt the system. As we have pointed out before, relay services thrive where interference is particularly bad.

Given these assurances that the Post Office will never compete with the Industry in the supply and maintenance of receivers and that their efforts to reduce electrical interference will not slacken, we see no reason why the new proposals should not proceed with the approval and even with the active support of the radio industry. But these assurances must come first.

COMPACT THREE-VALVE BATTERY RECEIVER

(Concluded from page 293
of last week's issue)

The Wireless
World

Stand-by Three

CONSTRUCTION AND TESTING

THE receiver is built as a unit on a metal chassis which can be of steel or aluminium as preferred. Unless the chassis is bought ready-made, aluminium is to be preferred to steel, since it is easier to work. The gang condenser is bolted to the top of the chassis, but wires should first be attached to the soldering tags on its underside, since these are rather difficult to reach when it is in position.

The coils must be mounted after most of the wiring has been done. This is readily carried out in spite of the small space available, but care must be taken to keep wires, condensers and resistances close to the chassis, so that they do not foul the coils when these are put in.

The cross-screen does not extend up to

HT. To avoid soldering many wires directly to this pin, which is not very easy, it is best to solder a length of fairly thick wire to the pin and bend it so that it stands up for about three-quarters of an inch. The various positive HT leads are then readily soldered to points along this wire.

The most awkward connections are some of those on the switch, and the easiest course is to attach wires to the least accessible lugs before mounting it in the set. The connections to the volume control should also be made before the switch is mounted.

The switch may be a little confusing at first, for it has so many contacts. If in doubt, the best way of identifying the con-

tacts is by a continuity test. For this an ohmmeter can be used, a voltmeter and battery, or a battery and a flash-lamp bulb. Set the switch in the middle one of its three positions and connect the coils to the contacts which show continuity. The battery and chassis connections must also be made to a pair showing continuity, and a further

the chassis top. There is a gap through which the cross-wires pass. The centre-pin (screen) of the output pentode is used as a general junction point for positive

which show continuity. The battery and chassis connections must also be made to a pair showing continuity, and a further

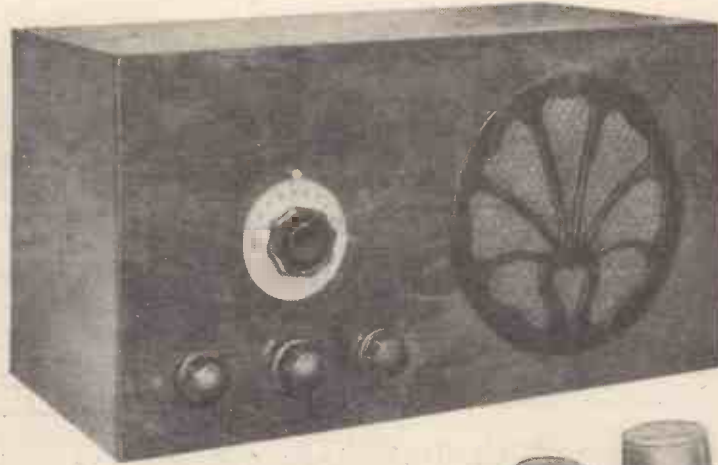

THE construction and adjustment of the receiver are dealt with in this article and the performance obtained from the original model is described. Notes on the LT supply are also given.

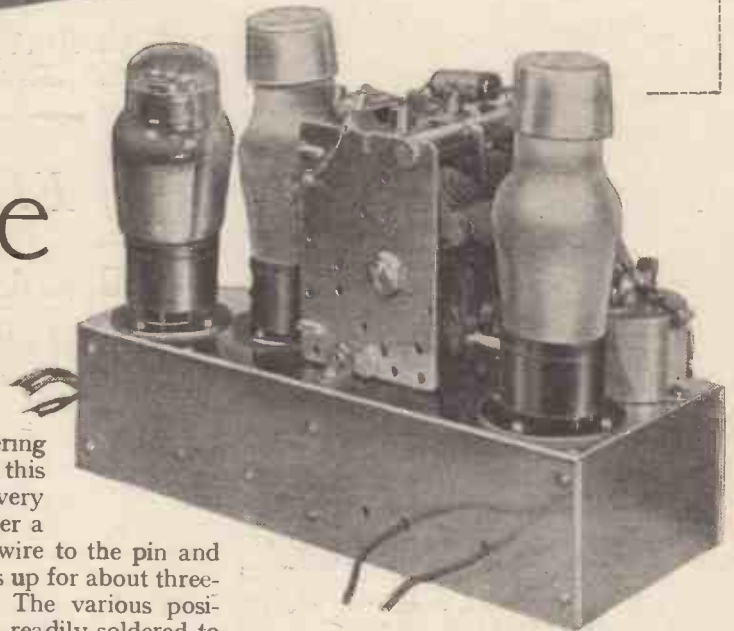

The back of the cabinet removed, showing how the batteries are stored.



lug connected so that there is again continuity when the switch rod is rotated clockwise. These notes, together with the drawings, should obviate any difficulty here.

The two intervalle coils are identified by their carrying a red spot on the former. The medium-wave coils are the ones with the tuned winding in several sections; incidentally, the coil numbers are stamped on the brass mounting strips.

In every case the pair of long solder tags is for the tuned winding, and the short pair for the primary or reaction. On the medium-wave coils the grid end of the winding is remote from the primary or reaction coil. This lead can readily be traced to its tag. Once the grid tag is found, all other connections follow automatically from the drawings. On the long waveband it does not matter which of the long tags is made the grid lead. The coils are multilayer side-by-side, and it is only their relative connections that matter.

Preliminary Tests

The receiver should be tried out before being fitted to its cabinet, since it is then easier to adjust the trimmers. The controls all operate logically; that is, minimum volume and reaction are obtained with the knobs turned anti-clockwise. The three positions of the switch are: left, off; centre, on, medium waves; right, on,

Stand-by Three—

long waves. A direct drive is used for the tuning condenser, since it is quite easy to tune with it, and it occupies less space and costs less than a dial with a reduction ratio.

Adjustment and Operation

The trimmer C3 is included because the trimmers fitted to the gang condenser have insufficient capacity for this receiver. With tuned grid coupling, the stray capacity on the intervalve circuit is rather high, so an unusually large amount of trimming capacity must be added to the first circuit. The gang condenser trimmer on C1 should be screwed up and forgotten, adjustments being made to C3 and the trimmer on the other section. Set this latter about half-way in, tune in a station on the lower end of the medium wave-band, using reaction, and then adjust C3 for maximum response. A rough adjustment can be made on a strong signal, but afterwards a weak one should be found upon which precise adjustments of the two trimmers can be carried out.

When satisfactory results have been secured, the set can be fitted to the cabinet. It is held in place by two wood-screws through the front; if the holes in

the chassis are small, the screws bite their way into the metal quite well and hold the chassis firmly.

The LT batteries fit behind the receiver and the HT behind the set and loud speaker. In connecting the LT batteries

door, or, better, outdoor aerial. An earth is advised wherever possible. It is not essential, but it improves stability. Without an earth there may be some instability, which can be corrected by the volume control.

The top of the receiver chassis with valves removed.

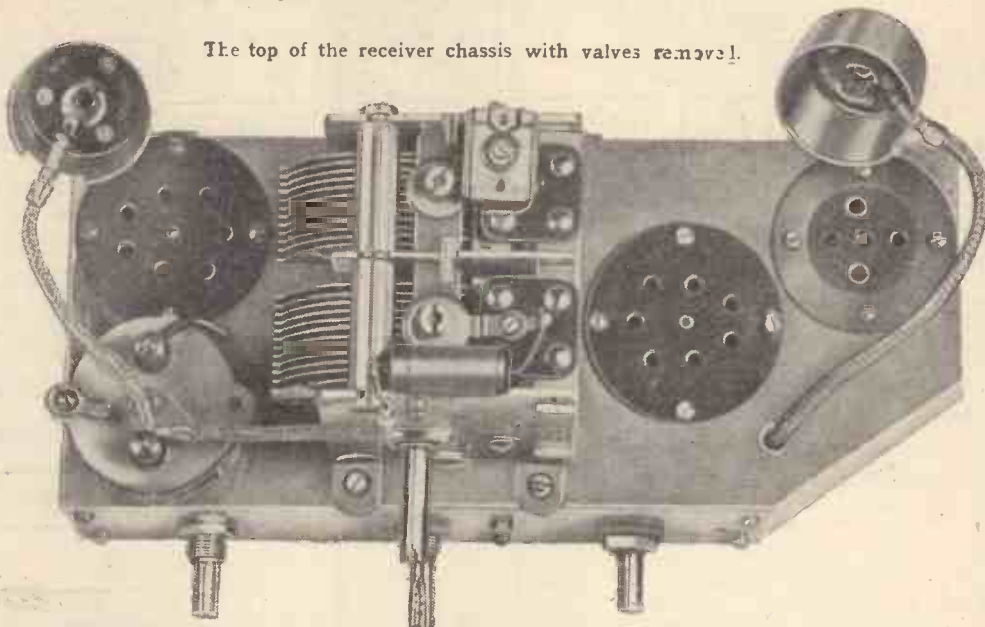

it is convenient to join the battery leads one to each battery and to place the resistance R11 to join the two batteries. The batteries then support the resistance at each end. The centre terminal of the battery is the positive.

The value of 10 ohms specified for R11 is correct for a new LT battery giving 6 volts, since the drop in it at the current of 0.2 ampere is 2 volts. If a high-resistance voltmeter is available, the voltage applied to the set should be checked occasionally so that R11 can be reduced in

Tested in London with a fifteen-foot length of wire for an aerial in a steel-framed building, both local stations were well received. By hanging the wire out of a window, these two, as well as Droitwich, provided a terrific signal, and at good strength many other stations could be

The cabinet dimensions and how the receiver, speaker and batteries are accommodated.

received in daylight. These included Fécamp, North Regional, Cologne, Brussels, Weather London, Radio-Paris.

The quality and volume proved surprisingly good in view of the low-current drain on the battery, and, in fact, considerably surpassed expectations. Selectivity is not high, but is adequate for the purpose for which the set is intended.

The set is not designed for use with a large aerial, and with one the selectivity is too low. It is intended for a short in-

value when it falls appreciably. Alternatively, an ammeter of low resistance can be inserted in series with the battery to check the current.

If no meter is available, the only course is to reduce the resistance arbitrarily when

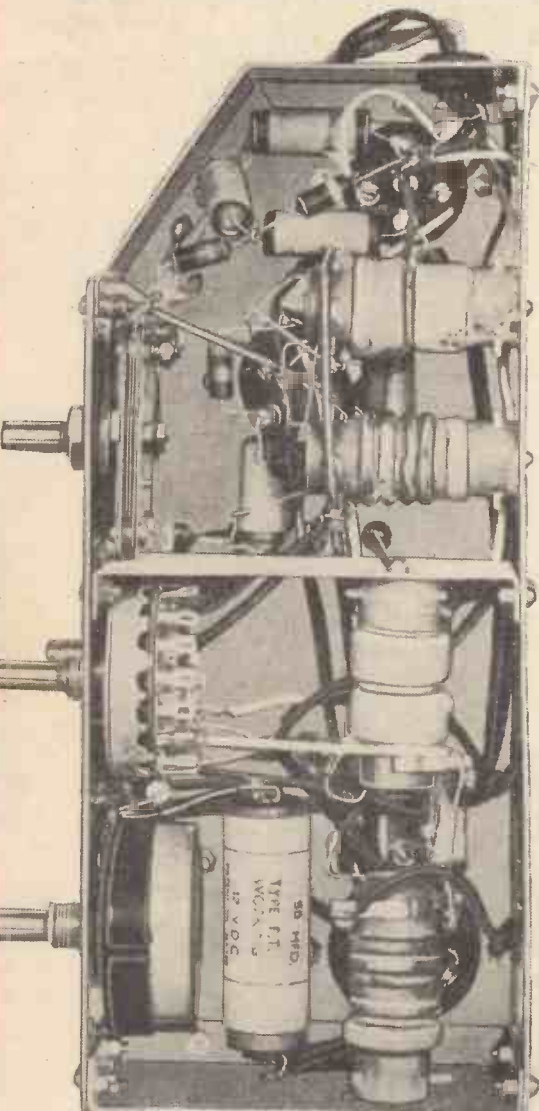
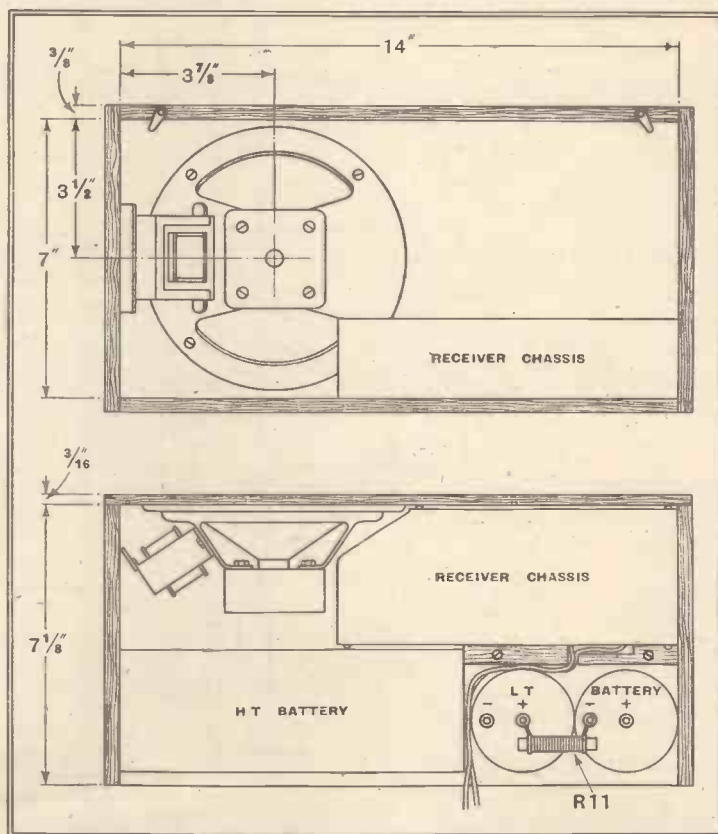

Underside of the receiver chassis.

The Wireless World STAND-BY BATTERY THREE. Wiring Diagram

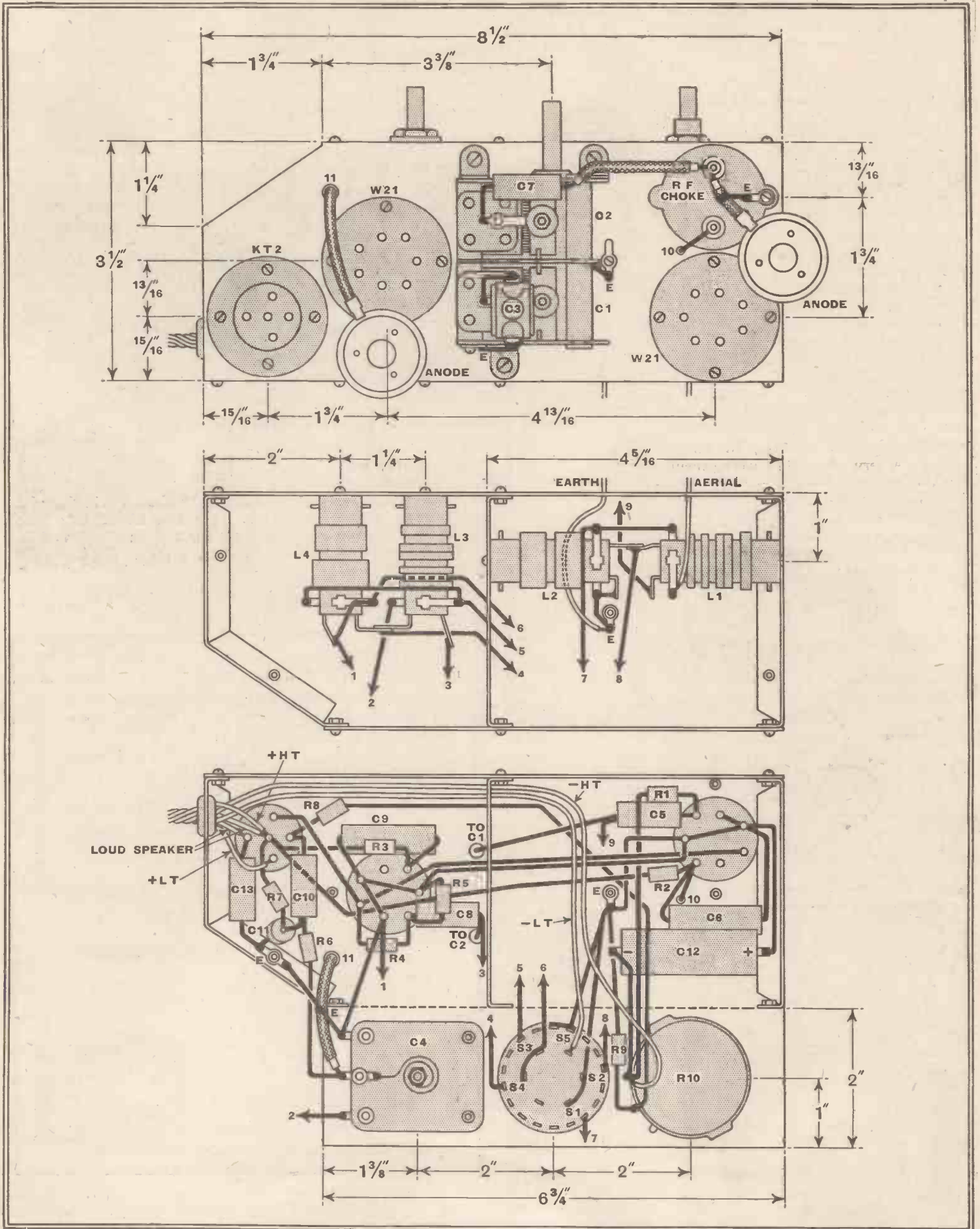

Full assembly and constructional details of the receiver chassis. The reference letters will make easy the identification of components when compared with the full circuit diagram included in last week's instalment of this article.

Stand-by Three—

the performance falls off. A drop of 0.5 volt in the battery will probably pass unnoticed, so that one can assume that the battery voltage is down by nearly one volt when the performance falls off. A value of 5 ohms is then indicated for RII.

In conclusion it should be pointed out that a receiver of this nature is not only extremely useful, but its construction is of value. The beginner will find the construction instructive, and this applies also to those who lack practical experience but have yet a good theoretical knowledge.

THE triangulated mast described in this article is easy to assemble from steel conduit tube, which is readily obtainable. As the structure is light in weight and has considerable inherent rigidity it can be erected with a minimum of trouble.

Steel Aerial Mast

ABOUT four years ago the writer had the need to erect an aerial, at that time intended as a temporary measure, and did not wish to expend much money, or to have to obtain assistance with the erection. Now even the simplest scaffold pole, if of any height, is heavy, and not very cheap to buy. Thin steel masts require to be lashed to a ladder during erection, as otherwise they are inclined to buckle, and they can be quite difficult to erect, particularly in windy weather. A very satisfactory arrangement for a temporary or even permanent mast is a framed structure consisting of bamboo poles fixed end to end and braced by means of cross-pieces and tensional wires. Poles of this kind, however, are not obtainable everywhere, and it was in the absence of these that the mast which is to be described was evolved.

EASY CONSTRUCTION IN CONDUIT TUBE

tions between the two tripods would each consist of six members, which number of members is the minimum with which triangulation producing complete stability is possible.

The method of construction was as follows: Three 15ft. lengths of $\frac{1}{2}$ in. diameter steel conduit of the cheapest quality were placed side by side and temporarily tied round with string. They were then drilled through near the end two at a time, and three $\frac{3}{16}$ in. eyebolts passed through and nuts lightly screwed on. This end was intended to be the top of the mast, and eyebolts were used to facilitate connection of guy wires. These bolts had to be placed at slightly different distances from the ends of the tubes so as not to foul one another (see Fig. 1.). Three lengths of $\frac{3}{8}$ in. diameter steel conduit, 15ft. long, were then treated in a similar manner, but plain bolts were used in place of eyebolts. The other ends of the three $\frac{1}{2}$ in. tubes were inserted for a few inches into the ends of the $\frac{3}{8}$ in. tubes and a hole was drilled through the junction of each tube and a $\frac{3}{16}$ in. bolt passed through the hole. Thus, an approximate 30ft. length of triple tube was produced.

A piece of $\frac{1}{2}$ in. diameter steel conduit was then flattened with a hammer at 2ft. intervals and also at the ends, and bent into an equilateral triangle. This was drilled through the flattened portions at the angles of the triangle. The three main steel tubes were then sprung apart and the triangle inserted in the centre and secured to the main tubes by the bolts which fastened the tubes together at the centres (see Fig. 2).

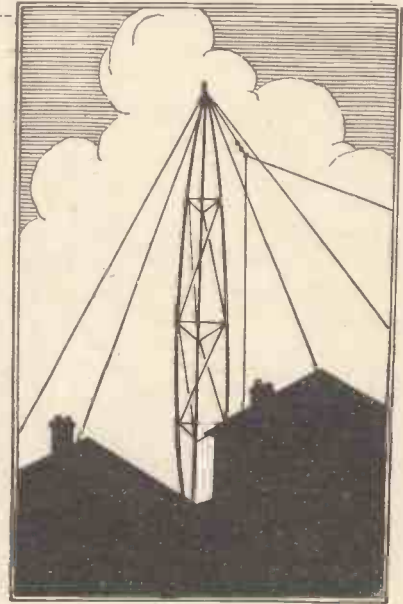

By A STRUCTURAL ENGINEER

The members of the mast then took up a curved form.

At approximately quarter intervals the

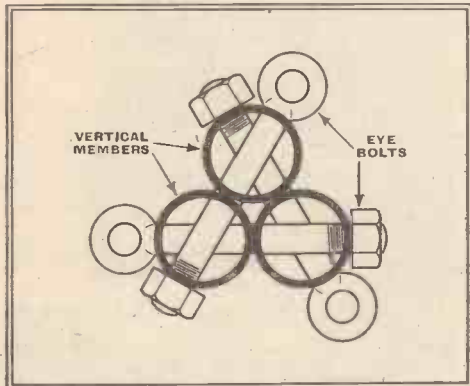

Fig. 1.—Method of bolting together the three vertical members at the top of the mast.

Steel electric-light conduit is inexpensive to buy and may be obtained anywhere, and for this reason it was selected as the material for construction. The method decided on was that used at Lisburn—that is, the mast would be purely a compressional strut held in position by guys reaching from the top to the ground. This would mean that the two ends would be pointed and the thickest part of the mast would be at the centre. To make erection easy, and to economise so far as possible in material, it was decided to make the strength as low as reasonably possible and to use the minimum number of individual members. This meant that the top section would be a tripod, the legs of which would be as long as they could possibly be without buckling. The bottom would be an inverted tripod, and the intermediate sec-

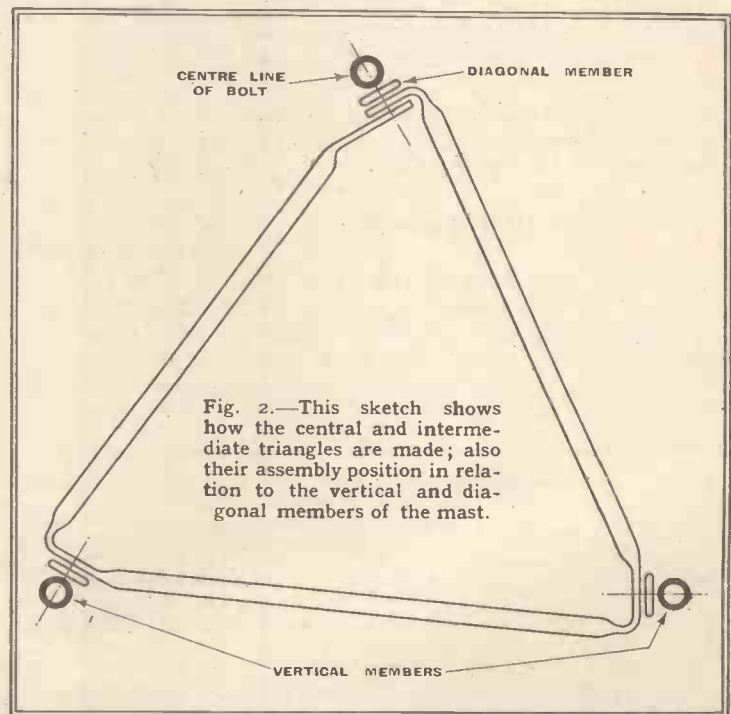
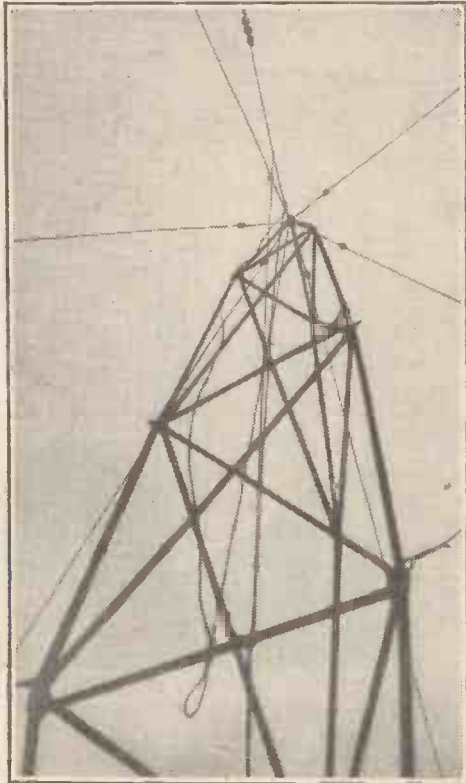

Fig. 2.—This sketch shows how the central and intermediate triangles are made; also their assembly position in relation to the vertical and diagonal members of the mast.

distances apart of the members were measured, and two triangles, similar to that previously mentioned, were made to fit, and the main members and the triangles were drilled and bolted together. The exact positions of these intermediate

Steel Aerial Mast—

triangles were determined when the diagonal members (to be described) were bent to shape and measured. The resultant structure was unstable in that it was not completely triangulated. To overcome this, three lengths of tube were taken and flattened at the centres and the ends so as



Although the mast—seen from below in this photograph—was set up as a temporary structure four year ago, it is still standing.

to form diagonal members. These were then drilled and bolted in position with the bolts that secured the triangles to the vertical members. Fig. 3 illustrates the side elevation of the mast during assembly; all three sides of the mast are similar.

Alternative Assembly

It was found that the diagonal members fitted into position better if placed between the triangles and the vertical members when bolting up. There are two ways in which these diagonal members may be placed. First, as shown in Fig. 3, a bent

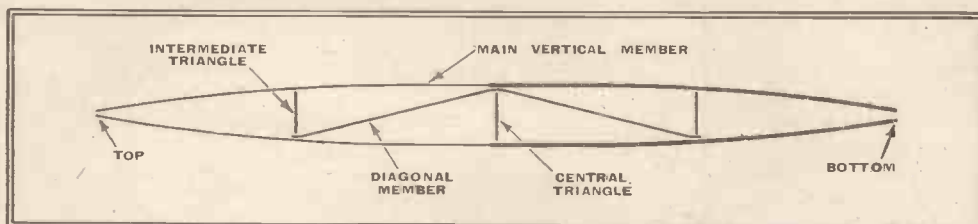

Fig. 3.—Side elevation of mast during assembly; all three sides are similar.

member may pass from one vertical tube to another and back to the first tube. Secondly, the diagonal member may be passed from the first tube to the second and then across another side of the mast to connect to the third vertical member.

This latter method was the one actually used during construction, although there is no particular advantage in one method over the other.

It was found to be important that during the drilling and bolting together of the members the ends and intermediate portions of the mast should be propped up at the correct distances from the floor, and kept propped up in this manner until the whole of the structure is completed and all bolts tightened up. If this is not observed, the mast may be visibly crooked or twisted on completion. When the bolts were tightened up the projecting ends were cut off and burred over.

Finally, to protect the structure from rust, the lower end—that is, the section constructed of $\frac{3}{8}$ in. tube—was placed in a small tin and set in molten lead and the top end similarly protected by a tin filled with putty. The joints were stopped thoroughly with putty, which was rubbed over all bolts and nuts, and afterwards bound with insulating tape. This method, although rough, did not give a bad appearance after painting. The whole structure was painted with two coats of grey paint.

To erect the structure it was necessary first to drive a central pin for the mast to rest on, to drive six $1\frac{1}{2}$ in. angle iron stakes 30 in. long, spread well out, for securing the six guys, and to connect the guys, which consisted of stranded galvanised steel wire. The mast was then seized by the centre, being held at the junctions of the members, and the bottom was placed on the central pin and tied to the pin to prevent the lower end from lifting. It was then lifted vertically, hand over hand, one of the distant guy ropes being pulled gently by an assistant until the mast was brought into a vertical position. The near guy ropes were previously temporarily fastened to their stakes at approximately the correct length. Aeroplane strainers had been fitted in the guy ropes, together with insulators, to break up the lengths, but the strainers were found to be unnecessary, as the required degree of adjustment could be made easily without them. The true vertical of the mast was found by using a cotton thread plumb line hung down the centre. The mast was provided with a permanent halyard, consisting of stranded wire passing through a pulley fastened to the mast, and supporting a

pulley through which was passed a plaited cord halyard. The idea of the metal halyard was to make possible easy renewal of the halyard normally in use. Incidentally, the use of two halyards doubled the load on the mast due to the pull of the aerial.

The mast when finally erected was found to be sufficiently strong to take the pull of a normal aerial in all weather conditions. Storms had no effect on it owing to its low wind resistance. It has now been standing four years, during which period two nearby trees have been blown down during a heavy gale. Nevertheless, slightly heavier members (say, about $\frac{3}{4}$ in. and $\frac{1}{2}$ in., in place of $\frac{3}{8}$ in. and $\frac{1}{2}$ in.) are perhaps to be recommended for general use, as the smaller sections require careful handling during erection. Proportionately larger sections should be used for higher masts.

Additional guys may be connected to the lower triangle of the mast in order to prevent a rotating motion that may occur during strong winds.

TWO NEW COSSOR SETS

A Table Model Superheterodyne and a Battery Portable

In the Model 73 superheterodyne there are five valves excluding the rectifier and cathode-ray tuning indicator. A radio-frequency amplifier functions on all three wavebands, the lowest of which covers 16 to 52.5 metres. The output valve is a large triode and the controls include a combined selectivity and tone control. The set is for manual tuning only and a large easily read dial has been provided. The price of the Model 73 is 12½ guineas.

The new Model P43 battery portable makes use of a "straight" circuit with a



The new Cossor Model 73 and (right) Model P43 battery portable.

pentode RF amplifier, pentode detector, triode first AF amplifier and either a pentode or tetrode output valve. An interesting feature is that the detector is an indirectly heated valve. The price of £6 15s. includes a 120-volt HT battery and an 18 ampere-hour accumulator which is easily removed through a door in the side of the cabinet. Controls are on the front panel and the tuning scale is on top. It is calibrated in metres and a replaceable list of station names is fitted in a frame behind the dial. The set is finished in blue leatherette with grey-moulded knobs and escutcheon.

The Television IF Amplifier

Practical Considerations in Design

By S. WEST

WHEN considering the design of the intermediate - frequency amplifying stages for a super-heterodyne vision unit, one is confronted with a somewhat bewildering choice in the type of coupling that can be employed. To cite some of the more well known of these, there are arrangements giving a form of low-pass coupling and there are conventional band-pass coupling units in which any of the usual methods of circuit coupling can be utilised, namely, mutual inductance, series inductance or capacity. Alternative arrangements, essentially elaborations of the above, are sometimes used and in reality assume the form of a filter network. Finally, there is the simple tuned-grid or tuned-anode circuit.

It is well known that the gain obtainable from a given stage in a wide-band amplifier varies inversely with the circuit capacity, which comprises the input and output valve capacities and a certain value of unavoidable stray capacity. Included in this value of stray capacity will be that created by the arrangements for adjusting the resonant frequency of the circuit.

The subject has already been dealt with theoretically in some detail in *The Wireless World*¹; the conclusions arrived at in that article were that the simple tuned anode circuit or a slight variation of it, has many advantages over the more elaborate forms of coupling. Not the least important of these is the ability to employ a simple mechanical arrangement

THE best arrangement for a television amplifier is often difficult to decide, for there are so many possible alternatives. In this article is described a simple system which is capable of a very good performance and which is not difficult to construct.

which enables the circuit's resonant frequency to be adjusted by varying the coil inductance. This results in increased gain, for the capacity present is restricted mainly to the unavoidable capacities mentioned earlier. There is, of course, inevitably some slight capacity due to the arrangement for varying the coil inductance, but this can be kept very low.

It should also be pointed out that, as shown in the article cited above, the performance of such circuits is entirely

dependent upon the fact that the circuit constants are not chosen to obtain a broad response curve with each circuit tuned to resonance at the desired intermediate frequency. They are rather determined experimentally so that a number of such stages are resonant at frequencies on either side of the true intermediate frequency and taken together provide quite high gain with the required overall response characteristic.

Dealing first with the mechanical arrangements for varying the inductance. The best way of effecting this is to arrange for a brass or copper plunger, which is a snug fit to the coil former, to be moved in and out of the coil's field, the induc-

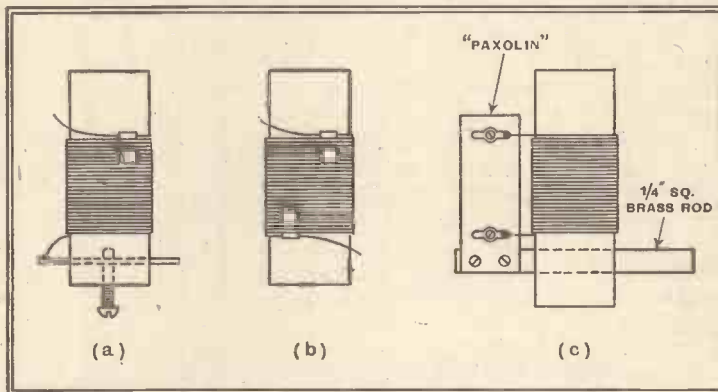

Fig. 2.—Various methods for terminating the coil windings when the coil bore is occupied by a tuning plunger are shown here.

tance being lowest with the plunger in the coil. This in statement is simple, but, in practice it is difficult to apply this simple scheme.

In the first place, with the plunger a snug fit in the coil former, it is obvious that some unconventional means for fastening the coil ends must be found. Secondly, if brass studding is employed to carry the plunger, it is highly desirable that this be earthed. It will necessarily protrude from the coil screen for adjustment purposes and can, therefore, either provoke regeneration, due to feedback between adjacent rods, or will act as a miniature aerial and pick up interference from stations operating in the IF pass-band. It is not always satisfactory from the mechanical viewpoint to have the bearing for the rod attached to the coil can, for then both accurate coil and can assembly is essential, if the plunger is to operate freely.

Thirdly, any arrangement that will necessitate the tuning to be accomplished from beneath the chassis should be shown disfavour, for nothing is more provoking than to carry out adjustments upon a reversed chassis or upon one that is hazardedly propped to render the controls accessible.

Before considering the details it is

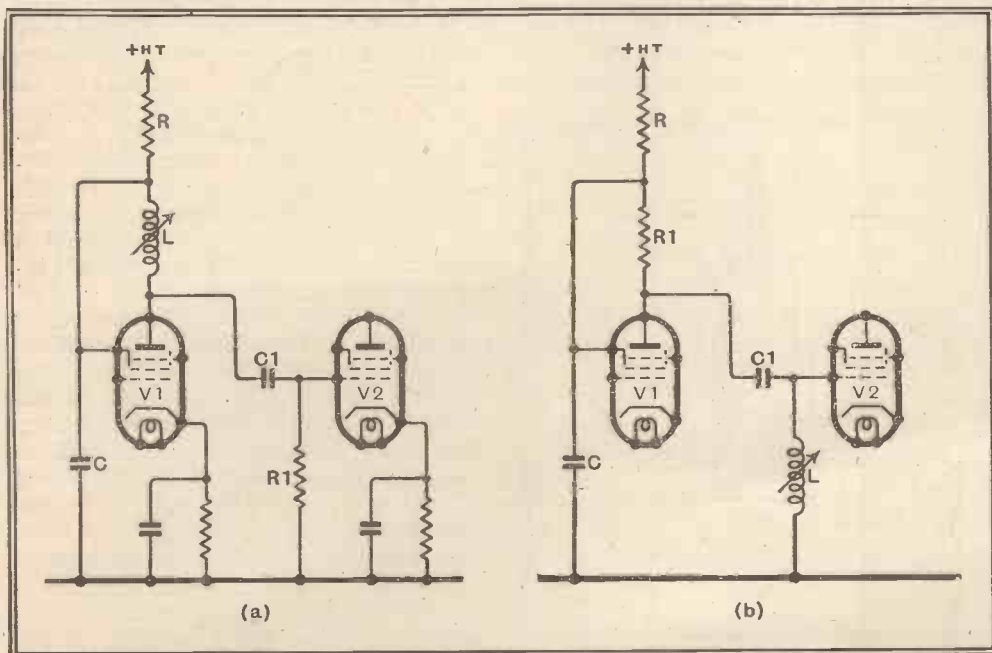

Fig. 1.—The familiar tuned-anode circuit is shown at (a) and at (b) the tuned grid arrangement in which the conventional RF choke is replaced by the resistance R1.

¹ High-Gain Television Amplifiers. *The Wireless World*, November 24th, 1938.

The Television IF Amplifier—

necessary to digress and to consider briefly the various forms that a simple inductance coupled circuit can assume and these are given in Fig. 1. At (a) is depicted the familiar tuned anode coupling. The resistance R and capacity C comprise the decoupling network, C₁ is the interstage coupling condenser and R₁ is the grid leak of the valve V₂. This grid leak can conveniently be of suitable value to damp the inductance L by the required amount.

In Fig. 1 (b) is shown a tuned-grid coupling. Here a resistance R₁ replaces the usual RF choke and is assigned a value such that the inductance L is damped to the necessary degree, normal values being in the region of 3,000-6,000 ohms. Obviously the anode voltage is reduced with this scheme; with R₁ some 5,000 ohms and V₁ a Mazda type-SP4I valve, by approximately 40 volts. This is, however, quite unimportant, for with the resistance values usually employed, the drop in voltage reduces neither the stage gain nor the output by an appreciable amount. As it is, in practice, satisfactory to work with the anode at a lower potential than the screen, common decoupling can still be used and is provided by R and C. Of course, if an abnormally high value of resistance R₁ can be used and the value is required to give more than a very small output, the lower anode voltage will be detrimental. The tuned anode coupling will then be the more suitable.

Coil Construction

If the straightforward tuned-anode arrangement of Fig. 1 (a) is to be employed, it is apparent that both ends of the coil winding are at anode potential; anchorage for one end cannot, therefore, be secured from the coil former support as is shown by Fig. 2 (a). In this sketch is also shown one way of anchoring the top termination. A strip of folded empire-tape is laid along the coil former a few turns from the end; the winding is completed over this and the free end is passed through the loop where it is securely held upon drawing back the tape. A similar

scheme can be adopted for both ends of the coil, see Fig. 2 (b), but the disadvantage of this arrangement is that it is

mounting purposes, a short length of 1/4 in. square rod is employed. It is a simple matter then to tap this at one end to per-

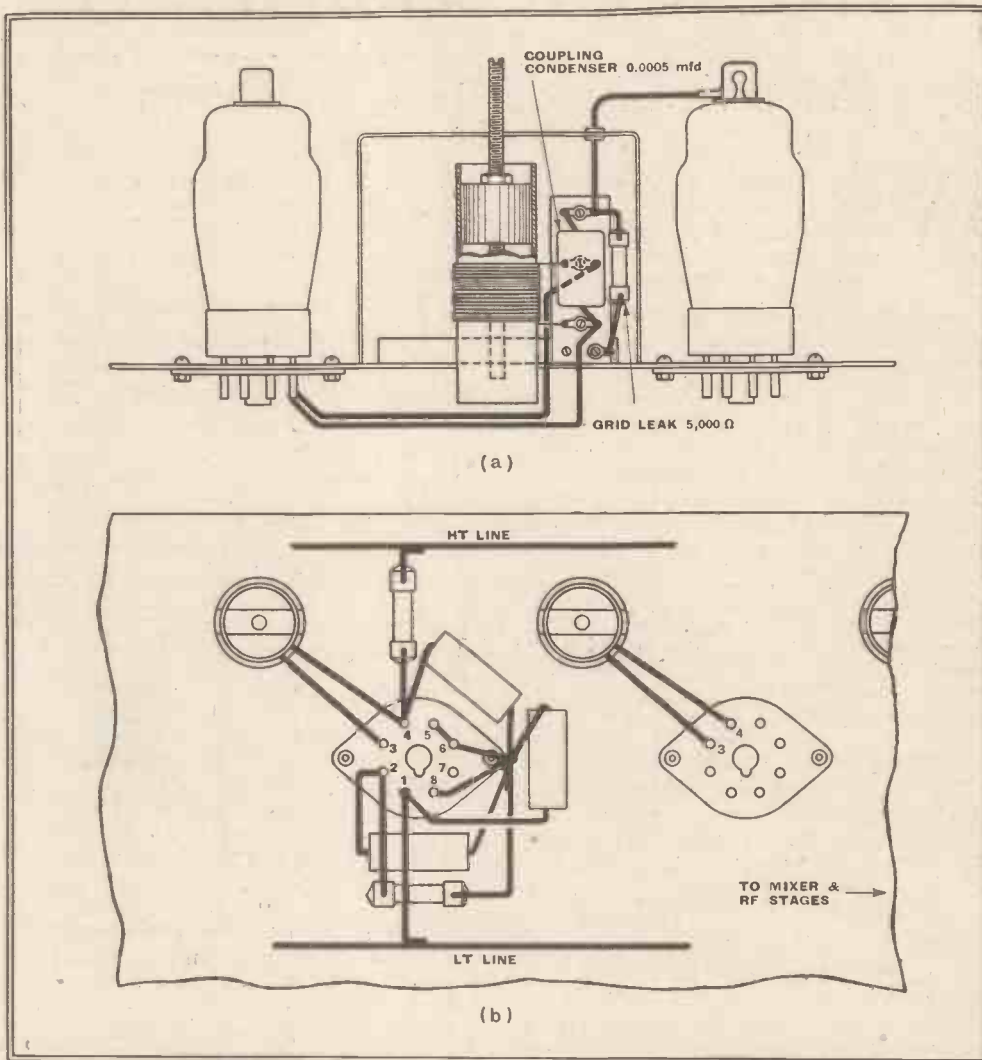

Fig. 4.—An excellent manner in which to connect the various components comprising a stage is shown here; (a) gives the connections to the coil and coupling components while (b) shows the under chassis wiring.

not an easy matter to adjust the number of turns once the coil is wound. A better scheme is depicted in Fig. 2 (c).

In place of the conventional flat brass strip passing through the coil former for

mit the mounting of a strip of paxolin carrying soldering tags at which the coil ends may be terminated. This square brass rod will also provide a simple means for mounting the tuning plunger. This can be effected in two ways [Figs. 3 (a) and (b)]. The arrangement of (a) necessitates adjustment to be effected from beneath the chassis, whereas in (b) the BA studding is carried through the top of the coil can. The fact that the studding is permanently in the coil's field will not influence the static inductance to any marked extent. This arrangement is convenient in all respects. The coil mounting and the tuning device are independent of the coil can, and the assembly is easily mounted in the chassis and its tuning effected, after which the screening can may be fitted.

Fig. 4 (a) shows the actual arrangement of the complete coupling unit when employing the circuit connections of Fig. 1 (a), the complete assembly comprising a robust, trouble-free unit. In Fig. 4 (b) is depicted a suggested layout for the complete stage as viewed from beneath the chassis. The advantages of such a layout are obvious. The method of wiring the

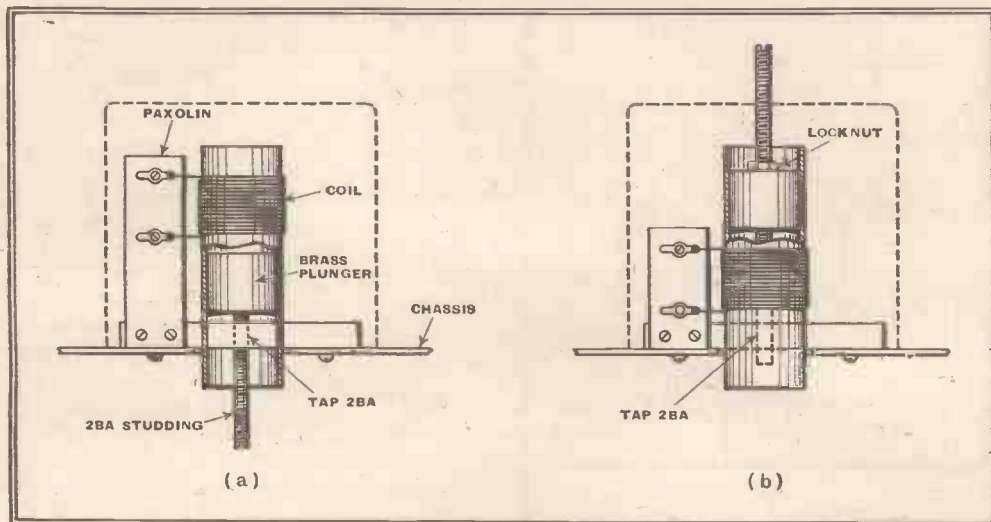

Fig. 3.—These diagrams show two methods of arranging a tuning plunger to permit variation of the coil inductance. That of (b) is preferable as adjustment is effected from above the chassis.

The Television IF Amplifier—

valve socket—this is for a Mazda type SP41 valve—is worthy of note. With the connections made in this manner, very short leads are preserved for all the decoupling components, an extremely important factor, which largely influences the gain and stability of the amplifier. In order to reduce the stray capacity for the coil leads passing below the chassis, these are actually extensions of the coil winding—i.e., they are of the same light gauge of wire.

Initial Adjustments

With the coils and valves staggered in this way the problem of holding the coil screening cans in position is easily solved. A strip of angle metal, suitably drilled, can be placed along the tops of the cans and held tightly with lengths of BA studing to the chassis. Alternatively, the normal can lid may be held between the square mounting rod and chassis.

Assuming an intermediate frequency of 13 Mc/s, the inductances can have approximately 27 turns of No. 26 gauge enamelled wire close-wound on a 3/8 in.-diameter coil former. The turns number is best determined, however, by pruning the coil until the resonant frequency is approximately correct. To facilitate this, the coils are slightly overwound, say, with 28 turns for the intervalve couplings and 30 turns for the diode detector coupling. It is assumed this valve will be a low-capacity type, such as the Mazda D1.

The adjustment procedure is then as follows. A signal generator is attached to the grid of the last IF valve, and the diode coupling adjusted to resonance at approximately 14 Mc/s, with the tuning plunger located midway in the coil winding. In

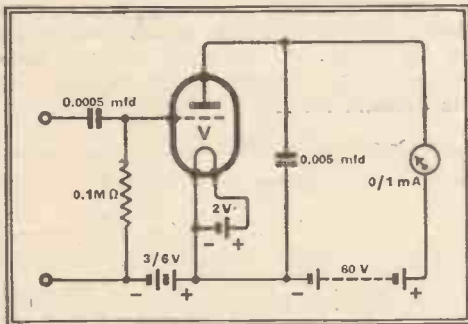

Fig. 5.—The circuit diagram for a simple valve-voltmeter which will facilitate tuning is given here. The valve V is any medium-impedance triode.

this case a meter in the diode load can be employed to indicate resonance. This procedure is continued for each IF circuit in turn, a valve voltmeter, which can be quite a simple affair (see Fig. 5), being employed to indicate resonance. The method of attaching both the signal generator and the valve voltmeter is shown in Fig. 6.

The tuning plungers are in each case set to be approximately mid-way in the coils. The variation in resonant frequency obtained at the two limits of the plunger's adjustment is a little over 2.5 Mc/s; it is,

therefore, apparent that some slight initial staggering of the resonant frequencies on either side of 13 Mc/s is required for a double-sideband amplifier. In practice, it is extremely simple to arrange this; for

It should be added that the intermediate frequency pass-band is equal to $f_2 - f_1 = 2f_m$, where f_m is the highest modulation frequency, and f_1 and f_2 are the frequencies at the edges of the pass-band. The intermediate frequency is given by the relation $f_2 - f_1 = f_i - f_1 = f_m$; this is a little higher than the resonant frequency $f_o = \sqrt{f_1 f_2}$, but this difference is negligible for intermediate frequencies of the order of 10 Mc/s and over.

The overall gain of the amplifier can be assessed with tolerable accuracy by applying the output of the signal generator to the detector diode and observing the meter deflection, then transferring this signal to the grid of the first valve and adjusting the attenuator until the same deflection is secured.

The signal generator is naturally set to provide a signal of appropriate frequency. The ratio of the attenuation then gives the gain. A very low-resistance L-type attenuator is necessary, and the accuracy or otherwise of this measurement will largely depend upon the efficiency of the screening of the signal source and upon the accuracy of the attenuator at high fre-

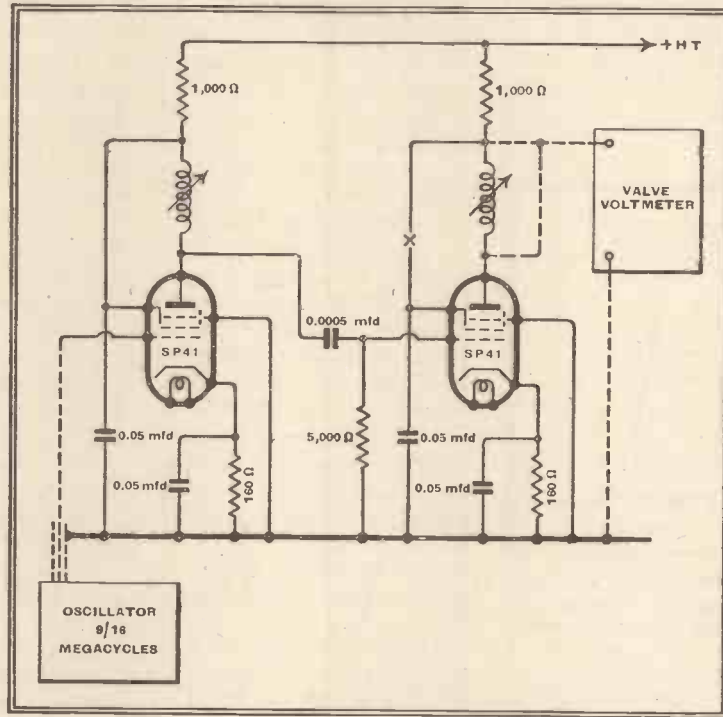

Fig. 6.—The method for connecting the signal generator and simple valve-voltmeter when carrying out tuning adjustments. The valve-voltmeter is attached to the anode of the valve and earth, the coil being short-circuited and the decoupling condenser disconnected at X.

example, with a four-stage amplifier there are five couplings, and these are evenly disposed at 0.5 Mc/s intervals on either side of 13 Mc/s. No particular accuracy when pruning the inductances is required, for the final tuning is accomplished with the plungers. To avoid any ambiguity, it must be added that the desired overall characteristic is not necessarily secured with the circuits uniformly mistuned; in many cases it is only necessary to mistune two or three of the circuits. However, by pruning the coils in this way it will be found possible to achieve the final tuning solely by adjusting the plungers.

The overall response of the amplifier can now be roughly checked by swinging the signal generator over the required bandwidth and observing the corresponding deflections on a meter in the diode load. Care must be taken not to overload the amplifier, and a low-resistance attenuator between the signal source and the grid of the mixer is desirable. With the adjustments satisfactorily completed, employing this approximate method, it is as well to plot the overall response characteristic, in the first place as against a vertical co-ordinate of readings in milliamperes, then converting these to decibels drop from the maximum response. A response of -3 db. at the edges of the pass-band is entirely satisfactory. The response between the limits of the pass-band should be substantially level; any marked non-uniformity must be eradicated, for this will result in unpleasant picture distortion.

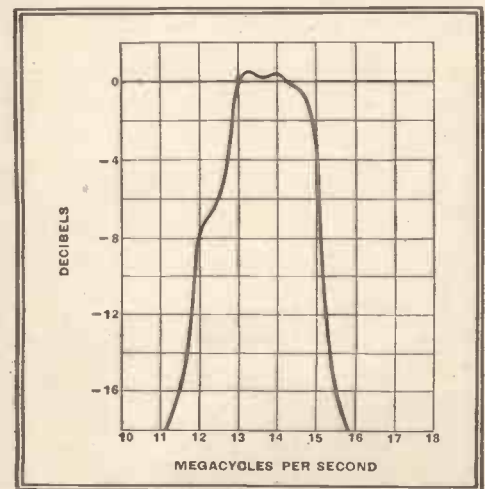

Fig. 7.—A typical overall response curve for an amplifier constructed on the lines described in the text. The oscillator frequency should be 58 Mc/s, single-sideband reception being employed.

quencies. The method is sufficiently accurate for the purpose needed, however, and where greater accuracy is required a signal of known voltage should be used.

The Television IF Amplifier—

An experimental four-stage amplifier that had circuit constants as given in Fig. 6, and employed Mazda type SP4I valves, had an overall characteristic as shown in Fig. 7. It can be seen that the lower modulation sideband is favoured, for this permits a reduced band-width in the RF amplifying stages, at the same time allowing an adequate response to the sound channel to be secured. The lower vision sideband extends from 43-45 Mc/s;

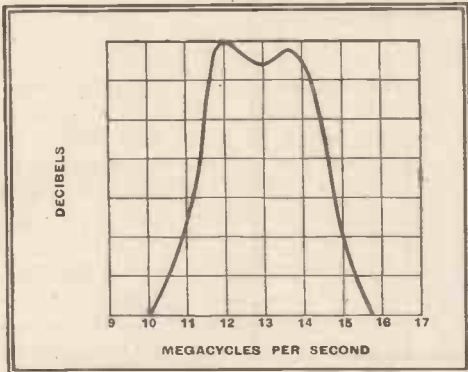

Fig. 8.—The same amplifier giving the response shown by Fig. 7 is here re-tuned to permit either single-sideband reception with an oscillator frequency of 57 Mc/s, or double-sideband reception with an oscillator frequency of 58 Mc/s. The advantages of this are described in the text.

the local oscillator frequency is 58 Mc/s, so that the intermediate frequency should be 58-45 Mc/s to 58-43 Mc/s—i.e., 13-15 Mc/s. This clarifies the apparent anomaly of the lower modulation sideband being favoured with the IF amplifier responding to the higher mixer valve output frequencies.

The overall gain measured to a reasonable degree of accuracy is approximately 13,500 times, giving an average stage gain of 10.8 times. This is quite an acceptable figure, and, moreover, is secured with comparative ease whilst retaining the desired frequency response. Of course, any

desired response characteristic is readily secured, and the considerations governing a decision upon this point will largely depend upon the receiving conditions.

The readiness with which almost any characteristic is secured is a useful feature of this form of amplifier, and to convey some idea of its versatility the same amplifier is shown retuned for double sideband reception with an oscillator frequency of 58 Mc/s, or, for single sideband reception, with the oscillator tuned to 57 Mc/s in Fig. 8. It often is advantageous to be enabled to vary, in this manner, the type of reception employed, as it gives a means of combating certain forms of interference that are not always present. Also, the inherent noise level of a receiver employed at some distance from the transmitter, where the signal strength will vary, can be reduced by restricting the frequency response, thus permitting reception of tolerable quality when poor reception conditions prevail. It should be noted that the best frequency response with an overall characteristic of the nature of that depicted in Fig. 8 is secured when employing an oscillator frequency of 57 Mc/s; that is to say, when single-sideband reception is employed.

In concluding, it is emphasised that care is very desirable during the tuning of such amplifiers, for the overall gain can, and will, vary over wide limits independently of the frequency response.

A jolly good thing I did, too, because they blow every time. But the funny thing is I can't find the short; everything seems quite O.K. As my prestige is at stake, do be a good egg and send along your usual infallible solution.

Yours ever,
Tony.

P.S.—I hope you hung on to the circuit diagrams and things I sent you.

The Work of the N.P.L.

RADIO RESEARCH IN 1938

THE Annual Report of the National Physical Laboratory, which has just been published (H.M. Stationery Office, price 2s. 6d.) contains in its radio section an interesting account of the year's progress in the research work which is going on continuously both at the Laboratory itself and at Slough and Leuchars research stations.

The two latter stations are used mainly for investigation into the origin and nature of atmospherics. Forty-four main types of these have been distinguished and it has been established that they have their origin in lightning discharges to the west or south-west of this country.

Meteorological observations by means of the well-known "sounding" balloons have also occupied the attention of the laboratory to a considerable degree. A compact transmitter, housed in an aluminium cylinder, has been specially developed for this work. The transmitter, which has a power of only 200 milliwatts, works on 35 megacycles (8.6 metres) and is modulated by two AF oscillators. The frequency of one oscillator varies between 700 and 1,000 c/s, according to air pressure, while the frequency of the other ranges from 1,400 to 1,700 c/s in accordance with the temperature.

Another most important section of the laboratory's work has been in connection with the cause of frequency variation in an ordinary valve-operated oscillatory circuit. Investigations have covered the valve itself and also the auxiliary components in the circuit. This particular line of research is of special importance in view of the widespread adoption of push-button tuning with its demand for freedom from "drift."

PROBLEM CORNER—14

Test your Powers of Deduction

All Hallows School,
Berkhamsted.

Dear Henry,

You remember the battery superhet I worried you about three weeks ago? Well, after all the short circuits and things I thought I'd be on the safe side and have fuses in the HT. I got a pair of those neat wander plug affairs with lamp fuses inside.

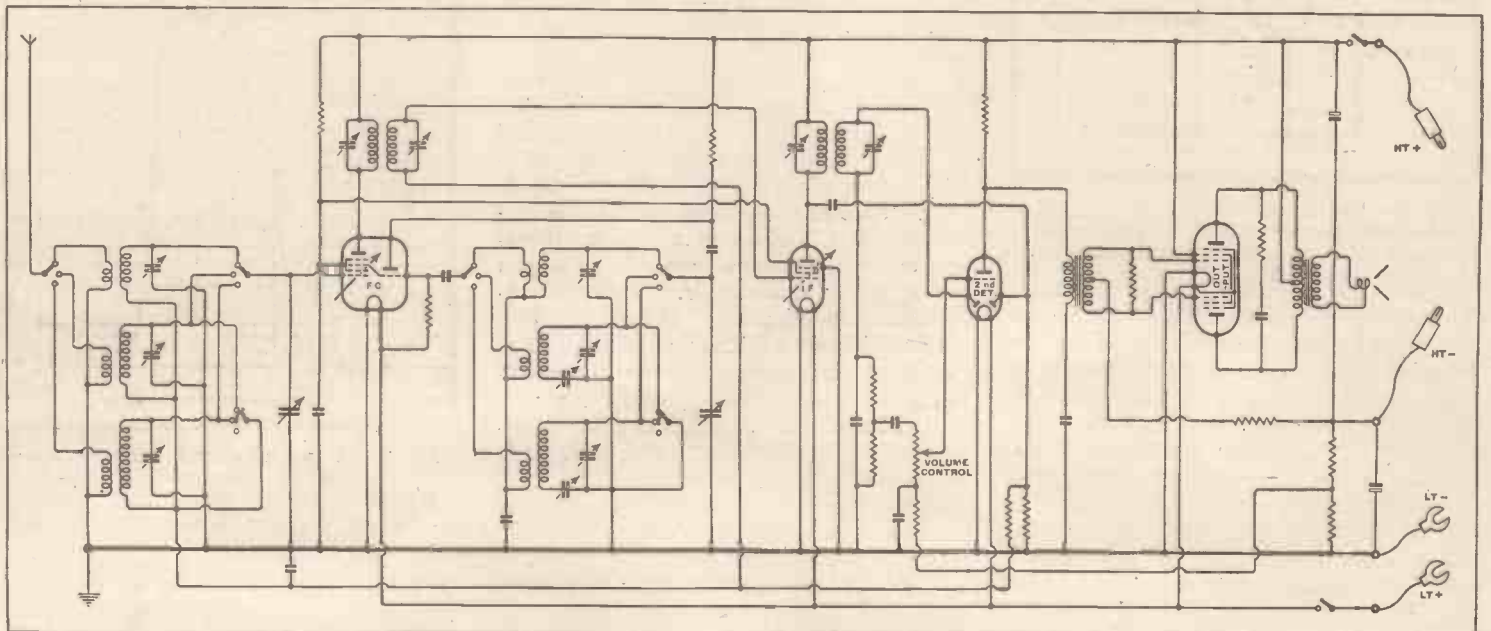

Here is the circuit diagram of Tony's receiver. If everything is O.K. why do the fuses blow? For the solution see page 326.

Wired Wireless Broadcasting

THE POST OFFICE RE-DIFFUSION SCHEME

THE announcement in the House of Commons that the Postmaster-General proposes to relay broadcasting by the telephone system is of great interest to all. The method is a form of wired wireless, and consists essentially of the utilisation of the ordinary telephone wires to carry the modulated radio-frequency carrier.

The proposal is to supply up to four alternative programmes on carrier fre-

The output impedance of the system is to be 100 ohms, and the aim is to provide 10 mV. of signal across this impedance. The subscriber will connect the aerial and earth terminals of his receiver to these output terminals and then tune in the relayed signals in the usual way. If he wishes to be able to use an aerial and obtain normal wireless reception as an alternative, he can do so by fitting a change-over switch so that the receiver

ceptible to interference from broadcasting stations. The carrier spacing to be adopted varies from 44 kc/s to 27.5 kc/s, and will thus be adequate for really high quality reproduction. It should be possible to retain modulation frequencies up to 10,000 c/s, and with this channel spacing their retention in the receiver presents no technical difficulty. The ordinary broadcast set will not, of course, be able to take full advantage of this, but special apparatus which will do so will no doubt be developed as the need arises.

The immunity from interference should enable high quality reproduction to be obtained even by those who are a long way from a broadcasting station, and a further advantage is that the system is expected to be largely free from man-made interference. On trolley-bus routes, however, it may be necessary to connect subscribers by twisted-wire cables instead of the usual open pairs.

In Time of Emergency

Another advantage of the system is that it is immune from deliberate jamming by other stations, such as might occur in the event of hostilities, and it is less susceptible to damage by bombing than is the ordinary broadcasting system. Although local interruption of the service might occur, it is unlikely that more than a small proportion of the subscribers would be affected.

The system would not interfere with the normal use of the telephone, and calls can be made or received as usual whether or not the receiver is in use.

Systems of this nature have been adopted in Germany, and one such was described in *Electrical Communication* for April, 1938. This was the Lorenz system, and the use of modulation depths up to 80 per cent. was contemplated. The appearance of the receiving equipment is well brought out by the photo-

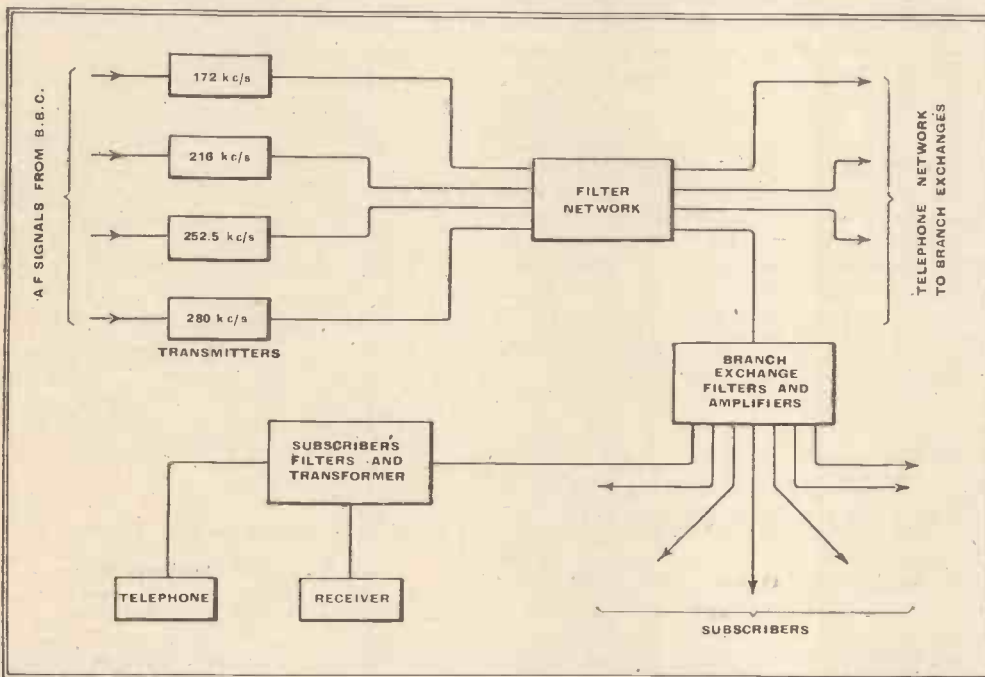

Fig. 1.—This diagram shows the general arrangement of the proposed scheme.

quencies of 172 kc/s, 216 kc/s, 252.5 kc/s, and 280 kc/s. The B.B.C. will provide the programme material and supply the audio-frequency signal by land-line to the Post Office, who will use it to modulate a small transmitter of a few watts output. Separate lines and transmitters will, of course, be needed for each of the four channels.

The outputs of the transmitters will be at different radio-frequencies, and can be combined with the aid of suitable networks and filters. The signals are then to be passed out over the telephone system. Amplifiers and filters will be provided at the branch exchanges, and the signals will finally reach the subscriber over his telephone lines.

At the Listener's End

The subscriber will be provided with a distribution box containing high- and low-pass filters together with an output transformer. These filters are to separate the radio-frequency currents of the relay system and the audio-frequency currents of the normal telephone service so as to avoid interaction between the two.

can take its input at will from the telephone line or from the aerial.

The general arrangement described is sketched in Fig. 1 in the form of a block diagram. The output of the transmitting filter network is shown as connected

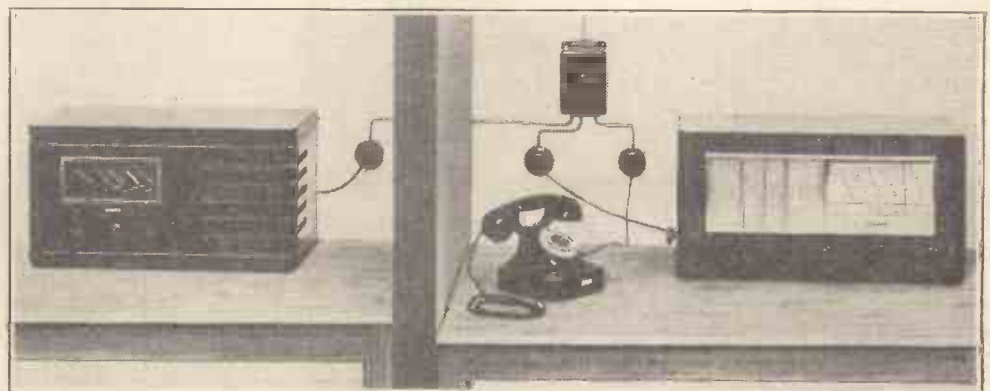

Fig. 2.—A view of the Lorenz apparatus in a subscriber's house; the distribution box is connected to three junction boxes for the receivers and telephone.

directly to the local exchange, but in many cases there will be several other intervening exchanges.

It is claimed that the system is not sus-

ceptible to interference from broadcasting stations. The appearance of the receiving equipment is well brought out by the photograph of Fig. 2, which shows the distributor unit on the wall and wired to three junction boxes. One of these is for the telephone and the others are for receivers.

Random Radiations

By "DIALLIST"

Batteries Abroad

"GO on giving us any news there is about battery sets," writes a reader from Northern Rhodesia; "and don't be put off by those who try to make out that the battery set is a museum piece. Apart from two or three million battery users at home, there are thousands upon thousands of us scattered over the Empire." My correspondent's great trouble is LT supplies. He can't get accumulators charged and is at present using large dry cells. These are not too bad, or rather they wouldn't be if you could be sure that they hadn't been in stock for some months when you buy them. I've written to suggest the air-depolariser cell as a possibility. Lots of people don't know that these have been made for years in this country and that the British product is much more suitable for LT work than the American. The latter can't be recharged; the former can. When it runs down after its first charge, only the zinc and the electrolyte need renewal; the fat porous carbon rod, which is the life and soul of the cell should be good for at least two zincs. If it has been well treated it may last longer than that. These cells also stand up very well to trying climatic conditions, which is more than can be said of many dry cells.

For A.R.P.

A good many people are investing in battery portables or transportables for their A.R.P. dug-outs. Sets using the new low-consumption valves, which draw their filament current from a single dry Leclanché cell are excellent for the purpose, save for one snag. The shelf life of dry cells is not indefinite; hence even an unused cell on open circuit deteriorates in time. The Army used to employ inert cells ("cells, electric, inert") for various purposes, and I believe that it still does. Are they purchasable by the civilian? If so, they would appear to be the very thing for the bomb-shelter set. The inert cell really is dry. So long as you keep it properly, it is completely inactive until you pour a little water into it. Hence it can remain for ages on the shelf in its original inert condition without suffering any adverse change. I bought a whole lot of such inert cells after the war, when surplus stocks were going cheap, and, wired in series, they made an HTB which lasted for an immense time. At one time, I think I'm right in saying you could buy inert HTBs. Are they still obtainable? I've an idea that Siemens made them.

Radio Links

Talking of A.R.P. (as a good many of us are nowadays!) I have often wondered why ultra-short-wave wireless hasn't been given more of a show in the various schemes for local communications. As it is, we are relying almost entirely on the Post Office telephone service for communications between warden's posts and report centres. The same applies to the medical, fire, decontamination and other services. Even with augmented staffs at the 'phone exchanges, this might mean delays; and if either the exchange itself or a multi-wire underground cable were badly damaged messages couldn't be got through at all by telephone. Small combined radio transmitting and receiving equipments wouldn't cost much and they'd enable communications to be kept going at all times and without congestion. If instruments designed to work on some very short wavelengths, such as two or three metres, were used their transmissions wouldn't interfere with those of the police or of the fighting services. There must be keen wireless folk in many areas who'd gladly rig up the necessary gear if permission to use it could be obtained.

W6XBE

IN a recent issue of *The Wireless World* I gave the transmission times of W6XBE as 04.00-07.00, Pacific Standard Time (12.00-15.00 GMT) and 15.30-17.00 PST (23.30-03.00 GMT), and stated that the 15.33-megacycle frequency was in use during both periods. A correspondent draws my attention to a paragraph in the April number of an American radio magazine which gives quite different information! In this it is stated that the station is at work from 03.00 to 09.00, Eastern Standard Time (08.00-14.00 GMT), and that alternative frequencies are used: 9.53 Mc/s when the path between the transmitter and the "target" of its beam is entirely in the dark, and 15.33 Mc/s when it is partly in daylight and partly in darkness. Well, my information came straight from the station—and so, in all probability, did that given in the magazine. A bit puzzling, but I think there's a satisfactory explanation. I believe that it was at first intended to operate the station only for one period a day, with alternative frequencies. That was

the latest information to reach the magazine before it went to press; mine reached me only the day before I wrote the paragraph, and I believe that it represents a correction of the original scheme and can be considered as accurate.

Melbourne Going Strong

THE best hour for listening for Australian stations used to be described as breakfast time by those whose habit it is to be afoot betimes. Saluting the dawn was never a strong point of mine; in fact, I'd far rather sit up for it than get up for it. Hence the occasions when I have received Australian stations haven't in the past been very numerous. I hail with joy the arrival now on 11.88 Mc/s (25.25 metres) of VLR3 of Melbourne at the altogether satisfactory hour of 20.30. No longer must I rise early to receive Melbourne; Melbourne most obligingly rises early (at 20.30 here it is 06.30 the next day on the other side of the world) to provide me with entertainment at a reasonable time. And what a splendid signal comes in from VLR3 for an hour or so, whilst the greater part of the track followed by the radiations is in darkness. Then, as daylight spreads westwards, it begins to lose both volume and steadiness, and by 22.00 it has usually become a mere fluttering ghost of what it was. What power is the station using, I wonder? In the lists it is credited with only 2 kilowatts; but the present figure must be a good deal more than that. At any rate, VLR3 is often much stronger than the 24 kW W8XK, though more than three times as far away.

M.R. Push-pull Output Transformer

THE overall dimensions of this component are 5½ in. x 5½ in. x 4½ in., and it has a massive closed iron core rated to carry 20 watts AC and 100 mA of DC per half primary. The secondary is wound in four sections, which by various series-parallel connections can be made to give ratios of 18, 24, 36 and 72 to 1. As all four sections are



in use for each ratio the frequency characteristic will not vary appreciably when the connections are changed.

The transformer was tested in a push-pull circuit using PX4 valves, and showed a well-maintained response up to 20,000 c/s. The output is only 3 db down at 18,000 c/s. At the lower frequencies there was no serious shunting of the load by the primary inductance, and the loss at 20 c/s under the conditions of test was less than 2 db.

The price of the transformer is 37s. 6d., and the makers are M.R. Supplies, 68, New Oxford Street, London, W.C.1.

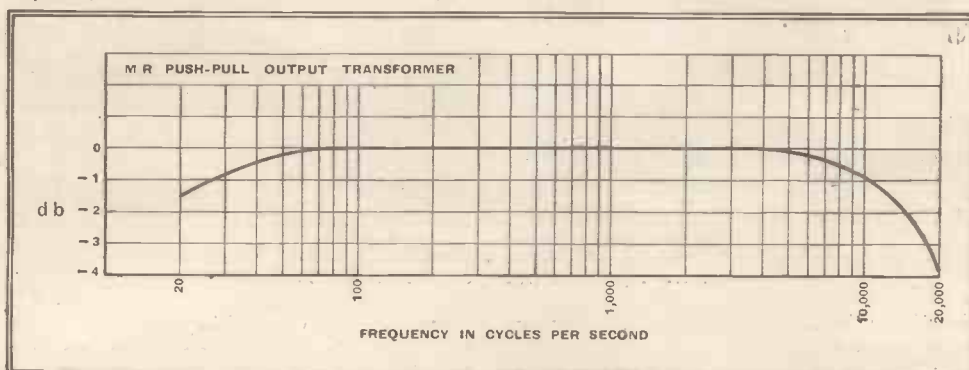

Frequency response of the M.R. push-pull output transformer when connected to two PX4s.

BASS

(The AF Kind, of Course)

THE title of this article suggests a controversial subject, whether pronounced with a long *a* or a short. As the latter variety is outside the scope of this journal (with the exception of Free Grid's page) I am confining my views strictly to the former. The fact that it is pronounced *bass* is significant, for it is the foundation of sound, giving depth and power to music and voices. On that point there will be little dispute. It is in its reproduction that the arguments and difficulties occur.

Years ago—*circa* 1925—bass was practically non-existent in the reproduction of broadcasting. There were a number of technical reasons why that was so. But when the thrill of hearing sounds from far distances began to wear thin, and the technical people turned their attention to throwing off the reproach about "tinniness," bass became a sort of El Dorado that all strove to find but nobody reached. I remember how impressed I was when I first heard the "Kone" loud speaker, which at that time was unique in having been designed on scientific lines to reproduce a wide range of frequencies. It seemed that at last here was true music in all its depth.

The Moving Coil Speaker

Then a rumour went round of a new loud speaker, the electrodynamic, now better known as the moving coil, with wonderful bass. And it was. The newly discovered low tones became the symbol of modernity in sets, and manufacturers entered a race for bassier and bassier reproduction. It was about this time that organs first began to be Mighty. Now, when the common varieties of output valve are rated to give about 8 watts each, and moving-coil loud speakers are universal, it is no longer clever to achieve the all-thumping tone that was fashionable a few years ago and even now—alas!—is not quite dead. Yet *really good* bass reproduction is still very rare indeed. That is why the vast majority of people are unaware that there is anything wrong with the bass they commonly hear. It needed the moving coil to show up the limitations of the "Kone"; and history repeats itself. Only now it is much more difficult to recognise an improvement even when it is heard, as well as being difficult to obtain even when it is understood.

The reasons are quite interesting. I mentioned above that it is easy to get at least the appearance of a full bass now that common output valves give several

watts of power. Readers who have not already gone some distance into the subject may wonder what this has to do with it. In a general sort of way it should not be difficult to see where power enters into the problem, for all instruments capable of producing very low notes are large and demand much more power to play than high-pitched instruments. One has only to think of the bass drum, which is operated on a similar principle to the "Try Your Strength" machines at fairs; or the tuba, which makes even a full-winded musician show symptoms of impending apoplexy if included in the composer's score for any length of time; and,

By
"CATHODE RAY"

above all, the pedal notes of an organ, which absorb most of the several horsepower that may be given by the blower motor. Like radio waves, or any other waves, the wavelength is got by dividing the speed by the frequency. As the speed of sound in air is about 1,100 feet per second, the wavelength of a high note, three octaves above middle C (frequency 2,088 cycles per second), is a little over 6 inches. But a very low rate, three octaves below middle C (frequency 33 c/s) has a wavelength of 33 feet. A child with a stick can make ripples of short wavelength on the surface of water, but it is only the passing of a liner driven by great power that gives any sort of imitation of full-sized ocean waves.

It is much the same with air waves. Actually the distance a loud speaker cone or other sound-producing surface has to vibrate between its backward and forward limits to produce sound of a given intensity is proportional to the square of the wavelength. So to extend the reproduction of bass notes from, say,

100 c/s to 50 c/s it is necessary to have a loud speaker that can vibrate four times as far. And it is very difficult to do that without causing serious distortion by the coil coming outside the uniform part of the magnetic field (see the accompanying drawing). One way is to reduce the necessary amplitude of vibration by increasing the size of the cone (which may make it difficult to reproduce the high notes as well as before); another is to increase the size of the magnet system, but there is still a risk of distortion due to the uneven constraint of the coil and cone suspension when they are pulled to and fro so violently. And either way is expensive.

Peculiarities of the Ear

There is another reason why a lot of power is needed. It is to do with the listener himself. I said just now that to produce a bass sound of the same intensity as the treble it is necessary to have a vastly greater vibration. *Intensity*. That is quite a different thing from *loudness*.

To make a 50-c/s sound just audible to the average pair of ears it is necessary for the sound to be 200,000 times as intense as a just-audible 2,000-c/s sound. And for a more complicated reason, which I explained some time ago as "Scale Distortion," the proportion of bass tone present in a programme apparently diminishes if the programme is reproduced at a lower intensity than the original performance. So even if the reproducing equipment is perfect, the result lacks bass unless the original intensity of sound is given. (To silence any scornful criticisms that may still remain after my frequent assurances on this point, I repeat that this does not necessarily

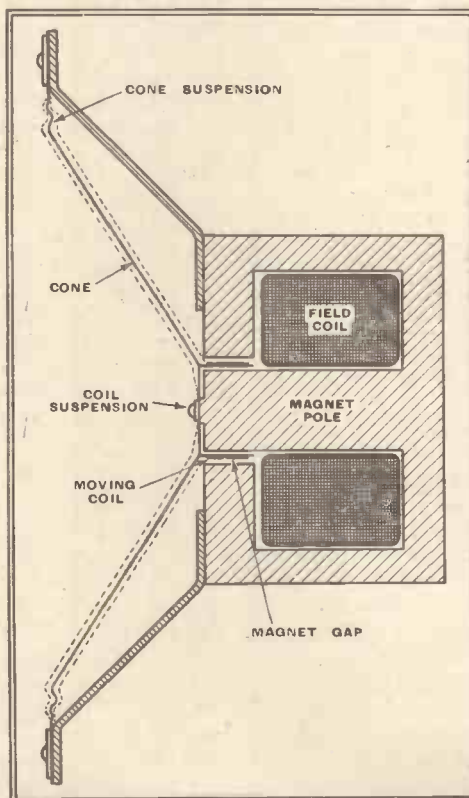

Cross-section of a moving coil loud speaker to show the difficulties that arise when the amplitude of vibration (indicated by the dotted lines) is large, as is necessary for reproducing very low notes at sufficient strength to be audible.

demand the full power of the original sound source. For example, a very high intensity can be produced in the ear by

Bass—
headphones fed with quite low power.)

For reproducing a programme by loud speaker in an ordinary room the early sets with their fraction of a watt output were unable to do justice to the bass even apart from their technical deficiencies. So power does matter.

Until now I have cast most of the blame on the loud speaker. But although the difficulties in the amplifier itself are far less, they must be attended to. There is one particular difficulty, in addition to the need for ample power output, that is important—the output transformer. To pass the ample power output from the amplifier to the loud speaker at very low frequencies without distortion it is necessary for the transformer to be much larger and more expensive than is generally supposed.

Expense again. Expensive methods are not popular with radio manufacturers, at any rate those who make "competitive" sets. Yet leaving out the bass is no longer tolerated. So this is an awkward dilemma. It has, however, been found possible to solve the problem to the satisfaction of perhaps 99 per cent. of the public. In this the manufacturers are helped by peculiarities of the very ears that make things difficult for them in the other ways that I have already explained.

Take an ordinary piano of what I believe is known as the "cottage" type. Its lowest note has a frequency of 27 c/s. That is a very low note indeed, far below the capabilities of the ordinary loud speaker. Yet it is not merely *audible* on the said O.L.S., it is heard with body and depth that satisfies all but the very critical listener. Surely a flat contradiction! Even the piano itself seems theoretically incapable of playing a note with a wavelength of 40 feet; requiring in an organ a pipe 20 feet high, not at all adapted to the bijou flatlet (or the "cottage").

The explanation of this seeming impossibility is that the cottage piano (and, still more, the O.L.S.) does *not* reproduce any really appreciable amount of 27-c/s sound. How, then, is it heard?

Creating an Illusion

Most of the sound is at harmonic frequencies—54, 81, 108, 135, etc.—some of which do come within the range of the reproducing equipment. It is a remarkable fact that if sound at the fundamental frequency—and even the first few harmonics—is entirely eliminated, the ear still recognises the fundamental pitch. Suppose, for example, that everything below 100 c/s is perfectly silent, the fundamental and the first two harmonics being removed, the listener does not hear what is left as a 108-c/s sound. It is still a 27-c/s sound; a little lacking in "body," no doubt, but quite recognisable. The more loudly it is heard the more the ear re-creates the missing low tones.

This is lucky for the manufacturers, for it covers up the shortcomings of their pro-

ducts. They are also favoured by the fact that the O.L.S. almost inevitably resonates at some frequency usually in the region of 85 c/s, and thereby boosts sounds of around that frequency, so making up for the falling-off due to the use of small output transformers and other deficiencies. Also the air space inside the cabinet resonates. If it does so at the same frequency as the loud speaker the result is an unbearable boominess, but things are generally contrived so that the cabinet resonance bolsters up some other part of the frequency scale.

When the lowest note in the piano is played, the loud speaker will probably respond strongly to the third harmonic (81 c/s). If it is definitely of a cheap variety, and is driven strongly, it is likely to distort a good deal, producing sound of double this frequency. But as that is the sixth harmonic of the piano fundamental it just strengthens what is already there, and the ear accepts it all quite happily.

True and Faked Bass

So much for the O.L.S. Now suppose that expense is no object; at least, not much object. Is true bass reproduction distinguishable at all from the fake just described, and, if so, how can it be obtained? In using the word "fake" I hope I will not be understood to class O.L.S. manufacturers along with forgers, counterfeiters, and other persons of unworthy motives. There is nothing at all reprehensible in the policy followed; I would do the same myself. Hardly anybody at all is critical enough to detect the fake without a direct comparison with the genuine article, and not many people are able to do so even then. And of those who are, few are able or willing to pay several times the ordinary price for the privilege of having it. After all, the fact that jewellery purchased at the sixpenny store is not constructed of genuine pearls and diamonds does not reflect adversely on the honesty of the business nor prevent it from giving pleasure to a vastly greater number than are served via Hatton Garden.

The difference between fake and genuine bass is not always obvious even to the experienced listener with facilities for a direct switch-over between the two. One tendency of the less good sets is to render speech boomy; but even perfect equipment does this if the reproduction is much louder than the original, so that is not an infallible guide! Programmes with an absence of bass instruments obviously are unsuitable for the comparison. Even when the bass is strong, if it is provided by instruments with fundamentals higher than about 70 c/s or with very pronounced harmonics the distinction is not clear. The tendency of the cheap equipment to tear up the higher parts of the programme when the bass is very strong is sometimes noticeable. But the best programmes for the test are those that include notes with relatively strong and very low fundamentals. Some of the

organ pedal notes (preferably *not* a cinema organ) and the "string bass" used by dance bands are good. It may be found that the high-quality equipment is uttering distinct "zoomps" that the O.L.S. won't touch. Or if it does, there is a subtle difference in tone, something like the difference between the "cottage" piano and a concert grand, or a harmonium and a pipe organ.

I'm afraid I can't start on a full account of how an approximation to true bass is achieved, but here is a quick sketch. A moving-coil loud speaker must have a very freely suspended movement, and either a large cone or a long magnet gap or both. Then to prevent the very low tones from running straight round from front to back and neutralising the sound it is necessary to have a huge baffle. To attempt to produce a useful amount of sound at, say, 20 c/s with a baffle-mounted loud speaker involves almost impossible requirements because of the enormous amplitude of vibration. That is because the cone gets a grip on such a relatively small amount of air. But by using a horn, the design of the speaker itself is much easier, because it is "matched" more efficiently to the load of air it moves (much as the output valve is matched to the loud speaker by a transformer). But the horn must be a big one.

So, as I said before, true bass is rare. Between the O.L.S. and the rather awkward (for domestic use) types just described there are those that can fairly be called "high quality"; that is to say, they fall short of perfection in dealing with the very lowest pure tones (which hardly ever occur in programmes, anyway) but are more or less substantial improvements on the mass-production article. The aim now is to make these better and cheaper.

Webb's Amateur Radio Station Log

THIS log book has been prepared especially for keeping records of all calls sent out and received at amateur transmitting stations. It contains 75 pages, with columns and headings for making all the necessary entries.

A semi-loose-leaf form of binding is adopted. One page is devoted to a list of the most used "Q" code signals, also the R.S.T. codes, while at the back is a quick reference to valve-holder connections.

It is obtainable from Webb's Radio, 14, Soho Street, London, W.1, and the price is 2s. 6d.

HENRY FARRAD'S SOLUTION

(See page 322)

A CONDENSER is shown across the HT battery, and as it is marked as an electrolytic type it can be assumed to be of at least several microfarads. The charging current at the moment of switching on is quite enough to blow a low-current lamp. If such a large capacity is essential, the fuses should be of a higher rating though sufficiently low to protect the valve filaments.

NEWS OF THE WEEK

GERMAN WIRED WIRELESS

New Method of Broadcast Distribution

THE German Post Office announces the introduction of a system of wired-wireless broadcasting similar to that proposed by the G.P.O. and described elsewhere in this issue.

The new high-frequency distribution service, which has been opened after tests which have extended over several years, will be made available to those who own a wireless receiver at no extra cost above the normal wireless licence fee of Rm.2 per month. At present, there will be a selection of three programmes—two regionals and the Deutschlandsender.

The system of distribution is carried out by using the main trunk telephone lines and the normal local cables up to the point of entry into the house whence a special two-way cable is connected to the aerial and earth terminals of the ordinary broadcast receiver.

Modulation is "piped" from the broadcasting station to the central telephone trunk exchange, where it is applied to a special low-powered "wired-wireless" transmitter. The radio-frequency output of this transmitter is then "piped" to a sub-transmitter in the area to be served, and so by telephone line to the listener's home.

The German authorities point out that the new service cannot be jammed, is free from electrical and atmospheric interference and can be used during hostilities when radiation from broadcasting stations would be stopped to obviate their use for direction finding.

Users of the service are not restricted to its use only, for by the simple procedure of changing the leads to the aerial and earth terminals of the receiver the normal method of reception can be used.

HEIGHT is a predominant factor in the location of a television transmitting aerial, and the N.B.C. aerial shown here on the top of the Empire State Building, New York, certainly covers a wide horizon. Designed by N. E. Lindenblad, of the R.C.A., the upper system consists of four dipoles for the sound, and the lower, which, as shown in our close-up picture on March 16th, resembles four footballs, consists of two dipoles for vision. The band to be accommodated by the vision carrier is 5.5 Mc/s and the aerial gives a constant low impedance over this wide band. No quality in the generated signal should therefore be lost by transmission through this aerial.



AMERICAN TELEVISION

Mr. Gerald Cock to Visit New York

WE understand that Mr. Gerald Cock, B.B.C. Director of Television, will leave England for New York on April 15th to see the inauguration of N.B.C. television, and will be away for about a month. He expects also to visit the Columbia Broadcasting System's television headquarters, where Mr. D. H. Munro, the B.B.C. Television Productions Manager, will be assisting in the establishment of the service a month later.

Difficulties of installing the C.B.S. television transmitter on the 73rd and 74th floors of the Chrysler Building in New York have taxed the ingenuity of the engineers to the utmost, but the work goes on, and the chief problem to be solved now is

the installation of the aerial.

It is to withstand a wind velocity of 150 miles an hour and must be anchored without support from the comparatively flimsy burnished steel plates which serve as a decorative covering for the tower.

Meanwhile the 6½ tons of power cable has been brought up through the conduit from basement level.

Because the cable almost filled the conduit there was danger of the lead covering expanding from heat generated by friction, and so causing a jam. This was avoided by lining the conduit with heavy grease and the cable was hauled up by the lift mechanism from which the actual lift had been disconnected.

WHITHER TELEVISION?

A Plea from Lord Hirst

IN a letter to *The Times* stressing the need for the establishment of provincial television centres, Lord Hirst, chairman of the General Electric Company, said: "I do not believe that any but a few people have yet realised what television is capable of giving this country."

"Not often does there emerge a new British industry with the clear opportunity of a lead over all other countries in the world market. Yet that is what television, resolutely, promptly, and imaginatively developed, will give us.

Financing the New Industry

"I should not in this difficult hour plead for any additional expenditure for the sake of a new form of entertainment. I do not hesitate to plead for the investment on behalf of a new British industry (which may well have incidental defence implications) of the very moderate sum which alone is needed. It could probably be provided by the transfer to the B.B.C. of that part of the wireless licence revenue which the Government still retains for its own purposes. If not, the Government might well allocate for this special purpose some small fraction of the £15,000,000 which it has received from the licence revenue during the last sixteen years."

EMPIRE LISTENERS

B.B.C. Advises on Set Purchase and Relaying

THE B.B.C. is bombarded with requests from Empire listeners for advice on purchasing a set. As the Corporation points out, it cannot give advice on, or make recommendations concerning, specific makes of receiver.

In general, however, Empire listeners are being advised to buy a set of reputable manufacture for which efficient servicing is available. Listeners are warned against buying obsolete receivers, especially if the set is bought abroad.

The Corporation is also opening a service of advice to broadcasting and other authorities intending to establish relay stations for re-diffusing the Daventry programmes to listeners within a certain area, the advice being based on the Corporation's own experience of relaying programmes during the past twelve years.

CINEMA TELEVISION

Mr. Ostrer's Views

AFTER the public showing of the B.B.C.'s television transmission of the Boat Race, which was marred by unfavourable weather conditions, at the Marble Arch Pavilion, Mr. Isidore Ostrer, chairman of Gaumont-British Picture Corporation, the owners of the



THREE FAMOUS MEN who worked for the rearrangement of wave-lengths at Lucerne and who now control the Comité du Plan at Montreux. Left to right, M. Braillard, Belgium, Dr. Muri, Chairman of the Conference, Switzerland, and Herr Giess, Germany.

News of the Week—

theatre, gave his views on the future of television and the cinema.

He stressed the point that it was the desire of Gaumont-British to obtain a television transmitting licence from the Postmaster-General for the sole purpose of covering outstanding sporting and national events for reproduction in their own cinemas, a number of which are now in the process of being equipped with Baird big-screen projector receivers. It was not, he said, the wish of Gaumont-British to compete with the B.B.C. who should remain the purveyors of home television.

AMATEUR AWARD

Nominations Closed for Third Annual Paley Trophy

NOMINATION of candidates in Canada and the U.S.A. was completed this week for the third annual William S. Paley amateur radio award. Nomina-



THE RADIO OFFICER at his post in the radio control room on the upper deck of Pan-American Airways Yankee Clipper, which inaugurated the new transatlantic air service. A hundred watt transmitter, WCBN, which was installed by the Columbia Broadcasting System for the transmission of commentaries during the initial flight, is located in the lower compartment of the plane's nose.

tions are being compiled in a brochure to be sent to members of the Board of Award, which is constituted by well-known personalities in various walks of life. For the first time since the award was instituted women have made their appearance with men as contenders for the title of the outstanding 1938 amateur radio operator.

The award was inspired by the 1936 flood disasters, when amateur wireless operators rendered valiant rescue service to stricken areas.

The first trophy went to Walter Stiles, jun., W8DPY, and last year Robert T. Anderson, W9MWC, received it for services rendered during the Ohio river flood.

The name of each year's winner is engraved on the base of the original trophy, which is kept in the custody of the American Radio Relay League, and a smaller replica becomes the permanent property of the winner.

RATIONALISING RADIO

Developments in the German Industry

FOLLOWING the example of the German motor industry, which has reduced the number of models to enable manufacturers to mass-produce a few types with the resultant reduction of costs, the German radio industry has decided to standardise not only sets, but also valves and components. At present eighteen special committees are sitting to discuss the proposed changes.

Each of the manufacturers will limit the number of types

to about three, as has already been done in the manufacture of superhets by the German Philips Company. It is expected that all straight receivers will in future be built on the reduced profits scheme of the People's Set.

The scheme will, of course, bring down the prices, with the result that not only will the German people benefit, but Germany will also be able to compete advantageously in foreign markets.

AMATEURS AND BROADCASTING

AMERICAN amateurs are concerned about the encroachment of broadcasting stations in the 7-Mc/s band. The Cairo Conference agreed that from September 1st, 1939, broadcasting stations could transmit on frequencies between 7.2 and 7.3 Mc/s, but the complaint of American amateurs, which is

voiced in *QST*, is that the French colonial station, Paris Mondial, is already broadcasting within this band—on 7.28 Mc/s.

The American Radio Relay League has appealed to the U.S.A. Department of State that representations be made to the French Administration to cease this "violation."

Foreign Language Transmission

THE early evening clash between the English programmes in German and the German transmissions in English has not gone unnoticed by the B.B.C. To disentangle this awkward situation steps may be taken to change the time of the German bulletins from this country. The problem then facing the B.B.C. would probably be that the German transmitters would follow suit.

Receipts from Sponsored Programmes

THE Minister of Posts and Telegraphs in Dublin announced that it is anticipated that the State will collect £35,000 from "advertising and other receipts" derived from the Radio-Eireann sponsored programmes.

North Atlantic Marine Wireless

COMPULSORY equipment of all vessels employed in North Atlantic and Arctic work with complete radio equipment is proposed in a Bill before the Norwegian Government. It is also proposed to raise the power of the two sub-Arctic commercial radio stations at Bear Island and Svalbard (Spitzbergen) which will in future chiefly radiate telephony.

Ship's S O S's to be Rebroadcast

THE Danish Government has ordered that all telegraphic and telephonic distress calls from ships received by Danish Authorities are in future to be rebroadcast during the normal programmes even if this procedure necessitates the interruption of a programme. In this way the messages may be picked up by small fishing craft which carry an ordinary broadcast receiver only, and it is hoped thereby to effect a speedier rescue.

Broadcasting in Russia

THE number of Russian listeners is reported as 22 per 1,000 inhabitants. Difficulties of receiver production have not yet been solved, and, according to the journal of the Russian Heavy Industry Commissariat, during the last three years of the present five-year plan only 25 per cent. of the production programme has been carried out.

Baird

It was announced by Sir Harry Greer, chairman, at the adjourned ninth Ordinary General Meeting of Baird Television, Ltd., held last Friday, that from July 1st Baird would be manufacturing and marketing their own televisions.

Record Sales

LAST year about 35,000,000 gramophone records were sold in the United States, which was equal to 1912. Some 100,000,000 records were sold in 1921. By the late 1920's radio had taken a firm hold, and the gramophone industry was given up for dead, though actually it continued to sell records by the million, and the low mark reached in 1933 was equal to that which had seemed a booming business in 1907. The sales curve rose from 1933 to 1938 identically with the rising curve of 1907-12.

FROM ALL
QUARTERS

B.B.C. Knapsack Transmitter

THE B.B.C. is testing a new type of portable transmitter which can be used by commentators at sports meetings. It is extremely light, and its low power is just sufficient to give it a range of a few hundred yards; its signals being picked up by one of the O.B. vans. Tests are being undertaken with a view to using the transmitter at sports fixtures during the summer. The transmitter uses an ultra-short wavelength, and permission for its general use has not yet been obtained from the Post Office.

French Television

THE first public demonstration of big-screen television in Paris was given last Sunday at the Theatre Marigny on a screen 6ft. by 4ft. The performance, which marks the beginning of a television drive in France, was attended by M. Jules Julien, Minister of Posts and Telegraphs. From April 15th outside broadcasts are to be televised.

New York Television

OUR New York correspondent informs us that the R.C.A. television transmitter at the top of the Empire State Building, New York, is being rebuilt, and will be working again early next month, in readiness for the opening of the New York World's Fair. As no service is yet available the production of television receivers is proceeding cautiously.

Television Debut

VISITORS to the Golden Gate Exposition at San Francisco will not only see practical home television demonstrated, but, like visitors to our own Radiolympia, will themselves have an opportunity to be televised. This will be the first public showing of high-definition television on the Pacific Coast.

Police Wireless

IN order to make police communications even more immune from air attack, a micro-wave transmitter operating a beam service to Scotland Yard has been installed at the police transmitting station near West Wickham, Kent.

The Modern Receiver

Part VI.—INTERMEDIATE-FREQUENCY AMPLIFICATION

Stage by Stage

FOLLOWING the frequency-changer there is the IF amplifier in which a single valve is usually employed.

In large receivers two stages, or even more, are often used, but most sets have only one.

Essentially, an IF amplifier differs from an RF amplifier only in the resonant frequency of its circuits being fixed and not tunable over a wide range. The same general design considerations apply but are modified in two ways by the fixed frequency of operation—it is possible to use circuits which would be unsuitable for ganging and there is no restriction set on the LC ratio of the circuits by any need for waveband coverage.

The two main requirements are amplification and selectivity. We saw earlier when considering the RF amplifier that

It is unwise, therefore, to make the inductance very high. No optimum figure can be given, for it depends on so many factors. There is also the question of the trimming condenser to be taken into account. With a moderate or low inductance coil the capacity required for resonance is likely to be 100-500 $\mu\mu\text{F}$.; this is greater than can be economically obtained with an air-dielectric condenser, and the compression-type mica trimmers are used.

As the inductance increases the capacity needed decreases. Both coil and condenser losses increase and a point is reached at which Q begins to fall off rapidly. With a capacity of 60 $\mu\mu\text{F}$. or less an air-dielectric trimmer becomes feasible and its lower losses lead to a higher Q for the circuit.

The air condenser also has the advantage that its capacity is much more stable than that of a condenser of the compression type. It is much less affected by temperature, humidity and vibration. Even in small-capacity form, however, it is more expensive and takes up more room.

Coupled Circuits

When the coils have powdered-iron cores it is possible to dispense with adjustable condensers and to arrange for the core to be movable for trimming. The condensers can then be of fixed capacity and of a low-loss and stable type. This course has not yet been generally adopted, but there are signs that it will become much more common than hitherto.

Single circuit couplings, such as are commonly used in the RF amplifier, are quite rare at intermediate frequency and it is usual to employ pairs of circuits coupled together. It is also usual to use mutual inductance coupling between the tuned circuits of each pair.

The arrangement is shown in Fig. 15; the primary circuit $L_1 C_1$ is usually identical with the secondary $L_2 C_2$, and the two are coupled by the mutual inductance between the coils. The coils are placed so that the magnetic field set up around L_1 by the current in this coil cuts the secondary coil L_2 . The changing primary field induces a voltage in the secondary which, in its turn, produces the secondary current.

Now this current also sets up a magnetic field around the secondary which cuts the primary coil L_1 . A voltage is consequently induced in L_1 by the secondary current and this acts to modify the primary current.

This reaction of the secondary back on to the primary leads to some important effects. We saw earlier that when two circuits are in cascade and separated by a valve the overall resonance curve is given by the product of the individual circuits.

The circuits are then coupled by a one-way device—the valve—so that the second circuit does not react back on to the first. When a reactive coupling is used and is very weak, the overall

response of a coupled pair of circuits is very similar. As the coupling is increased, however, the overall curve departs more and more from that given by the product of the individual circuits.

What happens is illustrated by the curves of Fig. 16. Here A shows the results with fairly loose coupling, while B is for optimum coupling. It is assumed that the circuit is of the form of Fig. 15, and that the only coupling is that provided by the mutual inductance M between L_1 and L_2 .

As M is increased, so the efficiency of transfer rises and the stage gain increases until the optimum value is reached; there-

In the superheterodyne the adjacent channel selectivity is obtained very largely in the intermediate-frequency amplifier, and in this article the more important factors governing its performance are discussed. The problems of variable selectivity are also touched upon.

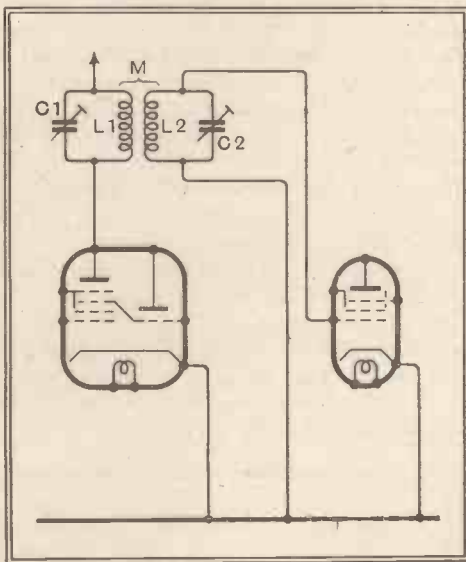

Fig. 15.—This diagram shows the usual IF transformer connected to act as the coupling between the frequency-changer and the IF valves.

the gain depends on the dynamic resistance of the tuned circuits ωLQ , and the selectivity upon Q . As we have no restriction imposed by waveband coverage on the choice of inductance we can have high gain with low selectivity by making L large and Q small, or we can have low gain and high selectivity with small L and large Q . Low gain and low selectivity can be obtained with small L and Q , and conversely high gain and high selectivity with large L and Q .

Now with coils of a given construction there is usually one value of inductance which gives the greatest Q and another higher value which gives the greatest dynamic resistance. The values referred to are those for the total circuit, including the losses introduced by other components.

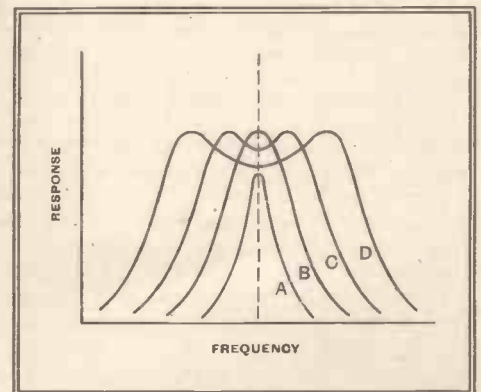

Fig. 16.—The effect of varying the coupling M of Fig. 15 on the resonance curves is well brought out here.

after, any further increase in M reduces the gain at the resonance frequency. Up to the optimum value of coupling the resonance curve maintains the same general shape, but selectivity falls off somewhat as M is increased.

The Modern Receiver Stage by Stage—

When the coupling exceeds optimum two peaks appear in the resonance curve with a trough between them, as shown by curves C and D in Fig. 16. In some ways the circuit behaves as though the primary and secondary were tuned to frequencies on either side of the central frequency, indicated by the dotted line.

Mutual inductance is by no means the only way of coupling two circuits. Top-end capacity coupling can be used; in Fig. 15 this would be obtained if M were zero and a capacity were connected from the anode of the first valve to the grid of the second.

Capacity Coupling

With sub-optimum coupling the results are much the same, but with the coupling greater than optimum the peaks are no longer symmetrically displaced about the resonant frequency of the circuits. The effect obtained is shown in Fig. 17, and it will be seen that one peak remains centred on the top of the single-peaked curve A, while the second appears on the side of it.

Now in the practical case of mutual inductance coupling there is always some capacity between the circuits. There is the capacity between the coils themselves and their wiring, and there is often appreciable capacity between their trimmers. The result is that the coupling

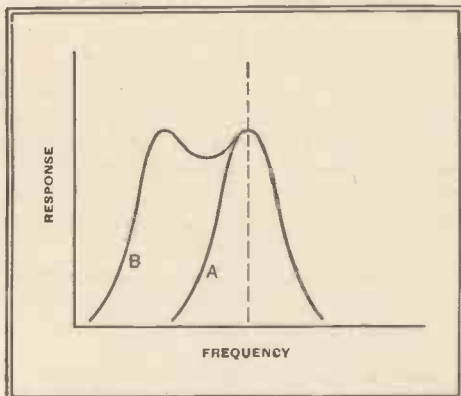

Fig. 17.—The use of "top-end" capacity instead of mutual inductance coupling makes the curve open out to one side of resonance.

really consists of a mixture of mutual inductance and top-end capacity coupling.

As might be expected, the effect of increasing the coupling now lies between that obtained with either form of coupling alone. The results are sketched in Fig. 18. With greater-than-optimum coupling the curve (B) opens out into two peaks. Neither peak remains on the original frequency, as one does with top-end capacity coupling alone, nor do the peaks move outwards symmetrically, as with mutual inductance coupling. They move outwards, but more on one side of resonance than on the other.

The importance of this lies in its relation to the problems of variable selectivity. It is well known that a transmitter does not radiate only a single frequency but a band of frequencies. The band has a width of

twice the modulation frequency. For a really high standard of reproduction frequencies of up to 10,000 c/s are needed, so that a station on 1,000 kc/s actually transmits a band of frequencies between 990 kc/s and 1,010 kc/s.

At an intermediate frequency of 465 kc/s, the equivalent band is 455-475 kc/s, and the top of the resonance curve should

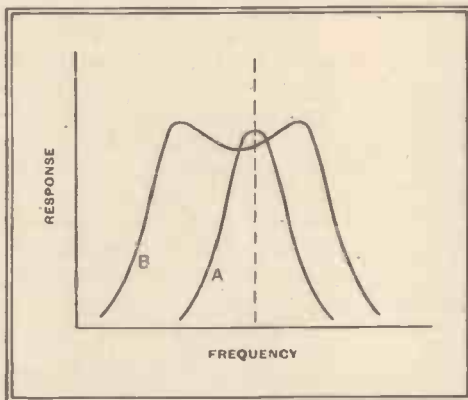

Fig. 18.—A mixture of capacity and mutual inductance coupling gives results between those with either alone.

be flat enough for all frequencies within this band to be evenly reproduced. The present station spacing is only 9 kc/s, however, so that interfering signals on 456 and 474 kc/s are likely to be found. If the IF resonance curve is broad enough to accept modulation frequencies up to 10,000 c/s it will equally well pass the interfering signals.

There is no way out of the difficulty, and the only course is to sacrifice quality to selectivity. The problem is, however, modified by the relative strengths of the wanted and unwanted signals. If the latter are initially much weaker than the wanted, as in local reception, then there may be no audible interference, and the band-width can be wide enough for the highest quality. On the other hand, if the interfering signals are stronger than the wanted one, then very considerable attenuation of the higher modulation frequencies must occur if the selectivity is adequate. In this case, little above 4,000 c/s can be reproduced.

There is thus an optimum degree of selectivity for the reception of any signal—a degree which gives the best compromise between quality and interference. Continuously variable selectivity over a wide range would seem to be ideal.

Variable Selectivity

Experience shows, however, that it is very difficult to secure a good system of continuously variable selectivity. It is extraordinarily difficult to secure a symmetrical resonance curve which opens out evenly as the coupling is increased. Instead of the curves being like those of Fig. 16 they are more like those of Fig. 19.

If the coupling is varied by moving one coil of a coupled pair relative to the other there are likely to be small changes in the capacity between them and between the moving coil and the screening can, as

well as the wanted changes in mutual inductance. In addition, the altering efficiency of transfer between primary and secondary affects the gain of the amplifier and hence the signal fed to the detector.

The automatic volume control system then operates to change the operating conditions of the valves to offset the change in gain. As a result of this the input and output impedances of the valves alter slightly and affect the tuning and damping of the IF circuits. Consequently, it sometimes happens that the major apparent effect of varying the selectivity is to shift the tuning!

Experience also shows that the optimum selectivity is usually in no way critical, and that it is quite adequate to be able to vary it in steps instead of continuously. This removes many difficulties, but an ideal solution is still difficult or costly.

Switching

If one is content with two degrees of selectivity and will tolerate a slight amount of asymmetry, then a very simple and cheap solution is possible. This is shown in Fig. 20 and is the scheme adopted in the Three-Band AC Super. The first transformer, between the frequency-changer and the IF valve, consists of two tuned circuits, L₁ C₁ and L₂ C₂, the positions of the coils being fixed to give slightly sub-optimum coupling. A small coil L₃, consisting of only a few turns of wire, is overwound on L₁ and can be connected in series with L₂ by means of the switch S. The coupling between primary and secondary is then considerably increased.

The coils being fixed there is no change in the capacities, but the inclusion of the extra inductance L₃ in series with L₂ does change the resonance frequency of the secondary. L₃ is so small in relation to L₂, however, that the change of frequency is of a very minor order.

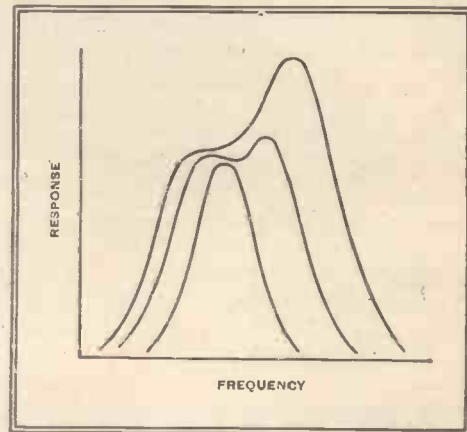

Fig. 19.—In practice the curves obtained are often of this form, through changes in capacity and regeneration.

In practice, the scheme works well and is better than many more elaborate and theoretically better systems. At high selectivity when L₃ is not in circuit the coupled pair, L₁ C₁ and L₂ C₂, which form the IF transformer T₁, gives a

The Modern Receiver Stage by Stage—single-peaked resonance curve. At low selectivity it gives a double-humped curve with a marked centre-trough.

In itself this is undesirable, but it is filled in by the response of the second transformer T2, which is not variable and which itself gives a single-peaked curve. The overall response of the two trans-

formers thus tends to the form of a flat top with steeply sloping sides. At high selectivity the resonance curve is single-peaked and quite sharp.

The secondary of the transformer T2 feeds into the detector, which will be dealt with in the next article. It is actually considerably damped by the input resistance of the detector.

The IF valve is naturally an RF pentode, and one with a mutual conductance of some 2.0 mA/v gives adequate gain. The precise type of RF pentode, however, depends upon whether or not AVC is applied to it, and we must consequently defer this until we have discussed AVC itself.

Fig. 20.—This diagram shows the IF amplifier; two degrees of coupling are provided in T1 to give two degrees of selectivity.

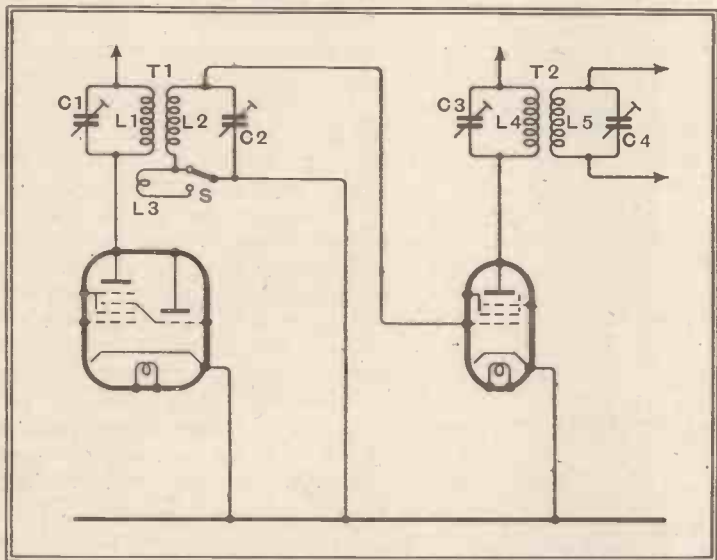

the case for a line to Toulouse. (As regards the Italians, the problem is complicated by the fact that there are, as a rule, several stations on each wavelength; but Rome appears to be especially bad, and the line to Rome is also along a coast.)

It strikes me as just possible that there may be interference between two radiations, one over land and one over water (cf., the false radiogoniometric bearings of stations so situated); it might be of interest to ask for observations from listeners so situated that similar geographical conditions occur.

R. RAVENHART (Major).
La Ciotat (B. du-R.), France.

Television Programmes

An hour's special film transmission intended for demonstration purposes will be given from 11 a.m. to 12 noon each weekday except during the Easter holiday.

THURSDAY, APRIL 6th.

3, Jack Payne and his Band. 3.30, British Movietonews. 3.40, 231st edition of Picture Page.

9, Henry Hall and his Orchestra. 9.30, Gaumont-British News. 9.40, Cartoon Film. 9.45, 232nd edition of Picture Page. 10.15, News.

FRIDAY, APRIL 7th.

3, Friends from the Zoo. 3.15, Pas Seul. 3.30, Gaumont-British News. 3.40, Cyril Smith, pianoforte, playing Beethoven's Concerto No. 2 with the Television Orchestra.

9, Friends from the Zoo. 9.15, British Movietonews. 9.25-10.25, "The Pilgrim's Progress," by John Bunyan, adapted for television by H. D. C. Pepler. Cast includes Dennis Arundel as Bunyan and Stafford Hilliard as Christian.

SATURDAY, APRIL 8th.

3-4.30, Jack Melford and Mary O'Neil in "Someone at the Door," a comedy thriller by Dorothy and Campbell Christie.

9, Alfredo and his Orchestra. 9.30, Gaumont-British News. 9.40, Cartoon Film. 9.45, The Vic-Wells Ballet in "The Rake's Progress," a ballet in six scenes. 10.30, News.

SUNDAY, APRIL 9th.

3, Cartoon Film. 3.5-4.5, "The Pilgrim's Progress" (as on Friday at 9.25 p.m.).

8.50, News. 9.5-10.35, "The Little Father of the Wilderness," by Austin Strong and Lloyd Osbourne (the Command play from the Coliseum).

MONDAY, APRIL 10th.

3, Alfredo and his Orchestra. 3.30, O.B. from Regent's Park of some of the outstanding entries in the Easter Monday Van Horses Parade. 3.50, British Movietonews.

9, "Candida," the first full-length Bernard Shaw play to be televised. Cast includes Marie Ney and Julien Mitchell. 10.30, News.

TUESDAY, APRIL 11th.

3, Cabaret Cruise No. 8, with Commander A. B. Campbell, Irene Prador and Walsh and Barker. 3.45, Gaumont-British. 3.55, Cartoon Film.

9, O.B. from Earls Court. The first of two visits to the Ideal Home Exhibition. 9.15, Cyril Fletcher in "Re-View." 9.45, Cartoon Film. 9.50, Schoolboy Howlers by Cecil Hunt. 10, British Movietonews. 10.5, Pas Seul. 10.25, News.

WEDNESDAY, APRIL 12th.

3, Edward Cooper in songs at the piano. 3.5, British Movietonews. 3.15-4, "The Rake's Progress" (as on Saturday at 9.45 p.m.).

9, O.B. from the Ideal Home Exhibition. 9.15, Gaumont-British News. 9.25, "The Taming of the Shrew," Shakespeare's play, prepared by David Garrick. 10.25, News.

Letters to the Editor

Receivers for the Tropics

SHORT-WAVE broadcasting has by now succeeded in reaching a standard of definite entertainment value for listeners in India. It is no longer necessary to explain to friends who come to listen to Daventry that "for some reason conditions are unusually bad to-day; you should have heard the set yesterday."

But there is still a defect in all receivers, which becomes a serious one for those who are almost entirely dependent on the short waves for their listening. It is the inability to tune rapidly to any wanted station and be sure of getting it. In every set which I have yet seen the tuning system has left much to be desired. A two-speed tuning drive is no solution when 20 or 30 stations may fall within a quarter of an inch on the dial. A few commercial receivers have introduced the "band-spread" principle, but I feel it does not provide the perfect solution.

The total coverage of a modern universal receiver for the tropics should be 23½ megacycles—that is, from about 12 metres to 550 metres. The long-wave band is not necessary. Call it 24 megacycles. That would sub-divide into eight bands of 3 megacycles each. The tuning dial should be broad enough to allow the printing in legible type of eight vertical columns of station names with their call signs, wavelength in metres and frequency in megacycles, and tall enough to allow the printing of all important station names for the most thickly populated 3-megacycle band. Twelve inches by eight inches should be ample, and this would not be impossibly large for the more expensive type of set, in which alone this tuning system could be incorporated.

If there are no technical snags I think such a tuning system could leave nothing to be desired. I am aware that eight bands

would necessitate rather a large number of coils and elaborate switching, but the system would only be for the man who wants the best available and does not mind paying a little more for it.

What do the experts think of my idea?

H. R. MEREDITH.

Bhagalpur, India

Interference from Domestic Appliances

YOUR editorial in *The Wireless World* of March 16th is very welcome. Having been kept in bed with the 'flu, I have used a mains portable to pass the time away, but find that reception before about 12 o'clock is almost impossible because of interference from vacuum cleaners.

About 7.30 a.m. there is a quite distinctive noise which I assume is an electric shaver. Are these latest "boons and blessings" to be yet another source of trouble for the radio man? G. A. HOSKINS.

South Croydon, Surrey.

Coastline Distortion

A FEW broadcasting stations as received here show an unusually vicious periodical distortion at intervals of about two to five minutes, usually unaccompanied by fading, occurring on soft passages as readily as on loud ones, and, therefore, not attributable to overloading. Nice is especially bad; the two Toulouse stations also show it; and several of the Italians. This place (somewhat east of the town of La Ciotat itself) is situated almost exactly half-way between Marseilles and Toulon; and it so happens that a line from here to Nice parallels the general coastline and cuts the actual coast repeatedly for part of the way, as is also

UNBIASED

By FREE GRID

One for Syd Walker

ALTHOUGH there are black sheep in every fold I think that I can say with some pride that the majority of my readers are law-abiding citizens, and this in spite of the fact that the law does very little to encourage them, but seems, on the contrary, by its irritating irrationalism and pettifogging puerilities, to go out of its way to discourage them.

Only the other day I came across a striking instance of the sort of thing I mean. A friend of mine who has been a broadcast listener since the early days and is now an ardent teleophile, recently received the customary wireless licence renewal notice commanding him to renew his licence within fourteen days. Unfortunately, he was rather financially embarrassed at the time, and his bank manager being as unaccommodating as these gentry usually are, he was faced with the necessity of temporarily carrying out the injunction on the licence renewal notice to disconnect the aerial and dismantle the set.

Now, there is no difficulty about disconnecting an aerial, but to take to pieces a television receiver is a far more formidable task and he sought the advice of the local postmaster as to whether it would suffice to take the receiver out of its cabinet since his dictionary told him that the fundamental meaning of "dismantle" is "to divest of clothing," and, after all, the cabinet does represent the receiver's clothing. There was an unfortunate misunderstanding at first as the postmaster thought that he was talking about sunbathing and



He sought advice

referred him to the Public Health Department of the local Town Council.

Eventually, however, my friend managed to explain matters, but I am sorry to say that an adverse decision was given and he is now faced with the prospect of taking to pieces the myriad parts of a sixty-guinea television set and then putting them together again after the lapse of

a week or two when he expects his financial condition to be sufficiently improved to enable him to afford the cost of a licence. He has asked me to advise him as to whether or not he should risk it and let the set remain undismantled. It is a most unfortunate state of affairs, and I have declined all responsibility in the matter and advised him to send a post card referring the whole problem to Mr. Syd Walker, who is used to this sort of thing.

What the Butler Saw

I SUPPOSE that most of you will be reading these few notes as you are consuming your hot-cross buns and Easter eggs on the chilly beaches of one of our damp and dismal seaside towns. It always surprises me that resorts within fifty miles or so of London do not make use of television to popularise their wind-swept piers and such-like "attractions." I have spent the past week making a brief tour of them and not one has installed a public viewing booth for demonstrating the wonders of television, thus missing a marvellous opportunity of popularising it during the weary hours when people shiver uncomfortably in these places in a hopeless endeavour to pass the time until the train leaves for home. Seaside authorities are, I found, still endeavouring in many cases to entertain patrons by the old-fashioned animated bioscope machines in which you are encouraged to put your penny in the slot, turn the handle, and see "What the butler saw." I very foolishly wasted some of my own hard-earned money on these out-of-date machines, and all I can say is that pre-war butlers must have been very easily shocked. What I saw would not have sufficed to bring a reproving tut, tut, from the lips of a newly-fledged curate.

Who is Right?

ONE of the most irritating things about a mains-driven set is that after switching on you have to sit cooling your heels for the best part of half a minute while the valves warm up. Some of my readers may, of course, think that half a minute is short and sweet, like a donkey's gallop, and so it is in certain circumstances. It would not, for instance, seem very long if you found yourself falling off the top of a skyscraper and realised that only this amount of time remained for you to enjoy life. On the other hand, when in the dentist's chair it seems an eternity.

This being so, it is not unnatural that I was very interested when a friend returned from America last autumn with a mains set purporting to have no time lag. I was very greatly impressed when I heard it, for it was as quick off the mark as a battery set and I railed bitterly at the slowness of our manufacturers in allowing Americans to beat them to it in producing a receiver of this type.

My friend was, however, very surprised at the comparative rapidity with which it lost its golden tone and relapsed into sullen silence. On investigation he found that valve failure was the cause, and he went to considerable expense in replacing them only to have the same trouble recur just recently, when he promptly did what he should have done in the first place, namely, called me into consultation.

I was not long in discovering the reason for it. The problem of waiting for the valves to heat up had been solved in a very simple manner by arranging that the on-off switch merely disconnected the HT supply, the valve heaters being on continuously once the set had been plugged into the mains. It seemed to me that



It seems an eternity.

with this gruelling test it was small wonder that the valves died young, and I promptly put through a transatlantic telephone call to tell the makers of the set what I thought of them.

To my amazement the firm, instead of expressing contrition, took a very high-handed attitude and explained that leaving the valve heaters continuously in operation not only did no harm to them but actually prolonged their lives. They explained that the valves certainly would not lose emission, since with the HT switched off all the emitted electrons would fall back like the water of a fountain. As for the heaters burning out, they stated that it was the violent contraction and expansion due to switching on and off which caused this, and if switched on continuously their lives would be nearly as long as if switched off continuously. They went still farther and explained that by leaving the valves on all the time the lives of smoothing condensers and chokes are prolonged, as they are relieved of the strain of HT surge voltages which occur when switching on and off. I must confess that it is all very bewildering, but it does not alter the fact that the valves *did* fail. What do you think about it?

Overcoming Harmonic Radiation

By A. G. CHAMBERS (G5NO)

IN the past transmitting amateurs have not had to worry very much about harmonic radiation, but now, with such a large increase in the number of stations and the ever-increasing popularity of television, the matter is becoming quite serious.

Overcoming harmonic radiation is neither difficult nor expensive. The trouble, when it exists, is usually due to either lack of knowledge or laziness on the part of the station owner. In this article three points will be covered which, if carried out successfully, will go a long way to help the novice overcome harmonic radiation.

The first and most important point is the matter of matching the aerial to the transmitter. Transmitters will radiate under very bad matching conditions, and it is not until the novice has gained sufficient experience to realise that his radiation is not so efficient as it might be that he starts to think about improving it. Unfortunately, his inefficient radiator will in the meanwhile have been causing a large amount of unnecessary interference while the amateur in question has been getting his experience.

For a transmitter to radiate efficiently and yet be reasonably free from harmonics, its output must be matched into a

The procedure for detecting whether the aerial load is reactive or not is quite simple. Disconnect the aerial and associated feeders. Tune the final tank circuit for minimum dip on the PA (power amplifier) anode current meter and note the reading on the condenser dial. Connect up the aerial and tune again for minimum dip on the meter. If it has been

necessary to alter the reading on the final PA condenser, the load is reactive, and this must be obviated either by tapping the aerial in a different place on the coupling unit, when one is used, or checking up on the impedance match of the untuned feeder system. (An untuned feeder system, of course, being the

type which has a certain constant line surge impedance throughout its length, and has no standing waves on it.)

The novice usually starts with either a Windom aerial (Fig. 1) or an aerial tuned by Zepp feeders (Fig. 2). In either case the feeders should be tapped on so that the load can be matched. The diagrams show the connections appropriate for these two types.

Single-wire Feeders

It might be pointed out that although Windom aerials are very popular they are bad harmonic radiators, the reason being that it is never quite possible to get a perfect match, due to the fact that the one and only feeder relies entirely on the earth for its balance. The earth, however, cannot quite take the place of another feeder.

Referring again to Fig. 1 the reader will notice that the feeders are taken to a matching section which, in this case, is a coil and condenser tuned to resonance with the transmitter output frequency. This matching section may be any standard system, a more elaborate one being the well-known "Collins Coupler." The system is now coupled into the PA by a low impedance line (say, 80 ohms) more commonly known as a link. This link may consist of standard lighting flex and the coupling coils may consist of one or two turns; the exact number will have to be found by trial and error, so that the transmitter draws its correct load current. If now the centre point of the link coil,

AN OBLIGATION OF ALL TRANSMITTERS

on the PA side, is taken to earth, the link will then act as a Faraday Screen. This screen will have no effect on the output of the transmitter; but will tend to suppress the harmonics. The earthing point should be made on the chassis of the transmitter with heavy copper wire (14 gauge) and the connection made as short as possible. The external earth is then connected to a terminal placed at this point.

The amount of capacity used in the final tank circuit is of vital importance and must be considered in connection with harmonic radiation. The correct amount

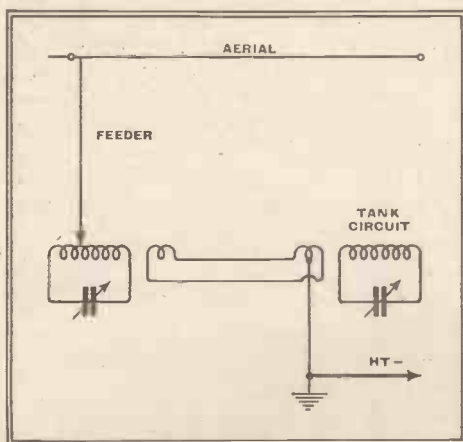

Fig. 1. End-fed or Windom aerial system in which a single-wire-feeder is used.

non-reactive load; in other words, a pure resistance, where a dummy load is used, or in the case of an aerial, a tuned circuit, the aerial being the tuned circuit.

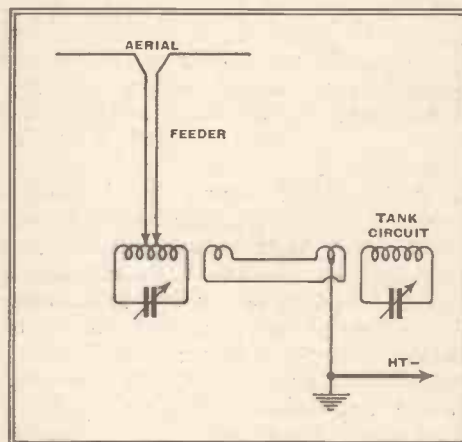

Fig. 2. Aerial with Zepp feeder.

to be used is a subject which would take too long to go into in this article. Those who are in doubt should consult any of the well-known handbooks on the subject. In the recent *Wireless World* article on PA design a value 1.5 m-mfds. per metre was suggested as a good rule to follow. Many amateurs believe that by eliminating nearly all the "C" out of their final tank circuits they are making their transmitters highly efficient. By cutting the "C" down they no doubt improve the "Q" of the circuit, but beyond a certain point this is of no value, since the harmonic output increases to a much greater extent and the increased efficiency usually leads to instability—and poor quality, if the station happens to be using phones.

Now here are a few points about aerials. Current-fed aerials should be used when possible, as these discriminate against radiation of even harmonics. (They are responsive, however, to odd harmonics.) Radiators fed by means of a shorted stub

Overcoming Harmonic Radiation—

and untuned line provide about the best discrimination against harmonics, but these will radiate some third and other odd harmonics. These, although outside the amateur bands, are not out of the present television band. For example, let us imagine a transmitter whose final tank circuit is tuned to 14 M/cs, the third harmonic being 42 M/cs. The television sound is 41.5 M/cs and the vision is 45 M/cs; a good vision receiver will accept all and sundry between these frequencies, including our third harmonic, which makes a nasty line on the screen of a television set.

Now to finish with a few final don't's.

Don't use valves in parallel, put them in pushpull for preference.

Don't use a doubler for the final amplifier.

Don't use more bias or excitation than is necessary for reasonable efficiency.

For a guide to the novice the writer has a 10-watt transmitter radiating on the 80-metre band, and after these points mentioned were put into practice the following results were obtained. At a distance of about a mile on a sensitive receiver no harmonics could be heard. However, at a distance of about 100 yards a harmonic could be picked up on the 20-metre band; even this could probably be overcome by the use of a filter in the feeder lines.

condenser when press-button tuning is in operation. In the oscillator section of the triode-hexode frequency changer, permeability tuned circuits are employed, the capacity being fixed.

The output transformer in the IF amplifier has an untuned secondary connected to the signal rectifier and AVC diodes, and a tuned tertiary winding feeds a double diode rectifier in a balanced circuit to produce a bias in its cathode resistances, depending on the degree to which the intermediate frequency is off-tune. This bias is applied to the triode section of the second detector stage which, in addition to its function of first AF amplifier, acts as a DC amplifier for the AFC system. Variations in its mean anode current pass through a special "transformer," the tapped secondary of which is connected in series with groups of the push-button oscillator circuits. In effect, this supplies a degree of auxiliary permeability tuning, the inductance of the secondary winding being controlled by the current in the primary, which always tends to bring the intermediate frequency back to its correct value.

The connections of the second detector and output stages are conventional with the exception of the tone-control circuit, which consists of a resistance-capacity filter between anode and grid of the tetrode output valve.

Performance.—The first thing that one learns on switching on the set is to use the volume control with restraint. The automatic volume control is effective in neutralising fading, but will not prevent overloading of the output stage and possibly the first AF amplifier on strong signals. When push-button tuning and the AFC circuit are in operation, motor-boating is added to the noise created by overloading, and there is little doubt that the designers have been generous to a fault in the supply of overall magnification.

With this proviso we have nothing but

Test Report

H.M.V. MODEL 1102

Table Model Superhet (6 Valves + Rectifier) with Automatic Frequency Controlled Push-button Tuning. Price 15 Guineas

THE cabinet design of this receiver breaks the sequence of polished walnut front panel and woven metal loud-speaker grilles which have been a characteristic of H.M.V. sets in recent years. There is a woven fabric covering extending over the whole of the sloping front panel, and the tuning dial is slightly offset to allow for the loud speaker, the exact position of which is not emphasised.

Although the basic circuit has only four valves in the direct line of amplification between aerial and loud speaker, the receiver is not intended to compete with the "bread-an-butter" superheterodynes in the £10 class, but to appeal to those who are willing to pay for a set with something more than the bare necessities. There are a number of refinements associated

with the manually operated side of the set and a really efficient push-button tuning

WAVERANGES

Short	- -	13.8—50 metres
Medium	- -	196—580 metres
Long	- -	726—2,000 metres

system with which automatic frequency control is included.

Circuit.—A high-impedance inductively coupled tuned aerial circuit includes provision for image rejection on long waves. Pretuned circuits with capacity trimmers are substituted for the two-gang tuning

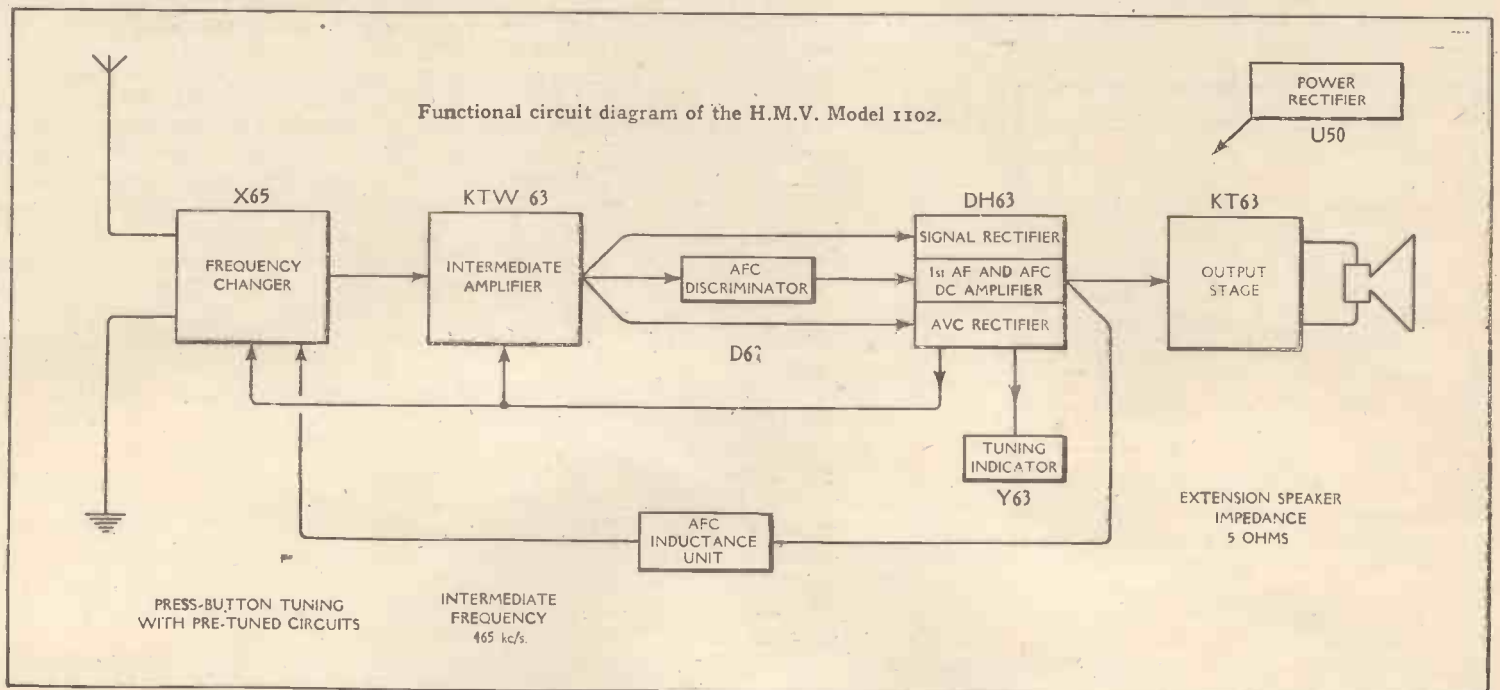

H.M.V. Model 1102—

praise for the performance of the receiver. The quality of reproduction is bright and clear, and no attempt has been made to coax more bass than one has a right to expect from a 5in. diaphragm. The set is excellent in speech, small orchestras and all transmissions which do not depend for their realism on a heavy foundation of low notes.

The short-wave performance is especially good and there is no microphonic instability. Without a circuit to refer to it would be easy to be persuaded from the silent background and high signal-to-noise ratio that a radio-frequency stage—and a really effective one at that—was functioning before the frequency changer. On some strong signals a few self-generated whistles were noted, but they were not sufficiently marked to interfere with what is undoubtedly an outstanding performance on short waves.

One whistle was found on the medium-wave band, but the long-wave range was clear. Sensitivity was well maintained at the ends of both these ranges and it will be seen from the table that a wide wavelength coverage has been provided.

The selectivity on medium waves is equivalent to the loss of 1½ channels on

an "off" button on the left. The automatic tuning action was tested by mistuning one of the trimmers and was found to be effective over a range of several turns of the adjusting screw on either side of its normal setting. The setting of the tuning point under the influence of AFC, as judged by the cathode-ray tuning indicator, is indistinguishable from that obtained by accurate adjustment of the manual tuning control.

Constructional Details.—The escutcheon plate covering the push-buttons is removable after unscrewing two knurled studs, one of which automatically operates a switch to cut out the AFC circuit. Behind the plate will be found an insulated screwdriver for adjusting the trimmers, which are easily identified by red lines connecting each button with its oscillator and aerial trimmer. The oscillator trimmers, which adjust the cores of the permeability tuned circuits, are provided with miniature wavelength scales which indicate the limits of the range covered as well as the approximate setting of the control.

The push-button facilities have not been developed to the exclusion of the amenities of manual control. A well-arranged wavelength and station dial carries in addi-

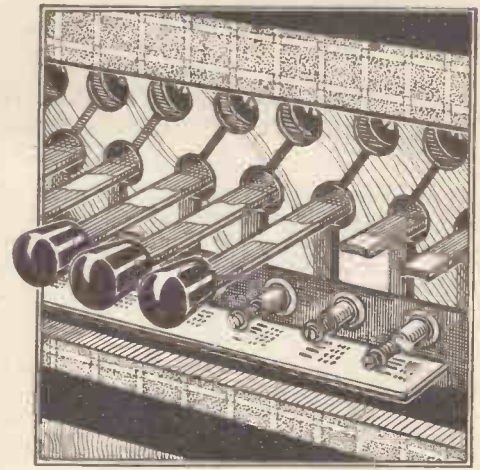

Individual wavelength scales are provided for each oscillator trimmer in the H.M.V. Model 1102. The appropriate aerial and oscillator trimmers are indicated in each case by red lines radiating from the push-button aperture.

chassis to various points on the low potential frame of the condenser.

Summary.—The Model 1102 is an admirable general-purpose receiver for manual operation in the usual way. It has an outstandingly good short-wave performance with very low background

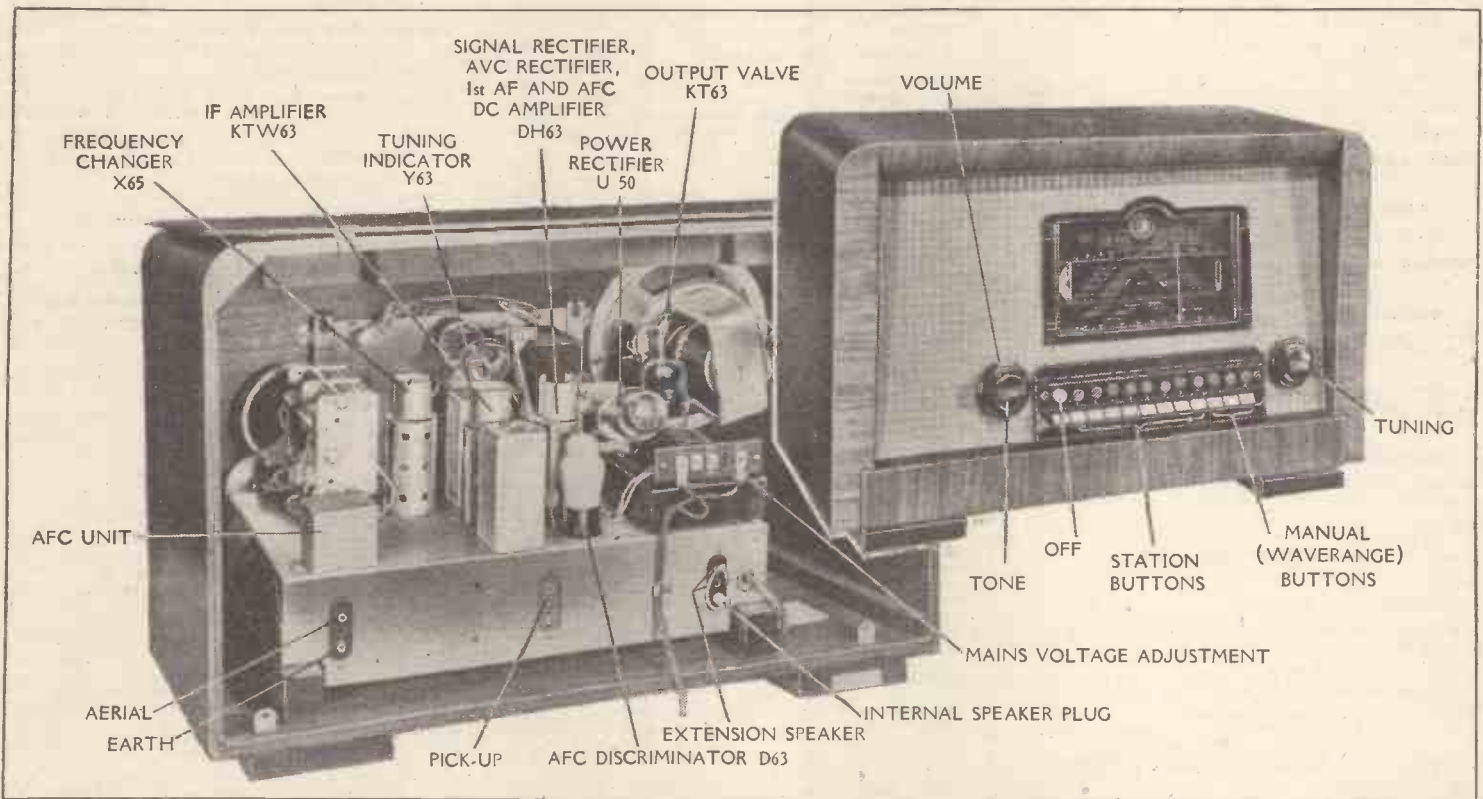

Controls and positions of valves in the H.M.V. Model 1102.

either side of the London Regional station at a distance of 15 miles. On long waves there is a clear space between Droitwich and Radio-Paris and the Deutschland-sender comes through at satisfactory volume and with only a slight background of sideband interference.

Under push-button control the receiver is easy to operate. The buttons are well spaced and clearly identified with wave-range controls on the extreme right and

tion to the tuning indicator a vernier slow-motion dial calibrated in arbitrary divisions for noting the setting of short-wave stations and a "thermometer" type volume control indicator. The tuning control has a light touch and just the right reduction ratio for short-wave tuning.

The tuning condenser has ceramic insulation and is exceptionally well sprung on thick rubber washers. There are no fewer than six flexible pigtailed from the

noise. Range and selectivity on medium- and long-waves are average for a four-valve superheterodyne. Quality of reproduction is clear and the balance is good for all transmissions except those with a preponderance of extreme bass. Overloading is, however, rather too easily provoked by mishandling of the volume control. The press-button tuning has been well carried out and accuracy of adjustment should be maintained indefinitely.

WIRELESS SOCIETIES

Directory of Amateur Clubs Throughout the British Isles

THIS list of clubs and societies whose reports appear from time to time in our pages is arranged in alphabetical order under towns. The name of the club is in each case followed by that of the Honorary Secretary, from whom prospective members and other interested persons may obtain information. Many of the local clubs and societies are affiliated to the national parent body, the Incorporated Radio Society of Great Britain, 53, Victoria Street, London, S.W.1. We shall be pleased to have details of any active societies whose names may have been inadvertently omitted.

ALDERSHOT

Aldershot and District Radio Society.—H. Atthill, "Ardivarney," College Road, Farnham, Surrey.

ASHTON-UNDER-LYNE

Ashton-under-Lyne and District Amateur Radio Society.—K. Gooding, 7, Broadbent Avenue, Ashton-under-Lyne, Lancs.

BARNSELY

Barnsley and District Radio Transmitters' Society.—W. Peacock, 12, Locke Avenue, Barnsley, Yorks.
Barnsley and District Wireless Association.—G. Webster, "Upland," Yews Lane, Worsbro Dale, Barnsley, Yorks.

BELFAST

City of Belfast Y.M.C.A. Radio Club.—J. Gallagher, 90, Somerton Road, Belfast.
Radio Society of Northern Ireland.—H. F. Ruberry, 19, Little Victoria Street, Belfast.

BIRKENHEAD

Wirral Amateur Transmitting and Short-Wave Club.—J. R. Williamson, 49, Neville Road, Bromborough, Cheshire.

BIRMINGHAM

Midland Amateur Radio Society.—F. E. Barlow, "Drakeford," Poolhead Lane, Wood End, Tanworth-in-Arden, Warwickshire.
Slade Radio.—G. C. Simmonds, 38, Rabone Lane, Smethwick, Birmingham.

BOLTON

Radio Signal Survey League (Bolton Chapter).—N. Moorcroft, 218, Deane Road, Bolton, Lancs.

BRADFORD

Bradford Experimental Radio Society.—S. Hartley, 7, Blakehill Avenue, Fagley, Bradford, Yorks.
Bradford Short-Wave Club.—S. Fischer, 10, Highfield Avenue, Idle, Bradford, Yorks.

BRENTWOOD

Brentwood Amateur Radio Society.—B. A. Pettit, "The Laurels," Worriu Road, Shenfield, Essex.

CARDIFF

Cardiff and District Short-Wave Club.—H. H. Phillips, 132, Clare Road, Cardiff.

CHATHAM

Medway Amateur Transmitters' Society.—S. A. C. Howell, "Veronique," Broadway, Gillingham, Kent.

CRANWELL

Royal Air Force Amateur Radio Society.—N. Davis, E. and W. School, R.A.F., Cranwell, Lincs.

DERBY

Derby Short-Wave Radio and Experimental Society.—H. Turner, Nunsfield House, Boulton Lane, Alvaston, Derby.

DONCASTER

Thorne Amateur Radio Society.—G. Beaumont, 15, Marshland Road, Moor-Ends, Near Doncaster, Yorks.

DOUGLAS, I.O.M.

Isle of Man Radio Society.—W. Lawson, 13, Second Avenue, School Road, Onchan, Isle of Man.

DUBLIN

Irish Amateur Radio Society.—J. Butler, 92, South Circular Road, Portobello, Dublin.

EASTBOURNE

Eastbourne and District Radio Society.—T. G. R. Dowsett, 48, Grove Road, Eastbourne, Sussex.

EXETER

Exeter and District Wireless Society.—W. J. Ching, 9, Sivell Place, Heavitree, Exeter, Devon.

GLOUCESTER

Gloucester Radio Club.—G. G. E. Lewis, 30, Kitchener Avenue, Gloucester.

HODDESDON

Hoddesdon and District Radio Society.—T. Knight, Caxton House, High Street, Hoddesdon, Herts.

KETTERING

Kettering Radio and Photographic Society.—I. L. Holmes, "Miami," The Close, Headlands, Kettering, Northants.

KILMARNOCK

Kilmarnock and District Short-Wave Society.—R. Mitchell, 151, Bonnyton Road, Kilmarnock, Scotland.

KINGS LANGLEY

West Herts Amateur Radio Society.—A. W. Birt, 6, Hempstead Road, Kings Langley, Herts.

LEICESTER

Leicester Amateur Radio Society.—T. Cribb, 55, Knighton Drive, Leicester.

LINCOLN

Lincoln Short-wave Club.—C. Babbs, 203, Wragby Road, Lincoln.

LITTLEHAMPTON

Sussex Short-wave and Television Club.—C. J. Rockall, "Aubretin," Seafeld Road, Rustington, Sussex, and E. C. Cosh, "Anslyn," Mill Road, Angmering, Sussex.

LIVERPOOL

Mersey-side Transmitting Society.—C. E. Cunliffe, 368, Stauley Road, Bootle, Liverpool, 20.

LONDON AND DISTRICT

British Sound Recording Association.—F. J. Chinn, 14, Tirlmout Road, South Croydon, Surrey.
City and Guilds College Radio Society.—J. D. McNeil, City and Guilds College, Exhibition Road, South Kensington, London, S.W.7.
Croydon Radio Society.—E. L. Cumbers, 14, Campden Road, South Croydon, Surrey.
Dollis Hill Radio Communication Society.—E. Eldridge, 79, Oxgate Gardens, Cricklewood, London, N.W.2.
Edgware Short-wave Society.—F. Bell, 118, Colin Crescent, Hendon, London, N.W.9.
Colders Green and Hendon Radio Scientific Society.—Lt.-Col. H. Ashley Scarlett, 60, Pattison Road, London, N.W.2.
Goldsmiths' Radio Society.—A. L. Beedle, 67, Hillcross Avenue, Morden, Surrey.
Ilford and District Radio Society.—C. E. Lagen, 44, Trelawney Road, Barking, Ilford, Essex.
International Short-wave Club.—A. E. Bear, 100, Adams Gardens Estate, London, S.E.16.
Kingston and District Amateur Radio Society.—D. N. Biggs, 44, Pooley Green Road, Egham, Surrey.
London Transmitters' Society.—G. Yale, 40, Raeburn Road, Edgware, Middlesex.
National Radio Society.—C. F. Biggs, 86, Lordship Lane, London, N.17.
North London Radio Society.—E. Jones, 60, Walmer Terrace, Firs Lane, Palmers Green, London, N.13.
Peckham District Short-wave Club.—L. J. Orange, 11, Greuard Road, London, S.E.15.

Radio, Physical and Television Society.—C. W. Edmans, 15, Cambridge Road, North Harrow, Middlesex.
Radio Society of Great Britain (District 13, Wimbledon and District Section).—H. M. Blaber, 9, Stanton Road, London, S.W.20.
Robert Blair Radio Society.—W. H. C. Jennings, 82, Craven Park Road, London, N.15.
Romford and District Amateur Radio Society.—R. C. E. Beardow, 3, Geneva Gardens, Chadwell Heath, Essex.
Short-wave Radio and Television Society of Thornton Heath.—R. E. Dabbs, 4, Nutfield Road, Thornton Heath, Surrey.
Southall Radio Society.—H. F. Reeve, 26, Green Drive, Southall, Middlesex.
South London and District Radio Transmitters' Society.—H. D. Cullen, 164, West Hill, London, S.W.15.
Surrey Radio Contact Club.—A. B. Willsher, 14, Lytton Gardens, Wallington, Surrey.
Television Society.—J. J. Denton, 25, Lisburne Road, Hampstead, London, N.W.3.
Thames Valley Amateur Radio Transmitting Society.—D. R. Spearing, York House, Queens Road, Teddington, Middlesex.
Tottingham Wireless Society.—W. B. Bodemeid, 56, Netherlands Road, East Barnet, Herts.
World Friendship of Radio Amateurs.—A. H. Bird, 35, Bellwood Road, Waverley Park, Nunhead, London, S.E.15.

MAIDSTONE

Maidstone Amateur Radio Society.—P. M. S. Hedge-land, 8, Hayle Road, Maidstone, Kent.

MANCHESTER

North Manchester Radio Society.—R. Lawton, 10, Dalton Avenue, Thatch Leach Lane, Whitefield, near Manchester.

NEWCASTLE-ON-TYNE

Newcastle and District Short-wave Club.—K. Scott, 1, Farquhar Street, Newcastle-on-Tyne.

OXFORD

Oxford University Wireless Society.—M. Ryle, Christchurch College, Oxford.

POOLE

East Dorset and West Hants Radio Club.—D. M. Williams, "Amberley," Cornwell Road, Poole, Dorset.

SCARBOROUGH

Scarborough Short-wave Club.—P. R. Briscoombe, 48, Fieldside, Northstead, Scarborough, Yorks.

SLOUGH

Slough and District Short-wave Club.—R. J. Sly, 16, Buckland Avenue, Slough, Bucks.

SOUTHEND

Southend and District Radio and Scientific Society.—J. M. S. Watson, 23, Eastwood Boulevard, Westcliff, Southend, Essex.

SOUTHPORT

Southport Amateur Transmitters' Association.—R. W. Rogers, 21, Chester Avenue, Southport, Lancs.

STAFFORD

Stafford and District Short-wave Club.—G. L. Wale, "Branksome," Acton Gate, Stafford.

STOCKPORT

Stockport Amateur Radio Society.—S. Pearson, 89, Northcliffe Road, Offerton, Stockport, Cheshire.

STROUD

Stroud and District Amateur Radio Club.—K. D. Ayers, 8, Hamwell Leaze, Cashes Green, Stroud, Glos.

TONYREFAIL

Tonyrefail and District Radio Society.—E. Powell, 44, Pritchard Street, Tonyrefail, Wales.

WATFORD

Watford and District Radio and Television Society.—P. G. Spencer, 11, Nightingale Road, Bushey, Herts.

WEYMOUTH

Weymouth and District Short-wave Club.—E. Kestin, 55, St. Mary Street, Weymouth, Dorset.

WOLVERHAMPTON

Wolverhampton Short-wave Radio Society.—V. C. Hague, 76, Darlington Street, Wolverhampton, Staffs.

WORTHING

Worthing Scientific Association.—C. J. Ainsworth, 31, Belvedere Avenue, Lancing, Sussex.

Club News

Aldershot and District Radio Society

Headquarters: 41, Grosvenor Road, Aldershot, Hants.
Hon. Sec.: Mr. H. Atthill, "Ardivarney," College Road, Farnham, Surrey.

This Society held its inaugural meeting on March 17th. The next meeting has been arranged for April 6th, at 8 p.m.

Lectures and Morse instruction are to be arranged as soon as possible, and during the summer it is hoped to hold DF field days and other outdoor events.

Croydon Radio Society

Headquarters: St. Peter's Hall, Ledbury Road, South Croydon, Surrey.

Meetings: Tuesdays at 8 p.m.
Hon. Pub. Sec.: Mr. E. L. Cumbers, 14, Campden Road, South Croydon, Surrey.

At the last meeting Mr. Humphreys, of A. C. Cossor, Ltd., gave a lecture entitled "Applications of the Cathode-ray Tube." The lecturer demonstrated a new oscillograph having dual beams, and dealt with its many uses, more especially those of a medical nature.

Exeter and District Wireless Society

Headquarters: Y.W.C.A., 3, Dix's Field, Exeter, Devon.

Meetings: Mondays at 8 p.m.
Hon. Sec.: Mr. W. J. Ching, 9, Sivell Place, Heavitree, Exeter, Devon.

Dr. C. Wroth gave an interesting lecture on March 20th on "X-rays and Gamma-rays." The lecture actually took place at the Royal Devon and Exeter Hospital, and was illustrated by lantern slides.

Kilmarnock and District Short-wave Society

Headquarters: Wardneuk Receiving Station, Glasgow Road, Kilmarnock, Scotland.

Meetings: Sundays at 2.30 p.m., Tuesdays and Thursdays at 8.0 p.m.

Hon. Sec.: Mr. R. Mitchell, 151, Bounton Road, Kilmarnock, Scotland.

This society, which has been recently formed, has twenty-seven members, including two fully-licensed transmitters, and three with artificial licences. The subscription is 5s. annually and 6d. weekly for seniors, and 2s. 6d. annually and 3d. weekly for members between the ages of 16 and 18. At present a series of lectures is being given on Thursday evenings, entitled "Short Wave Receiving and Transmitting for the Beginner." Morse instruction is also being given.

[A number of reports are unavoidably held over.—Ed.]

Recent Inventions

RECEIVING 7-METRE SIGNALS

THE invention discloses a convenient method of extending the tuning range of an "all-wave" broadcast receiver from the normal short-wave limit of 15 metres down to 5 metres so as to include the sound transmissions sent out with the 7-metre television programmes.

This is done by forcing the local oscillator valve to produce, when desired, a harmonic frequency of the right value to "beat" with the 7-metre carrier-wave so as to produce the required fixed intermediate frequency.

When operating on the usual wavelengths, the anode of the local oscillator valve includes a series resistance, which is short-circuited when it is desired to receive ultra-short wave signals. The resulting increase of potential on the anode "overdrives" the valve, so that it produces powerful harmonics, one of which is then selected by a suitably tuned circuit and mixed with the incoming signals.

F. R. W. Strafford and Belling and Lee, Ltd. Application date June 8th, 1937. No. 494979.

AUTOMATIC FREQUENCY CONTROL

THE lower part of the Figure represents a normal superhet circuit, comprising an RF amplifier V, a heptode frequency-changer V1 generating local oscillations in the circuit LO, and a band-pass intermediate-frequency

Brief descriptions of the more interesting radio devices and improvements issued as patents will be included in this section.

stage A which feeds the second detector and AF stages D. The object of the invention is to provide an automatic frequency control which is independent of the signals.

For this purpose the coil L of the input circuit to the frequency-changer V1 is centre-tapped to earth, one end being connected to the grid of that valve, as shown, whilst the other end is connected to the grid of an auxiliary amplifier V2. This accordingly receives part of the signal energy and is coupled, in turn, to a second frequency-changer V3. The local oscillator circuit of the latter is controlled by a piezo-electric crystal Q, which is tuned to the correct beat-frequency when the circuits are properly in tune. The frequency supplied from the valve V3, through the lead N and coil L1, to the circuit LO is therefore that which the latter circuit should have for correct tuning, and serves to force it to that frequency.

J. Robinson. Application dates March 24th, May 11th and August 27th, 1937. No. 494577.

THE control voltage available for correcting an initial tuning error, up to, say, 5 kc/s, will "hold" any subsequent frequency drift in the local oscillator

valve up to, say, 20 kc/s. But if the drift is continuous, a point will be reached when the control voltage can no longer "hold" the tuning. It is then found that the tuning tends to "jump" to a value some 30 kc/s away from the controlled point. The same thing happens if the manual tuning control is moved over a short distance, representing, say, 20 kc/s from the first point.

This tendency to "jump" three broadcast channels at once makes it difficult to change over from a strong station to a nearby weak station if the AFC control is left permanently in operation, so that it is usual to arrange for the control to be made ineffective during the actual process of inter-station tuning.

The object of the invention is to overcome this tendency to "jump," so that the AFC can be left permanently in operation without "masking" any weak station within the shadow of a stronger one. The desired effect is secured by designing the discriminator and frequency-adjusting circuits to follow selected characteristic curves.

Marconi's Wireless Telegraph Co., Ltd.; N. M. Rust; and O. E. Keall. Application date May 4th, 1937. No. 495313.

LOUD SPEAKERS

TWO or more diverging partitions, which extend inside and beyond the usual diaphragm, are used to improve the quality of reproduction. As shown in the

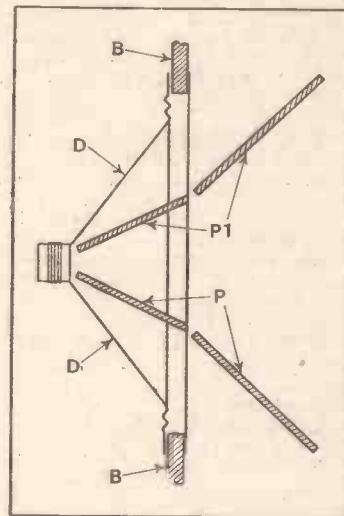

Disposition of deflectors in relation to a loud speaker diaphragm.

figure, the partitions P and P1 are hinged at a point in or near the plane of the baffle-board B, to which the edges of the ordinary conical diaphragm D are loosely secured, as usual.

The effect of the partitions is to break up or separate the radiation from those parts of the conical diaphragm which, particularly at high frequencies, may be vibrating out of phase. It is found that the use of the partitions increases the high-note content of the reproduction, and radiates a flat "beam" of sound with a large angular spread.

N. V. Philips Glöeilampfabrieken. Convention date (Holland) January 14th, 1937. No. 495240.

SIGNALLING ON CENTIMETRE WAVES

A TRANSMISSION line of the "dielectric-guide" type consists of two plane, or two circular and coaxial conductors, the ends of which are flared out to form a parabolic or cylindrical surface which serves as an aerial. Transfer of energy between the dielectric guide and the aerial takes place through the slit formed between the two flared surfaces, this being arranged to coincide with a current loop along the line.

Several flared surfaces may be located at different points along the line, the spacing being such that the radiation takes the form of a beam, similar to that produced by the well-known aerial array. The flared-out aerials may be fitted with side-walls to limit the spread of the radiated beam. A similar arrangement is used in reception.

O. Bormann (J. Pintsch. Ges). Convention date (Germany) March 6th, 1936. No. 493695.

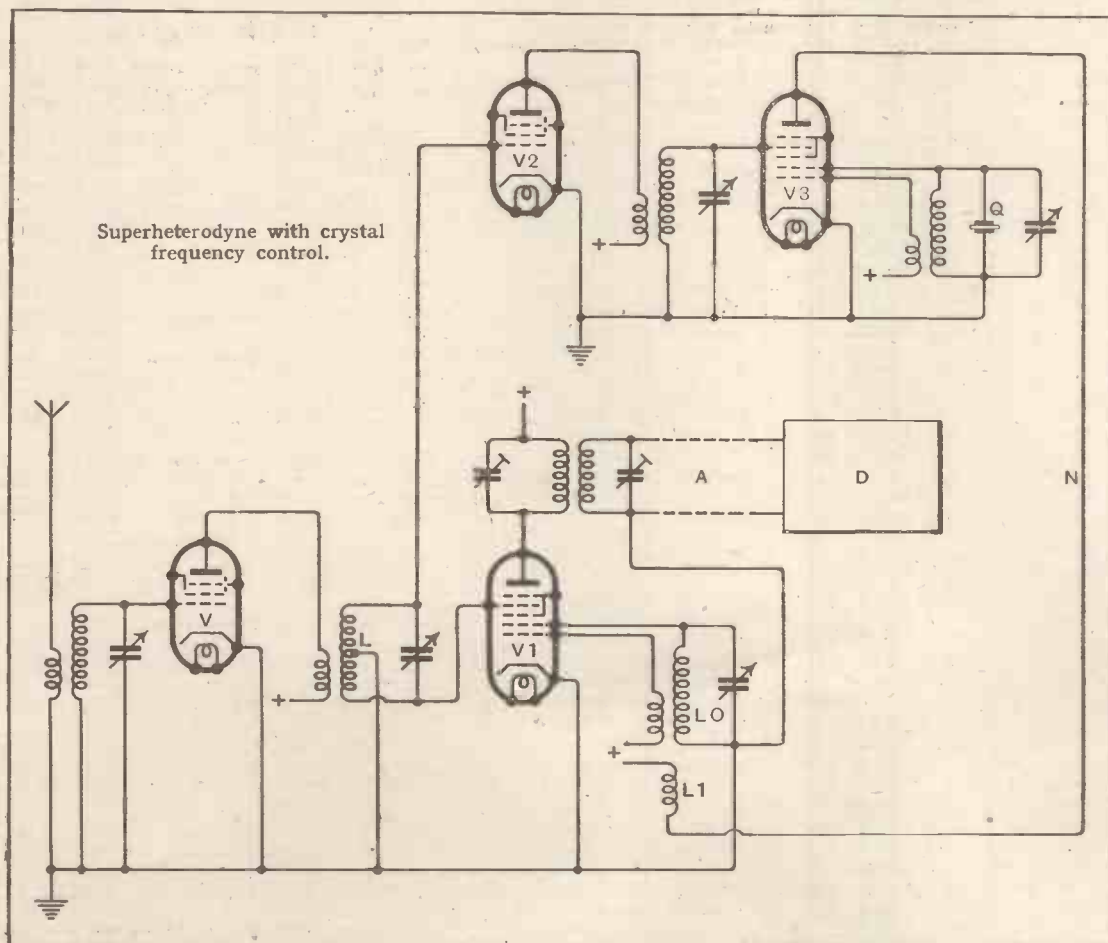

Superheterodyne with crystal frequency control.

The British abstracts published here are prepared with the permission of the Controller of H.M. Stationery Office, from specifications obtainable at the Patent Office, 25, Southampton Buildings, London, W.C.2, price 1/- each.

PRINCIPAL BROADCASTING STATIONS OF EUROPE

Arranged in Order of Frequency and Wavelength (Stations with an Aerial Power of 50 kW and above in heavy type)

Station.	kc/s.	Tuning Positions.	Metres.	kW.	Station.	kc/s.	Tuning Positions.	Metres.	kW.
Istanbul (Turkey)	152		1973.5	5	Bucharest (Romania)	823		364.5	12
Kaunas (Lithuania)	153		1961	7	Kiev (No. 2) (U.S.S.R.)	832		360.6	35
Hilversum (No. 1) (Holland)	160		1875	10-130	Stavanger (Norway)	832		360.6	100
Radio Romania (Romania)	130		1875	130	Berlin (Germany)	841		358.7	100
Lahti (Finland)	166		1807	150	Sofia (Bulgaria)	850		352.9	100
Moscow (No. 1) (U.S.S.R.)	172		1744	500	Valencia (Spain)	850		352.9	3
Paris (Radio Paris) (France)	182		1648	80	Simferopol (U.S.S.R.)	859		349.2	10
Ankara (Turkey)	183		1639	120	Strasbourg (France)	859		349.2	100
Irkutsk (U.S.S.R.)	187.5		1600	20	Poznan (Poland)	868		345.6	50
Deutschlandsender (Germany)	191		1571	60	London Regional (Brookmans Park)	877		342.1	70
National (Droitwich)	200		1500	150	Graz (Germany)	886		338.6	15
Minsk (U.S.S.R.)	208		1442	35	Linz (Germany)	886		338.6	15
Reykjavik (Iceland)	208		1442	100	Helsinki (Finland)	895		335.2	10
Motala (Sweden)	216		1389	150	Hamburg (Germany)	904		331.9	100
Novosibirsk (U.S.S.R.)	217.5		1379	100	Dniepropetrovsk (U.S.S.R.)	913		328.6	10
Warsaw (No. 1) (Poland)	224		1339	120	Toulouse (Radio Toulouse) (France)	913		328.6	60
Luxembourg	232		1293	150	Brno (Czechoslovakia)	922		325.4	32
Moscow (No. 2) (U.S.S.R.)	232		1293	100	Brussels (No. 2) (Belgium)	932		321.9	15
Kalundborg (Denmark)	240		1250	60	Algiers (Algeria)	941		318.8	12
Kiev (No. 1) (U.S.S.R.)	248		1209.6	100	Göteborg (Sweden)	941		318.8	10
Tashkent (U.S.S.R.)	256.4		1170	25	Breslau (Germany)	950		315.8	100
Bergen (Norway)	260		1153.8	20	Paris (Poste Parisien) (France)	959		312.8	60
Oslo (Norway)	260		1153.8	60	Madrid (EAJ7) (Spain)	968		309.9	5
Vigra (Aalesund) (Norway)	260		1153.8	130	Odessa (U.S.S.R.)	968		309.9	10
Leningrad (No. 1) (U.S.S.R.)	271		1107	100	Northern Ireland Regional (Lisnagarvey)	977		307.1	100
Tromsö (Norway)	282		1061	10	Bologna (Radio Marconi) (Italy)	986		304.3	50
Tiflis (U.S.S.R.)	283		1060	35	Torun (Poland)	986		304.3	24
Saratov (U.S.S.R.)	340		882.3	20	Hilversum (Holland)	995		301.5	15-65
Finmark (Norway)	347		864.6	10	Bratislava (Czechoslovakia)	1004		298.8	13.5
Bodö (Norway)	347		864.6	10	Chernigov (U.S.S.R.)	1013		296.2	4
Archangel (U.S.S.R.)	350		857.1	10	Midland Regional (Droitwich)	1013		296.2	70
Budapest (No. 2) (Hungary)	359.5		834.5	18	Barcelona (EAJ15) (Spain)	1022		293.5	3
Sverdlovsk (U.S.S.R.)	375		800	40	Königsberg (No. 1) (Germany)	1031		291	100
Banská-Bystrica (Czechoslovakia)	392		765	15-30	Paredo (Portugal)	1031		291	5
Lulea (Sweden)	392		765	10	Leningrad (No. 2) (U.S.S.R.)	1040		288.5	10
Rostov-on-Don (U.S.S.R.)	3 5		759	20	Rennes-Bretagne (France)	1040		288.5	120
Ostersund (Sweden)	413.5		723	10	West of England Regional (Washford)	1050		285.7	50
Voronezh (U.S.S.R.)	413.5		726	10	Bari (No. 1) (Italy)	1059		283.3	20
Oulu (Uleaborg) (Finland)	431		696	10	Tiraspol (U.S.S.R.)	1068		280.9	10
Baranowicze (Poland)	520		578	50	Bordeaux-Lafayette (France)	1077		278.6	60
Ljubljana (Yugoslavia)	527		569.3	6.3	Falun (Sweden)	1086		276.2	100
Viipuri (Finland)	527		569.3	10	Radio Normandie (France)	1095		274	20
Bolzano (Italy)	536		559.7	10	Vinnitsa (U.S.S.R.)	1095		274	10
Wilno (Poland)	536		559.7	50	Kuldiga (Latvia)	1104		271.7	50
Budapest (No. 1) (Hungary)	546		549.5	120	Tripoli (Libya)	1104		271.7	50
Beromünster (Switzerland)	556		539.6	100	Prague No.2 (Melnik) (Czechoslovakia)	1113		269.5	100
Klaipeda (Lithuania)	565		531	10	Nyiregyhaza (Hungary)	1122		267.4	6.25
Catania (Italy)	565		531	3	North-East Regional (Stagshaw)	1122		267.4	60
Palermo (Italy)	565		531	3	Hörby (Sweden)	1131		265.3	100
Radio Eireann (Ireland)	565		531	100	Genoa (No. 1) (Italy)	1140		263.2	10
Stuttgart (Germany)	574		522.6	100	Trieste (Italy)	1140		263.2	10
Alpes-Grenoble, (P.T.T.) (France)	583		514.6	20	Turin (No. 1) (Italy)	1140		263.2	30
Madona (Latvia)	583		514.6	50	London National (Brookmans Park)	1149		261.1	40
Vienna (Germany)	592		506.8	100	North National (Slathwaite)	1149		261.1	40
Athens (Greece)	601		499.2	15	Scottish National (Westerglen)	1149		261.1	50
Rabat (Morocco)	601		499.2	20	Kassn (Hungary)	1168		259.1	10
Sundsvall (Sweden)	601		499.2	10	Monte Ceneri (Switzerland)	1167		257.1	15
Florence (No. 1) (Italy)	610		491.8	20	Copenhagen (Denmark)	1176		255.1	10
Brussels (No. 1) (Belgium)	620		483.9	15	Nice-Côte d'Azur (France)	1185		253.2	60
Cairo (No. 1) (Egypt)	620		483.9	20	Frankfurt (Germany)	1195		251	25
Kouibychev (U.S.S.R.)	625		480	10	Freiburg-im-Breisgau (Germany)	1195		251	5
Christiansand (Norway)	629		476.9	20	Troppau (Germany)	1204		249.2	5
Lisbon (Emissora Nacional) (Portugal)	629		476.9	20	Lille (Radio P.T.T. Nord) (France)	1213		247.3	60
Trøndelag (Norway)	629		476.9	20	Rome (No. 2) (Italy)	1222		245.5	60
Prague (No. 1) (Czechoslovakia)	638		470.2	120	Gleiwitz (Germany)	1231		243.7	5
Lyons (P.T.T.) (France)	648		463	100	Görlitz (Germany)	1231		243.7	5
Petrozavodsk (U.S.S.R.)	648		463	10	Cork (Ireland)	1235		242.9	1
Cologne (Germany)	658		455.9	100	Saarbrücken (Germany)	1249		240.2	17
Jerusalem (Palestine)	668		449.1	20	Riga (Latvia)	1258		238.5	15
North Regional (Slathwaite)	677		443.1	100	Burgos (Spain)	1258		238.5	20
Sottens (Switzerland)	677		443.1	100	Nürnberg (Germany)	1267		236.8	2
Belgrade (Yugoslavia)	686		437.3	20	Aberdeen	1285		233.5	5
Paris (P.T.T.) (France)	695		431.7	120	Klagenfurt (Germany)	1294		231.8	5
Stockholm (Sweden)	704		426.1	55	Vorarlberg (Germany)	1294		231.8	5
Rome (No. 1) (Italy)	713		420.8	120	Radio Mediterranée (France)	1303		230.2	27
Hilversum (No. 2) (Jaarsveld) (Holland)	722		415.4	17	Naples (No. 1) (Italy)	1303		230.2	10
Kharkov, (No. 1) (U.S.S.R.)	722		415.4	10	Malmö (Sweden)	1312		228.7	2.5
Madrid (EAJ2) (Spain)	731		410.4	3	Bremen (Germany)	1330		225.6	2
Seville (EAJ5) (Spain)	731		410.4	5	Lódz (Poland)	1339		224	2
Turi (Estonia)	731		410.4	38	Dublin (Ireland)	1348		222.6	0.5
Munich (Germany)	740		405.4	100	Salzburg (Germany)	1348		222.6	2
Marseilles (P.T.T.) (France)	749		400.5	100	Genoa (No. 2) (Italy)	1357		221.1	5
Katowice (Poland)	758		395.8	10	Turin (No. 2) (Italy)	1357		221.1	5
Scottish Regional (Burghhead)	767		391.1	60	Milan (No. 2) (Italy)	1357		221.1	4
Scottish Regional (Westerglen)	767		391.1	70	Bordeaux-Sud-Ouest (France)	1366		219.6	25
Stalino (U.S.S.R.)	776		386.6	10	Warsaw (No. 2) (Poland)	1384		216.8	7
Toulouse (P.T.T.) (France)	776		386.6	120	Lyons (Radio Lyons) (France)	1393		215.4	25
Leipzig (Germany)	785		382.2	120	Vaasa (Finland)	1420		211.3	10
Barcelona (EAJ1) (Spain)	795		377.4	7.5	Kaiserlautern (Germany)	1429		209.9	2.5
Lwów (Poland)	795		377.4	50	Turin (No. 3) (Italy)	1429		209.9	5
Welsh Regional (Penmon) (Anglesey)	804		373.1	5	Paris (Eiffel Tower) (France)	1456		206	7
Welsh Regional (Washford)	804		373.1	70	Bournemouth	1474		203.5	1
Milan (No. 1) (Italy)	814		368.6	50	Plymouth	1474		203.5	0.3

CLASSIFIED ADVERTISEMENTS

NOTICES

THE CHARGE FOR ADVERTISEMENTS in these columns is

12 words or less, 3/- and 3d. for every additional word.

Each paragraph is charged separately and name and address must be counted.

SERIES DISCOUNTS are allowed to Trade Advertisers as follows on orders for consecutive insertions, provided a contract is placed in advance, and in the absence of fresh instructions the entire "copy" is repeated from the previous issue: 13 consecutive insertions 5%, 26 consecutive, 10%; 52 consecutive, 15%.

ADVERTISEMENTS for these columns are accepted up to **FIRST POST** on **MONDAY MORNING** (previous to date of issue) at the Head Offices of "The Wireless World," Dorset House, Stamford Street, London, S.E.1, or on **SATURDAY MORNING** at the Branch Offices, 8-10, Corporation Street, Coventry; Guildhall Buildings, Navigation Street, Birmingham, 2; 260, Deansgate, Manchester, 3; 26a, Renfield Street, Glasgow, C.2.

Advertisements that arrive too late for a particular issue will automatically be inserted in the following issue unless accompanied by instructions to the contrary. All advertisements in this section must be strictly prepaid.

The proprietors retain the right to refuse or withdraw advertisements at their discretion.

Postal Orders and Cheques sent in payment for advertisements should be made payable to **ILIFFE & SONS Ltd.**, and crossed **& Co.** Notes being untraceable if lost in transit should not be sent as remittances.

All letters relating to advertisements should quote the number which is printed at the end of each advertisement and the date of the issue in which it appeared.

The proprietors are not responsible for clerical or printers' errors, although every care is taken to avoid mistakes.

IMPORTANT NOTICE

Owing to the Easter Holidays, next week's issue of "THE WIRELESS WORLD" (dated April 13th) has gone to press earlier than usual.

In accordance with the notice that appeared last week, only those Miscellaneous Advertisements which have already been received can be inserted in next week's issue.

NEW RECEIVERS AND AMPLIFIERS

A. DEGALLIER'S "Challenger Radio Corporation," the best firm, for reliable fully-guaranteed ultra short-wave radio, have on view in London without exception the finest receivers ever made; for instance, a T.R.F. Midget at 65/-; Car Radio medium- and long-wave push-button tuning, 6½gns.; a 12-valve receiver, 5 bands, 5-2,100 metres, is only £13/7/6; any American Valve for receivers, 195-39, 5/6 each, only first Rathenon, etc.; they have a range like this right up to a 19-valve Challenger De Luxe chassis, valves and 2 auditorium speakers, 6 bands, 5-2,100 metres, 30 watts, undistorted, class "A," at 50gns.; Wireless World Report and 6-page illustrated brochure available on this set; why not call and handle these receivers at your leisure? No obligation to purchase. Or handsomely profusely illustrated catalogue forwarded on receipt of 2d. stamp.

D. DEGALLIER'S, 31, Craven Terrace, London, W.2. Paddington 6492. Nearest point Marble Arch, down Bayswater Rd., turn 5th right. [8326]

£9/19/6—The newest 8-valve all-wave super, 4 bands, 12½-2,000 metres, 8 watts push-pull output, automatic tuning, full A.V.C., low level bass compensation, Cathode ray tuning indicator, A.C./D.C. model, 10 valves, same price.

£11/10—10-valve all-wave Super 8, tuned circuits, bandpass I.F.s, 10in. speaker, automatic tuning, massive cabinet, hand finished in beautiful walnut.

A VERY Limited Number of These are Available, and only from:—

RADIOGRAPHIC Ltd., 66, Osborne St., Glasgow, C.1. Telephone: Bell 848. [8222]

"DUO-TRAC" Cell-o-phone Sound-on-Film Unit, with 8 sound reels, as fitted in the 48 gns. radio model, complete, new, perfect order, 230-volt, 50 cycle; £12/10.—Robinson, 256, Stockport Rd., Levenshulme, Manchester. [8316]

ARMSTRONG

A New Chassis of Exceptional Value!

MODEL R.F.96 — 8-STAGE

ALL-WAVE RADIOGRAM CHASSIS

Incorporating R.F. AMPLIFIER,

3-Stages of A.V.C. and corrected 3½ watts output.

Complete with Matched M.C. Speaker.

PRICE £8.0.0

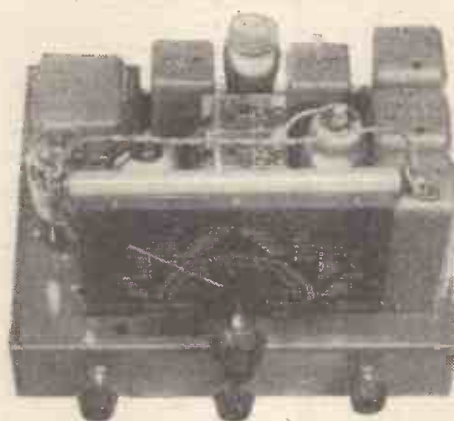

17.9—50, 200—550, 1000—2000m.

Accurately ganged and ready to switch on, this Chassis has Extension Speaker Sockets, Gramophone Switch separates Amplifier from H.F. side and Volume Control operates on both Radio and Gramophone. Guaranteed 12 months.

DEMONSTRATIONS daily till 7.30 p.m. Saturdays till 5.30 p.m.

ARMSTRONG MANFG. CO.

100 ST. PANCRAS WAY, CAMDEN TOWN, N.W.1

Phone: GULLiver 3105

SPECIAL CABINETS for the Stand-by Three



From 14/-

A range of high-class cabinets, fitted with perforated metal grill, rubber feet and chromium fitted leather carrying handle. High finish polishing in nine different shades of Oak, Mahogany or Walnut. Also in coloured enamelled finishes. Details free. Also literature on all Lockwood Radio and Radio-Gram Cases.

LOCKWOOD & CO., 65, Lowlands Road, Harrow. Byron 1818.

DIRECT SOUND RECORDING

In addition to our well-known Simplat Blanks, Apparatus & Accessories we can now supply



PYRAL AND NEO CIRE ACETATE DISCS

Full Particulars & Price Lists Free from **V. G. MANUFACTURING CO. LTD.** GORST ROAD, LONDON, N.W.10. Phone: WILlesden 1632/3.

NUMBERED ADDRESSES

For the convenience of private advertisers, letters may be addressed to numbers at "The Wireless World" Office. When this is desired, the sum of 6d. to defray the cost of registration and to cover postage on replies must be added to the advertisement charge, which must include the words Box 000, c/o "The Wireless World." All replies should be addressed to the Box number shown in the advertisement, c/o "The Wireless World," Dorset House, Stamford Street, London, S.E.1. Readers who reply to Box No. advertisements are warned against sending remittances through the post except in registered envelopes: in all such cases the use of the Deposit System is recommended, and the envelope should be clearly marked "Deposit Department."

DEPOSIT SYSTEM

Readers who hesitate to send money to advertisers in these columns may deal in perfect safety by availing themselves of our Deposit System. If the money be deposited with "The Wireless World," both parties are advised of its receipt.

The time allowed for decision is three days, counting from receipt of goods, after which period, if buyer decides not to retain goods, they must be returned to sender. If a sale is effected, buyer instructs us to remit amount to seller, but if not, seller instructs us to return amount to depositor. Carriage is paid by the buyer, but in the event of no sale, and subject to there being no different arrangement between buyer and seller, each pays carriage one way. The seller takes the risk of loss or damage in transit, for which we take no responsibility. For all transactions up to £10, a deposit fee of 1/- is charged; on transactions over £10 and under £50, the fee is 2/6; over £50, 5/-. All deposit matters are dealt with at Dorset House, Stamford Street, London, S.E.1, and cheques and money orders should be made payable to Iliffe & Sons Limited.

SPECIAL NOTE.—Readers who reply to advertisements and receive no answer to their enquiries are requested to regard the silence as an indication that the goods advertised have already been disposed of. Advertisers often receive so many enquiries that it is quite impossible to reply to each one by post. When sending remittances direct to an advertiser, stamp for return should also be included for use in the event of the application proving unsuccessful.

NEW RECEIVERS AND AMPLIFIERS

R TELEPHONE: Holborn 4631.

RADIO CLEARANCE, Ltd., 63, High Holborn, W.C.1 by offering brand new receivers, maintain their reputation as the leading Mail Order House for surplus radios. See our list (March 23 issue) of components, etc., under that heading.

ACE Model AW563 6-valve All-wave Superhet Receiver, fitted automatic tuning, providing choice of 5 stations instantly at the touch of a button, 3 wave-bands, mains superhet for A.C. mains only, 200-250 volt, British Octal valves are fitted as follows, pentagrid, frequency changer, band-pass coupled to H.F. pentode, I.F. amplifier, double diode valve, providing delayed A.V.C. and detection, followed by pentode I.F. amplifier coupled to power pentode output valve (3 watts undistorted output), provision for gramophone pick-up and extra loud-speaker, floodlit glass tuning scale calibrated with station names and wave lengths, cathode ray tuning valve and wave-band indicator, special slow motion tuning device, two-tone bentwood highly polished walnut cabinet, wave range 19-50, 200-550 and 800-2,000 metres, brand new listed 12 gns.; our price £5/19/6 to clear.

IMMEDIATE Delivery Now Offered of

BBRITISH Belmont 8-valve Plus Magic Eye All-wave A.C. Superhet Chassis, 4 wave-bands, two short, medium and long, fitted latest Mullard octal base American type valves. Brief specification: Short wave 6-18 metres (covers television sound), short wave 2, 18-50 metres, medium band 200-550 metres, long 900-2,000 metres. Valve combination 6K7, Pre H.F., 6J7 oscillator, 6J7 mixer, 6K7 I.F., 6Q7 (DDT) detector, A.V.C. and first I.F. two 6F6s parallel output, 5Y3 rectifier, plus 6G5 Magic Eye visual tuning, handsome dial, station names etched on glass; controls 2-speed tuning, volume and on/off, combined variable tone control and selectivity switch, wave change plus gram. switch. Size of chassis, 13½in. x 10in. x 3in. Supplied complete with valves, cutcheon, knobs, but less speaker; £5/19/6 each.

COMplete Receiver in Handsome Walnut Cabinet, details as above, complete with speaker; £7/7 each.

DECCA 6-valve 3 Wave-band Battery Chassis, fitted complete with Mazda and Osram valves, QPP output; these chassis give a sparkling performance on all wave-bands, and are the product of a well-known manufacturer; complete with valves, £3/3 each.

ALL Orders Post Free; enquiries 1½d. stamp if reply expected. Hours of business, week-days 9 a.m. to 7 p.m. Saturdays 9 a.m. to 1 p.m. Postal rates apply to the United Kingdom only, orders for Ireland and abroad must include sufficient postage to cover whatever the value of same.

RADIO CLEARANCE, Ltd., 63, High Holborn, W.C.1. Telephone: Holborn 4631. [8169]

Test with the Best—

The 46-RANGE UNIVERSAL

AVOMETER

Electrical Measuring Instrument Model 7

SERVICE jobs lose half their worries and laboratory tests are completed in half the time with the Model 7 Avometer. Dead beat in action, it quickly gives laboratory-accurate readings on all its 46 ranges. A.C. and D.C. amperes and volts, resistance, capacity, audio-frequency power output and decibels—any range instantly selected by means of two rotary switches. No external shunts or resistances required. A protective cut-out instantly disconnects the meter from the supply should a severe overload be applied. It is built to last with lasting accuracy.



BRITISH MADE

Write for descriptive pamphlet.

16 Gns. Model 7. Also the 36-range Universal Avometer ... 13 Gns. Range Extension Unit (for measurements down to 1/100th ohm) 12/6. 22-range D.C. Avometer ... 9 Gns. Carrying Cases ... 25/- DEFERRED TERMS IF DESIRED.

Sole Proprietors and Manufacturers:—

THE AUTOMATIC COIL WINDER & ELECTRICAL EQUIPMENT CO. LTD.,
Winder House, Douglas Street, London, S.W.1.
Phone: VICTORIA 3404-7.

"better than any we have so far tested,"
... says Wireless World (Aug. 18, 1938) of

MARCONI-EKCO
High-fidelity
EARPHONES



SPECIFICATION: Extremely high sensitivity; Input Impedance 22 ohms; Maximum Input 500 milliwatts; Frequency characteristic ± 10 dB from 100 to 6,000 c.p.s.; Weight 6 ozs. carpiece only, 16 ozs. double carpieces with band. Double earphones with headband, 29 0/0. Single earphone with moulded handle, 24 4/0.

Write for full details and copy of "Wireless World" report to **MARCONI-EKCO INSTRUMENTS LTD.,**
Electra House, Victoria Embankment, W.C.2.

No other method of sound reproduction approaches the near-perfection of Marconi-Ekco High Fidelity Earphones. Response is of the highest order over a frequency range of 50 to 8,000 c.p.s. Concrete advantages of this high-quality reproduction are: Those with defective hearing suffer no loss in tonal quality; the earphones are ideal for engineers' sound monitoring use; and many uses are opened up for the medical profession.

NEW RECEIVERS AND AMPLIFIERS

ARMSTRONG Amplifiers.
ARMSTRONG Range of High Fidelity Amplifiers are Designed for Use with Radio Feeder Units, gramophone pick-ups, or any other Audio input where wide frequency range (20-20,000 cycle) amplification is required.
ARMSTRONG 6- and 12-watt Output Units are Two Popular Models, both of these use 6 valves for amplification, this being arranged as three stages of push-pull resistance capacity coupled.
ARMSTRONG 6-watt Amplifier, Type A46/7, using 2 PX4's in the output stage; price 9 gns., with valves.
ARMSTRONG 12-watt Amplifier, Type 127/PX, using 2 PX25's in the output stage; price 12 gns., with valves.
ARMSTRONG Will be Pleased to Send Full Details, together with particulars of their local station feeder unit, Type PS2/4, and television sound feeder unit on request; special equipment available for quality reproduction in schools.
ARMSTRONG COMPANY, of 100, St. Pancras Way, Camden Town, London, N.W.1. [8298]

P.S.I 1939 Dance Band Amplifier, push-pull output 8-10 watts, entirely portable, high-class rexine covered cases, one control pre-stage piezo microphone, complete with moving coil microphone, 10in. latest type Celestion P.M. speaker, input for microphone or pick-up, high fidelity reproduction, 12 1/2 gns.; ditto, but in super finished portable cases, and their speakers, 14 1/2 gns.; 15 watt amplifiers, as above, 16 gns.; all fully guaranteed for 12 months.

PACKARD SOUND INDUSTRIES, 39, Lisle St., W.C.2. Gerrard 2817. [8328]

RECEIVERS AND AMPLIFIERS
CLEARANCE, SURPLUS, ETC.

ANGLO-AMERICAN RADIO (and MOTORS), Ltd.
ANOTHER Clearance of Demonstration Models.
£5/10—10-valve A.C. superhet receiver chassis with valves, push-pull output, 4 wavebands, 12-30, 30-75, 200-550, 1,000-2,000 metres, with magic eye, R.F. gain, tone, audio control selectivity, output approx. 6 watts; four only.
£5/10—A.C./D.C. 10-valve, as above; one only.
£10—9-valve Crosley superhet, complete with valves and auto-transformer in console cabinet, all-wave, 12in. speaker, output approx. 10 watts; one only.
£1/10—Short wave converter adaptor, mains and battery; three only.
£1/10—Healyberd H.T. eliminator for A.C. mains; one only.
£3/10—All-wave battery receiver, 6 valves in console cabinet; one only.
ALL the Above are in Good Working Order, but are being disposed of as a clearance line, and our usual service guarantee does not apply; cash with order or c.o.d.
ANGLO-AMERICAN RADIO (and MOTORS), Ltd.
Albion House, 59, New Oxford St., London, W.C.1. [8296]

PHILCO A.C. 7-valve Superhet, 4 waveband, push-pull output, show model only, guaranteed 6 months, cost £20, bargain; £7 cash.
FERGUSON 11-valve A.C.-D.C. All-wave De Luxe Receiver, push-pull output, as new; £7/19/6; cost 18 1/2 gns.
MURPHY 4-valve Superhet Console Model for A.C. mains, 14in. auditorium speaker, cost 22 gns., new condition; £7.
H.M.V. 10-valve A.C. Radiogram, with record changer, push-pull output, perfect condition; £10.
PACKARD SOUND INDUSTRIES, 39, Lisle St., W.C.2. Gerrard 2817. [8327]

BANKRUPT Bargains.—Brand new 1938 radio sets in makers' cartons with guarantees, at less than half retail prices; send 1/2d. stamp for list bargains.—261-3, Lichfield Rd., Aston, Birmingham. [8275]

USED SETS FOR SALE

ANSON
ANSON Auto Radiogramophone, changes any number of records, plays both sides, 1938 model, cost £150, used on exhibition only; £100, or offer.—McMurdo, 17, Hertford St., W.1. [8330]

SARGENT
SARGENT 1939 Communications Superhet, 9.5-550 meters, perfect; £8/8.—84, Arthur Rd., Southampton. [8318]

CAR RADIO

CROSLLEY Push-button 1939 10 guinea Models, 5 1/2 gns.; aeriels, overheads, police type, etc., from 8/6; trade enquiries solicited.—Shippers, 18, Corporation St., Manchester. [0622]

FINEST American Twin Running-board Aeriels, completely rubber covered, maximum signal pick-up, minimum noise, easy mounting, now only 17/6 pair complete; handsome chromium roof aeriels, to mount straight or "vee," complete, 15/-; immediate despatch, carriage paid; cash with order or c.o.d.

WIRELESS SUPPLIES UNLIMITED, Essex House, Stratford, E.15. Maryland 3191. [0577]

PUBLIC ADDRESS

FOR Sale, 50 watt B.S.R. amplifier, complete with all equipment and car trailer van; £65.—Lewis, Contractor, Sleaford. [8276]

QUALITY Amplifiers and Microphone Equipments for Hire or Permanent Installation.—Harmony House, 116, Cambridge Rd., Southport. [8307]

P.A. Hire Service; meetings, sports, speeches relayed any distance.—Parker Sound Equipment, 30, Goulden Rd., Manchester, 20. Didsbury 3136. [8287]

AN ALL-ROUND PORTABLE

"STAND-BY 3" KIT
for any emergency.

A self-contained Battery Portable Set is essential in the event of emergency and a highly desirable adjunct to the mains set. Easily moved from room to room and equally useful for outdoor use.
With the set described in this issue you are entirely independent of electric mains, as both H.T. and L.T. are obtained from **Dry Batteries**, an important consideration in the present unsettled conditions.

KIT including drilled chassis less valves, speaker, cabinet and batteries **67/6**

CABINET polished Oak with carrying handle **14/-**
3 SPECIFIED VALVES - - - - **27/-**
H.T. and L.T. BATTERIES - - - - **10/9**
GOODMANS SPEAKER, as specified - **21/-**

We can also supply any of the well-known Portable Sets on the market for Cash, C.O.D. or on our very **CONVENIENT TERMS**, including—

The New MULLARD PORTABLE SUPERHET

An entirely self-contained, powerful receiver giving excellent reproduction on both medium and long waves. Cash or C.O.D. 8 1/2 Gns. including batteries or 11/- with order and 12 monthly payments of 15/-.

Write for illustrated and fully descriptive folder.
WE supply all **ARMSTRONG CHASSIS** for Cash or on **EASY TERMS**. Details of full range upon request.
WHATEVER YOU REQUIRE WE CAN SUPPLY
Quotations by return of post.

Estd. - 1925 THE Phone NATIONAL 682
LONDON RADIO SUPPLY COMPANY
11-OAT LANE · NOBLE ST · LONDON EC2



See that **FLUXITE** is always by you—in the house—garage—workshop—wherever speedy soldering is needed. Used for 30 years in Government works and by leading engineers and manufacturers. Of Ironmongers—in tins, 4d., 8d., 1/4 and 2/8. Ask to see the **FLUXITE SMALL-SPACE SOLDERING SET**—compact but substantial—Complete with full instructions, 7/6. Write for Free Book on the art of "SOFT" SOLDERING—and ask for leaflet on CASE-HARDENING STEEL and TEMPERING TOOLS with **FLUXITE**.

TO CYCLISTS: Your wheels will NOT keep round and true unless the spokes are tied with fine wire at the crossings AND SOLDERED. This makes a much stronger wheel. It's simple—with **FLUXITE**—but IMPORTANT

THE FLUXITE GUN

is always ready to put **Fluxite** on the soldering job instantly. A little pressure places the right quantity on the right spot and one charging lasts for ages.
Price 1/6 or filled 2/5.



ALL MECHANICS WILL HAVE
FLUXITE
IT SIMPLIFIES ALL SOLDERING
FLUXITE LTD., Dept. W.W., DRAGON WORKS, BERMONDSEY ST., SE1

PUBLIC ADDRESS

VORTEXION P.A. Equipment, LIMITED, but unequalled. WE Invite You to a Demonstration.

- A.C.-D.C. Dance Band Amplifier, 10 watts output, complete in case, with moving coil microphone, speaker and cables, weight 22lb.; 12 gns.
A.C. 20 15-20 watt Amplifier, 30-18,000 cycles, independent mike and gram, inputs and controls, 0.037 volts required to full load, output for 4, 7.5, and 15 ohms speakers or to specification, inaudible hum level; ready for use; 8 1/2 gns., complete.
C.P. 20, 12-volt battery and A.C. mains model, as used by R.A.F., output as above; 12 gns.
A.C. 20, in portable case, with Collaro motor. Piezo pick-up, etc., £14; C.P. 20 ditto, £17/17.
50 WATT Output 6L6s, under 60-watt conditions, with negative feed back, separate rectifiers for anode, screen and bias, with better than 4% regulation, level response, 20-25,000 cycles, excellent driver, driver transformer and output transformer matching 2-30 ohms impedance electronic mixing for mike and pick-up, with tone control, complete with valves and plugs; £15.
COMPLETE in Case, with turntable B.T.H. Piezo pick-up and shielded microphone transformer, £20.
80 WATT Model, with negative feed back; £25, complete.
120 WATT Model, with negative feed back; £40, complete.
250 VOLT 250 m.a. Full Wave Speaker, field supply unit; 25/-, with valve.
ALL P.A. Accessories in Stock; trade supplied.

VORTEXION, Ltd., 182, The Broadway, Wimbledon, S.W.19. Phone: Lib. 2814.
ALEXANDER BLACK, Ltd.—Consult us on sound installations, temporary or permanent; booklet on request.—55, Ebury St., S.W.1. Sloane 6129 [0597]
PUBLIC Address Contractors Can Hire P.A. Vans, loud-speakers, microphones and equipments of all types from Hire Dept., Gramplan Reproducers, Ltd., Kew Gardens, Surrey. Tel.: Richmond 1175-67. [0618]
TWO Only, travellers' samples, 18-watt A.C./D.C. equipments, complete with playing desk, moving coil microphone and horn speaker, etc., £25 net; one only, ditto, but to operate also from 12-volt car battery, £28/10 net.—Gramplan Reproducers, Ltd., Kew Gardens, Surrey. Richmond 1175-67. [0625]
TWO Only, Gramplan horn public address speakers, horn type P.A. speakers, P.M., 15 ohms, speech coil handles, 20 watts, 55/- each; Epoch cinema model, D.C. 230 volt field, perfect, 30/-; Baker super auditorium model, 14in. cone, with rectifier equipment, 70/-; Epoch super 14in. loud-speaker, with rectifier equipment, 70/-; P.S.I Super Moving Coil Microphones, from 30/-; nickel plated collapsible stands for same, 17/6; heavy type super quality chromium plated, 25/-
PACKARD SOUND INDUSTRIES, 39, Lisle St., W.C.2. Gerrard 2817. [8329]

NEW MAINS EQUIPMENT

- VORTEXION Supply G.P.O., B.B.C., L.P.T.B. Why not you?
ALL Models Super Shrouded, primaries screened and tapped, 200-250v., filaments C.T.
ANY Model Fitted 5v. or 6.3v. Filaments if Required.
500-0-500 150 m.a., 4v. 4a., 2.5a., 4v. 2a., 4v. 2a., 4v. 2a., 35/-; 400 or 350v., same price.
500-0-500 120 m.a., 4v. 4a., 4v. 2.5a., 4v. 1-2a., 4v. 1-2a., 28/-; 400v. or 450v., same price.
425-0-425 150 m.a., 4v. 8-10a., 4v. 2.5a., 4v. 1a., 4v. 1a., 32/-;
350-0-350 120 m.a., 4v. 4a., 4v. 2.5a., 4v. 1-2a., 21/-; with extra 4v. 6a., 25/-;
350-0-350v. 75 m.a., 4v. 2.4a., 4v. 1-2a.; 18/-;
250-0-250v. 60 m.a., 4v. 2-4a., 4v. 1-2a.; 15/-;

AUTO Transformers. 100-120 to 200-240v., 80 watts, 11/-; 120 watts, 14/6; 200 watts, 21/-; 250 watts, 25/-; 300 watts, 28/-; 500 watts, 47/6.
W.W. Q.A. Output Transformer; 21/-.

MICROPHONE Transformers, in heavy magnetic shielding; 12/6.

CHOKES.—30h. 60 m.a., 7/6; 7-13h. 120 m.a., 12/6; 30h. 150 m.a., 15/-; 25h. 150 m.a., 21/-.

TRANSFORMERS and Chokes to Any Specification.

CAR Battery Charger, 6 and 12v., 1 1/2 to 2 amperes; 30/- complete.

VORTEXION, Ltd., 182, The Broadway, Wimbledon, London, S.W.19. Telephone: Liberty 2814. [8331]

CABINETS

- A CABINET for Every Radio Purpose.
CONVERT Your Set into a Radiogram at Minimum Cost; surplus cabinets from noted makers under cost of manufacture (undrilled); 30/- upwards; motors at wholesale prices.
"FIT-A-GRAM" Cabinet, 31x17x15; 21/-.
UNDRIILLED Table Console and Loud-speaker Cabinets, from 3/6.
INSPECTION Invited; photos loaned to country customers.
H.L. SMITH and Co., Ltd., 289, Edgware Rd., W.2. Tel.: Pad. 5891. [0485]
BRAND New Radiogram Cabinets (undrilled), 55/-; worth 10 gns.; also magnificent television cabinets, new, 35/-.—Particulars, Haines and Son, 23, Denmark St., W.C.2. Tem. 5900. [8069]

PREMIER 1939 RADIO

NEW PREMIER MULTI-RATIO OUTPUT TRANSFORMERS, 5/9 each. 11 ratios from 15:1 to 150:1. Two push-pull ratios.

Premier Short-Wave Kits.

Complete to the last detail including all Valves and coils, as well as theoretical and wiring diagrams and lucid instructions for building and working. Each kit is supplied with a steel Chassis and Panel and uses plug-in coils to tune from 13 to 170 metres.
1 Valve Short-Wave Receiver or Adapter Kit ... 17/6
1 Valve Short-Wave Superhet Converter Kit ... 20/-
1 Valve Short-Wave A.C. Superhet Converter Kit [22/6
2 Valve Short-Wave Receiver Kit ... 25/-
3 Valve Short-Wave Screen Grid and Pentode Kit 58/6
PREMIER U.S.A. QUARTZ TRANSMITTING CRYSTALS. 7 mc Band, 10/- each, with Calibration Certificate. Enclosed holder and Base, 3/-.

PREMIER MOVING COIL METERS

Table with 3 columns: Model No., Accuracy, and Case type. Includes models 21, 311, and 311.1 with various specifications for accuracy and case diameter.

VOLTAGE MULTIPLIER RESISTANCES, guaranteed accuracy ± 2 per cent.

TAPPED SHUNT to provide readings of 5 mA/A., 25 mA/A., 250 mA/A., and 1,000 mA/A., 5/6.
PREMIER S.W. H.F. Chokes, 10-100 metres, 9d. each. Pie-wound, 1/6 each. Screened, 1/6 each.
SHORT-WAVE COILS, 4- and 6-pin types, 13-26, 22-47, 41-94, 78-170 metres, 1/9 each, with circuit. Special set of S.W. Coils, 14-150 metres, 4/- set, with circuit. Premier 3-band S.W. coil, 11-25, 10-43, 38-86 metres. Suitable any type circuit, 2/6.
COIL FORMERS, 4- or 6-pin low-loss, 1/- each.
UTILITY Micro Cursor Dials, Direct and 100:1 Ratios, 3/6.
PREMIER Short-Wave Condensers, all-brass construction, with Trolitul insulation. 15 mmf., 1/6; 25 mmf., 1/7; 40 mmf., 1/9; 100 mmf., 2/-; 160 mmf., 2/3; 250 mmf., 2/6.
TROLITUL DOUBLE SPACED TRANSMITTING CONDENSERS. 15 mmf., 2/9; 40 mmf., 3/6; 100 mmf., 4/-; 160 mmf., 4/6.
NEW TROLITUL SPLIT STATOR CONDENSERS, 50 x 50 mmf., 10/6.
AMERICAN VALVES. We hold the largest stocks of U.S.A. tubes in this country and are sole British Distributors for TRIAD High-grade American Valves. All types in stock. Standard types, 5/6 each. All the new Octal Base tubes at 6/6 each, 210 and 250, 8/6 each.
EUROPA MAINS VALVES, 4 v. A.C. Types, A.C./H.L., A.C./L., A.C./S.G., A.C./V.M.S.G., A.C./H.P., A.C./V.H.P., A.C./P., and 1 watt D.H. Pentodes, all 4/6 each. A.C./Pens., I.H., 5/6; A.C./P.X.4, 6/6; Oct. Freq. Changers, 8/6; Double Diode Triodes, 7/6; Triode H. ex. Freq. Ch., 8/6; Trl. Grid Pen., 10/6; 3 1/2-watt D.H. Triode, 7/6. 350 v. and 500 v. F.W. Rect., 5/6. 13 v. 2 amps. Gen. Purpose Triodes, 5/6; H.F. Pens. and Var.-Mu. H.F. Pens., Double Diode Triodes, Oct. Freq. Changers, 7/6 each. Full-wave and Half-wave Rectifiers, 5/9 each.

Matchmaker Universal Modulation Transformers

Will match any modulator to any R.F. load. 50 watts, 17/6; 150 watts, 29/6; 300 watts, 49/6.
MATCHMAKER UNIVERSAL OUTPUT TRANSFORMERS. Will match any output valves to any speaker impedance. 11 ratios from 13:1 to 80:1. 5-7 watts, 13/6; 10-15 watts, 17/6; 20-30 watts, 29/6. Send for full details.

PREMIER 1939 HIGH FIDELITY AMPLIFIERS

A NEW COMPLETE RANGE OF 7 HIGH FIDELITY P.A. AMPLIFIERS FOR A.C. OR A.C./D.C. MAINS OPERATION With the exception of the 3-watt models, all Premier Amplifiers incorporate the new Premier Matchmaker Output Transformer, enabling any single or combination of speakers to be used. 6, 8/10-, and 15-watt systems are provided with two separate input channels which can be mixed to any level. The 30- and 60-watt systems have 3 input channels. The built-in Pre-Amplifiers ensure that the gain is sufficient for any low-level crystal or velocity microphone. The actual gain of the 6-, 15-, 30- and 60-watt amplifiers is over 100 decibels. Tone controls are also incorporated.

Table with 3 columns: Amplifier type, Kit of Parts with Valves, and Completely Wired and Tested. Lists prices for 3-watt, 6-watt, 10-watt, and 15-watt models.

Orders 5/- and over sent Post Free. Under 5/- please add 6d. Postage.

Have you our 1939 Catalogue, Handbook and Valve Manual? 90 pages of Radio Bargains and Interesting Data. Price 6d.

ALL POST ORDERS TO: Jubilee Works, 167, Lower Clapton Road, London, E.5. Amherst 4723.
CALLERS TO: Jubilee Works, or our NEW PREMISES, 169, FLEET STREET, E.C.4. Central 2833 or 50, High Street, Clapham, S.W.4. Maccaulay 2381

DYNAMOS, MOTORS, ETC.

D.C.—A.C. Convertors, motors, all voltages, for sale and wanted.—Easco, 18w, Brixton Rd., S.W.9. [0558]
ALL Types of Rotary Converters, electric motors, battery chargers, petrol electric generator sets, etc., in stock, new and second-hand.
A.C.-D.C. Conversion Units for Operating D.C. Receivers from A.C. Mains, 100 watts output, £2/10; 150 watts output, £3/10.
WARD, 46, Farringdon St., London, E.C.4. Tel.: Holborn 9703. [0518]
ELECTRADIX Rotary Converters for A.C. Radios on D.C. mains; alternators 50 to 500 cycles; mains motors and motor-generators for 1 to 600 cells; petrol engines and switchgear.—218, Upper Thames St., London, E.C.4. [0619]

RECORDING EQUIPMENT

ALL Recording Discs and Materials in Stock; tracker units, £4/7/6; recording motors, £3/17/6.—Write for further details, Will Day, Ltd., 19, Lisle St., W.C.2. [0595]
LIVERPOOL Sound Studios, 83a, Bold St., Liverpool.—Personal recordings from 3/6; amplifiers, microphones, recording motors and trackers, blank discs, etc. [8300]

NEW LOUD-SPEAKERS

SINCLAIR Speakers for all types.—Alma Grove, Copenhagen St., N.1. [0603]
BAKERS New Corner Horn Speakers are in Demand; every music lover interested in quality reproduction should write for details to the Pioneer Manufacturers of Moving Coil Speakers, Bakers Selhurst Radio, 75, Sussex Rd., South Croydon. [8157]

LOUD-SPEAKERS

SECOND-HAND, CLEARANCE, SURPLUS, ETC.
VAUXHALL.—Rola P.M. speakers, 8in., 14/9; 10in., 19/6; Rola energised 2,500, 10in., 17/6.
VAUXHALL UTILITIES, 163a, Strand, W.C.2. Over "Denny's," the booksellers. Send for free list. [8325]

ROLAS, for 6/11; G12's, 47/6; 1/4d. stamp for lists.—Shippers, 18, Corporation St., Manchester. [0606]

3,000 Speakers from 5/6 each. P.M. and energised 4in. to 14in., including several Epoch 18in.—Sinclair Speakers, Alma Grove, Copenhagen St., N.1. [0591]

BAKERS Offer a Number of the Famous Baker Super Power Speakers at Half Price; as solely specified for the "Wireless World" A.V.C. Straight Four Quality Receiver.—Bakers Selhurst Radio, South Croydon. [8158]

LOUD-SPEAKER CONVERSIONS

BAKERS Triple Cone or Corner Horn Conversions will Considerably Improve Reproduction from Your Present Speaker, whatever make; prices from 29/6.—Bakers Selhurst Radio, South Croydon. [8159]

TELEVISION

TELEVISION 1-valve Pre-amplifier, Spencer West's 6-gn. A.C. mains model, used few times, £4; 2-valve pre-amplifier, with power pack, A.C. mains, £4; 250ft. in one length K.I.A. concentric cable, used experiment only, cost 75/-, accept 40/-; Marconi tilting television aerial reduces interference, cost 75/-, accept 40/-; Eddy-stone 5-gn. 1-valve converter, 15-90 metres, as new, £3.—Walls, 49, High St., Saffron Walden, Essex. Phone: 45. [8310]

TRANSMITTING APPARATUS

BARGAINS.—Clearance of surplus stock, valves, components, transmitters, receivers; stamp for lists.—Fox Radio, Thrusington, Leicester. [8320]

A.C.S. RADIO, specialists in short-wave apparatus, communication receivers, including Hallicrafters, National and R.M.E. transmitting equipment, valves and components.—Send for free catalogue to A.C.S. Radio, 16, Gray's Inn Rd., W.C.1. Holborn 9894-5. G2NK, Technical Manager. [0650]

G5NI.—The oldest and largest distributors of amateur equipment, transmitting and receiving; short-wave catalogue, 1 1/4d.; G5NI 70-page Manual, 7 1/4d., post free; authorised direct distributors for Collins, National, R.M.E., Thordarson, Hammerlund, Biley, Taylor, Elmac, etc., etc.—44, Holloway Head, Birmingham. [0531]

VALVES

ANDERSON.
ALL Types of American Valves, first grade; 5/- each.
ANDERSON, 34, Wadham Ave., Walthamstow, London, E.17. Tel.: Larkwood 1574. [8152]

ALL Types of American Tubes in Stock of Impex and Arcurus makes, at competitive prices.
WE Can Also Supply a Full Range of Guaranteed Replacement Valves for Any British, non-ring, American or Continental type at an appreciably lower price.
SEND for Lists of These, and also electrolytic condensers, line cords, resistances, etc.
CHAS. F. WARD, 46, Farringdon St., London, E.C.4. Tel.: Holborn 9703. [0452]

2/9.—R.C.A. American valves, 50 popular types; also National Union, Hytron; also British non-ring valves; cheapest in Britain; 1/4d. stamp for revised lists.—Shippers, 18, Corporation St., Manchester [0607]

METROPOLITAN RADIO SERVICE.—Special offer: All American valves, in makers' cartons, 3/- each; Octals, 3/6 each; American valves, first grade in all types; trade supplied.—1021, Finchley Rd., N.W.11. Speedwell 3000. [0436]

METERS, ETC.

ELLIOT 50 m.a. Thermal R.F., 30/-; Ferranti 500 m.a. m.c., 15/-.—Harris, 43, Jordan Well, Coventry. [8321]

TEST EQUIPMENT

PHILCO Valve Tester (Made by Well Known Manufacturer) A.C. 200-250, complete with two panels and elaborate display stand, embodying three coloured lights for good, bad or weak valves, which work in conjunction with meter, listed £17/10; £8/5, carriage paid.

HENRY'S, 72, Wellington Av., Stamford Hill, N.15. Phone: Stamford Hill 2907. (8090)

COMPONENTS

SECOND-HAND, CLEARANCE, SURPLUS, ETC.

RADIO CLEARANCE, Ltd.

ALL Lines Previously Advertised Still Available.

RADIO CLEARANCE, Ltd., 63, High Holborn, W.C.1. Holborn 4651. (8297)

PREMIER SUPPLY STORES.

PLEASE See Our Displayed Advertisement on page 3. (0488)

MAINS RADIO DEVELOPMENT COMPANY.

MAINS RADIO DEVELOPMENT COMPANY'S Exclusive Offers, carriage paid, delivery by return; call mornings; telephone Tudor 4046; stamp for list 25/-.

POLAR Midget Latest Type Three-gang Condensers, fully screened, with trimmers, standard 1/4 in. spindle, 0.0005 mfd., with 110 kc tracker; also perfect as straight two-gang, 2/6 only; smashing offer.

ERIE 1 watt, colour coded unused resistors, any size. 50 ohms to 5 megohms, your selection, 3d. each. 2/6 dozen; 1/4 watt, 2 1/2 d. each, 2/- dozen; 2 watt, 6d. each.

CENTRALAB Latest Potentiometers, unused, long spindle, all sizes, 5,000 ohms to 2 megohms, 2/-; with mains switch, 2/5.

TUBES.—First grade American valves, finest make, fully guaranteed, boxed, all popular types, 4/-; glass Octal types, 4/6.

CLIX Unused Chassis Valve Holders, 5, 7, 9-pin, 3d. each; all American sizes, 6d.; best sleeving, 1 1/2 d. yard.

TUBULAR Condensers, 400 volt working, wire ends, best make, 0.0001-0.05 mfd., 4d.; 0.1 mfd., 4d.; 0.25, 0.5 mfd., 6d.

T.C.C. Metal 8 mfd., 600 volt peak electrolytics, 2/3; T.C.C. card, 8 mfd., 600 volt peak, 1/6.

FIFTY N.E.F. 1/2, 1, and 2 watt resistors, wire ends, marked and colour coded, 20 good sizes per parcel; 2/6 per 50 only.

FERRANTI Twin H.F. Choke Mains Interference Filters, extraordinarily effective; to clear, 1/-.

MAINS RADIO DEVELOPMENT COMPANY, 4-6, Muswell Hill Rd., London, N.6. Tudor 4046. (8271)

RYALLS RADIO 280, High Holborn, London, W.C.1.

AMPLIFIERS, 13w. output, 3-stage, Triodes resistance and transformer coupled to push-pull Beam valves, matched to pair elliptical speakers, with U.S. valves and speakers; 52/6; input 200-250 A.C.

AMERICAN Type Mains Transformers, 350-350, 70 ma., 5v. and 3.5v. drop through pattern, input 200-250V, 6/6; few 110v. input; British made.

WEARITE 110 kc. I.F.'s with Top Trimmers, 1/6 each; sets band pass air core superhet coils ex Halycon, screened chassis type, 4/9 set five; 110 kc. with coil details.

SATOR Volume Controls, 1/2 meg. with switch, 10,000 with switch, 5,000 with switch; 1/3 each or 6/6 dozen; Centralab 11,000, less switch, 1/3, 6/6 dozen.

B.I. Electrolytic, 12x8x5.50, 350-12v., 1/3 each or 7/6 dozen; B.I., 20x20x25, at 400v.-25v., 1/3, or 8/- dozen; Piesey 30x8x2, 350v., 1/6, or 10/- dozen.

B.I. Tubular, 4mt, 200v., 6d. each or 4/- dozen; B.I. 0.25, 1/3 dozen, 7/9 gross; B.I. 0.25mf. tubulars, 2/- dozen, 4/5 per three dozen.

SPEAKERS, pairs, brand new, elliptical cone speakers, made by first class firm, quality of reproduction outstanding, push-pull pentode transformer, fields 325 ohm for smoothing choke, 8.600 as bleeder, circuit available, handle 10-15w; 14/- pair—Ryalls Radio, see above. (8246)

VAUXHALL HiVac valves, all types, new prices; full range of pick-ups from 11/-.

VAUXHALL—Collaro A.C. gramophone motors, boxed, 28/-; flat sheet aluminium, 12x12in., 3/-; 18x18in., 5/6.

VAUXHALL—Iron-cored coils, on base with switch, terminals, circuit; 2-gang, 11/3; 3-gang, 17/-.

VAUXHALL UTILITIES, 163a, Strand, W.C.2. Ask for free list; post paid 2/6 and over; c.o.d. 5/- minimum. (8324)

COLLARO A.C./D.C. Record-changers, 200-250, plays eight 10in. or 12in. records, mixed, also incorporates repeater and rejector; limited quantity, £5/5, in sealed cartons.

GARRARD A.C. Motors, Model A.C.4, enclosed type with automatic stop, 110-250 volts, 30/-, carr. pd., sealed cartons.

MARCONI K25 Pick-up, unused and boxed; 14/-.

HENRY'S, 72, Wellington Ave., Stamford Hill, N.15. Stamford Hill 2907. (8216)

RESISTANCES, parcel of 50, 1/4-watt to 2-watt, consisting of 20 useful values; 1/9 per 50 only.—Harrison and Co., 89, Great Portland St., London, W.1. Lan. 2471. (8517)

OLIVERS Offer Aluminium Chassis, 18 s.w.g., 16in. x 10in. x 3in., undrilled, 6/6; any size made to order, quotations free.—Olivers, 676, Christchurch Rd., Boscombe, Hants. (8319)

SOUTHERN RADIOS Bargains.—Sale now proceeding of hundreds of bargain lines, goods previously advertised still available.—Southern Radio, 46, Lisle St., London, W.C.1. Gerrard 6653. (8236)

EXTENDED PAYMENTS

LONDON RADIO SUPPLY Co. (Established 1925) Supply on convenient terms, components, accessories and sets, any make; 10% down, balance over 12 months; send for list of requirements.—11, Out Lane, London, E.C.2. (0337)

ELECTRADIX RELAYS

We are able to offer the widest possible range of relays from the robust electro-magnet to the sensitive moving-coil relay.

The Relays Nos. 1 to 18 have their magnet windings distinct from the silver-tipped contact blades which carry about 250 m.a.

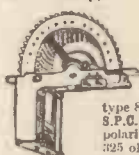

TYPE "S" SELECTOR RELAY SWITCHES.—As illus. 8 arms of 25 ways each. Relay solenoid operated or distant control. As used in "Tote and Auto" phone exchange, 10/- G.P.O. Vertical Relays, 5/- to 15/-.

SINGLE BLADE RELAYS.—No. 1 type 80D 1,000 ohms "on-off" s.p. 6 volts, 8 m.a. No. 2 type 802 s.p. 2,000 ohms "off" only, 10 volts 5 m.a., 8/-.

S.P.C.O. RELAYS. No. 5 type 309a, 80 or 450 ohms, polarised, 3 blade 2 volts, 20 m.a., 7/6. No. 6 type 194a, 325 ohms 2 bobbin, polarised, 3 blade, 6 volts 25 m.a., 8/6.

Ditto, No. 7 10,000 ohms, 20 volts, 21 m.a., 12/6. No. 8, type 1160B, 3 blade, 2,600 ohms, 10 volts, 4 m.a., 9/-.

No. 8a, type W.E. on 4in. chrome panel 40 ohms 6 v. 30 m.a., 10/-.

MULTI-BLADE RELAYS.—No. 9 type, A.G. 1,300 ohms, 2 coil, D.P. "on-off", 2/6. 22 volts, 150 m.a. No. 10 type A.H., 1,300/2,000 ohms 2 coil, 3 circuits, 6 blades "on-off", 15 volts, 100 m.a., 9/-.

No. 11 type 831, 1,200 ohms, 8 blade, 3 circuits "on-off", 3 circuits A.P.C.O., 12 volts, 12 m.a. Blades removable, 12/6. No. 12 type 27B Spare 1,000 ohm coil with armature, no contacts, for making relays, 2/6.

L.R. SERIES RELAYS.—No. 13 type LA, 1 ohm, 2 on 1 off, 12/6. No. 14 type L.R. ditto, 10 ohms, 12/6.

HARD RELAY.—No. 15 type 1,650 coil, 1,300 ohms, trip contacts "on" until hand reset, 12/-.

No. 16 ditto, but reverse, contact set "on" by hand, trip-off by relay coil, 1,500 ohms, 14 volts, 10 m.a., 12/-.

SPECIAL LIGHT S.P. RELAYS for model control. No. 3 type D 41 one blade "on-off", 10,000 ohms, 20 volts, 23 m.a., 12/6.

No. 4, 2,000 ohms, 10 volts, 5 m.a., 10/-.

No. 4a, 5 ohms, 2 volts, 1 amp., 7/6. Heavier Current Relay for Transmitters, etc. Boulder type, 5 ohms, 15/-.

American Ham Relays, 7/8. Ship Magnetic Key Relay, 15/-.

Creed high-class polarised 2-way Relays, 25/-.

SUPERSENSITIVE MOVING COIL RELAYS.—These work on really tiny currents from photo-cells, etc., and a small rectifier can be used for AC impulses. Two types, (1) The famous large double-acting Weston Relay, open type, model 30, 50/-.

List price 50 dollars; or mounted in mahogany case with glass top, 60/-.

For panel use, the small 2in. meter type W1 works on 50 micros., with 150 mho. on main contact, 55/-.

LIGHT DUTY SWITCHES for Wave-change and Semi-rotary D.P.C.O., 6d. R.A.P. Switch Boxes for 3 circuits, rocker type, 1/3. 6-way Rocker toggle, 2/-.

8-way ditto, 3/6. Vaxley and Rex Wave-change D.P. 8-way roller contact, new, 1/3.

Bulgin 3-point Wave-change, 6d. Tunwell A.P. on-off semi-rotary, 8d.

MAGNETIC SWITCHES.—Overload Trip, 2 to 4 amps., 7/6; 6 amps., 10/-; 10 amps., 12/-; 15 amps., 14/-; 20 amps., 16/-.

Venner 15-day Time Switches "on-off", 1 amp., 6 amps., 25 amps., 200 amps. Cheap.

TRANSMITTERS, MORSE AND SIGNAL KEYS.—Ex W.D., balanced, solid brass bar, tungsten contacts, indicator lamp.

Type KBSL, a galena key for 7/6. Other keys from 3/- to 30/-.

Learner's outfit complete, 4/9. Ask for special illustrated Key List "K.W."

A.E.P. HELPS—Portable Field Telephone Stations and Exchanges, few left.

SIGNAL LAMPS, Lucas day and night portable, £3/10. Aids, C.A.V. ditto, £3/5.

Army type DIII double headphones, pocket type, 2/6 pair. Biz Mains Alarm Bells, D.C. BATTERY CHARGING ON A.C. MAINS.

The A.C. NITMAY will keep your battery fit without attention. Model N/A6, 100/250 volts A.C. and D.C. 6/8 volts 1 amp., 15/-.

Model N/B6, 100/250 volts to D.C. 6/8 volts 1 amp., 25/-.

Model N/C6, 100/250 volts to D.C., 6/8 volts 2 amps., 35/-.

Model N/D 12, 100/250 volts to 12 volts 1 amp., 32/-.

Ditto, 12 volts 2 amps., with 6-volt tap, 55/-.

5 amp., £4/10/-.

D.C. GENERATORS, 120 watt 12 volt 10 amp., with vee pulley, 35/-.

1 Kw. 12/16 volts 30 amps., with vee pulley, 45/-.

Shunt wound, -110 volts 1 amp., 15/-; 200 volts 1 amp., 17/6; 200 volts 1 1/2 amp., 25/-.

WINDMILL GENERATORS, totally enclosed, ball-bearing, start charging at 300 revs., 0 to 12 volts, 8 amps., 35/-.

25 amps., 45/-.

DISC RECORDING TO LEARN MORSE.—Electric PEIGH set has ball bearing contact gear box and geared traverse rod. Set with Tracking Gear, pick-up and Tone-arm fitted diamond. Fitted on a Radiogram enables "hams" to hear their own dots, 37/6.

If unable to call, send for Bargain List of 16 illustrated pages or write, stating your wants.

ELECTRADIX RADIOS

218, UPPER THAMES STREET, LONDON, E.C.4.

Telephone: Central 4611.



BASEBOARD MOUNT for the type 85 unit, 1/3.

THE QUARTZ CRYSTAL CO. LTD., Kingston Road, NEW MALDEN, Surrey.

O.C.C. Type S5 FREQUENCY CONTROL UNITS

(As specified by "The Wireless World.")

Ground to within 5kc. of your specified frequency in the 7Mc. amateur band and supplied complete with official calibration certificate to an accuracy of 0.025%.

Send 1/6 stamp for our full price list of all types of quartz crystals and radio transmission components.

THE QUARTZ CRYSTAL CO. LTD., Kingston Road, NEW MALDEN, Surrey. Phone: Malden 0334.

Advertisement for W. BRYAN and SAVAGE LTD. featuring a cartoon character and text: 'We do quite a lot of business making up transformers for customers' and 'our specifications; but we have a standard list. May we send you a copy?' W. BRYAN WESTMINSTER RD., LONDON, N.W.6. SAVAGE LTD. PHONE, COLINDALE 7131.

REPAIRS AND SERVICE

"SERVICE with a Smile."

AMERICAN Valves, spares, lineords, rewinds; repairers of all types of American and British receivers.—F.R.L. Ltd., 22, Howland St., W.1. Museum 5675. (0434)

LOUD-SPEAKER Repairs, British, American, any make, 24-hours service; moderate prices.—Sinclair Speakers, Alma Grove, Copenhagen St., N.1. (0590)

GUARANTEED Repairs Any Transformers, choke, motors, armature, converter, dynamo, etc.; keenest prices, immediate quotation, prompt dependable service. See below.

L.T.P. (LONDON TRANSFORMER PRODUCTS, Ltd.), Willesden, N.W.10. Willesden 6486 (3 lines). (6892)

MAINS Transformer Service. Repairs, rewinds, or construction to specification of any type, competitive prices and prompt service.—Sturdy Electric Co., Dip-ton, Newcastle-on-Tyne. (0516)

EPOCH Speaker Replacements, cone assemblies supplied from 4/-; field coil and transformer rewinds; trade radio service.—National Radio Epoch Reproducers, 126, Elthorne Rd., N.19. Arc. 1319. (8306)

METROPOLITAN RADIO SERVICE.—Guaranteed repairs to American and British receivers; American valves, service parts and rewinds; trade supplied.—1021, Finchley Rd., N.W.11. Speedwell 3000. (0435)

SCOTT-SESSIONS REPAIR SERVICE.—All types of receivers overhauled, rebuilt, repaired, including American communication sets. W.W. Monodials, All-wave Super-Seven. Variable Selectivity IV, etc.

SCOTT-SESSIONS REPAIR SERVICE, popular for 15 years from Land's End to John-o-Groats; van collection London area; immediate, courteous and skilled attention to every instruction.

SCOTT-SESSIONS REPAIR SERVICE. Exchange Works, Muswell Hill, N.10. Tudor 4101-2. (7497)

REPAIRS to Moving Coil Speakers a Speciality: cones and coils fitted, fields altered; prices, including eliminators, quoted; loud speakers, 4/-; L.F. and output transformers, 4/-, post free; guaranteed satisfaction; trade invited; estimates free; prompt service.—Loud-Speaker Repair Works, 5, Balham Grove, London. Battersen 1321. (0394)

MISCELLANEOUS

WIRELESS WORLDS, July, 1933, to March, 1939, offers wanted; also quantity D.C.C. DSC and enamelled wire, cheap.—Harris, 43, Jordan Well, Coventry. (8322)

G.P.O. Engineering Dept. (no experience required); commencing £3 13s. per week; age 18-23; excellent prospects; free details of entrance exam. from: B.I.E.T. (Dept. 574), 17-19, Stratford Place, London, W.1. (8309)

EVERY Radio Dealer Who is Not a Regular Reader of "The Wireless and Electrical Trader" should send his trade card at once for a specimen copy and full details of the "Trader" Services. "The Wireless and Electrical Trader" has the widest influence, the largest weekly circulation, and is read by all the leading manufacturers and traders. Trade only, 15/- per annum, post free.—Published at Dorset House, Stamford St., London, S.E.1. (0615)

PATENTS

"PRACTICAL Hints on Patents," free on application.—The Imperial Patent Service, First Avenue House, High Holborn, W.C.1. Preliminary consultation free. (0481)

THE Proprietor of British Patent No. 368109, dated April 9, 1931, relating to Improvements in Antenna Systems, desires to arrange by licence or otherwise on reasonable terms to exploit the above and ensure its practical working in Great Britain.—Enquiries to Mr. B. Singer, Chrysler Building, New York City, N.Y., U.S.A. (8305)

TUITION

RADIO Training.—P.M.G. exams, and I.E.E. Diploma; prospectus free.—Technical College, Hull. (0611)

GUARANTEED Posts.—Complete wireless training; ship and shore services. Television. Day, evening and postal Boards taken. Propag. free.—W. London Radio College, Grove Park Rd., W.4. (Chiswick 3244). (0580)

WIRELESS Careers; increased salaries and pensions make radio a profitable and interesting profession; we train students for all branches and guarantee appointments; Britain's leading Colleges; boarders accepted; write for free prospectus.—Wireless College, Colwyn Bay, or Wireless College, Calmore, Southampton. (8220)

BUSINESSES AND PROPERTY FOR SALE, TO BE LET, OR WANTED

RADIO Service and Transformer Winding Business for Sale; convenient West End premises at very low rental; good trade connection; established six years; price £50, stock and fittings at valuation.—Box 9338, c/o The Wireless World. (8332)

THE Wireless and Electrical Trader "is an essential part of the equipment of every Wireless Trader; its pages reflect the very latest turn of trade events, and it is read by all the leading dealers and manufacturers, for particulars of businesses offered or wanted. By subscription to the trade only, 15/- per annum, post free.—Send your trade card for specimen copy to Dorset House, Stamford St., London, S.E.1. (0614)

RADIO Engineer Required, with experience of television problems; University degree or equivalent preferred; reply, stating experience, age and salary required, to Box 9202, c/o The Wireless World. (8256)

RADIO Engineer Required, with experience of high frequency measurements; University degree or equivalent preferred; reply, stating experience, age and salary required, to Box 9201, c/o The Wireless World. (8255)

INTELLIGENT Young Man (25-30) Required for Demonstration of Medical Apparatus; good address and electrical knowledge essential; University an asset.—Apply, stating salary required, to Box 9330, c/o The Wireless World. (8315)

SITUATIONS VACANT

TELEVISION Engineer Required, with experience of television problems; University degree or equivalent preferred; reply, stating experience, age and salary required, to Box 9202, c/o The Wireless World. (8256)

RADIO Engineer Required, with experience of high frequency measurements; University degree or equivalent preferred; reply, stating experience, age and salary required, to Box 9201, c/o The Wireless World. (8255)

INTELLIGENT Young Man (25-30) Required for Demonstration of Medical Apparatus; good address and electrical knowledge essential; University an asset.—Apply, stating salary required, to Box 9330, c/o The Wireless World. (8315)

McCarthy RADIO CHASSIS



This is THE big event of the radio year!

RS639—illustrated. 8 stages, 6 valves, 4 wavebands, for AC Mains. Price £9

RS639U. As above, for AC/DC Mains.

RS739. 9 stages, 7 valves, 4 wavebands, for AC Mains £10 17 6

RS739U. As above, for AC/DC Mains.

PP739. 9 stages, 7 valves, 4 wavebands, push-pull output, providing 10 watts undistorted, AC £11 11 0

PP939. 11 stages, 9 valves, 4 wavebands, push-pull output, providing 12 watts undistorted. Noise suppression, variable selectivity, non-drift, IF transformers, permeability tuned, wave range 10-2,200 metres, AC..... £14 14 0

PP939U. As above, for AC/DC Mains.

H. McCarthy Ltd.,
92, Queensway, Bayswater, London, W.2
Please send Abridged List of Chassis, free.

Name

Address

W.W. 64-39

RADIOMART

G.S.N.I. (BIRMINGHAM) LTD.

THE SHORT-WAVE SPECIALISTS

SPECIAL OFFER!!!

Fully shrouded Transformers by America's largest manufacturer. While they last.

All 230 v. primary and fully impregnated.	
T28708—375/375 v. 150 m/A., 6.3V5A. 2.5V5A. 5V3A	15/-
T19610—350/350 v. 150 m/A., 2.5V6A. 2.5V2A. 5V3A	12/6
T2326—375/375 v. 120 m/A., 6.3VCT. 4A. 5V3A	10/6
T2326—350/350 v. 120 m/A., 6.3VCT. 3A. 5V3A	8/6
T2367—350/350 v. 80 m/A., 6.3VCT. 3A. 5V3A	7/6
T7000—320/320 v. 80 m/A., 6.3V4A. 5V3A	7/6
T6625—320/320 v., 80 m/A. 2.5V6A. 5V3A	7/6
T464919—10V4A Primary Tapped 110—250 v.	5/6

The following chokes are interlined and impregnated.
T7007—250 m/A., 135 ohms, 20-8 Hy., cadmium shrouded 12/6
T7007A—150 m/A., 250 ohms 30-12 Hy., cadmium shrouded 12/6
100 m/A., 20 Hy., 500 ohms, unshrouded 4/11
60 m/A., 15 Hy., 250 ohms 1/11
HEAVY DUTY TRANSFORMER for models, bells, etc., 6 v. 3 a., 2/3.
4 m/A., 1,500 v. test 300 v. wkg. oil filled condensers, 2-
HEAVY DUTY Mains Transformer, worth 45/-, 350-350, 150 m/A.,
4 v., 2.5 a., CT, 4 v., 6 a., CT, 12/6; 300-300 v., 60 m/A., 4 v., 3 a.,
CT, 4 v., 2 a., CT, 6/6. Moving Coil Speech Transformers, 1/11.
GANG CONDENSERS with Airplane Dial, 8 and 80-1. Cost 35/-; few
only, 4/11. Utility, 7/6. Microdials, 3/6.
W.B. Sin. PERMANENT MAGNET SPEAKERS AT ONE-THIRD COST.
Extension Type (no Transformer), 8/11. Standard Type (with Transformer),
10/6. Energised 8", 1,240 ohms with Transformer, 6/11.
PUSHBACK Wire, 6 yds., 6d., heavy, 9d. Resin-cored Rolder, 6ft.
6d.; Screened Flex, single, 6d. yd.; twin, 9d. yd. Assorted Solder
Tags, 6d. packet. Humdimmers, 6d. each.
Centralab pots, all sizes, 1/8; switched, 2/-; tubular glass fuses, 2d.
Milliammeters, 0-25 m.a., upwards, 5/9; Super, 6/9.
OUR NEW 66 PAGE MANUAL, packed full of valuable information.
Post Free, 7d.
THE NEW RAYMART CATALOGUE shows dozens of New Short-wave
Components and is yours for 1d. post free.
VALVES.—A complete range of replacements, showing a saving of over
50 per cent. Quotations on receipt of types required. Quantity
Discounts to Service Engineers. TRADE enquiries for communication
equipment solicited.

RADIOMART Telephone: MIDland 3254.
G.S.N.I. (Birmingham) Ltd.
44, HOLLOWAY HEAD, BIRMINGHAM

SITUATIONS VACANT

AIR MINISTRY.

AERONAUTICAL Inspection Directorate.

VACANCIES Exist for Unestablished Appointments as Examiners in the W./T. and Instrument Branches. QUALIFICATIONS.

APPLICANTS for Vacancies in Instrument Branch must have good general education, theoretical knowledge of physics, optics, mathematics, training in light engineering or instrument making. Candidates must be able to read working drawings and specifications and use micrometers and other types of measuring instruments. Preference will be given to candidates having a good knowledge of thermometry, precision pressure measuring instruments as used on an aircraft, and of materials from which they are manufactured.

APPLICANTS for Vacancies in W./T. Branch having the following qualifications will receive preference: good general education, sound technical knowledge of high frequency engineering equal to City and Guilds final examination in Radio Communications, practical knowledge of modern methods of production and testing of W./T. transmitters, receivers, wavemeters and associated equipment; also electrical equipment such as generators, transformers, and of materials from which they are manufactured. Candidates must be able to read working drawings and specifications and to use micrometers and other measuring instruments.

THEY Must be Prepared to Serve in any part of the United Kingdom, to go into the air if required in connection with their duties, and to drive a car. SUCCESSFUL Candidates will be Required to Undergo a Period of Training in Aeronautical Engineering Inspection not exceeding 3 months.

DURING Training Candidates will be regarded as on probation and paid at the rate of £184 a year. On satisfactory completion of the training course, they will be appointed as Examiner and paid at £246 a year, rising by increments of £12 if service is satisfactory to £337, except that the starting salary for entrants below the age of 24 years will be reduced by £12 for each year below that age.

SUBSISTENCE Allowance at the rate of £1 5s. weekly is payable whilst under training to married men (and others with certain dependents) who normally reside outside the training centre.

SALARIES are Paid Monthly in Arrear.

NORMAL Age Limits 21—50 Years. Candidates between 50-55 years will be considered if they have had experience of engineering inspection.

CANDIDATES Who, on interview, fail to qualify for the Examiner Grade, may be considered for:—

ASSISTANT Examiner.—Salary scale £184-£10-£246.

ASSISTANT Examiners do not undergo training, but are appointed direct to an A.I.D. station. They may later become eligible for promotion to Examiner on attaining the requisite standard of efficiency, providing they are willing to undertake the obligations required of Examiners as above.

APPLICATION Must be Made on Form 786, copies of which can be obtained on application (by postcard only) to:—The Under Secretary of State, Air Ministry, I.G., 34, Berkeley Square House, Berkeley Square, W.1. [8308]

TELEVISION Engineer Required, junior television engineer having previous experience with well established firm; write.—Philco Radio and Television Corporation of G.B., Ltd., Wadsworth Rd., Perivale, Greenford, Middlesex. [8323]

RADIO Engineer or Television Engineer Required, with experience of ultra-high frequency measurements; University degree or equivalent preferred.—Reply, stating experience, age and salary required, to Box 9265, c/o The Wireless World. [8257]

ROYAL AIR FORCE.—Men of good education required for enlistment and training as wireless operators and armourers; age limits 17½-35; write or call.—R.A.F. Recruiting Depot, Victory House, Kingsway, London, W.C.2, or any R.A.F. Recruiting Depot. [8311]

VACANCY for two Apprentices; individual training given in construction latest types transmitters and receivers, in approved Air Ministry organisation; small premium first year, commencing salary second year; excellent opportunity for right type of young men.—Apply Box 9299, c/o The Wireless World. [8303]

ENGINEERS Required for Calibration and Development Work on Communication Instruments; applicants should have had experience on similar work and possess technical qualifications equivalent to higher National Certificate; write, giving details of previous experience, training and salary required.—E. K. Cole, Ltd., Ekco Works, Southend-on-Sea, Essex. [8304]

BOOKS, INSTRUCTION, ETC.

AMERICAN Valve Data.—The new 200-page Raytheon Valve Data Book gives full characteristics and applications of all types of American valves; invaluable to all servicemen; post free 2/3; abroad 3/-.—Leonard Heys, 36, Henry St., Blackpool. [0594]

THE INSTITUTE OF WIRELESS TECHNOLOGY (Incorporated),
4, Vernon Place, Southampton Row, London, W.C.1.

OVERSEAS EXAMINATIONS

Overseas Candidates for the November Examinations must submit their applications to the Secretary not later than July 31st, 1939. FULL INFORMATION, WITH PARTICULARS OF MEMBERSHIP, MAY BE OBTAINED FROM THE SECRETARY.

Pamphonic AMPLIFIERS

Pamphonic Reproducers Ltd. (Associated with PYE Ltd.)
45, St. Pancras Way, London, N.W.1.
Phone: EUSton 1727.

HEAR YOUR SET for the FIRST TIME!

With the Belling-Lee 'SKYROD' Aerial System, you hear the true performance of your receiver for the first time. Modern conditions have surrounded practically every house to-day with a field of electrical interference from power cables, telephone wires, vacuum cleaners, lighting circuits, etc., re-radiated by every piece of metalwork in the house, including the gutters. Pure signals lie above this field, where only the vertical 'SKYROD'—stretching 25ft. above the roof—can reach them. A special shielded down-lead then protects them as they travel down to the set.

MONEY-BACK GUARANTEE

The 'SKYROD' Aerial System improves reception, extends range and increases signal-to-noise ratio amazingly. You don't have to take our word for it, either. If you are disappointed with results, we will arrange for the full refund of your money. Ask your dealer, or write for interesting free booklet.

In four different mountings from

£3 - 19 - 6

to £6 - 7 - 0

or on H.P. Terms from 1/3 weekly.

Prices do not apply to Eire.



The BELLING-LEE SKYROD AERIAL SYSTEM

BELLING & LEE LTD.,
CAMBRIDGE ARTERIAL RD., ENFIELD, MIDDX.

7105

FOURTH EDITION

Revised and Enlarged with 50 Additional Pages

WIRELESS SERVICING MANUAL

By **W. T. COCKING**
(of "The Wireless World")

The most complete book of reference of its kind. A reliable practical guide for amateur and professional

The present Edition of the "Wireless Servicing Manual" brings the material of the book right up to date and includes an additional chapter on television receivers which is practically the only source of servicing information available on this subject.

Testing apparatus is fully dealt with and the methods of locating and curing faults in receiving equipment are explained.

Ganging, Automatic Volume Control, Instability, Distortion, Mains Hum, Whistles, Local Interference and Aerials, are all separately treated.

The reference material, including base-connections for British, Continental and American Valves, and the various colour codes for components, has been extended and revised.

BOUND IN CLOTH BOARDS

SIZE 7½ ins. × 5 ins.

288 Pages

5/- net. By post 5/5

Issued in conjunction with "THE WIRELESS WORLD" and Published by the Proprietors :-

ILIFFE & SONS LTD., DORSET HOUSE, STAMFORD STREET, LONDON, S.E.1

W.W.20.

INDEX TO ADVERTISEMENTS

	PAGE		PAGE		PAGE
Armstrong Manufacturing Co.	1	Halford Distributors, Ltd.		Partridge, N.	
Automatic Coil Winder Co., Ltd.	2	Hartley Turner Radio		Peto-Scott, Ltd.	
Belling & Lee, Ltd.	5	H.M.V.		Player's Cigarettes	3
Birmingham Radiomart G5N1	5	Institute of Wireless Technology	5	Premier Supply Stores	3
British Institute of Engineering Technology		International Correspondence Schools		Quartz Crystal Co., Ltd., The	4
British Insulated Cables, Ltd.	Inside Back Cover	Jackson Bros. (London), Ltd.		Salford Electrical Instruments, Ltd.	
British Mechanical Productions, Ltd.		Lockwood & Co.	1	Savage, W. Bryan, Ltd.	4
British Rola, Ltd.		London Radio Supply Co.	2	Sound Sales, Ltd.	Inside Front Cover
British Thomson-Houston Co., Ltd., The		McCarthy, H. Ltd.	5	Stratton & Co., Ltd.	6
Bulgin, A. F. C., Ltd.		McClure, John	6	Taylor Electrical Instruments Co.	
Candler System Co.		Marconi-Ekco Instruments, Ltd.	2	Technological Institute of Great Britain	
Electradix Radios	4	Midwest Radio, Ltd.		Universal Electric Co.	
Film Industries, Ltd.		M.R. Supplies		V.G. Manufacturing Co., Ltd.	1
Fluxite, Ltd.	2	Mullard Wireless Service Co., Ltd.	Inside Back Cover	Voigt Patents, Ltd.	
General Electric Co., Ltd.		New Times Sales Co.		Webb's Radio	Inside Front Cover
Goodmans Industries, Ltd.	Inside Front Cover	Pamphonic Reproducers, Ltd.	5	Westinghouse Brake & Signal Co., Ltd.	Back Cover
Grampian Reproducers, Ltd.				Wills's Gold Flake	Back Cover

To EMPIRE READERS & THE TRADE

We have a wide range of Receivers, Chassis, Tuning Units, etc., specially developed and built for Empire use, tropical and otherwise.

We also welcome enquiries for special designs and cater particularly for Manufacturers and Wholesalers throughout the Empire.

No business is too large, too small or too difficult for us to handle.

Agencies available in certain parts of the Empire.

JOHN McCLURE

ERSKINE ROAD, LONDON, N.W.3.

PR1mrose 5435

HERE IS A BOOK THAT WILL INTEREST YOU



Would you not like to receive a Book, that with the friendly freemasonry of a clever fellow-experimenter, goes thoroughly into the matter of Modern Short Wave practice—showing how to build various interesting Sets, gripping your keen attention with clear-cut demonstrations of little understood Short Wave appliances? Well, such a Book is the Eddystone Short Wave Manual.

It's packed with information and fully supported by illustrated constructional articles for building simple S.W. Receivers, low and medium power Transmitters Amateur Communication Receiver, Preslector, Cathode-Ray Oscilloscope, etc., etc. 30 photographs, nearly three dozen diagrams, details of "how to build," etc. Every page alive with up-to-the-minute interest for people like YOU. Get YOUR copy NOW.

Get the EDDYSTONE SHORT WAVE MANUAL

Price 1/- from W. H. Smith or Radio Dealers, or 1/2 Post Free from Stratton & Co., Ltd., Eddystone Works, Bromsgrove St., Birmingham, 5.

THIS COUPON WILL BRING YOU THE BOOK

To Stratton & Co. Ltd., Bromsgrove St., Birmingham, 5. I enclose 1/2. Please send me the Eddystone Manual.

Name:
Address:

INCREASE THE OUTPUT OF YOUR SERVICE DEPARTMENT INSTALL THE TIME-SAVING GM.3155

MORE jobs per day! That's the way to make service really profitable. Cut out the tedious, expensive business of fault-finding by uncertain methods, and automatically increase the capacity of your service department.

You can do it easily with the NEW MULLARD CATHODE RAY OSCILLOGRAPH TYPE GM.3155. Here's an instrument that quickly gets to the root of radio and television service problems. And remember, it's designed for the Service Department, not the laboratory. It's easy to master and easy to use.

WRITE FOR THE BROCHURE that describes the GM.3155 at work on fault-finding and circuit alignment, and compare it with old-fashioned methods.



LIST PRICE £25 *Special net price to Service Dealers*

These two well-known instruments can be used with the GM.3155. Service Signal Generator Type GM.2880F. With artificial aerial covering short, medium and long wavelengths. List Price £21 (subject). Frequency Modulated Oscillator Type GM. 2881. Permits direct reading of bandwidth with variable bandwidth control. List price £8.10 (subject). FULL DETAILS ON REQUEST.

COUPON

- Please send a copy of the brochure "The GM.3155 at Work."
- Please let us know when you can arrange a demonstration at this address.

NAME _____
ADDRESS _____
W.W.3

Mullard

VALVE SALES DEPARTMENT

225 TOTTENHAM COURT ROAD, LONDON, W.1

Third Edition of

WIRELESS DIRECTION FINDING

By R. KEEN, B. Eng.

A BOOK OF INSTRUCTION AND REFERENCE FOR ENGINEERS, TECHNICIANS, TELEGRAPHISTS AND OTHERS ENGAGED OR INTERESTED IN THE USE OF DIRECTIVE WIRELESS TELEGRAPHY FOR THE NAVIGATION OF SHIPS AND AIRCRAFT.

Deals with the principles of Wireless Direction Finding and gives an account of the circuits and apparatus used in its application to navigation. The Adcock Aerial has a separate chapter covering its principles, installation and performance. Shore, Ship and Aircraft installations, as well as a special section on the choice of a suitable site for the Aircraft Ground D.F. with Adcock Aerials are included.

Also useful references to a selected list of some 600 of the more important contributions to the literature of D.F.

800 pages
550 illustrations

25/- net

By post 25/9

From leading Booksellers or direct from the Publishers:

ELLIFFE & SONS LTD., DORSET HOUSE, STAMFORD STREET, LONDON, S.E.1

w.w.60

B.I. COPPER EARTHING RODS

for
WIRELESS
APPARATUS

(U.K. Patent Nos. 438598, 423395, 430040.)

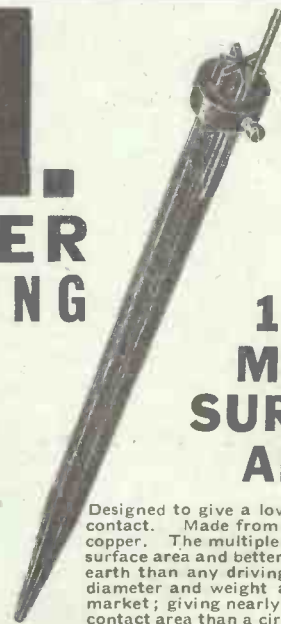

**100%
MORE
SURFACE
AREA**

Designed to give a low resistance earth contact. Made from solid drawn H.C. copper. The multiple fins ensure larger surface area and better contact with the earth than any driving earth of similar diameter and weight at present on the market; giving nearly 50 per cent. more contact area than a circular rod of equal diameter, or 100 per cent. more than a solid rod of equal weight. About 1 1/2" of the rod is left exposed and the earth lead is simply clamped against the rod by means of the copper clamping ring and screw. No sweating or soldering is required. Supplied in two standard sizes, 18" and 24". Longer rods of similar type can be supplied, if desired, to meet special requirements.

BRITISH INSULATED CABLES LTD.,
CABLE MAKERS AND ELECTRICAL ENGINEERS,
PRESCOT, LANCS. Tel. No. PRESCOT 6571

Mention of "The Wireless World," when writing to advertisers, will ensure prompt attention.

The price of silence



How easily the morning paper can come between a man and his wife. For men must read and women must chat! The solution of the problem is to hand over the cigarettes. Wills's Gold Flake, of course, for that's the cigarette women are smoking nowadays. They've discovered why Gold Flake have always been "the man's cigarette." They've learned to appreciate the flavour of the really fine Virginia tobaccos of which they are made. As the fragrant smoke ascends a quiet contentment reigns. Speech may be silver, but silence is Gold Flake!

WILLS'S
GOLD FLAKE
*is the man's cigarette
that women like*

Ten for 6d. Twenty for 1/-
and, for the week-end, Flat Fifty box 2/5d.
PLAIN OR CORK-TIPPED

CAN YOU DEPEND ON YOUR H.T. SUPPLY?

When your set fails to function, can you be sure that the fault is not due to a rectifier failure? Most rectifiers start to deteriorate immediately they are put into use. But . . . the Westinghouse Metal Rectifier delivers its rated output for years and years without any renewal. Use it and make your power supply absolutely reliable.

Send 3d. to Dept. W.W. for a copy of "The All Metal Way, 1939," which contains full details and circuits.

Westinghouse
METAL RECTIFIERS
won't let you down
WESTINGHOUSE BRAKE & SIGNAL CO. LTD.
82, York Way, King's Cross, London, N.1

The ELECTRICAL REVIEW

The Complete Technical Journal

Practical articles on all aspects of electricity supply and utilisation — industrial, commercial and domestic. Latest news of the electrical industry and developments. Advertisement pages form a comprehensive buyers' guide.

Contents of April 7th Issue:—

REFRIGERATION SURVEY
Latest Equipment and notes on selling.

THE RADIO MANUFACTURERS' ASSOCIATION
History and objects.

CENTRAL ELECTRICITY BOARD
Operations during 1938.

LIGHTING PROBLEMS IN COTTON MILLS
Methods adopted at Blackburn.

ALL THE WEEK'S NEWS

EVERY FRIDAY 6d.

Subscriptions: United Kingdom £1 14 8
Canada £1 12 6 Other Countries
£2 1 6 per annum, post free.

ELECTRICAL REVIEW LTD.
Dorset House, Stamford Street, London, S.E.1

The **Wireless** **World** **6^p**
THE PRACTICAL RADIO & TELEVISION JOURNAL

Thursday, April 13th, 1939

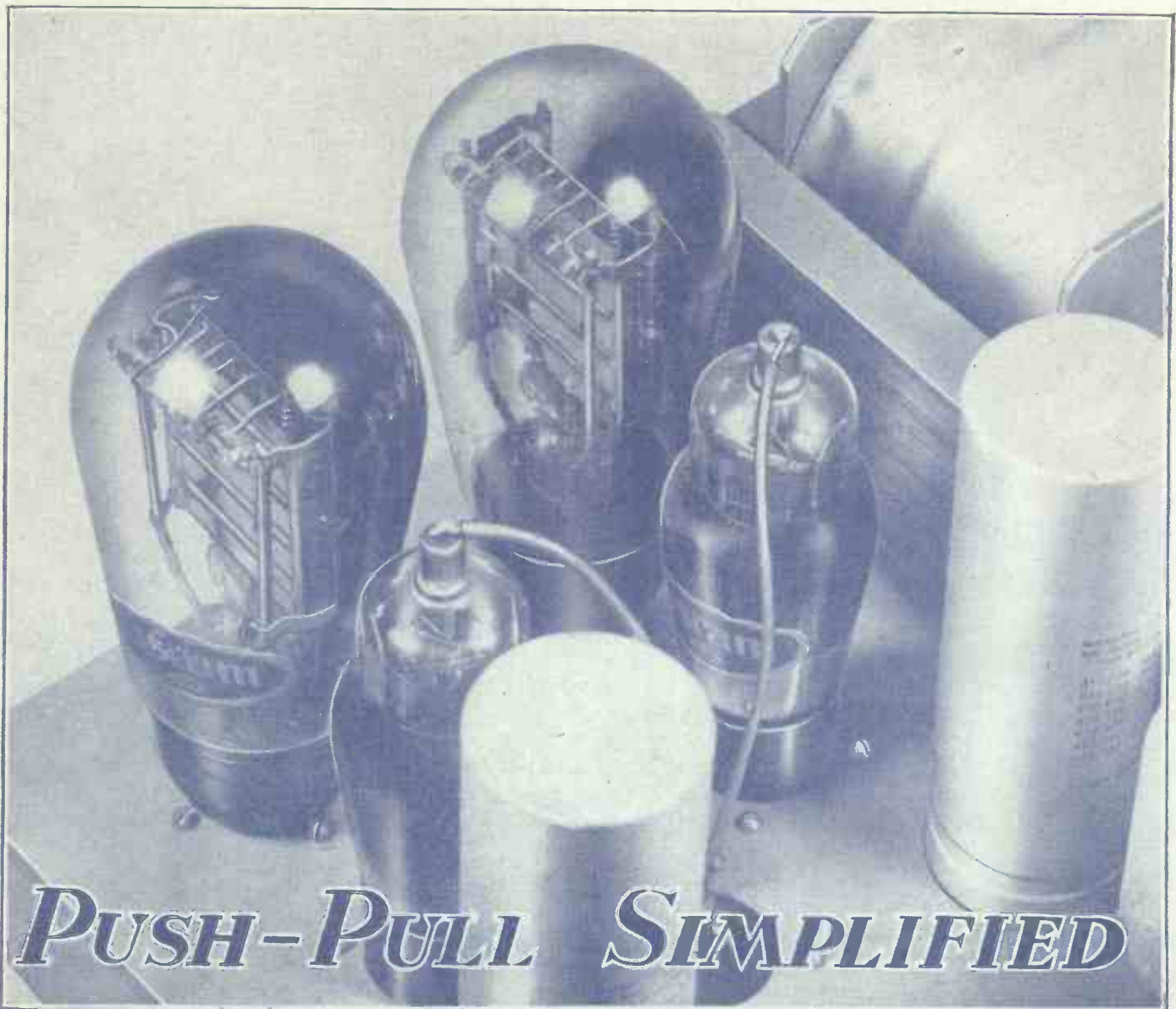

PUSH-PULL SIMPLIFIED

VALVE VOLTMETERS OF ALL TYPES

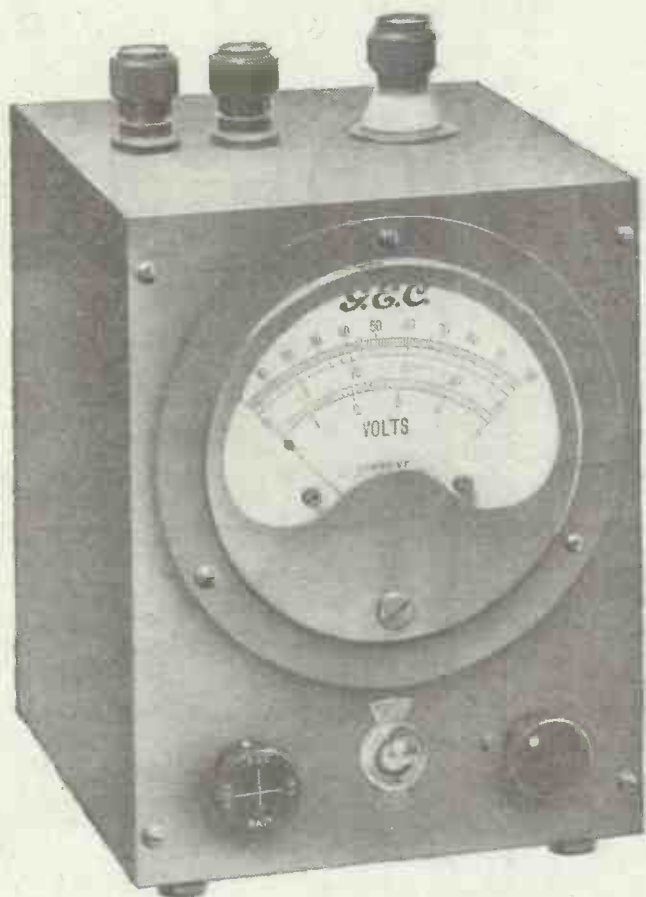

Miniature Valve Voltmeter
Type 105 X

SPECIFICATION :

VOLTAGE RANGES	- Three Ranges : 0/5v, 0/25v, and 0/100v. Direct reading.
FREQUENCY RANGE	- 20 cycles/p.s. to 10 megacycles/p.s.
ACCURACY	- 5v. Ranges $\pm 3\%$. 25v. and 100v. Range $\pm 2\%$.
INPUT IMPEDANCE	- 100v. Range, $\frac{1}{2}$ megohm. 25v. Range, $\frac{1}{4}$ megohm. 5v. Range, 50,000 ohms.
INPUT CAPACITANCE	15 $\mu\mu$ f.
SIZE	- 7 $\frac{1}{2}$ " x 5 $\frac{1}{2}$ " x 4 $\frac{3}{4}$ ".
NETT WEIGHT	- 4 lbs. 12 ozs.
FINISH	- Grey Enamel

PRICE—£12-2-0

A simple, inexpensive, accurate Valve Voltmeter, completely self-contained, operating from a 3-volt torch battery fitted within its case.

A highly sensitive micrometer is used in conjunction with a diode rectifier, the diode making the circuit substantially independent of valve characteristics, and permitting valve replacement without disturbing the calibration.

The battery voltage is kept constant by means of a rheostat and a voltage range selector switch is provided.

Of robust construction, this instrument is ideal for general test purposes on Radio, Audio or Power frequencies in the Laboratory, Test. Room or Workshop, wherever voltage measurement with negligible current consumption is essential.

We shall be pleased to send full details of this instrument and other Voltmeters for use up to the highest radio frequencies and also details of other H.F. measuring apparatus, on receipt of details of your requirements.

SALFORD ELECTRICAL INSTRUMENTS LTD.

PEEL WORKS, SALFORD, 3.

Telephones: BLACKfriars. 8889 (3 lines)

Telegrams and Cable: "SPARKLESS MANCHESTER"

PROPRIETORS: THE GENERAL ELECTRIC Co. Ltd., OF ENGLAND

The Wireless World

THE PRACTICAL RADIO JOURNAL
29th Year of Publication

No. 1024.

THURSDAY, APRIL 13TH, 1939.

VOL. XLIV. No 15.

Proprietors : ILIFFE & SONS LTD.

Editor :
HUGH S. POCOCK.

Editorial,
Advertising and Publishing Offices :
DORSET HOUSE, STAMFORD STREET,
LONDON, S.E.1.

Telephone : Waterloo 3333 (50 lines).
Telegrams : "Ethaworld, Sedist, London."

COVENTRY : 8-10, Corporation Street.
Telegrams : "Autocar, Coventry." Telephone : 5210 Coventry.

BIRMINGHAM :
Guildhall Buildings, Navigation Street, 2.
Telegrams : "Autopress, Birmingham." Telephone : 2971 Midland (5 lines).

MANCHESTER : 260, Deansgate, 3.
Telegrams : "Iliffe, Manchester." Telephone : Blackfriars 4412 (4 lines).

GLASGOW : 26B, Renfield Street, C.2.
Telegrams : "Iliffe, Glasgow." Telephone : Central 4857.

PUBLISHED WEEKLY. ENTERED AS SECOND CLASS MATTER AT NEW YORK, N.Y.

Subscription Rates :
Home and Canada, £1 10s. 4d. ; other countries, £1 12s. 6d. per annum.

As many of the circuits and apparatus described in these pages are covered by patents, readers are advised, before making use of them, to satisfy themselves that they would not be infringing patents.

CONTENTS

	Page
Editorial Comment	339
Phase-Splitting in Push-Pull Amplifiers	340
Problem Corner	344
Suppression and Car Performance	345
Magnetic Nickel Alloys	347
"Monarch" Multivibrator	349
Television Programmes	350
News of the Week	351
The Modern Receiver Stage by Stage. VII—Diode Detectors	353
Letters to the Editor	356
Automatic Frequency Control	357
Random Radiations	358
Club News	359
Recent Inventions	360

EDITORIAL COMMENT

News and Propaganda

How Long Will Listeners Respond ?

BY comparison with a year or so ago the broadcasting programmes of Europe have undergone a marked change. The proportion of music to talks has been greatly reduced so that broadcasting to-day no longer offers the variety of entertainment which it formerly did. The reason is, of course, that each country seems to have so much to talk about, and, not content with providing news and propaganda for its own listeners, devotes hours of broadcasting time to edifying the listeners of other countries.

How long this state of affairs can go on before listeners of all countries switch off their sets from sheer nausea it is difficult to predict but certainly the novelty of the thing will wear off in time. Meanwhile broadcasting as a source of entertainment and relaxation is deteriorating apace.

The next innovation we may expect is that programmes will be so compiled as to mix in the news and propaganda amongst the best items of musical entertainment as is done in so many advertising programmes in order to have the best chance of catching the listener even against his will. This stage in propaganda technique will not, of course, come until listeners have tired of the novelty of the present arrangements. Europe will no doubt have to call in the experts of America who compile the subtle propaganda of advertising in sponsored programmes to show how to make sure of catching the attention of those listeners who still remain sufficiently interested to provide an audience.

It is to be hoped that the rumoured

move on the part of the B.B.C. to change the time of transmission of their news in German to a much later hour will not materialise, for it seems to us to be very ill-advised when looked at from the point of view of a desire to reach the largest number of listeners.

Without having any substantiating information before us we would hazard the opinion that the majority of listeners on the Continent are earlier risers than in our own country and consequently go earlier to bed.

The B.B.C. have already discovered that far fewer people here listen to our second news bulletin as compared with the number who take the first, and it is presumed to be because so many retire to bed early.

How much greater therefore may we expect the loss of Continental audiences to be as a result of a late instead of an early foreign transmission by the B.B.C.

The Short-wave Side

Taking it Seriously

THERE are many "all-wave" broadcast receivers of which the sensitivity and selectivity on the short-wave bands are quite adequate, but few in which the tuning arrangements are entirely satisfactory. Adjustment is often too critical, and, worse still, it is seldom possible to tune with certainty to the desired frequency.

Existing artifices to overcome these difficulties are mostly susceptible to improvement, and further efforts in this direction would surely not be wasted. The needs of Empire listeners were voiced in last week's issue ; the matter is also of importance to those wireless users at home who in these troublous times are coming to depend more and more on short waves for news of world happenings.

Phase-Splitting in Push-Pu

DEVELOPING THE QUALITY AMPLIFIER

THE use of push-pull amplification with resistance coupling is now firmly established for ultra-high quality reproduction. Its popularity was established in large measure by *The Wireless World* Push-Pull Quality Amplifier, and although it is now five years since it was described no improvement in performance has yet been possible, nor would it be necessary if it were possible.

The frequency response is even, within the limits which the ear can detect, over a range wider than the audible, and the amplitude distortion is exceedingly low up to the rated output. The phase characteristics are also good, although it is still doubtful whether these are of importance. The output was originally 4 watts, but an alteration in the rating of the PX4 valve enabled this to be increased to 7 watts by increasing the anode voltage.

Since the performance cannot be improved, development has lain chiefly in the direction of obtaining as good results with less material. Experience has shown it to be permissible to omit certain by-pass condensers and decoupling components and a simpler version was produced for the Pre-tuned Quality Receiver.¹

The next step was to increase the output to 7 watts by taking advantage of the increased rating of the output valves. The changes which this necessitated were chiefly to the mains equipment, for the output stage needed some 350 volts at

¹ *The Wireless World*, Sept. 25th and Oct. 2nd, 1936.

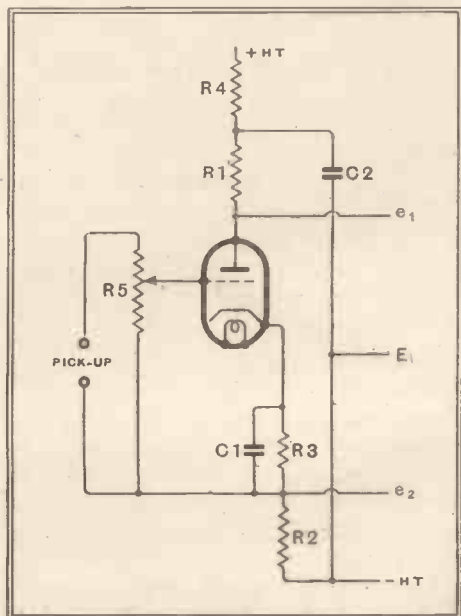

Fig. 1.—This phase-splitter is simple and gives high gain, but neither input terminal can be earthed.

100 mA. instead of 285 volts at 70 mA.

Originally, provision was made for energising the field winding of a loud speaker from the mains equipment, the field being inserted in series with the main HT supply and also acting as a smoothing choke. The resistance of the field was 1,250 ohms, and at 120 mA. the drop across it was 150 volts. This made an HT supply after the first choke of 435 volts necessary.

With the increased current consumption of the output valves, under the new rating, it proved very difficult to retain the field winding in the HT supply and at the same time have an economical supply. It was consequently decided in a later amplifier² to make no provision for energising a speaker field,

Fig. 2.—The arrangement of Fig. 1 can be applied to a grid detector, but the whole input circuit is floating.

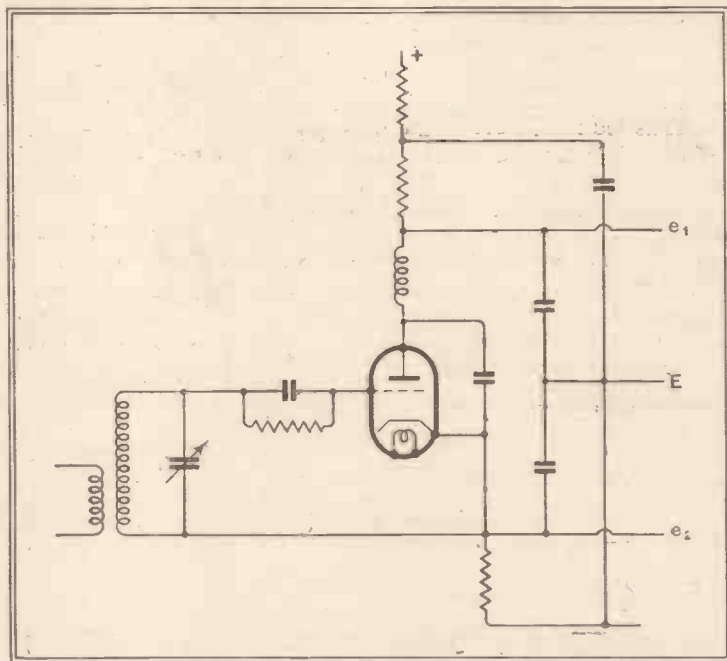

and this decision was arrived at after taking two further points into account. First, permanent-magnet speakers were widely used, and, secondly, the field requirements of energised speakers varied enormously.

The power needed varied from 6 watts to 20 watts and the resistance from 500 ohms to 5,000 ohms. No standard method of connection could be devised, therefore, which would meet all requirements with even reasonable economy.

The H.T. Supply.

Although connected as a smoothing choke and acting as such, the smoothing provided by the field in early models was not really necessary. No audible increase in hum was found to result from its omission, and there was also the saving of a smoothing condenser.

Instead of having to provide 435 volts after the first choke, only 350 volts were needed for the full rating of the valves, so that the voltage rating of the HT winding on the mains transformer could be reduced

² *The Wireless World*, Communication Receiver, Aug. 18th, 25th, Sept. 8th, 1938.

and the current rating increased. The lower voltage made it possible to use the cheaper electrolytic type of condenser for the reservoir capacity instead of the paper-dielectric condenser of the earlier models.

So far, the general arrangement of the amplifier proper had been retained; that is, a pair of push-pull PX4 valves were used in the output and preceded by a pair of push-pull MHL4 valves, or their equivalent, with resistance coupling. The preceding stage, however, had to be a phase-splitter, and considerable development took place here. As it is in connection

with phase-splitting that the newest development occurs, it is of interest to trace the various methods adopted and to see their advantages and disadvantages.

The original arrangement used for gramophone is shown in Fig. 1. Equal resistances R1 and R2 are connected in the cathode and anode circuits of a triode and equal voltages e1 and e2 are developed across them; e1 and e2 are in opposite phase, however.

The valve gives its normal stage gain, just as if R1 and R2 were both in the anode circuit. There is the minor disadvantage of a potential difference between heater and cathode of 50-100 volts, but the main drawback is that neither of the input terminals can be earthed.

The input terminal connected to R2 and R3 fluctuates with respect to earth by the output voltage e2, and the other terminal by e2 + eIN, where eIN is the input voltage. This is inconvenient, in practice, and although it can be made to work well, it is more liable to hum pick-up than other arrangements.

For radio, a similar method can be used with the valve functioning as a grid

Amplifiers

By
W. T. COCKING

MANY of the more important methods of feeding a resistance-coupled push-pull amplifier are discussed in this article with particular reference to the Push-Pull Quality Amplifier. The application of a new circuit is treated and is shown to lead to a simplification of the amplifier.

detector, as shown in Fig. 2, or else with a diode preceding Fig. 1. In either case, no point on the detector circuit can be earthed. This normally rules out its use in a straight set with ganged tuning, and in any case it makes it more difficult to secure RF stability. Nevertheless, very good results can be secured, and the method has been used in several receivers.

The next method to be used is shown in Fig. 3. The valve V_1 is a normal first-stage amplifier and its output e_1 across $R_1 + R_2$ is fed to one side of the push-pull amplifier. A portion of the output is tapped off across R_2 and fed to V_2 through the $C_1 R_4$ combination. The voltage e_2 developed across R_3 is in the opposite phase and feeds the other side of the push-pull amplifier.

For equality of the two outputs ($e_1 = e_2$) it is necessary that $R_2 / (R_1 + R_2)$ be equal

This self-balancing action makes very precise setting of the input control to V_2 unnecessary, and it is often satisfactory to feed it from a fixed tapping point as shown in Fig. 3. It should, however, be pointed out that we do not necessarily want perfect equality of the outputs, for the push-pull stages themselves may not be perfectly balanced. A deliberate inequality of output may be needed to obtain the correct overall balance.

However, if the pairs of push-pull valves are operated with a common unby-passed bias resistance, there is a self-balancing action in each stage. This is not always a possible condition in the output stage, for a by-pass condenser may be desirable for other reasons.

The balance on a signal in Fig. 3 is only good over a range of frequencies. At very low and very high frequencies it fails because of the circuit capacities. The voltage e_1 is produced from e_{IN} without any frequency discrimination or phase shift at low frequencies. The input to V_2 , however, and hence e_2 , is taken from e_1 through the coupling $C_1 R_4$.

Inevitably, e_2 falls off in respect to e_1 at low frequencies and is no longer 180 degrees out of phase with it. By making the product $C_1 R_4$ large enough, we can push the frequency at which the departure from balance occurs as low as we like, but we cannot avoid it.

Similarly, at high frequencies the stray capacities across $R_1 + R_2$ make the ratio of e_1 / e_{IN} fall off; e_2 / e_{IN} falls off more rapidly, however, because V_2 is fed with a fraction of e_1 and its anode circuit produces its own additional attenuation. Matters are made still worse by the input capacity of V_2 , which acts to make the input voltage to this valve less than the normal fraction of e_1 . By suitable design the frequency at which these effects

become important can be kept very high.

A normal push-pull stage is balanced as regards disturbances in the HT supply; that is, any hum or feed-back voltage affects both anodes equally and in the same phase. The circuit of Fig. 3, however, is not balanced from the point of view of the HT supply, for although equal voltages are applied to the anodes a portion is also applied to the grid of V_2 .

Decoupling of the HT supply is consequently necessary and is provided by R_6 and C_2 . This reduces the voltage applied to the valves and so restricts their output.

Negative Feed-back

It should be noted that these two valves do not operate in true push-pull, because the input of V_2 is derived from the output of V_1 . If V_1 introduces distortion the

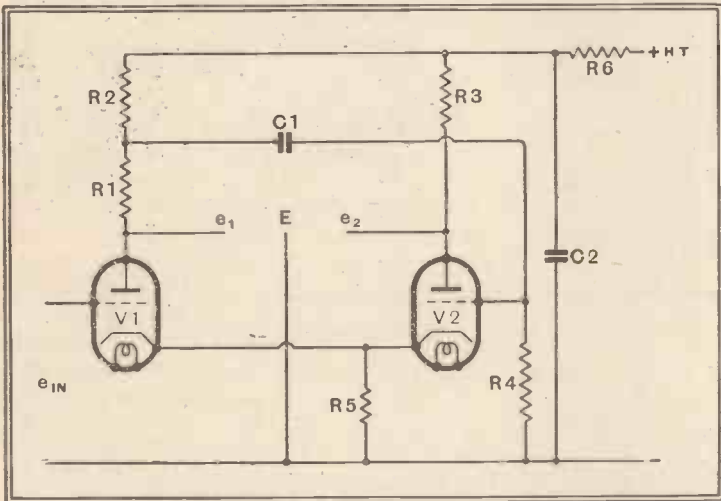

Fig. 3.—A well-known arrangement is shown here. V_2 is fed from a tapping on the coupling resistance of V_1 .

to the gain of V_2 . It is usual, therefore, to make the tapping point variable and to adjust it under working conditions. When $R_3 = R_1 + R_2$, the valves are similar, and $e_1 = e_2$, the alternating components of the anode currents through R_5 , are equal and opposite. No by-pass condenser is consequently needed to prevent negative feed-back.

If the stage is not properly balanced, however, there is feed-back which tends to restore balance. Thus, if the anode current of V_1 is greater than that of V_2 , so that e_1 is greater than e_2 , the voltage developed across R_5 gives negative feed-back on V_1 and positive feed-back on V_2 . It thus acts to reduce e_1 and increase e_2 .

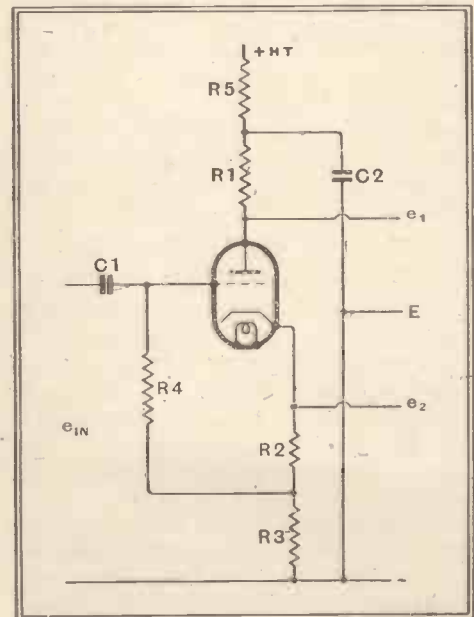

Fig. 4.—This circuit is similar to that of Fig. 1, but the input is applied between grid and earth. There is then heavy negative feed-back and the stage gain is very low.

Phase-Splitting in Push-Pull Amplifiers—input of V_2 is not a true copy of the input to V_2 .

The method of phase-splitting which has probably been most widely used in conjunction with the Push-Pull Quality Amplifier is a modification of Fig. 1. It is shown in Fig. 4, and the only essential difference is that the input is applied between grid and earth instead of between grid and cathode. The phase-splitting action remains unchanged, but there is now heavy negative feed-back along the

undistorted output with a reasonable HT supply and allowing for decoupling. The arrangement of Fig. 3 has the disadvantages already pointed out.

A new circuit¹ offers distinct possibilities, however, and its basic arrangement is shown in Fig. 5. R_4 and R_5 are provided for grid bias purposes; for the moment ignore them and consider the grid of V_2 as being returned to earth, as it is effectively for alternating currents. The input is applied to the grid of V_1 and causes variations in its anode current which produce e_1 across R_1 ; the variations also produce voltage variations across R_c , which are applied to the grid of V_2 and cause anode current changes in this valve, and hence produce e_2 .

The operation is more easily understood by assuming a small definite change of grid potential on V_1 and following its results. Suppose the grid potential changes in a positive direction. This causes a rise in anode current in

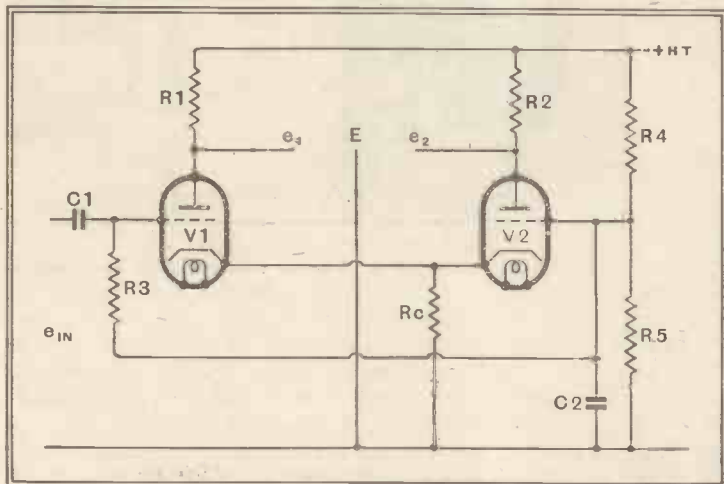

Fig. 5.—A new phase-splitting circuit is shown here. V_2 derives its input from the cathode circuit of V_1 . There is some negative feed-back on V_1 .

cathode resistance, with the result that the gain is only about 0.8—0.9 per side; that is, $e_1/e_{IN} = e_2/e_{IN} = 0.8$ to 0.9.

The feed-back results in great linearity and quite a large output can be obtained; it is not sufficient to feed the output stage directly, however, so that this valve precedes the push-pull MHL4 stage. For balance $R_1 = R_2 + R_3$, or if R_2 is shunted by a 50- μ F. condenser, $R_1 = R_3$.

Perfect balance is not obtained at very low frequencies because of the impedance of the decoupling circuit; at very low frequencies e_1/e_2 tends to rise somewhat. If the stray capacities across R_1 equal those across $R_2 + R_3$, the balance will be maintained at high frequencies, but if the cathode circuit capacity is higher than the anode e_1/e_2 will increase with frequency.

A New Circuit

As with the circuit of Fig. 1, there is a difference of potential of 50-100 volts between heater and cathode, but this is usually unobjectionable. The circuit is unbalanced as regards the HT supply, for although a ripple on the supply affects e_1 and e_2 in the same phase, it does not affect them in equal magnitude. Hence, the necessity for thorough decoupling.

Now it will be apparent that the obvious step in simplifying the Quality Amplifier is to obtain the phase-splitting in the stage immediately preceding the output valves. If this can be done without affecting the performance a valve will be saved. The circuits of Figs. 1, 2 and 4 are hardly suitable, because they will not give sufficient

V_1 , and consequently a rise in cathode potential and a fall in anode potential e_1 . The rise in cathode potential means that the cathode voltage of V_2 rises with respect to the grid, which is at a fixed potential. This is equivalent to a fall in the grid potential of V_2 relative to its own cathode, and so the anode current of this valve decreases. This fall in anode cur-

e_2 to be equal it is clear that the alternating anode currents of the two valves must also be equal. They flow in opposite directions through R_c , however, so they will set up no voltage drop across it; consequently, V_2 will have no input and be unable to produce an alternating anode current.

This is impossible, and if the valves are identical and R_1 and R_2 are equal, e_1 and e_2 cannot be equal. To make the outputs the same R_2 must be greater than R_1 , for to obtain an input to V_2 the alternating anode current of V_1 must be greater than that of V_2 .

Accuracy of Balance

Although with $R_1 = R_2$ perfect equality of output cannot be secured, the balance can be made as nearly perfect as we like by increasing R_c sufficiently. Then the input to V_2 is very nearly equal to the grid-cathode voltage of V_1 . So far as V_1 is concerned the voltage across R_c acts as a negative feed-back voltage and the stage gain of V_1 is very nearly one-half of what it would be if R_c were absent. The input required for a given total output $e_1 + e_2$ is almost the same as that needed by the same two valves in normal push-pull, but instead of the input voltage being balanced to earth it has one terminal earthed.

If we express the balance as the ratio e_1/e_2 , then the value of R_c for a given degree of balance is given by $R_c = (R_a + R_1)/(1 + \mu)(e_1/e_2 - 1)$, where R_a and μ are the AC resistance and amplification factor of the valves, assumed identical. With valves of the MHL4 type R_a is about 10,000 ohms and μ is 20, then if we permit 10 per cent. unbalance ($e_1/e_2 = 1.11$) and R_1 is 25,000 ohms, R_c should be 15,000 ohms. If R_c is made 20,000 ohms, then the error becomes 8.3 per cent.

The cathode resistance R_c cannot be increased indefinitely because of the voltage drop across it set up by the steady anode current of both valves. If the current is 7 mA. and R_c is 20,000 ohms, the voltage drop is 140 volts and the effective operating voltage of the valves is reduced by this amount.

As the cathodes are at a high voltage with respect to earth, the grids cannot be returned to earth, but must be taken to a positive point. This is provided by the voltage divider $R_4 R_5$. With the cathodes at +140 volts the valves might need -4 volts grid bias with respect to cathode, so in this case the potential at the junction of R_4 and R_5 must be +136 volts.

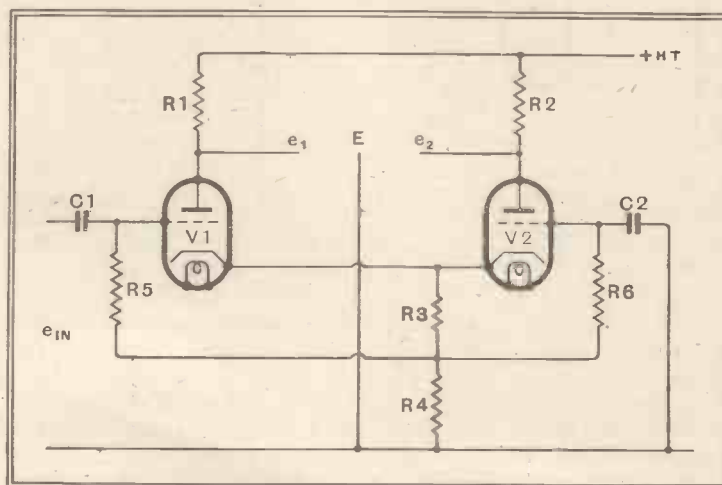

Fig. 6.—This modification of Fig. 5 shows a simpler way of obtaining grid bias by the voltage drop across R_3 .

rent causes a fall in cathode potential and a rise in anode potential e_2 . e_1 and e_2 thus change in potential in opposite directions.

If R_1 and R_2 are equal, then for e_1 and

¹ Journal of Scientific Instruments, March, 1938.

Phase-Splitting in Push-Pull Amplifiers—

For a given anode current it is desirable to make R_c as small as possible, for then the voltage lost across it is a minimum. The factors which affect R_c are the amplification factor of the valves, their AC resistances and the values of the coupling resistances. In general, R_1 must be roughly proportional to R_a to obtain reasonable stage gain and good linearity. As the current taken is also likely to be roughly proportional to R_a , the voltage drop across R_c will be nearly independent of valve resistance for constant unbalance.

The only way to reduce the cathode voltage, therefore, is by increasing the amplification factor μ . In fact, R_c and

rent of 5 mA.; therefore, $R_3 = 600$ ohms. As $R_3 + R_4$ is to be 15,500 ohms, R_4 should be 14,900 ohms. Actually, 15,000 ohms is quite near enough.

We thus find the following values suitable for Fig. 6: $V_1 = V_2 =$ Mullard 354v. or equivalent; $R_1 = R_2 = 50,000$ ohms, $R_3 = 600$ ohms, $R_4 = 15,000$, $R_5 = R_6 = 2$ megohms; $C_1 = C_2 = 0.01 \mu F$. The total current is 5 mA. at 350 volts and the output is just sufficient to load a PX4 push-pull stage. The stage gain $e_1/e_{IN} = 14.5$ and $e_2/e_{IN} = 13.1$. These are calculated, not measured, values and allow for 0.25 megohm grid leaks in the following stage.

The circuit of Fig. 6 is perfectly balanced at all frequencies as regards dis-

A balanced output can be secured by making R_2 somewhat larger than R_1 . If this is done the circuit is no longer perfectly balanced as regards the HT supply.

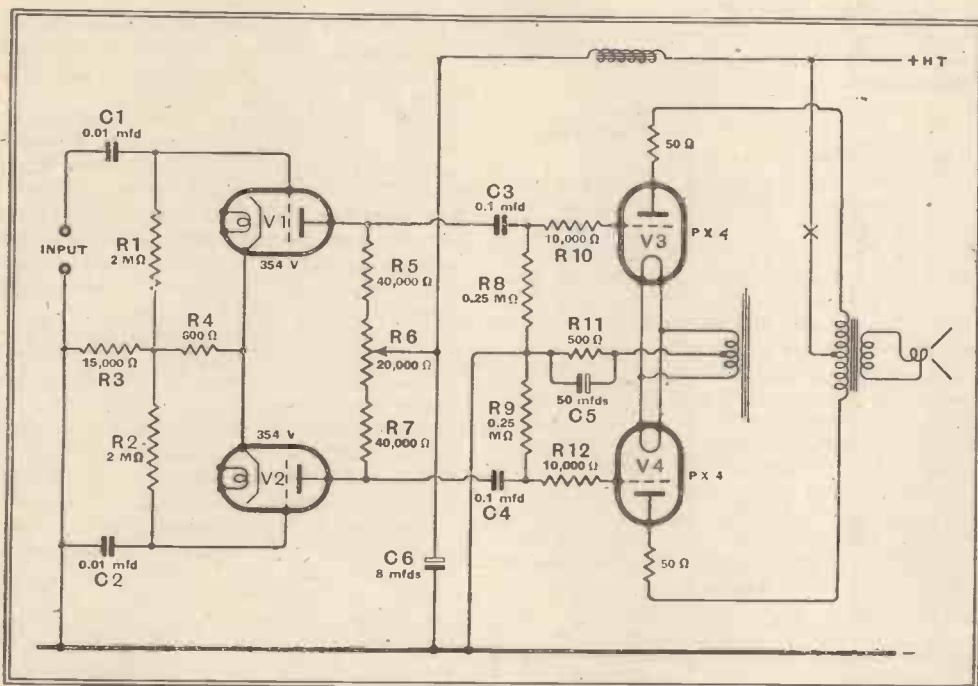

Fig. 7.—This diagram shows a phase-splitter feeding the output stage. This was the arrangement used for measurement purposes.

the cathode voltage are roughly inversely proportional to μ , assuming the other values to be constant. Valves of high mutual conductance are, therefore, desirable. The MH4 class should consequently be preferable to the MHL4.

Operating Conditions

The AC resistance R_a of the 354v. under normal working conditions for RC amplification is about 15,300 ohms and μ is about 37. Suppose we make $R_1 = 50,000 \Omega$, then for 10 per cent. unbalance $R_c = 15,500$ ohms. This is little lower than before, but the valves take less current, so the cathode potential is lower.

With 350 volts HT and grid bias of -3 volts each valve takes 2.5 mA., so that the cathode potential is +77.5 volts; the grids, therefore, must be returned to a point 74.5 volts above earth. The potentiometer for grid bias is rather inconvenient, and its use can be avoided by taking the grid return leads to a tapping on R_c as shown in Fig. 6. Here R_c is split into two parts, R_3 and R_4 .

In the particular case we are considering we need 3 volts across R_3 with a cur-

turbances in the HT supply so long as $V_1 = V_2$, $R_1 = R_2$, $C_1 = C_2$, $R_5 = R_6$, and the output impedance of the preceding stage is negligibly small. The arrangement of Fig. 5 is not quite so well balanced in this respect.

As regards the signal path the balance in Fig. 5 is substantially independent of frequency, but in Fig. 6 there is the extra coupling C_2 R_6 which upsets the balance

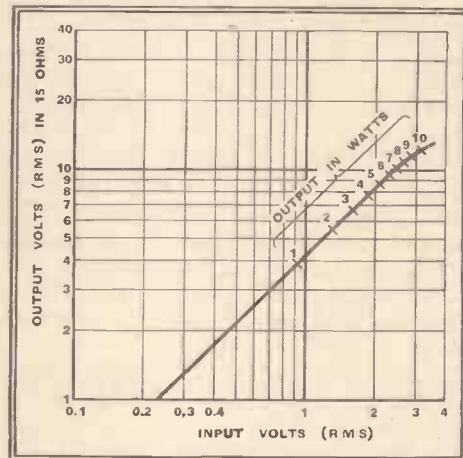

Fig. 8.—The input-output curve of the amplifier is linear up to 7 watts or slightly more.

The error is small, however, and if an adjustable balance is provided any lack of balance in the output stage can be corrected.

Measured Performance

The difference of potential between heater and cathode is a disadvantage, but most valves will withstand 80 volts between the two without harm. The Mullard 354v. is rated for a maximum of 50 volts, however. The difference of potential can be avoided by using a separate heater winding for these valves and connecting it to cathode. The capacity of this winding, and of the associated wiring to earth, then appears across R_c , but owing to the very low output impedance of the stage viewed across R_c , it does little harm. Even at 20,000 c/s the effect of shunting R_c by $0.001 \mu F$. is barely measurable.

In order to check the performance of this phase-splitter the amplifier shown in Fig. 7 was set up. No special precautions in the choice of valves or components were observed; resistances, for instance, were picked at random and might differ from their nominal values by the usual tolerances. No effort was made, either, to

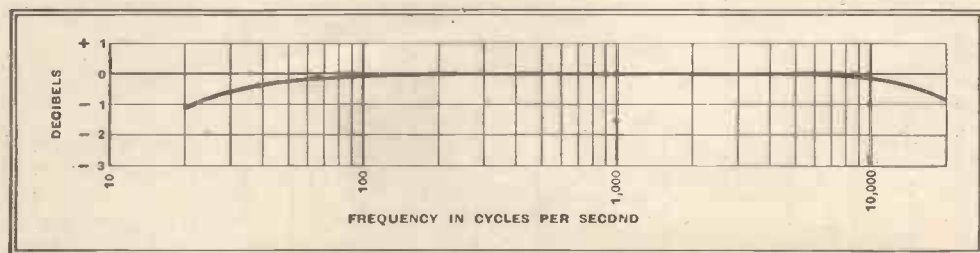

Fig. 9.—The frequency-response, including the output transformer, shows a drop of about 1 db. at 20 c/s and 20,000 c/s.

at very low frequencies. This is not important in many applications, however, and the method of biasing adopted here is the more convenient.

obtain matched valves, and the conditions were consequently such as one might expect in practice. In view of the possible variations one cannot expect very close

Phase-Splitting in Push-Pull Amplifiers—agreement between the measured performance and the calculated.

The input-output curve of Fig. 8 shows that for 7 watts output the input to V1 is 2.45 volts RMS, or 3.46 volts peak. The amplifier was, of course, balanced by means of R6. This is easily done by inserting a 50-ohm resistance in series with the HT lead to the output transformer at the point X in Fig. 7 and connecting a pair of 'phones or an oscilloscope across it. An AF oscillator, or a pick-up with a constant frequency record, is connected to the input, and R6 is adjusted for *minimum* output in 'phones or oscilloscope. With a small input the balance is quite sharp. The test frequency should be of the order of 400-1,000 c/s.

The overall frequency response is shown in Fig. 9; at 20 c/s the response is -1.2 db. and at 20,000 c/s it is -0.9 db. The maximum deviation over the range of 20-20,000 c/s is thus ± 0.6 db. It should be noted that this includes the output transformer which has itself a variation of about ± 0.5 db.; the amplifier alone thus is likely to vary by only ± 0.1 db. Such variations are quite unimportant and are, in fact, near the limit of accuracy of the measuring gear.

The input-output curve of Fig. 8 also includes the output transformer, so that the 7 watts output is available on the secondary. The component used was a Sound Sales Type SS036, with a resistance for the secondary load.

Comparative Advantages

Comparing this new arrangement with the amplifier of *The Wireless World* Communication Receiver, we find that one valve less is used and that for the same output the input required is 3.46 volts peak, or, say, 3.5 volts, as compared with 2.35 volts peak. The total anode current consumptions are about the same—105 mA.—but the heater current of the extra valve is saved. There is also a saving of four fixed resistances, one tubular condenser, one 8 μ F. electrolytic condenser and one valve-holder, against which must be offset the potentiometer R6. For the same accuracy of balance, this would be needed with the earlier circuit, however.

The saving effected is thus a worthwhile one, and if it lives up to its promise during extended tests it will undoubtedly be employed in future ultra-high quality apparatus described in *The Wireless World*. It should, perhaps, be pointed out that the amplifier of Fig. 7 does not give enough gain for many purposes; usually an additional stage will be needed. As a gain of some 4-7 times would be adequate for radio and for most pick-ups, there is the possibility of making this stage of the tone-control type.

PROBLEM CORNER—15

An extract from Henry Farrad's correspondence, published to give readers an opportunity of testing their own powers of deduction:—

"Radiovilla,"
Hackbridge.

Dear Mr. Farrad,

I have been making up a dynatron oscillator for experimental work, but so far have had no success. The valve seems all right; in fact I have taken a characteristic curve of it which I enclose. As I wanted to make use of the downward slope to the maximum advantage, I decided to work at an anode voltage of about 45, which, as you see, is about half-way down the slope. I am running the screen off a 90-volt battery (see circuit diagram), and to avoid tappings the anode is supplied through a voltage-dropping resistor. The anode current being 2½ mA at the working point, I think I am correct in using a 20,000-ohm resistor to drop 45 volts. The grid bias is supplied by a small separate cell as I believe it is advisable not to run the valve without bias.

Well, so far I have not succeeded in get-

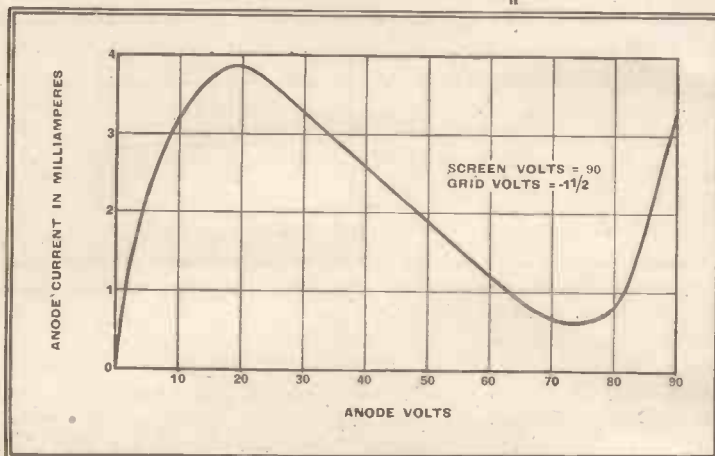
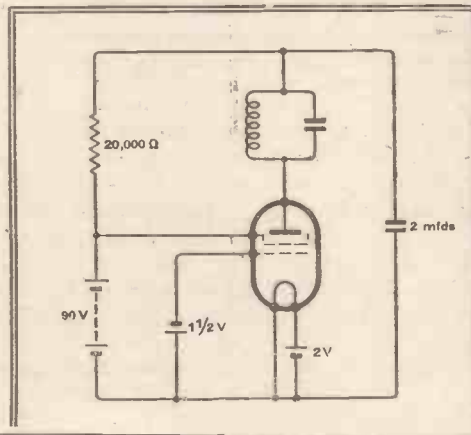

The circuit diagram and valve characteristic curve enclosed with Mr. Lea's letter. Do they disclose the reason for the failure to oscillate?

ting anything to oscillate. I have checked over all the connections many times and tried tuned circuits that I know should oscillate easily with the slope of this valve. Having heard that you are good at solving these little mysteries, I am writing in the hope that you will do me this favour.

Yours sincerely,
Ray Lea.

Turn to page 355 for Henry Farrad's solution.

The Elements of Radio Communication.
By O. F. Brown, M.A., B.Sc. (Oxon.), B.Sc. (Lond.), and E. L. Gardiner, B.Sc. (Lond.). 551 pp.+viii. Oxford University Press, Amen House, Warwick Square, London, E.C.4. Price 16s. net.

THIS book is at once recognisable as outstanding among elementary textbooks on radio communication, for it is one of the very few that give the general reader a really comprehensive and authoritative survey of the underlying principles without recourse to mathematical treatment. In the preface the authors point out that particular attention has been paid to lucid explanation of the principles and reasons underlying radio phenomena, and every effort made to treat the subject comprehensively, rather than with great depth.

Each branch of the subject is treated from the beginning, early methods and historical stages being considered first, and then followed up by modern developments. No attempt has been made to describe in detail all the modern devices of transmitting and receiving equipment, for, as the authors say, "countless existing works do this very completely." But the fundamental principles and the reasons for the various phenomena are very fully explained in a style easily read and understood by the beginner. The reader is given a sound general knowledge of his subject, enabling him subsequently to study the more highly specialised and technical works without loss of perspective.

The introductory chapter is a survey of historical aspects, from Maxwell's predictions to present-day achievement. Then follow chapters on high-frequency alternating currents, electrical oscillations and radiation, thermionic valves, etc. Where electrical formulæ have to be introduced, free use is made of that most useful expression: "It can be shown that..." and the small amount of AC theory required is very simply expounded. There are very few statements open to criticism.

It may be somewhat unexpected to find a whole chapter on the now obsolescent method of spark transmission, but this has been included as a convenient theoretical introduction to other systems, apart from its historical interest. The sections on valves, detection, amplification, selectivity and reception in general, taken as a coherent whole, give the reader a survey which is remarkably complete and detailed for a non-mathematical treatment.

Due prominence has been given to television in the last two chapters, covering no fewer than 65 pages. Basic principles and early methods are treated at somewhat great length in the first section, the second and shorter section being devoted to the principles of modern electronic television.

For the benefit of those studying for examinations in radio communication, selections of past examination questions have been appended to each chapter. O. P.

Suppression and Car Performance

ITS EFFECTS UNDER VARIOUS CONDITIONS

By C. ATTWOOD, B.Sc., B.Sc. (Eng.)

ATENTION has repeatedly been called in the pages of *The Wireless World*, both in Editorial articles and correspondence, to the lack of information on the effects of suppression on the performance of a vehicle. This article, which deals only with resistive suppression, gives the results of observations extending over more than three years on the practical effects produced by suppression on the running of two cars, both fitted with six-volt coil ignition, with which the author has been concerned during this period.

The alleged deleterious effects of suppression may be classified as:

1. Making starting difficult.
2. Sooting up the sparking plugs and increasing the necessity for decarbonising the engine.
3. Increasing the wear on contact breaker points.
4. Causing pinking.
5. Reducing engine power.

no experience of car interference suppression than by those motorists who have suppressors fitted to their cars. The only occasions on which the author has used the starting handle during the three years during which he has had suppressors fitted to his car are once when the starting pinion jammed and later during the time that an old run-down battery had deliberately been installed as part of the series of tests described below. During the unusually cold weather several months ago the engine (fitted with 25,000-ohm suppress-

THIS article gives the results of several years' experience and an exhaustive series of tests on the effects of resistance suppression on actual road performance of a popular type of car—a Ford 8 h.p.

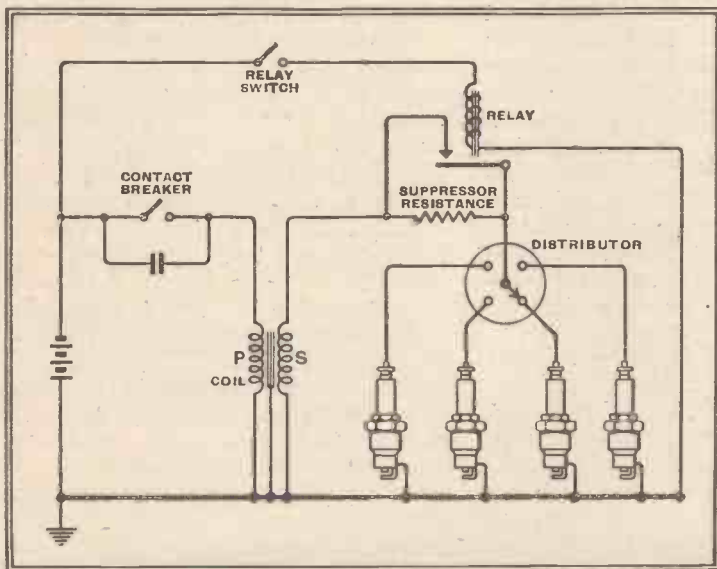

Circuit diagram of the ignition system, showing the addition of a relay for short-circuiting the suppressor resistance, thus permitting rapid comparative observations of the effect of the resistance on engine performance.

It is unwise to be dogmatic on any aspect of this subject, but it is the author's personal opinion that the first two effects are based more on imagination than on observation, for both complaints are more frequently uttered by those who have had

is not, as some readers may feel inclined to suggest, a case of blatant neglect: engine behaviour simply indicated that neither procedure was necessary. Starting troubles and sooting up are far more dependent on reasonable battery attention,

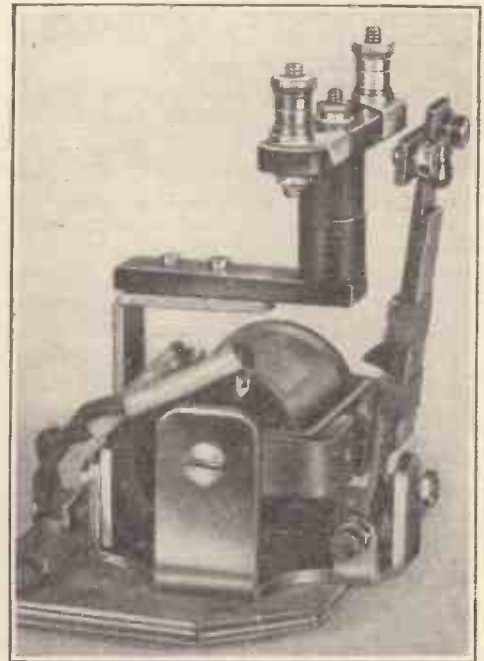

Construction of the magnetic relay; the use of two wide gaps in series prevent misleading results due to high-voltage flash-overs.

choice of suitable petrol, and correct carburettor and ignition adjustment than on the presence of interference suppression resistances.

The remaining three factors cannot be dealt with so easily. Wear on the contact breaker points is affected to a very pronounced extent by the electrical constants of the coil and condenser together with the time intervals of the make-and-break periods, and it is quite possible for wear of the contact breaker points in the primary circuit to be increased by the altered electrical conditions produced by series resistance in the secondary circuit of the coil. The author has never experienced excessive wear or undue need for adjustment on the small type of four-cylinder car, but these factors are so different on other cars, particularly those with six or eight cylinders, that reports of intelligent observation on this question by owners of the larger type of car would be interesting.

"Effects Entirely Negligible"

The author has long believed that the effects of suppression on engine performance—the effect on power and the proneness to pink—is entirely negligible, but an effort has been made to study the effects of suppression resistances in a more satisfactory manner than is possible by testing the car successively with and without suppressors. A relay has been devised that is suitable for making and breaking the high-tension ignition circuit, and this relay has been mounted a few inches from the distributor, the controlling switch being fixed by the side of the steering column of the car. In order to simplify the design of the relay a single resistance is used in the distributor lead instead of separate resistances in each sparking plug circuit, the relay being arranged to short-circuit this resistance. The effect on high-frequency suppression of the single resist-

SUMMARY OF TEST RESULTS

Suppression and Car Performance—

ance is, of course, entirely different from that of resistances of equal value, mounted one in each sparking plug lead, but it is believed that the effect on engine performance is approximately the same in each case. At first sight it might appear that the position of a series resistance in the high-tension circuit is immaterial, but the actual mechanism of ignition in an internal combustion engine is very complicated, and the fact that the capacity distribution is altered is one of several factors that suggest that this conclusion is not necessarily valid. However, tests indicate that even under the severest conditions detailed below the difference in engine behaviour between a resistance before distribution and four equal-valued resistances after distribution cannot be detected.

A relay of this nature must not only have its contacts very well insulated from earth but the contacts must be capable of opening a surprisingly large distance, for the size of gap that the voltage developed across a high-resistance suppressor is capable of bridging must be seen to be believed. The opening of the relay points must be sufficiently wide not only to prevent arcing but also to avoid a corona discharge which is visible only in the dark but which would completely invalidate the results of any test. The photograph shows the final design for the relay, the actual "gap" consisting of two gaps in series so as to keep the relay within reasonable dimensions.

Details of Tests

The procedure in this series of tests was to allow the car to travel at a steady speed and, without moving the throttle position, to try the effect of opening and closing the relay by seeing whether the slightest effect on speedometer reading was discernible. Observations were also made on the acceleration and pulling power, but no definite



How the relay was mounted on the engine.

Conditions of Test	Effects of Suppression
NORMAL	No difference in power up to 3 megohms. Idling speed reduced and running slightly erratic above 1 megohm. Will not start from cold above $\frac{1}{2}$ megohm.
SPARKING PLUGS WIDE. (0.065" instead of 0.022")	No difference in power up to 3 megohms. Effect on slow running of resistances above 1 megohm not so pronounced.
BATTERY VOLTAGE VERY LOW. (Normal = 6 volts.)	Tested with worn-out battery with car generator inoperative, and engine started by hand. Voltage controlled by parallel load. At 3 volts, no difference in power up to $\frac{1}{2}$ megohm. Engine can be started when hot with $\frac{1}{2}$ megohm but not when cold. At 2 volts, engine will operate with no resistance but will not start. Engine stalls with $\frac{1}{2}$ megohm but not with 25,000 ohms.
TIMING ADVANCED. (8° from normal)	No difference in power up to 3 megohms but bigger effect on slow running of values above $\frac{1}{2}$ megohm. No difference observed in onset of pinking.
TIMING RETARDED (6° from normal)	Effect of resistances the same as for normal conditions.
CONTACT BREAKER GAP TOO WIDE. (0.028" instead of 0.012")	No difference in power up to 3 megohms but bigger effect on slow running for values above $\frac{1}{2}$ megohm.
CONTACT BREAKER GAP TOO NARROW. (0.005" instead of 0.010")	Effect of resistances the same as for normal conditions.
PLUGS BADLY SOOTED UP.	No difference in power up to 3 megohms but slightly bigger effect on slow running of values above $\frac{1}{2}$ megohm.
INFERIOR PETROL.	Same as normal conditions. No difference observed in onset of pinking.

difference could be detected in any of these tests. The effect on starting from cold was also observed only when it was thought that this might be of interest, for a complete test of this nature would involve almost infinite patience.

The normal value for suppressor resistances is between 20,000 and 25,000 ohms. A 25,000-ohm resistance in the distributor circuit was connected to the relay so that it could be readily shorted and for several weeks a direct comparison was made under all kinds of running conditions. In no case could any difference in performance be detected. The value of the resistance was then increased in stages, and not until three megohms had been reached was there any suggestion of a difference in performance; and even then the possible difference was too small to be conclusive! The engine would start when warm, but starting from cold with this value of resistance was not possible. The resistance had to be reduced to 750,000 ohms before the engine would start from cold. The only other difference that could be detected was the effect when the engine was idling. Resistances greater than one megohm reduced the idling speed and made running slightly erratic.

At seven megohms the engine stalled immediately the relay contacts were opened. Caution is necessary when quoting the ohmic values of these high resistances. In the preliminary tests certain specimens behaved in such a manner as to suggest that their resistances under high-voltage conditions were very much lower than their measured DC resistances, but this trouble was traced to arcing between parts of the resistance element. In one case of a resistance that misbehaved itself the current was conducted by the paint of the manufacturer's trade mark, there being a spark from each end terminal of the resistance to the paint.

The remainder of the test was directed towards ascertaining the effects of sup-

pressor resistances when the car was operated with very low battery voltage, incorrect timing and other adverse adjustments. The differences produced by some of these incorrect operating conditions compared with normal running were, of course, pronounced, but under no set of conditions was it possible to detect the effect of the presence or absence of a suppressor resistance unless its value was excessively high. The conditions under which the car was tested and the effects observed are summarised in the accompanying table. The effect of all these faults together (in so far as they are not mutually exclusive) has not been tried!

To sum up, it may be stated as the author's conclusion that the effect on engine performance of suppression resistances on the type of car with which this article is concerned is entirely negligible. The "factor of safety" of the ignition system is so high that resistances must be increased to more than ten times the values normally used for suppression purposes before any effects become discernible, and even then the mechanical effects on the engine are very small. At the same time it should be pointed out that these conclusions are not necessarily to be inferred as applying to all car engines. The conclusions established in these tests would most likely least apply to engines built for extreme economy which operate, particularly at low throttle openings, with very weak mixtures. It would be interesting to hear of similar observations conducted by owners of this type of car and also by readers who possess six- or eight-cylinder cars.

Finally, in case any motorist reader should decide to conduct similar tests to those described here, it should be pointed out that the electrical stresses brought about by the high values of resistances used in these tests produce a very severe strain on the whole of the ignition system, particularly on the insulation of the coil.

Magnetic Nickel Alloys

THEIR USES IN RADIO EQUIPMENT

By A. B. EVEREST, Ph.D.

(The Mond Nickel Company Ltd.)

THE magnetic properties of nickel and its alloys have been described from time to time, and it has been emphasised that in this respect, as in many others, nickel demonstrates its wide versatility. Among its alloys are many that are non-magnetic, others, on the other hand, which have maximum permeability properties, while a third series represents the best permanent-magnet materials now commercially available. In addition, nickel itself has interesting magnetic properties, showing to a marked degree the phenomenon of magnetostriction—that is, change of dimensions on being subjected to a magnetic field.

All these materials find extensive application in the radio industry, and the purpose of this article is to give a brief review of some of their uses in this field.

Alloys of nickel and iron (which may also contain small proportions of other elements, such as copper) have been found to have an exceptionally high permeability, especially after heat-treatment, and they provide some of the magnetically "softest" materials known. This means that the material, in suitable form, shows a marked response when subjected to a magnetic field of low intensity, the induced

and other grades of "Permalloy," while in the third group are "Perminvar" and "Rhometal." The choice of the particular alloy for a given set of conditions is also determined by other factors, including the saturation value of the metal and its electrical resistance, so that combinations of properties may be selected, such as high permeability with low satur-

A SURVEY of the various applications of nickel-iron, nickel-aluminium and other alloys in the construction of wireless apparatus.

ation, or alternatively, constant permeability with high saturation.

In radio, and in communications generally, all these alloys are used in equipment where a high degree of magnetic response is required in weak magnetic fields, as in transformers, chokes and similar apparatus. Perhaps an equally important use of the alloys, however, is in the magnetic screening of sensitive equipment which must be shielded from the adverse influence of stray magnetic fields, or in screening off part of the equipment which might itself produce magnetic fields disturbing to neighbouring apparatus.

For some time past it has been the practice of most radio manufacturers to employ the high permeability nickel-iron alloys for the cores of audio-frequency transformers. These alloys, which can be used in the form of ordinary transformer stampings, have an effective permeability about twenty times that of ordinary transformer iron, and this has resulted in a very substantial reduction in the size of transformers. An accompanying photograph gives a comparison of the size of radio transformer stampings in nickel-iron and silicon steel to give corresponding results. Quite apart from any saving on account of the lower weight and smaller dimensions of the transformers, the use of the nickel-iron alloys materially reduces distortion, owing to the lower iron and copper losses resulting, respectively, from the better material and smaller size.

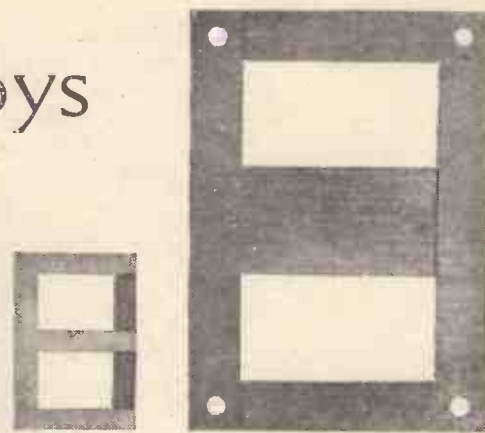

These two AF transformer stampings, the larger in silicon iron and the smaller in "Mumetal" nickel-iron alloy, have identical ratings (in the absence of polarising direct current).

The advantages of the nickel-iron alloys for cores is realised in inter-valve transformers, output transformers, microphone transformers and, more recently, in scanning transformers and, more recently, in scanning transformers for television. In the case of scanning transformers for television a peculiar type of wave form is required, and the clarity of the image obtained on the screen is absolutely dependent on the use, for the transformer core, of magnetic materials with a high degree of response at high frequencies. These conditions can only be met by the nickel-iron alloys.

The arguments which have led to the use of the high permeability nickel-iron alloys for transformer cores have also prompted their use for the cores of chokes in radio equipment. In fact, wherever a high degree of response at low field strengths is required, one or other of the nickel-iron alloys will give the highest degree of efficiency.

For Screening

The fact that the nickel-iron alloys have a good response to weak field strengths makes them eminently suitable for screens. As already mentioned, it is frequently necessary in radio equipment to isolate transformers or other parts which might produce stray magnetic fields and thus influence adjacent apparatus. Alternatively, in the case of other equipment, such as cathode-ray tubes used in television, it is frequently necessary to screen it from any possible interference by outside magnetic fields. The nickel-iron alloys are well established for use in both cases.

The wide range of properties available in the nickel-iron alloys offers a large choice of materials to meet particular conditions. Thus, if screening against only a weak field is required, one of the high permeability alloys will be most effective; if, however, the interfering field is strong, the alloy with the highest permeability may have the disadvantage that its saturation value is low, and for this reason it may not be sufficiently effective. In these circumstances a double screen is sometimes used. The interfering field is faced first with a material of high saturation value and moderately high permeability

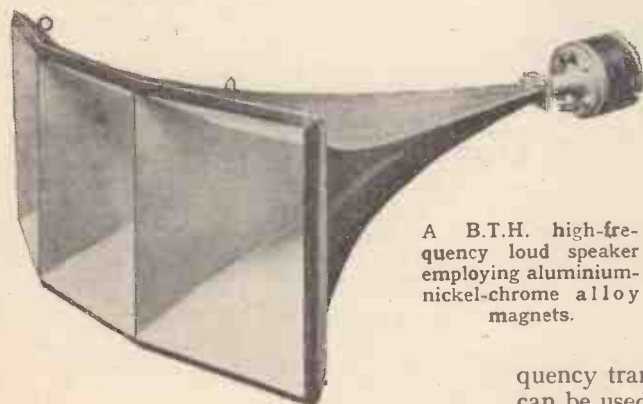

A B.T.H. high-frequency loud speaker employing aluminium-nickel-chrome alloy magnets.

magnetism often reaching the saturation value of the alloy. The behaviour of the metal in a magnetic field may be modified by varying the composition or the heat-treatment, and in this series different alloys have been developed to give, respectively, (1) maximum permeability at low field strengths, (2) high permeability at high inductions and under conditions of polarised magnetisation and (3) constancy of permeability over a relatively wide range of applied field strength.

The first group includes some of the well-known "Permalloys," "Mumetal," etc., the second group, "Radjometal,"

Magnetic Nickel Alloys—

which serves to intercept the greater part of the field. Anything which passes through the first screen, however, may subsequently be dealt with by a second screen of high permeability, low saturation material, thus effectively restricting the field and minimising interference.

Whilst cores for transformers, chokes, etc., on the one hand, and magnetic screening, on the other, represent the main uses of the high permeability alloys in radio, there are other applications of interest to the radio engineer. For example, "Mumetal" is used in the manufacture of gramophone pick-ups by reason of its low coercive force and low hysteresis loss, thus ensuring a rapid response where minute variations in flux are involved.

Another application of great technical interest is in connection with permeability tuning. In the first experiments in tuning high-frequency circuits by the insertion of a core of magnetic material within a tuning coil, nickel-iron alloys were employed for the core material. With the development of push-button tuning, equipment of this type is becoming of greater importance, and although pure iron in finely divided or powder form is to-day often used as the material for the core, interest is still being taken in the nickel-iron alloys, which with their lower loss and higher permeability, offer greater efficiency in this application.

Other applications of the high permeability alloys include the so-called "needles" for picking up speech from the magnetised tape used in magnetic recording machines, such as the Blattnerphone, and certain parts of the external magnetic circuits used in conjunction with cathode-ray tubes in television.

Loud-speaker Magnets

The development in the last few years of the nickel-containing permanent magnets has revolutionised the magnet industry. Permanent magnet "steels," such as the nickel-aluminium alloy "Alni" and the nickel-aluminium-cobalt type known as "Alnico," offer higher efficiency at a lower cost than before. Experience has shown that the new magnets are permanent, retaining their high magnetic energy content even under such adverse conditions as relatively high temperatures and shock. Another advantage which they offer over the earlier materials, such as cobalt steel, is a lighter specific weight, and this combined with the fact that a smaller magnet may be used for a given output, has led to substantial economies. The magnets are available only in the cast form, but this is no disadvantage to the radio industry since the modern type of loud-speaker unit, for example, is easily adapted to make the best use of the cast magnet.

For high-quality loud speakers, for speakers in battery-operated sets, and for extension speakers for ordinary domestic purposes, units incorporating the new nickel alloy magnets are now widely adopted. Compared with the electro-magnetic units employed in ordinary radio sets, those incorporating the new mag-

netic alloys have many advantages, including lower servicing costs, and less trouble with distortion of the moving coil due to overheating of the unit in service. No mains hum can be developed by the energising coil, and, moreover, no subsidiary coils, such as those used for "hum bucking," are necessary.

The advantages of the permanent-magnet unit become greater in the larger sizes of loud speaker, and for this reason, even in mains-operated sets of the larger sizes, permanent-magnet units are now used for the loud speakers.

The magnets used in loud speakers of the size employed in public halls and cinemas weigh as much as 7lb. each, and give a flux density in the air gap in the unit of some 14,000 to 15,000 lines per sq. cm.

In the case of microphones, as with loud speakers, efficiency and faithful reproduction depend on a high field strength. For this reason microphones incorporating permanent magnets are now designed to use the high efficiency offered by the "Alni" and "Alnico" types.

A specially interesting application of "Alnico" is in the so-called magnetron oscillator, in which control over ultra-short waves in radio apparatus is effected by means of an intense magnetic field. In the apparatus in question the wavelength of the oscillations inside the valve is



Magnet assembly of a ribbon microphone, as used by the B.B.C., embodying an aluminium-nickel-chrome alloy magnet (Darwins, Ltd.).

controlled by the magnetic field produced by the large block of "Alnico," the field being controlled by means of screwed pole extension pieces.

At the other end of the scale, minute magnets are now being employed in the construction of gramophone pick-ups. Some of these magnets are too small to cast, and alternative methods of construction, such as shaping the magnets by pressing from powder, are being worked out in different parts of the world.

A recent development is in connection with focusing magnets for cathode-ray tubes as used in television. In this case, ring or similar type magnets placed around the tubes serve to focus the cathode-ray beam.

Other applications of the magnets in

apparatus associated with the radio industry include instruments of all types for radio control rooms, and generators used in aircraft for providing energy for the operation of radio sets. In any applications, in fact, where permanent magnets are required the new materials offer interesting possibilities.

Magnetostriction Oscillators

In discussing the magnetic properties of nickel and its alloys in the radio industry, reference must be made to the magnetostriction oscillator, in which the peculiar properties of nickel have led to its use as the oscillating element in apparatus for establishing frequency standards. As already mentioned, the principle of magnetostriction is that the material alters its dimensions on being subjected to a magnetic field. It has been found that a bar of nickel, for example, when placed in a magnetic field, actually contracts to quite an appreciable extent, and when the field is alternating, it is obvious that the bar will contract and expand to the movement of the field. If the dimensions of the bar are adjusted so that the vibration induced in it by the alternating field corresponds to the natural frequency of vibration of the bar, then the resonance effect becomes operative, and the bar will vibrate with such amplitude that an audible note may be emitted. Alternatively, the vibration of the bar may be made to react on electrical circuits. This principle is applied to frequency standards for use in radio work. Provided that the dimensions and temperature of the rod of nickel are all standardised, then the frequency of the resonant vibration may be calculated. By determining experimentally the conditions under which resonant vibration takes place, it is possible either to check the frequency of unknown vibrations or, alternatively, to maintain a standard frequency, as, for example, in a broadcasting station.

Limitations of space preclude a detailed discussion of all the applications of nickel alloys for magnetic purposes in the radio field. Sufficient has been said, however, to indicate that for high-permeability purposes, as permanent magnets, and in other special directions, these alloys offer important and interesting properties, which have all contributed their share towards the development of high-efficiency radio and television.

Learning Morse

A NEW booklet with the above title has just been published to enable those desirous of learning Morse to master it with a minimum of effort. As more rapid progress can be made by memorising the sounds represented by the dots and dashes at the outset, a small self-contained Morse practice set is described and constructional details given.

The contents include the complete Morse code, "Q" code abbreviations, the QSA and RST codes employed by amateur transmitting stations, and a list of International Prefixes for identifying amateur stations.

It is obtainable from the publishing offices of *The Wireless World*, Dorset House, Stamford Street, London, S.E.1, and the price is 6d. net, or 7d. post free.



"Monarch" Multivibrator

AID TO RAPID ALIGNMENT OF SUPERHETS

All controls are mounted on the front panel, here partly removed to expose the chassis.

MUCH interest has been shown by readers in the article by H. Harris¹ on the advantages of the multivibrator for rapid and easy alignment of superhets. The following are particulars of a commercial multivibrator produced by the makers of the well-known "Monarch" Signal Generator.

It will be remembered that the object of the multivibrator is to supplement, not to supersede, the signal generator; and that the adjustment of oscillator padding condensers, which with a generator alone is a rather tricky and lengthy process, is made as simple and quick as straightforward trimmer adjustment. It can, therefore, be carried out expeditiously by

The difficulty about padder adjustment with the signal provided by the usual form of signal generator is that the frequency to which the preselector circuits are tuned is not known exactly, and that as they have already been set at the high-frequency end of the scale it is allowable to adjust them to the lower frequency generator signal only by means of the gang condenser, which carries the oscillator tuning, too. A process of trial and error is, therefore, needed to arrive at the setting of the gang condenser and padding condenser that are optimum for the signal frequency selected. If a continuous band or spectrum of signal were available, of substantially uniform strength over the small range of adjustment concerned, it would

sets by the thermal agitation noise; but the multivibrator supplies a suitable signal controllable up to a strength sufficient for even the least sensitive superhet. It does this by generating an oscillation at a frequency of a few hundred cycles, so rich in harmonics that all the usual radio-frequency tuning bands are covered by them.

In the "Monarch" the fundamental frequency is about 400 c/s, and harmonics up to and beyond the 50,000th are detectable. The result in the receiver to which it is applied is a 400-cycle note regardless of the frequency to which the receiver is tuned. The first stages of alignment are carried out as usual on a single signal produced by the signal generator; then for the padder adjustment the multivibrator is substituted.

Detecting "Flat Spots"

A further advantage of the multivibrator is that it enables the sensitivity (and hence the accuracy of tracking) of a receiver to be roughly checked over the whole of each waveband; a process that is generally omitted when only a signal generator is available, on account of its being excessively tedious.

The circuit diagram of the "Monarch" shows it to be similar to the one previously

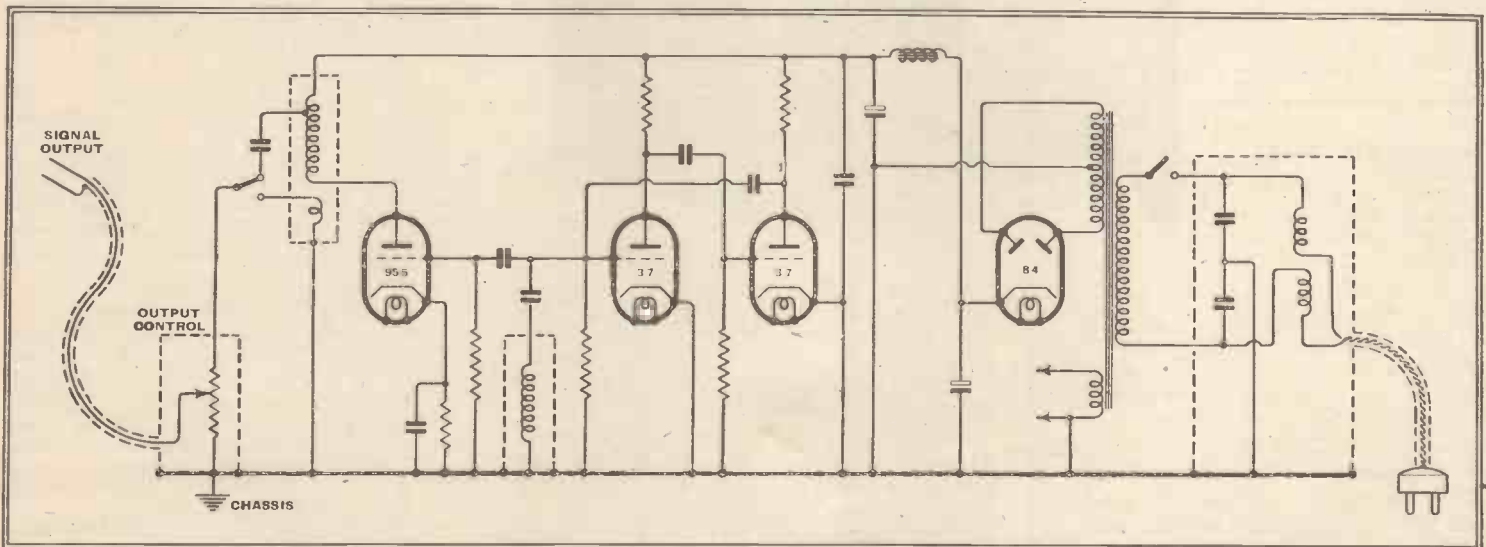

Circuit diagram of the "Monarch" multivibrator. The dotted lines indicate screening cans within the metal case of the instrument; the mains lead is also screened by a braided sheath.

comparatively unskilled operators; which is particularly helpful when large numbers of sets have to be dealt with economically.

¹ The Wireless World, February 23rd, 1939, p. 181.

merely be necessary to adjust the padder to maximum response, which would occur when it caused the oscillator to track correctly with the preselectors. Such a continuous signal is provided in very sensitive

described by Harris as regards the two back-coupled valves that generate the signal; but a valuable additional feature is an amplifying stage, employing an acorn triode, for counteracting the ten-

"Monarch" Multivibrator—
dency for the harmonics to diminish in strength as their frequency progresses, and so to secure a reasonably constant

with the valve capacity at about 20 Mc/s and at lower frequencies presents a load approximately proportional to frequency. Direct or inductive coupling to the out-

put control can be selected by a switch; on test the direct connection (switch to the left) was adopted, and gave a somewhat greater output than the other.

The instrument undoubtedly fulfils the claims made for it; and particularly it was confirmed that the character of the signal is such that padder adjustment can be judged quite well by ear, which is practically im-

possible in the usual method. Considerable numbers of "Monarch" multivibrators are in use in many of the American radio factories, and no doubt there is scope for them wherever receivers are

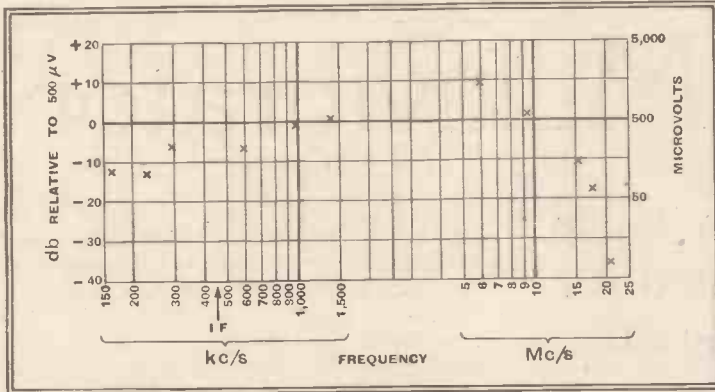

RMS values of 30 per cent modulated generator signal equal in peak voltage to the multivibrator signal at the frequencies indicated. Considering the very wide range of frequency, the strength is remarkable uniform.

signal strength over the whole of the bands from 150 to 20,000 kc/s (except for a deliberate hollow in the region of 460 Mc/s to prevent direct IF interference). That this has been satisfactorily achieved is shown by the results of measurements taken at some of the important signal frequencies. Incidentally, in testing the instrument some thought was required to arrive at a method of measurement that would give a fair comparison between the multivibrator signal and the usual 30 per cent modulated signal from a generator. The straightforward methods were found unsatisfactory, owing to the rather peculiar nature of the multivibrator

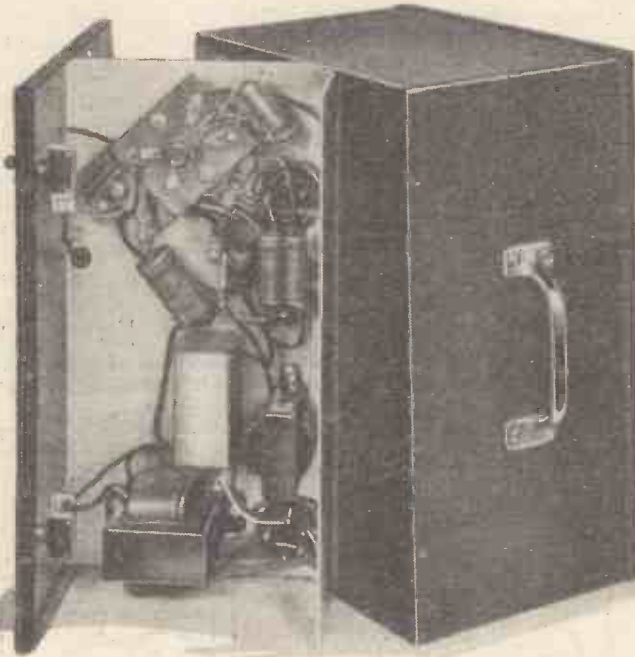

Although screening is thorough, the interior of the multivibrator is easily accessible.

signal, and eventually use was made of a receiver with a detector that could be "backed off" for muting purposes, and adjustment made until each signal could be just heard. The comparison is therefore on a basis of equal peak voltages.

The signal is smoothly controllable from this maximum down to zero, at which the screening of the instrument was found effective in excluding direct pick-up even by a sensitive receiver. In spite of this, the interior is quickly accessible for changing valves, etc.

The output from one of the pair of oscillator valves is shunted by an IF trap, and is led to an acorn valve, in the anode circuit of which is a coil that resonates

aligned in quantities. They are obtainable from Messrs. Claude Lyons, Ltd., 180-182a, Tottenham Court Road, London, W.1, and the price is £14 1s. net for single instruments.

Mains voltages are 200-260 volts 40-60 c/s AC; the black crackle-finished case measures 8½ in. high by 10½ in. broad by 6½ in. deep overall, and weighs 10 lb.

SPECIAL RECORDS

BOSWORTH and CO., LTD., 8, Heddon Street, London, W.1, have issued a classified catalogue of gramophone discs for use in arranging a musical background to broadcast programmes, amateur film displays, etc. The playing speed is 78 r.p.m., and the duration of each section is given to the nearest second. The price has been standardised at 2s. 6d., and the diameter of the records at 10 inches.

Television Programmes

Sound 41.5 Mc/s

Vision 45 Mc/s

An hour's special film transmission intended for demonstration purposes will be given from 11 a.m. to 12 noon each weekday. The National or Regional programme will be radiated on 41.5 Mc/s from approximately 7.45 to 9 p.m. daily.

THURSDAY, APRIL 13th.

3, Cyril Fletcher in "Re-View." 3.30, Gaumont-British News. 3.40, 233rd edition of Picture Page, introducing the Chester Hale Girls from the Dorchester Hotel.

9, Cabaret Cruise, with Commander A. B. Campbell, Irene Prador and Walsh and Barker. 9.45, British Movietone. 9.55, 234th edition of Picture Page. 10.25, News.

FRIDAY, APRIL 14th.

3, Vanity Fair, a parade of inexpensive Summer clothes. 3.15, Cartoon Film. 3.20, British Movietone. 3.30-4.5, "The Monkey's Paw," by W. W. Jacobs and Louis N. Parker.

9, Vanity Fair (as at 3 p.m.). 9.15, "The Shoemaker's Last," a new play by Geoffrey Thomas. Cast includes Hazel Terry and Cyril Chamberlain. 10.45, News.

SATURDAY, APRIL 15th.

3, Francis Redvers Miniature Theatre. 3.10, Gaumont-British News. 3.20, Joan Collier in Songs. 3.30, Cartoon Film. 3.35, Tom Walls in "The Van Dyck."

9, The Chester Hale Girls and Vera Haal, from the Dorchester Hotel. 9.15, Cabaret Cartoons. 9.30, British Movietone. 9.40, Demonstration of Catch-as-Catch-Can Wrestling. 10, Cartoon Film. 10.5, "The Almost Perfect Murder" a "telecrime" by Miles Horton. 10.20, News.

SUNDAY, APRIL 16th.

3, A Charlie Chaplin Film. 3.25, Friends from the Zoo. 3.40, Cartoon Film. 3.45, "The Charcoal Burner's Son," a play for the children.

8.50, News. 9.5, Irene Eisinger, soprano, accompanied by the Television Orchestra. 9.20-10.50, "A Night at the 'Hardcastles.'" A modern version of Goldsmith's play "She Stoops to Conquer," by Giles Playfair.

MONDAY, APRIL 17th.

3-4.30, "The Shoemaker's Last" (as on Friday at 9.15 p.m.).

9, Charles Heslop—"In the Barber's Chair." 9.10, "Derby Secrets"—Film. 9.20, "Diversification," a song and dance programme. 9.40, British Movietone. 9.50, "The Monkey's Paw" (as on Friday at 3.30 p.m.). 10.25, News.

TUESDAY, APRIL 18th.

3, Starlight. 3.10, Cartoon Film. 3.15, "In the Barber's Chair." 3.25, British Movietone. 3.35-4, "The Coffin," a one-act comedy by John Taylor.

9, Coliseum Night. O.B. from the stage of the London Coliseum. 10, Gaumont-British News. 10.10, "From the Tree," scientific, artistic and utilitarian treatments of wood. 10.30, News.

WEDNESDAY, APRIL 19th.

3-4.30, "Candida," the first full length Bernard Shaw play to be televised. Cast includes Marie Ney and Julian Mitchell.

9.5, Oliver Wakefield—The Voice of Inexperience. 9.15, Cartoon Film. 9.20, Demonstration of ballroom dancing. 9.35, British Movietone. 9.45, "Soho." Introducing personalities at the Café Cosella. 10.25, Leila Howell, 'cello and Henry Bronkhurst, piano. 10.35, News.

NEWS OF THE WEEK

ANTI-INTERFERENCE MEASURES

Radio-Interference-Free Mark for Electrical Appliances

IN 1937 a British Standards Specification for the limits of the magnitude, duration and frequency of occurrence of the interference with radio caused by electrical apparatus was published. The Specification indicated that a special Mark was being registered under the Trade Marks Act, the use of which would be permitted to manufacturers to denote that the apparatus bearing the Mark was radio-interference-free within the limits laid down in the Specification.

This Mark has now been registered, and the reproduction shown is from the new edition of British Standards Specification No. 800. It may therefore be expected that in due course electrical apparatus bearing the Mark will become available to the public, but some time must necessarily elapse to enable manufacturers to redesign their equipment and to dispose of existing stocks of unsuppressed apparatus. It should be noted that the Mark may only be used by manufacturers who have been licensed by the British Standards Institution.

Another important feature of the Specification is the description of the schemes of sampling and the respective tolerances permitted for compliance with the Specification, the original edition of which merely laid down the limiting figure for the magnitude of the interference, no indication being given as to the basis on which tests for compliance with this figure were to be carried out.



Copies of the Specification, No. 800-1939, may be obtained from the British Standards Institution, Publications Department, 28, Victoria Street, London, S.W.1. The price is 2s. 2d. post free.

BREAKING UP A STATION

Famous Long-wave Transmitter Scrapped

LONG waves have already been largely replaced by short waves for wireless communication, and many a station which was the pride of its constructors ten or twelve years ago is now silent or broken up.

The famous long-wave station at Caernarvon, which was one of the largest transmitters in the world, is now being dismantled by Thomas W. Ward, Ltd., of Sheffield.

The 400-ft. masts (ten tubular and six lattice) were built in rows 300 yards apart on the side of the Cefn-du, one of the lesser heights of Snowdonia. They originally supported an aerial 3,900 ft. long and a second aerial was added later.

At the outbreak of war the transmitter had only begun testing, and it passed straight into Government service.

A record of the changes and extensions at Caernarvon would indicate the various stages in the progress of long-wave transmission, for every type of transmitter, from synchronous spark to water-cooled valve, was tried out in turn. The "timed-spark" system, the most highly developed form of this method of transmission, was also employed.

Later the station was used for transatlantic traffic and subsidiary services in European and other countries. It has also been used extensively for the transmission of pictures to America, and words could be transmitted across the Atlantic at the rate of 100 per minute.

On September 22nd, 1918, the first message ever sent to Australia was transmitted from Caernarvon by means of the timed-spark system.

NATIONAL TELEVISION

Mr. Ogilvie's Observations

"WE want to take further steps to make television a national system at the earliest opportunity," said Mr. F. W. Ogilvie, Director-General of the B.B.C., when opening the B.B.C.'s travelling exhibition at Liverpool last week.

"The speed at which we can go forward," he added, "depends on the result of technical experience as to the means of transmission—it is hoped these results will be known before very long, although certainly not this year—and the question of finance."

A B.B.C. LOAN?

Reasons Against It

A GOOD deal of surprise has been expressed as to why the B.B.C., badly in need of money for television, does not exercise the right conferred in the Charter to float a loan.

The reasons against borrowing are that a loan could only be obtained for the period of the Charter, which, at the moment, is less than eight years. Doubt has also been expressed as to the value of the Corporation's realisable assets. In this respect the B.B.C. is at a disadvantage. Apart from buildings, it possesses very little that would satisfy speculators by way of security. Unlike a great newspaper, or a department store, with their machinery and goods, the Corporation has little of value to any other organisation.

It possesses a few lattice-masts which might appeal to the Electricity Commission for extensions to the Grid System; a collection of partly used valves for which readers of *The Wireless World* might make an offer; and three pipe organs, which might tickle the fickle fancies of cinema proprietors.

The B.B.C. will not attempt to raise a loan.

MOUNTAIN TELEVISION STATION

The Brocken Transmitter

GERMANY'S first mountain television transmitter, which has frequently been announced as completed, is now installed on the Brocken in the Harz Mountains, and will soon start operating; in fact, it may be testing by the time these notes are in print.

The 175-foot-high square tower, which forms the transmitter building, has been constructed of wood, as it is to house the aerial as well as the transmitter. The reason for placing the aerial within the building is to protect it from snow and frost and the consequential impairing of efficiency.

The engineers will have to ascend the 4,000-ft. mountain by a mountain railway; the only inhabitant of the fourteen-storey tower being a porter, who has a small apartment.

Programmes will emanate from the television studios in Berlin to which the transmitter is linked by cable. It is estimated that the station will have a range of one hundred miles and will serve a thickly populated area which includes Leipzig, Brunswick, Hanover and Magdeburg.

The television service from Berlin, which has been successively postponed from October last year, is now expected to be put into operation for the opening of the Berlin Radio Exhibition in July.

EUROPE'S FIRST mountain-top television transmitter on the Brocken (4,000ft.), which will serve a large area of Central Germany, is housed in the 175-ft. wooden tower on the right.



POLICE WIRELESS

National Short-wave Chain

HOME OFFICE plans for developing short-wave wireless for the Police Forces are now going ahead, and it is hoped that the force of every large town and city in Great Britain will soon have its own radio service.

The danger of a national emergency has given added impetus to the installation of police wireless, for a short-wave system would prove invaluable in the event of a breakdown in telephonic communications.

A general plan instituted four years ago by Sir John Simon, who was then Home Secretary, dividing the country into large regions each with a police wireless station having a service radius of at least fifty miles, has proved successful, and the plan will gradually be extended to smaller towns where the range of transmitters will be twelve or fifteen miles. Experiments recently carried out at Derby, in the presence of Home Office

News of the Week—

officials, produced extraordinarily good results.

Progress in police wireless has, however, been retarded owing to the delay of the G.P.O. in allocating wavelengths.

GRAMOPHONE RECORDS**Import Duty Exemption**

ON the recommendation of the Import Duties Advisory Committee, the Treasury has extended the exemption from duty of matrices for the pressing of gramophone records to cover all such matrices.

Wax and copper matrices were already on the Free List, and the Committee explains that the reason for its present recommendation is the development of the type made of aluminium with a cellulose coating. The new Order, which became operative on April 5th, allows duty-free importations not only of this type, but of any other matrices which may be introduced.

E.S.T. TO E.D.S.T.

WHEN on Sunday, April 30th, the time in the Eastern United States changes from Eastern Standard Time to Eastern Daylight Saving Time and advances one hour, the times of short-wave transmissions intended for listeners abroad will also be advanced one hour.

This will mean that in countries where they do not observe Summer Time, the American short-wave programmes will be received at their usual times. In Great Britain, which goes over to Summer Time on April 16th, and other countries observing Summer Time, the programmes will be received one hour later.

ULTRA-SHORTS FOR MERCHANTMEN

IT has been suggested to the Swedish Government by the National Association of Swedish Wireless Officers that ultra-short-wave transmitter-receivers should be fitted in all Swedish merchant ships trading between home and foreign ports. These would serve as a sure means of communication, with a reasonable degree of secrecy, between the vessels and the conveying warships which are already equipped with USW apparatus.

This Association has pointed out to the Government that the shortage of fully trained wireless operators has become acute, and that in the event of mobilisation less than half the required number for the Navy and Merchant Service would be available. This shortage is ascribed chiefly to the extensive malpractice of combining the duties

of radio operator with other offices in merchant ships and also to the growing use of automatic alarm apparatus.

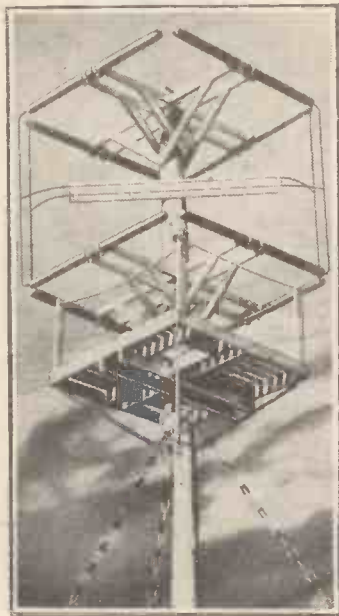

AMERICA'S FIRST hill-top television transmitter on the Helderberg Hills (1,500ft.), twelve miles from New York, is equipped with two of these new "cubic" aerials. Each aerial has eight elements, each of which are seven-foot copper tubes of 4 inches in diameter. The 10-kW station, which is owned by General Electric, has been assigned the call letters W2XB.

**FROM ALL
QUARTERS****Wireless in Coal Mines**

THE State coal mine at Lithgow, Australia, is to be equipped with two-way radio-telephone apparatus. Tests are being made by Amalgamated Wireless engineers, and already communication has been maintained over a distance of two miles. The innovation will enable the drivers of coal trucks to receive signals while they are travelling underground. It should also contribute generally to safety in coal mines.

Radio to Help Railways

THE National Union of Finnish Railway Employees has started a campaign to equip all important railway stations and junctions with wireless transmitting and receiving gear. Primarily designed as a national defence measure, these transmitters will also be a great asset in peace time, as the destruction of the railway signalling wires is a frequent occurrence during the winter months.

Gentlemen of the Force

MICROPHONE technique, or the art of speaking on the air, is part of the curriculum which Lancashire police undergo at the county's police road instruction centre near Preston.

STUDIOS IN BOURNEMOUTH

BOURNEMOUTH, although losing its transmitter, is to have new studios, these will be able to be linked to any B.B.C. transmitter, but will normally feed the Start Point station, the connection being through the control room at Bristol.

Incidentally, the B.B.C. is re-routing a considerable portion of the S.B. system, and the Gloucester relay point, formerly the focal point for all programmes destined for the west, will assume less importance. Bristol, on the other hand, promises to be a "Clapham Junction" for West of England radio.

INTERNATIONAL MEETING ON PHYSICS

DURING the Swiss National Exhibition, which opens on the shores of Lake Zurich on May 6th, will be held an International Meeting on Physics organised by the Federal Institute of Technology and the Physical Society of Zurich.

The meeting, which will take place from September 4th to 16th, will include sessions on television and high frequency. Among the lecturers on television will be Mr. Blumlein, of E.M.I., Dr. Okolicsanyi of Scophony, and Dr. Zworykin of R.C.A. The main lecturers on high frequency will be Mr. T. L. Eckersley of Marconi's and M. E. M. Deloraine of Le Matériel Téléphonique.

Televising the Cup Final

ALTHOUGH the B.B.C. is being permitted by the Football Association to televise the Cup Final from Wembley Stadium on April 29th, it cannot allow its transmission to be reproduced on large screens to paying audiences. This is because the F.A. has declined to grant the necessary permit.

Olympic Games Television

ACCORDING to the Finnish newspaper, *Hufvudstadsbladet*, negotiations have been opened between the television department of the German Reichspost and the Finnish Olympic Games Organising Committee regarding the installation of German television apparatus at the Olympic Games Arenas at Helsinki. Negotiations are also proceeding with the proprietors of the larger Helsinki cinemas for their temporary conversion into public television halls.

Recording on Lundy Island

PARTLY by air, and partly by sea, the components of the B.B.C. Recording Unit have been transported to Lundy Island, in the Bristol Channel, for the purpose of collecting material which, in a later broadcast, will tell the story of the island and its people.

School Radio

ILFORD Council are to spend over £500 in supplying wireless installations to all the senior and middle schools in the borough not already equipped with them.

The B.B.C. Exhibition

PUBLIC attendance figures registered at the B.B.C. travelling exhibition which has been touring the Midlands have been compiled by *The Nottingham Journal*. They include:—

Birmingham, 12 days	16,406
Nottingham, 15 days	10,562
Leicester, 13 days	7,486
Wolverhampton, 14 days	4,872

The exhibition is now in Liverpool, and will remain there until April 23rd, after which it will close down until the autumn.

Empire Public Relations

MR. DENIS MORRIS has been appointed Empire Public Relations Officer in the Overseas Intelligence Department of the B.B.C. He joined the Birmingham staff of the B.B.C. in 1936 as Talks Assistant, and the following year became Public Relations Officer for the Midland Region.

Norwegian Amateurs' Military Training

MEMBERS of the Norwegian amateur organisation, N.R.R.L., have been invited to co-operate with the Army. Those who join the spring manoeuvres are offered free uniform, billeting and pay equivalent to 5s. a day.

Indian Relay Station

A.I.R. has erected a receiving centre at Peshawar for picking up the Delhi transmissions. Peshawar, working on 200 metres, is now mainly a relay station taking Delhi transmission III except for an hour in the evening, when it gives local programmes. It is stated in *The Indian Listener* that this change has been necessitated by financial difficulties.

Television in the Operating Theatre

BY means of a television camera suspended directly above an operating table in the Israel Zion Hospital, New York, students in another part of the building obtained a close-up view of the surgeon at work, on vision receivers worked from a closed circuit.

Fishermen Fined

WHEN two fishermen were fined 10s. each at Campbeltown, near Edinburgh, for operating unlicensed wireless receivers on their skiffs, the authorities stressed the fact that a licence for a home receiver did not cover any other wireless installations belonging to the licensee.

French Power

It is reported from France that the power of the 20-kW Tunis P.T.T. transmitter will shortly be raised to 100 kW.

A New Aerial

A NEW 640-ft. mast-radiator of uniform cross-section and weighing 56 tons is to be installed for the Minneapolis station WCCO during May. It has been designed to handle 500 kilowatts.

Progress in Physics

THE fifth volume of the Physical Society's "Reports on Progress in Physics," which deals with advances in physical science up to the end of 1937, is now obtainable from the Physical Society, 1, Lowther Gardens, London, S.W.7, price £1 post free.

The Modern Receiver

Part VII.—DIODE DETECTORS

Stage by Stage

WHEN the wanted signal has been amplified and selected from other signals it is necessary to rectify it in order to obtain the modulation in a form which is suitable, after further amplification, for operating a loud speaker. The waveform of the signal at the output of the IF amplifier is as shown in Fig. 21(a), where there are two cycles of modulation.

It is clear that the amplitude of the radio-frequency carrier changes with the modulation; in fact, it is this change of amplitude that corresponds to modulation. There are, of course, many more cycles of carrier to each cycle of modulation than can be shown in a drawing. A loud speaker cannot respond to radio-frequencies and the average value of a modulated wave is zero, so that the application of the IF signal straight to a loud speaker has no result.

But suppose that in some way we wipe out one-half of the signal (a), so that it is like (b), then the half-cycles of signal have a mean value, for the changes all take place on one side of the zero line. The average is of the form (c) and is equivalent to an

alternating current of modulation frequency superimposed on a direct current.

The purpose of the detector is to provide an output of the form of Fig. 21 (c) from an input of the form (a). It does this by rectifying, or suppressing, one-half of the input and smoothing out the IF pulses of (b).

The Rectifier Action

Probably the most widely used detector is the diode with the basic circuit of Fig. 22. The IF signal is developed across the input transformer secondary and at first we shall consider it to be unmodulated. When the signal is applied the first positive half-cycles on the diode anode draw electrons from the cathode which flow into the condenser C, making the point A negative with respect to B.

The RF signal then goes negative, cutting off diode current; during this negative

part of the cycle some of the electrons on C leak away through the shunt resistance R.

The same action occurs on the next and succeeding cycles, and after a few cycles a condition of balance is reached when the number of electrons flowing into C during the time the diode is conductive is equal to the number flowing out through R during the time it is not conductive. The action is sketched in Fig. 23 after the steady state has been reached. At (a) are shown three cycles of the RF input voltage and at (b) the resulting anode current. Note that the current flows in pulses and only at the tips of the positive half-cycles of input; this is because of the negative voltage developed on C.

The condenser voltage is of the form (c) and of roughly saw-tooth waveform. This is because the condenser charges rapidly through the low resistance diode when this is conducting, but discharges slowly through the high resistance R when the diode is not conducting. The larger the value of the product CR, the longer it takes for the charge to leak away and hence the greater the voltage remaining on the

condenser at the next conductive cycle. A large CR product thus gives high efficiency and minimum ripple on the output. With a very large value the saw-tooth ripple of Fig. 23 (c) would be almost non-existent, and there would be a steady potential across C almost equal to the peak IF input to the diode. In practice, there is some ripple, and the mean value of the output (the DC output) is about 80 per cent. of the peak IF input. The ripple is small and of roughly saw-tooth waveform; it can be considered as made up of a series of sine waves of frequencies equal to the input and its harmonics. Those up to about the tenth may be appreciable, although they decrease as their order gets higher.

When the intermediate frequency is 465 kc/s, harmonics higher than the third are not usually important. It is necessary to confine this ripple to the detector, because serious trouble may arise if it is

FOLLOWING upon the discussion of the IF amplifier, the detector and AVC system are now dealt with and the importance of the correct values for the various circuit elements is shown. Some of the advantages attached to a particular method of obtaining delayed AVC are described.

allowed to reach other circuits. If it is allowed to reach the AF amplifier, for instance, it loads up the valves so that they cannot handle as much AF signal as they should do. Further, stray couplings from the AF amplifier to the RF or IF circuits may permit the ripple to be fed back to the input circuits.

Harmonics

This may also occur directly from the detector, and if there is feed-back in any appreciable intensity very unpleasant effects may occur. If the fundamental component of the ripple reaches the frequency changer there may be actual instability of the IF amplifier. If the harmonics reach the RF circuits there will be whistles when receiving signals on fre-

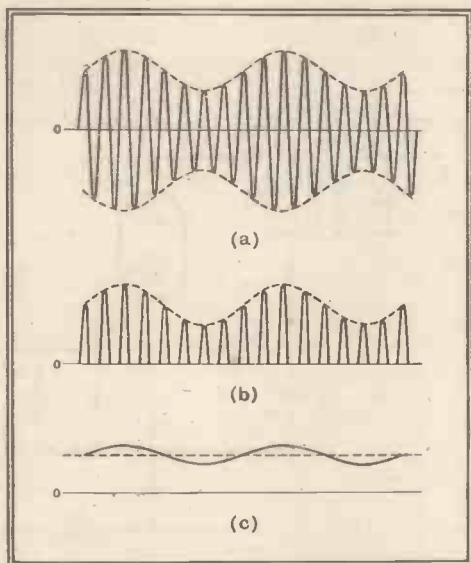

Fig. 21. The sketch (a) shows the form of a modulated wave and (b) the effect of wiping out one-half of it, as by a detector. The mean value of (b) is shown at (c).

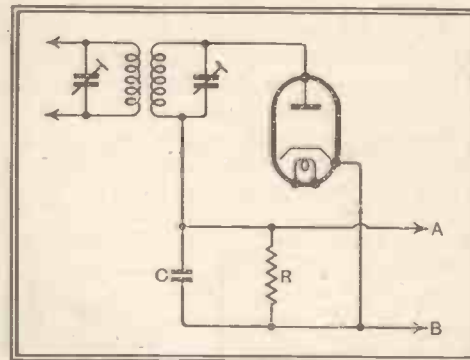

Fig. 22.—The basic detector circuit is shown here.

quencies near those of the harmonics. With a low intermediate frequency, such as 110 kc/s, it is quite possible for nearly every medium-wave station to have a whistle on it which is caused entirely by such feed-back.

The possibilities are much smaller with a higher intermediate frequency and with 465 kc/s are confined, on the medium-wave band, to a few stations around 930 kc/s and 1,395 kc/s. It is, however,

The Modern Receiver Stage by Stage—

important to see that the feed-back is not permitted in any appreciable intensity.

Adequate screening removes nearly all direct feed-back, and a filter is connected in the detector output to remove the

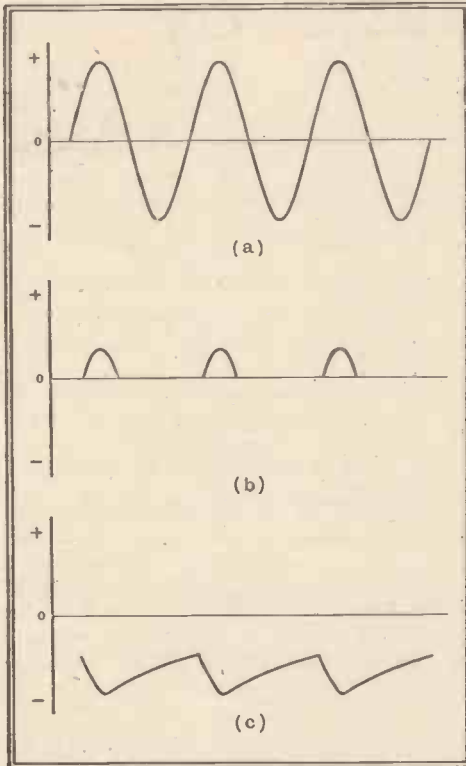

Fig. 23.—Several cycles of the IF input waveform to the detector are shown at (a) with the resulting anode current at (b). The detector output voltage takes the form indicated at (c).

ripple on the output. No filter can, of course, remove it entirely; it merely attenuates it to any desired degree. Such a filter is shown added to the detector in Fig. 24, and consists of the RF choke L and condenser C1. The choke offers a high reactance to radio-frequencies and the condenser a low reactance.

Across C1 we obtain a steady voltage which is about 80 per cent. of the peak RF input; if the input increases, the voltage across C1 increases also, and if it decreases then the output voltage decreases. Now a modulated input is nothing more than an RF input of varying amplitude, so it is clear that it will produce a voltage across C1 which varies in the same way.

The values of capacity and resist-

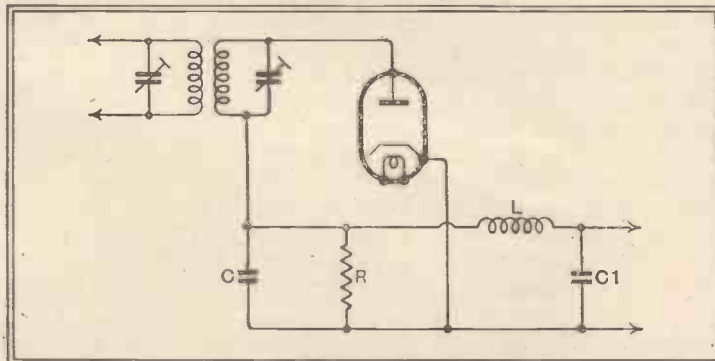

Fig. 24.—This diagram shows the basic detector circuit, with the RF filter L and C1 added.

ance are important, however, because the voltage across C1 may not be able to follow the modulation if they are too large. The charge on a condenser takes

a certain time to leak away through a resistance, and if the amplitude of RF input is changing more rapidly than the voltage across the condenser can fall the output is distorted.

The effect increases with modulation frequency and sets a limit to the values of capacity and resistance which can be used if good-quality reproduction is to be secured. In general, a resistance of the order of 0.25 MΩ is used with capacity not exceeding 0.0007 μF. Theoretically this capacity is actually on the large side from the quality point of view, but in practice the distortion introduced is exceedingly small and the improvement in the RF filtering is a decided advantage.

R.F. Filtering

The practical detector is rarely so simple as shown in Fig. 24, and the more general arrangement is illustrated in Fig. 25. Here R1 and C2 form the RF filter, a resistance being used instead of an RF choke because it is cheaper and more compact. R2 is now connected across C2 instead of C1 because it is often the AF volume control. It is then a potentiometer with C4 joined to its slider.

The action is substantially the same as before, but the voltages across R2 are slightly smaller because there is some loss in R1. This is small, however, if R1 is small in comparison with R2. Normally C1 may be 0.0002 μF,

Fig. 25.—The detector with the AF coupling C4 R4 and the AVC filter C3 R3 is shown here.

with C2 0.0005 μF and R1 10,000 ohms.

Across R2 we obtain a steady voltage, which is substantially proportional to the RF carrier input to the detector, with a superimposed modulation frequency alternating voltage dependent on the modulation. The voltage is negative with respect to the diode cathode.

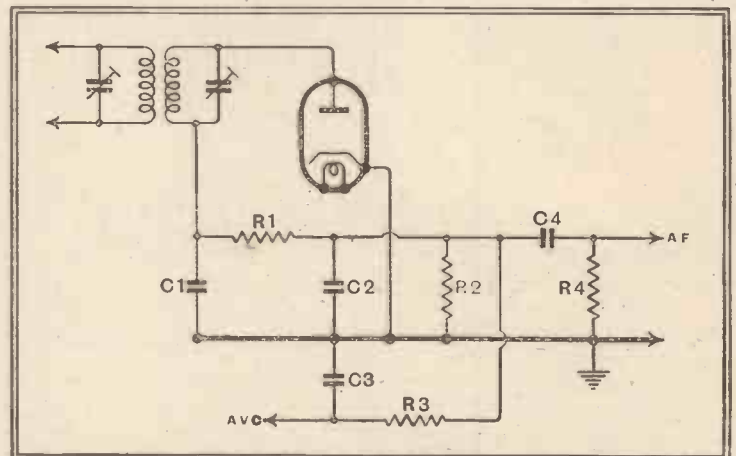

wanted, however. We thus take the detector output through a simple filter R3 C3, which substantially removes the AF modulation and leaves the steady voltage across C3.

The time-constant C3 R3 must not be too large, otherwise AVC will be too slow in operating; if it is not large enough, however, low-modulation frequencies will operate AVC. There are also limits to the maximum and minimum values of R3. Normally R3 is made 1-2 MΩ and C3 is 0.05 - 0.1 μF.

For the AF amplifier we need the AF voltages on R2 without the steady voltage; another simple filter is consequently used. This is R4 C4. It forms a complete barrier to the steady voltage, but allows the modulation to pass freely. R4 is 1-2 MΩ and C4 about 0.01 μF.

The values assigned to R3 and R4 are important from the point of view of quality, for the presence of these resistances reduces the depth of modulation that the detector can handle without distortion. Referring to Fig. 25, the load resistance of the detector is R1 + R2 as far as direct current is concerned, but for alternating current R2 is effectively shunted by R3 and R4.

With R1 = 10,000 ohms and R2 = 0.25 megohm, the DC load is 0.251 MΩ. If R3 is 2 megohms and R4 1.5 megohms, as in the Three-Band AC Super, the AC load is 0.1945 megohm. The maximum modulation depth which the detector will handle is equal to the ratio of the AC to the DC load resistances, or 77.5 per cent. in this case. Actually, unless the detector input is large, distortion does not occur in the practical case until the modulation is somewhat deeper than this.

It is not practicable to increase the values of R3 and R4 to obtain a better ratio, for these resistances are included in the grid circuits of other valves and their makers place a limit to the maximum grid-circuit resistance. Indeed, if it were not for the particular method adopted for delaying AVC, R3 would have to be considerably less than 2 megohms.

The only way of improving the ratio of the loads, therefore, is to reduce R2 or increase R1. Either course drops the efficiency. If R2 is reduced the detector efficiency falls off and the detector has a lower input resistance; that is, it damps

For automatic volume control purposes we require a voltage which is negative with respect to earth and which increases with detector input. No modulation is

The Modern Receiver Stage by Stage—

the input tuned circuit more heavily, thus reducing selectivity and the stage gain of the last IF valve. There is consequently a considerable drop in the overall efficiency. If R_1 is increased, while reducing C_2 proportionately, the detector input resistance increases, so making selectivity better and the IF gain higher. The detector output across R_2 , however, falls off seriously.

This is a case where a compromise between conflicting

Fig. 26.—Delayed AVC can be obtained with the aid of an additional diode V_2 ; the delay bias is obtained from R_5 R_6 .

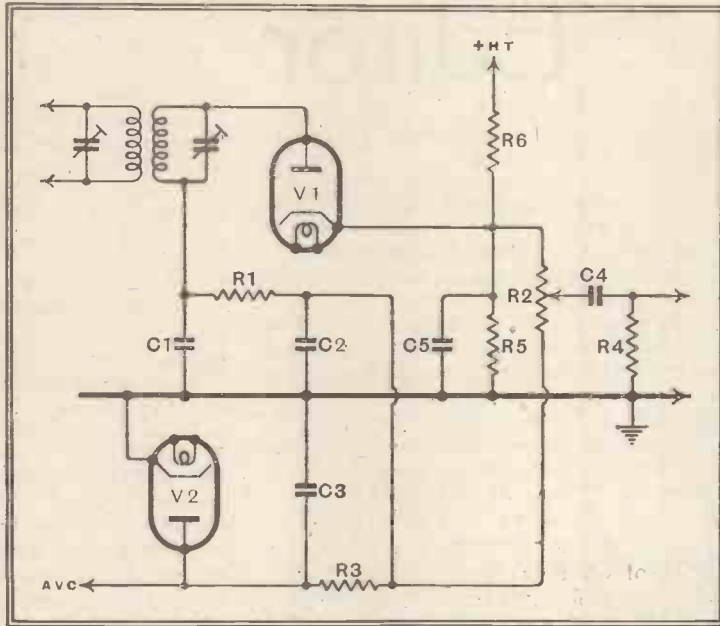

factors must be made, and the values selected in any case will depend largely upon the importance placed by the designer on the various effects. The values given in this case are chosen for a good compromise which sacrifices quality to a very small degree. It is not uncommon to find R_2 made higher than $0.25\text{ M}\Omega$, and then quality is necessarily somewhat poorer, although sensitivity and selectivity may be rather better.

Turning now to AVC, the steady voltage developed across C_3 is applied as grid bias to the early valves. These valves have variable- μ characteristics, and an increase in their negative-grid bias reduces their mutual conductances and, hence, their amplification. When a signal is tuned in, the steady component of the detector output is applied to these stages and reduces their amplification; the stronger the signal, the greater the detector output and their bias, and hence the lower the gain.

The simple circuit of Fig. 25 can be used in this way without any difficulty and gives very good results. One disadvantage is that the AVC action is always present and so reduces the sensitivity for weak signals. Another is that R_3 cannot be as high as $2\text{ M}\Omega$ if more than one stage is controlled.

This drawback may be overcome by using a particular form of delay, and this is shown in Fig. 26. Here V_1 is the detector diode and functions as already described. The cathode and the DC load resistance R_2 are joined together as before, but are not now returned to the earth line but to a point positive with respect to it. This point is the junction of R_5 and R_6 , and R_5 is shunted by a large capacity C_5 . This can be of the electrolytic type and a suitable value is $50\text{ }\mu\text{F}$.

Call the voltage across R_5 E , and the detector output e , then, ignoring the diode V_2 , the output voltage on the AVC line is no longer $-e$, but $E-e$. In the absence of a signal the AVC line is positive, and

as the signal increases the positive voltage falls to zero and then increases in a negative direction.

The diode V_2 , however, prevents the AVC line from becoming appreciably positive, for it conducts until its anode is more negative than about -1 volt. Its internal resistance is only a few thousand ohms at most, and as R_3 and R_2 are high in comparison, the diode acts nearly as a short-circuit across C_3 . No matter how large E is, the AVC line never becomes positive by more than a small fraction of a volt.

When the detector output is more than about 1 volt greater than E , the anode potential of V_2 is more than 1 volt negative with respect to its cathode, and this valve becomes non-conductive and plays no further part. Apart from introducing delay, V_2 completes the grid return circuits when it is conductive. It is for this reason that R_3 can be as high as $2\text{ M}\Omega$.

The inclusion of V_2 affects the detector slightly. When it is conductive the detector has a small negative bias applied to it, because R_2 , R_3 , and V_2 form a potentiometer across R_5 and the anode is taken to the junction of R_2 and R_3 . For this bias to be a minimum R_3 should be large compared with R_2 .

The effect of this bias is to mute the detector; that is, to prevent it from functioning on signals below a certain level. This is not disadvantageous in practice, for in a sensitive receiver of this nature all signals which are sufficiently stronger than the noise level to be useful will operate AVC. As soon as AVC works, the detector bias disappears.

In practice, of course, two separate diodes, V_1 and V_2 , are not used, but one of the duo-diode assemblies. The older types having a common cathode are unsuitable, but the newer ones have separate anodes and cathodes and can well replace the two separate valves of Fig. 26.

HENRY FARRAD'S SOLUTION

(See page 344)

THE voltage at the anode for any current passed through the $20,000\text{-ohm}$ voltage-dropping resistor can be indicated on the valve diagram by a straight line, as shown here. For example, when no current is passed the voltage is the full 90 ; when $4\frac{1}{2}\text{ mA}$ is passed the voltage is nil, because it is all absorbed by the resistor ($0.0045 \times 20,000 = 90$); and when the current is $2\frac{1}{2}\text{ mA}$ the voltage is 45 , as shown by the point B on the line. B also happens to be on the valve characteristic curve, so the 90-volt supply is correctly distributed between valve and resistor at that current, which is exactly what was intended. But it can be seen that there are two other points, A and C, where the same thing applies. So there are three possible ways in which 90 volts can be allocated between resistor and valve anode. Of these, the only one that has a negative resistance slope, and is therefore suitable for generating oscillations, is B. Unfortunately, of all three points that is the only one that cannot be maintained in practice, because it is an unstable condition, like balancing an egg on its point. Although theoretically possible, it is practically impossible, because the slightest disturbance of the balance (such as the start of oscillation) tends to drive the working point to either A or C. If Mr. Lea were to measure the anode current he would find it to be not $2\frac{1}{2}\text{ mA}$, but either 0.7 or 3.7 .

The cure is to supply the anode from a tapping or from a low-resistance potential divider. The latter is not very economical for battery HT, of course.

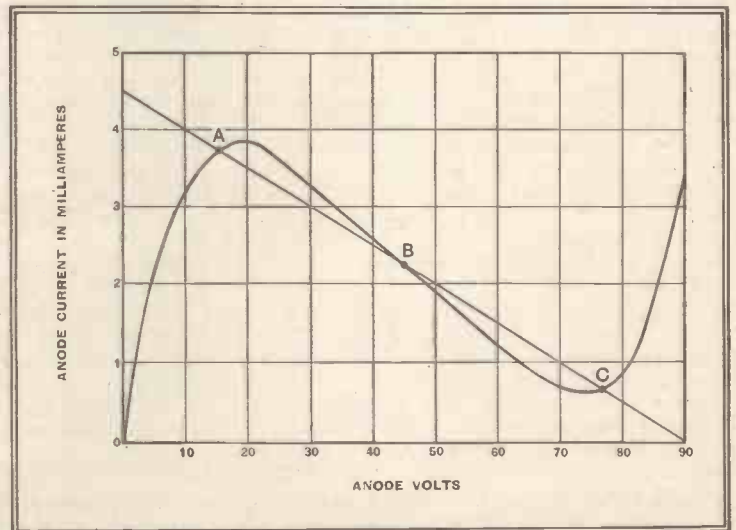

Why Ray Lea's dynatron refused to oscillate.

Letters to the Editor

The Editor does not necessarily endorse the opinions of his correspondents

Henry Hall from Germany

THE last statement of your correspondent, Mr. A. E. Thorn—"Compared with transmissions of this orchestra from the B.B.C. studios, the balance seemed much better," may have quite a lot to do with the improvement in quality.

It is almost certain that the orchestra in Germany was balanced by the studio engineers, specialists in this particular job.

I remember seeing a picture in a B.B.C. journal of Henry Hall balancing the orchestra himself. It is quite possible, therefore, that anyone combining this work with conducting, arranging, announcing, etc., etc., may not be able to devote so much attention to it as a specialist. J. R. HALE.

Harrow, Middlesex.

Television Service for the North

I READ with interest in the issue of *The Wireless World* for March 30th the paragraph by your contributor "Diallist," which stated as too optimistic a claim made by certain newspapers that a television transmitter at Manchester would cover most of the large towns in Lancashire and the West Riding of Yorkshire.

I am in complete agreement with your contributor, because for the past year I have been carrying out 5-metre tests in the West Riding of Yorkshire, particularly in the Sheffield district. Assuming that wavelengths of 5 metres are representative of the general characteristics of wavelengths which are now used, or have been allotted for future use for television purposes, I think my tests can be regarded as of value.

On the eastern side of the Pennine Range, taking Nottingham as the southern point and Leeds as the northern point, each within a radius of, say, 35 miles of Sheffield, exceptional field strengths have been obtained. These field strengths are consistent under all weather and atmospheric conditions, and thus give great promise of good television coverage in the area marked out. To the east of Sheffield results are not yet tabulated, but I think they will be as good as, or better than, those obtained to the north and south. To the west results are very poor because of the intervention of the Pennine Range, where you have between Sheffield and Manchester varying contours rising to 1,500 feet on peaks and averaging 800 feet or more. Lancashire 5-metre transmissions are not received very well at my station, but, of course, when a mobile transmitter is taken on to a peak extremely good results are obtained.

It is my opinion that if radio links are used for distributing television the possibilities of fixing a terminal distributing station on a peak between Sheffield and Manchester would enable good pick-up to be obtained from a link station at, say, Nottingham or Birmingham, and make easy the distribution of the link to Manchester, Leeds, Sheffield, Huddersfield, and many other towns. This scheme would involve the erection of a number of lower-power stations in the centre of populous areas, but I am sure that it would be much more efficient, and cheaper than

erecting a replica of Alexandra Palace in these hilly districts.

The experiments and tests on 5 metres are still proceeding, and I wish to acknowledge my indebtedness to several amateurs in the North Midland and South Yorkshire districts without whose help the experiments could not be carried out so efficiently. The information gained about ultra-high-frequency propagation in Sheffield and surrounding districts has been offered to interested Departments, and it is hoped that they will make full use of the information obtained, which may be the means of saving expense when field strength surveys are made.

Sheffield.

G. W. BAGSHAW,
G8KD, G8KF.

Electric Shock

THE American amateur, Phil C. Murray, whose death you report in your issue of March 30th, was killed by a shock from the microphone lead of his speech amplifier; a "short" had developed in the rectifier filament winding of his power transformer. The transmitter was not switched on.

The lesson to be learnt from the untimely death of Murray and others is that it is not only the high voltage circuits in a transmitter which are dangerous if not properly constructed, but lower voltage circuits in more commonplace pieces of apparatus as well. Even 200 volts can be fatal if you can't let go.

W. D. HORNIMAN,

Captain, Royal Signals.

Catterick Camp.

Reproduction Levels and "Scale Distortion"

IN a very interesting article entitled "New American 'Quality' Receiver" (*The Wireless World*, March 23rd) in the section devoted to "Scale Distortion," I noted the following passage: "The maximum allowable loudness in the home is much less than the best loudness for such musical items. Under these conditions tone compensation is absolutely necessary if the reproduced sound is to have the same tonal balance at domestic volume as it would have if listened to at concert volume." All that follows from this statement, in the way of the application of the "field of audition" diagram to the design of compensating networks to give the desired "tonal balance," is, of course, sound in every way and by now fairly well understood. In my view, however, the whole case is erected on a fundamentally incorrect foundation.

It is true, of course, that if we listen at a level lower than the original, then tone compensation is essential to preserve the original "tonal balance." It is, however, perfectly possible to produce, under domestic conditions, the same intensity at the ear as would exist at the ear if listening to the same item in the concert hall, although, naturally, in such a confined space, the acoustic output of the speaker need be only a fraction of the acoustic output of the orchestra. Presumably this latter point is the basis of the misconception.

We are concerned here with "high-fidelity" reproduction, and this all-too-common acceptance of the inevitability of incorrect level listening is a counsel of despair which must rule out the possibility of real high quality. If the loudness of an item when heard by radio is not the same as would be experienced in the concert hall, then the reproduction cannot fairly be called "high fidelity." The realism and the resulting emotional appeal of a symphony is not capable of simplification in terms of "tonal balance." Given the knowledge of harmonic analysis (and sufficient patience), no doubt one can analyse music in terms of frequencies and amplitudes. To do this to Beethoven is as ludicrous as to describe the work of Michael Angelo in terms of so many grams of different kinds of pigment. The loudness of a symphony is part of the symphony; if we change it, no amount of "tonal balance" can resurrect the murdered original.

Some may reply to this that they do not like too great a loudness, that they prefer to sit at the back of the concert hall, or even in the "gods." Perhaps they do, but, if so, then their "tonal balance" is "upset," and we hear of no demand for correcting appliances for the ears of such listeners. In no natural way is it possible to hear music softly and yet preserve the same "tonal balance" as exists when it is heard loudly. Why, then, should we try to introduce this unreal condition into our "high-fidelity" radios?

This letter is not an attempt to decry the value of compensating networks. Many faults still exist in the mechanism of sound reproduction and valuable work has been done on means of correcting these. Do let us be careful, however, not to introduce scientific over-simplification into the realms of Art and delude ourselves that a diminutive potted version of a symphony with a "corrected," but, in the circumstances, unreal "tonal balance" can ever sound like the original. High-quality reproduction must aim at the reproduction of the original, faithful in every respect, including loudness.

J. R. HUGHES, A.M.I.E.E.

London S.E.

STAND-BY THREE CABINET

A CABINET designed for *The Wireless World* Stand-by Three has been received from Lockwood and Co., of Lowlands Road, Harrow, Middlesex. It is solidly made of 3/4 in. oak-faced wood with 1/2 in. panel.

There are rubber feet, a removable back, perforated metal speaker grille, and carrying handle. Holes for the panel controls are drilled, and the cabinet is nicely finished in natural oak colour and polished. It is priced at 14s.

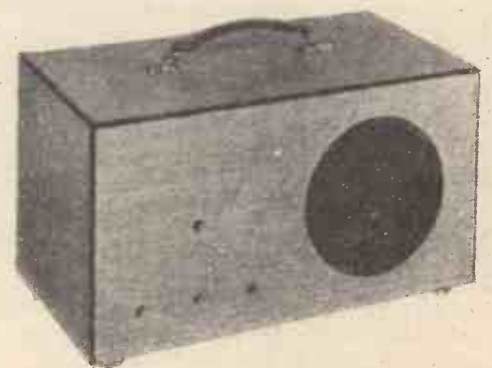

It can also be supplied with polished medium or dark oak, mahogany, walnut, or coloured enamel finishes at 16s. 6d.

Automatic Frequency Control

SIMPLE VARIABLE INDUCTANCE SYSTEM

AN ingenious method of obtaining automatic frequency control is adopted in the H.M.V. 1102 and Marconiphone 874 receivers. It operates on the push-button circuits only, and the control is effected by varying the permeability of the iron core of a coil connected in the oscillator circuit.

The arrangement is sketched in Fig. 1, where V1 is the IF valve and V3 performs several functions. The IF transformer primary L1 is tuned to the intermediate frequency, and the secondary L2 is untuned and feeds one diode in V3. This acts as the detector with the by-pass condenser C1, filter resistance R1, and load resistance R2. The AF output developed across R2 is applied through C2 and the volume control R3 to the grid of the triode section, and the AF output appears across R5 in the usual way. The other diode in V3 provides AVC, and as its circuit is normal it is not shown; it is fed through a condenser joined between the two diode anodes.

The duo-diode V2 is part of the discriminator, and is the first step in the AFC circuit. This part is normal, the diode being fed from L3, which is coupled to L1 partly magnetically and partly capacitively by C3. The voltages produced across R6 and R7 are of opposite polarity, and when the signal through the IF amplifier is exactly at the intermediate frequency they are equal. The total voltage across R6 and R7 is then zero.

The Control Circuit

When the signal is not exactly at the intermediate frequency the voltages do not balance exactly, and there is a voltage across R6 and R7 of polarity dependent on whether it is higher or lower than the intermediate frequency and of magnitude depending on the frequency difference.

This voltage is applied through the filter R8 C4 as grid bias to the triode section of V3 and changes the bias positively or negatively about the normal bias voltage provided by R4. These changes of bias alter the anode current of V3 and hence the current through the primary of the control transformer T.

The secondary of this transformer is connected in series with the oscillator coils L, the whole secondary being used for two of the coils, and portions only of it for the others. The oscillator circuit is of the Colpitt's type with fixed condensers C5 C6 to provide the cathode tap. The coils L have adjustable powdered-iron cores for trimming. V4 is, of course, the triode-hexode frequency-changer.

The transformer T is so designed that with the normal anode current of V3 through the primary the core is partly saturated. A change in the value of the primary current then alters the effective permeability of the core and hence the inductance of the secondary. As the secondary is connected in series with the oscillator coil, the total oscillator inductance changes.

If a trimmer is imperfectly set, so that

the intermediate frequency produced does not fall exactly on the peak frequency of the IF amplifier, the discriminator V2 produces an output which changes the anode current of V3. This alters the permeability of the core of T, and hence the oscillator inductance. This in turn changes the oscillator frequency and so brings the intermediate frequency nearer the correct value. The frequency error is thus kept very small.

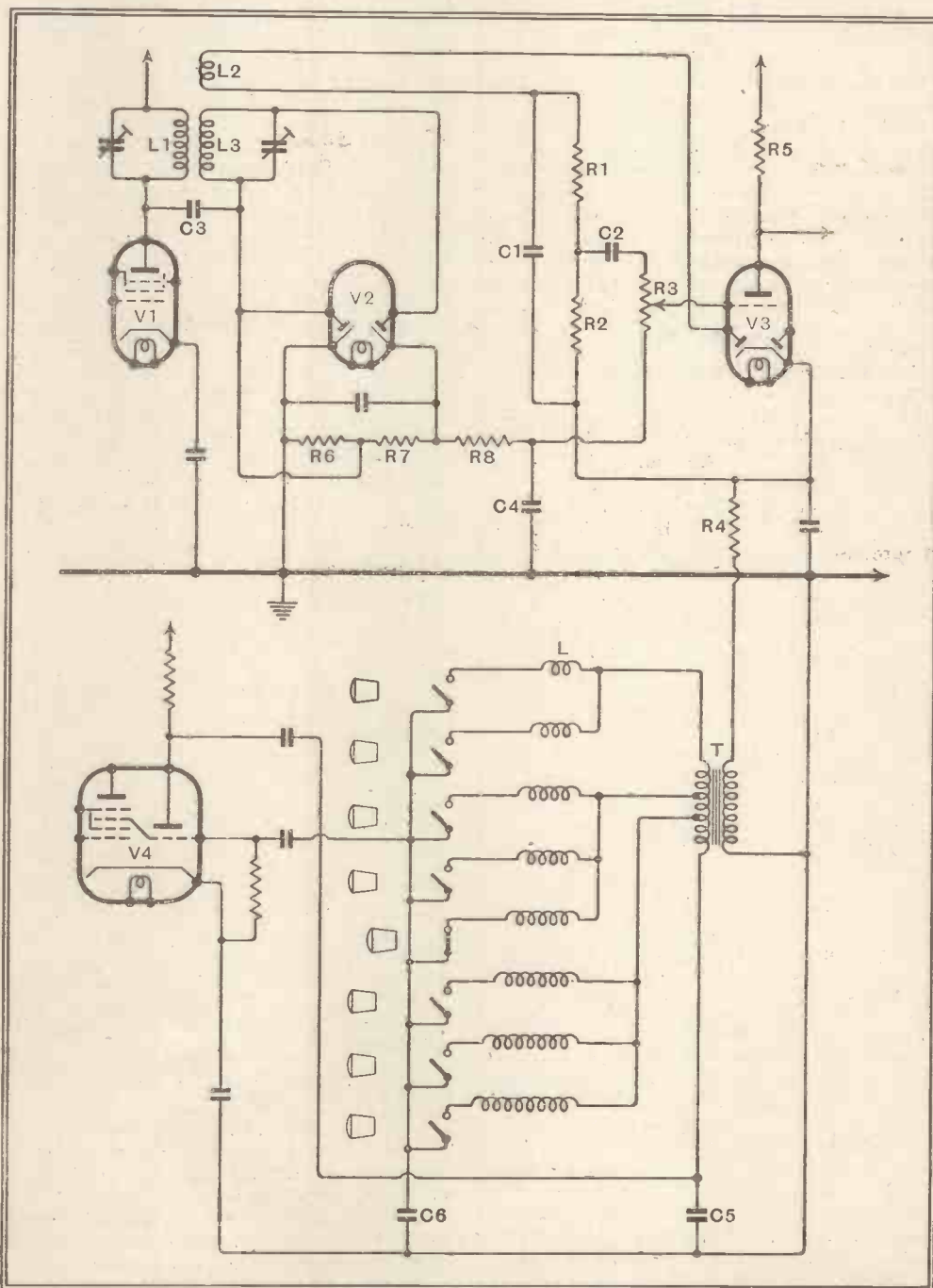

Fig. 1.—In this diagram V2 is the discriminator and control of the oscillator is effected by varying the current through the transformer T.

Random Radiations

By "DIALLIST"

The Boat Race

SOME hard things have been said about the televising of the boat race. There's no doubt that those responsible made the best job they could of it with the money, the material and the apparatus at their disposal. The boat race course is rather over 4 miles in length. To give anything like a continuous picture of the race you'd need dozens of emitron cameras, connected by co-axial cables or radio links to the Alexandra Palace. A vast staff would be required and the total cost of the televising of an event lasting 20 minutes or so would be enormous. I've no doubt that the O.B. department at A.P. would be wishing to give its collective ears for the chance of doing the thing on the grand scale; as it is, it must put up the best show that it can with very limited resources. I must say, though, that the method of showing large parts of the race by means of model boats and a relief map is not impressive. It is also hardly in keeping with the march of progress; I think I mentioned last year that I saw the same thing done in either 1906 or 1907 at the Union at Cambridge, the only difference being that the link was then the landline telephone, so that there was a time-lag of some minutes.

The Battle for Television

MR. OSTERER is not going to let the grass grow under his feet in the matter of television in the cinémas. His point of view is that the public wants television—particularly television of current events—and that the quickest and surest way of making it available to the largest numbers is to be found in the use of the big-screen process in the ciné theatres. He's not content with a single transmitting station, serving just the London area; he wants to see the television service extended rapidly to other parts of the country. This has hitherto been prevented by lack of funds, but Mr. Osterer has hinted (if it hasn't been rather more than a hint) that the cinémas might help to the tune of millions of pounds. Much hard thinking would have to be done and the most cast-iron of safeguards devised before any such offer could be accepted. Whatever happens, the birthright of television must not be thoughtlessly bartered away. At the same time we can't help realising that television badly needs a real boost—and hardly looks like getting it under present conditions.

A Nasty Noise

JUST before an outsize in colds caused me to retire to the bed where I am writing these notes, the worst interference that I've ever had with medium- and long-wave wireless reception developed quite suddenly. My better-half tells me that it still continues, so I must see what can be done about it when I'm allowed up again. The interference is, apparently, mains-borne. So loud is it with a mains receiver that it produces about a one-to-one noise to signal ratio when the London Regional is coming in. I just had time before retiring to bed to try a battery set on the same aerial and

earth. With this you had to listen hard to hear the noise when any strongly received station was tuned in, though it ruined any weak transmission. One of my neighbours, I suppose, has stood himself or herself a new domestic gadget of some kind and didn't bother to find out first of all whether or not it radiated interference. If only people would do that, what a difference it would make. I suppose, though, that they just won't and that's that.

A Puzzling Business

LOOKING through my morning paper the other day, I counted no fewer than seven advertisements extolling the merits of domestic appliances, every one of which radiates interference with wireless reception. That was rather saddening; but I received a far worse blow when I opened a copy of the trade journal *Radio and Electrical Marketing*. In this I found a list of 175 models of vacuum cleaners available in this country. Those of non-radiating types were starred; and how many of these do you think that there were? There were just 32 out of 175—18.28 per cent. In other words, nearly 82 per cent. of the vacuum cleaners offered for sale in the seventeenth year of broadcasting in this country are of a kind that interfere with wireless reception. One astonishing aspect of the business is that a considerable proportion of these interference-radiating appliances are made (or at any rate marketed) by firms concerned with the manufacture and distribution of wireless sets or the components that go to make them up!

What is the Idea?

To the best of my belief the motor car manufacturers do not encourage people to strew the roads with brickbats and large nails; they do not design and sell implements specially contrived to facilitate the making of pot-holes. They know that the better the roads, the greater will be their sales of cars. The wireless manufacturers should know that radio interference probably does more than anything else to cramp the sales of new wireless sets and of television receivers. Yet here they are helping to increase it! And the shops often gaily take a leaf out of the manufacturer's book. The van which delivers at your house a wireless set sent hopefully on trial may also deliver at your next-door neighbour's some domestic appliance that is certain to ruin its performance! Truly an amazing state of affairs and a priceless example of shortsightedness.

PA Quality

THE letter from Mr. D. W. Aldous on the subject of PA quality, which appeared in a recent issue, must, I am sure, have been welcomed by many readers. To me it has long been a mystery that the reproduction of sound in the average movie theatre should be so appallingly bad. One knows that cine photography has been brought to a fine art and that everything possible is done to ensure that the pictures projected on to the

screen shall be as nearly perfect as they can be made. Why are those who take all this trouble over the pictures content to let the accompanying speech and music be so vilely reproduced? Overloading is so common that one has almost come to regard it as inevitable. The loud speakers boom and blast, but those who operate them seem to regard that as their proper function. Often the low audio-frequencies are so strongly predominant that male characters are barely intelligible and even the ladies seem to speak from their boots. It's a pity that none of the big cine theatre chains has yet seen fit to specialise in high-quality sound reproduction. To do so might be well worth their while. As it is, there are many who, like myself, sigh for the old silent films.

Adventures with Records

WRITING from Winchester, a reader sends me an astonishing tale of his misfortunes with gramophone records. He bought a record of classical music, published by a well-known firm, and, after playing it twice, he found that a "repeat groove" had developed on one side and that on the other there was a place where the needle would jump about two grooves. Neither of these, he says, were in very loud passages. He returned the record to the shop from which he had bought it and was told there that they didn't think it was much use sending it back; that they had done so with others and had simply had the reply that a bad needle had been used. In this case the needle happened to be one of the record firm's own, so the reader insisted on a return being made. He obtained a replacement but the same two faults developed the first time that it was played. This reader agrees that records may become faulty when they have been used a good deal, but he doesn't see why records made apparently from a defective "master" should be sold. Neither do I. I shall be glad to hear if others have had similar experiences.

Surprising Figures

THE other day I was talking to a man who knows the ins and outs of wireless in India pretty intimately. Though I knew that the number of receiving sets in use wasn't very large, I was astonished, I must say, to learn from him that it probably wasn't more than 70,000 for the entire country. If those figures are correct—and I hope that they're not—they're most disappointing in view of the splendid efforts made by A.I.R., the Indian equivalent of our B.B.C. India's broadcasting service, with its medium-wave stations serving listeners at moderate distances, and its short-wave stations serving those farther away, is a remarkably good one, and its completion in a very short time was a splendid piece of work. I wonder why it is that broadcasting is so slow to catch on there? One knows that the number of very poor folk is immense; but in a country with nearly 400,000,000 inhabitants, there must be many times 70,000 who could afford to run receiving sets. It's rather a puzzling business.

C-R Tubes

ONE matter that urgently requires attention in the television world is the conditions of replacement of cathode-ray tubes in vision receivers? What is a new tube going to cost? What guarantee is it going

to carry? Does that guarantee cover other components of the receiver should a tube blow up and damage them? I am asked these questions by folk who are toying with the idea of installing televisions. I can't answer them, and when I refer enquirers to dealers I find that the latter are as much in the dark as I am. Surely it's about time that these things were properly cleared up?

The Wireless Industry

Taylor Electrical Instruments, Ltd., have moved to a new address at 45, Fouberts Place, London, W.1. (Gerrard 5255.)

A new booklet describing the Keates-Hacker Series 3 receiver and giving photographic examples of alternative cabinets in their appropriate settings has been issued by the Keates-Hacker Co., Ltd., 91/93, Bishopsgate, London, E.C.2.

Catalogue No. 640, issued by Siemens Electric Lamp and Supplies, Ltd., 38/39, Upper Thames Street, London, E.C.4, contains information on inert cells of the type discussed by "Diallist" last week.

The latest Bulgin "Bulletin" contains, among other things, particulars of a new range of vibrator HT eliminators with efficiencies of the order of 60-75 per cent. The approximate maximum voltage and current outputs are 150 volts and 50 mA respectively and the price for 4-, 6- or 12-volt inputs is £3 15s.

Grampian Reproducers, Ltd., Kew Gardens, Surrey, have sent us three recent leaflets dealing with their dance band outfits, 15-watt amplifiers for mains or battery operation, and projector type loud speakers.

Hints on the installation of the Belling-Lee "Eliminoise" anti-interference system for multi-point operation in blocks of flats are contained in Radio Interference Bulletin No. 59 and should prove useful to contractors who may have to estimate for such work.

Club News

Ashton-under-Lyne and District Amateur Radio Society

Headquarters: Commercial Hotel, 86, Old Street, Ashton-under-Lyne, Lancs.
Meetings: Alternate Wednesdays.
Hon. Sec.: Mr. K. Gooding, 7, Broadbent Avenue, Ashton-under-Lyne, Lancs.
On March 18th several members paid visits to transmitters at Oldham. From there seven amateurs went on to Royton to pay a visit to another transmitter. Mr. B. L. Simpson is now licensed as 2HAP.

Croydon Radio Society

Headquarters: St. Peter's Hall, Ledbury Road, South Croydon, Surrey.
Meetings: Tuesdays at 8 p.m.
Hon. Pub. Sec.: Mr. E. L. Cumbers, 14, Campden Road, South Croydon, Surrey.
At the annual general meeting on March 28th, Dr. Bailey made a point of applauding the encouragement given to the Society's own members in giving lectures. He pointed out that it was from this source that the amateur gained the most useful hints. Mr. P. G. Clarke suggested a scheme whereby members should meet at *The Wireless World* stand at Radiolympia next August and proceed thence round the Exhibition.

Dollis Hill Radio Communication Society

Headquarters: Braintrotft School, Warren Road, Cricklewood, London, N.W.2.
Meetings: Wednesdays at 8 p.m.
Hon. Sec.: Mr. B. Eldridge, 79, Osgate Gardens, Cricklewood, London, N.W.2.
The President has now completed a series of talks on the design of a power supply modulator and PA for a 25-watt transmitter. On April 11th a junk sale was held.
On April 25th, G6OV will lecture on methods of rendering first-aid in cases of electric shock.

Eastbourne and District Radio Society

Headquarters: The Science Room, Cavendish Senior School, Eastbourne, Sussex.
Hon. Sec.: Mr. T. G. R. Dowsett, 48, Grove Road, Eastbourne, Sussex.
On March 28th the Society held an exhibition night, at which there were many interesting exhibits, including a selection of old-time valves, and also crystal and electrolytic detectors and many other relics of the early days. There was also a very good example of a precision-built micro-ammeter.

Exeter and District Wireless Society

Headquarters: Y.W.C.A., 3, Dix's Field, Exeter, Devon.
Meetings: Mondays at 8 p.m.
Hon. Sec.: Mr. W. J. Ching, 9, Sivell Place, Heavitree, Exeter, Devon.
On March 27th the Society's amplifier, which has been reconstructed by Mr. C. J. Poulter, was demonstrated.
On April 17th a lecture will be given by Mr. D'Arcy Ford, entitled "Unusual Detector Experiments."

Golders Green and Hendon Radio Scientific Society

Headquarters: Regal Cinema, Finchley Road, Hampstead, London, N.W.2.
Hon. Sec.: Lt.-Col. H. Ashley Scarlett, 60, Pattison Road, Hampstead, London, N.W.2.
At a recent meeting Mr. G. Parr gave a talk on "Electro-Physiology." The lecture was illustrated by numerous lantern slides.

Radio, Physical and Television Society

Headquarters: 72a, North End Road, West Kensington, London, W.14.
Meetings: Fridays at 8.15 p.m.
Hon. Sec.: Mr. C. W. Edmans, 15, Cambridge Road, North Harrow, Middlesex.
On March 11th a party of members and friends visited the printing works of *The Sunday Graphic*. Particular interest was shown in the Wire Room and in the apparatus for the transmission and reception of photographs by wire.
At the last meeting Mr. G. Koyried, of H. Tinsley and Co., Ltd., gave a lantern lecture entitled "The Radio Frequency Dielectric Test Set Designed by the N.P.L."
On April 21st a representative of Partridge, Wilson and Co., Ltd., will lecture on "Rectifier Equipment."

Royal Air Force Amateur Radio Society

Headquarters: Electrical and Wireless School, R.A.F., Cranwell, Lincs.
Hon. Sec.: Mr. N. Davis, Electrical and Wireless School, R.A.F., Cranwell, Lincs.
Full membership of the Society is open to all serving members of the R.A.F., the Dominion or Colonial Air Forces, auxiliary air force, R.A.F. Reserve, or civilians who are, by virtue of their employment, directly connected with the R.A.F. Members must have had experience of research or experimental activities in radio-technology and be not less than twenty years of age. The subscription is 3s. annually for those at Cranwell, and 1s. 6d. for those stationed elsewhere.
Associate membership is open to all who are interested in radio-technology and who are, or have been, connected with the R.A.F. or with the Dominion or Colonial Air Forces in either a serving or a civilian capacity. The subscription is 9d.
Those stationed at Cranwell who are not eligible for ordinary membership can become student members. The subscription is 1s. 6d. If they do not wish to use the Society's experimental laboratory, the subscription is 6d., in which case they will be known as associate student members.
Both full and associate members receive copies of "QRV," the Society's journal.

Slough and District Short-wave Club

Headquarters: 35, High Street, Slough, Bucks.
Meetings: Alternate Thursdays at 7.30 p.m.
Hon. Sec.: Mr. R. J. Sly, 16, Buckland Avenue, Slough, Bucks.
At the last meeting there was a discussion on "The Causes and Effects of the Present Poor Conditions on all Short-wave Bands." This was followed by a talk entitled "The Short-Wave Receiver," given by Mr. F. J. Tuckfield.
The construction of the club receiver is proceeding under the direction of Mr. Baldwin (2BWV).
At the next meeting Mr. R. J. Sly will lecture on "The High Frequencies."

Southend and District Radio and Scientific Society

Headquarters: Strand Chambers, High Street, Southend, Essex.
Meetings: Alternate Fridays at 8.15 p.m.
Hon. Sec.: Mr. J. M. S. Watson, 23, Eastwood Boulevard, Westcliff, Essex.
On March 31st Mr. W. G. J. Nixon, of the General Electric Co., Ltd., lectured on "Some Aspects of Modern Valve Manufacture." On April 14th Mr. J. F. Veivers, of E. K. Cole, Ltd., will give a lecture entitled "Radio Receiver Measurements"; and on April 28th Mr. G. P. Britton, of Steatite and Porcelain Products, Ltd., will lecture on "The History, Properties and Manufacture of Ceramic Materials."

Tottenham Wireless Society

Headquarters: The Institute, 10, Bruce Grove, Tottenham, London, N.17.
Hon. Sec.: Mr. W. B. Bodehead, 56, Netherlands Road, East Barnet, Herts.
Great interest was shown in a recent lecture and demonstration given by Mr. Redgrave, of Voigt Patents, Ltd. Demonstrations were given from gramophone records, medium-wave broadcasting and the sound transmissions from the Alexandra Palace.

Watford and District Radio and Television Society

Hon. Sec.: Mr. P. G. Spencer, 11, Nightingale Road, Bushey, Herts.
Regular meetings of this newly formed society are held in the town, the next being fixed for this evening at 8 p.m. (April 13th) at the Carlton Tea Rooms, 77, Queen's Road, Watford.

Wirral Amateur Transmitting and Short-wave Club

Headquarters: Beecheroff Settlement, Whetstone Lane, Birkenhead, Cheshire.
Meetings: Last Wednesday evening in the month, at 7.30 p.m.
Hon. Sec.: Mr. J. R. Williamson, 13, Harrow Grove, Bromborough, Cheshire.
The annual general meeting was held on March 29th. Suggestions have been made for the holding of field days, and these will be discussed by club members. It is proposed to hold a discussion on "Antennae" at the April meeting.



BALLOON TRANSMITTER. Designed by the Blue Hills Observatory of Harvard University for the automatic transmission of meteorological information from the upper atmosphere, this miniature set is equipped with a clockwork mechanism (mounted on cover) a barometer, thermometer and hygrometer. The transmitted impulses are controlled by contact pins bearing on a rotating helix.

Recent Inventions

Brief descriptions of the more interesting radio devices and improvements issued as patents will be included in this section.

ELECTRON MULTIPLIERS

THE target electrodes in an electron multiplier are usually made as plane surfaces. It has been found that this allows the cross-section of the amplified stream to increase to such an extent that many of the electrons fail to strike against the later targets. The result is a falling-off in the efficiency of the tube.

According to the invention, the target electrodes are made either cylindrical or concave, so that they tend to form the stream into a definite beam, and to keep it in this condition during the whole of its passage through the tube to the collecting anode.

Fernseh Akt. Convention dates (Germany) April 11th and October 20th, 1936. No. 493714.

"HOMING" BY WIRELESS

WHEN a pilot is flying along a guideway marked out by wireless beams, the rectified signal voltages across the output of the homing indicator are as shown in diagram (a). If he is flying to the port side, they take the form shown at P, whilst S shows the signals to starboard. The unbroken line M, which keeps the indicator needle at zero, shows the centre-line course, where both signals merge together.

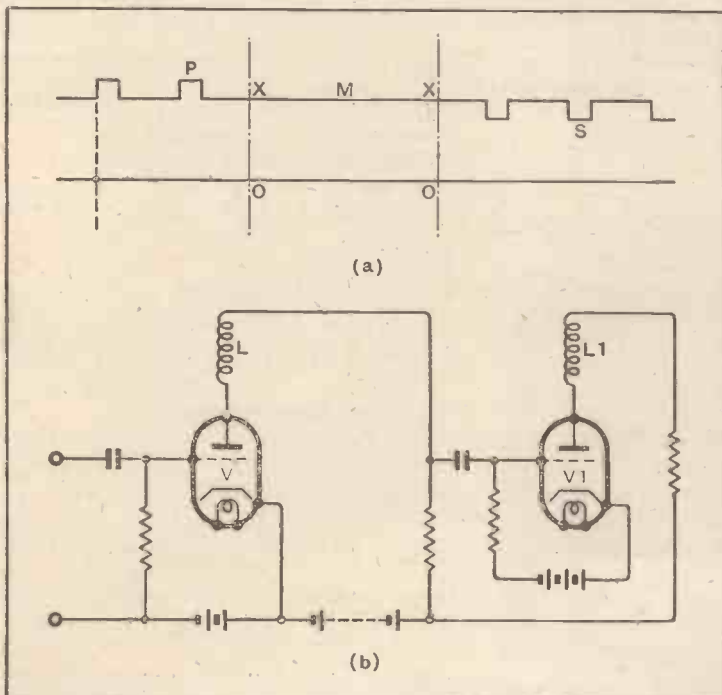

Arrangement for cancelling out the steady DC component of the actuating current fed to a homing indicator.

In all cases the current applied to actuate the indicator includes a comparatively large DC component OX on which the signal peaks or depressions are superposed. The latter supply the effective torque on the indicator, and the object of the invention is to eliminate the DC component OX since this

serves no useful purpose. The circuit used is shown in diagram (b) where the signal input is applied to the valve V and reappears in the coil L. The second valve V1 is adjusted until the steady current passed through the coil L1 equals OX. The two coils L and L1 are then reversely wound on the indicator magnet so that the effective torque on the needle is the difference between them, i.e., the amplified signal voltage P or S, freed from the DC component OX.

Standard Telephones and Cables, Ltd. (assignees of *Le Materiel Telephonique Soc. Anon.*) Convention date (France) December 17th, 1936. No. 495145.

LOUD SPEAKERS FOR TELEVISION SETS

A MOVING-COIL loud speaker, when mounted close to the cathode-ray tube of a television receiver, is likely to produce distortion owing to the effect of stray fields from the permanent magnet on the electron stream flowing through the tube. The risk can be reduced by using an intense magnetising field which helps to prevent the lines of force from leaving the surface of the iron and spreading outwards.

According to the invention, auxiliary energising coils are pro-

vided with a carrier-frequency in a so-called balanced modulator, and then rectifying the output. But to get efficient results in this way the modulation must be fairly deep, which means, especially when the available signal voltage is small, that the balance of the modulator must be critical, and must be kept so.

The invention discloses means for maintaining this working condition when handling television signals combined with periodical synchronising impulses. As shown in the Figure, the signals are applied at I to a balanced modulator M, where they are mixed with a carrier-frequency from a local source O. The output is amplified at A and rectified at R. A peak rectifier R1, with a time-constant longer than the synchronising impulses, but short enough to follow changes affecting balance, then feeds back a regulating voltage across the potentiometer P to stabilise the working conditions of the modulator M.

Baird Television, Ltd., and P. W. Willans. Application date March 30th, 1937. No. 493050.

AMPLIFYING SYSTEMS

TELEVISION signals, which include frequencies down to zero, can be amplified by first

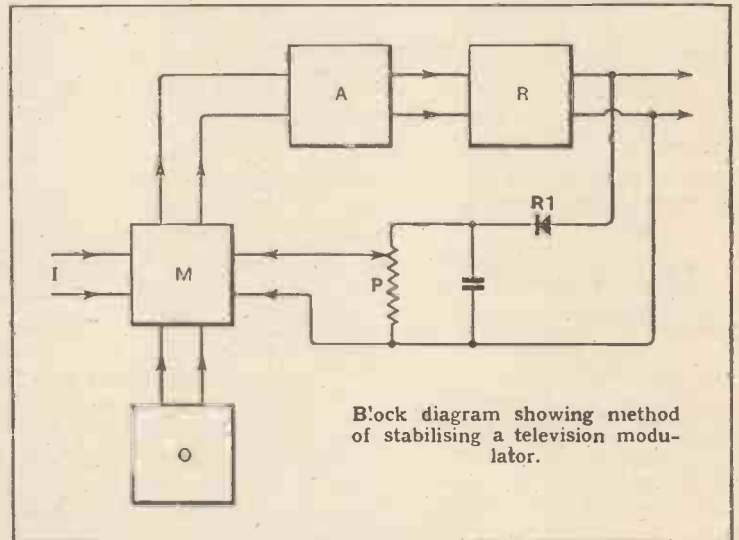

Block diagram showing method of stabilising a television modulator.

mixing them with a carrier-frequency in a so-called balanced modulator, and then rectifying the output. But to get efficient results in this way the modulation must be fairly deep, which means, especially when the available signal voltage is small, that the balance of the modulator must be critical, and must be kept so.

The invention discloses means for maintaining this working condition when handling television signals combined with periodical synchronising impulses. As shown in the Figure, the signals are applied at I to a balanced modulator M, where they are mixed with a carrier-frequency from a local source O. The output is amplified at A and rectified at R. A peak rectifier R1, with a time-constant longer than the synchronising impulses, but short enough to follow changes affecting balance, then feeds back a regulating voltage across the potentiometer P to stabilise the working conditions of the modulator M.

Baird Television, Ltd., and P. W. Willans. Application date March 30th, 1937. No. 493050.

NAVIGATIONAL WIRELESS

RELATES to short-wave transmitters of the kind used to mark out a navigational course, say, for an aeroplane, along the centre-line of two overlapping radio beams. When such a transmitter is installed at an aerodrome, it would be better to use quarter-wave instead of half-wave aerials, so as to minimise the height of the structure, but it is found that the shorter aerials tend to radiate an undue proportion of horizontally-polarised waves.

It appears that this is due to the fact that the "artificial earth" or counterpoise used with the aerials is itself set into oscillation, and since the earth-wires are horizontal the radiation from them is polarised in that plane. According to the invention, instead of using one common counterpoise, each aerial radiator (and reflector) is provided with a separate counterpoise. Each counterpoise is effectively insulated from the others, so that the undesirable earth currents are thus broken up.

R. J. Berry (communicated by *C. Lorenz Akt.*) Application date October 22nd, 1937. No. 498344.

MUTING CIRCUITS

IT is possible for the muting arrangements, normally provided to ensure noise-free interstation tuning, to come into operation when a station that is being received starts to "fade," thus cutting off reception inadvertently. One object of the invention is to prevent this from happening by improving the overall automatic regulation of a wireless set.

The circuits include a "director" designed to deliver a rectified output which varies according to the degree to which the RF input is mistuned, and a "corrector" which automatically brings the RF circuits into resonance. The director is so arranged that it is inoperative so long as the signal strength is below a threshold value.

The automatic regulation is independent of frequency; that is to say, it is constant over the whole tuning range of the set. It is also made to relinquish control if the tuning knob is advanced beyond a strong signal towards a relatively weak one in the near vicinity, thus allowing the latter signal to be easily tuned in.

Johnson Laboratories Inc. (assignees of *S. Y. White*) Convention date (U.S.A.) July 22nd, 1936. No. 493542.

The British abstracts published here are prepared with the permission of the Controller of H.M. Stationery Office, from specifications obtainable at the Patent Office, 25, Southampton Buildings, London, W.C.2, price 1/- each.

CLASSIFIED ADVERTISEMENTS

NOTICES

THE CHARGE FOR ADVERTISEMENTS in these columns is

12 words or less, 3/- and 3d. for every additional word.

Each paragraph is charged separately and name and address must be counted.

SERIES DISCOUNTS are allowed to Trade Advertisers as follows on orders for consecutive insertions, provided a contract is placed in advance, and in the absence of fresh instructions the entire "copy" is repeated from the previous issue: 13 consecutive insertions 5%, 28 consecutive, 10%; 52 consecutive, 15%.

ADVERTISEMENTS for these columns are accepted up to FIRST POST ON MONDAY MORNING (previous to date of issue) at the Head Offices of "The Wireless World," Dorset House, Stamford Street, London, S.E.1, or on SATURDAY MORNING at the Branch Offices, 8-10, Corporation Street, Coventry; Guildhall Buildings, Navigation Street, Birmingham, 2; 260, Deansgate, Manchester, 3; 26a, Renfield Street, Glasgow, C.2.

Advertisements that arrive too late for a particular issue will automatically be inserted in the following issue unless accompanied by instructions to the contrary. All advertisements in this section must be strictly prepaid.

The proprietors retain the right to refuse or withdraw advertisements at their discretion.

Postal Orders and Cheques sent in payment for advertisements should be made **& Co.** payable to **ILIFFE & SONS Ltd.**, and crossed **Notes** being untraceable if lost in transit should not be sent as remittances.

All letters relating to advertisements should quote the number which is printed at the end of each advertisement and the date of the issue in which it appeared.

The proprietors are not responsible for clerical or printers' errors, although every care is taken to avoid mistakes.

ARMSTRONG

100% The "Wireless World" says "Full marks are due to the designer . . ."

NEW VARIABLE SELECTIVITY MODEL AW125PP

12-V. 5-BAND ALL-WAVE RADIOGRAM CHASSIS (12-550 continuous, 1000-2000 m.)

with R.F. Pre-Amplifier, 2 I.F. stages with Variable Selectivity. Manual R.F. gain control and 10 watts R.C. coupled Triode P.P. Output **17 Gns.**



See Test Report, Jan. 5 issue.

DEMONSTRATIONS daily till 7.30 p.m. Saturdays till 5.30 p.m.

ARMSTRONG MANFG. CO.

100 ST. PANCRAS WAY, CAMDEN TOWN, N.W.1
Phone: GULiver 3105

RADIOMART

THE SHORT-WAVE SPECIALISTS

SPECIAL OFFER!!!
Fully shrouded Transformers by America's largest manufacturer. While they last.

All 220 v. primary and fully impregnated.	
T28708—375/375 v. 150 m/A., 6.3V5A, 2.5V2A, 5V3A	15/-
T19610—350/350 v. 150 m/A., 2.5V6A, 2.5V2A, 5V3A	12/6
T2236—375/375 v. 120 m/A., 6.3VCT, 4A, 5V3A	10/6
T7329—350/350 v. 100 m/A., 6.3VCT, 3A, 5V3A	8/6
T7307—350/350 v. 80 m/A., 6.3VCT, 3A, 5V3A	7/6
T7000—320/320 v. 80 m/A., 6.3V4A, 5V3A	7/6
T6025—320/320 v. 80 m/A., 2.5V6A, 5V3A	7/6
T464919—10V4A Primary Tapped 110—250 v.	5/6

The following chokes are interleaved and impregnated.

T7007—250 m/A., 135 ohms, 20-8 Hy., cadmium shrouded	12/6
T7007A—150 m/A., 250 ohms, 30-12 Hy., cadmium shrouded	12/6
100 m/A., 20 Hy., 500 ohms, unshrouded	4/11
60 m/A., 15 Hy., 250 ohms	1/11

HEAVY DUTY TRANSFORMER for models, balls, etc., 6 v. 3 a., 2/3.
4 m/l., 1500 v. test 500 v. w/kg. oil filled condenser, 2/-.

HEAVY DUTY Mains Transformer, worth 45/-, 350-350, 150 m/A., 4 v., 2.5 a., CT, 4 v., G.A., CT, 12/6; 300-300 v., 80 m/A., 4 v., 3 a., CT, 4 v., 2 a., CT, 6/6. Moving Coil Speech Transformers, 1/11.

GANG CONDENSERS with Airplane Dial, 8 and 80-1. Cost 35/- few only, 4/11. Utility 7/6. Microdials, 3/6.

W.B. 8in. PERMANENT MAGNET SPEAKERS AT ONE-THIRD COST. Extension Type (no Transformer), 8/11. Standard Type (with Transformer), 10/6. Energised 8", 1,200 ohms with T. transformer 6/11.

PUSHBACK Wire, 6 yds., 6d., heavy, 9d. Bead-core Solder, 6ft., 6d.; Soldered Flex, single, 6d. yd.; twin, 9d. yd. Assorted Solder: Tags, 6d. packet. Humdlumers, 6d. each.

Centralab pots, all sizes, 1/6; switched, 2/-; tubular glass fuses, 2d. Milliammeters, 0-25 m.a., upwards, 5/9; Super, 6/9.

OUR NEW 66 PAGE MANUAL, packed full of valuable information. Post Free, 7/6.

THE NEW RAYMART CATALOGUE shows dozens of New Short-wave components and is yours for 1/6, post free.

VALVES—A complete range of replacements, showing a saving of over 50 per cent. Quotations on receipt of types required. Quantity Discounts to Service Engineers. TRADE enquiries for communication equipment solicited.

RADIOMART Telephone: MIDland 3254.
G5NI (Birmingham) Ltd.
44, HOLLOWAY HEAD, BIRMINGHAM

NUMBERED ADDRESSES

For the convenience of private advertisers, letters may be addressed to numbers at "The Wireless World" Office. When this is desired, the sum of 6d. to defray the cost of registration and to cover postage on replies must be added to the advertisement charge, which must include the words Box 000, c/o "The Wireless World." All replies should be addressed to the Box number shown in the advertisement, c/o "The Wireless World," Dorset House, Stamford Street, London, S.E.1. Readers who reply to Box No. advertisements are warned against sending remittances through the post except in registered envelopes: in all such cases the use of the Deposit System is recommended, and the envelope should be clearly marked "Deposit Department."

DEPOSIT SYSTEM

Readers who hesitate to send money to advertisers in these columns may deal in perfect safety by availing themselves of our Deposit System. If the money be deposited with "The Wireless World," both parties are advised of its receipt.

The time allowed for decision is three days, counting from receipt of goods, after which period, if buyer decides not to retain goods, they must be returned to sender. If a sale is effected, buyer instructs us to remit amount to seller, but if not, seller instructs us to return amount to depositor. Carriage is paid by the buyer, but in the event of no sale, and subject to there being no different arrangement between buyer and seller, each pays carriage one way. The seller takes the risk of loss or damage in transit, for which we take no responsibility. For all transactions up to £10, a deposit fee of 1/- is charged; on transactions over £10 and under £50, the fee is 2/6; over £50, 5/-. All deposit matters are dealt with at Dorset House, Stamford Street, London, S.E.1; and cheques and money orders should be made payable to Iliffe & Sons Limited.

SPECIAL NOTE—Readers who reply to advertisements and receive no answer to their enquiries are requested to regard the silence as an indication that the goods advertised have already been disposed of. Advertisers often receive so many enquiries that it is quite impossible to reply to each one by post. When sending remittances direct to an advertiser, stamp for return should also be included for use in the event of the application proving unsuccessful.

NEW RECEIVERS AND AMPLIFIERS

R TELEPHONE: Holborn 4631.

RADIO CLEARANCE, Ltd., 63, High Holborn, W.C.1, by offering brand new receivers, maintain their reputation as the leading Mail Order House for surplus radios. See our list (March 23 issue) of components, etc., under that heading.

ACE Model AW563 6-valve All-wave Superhet Receiver, fitted automatic tuning, providing choice of 5 stations instantly at the touch of a button, 3 wave-bands, mains superhet for A.C. mains only, 200-250 volt, British Octal valves are fitted as follows, pentagrid, frequency changer, band-pass coupled to H.F. pentode, I.F. amplifier, double diode valve, providing delayed A.V.C. and detection, followed by pentode L.F. amplifier coupled to power pentode output valve (3 watts undistorted output), provision for gramophone pick-up and extra loud-speaker, floodlit g.v.s. tuning scale calibrated with station names and wave lengths, cathode ray tuning valve and wave-band indicator, special slow motion tuning device, two-tone bentwood highly polished walnut cabinet, wave range 19-50, 200-550 and 800-2,000 metres, brand new listed 12 gns.; our price £5/19/6 to clear.

IMMEDIATE Delivery Now Offered of

BBRITISH Belmont 8-valve Plus Magic Eye All-wave A.C. Superhet Chassis, 4 wave-bands, two short, medium and long, fitted latest Mullard octal base American type valves. Brief specification: Short wave 6-18 metres (covers television sound), short wave 2, 18-50 metres, medium band 200-550 metres, long 900-2,000 metres. Valve combination 6K7, Pre H.F., 6J7 oscillator, 6J7 mixer, 6K7 I.F., 6Q7 (DDT) detection, A.V.C. and first L.F. two 6F6s parallel output, 5Y3 rectifier, plus 6G5 Magic Eye visual tuning, handsome dial, station names etched on glass; controls 2-speed tuning, volume and on/off, combined variable tone control and selectivity switch wave change plus gram. switch. Size of chassis, 13 1/2 in. x 10 in. x 3 in. Supplied complete with valves, escutcheon, knobs, but less speaker; £5/19/6 each.

COMplete Receiver in Handsome Walnut Cabinet, details as above, complete with speaker; £7/7 each.

DECCA 6-valve 3 Wave-band Battery Chassis, fitted complete with Mazda and Osram valves, QPP output; these chassis give a sparkling performance on all wave-bands, and are the product of a well-known manufacturer; complete with valves, £3/3 each.

ALL Orders Post Free; enquiries 1 1/2 stamp if reply expected. Hours of business, week-days 9 a.m. to 7 p.m. Saturdays 9 a.m. to 1 p.m. Postal rates apply to the United Kingdom only, orders for Ireland and abroad must include sufficient postage to cover whatever the value of same.

RADIO CLEARANCE, Ltd., 63, High Holborn, W.C.1. Telephone: Holborn 4631. [8]69

NEW RECEIVERS AND AMPLIFIERS

HIGH Performance.
LOW Price.
NEW Features.
10-550 Metres, complete coverage-BFO-AVC-Phone Jack-Monitor speaker-band spread-pitch control Hallicrafters, new Buddy; £10; from
RADIOGRAPHIC, Ltd., 66, Osborne St., Glasgow, C.1. Telephone: Bell 848. [8339]

ARMSTRONG Amplifiers.
ARMSTRONG Range of High Fidelity Amplifiers are Designed for Use with Radio Feeder Units, gramophone pick-ups, or any other Audio input where wide frequency range (20-20,000 cycle) amplification is required.
ARMSTRONG 6- and 12-watt Output Units are Two Popular Models, both of these use 6 valves for amplification, this being arranged as three stages of push-pull resistance capacity coupled.
ARMSTRONG 6-watt Amplifier, Type A46/7, using 2 PX4's in the output stage; price 9 gns., with valves.
ARMSTRONG 12-watt Amplifier, Type 127/PX, using 2 PX25's in the output stage; price 12 gns., with valves.

ARMSTRONG Will be Pleased to Send Full Details, together with particulars of their local station feeder unit, Type PS2/4, and television sound-feeder unit on request; special equipment available for quality reproduction in schools.

ARMSTRONG COMPANY, of 100, St. Pancras Way, Camden Town, London, N.W.1. [8298]

DEGALLIER'S "Challenger Radio Corporation."
SEND 2d. Stamp for Handsome Illustrated Catalogue telling about our superb range of receivers; direct public sales policy; most exceptional value on the market from a T.R.F. Midget at £3/5 to a 19-valve general purpose receiver, 6 bands, with two P.A. speakers, at 30 gns.; 6-page brochure of "Wireless World" report on this receiver is available.

DEGALLIER'S, 31, Craven Terrace, London, W.2. Paddington 6492. Nearest point Lancaster Gate Tube Station. [8341]

RECEIVERS AND AMPLIFIERS CLEARANCE, SURPLUS, ETC.

BANKRUPT Bargains.—Brand new 1938 radio sets in makers' cartons with guarantees, at less than half retail prices; send 1 1/2d. stamp for list bargains.—261-3, Lichfield Rd., Aston, Birmingham. [8275]

GALPINS

ELECTRICAL STORES

75, LEE HIGH RD., LEWISHAM,
LONDON, S.E.13

Telephone: LEE GREEN 5240

Terms: Cash with Order or C.O.D. Charges Extra.

EX-NAVAL 1-VALVE BUZZER WAVEMETERS. 200/24,000 metres. Complete in solid teak case. Size: 15x10x8 (less valve). Tuner unit enclosed in copper tank (Sullivan high note buzzer). Price, 7/6 each, C/forward. Not sent C.O.D.

MAINS TRANSFORMERS for small Arc Lamps, etc., 200/250 volts input, 50 volts 8 amps. output, 10/6 each; another, same input, 250/0/250 volts 150 m/A, and 3x4 volt L.T. windings, also a 50 volt 4 amp. winding, 12/6 each, post 1/-.
E. TURNER AND WESTON MOVING COIL m/A METERS. 2in. dial. Model 501, 0 to 5 m/A., 12/6; 0 to 50 m/A., 12/6. All fully guaranteed.

MOVING COIL METER MOVEMENTS for recalibrating into multirange meters. Low m/A. deflection. 2 1/2in. dial, 5/- each; 4in. and 6in. dial, 6/- each. Post 1/-. (Note: All these meters are by good makers—Elliott, E. Edgumbe, etc.)

MAINS TRANSFORMERS, all fully guaranteed. for 200/240 volt 50 cy., 1-phase input; outputs 1/2 to 5 volts at 1,500 watts, 45/-; ditto, 5 volts at 2,500 watts, 65/-; ditto, from 10 to 220 volts in steps of 10 volts at 3,500 watts, 75/-; ditto, 2,000/0/2,000 volts 150 m/A. and 2 L.T. windings, 22/6; ditto, 3-4 and 7 1/2 volts at 650 watts, 17/6; ditto, 5 to 20 volts in 6 tappings, 1,250 watts, 40/-; ditto, 200-400 and 700 volts twice at 200 watts, 20/-.

All above double wound. Voltage Changer Transformers, 100/120 volts to 200/240 volts or vice versa. Auto. wound, 250 watts, 17/6; 500 watts, 25/-; 1,000 watts, 35-1,500, 45/-.

Another, 200 volts to 250 volts at 12 kilowatts, 90/-.

All carriage forward.

STANDARD TELEPHONE TWIN BELL WIRE. 23 S.W.G. enamelled tinned copper and braided (new), 150-yd. coils, 5/- post free. Also S.T. Copper Screened Wire, highly insulated. 23 S.W.G. enamelled tinned copper, approx. 100-yd. coils, useful as television lead-in, 4/6, P/F. Rubber-covered Flex, 23/36, in 100-yd. coils, 3/6, post 6d.

ZENITH WIRE-WOUND RESISTANCES (Vitreous). .6 ohm 10 amp., 1 1/2 ohm 6 amp., .154 ohm 8 amp., 5 ohms 2 amp., 6 ohms 5 1/2 amp., all 9d. each, post 3d.; 2,500 ohms 170 m/A., 10,000 ohms 50 m/A., 5,000 ohms 170 m/A., 255 ohms 500 m/A., 750 ohms 170 m/A., all at 1/- each, post 3d. Also a 4,000 ohms resistance wound on mica, carry 100 m/A., 1/6 each.

ELECTRIC LIGHT CHECK METERS for sub-letting, etc., 200/250 volts, 50 cy., 1-phase, 5-10-20 amps. 6/- each, post 1/-. Shilling Slot type, 5 and 10 amps., 15/- each, carriage 1/-.
THE (BUD) MOVING COIL HORN SPEAKER UNIT for Public Address, 10/15 watts, 6 volt field, 15/- each.

EX-R.A.F. ROTARY CONVERTERS. D.C. to D.C. 12 volts input, 500 volts 75/100 m/A. output, brand new 25/-, post 1/-. S.H. condition, 20/-, post 1/-. Also a few with damaged brush, gear windings O.K., 10/- each, post 1/-.
EX-R.A.F. EVERSHED VIGNOLS HAND GENERATORS. Useful by using ohmmeter, make perfect megger, and other testing gear, 800 volts 30 m/A. output, brand new, 35/- each; S.H. in good condition, 25/- each, C/F.

WESTINGHOUSE RECTIFIERS (secondhand) but fully guaranteed. 500 volts 250 m/A., in voltage doubler circuit, 17/6 each, post 1/-. 12 volt 100 m/A. Instrument Rectifiers, 2/6 each.

EX-G.P.O. GLASS TOP RELAYS, Type B. Useful as Keying Relays, 5/- each, post 6d. Also a few only that need points which are easily fitted, 2/6 each, P/F.
MAINS SMOOTHING CONDENSERS. T.C.C., 4mf, 750 volts working, 3/6; T.C.C., 2,000 mf, 25 volts working, 2/6 each; T.C.C., 2mf, 1,000 V.T., 1/6 each. Philips, 1 mf, 4,000 volts working, 4/6 each. Standard telephone, 1 mf, 400 volts working, 4 for 1/-, post 4d.; or in lots of 100, 12/6, post 1/6.
CHARGING DYNAMOS. All shunt wound and fully guaranteed. 100 volt 20 amp., 1,500 r.p.m., 90/-; another, 80/90 volts 8/10 amps., 1,800/4,000 revs., 70/-; another, 20 volts 8 amps., 27/6. Automatic Cut-outs to suit any dynamo up to 10 amps., 5/6 each (all dynamos carriage forward).

MARCONI EX-NAVAL TRANSMITTER AND RECEIVER COMBINED. 10 to 25 metres, 3 valve battery working, complete with an Everett Edgumbe 0 to 250 m/A., Thermo Coupled Meter, 50/- each. C/F.

TELEPHONE MAGNETO GENERATORS. Approx. 70 volts A.C., 4- each, P/F. Microphone Buttons, 9d. each. 30 hy. 150 m/A., Mains Chokes, 4/6 each. 2 mf. 500 volt working Condensers, 1/- each. Western Electric Microphones, 2/-. Microphone Transformers, 1/6, 1,000 ohm single earpieces, 9d. each.

STEEL CABINETS. Useful as transmitting racks, 40 x 17 1/2 x 24, 12/6 each, C/F. Philips pre-stage amplifiers for A.C. mains 220/240 volts, less valves, 15/- each.

NEON TRANSFORMERS, input 200/250 volts 50 cy. 1 ph. output, 10,000 volts 10 m/A., 12/6 each, post 1/-. Ditto, 7,000 volts 8 m/A., 10/-, post 1/-. Ditto, 5,000 volts 5 m/A., 7/6, post 1/-. (All brand new.)

10 K.V.A. AUTO VOLTAGE CHANGER TRANSFORMERS, 100/120 to 200/240 volts or vice versa, fully guaranteed, £8 10s. C/F.

USED SETS FOR SALE

W.W. QUALITY AMPLIFIER

W.W. Quality Amplifier with Superhet Chassis, 12in. mains Epoch speaker, gramophone motor, and Rothermel pick-up, with valves, working; £12, offer.—Phone: Western 8723. [8314]

MISCELLANEOUS

A NUMBER of Reconditioned Sets in Good Order; from £5 upwards.—Halford Radio, 31, St. George St., W.1. [0617]

CAR RADIO

CROSLLEY Push-button 1939 10 guinea Models, 5 1/2 gns.; aeriols, overheads, police type, etc., from 8/6; trade enquiries solicited.—Shippers, 18, Corporation St., Manchester. [0622]

FINEST American Twin Running-board Aeriols, completely rubber covered, maximum signal pick-up, minimum noise, easy mounting, now only 17/6 pair complete; handsome chromium roof aeriols, to mount straight or "vee," complete, 15/-; immediate despatch, carriage paid; cash with order or c.o.d.

WIRELESS SUPPLIES UNLIMITED, Essex House, Stratford, E.15. Maryland 3191. [0577]

PUBLIC ADDRESS

V

VORTEXION P.A. Equipment.

IMITATED, but unequalled.

WE Invite You to a Demonstration.

A.C.D.C. Dance Band Amplifier, 10 watts output, complete in case, with moving coil microphone, speaker and cables, weight 22lb.; 12 gns.

A.C. 20-15-20-watt Amplifier, 30-18,000 cycles independent mike and gram., inputs and controls, 0.037 volts required to full load, output for 4, 7.5, and 15 ohms speakers or to specification, inaudible hum level; ready for use; 8 1/2 gns., complete.

C.P. 20, 12-volt battery and A.C. mains model, as used by R.A.F., output as above; 12 gns.

A.C. 20, in portable case, with Collaro motor, Piezo pick-up, etc., £14; C.P. 20 ditto, £17/17.

50-WATT Output 6L6s, under 60-watt conditions, with negative feed back, separate rectifiers for anode, screen and bias, with better than 4% regulation, level response, 20-25,000 cycles, excellent driver, driver transformer and output transformer matching 230 ohms impedance electronic mixing for mike and pick-up, with tone control, complete with valves and plugs; £15.

COMPLETE in Case, with turntable B.T.H. Piezo pick-up and shielded microphone transformer, £20.

80-WATT Model, with negative feed back; £25, complete.

120-WATT Model, with negative feed back; £40, complete.

250-VOLT 250 m.a. Full Wave Speaker, field supply unit; 25/-, with valve.

ALL P.A. Accessories in Stock; trade supplied.

VORTEXION, Ltd., 182, The Broadway, Wimbledon, S.W.19. Phone: Lib. 2814. [8241]

QUALITY Amplifiers and Microphone Equipments for Hire or Permanent Installation.—Harmony House, 116, Cambridge Rd., Southport. [8307]

ALEXANDER BLACK, Ltd., pioneers of hiring microphone amplifying equipment since 1928. Booklet on request.—55, Ebury St., S.W.1. Sloane 6129. [0598]

PUBLIC Address Contractors Can Hire P.A. Vans, loud-speakers, microphones and equipments of all types from Hire Dept., Gramophone Reproducers, Ltd., Kew Gardens, Surrey. Tel.: Richmond 1175-6-7. [0618]

NEW MAINS EQUIPMENT

V

ALL Transformers at Last Week's Prices.

VORTEXION, Ltd., 182, The Broadway, Wimbledon, S.W.19. Phone: Lib. 2814. [8340]

CABINETS

A CABINET for Every Radio Purpose

CONVERT Your Set into a Radiogram at Minimum Cost; surplus cabinets from noted makers under cost of manufacture (undrilled); 30/- upwards; motors at wholesale prices.

"FIT-A-GRAM" Cabinet, 31x17x15; 21/-.

UNDRILLED Table Console and Loud-speaker Cabinets, from 3/6.

INSPECTION Invited; photos loaned to country customers.

H. L. SMITH and Co., Ltd., 289, Edgware Rd., W.2. Tel.: Pad. 5891. [0485]

TELEVISION TRANSFORMERS

SOUND SALES specialise in the design and production of Special Transformers for all purposes, including MODULATION, MAINS, L.F. and all types of low frequency transformers, together with an amazing selection of Chokes. In addition to these we are concentrating on the design and production of TELEVISION Transformers for use in the H.T., Time Base and Vision, also Frame and Line circuits.

Since we are enjoying the patronage of nearly every well known Laboratory in the country, this advertisement may only be a reminder to the majority of our Readers, so it is appropriate to conclude by thanking everybody for their valued patronage, which has resulted in record breaking activities in this section of our works.

MAY WE HAVE THE PLEASURE OF YOUR ENQUIRIES?

Specified by  the Experts
SOUND SALES
MARLBOROUGH RD., UPPER HOLLOWAY, LONDON, N.19. (Contractors to the G.P.O., etc.)
LIMITED. Tel.: Archway 1661/2/3
Hours of Business—
Monday to Friday, 8.30 a.m. to 6 p.m.
SATURDAYS CLOSED

The NEW "R.F. 41" HARTLEY TURNER IS BETTER THAN EVER



Receiving Unit for use in conjunction with an L.F. Amplifier. 12" x 10" x 8" overall.

Briefly:—4-valve superhet, 5 wavebands: (1) 6 to 10m.; (2) 12.8 to 51m.; (3) 65 to 230m.; (4) 200 to 550m.; (5) 900 to 2,100m. A pentode R.F. operates on all bands except No. 1. Triode-hexode frequency changer. Single pentode I.F. amplifier, two variable band-width transformers giving three degrees of selectivity. Variable IF gain. Linear diode signal and A.V.C. rectification. Proportionate application of A.V.C. bias to R.F. and I.F. stages provides good signal-to-noise ratio and signal-handling capacity. One triode stage of L.F. amplification. Volume and tone controls. Provision for pick-up. Walnut control panel. Floodlit glass dial, calibrated in metres and station names. Reverse vernier slow-motion tuning control. Calibrated magic eye tuning indicator. 18 SWG cadmium plated steel chassis, robust construction. Price including valves and coupling leads, £11.5.0

Full specification on request. Write now.



THE HARTLEY TURNER RADIO COMPANY
92 Queensway, London, W.2. Tel.: Bayswater 1102

DYNAMOS, MOTORS, ETC.

D.C.—A.C. Convertors, motors, all voltages, for sale and wanted.—Easco, 18w, Brixton Rd., S.W.9. [0558]

ALL Types of Rotary Convertors, electric motors, battery chargers, petrol electric generator sets, etc., in stock, new and second-hand.

A.C.—D.C. Conversion Units for Operating D.C. Receivers from A.C. Mains, 100 watts output, £2/10; 150 watts output, £3/10.

WARD, 46, Farringdon St., London, E.C.4. Tel.: Holborn 9703. [0518]

RECORDING EQUIPMENT

ALL Recording Discs and Materials in Stock; tracker units, £4/7/6; recording motors, £3/17/6.—Write for further details, Will Day, Ltd., 19, Lisle St., W.C.2. [0595]

LIVERPOOL Sound Studios, 83a, Bold St., Liverpool.—Personal recordings from 3/6; amplifiers, microphones, recording motors and trackers, blank discs, etc. [8300]

FEIGH Recording Sets are Within the Reach of All; ball bearing gear box, worm drive traverse, 2 seconds to d-tach, diamond fitted in cutter, pick-up on arm, set, 37/6; 6in. blank aluminium discs, 3/3 dozen; 10in. coated discs, 3/- each.—Electradix, 218, Upper Thames St., London, E.C.4. [0620]

NEW LOUD-SPEAKERS

SINCLAIR, Speakers for all types.—Alma Grove, Copenhagen St., N.1. [0603]

BAKERS New Corner Horn Speakers are in Demand; every music lover interested in quality reproduction should write for details to the Pioneer Manufacturers of Moving Coil Speakers, Bakers Selhurst Radio, 75, Sussex Rd., South Croydon. [8157]

LOUD-SPEAKERS

SECOND-HAND, CLEARANCE, SURPLUS, ETC.

ROLAS, for 6/11; G12's, 47/6; 1/2d. stamp for lists.—Shippers, 18, Corporation St., Manchester. [0606]

VAUXHALL.—Rola G12 P.M. speakers, 62/6; Rola G12 energised, 50/- with transformers, all brand new.

VAUXHALL UTILITIES, 163a, Strand, W.C.2. Over "Denny's," the booksellers. Send for free list. [8337]

3,000 Speakers from 5/6 each, P.M. and energised 4in. to 14in., including several Epoch 18in.—Sinclair Speakers, Alma Grove, Copenhagen St., N.1. [0591]

BAKERS Offer a Number of the Famous Baker Super Power Speakers at Half Price; as solely specified for the "Wireless World" A.V.C. Straight Four Quality Receiver.—Bakers Selhurst Radio, South Croydon. [8158]

LOUD-SPEAKER CONVERSIONS

BAKERS Triple Cone or Corner Horn Conversions will Considerably Improve Reproduction from Your Present Speaker, whatever make; prices from 29/6.—Bakers Selhurst Radio, South Croydon. [8159]

TRANSMITTING APPARATUS

A.C.S. RADIO, specialists in short-wave apparatus, communication receivers, including Hallicrafters, National and R.M.E. transmitting equipment, valves and components.—Send for free catalogue to A.C.S. Radio, 16, Gray's Inn Rd., W.C.1. Holborn 9894-5. G2NK Technical Manager. [0550]

G5NI.—The oldest and largest distributors of amateur equipment, transmitting and receiving; short-wave catalogue, 1 1/2d.; G5NI 70-page Manual, 7 1/2d., post free; authorised direct distributors for Collins, National, R.M.E., Thordarson, Hammerlund, Biley, Taylor, Eimac, etc., etc.—44, Holloway Head, Birmingham. [0531]

VALVES

ANDERSON. ALL Types of American Valves, first grade; 5/- each.

ANDERSON, 34, Wadham Ave., Walthamstow, London, E.17. Tel.: Larkwood 1574. [8152]

ALL Types of American Tubes in Stock of Impex and Arcturus makes, at competitive prices.

WE Can Also Supply a Full Range of Guaranteed Replacement Valves for Any British, non-ring, American or Continental type at an appreciably lower price.

SEND for Lists of these, and also electrolytic condensers, line cords, resistances, etc.

CHAS. F. WARD, 46, Farringdon St., London, E.C.4. Tel.: Holborn 9703. [0452]

2/9.—R.C.A. American valves, 50 popular types; also National Union, Hytron; also British non-ring valves; cheapest in Britain; 1/2d. stamp for revised lists.—Shippers, 18, Corporation St., Manchester [0607]

METROPOLITAN RADIO SERVICE.—Special offer: American valves, in makers' cartons, 3/- each; Octals, 3/6 each; American valves, first grade in all types; trade supplied.—1021, Finchley Rd., N.W.11. Speedwell-3000. [0436]

PREMIER 1939 RADIO

Premier Short-Wave Kits.

Complete to the last detail including all Valves and coils, as well as theoretical and wiring diagrams and lucid instructions for building and working. Each kit is supplied with a steel Chassis and Panel and uses plug-in coils to tune from 13 to 170 metres.

PREMIER MOVING COIL METERS

Table with columns: Model No. 21, Model No. 311, 3in. square case, 3 1/2in. diameter round case. Lists various meter specifications and prices.

VOLTAGE MULTIPLIER RESISTANCES, guaranteed accuracy ± 2 per cent. All standard ranges, 1/3 each. TAPPED SHUNT to provide readings of 5 m/A., 25 m/A., 250 m/A., and 1,000 m/A., 5/6. PREMIER S.W. H.F. Chokes, 10-100 metres, 9d. each. Pie-wound, 1/6 each. Screened, 1/6 each. SHORT-WAVE COILS, 4- and 6-pin types, 13-26, 22-47, 41-94, 79-170 metres, 1/9 each, with circuit. Special set of S.W. Coils, 14-150 metres, 4/- set, with circuit. PREMIER 3-band S.W. coil, 11-25, 19-43, 38-80 metres. Suitable any type circuit, 2/6. UTILITY Micro Cursor Dials, Direct and 100:1 Ratios, 3/9. PREMIER Short-Wave Condensers, all-brass construction, with Trolitul insulation. 15 mmf., 1/6; 25 mmf., 1/7; 40 mmf., 1/9; 100 mmf., 2/-; 100 mmf., 2/3; 250 mmf., 2/6. TROLITUL DOUBLE SPACED TRANSMITTING CONDENSERS. 15 mmf., 2/9; 40 mmf., 3/6; 160 mmf., 4/6. NEW TROLITUL SPLIT STATOR CONDENSERS, 50 x 50 mmf., 10/6. COIL FORMERS, 4- or 6-pin low-loss, 1/- each. AMERICAN VALVES. We hold the largest stocks of U.S.A. tubes in this country and are sole British Distributors for TRIAD High-grade American Valves. All types in stock. Standard types, 5/6 each. All the new Octal Base tubes at 6/6 each, 210 and 250, 8/6 each. EUROPA MAINS VALVES, 4 v. A.C. Types, A.C./H.L., A.C./L., A.C./S.G., A.C./V.M.S.G., A.C./H.P., A.C./V.H.P., A.C./P., and 1 watt D.H. Pentodes, all 4/6 each. A.C./Pens., 1 H., 5/6; A.C./P.X.4, 6/6; Oct. Freq. Changers, 8/6; Double Diode Triodes, 7/6; Triode H, ex. Freq. Ch., 2/6; Tri. Grid Pen., 10/6; 23-watt D.H. Triode, 7/6. 350 v. and 500 v. F.W. Rect., 5/6. 13 v. 2 amps. Gen. Purpose Triodes, 5/6; H.F. Pens. and Var.-Mu. H.F. Pens., Double Diode Triodes, Oct. Freq. Changers, 7/6 each. Full-wave and Half-wave Rectifiers, 5/9 each.

Matchmaker Universal

Modulation Transformers

Will match any modulator to any R.F. load. 50 watts, 17/6; 150 watts, 29/6; 300 watts, 49/6. MATCHMAKER UNIVERSAL OUTPUT TRANSFORMERS. Will match any output valves to any speaker impedance. 11 ratios from 13 : 1 to 80 : 1. 5-7 watts, 13/6; 10-15 watts, 17/6; 20-30 watts, 29/6. Send for full details.

PREMIER 1939 HIGH FIDELITY AMPLIFIERS

A NEW COMPLETE RANGE OF 7 HIGH FIDELITY P.A. AMPLIFIERS FOR A.C. OR A.C./D.C. MAINS OPERATION.

With the exception of the 3-watt models, all Premier Amplifiers incorporate the new Premier Matchmaker Output Transformer, enabling any single or combination of speakers to be used. 8, 8/10, and 15-watt systems are provided with two separate input channels which can be mixed to any level. The 30- and 60-watt systems have 3 input channels. The built-in Pre-Amplifiers ensure that the gain is sufficient for any low-level crystal or velocity microphone. The actual gain of the 6-, 15-, 30- and 60-watt amplifiers is over 100 decibels. Tone controls are also incorporated.

Table with columns: Kit of Parts with Valves, Completely Wired and Tested. Lists amplifier models and prices.

Orders 5/- and over sent Post Free. Under 5/- please add 6d. Postage.

Have you had our 1939 Catalogue, Handbook and Valve Manual? 90 pages of Radio Bargains and Interesting Data. Price 6d.

ALL POST ORDERS TO: Jubilee Works, 167, Lower Clapton Road, London, E.5. Amherst 4723. CALLERS TO: Jubilee Works, or our NEW PREMISES, 169, FLEET STREET, E.C.4. Central 2833 or 50, High Street, Clapham, S.W.4. Macaulay 2381

TEST EQUIPMENT

PHILCO Valve Tester (Made by Well Known Manufacturer), A.C. 200-250, complete with two panels and elaborate display stand, embodying three coloured lights for good, bad or weak valves, which work in conjunction with meter, listed £17/10; £8/5, carriage paid.

HENRY'S, 72, Wellington Av., Stamford Hill, N.15. Phone: Stamford Hill 2907. [8090]

COMPONENTS

SECOND-HAND, CLEARANCE, SURPLUS, ETC.

RADIO CLEARANCE, Ltd.

ALL Lines Previously Advertised Still Available.

RADIO CLEARANCE, Ltd., 63, High Holborn, W.C.1. Holborn 4631. [8297]

PREMIER SUPPLY STORES

PLEASE See Our Displayed Advertisement on this page. [0488]

MAINS RADIO DEVELOPMENT COMPANY.

MAINS RADIO DEVELOPMENT COMPANY Offer Outstanding Value; carriage paid by return. Telephone: Tudor 4046. Call mornings. Stamp for List 225.

POLAR Midget Latest Type 3-gang Condensers, fully screened, trimmers, standard 1/4in. spindle, 0.0005 mfd., with 110 k/c tracker, also perfect as straight 2-gang; 2/6 only, snatching offer.

ERIE 1-watt, colour coded, unused resistors, any size 50 ohms to 5 megohm, your selection; 3d. each, 2/6 dozen; 2-watt, 6d.

CENTRALAB Latest Potentiometers, unused, long spindle, all sizes 5,000 ohms to 2 megohm, 2/-; with mains switch, 2/3.

TUBULAR Condensers, 400-volt working, wire ends, best make; 0.0001-0.05 mfd. 4d., 0.1 mfd. 4d., 0.25 mfd., 0.5 mfd. 6d.

TUBES.—First grade American valves, finest make, fully guaranteed, boxed, all popular types, 4/-; glass octal types, 4/6.

CILIX Unused Chassis Valve-holders, 5-, 7-, 9-pin, 3d. each; all American sizes, 6d.; best sleeving, 1 1/2d. yard.

T.C.C. Metal Can 8 mfd. 600-volt Peak Dry Electrolytics, 2/3; T.C.C. card 8 mfd., 600v. peak, 1/6.

FIFTY N.S.F. 1/2-, 1- and 2-watt Resistors, wire ends, marked and colour coded, 20 good sizes per parcel; 2/6 per 50 only.

MAINS RADIO DEVELOPMENT COMPANY, 4-6, Muswell Hill Rd., London, N.6. Tudor 4046. [8338]

RYALLS RADIO, 280, High Holborn, London, W.C.1. offer new goods, post free.

AMPLIFIERS, 13w. output, 3-stage, Triodes resistance and transformer coupled to push-pull Beam valves, matched to pair: elliptical speakers, with U.S. valves and speakers; 52/6; input 200-250 A.C.

AMERICAN Type Mains Transformers, 350-350. 70 w.a., 5v. and 3.5v. drop through pattern, input 200-250v., 6/6; few 110v. input; British made.

WEARITE 110 kc. I.F.'s with Top Trimmers, 1/6 each; sets hand pass air core superhet coils ex Halcyon, screened chassis type, 4/9 set five; 110 kc. with coil details.

SATOR Volume Controls, 1/2 meg. with switch, 10,000 with switch, 5,000 with switch; 1/3 each or 6/6 dozen; Centralab 11,000, less switch, 1/-, 8/6 dozen.

B.I. Electrolytics, 12x8x50, 350-12v., 1/3 each or 7/6 dozen; B.I., 20x20x25, at 400v.-25v., 1/3, or 8/- dozen; Plessey 30x8x2, 350v., 1/6, or 10/- dozen.

B.I. Tubular, 4mf. 200v., 6d. each or 4/- dozen; B.I. 0.35, 1/3 dozen, 7/9 gross; B.I. 0.25mf. tubulars, 2/- dozen, 4/8 per three dozen.

SPEAKERS, pairs, brand new, elliptical cone speakers, made by first class firm, quality of reproduction outstanding, push-pull pentode transformer, fields 325 ohm for smoothing choke, 8,600 as bleeder, circuit available, handle 10-15w.; 14/- pair—Ryalls Radio, see above. [8246]

VAUXHALL.—Hivac valves, all types, new prices; full range of pick-ups from 11/-.

VAUXHALL.—2-gang 3-band 465 k/c superhet coils, complete terminals, wavechange switch; 15/3.

VAUXHALL.—T.C.C. dry 8 mfd., 2/6; 600v. aluminium containers; T.C.C. 600v. dry, cardboard containers, 8 mfd., 1/9; 8 and 8, 3/-.

VAUXHALL UTILITIES, 163a, Strand, W.C.2. Ask for free list; post paid 2/6 and over: c.o.d. 5/- minimum. [8336]

COLLARO A.C./D.C. Record-changers, 200-250, plays eight 10in. or 12in. records, mixed, also incorporates repeater and rejector; limited quantity, £5/5, in sealed cartons.

GARRARD A.C. Motors, Model A.C.4, enclosed type with automatic stop, 110-250 volts, 50/-, carr. pd., sealed cartons.

MARCONI K25 Pick-up, unused and boxed; 14/-.

HENRY'S, 72, Wellington Av., Stamford Hill, N.15. Stamford Hill 2907. [8216]

SOUTHERN RADIOS Bargains.—Sale now proceeding of hundreds of bargain lines, goods previously advertised still available.—Southern Radio, 46, Lisle St., London, W.C.1. Gerrard 6653. [8236]

AN ALL-ROUND PORTABLE

"STAND-BY 3" KIT for any emergency.

A self-contained Battery Portable Set is essential in the event of emergency and a highly desirable adjunct to the mains set. Easily moved from room to room and equally useful for outdoor use.

With the set described in recent issues of "The Wireless World" you are independent of electric mains, as both H.T. and L.T. are obtained from **Dry Batteries**, an important consideration in the present unsettled conditions.

KIT Including drilled chassis less valves, speaker, cabinet and batteries **67/6**

CABINET polished Oak with carrying handle **14/-**
3 SPECIFIED VALVES **27/-**
H.T. and L.T. BATTERIES **10/9**
GOODMANS SPEAKER, as specified **21/-**

We can also supply any of the well-known Portable Sets on the market for Cash, C.O.D. or on our very **CONVENIENT TERMS**, including—

The New

MULLARD PORTABLE SUPERHET

An entirely self-contained, powerful receiver giving excellent reproduction on both medium and long waves. Cash or C.O.D. 84 Gns. including batteries or 11/- with order and 12 monthly payments of 15/-.

Write for illustrated and fully descriptive folder.

We supply all **ARMSTRONG CHASSIS** for Cash or on **EASY TERMS**. Details of full range upon request.

WHATEVER YOU REQUIRE WE CAN SUPPLY Quotations by return of post.

Estd. - 1925 THE Phone NATIONAL 6828

LONDON RADIO SUPPLY COMPANY

11, OAT LANE · NOBLE ST · LONDON E.C.2

For PROMPT DELIVERY of High Quality

LOUDSPEAKERS, LOUD-SPEAKER CONES LOUD-SPEAKER COMPONENTS, TRANSFORMER LAMINATIONS, TRANSFORMER HOUSINGS, TRANSFORMER WINDINGS, CHOKE WINDINGS, FIELD COIL WINDINGS, PERMANENT MAGNETS, PRESS TOOLS AND PRESSINGS, JIG BORING. AUTOMATIC SCREW MACHINE PARTS UP TO 2" DIAMETER.

Contractors to the Admiralty, War Office and Air Ministry.

Call on BRITISH ROLA LTD.

MINERVA ROAD, PARK ROYAL, N.W.10. PHONE: WILLESDEN 4322-3-4-5-6

We do quite a lot of business making up transformers to customers own specifications; but we have a standard list. May we send you a copy?

W. BRYAN SAVAGE LTD

Westmoreland Rd., London, N.W.9. Phone: Colindale 7131

REPAIRS AND SERVICE

"SERVICE with a Smile."

AERICAN Valves, spares, linecords, rewinds; repairs of all types of American and British receivers.—F.R.L., Ltd., 22, Howland St., W.1. Museum 5675. [0434]

LLOUD-SPEAKER Repairs. British, American, any make, 24-hours service; moderate prices.—Sinclair Speakers, Alma Grove, Copenhagen St., N.1. [0590]

GUARANTEED Repairs Any Transformers, choke, motor armature, converter, dynamo, etc.; keenest prices, immediate quotation, prompt dependable service.—See below.

L.T.P. (LONDON TRANSFORMER PRODUCTS, Ltd.) Willesden, N.W.10 Willesden 6486 (3 lines). [6892]

MAINS Transformer Service, Repairs, rewinds, or construction to specification of any type, competitive prices and prompt service.—Sturdy Electric Co., Dip-ton, Newcastle-on-Tyne. [0516]

METROPOLITAN RADIO SERVICE—Guaranteed repairs to American and British receivers; American valves, service parts and rewinds; trade supplied.—1021, Finchley Rd., N.W.11. Speedwell 3000. [0435]

SCOTT-SESSIONS REPAIR SERVICE—All types of receivers overhauled, rebuilt, repaired, including American communication sets, W.W. Monodials, All-wave Super-Seven. Variable Selectivity IV, etc.

SCOTT-SESSIONS REPAIR SERVICE, popular for 15 years from Land's End to John-o-Groats; van collection London area; immediate, courteous and skilled attention to every instruction.

SCOTT-SESSIONS REPAIR SERVICE, Exchange Works, Muswell Hill, N.10. Tudor 4101-2. [7497]

REPAIRS to Moving Coil Speakers a Speciality; cones and coils fitted, fields altered; prices, including eliminators, quoted; loud speakers, 4/-; L.F. and output transformers, 4/-, post free; guaranteed satisfaction; trade invited, estimates free; prompt service.—Loud-Speaker Repair Works, 5, Ballam Grove, London. Battersea 1321. [0394]

EXTENDED PAYMENTS

LONDON RADIO SUPPLY Co. (Established 1925) Supply, on convenient terms, components, accessories and sets, any make; 10% down, balance over 12 months; send for list of requirements.—11, Oat Lane, London, E.C.2. [0637]

MISCELLANEOUS

CHEAP Printing.—1,000 billheads, 3/6; sample free.—Creteway Press, 18, Buxted, Sussex. [8180]

GP.O. Engineering Dept. (no experience required); commencing £3 13s. per week; age 18-23; excellent prospects; free details of entrance exam. from: B.I.E.T. (Dept. 574), 17-19, Stratford Place, London, W.1. [8309]

EVERY Radio Dealer Who is Not a Regular Reader of "The Wireless and Electrical Trader" should send his trade card at once for a specimen copy and full details of the "Trader" Services. "The Wireless and Electrical Trader" has the widest influence, the largest weekly circulation, and is read by all the leading manufacturers and traders. Trade only, 15/- per annum, post free.—Published at Dorset House, Stamford St., London, S.E.1. [0615]

"ENGINEER'S Guide to Success" Shows How to Quality in Television Radio Engineering and Servicing, sound recording, wireless communication, etc., by studying at home with the T.I.G.B. Write to day for this Great Guide—free—which gives full particulars, contains the world's widest choice of engineering courses—over 200—and alone gives the regulations for qualifications such as A.M.I.E.E., A.M.I.R.E., A.M.I.T.E., A.M.I.W.T., C. and G., etc. Training until successful guaranteed.—The Technological Institute of Great Britain, 82, Temple Bar House, London, E.C.4. (Founded 1917. 20,000 successes.) [8335]

PATENT AND TRADE MARK AGENTS

GEE and Co. (H. T. P. Gee, Mem. R.S.G.B. etc.), 51-52, Chancery Lane, London, W.C.2. Holborn 4547-9. Handbook free. [0001]

PATENTS

THE Proprietor of British Patent No. 368109, dated April 9, 1931, relating to Improvements in Antenna Systems, desires to arrange by licence or otherwise on reasonable terms to exploit the above and ensure its practical working in Great Britain.—Enquiries to Mr. B. Singer, Chrysler Building, New York City, N.Y., U.S.A. [8305]

TUITION

RADIO Training.—P.M.G. exams. and I.E.E. Diploma; prospectus free.—Technical College, Hull. [0611]

WIRELESS.—Complete training, marine, broadcast and television, posts waiting, mod. fees, boarders taken, approved college, prosp.—W., London Radio College, Grove Park Rd., London, W.4. (Chi 3244). [0580]

BUSINESSES AND PROPERTY FOR SALE, TO BE LET, OR WANTED

"THE Wireless and Electrical Trader" is an essential part of the equipment of every Wireless Trader; its pages reflect the very latest turn of trade events, and it is read by all the leading dealers and manufacturers for particulars of businesses offered or wanted. By subscription to the trade only, 15/- per annum, post free.—Send your trade card for specimen copy to Dorset House, Stamford St., London, S.E.1. [0614]

ELECTRADIX HELPS.

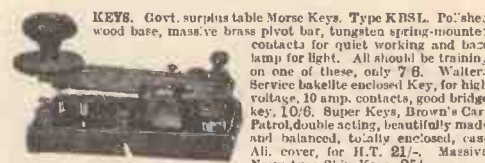

BELLS ALARM BELLS. Mains battery or magneto waterproof types, 1,000 British House Bells, wall and table. Priority for A.R.P. A.R.P. outdoor and especially Hams may want portable H.T. for emergency outdoor field transmitters. Portable Hand Generators in leak cases by Evershed, 800 and 1,600 volts D.C. Portable Field Emergency Telephone stations in leather case Light Army types, magnets, 60/-. Battery type for key and speech, 50/-. Not many left now. Lightweight twin field cable unbreakable Navy type, 55/- mile. Police and Fire Brigade, day and night Lucas and Aldis Army Signal lamps, telescopic sights, hand or tripod. Crystal sets, 7/6. Battery set kits, oak cabinet panel fitted 2 vari. condensers and range switch, terminal panel, etc., partly wired. Maker's surplus, 15/-.

EMERGENCY ENGINE SETS. Stuart petrol-electric sets, water-cooled, coupled to 30 volts 5 amp. dynamo, £12. Larger size, 50 volts 10 amps. £17. Portable air-cooled engine sets for field charging.

EDISON Steel Storage Cells. DYNAMOS and Switchboards from 50 watts to 50 kw. Several hundreds to select from. Morse chains and wheels, 25/- set. Skewgear boxes, 1 h.p., 10/-. Gear boxes, 2 1/2 h.p., 4/6. Electric Governors, 7/6. Bowden R.A.F. Remote Controls, 18 points, 7/6. TAPE MORSE RECORDERS. For radio to 30 w.p.m. or land line. New portable walnut case, very complete model with key and meter indicator. Standard G.P.O. type with tape reel or base. For experimenters we have a few incomplete with perfect spring drive. Paper tape reels, 6d.

RELAYS. We are able to offer the widest possible range of Relays from the robust electro-magnet to the sensitive moving-coil relay.

The Relays Nos. 1 to 18 have their magnet windings distinct from the silver-tipped contact blades which carry about 250 m.a.

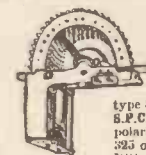

TYPE "J" SELECTOR RELAY SWITCHES.—As illustrated: 25 units of 25 ways each. Relay solenoid operated or distant control. As used in Tots and Auto phone exchange, 10/- G.P.O. Vertical Relays, 5/- to 15/-.

SINGLE BLADE RELAYS.—No. 1 type 50D 1,000 ohms "on-off" 10 volts, 8 m.a., No. 2 type 823 s.p. 2,000 ohms "off" only, 10 volts 5 m.a., 8/-.

S.P.C.O. RELAYS. No. 5 type 300 ohms, 80 or 450 ohms, polarized 3 blade 2 volts, 20 m.a., 7/6. No. 6 type 194 ohms, 3 blades 2 bobbin, polarized, 3 blades, 6 volts 25 m.a., 8/6. Ditto, No. 7, 10,000 ohms, 20 volts, 25 m.a., 12/6. No. 8 type 11603, 3 blade, 2,600 ohms, 10 volts, 4 m.a., 9/-. No. 8a, type W.E. on 4 in. ebonite panel 40 ohms 6 v. 30 m.a., 10/-. **MULTI-BLADE RELAYS.**—No. 9 type, A.H., 1,300 ohms, 2 coli, D.P. "on-off" 8/6. 22 volts, 150 m.a., No. 10 type A.H., 1,800/2,000 ohms 2 coli, 3 circuits, 6 blades "on-off" 15 volts, 100 m.a., 9/-. No. 11 type 851, 1,200 ohms, 8 blades, 3 circuits "on-off" 3 circuits 9 P.C.O., 12 volts 12 m.a. Blades removable, 12/6. No. 12 type 27B Spare 1,000 ohm. coil with armature, no contacts, for making relays, 2/6.

L.B. SERIES RELAYS.—No. 18 type LA, 1 ohm, 2 on 1 off, 12/6. No. 14 type LB ditto, 10 ohms, 12/6. **HAND RELAY.**—No. 15 type 1,900 coil, 1,300 ohms, trip contacts "on" until hand reset, 12/-. No. 16, ditto but reverse contact set "on" by hand, trip-off by relay coil, 1,500 ohms 14 volts, 10 m.a., 12/-. **SPECIAL LIGHT S.P. RELAYS** for model control. No. 3 type D 41 one blade "on-off" 10,000 ohms, 20 volts, 25 m.a., 12/6. No. 4, 2,000 ohms, 10 volts, 5 m.a., 10/-. No. 4a, 5 ohms, 2 volts, 1 amp., 7/6. Heavier: Current Relay for Transmitters, etc. Sounder type 5 amps. 15/- American Ham Relay, 7/6. Ship Magnetic Key Relay 15/-. Greed high-class polar set 2-way Relays, 25/-

SUPERSENSITIVE MOVING COIL RELAYS.—These work on really tiny currents from photo-cells, etc., and a small rectifier can be used for AG impulses. Two types, (1) The famous large double-acting Weston Relay, open type, model 30, 50/- List price 50 dollars; or mounted in mahogany case with glass top, 60/-. For panel use, the small 2 in. meter type W1 works on 50 microamps with 150 m.a. on main contact, 55/-

BATTERY CHARGING ON A.C. MAINS. The A.C. NITMDAY wt. keep your battery fit without attention. Model N/AG 100 250 volts A.C. and D.C. 6/8 volts 1 amp. 15/-. Model N/BB, 100/250 volts to D.C. 6/8 volts 1 amp. 25/- Model N/C8, 100/250 volts to D.C. 6/8 volts 2 amps., 35/- Model N/D 12, 100/250 volts to 12 volts 1 amp., 32/- Ditto, 12 volts 2 amps., with 6-volt tap, 55/- 5 amp., 24/10/-.

Send for LATEST BARGAIN LIST "W."

ELECTRADIX RADIOS

218, UPPER THAMES STREET, LONDON, E.C.4.

Telephone: Central 4611.

WALNUT SET CABINETS



(as illustrated) 21" long, 11" deep, 12" high.

A really first-class piece of furniture.

4/6

Carr. Paid

4 Pole Single Throw Yaxley Rotary Switches 8d. ea. .0005 Mica Dielectric Reaction Condensers 8d. ea. Screw Fuse or Bulb Holders 4d. ea. Mains Transformers, 350-0-350, 80M.A. 4v. 2 1/2 amp. 4v. 5 amp. 13v. 2 amp. Input 200 to 250 volts. 5/6 ea. All post free. See previous adverts. for other genuine bargains.

UNIVERSAL, 8 & 10, Brown Street, MANCHESTER, 2. Phone: Deansgate 5009.

THE INSTITUTE OF WIRELESS TECHNOLOGY (Incorporated), 4, Vernon Place, Southampton Row, London, W.C.1.

OVERSEAS EXAMINATIONS

Overseas Candidates for the November Examinations must submit their applications to the Secretary not later than July 31st, 1939. FULL INFORMATION, WITH PARTICULARS OF MEMBERSHIP, MAY BE OBTAINED FROM THE SECRETARY.

SITUATIONS VACANT

AIR MINISTRY.

AERONAUTICAL Inspection Directorate.

VACANCIES Exist for Unestablished Appointments as Examiners in the W./T. and Instrument Branches.

QUALIFICATIONS.

APPLICANTS for Vacancies in Instrument Branch must have good general education, theoretical knowledge of physics, optics, mathematics, training in light engineering or instrument making. Candidates must be able to read working drawings and specifications and use micrometers and other types of measuring instruments. Preference will be given to candidates having a good knowledge of thermometry, precision pressure measuring instruments as used on an aircraft, and of materials from which they are manufactured.

APPLICANTS for Vacancies in W./T. Branch having the following qualifications will receive preference: good general education, sound technical knowledge of high frequency engineering equal to City and Guilds final examination in Radio Communications, practical knowledge of modern methods of production and testing of W./T. transmitters, receivers, wavemeters and associated equipment; also electrical equipment such as generators, transformers, and of materials from which they are manufactured. Candidates must be able to read working drawings and specifications and to use micrometers and other measuring instruments.

THEY Must be Prepared to Serve in any part of the United Kingdom, to go into the air if required in connection with their duties, and to drive a car.

SUCCESSFUL Candidates will be Required to Undergo a Period of Training in Aeronautical Engineering Inspection not exceeding 3 months.

DURING Training Candidates will be regarded as on probation and paid at the rate of £184 a year. On satisfactory completion of the training course, they will be appointed as Examiner and paid at £246 a year, rising by increments of £12 if service is satisfactory to £337, except that the starting salary for entrants below the age of 24 years will be reduced by £12 for each year below that age.

SUBSISTENCE Allowance at the rate of £1 5s. weekly is payable whilst under training to married men (and others with certain dependents) who normally reside outside the training centre.

SALARIES are Paid Monthly in Arrear.

NORMAL Age Limits 21-50 Years. Candidates between 50-55 years will be considered if they have had experience of engineering inspection.

CANDIDATES Who, on interview, fail to qualify for the Examiner Grade, may be considered for:-

ASSISTANT Examiner.—Salary scale £184-£10-£246.

ASSISTANT Examiners do not undergo training, but are appointed direct to an A.I.D. station. They may later become eligible for promotion to Examiner on attaining the requisite standard of efficiency, providing they are willing to undertake the obligations required of Examiners as above.

APPLICATION Must be Made on Form 786, copies of which can be obtained on application (by postcard only) to:-The Under Secretary of State, Air Ministry, I.G., 34, Berkeley Square House, Berkeley Square, W.1. [8308]

AIR MINISTRY.

CIVILIAN Electrical Instructors Required.

VACANCIES Exist for Civilian Electrical Instructors at the Electrical and Wireless School, Royal Air Force, Cranwell, Lincs. The commencing rate of pay is £4 per week, inclusive, which may be increased to £4/5 per week after a short period of satisfactory service. Candidates must be capable of lecturing and must have a sound knowledge of general electrical principles, D.C. and A.C., dynamos, motors and alternators, electrical indicating instruments, circuits and wiring, accumulators, etc.

APPLICATIONS Should be Addressed to the Commanding Officer, No. 1 Electrical and Wireless School, Royal Air Force, Cranwell, Lincs, giving full particulars as to previous experience, age, etc. Candidates will be required to appear before a Selection Board for interview and test. The test will include the giving of a lecture on any subject, which may be chosen by the candidate, involving electrical principles. Lecturing sequence and style are most important. [0616]

RADIO Engineer With Experience in Design and Construction of Modern Super Heterodyne Receivers, capable of working without supervision. All applications will be replied to.—Box 9540, c/o *The Wireless World*. [8333]

ROYAL AIR FORCE.—Men of good education required for enlistment and training as wireless operators and armourers; age limits 17½-35; write or call.—R.A.F. Recruiting Depot, Victory House, Kingsway, London, W.C.2, or any R.A.F. Recruiting Depot. [8311]

ADAPTABLE Mechanic With Knowledge of Radio Inspection and Manufacture for Constructional and Sales Work on Specialised Instruments, North of England, good appearance and initiative essential. State full details, age, experience, salary.—Box 9557, c/o *The Wireless World*. [8334]

Have a
CAPSTAN

- they're
blended better

11½ for 20 6 for 10
AND FOR WEEK-ENDS
Flat-fifty box 2/5°
PLAIN OR CORK-TIPPED

THE DEMAND FOR CAPSTAN INCREASES DAILY

W. D. & H. O. WILLS, BRANCH OF THE IMPERIAL TOBACCO COMPANY (OF GREAT BRITAIN & IRELAND), LIMITED. C.C.645D

ENGINEERS!
ARE YOU EARNING
LESS THAN £10 PER WEEK?

If so, you cannot afford to carry on without reading our 268-page Handbook. The book explains clearly and definitely many ways of carving out a successful career. Among other things it explains the Services of our unique Appointments Department; outlines Home-Study Courses in all branches of Civil, Mechanical, Electrical, Motor, Aero, Wireless, "Talkie" Engineering, Building, Govt. Employment, etc., and gives details of B.Sc., A.M.I.C.E., A.M.I.E.E., A.M.I.Mech.E., A.M.I.A.E., A.M.I.W.T., A.M.I.R.E., G.P.O., MATRIC., and all Exams. We Guarantee —"NO PASS — NO FEE." Whether you be an old hand or a budding apprentice get this book to-day. FREE and POST FREE.

BRITISH INSTITUTE OF ENGINEERING TECHNOLOGY.
387, Shakespeare House, 17/19, Stratford Place, London, W.1.

268 PAGES Free!

Q.C.C. Type S5
FREQUENCY
CONTROL UNITS
(As specified by "The Wireless World.")

Ground to within 5kc. of your specified frequency in the 7Mc. amateur band and supplied complete with official calibration certificate to an accuracy of 0.025%.

Send 1/4d. stamp for our full price list of all types of quartz crystals and radio transmission components.

THE QUARTZ CRYSTAL CO. LTD., Kingston Road, NEW MALDEN, Surrey.
Phone: Malden 0334.

PRICES £1
S5 UNIT (as illus.)
S5 CRYSTAL, 15/-
without holder
ASEBOARD MOUNT for the 1/3
type S5 unit.

This John McClure

5 waveband receiver chassis incorporates the famous ACT 5 Tuning Unit, covering a wave range of 12.5-35m., 30-80 m.,

73-200 m., 200-550 m., and 660-2,000 m. Dual ratio drive, H.F. stage on all bands, delayed AVC, undistorted beam power output of 5 watts.

Our reputation for unrivalled performance is in every way upheld by this chassis.

Price, including valves . £12.10.0

Particulars of other models on request.

JOHN McCLURE LTD.
(G6JM)
ERSKINE ROAD, LONDON, N.W.3. PRImrose 5435.

Pamphonic AMPLIFIERS

Pamphonic Reproducers Ltd. (Associated with PYE Ltd.)
45, St. Pancras Way, London, N.W.1.
Phone: EUSton 1727.



SITUATIONS VACANT

VACANCY for two Apprentices; Individual training given in construction latest types transmitters and receivers in approved Air Ministry organisation; small premium first year, commencing salary second year; excellent opportunity for right type of young men.—Apply Box 9299, c/o The Wireless World. [8303]

SITUATIONS WANTED

ELECTRICAL Engineer (Foreign). 10 years' experience in large factory radio laboratory, first class theoretician, well versed in patent affairs, speaks 6 languages, seeks employment in factory or as technical consultant at overseas sales and servicing headquarters.—Write Box 9247, c/o The Wireless World. [8274]

BOOKS, INSTRUCTION, ETC.

AMERICAN Valve Data.—The new 200-page Raytheon Valve Data Book gives full characteristics and applications of all types of American valves; invaluable to all servicemen; post free 2/3; abroad 3/—Leonard Heys, 36, Henry St., Blackpool. [0594]

ELEMENTARY Principles of Wireless Telegraphy and Telephony.—By R. D. Banguay. Revised by O. F. Brown, B.Sc. Third edition (1930). The standard textbook for wireless students and beginners. Deals with the whole subject of wireless telegraphy and telephony, avoiding too technical a treatment of the problems involved. Well illustrated. Price 7/6 net. By post 8/-, from Iliffe and Sons, Ltd., Dorset House, Stamford St., London, S.E.1.

FOUNDATIONS of Wireless.—By A. L. M. Sowerby, M.Sc. Second edition. An elementary textbook on receivers. Deals fully with the construction of wireless sets, valves, and the process of detection. Price 4/6 net. By post 4/11, from Iliffe and Sons, Ltd., Dorset House, Stamford Street, London, S.E.1.

RADIO Data Charts.—By R. T. Beatty, M.A., B.E., D.Sc. Second edition. A series of Abacs providing most of the essential data required in receiver design and enabling problems to be solved without having recourse to complicated mathematical formulae. Price 4/6 net. By post 4/10, from Iliffe and Sons, Ltd., Dorset House, Stamford St., London, S.E.1.

THE Wireless World" Diary for 1939 contains 77 pages of facts, formulae and general information of the kind that is always wanted but is difficult to follow. Also a list of the most important European Broadcasting Stations and short-wave stations of the world. Twelve pages of circuit diagrams of receivers, amplifiers and units.—By post 1/7 from Iliffe & Sons, Ltd., Dorset House, Stamford St., London, S.E.1.



Made under the direct supervision of N. Partridge and personally guaranteed to be of the highest Electrical and Mechanical Efficiency. Set Manufacturers and the Trade who are interested in Reliable and cool working Transformers with a Super Safety-Factor Margin are invited to write for full technical details and prices.

FREE TO P.A. DEALERS. The PARTRIDGE P.A. MANUAL. Valuable information on Amplifier design. Equipment and service is yours for the asking. WRITE TO-DAY. CONSTRUCTORS can obtain this manual for 2/3.

N. PARTRIDGE, B.Sc., A.M.I.E.E.
KING'S Bldgs., DEAN STANLEY ST., LONDON, S.W.1



INDEX TO ADVERTISEMENTS

	PAGE
Armstrong Manufacturing Co.	1
Automatic Coil Winder Co., Ltd.	6
Birmingham Radiomart G5N1	1
British Institute of Engineering Technology	5
British Rola, Ltd.	4
Capstan Cigarettes	5
Electradix Radios	4
Galpin's Electrical Stores	2
Goodmans Industries, Ltd.	6
Hartley Turner Radio	2
Institute of Wireless Technology	4
London Radio Supply Co.	4
McClure, John, Ltd.	6
Pamphonic Reproducers, Ltd.	6
Partridge, N.	6
Premier Supply Stores	3
Quartz Crystal Co., Ltd., The	5
Salford Electrical Instruments, Ltd. . . Inside Front Cover	
Savage, W. Bryan, Ltd.	4
Sound Sales, Ltd.	2
Universal Electric Co.	4

Covers
CONTINUOUS
fundamental
frequency band
from
95 Kc. to 40 Mc.

BRITISH MADE.

The
ALL-WAVE
Avo-Oscillator

Regd. Trade Mark

Battery Model
9 Gns.
(Complete with Batteries)

A.C. Mains Model
10 Gns.
(Leather Carrying Case 35/-)

DEFERRED TERMS
IF DESIRED

Covers complete band from 95 Kc to 40 Mc. by six fundamental ranges Extended to 80 Mc. by harmonic calibration. Directly calibrated throughout. Externally modulated, internally modulated, or R.F. signal obtained at will. Internal modulation is 30% at 400 cycles, the L.F. signal being available for external use. Double attenuation enables signals to be varied from a few microvolts to 50 millivolts, with a force output of 1 volt.

● Write for fully descriptive leaflet.

Sole Proprietors & Manufacturers:
The Automatic Coil Winder & Electrical Equipment Co., Ltd.,
Winder House, Douglas Street, London, S.W.1. Phone: Victoria 3404/7.

Specified for the
"WIRELESS WORLD"
STAND-BY
THREE

GOODMANS
Type B/605/12000 PERMANENT MAGNET
LOUDSPEAKER

Complete with
transformer to
give 12,000
ohms load.
PRICE 21/-

Those interested in technical data and fundamental principles of Loudspeaker design are invited to send for a 20-page Brochure entitled "The Attainment of an Ideal." The technical treatise fully describes many problems encountered and solved in the quest of High Fidelity reproduction.

SEND FOR THIS FREE TECHNICAL BROCHURE

To GOODMANS INDUSTRIES LTD., Lancelot Rd., Wembley, Mdx.
Phone: Wembley 4001-5

Please send me a copy of "The Attainment of an Ideal." I enclose 1/4 stamp.

NAME

ADDRESS

W.W.13.4

FOURTH EDITION

Revised and Enlarged with 50 Additional Pages

WIRELESS SERVICING MANUAL

By **W. T. COCKING**
(of "The Wireless World")

The most complete book of reference of its kind. A reliable practical guide for amateur and professional

The present Edition of the "Wireless Servicing Manual" brings the material of the book right up to date and includes an additional chapter on television receivers which is practically the only source of servicing information available on this subject.

Testing apparatus is fully dealt with and the methods of locating and curing faults in receiving equipment are explained.

Ganging, Automatic Volume Control, Instability, Distortion, Mains Hum, Whistles, Local Interference and Aerials, are all separately treated.

The reference material, including base-connections for British, Continental and American Valves, and the various colour codes for components, has been extended and revised.

BOUND IN CLOTH BOARDS

SIZE 7½ ins. x 5 ins.

288 Pages

5/- net. By post 5/5

Issued in conjunction with "THE WIRELESS WORLD" and Published by the Proprietors:—
ILIFFE & SONS LTD., DORSET HOUSE, STAMFORD STREET, LONDON, S.E.1

W.W.20.

RADIO LABORATORY HANDBOOK

By **M. G. SCROGGIE, B.Sc., A.M.I.E.E.**

Issued in conjunction with "The Wireless World"

"Radio Laboratory Handbook" is the only practical and reliable handbook on the subject. It gives the serious wireless worker complete information from first-hand experience about laboratory equipment, the instruments which are necessary and the correct methods of operating them.

384 pp.
211
illustrations.

PRICE
8/6 net
By post 9/-

The fundamental principles are fully discussed, as well as the sources of power and signals, instruments and measurements. Other sections deal with ultra-high-frequency work, the working out of results, and reference data. There is also a collection of the most useful symbols, abbreviations, formulæ, laws, curves, tables and other data.

A complete index, numbered sections and cross references enable the reader to find what is required without loss of time.

from Bookstalls and Booksellers or direct from the Publishers

ILIFFE & SONS LTD., DORSET HOUSE, STAMFORD STREET, LONDON, S.E.1

The ELECTRICAL REVIEW

The Complete Technical Journal

Practical articles on all aspects of electricity supply and utilisation — industrial, commercial and domestic. Latest news of the electrical industry and developments. Advertisement pages form a comprehensive buyers' guide.

Contents of April 14th Issue:—

PROGRESS IN POLAND
Important electrical schemes in hand.

WORLD'S FAIR, NEW YORK
Advance notes on electrical exhibits.

CABLE-MAKING
A visit to the British Insulated Cable Works.

FACTORY INSTALLATIONS
Planned distribution layouts.

ALL THE WEEK'S NEWS

EVERY FRIDAY 6d.

Subscriptions: United Kingdom £1 14 8
Canada £1 12 6 Other Countries
£2 1 6 per annum, post free.

ELECTRICAL REVIEW LTD.

Dorset House, Stamford Street, London, S.E.1

Mention of "The Wireless World," when writing to advertisers, will ensure prompt attention.

What Does

BEVERLEY BAXTER

say about it?

The news is often confusing. One thing seems to contradict another, and events move too fast for a plain man to make up his mind.

That is why thousands of people turn to Beverley Baxter's article in the SUNDAY GRAPHIC. They know that his views are sound, clear and logical. They can rely upon Beverley Baxter, M.P.

Every Sunday in the

SUNDAY GRAPHIC

All the News and Pictures Fit to Print

WHEN SUPERHET PERFORMANCE IS DOWN

The **Wireless** **World** **6^D**
THE PRACTICAL RADIO & TELEVISION JOURNAL

Thursday, April 20th, 1939

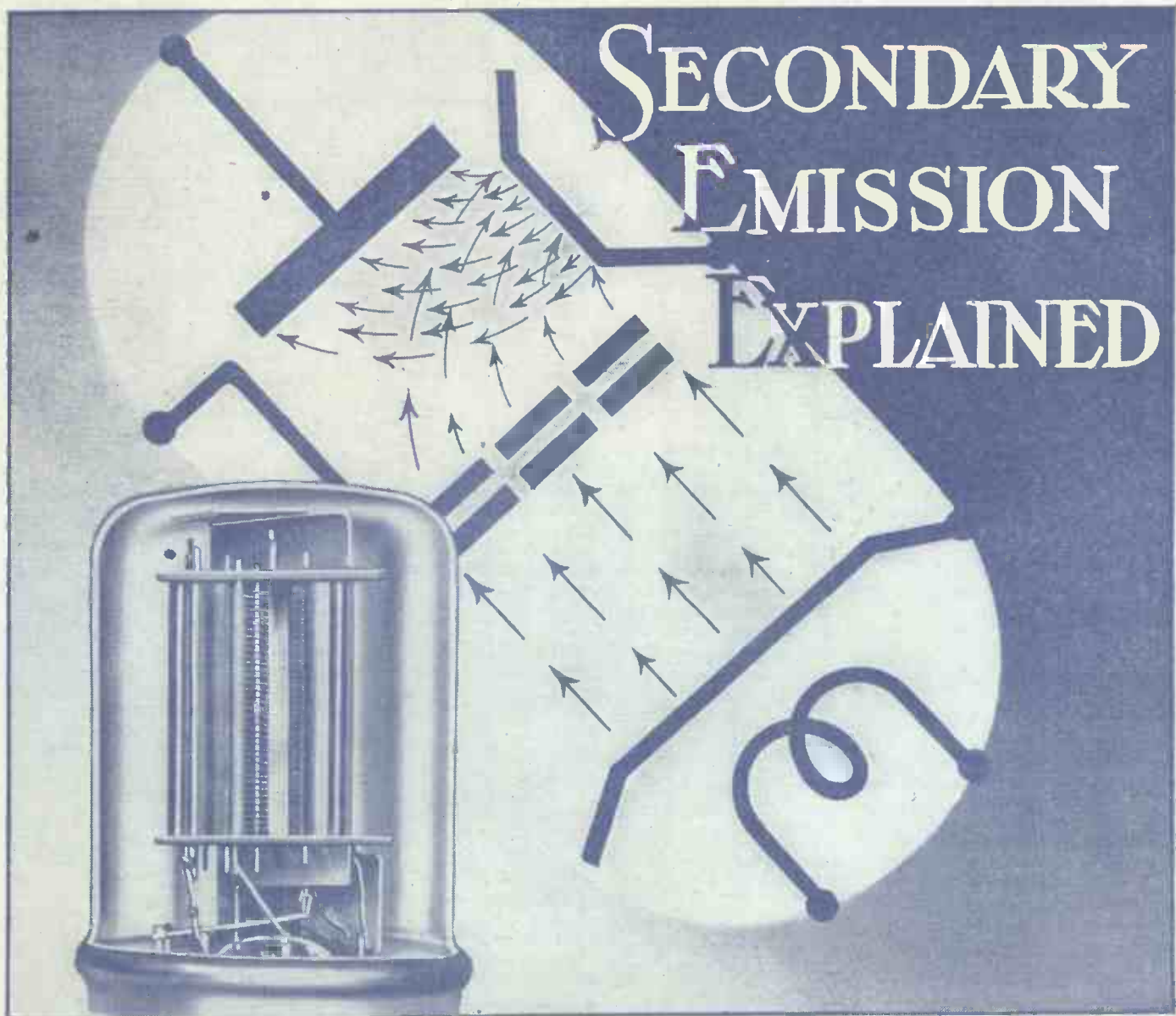



VERSATILITY

SOUND SALES have the pleasure to illustrate two further examples of their many products.

May we draw your attention to the illustration of the SPECIAL TRANSFORMER—compared in size with a match box and a small Microphone Transformer; also the SPECIAL AMPLIFYING EQUIPMENT in a steel case mounted on casters for portable use.

These items represent only a small part of SOUND SALES activities, which include Transformers from 6 watts to 12 K.V.A., Amplifiers of all types having an output from a few milliwatts to 650 watts with Rack and Panel Construction.

We shall be glad to send quotation for any Special Equipment you may require.

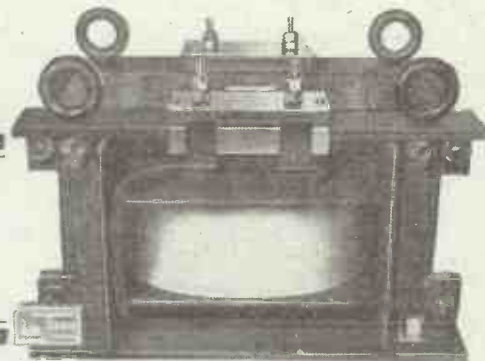

SOUND SALES LTD.

MARLBOROUGH ROAD, UPPER HOLLOWAY, LONDON, N.19.

Telephone: ARChway 1661-2-3.

Contractors to the Air Ministry, G.P.O., War Office, Office of Works, etc.

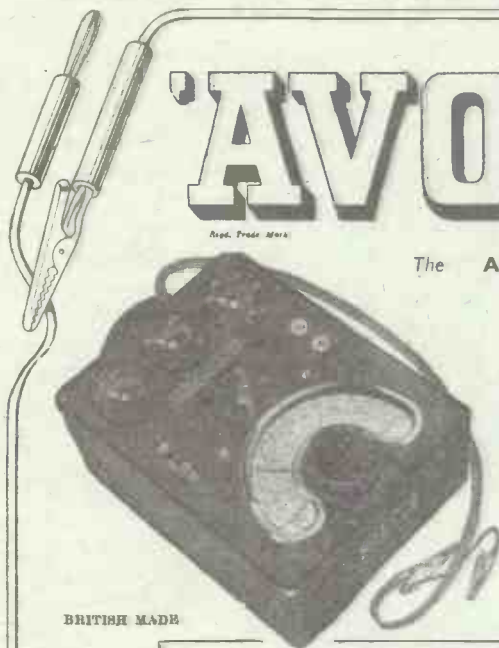

BRITISH MADE

All 'AVO' instruments are available on Deferred Terms.

The Model 7 - 46 RANGE UNIVERSAL AVOMETER

Electrical Measuring Instrument

A compact multi-range A.C. D.C. meter, with 46 ranges covering A.C. and D.C. amperes and volts, also resistance, capacity, audio-frequency power output, and decibels. No external shunts or series resistances required. Conforms with B.S. first grade accuracy requirements; 5in. mirror scale. Provided with automatic compensation for errors arising from temperature variations. Protected by an automatic cut-out against damage through overload

16 Gns.

Sole Proprietors and Manufacturers:
THE AUTOMATIC COIL WINDER & ELECTRICAL EQUIPMENT CO., LTD.,
Winder House, Douglas Street, London, S.W.1. Phone: Victoria 3404-7.

'AVO' Precision ELECTRICAL TESTING INSTRUMENTS

The ALL-WAVE AVO-OSCILLATOR

An accurate modulated oscillator covering from 95 Kc. to 40 Mc. by six fundamental ranges. Extended to 80 Mc. by harmonic calibration. Accuracy within 1%. Externally modulated, internally modulated, or R.F. Signal obtained at will. Double attenuation enables signals to be varied from a few microvolts to 50 Millivolts, with a force output of 1 volt. A barretter in the battery model increases L.T. Battery life.

BATTERY MODEL 9 Gns.
(including batteries)

A.C. MAINS MODEL 10 Gns.
(Leather carrying case 35/-)



The UNIVERSAL AVOMINOR
Electrical Measuring Instrument

22 Ranges of DIRECT READINGS

A compact precision moving-coil instrument for all A.C. and D.C. testing. It has 22 ranges for measuring A.C. voltage, D.C. voltage, current and resistance. All readings are direct. No calculations. The high total resistance of the instrument—200,000 ohms—ensures accurate readings. Complete with leads, interchangeable crocodile clips and testing prods; and instruction booklet £5.10 (Leather carrying case 10/-)

OTHER 'AVO' INSTRUMENTS include

36 Range Universal AvoMeter	13 gns.
22 Range D.C. AvoMeter	9 gns.
'Avo' Valve Tester (with Universal Panel)	12 gns.
'Avo' Universal Valve Panel alone	3 gns.

Write for fully descriptive leaflets.

"RADIO SERVICING SIMPLIFIED"

A popular text book written to conform with modern requirements and in the light of present day knowledge. Embraces the whole routine of testing modern receivers. Fully illustrated.

Price 2/6 (post free 2/10)

The Wireless World

THE
PRACTICAL RADIO
JOURNAL
29th Year of Publication

No. 1025.

THURSDAY, APRIL 20TH, 1939.

VOL. XLIV. No. 16.

Proprietors : ILIFFE & SONS LTD.

Editor :
HUGH S. POCOCK.

Editorial,
Advertising and Publishing Offices :
DORSET HOUSE, STAMFORD STREET,
LONDON, S.E.1.

Telephone : Waterloo 3333 (50 lines).
Telegrams : "Ethaworld, Sedist, London."

COVENTRY : 8-10, Corporation Street.
Telegrams : "Autocar, Coventry." Telephone : 5210 Coventry.

BIRMINGHAM :
Guildhall Buildings, Navigation Street, 2.
Telegrams : "Autopress, Birmingham." Telephone : 2971 Midland (5 lines).

MANCHESTER : 260, Deansgate, 3.
Telegrams : "Iliffe, Manchester." Telephone : Blackfriars 4412 (4 lines).

GLASGOW : 26B, Renfield Street, C.2.
Telegrams : "Iliffe, Glasgow." Telephone : Central 4857.

PUBLISHED WEEKLY. ENTERED AS SECOND
CLASS MATTER AT NEW YORK, N.Y.

Subscription Rates :
Home and Canada, £1 10s. 4d. ; other
countries, £1 12s. 6d. per annum.

*As many of the circuits and apparatus described in these
pages are covered by patents, readers are advised, before
making use of them, to satisfy themselves that they would
not be infringing patents.*

CONTENTS

	Page
Editorial Comment	361
Distortion in Recording Amplifiers. I	362
Estimating Coil Inductance	364
Problem Corner	364
Sound Accompaniments and Effects	364
Receiver Fault Finding	365
The Rider "Chanalyst"	368
High-frequency Resistance	369
Random Radiations	370
Television Programmes	371
News of the Week	372
Secondary Emission Explained	374
Pilot Model T.63 Test Report	376
News from the Clubs	377
The Modern Receiver Stage by Stage. VIII—AF Amplification, the DC Circuits and the Power Supply	378
Unbiased	381
Recent Inventions	382

EDITORIAL COMMENT

Post Office Relays

Assurances Given

POST OFFICE officials have met representatives of the Radio Industry and have given them the two assurances which *The Wireless World* asked for when commenting in the issue of April 6th on the position created by Post Office participation in the relay service.

The Post Office has stated that there is no intention of competing with private enterprise and that if ultimately special receivers are produced for the reception of programmes from the Post Office System, such sets would in no circumstances be sold by the Post Office, but through the usual marketing channels.

The second assurance given was that although the freedom of the new system from interference would be emphasised, the Post Office would not slacken its efforts to bring about general legislation to prohibit interference at as early a date as possible.

These are the assurances for which we asked, and we believe that the Post Office Relay System will now receive not only the approval, but the active support, of all branches of the radio industry.

Provincial Television

Ways and Means

EXTENSION of the television service to cover areas not already served by the Alexandra Palace transmitter is being urged from several influential quarters. Perhaps the most powerful appeal was that of Lord Hirst, Chairman of the General Electric Company, who, as reported in a recent issue of this journal, based

his plea on the importance of the matter to an industry in which this country has already gained a clear lead over all others. Lord Hirst emphasised the point that in these difficult times he would not advocate the allocation of money to a mere entertainment, but that he did not hesitate to plead for the investment of the relatively small sum necessary to establish a new British industry firmly on its feet. He proposed that the cost of extension should be met either by transfer to the B.B.C. of moneys deducted from wireless licence revenue or by a Government grant.

Another way of overcoming financial difficulties has been suggested by the Radio Manufacturers' Association, which has offered to bear any loss consequent on an extension of television to the Birmingham area. We venture to question both the practicability and desirability of this scheme. As television reception is covered by the normal broadcast licence fee, it is surely permissible to regard every penny spent on extending the service as "a loss" unless it can be proved that individual viewers would not take licences for sound reception only—indeed a difficult matter. Again, the scheme savours of a reversion to the original scheme of broadcast finance, in which the industry contributed directly to the B.B.C.

As to the technical means of distribution, opinion seems to be swinging over in favour of a wireless link, at any rate for the initial extensions. At the end of last year a scheme devised by E.M.I. (believed to be of this nature, although details were not made public) was submitted to the Television Advisory Committee and the Post Office. No statement has yet been issued as to whether the scheme was considered acceptable.

Distortion in Recording Amplifiers

By HUMFREY ANDREWES, B.Sc., A.M.I.E.E.

Part I.—The Right and Wrong Place to Effect Frequency Correction

A CONSIDERABLE amount of material has been published in connection with distortion in the output stage of broadcast sets, but there is far less information available concerning the equivalent part of a home recording amplifier.

Though many attempts have been made to record direct from the output stage of a broadcast set the writer is of the opinion that the serious home recordist does, or at least he should, employ a special amplifier for the purpose.

With amplifiers of the type employed by commercial companies, film studios and broadcasting organisations, and where special recording heads are used, the pro-

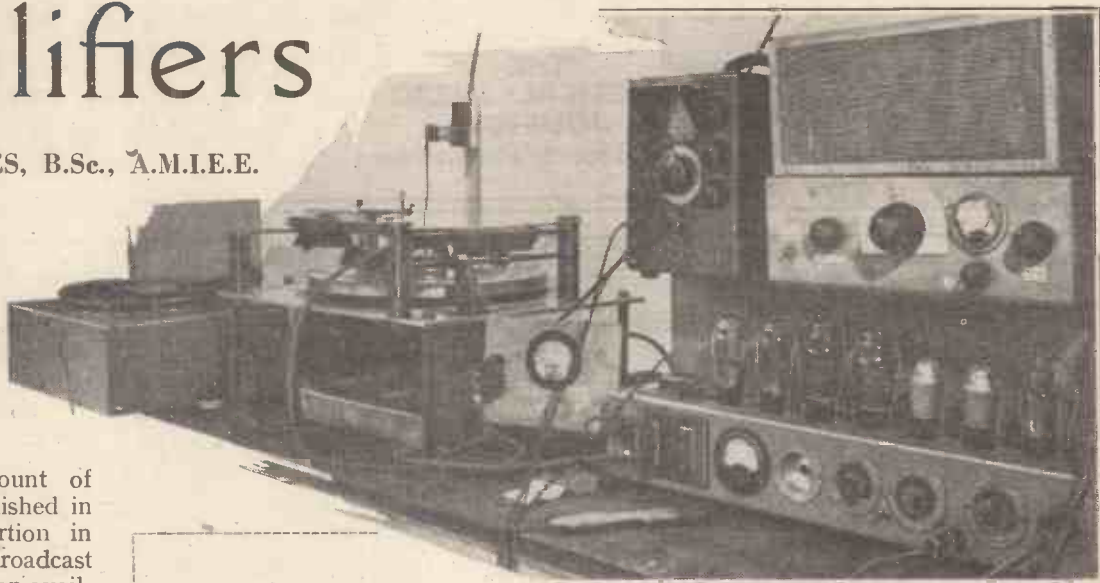

It is explained in this article that when frequency correction is employed in a recording amplifier certain precautions must be taken, as if incorrectly applied it may introduce an unusual form of distortion. Two methods that avoid this undesirable effect are then described.

unexpected difficulties appear on the scene.

For a number of fairly obvious reasons it is desirable that the records which are made should when played back, be as loud as possible at the points of maximum modulation.

In the first place they will usually be compared with commercial recordings, and, therefore, if of a lower general level, will not sound as satisfactory although they may be of equal fidelity, particularly on an acoustic reproducer. Secondly, in order that the great advantage of the directly recorded record, namely, its low surface noise, may be fully exploited, the recording level must be kept as high as possible. All this means that the last stage of the recording amplifier is often working "all out" on peak modulation, unless a very sensitive recording head is available or a larger output stage than that mentioned is used.

Monitor Loud Speaker

The output circuit of the amplifier must therefore be designed to give the most efficient working conditions, and care must be taken to see that all the energy available goes to the recording head, and that none of it is wasted.

The monitor speaker used to listen to the programme while we are recording is an example of this. Unless the experimenter has his head inside the cone, at least two or three watts are required to operate the speaker satisfactorily. As some recording machines make a fair amount of noise, this figure may have to be exceeded on occasion. The author has, therefore, always advocated feeding such a loud speaker from a separate one-valve amplifier, fed from the penultimate stage of the main amplifier or direct from the recording head terminals. By doing this all the energy from the output stage of the main amplifier is available.

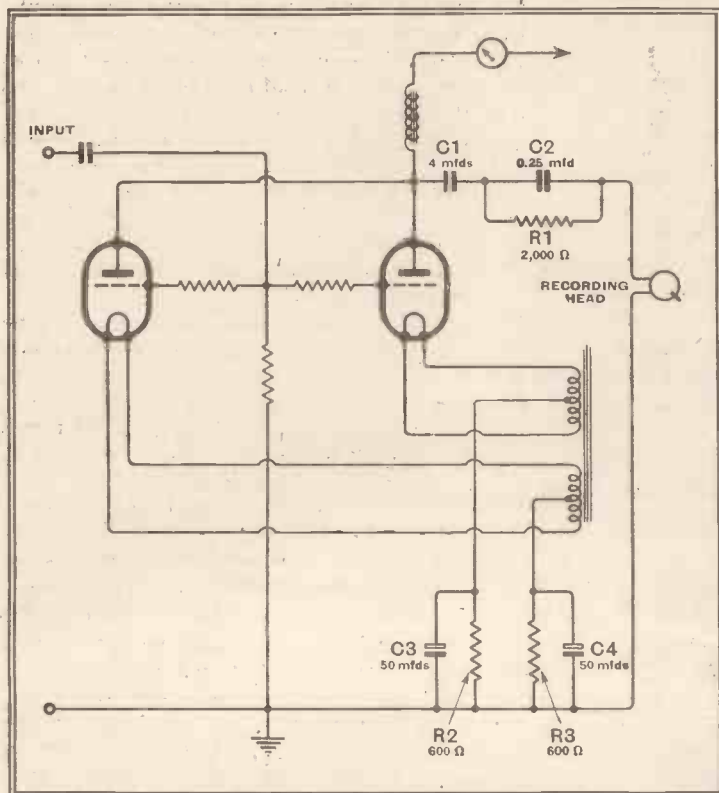

results of some recent experimental work may prove of interest.

In the first place the output power available from the recording amplifier is an important factor. This output is usually obtained from a power stage using two valves of the Marconi PX25 or Mullard DO24 class, which give some 10 or 12 watts per pair. When such a stage is used to feed a non-inductive load, or

Fig. 1.—Output stage of a recording amplifier having a bass attenuator joined in series with the recording head.

blems to be discussed do not arise. But where the best possible results are aimed at with a minimum financial outlay, the writer hopes that these notes giving the

well-designed loud speaker with associated transformer, no serious difficulties arise. When, however, such an output stage is coupled to a direct recording head certain

Distortion in Recording Amplifiers—

We next come to the question of the actual method of coupling the recording head to the output stage. In the experiments to be described later, an amplifier having two DO24 valves was used, initially connected in parallel. For reasons which have already been discussed (*The Wireless World*, August 4th, 1938), it is necessary to attenuate the lower frequencies to obtain the correct recording curve, and to do this a fixed bass attenuator was used in series with the recording head. Fig. 1 shows the general arrangement of the output stage. It will be seen that the circuit is quite conventional. The values of the condenser and resistance in the fixed bass attenuator found to be suitable for the recording head which was used, were 0.25 mfd. and 2,000 ohms respectively. This arrangement gave quite a satisfactory response curve, but, on observing the wave form of a gliding frequency record made under these conditions, appreciable distortion was noted below a frequency of about 500 c/s, although above this frequency the wave form was quite good. An examination of the wave form of the voltage applied to the recording head showed the same trouble. In these tests the voltage applied to the recording head was adjusted so that the last stage of the amplifier was just below the overload point at 1,000 c/s.

The circuit was therefore carefully examined to see how the difficulty could be overcome. The inductance of the recording head was first measured and found to be

Fig. 2.—Final stage of a recording amplifier with the bass attenuator connected in the grid circuit. Apart from R1, C1, the values of the components are the same as for Fig. 1.

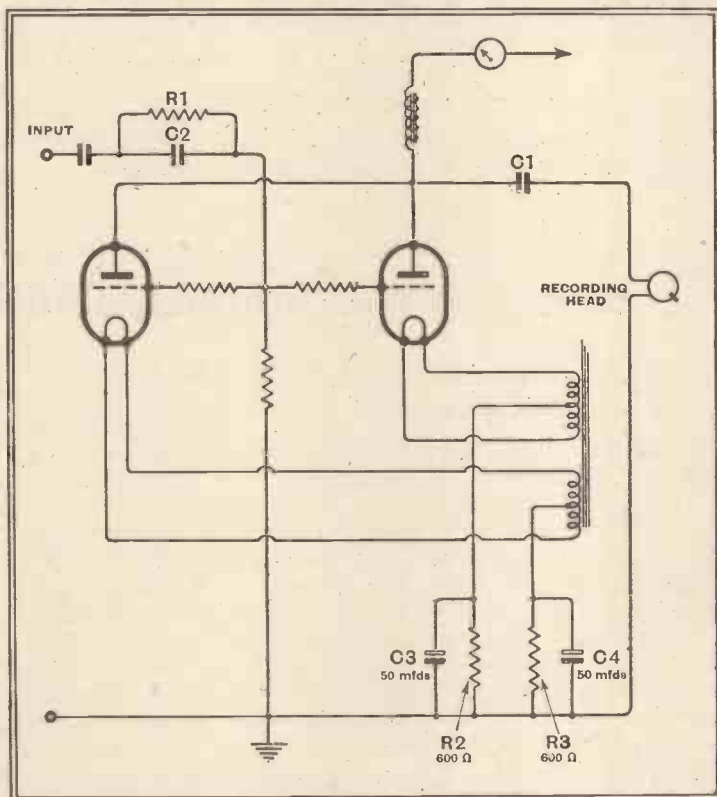

approximately 0.6 Hys. The DC resistance of the head was 250 ohms. On reference to Fig. 1 it will be seen that condenser C2 of the fixed bass attenuator and the recording head form a tuned circuit connected across the output of the amplifier, the resonant frequency of which is just over 400 c/s. The resonance curve of this circuit will not be sharp, as we have the DC resistance of the recording head and the shunt resistance across the condenser to consider, but it is obvious that such a state of affairs is not very satisfactory.

Another important point which must be considered in examining the output stage

of the recording amplifier is the fact that, with a balanced armature-type recording head, the impedance of the head varies widely with frequency and will offer a load below that of the optimum load of the valves at the lower frequencies. This, again, is unsatisfactory and must lead towards wave-form distortion, and coupled with the other difficulty just described calls for a modification of our original output circuit shown in the first figure. In passing, it may be mentioned that where a recording head of this type is used with a push-pull output stage, although the impedance of the head may be much higher, the same difficulties arise. In some recording heads the connections of the operating coils are brought out separately so that they may be connected in series or parallel, giving a 4 to 1 ratio of impedance. If the head is fed direct from the anodes of the push-pull stage, via condensers, using a centre tapped choke, although the values of the fixed bass attenuator will be different, the same tuned circuit exists.

The first and most obvious way of remedying matters is to remove the bass attenuator R1, C2 from the recording head

circuit as shown in Fig. 1 and arrange for the attenuation to take place earlier in the circuit. This may, of course, be done at the first stage of the amplifier or at any other suitable point in the circuit, such as the grid of the last stage. In the latter case we get the circuit shown in Fig. 2. Care must be taken to adjust the values of R1 and C2 so that the same attenuation curve is obtained as before, remembering that the circuit impedance is much higher in this case.

With such an arrangement it is no longer possible to feed the monitor amplifier direct from the last stage if the

response from the monitor speaker is to be reasonably flat, and probably the simplest way out of the difficulty is to feed the monitor amplifier from the anode circuit of the penultimate stage. Alternatively, the monitor amplifier may be fed from the output stage and a suitable boosting circuit introduced to correct the low frequency response. This arrangement is not too satisfactory as it is difficult to make the attenuation and boost curves correspond exactly.

Negative Feed-back

A simpler and, in the writer's opinion, more satisfactory solution of the difficulties described can be found, however, by utilising negative feed-back. Let us again consider Fig. 1. It has been shown that the fixed attenuator R1, C2 causes distortion, so let us short-circuit it. The condensers C3 and C4 each normally have a value of 50 mfd. or more. If, now, this value is made much smaller, the impedance between the filaments of the output valves and earth will increase as the frequency falls. Part of the output voltage will then be fed back to the grid circuit, the amount of feed-back being inversely proportional to the frequency from about 500 c/s downwards. Such an arrangement gives us, therefore, the bass attenuation which we require, and also has the advantage that at the lower frequencies where distortion is most likely to occur the greatest negative feed-back is being introduced.

The new bass attenuator circuit was therefore tried out on an experimental amplifier and a suitable value for the by-pass condensers was found to be 2 mfd. In order to check the recording curve readings were taken of the voltage across the recording head at different frequencies from 1,000 to 50 c/s. for constant input to the amplifier. A curve was first plotted for the old type condenser-resistance attenuator and then for the negative feed-back arrangement. The two curves were found to be very similar in shape, a maximum loss of about 18 db. being obtained at 50 c/s in each case.

Further check was made, using the Buckmann-Meyer image method described in *The Wireless World* of August 11th, 1938, and the photograph shown in Fig. 3 confirms the fact that the characteristics are similar for the two types of attenuator.

Actual recording tests were now made and the results fully confirmed expectations. Various different types of programme material were recorded, and it was immediately noted that there was a big improvement in the recording of the lower register. It has been previously found that certain instruments, particularly the French horn and alto saxophone, were difficult to record faithfully, but this trouble was largely overcome when the negative feed-back attenuator was used. A big improvement was also obtained with a piano recording. Readers who are musically inclined will realise that the fundamentals of the wind instruments mostly occur near the frequency of the

Distortion in Recording Amplifiers—
“tuned circuit” mentioned, and this clearly indicates that for once theory and practice show a tendency to agree. In a

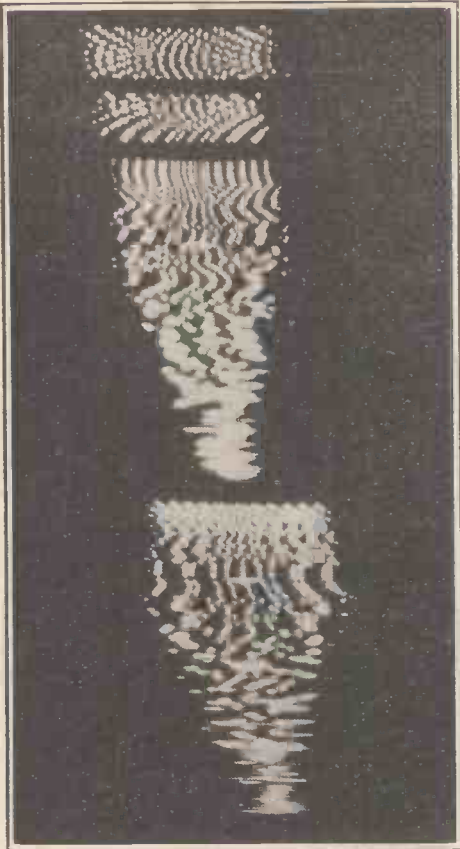

Fig. 3.—This Buckmann-Meyer image shows that either method of bass attenuation described in the text will yield the same results. Note, there are two recordings on this disc.

further article it is hoped to give quantitative data of the voltages which it is possible to produce from a recording amplifier without distortion, and also to give the results of a comparison between parallel and push-pull operation of the output stage.

Estimating Coil Inductance SIMPLIFIED APPROXIMATE FORMULA

RADIO experimenters interested in short-wave work frequently find it necessary to calculate the inductance of a coil from its physical dimensions, or alternatively to determine the number of turns required on a given former to obtain some required value of inductance.

In such cases *The Wireless World* book of Abacs proves invaluable, and these factors can be determined in a few minutes. When these Abacs are not available one may fall back on the classical formula, but this has the disadvantage that the dimensions must be in centimetres, and in any case a table giving values of the correction factor “K” for different ratios of diameter/length is necessary. Also the working is rather

laborious unless a slide rule or logarithm tables are at hand.

There is a formula which is widely used in America but does not appear to be so well known over here. In this formula all the dimensions are in inches, and calculations can be made quickly. The results obtained by it are stated to be accurate within about 5 per cent., which is sufficient for most practical purposes.

The formula is:—

$$\text{Inductance (microhenrys)} = \frac{0.2 D^2 N^2}{3D + 9L}$$

where D is diameter in inches, L length in inches, and N number of turns.

The alternative form is:—

$$N = \sqrt{\frac{3D + 9L}{0.2 D^2} \times \text{Inductance (microhenrys)}}$$

The writer has made considerable use of these formulae, and results have always agreed closely with those obtained from Abacs or the more usual formulae.

PROBLEM CORNER—16

An extract from Henry Farrad's correspondence, published to give readers an opportunity of testing their own powers of deduction:—

90, Fays Way,
Vectorford.

Dear Henry,

I have just acquired rather a nice multi-range meter—DC and AC—and in playing

about with it came across something that has been puzzling me. No doubt it will be quite clear to you, so perhaps you would enlighten me.

Our receiver picks up a lot of noise, and as I suspected it came along the AC mains I put in a simple filter circuit I read about somewhere, like this:—

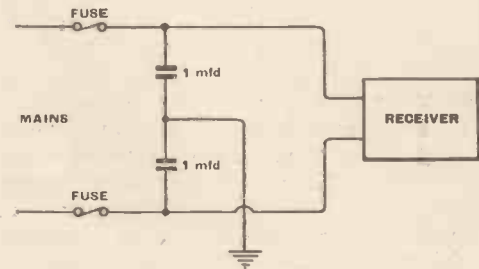

For something to do with my new toy I measured the current taken by the set, with and without the condensers connected, to see if they increased it much. I measured the current in each side of the mains by pulling out the branch fuses and substituting the meter, nothing else being on in that branch. With receiver only, as originally, the current was almost exactly 0.4 amp.; and when the filter was connected, instead of the current increasing, it did practically nothing at all in one line, and in the other it actually dropped slightly. How do you account for that?

Yours sincerely,
Fred New.

For Henry Farrad's explanation, turn to page 377.

Sound Accompaniments and Effects

LOCATING THE APPROPRIATE RECORD GROOVE

A NEW device, known as an Automatic Gramophone Pick-up Control, has recently been introduced by Kinevox Studios, 1a, Doughty Street, London, W.C.1. This mechanism is designed to enable an operator to lower the needle in a pick-up into any preselected groove of a record. This facility is of great value to amateur cinematographers for producing a sound accompaniment to films and also for ensuring that sound effects from gramophone records, when used in theatres, etc., will follow instantly to cue.

The outstanding feature of this device is that no link between projector and disc reproducing turntable is necessary, but accurate synchronisation between picture and sound is possible, dependent only on the alertness of the operator.

The method of working is as follows: the speech commentary must be divided into short paragraphs and the beginning of each paragraph should be inspired by a particular scene at the commencement of any sequence in the film requiring explanation. After making certain that the commentary is well within the running time of the film, it can be recorded at the Kinevox Studios, if desired. The ability of the operator to synchronise the commentary

throughout a film is due to the predetermined blank section on the record between each paragraph, by which the spoken words will always coincide with the scene commented upon. Thus, for instance, when Broadcasting House appears on the screen, the operator has only to depress a lever for the words “Broadcasting House, this imposing edifice . . .” to be radiated from the loud speaker.

At the end of the speech the operating lever is released, raising the pick-up ready to drop on the next section of the commentary. During the lifting of the pick-up a delayed action is incorporated, the short delay period corresponding with the blank space between the paragraphs and so prevents the repetition of the last words of the previous paragraph. With this system about 400 words can be recorded on one side of a 12-inch record. A white card indicator for marking preselected grooves is also provided. By using a second turntable, suitable background music can be employed to cover the gaps in the commentary.

A complete playing-desk, fitted with the Kinevox Pick-up Control unit, costs £10 10s. and the pick-up control mechanism alone costs £6 6s., exclusive of fitting. A descriptive folder is available from the manufacturers at the address above.

D. W. A.

Receiver Fault Finding

LOW SENSITIVITY IN THE SUPERHETERODYNE

By "TRIMMER"

THE superheterodyne which works but is somewhat below its proper standard in sensitivity or selectivity is often a much stiffer proposition from the fault-tracing point of view than the receiver which is dead or is drastically wrong.

Of the innumerable faults which can cause reduced sensitivity the majority will be found to reduce valve slope, to put out the circuit alignment, or to reduce the magnification of a tuned circuit. It must be admitted that the above represents an exceedingly broad generalisation, but it is worth keeping in mind, even if only to keep the testing work upon some sort of systematic basis.

Valve slope may prove to be down either as a result of an actual valve defect or through some fault which upsets the valve operating voltages. The circuit alignment may have been thrown out by some trimmer or padder misadjustment or by some fault which is responsible for giving a tuned circuit an abnormal LC value.

Any question of tuned circuit magnification is apt to prove awkward outside a

superheterodyne has much to do with the sensitivity of the receiver, as can readily be appreciated when it is remembered that the voltage built up across the circuit by current oscillating in it is equal to the internal EMF of the circuit \times magnification. A glance at the expression for circuit magnification will make it clear that any increase in the RF resistance of the circuit will drop the magnification. Where R of Fig. 1(b) is concerned any abnormally high value will be due to some fault directly associated with L, or C, or the wiring between these components.

THE complexity of the modern receiver often makes the location of faults difficult unless the correct testing procedure is adopted. In this article some notes are given on the tracing of those elusive defects which cause a drop in sensitivity, without entirely preventing the set from working.

Fig. 2(a) represents the same LC circuit, but with a shunt resistance R1 connected across it. R1 acts as a load upon the circuit and must account for a certain expenditure of energy abstracted from the tuned circuit. In effect, the presence of R1 modifies the circuit conditions in a manner equivalent to that of adding an extra series resistance to the circuit. In Fig. 2 (b), R represents the RF resistance of the circuit, without reference to R1. Fig. 2(c), however, is the electrical equivalent to Fig. 2(a), and in this diagram R2 represents the effective increase in the RF resistance of the LC circuit, produced by the presence of R1 across the circuit. ($R_2 = L/CR_1$)

Thus any shunt resistance on a tuned circuit increases the RF resistance of that circuit and drops its magnification. Assuming that the presence of R1 across LC (Fig. 2(a)) is in order, note particularly that it would be a reduction of the value of R1 which would cause the magnification to drop below normal (and not an increase in the value of R1). While the simple arrangement of Fig. 2(a) is sometimes to be found in practice, it is more usually the case that the damping load on a tuned circuit is of much more complex character than a plain resistance shunt. If grid and cathode of a valve are connected respectively to the two sides of the LC circuit it may become

necessary, if the circuit magnification is down, to direct suspicion not only to the valve itself but even items in its screen or anode circuits.

When working on a practical problem of reduced sensitivity, it is convenient to regard the superheterodyne as made of three sections: the signal-frequency section, including any RF amplifying stages; the frequency-changer stage, including the oscillator circuit; the IF and post-IF stages, including the detector.

If the faults causing the reduced sensitivity are confined to any one of the above-mentioned sections it is generally possible to detect which particular section is responsible by making very close observation of the performance of the receiver on a straightforward test. The first move, therefore, should be to make a survey of all the details of the receiver's performance.

The IF Amplifier

Since the amplification of the IF stages of a superheterodyne contributes so largely towards the overall sensitivity of the receiver special consideration should be given to the possibility of the IF amplification being down. With the exception of a special case, low IF amplification will reduce the sensitivity on all the wave ranges of the receiver. An exception may, however, be provided by the type of superheterodyne which incorporates IF circuit switching, giving one value of intermediate frequency for the medium- and long-wave ranges and a higher value for the short-wave bands. In such a case there could possibly be trouble in the intermediate-frequency circuits on short-

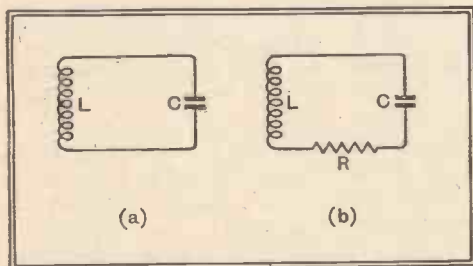

Fig. 1.—A tuned circuit containing inductance L and capacity C is shown at (a), and the electrical equivalent at (b) in which R symbolises the total RF resistance of the circuit.

well-equipped laboratory, but, fortunately, it very often happens that clues to the location of the fault can be found while making a check on the circuit alignment. In this connection it will do us no harm to refresh our memories regarding some of the facts about circuit magnification.

Fig. 1(a) is a theoretical diagram of a tuned circuit made up of an inductance L and a condenser C. Fig. 1(b) more closely indicates the electrical character of the circuit, R being an imaginary resistance inserted in series with the circuit and representing its total RF resistance. The "magnification" of the circuit is given by the expression $\omega L/R$, where $\omega = 6.28$ times frequency.

The magnification of any tuned circuit forming part of the amplifying chain of a

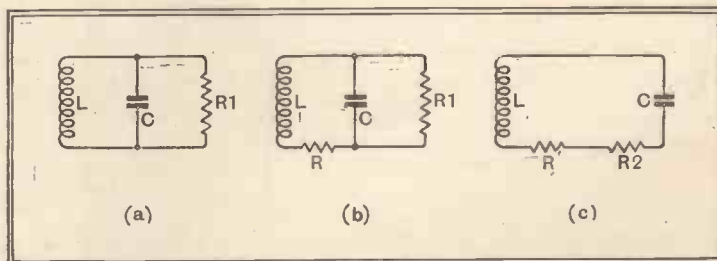

Fig. 2.—A tuned circuit associated with a shunt resistance R1 is shown at (a) and the equivalent diagram at (b) in which the RF resistance R is included. This has the equivalent of (c) where R2 symbolises the effective increase in the RF resistance of the circuit caused by the loading of R1.

waves, but not on medium and long, and vice versa.

It is useful to check up on the accuracy of the dial readings on any waverange

Receiver Fault Finding—

that is showing defective performance. When tuning a superheterodyne for maximum response on any signal two frequencies are being varied simultaneously—that of the signal-frequency circuits and that of the oscillator circuit. Since the frequency-changer stage, which includes the oscillator circuit, has all the amplification of the IF stages following it, the oscillator frequency normally takes charge of the tuning, in the sense that maximum response will be given by the ganged tuning setting which puts the oscillator frequency right for the conversion of the signal to the correct intermediate frequency. It follows that if there is any trouble in the oscillator circuit which makes its tuning in any way abnormal, then the dial readings will automatically provide a certain indication.

Valves

If the sensitivity is normal on one wave-range and down on another but the dial readings are reasonably accurate on the latter, then suspicion should be directed to the signal-frequency section of the receiver.

Once the maximum amount of information has been picked up from observation of the receiver's performance the real task of fault location can be tackled.

First, a valve check should be made. If the results obtained on the preliminary reception tests have pointed to one of the above-mentioned receiver sections as probably containing the whole trouble, then the valve, or valves, associated with this section should be checked either in a valve tester or by the direct (and quite unbeatable) method of substitution, using test valves known to be up to standard. If there is the slightest doubt as to which section of the receiver is faulty, or if it seems that there are faults spread through the receiver, it is to be strongly advised that

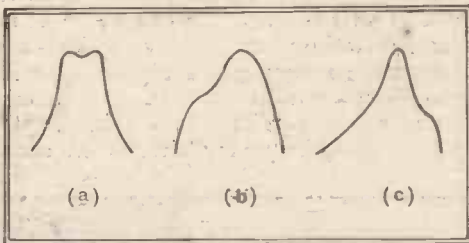

Fig. 3.—The normal response curve for the IF section of a particular superheterodyne is shown at (a), while (b) and (c) depict the effect of a single trimmer misadjustment.

all the valves be checked. It never pays to be careless where valves are concerned. The valve manufacturers have performed wonders in bringing valves to their present stage of efficiency, standardisation of characteristics and reliability, but it must never be overlooked that no thermionic valve has an everlasting life and that it must inevitably deteriorate sooner or later. So make *certain* of the valves.

Many of the simpler faults that cause low sensitivity are responsible for making

the valve-operating voltages incorrect and if the valve check has not revealed the trouble the next move should be to run over voltages at the valve-holder sockets. In particular, screen voltages are worth watching and, with a battery set, the filament voltages (a dry joint or defective LT connection in a 2-volt filament circuit can have devastating effects on the receiver performance).

The tests (assuming that further tests are necessary) have now reached the ganging check stage. The best procedure will vary according to the indications that were given by the receiver's performance on the preliminary reception tests and much, too, will depend upon the testing equipment available.

Certainty is important in connection with ganging adjustments and it is advisable to make the resolution that no trimming or padding adjustment will be altered unless—

1. You have very good reason to believe that any contemplated re-adjustment will be beneficial.

2. You know the circuit position and function of the particular trimmer or padder involved.

3. You can, with certainty, restore the adjustment to its original setting.

Haphazard turning of trimmers and padders must be avoided, whatever happens.

While making a ganging check it must be remembered that one is doing so not with the sole idea of tracing a misadjustment but also with a view to the possibility of spotting a fault, other than that of a misadjustment, which is having the effect of throwing the circuit alignment out. It is thus of great importance to look out for anything unusual in the results obtained while testing the adjustment of any trimmer or padder. Particularly look for such effects as: excessively "flat" tuning, a trimmer or padder adjustment making negligible variation in output on a test signal; any adjustment becoming abnormal for the best obtainable results, e.g., a trimmer condenser needing to be screwed hard in or full out; any intermittent effects caused by making a readjustment. The following examples are quoted from the many cases in the writer's experience where the clues leading to the location of faults have been obtained from the results of a ganging check and where the faults

have not been those of wrong-ganging adjustments:—

The trimmer condenser of the first tuned input circuit of a superheterodyne was found to produce exceedingly "flat" tuning. This effect led to the discovery that there was a bad resistance leak across the first section of the ganged condenser caused, actually, by a deposit of soldering flux, plus dirt, between the vanes.

Another excessively "flat" tuning case

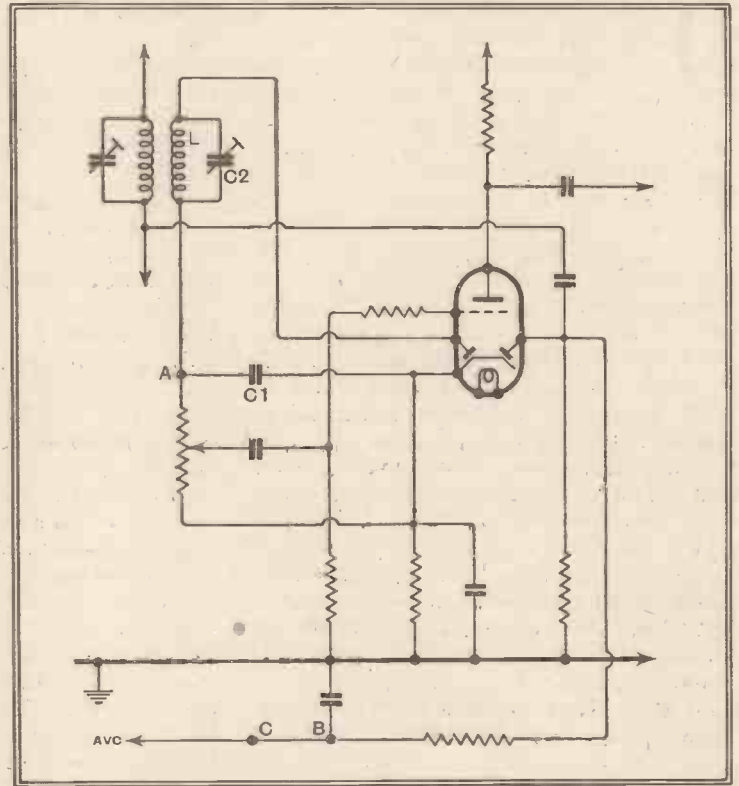

Fig. 4.—A duo-diode-triode circuit. For an oscilloscope response curve trace take the oscilloscope Y input from point A. To cut out AVC disconnect the AVC line between B and C and join C to chassis.

was associated with a secondary IF circuit and the following valve was found to be producing the heavy damping directly responsible for the effect. The valve itself, however, was not defective, and the actual fault was that of low capacity in a screen decoupling condenser.

Trimming Condensers

One receiver was down in sensitivity on long waves, and suspicion became directed to the LW tuned input circuit. When the trimming setting of this circuit was checked it was found that on a test signal the output progressively increased as the capacity of the LW trimmer was increased right up to the limit of the available variation. This particular circuit employed a fixed capacity trimmer condenser shunted across the variable trimmer. The effect obtained on the ganging check showed that most probably the fault was that of an open-circuit in this fixed condenser, and such proved to be the case. Needless to say, the original variable trimmer setting was actually the normally correct one.

Reverting to the general aspects of a ganging check, let us assume, first, that it seems advisable to check the IF section of

Receiver Fault Finding—

the receiver. A response curve test using a CR oscilloscope and a "wobulated" oscillator represents the ideal method. Not only will faults that are causing incorrect alignment adversely affect the response curve (which, of course, is visible on the CR tube screen), but it becomes a very simple matter to observe the exact effects of any trimmer readjustments that may be made.

Fig. 3 (a) shows the oscilloscope trace obtained from the IF section of a certain superheterodyne in normal condition. Very slight misadjustment of the secondary trimmer of the last IF transformer produced the curve of Fig. 3 (b). Fig. 3 (c) shows the effect produced by a misadjustment of the secondary trimmer of the first IF transformer.

Using a "Wobbly" Oscillator

When testing the IF stages with an oscilloscope the Y-plate input should be taken from the detector load resistance. Then, if the "wobbled" test signal is applied to the signal grid of the frequency-changer, the response of the IF section as a whole will be obtained. The oscillator section of the frequency-changer should be cut out, and it is advisable to cut out AVC also.

Fig. 4 represents a conventional duo-diode-triode circuit for detection, delayed AVC and AF amplification. For IF response curve testing the oscilloscope's Y-input can be taken from point A. To cut out AVC, disconnect between B and C and join C to chassis.

In the absence of an oscilloscope, but using a modulated oscillator and an output meter, one must be careful not to make a fetish of maximum meter reading on a given test signal. In the effort to regain lost sensitivity this is, of course, rather a natural tendency while making test readjustments. With IF stages designed for single-peak response, or of the variable selectivity type set for maximum selectivity, no harm would be done, but with stages designed (or set) for pronounced band-pass characteristics it is necessary to take particular care not to upset the response curve. It is possible, fortunately, to gain some idea of the shape of the response curve by watching the output meter variations as the oscillator frequency is slowly run up and down a few kc/s above and below the IF value. Such a check, rough though it may be, is to be advised as the first IF alignment test to be made, and a keen eye should be kept open for any double peaks of obviously unequal amplitude or for any signs of bad asymmetry of response characteristic. AVC should be kept out of action, and, if the output meter is sufficiently sensitive, this can be done by the simple expedient of working with a low amplitude of test signal.

If circumstances demand a check on the oscillator circuit adjustments peak output indications are to be aimed at, but it must be remembered that the accuracy of the dial readings over the scale is an equally

important criterion of success with any readjustments. This implies that the tests must include the oscillator tracking.

Trimming adjustments should, of course, be made near the lower wavelength end of the range and padding adjustments near the upper end. Where commercially built receivers are concerned, the adjustments should, strictly, be made at the particular trimming and padding frequencies specified by the manufacturers, which, incidentally, is a point indicating how useful the service manual for the receiver can be.

Details of the tracking arrangements vary between different receivers, and very often between different wave ranges of the same receiver. One outstanding difference between receivers is that some employ ganged condensers made up of sections all of similar kind, whereas other receivers have ganged condensers with the vanes of the oscillator sections specially shaped and differing from the other sections. As regards circuit variations and when padding condensers are used, some circuits will contain fixed capacity padders, others variable capacity ones, and others combinations of fixed and variable capacity padders.

If the tracking is out on any given wave range and cannot be corrected by any available padding and trimming adjustments, the circuit should be examined to see if any fixed capacity condensers are involved in the tracking arrangements. If so, it should be established with certainty that these condensers are not defective before any other move is made towards the fault location.

If the oscillator circuit proves to be obstinate and will *not* track properly, although no defect

Trimming a receiver with the aid of a modulated test oscillator.

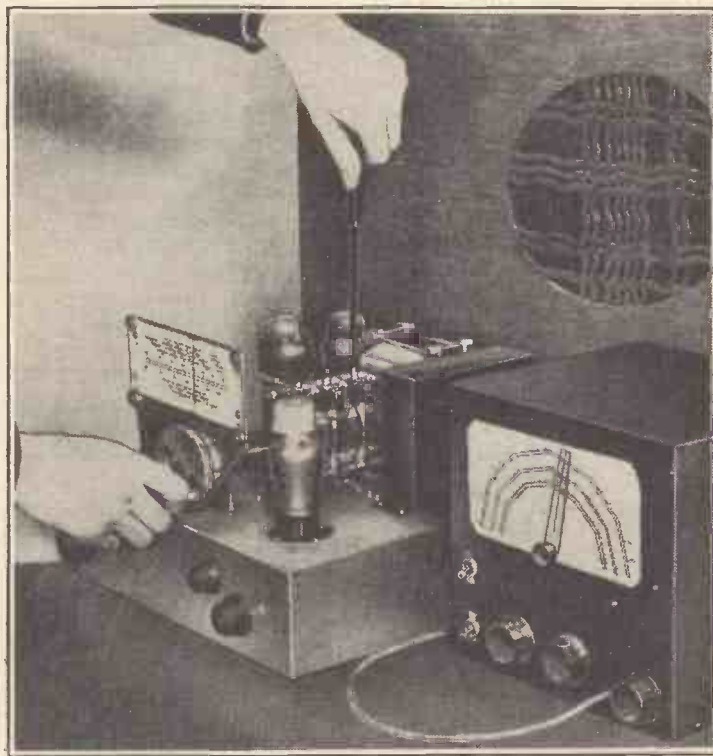

can be traced associated with any of the trimming and padding capacities, it does not necessarily follow that the oscillator coil is at fault (although this is a possibility that may have to be considered later).

It becomes of importance to know how the receiver behaves as regards tracking on the other wave ranges. If it is found that there are tracking difficulties on all the wave ranges, the following possibilities are worth considering:—

Vanes of ganged condenser rotor off

centre. This is a fault which could cause a lot of bother if unsuspected.

Pointer setting incorrect, relative to ganged condenser spindle. This would probably be spotted during the initial receiver tests, however.

IF stages lined up at the wrong intermediate frequency.

A check on the alignment of the signal-frequency circuits should be made only when it is evident that the IF and oscillator alignment is correct. Any test readjustments of trimmers should be made on a test signal near the lower wavelength end of the range (and, preferably, at the correct specified "trimming frequency" for the receiver). If oscilloscope gear is available, it is advisable, as a final check, to take an overall response curve for all stages up to the detector. In this case the "wobbled" signal should be applied to A and E of the receiver.

The detector and AF circuits must not be overlooked in many cases where the cause of reduced sensitivity is being sought. It will be understood that any fault in a post-IF circuit will affect the performance on all wavebands, a fact which, again, emphasises the importance of an initial check on the general performance of the receiver on all its wave ranges. Trouble in the detector circuit

will usually make itself obvious when the alignment of the IF-circuits is being tested. One example was provided by a receiver which contained the duo-diode-triode circuit of Fig. 4. The last IF secondary, LC₂, showed up very badly when the trimming was being checked, the secondary trimmer adjustment having very little effect. The fault was that of a defective diode load by-pass condenser C₁.

The adjacent channel selectivity of a superheterodyne is largely a matter concerning the design and ganging adjust-

Receiver Fault Finding—

ment of its IF stages, but if there is any trouble in the IF section of the receiver it will probably draw attention more on the score of distortion or of reduced sensitivity. Where reduced selectivity, and only reduced selectivity, calls for investigation, it generally becomes a matter of tackling whistles. The selectivity of the signal-frequency section of the receiver then demands the closest consideration.

An unwanted signal will appear in the IF stages (and tend to cause a whistle) if, first, it can reach the signal grid of the frequency-changer, and, secondly, beat with the oscillator fundamental, or an oscillator harmonic, or another signal oscillation, to produce the intermediate frequency. Additionally, interference may be caused if the beats work out to a value equal to a harmonic of the IF.

The oft-quoted case of second-channel interference is that in which an unwanted signal having a frequency equal to the frequency of the wanted signal plus twice the intermediate frequency beats with the oscillator fundamental. (There is the assumption here that the frequency of the wanted signal is lower than the oscillator frequency, which is normally the case.)

It will be appreciated that in all the above cases unwanted signal voltages are present at the input grid of the frequency-changer. The importance of the selectivity of the signal-frequency section of the receiver needs no further emphasis.

IF harmonic feed-back represents an exceptional case. The interference is caused by IF harmonics getting back to the input circuits, via stray couplings, from an IF stage, the detector, or an AF stage (assuming defective IF filtering).

Some receivers incorporate adjustable "image rejectors" for the suppression of second-channel interference. If the receiver does embody any adjustment which

is intended to cut out second-channel whistles it is as well, at the outset, to look specially for any signs of second-channel trouble, and, if such is found, to test the adjustment provided. It may, of course, prove to be necessary to search for defects in the suppression system.

The signal-frequency section of the receiver (including any preselector RF stages) should be checked most carefully for correctness of alignment, and no further move should be made until this can be established with certainty.

A check upon the frequency-changer valve, preferably by substitution, and upon its operating conditions, may prove to be worth while. Any excessive non-linearity of operation of the frequency-changer is a case of asking for trouble.

The work detailed above is associated with the majority of whistle interference possibilities, but there may still be IF harmonic feed-back to tackle. The valves, and operating conditions, in the IF stages may have to be investigated from the point of view of excessive harmonic generation, but where the IF stages are concerned perhaps the most likely possibility is that of defective screening. If any extensive overhaul work has previously been done on the receiver, the possibility of displaced wiring is worth more than a passing thought, too.

It is important that any voltages at intermediate frequency developed in the detector circuit shall be kept at negligible amplitude at the input of the AF section of the receiver. If the detector does apply appreciable input at IF to the AF stages, the possibilities of IF harmonic feed-back become considerable, so it is particularly advisable to make sure of the effectiveness of all the IF filtering arrangements provided in the detector circuit. Any screening associated with the detector circuit should be carefully checked.

bands, and the input is provided with a gain control. As the input capacity is only 1 micro-mfd. this circuit may be connected to the receiver oscillator to check the frequency for correct tracking and possible drift. The constancy of the output over the waveband may also be observed.

In the AF channel a triode amplifying stage, flat from 50 to 50,000 c/s, precedes the detector and indicator, and a calibrated input attenuator is provided.

The valve voltmeter channel is interesting for the fact that it has a centre zero and will indicate potentials either positive or negative with respect to earth. There are four ranges covering 0 to ± 500 volts.

Finally there is the power channel which measures the current supplied to the set, and on the assumption of constant mains voltage gives direct readings in watts. Faults resulting in an increased drain of the power supply are shown visually by a cathode-ray tuning indicator.

With the "Chanalyst" it is possible to check the amplification stage by stage, starting with the aerial input, IF and oscillator alignment, AVC voltages, and an almost infinite variety of cross checks such as leakage of IF into the AF circuits.

The instrument costs 30 guineas, and is obtainable in this country through Holiday and Hemmerdinger, Ltd., 74-78, Hardman Street, Manchester, 3.

The Murphy "70" Series

THIS range of instruments which includes consoles and radiogramophones as well as a table model has been developed to provide at a reasonable price what the makers regard as the minimum acceptable specification for a mains superheterodyne. The three waveranges cover 16.7-50 metres, 190-500 metres, 970-2,000 metres and the valve arrangement is as follows: Triode hexode frequency changer, pentode IF amplifier, double-diode-triode signal rectifier, AVC rectifier and first AF amplifier, tetrode output valve and power rectifier. AVC is undelayed.

An 8in. loud speaker is used and quality and selectivity are comparable with the performance of the "72" receiver with its selectivity switch in the intermediate position.

Like the "72" receivers the new models are adaptable for push-button tuning either on the set or with remote control. An ingenious sliding loud speaker fret on the consoles and radiogramophones conceals the recess for the push-button unit if the latter is not required.

Prices for the AC table model, console and radiogramophones are £10 5s., £14 15s. and £22 respectively. DC/AC versions are available at slightly higher prices. Push-button units may be added to the latter sets but not remote control units.

The Rider "Chanalyst"**A VERSATILE FAULT-TRACING INSTRUMENT**

THE principle of operation of this service instrument is different from that of the more familiar types. It is virtually a high-grade receiver in itself, and is divided into separate sections or channels, each calibrated and provided with its own indicating device.

The input to each section is through a flexible screened cable terminating in a probe or clip. In the case of the RF and oscillator sections the series capacity of the lead is only 1 micro-mfd., so that the instrument can be connected in parallel with the receiver under test without appreciably disturbing the circuit conditions. "Magic eye" indicators are provided for each section, and it is possible to leave the receiver on test and to see at a glance in which part of a receiver an intermittent fault is located.

There are five sections in the "Chanalyst." The first is the RF-IF channel with three amplifying stages tuned by a three-gang condenser, a diode rectifier and a cathode-ray tuning indicator. Three frequency ranges of 600-1,700 kc/s., 240-630 kc/s., and 95-260

kc/s are provided. The amplification is level over each range, and an attenuator in the input circuit gives a range of 10,000 to 1. An input of 6 micro-volts can be detected. There is an output jack which permits the use of phones or an oscillograph.

The "oscillator" section is virtually a wavemeter with a tuned amplifier stage preceding the diode detector and cathode-ray tuning indicator. The range is from 600 kc/s to 15 Mc/s in three

Visual indication of faults is given simultaneously in different parts of a superheterodyne circuit by the Rider "Chanalyst."



High-frequency Resistance

HOW IT IS CAUSED : MINIMISING THE EFFECTS

By F. R. W. STRAFFORD (Research Dept., Belling and Lee, Ltd.)

EVERY radio engineer and experimenter knows (or should know) that the resistance of an electrical conductor depends upon the frequency of the current which is made to flow through it.

Formulae are available from which it is not difficult to calculate this increase for any frequency, given additional information regarding the specific resistance (the resistance between spaces of one cubic centimetre) of the material and its dimensions.

The mathematical treatment of this interesting phenomenon is exceedingly complicated, and is probably one of the most difficult in radio physics. At the same time there is no reason why one should not attempt to understand how the

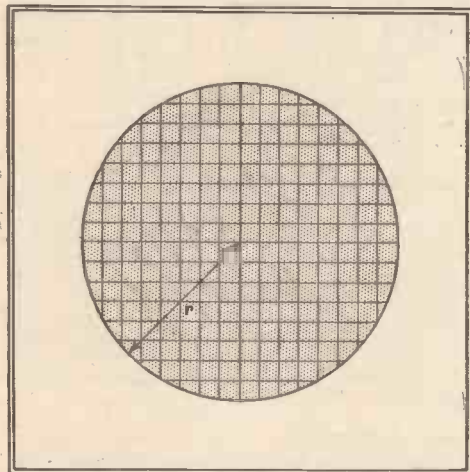

Fig. 1.—An end view of a conductor with uniform current distribution.

phenomenon occurs. Most people with a scientific turn of mind rather abhor the necessity for accepting technical propositions without some knowledge of their derivations, and this is as it should be.

Consider a wire of circular section of radius r , and apply between its ends a source of EMF, such as a dry cell or a dynamo. Current will flow through the conductor and, what is important, will be uniformly distributed through the section of the wire.

We may imagine that the wire is composed of a bundle of filaments all fitting snugly together, with each side contiguous with its neighbour, and each carrying an identical current flow.

The end section of the wire would look something like that depicted by Fig. 1, in which the uniform shading indicates a

It is well known that the resistance of a conductor increases with frequency, but the reason for this effect is not so generally realised. The mechanism involved is explained in this article.

uniform current distribution throughout the section.

We say that in such circumstances the current density is uniform within the conductor. If I is the total current as measured by an ammeter, and A is the cross sectional area of the wire, then the current density is obviously $I_d = \frac{I}{A}$, that is the current per unit area.

Under these conditions the resistance of a conductor may be calculated from the well-known formula

$$R = \frac{\rho l}{A}$$

where ρ is the specific resistance,
 l is the length,
 A is the cross sectional area.

Having conquered the field thus far we may now consider certain properties associated with this current flow.

This flow of steady current creates a magnetic field, the direction of force of which lies in concentric circles around and within the conductor. Fig. 2 shows this state of affairs, and the thickness of the lines indicates, roughly, their relative intensity.

It is seen that the magnetic force is greatest at the surface of the wire, and falls to zero at the centre, and also falls

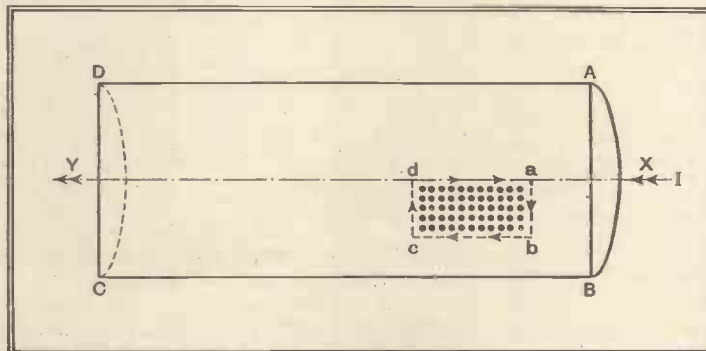

Fig. 2.—This sketch illustrates the distribution of the magnetic field around and inside a conductor.

have no effect (apart from a negligible effect which will not be described here) upon the properties of the wire, so that it might be considered as non-existent in the DC case.

Fig. 3 represents a length of the wire severed down its centre. The rectangle $A B C D$ represents the face of the lengthwise section, and since the lines of magnetic force are concentric circles about the axis $X Y$ of the wire, the direction of the force is through the page on which the illustration is printed.

The source of current is now replaced by an alternator instead of a steady voltage, so that the direction of the current I rapidly alternates at the frequency of the supply.

At the instant depicted in Fig. 3 the current is flowing to the left so that the mag-

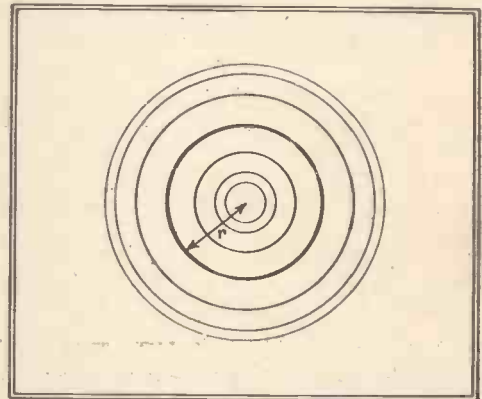

netic force acts into the page on the top and out of the page on the bottom.

At this stage the reader must not forget that these lines of force due to the current exist inside the conductor as well as external to it, so that in the little rectangle of area $a b c d$ the dots represent the ends of the lines of force passing through the face of the wire.

Now when a magnetic field is changing its intensity (it must do this to change its direction) an EMF

Fig. 3.—A lengthwise section of wire is shown here. The main current flows in the direction $X Y$ but there are eddy currents flowing as shown by the arrows around $a b c d$.

away as one recedes from the surface of the wire into space.

Now when the current is steady as in the case already discussed, the presence of the accompanying magnetic field will

is produced around any circuit affected by this changing magnetic field.

Faraday discovered this famous law, although the correct magnitudes were later established by Neumann.

High-frequency Resistance—

Thus an EMF is generated around the little dotted rectangle *a b c d*, and since this is a closed circuit it must cause a current to circulate around the periphery of this rectangle.

This current is called an eddy current

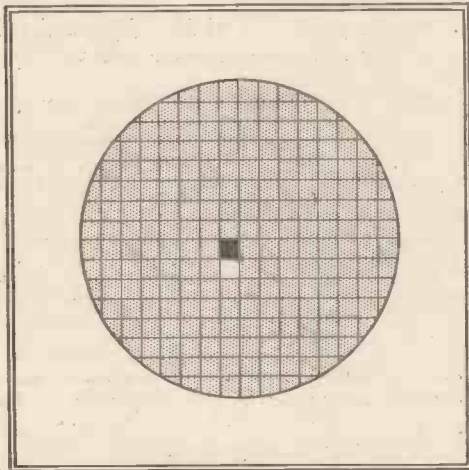

Fig. 4.—The white square indicates an element of the conductor which carries no current while the black square shows one which carries double the normal current.

and acts in such a manner as to oppose the current supplied through the wire. Thus over every element of longitudinal section of the wire these little circular currents are flowing, and the direction of their flow is indicated by the little arrows around the rectangle *a b c d*.

It can be seen that the direction of the arrow lying nearest the centre of the wire opposes the direction of the arrow representing the instantaneous direction of the current supplied to the wire. Now this is happening throughout the whole longitudinal section of the wire so that it is obvious that there is a net reduction in current at the centre of the wire, and a little thought will indicate that the current will tend to become denser towards the surface of the wire.

Effective Resistance

The greater the frequency of alternation from the applied generator, the greater will be the eddy current effect, so that at very high frequencies one can imagine that the current density is distributed only on the surface of the wire, possibly to a depth of a few thousandths of an inch.

The most important thing to observe is the fact that the eddy currents ultimately cause a departure from non-uniform current density in the section of the wire.

So far the foregoing does not explain why the resistance of the wire is going to increase because of this non-uniform distribution of current. Surely, asks the reader, the specific resistance of the material is a function of the material only, and cannot change therefore with current distribution. Nor have the dimensions altered. The answer is simple.

In order to understand clearly the reason for the increase of resistance due to the non-uniform distribution of current

density within the wire we must turn again to Fig. 1, in which each filament of wire carries an equal current density.

Let us by some agency reduce the current in one of the filaments to zero, and double the current in a neighbouring or another filament. This state of affairs is shown in Fig. 4, in which the black square indicates that it is carrying twice the current of any other of the shaded squares, and the white square is carrying zero current.

The resultant total current is the same, but the current density is not uniform.

Now the power dissipated in each filament of wire is equal to the square of its current multiplied by its resistance. All the filaments of current have the same resistance, and when they are all carrying the same current the result is that each filament is dissipating the same amount of electrical power.

When, however, the current is doubled in one of the filaments the power is obviously increased by four times, in which case, for the same total current flow through the conductor, the power has been increased by a small quantity. Thus we must infer only that the total resistance of the conductor has increased since the total current has remained constant.

It is not difficult to appreciate that the

effects of the non-uniform current distribution within a conductor are going to be greatest when the conductor has a large radius, and for this reason it is important that wires which are used for apparatus in which known resistances are required over a wide range of frequencies, or are required to be independent over a wide range of frequencies, should have as small a diameter as possible consistent with their current-carrying capabilities. For example, at television wavelengths corresponding to a frequency of 45 megacycles per second, a length of 22 SWG copper wire has an HF resistance some sixteen times greater than its DC resistance. If, on the other hand, 40 SWG copper wire is used, this increase only amounts to approximately twice.

The general formula from which the resistance of any conductor may be calculated at different frequencies is very complicated, and makes use of particular forms of Bessel functions. Providing certain precautions are taken with regard to the frequency and the diameter of the wire to be employed, the formula is very much simplified, and certain formulæ have been derived by E. B. Moullin in his book "Radio Frequency Measurements" for application with negligible error in particular circumstances.

RANDOM RADIATIONS

By "DIALLIST"

Short-wave Transmitters . . .

WHAT amazing advances have been made in short-wave broadcasting in recent times! Not so long ago the only distant transmissions on these wavelengths that we could feel anything like certain of receiving with ample volume and good quality were those of stations in the United States. Other far-away countries were heard, it is true, and very well heard indeed at times; but there was always a considerable element of luck about picking them up. Nowadays, when conditions are not entirely adverse, one can be almost as sure of tuning in India, China, Australia, South Africa or South America as of hearing the news bulletins from Droitwich. It isn't only that so many more high-powered short-wave transmitters are in action; the reliability of distant short-wave stations is due also to a very great extent to the use of wavelengths which have been found as the result of research and of experience to be best suited to particular times, seasons and conditions.

. . . and Receivers

The pity of it is that the receiving sets used by listeners at large have not kept pace with the improvements made in short-wave transmission. The "all-wave" receiver was really launched before the time was quite ripe for it. It appeared with a flourish of publicity trumpets and the announcement that the world was the oyster of anyone who bought a receiver with a short-wave range. The world proved to be an oyster whose opening then demanded rather more patience and skill than the man

in the street was prepared to give and a tool somewhat better than the average "all-wave" set. Hence short-wave listening did not leap into the popularity that had been predicted for it. Tuning was too difficult; results too uncertain. To-day I doubt whether one per cent. of the "all-wave" sets of the country are used oftener than once in the proverbial blue moon for short-wave reception.

Something Better Needed

Consider the short-wave tuning arrangements of the average moderately priced "all-wave" set. The frequency range covered is probably 18 to 6 megacycles per second, against 1,500 to 500 kilocycles on the medium-wave range. Thus, on the short waves the pointer travels just the same distance to cover 12,000 kilocycles as it does to cover one thousand on the medium-wave range. On the average, then, tuning on the former appears to be twelve times as difficult as it is on the latter. Actually, it may well be more difficult even than that! In the cheaper "all-wave" sets the calibrations marked on the short-wave dial are often a long way out; no attempt is made to suppress second-channel images; hence each station comes in at two different settings at least. I say "at least" because the oscillator often produces harmonics strong enough to bring in the better received stations at a variety of highly improbable readings. Last, and perhaps worst of all from the point of view of the man in the street, the short-wave dial may be so cramped and so coarsely graduated that it is next to impos-

Random Radiations—

sible to note the setting of a received station for future reference. Something better than this is needed, and now that such vast improvements in short-wave transmission have been made and still are being made, there would seem to be a golden opportunity for introducing the "all-wave" receiver whose short-wave department is not just a poorly designed makeshift.

More Crackle Makers

LAST week I described how I had found to my dismay that not a few of the vacuum cleaners made or marketed by firms closely connected with the radio industry were of the kind that radiate interference. Since then I've been looking through some catalogues of domestic electrical appliances with still more saddening results. I wonder how many of those who manufacture or distribute wireless sets, valves and so on could put their hands on their hearts and say, "We neither make nor sell any apparatus that can cause interference with broadcast reception?" The list of the things that can cause listeners to tear their hair by filling their loud speakers with crackles and other horrible noises is a formidable one. Fans, washing machines, plate-washers, lawn-mowers, refrigerators, hair-dryers, electric razors, floor-polishers, coffee-mills, cream-whippers, ironers are just a few of the commoner kinds of household electrical gear that are liable to cause trouble unless fitted with suppressors. And how many of those made or sold by firms bound up with the radio industry are so fitted? The answer should be *all*, but I sadly fear that it isn't.

Chungking Calling

QUITE a number of people have told me that they've heard that a Chinese station is coming in strongly just now, and asked when and where to find it. The station is XGOY, of Chungking, which works on 11.90 Mc/s (25.21 metres). If you've been listening to VLR3 of Melbourne on 11.88 Mc/s (25.24 metres) from 20.30 onwards, you'll find the Chinese station just a little above

or below it, according to whether you think in metres or megacycles. It may be heard (probably giving weird Chinese music) at just about the time when VLR3 goes fluttery and then fades out. A little later there comes a news bulletin read by an announcer in most excellent English. The station is one of the best received of the distant short-wave transmitters just now. On most nights it is as loud and as clear as any of the European "locals."

U.S.A. Facsimile Broadcasting

YOU may remember that some time ago certain American stations decided to test the probable public response to facsimile broadcast of news and pictures by lending a number of receivers to selected owners of radio sets? The results have been so promising that simultaneous broadcasts are now being made weekly by the three Mutual network stations WGN of Chicago, WOR of Newark, N.J., and WLW of Cincinnati. The transmissions are made between 2 and 3.30 a.m. E.S.T. (07-08.30 G.M.T.) on Saturdays. The service may shortly be extended to all other Mutual stations licensed by the Federal Communications Commission to transmit facsimile. About 1,000 receivers are believed to be in use in the area covered by the three stations mentioned, and it is expected that these regular broadcasts will lead to a considerable increase in their numbers. It is hoped later on to make the broadcasts bi-weekly and eventually daily.

One rather wonders whether those responsible for inaugurating the service are not being unduly optimistic about the numbers of people that it is likely to attract. The history of facsimile broadcasting in this country was not precisely encouraging—you remember the Fultograph? Admittedly, the two cases are not exactly parallel. Our B.B.C. confined the transmissions to pictures—and mostly "demmed dull" pictures at that. The Fultograph, too, was rather a messy contraption; you had to soak the special sheets of paper in a developing dish filled with a chemical solution and put them on to the machine damp.

However good they make facsimile broadcasting over there, I have a feeling that people will be inclined to hang back, just as they did in this country, in the fond hope that television will shortly be available for all.

New Marconiphone Push-Button Receivers

THE Model 878 table receiver and the Model 883 console released this month have four-valve (plus rectifier) superheterodyne circuits for AC mains with push-button selection of waverange for manual tuning as well as pre-set tuning for two long-wave and six medium-wave stations.

The oscillator circuits are permeability tuned and each circuit is capable of covering half the waveband. Thus, three of the medium-wave buttons cover 195 to 340 metres and the remainder 310 to 600 metres. Both long-wave buttons may be adjusted for stations lying between 1,200 and 2,100 metres.

A new style of loud speaker grille with louvres finished in light gold has been adopted for the table model, and in the console model is provided with a sloping front panel.

The Model 883 (left) is a console version of the Model 878.



Push button selection of six medium-wave and two long-wave stations is provided in the Marconiphone Model 878 (right).

**Television
Programmes**

An hour's special film transmission intended for demonstration purposes will be given from 11 a.m. to 12 noon each weekday. The National or Regional programme will be radiated on 41.5 Mc/s from approximately 7.45 to 9 p.m. daily.

Sound 41.5 Mc/s Vision 45 Mc/s

THURSDAY, APRIL 20th.

3, Cabaret. 3.30, British Movietonews. 3.40, 235th edition of Picture Page.

9, "Grandfather's Further Follies": The Grosvenor House cabaret, with the B.B.C. Television Orchestra, conducted by Sydney Lipton. 9.30, Gaumont-British News. 9.40, 236th edition of Picture Page. 10.20, News.

FRIDAY, APRIL 21st.

3, Training a Police Horse, O.B. from Imber Court. 3.25, Jane Carr and Marianne Davis. 3.35, Gaumont-British News. 3.45, "The Almost Perfect Murder," a "telecrime" by Mileson Horton.

9, Cyril Fletcher in Intimate Cabaret. 9.20, British Movietonews. 9.30, Margaretta Scott in "Shall We Join the Ladies?" a one-act play by J. M. Barrie. 10.15, News.

SATURDAY, APRIL 22nd.

3, Ballet—"The Selfish Giant"; choreography by Joy Newton, music by Eric Coates. 3.20-4.20, "Katharine and Petruchio." The acting version of Shakespeare's "The Taming of the Shrew," prepared by David Garrick in 1754.

9, Cabaret. 9.30, Gaumont-British News. 9.40, Golf Demonstration by Ernest Bradbeer. 9.55, "The Coffin," a one-act comedy by John Taylor. 10.20, News.

SUNDAY, APRIL 23rd.

3, "Mr. Ramshaw" the tame golden eagle pays a return visit to the studio with his master Captain C. W. R. Knight. 3.15, Cartoon Film. 3.20, Variety by the Hogarth Puppets. 3.35, "The Story of the Life Boat"—Film. 3.45, Music Makers.

8.50, News. 9.5, Repetition of 3 p.m. programme. 9.20-10.50, The third act of "Geneva," Bernard Shaw's play from St. James's Theatre.

MONDAY, APRIL 24th.

2.30, O.B. from the Royal Academy—Varnishing Day. 3.30-4.30, "A Night at the Hard-castles," Giles Playfair's modernised version of "She Stoops to Conquer."

9.5, Douglas Byng in "Byng-Ho," with Edward Cooper and Patricia Burke. 9.40, Cartoon Film. 9.45, Announcers' English—a discussion between Professor Lloyd James and Stuart Hibberd. 9.55, Gaumont-British News. 10.5, Billiards Demonstration. 10.25, Thelma Reiss, cello, with Henry Bronkhurst at the piano. 10.35, News.

TUESDAY, APRIL 25th.

3, Intimate Cabaret. 3.10, Gaumont-British News. 3.20-4.5, "Shall We Join the Ladies?" (as on Friday at 9.30 p.m.).

9, Starlight. 9.10, Cartoon Film. 9.15, Friends from the Zoo. 9.30, British Movietonews. 9.40, Bee for Budget. A topical tug-o'-war between taxpayers and experts. 10.15, Frederic Lamond, pianoforte. 10.30, News.

WEDNESDAY, APRIL 26th.

3, Jack Jackson and his Band. 3.30, British Movietonews. 3.40, "Bridge Without Sighs," verse and cartoons by Reginald Arkell and Harry Rutherford. 3.50, Cartoon Film. 3.55, Eunice Gardner, pianoforte.

9, "Rake's Progress," a play by Olga Katzin of the Life of John Wilkes, rake, scholar, wit and man of fashion who fought George III on the question of English liberty—and won. 10.30, News.

NEWS OF THE WEEK

BALANCE AND CONTROL

A New B.B.C. Unit

ANOTHER department has been formed by the B.B.C. The head of this Programme Engineering Department, as it will be called, will be Dr. F. W. Alexander, who has been in the Research Department since he joined the B.B.C. six years ago. He was responsible for the design of the ribbon microphone now used almost exclusively in the B.B.C. studios.

The Department has been formed to handle the balance and control apparatus in London, although the technical efficiency of the apparatus will still be the responsibility of the Engineering Division. The new Department will consist of all the balance and control technicians hitherto attached to each of the programme departments and the "effects" staff.

"Balance" can be described as the skilled technique by which microphones are placed in relation to the artistes, and their output so mixed and varied that the best possible effect is obtained in accordance with the wishes of the artistic producer or musician. "Control" mainly consists of electrically adjusting the volume of sound in an artistic way, to prevent, on the one hand, the sound being too weak for the listener to hear or, on the other hand, so loud that the transmitter is overloaded.

The correct performance of these two functions, which will now be the task of Dr. Alexander and his staff, results in transmission of a faithful sound picture of the actual performance in the studio.

P.A. REGULATIONS

No Distortion Permitted

A POLICE permit costing up to 10 marks now has to be obtained before loud speakers can be operated in streets and public places in Germany.

All loud speakers, unless erected at a greater distance than 1,000 feet from the nearest inhabited building, must be limited to an output of 18 watts.

Loud speakers installed by officials of the Government or by the Nazi Party do not, of course, require this police permit.

By far the most interesting of these new regulations is that loud speakers which distort music or speech will not be permitted to continue operations. When informed of noisy loud speakers, Nazi radio officers, after investigation, will see that the speaker is repaired or removed.

TELEVISIONING THE DERBY

Plans for the Transmission

THE Derby will be televised on May 24th from start to finish. Two television cameras equipped with telephoto lenses will be mounted on the grandstand and will cover the entire course. One of these cameras will follow the beginning of the race as far as Tattenham Corner, when the other will take over to show the run-in to the winning post. A third camera, mounted on the scanning van near the enclosures, will show the weighing-in and saddling,

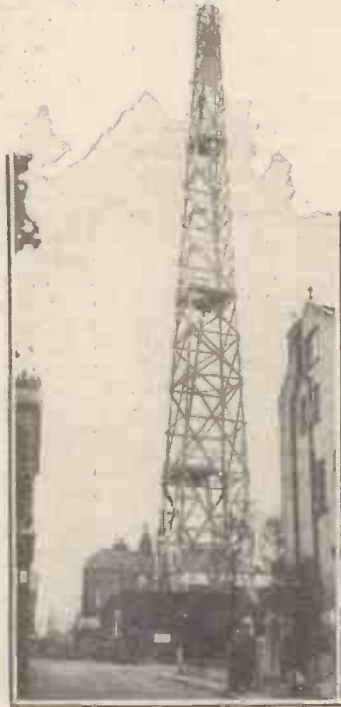

THE LINK between Alexandra Palace and the mobile television transmitter is the receiving station at Swain's Lane, Highgate. The mast, 150ft. high, replaces a temporary 75ft. mast which previously occupied the same site. It is made of teak and is expected to increase the quality of O.B.s from points beyond the network of special P.O. cables. The Derby transmission will be relayed from Epsom to Alexandra Palace through this aerial.

and viewers will see close-ups of the owner leading in the winning horse.

Cinemas will be permitted, by arrangement with the Epsom Grandstand Association, to reproduce the B.B.C. transmission on large screens for the benefit of paying audiences.

It is expected that even better results will be obtained than last year, as the new B.B.C. receiving station at Swain's Lane, Highgate, will be in operation.

C.B.S. TELEVISION

Transmitter Approaches Completion

WITH the solving of the aerial problem, installation of the Columbia Broadcasting System's television transmitter in the Chrysler Building, New York, approaches completion.

As stated in these pages on April 6th, the transmitting aerial had to be erected without support from the comparatively flimsy steel plates which cover the top of the building. Experiments with various types of aerial have been conducted on an "electrical replica" of the building constructed of wood and wire mesh, and as a result a system of horizontal dipoles has been chosen.

Sixteen of these dipoles, eight for sound and eight for vision radiations, are being built around that portion of the tower immediately below the steel roof. This will mean a distance of less than 100ft. will separate the transmitter from the aerial, which will be 940ft. above the ground.

The C.B.S. television transmitter is to use channel No. 2, which provides a picture frequency on 51.25 Mc/s and a sound frequency on 55.75 Mc/s.

NEW MICROPHONE

3-Way Unit for All Purposes

A MICROPHONE which by means of a switch at its base can be instantly adapted for uni-directional, bi-directional or non-directional reception, has been designed by the R.C.A. Manufacturing Company.

With the control switch in the uni-directional position, the instrument picks up only sounds reaching the front—or live side. As a bi-directional microphone, it performs like an ordinary velocity instrument, being responsive on only two sides. In the third position of the switch, sounds coming from any angle are picked up.

The microphone is actually two in one, a bi-directional velocity mike and a non-directional pressure instrument. The output of each comes down to the control switch, which cuts in one or the other or both. When the two are connected in series they give the uni-directional response.

Identified as Model 77-C, the instrument weighs only 2 lb. and measures 2½ inches by 8½ inches. A high order of sensitivity has been achieved, in spite of these small dimensions,

SUCCESS OF B.B.C. MICROPHONE

Adopted For Overseas Use

INCREASING use is being made by the B.B.C. of the Type "B" ribbon microphone, especially for outside broadcasts and in studios to which public audiences are admitted. The microphone is both sensitive and inconspicuous. In this latter respect it scores over the original "A" type. Round in shape, the new instrument is half the size of its predecessor without sacrificing its bi-directional properties and the simpler balance technique which the "A" type made possible for the first time.

Size has been reduced by the use of new magnetic materials. In Type "A" it was necessary to employ a nickel-cobalt magnet having a minimum path-length of about twelve inches, but in the Type "B" an aluminium-nickel-cobalt alloy is used, enabling the path-length to be reduced to less than six inches without loss of sensitivity.

Owing to the success of this B.B.C.-Marconi microphone, it is being adopted by broadcasting organisations in South Africa, South America, India and in the Colonies.

by new structural design and the use of new magnetic material.

Its directional characteristics at all frequencies are uniform, an advantage which has come to be accepted by many engineers as exclusive to velocity-type microphones. This has been accomplished in the 77-C by using ribbon units for both the velocity and pressure sections.

REPORTS WANTED

THE Central Broadcasting Administration of the Chinese Government is anxious to receive reports of the reception of the broadcasting station XGOY at Chungking, which, as stated in a previous issue, now transmits on 25.21 metres (11.9 Mc/s). This 35-kW British-built Marconi station, which daily transmits from 10 p.m. to 12.30 a.m. B.S.T., broadcasts a bulletin in English at midnight. In addition to four omni-directional aeriels the station has directional aeriels orientated on Europe and America. Reports sent to *The Wireless World* offices will be forwarded.

MONTREUX: Some Results of the Wave-length Conference

AFTER more than six weeks' deliberations the Conférence Européenne de Radiodiffusion, Montreux, 1939, which opened on March 1st, ended last Saturday. The final wavelength plan, which was signed by the representatives of thirty-one countries, has not yet been fully disclosed, but it is known that the changes will take effect from the night of March 3rd-4th next year, instead of October 1st this year as was previously planned. This change will give manufacturers more chance of producing receivers with tuning systems calibrated to the new wavelengths.

It had been suggested by manufacturers in England and on the Continent that the proposed date of application should be postponed until October, 1940, for by so doing it would have meant that the new season's sets would be adapted to the changes. What is going to happen at *this* year's radio shows? Will the new season's sets be "post dated," which would mean a little mental gymnastics for purchasers until the Plan became operative?

Will the situation in the ether be very much improved when the new plan comes into force? There are five countries who are not signatories: Luxemburg; the U.S.S.R., which operates some 57 stations with an aggregate aerial power of nearly 1,600

kW; Greece; Iceland; and Turkey. Seven countries represented at the Lucerne Conference of 1933 did not sign the Convention; these were Holland, Finland, Hungary, Sweden, Poland, Lithuania and Luxemburg.

Limiting Power

Power limitations have been imposed by the Convention. Long-wave stations will, as was expected, be permitted to use 500 kW by day and 200 kW at night. Medium-wave stations are divided into three categories: Between 192.3 and 200 metres, 10 kW; between 200 and 230.8 metres, 30 kW; and between 230.8 and 1,250 metres, 120 kW.

Commenting on the general result of the Plan, *The Times* says "That so great a measure of satisfaction has been given—particularly in a period of political tension—is a tribute to the skill displayed in the setting of the foundations of the Plan, to the goodwill shown by the various national delegations, and to the tenacity of the Chairman of the Conference, M. Muri (Swiss Télégraph Administration) and his chairmen of commissions, Col. A. S. Angwin (Great Britain), Dr. Hermann Giess (Germany), M. Mulatier (France), and Dr. Arnold Rastad (Norway).

FOREIGN LANGUAGE TRANSMISSIONS

FOR satisfactory reception of medium-wave transmitting stations at considerable distances it is well known that the path between the transmitter and the listener's receiving aerial should be in darkness. It is for this reason, says the B.B.C., that foreign bulletins are now broadcast on weekdays between 10 and 10.45 p.m., B.S.T. The news bulletin in French is read at 10 p.m. and the German bulletin at 10.15

p.m. The short German news bulletin is being radiated at 10.45 p.m. on Sundays only.

This change was foreshadowed in *The Wireless World* on April 6th, when it was stated that the early evening clash between the English programmes in German and the German transmissions in English had not gone unnoticed by the B.B.C. It remains to be seen whether the German transmitters will follow suit.

FROM ALL QUARTERS

Palestinian Licences

AN increase of 50 per cent. on the present annual receiving licence of 500 mils. (approx. 10s.) was announced by the Palestine Broadcasting Service at the beginning of April. With the continued increase in the number of listeners, this addition will raise the licence revenue, which last year amounted to £P.18,000, to roughly £P.30,000.

THIS ACOUSTIC GUN is used by Telefunken in measuring the reverberation time of a studio. Blank cartridges are fired by the "gun" at regular intervals and by pre-selecting frequencies in the recording apparatus the reverberation time of the studio at those frequencies is automatically recorded. It has been found that a shot includes all audible frequencies at approximately the same amplitude.

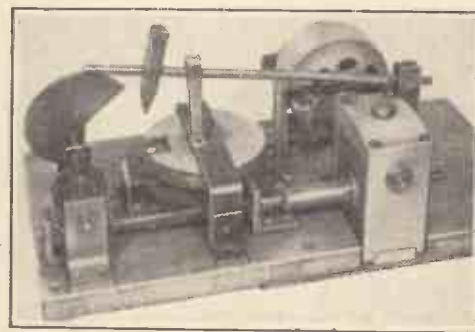

Exhibition Reception of America

AMID the electrical interference common to exhibitions, visitors to the Ideal Home Exhibition at Earls Court have heard excellent reception of American stations on a radiogram shown by Keates-Hacker. Working from a Belling Lee aerial, the set has achieved a record for working perfectly in adverse conditions. Interesting possibilities might be opened up, if permission for short-wave reception were granted at Radiolympia.

Exit "Dramatic Control Panel"

WHEN R. E. Jeffrey devised the first control table for the B.B.C. at Savoy Hill for co-ordinating the outputs of different studios for radio drama, the new device was known as the dramatic control panel. Now, more than ten years later, it has been decided to drop this appellation and to refer to "production panels." The reason given is that the dramatic control panel is used for many types of programme besides dramatic work. Studio listening rooms are now "studio control cubicles."

Great Britain's Wireless Licences

THE approximate number of wireless receiving licences in force at the end of last month was 8,968,600 as compared with 8,588,676 at the end of March, 1938. The increase since January 1st, 1939, was 59,700.

Ideal Home Exhibition

TELEVISION demonstrations are being given at the Ideal Home Exhibition by Marconiphone in a garden lounge. Between normal times of transmission, a demonstration film is shown.

Safety Campaign

A WIRELESS amateur in Pennsylvania was severely injured when he received a 3,500-volt shock from his equipment. His father, also an amateur, saved his life by the immediate application of artificial respiration. This is the first big indication of the success of the American Radio Relay League's safety campaign, but for which the father of the victim in this case would have been ignorant of the methods of resuscitation.

New Station at Renfrew

A NEW direction-finding wireless station has been completed at Renfrew Airport at an approximate cost of £3,000. Staffed by Air Ministry operators, its service area will extend to Stranraer and Berwick in the south, and Fort William, Pitlochry, and Montrose in the north.

I.E.E. Summer Meeting

FROM June 19th to 23rd the I.E.E. will be holding its summer meeting with headquarters at the Midland Hotel, Manchester. Features of the meeting will include visits to the works of the Chloride Electrical Storage Co. and the Trafford Park Works of the Metropolitan-Vickers Electrical Co.

Summer Tuition

SHORT courses of instruction, which might be of interest to readers of *The Wireless World* in the London area, have been arranged by the Borough Polytechnic, Borough Road, London, S.E.1. On Wednesday evenings at seven o'clock, commencing on May 10th, Mr. S. N. Ray, M.Sc., will lecture on "Noise: Its Measurement and Elimination." A course on the recent developments in television will be given on Thursdays at 7.30 p.m., commencing April 27th. "Sound" is the title of the Friday evening course, which begins on April 28th at 7 o'clock.



A NEW BROADCASTING TECHNIQUE was introduced when Howard Marshall (right) interviewed sportsmen in the drawing room of his home at Knightsbridge, London, last week. To get away from the studio atmosphere his drawing room has been wired as a semi-permanent studio which will be used for the six scheduled sportsmen's "at homes."

Secondary Emission

LATEST METHODS OF AMPLIFICATION

THE way that the new science of electronics is thrusting itself into everyday affairs is one of the things that makes me wish I had devoted more attention in my mis-spent youth to the somewhat unpalatable subject of theoretical physics, on which electronics is based. Even a year or two ago some of it seemed much too theoretical for real life, and yet here it is right over the counter of the shop. People who are actually on the job find it hard enough to keep pace with the developments of electronics; still more do those whose opportunity for doing so is confined to a hasty perusal of *The Wireless World* on the homeward 'bus. And yet some smattering of it is necessary in order to get any idea of how the latest valves, television systems, and so forth, work. That is why I try every now and again to serve up some of the fundamental principles in not too repellent a form, hoping that it will make explanations of new developments a little less difficult to follow.

As a matter of fact, people who are keen on almost any branch of modern science will sooner or later be glad to have some sort of acquaintance with the nimble electron, because he can't be kept out. Take photography: almost directly, you run

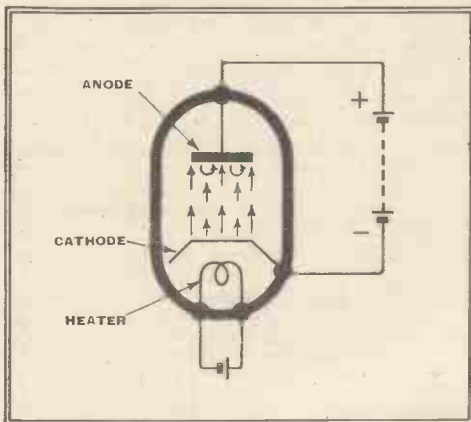

Fig. 1.—Secondary electrons are emitted in a simple diode valve due to the bombardment of the anode by the primary electrons from the cathode (when the anode voltage is not too low), but are not noticed because they are immediately attracted back to the anode.

into the question of the merits of different exposure meters, employing various photo-cells depending on electronic action of one sort or another. And if one goes into the chemistry of the thing—well, modern chemistry fairly reeks of electrons. If you try to escape from the electron—the smallest known thing—by interesting yourself in the science that deals with the largest known things—astronomy—you

find yourself up against innumerable electrons at every turn, and throughout whole chapters of the books.

That by way of apology, if any be needed, for introducing electronics once more.

Electric currents of all sorts depend on the movements of electrons, and until fairly recently most electric currents of any practical interest were those confined to solid and liquid materials, like copper wires and accumulator acid. It is not so long ago that it was thought impossible for electricity to flow across a vacuum. Now it is being found that electric currents can be much more delicately controlled in a vacuum than elsewhere. As the vacuum

By
"CATHODE RAY"

itself is just nothing, it is obvious that the means for carrying the current must be produced somewhere. There must be a source of electrons—"electricity carriers." The science of electronics is generally understood to be concerned with ways of producing and controlling electrons in a vacuum, or at least a rarified gas (strictly speaking it is impossible to obtain a perfect vacuum, so it is just a matter of the degree of rarefaction). There seems to be no end to ingenious electronic devices.

Practically everybody is more or less familiar now with the commonest electronic device—the wireless valve. Here the supply of electrons is produced by heating a suitably treated piece of metal, generally called the cathode. In the early experiments, especially on X-rays, the only way of persuading electrons to part from the cathode was by forcible extraction with the aid of perhaps 50,000 volts or even more. If no advance had been made on this method, it is unlikely that the world would have reached the stage of counting its yearly production of electronic devices in hundreds of millions. But with the aid of a little gentle heat it is possible to draw the electrons across with comparatively insignificant voltages. A third method, not used on quite such a gigantic scale, but common enough in the cinema, in television photography, and scores of other applications, is by shedding light on special types of cathode. A fourth method, which at last is what I

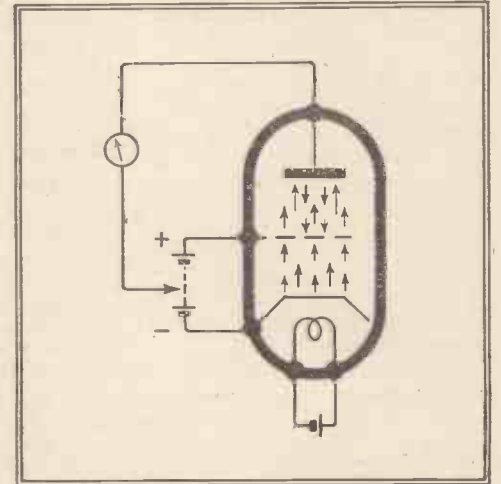

Fig. 2.—The peculiar behaviour of a triode with the grid more positive than the anode is due to the secondary electrons released at the anode being attracted away by the higher voltage of the grid, causing in some circumstances a current that flows in the opposite direction to the voltage.

really set out to talk about, is by using a supply of electrons obtained by any of the above methods to bombard another cathode. The electrons dislodged from this second cathode are not unnaturally called secondary electrons. And they are getting very important. But to avoid confusion it is as well to realise that what I have called the second cathode is not always referred to under that name; sometimes it is called an anode, and so it may be in relation to the first cathode.

Electron Multiplication

The reason why secondary electrons are becoming important is that in favourable circumstances several of them may be emitted for every one primary electron that arrives. If, then, they can be collected it is possible to obtain a corresponding degree of *amplification*. At first this may not seem to be very thrilling news,

seeing we already know quite a lot about how to get amplification in large or small quantities. The reasons why the secondary emission brand of amplification is especially desirable are often rather involved, but generally it is because it is applicable to certain cases where other methods fail, perhaps due to the amount of noise introduced along with an extremely weak

signal, or because the normal methods would be more difficult or expensive.



A recently introduced valve in which the principle of secondary emission is employed.

Secondary Emission—

Secondary electrons can be, and almost inevitably are, produced whenever any ordinary valve works. Take the diode, because it is the simplest. Electrons are liberated from the hot cathode, and when a positive voltage is applied to the anode they are attracted across in accordance with the law of attraction of the unlike. The voltage in a detector diode is usually rather small, but in the power rectifier where it is generally about 350 volts there is a considerable bombardment of the anode by the electrons, and no doubt many secondary electrons are knocked out. Whether they are or not, nobody is any the wiser, for directly they quit the anode the 350 volts says "No you don't!" and pulls them back again (Fig. 1).

The same story applies to the triode as ordinarily used. The grid, being negative, tends only to assist in preventing any electrons from escaping from the anode. But if a triode is used in an unconventional manner by applying the positive voltage to the grid instead of the anode, many of the primary electrons that are attracted from the cathode by the positive grid fail to make contact, owing to the spaces in between the grid wires, and go on until they collide with the anode sufficiently

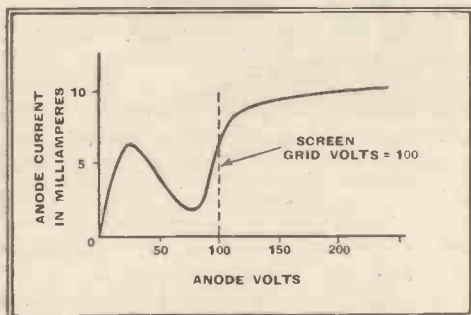

Fig. 3.—The "kink" in the characteristic of the screen grid tetrode, due to loss of current by secondary emission when the screen voltage is higher than the anode voltage.

forcibly to dislodge secondary electrons. These find little to hold them back; on the contrary, there is a large positive attraction at the grid, which promptly collects them. If a milliammeter is inserted in the anode circuit (Fig. 2) it is found that over a certain range of anode voltage (always less positive than the grid voltage) the increase in primary electrons collected is more than counterbalanced by the loss of secondary electrons, and instead of conforming respectably to Ohm's Law the current actually drops when the voltage is increased. A valve acting in this way was named the dynatron.

Screen Grid Valves

As I have said, this is a cockeyed way of using a triode, so secondary electrons never came into prominence until the next stage in valve development arrived with the fourth electrode, turning it into the tetrode, or screen grid valve as it was then called. The second grid came in between the first grid and the anode, and required a positive voltage. So long as the anode voltage was more positive still, all went

well; but when in an effort to get appreciable power out of the valve it was allowed to swing below the outer grid voltage during part of the cycle, it turned into a dynatron and did all sorts of tricks (such as oscillating) that were all very well at the right time and place but not at all amusing here (Fig. 3) So the valve makers got busy again and stuck in a third grid between the second grid and the anode. This grid was designed to be kept at zero volts, so acting as a sort of policeman to prevent secondary electrons from escaping from the anode to the positive middle grid.

So far, except for certain laboratory applications, secondary electrons are only a nuisance. It was in television that the black sheep really began to make good. My object just now is to explain what secondary electrons are, not to go into detail about the ways of using them, so I merely mention the beneficial effects of them in the "Super-emitron" now used in the B.B.C. television cameras, and the television receiving valves now being introduced (and described in *The Wireless World* of Feb. 23rd). In the latter, the exceptionally high mutual conductance necessary for reasonably good amplification over the broad television band is obtained by shepherding the primary electrons, which have been controlled in the usual way by the signal input grid, to a second cathode, and then collecting the resulting secondary electrons from it by the anode. In this and other applications where the object is to get an amplified result it is obviously necessary to get more secondary electrons than primary electrons. This doesn't just happen automatically; some metals can never be persuaded to yield even head for head. Special surfaces, such as caesium on silver, can be made to yield up to about 8 secondaries per primary. But the primaries have to hit hard enough, of course, by being pulled across with a sufficient voltage.

It might seem to be a good idea to make more of this by using several stages of secondary electron amplification, causing the 8 secondary electrons to release 64 tertiary electrons, and so forth. Well,

that has been done, but there is one snag—probably more!—that prevents it from being adopted everywhere. In a valve the number of electrons controlled by a weak signal is only a minute proportion of the total flowing. Take a valve in which the

normal anode current is 5 milliamps. That is to say, the rate of flow is 31,500,000,000 electrons per second. With an input of a few microvolts the variation produced in this flow may be only one or two electrons in a million, say, 0.00001 milliamp. If a stage of secondary emission is successful in increasing this to 0.00008 mA, the "standing" current is 40 mA. This

might be tolerable, but the result of a third stage, 320 mA, would be alarming, even if it were practicable at all. In the ordinary methods of valve amplification only the variation is passed on to the next stage and amplified. Obviously in a secondary emission amplifier every effort must be made to reduce the standing current to a minimum. But if this is carried far the mutual conductance of the valve suffers and amplification is lost heavily, so defeating the object.

Light-controlled Emission

Things are not quite the same when the releaser and the controller of the primary electrons are one and the same. In a valve the heater releases billions of electrons and the weak signal controls merely millions. But in television cameras and some other



Super-Emitron camera: secondary emission has so far found its chief application in television.

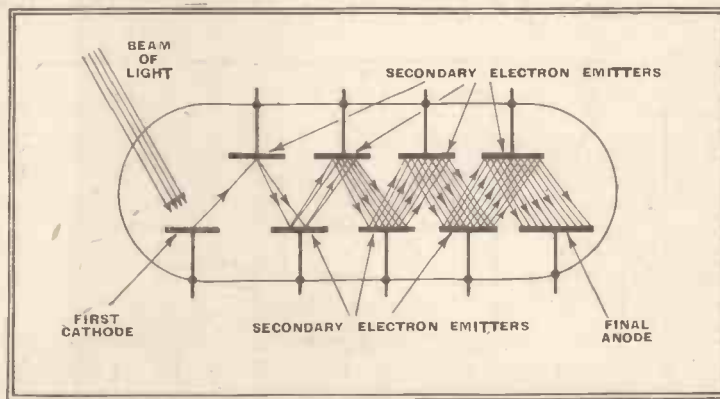

Fig. 4.—Very diagrammatic illustration of a multi-stage electron multiplier. Here the original release of electrons is due to light, say in television or sound film practice. The successive emitters, acting both as anodes and cathodes, are maintained at progressively increasing voltages, to attract the electrons to the next stage. Even so, in practice special means have to be provided to keep them to the right paths.

devices the signal is in the form of light, which also is the electron releaser. All the primary electrons are controlled electrons. So the final result of a number of stages of amplification is all signal, or at any rate

Secondary Emission—mainly so (Fig. 4). Working multipliers with as many as 12 stages in a single "bottle" have been made; for example, those demonstrated by Zworykin a few years ago.

These are only a few of the secondary emission devices that have appeared to date. And who knows what will come next? So it is not a waste of time learning something about the underlying principles now.

remarkably uniform, and with adequate backing of a good automatic volume-control system the volume control needs very little attention throughout the course of an evening's varied listening.

The "organ key" tone-control system, which we were at first inclined to regard as an unnecessarily complicated substitute for a simple variable tone-control knob, won unqualified approval after a few tests. Instead of having to find by ear the setting of the tone control which best suits speech or music (incidentally, why are so few conventional tone controls calibrated to help one in doing this?) all one has to do is to click down the appropriate key as soon as the nature of the programme is announced. We found the "Speech" and "Mellow" keys most generally useful, as the "Treble" gave a rather shrill top and the "Bass" control would only

Test Report

PILOT MODEL T.63

Table Model AC Superhet (4 Valves + Rectifier and Tuning Indicator) Price 12½ Guineas

IN appearance this set is very similar to the Pilot Model PT36 with "piano key" tuning shown at Olympia last August. It has the same drum dial and row of control keys, but in the Model T.63 they are not coupled to the tuning mechanism, but are used for waveband switching and for tone control.

Circuit.—There are four valves in the direct line of amplification between aerial and loud speaker. The first is a triode-hexode frequency changer preceded on each waveband by a single tuned circuit

wavebands. Control for the cathode-ray tuning indicator is taken from the AVC line. A jack switch disconnects the diode load resistance when a pick-up is in use.

The resistance-capacity coupling to the output stage includes two coupling condensers in series, one of which is normally short-circuited. When the "Speech" tone-control key is depressed, both condensers are in circuit and the bass response is reduced. The "Mellow" tone-control key introduces a resistance-capacity filter across the anode circuit of the pentode output valve, and the "Bass" control gives a still further reduction of top response by connecting the condenser only. The action of the "Treble" key is purely mechanical and releases all the other switches, thus leaving the circuit with no top cut in the output stage and with the normal single coupling condenser to give full bass response.

A jack switch similar to that used for the pick-up is employed for the external loud speaker. Thus the external loud speaker may be used with the internal unit disconnected or the two loud speakers may be used together. The plug should not be inserted unless a loud speaker is connected, as there is no artificial load resistance in the set to take its place.

Performance.—This is a well-balanced set in the sense that the range, selectivity

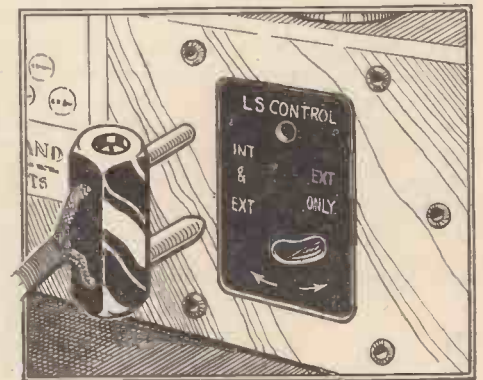

Combined plug and switch for the external loud speaker in the Pilot T.63. A similar arrangement is provided for the pick-up connection.

WAVERANGES	
Short	16—53 metres
Medium	190—565 metres
Long	800—2,200 metres

inductively coupled to the aerial. The intermediate frequency amplifier is a variable-mu pentode with an iron-cored input transformer and an air-cored output transformer. In the double-diode-triode stage, which follows, the diodes are strapped together and connected in the simplest form of combined signal and

be called for to eliminate severe background noise. The balance given by the "Mellow" key contains far more useful high-frequency response than is generally implied by the usual connotation of this term.

As regards selectivity it is possible to tune to within 1½ channels of the London Regional transmitter at a distance of 15 miles without incurring interference, and on long waves, while Droitwich and Radio Paris are easily separated, there is rather too much sideband interference on the Deutschlandsender for it to be accepted as a station of regular programme value.

The short-wave performance upholds the reputation which sets of this make have held in the past for liveliness and efficiency. There was, however, some evidence of double tuning points on the 16- and 19-metre bands, but no case of actual interference due to second-channel break-through was discovered.

A few minor whistles were noted below the broadcast stations in the lower half of the long-wave range, but the medium-wave range was clear except when using too large an aerial, when overloading of the frequency-changer produced a whistle adjacent to the local station.

Constructional Details.—The front of the cabinet with its single concentric tuning and volume-control knob presents a neat appearance. The slow-motion

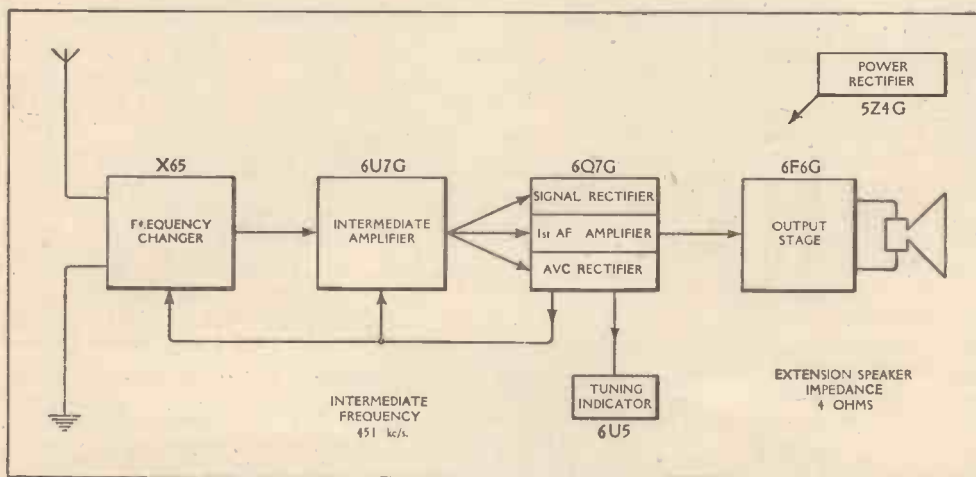

Schematic circuit diagram of the Pilot Model T.63.

AVC rectifier circuit. The AVC bias is delayed and applied to both the IF amplifier and the frequency-changer on all

and signal-to-noise ratio appears to be the same whatever the waverange. Over each waveband, too, the sensitivity is

Pilot Model T.63—

drive is of the two-speed type, with a high reduction ratio over a limited range when the direction of rotation is reversed.

An efficient cord drive, free from backlash, controls the cylindrical tuning scale, which carries parallel scales for the three wavebands. Station names are clearly marked, but the wavelength sub-divisions, while decorative, are not too easy to interpret if one is tuning on a wavelength basis. The waveband in use is indicated

HENRY FARRAD'S SOLUTION

(See page 364)

AS the receiver is for AC mains it is almost certain to derive its power through a transformer. Of the 0.4 amp. taken by it, part is required for magnetising the core of the transformer and is inductive or lags nearly 90 degrees behind the voltage. A likely amount for this lagging current would be 0.06 amp.

As one side of the mains is generally

reactance of 1 mfd. at 50 c/s is roughly 3,000 ohms, and assuming 230-volt mains it draws a current of 0.075 amp., which, being capacitive, leads the voltage 90 degrees, and is therefore 180 degrees different from the magnetising current. In other words, it is in the opposite direction, and the combination of the two is therefore the difference between them, 0.015 amp. capacitive, or less than the original inductive current. The lagging current is shown by full line arrows and the leading current by dotted arrows, and it can be seen how the current through one fuse is unaffected and the other is reduced. The currents indicated are, of course, in addition to the in-phase working current supplied to the receiver, which is the same all the time and need not be shown.

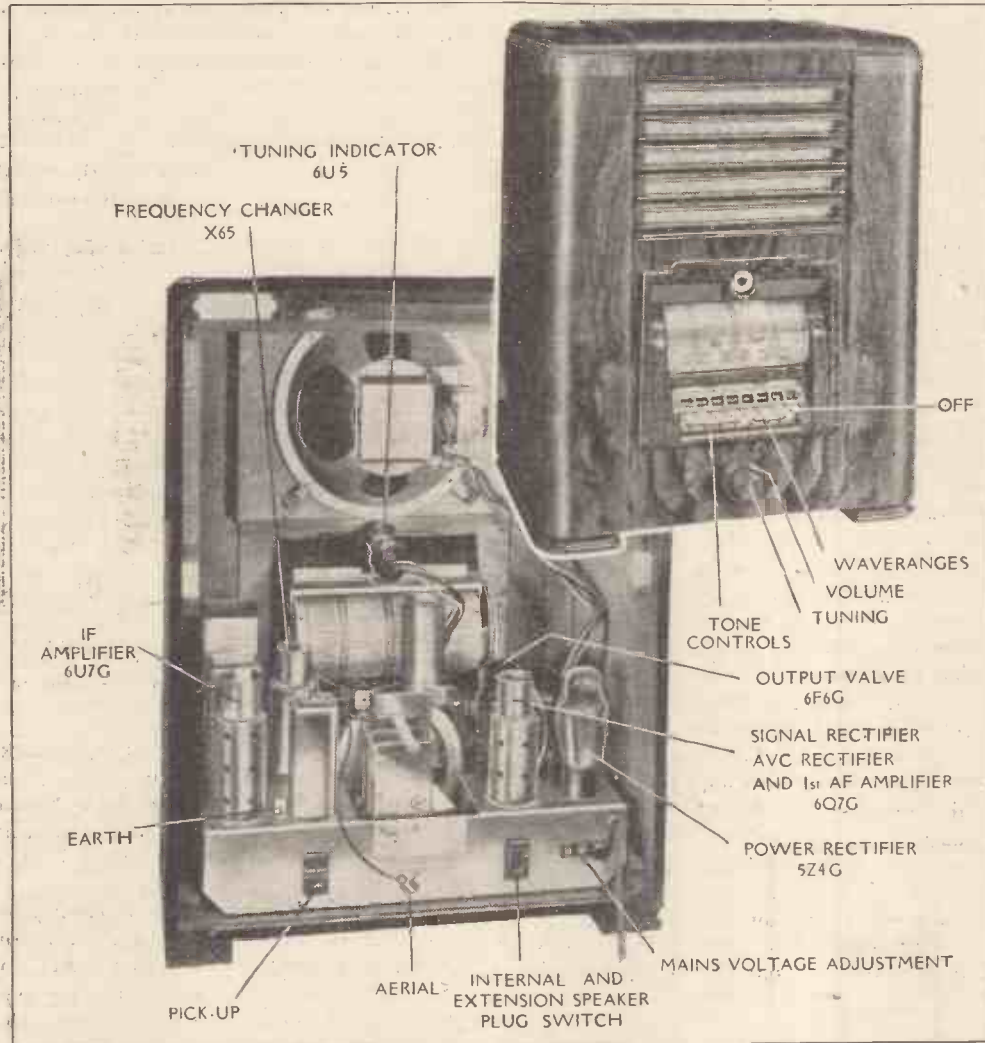

Layout of valves, controls and external connections in the Pilot Model T.63.

by an illuminated panel immediately below the dial as well as by the setting of the control key.

Instead of the usual socket connections for aerial and earth, clips are provided from which the wires cannot easily become detached.

Summary.—The application of press-button technique to tone control has much more to commend it than mere novelty. For those who are tuned to their local station for a large proportion of their listening time it is more convenient to be able to adapt the quality to changes in broadcast material than to change rapidly to another station. When it is desired to indulge in distant station reception the T.63 can be relied upon to give a good account of itself, and the provision of a cathode-ray tuning indicator implies that it will be used frequently for this purpose.

earthed somewhere on the system, one condenser has practically no effect on the current, while the other has the full mains voltage; so the effective circuit, as far as current is concerned, is as shown here. The

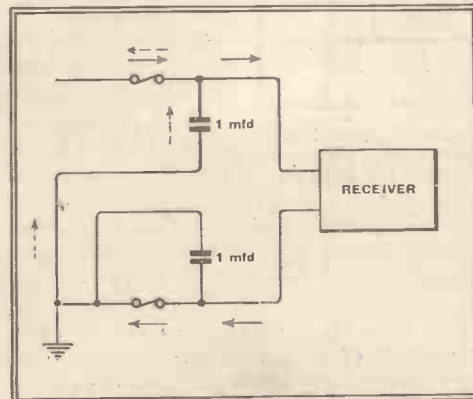

NEWS FROM THE CLUBS

Exeter and District Wireless Society

Headquarters: Y.W.C.A., 3, Dix's Field, Exeter, Devon.

Meetings: Mondays at 8 p.m.

Hon. Sec.: Mr. W. J. Ching, 9, Sivell Place, Heavitree, Exeter, Devon.

At the April 3rd meeting an illustrated lecture was given by Mr. D. R. Barber, of the Norman Lockyer Observatory his subject being "Atmospheric Electricity." He dealt with various aspects of his subject, including ionisation due to radio-active matter. He stated that it has been calculated that the Heaviside Layer is at a potential of 300,000 volts above the earth.

Medway Amateur Transmitters' Society

Headquarters: The Navy Wives' Club, Dock Road, Chatham, Kent.

Meetings: Tuesdays at 8.15 p.m.

Hon. Sec.: Mr. S. A. C. Howell, "Veronique," Broadway, Gillingham, Kent.

Several members attended the Maidstone Society's "ham" evening during March. It is intended to hold a similar event at Chatham on May 10th, and all amateurs in Kent are invited to attend. Several lectures have been arranged for May, including one by a representative of A. C. Cossor, Ltd., entitled "Cathode Ray Measuring Instruments."

Smethwick Wireless Society

Headquarters: New Talbot Inn, High Street, Smethwick, Staffs.

Hon. Sec.: Mr. E. Fisher, 33, Freeth Street, Oldbury, Nr. Birmingham.

The Secretary asks us to draw the attention of readers in the Smethwick district to the existence of this club, which was not included in the directory of amateur clubs published in *The Wireless World* of April 6. Full details of membership can be obtained on application to the Secretary.

South Hants Radio Transmitting Society

Headquarters: Senior Boys' School, Fareham, Hants.

Hon. Sec.: Mr. E. J. Williams, 34, London Road, Purbrook, Portsmouth.

At the meeting held on March 30th a representative of the Mullard Wireless Service Co. gave a lantern lecture entitled "Receiver Valve Development." A large audience was present, including visitors from Southampton and Winchester. This society is additional to those published in our directory of wireless clubs.

Surrey Radio Contact Club

Headquarters: 79, George Street, Croydon, Surrey.

Meetings: First Tuesday in the month at 8 p.m.

Hon. Sec.: Mr. S. A. Morley, 22, Old Farleigh Road, Selsdon, Surrey.

At the April meeting there was an auction sale of members' surplus gear.

The club is taking charge of the 1.7 megacycle national field day station, which has been allotted to Croydon. A site has been chosen at Riddlesdown which is 600 ft. above sea level, and at the present time members are busily engaged in preparing the gear for this event, which takes place during the first week-end in June.

Readers are asked to note that there has been a change in the name and address of the secretary and in the address of the headquarters since the publication of our directory of clubs.

Tufnell Park Radio Club

Headquarters: 33, Pemberton Terrace, Tufnell Park, London, N.19.

Meetings: Tuesdays and Fridays at 8 p.m.

Hon. Sec.: Mr. J. G. Wright, 78, Gladsmuir Road, Highgate, London, N.19.

This society has been formed since the publication of our directory, and the secretary asks us to make it known that he will be pleased to hear from anybody in the district who is interested.

The Modern Receiver

Part VIII.—AF Amplification, the DC Circuits and the Power Supply

IT is necessary to use an audio-frequency amplifier after the detector in order to obtain sufficient output to operate the loud speaker. Theoretically, there is no reason why the loud speaker should not be fed directly from the detector, for the signal at this point is of the correct nature. In practice it would be very inefficient to do so.

The loud speaker requires power to operate it, which must come from the HT supply. Now the peak value of a 100 per cent. modulated wave is twice the carrier value and twice the AF detector voltage output with a perfect detector. The instantaneous peak power input is four times the output, therefore, and when the detector input resistance and efficiency are taken into account the input power on peaks is rather more than eight times the output.

This power has to be supplied by the last IF valve, so that if we want to feed 4 watts to the loud speaker and we feed it straight from the detector, the last IF valve must be capable of an output of something like 32 watts! This is absurdly uneconomical, and an AF amplifier is consequently always used.

The detector is operated at a convenient signal level from the points of view of obtaining low distortion, a suitable AVC voltage, and freedom from overloading in the IF valve. The output stage is then selected, and the intermediate AF amplifier chosen so that the output of the detector, or gramophone pick-up, whichever is the less, will fully load the output stage.

The precise arrangement used depends on the output required and the apparatus available, and there is probably more latitude here than anywhere else for individual preferences. Any type of amplifier can be employed, but when economy is important the pentode output valve naturally comes up for serious consideration.

In the case of the Three-Band AC Super

a pentode in the same range as the other valves—the Mullard E series—was chosen. It is the EL3 with an output of the order of 4.5 watts into a load of 7,000 ohms. The valve normally operates with 250 volts and 265 volts anode and screen potentials, and takes 36 mA. and 4.5 mA. anode and screen currents at -6.6 volts grid bias. The signal input should be about 4 volts RMS.

It is convenient to take the detector and pick-up output as about 0.5 volt. It will often exceed this, but this figure allows a factor of safety for weak signals. An AF gain of about eight times is therefore needed between the detector and output valves.

Such low gain is easily obtainable, but it is advantageous to provide more and then to reduce it by means of negative feed-back, for this removes most of the disadvantages of the pentode output valve while leaving its advantages.

The basic arrangement of the AF amplifier takes the form shown in Fig. 27; the bias resistance of the output valve V2 is omitted. For the moment, consider that

R4 is disconnected from R3 so that C2 and R4 play no part in the operation. Then a signal applied between grid and earth of V1 makes the anode current fluctuate in sympathy with the grid voltage and hence there is a voltage developed across R1 and R3.

A change of grid voltage in a positive direction, for instance, makes the anode current rise. The voltage drops across R1 and R3 increase, and hence the anode potential falls while the

cathode potential rises. This change of voltage across R3 acts to offset the signal input, for the voltage which operates the valve is not the input between grid and earth, but the voltage between grid and cathode. If 1 volt change between grid and cathode produces 20 volts change on

the anode and 2 volts change on the cathode, the input between grid and earth must be 3 volts, and the effective stage gain is not 20 times, as it would be if R3 were absent, but 20/3 times.

This is negative feed-back, but in this form it has little effect and is merely incidental to the main path. It is not introduced intentionally, but because it cannot be avoided while retaining the wanted feed-back path.

The output voltage of this first stage is developed across R1 and applied through the RC coupling C1 R2 to the output pentode which develops power in the output load circuit. There is, of course, also a

voltage developed across the output transformer primary, and a fraction of this voltage is applied by R3 R4 to the cathode circuit of V1. This is the main feed-back path, and the condenser C2 is merely to insulate the circuit from the HT supply.

As before, consider a positive grid voltage change on V1. This makes the anode current rise and the anode voltage fall. There is consequently a negative voltage change on the grid of V2. The voltage across R3 rises and so gives direct negative feed-back on V1. The anode current of V2 falls and its anode potential rises. A fraction of this rise in potential is communicated by R3 R4 to the cathode of V1, making it rise in potential still more. This is the main feed-back path.

Negative Feed-back

One of the advantages of feed-back is that it reduces distortion. Supposing V2 distorts, then the output of this valve is no longer a copy of the input. The voltage fed back to V1 is distorted and so makes the input to V2 distorted in the opposite sense. The distortion introduced by the valve V2 then tends to cancel the distortion of the input and the output is nearer a true copy of the input of V1.

In general, if A is the amplification and B the feed-back, then all forms of distortion and the gain are divided by 1 + AB. In the limit, if AB is made large compared with unity, the characteristics of the amplifier tend to become those of the feed-back path alone. This condition is not often used, and in practice B is often 0.1 or less, while A may be 200-500.

IN this concluding instalment of the series the audio-frequency circuits are dealt with as well as the HT supply system and the voltage-dropping and decoupling arrangements. The use of negative feed-back in the AF amplifier is also explained.

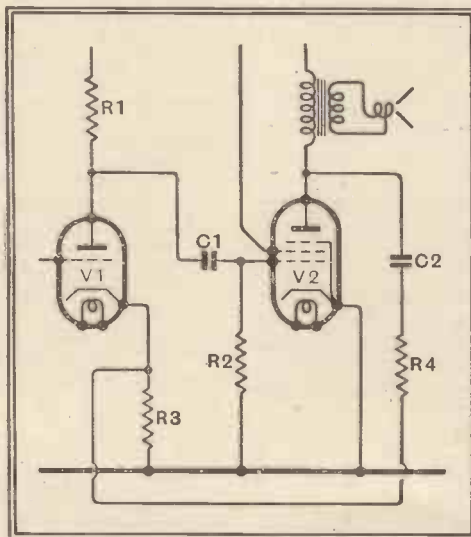

Fig. 27.—This diagram shows the basic arrangement of the AF amplifier. Negative feed-back is obtained through R3 and R4.

The Modern Receiver Stage by Stage—

Another advantage of this form of feed-back is that it makes the output valve behave as though it had an output resistance of only a few thousands of ohms instead of being 20,000-100,000 ohms—normal figures for pentodes. This results in the loud speaker being properly damped

heavily and so prevents the oscillation, while having no harmful effect. The voltage drop across it due to the screen current is so small that it can be neglected. The total HT voltage needed is $265 + 6.6 = 271.6$ volts, or, say, 270 volts.

In order to avoid the introduction of negative feed-back by R₄, it is shunted by the condenser C₄, a capacity of 50 μF. being adequate. The reactance of the condenser should be small compared with the resistance of R₄ at the lowest frequency required. Actually, 50 μF. has a reactance of 64 ohms at 50 c/s, a figure which is reasonably low.

forms part of the feed-back network, is 2,000 ohms. Decoupling is inserted in the anode circuit to serve two purposes—to prevent unwanted feed-back and to reduce hum.

Any ripple on the HT supply is greatly reduced by R₃ and C₁ and the larger the values of these components the greater the reduction. The anode current of V₁ passes through R₃, however, so that there is a loss of voltage across it; consequently its value must not be too high. A suitable value is 20,000 ohms and C₁ can be 8 μF.

The Early Stages

The total resistance in the circuit of V₁ is thus 72,000 ohms and the current is 1.8 mA, so that the voltage drop is 130 volts, leaving an anode potential of 140 volts on the valve. The grid bias is 3.6 volts.

The detector itself takes no current from the HT supply, but the potentiometer for obtaining the delay voltage does. As shown in Fig. 26, this comprises R₆ and R₅, and suitable values are 100,000 ohms and 1,500 ohms respectively, so that the current is 2.66 mA. and the delay voltage is 4 volts.

The total current so far is thus $40.5 + 1.8 + 2.66 = 44.96$ mA.

We now come to the early circuits and the arrangement is shown in Fig. 29; the RF and IF circuits are here shown in skeleton form without switching. The IF valve V₃ is the EF9 and for normal operation requires 250 volts anode and 100 volts screen potentials; with 2.5 volts grid bias the anode and screen currents are 6 mA. and 1.7 mA. respectively.

As the current through R₉ is to be 7.7 mA. it should be 324 ohms for 2.5 volts to be developed across it. For the anode

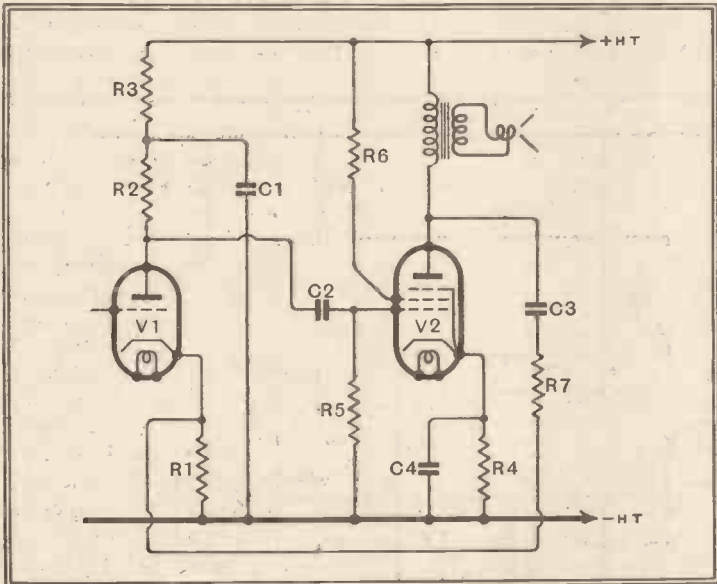

Fig. 28. The actual circuit of the AF amplifier shows the decoupling R₃ C₁, the output valve bias circuit R₄ C₄, and the anti-parasitic resistance R₆.

by the circuit, and bass resonances become less prominent.

We have now followed the Three-Band AC Super through from the aerial circuit to the loud speaker, and we must next turn to the DC circuits, which we have hitherto neglected. We have seen that the output valve needs 265 volts screen potential with 250 volts on the anode. The lower anode voltage is to allow for the drop in the output transformer primary. As the current is 36 mA. and 15 volts drop is allowed, it is assumed that the primary resistance is 416 ohms.

Cathode Bias

The valve requires -6.6 volts grid bias, and we obtain this by inserting a resistance in the cathode lead, as shown by R₄ in Fig. 28. The anode and screen currents—40.5 mA.—flow through this resistance and so make the cathode positive with respect to earth, and consequently the grid negative with respect to cathode. For 6.6 volts at 40.5 mA., R₄ must be 163 ohms. The value actually used is 150 ohms, since this is a standard value, and in this case is near enough to the optimum.

A 50-ohm resistance R₆ is inserted in the screen lead to suppress any tendency to parasitic oscillation. It must be remembered that there are tuned circuits connected to all the electrodes of a valve, being formed of the inductance and capacity of the connecting leads both internal and external to the valve. When the mutual conductance is high it is quite possible for the valve to oscillate at a frequency determined by these inductances and capacities—a frequency usually above 50 Mc/s. The resistance R₆ damps these circuits

Turning now to the penultimate stage V₁, the valve selected is the EBC3, but the diodes which it includes are not used. Actually, the type of triode used at this point is not very critical, and any valve with an AC resistance of 10,000-30,000 ohms and a mutual conductance of 2-3 mA/v. will work well. Minor changes in circuit values are, of course, necessary.

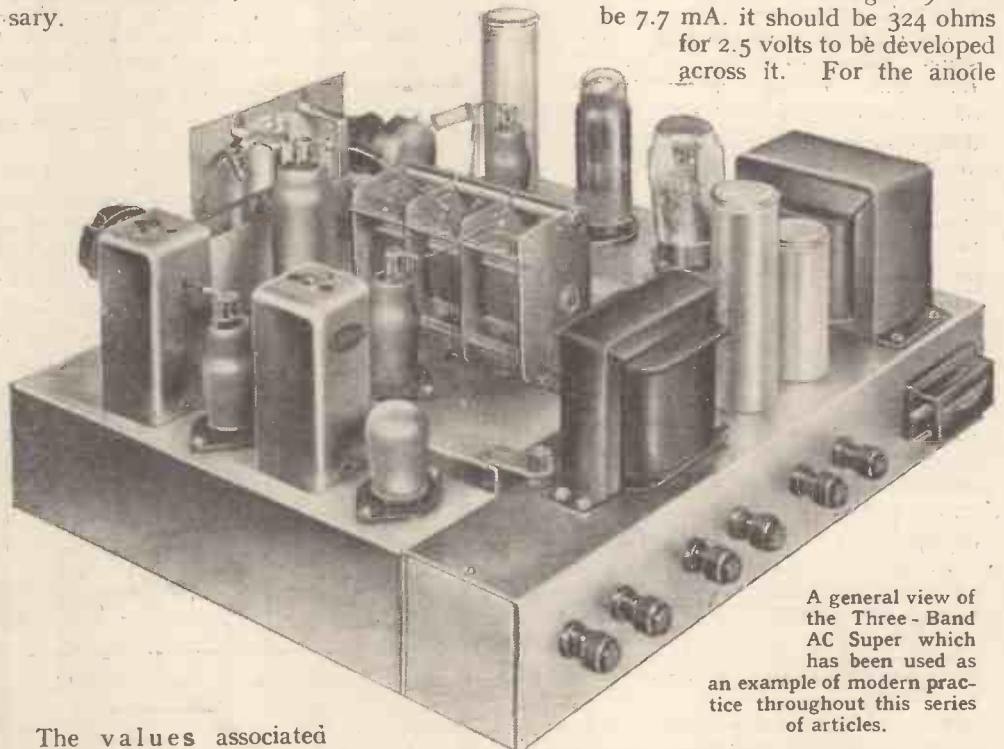

A general view of the Three-Band AC Super which has been used as an example of modern practice throughout this series of articles.

The values associated with V₁ are chosen in the usual way for resistance coupling.¹ The coupling resistance R₂ is 50,000 ohms, and the bias resistance R₁, which also

¹ The Wireless World, October 30th, 1936, et. seq.

supply we have to drop $270 - 252.5 = 17.5$ volts at 6 mA. across R₁₀, and for the screen $270 + 102.5 = 167.5$ volts at 1.7 mA. across R₇. Consequently, R₁₀ should be 2,920 ohms and R₇ should be 98,500

The Modern Receiver Stage by Stage—
ohms. The values actually used are the standard ones of 350 ohms for R₉, 4,000 ohms for R₁₀, and 100,000 ohms for R₇. The increase in R₉ means some increase in grid bias and therefore lower anode and screen currents; hence, the increase in R₇ and R₁₀. The changes in current are quite small and it is reasonable to take the figure of 7.7 mA. when computing the total for the receiver.

The frequency-changer V₂ is the

would not be as good. This also applies in the case of V₃, but here the valve must be capable of handling a large signal at a high bias voltage. It is more easily able to do this at a high screen voltage than at a low one, and so a dropping resistance is used for the screen supply in preference to a potentiometer.

In the case of the RF stage V₁ the EF8 is used. This valve requires the same screen and anode voltages, 250 volts, and a common dropping resistance

The total current for the receiver works out at some 85 mA. at 270 volts and this is the output which the mains equipment must provide.

Before turning to this, however, we must finish with Fig. 29. It will be seen that the voltage dropping resistances discussed can also serve for decoupling, and this is, in fact, the object of using separate resistances for each stage. Bypass condensers are consequently provided and in no case are these values

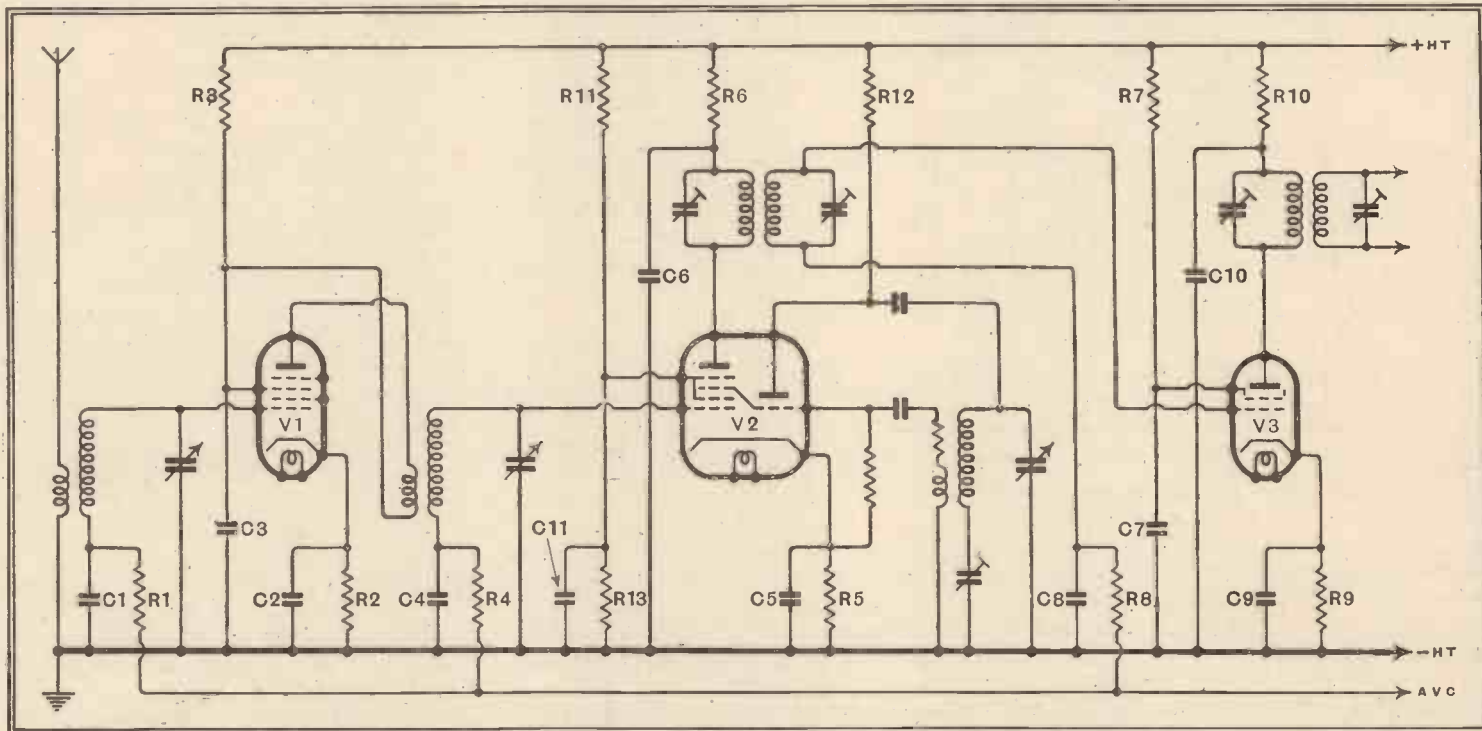

Fig. 29.—In this diagram of the early stages of the receiver the DC circuits are shown fully, while the RF and IF circuits are in skeleton form only.

ECH₂. The anode current of the triode section depends on the amplitude of oscillation and thus varies somewhat with the tuning. A suitable value for R₁₂ is 30,000 ohms, but it is not very critical. With this resistance the current is of the order of 6 mA.

The heptode section needs a bias of 2.5 volts and the anode and screen currents are 3.25 mA. and 6 mA. respectively. The total current through R₅ is thus about 15.25 mA. and the resistance should be 164 ohms. The nearest standard value of 150 ohms is used.

The anode requires 250 volts, so that 17.5 volts at 3.25 mA. must be dropped in R₆, making its value 5,390 ohms. Actually, 5,000 ohms is used. For the screen supply, R₁₃ is picked arbitrarily to pass a larger current than the screen current. If we make it 10,000 ohms the current is very nearly 10 mA. and so the current through R₁₁ is 16 mA.; the drop here is to be 167.5 volts, so the resistance is 10,450 ohms, and 10,000 ohms is quite near enough.

The object of using a potentiometer for the screen supply to this valve is to prevent the screen voltage from rising greatly when the valve is biased back by the AVC system. If the voltage were allowed to rise, more AVC voltage would be needed to reduce the gain and AVC

R₃ can be used. The anode and screen currents are 8 mA. and 0.25 mA. respectively and the grid bias is 2.5 volts. Consequently R₂ and R₃ should be 303 ohms and 2,120 ohms respectively.

This is for the normal full gain condition. Actually, however, it is not always desirable to run an RF stage at full gain because of the possibility of overloading the frequency-changer. In this receiver, therefore, R₂ and R₃ were made 350 ohms and 8,000 ohms respectively to reduce the gain somewhat.

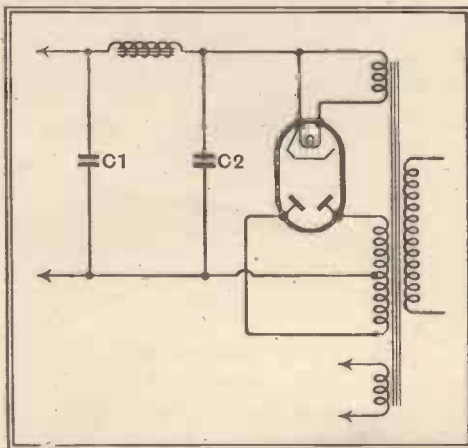

Fig. 30.—The mains equipment is extremely simple and has this circuit. C₂ is the reservoir condenser.

critical. The usual values of 0.1 μF. are adopted because there is no advantage to be gained by using other values.

The AVC voltage is applied through the resistances R₁, R₄ and R₈, while the decoupling is provided by C₁, C₄, and C₈. The condensers C₁ and C₄ are important, since they complete the two signal-frequency tuned circuits and are effectively in series with the tuning capacities. If their capacity is too small they will restrict the tuning range, and if they are not alike they will affect the ganging. A suitable value is 0.1 μF. and R₁ and R₄ can then be 50,000 ohms, although these are not critical. The effect of C₁ and C₄ on the tuning is corrected in the oscillator circuit by an alteration in the value of the padding condenser.

The IF feed-circuit for AVC can have the same values as the RF, but there is some slight advantage to be gained by making C₈ 0.05 μF. and R₈ 100,000 ohms.

Turning now to the mains equipment we require an output of 270 volts at 85 mA. With C₁ at 8 μF. a single choke of 30 H. inductance gives sufficient smoothing. If the choke is of very low DC resistance it will be expensive, but with one of high inductance we shall have to provide a higher voltage across C₂. The component selected has a resistance

The Modern Receiver Stage by Stage—

of 800 ohms, so that there will be a drop of 68 volts across it, making the required voltage across C2 338 volts.

Inspection of the curves of the AZ3 rectifier shows that with a 4 μ F. condenser for C2 this output is obtained with a transformer winding of 300-0-300 volts RMS. With a different rectifier, or different capacity for C2, the transformer rating would not be the same. A choke of different resistance would also alter matters. It is worthy of note, however, that if the output is too high it can always be reduced by adding resistance in series with the choke. If it is too small, how-

ever, it cannot so readily be increased.

A common LT winding is used for all valves, and is not provided with a centre tap. This is because it has been found desirable in the RF circuits to earth one side of the heaters directly in order to eliminate feed-back effects on the heater wiring. Of course, the presence of a centre-tap on the transformer winding is no objection, for it need not be used.

We have now been right through the circuit of the Three-Band AC Super, and it is hoped that this series of articles has been found interesting and instructive and has given a good insight into the working of a typical modern receiver.

UNBIASED

By FREE GRID

Aerial Espionage

THOSE of us who look-in regularly to television sometimes see curious things on our screens. I am not, of course, referring to the B.B.C.'s artists, but to the curious effects caused by certain technical troubles. Recently I have experienced a very persistent trouble of this nature, and for some time I thought that I had succeeded in picking up a distorted version of the Eiffel Tower transmissions and became quite excited about it.

I happened to be in the throes of struggling with this trouble one evening when Mrs. Free Grid came in and announced that a mysterious aircraft was, to quote her own words, "hovering over the house," and that in her opinion this was the cause of the trouble. Actually the interference was totally unlike that due to



Pounced upon by a game-keeper.

aircraft, but, nevertheless, I went out of the house to look and to my astonishment saw a balloon drifting rapidly across the sky. It quickly disappeared, however, and I put it down to the cheese which both Mrs. Free Grid and I had had for supper, since it is well known that digestive disturbances sometimes play strange tricks with the eyesight.

Two nights later, however, the same sort of thing happened, and the thought at once occurred to me that nocturnal espionage on a grand scale was probably being carried out by some foreign power and that in all probability what I was getting

on my television screen was a visual representation of the surrounding countryside which was being televised from the balloon to some secret ground station. Without wasting a moment I sprang to the telephone and was soon pouring my suspicions into the ears of an astonished police inspector and within a few minutes a police car was on my doorstep. Unfortunately, however, the balloon had by then completely disappeared, and I was viewed by the police with some suspicion.

On the next occasion that it happened the balloon appeared to be so low that it scarcely cleared the treetops. I at once saw that it was very small indeed—far too small, in fact, to contain passengers, and that it was probably a radio-controlled affair. Fortunately, my gun case was just inside the door where I had left it at the end of the pheasant-shooting season, and it was but the work of a moment for me to bring the whole affair down. Unluckily, it fell in the grounds of a neighbouring estate and in my efforts to retrieve it I was pounced upon by gamekeepers on the look-out for poachers.

In the subsequent explanations before the owner of the estate, a rather peppery old colonel of apparently Indian Mutiny vintage, it was revealed that the balloon was one of several fitted with automatic USW transmitters which are being released by the N.P.L. in connection with their meteorological research work. To add insult to injury, the colonel impounded the balloon and intends, I understand, to claim the reward offered by the N.P.L. for the recovery of these devices.

AVC : A Fraudulent Photographic Claim

IT is almost impossible to discuss any new scientific invention with a certain type of person without his endeavouring to prove that it is not new at all but was known to the Chinese thousands of years ago. If it is true that the Chinese fore-

stalled every modern invention, all I can say is that they seem to have made singularly little use of their remarkable discoveries. Even in the case of gunpowder which, I believe, they really were the first to produce, all they did was to make fireworks with it for their amusement instead of devoting it to serious and proper uses such as the production of high explosive shells and suchlike things.

Bearing all this in mind, it was with a sense of keen relief that the other day I heard a prior claim to an invention staked on behalf of somebody other than the Chinese. Actually the invention was AVC which, as I correctly surmised, was *not* known to the Chinese. Apparently, however, the idea was thought of by the Photographic Fraternity, and all that wireless engineers did was to steal it without so much as an acknowledgment; at least, so it was alleged by my informant, a figure well known in the world of amateur photography.

In reply to my challenge my informant first drew my attention to the fact that AVC was really a misnomer for ASC (automatic sensitivity control) since all that the invention does is to regulate the sensitivity of the set according to the strength of the incoming signal. I fully agreed with this,



An enthusiastic amateur photographer.

of course, but I was compelled to dissent strongly from the further statement that automatic sensitivity control was a child of the amateur photographic world born in the year 1930 or thereabouts.

It appears that in that year somebody thought of the idea of coating a film with two emulsions, one very sensitive and one far less so and making some tomfool automatic arrangement whereby the film chooses one or the other according to the degree of light prevailing, with the result that exposure is always more or less correct. It appears that all films with the termination "chrome" at the end of their name are of this type.

It was further pointed out to me that the man responsible for the AVC idea in wireless was also an enthusiastic amateur photographer, and that it was obvious where he got the AVC idea from. I must admit that there does seem strong presumptive evidence leading to what the law would call a *prima facie* case but, as every legal-minded reader will know, this falls far short of actual proof. If it is really true, no doubt there are just as many instances of the same sort of thing on the other side, and I hope you will all endeavour to provide me with some of them.

Recent Inventions

AIRWAY NAVIGATION

WHEN an aeroplane is flying along a definite course it is desirable, particularly in conditions of low visibility, to give the pilot an occasional positive indication of his distance from the port of destination. With this object in view "marker beacons" are arranged at specified intervals and radiate an upwardly directed beam through which the machine must fly.

In order to ensure that the pilot will receive the distance-marking signal, even if he happens to be flying some distance off his proper course, the transmitter is designed to throw a fairly narrow beam over a large arc at right angles to the line of route. The transmitter consists of two dipole aerials, each with its own parabolic reflector, the pair being mounted back-to-back, while the whole assembly is constantly rotated about a horizontal axis. As each reflector swings upwards, its aerial is automatically energised so that a beam of signals is swept across the sky. As that reflector swings downwards, its aerial is automatically cut out of circuit and the second or uprising aerial is brought into operation.

R. J. Berry (communicated by C. Lorenz, Akt.). Application date March 1st, 1938. No. 495613.

AERIAL COUPLINGS

THE drawing shows a branched coupling from an aerial A to a combined speech-and-vision receiver, in which the separation of the two sets of signal frequencies is effected by a suitable adjustment of the length of the two branches FV and FS. In the first place, all the feed-lines FA, FV and FS have the same characteristic impedance, say 75 ohms.

The length of the feeder FV, coupling the aerial to the input transformer TV of the television amplifier, is adjusted until it is approximately equal to one-quarter of the wavelength of the sound carrier wave. It will then present a substantially infinite

impedance to that frequency. Similarly, the length of the "sound" branch FS is made equal to one-quarter the wavelength of the vision carrier wave, to which it will similarly offer infinite impedance.

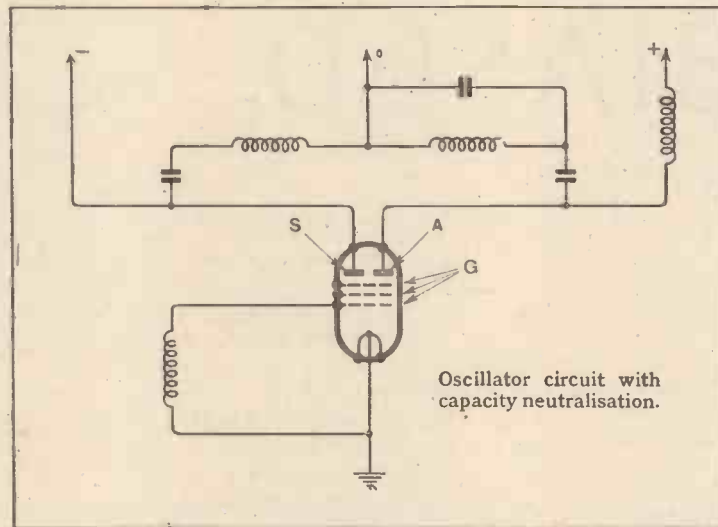

The transformer TV is designed to match the feeder impedance, i.e., 75 ohms at the vision carrier-frequency, but to present a low impedance to the sound carrier, thus tending to attenuate the latter. Similarly, the transformer TS is matched to the sound carrier-frequency, but presents low impedance to the vision carrier-frequencies. Under these conditions, sound signals will pass through the transformer TS at considerably higher amplitude than vision signals, whilst the reverse holds good at the transformer TV.

A. C. Cossor, Ltd.; L. H. Bedford; and R. Pollock. Application date July 6th, 1937. No. 498475.

INTER-ELECTRODE CAPACITIES

THE Figure shows a short-wave valve oscillator fitted with a special screening-grid designed to neutralise all inter-electrode capacity. The ordinary grids are

shown at G, the screening grid S being shown schematically in order to illustrate its symmetrical relation to the anode A. Actually the grid S and anode A are both formed as divided cylinders, parts of one cylinder being interspersed with parts of the other.

The grid S is negatively biased, so that it is not driven positive by any high-frequency potential to which it is subjected. Because of the symmetrical spacing of the electrodes, and of the coupling circuits shown, the capacity effect of the screening-grid S on the normal grids G (and cathode) of the valve is always equal and opposite to that of the anode A, so that the whole electrode system is effectively stabilised.

The British Thomson-Houston Co., Ltd. Convention date (Germany) September 5th, 1936. No. 498339.

MODULATING LIGHT SIGNALS

LIGHT signals to be modulated are projected on to the photoelectric cathode of an electron multiplier of the kind in which primary electrons are forced to impact against a series of target electrodes, so that the main stream is intensified by secondary emission. According to the invention the magnetic field which serves to control the path of the electrons is varied at the carrier frequency. The effect on the primary stream from the cathode is to shorten or

lengthen the curved path it takes towards the first target electrode.

The latter electrode is formed with an aperture, and when the curved path is at its shortest the primary stream passes completely through this aperture into a Faraday cage, so that the output current from the tube sinks to zero. On the other hand, when the curved path is longest the primary stream jumps completely over the aperture and so produces its full quota of secondary electrons, the output current then rising to a maximum.

Fernseh Akt. Convention date (Germany) July 10th, 1936. No. 498304.

TUNING CONTROLS

WHEN tuning a set fitted with a "magic eye" indicator, the operator usually brings the circuits roughly to the required setting by observing the station dial. He then shifts his attention to the visual indicator, and moves the control knob more or less blindly until the dark zone shrinks to its minimum width. He then knows that the circuits are accurately in resonance. But on a crowded part of the scale it is quite possible to make the final (or "magic-eye") adjustment on the wrong station, particularly if one fails to check up on the frequency or station indicator.

As shown on the Figure, the cathode ray tube C forming the "magic-eye" is so arranged that the axis about which the dark zone K expands and contracts is in line with the indicator needle N for the frequency or station-indicator scale, so that the operator can see, at a glance, not only when the circuits are accurately in resonance, but also the particular frequency,

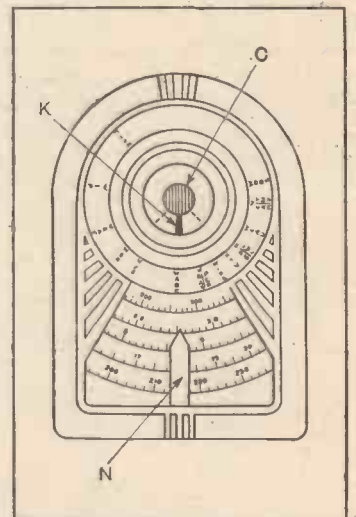

Tuning scale in which the "magic eye" acts as an indicator of frequency, wavelength or station name, in addition to showing exact resonance.

or station, to which they are in tune.

Marconi's Wireless Telegraph Co., Ltd. (Assignees of W. La. V. Carlson and J. E. Albright.) Convention date (U.S.A.) March 28th, 1936. No. 493056.

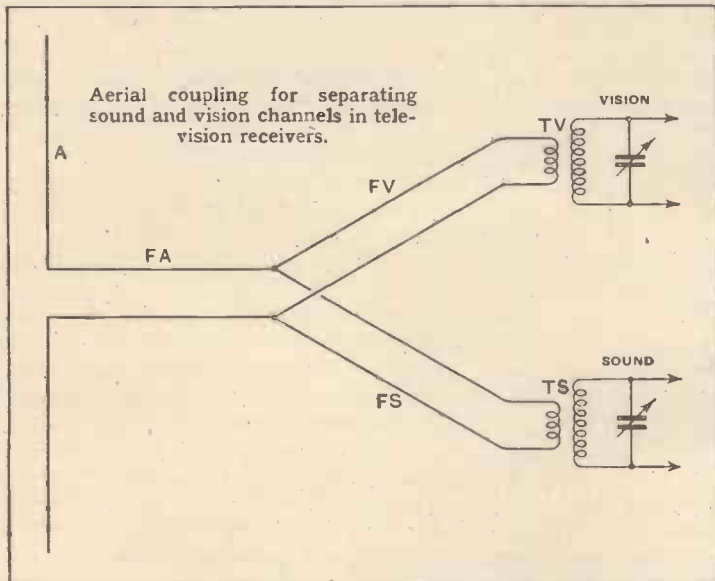

The British abstracts published here are prepared with the permission of the Controller of H.M. Stationery Office, from Specifications obtainable at the Patent Office, 25, Southampton Buildings, London, W.C.2, price 1/- each

CLASSIFIED ADVERTISEMENTS

NOTICES

THE CHARGE FOR ADVERTISEMENTS in these columns is

12 words or less, 3/- and 3d. for every additional word.

Each paragraph is charged separately and name and address must be counted.

SERIES DISCOUNTS are allowed to Trade Advertisers as follows on orders for consecutive insertions...

ADVERTISEMENTS for these columns are accepted up to FIRST POST ON MONDAY MORNING (previous to date of issue) at the Head Offices of "The Wireless World," Dorset House, Stamford Street, London, S.E.1.

Advertisements that arrive too late for a particular issue will automatically be inserted in the following issue unless accompanied by instructions to the contrary.

The proprietors retain the right to refuse or withdraw advertisements at their discretion.

Postal Orders and Cheques sent in payment for advertisements should be made payable to ILIFFE & SONS Ltd., and crossed.

All letters relating to advertisements should quote the number which is printed at the end of each advertisement and the date of the issue in which it appeared.

The proprietors are not responsible for clerical or printers' errors, although every care is taken to avoid mistakes.

ARMSTRONG

100% The "Wireless World" says "Full marks are due to the designer..."

NEW VARIABLE SELECTIVITY MODEL AW125PP 12-V. 5-BAND ALL-WAVE RADIOGRAM CHASSIS

(12-550 continuous, 1000-2000 m.) with R.F. Pre-Amplifier, 2 I.F. stages with Variable Selectivity. Manual R.F. gain control and 10 watts R.C. coupled Triode P.P. Output 17 Gns.



See Test Report, Jan. 5 issue.

DEMONSTRATIONS daily till 7.30 p.m. Saturdays till 5.30 p.m.

ARMSTRONG MANFG. CO. 100 ST. PANCRAS WAY, CAMDEN TOWN, N.W.1 Phone: GULiver 3105

ELECTRADIX

To Readers of "The Wireless World."

Those who have read the various wireless journals during the last fifteen years and have noticed our regular advertisements during that time, include thousands of satisfied customers.

To those more recent readers we wish to point out that the selection of items advertised weekly are not obtainable elsewhere and are only a very small portion of the goods we have in stock.

The First Edition of our 1939 Big Buff Illustrated 15-page List went so fast that we have another edition (No. 48) now in print.

Whatever you want it may save you pounds to send a stamped envelope for a copy at once.

HOME SOUND RECORDING AS AN AID TO LEARNING MORSE.

THE FEIGH RECORDER fits any Radiogram, positive drive, worm gear and rack. Complete ready for use, only 37/6. Super Feigh Fidelity Set, 42/6. Tracking Gear only, 21/-. Blank Discs only, 3/3 per dozen. Pre-amplifiers for Recording Mikes, 1-valve Battery Model in cabinet, 25/-. A.C. Mains pre-amplifiers with valve rectifier, steel-cased model, 60/-.

ELECTRIC LIGHT, 1,000 Porcelain Ceiling

Roses with Basic Junction Connectors, 3/- doz.

KEEP YOUR BATTERY FULL!!

RADIO AND CAR CHARGERS. The A.C. NITNDAY will keep your battery fit without attention. Model N/A6, 100/250 volts A.C. and D.C. 6/8 volts 1 amp., 15/-. Model N/B6, 100/250 volts to D.C. 6/8 volts 1 amp., 25/-. Model N/C6, 100/250 volts to D.C. 6/8 volts 2 amps., 35/-. Model N/D12, 100/250 volts to 12 volts 1 amp., 32/-. Ditto, 12 volts 2 amps., with 6-volt tap, 55/-. 5 amps. 44/10/-.

TAPPER KEYS for Morse or Signal Transmission. R.A.F. Key K8S1, massive balanced brass pivot bar, spring mounted tungsten contacts.

On polished wood base with lamp sockets, 7/6. Walter's H.T. key. All bakelite with cover, 10-amp. contacts, 10/6. Brown's car patrol double-acting, cast aluminium-cased. Keys, finest ever made, 21/-. Maremont type ship keys, 25/-. 3-point triple switch box with master key for signals on either circuit, 4/6.

PARCELS of experimental coils, magnets, wire, chokes, mikes, condensers, switches, terminals, etc., post free, 10 lbs. 7/-; 7 lbs., 5/-; 1,000 other Bargains in New Sale List "W."

ELECTRADIX RADIOS 218, UPPER THAMES ST., E.C.4

Phone: Central 4611

NUMBERED ADDRESSES

For the convenience of private advertisers, letters may be addressed to numbers at "The Wireless World" Office. When this is desired, the sum of 6d. to defray the cost of registration and to cover postage on replies must be added to the advertisement charge...

DEPOSIT SYSTEM

Readers who hesitate to send money to advertisers in these columns may deal in perfect safety by availing themselves of our Deposit System. If the money be deposited with "The Wireless World," both parties are advised of its receipt.

The time allowed for decision is three days, counting from receipt of goods, after which period, if buyer decides not to retain goods, they must be returned to sender. If a sale is effected, buyer instructs us to remit amount to seller, but if not, seller instructs us to return amount to depositor.

SPECIAL NOTE.—Readers who reply to advertisements and receive no answer to their enquiries are requested to regard the silence as an indication that the goods advertised have already been disposed of.

NEW RECEIVERS AND AMPLIFIERS

R.C. TELEPHONE: Holborn 4631.

RADIO CLEARANCE, Ltd., 63, High Holborn, W.C.1, by offering brand new receivers, maintain their reputation as the leading Mail Order House for surplus radios.

BRITISH Belmont 8-valve Plus Magic Eye All-wave A.C. Superhet Chassis, 4 wave bands, 2 short medium and long, fitted latest Mullard octal base American type valves. Brief specification: Short wave 6-18 metres (covers television sound), short wave 2-18.50 metres, medium band 200-550 metres, long 900-2,000 metres; valve combination 6K7 Pre H.F., 6J7 oscillator, 6J7 mixer, 6K7 I.F., 6Q7 (DDT) detection, A.V.C. and first L.F., two 6F6s, parallel output, 5Y3 rectifier, plus 6G5 Magic Eye visual tuning, handsome dial, station names etched on glass, controls 2-speed tuning, volume and on-off, combined variable tone control and selectivity switch, wave change plus gramo. switch; size of chassis 13 1/2 in. x 10 in. x 3 in.; supplied complete with valves, escutcheon, knobs, but less speaker, 25/19/6 each; complete receiver in handsome walnut cabinet, details as above, complete with speaker, 27/7.

DECCA 6-valve 3-waveband Battery Chassis, fitted complete with Mazda and Osram valves, QPP output; these chassis give a sparkling performance on all wavebands, and are the product of a well known manufacturer, complete with valves, 23/3 each; complete receiver in handsome walnut cabinet, details as above, complete with speaker, 23/19/6 each.

LISSEN 5-valve Plus Magic Eye All Wave A.C. Superhet, three separate scales, operated by wave-change switch; fitted in magnificent walnut table cabinet, triode output, fitted ring valves throughout, brand new in carton; our price, 25/19/6.

LISSEN 5-valve All Wave A.C. Superhet, fitted in upright walnut table cabinet, brand new in carton; 25/5.

LISSEN 4-valve 2 Wave A.C. Superhet, fitted in modern oblong type walnut cabinet, brand new, in carton; 24/4.

LISSEN 5-valve All Wave Battery Superhet, Class B output, fitted in handsome walnut table cabinet, complete but less batteries, brand new in carton; 23/17/6.

LISSEN 4-valve All Wave Battery Superhet, as above, but pentode output; 23/15.

ALL the Above Fitted Ring Valves Throughout.

SEE Our Advertisement under Components.

RADIO CLEARANCE, Ltd., 63, High Holborn, W.C.1. Telephone: Holborn 4631. [8380]

NEW RECEIVERS AND AMPLIFIERS

*

*

DEGALLIER'S "Challenger, Radio Corporation"

SEND 2d. Stamp for Handsome Illustrated Catalogues Telling of our Superb Range of Receivers; direct public sales policy (saves you 40%), most exceptional value on the market, from a T.R.F. Midget at 23/5 to a 19-valve general purpose receiver, 6 bands, with two P.A. speakers, at 30 gns.; 6-page brochure of Wireless World report on this set is available; car radio; any known American valve, all 5/6 each; if interested ask for particulars of American samples at less than cost; even samples covered by usual guarantee.

DEGALLIER'S, 31, Craven Terrace, London, W.2. Paddington 6492. Nearest point: Lancaster Gate Tube Station. [8382]

ARMSTRONG Amplifiers.

ARMSTRONG 6- and 12-watt High Fidelity Amplifiers.

ARMSTRONG Local Station Feeder Units.

ARMSTRONG Special Equipment for Schools, institutes, etc.

ARMSTRONGS Will be Pleased to Forward Details of the Above Standard Equipment on Request and/or to Quote for the Manufacture of Apparatus for Special Purposes.

ARMSTRONG Co., 100, St. Pancras Way, Camden Town, N.W.1. [8374]

RADIOGRAPHIC (SERVICE) Co.

POWER Packs.—Chassis drilled ready for six tube sockets, etc., complete with transformer, condenser, rectifier, etc.; ideal for power units, amplifiers, etc.

325 Volts, 60-70 mlls., 6.3 volts, 2 1/2 amps., 19/6.

370 Volts, 90-100 mlls., 6.3 volts, 4 amps., 22/6.

400 Volts, 200 mlls., 6.3 volts, 5 amps., 31/6.

RADIOGRAPHIC (SERVICE) Co., 117, Station Rd., E.4. Silverthorn 3512. [8363]

RECEIVERS AND AMPLIFIERS CLEARANCE, SURPLUS, ETC.

HALLICRAFTERS Sky Chief Communication Receiver, brand new, list 25/4; unrepeatable opportunity, 12/-—Bray, 763c, Finchley Rd., N.W.11. Speedwell 9633. [8349]

BANKRUPT Bargains.—Brand new 1938 radio sets in makers' cartons with guarantees, at less than half retail prices; send 1d. stamp for list bargains.—261-3, Lichfield Rd., Aston, Birmingham. [8275]

**USED SETS FOR SALE
EXCHANGE OR WANTED**

WANTED, communications set or powerful all-wave chassis.—Blakeborough, "Harcourt," Healing, Lincolnshire. [8360]

CAR RADIO

CROSLEY Push-button 1939 10 guinea Models, 5½ gns.; aerials, overheads, police type, etc., from 2/6; trade enquiries solicited.—Shippers, 18, Corporation St., Manchester. [0622]

FINEST American Twin Running-board Aerials, completely rubber covered, maximum signal pick-up, minimum noise, easy mounting, now only 17/6 pair complete; handsome chromium roof aerials, to mount straight or "vee", complete, 15/-. Immediate despatch, carriage paid; cash with order or c.o.d.

WIRELESS SUPPLIES UNLIMITED, Essex House, Stratford, E.15. Maryland 3191. [0577]

PUBLIC ADDRESS

VORTEXION P.A. Equipment, Imitated, but unequalled.

WE Invite You to a Demonstration.

A.C.-D.C. Dance Band Amplifier, 10 watts output, complete in case, with moving coil microphone, speaker and cables, weight 22lb.; 12 gns.

A.C.-20 15-20-watt Amplifier, 30-18,000 cycles, independent mike and gram, inputs and controls, 0.037 volts required to full load, output for 4, 7.5, and 15 ohm speakers or to specification, inaudible hum level; ready for use; 8½ gns., complete.

C.P. 20, 12-volt battery and A.C. mains model, as used by R.A.F., output as above; 12 gns.

A.C. 20, in portable case, with Collaro motor, Piezo pick-up, etc., £14; C.P. 20 ditto, £17/17.

50-WATT Output 6L6s, under 60-watt conditions, with negative feed back, separate rectifiers for anode screen and bias, with better than 4% regulation, level response, 20-25,000 cycles, excellent driver, driver transformer and output transformer matching 2-30 ohms impedance electronic mixing for mike and pick-up, with tone control, complete with valves and plugs; £15.

COMPLETE in Case, with turntable B.T.H. Piezo pick-up and shielded microphone transformer, £20.

80-WATT Model, with negative feed back; £25, complete.

120-WATT Model, with negative feed back; £40, complete.

250-VOLT 250 m.a. Full Wave Speaker, field supply unit; 25/-, with valve.

ALL P.A. Accessories in Stock; trade supplied.

VORTEXION Ltd., 182, The Broadway, Wimbledon, S.W.19. "Phone: Lib. 2814. [8241]

AMPLIFYING Equipment, P.A. vans for sale or hire. Booklet on request.—Alexander Black, Ltd., 55, Ebury St., S.W.1. Sloane 6129. [0599]

QUALITY Amplifiers and Microphone Equipments for Hire or Permanent Installation.—Harmony House, 116, Cambridge Rd., Southport. [8307]

PUBLIC Address Contractors Can Hire P.A. Vans, loud-speakers, microphones and equipments of all types from Hire Dept., Gramplan Reproducers, Ltd., Kew Gardens, Surrey. Tel.: Richmond 1175-6-7. [0618]

"P.S.I." Brand New A.C./D.C. Dance Band Amplifiers, completely portable, 8-10 watts output, 5 valves, pre stage for piezo, tone control with Celestion 10in. P.M. speakers, moving coil microphone, and folding heavily plated stand, 10½ gns., with piezo microphone, 12½ gns.; De Luxe model (2 speakers), 14½ gns.; above guaranteed 12 months.

PIEZO Microphones (hand type), brand new, cost £6/10, 55/- each; M.C. microphones, 35/-; microphone stands, heavily chromium plated, 25/-.—Packard Sound Industries, 39, Lisle St., W.C.2. Ger. 2817. [8379]

NEW MAINS EQUIPMENT

VORTEXION Supply G.P.O., B.B.C., L.P.T.B. Why not you?

ALL Models Super Shrouded, primaries screened and tapped, 200-250v., filaments C.T.

ANY Model Fitted 5v. or 6.3v. Filaments if Required.

500-0-500 150 m.a., 4v. 4a., 2.5a., 4v. 2a., 4v. 2a., 4v. 2a., 35/-; 400 or 350v., same price.

500-0-500 120 m.a., 4v. 4a., 4v. 2.5a., 4v. 1.2a., 4v. 1.2a., 28/-; 400v. or 450v., same price.

425-0-425 150 m.a., 4v. 8-10a., 4v. 2.5a., 4v. 1a., 4v. 1a., 32/-.

350-0-350 120 m.a., 4v. 4a., 4v. 2.5a., 4v. 1.2a., 21/-; with extra 4v. 6a., 25/-.

350-0-350v. 75 m.a., 4v. 2.4a., 4v. 1.2a.; 18/-.

250-0-250v. 60 m.a., 4v. 2.4a., 4v. 1.2a.; 15/-.

AUTO Transformers, 100-120 to 200-240v., 80 watts, 11/-; 120 watts, 14/6; 200 watts, 21/-; 250 watts, 25/-; 300 watts, 28/-; 500 watts, 47/6.

W.W. Q.A. Output Transformer; 21/-.

MICROPHONE Transformers, in heavy magnetic shielding; 12/6.

CHOKES—30h. 60 m.a., 7/6; 7-13h. 120 m.a., 12/6; 30h. 150 m.a., 15/-; 25h. 150 m.a., 21/-.

TRANSFORMERS and Chokes to Any Specification.

CAR Battery Charger, 6 and 12v., 1½ to 2 amperes; 30/- complete.

VORTEXION Ltd., 182, The Broadway, Wimbledon, London, S.W.19. Telephone: Liberty 2814. [8377]

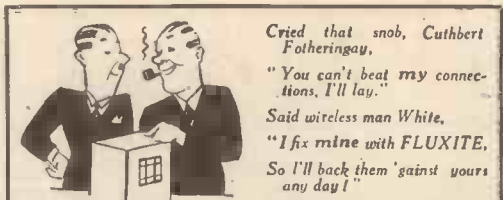

Cried that snob, Cuthbert Fotheringay,
"You can't beat my connections, I'll lay."
Said wireless man White,
"I fix mine with FLUXITE,
So I'll back them 'gainst yours any day!"

See that FLUXITE is always by you—in the house—garage—workshop—wherever speedy soldering is needed. Used for 30 years in Government works and by leading engineers and manufacturers. Of Ironmongers—in tins, 4d., 8d., 1/4 and 2/8. Ask to see the FLUXITE SMALL-SPACE SOLDERING SET—compact but substantial—Complete with full instructions, 7/6. Write for Free Book on the art of "SOFT" SOLDERING—and ask for leaflet on CASE-HARDENING STEEL and TEMPERING TOOLS with FLUXITE.

TO CYCLISTS! Your wheels will NOT keep round and true unless the spokes are tied with fine wire at the crossings AND SOLDERED. This makes a much stronger wheel. It's simple—with FLUXITE—but IMPORTANT

THE FLUXITE GUN

is always ready to put Fluxite on the soldering job instantly. A little pressure places the right quantity on the right spot and one charging lasts for ages. Price 1/6 or filled 2/6.



ALL MECHANICS WILL HAVE
FLUXITE
IT SIMPLIFIES ALL SOLDERING
FLUXITE LTD., Dept. W.W., DRAGON WORKS, BERMONDSEY ST., SE.1

DIRECT SOUND RECORDING

PYRAL AND NEOCIRE ACETATE DISCS

can now be obtained from the suppliers of the well-known

"Simplat" Blanks, Apparatus and Accessories
PYRAL DISCS from 8d. upwards

V. G. MANUFACTURING CO. LTD.
GORST ROAD, LONDON, N.W.10
"Phone: WILLESDEN 1632/3

Pamphonic AMPLIFIERS

Pamphonic Reproducers Ltd. (Associated with PYE Ltd.)
45, St. Pancras Way, London, N.W.1.
"Phone: EUSTon 1727.

CABINETS

ACOUSTICALLY DESIGNED.

We specialise in manufacturing Radio and Radiogram Cabinets to customers' requirements. Special Sketches FREE OF CHARGE. Send 1½d. in stamps for details of Standard Models. Demonstrations arranged by appointment.

LOCK WOOD & CO. 65, Lowlands E.L., Harrow, Mdx. "Phone: BYEon 1918, Ext. 1.

EPOCH LOUDSPEAKERS

GIVE FIDELITY IN REPRODUCTION
RELIABILITY IN LONG SERVICE

HALFORD DISTRIBUTORS LTD.,
31, George Street, Hanover Square, W.1.

NEW MAINS EQUIPMENT

MAINS Transformers.—All primaries 215-230-250 volts.
R-G.7.—325 volts, 60-70 mills., 6.3 volts, 2½ amps., 5 volts, 2 amps., 10/6.
R-G.53.—370 volts, 90-100 mills., 6.3 volts, 4 amps.; 5 volts, 2 amps., 12/6.
R-G.200.—400 volts, 200 mills., 6.3 volts, 5 amps., 5 volts, 3 amps., 26/-.
R-G.250.—500 volts, 250 mills., 26/-.
AUTO. Trans.—110v. to 215-250, 100 watts; 10/-.
CHOKES.—20h. 200 ohms, 100 mills.; 12/-.
RADIOGRAPHIC (SERVICE) Co., 117, Station Rd., E.4. Silverthorn 3512. [8364]

CABINETS

A CABINET for Every Radio Purpose.
CONVERT Your Set into a Radiogram at Minimum Cost; surplus cabinets from noted makers under cost of manufacture (undrilled); 30/- upwards; motors at wholesale prices.
FIT-A-GRAM" Cabinet, 31x17x15; 21/-.
UDRILLED Table Console and Loud-speaker Cabinets, from 3/6.
INSPECTION Invited; photos loaned to country customers.
H. L. SMITH and Co., Ltd., 289, Edgware Rd., W.2. Tel.: Pad. 5891. [0485]
BRAND New Radiogram Cabinets (undrilled), 55/-; worth 10 gns.; also magnificent television cabinets, new, 35/-.—Particulars, Haines and Son, 23, Denmark St., W.C.2. Telem. 5900. [8353]

DYNAMOS, MOTORS, ETC.

DC.—A.C. Convertors, motors, all voltages, for sale and wanted.—Easco, 18w, Brixton Rd., S.W.9. [0558]
ALL Types of Rotary Convertors, electric motors, battery chargers, petrol electric generator sets, etc., in stock, new and second-hand.
A.C.-D.C. Conversion Units for Operating D.C. Receivers from A.C. Mains, 100 watts output, £2/10; 150 watts output, £3/10.
WARD, 46, Farringdon St., London, E.C.4. Tel.: Holborn 9703. [0518]
ELECTRADIX Rotary Convertors for A.C. Radios on D.C. mains; alternators 50 to 500 cycles; mains motors and motor-generators for 1 to 600 cells; petrol engines and switchgear.—218, Upper Thames St., London, E.C.4. [0619]

RECORDING EQUIPMENT

ALL Recording Discs and Materials in Stock; tracker units, £4/7/6; recording motors, £3/17/6.—Write for further details, Will Day, Ltd., 19, Lisle St., W.C.2. [0595]
LIVERPOOL Sound Studios, 83a, Bold St., Liverpool.—Personal recordings from 3/6; amplifiers, microphones, recording motors and trackers, blank discs, etc. [8300]

NEW LOUD-SPEAKERS

SINCLAIR Speakers for all types.—Alma Grove, Copenhagen St., N.1. [0603]
BAKERS.—New corner horn speakers for realistic reproduction; leaflets free.—Bakers Selhurst Radio, South Croydon. [8369]

LOUD-SPEAKERS

SECOND-HAND, CLEARANCE, SURPLUS, ETC.
VAUXHALL.—Rola P.M. speakers, 8in., 14/9; 10in., 19/6; Rola energised 2,500, 10in., 17/6.
VAUXHALL UTILITIES, 163a, Strand, W.C.2. Over "Denny's," the booksellers. Send for free list. [8375]

BAKERS.—Famous super power speakers at half price; as solely specified for "Wireless World" Quality receiver.—Bakers Selhurst Radio, South Croydon. [8370]
ROLAS, for 6/11; G12's, 47/6; ½d. stamp for lists.—Shippers, 18, Corporation St., Manchester. [0606]
GOODMAN'S High Fidelity 12in. Auditorium Twin Diaphragm Chassis, £5, or offer; Rola G.12 P.M., 45/-, both new.—Wood, 46, Freeman St., Grimsby. [8357]
3,000 Speakers from 5/6 each, P.M. and energised 4in. to 14in., including several Epoch 18in.—Sinclair Speakers, Alma Grove, Copenhagen St., N.1. [0591]

LOUD-SPEAKER CONVERSIONS

BAKERS.—Triple cone conversions immensely improve reproduction from any speaker; price 29/6.—Bakers Selhurst Radio, South Croydon. [8371]

TELEVISION

H.M.V. Model 903, as new; £32.—Seen working at 22, Mayford Rd., Wandsworth Common, S.W.12. [8359]

TRANSMITTING APPARATUS

A.O.S. RADIO, specialists in short-wave apparatus, communication receivers, including Hallcrafters, National and R.M.E. transmitting equipment, valves and components.—Send for free catalogue to A.C.S. Radio, 16, Gray's Inn Rd., W.C.1. Holborn 9894-5. G2NK, Technical Manager. [0550]
G5NI—The oldest and largest distributors of amateur equipment, transmitting and receiving; short-wave catalogue, 1½d.; G5NI 70-page Manual, 7½d., post free; authorised direct distributors for Collins, National, R.M.E., Thordarson, Hammerlund, Biley, Taylor, Eimac, etc., etc.—44, Holloway Head, Birmingham. [0531]

VALVES

RADIOGRAPHIC (SERVICE) Co.

ALL Popular American Valves: 3/3 glass, 4/- octal; full stocks of KenRad and Raytheon, 4/- to 7/6.

WE Can Also Supply a Full Range of Guaranteed Replacement Valves for Any British, non-ring, American or Continental type at an appreciably lower price.

AMERICAN Valves, fully guaranteed, popular types, 2/9; glass octals, including, 6L6G, 6N7G, 3/6; 210, 4/6; send for lists.—John Myerscough, Sandy Rd., Liverpool, 21.

SPECIAL 3in. Cathode Ray Tubes, hand, vacuum green screen, 37/6; or with Agnadag coating, £2, guaranteed; every American valve in stock, of course; new valve manuals, 1/6.

AMERICAN Valves, first grade, by leading makers, guaranteed, popular types; standard base 5/6, octal base 6/6; 6L6G, 7/6.—General Radio Distributors, 309, Falloon Way, N.W.11.

2/9.—R.C.A. American valves, 50 popular types; also National Union, Hytron; also British non-ring valves; cheapest in Britain; 1/4d. stamp for revised lists.—Shippers, 18, Corporation St., Manchester

METROPOLITAN RADIO SERVICE.—Special offer: American valves, in makers' cartons, 3/- each; Octals, 3/6 each; American valves, first grade in all types; trade supplied.—1021, Finchley Rd., N.W.11. Speedwell 3000

METERS, ETC.

36 Range Avometer, with case; £5/10.—39, Avenue Gardens, Acton, W.3.

TEST EQUIPMENT

PHILCO Valve Tester (Made by Well Known Manufacturer), A.C. 200-250, complete with two panels and elaborate display stand, embodying three coloured lights for good, bad or weak valves, which work in conjunction with meter, listed £17/10; £8/5, carriage paid.

HENRYS, 72, Wellington Av., Stamford Hill, N.15. Phone: Stamford Hill 2907.

NEW COMPONENTS

RADIO Components, all makes in stock; complete range of Bulgin and Eddystone short wave parts; American valves specialists; all goods cash with orders; post free; established 20 years.—C. Nojés, 163, Shepherd's Bush Market, London, W.12.

COMPONENTS

SECOND-HAND, CLEARANCE, SURPLUS, ETC.

RADIO CLEARANCE, Ltd.

63, High Holborn, W.C.1. Holborn 4631.

ALL-WAVE Tuning Pack.

SIX Wavebands with pre-H.F. stage, product of a well known manufacturer; tuning range: Short wave 1 television sound; short wave 2, 1 1/2 to 25 metres; short wave 3, 25-50 metres; short wave 4, 50-100 metres; medium wave, 190-550 metres; long wave band, 900-2,000 metres; intermediate frequency of I.F. stage 465 k/c; valve combination: HF VP4B, frequency changer TH4 or TH4A, or alternatively direct equivalent; supplied as tuning pack, only less valves, I.F.s and gang; £1/19/6.

RADIO-HEART Tuning Unit, with pre-H.F. stage, 3 bands, supplied complete as follows: Radio-Heart tuning unit, dial and escutcheon, 2 pilot lamps, 2 variable selectivity I.F. transformers, one switch; Radio-heart tuning units are aligned at the factory while operating in an actual set circuit; as above but less valves (American types required); £1/17/6.

T.C.C. New Range of Compact Electrolytic Condensers, as follows:— T.C.C. 8 Mfd. Tubular Electrolytic, wire ends, 500 volt working, 600 volt surge; 1/6 each. T.C.C. 8 Mfd. Midget, wire ends, size 2 1/2in. x 1 1/2in., 500 volt working, 600 volt surge; 1/6 each. T.C.C. 8 plus 8 4-lead Midget Electrolytics, 500 volt working, 600 volt surge; 2/9 each. T.C.C. 1 Mfd. Tubular, wire ends; 1/- each.

T.C.C. Bias Condensers:—

- 50 Mid. 12 volt; 1/-
25 Mid. 25 volt; 1/-
25 Mid. 50 volt; 1/3.
50 Mid. 25 volt; 1/3.
50 Mid. 50 volt; 1/6.

FULL Wave Mercury Vapour Tube Rectifier Unit, type 4002-A.

THIS Rectifier is Suitable for Operating a Mains Driven D.C. Radio Set from A.C. Mains, output 200v. at 500 m.a., secondary is double tapped at 260-0-260 and 220-0-220 volts, the first for use on a 200-250v. 0.25-0.5 amp. D.C. radio set, and the latter for use on a 200-250 volts, 0.15-0.25 amp. D.C. radio set; comprises two 6 mid. condensers, and one 0.1 mid., tested for breakdown at 1,200 volts D.C., vacuum type thermal delay switch, plus electro-magnetic relay, complete with valve relay, but less rectifiers, overall dimensions 12 1/2in. x 9 3/4in. base x 5 1/2in. high; price 32/6 each.

RADIO CLEARANCE Bargains Continued in Third Column.

PREMIER 1939 RADIO

Premier Short-Wave Kits.

Complete to the last detail including all Valves and coils, as well as theoretical and wiring diagrams and lucid instructions for building and working. Each kit is supplied with a steel Chassis and Panel and uses plug-in coils to tune from 13 to 170 metres.

- 1 Valve Short-Wave Receiver or Adapter Kit ... 17/6
1 Valve Short-Wave Superhet Converter Kit ... 20/-
1 Valve Short-Wave A.C. Superhet Converter Kit 22/6
2 Valve Short-Wave Receiver Kit ... 25/-
3 Valve Short-Wave Screen Grid and Pentode Kit 53/6
PREMIER U.S.A. QUARTZ TRANSMITTING CRYSTALS. 7 mc Band, 10/- each, with Calibration Certificate. Enclosed holder and Base, 3/-.

Premier Mains Transformers.

Screened primaries 200-250 volts. Fully guaranteed. Wire end types.

- S.P. 351. 350-350 v. 150 m/A. 4 v. 1-2 a., 4 v. 2-3 a., 4 v. 4 a., all C.T., 13/-
S.P. 352. 350-350 v. 150 m/A. 5 v. 2 a., 6-3 v. 2 a., 6-3 v. 2 a., all C.T., 13/6.
The above can be supplied fitted with Panel and Terminals, at 1/6 extra.
S.P. 500. 500-500 v. 150 m/A., 15/-
S.P. 501. 500-500 v. 150 m/A. 4 v. 2-3 a., 4 v. 2-3 a., 4 v. 2-3 a. 4 v. 3-5 a., all C.T., 21/-
S.P. 503. 500-500 v. 200 m/A. 5 v. 3 a., 6.3 v. 3 a., 7.5 v. 3 a., or 2.5 v. 5 a., all C.T., 25/-
The above can be supplied fitted with Panels and Terminals, at 2/- extra. Details of complete range available. Special Transformers wound to order.

PREMIER S.W. H.F. Chokes, 10-100 metres, 9d. each. Pie-wound, 1/6 each. Screened, 1/6 each. SHORT-WAVE COILS, 4- and 6-pin types, 13-26, 22-47, 41-94, 78-170 metres, 1/9 each, with circuit. Special set of S.W. Coils, 14-150 metres, 4/- set, with circuit. Premier 3-band S.W. coil, 11-25, 10-43, 38-86 metres. Suitable any type circuit, 2/6. UTILITY Micro Cursor Dials, Direct and 100.1 Ratios, 3/9. PREMIER Short-Wave Condensers, all-brass construction, with Trolitul insulation. 15 mmf., 1/8; 25 mmf., 1/7; 40 mmf., 1/9; 100 mmf., 2/-; 160 mmf., 2/3; 250 mmf., 2/6. TROLITUL DOUBLE SPACED TRANSMITTING CONDENSERS. 15 mmf., 2/9; 40 mmf., 3/6; 160 mmf., 4/6. NEW TROLITUL SPLIT STATOR CONDENSERS, 50 x 50 mmf., 10/6. COIL FORMERS, 4- or 6-pin low-loss, 1/- each. AMERICAN VALVES. We hold the largest stocks of U.S.A. tubes in this country and are sole British Distributors for TRIAD High-grade American Valves. All types in stock. Standard types, 5/6 each. All the new Octal Base-tubes at 6/6 each, 210 and 250, 8/6 each.

EUROPA MAINS VALVES, 4 v. A.C. Types, A.C./H.L., A.C./L., A.C./S.G., A.C./V.M.S.G., A.C./H.P., A.C./V.H.P., A.C./P., and 1 watt D.H. Pentodes, all 4/6 each. A.C./Pens., I.H., 5/6; A.C./P.X.4, 6/6; Oct. Freq. Changers, 8/6; Double Diode Triodes, 7/6; Triode H. ex. Freq. Ch., 8/6; Tri. Grid Pen., 10/6; 24-watt D.H. Triode, 7/6. 350 v. and 500 v. F.W. Rect., 5/6. 13 v. 2 amps. Gen. Purpose Triodes; 5/6; H.F. Pens. and Var.-Mu. H.F. Pens., Double Diode Triodes, Oct. Freq. Changers, 7/6 each. Full-wave and Half-wave Rectifiers, 5/9 each.

Matchmaker Universal Modulation Transformers

Will match any modulator to any R.F. load. 50 watts, 17/6; 150 watts, 29/6; 300 watts, 49/6. MATCHMAKER UNIVERSAL OUTPUT TRANSFORMERS. Will match any output valves to any speaker impedance. 11 ratios from 13 : 1 to 80 : 1. 6-7 watts, 13/6; 10-15 watts, 17/6; 20-30 watts, 29/6. Send for full details.

PREMIER 1939 HIGH FIDELITY AMPLIFIERS

A NEW COMPLETE RANGE OF 7 HIGH FIDELITY P.A. AMPLIFIERS FOR A.C. OR A.C./D.C. MAINS OPERATION.

With the exception of the 3-watt models, all Premier Amplifiers incorporate the new Premier Matchmaker Output Transformer, enabling any single or combination of speakers to be used. 6-, 8/10-, and 15-watt systems are provided with two separate input channels which can be mixed to any level. The 30- and 60-watt systems have 3 input channels. The built-in Pre-Amplifiers ensure that the gain is sufficient for any low-level crystal or velocity microphone. The actual gain of the 6-, 15-, 30- and 60-watt amplifiers is over 100 decibels. Tone controls are also incorporated.

Table with 3 columns: Kit of Parts with Valves, Completely Wired and Tested, Price. Rows include 3-watt A.C. Amplifier (£2 0 0), 3-watt A.C./D.C. (£2 15 0), 6-watt A.C. (£5 5 0), 8-10-watt A.C./D.C. (£4 10 0), 15-watt A.C. (£5 15 0).

Black Crackle Steel Cabinet 15/- extra. Orders 5/- and over sent Post Free. Under 5/- please add 6d. Postage.

Have you had our 1939 Catalogue, Handbook and Valve Manual? 90 pages of Radio Bargains and Interesting Data. Price 6d.

ALL POST ORDERS TO: Jubilee Works, 167, Lower Clapton Road, London, E.5. Amherst 4723. CALLERS TO: Jubilee Works, or our NEW PREMISES, 165, FLEET STREET, E.C.4. Central 2833 or 50, High Street, Clapham, S.W.4. Macaulay 2381.

COMPONENTS—SECOND-HAND, CLEARANCE, SURPLUS, ETC.

RADIO CLEARANCE, Ltd., continuing bargains in components, etc.

WEARITE Mains Transformers, standard for the season and exclusive to us, made to strict electrical standards, wire end type, all windings centre tapped, screened primaries, tapped inputs, 200-250 volts, screw adjustment.

- TYPE R.C.1, 250-0-250, 80 m.a. 4 volts 2.5 amp., 4 volts 4.5 amp.; 9/6 each.
TYPE R.C.2, 350-0-350, 120 m.a. 4 volts 2.5 amp., 4 volts 5 amp.; 11/- each.
TYPE R.C.3, 350-0-350, 150 m.a. 4 volts 2.5 amp., 4 volts 2 amp., 4 volts 5 m.a.; 12/6 each.
R.C.4 500-0-500, 150 m.a., 4 volts 2 amp., 4 volts 2 amp., 4 volts 2.5 amp., 4 volts 5-6 amp.; 19/6 each.

TYPES R.C.1 and R.C.2 Drop Through Type, capped. TYPES R.C.3 and R.C.4 Upright Mounting Type, fully shrouded. WEARITE Auto Transformers, type R.C.5, fully shrouded; input 100-110 volts, output 200-250 volts, 100 watts; 12/- each.

CENTRALAB Volume Controls Available as Follows, with switch, long spindle. 1,000 5,000, 10,000, 25,000, 50,000, 100,000, 250,000, 500,000. Ohm Midget Energised Type Speakers, fitted Pentode transformer; 4/6 each. G.E.C. Relays, make and break type, 3,300 ohms; 4/- each. 100 Watt Auto Transformers, 100-250 volts reversible, wire end type; 5/11 each.

CRYSTAL Pick-up, high grade American, bronze finish complete with arm; £1/5 each. STANDARD Octal Base Valve Holders; 6d. each.

AMERICAN Valve Holders, best quality, 4, 5-, 6-, and 7-pin; 4d. each. CLIX 5-pin Chassis; 3d. each. CLIX 7-pin Chassis, 4d. each.

BULGIN S.P.S.T. Twist Switch; 9d. each. BULGIN D.P.D.T. Twist Switch; 1/- each.

T.C.C. Paper Tubular Condensers; all sizes up to 0.1/5d. each, 4/6 doz.; 0.25 ditto, 7d. each; 0.5, 16d. each.

POLAR N.S.F. 1 Watt Resistances; 3 1/2d. each, 3/- doz.; all sizes up to 2 meg. MAINS Smoothing Chokes, Wearite unshrouded, fitted wire ends.

30 HENRY 80 m.a., 500 ohms; 7/6 each. 40 HENRY 150 m.a., 500 ohms; 10/6 each.

AMERICAN Valves.—Complete range of Raytheon 1st Grade stocked; competitive prices consistent with quality; write for lists. HIGH Tension Unit Type 4001-A. THIS Rectifier is Suitable for Supplying H.T. Current to a Radio Receiver which already derives its high tension from the D.C. mains; as no smoothing is incorporated it is necessary to place the rectifier before the D.C. eliminator installed; output 250 volts at 40 m.a.; comprises 800 m.a. fuse, R.2 rectifier valve, 4 mid. condenser, 15,000 ohms resistance and mains transformer; the overall dimensions are 6in. x 8in. base x 5 1/2in. high; price 16/- each.

HUGE Purchase Lissen Valves, brand new, boxed, as follows:— H2 L2; 2/- each. BB 220A; 3/11 each. SGV, SG 215; 3/11 each.

FULL Wave Vacuum Tube Rectifier Unit, Type 4003A. THIS Rectifier is Suitable for Supplying D.C. to ALL Mains D.C. Radio Receiver of the type incorporating 0.1 amp. filament valves from A.C. mains, output 250 volts at 200 m.a., comprising two rectifying valves, condenser block, 40,000 ohms resistance and condensers and one 16 mid. overall dimensions 6in. x 8in. base x 5 1/2in. high; price 32/6 each.

ABOVE Units are Fitted in Attractive Metal Safety Cabinets. STANDARD Telephone Mains Transformer, Type 1, input 200-250 volt, output 250v. 40 m.a., 4 volt 2.5 amp.; 4/6 each. TYPE 2, input 200-250 volt, output 250 volt 200 m.a., 4 volt 2.5 amp.; 6/9 each. TYPE 3, input 200-250 volt, output 200 volt 500 m.a., 4 volt 4 amp.; 10/6 each. HELSEN 8 mid. Cardboard Electrolytics, 450 volt working, wire end; 1/- each. CONDENSER Block, four, 0.05 mid., metal cased, 500 volt working; 3/- each. TYPE 4 Smoothing Choke, 500 m.a. 100 ohms 12 henrys; 12/6 each. CONDENSER Block, two, 6 mid., 2.1 mid., metal cased, 500v. wkg.; 4/- each.

METAL Safety Case with Base and 2 Valve Holders, size 7 1/2 x 6in. x 5 1/2in.; 2/6 each; finished brown crackle. METAL Safety Case with Base and 2 Valve Holders, size 12 1/2in. x 8 3/4in. x 5 3/4in.; 3/6 each; finished brown crackle. ALL Orders Post Free; enquiries 11/4d. stamp if reply expected. Hours of business: Week-days, 9 a.m. to 7 p.m.; Saturdays, 9 a.m. to 1 p.m. Postal rates apply to the United Kingdom only, orders for Ireland and abroad must include sufficient postage to cover whatever the value of same.

RADIO CLEARANCE, Ltd., 63, High Holborn, W.C.1. Telephone: Holborn 4631.

COMPONENTS—SECOND-HAND, CLEARANCE, SURPLUS, ETC.

PREMIER SUPPLY STORES.

PLEASE See Our Displayed Advertisement on page 3. 10486

MAINS RADIO DEVELOPMENT COMPANY.

MAINS RADIO DEVELOPMENT COMPANY Offer Outstanding Value; carriage paid by return. Telephone: Tudor 4045. Call mornings. Stamp for List 225.

POLAR Midget Latest Type 3-gang Condensers, fully screened, trimmers standard 1/4in. spindle, 0.0005 mfd., with 110 k/c. tracker, also perfect as straight 2-gang; 2/6 only, smashing offer.

ERIE 1-watt, colour coded, unused resistors, any size 50 ohms to 5 megohm, your selection; 3d. each, 2/6 dozen; 2-watt, 6d.

CENTRALAB Latest Potentiometers, unused, long spindle, all sizes 5,000 ohms to 2 megohm, 2/-; with mains switch, 2/3.

TUBULAR Condensers, 400-volt working, wire ends, best make; 0.0001-0.05 mfd. 4d., 0.1 mfd. 4d., 0.25 mfd., 0.5 mfd. 6d.

TUBES.—First grade American valves, finest make, fully guaranteed, boxed, all popular types, 4/-; glass octal types, 4/6.

CLIX Unused Chassis Valve-holders, 5-, 7-, 9-pin, 3d. each; all American sizes, 6d.; best sleeving, 1 1/2d. yard.

T.C.C. Metal Can 8 mfd. 600-volt Peak Dry Electrolytics, 2/3; T.C.C. card 8 mfd., 600v. peak, 1/6.

FIFTY N.S.F. 1/2-, 1- and 2-watt Resistors, wire ends, marked and colour coded, 20 good sizes per parcel; 2/6 per 50 only.

MAINS RADIO DEVELOPMENT COMPANY, 4-6, Muswell Hill Rd., London, N.6. Tudor 4046. [8358]

ANNOUNCING Three Winners from Radiographic.

22/6—500-0-500 volt at 250 ma., H.T. transformer, a real husky job, weight 14lb., fully cast shrouded, 200-230-250.

10/6—100 ma. at 20 henry, smoothing choke, conservatively rated, fully shrouded, weight 7 1/2lb. approximately.

10/-—Power transformer, primary 200-230-250, secondaries 370-0-370 volts at 100 ma., 6.3 volts at 4 amp., 5v. at 2 amp.

RADIOGRAPHIC, Ltd., 66, Osborne St., Glasgow, C.1. [8350]

RYALLS RADIO, 280, High Holborn, London, W.C.1. Offer new goods, post free.

AMPLIFIERS, 13w. output, 3-stage, Triodes resistance and transformer coupled to push-pull Beam valves, matched to pair elliptical speakers, with U.S. valves and speakers; 52/6, input 200-250 A.C.

AMERICAN Type Mains Transformers, 350-350, 70 ma., 5v. and 6.3v., drop through pattern, input 200-250v., 6/6; few 110v. input; British made.

WEARITE 110 k.c. I.F.'s with Top Trimmers, 1/6 each; sets hand pass air core superhet coils ex Halcyon, screened chassis type, 4/9 set five; 110 kc. with coil details.

SATOR Volume Controls, 1/2 meg. with switch, 10.000 with switch, 5,000 with switch; 1/3 each, or 6/6 dozen; Centralab 11,000, less switch, 1/-, 6/6 dozen.

B.I. Electrolytics, 12x8x50, 350-12v., 1/3 each or 7/6 dozen; B.I. 20x20x25, at 400v.-25v., 1/3, or 8/- dozen; Plessey 30x8x2, 350v., 1/6, or 10/- dozen.

B.I. Tubular 4mf, 200v., 6d. each or 4/- dozen; B.I. C.05. 1/3 dozen; 7/9 gross; B.I. 0.25 mf. tubulars, 2/- dozen, 4/6 per three dozen.

SPEAKERS, pairs, brand new, elliptical cone speakers, made by first class firm, quality of reproduction outstanding, push-pull pentode transformer, fields 325 ohm for smoothing choke, 8,600 ohm bleeder, circuit available, handle 10-15w.: 14/- pair.—Ryalls Radio, see above. [8246]

VAUXHALL—Hivac valves, all types, new prices; full range of pick-ups from 11/-.

VAUXHALL—Collaro A.C. gramophone motors, boxed, 28/-; flat sheet aluminium, 12x12in., 3/-; 18x18in., 5/6.

VAUXHALL—Iron-cored coils, on base with switch, terminals, circuit; 2-gang, 11/3; 3-gang, 17/-.

VAUXHALL UTILITIES, 163a, Strand, W.C.2. Ask for free list; post paid 2/6 and over; c.o.d. 5/- minimum. [8376]

OLIVERS Offer: Aluminium chassis, 18 s.w.g., 16in x 10in x 3in., undrilled, new, 6/6; any size constructed to order.

DUBLIER Resistances, 3/4d. each; 1-watt, Polar 2-gang, 0.0005 mfd., 2/6; 3-gang, 3/-; brand new.

SEND for Lists.—Olivers, 676, Christchurch Rd., Boscombe, Hants. Enquiries invited. [8367]

GARRARD Record Changer, latest type, A.C.3, £4/10; Collaro Universal Gramotor, £1/10.—41, Glebe Ave., Kenton, Middlesex. [8361]

HANMARLUND Frequentite Trimmers; 2x250, 2x140, 2x100 mfd., 6d.; 30 mfd., 3d.; paxolin trimmers, 100 mfd., 30 mfd., 2d.

TUBULAR Condensers, good makes, Dublier, T.C.C., Hunts, Wego; 300-400 volts working, used, but guaranteed O.K.; 0.5 mfd., 4d.; 0.1, 0.05, 3d.; 0.02, 0.006, 0.001, 2d.; 0.02 and 0.006, 1/6 dozen.

BIAS Condensers, T.C.C., 25 mfd., 25 volts working, 4d.; insulated single screened wire, well insulated, 2d. per yard.

SATISFACTION Guaranteed; post paid over 2/6.—Brown and Welch, 371a, Green Lanes, Palmer's Green, London, N.13. [8378]

RESISTANCES!!!—Parcel of 50, 1/2-watt to 2-watt, consisting of 20 useful values; 1/9 per 50 only.—Harrison and Co., 89, Great Portland St., London, W.1. Ian. 2471. [8362]

RADIOMART

GSNI (CHAM) LTD.

THE SHORT-WAVE SPECIALISTS

SPECIAL OFFER!!!

Fully shrouded Transformers by America's largest manufacturer. While they last.

Table listing various transformers and their prices, including AH 230 v. primary and fully impregnated, T28708-375/375 v. 150 m/A., G.3V8A. 2.5V5A. 5V3A., etc.

The following chokes are interleaved and impregnated.

Table listing chokes and their prices, including T7007-250 m/A., 135 ohms, 20-8 Hy., cadmium shrouded, T7007A-150 m/A., 250 ohms, 30-12 Hy., cadmium shrouded, etc.

HEAVY DUTY TRANSFORMER for models, bells, etc., 6 v. 3 a., 2/3. 4 mf., 1,500 v. test 500 v. wkg. oil filled condensers, 2/-.

HEAVY DUTY Malas Transformer, worth 45/-, 350-350, 150 m/A., 4 v. 2.5 a. CT, 4 v. 0 a. CT, 12/3; 300-300 v., 80 m/A., 4 v. 3 a. CT, 4 v. 2 a. CT, 6/6. Moving Coil Speech Transformers, 1/11.

GANG CONDENSERS with Airplane Dial, 8 and 80-1. Cost 35/-, few only, 4/11. Utility, 7/6. Microdials, 3/9.

W.B. Six PERMANENT MAGNET SPEAKERS AT ONE-THIRD COST-Extension Type (no Transformer), 8/11. Standard Type (with Transformer), 10/6. Energised 8", 1,200 ohms with Transformer, 6/11.

PUSHBACK Wire, 6 yds., 6d., heavy, 9d. Bead-cored Solder, 6ft. 6d.; Screened Flex, single, 6d. yd.; twin, 9d. yd. Assorted Solder Tags, 6d. packet. Humdimers, 6d. each.

Centralab pots, all sizes, 1/6; switched, 2/-; tubular glass fuses, 2d. Milliameters, 0-25 m.a., upwards, 5/9; Super, 6/9.

OUR NEW 86 PAGE MANUAL, packed full of valuable information. Post Free, 7/4.

THE NEW 86 PAGE CATALOGUE shows dozens of New Short-wave Components and is yours for 1/4d. post free.

VALVES.—A complete range of replacements showing a saving of over 50 per cent. Quotations on receipt of types required. Quantity Discounts to Service Engineers. TRADE enquiries for communication equipment solicited.

RADIOMART Telephone: MIDland 3254.

GSNI (Birmingham) Ltd., 44, HOLLOWAY HEAD, BIRMINGHAM

FOR ALL RADIO PURPOSES

You can obtain from us any of the well-known makes of Portable Sets on our very

CONVENIENT TERMS

Also The Wireless World

"STAND-BY THREE" KIT

(described March 30 and April 6)

A self-contained DRY (H.T. & L.T.) BATTERY PORTABLE. Essential in emergency and ideal for normal indoor and outdoor use.

KIT including drilled chassisless valves, speaker, cabinet and batteries 67/6

CABINET polished Oak with carrying handle 14/-

3 SPECIFIED VALVES - - - - - 27/-

H.T. and L.T. BATTERIES - - - - - 10/9

GOODMANS SPEAKER, as specified - - - 21/-

ARMSTRONG CHASSIS for Cash or on EASY TERMS. Details of full range upon request. Quotations by return of post.

The LONDON RADIO SUPPLY COMPANY 11, OAT LANE, NOBLE ST., E.C.2. Phone: NATional 6828.

ENGINEERS! ARE YOU EARNING LESS THAN £10 PER WEEK?

If so, you cannot afford to carry on without reading our 268-page Handbook. The book explains clearly and definitely many ways of carving out a successful career. Among other things it explains the Services of our unique Appointments Department; outlines Home-Study Courses in all branches of Civil, Mechanical, Electrical, Motor, Aero, Wireless, "Talkie" Engineering, Building, Govt. Employment, etc., and gives details of B.Sc., A.M.I.C.E., A.M.I.E.E., A.M.I.Mech.E., A.M.I.A.E., A.M.I.W.T., A.M.I.R.E., G.P.O., MATRIC., and all Exams. We Guarantee "NO PASS—NO FEE." Whether you be an old hand or a budding apprentice get this book to-day. FREE and POST FREE.

BRITISH INSTITUTE OF ENGINEERING TECHNOLOGY. 387, Shakespeare House, 17/19, Stratford Place, London, W.1.



Mains Transformers as specified for The Wireless World High Quality Communication Receiver Type WW51-45/-.

W. BRYAN SAVAGE LTD.

Westmorland Rd., London, N.W.9. Phone: Colindale 7131

COMPONENTS—SECOND-HAND, CLEARANCE, SURPLUS, ETC.

COLLARO A.C./D.C. Record-changers, 200-250, plays eight 10in. or 12in. records, mixed, also incorporates repeater and retractor; limited quantity, £5/5, in sealed cartons.

GARRARD A.C. Motors, Model A.C.4, enclosed type with automatic stop, 110-250 volts, 30/-, carr. pd., sealed cartons.

MARCONI K25 Pick-up, unused and boxed; 14/- HENRY'S, 72, Wellington Ave., Stamford Hill, N.15, Stamford Hill 2907. [8216]

SOUTHERN RADIOS Bargains.—Sale now proceeding of hundreds of bargain lines, goods previously advertised still available.—Southern Radio, 46, Lisle St., London, W.C.1. Gerrard 6653. [8236]

Wanted

WANTED, buzzers, Morse keys; state price.—Atlantic Wireless College, 1, Leeson Park, Dublin. [8355]

WE Buy for Cash All Types of Modern Second-hand Radio Sets and Accessories, test meters, parts, etc. We pay more than any other dealer. Part exchanges. Bring, send or will call.—University Radio, Ltd., 238, Euston Rd., London, N.W.1. Phone: Euston 3810. [8366]

SITUATIONS VACANT

AIR MINISTRY.

CIVILIAN Wireless Instructors Required.

VACANCIES Exist for Civilian Wireless Instructors at the Electrical and Wireless School, Royal Air Force, Cranwell, Lincs. The commencing rate of pay is £4 a week inclusive which may be increased to £4 5s. a week after a short period of satisfactory service. Candidates must be capable of lecturing and must have a sound knowledge of electrical principles and their application to radio and low-power electrical engineering. Applications should be addressed to the Commanding Officer, Electrical and Wireless School, Cranwell, Lincs, giving full particulars as to previous experience, age, etc. Candidates will be required to appear before a Selection Board at the School for interview and test. The test will include the giving of a lecture on any subject which may be chosen by the candidate, involving the principles of modern radio. Lecturing sequence and style are most important. [0571]

CROWN Agents for the Colonies.

COLONIAL Government Appointments.

APPLICATIONS from Qualified Candidates are Invited for the following Post:—

WIRELESS Engineer Required for the Posts and Telegraphs Department of Malaya for 3 years, with possible permanency; salary \$400 a month, rising by annual increments of \$25 a month to \$800 a month. (The Government rate of exchange is now 2/4 to the dollar.) A children's allowance is payable to married officers with children. Free passages and, if married, for wife and children, not exceeding four persons. Liberal leave on full salary. Candidates, aged 23-28, must have been definitely trained as electrical engineers for telecommunication work and have had not less than two years' experience in wireless work. They must be Associate Members or Graduates of the Institution of Electrical Engineers, or possess educational qualifications carrying exemption from the Graduateship examination. APPLY at once by letter, stating age, whether married or single, and full particulars of qualifications and experience and mentioning this paper to the Crown Agents for the Colonies, 4, Millbank, London, S.W.1. quoting M/8386. [8352]

COMMUNICATION Engineers.—Applications are invited for the following vacancies:—

(A) Senior Engineers, capable of undertaking original development work on thermionic instruments for communication and industrial use.

(B) Assistant Engineers, to participate in the above work, must have good theoretical knowledge and at least three years practical experience in communication engineering.

APPLICATIONS, with fullest particulars and salary required, to Instrument Department, E. K. Cole, Ltd., Ekco Works, Southend-on-Sea. [8347]

VACANCY for Development Engineer Able to Make Up and Test Experimental Broadcast Receivers.—Apply, stating age, experience, qualifications and salary required, to Box 9423, c/o The Wireless World. [8348]

TELEVISION and Radio Engineers Required by Leading Television Firm in South London.—Write, stating age, experience and salary required, to Box No. B.T.29853, c/o Knight's, 55, Chancery Lane, W.C.2. [8343]

ROYAL AIR FORCE.—Men of good education required for enlistment and training as wireless operators and armourers; age limits 17 1/2-35; write or call.—R.A.F. Recruiting Depot, Victory House, Kingsway, London, W.C.2, or any R.A.F. Recruiting Depot. [8311]

SERVICE Engineer-Salesman, thoroughly experienced retail service, sales, contact with customers and driving wanted by Murphy dealer as second engineer; salary £2/10 to £3 (according to experience).—Write Chattell, 40, High St., Dunstable, Bedfordshire. [8354]

VACANCY for two Apprentices; individual training given in construction latest types transmitters and receivers in approved Air Ministry organisation; small premium first year, commencing salary second year; excellent opportunity for right type of young men.—Apply Box 9299, c/o The Wireless World. [8303]

DRAUGHTSMAN Required by Large Electrical Engineering Firm in the Midlands, preferably with experience in design of short wave radio transmission equipment, or similar electrical apparatus.—Reply, with full particulars of age, education, experience and salary required, Box 9394, c/o The Wireless World. [8344]

A. C. COSSOL, Ltd., have had vacancies occur in their laboratories for one or two physicists experienced in the design of cathode ray tubes, fully qualified persons who have had actual commercial experience are required; applicants with production or academic experience only cannot be considered.—Reply by letter to CRO, Employment Office, Highbury Grove, N.5, giving full details of previous experience, salary required and stating when free. [8356]

WELBURN 12 WATT AMPLIFIER

Built on a single steel chassis and housed in heavy gauge dust-proof steel case, this general purpose high gain amplifier is completely enclosed and self-contained. It requires no pre-amplifier or accessories, excepting loud-speaker and microphone or pick-up.

BRIEF SPECIFICATION

Maximum Undistorted Output 12 watts; Required Input 0.008 v.; Overall Gain 116 dBs; Output Impedances 8 and 16 ohms.



STANDARD MODEL £14

Write for full details.

WELBURN RADIO LTD.
QUEENSWAY, TEAM VALLEY
GATESHEAD-ON-TYNE

THE INSTITUTE OF WIRELESS TECHNOLOGY

(Incorporated)

4, Vernon Place, Southampton Row, London, W.C.1.

OVERSEAS EXAMINATIONS

Overseas Candidates for the November Examinations must submit their applications to the Secretary not later than July 31st, 1939. FULL INFORMATION, WITH PARTICULARS OF MEMBERSHIP, MAY BE OBTAINED FROM THE SECRETARY.



Highly Polished Speaker Cabinet, 13" long, 10 1/2" high, 7 1/2" deep, with baffle.

5/- Carriage Paid.

Universal 3-Valve Battery Sets

with British Ring Valves Det. L.F. and Power, and W. B. P. M. Moving Coil Speaker. Walnut Cabinet, as illus. Real station getter fully Gtd. Carr. Paid 22/6.

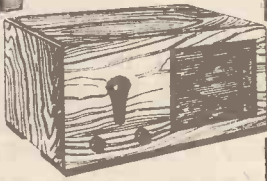

UNIVERSAL, 8 & 10, Brown Street, MANCHESTER, 2
*Phone: Deansgate 5009.

BRIGHTER PHOTOGRAPHY

By DAVID CHARLES, F.R.P.S.

The carefully arranged chapters cover the whole field from the choosing of a camera to developing and printing the finished picture. Details of the various photographic materials on the market are given, and there are important sections dealing with Focusing, Aiming the Camera, Photographic Groups, Lighting and Exposing.

In addition there are over one hundred and sixty illustrations, each numbered and each conveying a really useful hint.

Price 2/6 net. By post 2/9

ILIFFE & SONS, LTD.

Dorset House, Stamford Street, London, S.E.1

W.W.40

REPAIRS AND SERVICE

"SERVICE with a Smile."

AMERICAN Valves, spares, line-cords, rewinds; repairs of all types of American and British receivers.—F.R.I., Ltd., 22, Howland St., W.1. Museum 5675. [0434]

BAKERS.—Take advantage of 15 years' experience; send your next speaker repair, any make, to Bakers Selhurst Radio, South Croydon. [8372]

LOUND-SPEAKER Repairs, British, American, any make, 24-hours service; moderate prices.—Sinclair Speakers, Alma Grove, Copenhagen St., N.1. [0590]

GUARANTEED Repairs Any Transformers, choke, motor armature, converter, dynamo, etc.; keenest prices, immediate quotation, prompt dependable service.—See below.

LT.P. (LONDON TRANSFORMER PRODUCTS, Ltd.), Willesden, N.W.10. Willesden 6486 (3 lines). [6802]

MAINS Transformer Service, Repairs, rewinds, or construction to specification of any type, competitive prices and prompt service.—Sturdy Electric Co., Dip-ton, Newcastle-on-Tyne. [0516]

METROPOLITAN RADIO SERVICE.—Guaranteed repairs to American and British receivers; American valves, service parts and rewinds; trade supplied.—1021, Finchley Rd., N.W.1. Speedwell 3000. [0435]

SCOTT-SESSIONS REPAIR SERVICE.—All types of receivers overhauled, rebuilt, repaired, including American communication sets, W.W. Monodials, AM-wave Super-Seven. Variable Selectivity IV., etc.

SCOTT-SESSIONS REPAIR SERVICE, popular for 15 years from Land's End to John-o-Groats; van collection London area; immediate, courteous and skilful attention to every instruction.

SCOTT-SESSIONS REPAIR SERVICE, Exchange Works, Muswell Hill, N.10. Tudor 4101-2. [7497]

EPOCH Speaker Replacements, cone assemblies supplied from 4/-; field coil and transformer rewinds; trade radio service.—National Radio Epoch Reproducers, 126, Elthorne Rd., N.19. Arc. 1319. [8368]

REPAIRS to Moving Coil Speakers a Speciality; cones and coils fitted, fields altered; prices, including eliminators, quoted; loud speakers, 4/-; L.F. and output transformers, 4/-, post free; guaranteed satisfaction; trade invited, estimates free; prompt service.—Loud-Speaker Repair Works, 5, Balham Grove, London. Battersea 1321. [0394]

MISCELLANEOUS

CHEAP Printing.—1,000 billheads, 3/6; sample free.—Creteway Press, 18, Buxted, Sussex. [8180]

GP.O. Engineering Dept. (no experience required); commencing £3 15s. per week; age 18-23; excellent prospects; free details of entrance exam. from: B.I.E.T. (Dept. 574), 17-19, Stratford Place, London, W.1. [8309]

EVERY Radio Dealer Who is Not a Regular Reader of "The Wireless and Electrical Trader" should send his trade card at once for a specimen copy and full details of the "Trader" Services. "The Wireless and Electrical Trader" has the widest influence, the largest weekly circulation, and is read by all the leading manufacturers and traders. Trade only, 15/- per annum, post free.—Published at Dorset House, Stamford St., London, S.E.1. [0614]

EXTENDED, PAYMENTS

LONDON RADIO SUPPLY Co. (Established 1925) Supply, on convenient terms, components, accessories and sets, any make; 10% down; balance over 12 months; send for list of requirements.—11, Oat Lane, London, E.C.2. [0337]

PATENTS

PRACTICAL Hints on Patents, free on application.—The Imperial Patent Service, First Avenue House, High Holborn, W.C.1. Preliminary consultation free. [0481]

TUITION

RADIO Training.—P.M.G. exams. and I.E.E. Diploma; prospectus free.—Technical College, Hull. [0611]

WIRELESS.—Complete training, Marine, Broadcast and Television. Posts waiting. Mod. fees. Boarders taken. Approved college, prosp.—W. London Radio College, Grove Park Rd., London, W.4. (Chi. 3244.) [0580]

BUSINESSES AND PROPERTY FOR SALE, TO BE LET, OR WANTED

"THE Wireless and Electrical Trader" is an essential part of the equipment of every Wireless Trader; its pages reflect the very latest turn of trade events, and it is read by all the leading dealers and manufacturers, for particulars of businesses offered or wanted. By subscription to the trade only, 15/- per annum, post free.—Send your trade card for specimen copy to Dorset House, Stamford St., London, S.E.1. [0614]

BOOKS, INSTRUCTION, ETC.

AMERICAN Valve Data.—The new 200-page Raytheon Valve Data Book gives full characteristics and applications of all types of American valves; invaluable to all servicemen; post free 2/3; abroad 3/-.—Leonard Heys, 36, Henry St., Blackpool. [0594]

ELEMENTARY Principles of Wireless Telegraphy and Telephony. By R. D. Banguay. Revised by O. F. Brown, B.Sc. Third edition (1930). The standard textbook for wireless students and beginners. Deals with the whole subject of wireless telegraphy and telephony, avoiding too technical a treatment of the problems involved. Well illustrated. Price 7/6 net. By post 8/-, from Iliffe and Sons, Ltd., Dorset House, Stamford St., London, S.E.1.

The NEW "R.F. 41" HARTLEY TURNER: ITS WELCOME EXCEEDS ALL EXPECTATIONS!



Receiving Unit for use in conjunction with an L.F. Amplifier. 12" x 10" x 8" overall.

Briefly:—4-valve superhet, 5 wavebands: (1) 6 to 10m.; (2) 12.5 to 51m.; (3) 65 to 230m.; (4) 200 to 550m.; (5) 900 to 2,100m. A pentode R.F. operates on all bands except No. 1. Triode-hexode frequency changer. Single pentode I.F. amplifier, two variable band-width transformers giving three degrees of selectivity. Variable IF gain. Linear diode signal and A.V.C. rectification. Proportionate application of A.V.C. bias to R.F. and I.F. stages provides good signal-to-noise ratio and signal-handling capacity. One triode stage of L.F. amplification. Volume and tone controls. Provision for pick-up. Walnut control panel. Flood-lit glass dial, calibrated in metres and station names. Reverse vernier slow-motion tuning control. Calibrated magic eye tuning indicator. 18 SWG cadmium plated steel chassis, robust construction. Price including valves and coupling leads, £11.5.0. Full specification on request. Write now.

HARTLEY TURNER
RADIO & TELEVISION

THE HARTLEY TURNER RADIO COMPANY
92 Queensway, London, W.2. Tel.: Bayswater 1102

INDEX TO ADVERTISEMENTS

	PAGE
Air Ministry	
Air Service Training Ltd.	
Ambassador Radio Works	
Armstrong Manufacturing Co.	1
Automatic Coil Winder Co., Ltd.	
Inside Front Cover	
Belling & Lee, Ltd.	6
Birmingham Radiomart G5N1	4
British Centralab, Ltd.	
British Institute of Engineering Technology	4
British Insulated Cables, Ltd.	
Inside Back Cover	
British McMurdo Silver Co., Ltd., The ...	
Cosmocord, Ltd.	
Edison Swan Electric Co., Ltd. ... Back Cover	
Electradix Radios	1
Fluxite, Ltd.	2
General Electric Co., Ltd.	
Gramphon Reproducers	6
Halford Radio	2
Hartley Turner Radio, Ltd.	5
Haynes Radio	
Institute of Wireless Technology	5
International Correspondence Schools	
Jackson Bros. (London), Ltd.	
Lockwood & Co.	2
London Radio Supply Co.	4
Pamphonic Reproducers, Ltd.	2
Partridge, N.	
Player's Cigarettes	Inside Back Cover
Premier Supply Stores	3
Savage, W. Bryan, Ltd.	4
Sound Sales, Ltd.	Inside Front Cover
Universal Electric	5
V.G. Manufacturing Co.	2
Voigt Patents, Ltd.	
Welburn Radio, Ltd.	5
Westinghouse Brake & Signal Co.	
Inside Back Cover	



This Cinderella of Radio . . .

SINCE the introduction of radio, the aerial has been taken for granted. Vast strides in set design have tended to reduce in people's minds the importance of an efficient installation and, frequently, listeners proudly claim that their set works on a few feet of wire—completely disregarding the signal-to-noise ratio. To-day, however, electrical interference has become an acute problem. The B.B.C. handbook on "Receiving Aerials and Electrical Interference" shows that most aerials are so poor that suppression of all interference at the source would be an extremely expensive business, whereas with good aerials, simple suppression at the source is ample. The remedy, therefore, lies largely in improving the aerial itself. Firstly, pure signals, must be received outside the static-ridden area surrounding present-day houses. Secondly, these signals must be completely protected from interference as they travel down to the set. This, briefly, is the principle of the Belling-Lee "SKYROD" aerial system. The vertical "SKYROD" rises 25 feet above the roof, and is connected to the receiver by a special shielded down-lead working in conjunction with two "Eliminoise" units. By this means, interference is reduced to insignificance, range increased and signal-to-noise greatly improved. Thousands of "SKYROD" installations have already been made, each one backed by a guarantee of money refunded if unsatisfactory, and letters have been received from delighted users all over the country. See your dealer to-day and ask him to demonstrate.

The BELLING-LEE SKYROD AERIAL SYSTEM

In four different mountings from £3.19.6 to £6.7.0 or on H.P. Terms from 1/3 weekly. Prices do not apply to Etre.

TRADE MARK, BEST DESIGN & PATENTS APPLIED FOR

BELLING & LEE LTD., Cambridge Arterial Road, Enfield, Middx.



7225

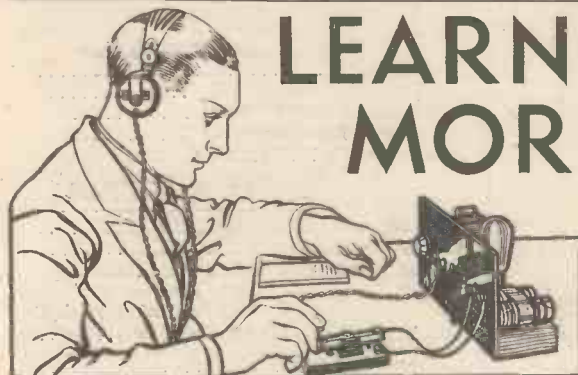

LEARNING MORSE

AN EASY METHOD OF MASTERING THE INTERNATIONAL SIGNAL CODE

Published from the Offices of **The Wireless World** ILIFFE & SONS LTD., Dorset House, Stamford St., London, S.E.1

6^D NET BY POST 7d.

THE WIRELESS ENGINEER

The Journal for Professional Engineers and Advanced Wireless Experimenters

Monthly 2/6 net. Annual Subscription 32/- post free.

ILIFFE & SONS LTD., Dorset House, Stamford St., London, S.E.1

W.W.2

1001

GRAMPIAN
REPRODUCERS LTD.

MEMORANDUM

From *Chief Research Engineer*
To *All Sound Engineers*
Date *20-4-39*

Experiments to reduce 'speaker echo' entirely successful. Results embodied in

GRAMPIAN 'JEKTA' DIFFUSER SPEAKER.

Freedom from echo and 'wind distortion' achieved by use of inverted wave front principle and even spread of high and low frequencies over an arc of approximately 160°. Bass response particularly good. Quality excellent. Frequency response extremely wide - equivalent to that obtained when using an open baffle of infinite area. Efficiency three times that of a baffle speaker. No back radiation. Feed back materially reduced.

Medium Model, handles continuous loading of 15 watts and peaks of 21 watts £10.
Senior Model, handles continuous loading of 30 watts and peaks of 42 watts £15.



GRAMPIAN
Reproducers Limited
KEW GARDENS, SURREY. Tel.: RICHMOND 1175/6/7

FOURTH EDITION Revised and Enlarged with 50 additional pages

WIRELESS SERVICING MANUAL

By **W. T. COCKING** (of "The Wireless World")

The most complete book of reference of its kind. A reliable practical guide for amateur and professional.

The present edition brings the material of the book up to date and includes an additional chapter on television receivers which is practically the only source of servicing information available on this subject.

Ganging, Automatic Volume Control, Instability, Distortion, Mains Hum, Whistles and Local Interference, all are separately treated.

Information on short-wave receivers, and on methods of operating extension loud speakers is included, as well as a special chapter on the Aerial-Earth System. The reference material, including base-connections for British, Continental and American valves and the various colour codes for components, has been extended and brought up to date.

BOUND IN CLOTH BOARDS
SIZE 7½ ins. x 5 ins.

5/- net. By post 5/5

Issued in conjunction with "THE WIRELESS WORLD" and published by the Proprietors:—

ILIFFE & SONS LTD., DORSET HOUSE, STAMFORD STREET, LONDON, S.E.1.

W.W. 20.

Printed in England for the Publishers, ILIFFE AND SONS LTD., Dorset House, Stamford Street, London, S.E.1, by The Cornwall Press Ltd., Paris Garden, Stamford Street, London, S.E.1. "The Wireless World" can be obtained abroad from the following: FRANCE: W. H. Smith & Son, 248, Rue Rivoli, Paris; Hachette et Cie, Réaumur, Paris, and branches; Messageries Dawson, 4, Rue de Faubourg Poissonniere, Paris. BELGIUM: W. H. Smith & Son, 74-75, Boulevard Adolphe Max, Brussels. AUSTRALIA: Gordon & Gotch, Ltd., Melbourne (Victoria), Sydney (N.S.W.), Brisbane (Queensland), Adelaide (S.A.), Perth (W.A.), and Launceston (Tasmania). NEW ZEALAND: Gordon & Gotch, Ltd., Wellington, Auckland, Christchurch and Dunedin. INDIA: A. H. Wheeler & Co., Bombay, Allahabad and Calcutta. CANADA: Imperial News Co., Toronto, Winnipeg and Vancouver; Benjamin News Co., Montreal; Gordon & Gotch, Ltd., Toronto. SOUTH AFRICA: Central News Agency, Ltd.; Wm. Dawson & Sons (S.A.), Ltd., Cape Town. UNITED STATES: The International News Co., New York.

TECHNICAL INFORMATION

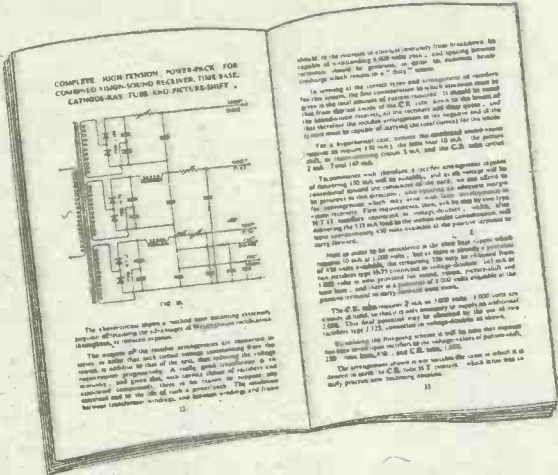

You need this book. It contains up-to-date information on rectifier problems and contains many circuits.

COUPON

Westinghouse Brake & Signal Co. Ltd., 82, York Way, King's Cross, London, N.1.

Please send me "The All Metal Way, 1939." I enclose 3d. in stamps.

NAME

ADDRESS

W.W. 20/4/39

B.I. CONDENSERS

for
RADIO & GENERAL USE

B.I. CONDENSERS for Radio Receivers, Battery Eliminators, Smoothing Circuits, etc., are made in several different types to suit the various uses for which Condensers are required in connection with Wireless circuits.

These Condensers are the result of 36 years' experience in the manufacture of all kinds of Condensers from the smallest sizes up to those weighing more than 2 tons.

In addition to the Standard Types, B.I. Condensers can be supplied in special forms to suit manufacturers' requirements.

The illustration shows Type 212 recommended for use with eliminators.



BRITISH INSULATED CABLES LTD.

Cable Makers and Electrical Engineers

PRESCOT, LANCS.

Telephone No.: PRESCOT 6571.

London Office: SURREY HOUSE, EMBANKMENT, W.C.2

Telephone No.: Temple Bar 7722

The ELECTRICAL REVIEW

The Complete Technical Journal

Practical articles on all aspects of electricity supply and utilisation — industrial, commercial and domestic. Latest news of the electrical industry and developments. Advertisement pages form a comprehensive buyers' guide.

Contents of April 21st Issue:—

ELECTRIFICATION IN SCOTLAND
Progress made in the sparsely populated Lothians area.

HIGH-VOLTAGE SWITCHGEAR
Fire risk reduced by employing little or no oil.

THE AUSTRALIAN MARKET
Survey by a man on the spot of the present situation.

IDEAL HOME EXHIBITION
Notes on the electrical equipment displayed at Earls Court.

NEWS AND COMMENTS

EVERY FRIDAY 6d. Subscriptions: United Kingdom £1 14 8
Canada £1 12 6 Other Countries
£2 1 6 per annum, post. free.

ELECTRICAL REVIEW LTD.

Dorset House, Stamford Street, London, S.E.1

*Player's
Please*

EVERYONE



MEDIUM OR MILD

**BOTH BLENDS ARE
CORK-TIPPED or PLAIN
10 for 6^D 20 for 11¹/₂^D**

N.C.C.451E

Mention of "The Wireless World," when writing to advertisers, will ensure prompt attention.

HOT FROM THE PRESS!

THE NEW

MAZDA

RADIO VALVE MANUAL

contains the LATEST VALVE INFORMATION

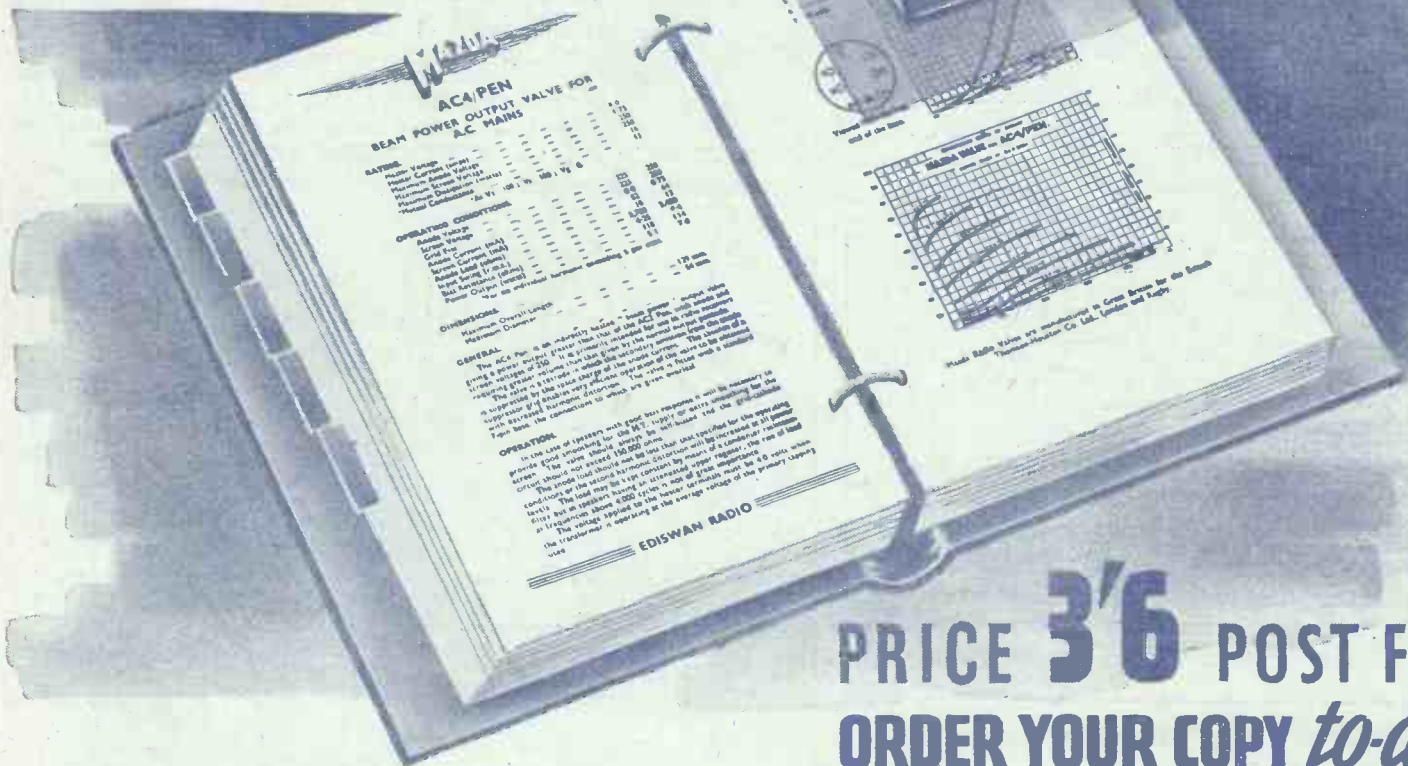
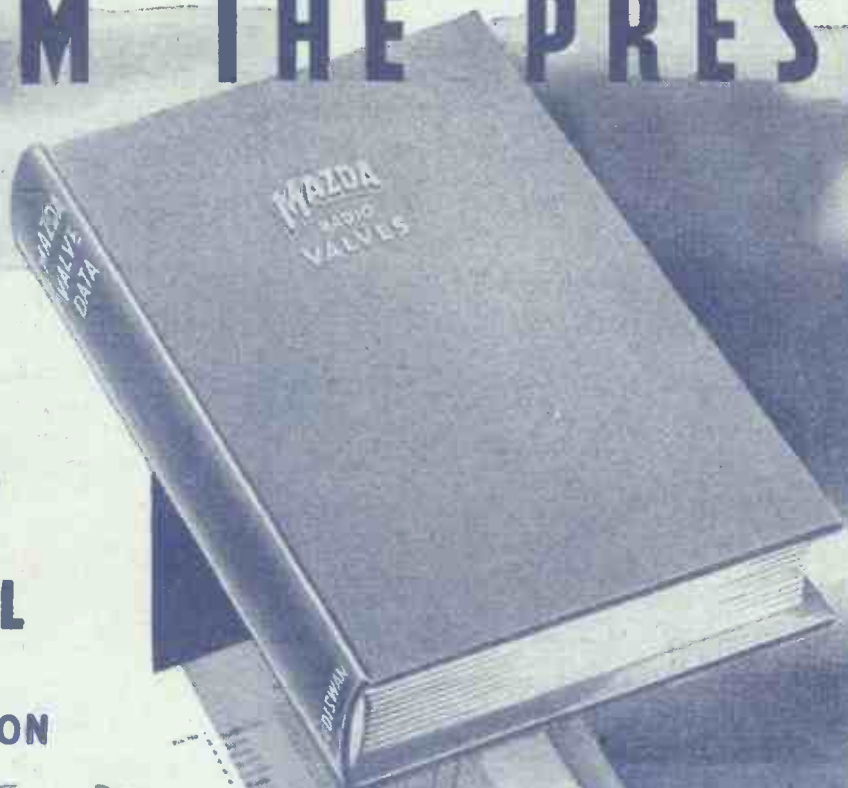

PRICE 3'6 POST FREE ORDER YOUR COPY *to-day!*

Here is a book no Radio Engineer or Wireless enthusiast can afford to be without. It is a comprehensive reference—packed with data of the range of Mazda Valves and their application. This invaluable volume is in the handiest form . . . loose leaf. It provides for the addition of new sheets as issued. These will be posted to you FREE of charge for the inclusive price of 3/6.

This method enables you always to have up-to-date Mazda Valve news before you for ready reference. Be sure you get a copy. Fill in and return the coupon NOW! Remember, too, our technical department is always at your service. Information regarding special application of Mazda Valves may be obtained without obligation.

Mazda Radio Valves are manufactured in Great Britain for the British Thomson-Houston Co. Ltd., London and Rugby and distributed by:—

THE EDISON SWAN ELECTRIC COMPANY LIMITED
155 CHARING CROSS ROAD · LONDON · W.C.2



To The Edison Swan Electric Co. Ltd.,
155 Charing Cross Road, London, W.C.2.

Please send me a copy of the MAZDA RADIO VALVE MANUAL, for which I enclose 3/6 covering the cost of the binder and additional sheets as issued.

Name

Address

Please write in block letters

W.W.

The **Wireless** **World** **6^D**
THE PRACTICAL RADIO & TELEVISION JOURNAL

Thursday, April 27th, 1939



HIGH ACCURACY

A.C., D.C.,
AND
RESISTANCE

MULTI-RANGE TEST SET

A.C., D.C.,
AND
RESISTANCE

2
0
0
0
OHMS
per
VOLT!

ACCURACY.
B.S.S. 1st Grade.

28
RANGES
FOR THE
ACCURATE
MEASUREMENT
OF

SELF-CONTAINED
RANGES.

.2 m/A to 5 Amps.
60 m/V to 500 Volts.

Resistances up to
500,000 OHMS.

External Resistance,
Shunts and Transformer
can be supplied to increase
Ranges up to:—

1000 Volts D.C. or A.C.
1000 Amps D.C. and 600
Amps A.C.

Voltage
Current on D.C.
Resistance on Circuits
AND

Voltage
Current on A.C.
Supply and Audio
Frequency Circuits

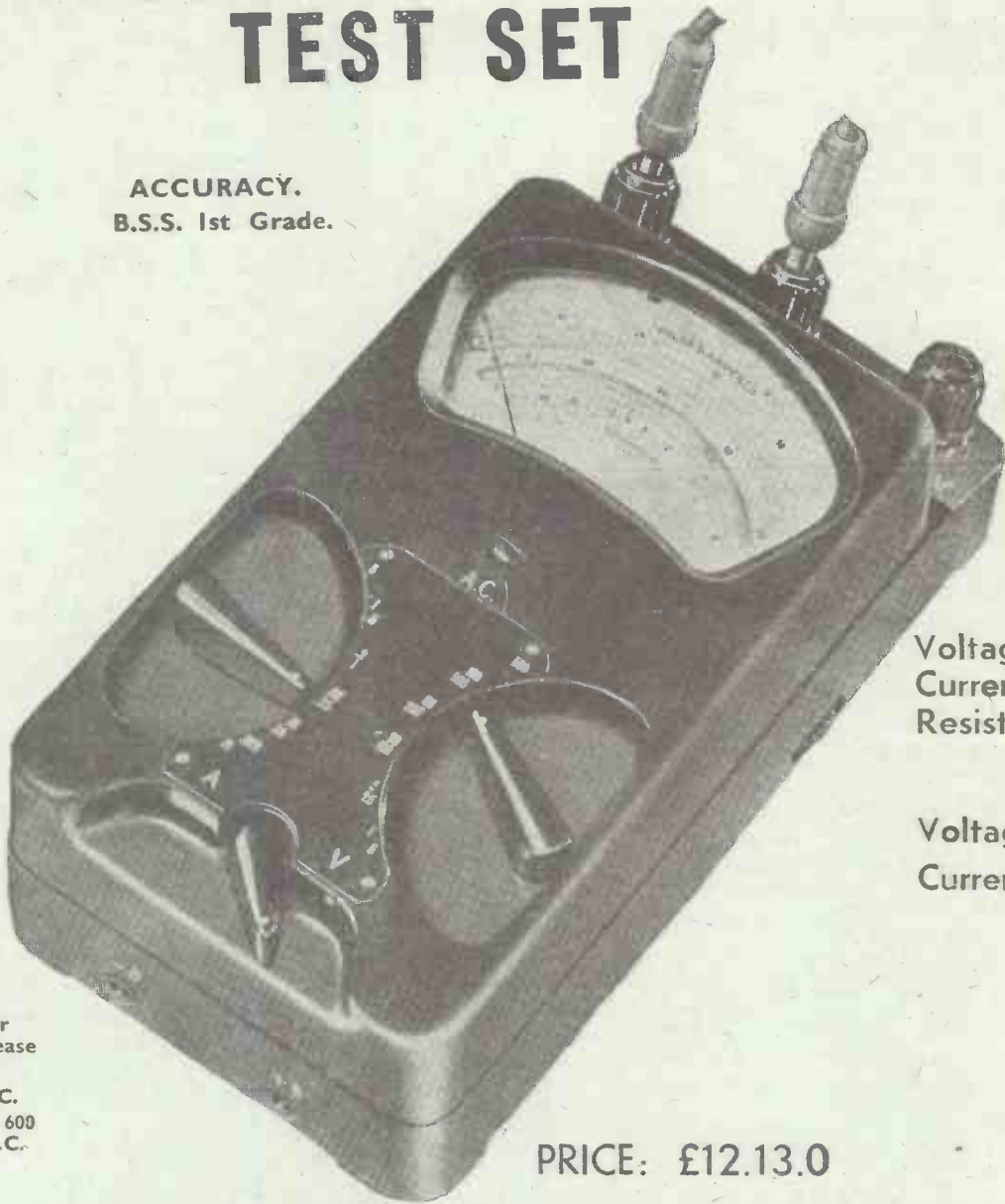

PRICE: £12.13.0

THE MULTI-RANGE INSTRUMENT WITH THE LONGEST RANGE

.000004 to 5 Amps.

.0012 to 500 Volts.

Lowest Reading of any Multi-Range A.C. and D.C. Test Sets. Can be read easily down to .000004 ampere.

Temperature compensation by patented bridge system makes errors negligible on all ranges.

It is possible to change over in a circuit being measured direct from a voltage to a current measurement without disconnecting the instrument or disturbing the circuit conditions in any way.

Write for full particulars to

SALFORD ELECTRICAL INSTRUMENTS LTD.

PEEL WORKS, SALFORD, 3.

Telephones: BLAckfriars 8888 (3 lines)

Telegrams and Cables: "SPARKLESS, MANCHESTER"

PROPRIETORS: THE GENERAL ELECTRIC Co. Ltd., OF ENGLAND

Mention of "The Wireless World," when writing to advertisers, will ensure prompt attention.

The Wireless World

THE
PRACTICAL RADIO
JOURNAL
29th Year of Publication

No. 1026.

THURSDAY, APRIL 27TH, 1939

VOL. XLIV. No. 17.

Proprietors : ILIFFE & SONS LTD.

Editor :
HUGH S. POCOCK.

Editorial,
Advertising and Publishing Offices :
DORSET HOUSE, STAMFORD STREET,
LONDON, S.E.1.

Telephone : Waterloo 3333 (50 lines).
Telegrams : "Ethaworld, Sedist, London."

COVENTRY : 8-10, Corporation Street.
Telegrams : Telephone :
"Autocar, Coventry." 5270 Coventry.

BIRMINGHAM :
Guildhall Buildings, Navigation Street, 2.
Telegrams : Telephone :
"Autopress, Birmingham." 2971 Midland (5 lines).

MANCHESTER : 260, Deansgate, 3.
Telegrams : Telephone :
"Iliffe, Manchester." Blackfriars 4412 (4 lines).

GLASGOW : 26B, Renfield Street, C.2.
Telegrams : "Iliffe, Glasgow." Telephone : Central 4857.

PUBLISHED WEEKLY. ENTERED AS SECOND
CLASS MATTER AT NEW YORK, N.Y.

Subscription Rates :
Home and Canada, £1 10s. 4d. ; other
countries, £1 12s. 6d. per annum.

As many of the circuits and apparatus described in these
pages are covered by patents, readers are advised, before
making use of them, to satisfy themselves that they would
not be infringing patents.

CONTENTS

	Page
Editorial Comment	383
Modern Insulating Materials	384
Valve Trend	386
Aerial Vagaries	387
Problem Corner	388
Double-beam Cathode-ray Tube	389
Attenuators	391
Earthing	394
Rating of PA Equipment	396
News of the Week	397
Distortion in Recording Ampli- fiers—II	399
Random Radiations	400
Unbiased	402
Letters to the Editor	403
Readers' Problems	405
Recent Inventions.. ..	406

EDITORIAL COMMENT

The Montreux Plan

New Broadcasting Wavelengths

PERHAPS the greatest disappointment of the new official Plan for allotting European broadcasting wavelengths is that the cleaning-up of the long-wave band has not materialised in accordance with the Brussels draft plan, which formed the basis for discussion by the delegates at Montreux. It will be remembered that it was proposed that the long-wave band should be divided into 14 channels with a minimum of 9 kc/s separation—in some cases more. There may be some slight improvement in conditions, but even this comparatively modest ideal has certainly not been attained. Long waves, though rather out of fashion, are important because they provide extremely dependable channels for medium-distance broadcasting, especially in Northern Europe, where atmospherics are seldom troublesome.

So far as Droitwich, our own long-wave station, is concerned, there is virtually no change, although its frequency has been reduced from 200 to 198.5 kc/s. Its neighbours are, on the one side, the Deutschlandsender, with 9 kc/s separation, and, on the other, a shared channel, spaced 8 kc/s, to be used by Ankara, Reykjavik and Minsk. The fact that one of the adjacent channels is a shared one rather increases the possibilities of interference, so far as reception abroad is concerned, but the new arrangement should have little, if any, effect in this country.

Turning to the medium-wave band, the Brussels project seems to have been followed rather more closely, and Germany has been allotted the largest share of exclusive channels, amounting to eleven in all ; one of these is to be

shared between various German stations. Great Britain's allocation of two exclusive channels may seem to be relatively small, but, as Sir Noel Ashbridge (reported elsewhere in this issue) has pointed out, our geographical position on the outer fringes of Europe is such that we can share wavelengths with other countries in a way that would be impracticable for the central European states.

The exclusive British channels are : 916 kc/s, allotted to Brookmans Park (London Regional) with shared channels on each side to be used by Graz-Klangenfurt and Lwow-Valladolid ; 1087 kc/s, to be occupied by Droitwich (Midland Regional) with Heilsberg and Bratislava as neighbours. The nine non-exclusive channels allotted to this country are mainly shared with other British stations and with Russian and other distant transmitters mostly situated in the south-eastern corner of Europe.

The Voice of Britain

The medium-band allocations seem to be adequate for a home service, and at any rate there is no need to anticipate a change for the worse, thanks largely to the distance separating us from the stations with which we are sharing channels. It must be remembered that the Montreux Conference was primarily concerned with internal broadcasting, and its labours were directed towards ensuring an adequate domestic service for each country. However, the international aspects of broadcasting cannot be ignored nowadays ; it would appear that the changes made will, when they come into effect next year, have little effect on the way in which the voice of Britain is heard abroad, although there may be some deterioration of reception in eastern and south-eastern Europe.

Modern Insulating Materials

COMPOSITION AND PROPERTIES OF THE PRINCIPAL TYPES

Part I.—Rubber Compounds, Synthetic Resins, Vitreous Materials and the "Organic Glasses"

By L. HARTSHORN, D.Sc.

IN the early days of wireless the most widely used insulating material was ebonite, which, as most readers will know, is a compound made by heating together rubber and sulphur. This compound when new is an excellent general-purpose insulator, and was, and indeed still is, deservedly popular with experimenters who construct their own components. It is easily drilled and turned, is mechanically strong and not too brittle, of exceptionally high electric strength (breakdown voltage) and resistivity, and of low power factor.

Its disadvantage is that, on exposure to light and moist air, some of the sulphur which it contains becomes oxidised with the formation of sulphuric acid. The colour changes from black to a muddy green or brown, and not only are the good insulating properties lost, but the acid formed is apt to corrode metal fittings mounted on the panel. These troubles may be largely prevented by protecting the ebonite from light, e.g., by using it inside metal screens, but this is not always convenient. Another remedy consists of the use of certain "loaded" ebonites, i.e., rubber-sulphur compounds to which other ingredients have been added. An example in this category is "Keramot," a reddish-brown material made by Siemens Bros. Although not quite so good electrically as pure unloaded ebonite when new, this material shows very little surface deterioration with age.

Another limitation of pure ebonite is that it tends to yield mechanically at temperatures of about 60 deg. C. Thus it

THE properties of insulating materials may exercise a controlling influence on the stability, selectivity or cost of radio apparatus, and these materials are therefore the subject of constant research. In the present article some of the more important recent developments in this direction are outlined.

frequencies, besides making it more brittle.

These loaded ebonites are therefore not much used for radio work, but quite recently ebonites loaded with special forms of silica have been developed, and these are found to retain the good electrical properties of pure ebonite, with a yield temperature some 20 deg. C. higher. These materials, an example of which is "Silvonite," promise to be of considerable value for high-class radio instrument work, such as is required for commercial or service work.

Insulators of the ebonite class are nowadays to be found only in instruments and components which are individually made. Modern radio apparatus is, to a very large extent, assembled from mass-produced components, and for such work ebonite has been superseded by substances com-

the mixture can easily be moulded to any shape. Then, on continued application of heat and pressure, the resins set, producing a material which is extremely hard and no longer softens on heating. Components of the most complicated shape can be produced by a comparatively simple combined moulding and curing process. Since the material hardens on

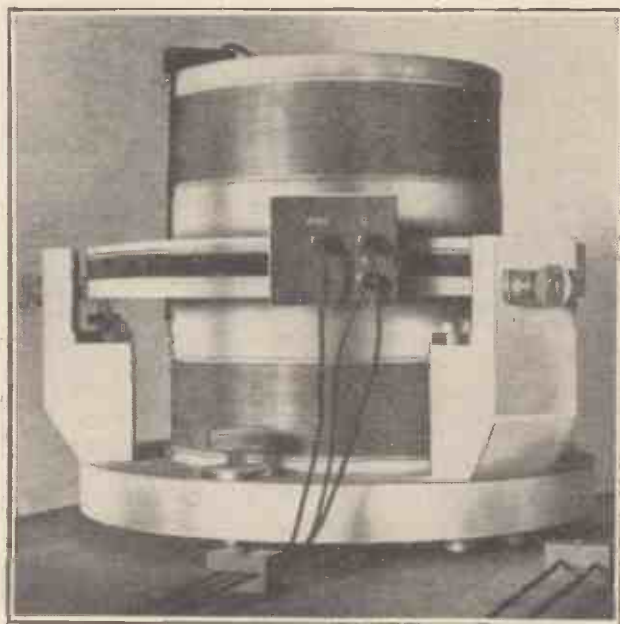

Fig. 2.—The Primary Standard of Inductance at the National Physical Laboratory. The standard, which weighs about a hundredweight, is supported on levelling screws machined from an "organic glass."

heating, the component can be ejected from the mould while still hot, and production is therefore very rapid. Thin boards made by bonding paper with synthetic resin also lend themselves to mass production, since the sheets are very tough mechanically, and complicated shapes can

be produced from them by stamping or punching, another very rapid process. Thus, although these materials are electrically inferior to ebonite in several respects, they have superseded it on account of their superior moulding and punching qualities. They have also the advantage of not suffering surface deterioration from exposure to light and air and of being

usable at higher working temperatures.

It is obvious from their very nature that such materials may be very variable in quality. Their principal constituents might be described as something of the nature of sawdust, paper, or rags with sufficient synthetic glue to hold it together

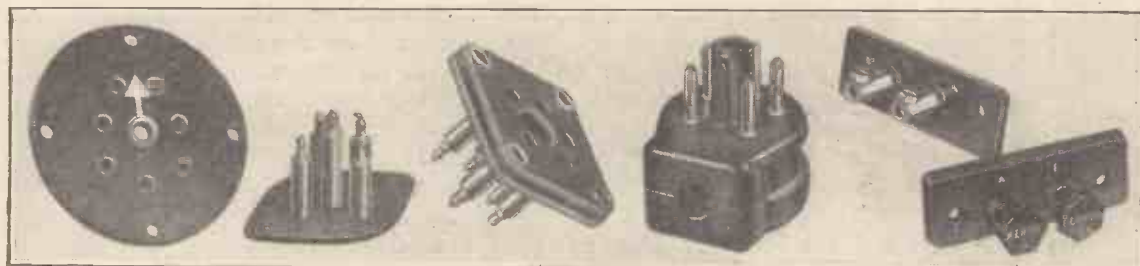

Fig. 1.—Typical modern components making use of punchings from thin laminated sheets of synthetic resin and paper and synthetic resin mouldings.

cannot be used for apparatus which is required to be mounted near high-power valves and yet remain rigid. Ebonite is often loaded with mineral fillers such as magnesium carbonate in order to raise its yield temperature, but this usually has the effect of increasing its power factor at radio

pounded of synthetic resins such as "Bakelite."

These materials consist essentially of paper, wood meal, or some such filling, bonded together with certain organic compounds of a resinous or gummy character. When heated the resins first soften, so that

Modern Insulating Materials— and make it mouldable. Engineers naturally were at first inclined to view such a concoction with a certain amount of suspicion. The chemical technologist terms this class of materials "plastics," and I have heard it said that this term is apt to prejudice the engineer against them. But the engineer's familiar term of "the muckites" suggests that any prejudice he may entertain arises from doubts about the filling material.

Importance of Fillers

It should be remembered that paper, cotton, and wood are essentially forms of cellulose, which, when quite dry, is an excellent insulating material. The electrical quality of the composite material depends largely on the extent to which the resin seals the filler from the moisture in the air. The ordinary grades of these materials are quite satisfactory for many purposes, but it is recognised that they are inferior to ebonite in power factor, and therefore for components in which freedom from power loss is of the highest importance, e.g., the insulators of condensers for short-wave work, special low-loss composite materials have been devised. These usually contain as fillers materials like mica and forms of silica which are of specially low power factor and comparatively little affected by moisture. As regards mechanical strength, it should be mentioned that the fabric-resin materials are the toughest and generally strongest insulating materials in existence, while the paper-filled materials are also remarkably good.

It is common knowledge that materials to be used in the construction of highly selective tuned circuits should have the lowest possible power factor. Fused quartz is probably the best of these materials, but is too expensive for general use. Glasses of the "Pyrex" type are a useful substitute for fused quartz, and tubes of "Pyrex" have been used as formers for commercial coils of high quality. Most vitreous materials can only be cut or machined by special methods. They are consequently inconvenient for experimental work, but find many applications when the quantities justify special mouldings.

"Mycalex" is a material of a more or less vitreous character in which this limitation has been overcome. There is a story

that this material had its origin in an attempt to find a use for mica scraps by mixing them with molten glass. The material is certainly not made in this way to-day, for it is moulded at high temperature and pressure from a mixture of powdered mica and metallic borates, but it may be regarded as a cross between glass and mica. It is much less brittle than glass, and can be drilled and tapped, although it is very hard on tools. Like mica, it may be used at high working temperatures, and although its power factor is not as low as that of mica, it is lower than that of most ordinary materials, especially at radio frequencies. It may be obtained in the form of sheets, rods, etc., and is particularly valuable where great rigidity and mechanical strength are required over a great range of temperatures. An interesting example of its use was afforded by a short-wave transmitter exhibited by the research section of the Marconi Co. at one of the exhibitions held by the Physical Society. Here rigidity of the whole assembly was of the first importance. Very thick horizontal condenser plates with edges carefully rounded to avoid ionisation of the surrounding air at high voltages were supported at either end by thick vertical slabs of "Mycalex."

In recent years organic chemists have succeeded in synthesising various resinous materials which are colourless and transparent like glass. They are sometimes called organic glasses, or, since they are far less brittle than ordinary glasses, unbreakable glass. These materials vary considerably in chemical composition; indeed, it appears that the resinous condi-

familiar as a wrapping material, and "Perspex," a material with such good optical properties that it can be used for moulding photographic lenses), certain others are pure hydrocarbons and are of special importance in radio work, for it is a characteristic of all the hydrocarbons that they are of exceptionally low power factor; indeed, their power factor when pure is barely measurable. It follows that the hydrocarbon resins are extremely valuable for all work in which the minimum of power loss is an essential condition. Examples are "Trolitul," made in Germany, "Victron" in America, and "Distrene," recently produced in this country.

Working the Organic Glasses

All these materials are thermoplastic—that is to say, on heating they merely melt, and solidify again without chemical change on cooling, thereby differing from the thermosetting resins first discussed, such as "Bakelite." They require a somewhat different moulding technique, but moulded components are easily made from them.

They are also available in the form of sheets and rods which are extremely useful for experimental work as the materials are very easily machined, although they require very careful treatment on drilling. Owing to their very low thermal conductivity the heat generated by the drill cannot easily escape, and as the materials begin to soften at about 60 deg. C. they tend to become slightly gummy under the drill. Moreover, the subsequent solidification seems to set up

internal strains, which may lead to subsequent cracking of the machined component. Drilling should, therefore, be done slowly and water should be fed on to the drill to assist cooling.

These hydrocarbon resins dissolve readily in benzene, and the solution makes an admirable "low-loss" varnish, and a cement for joining together pieces of the resin.

Examples of the use of these materials are moulded brackets for the insulation of variable air condensers, formers for coils, and insulating spacers in high-frequency cables. Flexible forms of some of these materials have also been produced, and these are used for insulated sleeving and in the form of very thin film for condenser construction. These

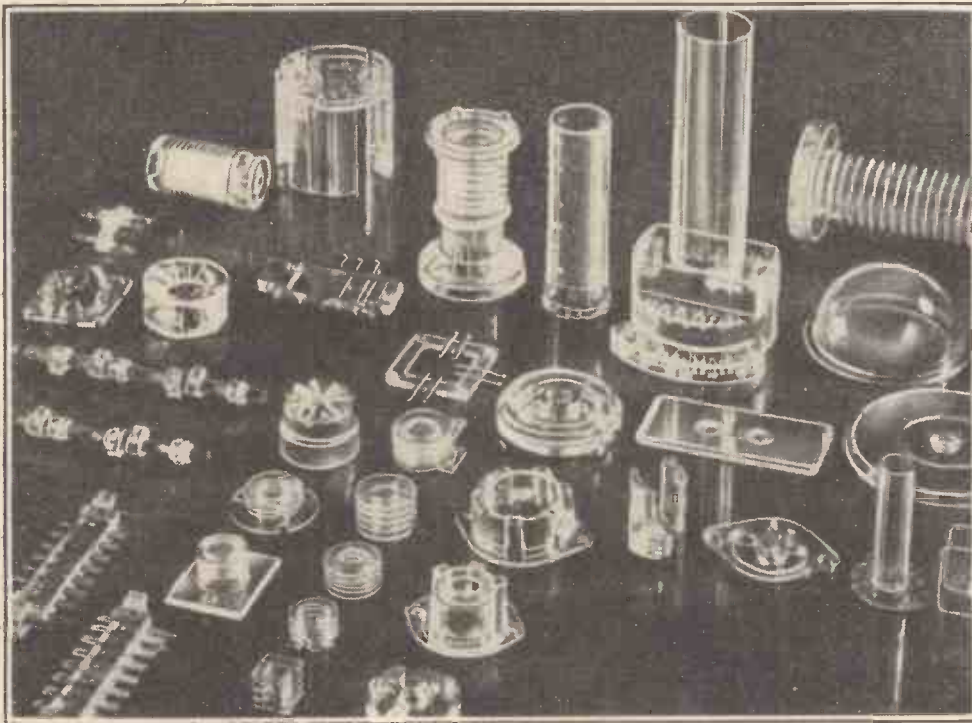

Fig. 3.—Small components moulded in Trolitul, a pure hydrocarbon plastic of very low power loss at all frequencies.

tion depends on the size and flexibility of the molecule rather than its purely chemical properties. Thus, while most of these transparent resins are acid derivatives (e.g., celluloid, cellulose acetate,

in high-frequency cables. Flexible forms of some of these materials have also been produced, and these are used for insulated sleeving and in the form of very thin film for condenser construction. These

Modern Insulating Materials— materials are still so new that their full possibilities cannot yet be estimated, but

up to 100 megacycles it will be clear that from the point of view of power loss they leave little to be desired. For

very similar. The American valves may be somewhat smaller externally, but there is often little difference in the length of the cathode connection.

The most recent trend, therefore, is towards methods of construction which enable a shorter cathode lead to be obtained. Such valves are often noticeable for a reduction of their overall length from the base pins to the top of the bulb. In most cases this has necessitated the adoption of a different form of base, of which there are two examples—the British octal and the Continental side-contact.

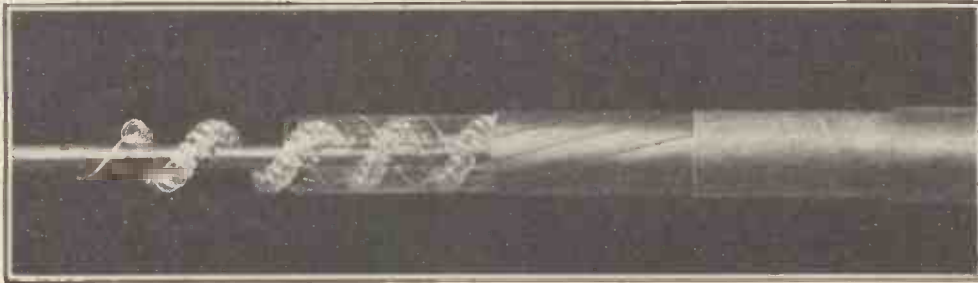

Fig. 4.—Spiral Trolitul insulation in a television cable.

when it is realised that their power factors may be as low as 0.0002 at all frequencies

much experimental work they are almost ideal.

Input Resistance

A considerable increase in the input resistance is obtainable with these forms of construction and it is interesting to note that an intermediate value of mutual conductance has been selected for these valves. It is usually about 2 mA/v. for RF amplifiers and is intermediate between the conventional British and American types.

It seems probable that such a figure represents a good compromise between the extremes, and it is interesting to speculate whether in time it will supersede the two earlier rival trends. The mutual conductance is high enough to be satisfactory even in the small set of few valves and not too high to be embarrassing in the large set. Combined with small physical dimensions this form of valve is exceedingly good for short waves and its higher input resistance considerably improves second-channel rejection in SW superheterodynes.

The high mutual conductance valve of small size will still be needed for television and could also find application in broadcast receivers in special cases, just as it does at present. Probably in the distant future some such compromise will be agreed upon, with a welcome reduction in the number of valve types made. At present, however, the class represents a further increase in the number of valves, which will probably grow still more in the next few years since development is still proceeding rapidly.

Valve Trend

HIGH OR LOW MUTUAL CONDUCTANCE ?

UNTIL recently, valve development in this country has always lain along the lines of improving the performance—especially the mutual conductance. In the case of mains types a mutual conductance of 2 mA/v. has often been thought low and a normal figure for small triodes, tetrodes and pentodes has been 3-4 mA/v., while output valves have been some 4-10 mA/v.

This trend still continues and has even been accelerated by television, for there are now RF amplifiers with mutual conductances up to 14 mA/v. In America, however, valves have always been much less efficient, judged by this standard, and the average figure for mutual conductance has been 1-1.5 mA/v. Even now figures are not much greater and except for output valves there are few with a mutual conductance greater than 2 mA/v.

Within the last few years the American trend has found its way over here and is additional to the normal British trend towards high mutual conductance. The low mutual conductance valves made in this country are usually counterparts of the American valves and often have the same type numbers.

Number of Stages

The advocates of the American-type valve point out that it is possible to obtain greater uniformity between different specimens with valves of low mutual conductance, and that this leads to easier manufacture and fewer rejects, thus reducing costs. Moreover, it may prove possible to obtain a more desirable shape of characteristic. On short waves, too, the low mutual conductance means a relatively high input resistance, other factors being constant, and the valve may then give as much amplification as one of higher mutual conductance.

On the average, however, a receiver must contain more valves when they are

of this type than when they are the conventional British high mutual conductance specimens. In America this is held to be no great disadvantage, but here the matter is looked at rather differently. Three- and four-valve sets are still very popular and it is, then, hardly possible to get the same performance with American as with British valves.

Short Waves

These factors apply chiefly to the broadcast bands, and, of course, the IF amplifier, detector and AF circuits in any receiver, and there seems little doubt that the conventional British type of valve is the best for small receivers. With large sets, however, it is easy to obtain all the gain one wants from valves of low mutual conductance, and if high-mutual conductance valves are used it is often necessary to operate them with increased grid bias to bring the amplification down to a reasonable figure. Here the American type is just as good and may have advantages.

Matters are rather different on short waves. The input resistance of the valve then plays a large part and is very dependent on mutual conductance, being roughly inversely proportional to it. With highly efficient couplings the stage gain then becomes almost independent of mutual conductance, but the selectivity of the tuned coupling increases as the mutual conductance gets lower, because the higher input resistance damps the circuit less.

The matter is actually very complicated, because the input resistance does not depend only on the mutual conductance but also upon the physical dimensions of the valve—especially the length of its internal cathode lead. The ordinary British and American valves are about equal in this respect because the internal construction and basing arrangements are

New "2in." Salford Meters

THESE instruments, which are produced to British Standards Specification No. 89, have 2in. diameter moulded cases and



are fitted with a knife-edge pointer. As ammeters they are available with self-contained shunts up to 10 amps. and as voltmeters up to 250 volts. The resistance is standardised at 200 ohms per volt.

Aerial Vagaries

EFFECTS OF NEAR-BY CONDUCTORS

INDOOR aerials are usually surrounded by a veritable maze of electric wiring, water pipes and other conductors; it is, therefore, not surprising that they are subject to various effects for which explanations are not readily apparent. These effects are discussed in the present article, which also deals with the connection of the earth lead to the aerial terminal—a well-known and often surprisingly successful subterfuge in cases where no aerial is available.

THOSE who use indoor aerials will probably have noticed various puzzling effects; for example, the switching of a local power or lighting circuit (perhaps the hall lamp or the kitchen flat-iron) may be accompanied by a change in volume from the receiver, corresponding, of course, to a variation in signal voltage between the aerial and earth terminals of the set.

These effects are usually more noticeable when one is listening to weak signals, on which the AVC system does not afford a linear correction.

In other words, if the pipes, stacks and girders of system (a) melted into thin air, the numerous effects noticed would include that of an increase of available signal voltage at the receiver terminals.

Sudden variations in signal strength would not be attributable to (a) unless, of course, structural changes were in progress while the tests were being made.

As regards system (b), the behaviour of the wiring circuit from a high-frequency viewpoint depends upon whether it is open or closed by its switches. It is likely under closed-switch conditions that more energy will be abstracted from the incoming signals, thereby producing at the indoor aerial itself a contrary field which will act in opposition to that which would exist in its absence, thereby resulting in an effective field very much lower than that which was originally present.

On the other hand, the closing of the circuit switches might conceivably result in an increase of available signal voltage, and in such a case will most certainly be due to an increased coupling factor between the poor indoor aerial and the mains wiring, which, in itself, is very often a good collector of signal energy (but a bad distributor of electrical interference).

to energy absorption more likely to occur at low frequencies (long waves), and

(2) An increase in signal strength due to an improved coupling between the inefficient indoor aerial and a more efficient mains wiring network, and this effect is more likely to occur on the medium and short wavelengths.

These variations would be much more noticeable if AVC were not in existence to counteract the variations of signal input, and the writer remembers reductions of volume of the order of several times in the early days of manually controlled radio-frequency gain.

These sort of effects contribute in proving how really bad indoor aerials are, and

serve to stress the importance and the necessity for efficient outdoor aerials wherever possible.

A second and very interesting

problem concerns the performance of receivers when the earth wire is connected into the aerial socket of the receiver, and the explanation of this phenomenon is by no means as simple as that which has already been given in respect of the effects of opening and closing electric circuit switches. In the first instance, let us consider a modern mains-operated receiver. It is not difficult to show that from a high-frequency viewpoint the chassis of the receiver is at the same potential as the mains (neutral) is earthed so that at radio frequencies the receiver is earthed by the mains connection.

This can usually be proved in practice, because disconnecting the normal earth from such a receiver does not usually vary the signal strength to any noticeable degree. In fact, the major purpose of earth leads is to render the receiver safe should

By

F. R. W. STRAFFORD

(Research Department, Belling & Lee, Ltd.)

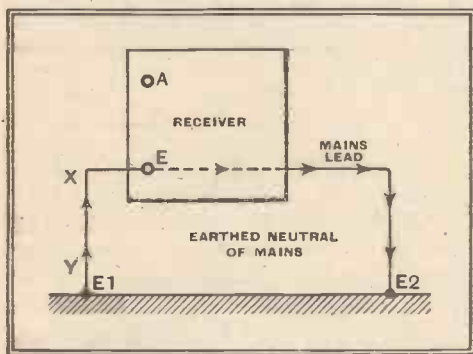

Fig. 1.—Showing how a mains receiver is normally earthed at two points.

This change in volume usually manifests itself as a decrease when circuits are closed, but, on the other hand, it is often possible for an increase to occur as a result of closing the switch.

When an aerial is located within a building which is not totally devoid of electrical conductors the energy from the signal reaches the aerial only after its amplitude and distribution have been modified by the presence of these conductors.

Network of Conductors

In a modern building an indoor aerial is surrounded by (a) a system of fixed conductors comprising gas, water, and stack pipes, often with additional metal girder work incorporated in the building structure; (b) the electric supply wiring and its associated shielding and bonding (if any).

The effect of (a) is to reduce the magnitude of the signal field strength in the vicinity of the aerial due to what is, in effect, the absorption of useful signal energy by the fixed electrical conductors.

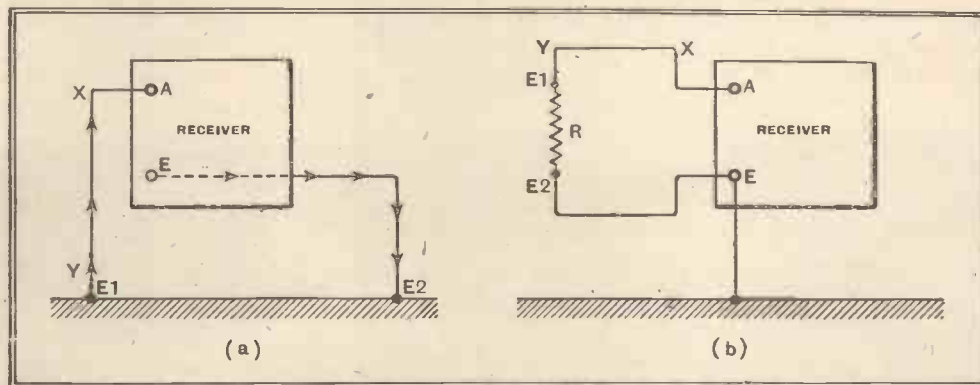

Fig. 2.—By joining the earth lead to the aerial terminal, a large single-turn loop aerial is formed, as shown in diagram (b), which represents the equivalent circuit; R is the earth resistance between E1 and E2.

Thus, the effect of closing the switch may be twofold and summarised as follows:—

(1) A reduction of signal strength due

its chassis take up the mains potential through some fault in the receiver; and, in addition, to reduce mains-borne interference.

Aerial Vagaries—

Bearing the foregoing in mind, the equivalent radio-frequency earth path of a mains-operated receiver is as shown in Fig. 1, in which distributed capacities, resistances and inductances are left out of the picture, as they do not concern us fundamentally in these circumstances.

If now the earth lead itself (XY) is connected to the aerial terminal of the receiver, the resultant circuit is modified to that of Fig. 2 (a). Now, this circuit is nothing more or less than a single turn loop aerial of fairly high resistance due to the separate connections at E1 and E2, and may be replaced by an equivalent loop aerial, as shown in Fig. 2 (b).

Although in practice the periphery of this loop is dictated by the tortuous route it may follow, it has a certain effective area to the signals. If its whole area were located in one plane, then the signal pick-up would be proportional to the total area, but as it more likely occupies several planes, the resultant signal pick-up will be some function of the area in each plane and the direction and intensity of the incoming signal field strength.

Nevertheless, it is fairly obvious that as the receiver is raised above ground level the effective area of the loop becomes greater in a vertical plane. Thus, fifth-floor listeners who connect the earth wire to the aerial terminal will expect a greater signal input than ground-floor inhabitants—a known fact, indicating one of the possible advantages of being poor!

Piezo Selectivity

PRESSURE WAVES IN LIQUID

A PIEZO-ELECTRIC crystal is one of those strange combinations which Nature occasionally produces to astonish and delight the connoisseur. It may be described as a perfect motor-generator unit, in miniature, because it will vibrate bodily at the frequency of an applied AC voltage, or, with equal facility, will generate electric oscillations in response to applied pressure-variations. By cutting it to a certain size and shape it can be made extremely selective, even to frequencies

which are regarded as "high" in the radio field.

It has already found various practical uses in wireless technique, particularly for stabilising the frequency of transmitters, and as a highly selective "gateway" in filter circuits. In television, too, an interesting type of light-cell has been developed in which a piezo-electric crystal sets up a

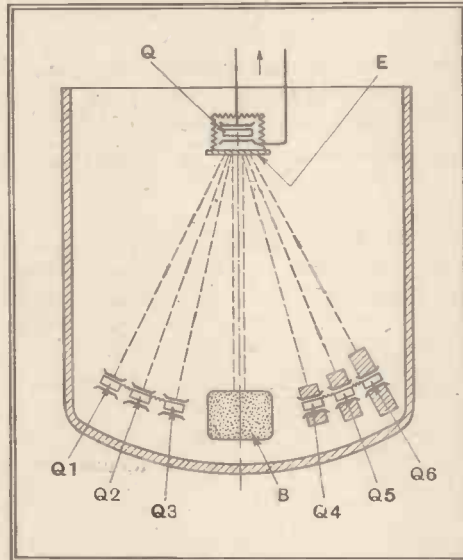

Electro-mechanical selectivity device employing piezo-electric crystals.

train of supersonic "pressure" waves in a liquid through which the light-ray to be modulated is passed. The idea of producing mechanical vibrations at radio frequency has recently inspired a new line of attack on the old problem of selective reception. Presumably the object aimed at is a higher degree of discrimination than can be attained with present methods of electrical tuning.

The principle of the new method is illustrated in the accompanying drawing (from Patent No. 499142) which shows a group of piezo-electric crystals enclosed in a vessel or cell containing water or other liquid. The incoming signals are applied after high-frequency amplification to a piezo-electric crystal Q, which is cut to respond periodically to a comparatively wide band of frequencies. The resulting crystal vibrations set up supersonic "pressure" waves in the liquid in which the crystal is immersed. The waves pass

through a screen E made with apertures or slots so that it acts as a diffraction grating to form a series of "interference bands" in which waves of different length are spaced apart from the central axis according to their wavelength.

Piezo-electric crystal resonators Q1, Q2, etc., each cut to respond to a different wavelength, are suitably spaced apart, as shown, so that each picks out its own frequency, and converts the pressure-waves into equivalent voltage variations. These are then passed on to separate amplifiers and detectors (not shown).

The crystals may be "loaded," as shown on the right-hand side of the drawing, in order to accept any desired width of sideband frequencies. A block B of sponge-rubber absorbs the undiffracted waves which travel along the central axis of the cell.

PROBLEM CORNER—17

An extract from Henry Farrad's correspondence, published to give readers an opportunity of testing their own powers of deduction:—

90, Fays Way,
Vectorford.

Dear Henry,

Thank you for explaining the condenser current affair; evidently I must swot up some AC theory! In the meantime I am thinking of making up a simple valve voltmeter according to a circuit I saw some time ago. Here it is:—

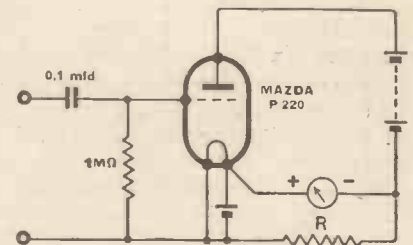

I gather that the object of the resistance R is to balance out the valve current (about 2 milliamps) through the meter so that it can start from scratch, as it were. But I am not sure what value R ought to be. I should be very much obliged if you would let me know.

Yours sincerely,
Fred New.

Henry Farrad's solution is given on page 404.



WHEN IN VENICE

A number of new regional headquarters are being planned by the Italian Broadcasting Authorities. The Venetian centre, a model of which is illustrated here, will, in common with many other buildings in that city, be accessible only by water.

Double - beam Cathode - ray Tube

DEVELOPMENT in cathode-ray tubes proceeds nearly as rapidly as in valves; this is not surprising in view of their value for research, servicing and television. In this article is described a double-beam tube which enables two images to be produced simultaneously.

THE cathode-ray tube is now becoming so well known that there is no need to enlarge on its merits and versatility in solving problems of innumerable varieties, not only in radio but general electrical, mechanical, medical and other fields. Its great advantage over most other indicators, such as pointer instruments—voltmeters, etc.—is that it works in two dimensions simultaneously and shows the relationship between a pair of quantities such as voltage and time, amplitude and frequency, etc. Although the ordinary single-beam tube, plus a little ingenuity, clarifies the majority of problems, a still wider field of usefulness is opened up if we have two beams to play about with in one tube, for this allows the relationship between three quantities to be observed; for example, current, voltage and time.

The means by which the two beams are provided in the Cossor double-beam tubes is extremely simple; it consists of one extra plate, located midway between the first pair of deflector plates that the cathode-ray encounters (the Y plates). As at this stage the ray is undeflected and, moreover, is in a diffuse condition, it is split in halves by this central plate, which is internally connected to the main anode and hence is at zero or reference potential so far as the deflection system is concerned. This extra plate can be seen in Fig. 1. Fig. 2 is a general view of the whole electrode system.

When the split beam proceeds to come under the influence of the X-plates, both halves are equally deflected by them. So if, for example, a time-base voltage is applied to the X-plates, both beams are drawn horizontally across the screen, but they can be independently deflected vertically by the Y-plates so as to show both

Examining Relationships Between Three Quantities

By M. G. SCROGGIE, B.Sc., A.M.I.E.E.

current and voltage waves or any other two quantities that may be of interest. Also, since the horizontal displacement is the same for both, any phase difference between the two waves is accurately depicted, and in the form that is most familiar in diagrams, as, for example, in Fig. 3. It is possible to show and measure phase differences with a single-beam tube, too, but generally not so accurately or conveniently, nor is it such a simple matter to tell whether the phase shift is a lag or a lead.

Not only is the construction of the double-beam tube nearly as simple as the corresponding single-beam type (reflected in the comforting fact that there is no increase in the price, which is £6), but it is obvious that no additions to the external apparatus are needed, with possibly the slight exception of provision for biasing each beam independently in order to adjust its position on the screen. Sometimes it is a definite advantage for the two patterns to be superimposed, for direct comparison; in other cases it is preferable for them to be separated one above the other. Obviously this can be done by applying a suitable steady voltage in series with the signal voltage. The complete interchangeability with the single-beam tube is a great convenience in the design of the oscillograph in which the tube is used.

The double-beam cathode-ray oscillograph removes the one remaining excuse for the moving-mirror type of oscillograph, so inferior in most respects but retained by some workers for the facility of examining two traces simultaneously.

An alternative method of showing two patterns on one screen simultaneously is by means of what is known as an electronic switch—a valve oscillator arrangement for rapidly alternating the connections from one source of deflection to the

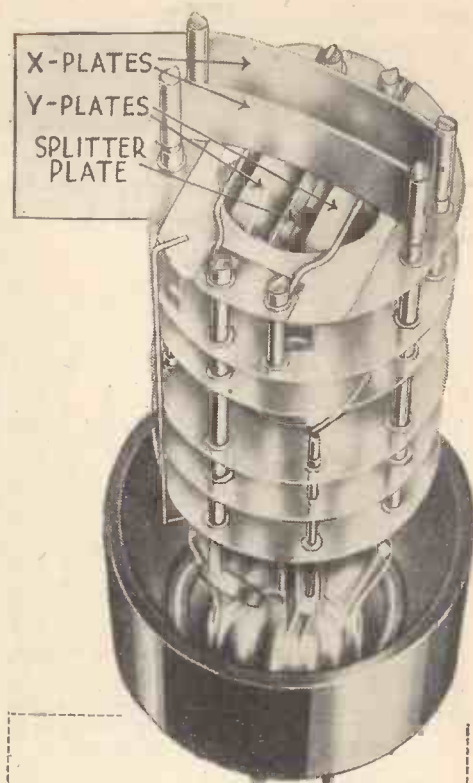

Fig. 1.—Close-up view of deflector plate system, showing extra plate for splitting the beam.

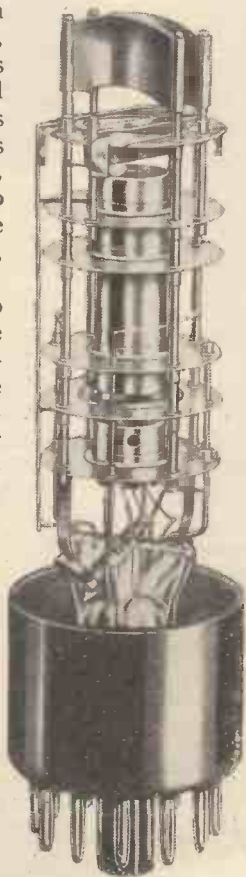

Fig. 2.—The electrode system in general is similar to that of the ordinary single-beam tube.

other. Such a device is more complicated, much more expensive, less reliable and less effective than the double-beam system, being subject to phase delay and frequency limitations. On the other hand, the disadvantages of the double-beam tube are comparatively slight. Obviously the brightness of each beam cannot exceed half the brightness of an undivided beam, other things being equal; but a slight reduction in negative grid bias can put this right. Then, as it is obviously impossible to employ symmetrical (or push-pull) deflection to the Y-plates of the double-beam tube there may be a slightly increased tendency to trapezium distortion or wide-deflection defocusing of the pattern. In the Cossor 3229 4½ in. double-beam tube, however, as in the corresponding single-beam type, the 3243, special precautions have been taken in the design to minimise trapezium distortion when either symmetrical or asymmetrical deflection is employed.

Test Connections

The method of use is almost self-explanatory, as, apart from the separate action of the two Y-plates, everything is the same as for the conventional single-beam tube. Fig. 4 shows the simplest possible connections, an arrangement that is useful as a preliminary test to satisfy oneself that the tube is functioning correctly. Any AC source, conveniently about 50 volts from the mains, is connected across the X-plates and also between both Y-plates and A₃. If it were not for the middle plate separating the two beams there would be no Y deflection at all, for the Y-plates are of the same

Double-beam Cathode Ray Tube—

sign; with it the beams are deflected in opposite directions giving a St. Andrew's cross-pattern as shown. It is as well that this fact should be thus impressed on the memory, so that this 180 deg. phase shift

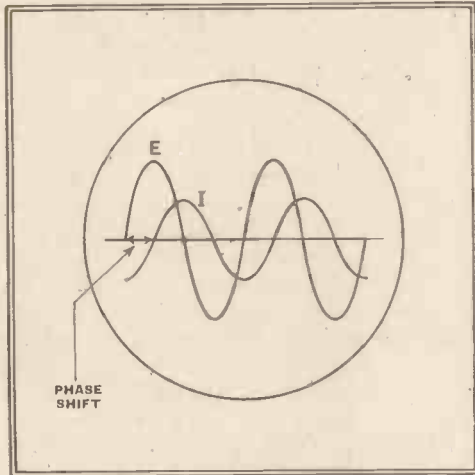

Fig. 3.—Phase difference between current and voltage—or between two voltages—can be observed in the usual diagram form by means of the double-beam tube.

may not be left out of account when considering wave patterns.

If either Y-plate is disconnected from the signal (and of course earthed to A3 instead) the beam affected draws a horizontal line, as shown dotted. This, incidentally, is often a convenience even when the tube is being worked in the single-beam manner, because it forms a base line from which the amplitude of deflection can be measured or judged.

One of the most obvious applications of the double-beam tube has already been suggested—examination of both current and voltage waves simultaneously. If both of these refer to a particular impedance, the phase angle of that impedance can be seen at once by inspection. But, as emphasised above, it is necessary to remember that one of the waves is inverted. Thus in Fig. 3, what looks at first like about 90 deg. current lag is actually a lead of that amount, showing the impedance to be nearly a pure capacity. The method of connection, of course, is to apply a linear time base to the X-terminals, the voltage

across the impedance to one Y-terminal, and the amplified voltage across a small resistance in series with the impedance to the other Y-terminal. The resistance must be negligibly small in comparison with the impedance, hence the necessity for amplification. Needless to say, the amplifier must be free from distortion and phase shift at the frequency concerned. An interesting application is examining the current and voltage in a power rectifier circuit. The way in which the amplitude, waveform, and phase of the current pulses vary with conditions can be observed as the conditions are changed.

Another application is comparing the waveforms at different stages of a system, such as input and output. When both are in phase, the simplest and best method is by applying them to X- and Y-plates of any tube; because no time-base generator is needed, the signal generator need not be of pure waveform, and distortion is much more clearly indicated than in the method usually recommended in which a pure waveform must be kept in the mind's eye for comparison. But when there is an appreciable phase difference, the simple method is not so satisfactory. The disadvantages of the usual time-base method can be largely overcome with a double-beam tube, however; for the input waveform can be displayed for comparison, and it is not essential for it to be exactly sinusoidal. In fact, the way is opened for much more searching tests, more representative of working conditions. If, for example, a saw-tooth wave is supplied, amplitude-, phase-, and frequency-distortion are all shown up at once. This is particularly valuable in investigating television amplifiers. The advantage of having the test waveform visible for comparison is obvious.

Valve characteristics can be examined much more thoroughly and quickly by cathode-ray tube methods than by laboriously plotting curves, which in any case cannot be applied to dynamic or working conditions. As most modern valves have numerous electrodes, even the cathode-ray tube, of the usual type, grapples imperfectly with the problem; and it is a great advantage to have the twin beam so that, for example, the varia-

tions of both anode and screen current can be observed as a function of varying grid voltage, or over a cycle of oscillation.

Departing from exclusively current and voltage parameters, the examination of resonance curves of both primary and secondary windings of a final intermediate-frequency transformer is usually desirable, because it is common practice for the AVC rectifier to be driven from the primary in order to make use of a less selective characteristic than the secondary to which the signal rectifier is connected, and thereby to minimise "side-band shriek." Lining up the IF circuits in the factory is greatly facilitated if the two resonance curves are seen on the screen together, as is easily possible with the double-beam tube. Fig. 5 is an oscillogram taken in this way. The double-beam tube can also be applied to test superhet receivers for accuracy of tracking.

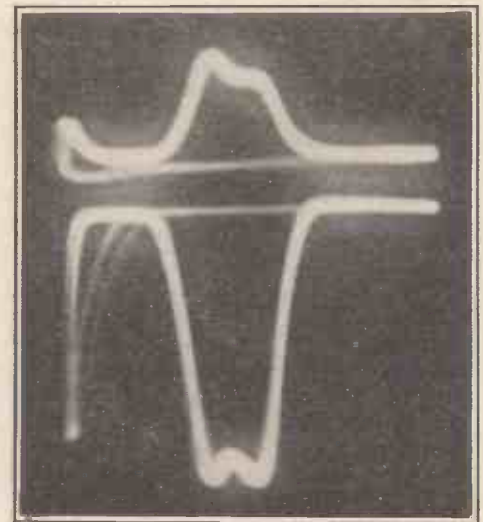

Fig. 5.—Simultaneous oscillogram of resonance curves across primary and secondary of an IF transformer.

These few of the many possible applications will probably be enough to suggest the value of the double-beam cathode-ray tube. Although, as already pointed out, it is a shade inferior to the corresponding single-beam tube for single-beam use, the added facilities make it worth considering as an alternative to the latter for general purposes.

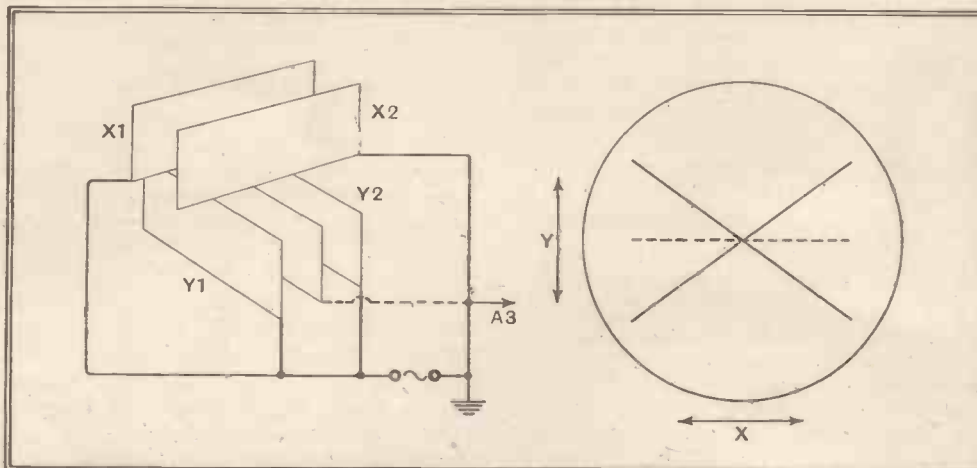

Fig. 4.—Simple test connections to the deflection plates, and the St. Andrew's cross figure that is obtained.

"Output Stage and Loud Speaker"

REFERRING to the article published under the above heading in our issues of February 9th and 16th, the author writes:—

"In the second part of my article, on page 168, there appeared a very obvious error under the heading, 'Transformer Design.' It is stated that 'the inductance of the transformer should, in the assumed case, be six times that given by the more usual calculations.' While this would be the case with a valve having extremely high plate resistance, it is not the case with a triode, owing to the comparatively low plate resistance of the latter, which is effectively in parallel with the load resistance. The inductance of the transformer should therefore be calculated on the basis of a shunt load equal to the impedance of the load impedance and the valve plate resistance in parallel. I apologise for this error and hope that it is so obvious that no one has been misled by it."

F. LANGFORD SMITH.
Sydney, Australia.

Attenuators

By "CATHODE RAY"

GLORIFIED POTENTIOMETERS OR VOLUME CONTROLS

Have you ever been puzzled by noticing that the component represented on a circuit diagram thus:—

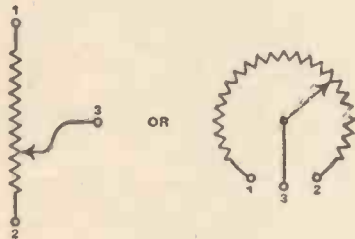

Fig. 1.

is called a *volume control* when it is in an ordinary set, but in expensive apparatus, such as a "communication receiver," a public address amplifier, or a signal generator, it is entitled *attenuator*?

CONSIDERED by itself, the device shown in Fig. 1 is commonly referred to as a *potentiometer*.

Finally, sticklers for accuracy sometimes describe it as a *potential (or voltage) divider*. For no discernible reason, there seems to be a tendency to use the last two of these names to distinguish between variable and fixed arrangements respectively. It is all very illogical and muddling. But then I have often had to point out that, although in these days, and in such a modern pursuit as radio, one would expect things to be highly systematic, the terms actually used are often based on an entire absence of clear thought. Not long ago this muddling led to the loss of a lawsuit, when the Judge ruled that the man-in-the-street's understanding of the term "all-mains" was more sensible than the expert's. That is by the way. But it just points the necessity for explaining what one's terms mean.

Attenuator, then. To attenuate, according to the dictionary, means to make thin, or, by association, to lessen the amount, force, or value of. The component indicated by Fig. 1 is generally used for tapping off a fraction of a voltage applied from end to end, and thereby reducing it to any desired extent. So logically there is no reason why it should not be called an attenuator. But engineers who work in the field now known as "Telecommunications" (see your telephone bill envelope) seem to have established a custom of restricting the term *attenuator* to certain special types that I shall deal with in a moment. Accepting this custom, then, to refer to Fig. 1 as an attenuator is like calling the toolshed a garage.

Potential Measures and Dividers

The term *volume control* applies only when the ultimate result of controlling the voltage is to control a volume of sound; in those applications it is correct and is also upheld by custom. *Potentiometer*

means *measurer* of potential or voltage, and although custom allows the word to be applied to the ordinary volume-control type of component, it is a very bad and wrong custom; this term should be used only for instruments (based, it is true, on the same principle, but generally very precise and costly) that do actually *measure*. *Potential divider* is, perhaps, the most correct term for the component wherever used, but, as I have said, there is a tendency to restrict the name to arrangements in which the tapping is fixed, such, for example, as simply two resistors connected in series so that a reduced voltage can be taken from across one of them.

To come now to attenuators proper, I am not sure that the term has ever been rigidly defined, but it is taken to apply to arrangements for reducing *power* rather

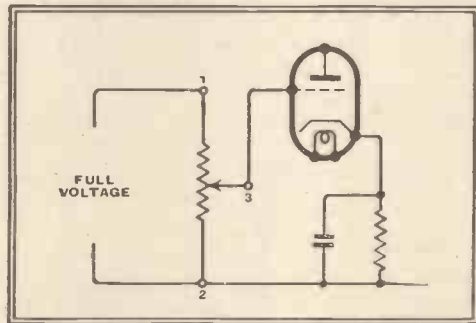

Fig. 2.—The simple "potentiometer" is suitable in unloaded circuits like this, for all except a very wide range of control . . .

than voltage. To see the difference, consider how the ordinary volume control is used. It is connected so that the portion of signal voltage tapped off is applied to the grid of a valve (Fig. 2). Used with suitable negative grid bias and for audio-frequency input, no appreciable current flows through the valve from 3 to 2. Therefore no *power* is *directly* controlled, only voltage. Power is controlled indirectly in the anode circuit of the valve, but the volume control need know nothing about that.¹ As there are generally good reasons for avoiding a low resistance between 1 and 2, the usual value chosen is quite high—half a megohm. The voltage tapped off is, of course, proportional to the resistance between 3 and 2. If 10 volts is applied between 1 and 2 and the resistance from 3 to 2 is 0.1 megohm, the voltage passed on to the valve is

$$10 \times \frac{0.1}{0.5}, \text{ or } 2.$$

¹ To be strictly correct, it may know a little about it, due to "Miller effect"; but that does not materially affect the argument.

Now suppose that a "volume control" is used for directly attenuating *power*—that is to say, there is a load circuit between 3 and 2, into which a part of the full current flows (Fig. 3). Continuing to use the values that I have just given as an example, and supposing that the load circuit is 0.1 megohm, it is clear that the resistance between 3 and 2 is no longer 0.1 megohm, but, due to the load in parallel, is now only 0.05 megohm. The resistance from 1 to 2 is reduced to 0.45 megohm, and the voltage passed to the load is $10 \times \frac{0.05}{0.45}$, or 1.11 instead of 2.

So, unless the resistance of the load into which the simple potential divider works is infinitely large—at least, very much larger than the total resistance of the potential divider itself—the scale cannot be calibrated to show what attenuation is being given. The amount of attenuation depends not only on the setting of the control, but also on the load resistance. Another thing: the resistance between 1 and 2 also varies with the setting—in this case from 0.5 megohm at zero to 0.083 megohm at maximum—and this may have a considerable effect on the input power if it comes from a source having appreciable resistance. Both these effects can be reduced by making the resistance of the potential divider very low, but generally that is impracticable, because it more or less short-circuits the source of power. Still another drawback is that it is difficult to cover a very wide range of control; usually adjustment becomes very critical near the "zero" end.

Real Attenuators

This is where real attenuators, in the generally accepted sense, come in. Even they cannot be arranged to give a power reduction that is quite independent of the load resistance. For one thing, power is proportional to the square of the voltage, but only when the resistance is fixed. Then even the voltage attenuation depends

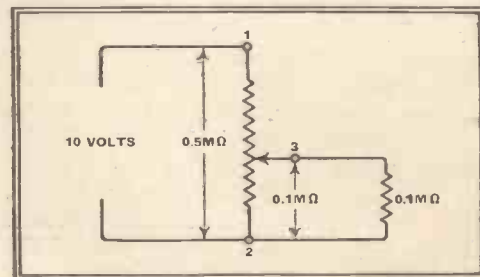

Fig. 3.—. . . but is less satisfactory for controlling power.

Attenuators—

on the load resistance and also on the resistance of the source, but in certain types of attenuators these effects may be much smaller than in the simple Fig. 2 scheme. I am not going to go deeply into the theory of attenuators—plenty of text-books do that—but a few illustrative figures will give some idea of the principles on which they work.

In order that it should not seem too much up in the air, I shall take as an example the working of a loud-speaker load from an amplifier source. This has the advantage of being a familiar case, although, on the other hand, it will be necessary, for the sake of simplicity, to ignore complications arising from the fact that a loud speaker is not a pure, constant resistance at all frequencies. Still, it will be found that a proper attenuator is a great advance on a simple volume control in those circumstances where it is necessary to adjust the volume actually in the loud-speaker circuit rather than at an earlier stage in the amplifier. Such conditions arise in public-address and extension loud-speaker installations.

Suppose, then, that we have a 15-ohm loud speaker working from a tetrode valve for which the optimum load is 6,000 ohms. A step-down transformer is necessary to make these fit one another, and its ratio is calculated in the usual way by taking the square root of the resistance ratio, $\frac{6,000}{15}$, or 400. The square root of 400 is 20. So much for the transformer. Now

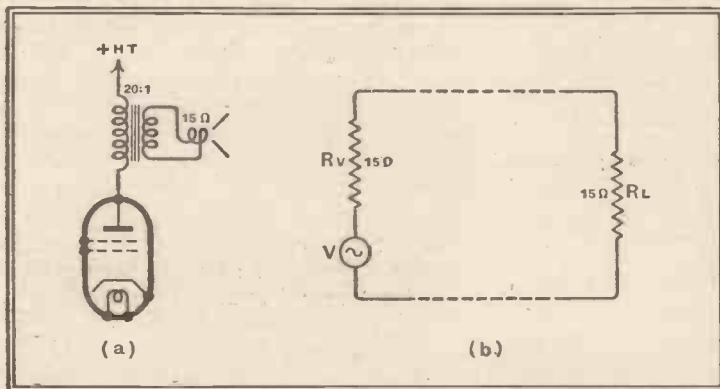

Fig. 4.—The valve and loud speaker circuit (a) can be reduced to (b) for purposes of calculation.

suppose it is desired to reduce the power reaching the loud speaker. If the load resistance into which the tetrode works is altered, there is a likelihood of distortion. So it is not satisfactory simply to put a resistance in between valve and speaker, or to shunt the valve with a parallel resistance. The simple potential divider is slightly better. But the attenuator circuit can do it perfectly.

One has the choice of connecting the attenuator on the high-impedance (or primary) side of the transformer, or on the low-impedance (or secondary) side. As the transformer is usually part of the amplifier and the attenuator may be needed near the speaker, we shall adopt the latter. The transformer, then, can be regarded as having the effect of dividing

the valve resistance by 400. The actual circuit, shown in Fig. 4(a), is then equivalent to Fig. 4(b), where V represents the signal voltage generated in the valve, R_L is the load resistance (loud speaker), and R_v is the valve's own resistance. And here a little explanation is necessary. We were given a valve having an optimum load resistance (referred to the secondary) of 15 ohms. That does

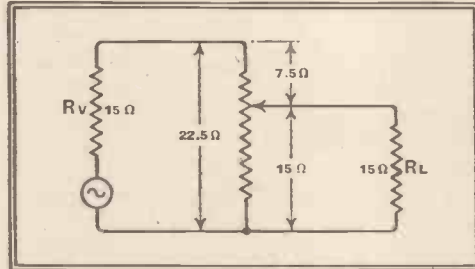

Fig. 5.—An example to demonstrate the shortcomings of the "potentiometer" when used as a volume control in a power circuit.

not mean that R_v is also 15 ohms. Being a tetrode, it is probably much greater; if it were a triode it would be less.

It is true that $R_L = R_v$ is the condition for maximum power output, but not for best results, taking distortion into account. Calculation of attenuators (and filters) is much easier if R_L and R_v are equal, however; and as for this purpose it is quite a simple matter to make them equal by the use of a little negative feedback, we shall do this, giving the equivalent circuit shown in Fig. 4(b).

Full volume is obtained when the dotted connections are taken straight across. Now suppose a simple potential divider is used to halve the voltage across R_L (and therefore to quarter the power). A potential divider of almost any resistance can be used to do this; but it can be calculated that the only one that can do so, and yet keep the load resistance at 15 ohms, must

have a resistance of 22.5 ohms, and the desired result is obtained when the tapping is 15 ohms up (see Fig. 5). (It is quite easy to see that R_L in parallel with this 15 ohms is 7.5 ohms, and added to the upper 7.5 ohms the total is 15). The resistance in parallel with the loud speaker is no longer 15 ohms; it is rather less because there are two paths, but that doesn't matter, in fact it is all to the good.

So far so good, but when any different adjustment is made the total load resistance alters and the valve is no longer working at optimum. Suppose, for example, that the voltage is to be reduced to one-tenth of what it would be with no potential divider in circuit. R_L would have to be tapped across 2.1 ohms, and the load on the valve would be 22.2 ohms,

Again, with the control at "Maximum," not only would the total load resistance be down to 9 ohms, but 40 per cent. of the output from the valve would be wasted in the volume control, and could not be recovered without taking it out of circuit. Even some of the more elaborate attenuators suffer from this defect; it is specified as the *insertion loss*. Of course, all these data are given in decibels, but for the sake of readers who haven't yet got the knack of thinking in db's. I am sticking to ordinary figures.

One way of getting over the difficulty about constant load resistance is to make the upper and lower parts of the potential divider separate, so that one is no longer bound to have them add up to the same amount all the time. They can take the form of two ganged rheostats of the rotary slider type with windings specially "tapered" to give the right characteristics. Or if continuously variable adjustment is not needed it can be worked by ganged stud switches and fixed resistors; this method enables the insertion loss to be avoided. To distinguish these attenuators from simple potential dividers the two parts are generally drawn at right angles, as in Fig. 6, and this is why they are known as the L type (upside down, in this case).

Constant Resistance

There are two chief lines of elaboration from this stage onward. One is with the object of making the attenuator suitable for certain uses in which it is essential for the resistance to be constant, looked at from both ends. The L type can be designed to keep the resistance constant from one end only, as we have just seen; but by elaborating it into a T it is possible to look after both ends. Still stricter requirements—which we are not likely to come up against, though I believe telephone engineers do—make it necessary to have a 5-element attenuator, known as the H type, for use in balanced systems. I won't even trouble to draw the diagrams; they are obvious, anyway, if it is realised that the H lies on its side.

The other line of development, though less orthodox, is of more interest to us. It is used in many signal generators and the more elaborate types of public-address volume controls, and consists of a string of L units, known for obvious reasons as a ladder. It is not a perfect attenuator: the resistance looked at from one of the

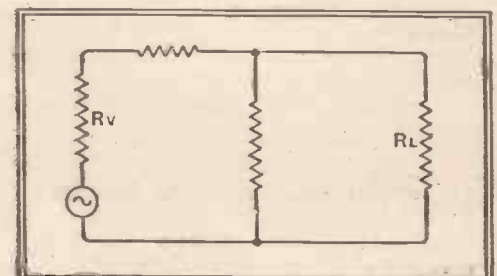

Fig. 6.—Theoretical diagram of the L attenuator, which differs from the potential divider only in the manner in which the two arms are varied for control purposes.

Attenuators—

two ends is bound to vary, as in the simple L; and there is an insertion loss. On the other hand, it can be made fairly cheaply, and the amount of attenuation introduced by each step is hardly affected even by variations in the load resistance, except for the one or two steps nearest the RL end. There are several variations of it: Fig. 7 shows one; another is switched from the source end; and for continuous variability Fig. 8 shows a useful compromise in which the input and output resistances of the attenuator vary only slightly, and can be exact at each point where the slider is at a junction with one of

be worked out with little more than the knowledge of Ohm's Law, it is liable to land one in fairly involved calculations. It is not that the mathematical requirements are advanced—only simple algebra is needed—

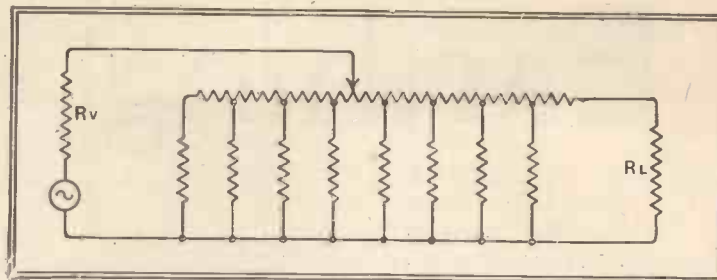

Fig. 8.—A cheap form of continuously variable attenuator.

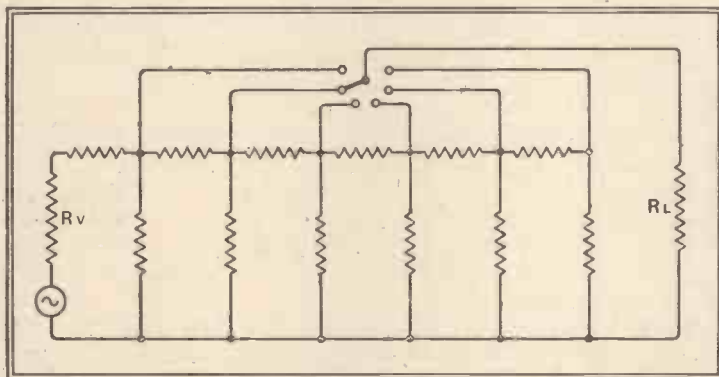

Fig. 7.—One form of the ladder attenuator—a type commonly used in signal generators.

the vertical or shunt resistance elements. Although the design of attenuators can

but it is a test of clear thinking, and therefore an excellent exercise.

News from the Clubs

Ashton-under-Lyne and District Amateur Radio Society

Headquarters: Commercial Hotel, 86, Old Street, Ashton-under-Lyne, Lancs.
 Meetings: Alternate Wednesdays.
 Hon. Sec.: Mr. K. Gooding, 7, Broadbent Avenue, Ashton-under-Lyne, Lancs.
 At the annual dinner on April 2nd there was a debate on the respective merits of superhets and straight receivers. There is considerable activity among certain transmitting members in the matter of experiments with different types of aeriols.

British Sound Recording Association

Headquarters: 44, Valley Road, Shortlands, Kent.
 Hon. Sec.: Mr. E. J. Chinn, 14, Tirlemont Road, South Croydon, Surrey.
 On April 13th a large party of members visited the Imperial Sound Studios at 84, Wardour Street, London, W.1. Prior to members' inspection of the equipment, a talk was given to them by Mr. H. L. Sheridan on the beginnings of the sound film industry. Apparatus is available at the studios for recording direct on 16 mm. film stock as well as on standard 35 mm. film stock.

Croydon Radio Society

Headquarters: St. Peter's Hall, Ledbury Road, South Croydon, Surrey.
 Meetings: Tuesdays at 8 p.m.
 Hon. Pub. Sec.: Mr. E. I. Cumbers, 13, Campden Road, South Croydon, Surrey.
 The session was concluded on April 4th by a musical evening, using a selection of gramophone records supplied by members and played on Mr. S. F. Webster's high-quality apparatus. The new session will open on the first Tuesday in October.

Golders Green and Hendon Radio Scientific Society

Headquarters: Regal Cinema, Finchley Road, Hampstead, London, N.W.2.
 Hon. Sec.: Lt.-Col. H. Ashley Scarlett, 60, Pattison Road, Hampstead, London, N.W.2.
 On April 26th Mr. Maurice Child lectured on 40-metre DF work and explained the salient features of his latest apparatus.
 The annual 40-metre DF competition will be held on May 21st, the field of operation being in the St. Albans-Berkhamsted-Dunstable-Stevenage area. Clubs which wish to participate should communicate with the secretary as soon as possible.

Edgware Short-wave Society

Headquarters: Constitutional Club, Edgware.
 Meetings: Wednesdays at 8 p.m.
 Hon. Sec.: Mr. F. Bell, 118, Colin Crescent, Hendon, London, N.W.9.
 Mr. Hardy gave a talk on DF and aircraft-landing equipment at the March 22nd meeting. At the follow-

ing meeting another member dealt with aerial experiments. On April 5th Mr. Rice, of the Mullard Co., described his firm's oscilloscope and signal generator. Guest night was held on April 12th, and on April 19th a QSL card night took place. On April 26th there was a discussion on the proposed equipment for the R.S.G.B. field day.
 A junk sale will be held on May 3rd.

Romford and District Amateur Radio Society

Headquarters: Y.M.C.A. Red Triangle Club, North Street, Romford, Essex.
 Hon. Sec.: Mr. R. C. E. Beardow, 3, Geneva Gardens, Chadwell Heath, Essex.
 A lecture on amplifiers was recently given by a Tungsram representative.
 On April 16th the club participated in a field day arranged by the Brentwood Society. Plans are also being formulated for joint field days to be held by the Brentwood, Southend, Welwyn, Ilford and Romford Societies.

Slough and District Short-wave Club

Headquarters: 35, High Street, Slough, Bucks.
 Meetings: Alternate Thursdays at 7.30 p.m.
 Hon. Sec.: Mr. R. J. Sly, 16, Buckland Avenue, Slough, Bucks.
 On April 13th the chief item of interest during the evening was a talk given by Mr. R. J. Sly on the ultra-high frequencies. Morse practice followed. At the next meeting, which is being held this evening (April 27th), there will be a discussion on etheric conditions.

Southend and District Radio and Scientific Society

Headquarters: Strand Chambers, High Street, Southend, Essex.
 Meetings: Alternate Fridays at 8.15 p.m.
 Hon. Sec.: Mr. J. M. S. Watson, 23, Eastwood Boulevard, Westcliff, Essex.
 On April 14th Mr. J. F. Veevers, of the Government Contract and Instrument Dept. of E. K. Cole, Ltd., gave a lecture on "Radio Receiver Measurements."
 On April 28th a lecture will be given by Mr. G. P. Britton, of Steatite and Porcelain Products, Ltd.

Watford and District Radio and Television Society

Hon. Sec.: Mr. P. G. Spencer, 11, Nightingale Road, Bushey, Herts.
 A meeting was held on April 24th at the Carlton Tea-rooms, Watford, when a demonstration was given by the Hamrad Company.

British Automatic Lecturer

APPARATUS similar to that described on page 255 of our March 16th issue is marketed in this country by Visual Sound Equipment, Ltd., 10, Golden Square, London, W.1.

Two models are made and in the "Flat" model illustrated, a translucent screen measuring about 11in. x 15in. is incorporated in the lid. If required, a longer focus lens can be supplied for projection to a larger screen up to distances of 30 feet. The "Upright" model is suitable for larger audiences and has a more powerful projector lamp.

The sound is recorded on 10, 12 or 16-inch discs and the motor can be run at 33.3 or 78 rpm. A piezo-electric pick-up is used, and the 4-valve AC/DC amplifier supplies a 6½-inch Goodmans loudspeaker. The visual illustrations take the form of still pictures on a standard 35 mm. non-inflammable film usually five feet in length with about 75 frames.

Both models pack into a case constructed of 9-ply measuring 19in. x 19in. x 9in. and weighing approximately 45lb.



The "Audi-Vision" automatic lecturer projects "still" pictures from 35 mm. film with sound commentary or accompaniment from slow-running gramophone records.

Earthing

THE IMPORTANCE OF LOW-RESISTANCE CONNECTIONS

EVEN ignoring the purely radio aspects of the subject, the earth connection plays an important part in providing protection against shock and other untoward results of electrical breakdown in wireless apparatus. The importance of low earth resistance is stressed in this article, and methods of reducing resistance are described

By H. G. TAYLOR, M.Sc. (Eng.), A.M.I.E.E. (Electrical Engineer, Copper Devpt. Assoc.)

THE average owner of a wireless set knows that he provides an earth to improve reception, but he seldom realises that, with a mains-operated set, the earth is also necessary for protective purposes. Whatever the requirements from the point of view of reception—and considerable variation in characteristics is possible without a great variation in results—the requirements from the aspect of protection are very rigid. A set is not often protected with less than a 5-ampere fuse, and to blow such a fuse within a minute requires a total earth path resistance of not more than 23 ohms on a 230-volt circuit. In urban areas it may be assumed that the sub-station earth resistance is small and that the majority of the 23 ohms may be situated at the set earth electrode. In rural areas such an assumption would be unjustified because the supply is frequently obtained from a pole-mounted transformer where the earthing consists of a single pipe or plate which may have a resistance of ten ohms or even more in exceptional cases. To ensure the 5-ampere fuse blowing in such cases, the set earth electrode must have a correspondingly lower resistance.

Unless an appropriate value of earth resistance is obtained the fuse will not blow when there is an earth fault on the set, and this will give rise to the following possibilities:—

- (1) A risk of shock by touching the metalwork of the set or a bare earthing lead.
- (2) A fire risk due to the overheating of the earthing lead.
- (3) The risk of shock to human beings and animals due to voltage gradient

on the surface of the ground around the earth electrode.

- (4) Abnormal current consumption due to a fault which remains undetected for months.

These possibilities are no mere chimeras—cases have actually been known, and doubtless many faults have existed undetected and probably still exist to-day. With regard to item (4) it might be pointed out that a current of 5 amperes flowing to earth on a set used for an average of 6 hours per day would cost over 14s. per month if the current cost were one penny per unit.

Many different forms of earth electrode may be used, but for radio purposes the simplest and cheapest is the driven rod. Examples of this are shown in Fig. 1. The resistance of such electrodes, in fact of all electrodes, is not a contact effect between the metal and the soil, but is due to the resistivity of the soil itself. The type of soil has a very material effect on its resistivity, which may range from about 100 ohm-cms. in a salt marsh to 1,000,000 ohm-cms. in dry sand. The usual range of resistivities is, however, between 500 ohm-cms. and 50,000 ohm-cms. At the lower end of the scale is clay, which varies from 500 ohm-cms. up to several thousand ohm-cms. Then comes loamy soil, which can vary considerably according to whether it is wet or dry, and, finally, sand and gravel. In proximity to houses there is invariably a certain amount of loam and humus mixed with sand or gravel which tends to reduce the resistivity, but, nevertheless, the net value may be

of the order of 10,000 ohm-cms. or more. In such a soil the resistance of a 1-in. dia. electrode 6ft. long is about 50 ohms, which, it will be appreciated, is useless as a form of protection.

The resistance of rod electrodes is given by the formula:—

$$R = \frac{\rho}{83L} \cdot \log_{10} \frac{48L}{d}$$

Where ρ = soil resistivity in ohm-cms.

L = length of electrode in feet.

d = diameter of electrode in inches.

A curve based on this formula is shown in Fig. 2, where the earth resistance of a ½-in. dia. electrode is plotted against the length for soil having a resistivity of 1,000 ohm-cms. Where the soil resistivity has

some other value, say ρ^1 , the resistance may be determined by multiplying the value given by the curve by $\rho^1/1,000$. If the diameter of the electrode is halved or doubled, the resistance of a 6ft. rod is increased or decreased by some 12½ per cent., and it will, therefore, be clear that increase of length is much more important than that of diameter. For this reason, to obtain the lowest resist-

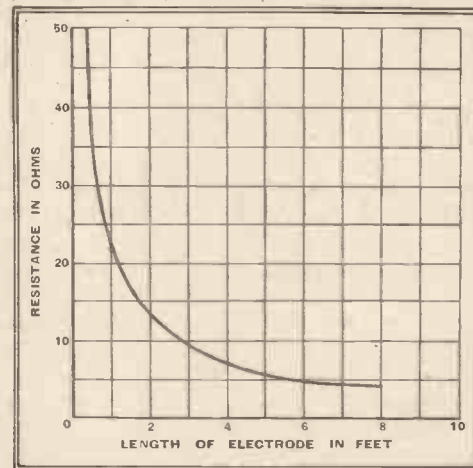

Fig. 2.—Earth resistance of a ½-in. dia. electrode in soil having a resistivity of 1,000 ohm-cms.

ance for a given cost, the tube or rod should have as small a diameter and as great a length as it is possible to drive into the soil. A particularly convenient form of electrode is a pointed ½-in. dia. hard-drawn copper-rod. By the application of a large number of light blows applied with a 2½- or 4-lb. hammer, such electrodes may be driven many feet into the soil.

The electrode normally used for wireless purposes is practically useless for protection. This is due to the fact that it is invariably too short. It will be seen from Fig. 2 that even in soil having a resistivity as low as 1,000 ohm-cms. an 18-in. to 30-in. electrode has a resistance between 10 and 20 ohms. This is in a particularly favourable soil—frequently the resistivity is much higher than 1,000 ohm-cms. at the surface, especially when drying out occurs in summer.

There are three ways of reducing the resistance: (a) by using a longer electrode, (b) by connecting several electrodes in parallel, and (c) by treating the ground around the electrode with salt.

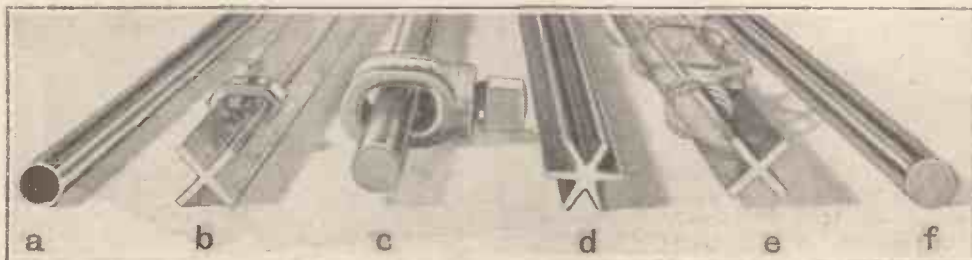

Fig. 1.—Copper earth electrodes of various types. (a) Plain copper tube; (b) "Anacos" rod (Frederick Smith and Company); (c) "Copperweld" rod (British Insulated Cables); (d) "Javelin" power earth rod (B.I.C.); (e) "Anacos" rod with different type of connection; (f) plain copper rod.

Earthing—

The first is the best and most satisfactory method, since by this means low resistivity moist soil is reached which does not dry out in the summer. The only disadvantages are the patience required for driving and the possibility of driving the electrode into other buried metalwork. Power engineers seldom use a length of less than 6ft.; 8ft. is common, and recent developments employing coupled rods and mechanical hammers for driving have shown the possibility of using lengths of 50 or even 100 feet of copper rod.

The second method (b) must be resorted to in addition to the first (a) in certain cases, but the electrodes should always be well separated. The effect of proximity is shown in Fig. 3, and indicates that at least 6ft. should separate the rods if possible. The third method of reducing the resistance, viz., the use of salt, is very effective, and, provided that sufficient salt is used, is very lasting in some soils. By this means the resistance may possibly be reduced by as much as 90 per cent., but this is only likely in a sandy soil which normally has a very high resistivity. In clay the percentage reduction is much less, but naturally it is not so necessary. For 6-ft. rods at substations 1 cwt. of agricultural salt is generally recommended—this may seem a lot for a radio earth, but it may be obtained for about 3s. 6d., provided that only a coarse quality is used. The usual

more effective than frequent watering.

In the early days of the electrical industry, it was customary to measure the resistance of earth electrodes by means of batteries, but considerable skill and

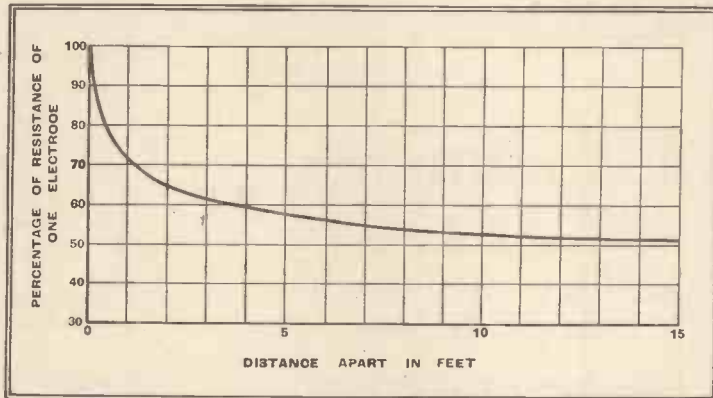

Fig. 3.—Variation of earth resistance with spacing of two 1-in. tube or rod electrodes connected in parallel.

trouble were required to secure accurate results. A much more convenient method is now generally adopted, using a special test set similar to a "Megger." Provided an AC supply, an ammeter and a voltmeter are available, a qualified person may, however, dispense with the use of a special instrument. If great care is used the earth electrode resistance may be measured by connecting up as shown in Fig. 4.

Methods of Measurement

The live wire of the supply is connected to the earth electrode for a few seconds through an ammeter, and a resistance of *not less than 100 ohms* and the voltage drop across the electrode is measured. For this purpose a temporary earth electrode is driven into the ground at not less than 10ft. from the radio earth and well away from any buried metalwork. The resistance of the voltmeter must be high compared with that of the temporary earth electrode or otherwise too low a voltage will be measured and too low a resistance calculated. If no voltmeter is available, an approximate idea of the resistance may be obtained by assuming the supply voltage, measuring the current, calculating the total resistance and deducting the known added resistance. If no ammeter is available, the resistance may be determined by comparing the voltage drop across the additional inserted resistance and across the earth electrode. In making tests of this nature, particular care should be taken to avoid the risk of shock especially when standing on the ground outside

the house, since in such circumstances an excellent earth connection is made by the feet; it is preferable to make all tests indoors and to run insulated wires to the earth electrodes before connecting to the supply. No one should be allowed near the electrode while the current is on.

Reference is made above to the risk of shock from an earth lead. This is most likely to occur if the earth electrode is of insufficient resistance to blow the fuse, but it can also occur if resistance exists at the fault point between the live wire and earth. To avoid the danger arising from such a situation the earthing lead on an all-mains set should always be insulated. Reference was also made to the danger from voltage gradient around an electrode. This is particularly steep adjacent to a rod, as is shown in Fig. 5. This voltage difference between two points on the ground surface may be felt by a person taking a long stride away from an electrode, and to cattle such gradients have proved fatal; to domestic animals they might at least prove unpleasant and, if such an animal touched the top of the electrode, might be dangerous. The

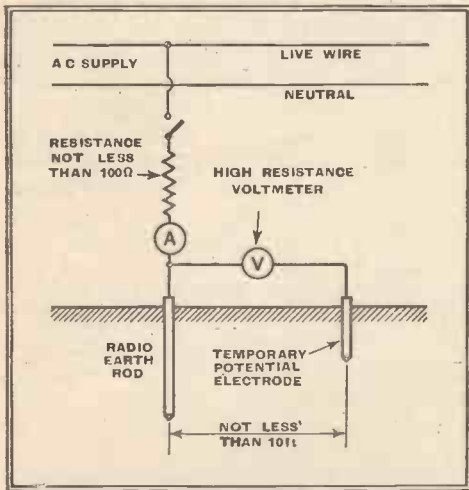

Fig. 4.—Circuit for measuring earth electrode resistance.

method of applying it is to excavate a hole about 4ft. in diameter and 18in. deep around the electrode, insert the salt, water it well and replace the soil on top—not forgetting that the soil will sink down as the salt dissolves. This treatment will maintain an electrode at a low resistance for several years, and is considerably

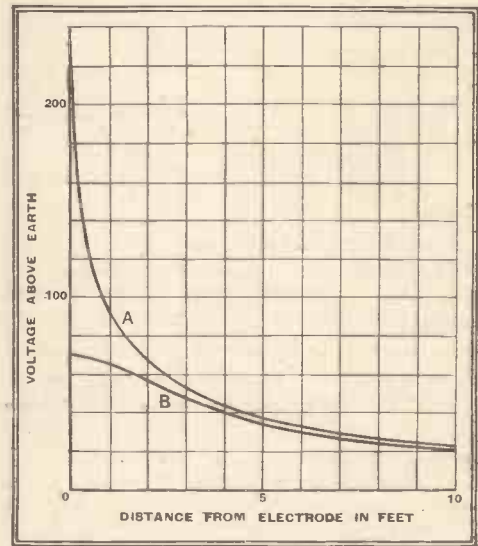

Fig. 5.—Voltage gradients around rod electrode. Curve A : upper end of rod at the surface. Curve B : upper end of rod 1ft. below the surface (or upper end insulated to a depth of 1ft.).

steepness of the gradient is very considerably reduced by insulating the top foot of the rod, and this may readily be done by slipping a length of earthenware pipe over it. The top of the electrode and the connection should then be insulated with tape, several coats of paint or preferably bitumen.



Fig. 6.—Typical clamps for making connection to a rod electrode.

Earthing—

To ensure the avoidance of corrosion at the connection a substantial bronze or other copper alloy clamp should be used; good examples are shown in Fig. 6.

It should never be forgotten that earths exist for protective purposes as well as to facilitate reception, and that because they

are more neglected than any other part of an electrical installation the very greatest care should be taken initially to install them correctly. The wires, clamps and rods should be of efficient design and adequate size, and they should be constructed of non-ferrous materials to ensure a long and satisfactory life.

for its operation input volts, it is surely preferable to express the output of a microphone by a system using tangible units, in which the actual rating is expressed in volts.

The frequency response is of great importance and is best expressed as the maximum variation in decibels (useful here as we are comparing like units) over the recommended ranges. It is felt that an actual graph is not essential except in special cases as it is difficult to produce one accurately and in any case the actual shape of the "curve" is inherent in the type rather than in the individual design. The same applies to the polar diagram, which is a circular graph showing the variation in output volts caused by the direction of the incident sound being shifted through various angles to the normal direction of operation. It should be borne in mind that in certain types of microphones this variation in the direction of incident sound considerably affects the frequency response curve.

The internal impedance or capacity are useful facts to know, especially in condenser or crystal microphones where these factors begin to be of such a high value as to make it difficult to match them to the amplifier.

The recommendation for the expression of output power of amplifiers is, in the case of a normal PA amplifier, the power delivered on the secondary of the output transformer to a correctly matched load. The frequency response (expressed in decibels) has also to include the performance of the output transformer. This is of the greatest importance as this component can sometimes be the weakest link in the PA chain. Many amplifiers have high undistorted output and a fine response curve on the anodes of the output valves, but a very different story has sometimes to be told when one considers the power and quality actually available to the speaker load.

A noteworthy distinction is made in the recommendations between the acoustically practicable working load of a loud speaker and the safe overload. These are both recommended to be continuous loads and not just mere peak powers. Power handling and impedance vary erratically throughout the audio spectrum, and the definition is intended to cope with this fact.

The electro-acoustic efficiency, although difficult to measure, is of great interest. As this figure can vary between about 3 per cent. and 45 per cent. it is well worth knowing.

The suggestion for standardising a 15-ohm impedance will surely meet with universal approval. It is suggested that this should be the mean impedance between 400 and 1,000 c/s as it may rise considerably above the minimum value at the limits of even this restricted frequency range.

The recommendation for lines suggests not only that cable of a standard characteristic impedance should be used, but that amplifiers should have a high-impedance output winding of this value.

Rating of PA Equipment

THE Council of the Institute of Public Address Engineers has long been impressed, as surely must be everybody connected with the public address industry, with the entire absence of any generally accepted standard basis for expressing the performance of public address equipment.

The Council set up a Technical Sub-Committee consisting of G. A. V. Sowter, B.Sc. (Eng.), A.M.I.E.E. (Chairman), N. Partridge, B.Sc. (Eng), A.M.I.E.E., and D. B. H. Robinson, A.M.I.R.E. (Secretary) to consider this matter. After some preliminary work a meeting was called to deal with some of the more basic definitions, and was attended by representatives of the R.M.A., the N.P.L., and other interested bodies.

The following extract from the minutes of the meeting has subsequently received the approval of the Council and forms the basis of its recommendations.

(1) MICROPHONES.

(a) **Sensitivity**, to be expressed in the form of EMF generated by a pressure of 1 dyne per square centimetre, the direction of the incident sound being that for normal operation of the microphone. The EMF is that value which exists across the secondary winding of the microphone transformer or load resistance and, in the case of condenser or crystal microphones the open circuit value. Values of internal impedance or capacity are also desired.

(b) **Frequency Response**. The variation in level expressed in decibels over a specified frequency range (such as 60 to 6,000 c/s) is considered adequate for general purpose instruments. The range might be extended to 30 and 10,000 c/s for high fidelity types.

(c) **Polar Curve**. Although it is appreciated that a polar curve involves a considerable amount of measurements, all available information is desired.

(d) **Distortion**. Where the type of microphone is known to be susceptible to distortion limiting values are requested.

(2) RATING OF AMPLIFIERS.

Maximum Input. The RMS voltage (across the stated value of input impedance) which will fully load the amplifier is to be specified.

Rated Output. The output is to be expressed as the true watts which can be dissipated in the resistive load of value, equivalent to the nominal load demanded by the amplifier. The permissible distortion should not exceed 5 per cent. harmonic content or, alternatively, should be expressed in accordance with R.M.A. definition the frequency range being specified and covering the alternative ranges of 60 to 6,000 c/s or 30 to 10,000 c/s as mentioned in connection with microphones.

In the case of pre-amplifiers, the output is to be expressed as the voltage set up across the specified resistive load.

Frequency Response. The variation in output level over one or other of the alternative frequency ranges for constant input voltage is to be stated:

Recommendations of the Institute of Public Address Engineers

By DONALD ROBINSON

(Gramplan Reproducers, Ltd.)

Noise and Hum Level. This is to be expressed in the form of energy level in decibels below the maximum output.

(3) LOUD SPEAKERS.

Loading. This is to be stated as the value of watts in the form of speech or music currents and voltages which can be handled without audible distortion. The electro-acoustic efficiency or values of maximum radiated energy are desirable.

Safe Overload. The value of maximum watts (speech or music)* which can be handled indefinitely by the speaker without mechanical damage is also requested.

Coil Impedance. In all cases the nominal value of coil impedance should be stated. It is suggested that the 15 ohms voice coil be recommended to manufacturers as likely to find most favour with PA engineers. The coil impedance is to be defined as the average measured value over the frequency range 400 to 1,000 c/s.

(4) LINES.

Where characteristic impedance is of importance, as in the case of lines longer than, say, half a mile, the recommended value is to be either 200 or 600 ohms. In view of the possibilities of coupling PA equipment to Post Office lines in the event of National emergency, the value of 600 ohms is preferable.

The remarks on the report given below, it must be noted, are but my personal opinion, and are set out to help people to appreciate the reasons behind our recommendations, and the necessity for them.

Dealing first with microphone sensitivity it was considered that the use of the decibel notation in this instance laid itself open to too many objections, and that the system recommended was more easily measured, more accurate and more in conformity with the suggested method of rating amplifiers. The decibel is not a tangible, defined unit like the volt, but a mathematical device utilised for the comparison of like units. The oft-used microphone rating of "so many decibels down" means just nothing unless a whole host of relevant data is also given. As an amplifier is a piece of apparatus requiring

* By this is meant that the output from a 12 watt amplifier is to be referred to as 12 watts speech or music, although it is appreciated that the mean output during the normal programme will be considerably less. The figures stated for speakers will thus be directly related to the rating of amplifiers.

NEWS OF THE WEEK

WAVELENGTH CHANGES

Great Britain's Position

ALTHOUGH the Montreux Wavelength Plan has been settled, whatever is said about our neighbours on adjacent channels and the stations with which it is planned we shall share wavelengths, it is entirely a matter of speculation until it is known what wavelengths will be adopted by the non-signatories, the U.S.S.R., Luxemburg, Greece, Turkey and Iceland.

British stations have, without exception, as is shown in the appended list, had their frequencies changed, and although most of the changes are comparatively small, it will mean that the tuning system of all receivers will have to be recalibrated when the Plan is inaugurated in March next year.

As most of the English stations will be sharing wavelengths, it is thought by some that Great Britain has been unfairly treated over the matter of exclusive wavelengths, for she now has only three; one long-wave and only two medium-wave. When the point was raised with Sir Noel Ashbridge, B.B.C. Controller of Engineering, he pointed out that, whereas it would be impracticable for central European stations to

share wavelengths, a peripheral country like Great Britain can do so, without fear of interference.

	Frequencies, kc/s.	
	Present.	Future
Droitwich	200	198.5
North Reg.	668	671
Westerglen (Scottish Reg.) and Burghhead	767	789
Washford and Penmon	804	871
London Reg.	877	916
Lisnagarvey	977	1051
Midland Reg.	1013	1087
London, North and Scottish Nationals	1149	1141
Stagshaw	1122	1186
Start Point	1050	1222
Norwich	—	1402
Aberdeen	1285	1411
Clevedon	1474	1465

Of the total of forty exclusive wavelengths in the medium band, Germany has eleven, Italy six (two of which must be used by several Italian stations), Russia four, France four (one to be shared by three French stations), Holland two, Spain two, one being the new Madrid frequency of 587 kc/s, and Lithuania one. On the long-wave band Russia has four exclusive wavelengths.

The question of the depth of modulation has also been settled at Montreux, and it is to be hoped that stations which continually overmodulate on speech in an endeavour to increase range will cease to do so.

MARINE COMMUNICATIONS

A Survey of the British Situation

AT the annual meeting of the Marconi International Marine Communication Company in London last week, it was announced that on December 31st, 1938, there were in force 7,725 rental contracts covering various types of wireless installations. This figure, which represents an increase of 730 such contracts during the year, was largely due to the replacement of spark sets required by international regulations. At the end of last month the re-equipment of approximately 750 vessels had been carried out.

Mr. H. A. White, the chairman of the Company, announced an increase of fifty per cent. in the number of rental contracts for short-wave installations during the year under review. He stressed the advantages in the present critical times of the world-wide communication which was possible with short-wave apparatus.

He then outlined the situation with regard to direction finding for trawlers, and welcomed the decision of so many ship owners to acquire wireless equipment for vessels of less than 1,600 tons,

which are not compelled by law to carry such equipment.

"The majority of British trawlers," said Mr. White, "are already fitted with the Marconi sounding device, and the importance of supplementing that equipment with a direction finder was strongly emphasised at the Board of Trade enquiry into the loss at Bear Island of the trawler *St. Sebastian*."

Ship-to-Shore Telephones

In addition to the Humber radio station on the East Coast, and the Seaforth station on the West Coast, the Port Patrick wireless station on the West Coast of Scotland has been equipped with apparatus by means of which wireless telephony transmissions from ships at sea can be linked up directly with any subscribers to the inland telephone service. Mr. White reported a marked increase in demand for wireless telephone sets which would enable vessels to benefit from this service, and stated that wireless telephone facilities for the remaining eight coast stations in the British Isles would follow.

R.A.F. CIVILIAN PERSONNEL

Appointments for Operators and Electrical Mechanics

AN offer of employment, which provides a means whereby wireless men can make their contribution to National Defence and at the same time obtain useful experience in aeronautical communications and in the operation and maintenance of modern radio apparatus, is made by the Royal Air Force.

To meet the immediate requirements for large numbers of trained wireless operators and wireless electrical mechanics in the expanded R.A.F., it has been decided to augment the supply of personnel trained at the R.A.F. Electrical and Wireless Schools by the employment of civilians.

Applications, which should be addressed to the Under Secretary of State (S.5.f), Air Ministry, London, W.C.2, are invited from candidates with a practical experience of wireless, including those who have gained their knowledge and experience as amateurs. The selected candidates will be employed as civilians for ground work at R.A.F. stations at home and, moreover, as near as possible to the districts which they choose.

Applicants' Qualifications

Civilian wireless operators must be capable of sending and receiving Morse at 20 words a minute, and should have had experience of WT communication. It is also essential to have a general knowledge of electricity and wireless receivers. The rate of pay for this trade is from £3 per week, with an annual increase of 3s. per week up to a rate of £3 15s. per week.

Civilian wireless and electrical mechanics must be qualified as wireless operators and must also be capable of installing, maintaining and repairing wireless and electrical equipment both for aircraft and ground stations. The duties involve testing and servicing aircraft transmitters and receivers and their associated equipment. The rate of pay for this trade is from £3 15s. per week, with an annual increase of 3s. per week up to a rate of £4 10s. per week.

The appointments will be on a temporary basis, although a proportion of suitable applicants are likely to be retained for some years. The rates of pay are inclusive and men engaged will, as in other civil employments, find their own lodging, food and clothing.



ON MANŒUVRES. "... the ranks are open to all interested."

MILITARY COMMUNICATIONS

Opening for Amateurs

SIGNALLING in the modern army is a combination of scientific methods and sharp wits. A signaller must get his message through, and when one means fails he must employ another. The principal means of inter-communication employed are wireless and line telegraphy and telephony and dispatch riders.

The Territorial Army is in need of recruits to the Signal Sections, not only for the actual sending and reception of messages but for the maintenance and repair of equipment. Whilst there is at the present time a serious demand for those already experienced in the handling of signalling and associated equipment, the ranks are open to all interested in the subject, who will be trained to specialise in one or more of the sections.

Further information can be had from the following headquarters:—

- LONDON CORPS SIGNALS, Fulham House, Putney Bridge, London, S.W.6.
- LONDON DIVISIONAL SIGNALS, 20, Atkins Road, Clapham Park, London, S.W.12.
- 44th DIVISIONAL SIGNALS, Stamford Brook Lodge, London, W.6.
- MOBILE DIVISIONAL SIGNALS, Duke of York's Headquarters, Chelsea, London, S.W.3.
- 203rd FIELD REGT. (Signal Section), Boudry Road, Chatham, Kent.
- 1st ANTI-AIRCRAFT DIVISIONAL SIGNALS, 56, Regency Street, London, S.W.1.

NEW B.B.C. TRANSMITTERS

THE B.B.C. has given a contract to Marconi's Wireless Telegraph Co. for the construction of two regional transmitters to replace Brookmans Park and Moorside Edge. The transmitters will work with a power

News of the Week—

of 120 kW, the maximum admissible, and they are to be completed by the spring of 1940, when the Montreux Plan comes into force.

The new B.B.C. transmitting stations at Start Point and Clevedon will be opened by the Right Hon. the Earl Fortescue, Lord Lieutenant of Devonshire, on June 14th.

Start Point, South Devon, will use a power of 100 kW and the wavelength of 285.7 metres, freed by the closing of the Washford transmitter. Clevedon will use a power of 20 kW and the wavelength of 203.5 metres, at present shared by the Plymouth and Bournemouth transmitters, which will also be closed.

TELEVISION PRESIDENT
ROOSEVELT

Great Inauguration for N.B.C.
Television

PRESIDENT ROOSEVELT will be televised when he gives the opening address at the New York World's Fair on Sunday, April 30th.

The opening of the Fair also marks the inauguration of the regular television service in New York, and both sound and pictures from the Fair ground will be relayed by the N.B.C. mobile television station and broadcast from the transmitter in the Empire State Building.

The present television schedule of the National Broadcasting Company provides for a minimum weekly service of two evening programmes of one hour each, but it is expected that outside events from the World's Fair will provide interesting material for additional transmissions.

POST OFFICE
ENGINEER-IN-CHIEF

Successor to Sir George Lee

THE Postmaster-General has appointed Col. A. S. Angwin, Deputy Engineer-in-Chief, to be Post Office Engineer-in-Chief on the retirement on May 31st of Sir George Lee. Col. Angwin, who served in the Royal Engineers throughout the Great War, had a great share in the design of the Post Office stations at Leafeld and Rugby, and has contributed largely to the solution of the problems of reception encountered in the establishment of commercial wireless telephony. He is a member of the Television Advisory Committee, and has represented the Post Office at many international conferences.

The post of Deputy Engineer-in-Chief will be filled by Mr. P. J. Ridd, who was largely responsible for the London radio terminals when the transatlantic wireless-telephony service was inaugurated in 1927.

MARINE ENTERTAINMENT

Advantages of a New System

SOME time ago the International Marine Radio Company, in collaboration with British Ozaphane, set out to devise a system of recorded sound reproduction for use in ships; this has now made its appearance as the I.M.R.C.-Duotrac. The system is one of sound-on-film recording, but

the reversing of the sound reels, had to be replaced by a micro-relay switch as every roll of the ship reversed the record!

Some of the advantages for marine use of the I.M.R.C.-Duotrac system are: Its freedom from surface noise, as there is no emulsion used; the recordings do not deteriorate after countless

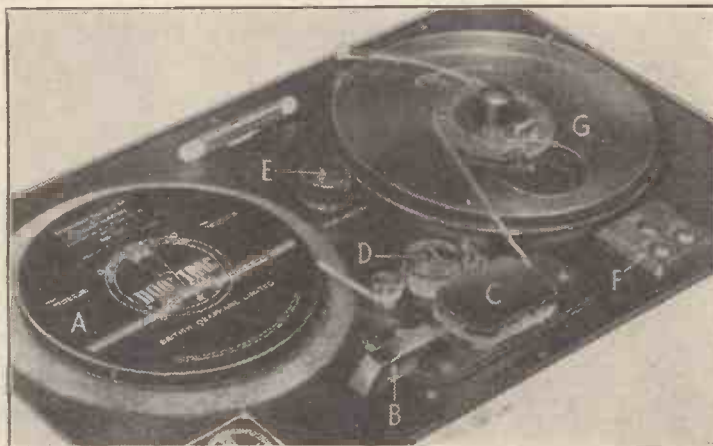

The playing desk of the I.M.R.C.-Duotrac. A is the reel of film which passes round the rollers D and past the exciter lamp and photo-electric cell B, round the optics gate C and on to the take-up reel G. E is the play-rewind switch and F the forward, reverse and stop press buttons.

whereas on ordinary sound-track film the photographic image is carried in an emulsion spread over a film base of celluloid or other material, on the I.M.R.C.-Duotrac sound film the image is actually dyed straight into the "Ozaphane" ribbon, and therefore cannot become worn or blurred.

The film, only an eighth of an inch wide, carries two parallel sound tracks. The track, with its varying black and white shapes, passes in front of a powerful lamp, so that continually varying areas of light pass through the track and play upon a light-sensitive photo-electric cell which translates the light back into electrical impulses.

Half of a recording is carried on each of the two parallel sound tracks, the upper track being played in the forward direction, and when the end of the film is reached the ribbon automatically reverses; the beam of light is refocused on to the lower track, which is then played in the reverse direction without any human intervention.

The instrument, which was installed and demonstrated on board the S.S. *Erin*, of the Standard Fruit Steamship Co., lying in the Royal Albert Dock, incorporated a Scott-Phantom receiver. Various modifications of the standard British Ozaphane Duotrac reproducer were necessary. Metal parts had to be treated to withstand the effects of the sea air, and a mercury switch, which normally operates

playings; they are non-inflammable; and, above all, the playing of the records is unaffected by the motion of the ship.

RADIO LINK FOR
SERVICE VANS

AN ambitious scheme of radio communication, designed to facilitate continuous contact with its service and repair vehicles, is being put into operation by the Yorkshire Electric Power Company which has a service area of over 3,000 square miles. Evolved by Standard Telephones and Cables in collaboration with the Power Company; it comprises wireless transmitters and receivers at three fixed stations together with two mobile outfits.

A frequency of 1,770 kc/s has been allocated to the service, which will be conducted by telephony. The two mobile stations and the main transmitter at Thornhill Power Station are rated at 250 watts and the others at 90 watts (carrier power); all will be crystal controlled.

FROM ALL
QUARTERS

Paris Excursion

A SPECIAL Whitsun week-end excursion to Paris has been arranged by Mr. S. Gould to enable readers of *The Wireless World* to visit the Paris Radio Show. The inclusive return fare from Victoria is £2 5s. 6d. No passports are necessary. Fares must be paid in by May 13th, and tickets and all information can be obtained from Mr. Gould, at 65, Shortcrofts Road, Dagenham.

Radio Fire Fighting

IN an attempt effectively to fight forest fires, which last year caused £40,000 worth of damage on some 2,000 acres of English forest land, the Forestry Commission is making enquiries anent the use of portable transmitter-receivers by forest rangers in areas where communication and transport are difficult. No tenders have so far been sought.

Sponsored Programmes from North

MR. OTTO SCHRAYH, a former Danish broadcasting announcer, is acting on behalf of a group of publicity agents. His recent offer to the Danish Broadcasting Organisation of a five-year contract involving six million kroner for the right to radiate sponsored programmes in English from Danish stations for a couple of hours daily was promptly turned down. He met with a similar setback when he made the same offer to the Norwegian authorities with regard to the use of the new 100-kW transmitter at Stavanger.

Electron Optics

A COURSE of six lectures on the above subject will be given by Asst.-Prof. L. C. Martin and Dr. W. D. Wright at the Imperial College of Science and Technology, South Kensington, London, S.W.7, on Tuesdays and Thursdays at 4 p.m., commencing on May 2nd. Students of the college and inter-collegiate students will be admitted free, but the fee for others is one guinea. Early application for admission should be made to the Registrar.

R.M.A. Publicist

THE Radio Manufacturers' Association has appointed Mr. A. John Dannhorn to its staff as publicity officer. He will be available at the Association's offices, 59, Russell Square, London, W.C.1, on Tuesday, Wednesday and Thursday mornings.

Cooling Marshes

MEMBERS of the Wireless Section of the I.E.E. are to visit the new Post Office Ray Diversity Station at Cooling Marshes, near Rochester, on May 27th.

MAY MEETINGS

Wednesday, 3rd, 6 p.m. I.E.E. Wireless Section, Savoy Place, London, W.C.2. "Audio-Frequency Equipment at the London Television Station," I. L. Turnbull and H. A. M. Clark.

Thursday, 4th, 5.30 p.m. Physical Society, joint meeting with the Chemical and Royal Meteorological Societies at the Royal Institution, 21, Albemarle Street, London, W.1. Discussion on "Chemical and Physical Investigations of the Upper Atmosphere," opened by Prof. F. A. Paneth.

Friday, 5th, 6 p.m. I.E.E. Meter and Instrument Section, Savoy Place. "Permanent Magnets for Integrating and Deflectional Instruments," D. A. Oliver.

Distortion in Recording Amplifiers

Part II.—Merits of Push-Pull and Parallel-connected Output Valves

By HUMFREY ANDREWES,
B.Sc., A.M.I.E.E.

IT has been explained that incorrect placing of the frequency correcting circuits can be a cause of distortion in records made with a recording amplifier, and it was shown that by replacing the fixed attenuator connected in series with the recording head, by a negative feed-back attenuator, distortion could be very considerably reduced. The discussion was mainly concerned with amplifiers in which the output valves were operated in parallel, and it is now proposed to give some comparisons that have been made experimentally between parallel and push-

fixed bass attenuation using a condenser with parallel resistance in series with the recording head, in effect an attempt is made to keep the impedance of the recording head circuit as a whole equal to the optimum load of the output stage and independent of frequency, but this is not very successful. In the case of the negative feed-back method, the load is allowed to fall, but at the same time the grid swing on the last stage is decreased, and hence overload does not occur at the lower frequencies.

Fig. 4 shows how these effects work out in practice. A typical recording head was connected to an amplifier consisting of four resistance capacity coupled stages, the output stage being two DO24's in parallel. A valve-voltmeter was connected across the input and fed from an audio oscillator. Curve (A) shows the input volts, for overhead point, plotted against frequency with the recording head directly connected to the amplifier, that is to say without any fixed bass attenuator. Curve (B) is taken under the same conditions but using the condenser and parallel resistance attenuator. Curve (C) shows the effect of using a negative feed-back bass attenuator. A cathode-ray oscillograph was connected across the output of the

IN this article the author describes some experiments undertaken with a recording amplifier in order to ascertain whether push-pull or parallel-connected output valves yield the better results.

ance of the recording head. In the case of Curve (B) conditions are better, but far from satisfactory. Curve (C) clearly shows the advantage of the negative feed-back method, and indicated that under these conditions the overload point of the amplifier is practically independent of frequency, as, of course, should be the case.

It was also found that, on measurement, it was possible to obtain a slightly higher voltage across the recording head before overload occurred over the whole frequency range using the negative feed-back arrangement. For example, at 500 c/s, using the condenser-resistance circuit, the maximum RMS voltage obtainable was approximately 120, whereas using the negative feed-back method this voltage

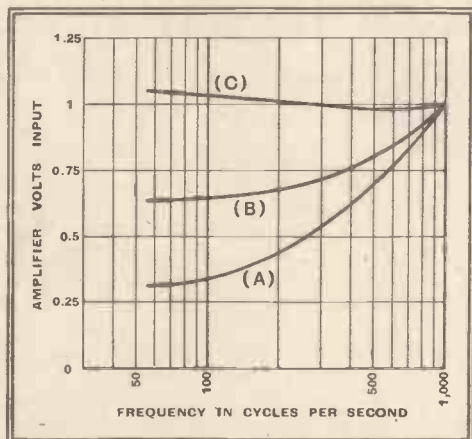

Fig. 4.—Curves relating input voltage and frequency for a recording amplifier; (A) with no correction, (B) with resistance and condenser bass attenuator and (C) with negative feed-back bass attenuator.

pull operation, and also some experimental results showing the advantages of the negative feed-back bass attenuator.

Parallel Output Valves

Let us first reconsider the case of the parallel-connected output stage, resistance-capacity fed from the penultimate stage. The milliammeter in the anode circuit of the output stage will remain steady until overload occurs and as this increases will at first rise slightly and then fall sharply. This phenomenon is, of course, very well known and is sometimes referred to as "blocking." It is often accentuated in the case of a recording amplifier due to the load conditions imposed by the recording head. As was explained in Part I, the impedance of the recording head inevitably falls with frequency, and hence the grid swing allowable without distortion also falls with frequency. An examination of the load line curves of the particular output valves will readily confirm this point. In the case of the first method of

Fig. 5.—A push-pull experimental amplifier using negative feed-back frequency correction.

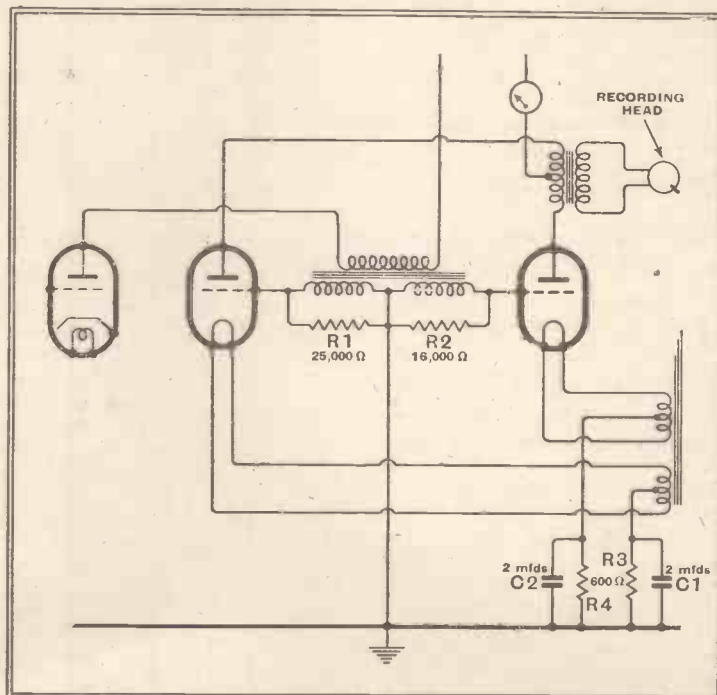

amplifier during these experiments to assist in determining the exact overload point, although it was found in practice that the movement of the output milliammeter was just as accurate a method. It will be seen that in the case of Curve (A) the input voltage drops badly towards the lowest frequencies observed, clearly showing the effect of the drop in imped-

rose to 150 volts RMS under otherwise similar conditions. A comparison was made next between parallel and push-pull operation of the stage feeding the recording head.

The experimental amplifier used in the previous experiments was altered so that either parallel or push-pull output could be used at will. It was decided to use

Distortion in Recording Amplifiers—

transformer coupling to the output stage instead of resistance-capacity for the following reasons. In the first place, it was, in this instance, simpler to arrange, as no phase reversal valve was involved. Secondly, nowadays it is possible to obtain quite satisfactory input transformers and no loss in frequency characteristic need be feared over the range of frequencies to be dealt with. Thirdly, by using transformer coupling the resistance of the grid circuit of the output valves may be kept low, and the blocking effect at low frequencies avoided.

It is, of course, very important in recording work to use robustly constructed transformers, as they may sometimes be subjected to severe strains, and for these experiments an intervalve transformer manufactured by N. Partridge, Type IV120, was used. This transformer does not require to be parallel fed, and it has a low turns ratio.

To obtain exact balance of the two halves of the secondary, resistances of different values were connected across them as shown in Fig. 5, which is the

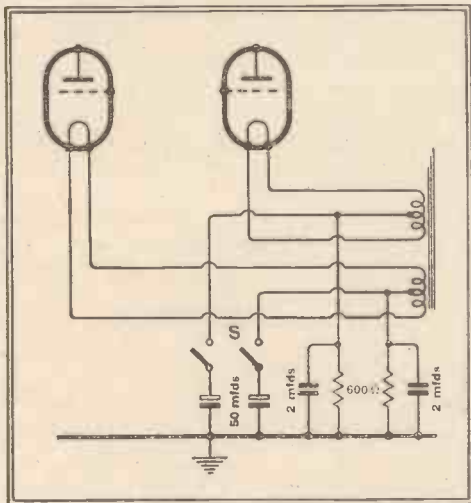

Fig. 6.—Switching to restore amplifier characteristic to linear form for "Playback" purposes.

arrangement of the last stage of a push-pull experimental amplifier. It will be noted that negative feed-back frequency correction is used. The bias resistors are, in this case, 600 ohms and the by-pass condensers 2 mfd. The attenuation curve of the push-pull amplifier was checked and found to be satisfactory.

Parallel versus Push-pull

A comparison was now made between the two amplifier arrangements to observe the voltage output which could be obtained without overload in each case. At the same time the wave form was observed with the oscillograph connected across the output of the amplifier.

It was found that, with a parallel amplifier, a really good wave form was maintained up to 150 volts RMS across the recording head. With the push-pull amplifier, however, 200 volts could easily be reached, and at that voltage the wave form was still good. The same recording

head was used throughout for all the experiments. These figures show the improvement in the handling capacity of the push-pull arrangement, though the increase was not as large as the author had anticipated. Recordings were now made to compare the push-pull and parallel circuits, and the results clearly indicated that the former was definitely superior.

It was found that if either amplifier was worked well below the overload point, there was no noticeable superiority in either arrangement. When, however, recordings were made where it was impossible to avoid slight overloads on peak modulation, on replay the distortion was most obvious with the parallel circuit. With the push-pull output, on the other hand, only by careful listening was it possible to detect distortion.

In changing from parallel to push-pull it was found convenient to arrange a

double pole switch in the output valves' bias circuits, so that the capacity of the by-pass condensers across the bias resistances could be varied at will. This gave a "Record-Playback" switch as shown in Fig. 6, so that we may have a flat characteristic when the recording head is disconnected. The by-pass capacity will then be the usual 50 mfd.

In the case of this amplifier a volume level indicator, an AC voltmeter reading up to 200 volts, was connected across the recording head terminals. In observing this it has to be remembered that low-frequency peaks will not give such a high voltage reading as the higher frequency ones owing to the action of the bass attenuator.

In conclusion the writer wishes to state that these notes are intended as a guide to obtaining better recordings, and the article is not a comprehensive treatment of the subject.

Random Radiations

By "DIALLIST"

An American's Views

AN American friend, who is one of the pioneers of radio, has just sent me a letter, a considerable part of which is devoted to the prospects of television in his country. He doesn't believe that it is going to make anything like the splash predicted for it by the lay and the popular technical papers of the United States. His view is that the small screen—7in. by 5in. or thereabouts—won't appeal to Americans. "I have seen a football game televised," he writes, "on such an instrument, and it did not thrill me; too much like looking at it through a telescope." The bigger-screen television receiver doesn't appear to have been developed to any great extent over there, and he feels that if and when it does come it will be too expensive for the average household. I gather from what he tells me that American technique is still some way behind ours, for I can't say that I've been struck, when viewing the Alexandra Palace transmissions, by such imperfections and shortcomings as he mentions. I've an idea that once television has had time to find its feet in America my friend will be much more favourably impressed by what he sees on the viewing screen.

Ambitious Plans

If television doesn't catch on in the U.S.A. it won't be for want of a good start. It's not going to be confined to just one area, for besides the Radio City plant in New York itself there will soon be the G.E.C. transmitter in the Helderberg Hills, near Schenectady. Owing to its high position this station is expected to have a wide service area. It is some 150 miles from the middle of New York City; when both it and the Radio City transmitter are at work a large part of the State of New York should be covered, as well as considerable portions of Vermont, New Jersey, Massachusetts and

Connecticut. It is now announced that the Crosley Company which runs the giant WLW, has applied to the Federal Communications Commission for a licence to transmit television, and has earmarked the 48th floor of a 574ft. building for studios. Cincinnati lies nearly 600 miles from New York in the south-west corner of Ohio. If the licence is granted the station's service area would lie not only in that State, but partly in Kentucky and Indiana as well. So here are three projected stations right away, and others are under consideration.

Higher Frequencies

It is interesting to note that the U.S.A. television stations are likely to operate on higher frequencies or shorter wavelengths than the Alexandra Palace station. The latter transmits vision on 45 Mc/s (6.67 metres) and sound on 41.5 Mc/s (7.23 metres). The band at present set aside for American television is 50-56 Mc/s (6.00-5.36 metres), and one has heard even higher frequencies suggested as not unlikely. Given equal power output, which will probably have the wider service area, a station transmitting on 45 Mc/s or one on something above 50 Mc/s? On such data as we have it's almost impossible to say. On the face of it, one might expect quasi-visual characteristics to be more and more in evidence, with a consequent reduction in the service area radius as the frequency is increased. But the ultra-short waves may have some surprises in store for us yet. Sound transmissions made on very high frequencies in the United States have been received in this country.

Too Much Power?

FOR just five years the Cincinnati station WLW has been broadcasting with an output rating of 500 kilowatts. Now the

Federal Communications Commission has revoked its licence, and unless this decision is quashed on appeal it may have to revert to its pre-1934 allowance of 50 kilowatts. It is rather interesting that each increase in the station's power has been a tenfold one. It opened in March, 1922, with a 50-watt transmitter. Subsequently this was replaced in succession by 500-watt, 5-kilowatt, 50-kilowatt and 500-kilowatt plants. The main objection to the station's use of 500 kW was apparently that it swamped the smaller and less selective receivers when they were used at fairly close quarters. Against that must be set the vast area that it covered. The station has often proved disappointing in this country in the small hours when other U.S.A. stations on shorter wavelengths were coming in well. A year or so ago a reader suggested that this was because WLW was not allowed to use its full power before midnight. I have it on the authority of Mr. Powel J. Crosley himself that, except for a few months immediately after its opening in 1934, the station has used the whole of the 500 kilowatts at all times.

Talkie Quality

A SWINDON reader sends me what he believes to be the explanation of the villainous quality of the sound reproduction in cinemas, about which so many have complained. According to him, the control of the sound reproduction is now left to the already overworked projectionist. In his box he cannot hear properly what goes on in the auditorium, and even could he do so he would have little or no time to make the adjustments of the monitor and volume controls that are called for by changes in the size of the audience, in the temperature and so on. Nor, again, can he use his control knobs to minimise the effects of those bad patches in recording which do occasionally occur or those of scratches and oil on the surface of a worn film. Those who run the ciné theatres seem to have found that their audience cared too little about the quality to make it worth while for them to maintain staffs of sound engineers. According to my correspondent, the guiding principle now is: "As long as nobody complains that he can't hear, all is well; so shove the fader well up and leave it there"! That's what it sounds like.

No New Thing!

WERE you to ask a number of your friends when the heterodyne or beat principle was discovered, many of them would no doubt reply that it didn't date back much beyond the early days of radio. I knew that the discovery was made long before that with regard to sound waves, but I'd no idea until just the other day that it is now two whole centuries old. I was looking up something or other in an encyclopædia when a paragraph on an entirely different subject happened to catch my eye as I turned the pages. That's the worst of encyclopædias! Don't you often find, when you're turning up something, that you come across so many interesting things on your way to it that your search takes far longer than it should? Before now I've become so engrossed in some article that simply cried out to be read that I've been hard put to it to recall what I originally set out to look for! Anyhow, whilst I was seeking Table, Mathematical, the words "a third note is heard, whose vibration number is the difference of those of the two primary notes"

forced themselves on my attention, and I had to stop to read the article containing them, which was headed Tartini, Giuseppe (1692-1770).

Try It on the Dog—Whistle

Tartini was a violinist, not a man of science, though he was interested in the theory of music. He discovered the sound-wave heterodyne beat about 1740, and used to tell his pupils that their double-stopping was not in tune unless they could hear the true beat note. I've come across people before now who were sceptical about the existence of audio-frequency beats. There's rather a striking way of convincing such that they do exist if you can get hold of a couple of the "silent" dog-whistles invented by Professor Galton. These produce a note whose pitch is some way beyond the highest frequency audible by the human ear, though dogs hear it well enough. They are tunable, and, by a little fiddling with the screws that vary the pitch, you can so adjust a pair that, though nothing is heard by the average human being when either is blown separately, a strongly audible beat note is produced when both are blown simultaneously. The discovery of sound-wave beats seems to have been made quite independently and almost at the same time by Tartini and Sorge.

Wavelength Changes

AFTER several strenuous weeks devoted to working out a new wavelength plan for Europe, the Montreux Conference has come to an end with, no doubt, sighs of relief from its members. Thirty-one nations have signed the undertaking to abide by the decision of the Conference, and, as usual, there are a few irreconcilables. These are Greece, Iceland, Luxembourg, Turkey and Russia. It looks as if failure to see eye to eye with the rest in the settlement of long-wave problems was the reason why four of these countries did not sign up. At present Russia is operating nine long-wave stations, Turkey two, and Iceland and Luxembourg one apiece. There seems to be no hope of finding a distribution of long-wave channels that will give satisfaction to all. The plain truth is that almost every country wants one of these channels, and there are not enough to go round. Greece is just beginning to develop a broadcasting system. Her only stations now are the 15-kilowatt Athens, which shares 601 kc/s with Rabet, and a small transmitter at Salonica, which

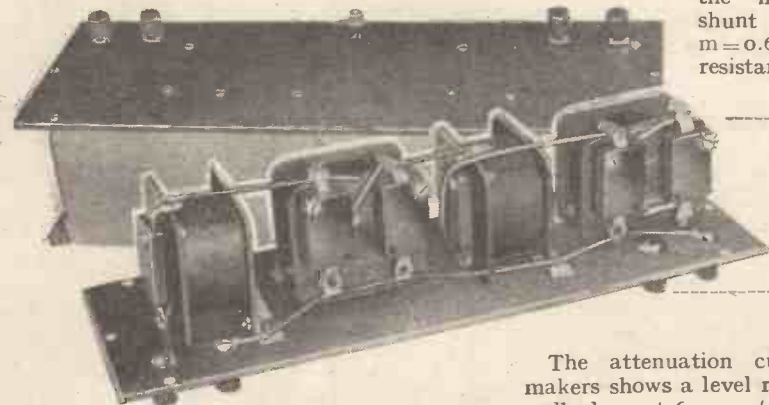

The Haynes low-pass filter is designed to give a sharp cut-off above 6,000 c/s.

has somehow managed to acquire the queer-looking frequency of 1,363.5 kc/s. It is reported that there will be some change in Droitwich's channel, though I do not think it will be a big one.

The Medium Waves

It is good news that Holland and Romania have signed up. Probably they have had rather more than enough of sharing a long-wave channel to their mutual disadvantage. There are sure to be a great many changes on the medium waves, for the number of stations and their average output rating have both increased a good deal in the six years that have passed since the Lucerne Plan was drawn up. One only hopes that it has not been found necessary to base the new plan for the medium waves on a separation of less than 9 kilocycles. Anything smaller would have evil effects on the reception of any but local stations. Sideband splutter is annoying enough at times with stations 9 kilocycles apart; it might well become vastly more so with a smaller basic interval. When the details of the new Plan are published I expect to find greater use made of national and international common wavelengths for the lower-powered relay stations serving comparatively small areas.

The Wireless Industry

A VERY well prepared and illustrated catalogue of Clix radio and electrical components has just been issued by British Mechanical Productions, Ltd., 79a, Rochester Row, London, S.W. 1.

The newly formed Hartley Turner Radio Company, 92, Queensway, London, W. 2, have introduced a radio receiver unit (RF41) for use in conjunction with existing power amplifiers. A leaflet giving a technical summary is available.

The Welburn Type A412 high gain amplifier is described in a leaflet issued by Welburn Radio, Ltd., Queensway, Team Valley, Gateshead-on-Tyne.

The address of Armstrong Manufacturing Co. is now Walters Road, Holloway, N. 7. Telephone No.: North 1784.

Haynes Low-pass Filter

DESIGNED primarily for connection between a quality receiver unit and its amplifier, this filter is designed for a cut-off frequency of 6,000 c/s, and should prove useful for gramophone reproduction to reduce surface noise as well as for removing heterodyne whistles on distant stations.

The filter consists of two intermediate pi sections, one of which is shunt derived with $m=0.4$, and the other of constant K ($m=1$). The terminal half-sections are of the mid-series connected shunt derived type with $m=0.6$. The terminating resistance is 23,000 ohms.

The attenuation curve taken by the makers shows a level response to 5,500 c/s, 1 db drop at 6,000 c/s, 38 db at 6,500 c/s and 50 db at 6,900 c/s.

The dimensions of the unit, which is housed in a metal box with bakelite top panel, are 9½ in. x 3½ in. x 3½ in., and the price is £2.

UNBIASED

By FREE GRID

More Snobbery in Our Ranks

I READ with very great interest the letter which was published recently in *The Wireless World* (page 258, March 16th) about "Short-Wave Snobbery." To my mind a far worse form of snobbery is that which exists among wireless experimenters of a certain type who regard it as a sign of superiority to decry all wireless developments which make the handling of a wireless set easier for the ordinary individual.

Not so very long ago these gentry were all decrying the ganging together of the various tuning condensers of a set in order to provide one-knob control, and now certain of them are attacking push-button tuning. I well recollect some forty years ago the look of withering scorn with which one of the experimenters of the old Hertzian school endeavoured to shrivel me up when he found me using an ultra-modern coherer in place of the old Hertzian resonator, but I am happy to say that I survived it.

It is, however, some remarks that I have recently been reading about push-button tuning which have got under my skin. Let me say in the first place that I am as keen an experimenter as anybody, and my laboratory is a place to which I would not be ashamed to invite any wireless enthusiast. It is, however, the ordinary set-owning citizen whom I am defending. He is, I am told, thoroughly lazy, and his shortcomings in this direction are being pandered to by the wireless manufacturer. A similar accusation has



Dictating to my houri.

been made in connection with every single invention designed to make wireless more trouble-free; even the development of mains-operated sets was, I recollect, sneered at as pandering to the laziness of the man who did not want to lug his heavy accumulator to the charging station.

Push-buttons are here and have come to stay until something better takes their place. This year, of course, laziness is

being taken a step further by sticking the buttons on an extension unit for armchair use. It is not very hard to tune an ordinary set, but it is certainly easier to push a button. After all, who would want to give up the electric light switch in favour of a variable rheostat and a voltmeter or "magic tuning eye" to indicate when the voltage across the lamp was correct? We who suffered in the old gas-lighting days from the necessity of fiddling about with the air-inlet adjustment were glad enough to welcome the electric lighting switch. If push-buttons make ordinary wireless listeners lazy, well, good luck to them. I only wish somebody would invent something to enable these few thoughts to be transmitted directly to paper without the necessity of clapping my hands to summon an houri to come and take them down. If you inventors can think of anything I will willingly give you the houri in exchange.

Sea Breezes

SEVERAL readers who live at the seaside have written to me to refute indignantly the aspersions which they allege that I cast on their respective home towns in my notes in the April 6th issue, in which I lamented their lack of enterprise in not attempting to provide public televising rooms for the edification of their visitors. In the first place, my correspondents state that so far from being damp, chilly and windswept, the beaches and piers of these resorts were warmer and sunnier than the olive groves of Italy during the Easter holidays. This is admitted, but one swallow does not make a summer, any more than it does a decent drink. As for television, one reader, writing from a very well-known waterside town, challenges me to name any metropolitan borough of equivalent size having an equal number of television aerials. I shall certainly not take up the challenge as I can well understand television being badly needed at this particular health resort, if only to see the sea when the tide goes out.

A Post Office Plot

ALTHOUGH, as a good wireless man, I am rather taken aback at the P.M.G.'s poaching activities in connection with his recently-announced broadcasting-by-phone system, I am not one to bear ill-will, and have decided to have the system duly laid on at home as I think it will serve as a useful check on the quality of reproduction given by the various broadcasting stations; in fact, I think it will result in a veritable eye-opener, or ear-opener, as I suppose I

should say, in the matter of the poor quality churned out by many broadcasting stations, not excepting certain of those belonging to the B.B.C.

The P.M.G. is going to supply us with transmissions having a very wide frequency band indeed, and our receivers and amplifiers will have to be fully up to snuff in the matter of quality if they are going to do justice to them. What I wish to point out, however, is that it is of little use our building first-class receiving apparatus if the broadcasting stations are



I got into touch with one of my spies.

only putting out a restricted frequency band. Obviously, if the P.M.G. picked up the B.B.C. transmissions on a wireless set in the ordinary way, his wide frequency efforts would be a sheer waste of time because they could produce no better quality than that which they picked up from the transmitting station.

I understand, however, that the P.M.G. will short-circuit the B.B.C. transmitters by taking programmes straight from the control room by landline. We shall thus be able to discover for ourselves by direct comparison just how far the wireless transmissions fall short of really good quality, and, as I have already said, we are likely to have an ear-opener. According to the information so far available, we are to get only B.B.C. programmes from the P.M.G.'s landlines, no bacchanalian revels from the Continent being permitted. As no fewer than four programmes are to be provided by the P.M.G., I at once smelt a rat, for with all the diagonalising of programmes that the B.B.C. does, the P.M.G. will sometimes be hard put to it to rake up four separate programmes to give us.

Naturally I at once got into touch with one of my paid spies in the Post Office telephone service, and I am told that the ever-resourceful P.M.G. has thought of this and intends, on such occasions as there is not a fourth programme available, to switch us over to a microphone permanently installed among the riveters in a well-known ship-building yard. He argues that by this means he will satisfy the tastes of people at either end of the listening scale, as both jazz and chamber music addicts will mistake the noise for their favourite brand of music, and as for us great band of middlebrows, we are, he reckons, so used to being ignored by the B.B.C., that it won't worry us and we shall let him get away with it.

Letters to the Editor

The Editor does not necessarily endorse the opinions of his correspondents

Interference Suppression and Engine Performance

THE article, "Suppression and Car Performance," in *The Wireless World* of April 13th is one which has long been needed, and is none the less interesting to me because the author's findings run almost entirely contrary to my own experience.

My car is a 9 h.p. Singer Le Mans sports model, with a high-compression, overhead-camshaft engine which depends for its power upon fast revving. The ignition system, including the plugs, is in very good condition. The previous owner had fitted it up with a suppressor in the HT lead near the distributor, but none in the plug leads. I left this in, and made careful note of the starting, tick-over, slow running and maximum speed, and of the petrol consumption. After about 3,000 miles I took the suppressor out. There appears to be no difference in the starting, tick-over or slow running, but the engine is very definitely more lively at high speeds, gives better acceleration, and about 4 m.p.h. better maximum. The petrol consumption also has improved by 3 m.p.g. and the engine does not seem to get so hot when pulling up a hill, though this may be imagination.

The suppressor was not at all efficient on the short waves, though it made it possible to use a medium-wave set in the car. If such a system has a notable effect on performance, I find it hard to believe that a thorough system of suppressors in each lead would not have a marked effect.

It would be most interesting and helpful to know what types of engines are most affected, and why. RICHARD MORT.
Teddington, Middx.

Inert Dry Cells

YOUR contributor, "Diallist," in the April 6th issue of *The Wireless World*, in mentioning in his second paragraph the use of inert cells for an HTB, awoke the recollection that, during the war, cells of this type were used for applying the anode potential to a Round valve doing service at the old SUC station at Abu Zabal, Egypt.

Valves in those days were as temperamental as a prima donna, and I recall my misgivings at the time when these same inert cells momentarily varied in their output as a result of inconsistent chemical reaction. The voltage drop or rise, according to the mood of any one particular cell at the moment, was sufficient to alter the total voltage on the anode and to cause the valve to jib. And this after careful nursing to get it to function at all!

During 1916, when in the tropics, I ordered from the United States two de Forest audions by way of satisfying my curiosity as to the truth of all the claims made for them. From a native ship's chandler I was able to procure a number of very dusty and battered inert cells, presumably of the type discussed by "Diallist," and with these, a tapped loose-coupler made up of two tubes, one sliding within the other, a 0.001 mfd. variable air condenser and my two audions, I received over what were then enormous distances. Bearing in mind that the signals received were from spark stations using in most cases a

transmitter rated at something like 5 kW, the results were beyond my wildest hopes, and save for an occasional "blueing" of the valves following a tropical atmospheric, reception was uninterrupted.

Twenty-three years have passed since those days, during which the valve has developed out of all recognition, both with respect to sensitivity and stability. That being so it seems to me that an HTB made up of inert cells to-day would give results equal to those obtainable with standard dry cells and at the same time overcome that problem of shelf life so annoying to battery users and sellers alike.

With A.R.P. so much under discussion the time seems opportune for some enterprising manufacturer to put on the market a battery of inert cells, made up in a neat wooden case with carrying handle, ready for an emergency and so designed that the cells may be replaced as desired.

London, E.C.4. STANLEY G. RATTEE.

"Estimating Coil Inductance"

I NOTE with interest the simplified inductance formula "widely used in America" which is quoted on page 364 of last week's issue.

This is actually a modification of the formula originally devised by myself as far back as 1925, and published in "Radio Communication," "Short Wave Radio" and other of my works.

The full formula may be used for solenoids or multilayer coils, a second term being used in the latter case. As a matter of interest I give the formula below.

$$L = \frac{0.2 N^2 D^2}{3.5D + 8l} \quad \begin{matrix} D - 2.25d \\ D \end{matrix}$$

omit second term for solenoids.

Note that D is the outside diameter.

Dimensions in inches; L in microhenrys.

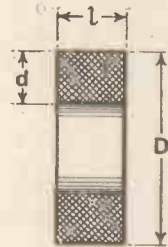

J. H. REYNER.
Boreham Wood, Herts.

Best Reproduction Level

I WAS pleased to read the letter from J. R. Hughes (*The Wireless World*, April 13th), as I share his views on the fallacy of the usual argument about scale distortion. Assuming a high-fidelity receiver with the necessary power-handling capacity there is only one correct setting for the volume control; that is, such that the sound intensity produced by the loud speaker at the ear is similar to that produced at the ear if the listener were seated in the ideal position in the concert hall. It is the function of high-quality apparatus to provide realistic reproduction; not to provide a musical background for a game of bridge. In "Talking Pictures and Acoustics," by C. M. R. Balbi, occurs the following statement "The first important step regarding the design of an auditorium for reproduced sounds has been to determine that for satisfactory listening conditions and for satisfactory illusion the

average sound level should approximate to 70 decibels above the threshold of hearing."

Although this refers to reproduced sound, it is obvious that for reproduction to be realistic the average sound level must be approximately the same as the original. It is therefore safe to assume that a listener seated in an ideal position in a concert hall experiences an average sound intensity of this order; i.e., 70 decibels above the threshold of hearing.

I now have a suggestion to put forward for the benefit of listeners who possess high-fidelity equipment. Would it not be a help if the B.B.C. introduced a means by which the listener could adjust his set to the correct volume level? This might be done as follows: Suppose a concert is to be broadcast from the Queen's Hall, a note of, say, 2,000 cycles could be fed into the microphone at a level 70 decibels below the average level of the concert that is to follow. The listener seated in his home, in the actual position he is to occupy during the concert, could by means of a remote volume control adjust his seat until he could only just hear the note; this would fix his threshold of hearing and the concert which would follow at an average level; 70 decibels above this note would therefore be at the correct volume.

Of course, the figure of 70 decibels is used here mainly to illustrate the principle involved. It may be that different types of programme would require different volume levels, in which case the intensity of the original note would be adjusted accordingly. Also, as loudness is bound up with reverberation period, the difference in acoustical properties between the average living room and a concert hall would have to be taken into account in the fixing of the intensity of the original note.

A note of 2,000 cycles is suggested, as it is right at the bottom of the audition curve, but in practice two or three notes of different frequencies would probably be desirable, as speakers often have a resonance around 2,000 cycles, which would upset the working of the scheme.

Possibly there are not yet sufficient really good receivers in use, or sufficient listeners who desire to get the very best out of their sets, to render this scheme worthwhile, but in any case I should be interested to read other listeners' views. G. M. LE TALL.
Sheffield, 2.

I SEE that Mr. Hughes has revived the old "Scale Distortion" controversy, and although his statements are very sound, I fail to see his complaint against the article in question, which surely implies intensity at the ear when it mentions loudness.

As "Cathode Ray" has once more pointed out in last week's article on "Bass":

"Intensity . . . does not necessarily demand the full power of the original sound source."

The fact remains, however, that if for any reason (usually domestic) the intensity at the ear in the home is less than the intensity at the ear in the concert hall, then drastic tone correction is necessary to maintain the

tonal balance, though I agree with Mr. Hughes that it is not "high fidelity," although it may be quite a pleasing noise.
DOUGLAS WINGET.

London, N.W.10.

"Light Storage in Television"

AN interesting abstract under the above title appeared in the March 30th issue of *The Wireless World*.

It may be of interest to your readers that nearly eleven years ago, in 1928, I conducted experiments of a similar nature, and was granted a British Patent No. 320,993, dated August 24th, 1928, relating to the reflection of light from a composite plate under the impingement of cathode rays to be used in television and telecinematography.

The late Mr. Campbell Swinton took a considerable interest in the scheme, and I had the pleasure of visiting him many a time at his house in Chester Square as well as at the Athenæum.

Recently, Marconi's Telegraph Co., Ltd., has been granted a patent of a similar nature; and Mr. Puckle's references to this subject in his articles in *The Wireless World* relating to cathode-ray tubes are also of considerable interest.

London, N.1. D. N. SHARMA,
B.Sc. (Hons).

"Steel Aerial Mast"

IN connection with the article on building a steel mast in *The Wireless World* of April 6th, I think the following verse is appropriate:—

When British multitudes observed with frowns,

That those who came before had spoiled the towns,

"This can no longer be endured," they cried,

And set to work to spoil the countryside.

Farnham, Surrey. R. H. PAYNE.

YOUR recent article on the home construction of an aerial mast from steel conduit tubing is welcome, if only for the encouragement it gives to those of us who realise that an effective aerial system is a vitally important part of an efficient receiving installation.

May I submit, however, that the appearance of the mast would be improved if the supporting stays were taken from the centre point instead of from the top? This method of staying would also resist the torsional strains mentioned by the author in his last paragraph, although admittedly with an unstayed top section it might be necessary to use tubing of rather greater diameter than that suggested.

Modified in this way, the structure would approach much more closely to the ideal of a self-supporting mast, which you advocated editorially some time ago. Alternatively, a still closer approach to that ideal might be attained by the design of a mast on the extremely practical lines devised by "Structural Engineer," but with a larger base. It is realised, of course, that unstayed or lightly stayed masts are more costly than those requiring a multiplicity of supporting wires, but I feel that on aesthetic grounds they have a much wider appeal.

London, N.W.3. "RADIOPHARE."

Single-wire Feeders

I SHOULD like to comment upon A. G. Chambers' article, "Overcoming Harmonic Radiation," in the April 6th issue of *The Wireless World*. Mr. Chambers

points out that it is never quite possible to get a perfect match with a single-wire feeder, due to the fact that the earth is relied on for balance.

I suggest that instead of the voltage-fed aerial, illustrated in Fig. 1 in the article, a current-fed aerial would be much more suitable for the novice, as this, in my opinion, would prove easier to match.

In a resonant aerial the single-wire feeder should be connected to either side of a current loop. Assuming a half-wave aerial is to be used, the current loop will, of course, be found at the centre of the wire, and the impedance at this point will be approximately 72 ohms. Now, as the characteristic surge impedance of a single-wire feeder is 500 to 600 ohms, it will be necessary to connect the feeder to the aerial at a point approximately one-seventh of the total length of the aerial wire either side of the centre. The exact position may be easily located by trial and error. When the impedances are perfectly matched, as they can be for all practical purposes, there will be no standing waves on the feeder, and the greatest efficiency will be obtained.

Rotherham, Yorks. S. REDFERN.

Anti-interference Measures

SINCE it is becoming increasingly likely that legislation to deal with interference will not arrive during our lifetime, perhaps a few suggestions as to how man-made static may at least be mitigated in some cases will not be unwelcome.

To start with, the B.B.C. should take immediate steps to increase the power of their regional stations up to 100 kW or more. Of all bands, the medium is probably the most used by the vast majority of listeners, certainly by those who like to "listen abroad" occasionally, but are not necessarily short-wave enthusiasts.

Next, the modulation of the carrier waves of B.B.C. stations should be made greater. It is no use the B.B.C. saying that modulation is as great as is consistent with the maintenance of good quality. To this I reply that no exception can be taken to the quality of German stations, as regards sound transmission, yet the modulation of their carrier waves is undoubtedly greater than is the case here. A simple test will prove the correctness of my contention.

T. J. E. WARBURTON.

St. Leonards-on-Sea.

HENRY FARRAD'S SOLUTION

(See page 388)

AS the circuit stands no possible value of R would balance out the anode current through the meter, because with the LT cell connected as shown its current would add to the anode current instead of subtracting from it. The cell must first be reversed.

In order that no current shall pass via the meter it is necessary for all the anode current to pass through R, and for the voltage drop so produced to balance the LT voltage exactly; thus the voltage applied to the meter will be nil. As the valve is a P220 the LT is 2 volts, and the resistance required to drop this amount when 2 mA.

(0.002 amp.) is flowing is $\frac{2}{0.002}$, or 1,000 ohms. To allow for exact adjustment it might be convenient to have a 500-ohm variable resistance in series with 750 ohms fixed.

The circuit is still not right, however, because, judging from the absence of grid bias

and the relatively large initial anode current, the valve voltmeter is of the grid-current type, in which the anode current decreases when a measurement is being made. The voltage drop across R fails, and current passes from the LT cell through the meter. Unless the meter is reversed, too, the pointer will move off the scale.

Television Programmes

Sound 41.5 Mc/s

Vision 45 Mc/s

An hour's special film transmission intended for demonstration purposes will be given from 11 a.m. to 12 noon each weekday. The National or Regional programme will be radiated on 41.5 Mc/s from approximately 7.45 to 9 p.m. daily.

THURSDAY, APRIL 27th.

3, Douglas Byng in "Byng Ho." 3.35, Gaumont-British News 3.45, 237th edition of Picture Page.

9, Carson Robison and his Pioneers in Cabaret. 9.35, British Movietonews. 9.45, Cartoon Film. 9.50, 238th edition of Picture Page. 10.20, News.

FRIDAY, APRIL 28th.

3, "Grandfather's Further Follies"—Grosvenor House Cabaret. 3.30, British Movietonews. 3.40, Demonstration of Catch-As-Catch-Can Wrestling.

9, "The Mizzen Cross Trees," a revue of nautical songs and dances. 9.35, Gaumont-British News. 9.45, Cartoon Film. 9.50, "Two Gentlemen of Soho," a play by A. P. Herbert. Cast includes Robert Atkins and Olga Edwardes. 10.25, News.

SATURDAY, APRIL 29th.

2.45-4.30, F.A. Cup Final. O.B. from Wembley Stadium of the match between Portsmouth and Wolverhampton Wanderers. The King will be seen shaking hands with the teams, and at the end of the match it is hoped to show the presentation of the Cup by His Majesty.

9, "On the Spot," by Edgar Wallace. Cast includes Percy Parsons and Joan Miller. 10.30, British Movietonews. 10.40, News.

SUNDAY, APRIL 30th.

3, Children's Bee, a puzzle party for boys and girls. 3.25, "Birds"—Film. 3.35, "Spanish Castle," a programme of dances to music by Spanish composers.

8.50, News. 9.5, "The Twelve Pound Look," by J. M. Barrie. 9.35, Cartoon Film. 9.40-10.20, Lawrence of Arabia: personal recollection; of friends from different periods of his life.

MONDAY, MAY 1st.

3, "The Mizzen Cross Trees" (as on Friday at 9 p.m.). 3.35, Gaumont-British News. 3.45-4.10, "Two Gentlemen of Soho" (as on Friday at 9.50 p.m.).

9, "Me and My Girl," O.B. from the stage at Victoria Palace. 11.15, News.

TUESDAY, MAY 2nd.

3-4.30, "Rake's Progress," a play by Olga Katzin on the life of John Wilkes, rake, scholar, wit and man of fashion who fought George III on the question of English liberty—and won.

9, Charles Heslop—"In the Barber's Chair." 9.10, Cartoon Film. 9.15, Eric Wild and his Band. 9.40, Gaumont-British News. 9.50, "Ennjanska," a revolutionary romancelet by G. B. Shaw. 10.35, News.

WEDNESDAY, MAY 3rd.

3, "Down on the Farm," another visit to Bull's Cross Farm, where A. G. Street and the farmer will survey the work for May. 3.20, "In the Barber's Chair." 3.30, Gaumont-British News. 3.35, Cartoon Film. 3.45, Vanity Fair—fashion parade.

9, Vanity Fair. 9.15, British Movietonews. 9.25, "Perseverance," an operetta by A. P. Herbert and Vivian Ellis. 9.50, "Derby Secrets, No. 3"—Film. 10, Tennis Demonstration. 10.15, News.

Readers' Problems

A Selection of Queries dealt with by the Information Bureau, and chosen for their more general interest, is published on this page.

Gramophone Pre-Amplifier

IT is desired to use an existing receiver for gramophone reproduction, but as the set has only one AF amplifying stage, which is the output valve, our enquirer is at a loss to know quite what to do.

The detector and output stage of the set in question is reproduced here and consists

of that portion of the circuit above the earth line. While there are certain gramophone pick-ups that might give sufficient output to load a single pentode valve, we think it would be worth the trouble involved to construct a separate unit to be used as a pre-amplifier for gramophone reproduction.

This can be arranged as shown below the earth line in the diagram, and a double-pole change-over switch comprising the parts S1 and S2 should be included in the set. The spare contact on S2 can be used to break the screen-grid supply for the RF, FC and IF valves, as otherwise the wireless programme may be audible as a background on gramophone reproduction. Alternatively, the

Pre-amplifier for gramophone reproduction.

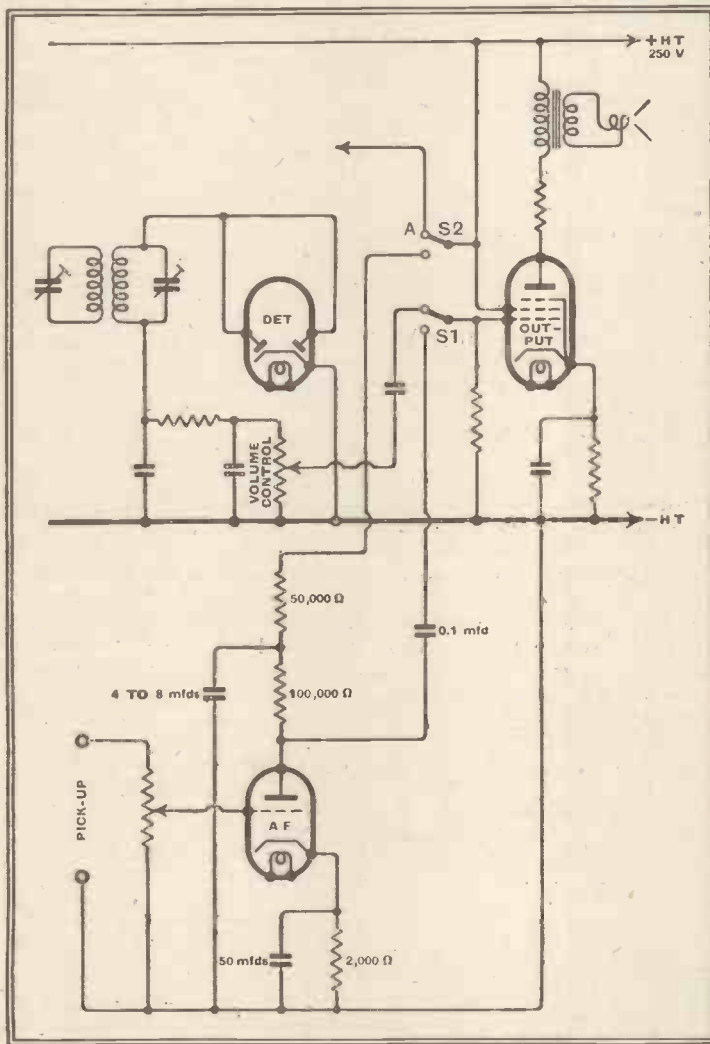

receiver's AF volume control could be turned down to the minimum position and the connection from A on S2 omitted. The lead A would, of course, have to join to the high-voltage end of the potentiometer supplying the screen grids of the valves.

If the mains transformer in the set will not stand the extra filament load, then a separate filament transformer will have to be used, but HT can be taken from the set, as only a few milliamps are needed.

Parasite Oscillation in SW Frequency-changers

HAVING constructed a short-wave superheterodyne, a reader is experiencing difficulty in obtaining a satisfactory performance on the highest frequency range, which just takes in the television sound wavelength. At frequent intervals over the scale there is encountered what is described

as very strong unmodulated carrier waves, and at these points the set shows a tendency to develop a howl. No sign of this effect is noticed on the other ranges.

Spurious oscillation of the kind described is usually due to excessive oscillator voltage on the injector grid in the frequency-changer valve, and it can often be cured by damping the offending circuit in the oscillator by a

resistance. The object is to reduce the amplitude of the local oscillations so that they do not exceed the value stated by the makers of the valve.

This is not, however, an infallible cure, as parasitic oscillation, which is the cause of the trouble in cases of this kind, may be due to other causes. RF by-pass condensers from the screen grid to earth and from the cathode to earth in the frequency-changer circuit that have appreciable inductance at the very high frequencies may be responsible, and often joining a good mica condenser of 100 or 200 m-mfds. in parallel with the larger paper type usually employed will suppress these oscillations. Also, the lead from the anode of the frequency changer to the first IF transformer should be kept short.

If it can be arranged to use a relatively high intermediate frequency—1,500 kc/s, for example—there will be less likelihood of

any trouble from parasitic oscillation being encountered.

Finally, AVC should not be applied to the frequency-changer valve. Some or all of these measures may be needed to suppress parasitic oscillation on the ultra-high frequency band in sets of this kind.

Extension Loud Speaker

HAVING two loud speakers with speech coil impedances of 5 and 15 ohms respectively, a reader wishes to use one as an extension unit and asks what impedance figure to assume for calculating the output-transformer ratio. It is also asked if the idea is practicable and, if so, which of the two should be used as the extension speaker.

Assuming it is proposed to connect the loud speakers in parallel and to a common secondary winding, the secondary load impedance will be the product divided by the sum of the two loud speaker impedances, i.e., 3.75 ohms.

The output power will be divided between the two speakers in a ratio of one to three, the 5-ohm model taking three-quarters of the output.

If a slightly reduced volume will answer at the extension point the 15-ohm model can be used, but if equal volume is essential, then the output transformer must have two secondary windings each arranged to match its own loud speaker to twice the valve's optimum load. Alternatively, a tapped secondary winding could be used and the ratios calculated in the same way as for separate windings.

Modern HT Rectifier in an Old Set

A RECEIVER that is many years old is being reconditioned for use as a stand-by set. Originally it was fitted with a 6-volt rectifier taking 0.5 amp., and it is proposed to replace this by a modern valve, such as 4-volt 1-amp. type. Advice on the best way of making this change is required.

There are two solutions to a problem of this kind: one is to include resistance in the rectifier filament supply to drop the surplus voltage, and the other is to fit a small auto-transformer designed to give 4 volts, when supplied by the existing 6-volt winding.

If the first-mentioned scheme is adopted a resistance of 2 ohms to carry 1 amp. will be needed. To preserve the symmetry of the filament circuit a 1-ohm resistance can be connected in each filament lead.

The possibility of fitting a 6.3-volt rectifier might be considered, as it is possible to obtain one that takes 0.4 amp. only. Such a valve is listed in *The Wireless World Valve Data Supplement*. A valve of this type would be quite satisfactory if the filament supply were found to be nearer 6.3 than 6 volts with a current of 0.4 amp.

Mesh Electrodes for CR Tubes

IN order to avoid disturbances of the magnetic field, cathode-ray tubes designed for magnetic deflection may be provided with electrodes of mesh construction. In this way the production of eddy currents is reduced, but the solution is not a perfect one as each mesh may act as a short-circuited turn, albeit one of very small dimensions.

It is now suggested that the effectiveness of this method of electrode construction may be improved by coating the wires of the mesh with an insulating layer consisting, say, of oxide. The mesh electrodes may accordingly be made of oxidised wire; after construction the oxide coating is removed, except at the crossing points of the mesh.

Recent

Apparatus for ascertaining the speed over the ground of an aeroplane.

Inventions

Brief descriptions of the more interesting radio devices and improvements issued as patents will be included in this section

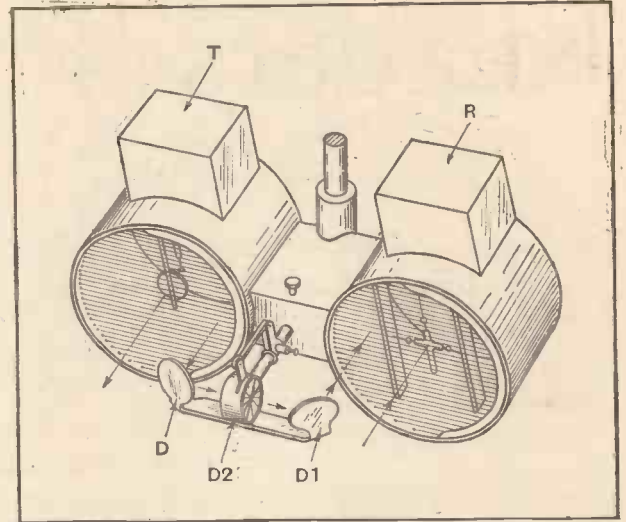

MODULATING LIGHT
It is known that a ray of light can be modulated by passing it through a liquid or solid in which mechanical waves of supersonic frequency are set up by contact with a piezo-electric crystal.

It is now proposed to pass the light through the piezo-electric crystal itself, and to depend upon the diffraction effect of the vibrating molecules of the crystal. The method is stated to give a greater depth of modulation, and one more strictly proportional to the variations in intensity of the incident ray. The crystal is energised at carrier-wave frequency by a high-frequency source connected across metal coatings which are laid on the upper and lower surfaces of the crystal, parallel to the path of the ray of light.

S. Sokoloff. Application date May 13th, 1937. No. 498816.

SOUND "PICK-UPS"
CARELESS handling of the sound-arm of a radiogram may do damage to the armature of the pick-up, or break the point of a sapphire "needle," or cause

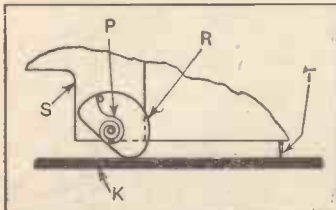

Roller device for safeguarding pick-up and record.

permanent injury to the gramophone record. As a safeguard against any such mishap, the end of the sound-arm S, near the stylus T, is fitted with a small roller-shaped member R which is so biased by a spring P that its curved edge is normally lowermost. That edge, therefore, makes first contact with the surface of the record disc K (or any other support on to which the sound-arm may be placed) and so acts to protect the point of the stylus.

As soon as the sound-arm is placed on a gramophone record, the rotation of the latter automatically swings the roller R round, until its flattened portion comes lowermost. This allows the stylus to fall gently into contact with the record disc, and so safeguards both the pick-up and the record.

Telefunken Ges für drahtlose Telegraphie m.b.H. (Assignees of Siemens and Halske Akt). Convention date (Germany) March 25th, 1937. No. 498963.

The British abstracts published here are prepared with the permission of the Controller of H.M. Stationery Office, from specifications obtainable at the Patent Office, 25, Southampton Buildings, London, W.C.2, price 1/- each.

PUBLIC ADDRESS SYSTEMS

To ensure a realistic effect, a loud speaker should be mounted so that the sounds from it appear to come direct from the real or original source. A suitable point, for instance, is near the ceiling and directly above the real speaker's head. At the same time the microphone must be located within the acoustic shadow of the loud speaker, in order to permit of adequate amplification without "singing."

According to the invention, one wall of the horn of the loud speaker is formed by the ceiling, so that the latter, in effect, divides the horn along an axis of symmetry. Since there is no flow of energy along this axis, the wave-front is not distorted and the overall effect is that which would otherwise be obtained from a horn of twice the actual dimensions. The inside of the horn is divided by vertical partitions, which are logarithmic in cross-section. In this way the sound waves are projected as a uniform beam, without undue directivity, and without producing diffraction at the mouth of the horn.

Standard Telephones and Cables, Ltd. (Assignees of E. C. Wentz). Convention date (U.S.A.) November 13th, 1936. No. 495594.

CONDENSER MICROPHONES

A "HIGH-FIDELITY" microphone set consists of two condenser instruments A, B con-

nected in parallel to a common transformer T. The larger instrument A, which handles the lower frequencies, is 8 cm. in diameter, whilst B, which deals with the higher frequencies, is 3 cm. in diameter, the two instruments being mounted at the front and rear respectively of a common holder or support.

The larger current normally passed by the instrument A is reduced, relatively to the output from B, by a resistance R. The inductance of the primary winding of the output transformer is such that, when combined with the capacity of both microphones, its resonant frequency falls below the audible 50-cycle limit. The necessary biasing potential for the two instruments is taken from a common battery K through a regulating resistance R1, a blocking condenser C1 being inserted to prevent a short-circuit through the primary winding of the transformer.

E. Reisz. Application date February 14th, 1938. No. 498435.

RADIO SPEED-INDICATOR

THE speed of an aeroplane, relatively to the ground, is measured by applying Döppler's principle to a beam of ultra-short waves transmitted from the

machine and reflected back to it from the ground. Döppler's principle, in brief, states that if a source of waves moves, relatively to an observer, an apparent change of frequency occurs. The rise and fall in pitch of the whistle of a passing train is a case in point.

According to the invention, the aeroplane carries a short-wave transmitter T and a short-wave receiver R, mounted side by side in separate parabolic reflectors, as shown. The transmitter radiates to the ground a clear-cut beam of energy which is reflected back, at least in part, towards the receiver, where it produces Döppler's apparent change in frequency. The change is proportional to the speed of the machine relative to the point of reflection, and is measured by the beat-note produced by combining the returning wave with a fraction of the outgoing wave. A small ray is diverted directly from the transmitter into the receiver by a pair of small "disc" reflectors D, D1, placed just in front of the outgoing beam. An iris diaphragm D2 serves to regulate the strength of the diverted ray.

The British Thomson-Houston Co., Ltd. Convention date (U.S.A.) April 9th, 1936. No. 493708.

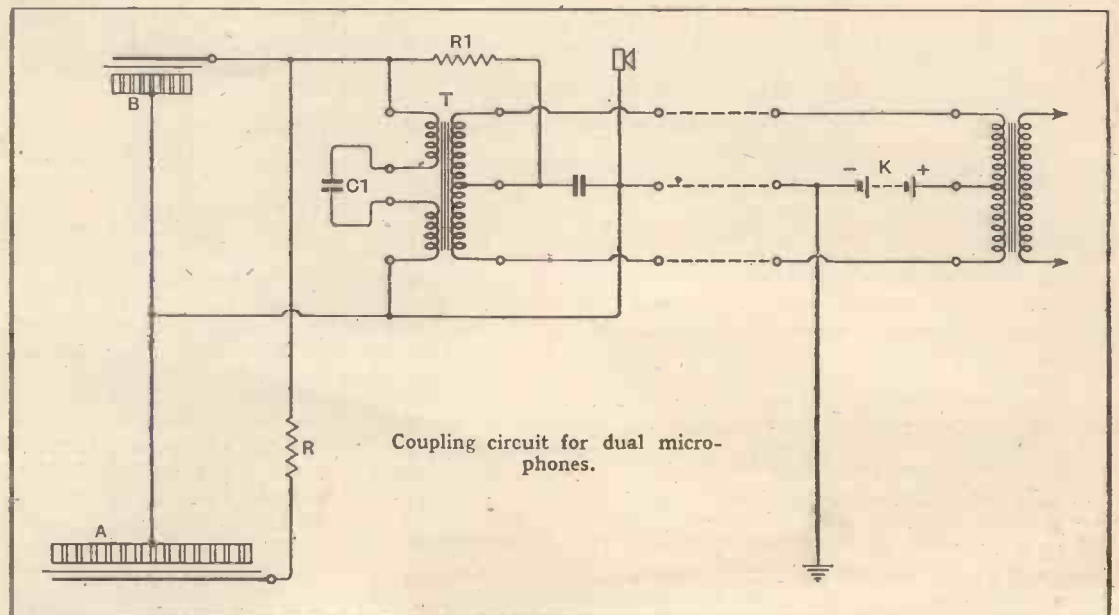

Coupling circuit for dual microphones.

INCREASE THE OUTPUT OF YOUR SERVICE DEPARTMENT INSTALL THE TIME-SAVING GM.3155

MORE jobs per day! That's the way to make service really profitable. Cut out the tedious, expensive business of fault-finding by uncertain methods, and automatically increase the capacity of your service department.

You can do it easily with the NEW MULLARD CATHODE RAY OSCILLOGRAPH TYPE GM.3155. Here's an instrument that quickly gets to the root of radio and television service problems. And remember, it's designed for the Service Department, not the laboratory. It's easy to master and easy to use.

WRITE FOR THE BROCHURE that describes the GM.3155 at work on fault-finding and circuit alignment, and compare it with old-fashioned methods.



LIST PRICE £25 *Special net price to Service Dealers*

These two well-known instruments can be used with the GM.3155.
Service Signal Generator Type GM.2880F. With artificial aerial covering short, medium and long wavelengths. List Price £21 (subject).
Frequency Modulated Oscillator Type GM. 2881. Permits direct reading of bandwidth with variable bandwidth control. List price £8.10 (subject).
FULL DETAILS ON REQUEST.

COUPON

- Please send a copy of the brochure "The GM.3155 at Work."
- Please let us know when you can arrange a demonstration at this address.

NAME _____

ADDRESS _____

W.W.4

Mullard

VALVE SALES DEPARTMENT

225 TOTTENHAM COURT ROAD, LONDON, W.1



SOUND AMPLIFYING EQUIPMENT

Designed to meet your special requirements.

Incorporating:—

- **VOLUME CONTRACTION**—giving automatic control when used with microphones.
- **VOLUME EXPANSION**—automatically restoring tone contrast when used with gramophone records.

For installations in:—

Town Halls, Law Courts, Swimming Baths, Aerodromes and any other location, indoor or outdoor, where sound amplification is desirable.

Send your enquiries to:

SOUND REPRODUCER SALES.

BTH RUGBY

THE BRITISH THOMSON-HOUSTON COMPANY LIMITED, RUGBY, ENGLAND
A2698N



The newest Hallicrafter communication receiver

The NEW SKYRIDER 23 offers a really exceptional performance in sensitivity, selectivity and range. A brand-new method of stabilising tuned circuits to reduce frequency drift; an improved noise silencer; eight bands—four covering 10 to 540 metres and four for band spreading 10-20-40-80 metres amateur bands. A specialised precision instrument of outstanding merit. Wide choice of communication receivers from £10 to £162. 68-page Catalogue post free 2d.

NEW SKYRIDER 23

Eleven Tubes; Specially tested Bliley 455 KC crystal; improved wide range variable selectivity circuit; remarkably high signal-to-noise ratio.

Price £33 10s. Matching speaker £4. Attractive easy terms.

WEBB'S LONDON

Birmingham Depot:—41, CARRS LANE

THE HOME OF THE
SHORT WAVE ENTHUSIAST
14 SOHO ST., OXFORD ST., W.1

Telephone: Gerrard 2089

Phone: Mid 5669

Mention of "The Wireless World," when writing to advertisers, will ensure prompt attention.

CLASSIFIED ADVERTISEMENTS

NOTICES

THE CHARGE FOR ADVERTISEMENTS in these columns is

12 words or less, 3/- and 3d. for every additional word.

Each paragraph is charged separately and name and address must be counted.

SERIES DISCOUNTS are allowed to Trade Advertisers as follows on orders for consecutive insertions, provided a contract is placed in advance, and in the absence of fresh instructions the entire "copy" is repeated from the previous issue: 13 consecutive insertions 5%, 26 consecutive, 10%; 52 consecutive, 15%.

ADVERTISEMENTS for these columns are accepted up to **FIRST POST** on **MONDAY MORNING** (previous to date of issue) at the Head Offices of "The Wireless World," Dorset House, Stamford Street, London, S.E.1, or on **SATURDAY MORNING** at the Branch Offices, 8-10, Corporation Street, Coventry; Guildhall Buildings, Navigation Street, Birmingham, 2; 260, Deansgate, Manchester, 3; 26a, Renfield Street, Glasgow, C.2.

Advertisements that arrive too late for a particular issue will automatically be inserted in the following issue unless accompanied by instructions to the contrary. All advertisements in this section must be strictly prepaid.

The proprietors retain the right to refuse or withdraw advertisements at their discretion.

Postal Orders and Cheques sent in payment for advertisements should be made **& Co. payable to ILIFFE & SONS Ltd.**, and crossed **& Co. Notes being untraceable if lost in transit should not be sent as remittances.**

All letters relating to advertisements should quote the number which is printed at the end of each advertisement and the date of the issue in which it appeared.

The proprietors are not responsible for clerical or printers' errors, although every care is taken to avoid mistakes.

ARMSTRONG'S NEW HEADQUARTERS



After many years at our old premises in Camden Town, we have moved our Offices, Show Rooms and Development Department to a modern building centrally situated in

WALTERS ROAD, HOLLOWAY, N.7
(Adjoining Holloway Arcade).

which is conveniently reached by bus or tube from any part of London.

We take this opportunity of sincerely thanking the vast number of "Wireless World" readers whose consistent custom it has been our pleasure to receive for so many years.

Incidentally, this is the seventh year we have advertised in the "Wireless World" without a break. The facilities afforded by these larger premises will enable us to give the same personal attention and service to our constantly growing list of customers, as we have given in the past.

We shall be glad to see you in our new "Home" where you can hear, in comfort, demonstrations of any or all the latest Armstrong Models.

Send for Illustrated Catalogue of our full range, which includes the following outstanding chassis.

MODEL AW125PP . Price £17.17.0 12-V. ALL-WAVE RADIOGRAM CHASSIS

5 wavebands, 12-550 continuous, 1,000-2,000 m., R.F. Pre-Amplifier, 2 I.F. stages with Variable Selectivity, Manual R.F. gain control and 10 watts R.C. coupled Triode P.P. output.

Every worthwhile modern refinement has been incorporated in the design of this chassis. A considerable amount of research has been necessary to obtain the high standard of performance at which we aimed. Only the best British components have been used, thereby ensuring a high degree of reliability and first-class performance.

MODEL AW93PP . Price £10.10.0 9-V. ALL-WAVE RADIOGRAM CHASSIS

3 wavebands, R.F. Pre-amplifier, 3 stages of A.V.C. and 8 watts R.C. coupled Triode P.P. Output.

Specially designed for those requiring particularly good quality reproduction. Gramophone amplification has been carefully studied so that it is possible to load the output Triodes when using a fibre needle. The highly efficient short-wave band is from 16 metres upwards.

KINDLY NOTE:

All communications to be addressed to

**ARMSTRONG MANUFACTURING CO.,
WALTERS ROAD, HOLLOWAY, LONDON, N.7**

(Adjoining Holloway Arcade).

Telephone: NORTH 3213.

EASY TERMS by L.R.S

ON ALL

ARMSTRONG CHASSIS

MODEL AW125PP - - - - - 12-VALVE
ALL-WAVE RADIOGRAM CHASSIS
Cash 17 Gns. or £2 with order and 12 monthly
payments of - - - - - £1.8.0

MODEL AW93PP - - - - - 9V. ALL-WAVE
RADIOGRAM CHASSIS - - - - - Cash 10 Gns. or
21/- with order and 12 monthly payments of 17/-
(See Armstrong Advt. above)

Send for details of the 11 Armstrong Models
and our CONVENIENT TERMS.

Estd. - 1925 THE 'Phone NATIONAL 6828

**LONDON RADIO SUPPLY
COMPANY**
11-OAT LANE · NOBLE ST · LONDON EC2

NUMBERED ADDRESSES

For the convenience of private advertisers, letters may be addressed to numbers at "The Wireless World" Office. When this is desired, the sum of 6d. to defray the cost of registration and to cover postage on replies must be added to the advertisement charge, which must include the words Box 000, c/o "The Wireless World." All replies should be addressed to the Box number shown in the advertisement, c/o "The Wireless World," Dorset House, Stamford Street, London, S.E.1. Readers who reply to Box No. advertisements are warned against sending remittances through the post except in registered envelopes: in all such cases the use of the Deposit System is recommended, and the envelope should be clearly marked "Deposit Department."

DEPOSIT SYSTEM

Readers who hesitate to send money to advertisers in these columns may deal in perfect safety by availing themselves of our Deposit System. If the money be deposited with "The Wireless World," both parties are advised of its receipt.

The time allowed for decision is three days, counting from receipt of goods, after which period, if buyer decides not to retain goods, they must be returned to sender. If a sale is effected, buyer instructs us to remit amount to seller, but if not, seller instructs us to return amount to depositor. Carriage is paid by the buyer, but in the event of no sale, and subject to there being no different arrangement between buyer and seller, each pays carriage one way. The seller takes the risk of loss or damage in transit, for which we take no responsibility. For all transactions up to £10, a deposit fee of 1/- is charged; on transactions over £10 and under £50, the fee is 2/6; over £50, 5/-. All deposit matters are dealt with at Dorset House, Stamford Street, London, S.E.1, and cheques and money orders should be made payable to Iliffe & Sons Limited.

SPECIAL NOTE.—Readers who reply to advertisements and receive no answer to their enquiries are requested to regard the silence as an indication that the goods advertised have already been disposed of. Advertisers often receive so many enquiries that it is quite impossible to reply to each one by post. When sending remittances direct to an advertiser, stamp for return should also be included for use in the event of the application proving unsuccessful.

NEW RECEIVERS AND AMPLIFIERS

R.

C.

TELEPHONE: Holborn 4631.

RADIO CLEARANCE, Ltd., 63, High Holborn, W.C.1, by offering brand new receivers, maintain their reputation as the leading Mail Order House for surplus radios.

BRITISH Belmont 8-valve Plus Magic Eye All-wave A.C. Superhet Chassis, 4 wave bands, 2 short medium and long, fitted latest Mullard octal base American type valves. Brief specification: Short wave 6-18 metres (covers television sound), short wave 2, 18-50 metres, medium band 200-850 metres, long 900-2,000 metres; valve combination 6K7 Pre H.F., 6J7 oscillator, 6J7 mixer, 6K7 I.F., 6Q7 (DDT) detector, A.V.C. and first I.F., two 6F6s, parallel output, 5Y3 rectifier, plus 6G5 Magic Eye visual tuning, handsome dial, station names etched on glass, controls 2-speed tuning, volume and on-off, combined variable tone control and selectivity switch, wave change plus gram. switch; size of chassis 13 1/2 in. x 10 in. x 3 in.; supplied complete with valves, escutcheon, knobs, but less speaker, £5/19/6 each; complete receiver in handsome walnut cabinet, details as above, complete with speaker, £7/7.

DECCA 6-valve 3-waveband Battery Chassis, fitted complete with Mazda and Osram valves, QPP output; these chassis give a sparkling performance on all wavebands, and are the product of a well known manufacturer, complete with valves, £3/3 each; complete receiver in handsome walnut cabinet, details as above, complete with speaker, £3/19/6 each.

LISSEN 5-valve Plus Magic Eye All Wave A.C. Superhet, three separate scales operated by wave-change switch, fitted in magnificent walnut table cabinet, triode output, fitted ring valves throughout, brand new in carton; our price: £5/19/6.

LISSEN 5-valve All Wave A.C. Superhet, fitted in upright right walnut table cabinet, brand new in carton; £5/5.

LISSEN 4-valve 2 Wave A.C. Superhet, fitted in modern oblong type walnut cabinet, brand new, in carton; £4/4.

LISSEN 5-valve All Wave Battery Superhet, Class B output, fitted in handsome walnut table cabinet, complete but less batteries, brand new in carton; £3/17/6.

LISSEN 4-valve All Wave Battery Superhet, as above, but pentode output; £3/15.

ALL the Above Fitted Ring Valves Throughout.

SEE Our Advertisement under Components.

RADIO CLEARANCE, Ltd., 63, High Holborn, W.C.1. Telephone: Holborn 4631. [8380]

NEW RECEIVERS AND AMPLIFIERS

*

*

DEGALLIER'S "Challenger Radio Corporation."

SEND 2d. Stamp for Handsome Illustrated Catalogues Telling of our Superb Range of Receivers; direct public sales policy (saves you 40%), most exceptional value on the market, from a T.R.F. Midget at £3/5 to a 19-valve general purpose receiver, 6 bands, with two P.A. speakers, at 30 gns.; 6-page brochure of *Wireless World* report on this set is available; car radio; any known American valve, all 5/6 each; if interested ask for particulars of American samples at less than cost; even samples covered by usual guarantee; also American P.A. Speakers and Cabinets. Hours business 11 a.m. until 9.30 p.m.

DEGALLIER'S, 31, Craven Terrace, London, W.2. Paddington 6492. Nearest point Lancaster Gate Tube Station. [8382]

ARMSTRONG Amplifiers

ARMSTRONG 6- and 12-watt High Fidelity Amplifiers.

ARMSTRONG Local Station Feeder Units.

ARMSTRONG Special Equipment for Schools, institutes, etc.

ARMSTRONGS Will be Pleased to Forward Details of the Above Standard Equipment on Request and/or to Quote for the Manufacture of Apparatus for Special Purposes.

ARMSTRONG MANUFACTURING Co. Head Office, Walters Rd., Holloway, N.7. 'Phone: North 3213. [8374]

RADIOGRAPHIC (SERVICE) Co.

POWER Packs.—Chassis drilled ready for six tube sockets, etc., complete with transformer, condenser, rectifier, etc.; ideal for power units, amplifiers, etc.

325 Volts, 60-70 mills., 6.3 volts, 2 1/2 amps., 19/6.

370 Volts, 90-100 mills., 6.3 volts, 4 amps., 22/6.

400 Volts, 200 mills., 6.3 volts, 5 amps., 31/6.

RADIOGRAPHIC (SERVICE) Co., 117, Station Rd., E.4. Silverthorn 3512. [8363]

FREE, Radio Handbook and Summer Call Book, with new Hallcrafters Sky Buddy, which covers 10-metre band, has electrical band spread, BFO, A.V.C. Phone Jack, complete coverage to 550 metres, great job; all in £10.

RADIOGRAPHIC, Ltd., 66, Osborne St., Glasgow, C.1. [8372]

RECEIVERS AND AMPLIFIERS CLEARANCE, SURPLUS, ETC.

BANKRUPT Bargains.—Brand new 1938 Philco Model 847 Empire 8, finest 8v. all-wave superhet available, exceptional short wave performance, 4 W.B., in maker's sealed carton, with guarantee, list price 29 gns.; cash price £13/13; send 14d. stamp for list of other bargains.—261-3, Lichfield Rd., Aston, Birmingham. [8376]

USED SETS FOR SALE EDDYSTONE

1939 Model Eddystone "All World Eight" Battery Superheterodyne Receiver, 9 to 2,000 metres, cost £29, perfect; reasonable offer.—Box 9506, c/o The Wireless World. [8373]

PYE

PYE Receiving Portable 5-valve P.B., complete; £5.—Blackmore, 6, Lyndhurst Rd., Maidstone. Phone: 2539. [8381]

MISCELLANEOUS

A NUMBER of Reconditioned Sets in Good Order; from £5 upwards.—Halford Radio, 31, St. George St., W.I. [0617]

CAR RADIO

CROSLEY Push-button 1939 10 guinea Models, 5½ gns.; aerials, overheads, police type, etc., from 8/6; trade enquiries solicited.—Shippers, 18, Corporation St., Manchester. [0622]

FINEST American Twin Running-board Aerials, completely rubber covered, maximum signal pick-up, minimum noise, easy mounting, now only 17/6 pair complete; handsome chromium roof aerials, to mount straight or "vee", complete, 15/-; immediate despatch, carriage paid; cash with order or c.o.d.

WIRELESS SUPPLIES UNLIMITED, Essex House, Stratford, E.15. Maryland 3191. [0577]

PUBLIC ADDRESS

VORTEXION P.A. Equipment. IMITATED, but unequalled.

WE Invite You to a Demonstration. A.C.-D.C. Dance Band Amplifier, 10 watts output, complete in case, with moving coil microphone, speaker and cables, weight 22lb.; 12 gns.

A.C.-20 15-20-watt Amplifier, 30-18,000 cycles, independent mike and gram, inputs and controls, 0.037 volts required to full load, output for 4, 7.5, and 15 ohms speakers or to specification, inaudible hum level; ready for use; 8½ gns., complete.

C.P. 20, 12-volt battery and A.C. mains model, as used by R.A.F., output as above; 12 gns.

A.C.20, in portable case, with Collaro motor, Piezo pick-up, etc., £14; C.P.20 ditto, £17/17.

50-WATT Output 6L6s, under 60-watt conditions, with negative feed back, separate rectifiers for anode screen and bias, with better than 4% regulation, level response, 20-25,000 cycles, excellent driver, driver transformer and output transformer matching 2-30 ohms impedance electronic mixing for mike and pick-up, with tone control, complete with valves and plugs; £15.

COMPLETE in Case, with turntable B.T.H. Piezo pick-up and shielded microphone transformer, £20.

80-WATT Model, with negative feed back; £25, complete.

120-WATT Model, with negative feed back; £40, complete.

250-VOLT 250 m.a. Full Wave Speaker, field supply unit; 25/-, with valve.

ALL P.A. Accessories in Stock; trade supplied.

VORTEXION, Ltd., 182, The Broadway, Wimbledon, S.W.19. Phone: Lib. 2814. [8241]

QUALITY Amplifiers and Microphone Equipments for Hire or Permanent Installation.—Harmony House, 116, Cambridge Rd., Southport. [8307]

ALEXANDER BLACK, Ltd., Established 1925.—For microphone equipment when quality counts, Booklet on request.—55, Ebury St., S.W.1. Sloane 6129. [0596]

PUBLIC Address Contractors Can Hire P.A. Vans, loud-speakers, microphones and equipments of all types from Hire Dept., Gramplan Reproducers, Ltd., Kew Gardens, Surrey. Tel.: Richmond 1175-6-7. [0618]

NEW MAINS EQUIPMENT

ALL Transformers at Last Week's Prices. VORTEXION, Ltd., 182, The Broadway, Wimbledon, S.W.19. Phone: Lib. 2814. [8389]

MAINS Transformers.—All primaries 215-230-250 volts.

R-G.7.—325 volts, 60-70 mills., 6.3 volts, 2½ amps., 5 volts, 2 amps., 10/6.

R-G.53.—370 volts, 90-100 mills., 6.3 volts, 4 amps., 5 volts, 2 amps., 12/6.

R-G.200.—400 volts, 200 mills., 6.3 volts, 5 amps., 5 volts, 3 amps., 26/-.

R-G.250.—500 volts, 250 mills., 26/-.

AUTO. Trans.—110v. to 215-250, 100 watts; 10/-.

CHOKES.—20h. 200 ohms, 100 mills.; 12/-.

RADIOGRAPHIC (SERVICE) Co., 117, Station Rd., E.4. Silverthorn 3512. [8364]

GRAMPION 1002 REPRODUCERS LTD.

MEMORANDUM

From Chief Research Engineer

To All Sound Engineers

Date 27.4.39

Results of final tests on High Velocity Projector Speaker Unit Type P.V.H.

show this model to be ideal for rough usage - outdoor work: Maximum results from minimum input. Audible at 2 miles. Normally rated at 10 watts, will handle peak powers of 18 and 35 watts (according to size of horn). Efficiency approximately 45%, 2½ times that of usual horn speaker embodying cone unit. Will project speech ¼ mile with only 6 watts loading. Specially suitable for noisy conditions. Entirely weatherproof - unaffected



GRAMPION REPRODUCERS LTD.

CONTINUATION

by damp or heat. Response curve smooth in critical region between 200 and 2,000 C.P.S. falling off slightly at 5,000 C.P.S. but steadily increasing above 7,000 C.P.S. Construction is unique. Diaphragm of moulded, seamless bakelite is fitted with copper. (NOT aluminium) speech coil. Difficulty of connecting lead-out wires to usual aluminium coil thus avoided. Accessibility a special feature. Diaphragm can be centred or replaced by even a semi-skilled person in less than five minutes. Recommended to cover large areas or where excessive noise has to be overcome.

Prices: with straight 42 in. Horn 11 Gns. with "Diaka" Co-axial Horn 12 Gns.



GRAMPION REPRODUCERS LTD. KEW GARDENS SURREY PHONE RICHMOND 1175

CABINETS

A CABINET for Every Radio Purpose.

CONVERT Your Set into a Radiogram at Minimum Cost; surplus cabinets from noted makers under cost of manufacture (undrilled); 30/- upwards; motors at wholesale prices.

FIT-A-GRAM Cabinet, 31x17x15; 21/-.

UNDRILLED Table Console and Loud-speaker Cabinets, from 3/6.

INSPECTION Invited; photos loaned to country customers.

H. L. SMITH and Co., Ltd., 289, Edgware Rd., W.2. Tel. Pad. 5891. [0485]

BRAND New Radiogram Cabinets (undrilled), 55/-; worth 10 gns.; also magnificent television cabinets, new, 35/-.—Particulars, Haines and Son, 23, Denmark St., W.C.2. Tel. 5900. [8353]

DYNAMOS, MOTORS, ETC.

D.C.—A.C. Convertors, motors, all voltages, for sale and wanted.—Easeco, 18w, Brixton Rd., S.W.9. [0558]

ALL Types of Rotary Convertors, electric motors, battery chargers, petrol electric generator sets, etc., in stock, new and second-hand.

A.C.-D.C. Conversion Units for Operating D.C. Receivers from A.C. Mains, 100 watts output, £2/10; 150 watts output, £3/10.

WARD, 46, Farringdon St., London, E.C.4. Tel.: Holborn 9703. [0518]

ROTARY Converter, Crypto, 200-240 D.C., 230v. 50c. R.A.G., 100 watts, with filter, excellent condition; offers.—Box 9524, c/o The Wireless World. [8382]

RECORDING EQUIPMENT

ALL Recording Discs and Materials in Stock; tracker units, £4/7/6; recording motors, £3/17/6.—Write for further details; Will Day, Ltd., 19, Lisle St., W.C.2. [0595]

FEIGH Recording Sets are Within Reach of All; ball bearing gear box, worm drive traverse; records on any disc; Morse; speech or music; diamond cutter-pickup on tone arm the set 37/6; 6in. blanks, 3/3 doz.; 10in. discs, 7/- doz.—Electradix, 218, Upper Thames St., London, E.C.4. [0620]

NEW LOUD-SPEAKERS

SINCLAIR Speakers for all types.—Alma Grove, Copenhagen St., N.1. [0603]

BAKERS.—New corner horn speakers for realistic reproduction; leaflets free.—Bakers Selhurst Radio, South Croydon. [8369]

LOUD-SPEAKERS

SECOND-HAND, CLEARANCE, SURPLUS, ETC.

ROLAS, for 6/11; G12's, 47/6; ¼d. stamp for lists.—Shippers, 18, Corporation St., Manchester. [0606]

VAUXHALL UTILITIES, 163s., Strand, W.C.2.—Rola G12 P.M. speakers, 62/6; G12 energised, 50/-; with transformers, brand new. [8385]

BAKERS.—Famous super power speakers at half price; as solely specified for "Wireless World" Quality receiver.—Bakers Selhurst Radio, South Croydon. [8370]

3,000 Speakers from 5/6 each, P.M. and energised 4in. to 14in., including several Epoch 18in.—Sinclair Speakers, Alma Grove, Copenhagen St., N.1. [0591]

Wanted

VOIGT Corner Reflector Cabinet, less speaker.—Sault, 8, Westleigh Rd., Leicester. [8369]

LOUD-SPEAKER CONVERSIONS

BAKERS.—Triple cone conversions immensely improve reproduction from any speaker; price 29/6.—Bakers Selhurst Radio, South Croydon. [8371]

TELEVISION

EKCO Add-on Vision Unit, perfect condition; 17 gns.—A.C.S. Radio, 16, Gray's Inn Rd., W.C.1. [0627]

TRANSMITTING APPARATUS

A.C.S. RADIO, specialists in short-wave apparatus, communication receivers, including Hallicrafters, National and R.M.E. transmitting equipment, valves and components.—Send for free catalogue to A.C.S. Radio, 16, Gray's Inn Rd., W.C.1. Holborn 9894-5. G2NK, Technical Manager. [0550]

G5NI.—The oldest and largest distributors of amateur equipment, transmitting and receiving; short-wave catalogue, 1½d.; G5NI 70-page Manual, 7½d., post free; authorised direct distributors for Collins, National, R.M.E., Thordarson, Hammerlund, Biley, Taylor, Eimac, etc., etc.—44, Holloway Head, Birmingham. [0531]

VALVES

RADIOGRAPHIC (SERVICE) Co.

ALL Popular American Valves: 3/3 glass, 4/- octal; full stocks of KenRad and Raytheon, 4/- to 7/6. RADIOGRAPHIC (SERVICE) Co., 117, Station Rd., E.4. Silverthorn 3512. [8365]

ALL Types of American Tubes in Stock of Impex and Arcturus makes, at competitive prices.

WE Can Also Supply a Full Range of Guaranteed Replacement Valves for Any British, non-ring, American or Continental type at an appreciably lower price.

SEND for Lists of These, and also electrolytic condensers, line cords, resistances, etc.

CHAS. F. WARD, 46, Farringdon St., London, E.C.4. Tel.: Holborn 9703. [0452]

LET SOUND SALES "TRANSFORM" YOUR REPRODUCTION

Of course you read the very interesting article on the eternal subject of BASS (whether the A.F. kind or otherwise), "W.W." April 6, by "Cathode Ray."

This article constituted a definite recommendation in favour of SOUND SALES unrivalled 036 type Output Transformer which came through "The Wireless World" Laboratory tests with flying colours, showing a straight line response of plus or minus 0.5 db from no less than 20 to 20,000 cycles.

Price **35/-**

"Cathode Ray" has again substantiated our statement that the best Radio can be no better than its weakest link—**THE OUTPUT TRANSFORMER**

Specified by  the Experts

SOUND SALES

MARLBOROUGH RD., UPPER HOLLOWAY, LONDON, N.19. (Contractors to the G.P.O., etc.) LIMITED. Tel.: Archway 1661/2/3

Hours of Business—
Monday to Friday, 8.30 a.m. to 6 p.m.
SATURDAYS CLOSED

ALL THE HEAT
Where you want it



The Solon Electric Soldering Iron has the element clamped within the copper bit. Simply plug in to your supply and you have constant maximum heat where you want it—at the point. No troublesome heating up. Plus these big advantages:—

- SPEEDY** Plug in, ready in 4 mins.
- CLEAN** No flames, no dirt.
- ECONOMICAL** 15 hours' use for 1 unit.
- CONVENIENT** All wearing parts easily replaceable.

With solder, flex & lamp adaptor 8/6

It's Easier with a



SOLO

Electric SOLDERING IRON

W. T. HENLEY'S TELEGRAPH WORKS CO., LTD.
(Dept. 109C/E) Holborn Viaduct, London, E.C.1

VALVES

SPECIAL 3in. Cathode Ray Tubes, hand. vacuum green screen, 37/6; or with Agnadag coating, £2, guaranteed; every American valve in stock, of course; new valve manuals, 1/6.

RADIOGRAPHIC, Ltd., 66, Osborne St., Glasgow, C.1 [8351]

American Valves, first grade, by leading makers, guaranteed, popular types; standard base 5/6, octal base 5/6; 6L6G, 7/6.—General Radio Distributors, 309, Falloden Way, N.W.11. [0626]

2/9—R.C.A. American valves, 50 popular types; also National Union, Hytron; also British non-ring valves; cheapest in Britain; 1/2d. stamp for revised lists.—Shippers, 18, Corporation St., Manchester [0607]

METROPOLITAN RADIO SERVICE—Special offer: American valves, in makers' cartons, 3/- each; Octals, 3/6 each; American valves, first grade in all types; trade supplied.—1021, Finchley Rd., N.W.11. Speedwell 3000. [0436]

TEST EQUIPMENT

PHILCO Valve Tester (Made by Well Known Manufacturer), A.C. 200-250, complete with two panels and elaborate display stand, embodying three coloured lights for good, bad or weak valves, which work in conjunction with meter, listed £17/10; £8/5, carriage paid.

HENRYS, 72, Wellington Av., Stamford Hill, N.15. Phone: Stamford Hill 2907. [8090]

NEW COMPONENTS

RADIO Components, all makes in stock; complete range of Bulgin and Eddystone short wave parts; American valves specialists; all goods cash with order; post free; established 20 years.—C. Noyes, 163, Shepherd's Bush Market, London, W.12. [8346]

COMPONENTS

SECOND-HAND, CLEARANCE, SURPLUS, ETC.

PREMIER SUPPLY STORES.

PLEASE See Our Displayed Advertisement on page 5. [0488]

MAINS RADIO DEVELOPMENT COMPANY.

MAINS RADIO DEVELOPMENT COMPANY Offer Outstanding Value; carriage paid by return. Telephone: Tudor 4046. Call mornings. Stamp for List 226.

POLAR Midget Latest Type 3-gang Condensers, fully screened, trimmers, standard 1/4in. spindle, 0.0005 mfd., with 110 k/c. tracker, also perfect as straight 2-gang; 2/6 only, smashing offer.

ERIE 1-watt, colour coded, unused resistors, any size 50 Ohms to 5 megohm, your selection; 3d. each, 2/6 dozen; 2-watt, 6d.

CENTRALAB Latest Potentiometers, unused, long spindle, all sizes 5,000 ohms to 2 megohm, 2/-; with mains switch, 2/3.

TUBULAR Condensers, 400-volt working, wire ends, best make; 0.0001-0.05 mfd. 4d., 0.1 mfd. 4d., 0.25 mfd., 0.5 mfd. 6d.

TUBES.—First grade American valves, finest make, fully guaranteed, boxed, all popular types, 4/-; glass octal types, 4/6.

CLIX Unused Chassis Valve-holders, 5-, 7-, 9-pin, 3d. each; all American sizes, 6d.; best sleeving, 1 1/2d. yard.

T.C.C. Metal Can 8 mfd. 600-volt Peak Dry Electrolytics, 2/3; T.C.C. card 8 mfd., 600v. peak, 1/6.

FIFTY N.S.F. 1/2-, 1- and 2-watt Resistors, wire ends, marked and colour coded, 20 good sizes per parcel; 2/6 per 50 only.

MAINS RADIO DEVELOPMENT COMPANY, 4-6, Muswell Hill Rd., London, N.6. Tudor 4046. [8338]

RESISTANCES!!!—Parcel of 50, 1/2-watt to 2-watt, consisting of 20 useful values; 1/9 per 50 only.—Harrison and Co., 89, Great Portland St., London, W.1. Lan. 2471. [8362]

RYALLS RADIO, 280, High Holborn, London, W.C.1, offer new goods, post free.

ELLIPTICAL Speakers, Celestion, suitable Ekco replacements, 750 and 1,250 ohms, less transformers, speech 25 ohms, new, handle 8-watts, carry up to 120 m.a.; 5/6 each.

SPPECIAL Offer of New Ferranti Transformers, AF5cs, OPM6c, B5 chokes, 12/6; AF5, OPM6, AF6c, OPM6c, 8/9; AF7c, B2 chokes, 6/9; OPM8 (15-1), AF10, B8 chokes, OPM1c, 4/9; all each.

American Type Mains Transformers, 350-350, 70 ma., 5v. and 6.3v., drop through pattern, input 200-250v., 6/6; few 110v. input; British made.

WEARITE 110 k.c. I.F.'s with Top Trimmers, 1/6 each; sets band pass air core superhet coils, ex Halycon, screened chassis type, 4/9 set five; 110 kc. with coil details.

B.I. Tubular 4ml. 200v., 6d. each or 4/- dozen; B.I. 0.05, 1/3 dozen, 7/9 gross; B.I. 0.25 ml. tubulars, 2/- dozen, 4/6 per three dozen.

SPKERS, pairs, brand new, elliptical cone speakers, made by first class firm, quality of reproduction outstanding, push-pull pentode transformer, fields 325 ohm for smoothing choke, 8,600 as bleeder, circuit available, handle 10-15w.; 14/- pair.—Ryalls Radio, see above. [8374]

VAUXHALL UTILITIES, 163a, Strand, W.C.2.—Ask for free list; metal rectifiers, HT10, 10/-; HT9, 9/-.

VAUXHALL.—Hivac valves, all types; full range of pick-ups, from 11/-.

VAUXHALL.—T.C.C. dry, 8mfd., 2/6; 600v. aluminium containers; T.C.C. 600 v. dry, cardboard containers, 8mfd., 1/9. [8386]

The NEW "R.F. 41" HARTLEY TURNER: ACCLAIMED AS A MASTERPIECE!



Receiving Unit for use in conjunction with an L.F. Amplifier. 12" x 10" x 8" overall.

Briefly:—4-valve superhet, 5 wavebands: (1) 6 to 20m.; (2) 12.8 to 51m.; (3) 65 to 230m.; (4) 200 to 550m.; (5) 900 to 2,100m. A pentode R.F. operates on all bands except No. 1. Triode-hexode frequency changer. Single pentode I.F. amplifier, two variable band-width transformers giving three degrees of selectivity. Variable I.F. gain. Linear diode signal and A.V.C. rectification. Proportionate application of A.V.C. bias to R.F. and I.F. stages provides good signal-to-noise ratio and signal-handling capacity. One triode stage of L.F. amplification. Volume and tone controls. Provision for pick-up. Walnut control panel. Floodlit glass dial, calibrated in metres and station names. Reverse vernier slow-motion tuning control. Callibrated magic eye tuning indicator. 18 SWG cadmium plated steel chassis, robust construction. Price including valves and coupling leads, £11.5.0

Full specification on request. Write now.

HARTLEY TURNER
RADIO & TELEVISION

THE HARTLEY TURNER RADIO COMPANY
92 Queensway, London, W.2. Tel.: Bayswater 1102

This John McClure

MODEL A.C.7.A.W.6. 6 waveband receiver chassis incorporates the famous ACT6 Tuning Unit, covering a wave range of 5.5—12.5 m., 12.5—35 m., 30—80 m., 75—200 m., 200—600 m. and 750—2000 m. Dual ratio drive H.F. stage on all bands, delayed AVC, undistorted beam power output of 5 watts.

Our reputation for unrivalled performance is in every way upheld by this chassis.

When we designed this model only a moderate demand was anticipated, but the sales have greatly exceeded our expectations. Producing in larger quantities enables us to buy material on a more economic basis with the result that the price, including valves, is now reduced from £18.10.0 to

£16

UNIVERSAL AC/DC Model U.7.A.W.6 (formerly £20) Price £17.10.0

Particulars of other models on request.

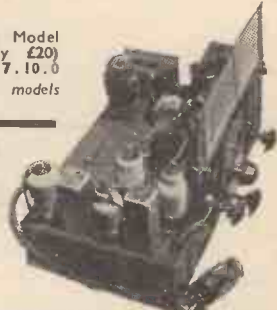

**JOHN
McCLURE
LTD.** (G6JM)

ERSKINE ROAD,
LONDON, N.W.3.

PR1mrose 5435.

Pamphonic AMPLIFIERS

Pamphonic Reproducers Ltd. (Associated with PYE Ltd.)
45, St. Pancras Way, London, N.W.1.

'Phone: EUSton 1727.

RELAYS & SWITCHES

We are able to offer the widest possible range of Relays from the robust electro-magnet to the sensitive moving-coil relay. The Relays Nos. 1 to 18 have their magnet windings distinct from the silver-tipped contact blades which carry about 250 m.a.

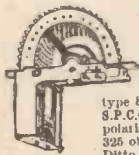

TYPE "S" SELECTOR RELAY SWITCHES.—As illus. 8 arms of 25 ways each. Relay solenoid operated for distant control. As used in Tote and Auto 'phone exchange, 10.-. G.P.O. Vertical Relays, 5.- to 15.-

SINGLE BLADE RELAYS.—No. 1 type 80D, 1,000 ohms "on-off", a.p. 6 volts, 8 m.a. No. 2 type 832 s.p., 2,000 ohms "on-off" only, 10 volts 5 m.a., 8.-. S.P.C.O. RELAYS.—No. 5 type 30A, 80 or 450 ohms, 325 ohms, 3 blade 2 volts, 20 m.a., 7/6. No. 6 type 194a, 325 ohms 2 bobbin, polarised, 3 blade, 6 volts 25 m.a., 8/6. Ditto, No. 7, 10,000 ohms, 20 volts, 21 m.a., 12/6. No. 8a, type W.E. type 11803, 3 blade, 2,600 ohms, 10 volts, 4 m.a., 9.-. No. 8a, type W.E. on 4in. ebonite panel 30 lms 6 v. 30 m.a., 10.-

MULTI-BLADE RELAYS.—No. 9 type 1G, 1,300 ohms, 2 coil, D.P. "on-off", 8/6. 22 volts, 150 m.a. No. 10 type A.H., 1,300/2,000 ohms, 2 coil, 3 circuits, 6 blades "on-off", 15 volts, 100 m.a., 9/-. No. 11 type 831, 1,200 ohms, 8 blades, 3 circuits "on-off", 3 circuits S.P.C.O., 12 volts, 12 m.a. Blades removable, 12/6. No. 12 type 27B Spare, 1,000 ohm coil with armature, no contacts, for marking relays, 2/6.

L.R. SERIES RELAYS.—No. 13 type 1A, 1 ohm, 2 on 1 off, 12/6. No. 14 type LB ditto, 10 ohms, 12/6.

HAND RELAY.—No. 15 type 1,950 coil, 1,300 ohms, trip contacts "on" until hand reset, 12/-. No. 16, ditto, but reverse, contact set "on" by hand, trip-off by relay coil, 1,500 ohms, 14 volts, 10 m.a., 12/-.
SPECIAL LIGHT S.P. RELAYS for model control. No. 3 type D 41 one blade "on-off", 10,000 ohms, 20 volts, 21 m.a., 12/6. No. 4, 2,000 ohms, 10 volts, 5 m.a., 10.-. No. 4a, 5 ohms, 2 volts, 1 amp., 7/6. Heavier Current Relays for Transmitters, etc. Sounder type 5 amps., 15/-, American Ham Relays, 7/6. Ship Magnetic Key Relay, 15/-.

Cred high-class polarised 2-way Relays, 25/-.

SUPERSENSITIVE MOVING COIL RELAYS.—These work on really tiny currents from photo-cells, etc., and a small rectifier can be used for AC impulses. Two types. (1) The famous large double-acting Weston Relay, open type, model 30, 50/-, last price 50 dollars; or mounted in mahogany case with glass top, 60/-, for panel use, the small 2in. meter type W1 works on 50 micros. with 150 micros. on main contact, 55/-.

TRANSMITTERS, MORSE AND SIGNAL KEYS.—Ex W.D., balanced, solid brass bar, tungsten contacts, indicator lamp. Type K881, a guinea key for 7/6. Other keys from 3/- to 30/-. Learner's outfit complete, 4/9. Ask for special illustrated Key List "K.W."

A.R.P. HELPS.—Portable Field Telephone Stations and Exchanges, few left. **SIGNAL LAMPS,** Lucas day and night portable, £3.10. Aldis, C.A.V. ditto, £3.5/-.

Army type D111 double headphones, pocket type, 2/6 pair. Big Mains Alarm Bells, D.C. and A.C. Mains Motor Browsers, D.C., 55/-, A.C. 55/-.

KEYS

Unbreakable cable, 55.- per mile. **SIGNAL LAMPS,** Lucas day and night portable, £3.10. Aldis, C.A.V. ditto, £3.5/-.

Army type D111 double headphones, pocket type, 2/6 pair. Big Mains Alarm Bells, D.C. and A.C. Mains Motor Browsers, D.C., 55/-, A.C. 55/-.

SWITCHES, LIGHT DUTY SWITCHES for Wave-change and Semi-rotary D.P.C.O., 6d. R.A.F. Switch Boxes for 3 circuits, rocker type, 1/3. 6-way Rocker-toggle, 2/-. 8-way ditto, 3/6. Yaxley and Rex Wave-change, D.E., 3-way roller contact, new, 1/3. Bulgin 3-point Wave-change, 9d. Tunwell S.P. on-off semi-rotary, 8d.

MAGNETIC SWITCHES.—Overload Trip, 2 to 4 amps., 7/6; 5 amps., 10/-; 10 amps., 12/-; 15 amps., 14/-; 20 amps., 16/-.

Venner 10-day Time Switches "on-off", 1 amp., 9 amps., 25 amps., 200 amps. Cheap.

BATTERY CHARGING ON A.C. MAINS. The A.C. NITDAY will keep your battery fit without attention. Model N/A6, 100/250 volts A.C. and D.C. 6/8 volts 1 amp., 15/-.

Model N/B6, 100/250 volts to D.C. 6/8 volts 1 amp., 25/-. Model N/C6, 100/250 volts to D.C., 6/8 volts 2 amps., 35/-.

Model N/D12, 100/250 volts to 12 volts 1 amp., 32/-. Ditto, 12 volts 2 amps., with 6-volt tap, 55/-.

5 amp., 24/0/-.

D.C. GENERATORS, 120 watt 12 volt 10 amp., with vee pulley, 35/-.

4 Kw. 12/16 volts 30 amps., with vee pulley, 45/-.

Mount without—110 volts 1 amp., 15/-; 200 volts 1 amp., 17/6; 300 volts 1 amp., 26/-.

WINDMILL GENERATORS totally enclosed, ball-bearing, start charging at 300 revs., 6 to 12 volts, 6 amps., 35/-; 45 amps., 45/-.

If unable to call, send for Bargain List of 10 illustrated pages or write, asking your wants.

ELECTRADIX RADIOS
 218, UPPER THAMES STREET, LONDON, E.C.4.
 Telephone: Central 4611.

TRANSFORMERS AND CHOKES

PARTRIDGE

The best materials, experienced workmanship and a Super Safety-Factor Margin have earned for PARTRIDGE PRODUCTS an outstanding reputation for Reliability and cool running. Men of experience, trade and public know that any trouble developing in a set or amplifier embodying Partridge Products will not be in the Transformer or Choke which are noted for their Electrical and Mechanical efficiency. Manufacturers are invited to write for full technical details and prices.

FREE TO P.A. DEALERS.
 The PARTRIDGE P.A. MANUAL. Valuable information on Amplifier design, equipment and service is yours for the asking. WRITE TO-DAY. CONSTRUCTORS can obtain this Manual for 2/6.

THE SIGN OF PERSONAL SERVICE & GUARANTEE

N. Partridge
 B.Sc., A.M.I.E.E.
 KINGS BLDGS., DEAN STANLEY ST.,
 Phone: Victoria 5035. LONDON, S.W.1

COMPONENTS—SECOND-HAND, CLEARANCE, SURPLUS, ETC.

SOUTHERN RADIOS Bargains.—Sale now proceeding of hundreds of bargain lines, goods previously advertised still available.—Southern Radio, 46, Lisle St., London, W.C.1. Gerrard 6653. [8236

FOR Disposal Below Cost, quantity of new receivers, amplifiers, feeder units, chokes, condenser banks, Ferranti and other transformers, etc.; state requirements; write, 'phone or call—W. T. Rickards, 17, Heathfield Rd., King's Heath, Highbury 1804. [8390

Wanted

WE Buy for Cash All Types of Modern Second-hand Radio Sets and Accessories, test meters, parts, etc. We pay more than any other dealer. Part exchanges. Bring, send or will call.—University Radio, Ltd., 238, Euston Rd., London, N.W.1. 'Phone: Euston 3810. [8366

SITUATIONS VACANT

WAR DEPARTMENT.

TELE-COMMUNICATION Assistants Required for Radio Work at Army Stations in Great Britain. Pay 95/- a week by annual increments of 2/6 a week for approved service to 102/6 a week.

CANDIDATES Should Preferably be Under 45 and must Possess Sound Practical and Theoretical Knowledge of Commercial Short-wave Transmitters and Receivers, and should hold the Final (Grade III) Certification of the City and Guilds of London Institute Examination in Radio Communication or an equivalent qualification. A thorough knowledge and practical workshop experience of testing, servicing and the repair of short-wave transmitters and receivers is essential.

SUITABLE Candidates may be Given a Short Theoretical and Practical Test. Those selected will undergo a course of instruction and will be required to enlist in the Territorial Army (with rank of Staff Sergeant).

PREFERENCE Given to Ex-service Men, other things being equal.

APPLICATION Forms Obtainable by Post-card from the Under-Secretary of State (C.5), The War Office, London, S.W.1, and to be lodged by 12th May, 1939. Quote Appts' No. 134 (G). [8378

ROYAL ARMY ORDNANCE CORPS.

SHORT Service Commissions.

APPLICATIONS are Invited from Fully Qualified Radio Engineers for Appointment to Short Service Commissions for a Period of Five Years.

PAY will be as for a Lieutenant (Ordnance Mechanical Engineer, 4th Class).

GRATUITY of £500 for Five Years' Service, and also 10% outfit allowance, will be granted.

CANDIDATES, before final selection, will be required to attend at the War Office for interview.

PREFERENCE will be Given to Candidates with the Following Qualifications:—

(A) A University Degree in Electrical Engineering.

(B) Experience in the Design, manufacture, or repair of short wave transmitters and receivers, or laboratory experience in short wave communication work.

FORMS of Application and Full Conditions can be Obtained from the Under Secretary of State (A.G.9), The War Office, London, S.W.1. [8379

CHASSIS Testers, good, wanted.—Invicta Radio, Ltd., 79a, Parkhurst Rd., Holloway, N.7. [8387

ASSEMBLERS for Radio Amplifier Manufacturers, S.E. London; technical knowledge an advantage; write experience and wages.—Box 9511, c/o The Wireless World. [8377

ROYAL AIR FORCE.—Men of good education required for enlistment and training as wireless operators and armourers; age limits 17½-35; write or call.—R.A.F. Recruiting Depot, Victory House, Kingsway, London, W.C.2, or any R.A.F. Recruiting Depot. [8311

VACANCIES Exist for Civilian Wireless Instructors at the Electrical and Wireless School, Royal Air Force, Yatesbury, Wilts. The commencing rate of pay is £4 a week inclusive, which may be increased to £4 5s. a week after a short period of satisfactory service. Candidates must be capable of lecturing and must have a sound knowledge of electrical principles and their application to Radio and low-power electrical engineering. Applications should be addressed to the Commanding Officer, No. 2 Electrical and Wireless School, Yatesbury, Wilts, giving full particulars as to previous experience, age, etc. Candidates will be required to appear before a Selection Board at the School for interview and test. The test will include the giving of a lecture on any subject which may be chosen by the candidate involving the principles of modern radio. Lecturing sequence and style are most important. [0616

DRAUGHTSMAN Required by Large Electrical Engineering Firm in the Midlands, preferably with experience in design of short wave radio transmission equipment, or similar electrical apparatus.—Reply, with full particulars of age, education, experience and salary required, Box 9394, c/o The Wireless World. [8344

ASSISTANT Required in Engineering Department for Design and Maintenance of Factory Test Equipment; some knowledge of radio fundamentals essential; B.Sc. or Graduate I.E.D. standard; apply in writing, stating full details regarding age and experience, to Employment Dept., Murphy Radio, Ltd., Welwyn Garden City, Herts. [8380

SITUATIONS WANTED

RADIO Service Man, age 20, with three years' practical experience, seeks situation in any district.—Box 9525, c/o The Wireless World. [8383

For PROMPT DELIVERY of High Quality

LOUDSPEAKERS, LOUD-SPEAKER CONES LOUD-SPEAKER COMPONENTS, TRANSFORMER LAMINATIONS, TRANSFORMER HOUSINGS, TRANSFORMER WINDINGS, CHOKE WINDINGS, FIELD COIL WINDINGS, PERMANENT MAGNETS, PRESS TOOLS AND PRESSINGS, JIG BORING.

AUTOMATIC SCREW MACHINE PARTS UP TO 2" DIAMETER.

Contractors to the Admiralty, War Office and Air Ministry.

Call on
BRITISH ROLA LTD.
 MINERVA ROAD, PARK ROYAL, N.W.10.
 PHONE: WILLESDEN 4322-3-4-5-6

RADIOMART

5NI CHAM LT

THE SHORT-WAVE SPECIALISTS

SPECIAL OFFER!!!
 Fully shrouded Transformers by America's largest manufacturer. While they last.

All 230 v. primary and fully impregnated.	
T28708—375/375 v. 150 m/A., 6.3V6A, 2.5V2A, 5V3A.	15/-
T19810—350/350 v. 150 m/A., 2.5V6A, 2.5V2A, 5V3A.	12/6
T2230—375/375 v. 120 m/A., 6.3VCT, 4A, 5V3A.	10/6
T7325—350/350 v. 100 m/A., 6.3VCT, 3A, 5V3A.	8/6
T7307—350/350 v. 80 m/A., 6.3VCT, 3A, 5V3A.	7/6
T7000—320/320 v. 80 m/A., 6.3V4A, 5V3A.	7/6
T6925—320/320 v. 80 m/A., 2.5V6A, 5V3A.	7/6
T464919—10V4A Primary Tapped 110—250 v.	5/6
T1113AB—110/230 v. 300 watt Auto Transformer	29/6

The following chokes are interwired and impregnated:

T7007—250 m/A., 135 ohms, 20-8 Hy., cadmium shrouded.	12/6
T7007A—150 m/A., 250 ohms, 30-12 Hy., cadmium shrouded.	12/6
100 m/A., 20 Hy., 500 ohms, unshrouded.	4/11
60 m/A., 15 Hy., 250 ohms.	1/11

HEAVY DUTY TRANSFORMER for models, bells, etc., 6 v. 3 a., 23. 4 m.f., 1,500 v. test, 500 v. w.k.g. oil filled condensers, 2v.

HEAVY DUTY MAINS Transformer, worth 45/-, 350-350, 150 m/A., H 4 v. 2.5 a. CT, 4 v. 6 a., CT, 12/6; 300-300 v., 80 m/A., 4 v. 3 a., CT, 4 v. 2 a., CT, 6/8. Moving Coil Speech Transformers, 1/11.

GANG CONDENSERS with Airplane Dial, 8 and 80-1. Cost 35/-, Pw only, 4/11. Utility, 7/6. Microdials, 3/9.

T.H. 5in. PERMANENT MAGNET SPEAKERS AT ONE-THIRD COST Extension Type (no Transformer), 8.11. Standard Type (with Transformer), 10/6. Energised 8", 1,200 ohms with Transformer, 6/11.

PUSHBACK Wire, 6 yds., 6d., heavy, 9d. Resin-cored Solder, 6ft., 6d.; Screened Flex, single, 6d. yd.; twin, 9d. yd. Assorted Solder Tags, 6d. packet. Humldimmers, 6d. each.

Centralab pots, all sizes, 1/6; switched, 2/-; tubular glass fuses, 2d. Milliammeters, 0-25 m.a. upwards, 5/9; Super 8/9.

OUR NEW 68-PAGE MANUAL, packed full of valuable information. Post Free, 7/4.

THE NEW RAYMART CATALOGUE shows dozens of New Short-wave Components and is yours for 1/6, post free.

VALVES.—A complete range of replacements, showing a saving of over 50 per cent. Quotations on receipt of types required. Quantity Discounts to Service Engineers. TRADE enquiries for communication equipment solicited.

RADIOMART Telephone: MIDland 3254.
 5NI (Birmingham) Ltd.
 44, HOLLOWAY HEAD, BIRMINGHAM

WELBURN 12 WATT AMPLIFIER

Two Mazda output tetrodes are used in push-pull, with 15% Negative Feed-Back, in a high gain circuit; while microphone and gramophone can be mixed. The symmetrical output transformer winding for any output impedance, instead of tapped secondary, gives improved performance.

BRIEF SPECIFICATION
 Maximum Undistorted Output 12 watts; Required Input 0.003 v.; Overall Gain 116 db; Output Impedances 8 and 16 ohms.

STANDARD MODEL £14
 Write for full details.

WELBURN RADIO LTD
 QUEENSWAY TEAM VALLEY GATESHEAD-ON-TYNE

An Inexpensive PRECISION D.C. Meter



with
13 RANGES

CURRENT
0-6 milliamps
0-30 milliamps
0-120 milliamps

VOLTAGE
0-6 volts
0-12 volts
0-120 volts
0-240 volts
0-300 volts
0-600 volts

RESISTANCE
0-10,000 ohms
0-60,000 ohms
0-1,200,000 ohms
0-3 megohms

BRITISH MADE

The **D.C. AVO MINOR**

Regd. Trade Mark

ELECTRICAL MEASURING INSTRUMENT

This instrument provides precision testing facilities at a truly modest cost. Incorporating a fully jewelled moving-coil movement and a 2½-ins. scale, it permits accurate readings of milliamps., volts and ohms, with ranges adequate enough for the majority of normal circuit, battery and resistance tests. The total resistance of the meter is 100,000 ohms; full scale deflection of 300v. or 600v. is obtained for a current consumption of only 3mA. and 6mA. respectively.

In case, complete with leads, interchangeable crocodile clips and testing prods; and with comprehensive instruction booklet **45/-**

DEFERRED TERMS IF DESIRED

• Write for fully descriptive pamphlet.

Sole Proprietors & Manufacturers:

THE AUTOMATIC COIL WINDER AND ELECTRICAL EQUIPMENT Co. Ltd.

Winder House, Douglas St., London, S.W.1. Phone: VICTORIA 3404-7



We don't claim to make the cheapest transformers but we do claim to make good ones. Most of the professional P.A. men seem to think so, too.

W. BRYAN SAVAGE LTD.
Westmoreland Rd., London, N.W.9. *Phone: Colindale 7131

YOU GET MORE WITH THE TAYLOR ALL-WAVE (6.5-3000 Metres) SIGNAL GENERATOR

This NEW British Made Model is remarkable value. Complete with screened output lead, it has a frequency range from 100 Kc. to 46 Mc. in six bands, directly calibrated—Almost constant Output with low Harmonic content. Up to 50% variable Internal or External Modulation. Up to 5 volts at 400 cycles of good wave form for testing audio amplifiers, and many other outstanding features.

Let us send you full specification.



10 GUINEAS
Low Deposit Easy Terms Available

Post this Coupon

To **TAYLOR ELECTRICAL INSTRUMENTS LTD.**,
45, Foubert's Place, Regent St., LONDON, W.1

Please send me full details of the TAYLOR MODEL 60 ALL WAVE SIGNAL GENERATOR.

Name
Address

W.W.9

REPAIRS AND SERVICE

"SERVICE with a Smile."

A MERICAN Valves, spares, linecords, rewinds; repairers of all types of American and British receivers.—F.R.I., Ltd., 22, Howland St., W.1. Museum 5675. [0434

L OUD-SPEAKER Repairs, British, American, any make, 24-hours service; moderate prices.—Sinclair Speakers, Alma Grove, Copenhagen St. N.1. [0590

B AKERS.—Take advantage of 15 years' experience; send your next speaker repair, any make, to Bakers Selhurst Radio, South Croydon. [8372

G UARANTEED Repairs Any Transformers, choke, motor armature, converter, dynamo, etc.; keenest prices, immediate quotation, prompt dependable service.—See below.

L T.P. (LONDON TRANSFORMER PRODUCTS. Ltd.), Willesden, N.W.10. Willesden 6486 (3 lines). [6892

M AINS Transformer Service. Repairs, rewinds, or construction to specification of any type, competitive prices and prompt service.—Sturdy Electric Co., Dip-ton, Newcastle-on-Tyne. [0516

E POCH Speaker Replacements, cone assemblies supplied from 4/-; field coil and transformer rewinds; trade radio service.—National Radio Epoch Reproducers, 126, Elthorne Rd., N.19. Arc. 1319. [8368

M ETROPOLITAN RADIO SERVICE.—Guaranteed repairs to American and British receivers; American valves, service parts and rewinds; trade supplied.—1021, Finchley Rd., N.W.1. Speedwell 3000. [0435

S COTT-SESSIONS REPAIR SERVICE.—All types of receivers overhauled, rebuilt, repaired, including American communication sets, W.W. Monodials, All-wave Super-Seven. Variable Selectivity IV., etc.

S COTT-SESSIONS REPAIR SERVICE, popular for 15 years from Land's End to John-o-Groats; van collection London area; immediate, courteous and skilled attention to every instruction.

S COTT-SESSIONS REPAIR SERVICE, Exchange Works, Muswell Hill, N.10. Tudor 4101-2. [7497

R EPAIRS to Moving Coil Speakers a Speciality: cones and coils fitted, fields altered; prices, including eliminators, quot-; loud speakers, 4/-; L.F. and output transformers, 4/-, post free; guaranteed satisfaction; trade invited, estimates free; prompt service.—Loud-Speaker Repair Works, 5, Balham Grove, London. Battersea 1321. [0394

MISCELLANEOUS

C HEAP Printing.—1,000 billheads, 3/6; sample free.—Creteway Press, 1B, Buxted, Sussex. [8180

P HOTO-ELECTRIC Cells, brand new; 15/- each.—Univer-sal, 221, City Rd., London, E.C.1. [8370

G.P.O. Engineering Dept. (no experience required); com-mencing £3 13s. per week; age 18-23; excellent prospects; free details of entrance exam. from: B.I.E.T. (Dept. 574), 17-19, Stratford Place, London, W.1. [8309

E VERY Radio Dealer Who is Not a Regular Reader of "The Wireless and Electrical Trader" should send his trade card at once for a specimen copy and full details of the "Trader" Services. "The Wireless and Electrical Trader" has the widest influence, the largest weekly circulation, and is read by all the leading manu-facturers and traders. Trade only, 15/- per annum, post free.—Published at Dorset House, Stamford St., Lon-don, S.E.1. [0615

"ENGINEER'S Guide to Success" Shows How to Qualify in Television Radio Engineering and Ser-vice, sound recording, wireless communication, etc., by studying at home with the T.I.G.B. Write to-day for this Great Guide—free—which gives full particulars, contains the world's widest choice of engineering courses—over 200—and alone gives the regulations for qualifications such as A.M.I.E.E., A.M.I.R.E., A.M.I.T.E., A.M.I.W.T., C. and G., etc. Training until successful guaranteed.—The Tech-nological Institute of Great Britain, 82, Temple Bar House, London, E.C.4. (Founded 1917. 20,000 successes.) [8335

FINANCIAL PARTNERSHIPS

Y OUNG Man (29), with capital, wishes to acquire partnership in established radio, gramophone, photo-graphic or electrical business; Glasgow or district preferred.—Write, giving full particulars, Box 9512, c/o The Wireless World. [8375

PATENT AND TRADE MARK AGENTS

G EE and Co. (H. T. P. Gee, Mem. R.S.G.B., etc.), 51-52, Chancery Lane, London, W.C.2. Holborn 4547-8. Handbook free. [0001

BUSINESSES AND PROPERTY FOR SALE, TO BE LET, OR WANTED

N EED for Radio and Cycle Dealer on Large New Estate. Main road position. Success assured. No premium.—Apply Fairway Homes, Mutton Lane, Potters Bar. Tel.: 931. [8371

"THE Wireless and Electrical Trader" is an essential part of the equipment of every Wireless Trader; its pages reflect the very latest turn of trade events, and it is read by all the leading dealers and manufacturers for particulars of businesses offered or wanted. By subscrip-tion to the trade only, 15/- per annum, post free.—Send your trade card for specimen copy to Dorset House, Stam-ford St., London, S.E.1. [0614

There is only one test for good P.A.

That everybody hears perfectly and nobody realises there are loudspeakers in use.

Is yours the best in the district ?

Then it looks as if you are using Voigt speakers. But—if your gear is not praised each time it is used, that is a sure hint to you to improve matters before it is too late. If your P.A. is not better than your competitor's, then he will go on taking your regular contracts on price. If you have the best, then even if a customer "strays," he will come back—to the best.

Investigate the 'VOIGT'

It speaks for itself, and wins every sales argument.

We have a few units and horns available for hire—(1 guinea the first week plus transport), and we waive the hire charge if a sale results during the trial period.

The price of the normal twin diaphragm unit (which requires protection from rain) is £15 (Ex Works)

The showerproof model illus-trated below costs £18.15 (Ex Works)

Horns from £2.15



Protected showerproof model with D.P. diaphragm and compo. horn.

Remember that with a domestic horn (from £2.15), these speakers will entertain you at home.



THE COURTS, SILVERDALE, LONDON, S.E.26
Tel.: SYDenham 6666
Regd. Office: 22, Castle Street, E.C.1.

ENGINEERS! ARE YOU EARNING LESS THAN £10 PER WEEK?

If so, you cannot afford to carry on without reading our 268-page Handbook. The book explains clearly and definitely many ways of carving out a successful career. Among other things it explains the Services of our unique Appointments Department; outlines Home-Study Courses in all branches of Civil, Mechanical, Electrical, Motor, Aero, Wireless, "Talkie" Engineering, Building, Govt. Employment, etc., and gives details of B.Sc., A.M.I.C.E., A.M.I.E.E., A.M.I. Mech. E., A.M.I.A.E., A.M.I.W.T., A.M.I.R.E., G.P.O., MATRIC., and all Exams. We Guarantee "NO PASS—NO FEE." Whether you be an old hand or a budding apprentice get this book to-day. FREE and POST FREE.

BRITISH INSTITUTE OF ENGINEERING TECHNOLOGY.

337, Shaftesbury House, 17(1), Stratford Place, London, W.1.



WALNUT SET CABINETS

(as illustrated)

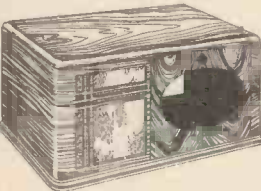

21" long, 11" deep, 12" high.

A really first-class piece of furniture.

4/6

Carr. Paid

4 Pole Single Throw Xaxley Rotary Switches 8d. ea. .0005 Mica Dielectric Reaction Condensers 8d. ea. Screw Fuse or Bulb Holders 4d. ea. Mains Transformers, 350-0-350. 80M.A. 4v. 2½ amp. 4v. 5 amp. 13v. 2 amp. Input 200 to 250 volts. 5/6 ea. All post free. See previous adverts. for other genuine bargains.

UNIVERSAL, 8 & 10, Brown Street, MANCHESTER, 2.

*Phone: Deansgate 5009.

THE INSTITUTE OF WIRELESS TECHNOLOGY

(Founded in 1925. Incorporated).

PROFESSIONAL MEMBERSHIP

The advantages of professional membership are open to all qualified wireless engineers.

Full information, with syllabus, may be obtained from the Secretary, Institute of Wireless Technology, 4, Vernon Place Southampton Row, London, W.C.1. *Phone: Holborn 4879.

EXTENDED PAYMENTS

LONDON RADIO SUPPLY Co. (Established 1925)
L Supply, on convenient terms, components, accessories and sets, any make; 10% down, balance over 12 months; send for list of requirements.—11, Oat Lane, London, E.C.2. [0337]

TUITION

RADIO Training—P.M.G. exams. and I.E.E. Diploma; prospectus free.—Technical College, Hull. [0611]

WIRELESS—Complete training, Marine, Broadcast and Television. Posts waiting. Mod. fees. Boarders taken. Approved college, prosp.—Dept. W., London Radio College, Grove Park Rd., London, W.4. (Chi. 3244.) [0580]

BOOKS, INSTRUCTION, ETC.

AMERICAN Valve Data—The new 200-page Raytheon Valve Data Book gives full characteristics and applications of all types of American valves; invaluable to all servicemen; post free 2/3; abroad 3/-.—Leonard Heys, 36, Henry St., Blackpool. [0594]

"ELEMENTARY Principles of Wireless Telegraphy and Telephony" By R. D. Banguay. Revised by O. F. Brown, B.Sc. Third edition (1930). The standard textbook for wireless students and beginners. Deals with the whole subject of wireless telegraphy and telephony, avoiding too technical a treatment of the problems involved. Well illustrated. Price 7/6 net. By post 8/-. from Iliffe and Sons, Ltd., Dorset House, Stamford St., London, S.E.1.

"FOUNDATIONS of Wireless." By A. L. M. Sowerby, M.Sc. Second edition. An elementary textbook on receivers. Deals fully with the construction of wireless sets, valves, and the process of detection. Price 4/6 net. By post 4/11, from Iliffe and Sons, Ltd., Dorset House, Stamford Street, London, S.E.1.

"RADIO Data Charts." By R. T. Beatty, M.A., B.E., D.Sc. Second edition. A series of Abacs providing most of the essential data required in receiver design and enabling problems to be solved without having recourse to complicated mathematical formulae. Price 4/6 net. By post 4/10, from Iliffe and Sons, Ltd., Dorset House, Stamford St., London, S.E.1.

"THE Wireless World" Diary for 1939 contains 77 pages of facts, formulae and general information of the kind that is always wanted but is difficult to follow. Also a list of the most important European Broadcasting Stations and short-wave stations of the world. Twelve pages of circuit diagrams of receivers, amplifiers and units. —By post 1/7 from Iliffe and Sons, Ltd., Dorset House, Stamford St., London, S.E.1.

D E N C O

BRITISH POLYSTYRENE (Trolitul)

The ultra low loss insulating material, better than ceramic, yet as easy to work as ebonite. Absolutely non-hygroscopic, transparent, unaffected by weather conditions. Stocked in sheets 15" x 9" x ¼" or ½". Rod ½", ¾" and 1" and Tube ½" and 1" diameter.

Send for detailed Lists "D.W."

DENCO, 234, Burrs Rd., Clacton, ESSEX. Tel.: 770

INDEX TO ADVERTISEMENTS

	PAGE
Air Ministry	1
Air Service Training, Ltd.	1
Ambassador Radio Works	2
Armstrong Manufacturing Co.	7
Automatic Coil Winder Co., Ltd.	7
Belling & Lee, Ltd.	6
Birmingham Radiomart G5N1	6
British Institute of Engineering Technology	8
British Rola, Ltd.	6
British Thomson-Houston Co., Ltd.	1
Cosmocord, Ltd.	8
Denco	8
Edison Swan Electric Co., Ltd.	6
Electradix Radios	6
Grampian Reproducers, Ltd.	3
Hartley Turner Radio Co.	4
Henlys, W. T., Telegraph Works Co., Ltd.	4
Institute of Wireless Technology	8
London Radio Supply Co.	2
McClure, John, Ltd.	4
Mullard Wireless	1
Pamphonic Reproducers, Ltd.	4
Partridge, N.	6
Premier Supply Stores	5
Salford Electrical	Inside Front Cover
Savage, W. Bryan, Ltd.	7
Sound Sales, Ltd.	4
Stratton & Co.	Inside Back Cover
Taylor Electrical Co., Ltd.	7
Universal Electric	8
Voigt Patents, Ltd.	7
Webbs Radio	1
Welburn Radio, Ltd.	6
Westinghouse Brake & Signal Co.	1
World Radio	Inside Back Cover

RADIO LABORATORY HANDBOOK

By M. G. SCROGGIE, B.Sc., A.M.I.E.E.
issued in conjunction with "The Wireless World"

384 pp.
211 illustrations

PRICE 8/6 NET
By post 9/-

"Radio Laboratory Handbook" is the only practical and reliable handbook on the subject. It gives the serious wireless worker complete information from first-hand experience about laboratory equipment, the instruments which are necessary and the correct methods of operating them.

The fundamental principles are fully discussed, as well as the sources of power and signals, instruments and measurements. Other sections deal with ultra-high-frequency work, the working out of results, and reference data. There is also a collection of the most useful symbols, abbreviations, formulae, laws, curves, tables and other data.

A complete index, numbered sections and cross references enable the reader to find what is required without loss of time.

From Bookstalls and Booksellers or direct from the Publishers

ILIFFE & SONS LTD., DORSET HOUSE, STAMFORD STREET, LONDON, S.E.1

Printed in England for the Publishers, ILIFFE AND SONS LTD., Dorset House, Stamford Street, London, S.E.1. by The Cornwall Press Ltd., Paris Garden, Stamford Street, London, S.E.1.

"The Wireless World" can be obtained abroad from the following: FRANCE: W. H. Smith & Son, 248, Rue Rivoli, Paris; Hachette et Cie, Rue Réaumur, Paris, and branches; Messageries Dawson, 4, Rue de Faubourg Poissonniere, Paris. BELGIUM: W. H. Smith & Son, 71-75, Boulevard Adolphe Max, Brussels. AUSTRALIA: Gordon & Gotch, Ltd., Melbourne (Victoria), Sydney (N.S.W.), Brisbane (Queensland), Adelaide (S.A.), Perth (W.A.), and Lancaster (Tasmania). NEW ZEALAND: Gordon & Gotch, Ltd., Wellington. Auckland, Christchurch and Dunedin. INDIA: A. H. Wheeler & Co., Bombay, Allahabad and Calcutta. CANADA: Imperial News Co., Toronto, Winnipeg and Vancouver; Benjamin News Co., Montreal; Gordon & Gotch, Ltd., Toronto. SOUTH AFRICA: Central News Agency, Ltd.; Wm. Dawson & Sons (S.A.), Ltd., Cape Town. UNITED STATES: The International News Co., New York.

APRIL 21, 1939

American Page

Selected U.S.A. Short-Wave Programmes

Note: For complete time schedules of U.S. Short-Wave Broadcasting Stations see p. 20.
(All times are given this week in G.M.T.; for B.S.T. add 1 hour.)

SUNDAY, Apr. 23

- 14.00 — Children's Hour (W3XL, 16.87 m.)
- 15.00 — American String Quartet (W3XL, 16.87 m.)
- 15.30 — Children's Programme (W2XE, 13.91 m.)
- 15.30 — Russian Melodies (W3XL, 16.87 m.)
- 16.00 — Music Appreciation Hour (W3XL, 16.87 m.)
- 17.00 — Radio City Symphony Concert (W2XAD, 19.57 m.)
- 17.00 — Major Bowes' Amateurs (Variety) (W2XE, 19.65 m.)
- 17.15 — Programme Information (W3XL, 16.87 m.)
- 17.17 — "Silver Tones" (W3XL, 16.87 m.)
- 17.30 — For Stamp Collectors (W3XL, 16.87 m.)
- 17.45 — "Tone Colours" (W3XL, 16.87 m.)
- 18.00 — Musical Plays (W2XAD, 19.57 m.)
- 19.00 — Symphony Concert Band (W2XAD, 19.57 m.)
- 20.00 — Armico Concert (W2XAD, 19.57 m.)
- 20.00 — Symphony Concert (W2XE, 25.36 m.)
- 20.30 — Maurice Spitalny's Concert (W2XAD, 19.57 m.)
- 21.00 — "Vivian Della Chiesa" (W2XAF, 31.48 m.)
- 21.30 — "Caravan" (W2XAD, 19.57 m.)
- 21.30 — Crawford m.; W8XK, 25.26 m.)
- 21.30 — Metropolitan Opera Audi-

TUESDAY, Apr. 25

- 02.00 — Drama (W3XAU, 31.28 m.)
- 02.05 — "Hour of Charm" (W2XAF, 31.48 m.)
- 03.00 — Guy Lombardo's Orch. (W3XAU, 31.28 m.)
- 03.30 — "Columbia Workshop" (W3XAU, 31.28 m.)
- 04.00-05.00 — Dance Orchs. from NBC Networks (W2XAF, 31.4 m.)
- 05.00-06.00 — Dance Orchs. from CBS Networks (W3XAU, 49 m.)
- 05.00-06.00 — Dance Orchs. from NBC Netw'ks (W8XK, 48.86 m.)
- 12.30 - 15.00 — Light Music a Entertainment (W2XE, 13.91 m)
- 13.30 — "Swing Serenade" (W8XK, 13.93 m.)
- 14.05 — "Breakfast Club" (W8XK, 19.72 m.)
- 15.00 — "Musical Interlude" (W3XL, 16.87 m.)
- 16.00 — "Melody Matinee" (W3XL, 16.87 m.)
- 17.00 — Dance Music (W3XAU, 19.65 m.)
- 17.30 — Science Talk (W8XK, 17.45 m.)
- 17.45 — "Tone Colours" (W3XL, 16.87 m.)
- 18.15 — Glen Darwin (Barit) (W2XAD, 19.57 m.)
- 18.45 — Fashion Hints (W2XAD, 19.57 m.)
- 18.45 — Dancing (W2XE, 19.65 m.)
- 19.30 — "Little Variety" (W2XAD, 19.57 m.)

This is a quick reference guide giving the pick of the U.S. short-wave programmes, hour-by-hour for each day of the week; explanatory notes and a table of news broadcasts. You will find this a help in two ways: it will add to your enjoyment of American programmes by showing you the "high-spots" and it will save you wasting time (and temper!) in aimless searching.

It begins with the current (April 21st) issue.

It is accompanied by a complete list of transmission periods, wavelengths, frequencies, power and aerial directions of the American short-wave stations, which will be printed again only as and when alterations occur in the working of any station.

Your local newsagent or bookstall will gladly deliver

World-Radio

EVERY FRIDAY, 3d.

YOU'LL FIND HOURS OF INTEREST.....IN THE EDDYSTONE SHORT WAVE MANUAL

Did you respond to our last announcement in this Journal—and get a copy of the EDDYSTONE SHORT-WAVE MAGAZINE? If not, get a copy to-day—you'll find it one of the best shillingsworth you ever bought. It goes thoroughly into the matter of modern Short-Wave Practice, providing intensely interesting constructional explanations of how to build various Short-Wave Receivers, low and medium Power Transmitters, Amateur Communication Pre-selector, Cathode-Ray Oscilloscope, etc., etc., etc. Illustrated with 30 photographs and nearly three dozen diagrams. Alive and exceedingly informative—just the book to have at your elbow. If you haven't already got a copy—don't forget this time—act now!

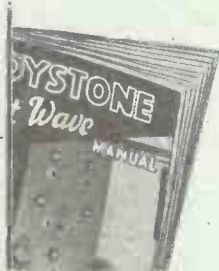

Get the **EDDYSTONE SHORT WAVE MANUAL**

from W. H. Smith, or Radio Dealers, or 1/2 post free from Stratton and Co. Ltd., Eddystone Works, Bromsgrove Street, Birmingham, 5.

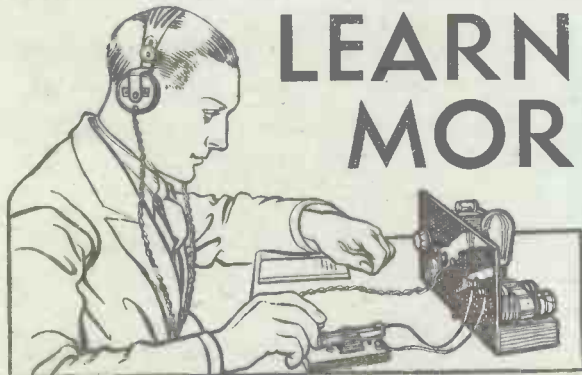

LEARNING MORSE

AN EASY METHOD OF MASTERING THE INTERNATIONAL SIGNAL CODE

Published from the Offices of **The Wireless World** 6^D NET
ILIFFE & SONS LTD., Dorset House, Stamford St., London, S.E.1

BY POST 7d.

The ELECTRICAL REVIEW

The Complete Technical Journal

Practical articles on all aspects of electricity supply and utilisation—industrial, commercial and domestic. Latest news of the electrical industry and developments. Advertisement pages form a comprehensive buyers' guide.

Contents of April 28th issue:—

GERMAN RURAL ELECTRIFICATION

An account by a British electrical engineer of developments seen during a recent visit.

ELECTRIC STEAM BOILERS

Showing the scope existing for raising process steam electrically, a number of installations being mentioned.

ELECTRICAL QUANTITIES

A simple method of demonstrating current, voltage, resistance, capacity, etc., by mechanical analogy.

PROSPECTS IN CHINA

The Chinese change of attitude towards mechanisation means work for British factories.

EVERY FRIDAY 6d.

Subscriptions: United Kingdom £1 14 8
Canada £1 12 6 Other Countries
£2 1 6 per annum, post free.

ELECTRICAL REVIEW LTD.

Dorset House, Stamford Street, London, S.E.1

The Rev.
W. H.
ELLIOTT

has one and a half million members
in his League of Prayer. Read
his intimate and inspiring message
which appears exclusively every
week in the **SUNDAY GRAPHIC.**

He writes for you in the

SUNDAY
GRAPHIC

All the News and Pictures Fit to Print

