

# The Wireless World

4<sup>D</sup>

**THE PRACTICAL RADIO & TELEVISION JOURNAL**

Friday, July 2nd, 1937

THE NEW

# MAZDA

INDICATOR

*Type*

**AC.ME**

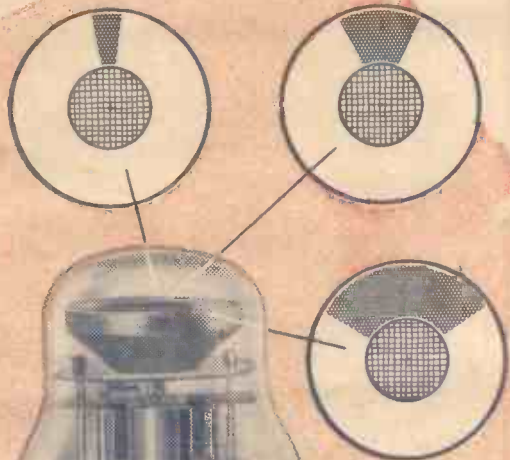

The Mazda AC.ME enables exceedingly accurate tuning of a receiver to be obtained by purely electrical means. It consists of an electrode system surmounted by a target coated with a fluorescent material. The area of glow on the target is controlled by the bias applied to the control grid of the electrode structure.

The AC.ME is suitable for use in circuits employing diode detection.

For AC/DC receivers type ME.920 should be used. This has characteristics identical with the AC.ME with a 9-volt .2 amp. heater.

**CHARACTERISTICS**

Heater Volts . . . . .	4
Heater Current . . . . .	.5
Max. Anode Volts . . . . .	250
Max. Target Volts . . . . .	250
Grid Volts for zero shadow . . . . .	22
Anode Current . . . . .	.24

**BASE CONNEXIONS**

Pin No. 1 . . . . .	—
" " 2 . . . . .	G1
" " 3 . . . . .	Target
" " 4 . . . . .	Heater
" " 5 . . . . .	Heater
" " 6 . . . . .	Cathode
" " 7 . . . . .	Anode

The AC.ME is fitted with a standard 7-pin base.

**PRICE 10/6**

*Mazda Radio Valves are manufactured in Great Britain for The British Thomson-Houston Co. Ltd., London and Rugby and distributed by*

**THE EDISON SWAN ELECTRIC CO. LTD., 155 CHARING CROSS RD., LONDON, W.C.2 RM315**





**Why use**

**Dubilier Condensers ?**

Do you use them because you have found the new medium calls for components that are absolutely reliable? Do you use them because it necessitates condensers that can be trusted to do their own work without trouble—that will play their part in giving perfect reception? We hope you do.

But if you have not yet had the opportunity to use them for those reasons, we hope you will do so because so many are specified by "Wireless World" for their Television Receiver—a rather significant fact

**VISION RECEIVER**

3 0.5  $\mu$ F tubular. 4428 Type S, 350 v. D.C. wkg., 1 50  $\mu$ F, 12 volts, electrolytic, 3016 Type, 1 10  $\mu$ F, ceramic, CDS3 Type.

**TIME-BASE**

1 0.0005  $\mu$ F, mica. 690 W Type, 2 0.001  $\mu$ F, mica. 690 W Type, 2 0.002  $\mu$ F, 5,000 volts D.C. test. 680 Type, 1 0.1  $\mu$ F, 1,500 volts working, 950A Type. 1 0.5  $\mu$ F, 1,500 volts working, 950A Type, 1 1  $\mu$ F, 1,000 volts working. 950A Type, 1 0.1  $\mu$ F, tubular. 4523 Type, 350 v. D.C. wkg., 1 0.2  $\mu$ F, tubular. 4425 Type S, 350 v. D.C. wkg., 2 25  $\mu$ F, 25 volts, electrolytic. 3016 Type, 1 50  $\mu$ F, 50 volts, electrolytic, 3004 Type.

**SOUND RECEIVER POWER PACK**

1 50  $\mu$ F 50 v. electrolytic. 3004 Type.

**HIGH VOLTAGE UNIT**

1 0.1  $\mu$ F, 7,000 volts, oil-immersed, 951 Type, 1 1  $\mu$ F, 2,000 volts, oil-immersed, 951B Type, 1 1  $\mu$ F, 3,000 volts, oil-immersed, 951C Type.

1 2  $\mu$ F, 1,000 volts, oil-immersed, 950A Type, 1 10  $\mu$ F, (multiple block). BE526 Type.

**FRAMEWORK AND ASSEMBLY OF UNITS**

2 0.1  $\mu$ F, 5,000 volts, tubular, 2 0.01  $\mu$ F, 5,000 volts, tubular.

**VISION RECEIVER POWER PACK**

1 electrolytic 8-8  $\mu$ F, 9203EW Type

**SOUND RECEIVER**

(Ultra-Short-Wave Quality Receiver, April 23rd, 1937).

**RESISTANCES**

1 100 $\Omega$ ,  $\frac{1}{2}$  watt. Type F, 1 500 $\Omega$ ,  $\frac{1}{2}$  watt. Type F, 1 2,000 $\Omega$ ,  $\frac{1}{2}$  watt. Type F, 1 10,000 $\Omega$ ,  $\frac{1}{2}$  watt. Type F, 325,000 $\Omega$ ,  $\frac{1}{2}$  watt. Type F, 1 50,000 $\Omega$ ,  $\frac{1}{2}$  watt. Type F, 1 75,000 $\Omega$ ,  $\frac{1}{2}$  watt. Type F, 1 100,000 $\Omega$ ,  $\frac{1}{2}$  watt. Type F, 1.2M $\Omega$ ,  $\frac{1}{2}$  watt. Type F, 1 40,000 $\Omega$ , 2 watt. Type F.

**DUBILIER  
CONDENSERS**

DUBILIER CONDENSER CO. (1925) LTD., DUÇON WORKS, VICTORIA ROAD, NORTH ACTON, LONDON, W.3



G. R. Casson 130

Mention of "The Wireless World." when writing to advertisers, will ensure prompt attention.

# The Wireless World

THE PRACTICAL RADIO JOURNAL  
27<sup>th</sup> Year of Publication



No. 931.

FRIDAY, JULY 2ND, 1937.

VOL. XLI.

No. 1.

Proprietors: ILIFFE & SONS LTD.

Editor:  
HUGH S. POCKOCK.

Editorial,  
Advertising and Publishing Offices:  
DORSET HOUSE, STAMFORD STREET,  
LONDON, S.E.1.

Telephone: Waterloo 3333 (50 lines).  
Telegrams: "Ethaworld, Sedist, London."

COVENTRY: Hertford Street.  
Telegrams: "Autocar, Coventry." Telephone: 5210 Coventry.

BIRMINGHAM:  
Guildhall Buildings, Navigation Street, 2.  
Telegrams: "Autopress, Birmingham." Telephone: 2971 Midland (4 lines).

MANCHESTER: 260, Deansgate, 3.  
Telegrams: "Iliffe, Manchester." Telephone: Blackfriars 4412 (4 lines).

GLASGOW: 26B, Renfield Street, C.2.  
Telegrams: "Iliffe, Glasgow." Telephone: Central 4857.

PUBLISHED WEEKLY. ENTERED AS SECOND-CLASS MATTER AT NEW YORK, N.Y.

Subscription Rates:  
Home, £1 1s. 8d.; Canada, £1 1s. 8d.; other countries, £1 3s. 10d. per annum.

As many of the circuits and apparatus described in these pages are covered by patents, readers are advised, before making use of them, to satisfy themselves that they would not be infringing patents.

## CONTENTS

	Page
Editorial Comment .. ..	1
The Wireless World Television Receiver—I. The Vision Receiver and Power Unit .. ..	2
Delayed Switching .. ..	7
Current Topics .. ..	9
Periodic Variations of the Ionosphere .. ..	10
Listeners' Guide for the Week ..	12
Principal Broadcasting Stations of Europe .. ..	14
Random Radiations .. ..	16
Broadcast Brevities .. ..	18
Practical Hints and Tips .. ..	19
Letters to the Editor .. ..	20
Recent Inventions .. ..	22

## EDITORIAL COMMENT

### Television

#### Our Receiver Design

**I**N this week's issue we begin a series of articles describing the practical design and construction of a complete sound and vision receiver for the B.B.C. television transmissions. We make no excuse for the apparent complexity of the apparatus—this is inevitable at present, and is, of course, common to all television receivers, but the complexity can be said to resolve itself into only a question of quantity when the equipment is dissected into its component units. The construction, taken as units stage by stage, offers no greater difficulty than an ordinary receiver and, in fact, may be considered to be less exacting in many respects.

Very special attention has been given in the design to make initial adjustment simple and to render the operation of controls as little critical as possible, so that, when constructed, no technical knowledge or special skill will be necessary in order to work it.

#### High Quality Throughout

The different units have been made easily accessible by the particular design adopted for the cabinet framework. No attempt has been made to cheapen construction by the use of components with a bare margin of safety, but every component is chosen to have ample voltage and power rating to guard against risk of breakdowns.

All high voltage sections are provided with proper protection so that the constructor who undertakes building the equipment should be involved in no risks, provided the ordinary precautions, such as his experience in building other mains-operated apparatus will already have taught him, are observed.

Even for those who may not contemplate building a television receiver themselves, the articles will nevertheless be found a source of complete information of a practical nature such as it has not hitherto been possible to obtain from any other source. These practical articles, studied in conjunction with general articles on television which have been appearing for some time in *The Wireless World*, may be regarded as a complete course of instruction in the subject.

The design is one which is particularly suited to the requirements of the student and experimenter, because of the accessibility of every part, whilst for instruction and demonstration requirements this feature is invaluable.

### Radio Propaganda

#### Probable Official Attitude

**W**HILST we know that the Government deplores the policy of some foreign governments of broadcasting, particularly on short waves, anti-British propaganda, yet we believe that there is no evidence at present to justify the rumours that action is to be taken to compete in this sphere. It can be regarded as certain that any move which it is decided to make will not be in the nature of reprisals, but will take the form of seeing that, wherever anti-British propaganda reaches, there also would the influence of accurate British news be extended with at least equal radio power.

On the question of language, any broadcast to counteract the effect of propaganda would, no doubt, be put out in the same languages as were being used by the offending foreign stations. This use of languages was foreshadowed in the Broadcasting Report.

# The Wireless World Television

## I.—FULL DETAILS OF THE VISION

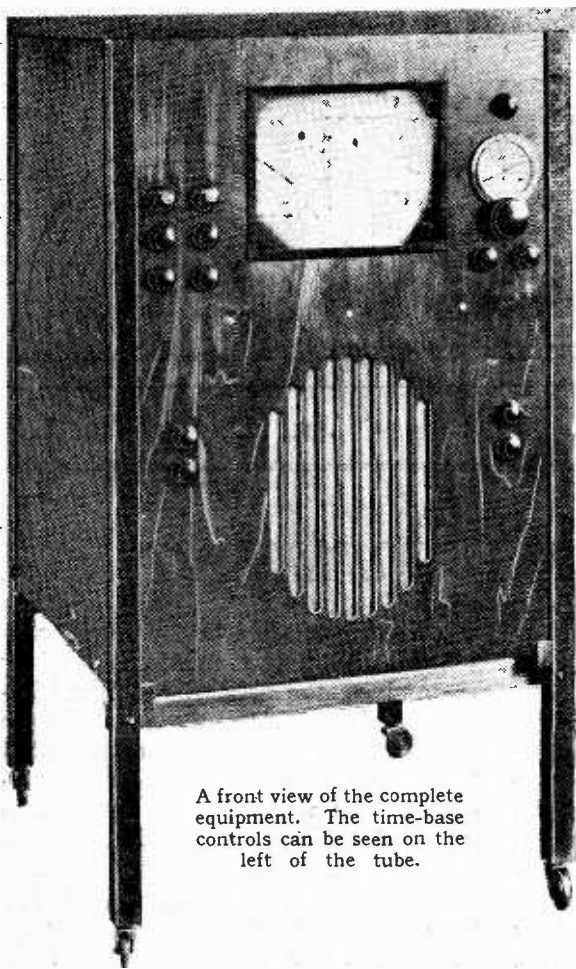

A front view of the complete equipment. The time-base controls can be seen on the left of the tube.

*F*OLLOWING upon the theoretical articles which have been appearing in "The Wireless World," complete constructional details of a television receiver are being given in a new series of which this is the first. The vision receiver and its power unit, which also supplies LT for tube and time-base, is described here in detail.

A STRAIGHT set has been selected as the most suitable type of vision receiver for reasons which have been given in recent articles in *The Wireless World*. These reasons are briefly that it requires fewer valves, is simpler to construct and adjust, and, most important, is free from the serious interference problems of the superheterodyne.

The circuit diagram of the receiver, which has been based upon many months of theoretical and practical research with many types of set, is shown in Fig. 1. It

will be seen that three RF stages are used with a diode detector and one VF stage; the remaining two valves are a diode for restoring the DC component to the output signal and an RF pentode for sync separation.

For the RF stages pentodes of high mutual conductance have been selected, and they operate with the screens at the same steady potentials as the anodes. It is consequently possible to use common decoupling for screen and anode and so effect a saving in the number of components required. This decoupling is effected by the resistances and condensers R3 and C3, R5 and C7, and R8 and C11

for the first, second and third stages.

Single tuned circuits are used for the interval couplings and are suitably damped so that the requisite band-width can be secured. No artificial damping is employed in the case of the first three circuits, for the low input impedance of the pentodes at ultra-high frequencies is chiefly relied upon for damping. In the case of the first circuit L2 C1, damping is also imposed by the aerial circuit.

The second and third couplings are of the tuned anode type, the tuning coils being L3 and L4 tuned by the condensers C5 and C9. Because the input impedance of the diode detector is much higher than that of an RF pentode at very high

Fig. 1.—The complete circuit diagram of the vision receiver and amplitude filter is shown here. Three RF stages are used with a diode detector and one VF stage; the remaining valves are the DC restorer and the sync separator.

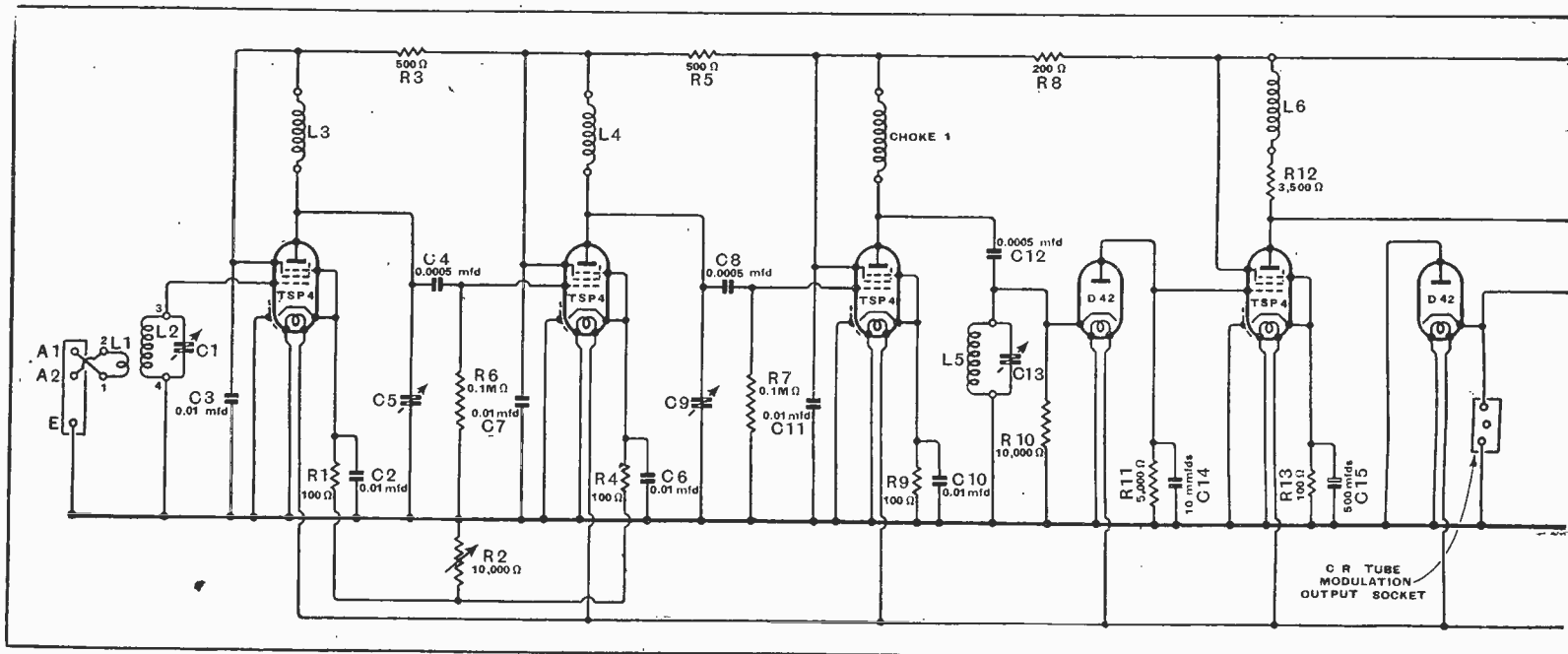

DESIGNED BY W. T. COCKING

# Receiver

## RECEIVER AND ITS CONSTRUCTION

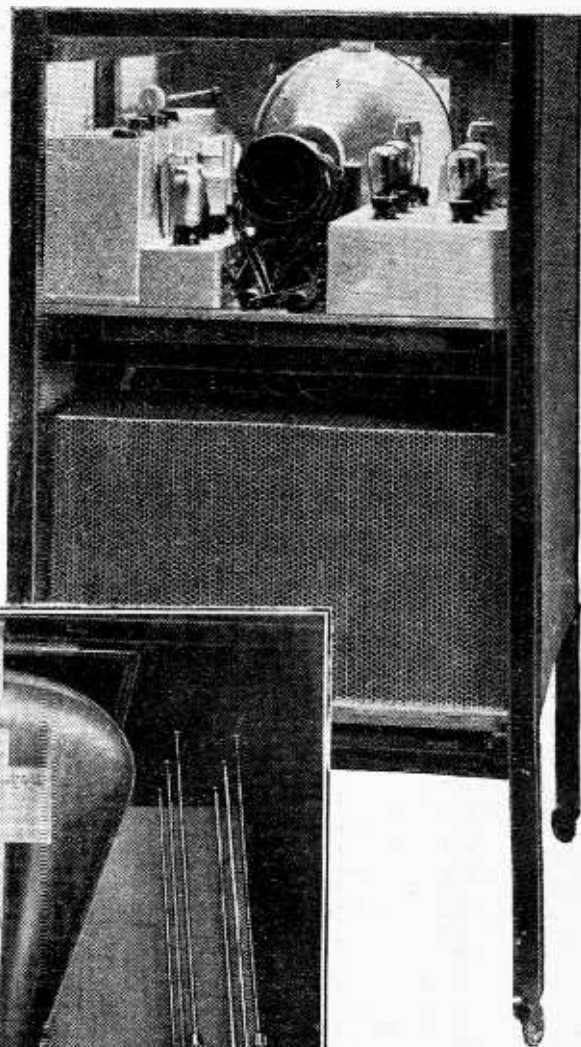

A rear view of the equipment with the back removed.

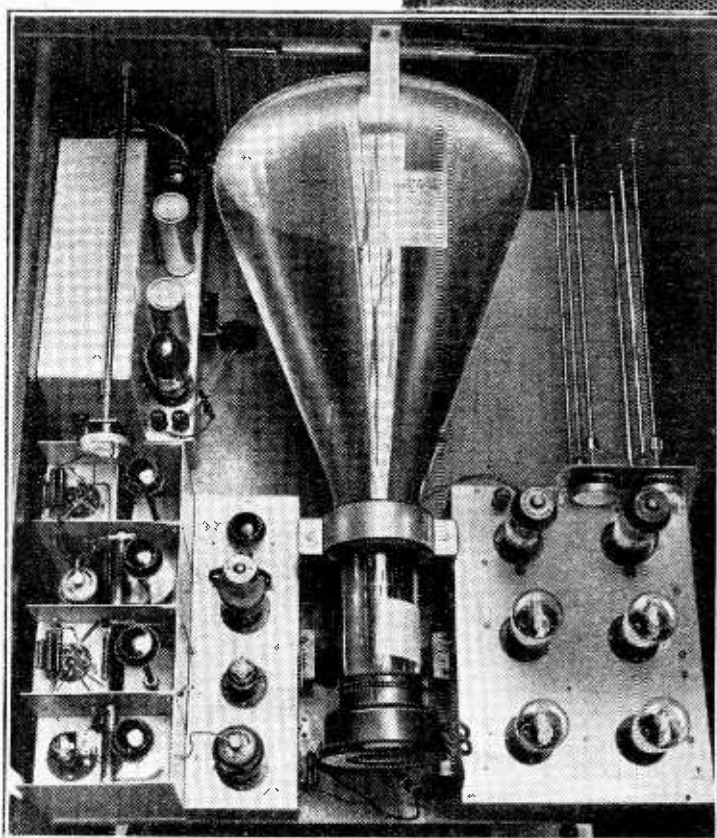

A view of the upper shelf showing the vision receiver and time-base to the left and right of the tube.

frequencies the fourth and last tuned circuit must be artificially damped by the resistance R10. This last RF coupling differs from the others in being of the tuned grid type; this is necessary because the detector must have an external path of low DC resistance apart from its load resistance R11.

A choke feed with Ch1 and C12 is adopted for this circuit, therefore, and this last RF valve is operated with fixed bias provided by R9. The two early valves have initial bias provided by R1 and R4, but can be further biased for gain control by the variable resistance R2.

### The Vision-Frequency Stage

The detector is a low impedance diode with a 5,000-ohm load resistance R11, and a 10 $\mu$ F by-pass condenser C14. The output is applied directly to the grid of the VF amplifier, which is another RF pentode. Bias is obtained from the 100-ohm resistance R13 which is shunted by the 500- $\mu$ F condenser C15. The full HT voltage is applied to the screen, no decoupling either of this or the anode circuit being necessary. The output coupling consists of the resistance R12

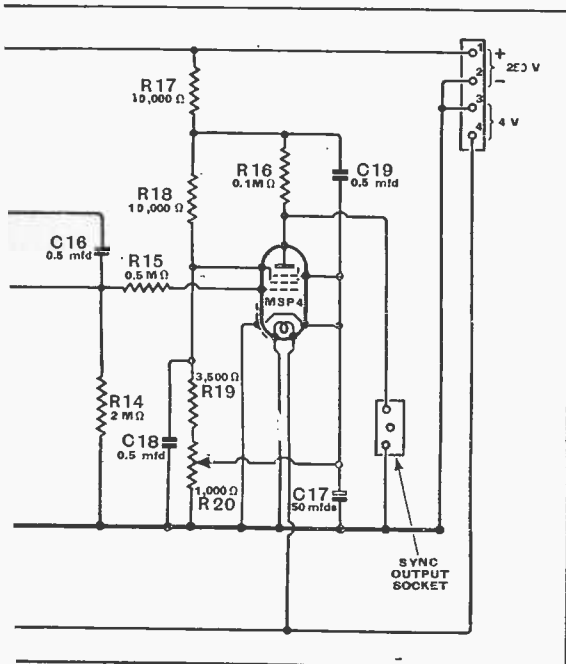

and the coil L6, and enables a response characteristic to be obtained which is flat within some 3 db. up to the extremely high frequency of 2.0 Mc/s, and this with a stage gain of about 20 times.

The vision signals developed across the coupling impedance are applied through C16 to the CR tube, the DC restorer, and the sync separator. The DC restoration, which is only rendered necessary by our having to include C16, is effected by the low impedance diode shunting R14. This resistance has a value of 2.0 M $\Omega$ , but it is shunted externally to the receiver by another resistance of the same value. This is done in order to safeguard the CR tube and prevent its being damaged should it be accidentally disconnected from the receiver. The effective load circuit of this diode thus has a value of 1.0 M $\Omega$ , not 2.0 M $\Omega$ .

The volts developed across this circuit

are also applied through R15 to the grid of the RF pentode, which functions as a sync separator. This valve is operated with some 40 volts screen, 140 volts anode, and -4 volts grid potentials. These voltages are obtained from the voltage divider comprising R17, R18, R19, and R20, and decoupling is effected by C17, C18, and C19. The resistance R20 is actually an adjustable potentiometer varying grid bias and anode voltage simultaneously in order to permit compensation being obtained for variations in components and valves. It is a pre-set, and not a panel, control.

Since there is only a single television transmitter variable tuning is unnecessary, and the four tuning condensers are accordingly regarded as pre-set controls, and are not brought out to the panel. The only panel control for the vision receiver is the gain control R2.

HOW THE COILS ARE MADE, DETAILS OF THE CHASSIS CONSTRUCTION, AND THE WIRING CONNECTIONS

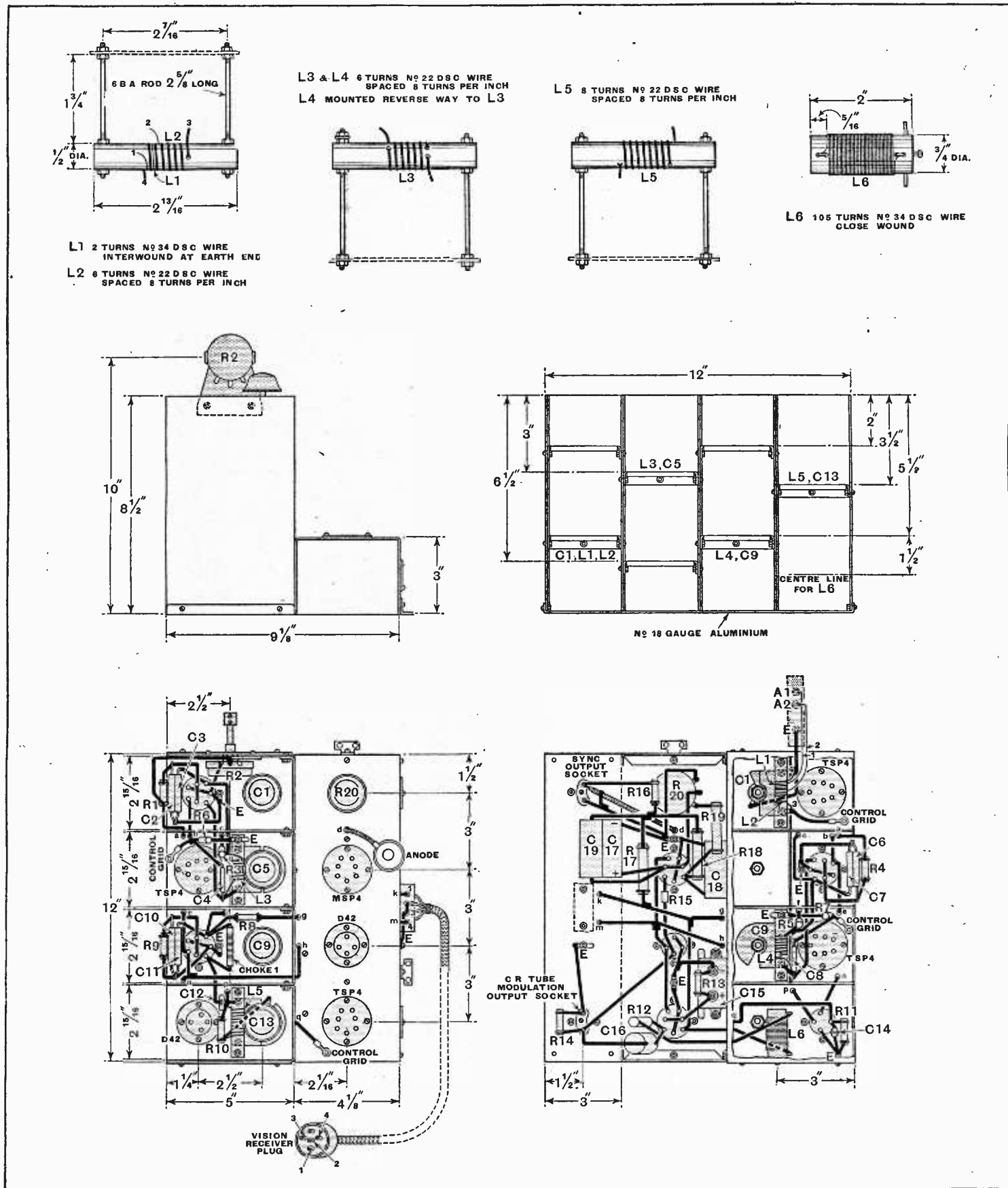

Complete constructional details of the receiver, together with wiring, are given in these drawings as well as coil winding data.

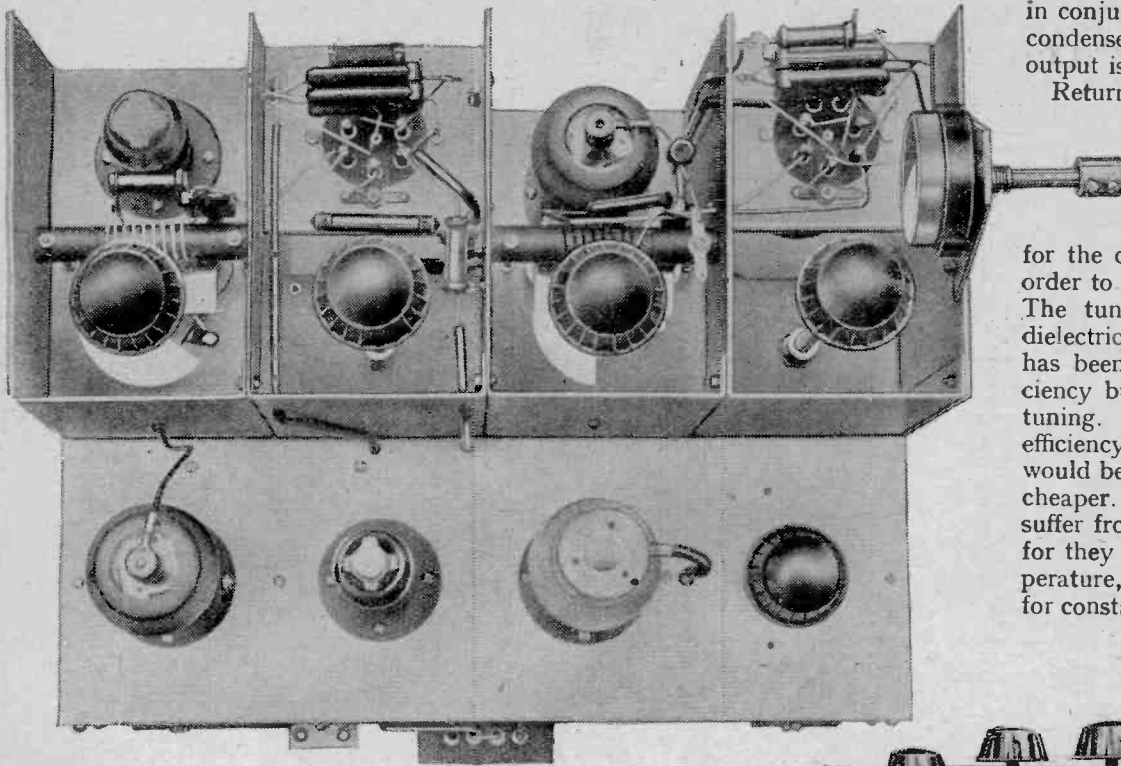

A plan view of the vision receiver.

The power unit is built as a separate unit, and its circuit diagram appears in Fig. 2. Not only does it supply HT and LT for the vision receiver, but it also supplies LT for the tube and time-base, and it also includes the delay-switch for the high-voltage unit. The mains transformer has windings rated at 2.0 volts 1.5 amps. for the CR tube heater, 4.0 volts 8.0 amps. for the vision receiver valve heaters, 4.0 volts 8.0 amps. for the time-base valve heaters, and 4.0 volts 2.5 amps. for the rectifier filament. This rectifier is a U12, and its anodes are supplied from the 350-0-350 volts winding. A single high-inductance smoothing choke

The VF amplifier can be seen on the left with the sync separator on the right and the DC restorer between them.

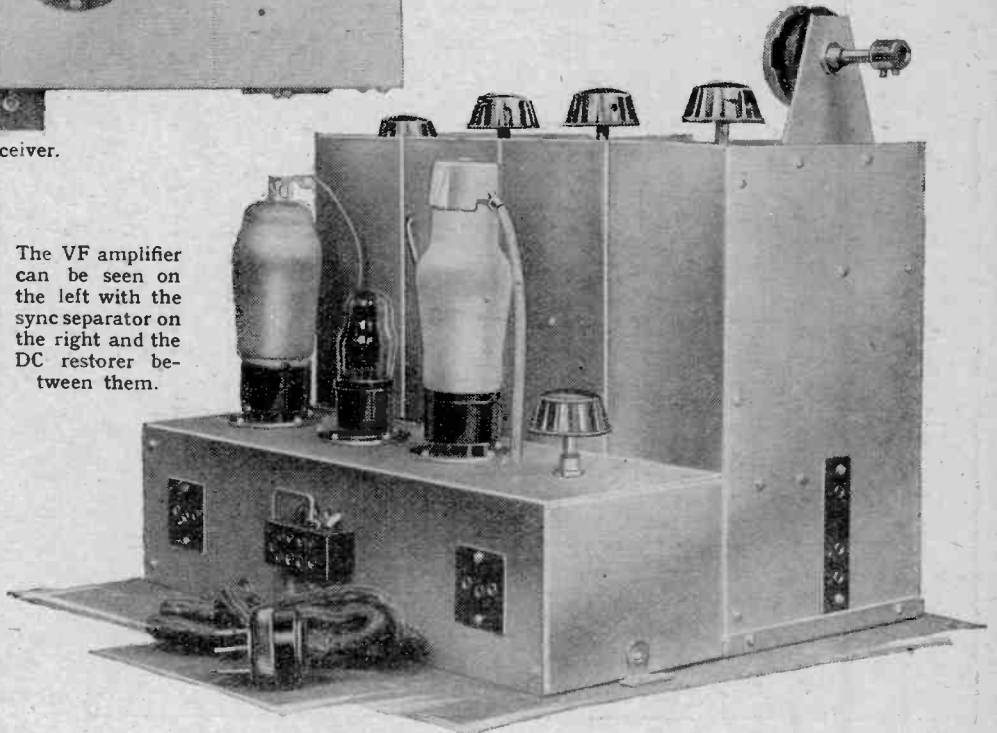

A side view of the RF amplifier; short connections are obtained by inverting alternate valves.

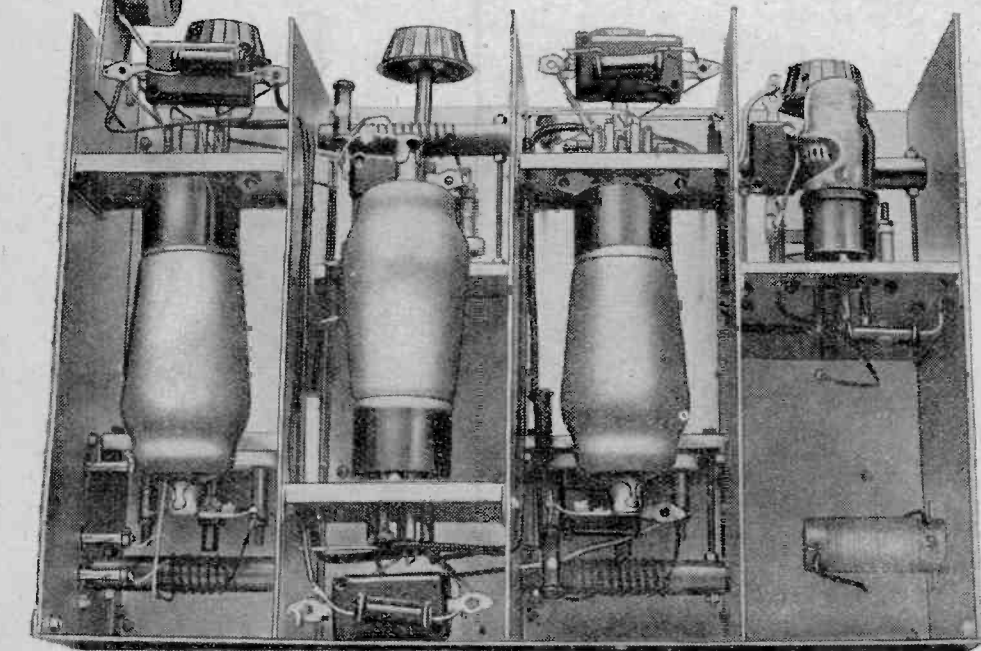

in conjunction with two 8- $\mu$ F. electrolytic condensers suffices for smoothing, and the output is about 250 volts at 75 mA.

Returning to the vision receiver, the components are in most cases standard in spite of the high operating frequency, for there is no point in using special low-loss types when it is essential for the circuits to be heavily damped in order to secure the necessary band-width. The tuning condensers are of the air-dielectric type, however, but this choice has been made not on the score of efficiency but in order to secure stability of tuning. From the point of view of efficiency the ordinary mica-dielectric type would be quite satisfactory and somewhat cheaper. Mica condensers, however, suffer from some inconstancy of capacity, for they are appreciably affected by temperature, vibration and humidity. Again for constancy, the coils are former wound.

The method of construction adopted is somewhat unorthodox, but combines a maximum of screening with a minimum of stray circuit capacity, and maintains the overall dimensions within reasonable limits. It is unnecessary to explain this in detail, for it will be abundantly clear from the photographs and drawings; it may be as well to say, however, that the chassis is in two pieces. One consists of the four compartments for the RF valves and detector, and the other of the side chassis carrying the VF stage and sync separator. This latter chassis has an extension which forms the base of the compartments. The compartments should consequently be completely wired before the two sections are screwed together. In most cases the wiring can be carried out with wire such as No. 22 tinned copper run in insulating sleeving. For the heater connections, however, No. 16 must be used on account of the heavy

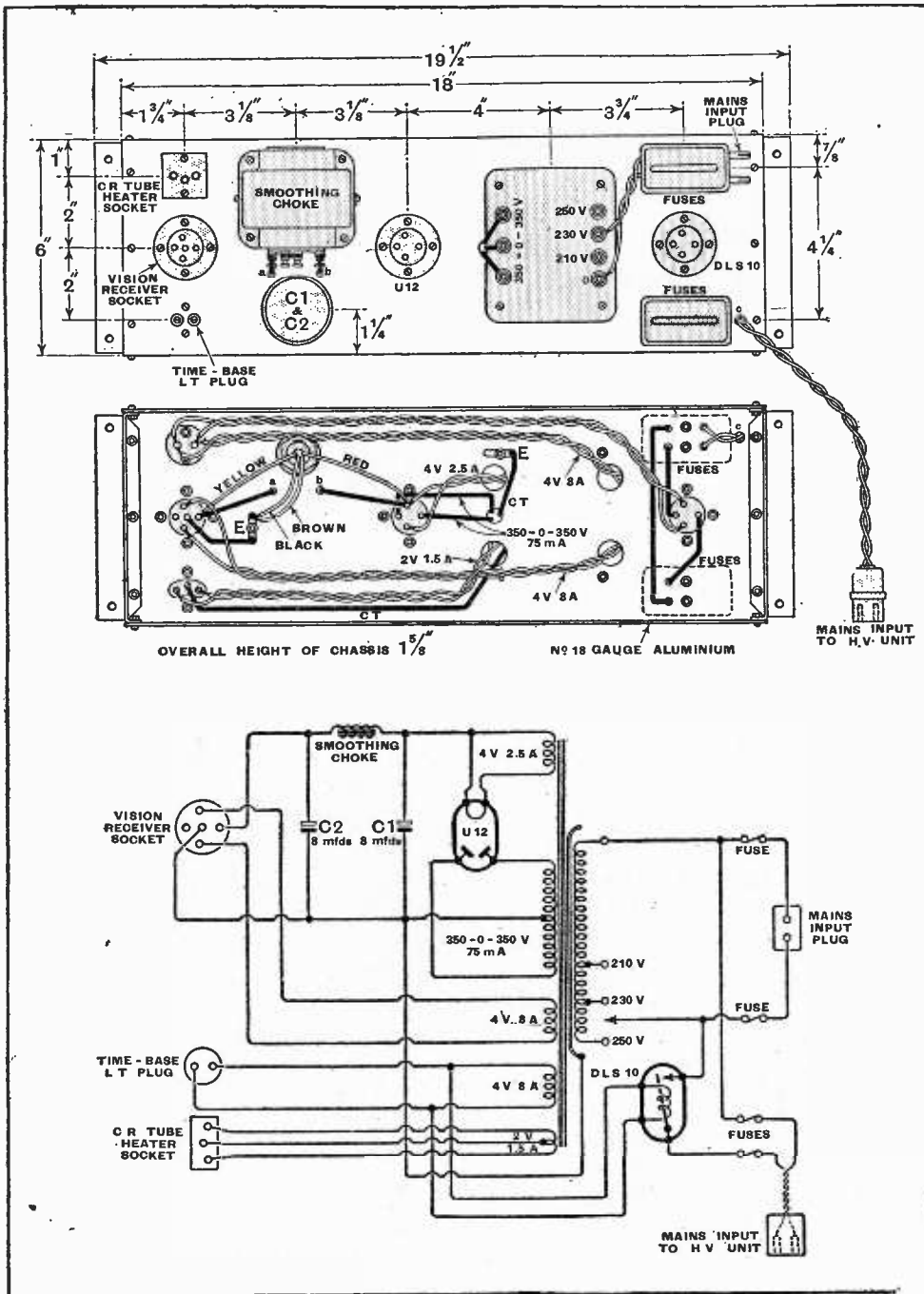

Fig. 2.—These drawings show the theoretical circuit, constructional details and practical wiring plan of the vision receiver power unit.

current, and this gauge is also convenient for a few other cases where especial rigidity is desirable.

When receiver and power unit have been completed they can with advantage be tested independently of the remainder of the equipment with the aid of a pair of phones or even a loud speaker. The phones or speaker transformer primary should be connected across R14, a condenser of 0.1μF. or more being interposed to prevent the DC load resistance of the diode becoming too low for safety.

Choose a time when the vision transmitter is working, and with the gain control set somewhere near maximum tune in this signal by means of the four tuning

condensers. Their optimum settings will be towards their minimum capacities. No difficulty should be experienced in finding the signal, for it is on a lower wavelength than the sound, and the characteristic signal of a vision transmitter is easily recognised, consisting chiefly of the frame synchronising pulses. If the phones are unusually good it may also be possible to hear the very high pitched note of the line synchronising pulses.

### Testing the Receiver

It should readily be possible to obtain very loud phone signals, and such signals are about the strength necessary for operation of the CR tube. Provided that strong signals are obtained it is unnecessary to make any attempt at adjusting the circuits accurately, for this must be done for the best picture quality. In general, the circuits should not be all tuned accurately to the signal, but some of them staggered, notably the coupling to the detector. Naturally this can only be done with the tube connected and working so that the effect of the tuning on the picture quality can be observed.

At this stage, therefore, one should be content with determining that the receiver works properly in producing loud phone signals.

Before pictures can be obtained it is, of course, necessary to have a time-base and other associated equipment. Constructional details of the time-base will be given next week, while the high-voltage unit, tube assembly and sound equipment will be dealt with later in this series of articles. The operation and adjustment of the apparatus will be fully treated in the concluding instalment.

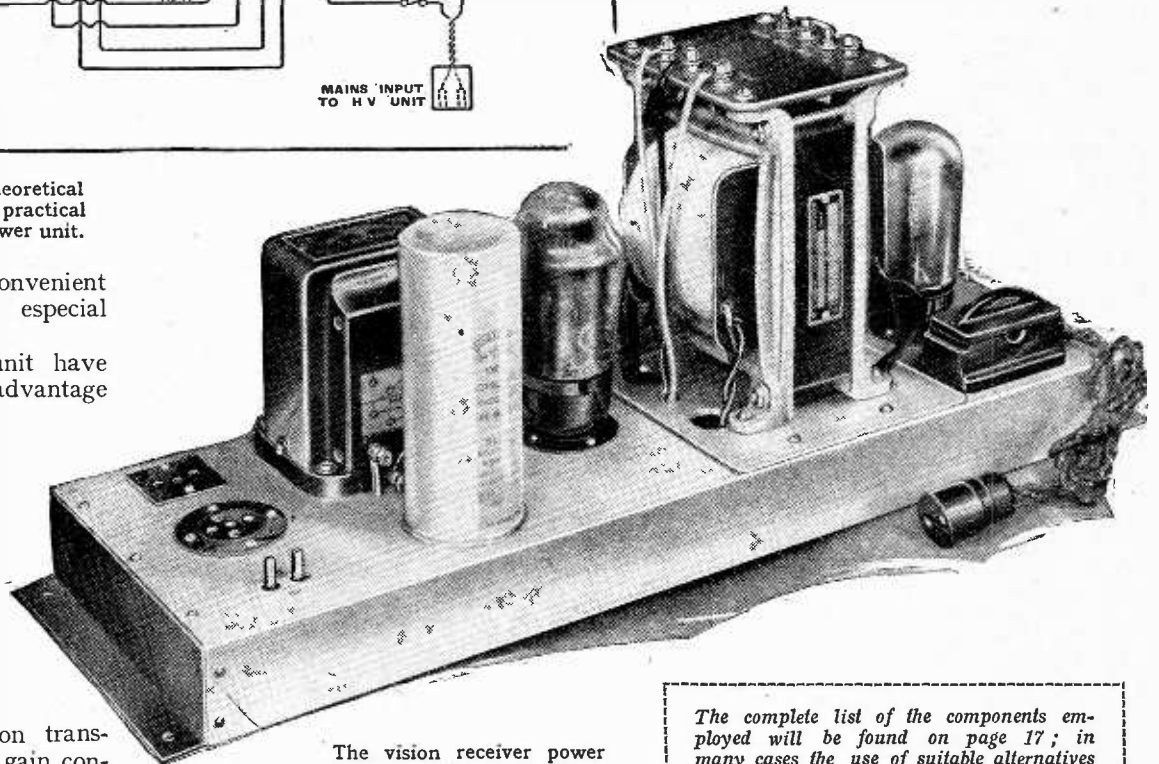

The vision receiver power unit contains the delay switch controlling the high-voltage unit.

The complete list of the components employed will be found on page 17; in many cases the use of suitable alternatives is permissible.



# Delayed Switching

## VALVE-ACTUATED RELAY FOR PROTECTING GAS-FILLED RECTIFIERS

By PAUL D. TYERS

THE properties of a gas rectifier are such that the full load must not be taken until the cathode has reached the necessary operating temperature. Accordingly, it is usual to provide some form of time delay switch. Many arrangements have been suggested and used, one of the most familiar being a pair of contacts rendered operative by the displacement of a bi-metal strip associated with a heater coil connected in parallel with the filament of the rectifier. A thermal delay is introduced, and the contacts are arranged to operate the HT or load circuit after an appreciable period has elapsed. Arrangements of this type are sometimes mounted in a vacuum, the bi-metal strip being heated by direct radiation from a filament. Alternatively, use is made of a simple heating coil wound round a bi-metal strip which actuates the high-tension contacts.

Thermally actuated contacts sometimes give trouble, since the operating force is not very great whether of the open or vacuum type. Such arrangements have also proved microphonic and are liable to be upset by vibration. In an endeavour to overcome these difficulties the following arrangement was devised by the writer and was found to be highly successful in practice.

### Device Described

The contact device constitutes an ordinary relay, which is a very rigid and mechanically sound piece of apparatus. Its reliability is proved by the multiplicity of such devices employed in ordinary telephone communication circuits which are in use every day. Moreover, the device is cheap. It is actuated by the anode current of a hard valve fitted with an indirectly heated cathode with an appreciable thermal delay. The theoretical circuit is shown in Fig. 1.

It is obvious that if an appreciable time elapses before the cathode emission is obtained after switching on the heater current, there will be a delay in operation of the relay, and the scheme provides a very effective and reliable delay device.

When a very long delay period is required, it is preferable to construct a valve in which there is rather more thermal insulation between the heater

and the inside of the equi-potential cathode than usual. Certain valves, however, can be given a heating period of sufficient duration to be suitable for use with existing gas rectifiers. A modification of the circuit is shown dotted, in which the delay period is increased by reducing the heater temperature by added series resistance R2. This means that the full emission of the cathode is not necessarily obtained, but as relays will operate on comparatively low currents, this is of no importance. The table shows the heating time of various representative valves. From this it is quite easy to choose a suitable combination of valves, relay and operating conditions which give a delay of a suitable period. The delay valve can be energised either from the AC mains or from the supply for an early amplifier.

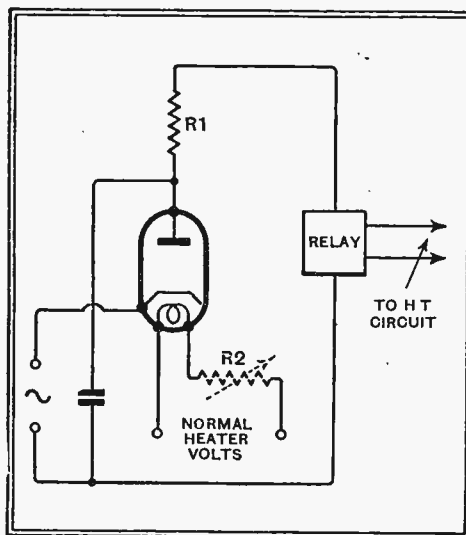

Fig. 1.—Theoretical circuit of the valve-operated relay; the resistance shown dotted enables the delay to be increased by reducing the cathode temperature.

It is easy to elaborate the fundamental idea so as to ensure even greater protection. While a long thermal delay may be introduced by increasing the quantity of insulated material between the heater and the inside of the cathode, it is obvious that one has a greater mass of material at a high temperature, and accordingly the cooling period is equally lengthened. This means that should the amplifier be temporarily switched off and should the cathode of the gas rectifier cool far more rapidly than the cathode in the delay

THE heating element of a gas-filled valve must be raised to full working temperature before HT voltage is applied to its anode. A new method of introducing the necessary delay automatically is described in this article.

tube, then there is a chance of the high-tension load circuit being applied before the gas rectifier cathode is sufficiently hot. This difficulty can be overcome if it is thought worth considering, by so constructing the cathode of the delay tube that there is more radiation than usual. This can be achieved, for example, by adding radiating fins to the cathode. The cathode can be extended well beyond the end of the anode. As the tube does not have to function as an efficient thermionic device, the radiation surface can be made large by using an appreciable anode distance so as to accommodate the necessary radiating fins.

### Practical Points

Further protection can be introduced by circuit arrangements. In this case the heater of the delay tube can be connected in series with the heater of the gas rectifier valve so that should either fail the high-tension circuit is opened. Providing the delay tube has a far quicker cooling time than the cathode of the gas rectifier, then there is no possibility of damage occurring. This scheme, outlined above, is being utilised in commercial design and is actually covered by pending patents, but it is one which should prove useful to the experimenter.

If use is made of a mains rectifier for the delay valve, quite heavy currents (of the order of 60 to 100 milliamps) are available. This means that a fairly heavy power relay can be employed if

### Delay Introduced by Different Valves

UR3c .. .. .	75 seconds
1W4 at 3 volts .. .. .	90 seconds
1W4 at 2 volts .. .. .	240 seconds
(Reduced output)	

desired, and this is advantageous if it is very robust, and it can be used to operate comparatively heavy contacts with appreciable pressure. On the other hand, a small relay operating with a current of

**Delayed Switching—**

a few milliamps can also be employed. It will be noticed in the diagram that a series resistance is shown in the relay circuit. The function of this is really two-fold.

In the first place, it acts as a safety resistance and prevents too heavy a load being placed on the rectifier if the relay winding is of quite low resistance. It can also be used to regulate the current at which the relay will operate. It may be found convenient to shunt the relay either with a fixed or variable resistance. It will be appreciated that as the valve warms up, so the current begins to increase, and low currents of the order of a few milliamps will pass through the relay circuit before the final cathode temperature is reached. It is obvious, therefore, that if use is made of a low current relay, the relay must be heavily shunted to ensure that it does not operate too soon.

It is best to aim at using a relay which will operate at a heavy current for the reasons mentioned above, but if such a type is not available it is quite an easy matter to experiment with shunt and series resistances until a current value is found that will cause the relay to operate at the end of the heating period.

On the other hand, it should not be assumed that the adjustment is very critical, and, once the experiments have been made with the actual relay, the resistances can be substituted by ordinary fixed carbon types. Some consideration, however, must be given to the total power in the circuit, and it will readily be seen that this is of the order of several watts, and accordingly a resistance with an ample rating should be employed.

**National Physical Laboratory**

ONCE a year the National Physical Laboratory opens its gates to visitors and shows them something of the work carried on throughout the year. This work covers all branches of physics, and wireless forms a comparatively small proportion of the activities.

Little new was to be seen this year in the sections devoted to radio and allied matters. Doubtless, the time has not yet come to reveal the secrets of the year's research.

A portable ultra-short-wave direction finding receiver was demonstrated in the grounds on signals from the Alexandra Palace and also from a small local transmitter about a hundred yards away. Sharp null points were obtained with the result that the apparatus was easy to handle.

The receiver is a superheterodyne with a push-pull frequency-changer operating from a single-turn screened frame aerial. This portion of the apparatus is mounted with its batteries in a screening box on a tripod and is connected by a screened cable to the IF amplifier on the ground.

Among the precision apparatus mentioned must be made of the direct reading frequency-measuring equipment, which is designed for frequencies ranging from 1 Mc/s to as high as 75 Mc/s; it is self-checking. Radio-frequency bridges and apparatus for the measurement of current at radio-frequencies were also shown.

**DISTANT  
RECEPTION NOTES***The High-power Mysteries*

SOME of the giant stations which ought to be coming into operation by now seem to have been delayed in their construction by one cause or another. Labour troubles probably give the reason why France's Radio National is still some way from being ready. But what of the new Deutschlandsender? This station is still largely wropt in mystery. There have been all kinds of rumours about the power that it's going to possess when it comes into action, but I think we can discount those which credit it with more than 200 kilowatts at the outside. It will most likely fall into line with most of the other big stations on the long waves by adopting a 150-kilowatt rating for general working purposes, though possibly there will be a good deal in hand for special occasions.

And then there are the expected Italian high-powered stations, including two of 120 kilowatts for Rome. Work on these also seems to have gone forward more slowly than was anticipated, but I hear that a big speed-up is taking place now.

Amongst other high-powered transmitters

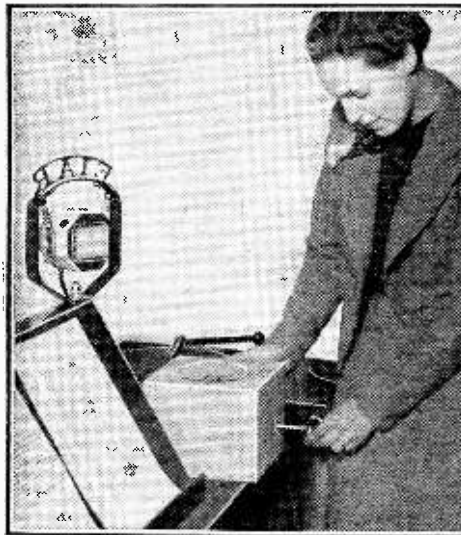

The origin of the well-known nightingale interval signal from Trieste is disclosed when we see Miss Paola Guastalla of the station staff winding up the clockwork unit that supplies the distinctive call.

that have not yet materialised are the two Brussels stations, which long ago announced their intention of going up from 15 to 75 kilowatts. Probably there will be a spate of newcomers as autumn draws near.

Meantime I have news from America that WBZ, of Boston, Massachusetts, has applied for permission to increase its power from 50 to 500 kilowatts. It is prophesied that the application will be granted fairly soon, and when it is the plant will be moved to that queer-shaped piece of land, Cape Cod.

I mentioned some time ago that several other U.S.A. stations had put in applications to increase their power to 500 kilowatts, but so far no news has come that any of them has been successful. The Federal Communications Commission is rightly a

most cautious body, which never grants any such application until possible problems have been considered in all their aspects. WLW, however, the Cincinnati station, has proved so completely successful as a 500-kilowatt plant that others are bound to follow. Possibly the Commission doesn't want to issue its decisions until it has received all the applications that are likely to come in, so that the problem can be considered as a whole. Would that in Europe we had something with the powers of the F.C.C.!

I don't know about you, but I always find it difficult to remember whether it is yesterday or to-morrow in places such as New Zealand, Australia and the South Sea Islands. Working out the local time in countries whose shortwave transmissions you pick up can be, in fact, quite a puzzling business.

D. EXER.

**Television  
Programmes**

Transmissions are from 3-4 and 9-10 daily.

Vision 45 Mc/s.

Sound 41.5 Mc/s.

FRIDAY, JULY 2nd.

3, Animals from the Zoo, presented by G. M. Vevers. 3.15, Gaumont-British News. 3.25, "From West-End Cabarets"—a variety with music by the Television Orchestra; presentation by D. H. Munro; compère, Paul Gerrits. 9, Repetition of 3 programme. 9.15, British Movietonews. 9.25, Repetition of 3.25 programme.

SATURDAY, JULY 3rd.

3, "Thrust and Parry": a demonstration of the Art of the Foil, by Gwendoline Neligan and Maestro Leon Bertrand, in Alexandra Park. 3.20, The Hogarth Puppet Cabaret. 3.35, British Movietonews. 3.45, Operetta. 9, Maria Luth in Period Songs. 9.10, "Coffee Stall." 9.25, Gaumont-British News. 9.35, Les Allen and his pianists in "Queue for Song."

MONDAY, JULY 5th.

3, Anona Winn in Songs. 3.10, More Marine Models: a review of prototype power boats on the lake in Alexandra Park. 3.35, "Ad Lib": a revue by Herbert Farjeon, with music by Michael Sayer; production by Stephen Thomas. 9, Music-Makers: Maria Korchinska, harp. 9.10, Artists and Their Work—talk by Miss Rhodes Dawson. 9.25, Gaumont-British News. 9.35, Repetition of 3.35 programme.

TUESDAY, JULY 6th.

3, Naunton Wayne. 3.10, Gaumont-British News. 3.20, "Derby Day," an operetta by A. P. Herbert, produced by Stephen Thomas. 9, Men's Dress Reform: masculine fashion parade. 9.10, British Movietonews. 9.20, Repetition of 3.20 programme.

WEDNESDAY, JULY 7th.

3, The Charlot Starlets, with John Byron, Patricia Leonard and Patricia Russell. 3.30, Picture Page, 69th edition. 9, Repetition of 3 programme. 9.20, Gaumont-British News. 9.30, Picture Page, 70th edition.

THURSDAY, JULY 8th.

3, Relache. 3.20, Gaumont-British News. 3.30, "How She Lied to her Husband," a play by George Bernard Shaw, with Greer Garson and D. A. Clarke-Smith. Produced by George More O'Ferrall. 9, Repetition of 3 programme. 9.20, British Movietonews. 9.30, Repetition of 3.30 programme.

# Current

EVENTS OF THE  
WEEK IN  
BRIEF REVIEW

# Topics

## New Station for West Africa

IT is proposed to erect a broadcasting station at Dakar, to be used in conjunction with a special receiving station. The intention is to pick up programmes from France and re-broadcast them for the benefit of the French-speaking inhabitants of Senegal.

## American Plans

A CONSIDERABLE extension of activities is being contemplated by the N.B.C., and plans are being made for the erection of new studios and offices in different parts of the country. Headquarters, modelled on those at Radio City, New York, are to be erected in several important cities at a total cost of over 3 million dollars.

## Interference in France

A REPORT issued by the French P.M.G. announces that, so far, anti-interference measures have only been taken in twenty-seven towns. As a result of numerous requests from various parts of the country it is hoped, however, that before long the organisation of the anti-interference section of the French post office will be improved.

## Trouble in Norway

THE recent strike of Norwegian ships' officers was partly concerned with a dispute regarding the remuneration of mates who also operate the wireless installation in addition to their other duties. The new agreement provides that this extra work shall be paid for at the rate of £3 per month.

## Japan Prefers Talks

ACCORDING to recent statistics published concerning broadcasting in Japan, it appears that, on the whole, listeners prefer talks of some kind or another. No less than 51 per cent. of the total programme time during 1936 was devoted to a combination of news and topical talks, music occupying less than 10 per cent. of the time.

## Bombay Police Wireless

VERY exhaustive wireless experiments are being carried out by the Commissioner of Police in Bombay, who has received a grant of 5,000 rupees from the Government with a view to establishing an effective

system of communication between headquarters and a number of mobile units. Several constables are being trained as telegraphists. It is proposed at a later date to extend the wireless network to the surrounding country so that the police stationed there can co-operate more closely with their city colleagues.

## Gramophone War

THE dispute between the Danish State Broadcasting Corporation and the gramophone industry which has been dragging on for several years in a desultory manner, is now likely to be brought to a head by the decision of the broadcasting authorities to encourage a new company which was registered at Copenhagen the other day to manufacture gramophone records.

## More New Stations

ACCORDING to an Italian report a very powerful short-wave broadcasting station is to be built at Prato Smeraldo, near Rome. It is said that the power will be not less than 100 kW. Turkey has just ordered a 120 kW medium-wave transmitter for Ankara and a 20 kW short-wave one. These are to be ready in August, 1938.

## Tristan da Cunha

THE inhabitants of what is often referred to as "the loneliest island in the world," namely, Tristan da Cunha in the South Atlantic, have been presented with a wireless set with which it is hoped they will be able to enjoy broadcasting all the year round. The set, which has been given by the Ekco Co. of Southend, was recently handed over to the Rev. H. Wilde, of Tristan da Cunha, who is at present visiting this country.

Hitherto, the battery problem has prevented the successful running of a set in the island as the mailboat, with a supply of fresh batteries, only visits Tristan da Cunha once a year. To overcome the HT part of the problem, the all-wave set supplied is of the "no HT" type exhibited at Olympia last year, while the LT problem is being solved by means of a wind-driven generator.

## WORDS NOT BULLETS

A new type of "O.B." van is now being used by the broadcasting organisation in France. The design favours the contours of an armoured car.



## Popularity of Wireless

TEN thousand families in Chicago were recently asked what they planned to buy next as soon as funds permitted. New automobiles came an easy first with fresh insurance policies second; wireless sets were, however, a good third.

## New Use for Car Radio

MANY screen and stage directors, always on the lookout for new talent, make a point of listening assiduously to the broadcasting programmes in the hope of a "find." Mr. Leslie Cardew, of the Pinewood Film Studios, carries on this policy to such an extent that he has had his car fitted with radio solely for the purpose of enabling him to keep his ears open for likely talent when on the road.

## A Famous Radiophobe

M. EDOUARD BRANLY, of coherer fame, has, it is said, always had an aversion to broadcasting as a means of entertainment. He recently delivered a talk before the microphone in which he frankly confessed that although he listened to certain transmissions on his grandchildren's receiver he was by no means an enthusiastic listener.

## America Wants Better Quality

THE sale of wireless sets is booming in the U.S.A., figures for the first four months of the year being from 20 to 40 per cent. greater than for the corresponding period of 1936. It is estimated that during the present year over 10 million sets will be sold. There is now a much greater demand for the

higher-priced sets, this being accounted for partly by the desire for better quality of reproduction and partly by the fact that more expensive cabinets of the console type are being demanded.

## Radio Romance

LAST summer the well-known Swedish opera singer, Sigurd Björling, visited Iceland to give a special broadcast from the Reykjavik station. As a result of this visit he was recently married to the lady announcer of that station.

## Australian SW Transmissions for July

SYDNEY, VK2ME, 9,590 kc/s, 31.28 metres. Sundays, 0500 to 0700, 0930 to 1330, 1630 to 1830. Mondays, 1630 to 1830.

Melbourne, VK3ME, 9,510 kc/s, 31.50 metres. All weekdays, 0900 to 1200.

Perth, VK6ME, 9,590 kc/s, 31.28 metres. All weekdays 1100 to 1300.

## News from Panama

SINCE the establishment of broadcasting in Panama in 1935 there has been a tremendous increase in imports of receiving sets. Nearly all the receivers come from the United States.

## Holidays Guide for Motorists

WITH each copy of *The Motor Cycle*, dated July 1st, a 32-page Holidays Guide will be presented free. The Guide contains a wealth of detail about many of England's finest beauty spots and clearly marked maps of all the country between Land's End and John O'Groats are included.

# Periodic Variations of the

## THEIR PRACTICAL EFFECT ON SHORT-WAVE RECEPTION

**O**UR conception of the ionosphere and of the part it plays in radio wave propagation is continually changing, and from time to time some new discovery causes us materially to alter our ideas on the subject. The recent announcement by Watson Watt of the presence of a number of ionised layers at comparatively low altitudes is a case in point, and although this particular discovery may not directly affect ordinary short-wave reception, it brings home to us, in a startling way, the fact that we have yet a great deal to learn about the upper atmospheric regions. Perhaps the most clearly evident thing about the ionosphere, from the viewpoint of short-wave reception, is that it is in a constantly changing state, and it is interesting to try and correlate the periodic changes in short-wave reception conditions with coincident changes in the medium which alone makes such reception possible.

### Structure of the Ionosphere

The atmospheric region popularly known as the ionosphere is mainly comprised of the two layers of ionised air, which surround the earth in the form of concentric shells, the inner or E layer at a distance of about 60 miles, and the outer or F layer about 180 miles from the earth, together with a belt of much less highly ionised air in between them. At certain times of the day subsidiary layers are formed, namely, the E2 region, situated just above the E layer, and the F2 region just above the F layer, looking upward from the earth. In addition to these regions of the ionosphere proper, there appear to be the two bunches of layers in the lower atmosphere\* announced by Watson Watt, called the C and D regions, and far out into space beyond the F layer (according to Alway and Philips) there appears at certain times a belt of air ionised to a degree comparable to that of the F layer and named the G region.

As, however, these latter regions do not play a regular part in the propagation of the frequencies we are considering, we will henceforward confine our attention to the ionosphere proper, viz., that part of the atmosphere from the lower boundary of the E layer to the upper boundary of the F.

When the molecules of gas comprising the air in the layers are subjected to the sun's influence they become split up by the action of solar radiation, so that electrons are liberated, and the layers contain, to a greater or less degree, free electrons

and positive ions. The agents producing this ionisation are of two kinds, viz., a solar wave radiation of a frequency in the ultra-visible part of the spectrum (ultra-violet light), and a stream of corpuscles which are shot off from the sun so as to bombard the molecules of gas and thus liberate electrons by direct collision. Both these agents appear to play a part in the ionisation of both the layers, so that the ionising influence exerted at the E layer depends to some extent on the amount of solar radiation absorbed at the F, and thus on the amount of filtration to the lower layer. While the radiation is much more intense at the F than at the E, and the level of ionisation produced is thus much higher, yet the intensity of the radiation at the F is not the major factor which determines the ionisation level reached there. For, since much of the ionising energy is not absorbed, owing to the comparative rarity of the air molecules, it is evident that the density of the molecules or gas pressure is the main determining factor. On the other hand, the gas pressure at the E layer is high, but the amount of ionising agent reaching this layer is limited, and thus the ionisation level reached is very much lower than at the F layer, and is determined mainly by the intensity of the radiation, and not by the gas pressure.

Ions and electrons in a dissociated state have a strong tendency to combine, and in the ionosphere they can do this at a rate depending on the gas pressure. As this is very much higher in the lower layer than in the higher, the E layer recombination rate will greatly exceed that of the F layer.

### Refracting and Attenuating Layers

Radio waves higher in frequency than about 3 Mc/s pass through the E layer and undergo refraction or "bending" in the F. The degree of bending and also the attenuation suffered will vary directly as the density of the free electrons and inversely as the square of the frequency, and, while the ion content of the E layer will rarely be sufficient to cause complete bending, yet it will cause the wave to be attenuated. And, since the wave will expend more energy in passing twice through the E than it will during its excursion into the F, we may regard the E layer as the main source of attenuation, and the F layer as the bending layer.

Thus we see that the upper limit for good reception is set by the penetration frequency of the F layer, and the lower by the frequency which suffers complete attenuation in the E. The optimum fre-

quency will lie just below the penetration frequency, for that is the frequency which, while it is adequately refracted by the F layer, suffers least attenuation in both the E and F regions. In this connection it is as well to remember that the penetration frequencies in the case of a short-wave broadcast station will be far higher than those given by scientific experiments made to determine the penetration frequency of the layers, because in the former case the wave is projected at a relatively small angle to the ground, so as to have a glancing incidence at the layer, whereas in the latter case the wave is sent vertically upwards. It is easy to see that a wave reaching the layer at glancing incidence would be completely refracted at an ionisation level which would allow a vertically incident wave of the same frequency to penetrate.

### The Diurnal Variation

As is well known, the ion content of the layers is not constant, but undergoes pronounced periodic changes of three kinds—diurnal, seasonal, and an eleven-year variation due to the sunspot cycle. There are also sharp day-to-day variations of an erratic nature.

Considering first the diurnal change, we see that soon after dawn the ionisation levels of both layers commence to rise with the increasing intensity of the solar radiation, and continue to increase towards noon. At the E layer, where the gas pressure and consequently the recombination rate are high, the ionisation level follows closely the intensity of the radiation, so that at noon it commences to fall, and at dark the fall becomes much accelerated, so that by midnight the attenuating effect of the layer upon the frequencies we are considering is very small.

The recombination rate at the F layer is so low that the rate of ion production about midday exceeds it to such an extent that a time lag is introduced, with the result that the maximum level is not reached till late in the afternoon. Then the level falls slowly and continues to do so throughout the night, though it remains at a relatively high level until past midnight. Remembering what has been said about limiting frequencies, we see that the effect of these changes on long-distance short-wave receptions will be as indicated in Fig. 1. During the morning rise in ionisation level the band of frequencies for good reception is moved toward the higher frequency end of the spectrum, but at noon the band begins to broaden, since the higher limiting frequency continues to rise, while the lower limit commences to fall. Even when the ion content of the F layer starts falling, the broadening effect of the good reception band continues, because the lower limit falls more rapidly than the higher. Nevertheless, the opti-

# Ionosphere

imum frequency now begins to fall, and while it continues to do so throughout the night there comes a time (usually near midnight) when the good reception band is at its broadest, since then the ion content of the E layer is so low that the layer has very small attenuating effect on fre-

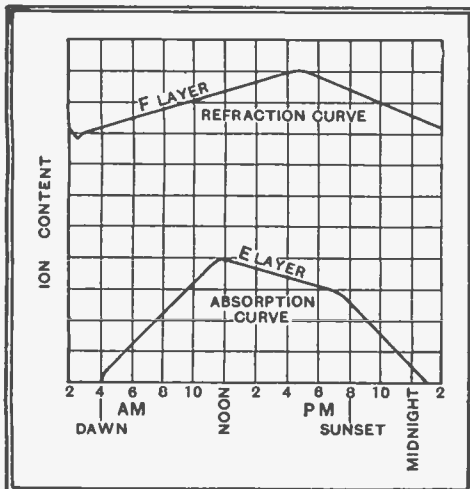

Fig. 1. The characteristics of both E and F layers determine the highest frequency for good short-wave reception. Attenuation takes place mainly in the E region and refraction in the F region. The changes in these two at different times of the day are shown by these curves.

quencies in the S/W band, while the F layer level is still high enough to refract frequencies as high as 20 Mc/s, or even higher. Of course, when considering diurnal changes in short-wave reception we must consider the daylight conditions over the whole transmission path, remembering that stations in the opposite hemisphere will have winter conditions when we have summer, so that, even if they are on the same meridian as ourselves, conditions will often vary from daylight to darkness over the path. Nevertheless, the broadening effect of the good reception band can easily be observed on a transmission path such as that from the U.S.A. to this country in the evening hours.

## Seasonal and Long Period Variations

In winter the solar radiation is at its lowest ebb, but is, nevertheless, sufficient to raise the ion content of the F layer to a high value. As the season advances and the sun's effect becomes more powerful the air heats up and consequently becomes much less dense, so that, although there is now a greater amount of ionising radiation reaching the F layer, it is largely ineffective, owing to the increasing rarity of the gas molecules. Although the solar radiation has increased, the gas pressure has fallen, and the net result is that the F layer ionisation level falls towards midsummer and then rises towards the winter again. A different effect occurs at the E

AT certain distances above the earth are well-defined layers of ionised air which play a very important part in short-wave reception. Though the ionisation of these layers is continually changing it is explained in this article that the variations are mainly aperiodic, and by applying such knowledge that is available it is possible to reach a decision regarding the frequencies to use for best reception at different times of the day and at different seasons.

layer, where gas pressure is not the controlling factor. In winter the ion content of the layer is low because the amount of solar radiation affecting the layer is small, but, as the season advances, although the density of the air decreases, the molecules are still sufficiently numerous to absorb the maximum amount of the radiation, and this is increased for two reasons: (a) the amount of radiation from the sun is greater, and (b) less of this is absorbed at the F layer and so reaches the E. Thus the ion content of the E layer rises, so that a peak is reached at midsummer. The result of these variations is as indicated in Fig. 2. In winter the frequency band for good reception will be at its broadest, both high and low frequencies being well received. In summer the penetration frequency of the F layer is lowered, and the attenuating effect of the E layer is raised, so that the very high frequencies heard in winter will no longer be received. Nevertheless, the best received signals will be towards the higher frequencies, as a large band of the lower frequencies will suffer heavy E layer attenuation, and the good reception band is considerably narrowed. If one observes the U.S.A. stations, one can already observe these effects, the very high frequencies no longer being heard, with conditions generally worse than in winter.

## Eleven-Year Cycle

Lastly we must take into account the effect of the eleven-year sunspot cycle. Sunspots are the main cause of the erratic day-to-day variations in short-wave reception, for when they are prevalent there is an increased amount of solar radiation, so that higher ionisation levels are reached in both layers. But, although they increase in numbers and in size so as to reach a peak every eleven years, they are not obliging enough to do so in a regular manner, and consequently we get all sorts of irregular variations in the ion content of the layers. However, if we ignore these and consider only the average values, we see that there is a gradual rise in the ionisation levels towards the sunspot maximum period. According to Professor Appleton, the F layer level is now 300 per cent. and the E layer level 50 per cent. above its minimum sunspot level. Consequently the optimum frequency for any transmission path, whether in daylight or darkness, is now much higher than it was during the sunspot minimum period, and will possibly be higher still before the sunspot maximum is reached. Also, the frequency band for good reception after darkness is particularly broad, for the residual

ionisation level of the F layer is much higher than at the minimum period, and provides adequate bending for the high frequencies, while the normal recombination process in the E layer after dark removes its attenuating effect on the lower frequencies.

From this we may deduce that the best possible conditions for short-wave reception would exist after darkness in the winter of a sunspot maximum year, for then it appears that we might have the highest possible F layer ionisation with very little E, permitting us to receive a very large range of frequencies in the short-wave band.

There remain those erratic day-to-day variations that play such havoc with consistent short-wave broadcast reception, the

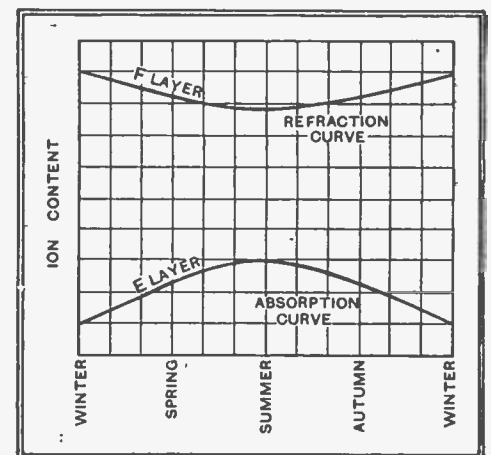

Fig. 2. These curves show the variation in the ion content of the E and F layers at different seasons of the year.

cause of which is undoubtedly a fluctuation of the solar radiation, possibly due to sunspots. Could these be minimised and a reliable service maintained at all times? It seems that their effect might be reduced to a considerable extent if the transmission engineer were able to forecast the sunspot conditions a day ahead (and this he well might do in co-operation with an Astronomical Observatory), and so change his frequencies from day to day to suit conditions. But this no listener would tolerate, even if it were possible from the point of view of the international authorities. And so he is limited in the scope of his attack. However he does (in the case of the larger broadcast organisations), from time to time, so consider the frequencies at his disposal, the transmission paths to be traversed, and the prevailing seasonal and sunspot conditions, as to give the best service with the power at his disposal and within the limits he is obliged to work.



ALAN PAUL, who wrote musical comedy for a wager—now his chamber music is to be broadcast Nationally on Thursday evening.

IN recent years, during the months of July, August and September, the listener has had to accept the radiation of a single programme as an unpleasant inevitability. This year alternative programmes on the National and Regional wavelengths respectively will be broadcast, and so it is natural that new week-by-week features should be presented. July seems to associate itself with blue skies, a warm sun, the seaside with its gay colours and, of course, the pier. The B.B.C. have tracked just such a train of associations as this to its logical conclusion, so next Thursday at 7.25 on the National wavelength we get Shows from the Seaside, the first of a series of concert party broadcasts, arranged by Harry Pepper. Instalment No. 1 comes from the Pier Pavilion, Worthing. Harry Pepper with Davy Burnaby will introduce Richard Jerome's "Gay Parade."

#### ANOTHER SERIES

THE first of the series called "Tricks of the Trade," which was referred to in *The Wireless World* some weeks ago, is to be heard Nationally at 6.20 on Monday. This will bring to the microphone a journeyman cooper from Burton-on-Trent, a woman who makes dresses for dolls, and a man who for many years has been making toys.

The cooper, Mr. R. P. Stanesby, was chairman only a few weeks ago at a typical ceremony, and this should brighten that part of his story which describes the ancient custom of "initiating" a

# Listeners' Guide for

## Outstanding Broadcasts at Home and Abroad

young cooper at the end of apprenticeship, when he is rolled in a large barrel that has been built around him for the occasion.

Mr. C. L. Homer, a foreman enameller in a Black Country hard toy factory, has been learning the tricks of his trade for 21 years, and he will describe them to listeners. Still on the subject of toys, Miss M. Guest will talk about dresses that she designs for dolls. The whole programme will be compered by F. H. Grisewood—thus is success ensured!

#### THE SONG IS ENDED

"THE Melody Lingers On" is the title of a reminiscent pro-

gramme of dance music to be heard on the National wavelength on Tuesday at 8. Ben Frankel, the well-known arranger of film and radio music, impressed with the number of requests from listeners asking band leaders to play popular melodies of recent years, conceived the idea of a musical presentation consisting of popular tunes of the past, orchestrated in modern-day manner. Many favourite numbers of the past twenty years are dated as regards their tempo and orchestration, but are capable of rivalling the modern rhythm melodies if given modern treatment. Hence the title of the programme which has been arranged by Jack Davies, Jr. Ben Frankel has scored the music and will be conducting the orchestra

#### POT-POURRI OF SPORT

THE O.B. Department will be especially active to-morrow between 2 and 5.15, when National listeners will hear commentaries on three outstanding events.

John Snagge, who has made in recent years such a great success of his boat-race broadcasts (he is himself an enthusiastic oarsman and got his trial eights at Oxford) will be stationed in a special stand erected by the Regatta authorities at the finishing post at Henley. One of the typically

TO-MORROW AFTERNOON some of the events at Henley Regatta will be described to listeners by John Snagge.



English scenes which Britons in exile remember when languishing beneath the torrid sun is the tableau which the Henley Regatta presents. The river is a great jewel, glittering in a verdant setting of glorious foliage while the water's edge is fringed with punts filled with youth, gaily dressed in summer attire.

It is from this scene that the commentator will describe the progress of the boats, and it is hoped to include the finals of the Grand Challenge Cup and the Diamond Sculls.

On this day, in all probability, the finals of the All-England Lawn Tennis Championship will be fought at Wimbledon. Colonel Brand and Captain Wakelam will describe the final contest of the struggle.

In the afternoon it is also

proposed to take listeners to the Festival of Youth at Wembley. This is the first assembly of its kind in this country. In aid of King George's Jubilee Trust, there will be ten thousand performers, and Their Majesties' arrival will be announced by fanfares followed by the National Anthem played by the massed bands of the Brigade of Guards.

The vivid description by the commentator, the stirring strains of the bands, and the voices of the eager thousands of youth assembled on this occasion should make an inspiring outside broadcast.

In the evening, at 8.45, on the Regional programme, Bernard Grey, one of the North's sports commentators, will describe the Speedway Test Match between England and Australia at Belle Vue, Manchester.

#### STARS FOR "MUSIC HALL"

GOOD news for "Music Hall" listeners: John Sharman has arranged for Flanagan and Allen to appear in his show to-morrow at 8 in the National programme. This is their fourth recent appearance, and in the same show the ever-popular Bebe Daniels and Ben Lyon will be making their last broadcast in this country before going on a tour of South Africa. Phyllis Robins makes a welcome return to the "Music Hall," and Rupert Hazell and Elsie Day take their part in what they call "Harmonyariety."

#### IN PRAISE OF QUIET

AN escape from the clatter and busy hum of city streets, the maddening hubbub of modern existence, an escape from it all—just for forty minutes. That is what Alan Paul has planned for those who care to listen to his programme, "In Praise of Quiet Things," to be broadcast in the National programme at 10.20 on Thursday evening. Those taking part include Jean Pougnet, violin; David Martin, violin; Anthony Pini, cello; with Alan Paul himself at the piano. Garda Hall, soprano, will be the vocalist. Appropriate verse

# the Week

and prose selected by Anne Barker will be spoken between the items, and the programme is presented by William Maeburg.

To those who are prejudiced, perhaps not without reason, against chamber music of all varieties, let it be known that Alan Paul has written a successful musical comedy, complete with dance music, as the result of a remark made to him by a friend: "I don't expect you could write a dance tune if you tried"; therefore this programme should have an interest for even the rhythm section of the listening public.

## MUSIC

WITH the B.B.C. Symphony Orchestra away on annual leave, there will be fewer studio broadcasts of orchestral music during the month of July until the Proms. begin on August 7th. The B.B.C. Empire Orchestra, however, will broadcast Mendelssohn's First Symphony on Tuesday at 9 (Regional); when they will be conducted by Clifton Hellwell.

On Thursday, at 8 (National), Julius Harrison will conduct the London Symphony Orchestra in a broadcast performance of Dvorak's First Symphony and Sibelius' "Tapiola."

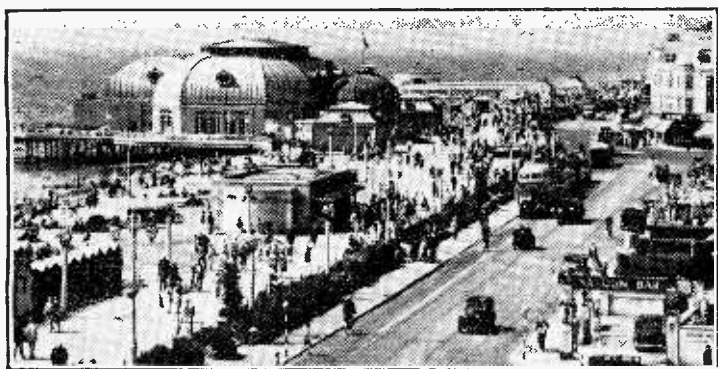

SONGS FROM THE SEASIDE. No. 1 comes from the Pier Pavilion, Worthing, on Thursday at 7.25 (National).

The Opera Group, a company of young English singers, founded about two years ago by Dr. Ernst Schoen and George Knepler, presents Offenbach's comic opera, "Bluebeard." The group, which will be broadcasting for the third time, specialises in smaller opera, in which both Schoen and Knepler have

acquired considerable experience, the former when he was programme director of a radio station abroad, and the latter when he was conducting at Austrian and German opera houses.

"Bluebeard" will be broadcast on Wednesday between 8 and 9 in the National programme; the Group will be assisted by the Revue Chorus and the Theatre Orchestra.

## ROYAL AGRICULTURAL SHOW

VIEWPOINTS and personalities will be broadcast from the Royal Show, held this year at Wrottesley Park, Wolverhampton. The idea is to bring to the microphone several speakers who are attending the show and have interesting points of view to express about new developments as seen at the show or about agriculture generally. The transmission will be heard Nationally at 6.20 on Wednesday.

## CRICKET

THE annual 'Varsity cricket match is, as a rule, a fast-moving game, played on the "get on or get out" principle. This adds to its value from the commentary point of view, and it should give Howard Marshall plenty to talk about during his

German Opera House by Berlin at 8 p.m. on Saturday, should find many listeners in this country for it was made extremely popular by Jenny Lind with her vivacious singing in the title rôle. Of all the composer's works, this can be truly described as the most brilliant. The glorious finale, "Salute to France," has few equals in operatic music.

Not unnaturally Verdi is the choice on the 9 Rome programme when his "Force of Destiny" will be relayed from Cremona. The music is fine, but the theme is indubitably a "gory" one; all the principals come to a violent end, and the opera eventually peters out for lack of characters to carry on! The singing could not be in better hands—both Gina Cigna and Borgioli, so recently heard at Covent Garden, are in the cast.

## FROM DENMARK

A number of English and American rhythm songs will be presented by "The Five Kentucky Singers," who are broadcasting from Denmark at 9.25 on Monday. This transmission will be preceded



EFFORT. "Bunny" Austin in attitude symbolical of championship tennis. Commentaries will be heard from Wimbledon at various times during the afternoons of to-day and to-morrow (National).

at 8 by an O.B. from Silkeborg, Jutland, in the shape of a concert by the Silkeborg Koncertorkester, a popular provincial orchestra, the members of which have earned the reputation as specialised exponents of Scandinavian music.

THE AUDITOR.

## HIGHLIGHTS OF THE WEEK

FRIDAY, JULY 2nd.  
Nat., 7.30, Peter Yorke and his Orchestra. ¶B.B.C. Scottish Orchestra. 9.20, Caf' Chant—another little show.

Reg., 7.25, Recital by Susan Metcalfe Casals (mezzo-soprano). 8, Stanelli's Batchelor Party, No. 13. Produced by Max Kester and Stanelli.

Abroad.  
Breslau, 8.10, German Folk Songs and Music in old and new settings.

SATURDAY, JULY 3rd.  
Nat., 7.30, A.B.C. 8, Music Hall. 10, My Own Poetry. 10.20, Chamber Music.

Reg., 6, Dance Music. ¶From the London Theatre. 8, B.B.C. Northern Orchestra. ¶King's Muster: George IV Visits Scotland.

Abroad.  
Rome, 9, "The Force of Destiny"—Four-act opera (Verdi).

SUNDAY, JULY 4th.  
Nat., 6.45, Fred Hartley and his Sextet. 7.30, Bransby Williams. 7.55, Service from the City Temple.

Reg., 6.45, Eugene Pini and his Tango Orchestra. 9.5, As You Like It. ¶Epilogue.

Abroad.  
Hamburg 8, "A Century of Garden Music"—a romantic serenade.

MONDAY, JULY 5th.  
Nat., 7, B.B.C. Scottish Orchestra. ¶Tricks of the Trade. 9.35, Dove Days, or the Derbyshire Angler.

Reg., 6.35, Pianoforte Recital by Claud Biggs. 9.45 Melody and Rhythm.

Abroad.  
Radio-Paris, 8.40, Casino Concert from Vichy—also relayed by most other French stations.

TUESDAY, JULY 6th.  
Nat., 6.25, B.B.C. Theatre Organ. ¶Storm in a Tea Cup. 9.20, America. To-day—talk on economic problems by Geoffrey Crowther.

Reg., 7.30, Alfredo Campoli and his Salon Orchestra. B.B.C. Singers (A). ¶Pleas for Pleasure. 9.40, Is it the Law?

Abroad.  
Konigsberg, 8.10, "A Dance Medley." Erich Börschel Dance Band.

WEDNESDAY, JULY 7th.  
Nat., 5.15, Ambrose and his Orchestra from the Paris Exhibition. 9.20, "I Protest": a talk on common nuisances.

Reg., 7.30, Kaleidoscope. ¶Pianoforte Recital by Leopold Muenger. 9.45, Robb Wilton as Mr. Muddlecombe, J.P.

Abroad.  
Leipzig, 8, Concert from the Belvedere Open-Air Theatre, Weimar.

THURSDAY, JULY 8th.  
Nat., 6.20, Book Talk by Allen Ferguson. ¶B.B.C. Military Band. 8, London Symphony Orchestra.

Reg., 6, B.B.C. Northern Orchestra. ¶Beatrice Harrison, 'cello. 8, Melody Out of the Sky—Jay Wilbur and his Band.

Abroad.  
Luxembourg, 9.30, Symphony Concert with Lazare Lévy (pianoforte).

# PRINCIPAL BROADCASTING STATIONS OF EUROPE

Arranged in Order of Frequency and Wavelength

(This list is included in the first issue of each month. Stations with an Aerial Power of 50 kW. and above\*in heavy type)

Station.	kc/s.	Tuning Positions.	Metres.	kW.	Station.	kc/s.	Tuning Positions.	Metres.	kW.
Ankara (Turkey)	152		1973.5	5	Leipzig (Germany)	785		382.2	120
Kaunas (Lithuania)	153		1961	7	Barcelona, EAJ1 (Spain)	795		377.4	7.5
Radio Romania (Brasov) Romania	160		1875	150	Lwow (Poland)	795		377.4	50
Hilversum, No. 1 (Holland) (10 kW. till 1840)	160		1875	150	North Welsh Regional (Penmon)	804		373.1	5
Lahti (Finland)	166		1807	150	Welsh Regional (Washford Cross)	804		373.1	70
Moscow, No. 1, RW1 (Komintern) (U.S.S.R.)	172		1744	500	Milan, No. 1 (Italy)	814		368.6	50
Paris (Radio Paris) (France)	182		1648	80	Bucharest (Romania)	823		364.5	12
Istanbul (Turkey)	185		1622	5	Kiev, No. 2, RW9 (U.S.S.R.)	832		360.6	35
Irkutsk (U.S.S.R.)	187.5		1600	20	Agen (France)	832		360.6	1.5
Deutschlandsender (Germany)	191		1571	60	Berlin (Germany)	841		356.7	100
Droitwich	200		1500	150	Sofia (Bulgaria)	847.5		354	1
Minsk, RW10 (U.S.S.R.)	208		1442	35	Norwegian Relay Stations	850		352.9	—
Reykjavik (Iceland)	208		1442	18	Valencia (Spain)	850		352.9	3
Motala (Sweden)	216		1389	150	Simferopol, RW52 (U.S.S.R.)	859		349.2	10
Novosibirsk, RW76 (U.S.S.R.)	217.5		1379	100	Strasbourg (France)	859		349.2	100
Warsaw, No. 1 (Poland)	224		1339	120	Poznan (Poland)	868		345.6	16
Luxembourg	232		1293	150	London Regional (Brookmans Park)	877		342.1	70
Leningrad, No. 1 RW53 (Kolpino) (U.S.S.R.)	232		1293	100	Linz (Austria)	886		338.6	15
Kalundborg (Denmark)	240		1250	60	Graz (Austria)	886		338.6	15
Vienna, No. 2 (Austria)	240		1250	0.5	Helsinki (Finland)	895		335.2	10
Kiev, No. 1 (U.S.S.R.)	248		1209.6	100	Limoges, P.T.T. (France)	895		335.2	1.5
Vigra (Aalesund) (Norway)	253		1188	10	Hamburg (Germany)	904		331.9	100
Tashkent, RW11 (U.S.S.R.)	256.4		1170	25	Dnepropetrovsk (U.S.S.R.)	913		328.6	10
Oslo (Norway)	260		1153.8	60	Toulouse (Radio Toulouse) (France)	913		328.6	60
Moscow, No. 2, RW49 (Stechkovo) (U.S.S.R.)	271		1107	100	Brno (Czechoslovakia)	922		325.4	32
Tromsø (Norway)	282		1065	10	Brussels, No. 2 (Belgium)	932		321.9	15
Tiflis, RW7 (U.S.S.R.)	283		1060	35	Algiers (Algeria)	941		318.8	12
Saratov (U.S.S.R.)	340		882.3	20	Göteborg (Sweden)	941		318.8	10
Finmark (Norway)	347		864	10	Breslau (Germany)	950		315.8	100
Archangel (U.S.S.R.)	350		857.1	10	Paris (Poste Parisien) (France)	959		312.8	60
Rostov-on-Don, RW12 (U.S.S.R.)	355		845.1	25	Bordeaux-Sud-Ouest (France)	968		309.9	30
Budapest, No. 2 (Hungary)	359.5		834.5	18	Odessa (U.S.S.R.)	968		309.9	10
Sverdlovsk, RW5 (U.S.S.R.)	375		800	40	Northern Ireland Regional (Lisburn)	977		307.1	100
Voroneje, RW25 (U.S.S.R.)	390		769	10	Genoa (Italy)	986		304.3	10
Boden (Sweden)	392		765	0.6	Torun (Poland)	986		304.3	24
Banska-Bystrica (Czechoslovakia) (15 kW. after 1700)	392		765	30	Hilversum No. 2 (Holland) (15 kW. till 1840)	995		301.5	60
Geneva (Switzerland)	401		748	2	Bratislava (Czechoslovakia)	1004		298.8	13.5
Moscow, No. 3 (RCZ) (U.S.S.R.)	413.5		726	100	Midland Regional (Droitwich)	1013		296.2	70
Ostersund (Sweden)	413.5		726	0.6	Chernigov (U.S.S.R.)	1013		296.2	4
Oulu (Finland)	431		696	10	Barcelona, EAJ15 (Spain)	1022		293.5	3
Tartu (Estonia)	511		587.1	0.5	Cracow (Poland)	1022		293.5	2
Hamar (Norway)	519		578	0.7	Oviedo (Spain)	1022		293.5	0.7
Innsbruck (Austria)	519		578	1	Königsberg, No. 1 (Heilsberg) (Germany)	1031		291	100
Ljubljana (Yugoslavia)	527		569.3	6.3	Pareda (Portugal)	1031		291	5
Viipuri (Finland)	527		569.3	10	Leningrad, No. 2, RW70 (U.S.S.R.)	1040		288.5	10
Bolzano (Italy)	536		559.7	10	Rennes-Bretagne (France)	1040		288.5	120
Wilno (Poland)	536		559.7	50	West Regional (Washford Cross)	1050		255.7	20
Budapest, No. 1 (Hungary)	546		549.5	120	Bari No. 1 (Italy)	1059		283.3	20
Beromünster (Switzerland)	556		539.6	100	Paris (Radio Cité) (France)	1068		280.9	0.8
Athlone (Irish Free State)	565		531	100	Tiraspol, RW57 (U.S.S.R.)	1068		280.9	10
Klaipeda (Lithuania)	565		531	10	Bordeaux-Lafayette (France)	1077		278.6	35
Palermo (Italy)	565		531	3	Zagreb (Yugoslavia)	1086		276.2	0.7
Stuttgart (Germany)	574		522.6	100	Falun (Sweden)	1086		276.2	2
Alpes-Grenoble, P.T.T. (France)	583		514.6	20	Madrid, EAJ7 (Spain)	1095		274	5
Madona (Latvia)	583		514.6	50	Vinnitsa (U.S.S.R.)	1095		274	10
Vienna, No. 1 (Austria)	592		506.8	100	Kuldiga (Latvia)	1104		271.7	10
Rabat (Morocco)	601		499.2	25	Naples (Italy)	1104		271.7	1.5
Sundsvall (Sweden)	601		499.2	10	Moravska-Ostrava (Czechoslovakia)	1113		269.5	11.2
Florence (Italy)	610		491.8	20	Radio Normandie (Fécamp) (France)	1113		269.5	10
Cairo, No. 1 (Egypt)	620		483.9	20	Alexandria, No. 1 (Egypt)	1122		267.4	0.5
Brussels, No. 1 (Belgium)	620		483.9	15	Newcastle	1122		267.4	1
Lisbon (Portugal)	629		476.9	15	Nyiregyhaza (Hungary)	1122		267.4	6.25
Trøndelag (Norway)	629		476.9	20	Hörby (Sweden)	1131		265.3	10
Christiansand (Norway)	629		476.9	20	Turin, No. 1 (Italy)	1140		263.2	7
Prague, No. 1 (Czechoslovakia)	638		470.2	120	Trieste (Italy)	1140		263.2	10
Lyons, P.T.T. (France)	648		463	100	London National (Brookmans Park)	1149		261.1	20
Petrozavodsk (U.S.S.R.)	648		463	10	North National (Slaithwaite)	1149		261.1	20
Cologne (Germany)	658		455.9	100	Scottish National (Falkirk)	1149		261.1	50
North Regional (Slaithwaite)	668		449.1	70	Kosice (Czechoslovakia)	1158		259.1	10
Jerusalem (Palestine)	668		449.1	20	Monte Ceneri (Switzerland)	1167		257.1	15
Sottens (Switzerland)	677		443.1	100	Copenhagen (Denmark)	1176		255.1	10
Belgrade (Yugoslavia)	686		437.3	2.5	Nice-Corse (France)	1185		253.2	60
Paris, P.T.T. (France)	695		431.7	120	Frankfurt (and Relays) (Germany)	1195		251	25
Stockholm (Sweden)	704		426.1	55	Prague, No. 2 (Czechoslovakia)	1204		249.2	5
Rome, No. 1 (Italy)	713		420.8	50	Lille, P.T.T. (France)	1213		247.3	60
Kharkov, No. 1, RW20 (U.S.S.R.)	722		415.4	10	Bologna (Radio Marconi) (Italy)	1222		245.5	50
Fredrikstad (Norway)	722		415.4	1	Gleiwitz (Germany)	1231		243.7	5
Tallinn (Estonia)	731		410.4	20	Cork (Irish Free State)	1235		242.9	1
Madrid, EAJ2 (Spain)	731		410.4	3	Saarbrücken (Germany)	1249		240.2	17
Seville (Spain)	731		410.4	5.5	Riga (Latvia)	1258		238.5	15
Munich (Germany)	740		405.4	100	Rome, No. 3 (Italy)	1258		238.5	1
Marseilles, P.T.T. (France)	749		400.5	100	Bilbao, EAJ8 (Spain)	1258		238.5	1
Pori (Finland)	749		400.5	1	Nürnberg (Germany)	1267		236.8	2
Katowice (Poland)	758		395.8	12	Radio Méditerranée (Juan-les-Pins) (France)	1276		235.1	27
Scottish Regional (Falkirk)	767		391.1	70	Dresden (Germany)	1285		233.5	0.25
North Scottish Regional (Burghead)	767		391.1	60	Aberdeen	1285		233.5	1
Stalino (U.S.S.R.)	776		386.6	10	Klagenfurt (Austria)	1294		231.8	5
Toulouse, P.T.T. (France)	776		386.6	120	Vorarlberg (Austria)	1294		231.8	5
					Danzig	1303		230.2	0.5



Station.	kc/s.	Tuning Positions.	Metres.	kW.	Station.	kc/s.	Tuning Positions.	Metres.	kW.
Swedish Relay Stations	1312	.....	228.7	—	Vaasa-Vasa (Finland)	1420	.....	211.3	10
Magyarovar (Hungary)	1321	.....	227.1	1.25	Alexandria, No. 2 (Egypt)	1429	.....	209.9	0.5
German Relay Stations	1330	.....	225.6	—	Turku (Finland)	1429	.....	209.9	0.5
Montpellier, P.T.T. (France)	1339	.....	224	1.5	Miskole (Hungary)	1438	.....	208.6	1.25
Lodz (Poland)	1339	.....	224	2	Paris (Eiffel Tower) (France)	1456	.....	206	7
Dublin (Irish Free State)	1348	.....	222.6	0.5	Pecs (Hungary)	1465	.....	204.8	1.25
Rjukan (Norway)	1348	.....	222.6	0.15	Belgian Relay Stations	1465	.....	204.8	0.1
Salzburg (Austria)	1348	.....	222.6	2	Bournemouth	1474	.....	203.5	1
Tampere (Finland)	1348	.....	222.6	0.7	Plymouth	1474	.....	203.5	0.3
Cairo No. 2 (Egypt)	1348	.....	222.6	0.5	Binche (Belgium)	1487	.....	201.7	0.1
Königsberg (Germany)	1348	.....	222.6	2	Belgian Relay Stations	1492	.....	201.1	0.1
Nottoden (Norway)	1357	.....	221.1	0.15	Nimes (France)	1492	.....	201.1	0.7
Italian Relay Stations	1357	.....	221.1	—	Albacete (Spain)	1492	.....	201.1	0.2
L'Ile de France (France)	1366	.....	219.6	2	Santiago (Spain)	1492	.....	201.1	0.5
Basle (Switzerland)	1375	.....	218.2	0.5	Belgian Relay Stations	1500	.....	200	0.1
Berne (Switzerland)	1375	.....	218.2	0.5	Pietarsaari (Finland)	1500	.....	200	0.25
Warsaw, No. 2 (Poland)	1384	.....	216.8	10	Radio Alcalá (Spain)	1500	.....	200	0.2
Lyons (Radio Lyons) (France)	1393	.....	215.4	25	Karlskrona (Sweden)	1530	.....	196	0.2
Stara-Zagora (Bulgaria)	1402	.....	214	2	Liepāja (Latvia)	1734	.....	173	0.1

# SHORT-WAVE STATIONS OF THE WORLD

Station.	Call Sign.	kc/s.	Tuning Positions.	Metres.	kW.	Station.	Call Sign.	kc/s.	Tuning Positions.	Metres.	kW.
Batavia (Java)	YDA	3,040	.....	98.68	5	Lisbon (Portugal)	CTICT	9,680	.....	31.00	0.5
Kharbarovsk (Russia)	RV15	4,273	.....	70.20	20	Madrid (Spain)	EAQ	9,860	.....	30.43	20
Caracas (Venezuela)	YV5RH	5,800	.....	51.72	1	Lisbon (Portugal)	CSW	9,940	.....	30.18	5
San Jose (Costa Rica)	TIGPH	5,820	.....	51.52	0.5	Bandoeng (Java)	PMN	10,260	.....	29.24	3
Vatican City (Vatican State)	HVJ	5,970	.....	50.28	10	Ruyssedele (Belgium)	ORK	10,330	.....	29.04	9
Mexico City (Mexico)	XEBT	6,000	.....	50.00	1	Buenos Aires (Argentina)	LSX	10,350	.....	28.99	12
Moscow (Russia)	RW59	6,000	.....	50.00	20	Teneriffe (Canary Isles)	EAJ43	10,360	.....	28.94	4
Montreal (Canada)	CFCX	6,005	.....	49.96	—	Tokio (Japan)	JVM	10,740	.....	27.93	20
Havana (Cuba)	COCO	6,010	.....	49.92	0.5	Bandoeng (Java)	PLP	11,010	.....	27.25	3
Prague (Podebrady) (Czechoslovakia)	OLR	6,010	.....	49.92	30	Lisbon (Portugal)	CSW	11,040	.....	27.17	5
Bogota (Colombia)	HJ3ABH	6,018	.....	49.90	1	Motala (Sweden)	SBG	11,700	.....	25.63	1
Zeesen (Germany)	DJC	6,020	.....	49.83	50	Winnipeg (Canada)	CJRXX	11,720	.....	25.60	2
Boston (U.S.A.)	W1XAL	6,040	.....	49.87	10	Paris (Radio-Colonial) (France)	TPA4	11,720	.....	25.60	12
Miami (U.S.A.)	W4XB	6,040	.....	49.87	2.5	Daventry (Gt. Britain)	GSD	11,750	.....	25.53	10-50
Daventry (Gt. Britain)	GSA	6,050	.....	49.59	10-50	Zeesen (Germany)	DJD	11,770	.....	25.49	50
Cincinnati (U.S.A.)	W8XAL	6,060	.....	49.50	10	Boston (U.S.A.)	W1XAL	11,790	.....	25.45	20
Philadelphia (U.S.A.)	W3XAU	6,060	.....	49.50	10	Tokio (Japan)	JZJ	11,800	.....	25.42	20
Skamlebaek (Denmark)	OXY	6,060	.....	49.50	0.5	Vienna (Austria)	OER2	11,800	.....	25.42	1.5
Motala (Sweden)	SBG	6,060	.....	49.50	1	Rome (Italy)	I2RO4	11,810	.....	25.40	25
Chicago (U.S.A.)	W9XAA	6,080	.....	49.34	0.5	Daventry (Gt. Britain)	GSN	11,820	.....	25.38	10-50
Nairobi (Kenya)	VQ7LO	6,083	.....	49.31	0.5	Wayne (U.S.A.)	W2XE	11,830	.....	25.36	10
Toronto (Bowmanville) (Canada)	CRXC	6,090	.....	49.26	0.5	Lisbon (Portugal)	CT1AA	11,830	.....	25.36	2
Hong Kong (China)	ZBW2	6,090	.....	49.26	2	Prague (Podebrady) (Czechoslovakia)	OLR	11,840	.....	25.34	30
Johannesburg (South Africa)	ZTJ	6,100	.....	49.20	5	Zeesen (Germany)	DJP	11,850	.....	25.31	50
Bound Brook (U.S.A.)	W3XAL	6,100	.....	49.18	35	Daventry (Gt. Britain)	GSE	11,860	.....	25.29	10-50
Chicago (U.S.A.)	W9XF	6,100	.....	49.18	10	Pittsburgh (U.S.A.)	W8XK	11,870	.....	25.27	40
Belgrade (Yugoslavia)	.....	6,100	.....	49.18	1	Paris (Radio-Colonial) (France)	TPA3	11,880	.....	25.23	15
Manizales (Colombia)	HJ4ABB	6,105	.....	49.12	1	Moscow (Russia)	RNE	12,000	.....	25.00	20
Daventry (Gt. Britain)	GSL	6,110	.....	49.10	10-50	Lisbon (Portugal)	CTICT	12,082	.....	24.83	0.5
Calcutta (India)	VUC	6,110	.....	49.10	0.5	Reykjavik (Iceland)	TFJ	12,235	.....	24.52	7.5
Wayne (U.S.A.)	W2XE	6,120	.....	49.02	10	Paredo (Portugal)	CT1GO	12,400	.....	24.20	0.35
Pittsburgh (U.S.A.)	W8XK	6,140	.....	48.86	40	Warsaw (Poland)	SPW	13,635	.....	22.00	10
Winnipeg (Canada)	CJRO	6,150	.....	48.78	2	Amateurs	.....	14,000	.....	21.42	0.01
Lisbon (Portugal)	CSL	6,150	.....	48.78	0.5				to		
Caracas (Venezuela)	YV5RD	6,150	.....	48.78	1				to		
Paredo (Portugal)	CT1GO	6,200	.....	48.40	5	Sofia (Bulgaria)	LZA	14,970	.....	20.04	1.5
San Jose (Costa Rica)	TIPG	6,410	.....	46.80	0.5	Zeesen (Germany)	DJL	15,111	.....	19.85	50
Valencia (Colombia)	YV4RV	6,520	.....	46.00	0.5	Vatican City (Vatican State)	HVJ	15,123	.....	19.84	10
Riobamba (Ecuador)	PRADO	6,620	.....	45.31	2	Daventry (Gt. Britain)	GSF	15,140	.....	19.82	10-50
Amateurs	.....	7,000	.....	42.86	0.01	Bandoeng (Java)	YDC	15,160	.....	19.80	3
						Daventry (Gt. Britain)	GSO	15,180	.....	19.76	10
						Hongkong (China)	ZBW4	15,190	.....	19.75	2
Moscow (U.S.S.R.)	RW96	7,300	.....	41.10	25	Zeesen (Germany)	DJB	15,200	.....	19.74	50
Prangins (Radio-Nations) (Switz'ld)	HBP	7,520	.....	38.89	20	Pittsburgh (U.S.A.)	W8XK	15,210	.....	19.72	40
Budapest (Hungary)	HAT4	9,125	.....	32.88	5	Huizen (Holland)	PCJ	15,220	.....	19.71	20
Bangkok (Siam)	HS8PJ	9,350	.....	32.09	20	Prague (Podebrady) (Czechoslovakia)	OLR	15,230	.....	19.70	30
Madrid (Spain)	EAQ2	9,480	.....	31.65	20	Paris (Radio-Colonial) (France)	TPA2	15,243	.....	19.68	12
Rio de Janeiro (Brazil)	PRF5	9,500	.....	31.58	5	Boston (U.S.A.)	W1XAL	15,250	.....	19.67	20
Daventry (Gt. Britain)	GSE	9,510	.....	31.55	10-50	Daventry (Gt. Britain)	GSI	15,260	.....	19.66	10-50
Melbourne (Australia)	VK3ME	9,510	.....	31.55	1.5	Wayne (U.S.A.)	W2XE	15,270	.....	19.65	10
Hongkong (China)	ZBW3	9,520	.....	31.49	2	Zeesen (Germany)	DJQ	15,280	.....	19.63	50
Jeløy (Norway)	LKJ1	9,520	.....	31.49	1.5	Buenos Aires (Argentina)	LRU	15,290	.....	19.62	5
Schenectady (U.S.A.)	W2XAF	9,530	.....	31.48	35	Daventry (Gt. Britain)	GSP	15,310	.....	19.60	10-50
Zeesen (Germany)	DJN	9,540	.....	31.45	50	Schenectady (U.S.A.)	W2XAD	15,330	.....	19.57	18
Suva (Fiji)	VPD2	9,540	.....	31.45	3	Zeesen (Germany)	DJR	15,340	.....	19.56	50
Prague (Podebrady) (Czechoslovakia)	OLR	9,550	.....	31.41	30	Budapest (Szekesfehervar) (Hungary)	HAS3	15,370	.....	19.52	25
Zeesen (Germany)	DJA	9,560	.....	31.38	50	Hongkong (China)	ZBW5	17,750	.....	16.90	2
Bombay (India)	VUB	9,565	.....	31.36	4.5	Zeesen (Germany)	DJE	17,760	.....	16.89	50
Millis (U.S.A.)	W1XK	9,570	.....	31.35	10	Wayne (U.S.A.)	W2XE	17,760	.....	16.89	10
Daventry (Gt. Britain)	GSC	9,580	.....	31.32	10-50	Huizen (Holland)	PHI	17,770	.....	16.88	23
Lyndhurst (Australia)	VK3LR	9,580	.....	31.32	1	Bound Brook (U.S.A.)	W3XAL	17,780	.....	16.87	35
Philadelphia (U.S.A.)	W3XAU	9,590	.....	31.28	10	Daventry (Gt. Britain)	GSG	17,790	.....	16.86	10-50
Sydney (Australia)	VK2ME	9,590	.....	31.28	20	Bandoeng (Java)	PLE	18,830	.....	15.93	60
Huizen (Holland)	PCJ	9,590	.....	31.28	20	Bangkok (Siam)	HS8PJ	19,020	.....	15.77	20
Prangins (Radio-Nations) (Switz'ld)	HBL	9,595	.....	31.27	20	Bandoeng (Java)	PMA	19,350	.....	15.50	60
Moscow (Russia)	RW96	9,600	.....	31.25	20	Daventry (Gt. Britain)	GSH	21,470	.....	13.97	10-50
Rome (Italy)	I2RO3	9,635	.....	31.13	25	Wayne (U.S.A.)	W2XE	21,520	.....	13.94	10
Sourabaya (Java)	YDB	9,640	.....	31.11	1	Daventry (Gt. Britain)	GSJ	21,530	.....	13.93	10-50
Lisbon (Portugal)	CT1AA	9,655	.....	31.09	2	Pittsburgh (U.S.A.)	W8XK	21,540	.....	13.93	40
Buenos Aires (Argentina)	LRX	9,660	.....	31.06	5	Daventry (Gt. Britain)	GST	21,550	.....	13.92	10-50

# Random Radiations

By  
"DIALLIST"

## Frequencies or Wavelengths ?

IT'S a thousand pities that we ever adopted wavelengths for the tuning of our wireless sets and for indicating the positions of stations in the radio scale. Wavelengths are an instance of those unhappy legacies from the early days of a new department of science which often cause so much embarrassment later on. They came into use because of the old methods of "explaining" wireless by analogies with the waves of the sea, the ripples moving in widening circles over the surface of a pond after the impact of a stone, and so on. They were all very well so long as all wireless transmissions that came the way of the man in the street were of the "long-wave" or "medium-wave" types; but with the coming of "short-wave" and "ultra-short-wave" broadcasting, wavelengths have become just a clumsy absurdity. There are, for example, twenty-two stations listed on wavelengths between 19.52 and 19.95 metres—twenty-two stations with a total wavelength-difference of a little under seventeen inches!

## Is It Too Late ?

Is it, I wonder, too late now to try to get the man in the street to think and tune in kilocycles or megacycles? The B.B.C. made the attempt a good while ago, with marked lack of success; but that, I think, was largely due to their endeavour to introduce yet a third term to the already perplexed average listener. They tried to make him adopt the kilohertz, which, if more academically correct, was likely to be forbidding as being a new thing to him. America abandoned wavelengths years ago, but in that country the transition from wavelengths was easy. The authorities adopted a 10-kilocycle basis for their broadcasting distributing scheme, and as the frequencies were all multiples of ten they at once appealed to the listener as being far more straightforward than bits and pieces of metres denoted by decimal places. Unfortunately we've nothing like that to help us, but now that so many ordinary listeners have swallowed the kilocycle and the megacycle on the short-wave ranges of their receivers it probably would not be very difficult to extend the reform to other ranges. And there's another thing that has removed some of the difficulties in the way. In the years before tuning dials marked with the names of stations became pretty well universal most listeners knew by heart the wavelengths of a good many stations. Enthusiasts could probably have told you those of most stations within their ken without many mistakes. But nowadays the majority of listeners neither know nor need to know the wavelengths of any of the medium-wave or long-wave broadcasting stations that they use in the ordinary way. There thus wouldn't be anything like so much opposition to the introduction of the kilocycle and megacycle as the only units of measurement; already a good many sets have scales calibrated in both frequencies and metres.

## South Ken. Revisited

WHEN I wrote my recent note on the Television Show at the Science Museum I had had time for only the briefest of visits.

Since then I have been able to "do" the exhibition more thoroughly and here are some impressions. To those, like you and me, who are interested in the history and the technicalities of television, the whole thing is of the greatest interest; but I don't think that quite enough is being done to show the man in the street and his wife and family what it all means. I may have been unfortunate, but I didn't see anyone there acting as an official guide or prepared to give explanations to the puzzled. To take just one example, the Emitron camera, about which most people have read something in their newspapers as one of the wonders of modern scientific development, was just standing forlornly by itself with no one to answer questions or show how it worked.

## Worth Trying ?

Here's a suggestion which the authorities might well consider. In many departments of the British Museum, including the main building in Bloomsbury, and, I believe, the Natural History Museum and the Science Museum itself, there are officials known as guide-lecturers who conduct parties at given times each day. Their services are very much appreciated by the public, as is shown by the size of the parties that collect at the times billed for tours. Wouldn't it be a first-rate plan for those who are running the Television Exhibition to give the guide-lecturer system at any rate a trial? I am sure it would catch on at once with the public, and it might do a great deal for television just at the time when its greatest need is to establish a firmer hold on public interest.



CAR RADIO AERIAL. Fitted just forward of the front door this Philco aerial is only 20 inches long when closed up but can be extended to over five feet when required.

## Comparative Viewing

It's extremely interesting to make your way down the line of viewing booths when a demonstration is in progress and to compare the reproduction of the various receivers at work. All of them are pretty good, but there are distinct differences in the results, as you may see to the best advantage if you place yourself rather far back and opposite the partition between any pair of booths so that you can turn your gaze instantly from one screen to the other and back again. I confess I am disappointed with the Scopphony results. The definition is distinctly good for 240-line television, and the big flat screen is a wonderful achievement. Flicker there probably must be with a system using only 25 frames a second; but in the Scopphony reproduction there are two other points which call for friendly criticism. The first is that the illumination appears to be much less good near the edges of the screen than in the middle; the second, that you are very, very conscious of the whirling scanner right in the centre of the picture. So much so that the effect, on me at any rate, is that, willy-nilly, attention is apt to be concentrated on that small spiralling area in the middle of the image.

## The Valve Question

FROM an Enfield correspondent I have a letter criticising my recent remarks about the large numbers of valves and valve parts that we import each month from America and from the Continent. He's inclined to take me to task for suggesting that such a vast importation is a bad thing. "On the contrary," he writes, "it is in my opinion the only thing that will wake up the British valve makers and set makers." My correspondent has rather missed the point of my note. I have always contended that prices of British valves were far too high, and my feeling is that we should be able to make our own valves at prices which will bear direct comparison with those that come in from America. And then valve parts: It does seem to me perfectly absurd that we should have to pay the foreigner thousands of pounds each month for parts which are presumably turned eventually into "British-made" valves. If we are going to keep valve prices at their present ridiculous level there is no excuse whatever for buying their components abroad.

## Why Shouldn't We ?

If, on the other hand, the big reduction in prices that is so long overdue is at last going to take place, surely our proper course is to install the machinery which will enable us to make our own parts as cheaply as anyone can make them for us. It can't be a question of wages, for the labour which makes American valves is, I believe, more highly paid than our own in actual money, though what the workman pockets over there may not go so far when he comes to spend it as the smaller pay of his British counterpart. The secret of low costs in America appears to be mass production on the grand scale by means of the most modern machinery. The market for American valves is admittedly bigger than that for

**Random Radiations—**

ours, but we could increase our own both at home and abroad enormously if prices were more reasonable. We could, for example, make and sell at home the greater part of the millions of valves that America sends us each year.

**Flimsy Condensers**

THERE'S nothing much wrong with the fixed condensers used in our receiving sets if they are of first-rate make and well up to the strains that are likely to be imposed upon them. But you do need a considerable margin of safety in the wireless set of to-day, and, unluckily, condensers which possess it are more expensive than those that don't. The problem of the set designer nowadays must be a very difficult one. The prices of receiving sets have come down and down and down in recent years and there still seems to be no end in sight to this kind of competition between manufacturers. The wretched designer is told that he must produce a set at a figure which not so long ago would have seemed fantastically small, and all that he can do is to pare down costs of materials and manufacture to the uttermost fraction of a penny. Can you blame him, then, if he gives way to the temptation to save something by using here and there fixed condensers which are just, and only just, up to the work imposed upon them in the ordinary way? Can you wonder if in the very cheap set the margin of safety is insufficient or that one of the commonest causes of breakdowns nowadays is the failure of a fixed condenser to carry on with its job?

**Coursey Slide Rule**

A SLIDE rule designed especially for the solution of electrical problems is obtainable from the Dubilier Condenser Co., Ltd., of Ducon Works, Victoria Road, North Acton, London, W.3. It consists essentially of a combination of two slide rules. One is of the normal type with the A, B, C and D scales, and carrying on the back the usual log, sine, and tangent scales. The other has fixed scales for voltage, frequency and wavelength and moving scales for capacity and current.

All scales can, of course, be used in conjunction with one another, and many problems which are constantly arising in electrical work can rapidly be solved. The rule is obtainable at the price of 39s. 6d.

**New Cossor Frequency-Changer**

A NEW frequency-changer of the triode-hexode type, the 202STH, is announced by Cossor. It is an addition to the AC/DC range, and has a heater consuming 0.2 ampere at 20 volts. The hexode section is rated for anode and screen supplies of 250 volts and 100 volts respectively, while the minimum grid bias is -1.5 volts; for medium and long waves a bias resistance of 175 ohms is recommended, but for short waves it should be increased to 400 ohms.

Under normal conditions the conversion conductance is 0.6 mA/V, and an oscillator voltage of 8 volts RMS is required. The valve is fitted with the standard 7-pin base and is priced at 15s.

**The Wireless World TELEVISION RECEIVER**

(See description on pp. 2-6 of this issue)

**THE LIST OF PARTS USED.**

*Certain components of other makes but of similar characteristics may be used as alternatives to those given in the following list.*

- VISION RECEIVER**
- 4 Air Condensers, 15 mmfds., C1, C5, C9, C13 Raymart VC15X
  - 5 Shaft Couplings, ¼ in. Bulgin
  - 4 Knobs Bulgin K16
  - 1 RF choke, ultra-short wave type, Ch 1 Eddystone 1011
  - 4 Coils B.T.S.
  - 1 VF Coupling Coil B.T.S.
  - 1 Potentiometer wire-wound, 10,000 ohms, R2 Reliance "TW"
  - 1 Potentiometer wire-wound, 1,000 ohms, R20 Reliance "TW"
- Fixed Condensers:**
- 6 0.01 mfd., mica, C2, C3, C6, C7, C10, C11 T.C.C. "M"
  - 3 0.0005 mfd., mica, C4, C8, C12 T.C.C. "M"
  - 3 0.5 mfd., tubular, C16, C18, C19 Dubilier 4428
  - 1 50 mfd., 12 volts, electrolytic, C17 Dubilier 3016
  - 1 500 mfd., 12 volts, electrolytic, C15 T.C.C. 501
  - 1 10 mmfds., ceramic, C14 Dubilier CDS3
- Resistances:**
- 4 100 ohms, ½ watt, R1, R4, R9, R13 Erie
  - 1 200 ohms, ½ watt, R8 Erie
  - 2 500 ohms, ½ watt, R3, R5 Erie
  - 1 5,000 ohms, ½ watt, R11 Erie
  - 1 10,000 ohms, ½ watt, R10 Erie
  - 3 100,000 ohms, ½ watt, R6, R7, R16 Erie
  - 1 0.5 megohm, ½ watt, R15 Erie
  - 1 2 megohms, ½ watt, R14 Erie
  - 2 3,500 ohms, 2 watts, R12, R19 Erie
  - 2 10,000 ohms, 2 watts, R17, R18 Erie
- 5 Valve holders, 7-pin (without terminals) Clix Chassis Mounting Standard Type V2
  - 2 Valve holders, 4-pin (without terminals) Clix Chassis Mounting Standard Type V1
  - 2 Plugs and sockets, 3-pin Belling-Lee 1119
  - 1 Socket strip, A1, A2, and E Clix "C"
  - 4 Plug-top valve connectors Belling-Lee 1175
  - 1 Screened top connector Bulgin P64
  - 1 Cable, 5-way, with twin 70/36 leads and 5-pin plug Goltone
  - 1 Connector, 4-way Bryce 5C2
  - Chassis B.T.S.
  - Miscellaneous: Peto-Scott
  - Wire, systoflex; brackets, screws, etc.
- Valves:**
- 4 TSP4 Mullard
  - 2 D42, 1 MSP4 Osram
- VISION RECEIVER POWER PACK**
- 1 Mains transformer, Primary: 200-250 volts, 50 c/s; Secondaries: 350-0-350 volts 75 mA., 4 volts 2.5 amps., 4 volts 8 amps., 4 volts 8 amps., 2 volts 1.5 amps., C.T. Sound Sales TEL/350
  - 1 Smoothing choke Varley Dual DP11
  - 1 Condenser, electrolytic, 8-8 mfd., C1, C2 Dubilier 9203EW
  - 2 Valve holders, 4-pin (without terminals) Clix Chassis Mounting Standard Type V1
  - 1 Valve holder, 5-pin (without terminals) Clix Chassis Mounting Standard Type V1
  - 1 Fused mains input connector with 2 amp. fuses Belling-Lee 1114
  - 1 Twin safety-fuse holder with 1 amp. fuses Belling-Lee 1033
  - 1 Plug and socket, 3-pin Belling-Lee 1119
  - 1 Mains connector, 2-way Bulgin P76
  - Chassis B.T.S.
  - Miscellaneous: Peto-Scott
  - Wire, systoflex, screws, etc.
- Valves:**
- 1 U12 Osram
  - 1 DLS/10 Mazda



**OUTSTANDING 9-VALVE ALL-WAVE SUPERHET For all-wave reception at its very best**

To the all-wave enthusiast, this exceptional receiver offers a number of interesting features, with quite unusual range, and power output. Few receivers at present on the market can claim so high a standard of design and performance.

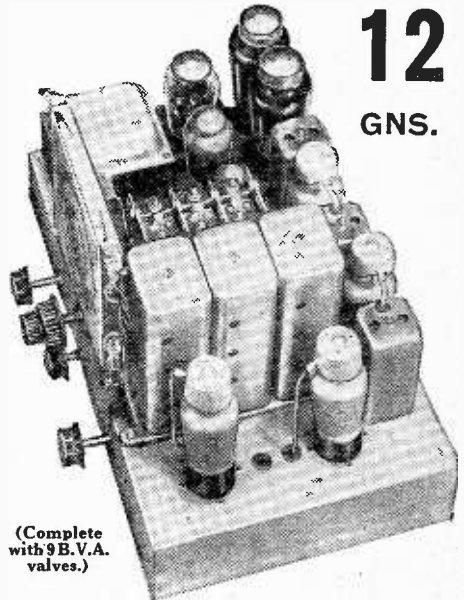

(Complete with 9 B.V.A. valves.)

4 wavebands: 12.8-33, 29-80, 190-550, 800-2000 metres. Illuminated dial with principal station names. Separate coloured lights for each waveband.

**Controls.**—A feature of the receiver is the number of independent controls fitted, making it extremely interesting to operate. These include: sensitivity control (varying bias on R/F stage). Q.A.V.C. with manual muting control, and switch for inter-station noise suppression. Separate potentiometer bias controls for output valves. 5-position wave-change and gramophone switch. Progressive variable tone control operative on radio and gram.

**Circuit in Brief.**—Aerial input to pre-selector circuit, radio frequency amplifier, latest type triode-hexode frequency changer, 2 band-pass I.F.T. coupled I.F. amplifiers, double diode detector, L.F. amplifier, parafeed transformer-coupled push-pull triode output giving 6 watts. Heavy cadmium-plated steel chassis. Finest components and workmanship throughout.

A.C. models ready for immediately delivery. A.C./D.C. models also in production, and will be available for delivery shortly.

DE LUXE MODEL 14 GNS. Several additional refinements—full particulars on application.

**IMPORTANT**

The prices at which McCarthy Chassis are advertised include Marconi Royalties. "Wireless World" readers should, for their own protection, make sure before purchasing any receiver that the quoted price includes the Royalty payment.

All McCarthy receivers supplied complete with valves, knobs, pilot lamps, leads, mains cable and plug. 12 months' guarantee.

Deferred terms on application, or through London Radio Supply Co., 11, Oat Lane, E.C.2.

Cash with order on 7 days' approval. Also write for illustrated catalogue of complete range of all McCarthy receivers.

**MCCARTHY RADIO LTD.**  
44a, Westbourne Grove, London, W.2  
Telephone: Baywater 3201/2.

# Broadcast Brevities

## NEWS FROM PORTLAND PLACE

### "D.G.": The Truth

MYSTERY has been made of Sir John Reith's recent flying visit to Gibraltar, the suggestion being that the D.G. was taking the first steps to inaugurate a system of propaganda stations.

The real motive of the visit was to watch an inspection of the Mediterranean fleet. Sir John had been present a few days earlier at Spithead during the celebrated illuminations, and, being in nautical mood, readily accepted an invitation to see how they do these things at "Gib."

### A Propaganda Service

Talking of propaganda, even odds are now being laid that a British radio propaganda service will come into existence within the next twelve months.

The B.B.C., of course, can take no decisions in the matter, which is the responsibility of the Foreign Office. But there is a growing feeling of discontent in Parliament and elsewhere that certain Continental stations should broadcast inaccuracies in English without fear of radio contradiction.

One European station produces a daily spate of "news" in sixteen languages, English included.

### Daventry to Tell the World?

Indications from reliable sources are that Daventry will eventually be used for world propaganda. The service would come under the general surveillance of the B.B.C. Empire Director, but a sub-department would be formed under a Director of Propaganda who would arrange multi-lingual transmissions at hours which would not conflict with the existing Empire service.

### Hearsay About Portland Place

THE iron hand of Portland Place was once supposed to weigh heavily on the provincial stations, but we have heard less of this of late. Actually, decentralisation is so nearly achieved that there seem to be B.B.C. employees in the North and West who have "heard tell" of headquarters only at second hand from Regional Directors and other officials who occasionally make the long and perilous journey to London.

### "What is Broadcasting?"

To counteract this aloofness, Portland Place is now issuing bright little bulletins so that the country cousins can tell the inquiring public just what it's all about. They are designed to answer the judicial question: "What is Broadcasting?"

### Long-haired Intellectuals

The first bulletin of the series shows that the B.B.C. does, to a large extent, see itself as others see it.

"The staff," says the bulletin, "must, in the interests of efficiency, be shut away in transmitting stations or studios, and cannot be seen by the public at their work. Hence, perhaps, some of the legends . . ."

"Sometimes their chiefs are depicted as rigid disciplinarians on the quarter-deck. . . . At other times the staff are represented as a bunch of long-haired intellectuals.

"Anyone who really knows the B.B.C. from the inside is aware that the staff is a 'happy ship' . . ."

### B.B.C. Staff Association

THE B.B.C. staff will soon have its own "Union." Following the special investigation of the Director of Staff Administration, Mr. St. J. Pym, a Committee has been formed to make recommendations as to the constitution of this unique staff association, the members being Sir James Ray, representing the Treasury, Mr. Bowen, joint general secretary of the Union of Post Office Workers, and Mr. Darbyshire, establishment officer of the L.M. & S. Railway.

### Musicians and Office Boys

The association will be unique

in that it will represent the most motley group of people that could be imagined. Its members will include some of the leading musicians in the country, ex-actors, at least two clergymen, office boys, stenographers, advertisement canvassers, journalists, trained nurses and representatives of fifty other vocations and professions.

To draw up rules which will suit all these varied interests will call for the wisdom of Solomon, whose own domestic troubles were not dissimilar.

### It Cured the Rajah

That certain people have supreme faith in the B.B.C. is evidenced by the correspondence files. A butler wrote to ask what was the correct way to address an Italian duchess. A Serbo-Macedonian asked the B.B.C. to broadcast the name of the drug which had cured the Rajah Bahedar Ramdidla of insomnia. Another man—an Englishman this time—desired the Corporation to indicate a spot where he could live at least ten miles from any woman.

### The Angler Largo

In fact, the present year has been a good one in the correspondence department. A "lover of music" wrote: "Please thank the young man that played the B.B.C. organ for playing the Angler Largo—it is very nice, that is my sort of music." Another writer asked: "What form of salute would a guardsman at the Tower give to a lady in 1520?"



LISTENING  
IN  
COMFORT

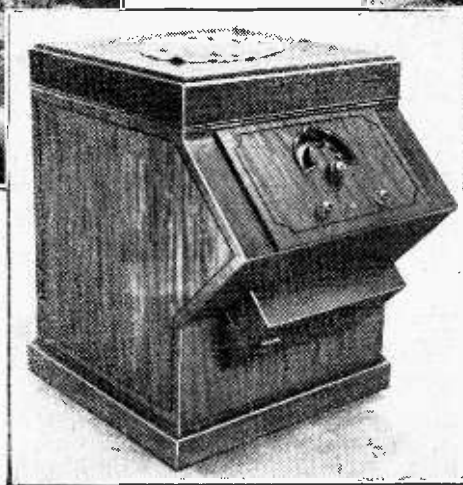
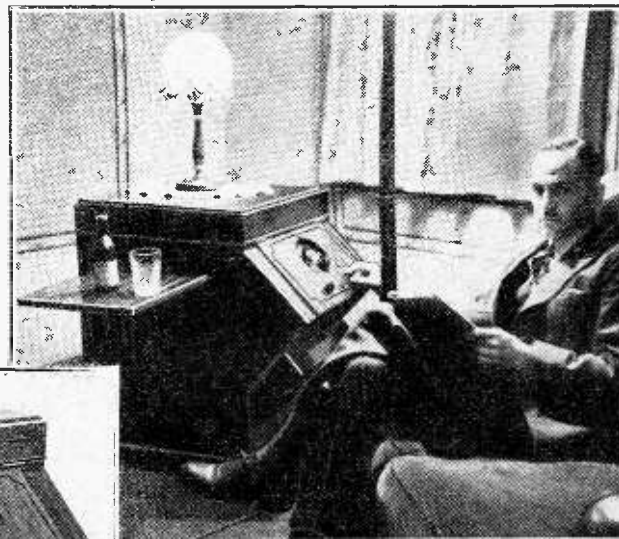

Although the unhandiness of the typical broadcast receiver—and more particularly that of the typical radio-gramophone—is generally admitted, external design has become so conventionalised that few are bold enough to introduce radical changes making for greater convenience in operation. One of the exceptions to this rule is illustrated in these photographs, sent to us by Mr. W. Ewart Puddicombe. His "Wireless World" Single-Span Receiver and Quality Amplifier

are housed in a cabinet fitted with ball-bearing castors so that it can be turned round easily for either radio or gramophone operation at armchair level, all dimensions being arranged for effortless control. Note the record storage space, the shelf (which fits flush when not in use) and the cupboard for programme journals, etc., under the tuning panel. As the loud speaker is external it can, of course, be mounted in an acoustically satisfactory position.

# Hints and Tips

PRACTICAL AIDS TO BETTER RECEPTION

THE greatest disadvantage of the simple regenerative detector circuit is the fact that, whatever form of reaction control is used, the feed-back effect always increases with frequency, necessitating, broadly speaking, a readjustment of the

## Constant Reaction

reaction knob for every station. Ingenious mechanical devices, which aimed at keeping the reaction condenser in step with the tuning condenser, have from time to time appeared in patent specifications, but as meanwhile the "straight" circuit was rapidly disappearing in favour of the superheterodyne they apparently aroused little enthusiasm.

However, since the TRF type of set still has certain advantages, particularly to the quality enthusiast, possibly a method of obtaining more or less constant reaction by purely electrical means may be of sufficient interest to warrant description.

The circuit arrangement is shown in Fig. 1; a conventional regenerative circuit is modified by shunting a variable resistance R across the reaction condenser C<sub>1</sub>, the extra condenser C being necessary to prevent short-circuiting the HT.

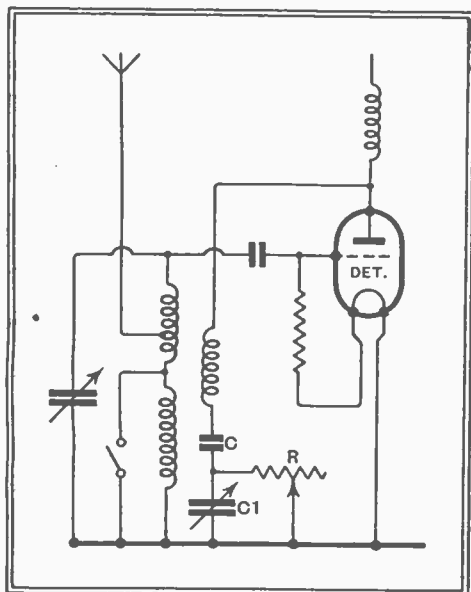

Fig. 1.—The semi-fixed reaction circuit discussed in the text.

The underlying principle is that, whereas the reactance of a condenser increases with wavelength, the impedance of a pure resistance is constant. The function of R therefore is to provide an alternative low-impedance path to RF currents above a certain wavelength (usually about 300 metres) and so produce regeneration independently of C<sub>1</sub>. It is not claimed that absolutely constant reaction at all wavelengths is possible by this modification, but rather that a much more uniform sensitivity throughout the tuning range is obtained; the use of critical reaction when

the very last ounce is desired is still possible.

In practice, R, which is intended to be mounted as a pre-set control, is adjusted until the set oscillates and is then slackened off gradually until there is no oscillation at any wavelength; once set, it should not require further attention. C<sub>1</sub> should normally be set at zero during this process, but it must be realised that adjustment is largely a matter of trial and error; the values of C and C<sub>1</sub>, for instance, depend largely upon the characteristics of the tuning coil and reaction coil, the degree of coupling and even the detector anode voltage; C<sub>1</sub> should be small, but must be large enough to produce oscillation at any wavelength, while C may be between 0.0005 and 0.001 mfd. A convenient value for R, which should be wire-wound, is 5,000 ohms.

THOSE having experience in winding their own low-loss coils with *litzendraht* may remember that the difficulty of baring each and every strand of the terminating wires without breaking any of them is apt to be rather a laborious business. Now that the use of litz wire is becoming more and more general, both for RF and IF coils, even

## Soldering Litz Wires

in the cheaper factory-built sets, it must have occurred to many that the original method of carefully sand-papering off the silk covering from each separate strand before attempting to apply solder would hardly be compatible with mass-production processes, and that there must surely be a quicker way of dealing with the enamel-covered wire that is almost always used nowadays.

The method actually adopted is the essence of speed and simplicity. It consists of holding the end of the wire for a second or two in the flame of a spirit lamp and then dipping it, red hot, straight into a bath of methylated spirits. The insulation is completely removed by the operation, leaving the wires so clean that they may now be wrapped round their fixing tags and soldered without difficulty.

Incidentally, it may be of interest to note that in the case of litz-wound IF transformers, where the frequency is usually about 465 kc/s, the effect of breaking one or two of the strands is not nearly so serious as might be supposed—the drop in sensitivity is not, in fact, appreciable to the ear, although measurable with suitable apparatus.

## Regent's Park Theatre

THE Open Air Theatre in Regent's Park has been installed for the third year in succession with Trix sound equipment. This installation comprises more than fifteen microphones, with multiple mixing panel and double channel amplifiers. Improvements have been made this year in a number of details.



WHATEVER YOUR NEED THERE'S A

"T.C.C."

which means

A PRODUCT BACKED BY OVER 28 YEARS' SPECIALISED CONDENSER EXPERIENCE

T.C.C.

ALL-BRITISH

CONDENSERS

The Telegraph Condenser Co. Ltd., Wales  
Farm Road, N. Acton, W.3.

# Letters to the Editor

The Editor does not hold himself responsible for the opinions of his correspondents

## Superhets v. Straight Receivers

THE views expressed by "Nauticus" in your issue of May 28th are interesting, more so when one considers that manufacturers are now designing sets for the forthcoming season.

Whilst agreeing with "Nauticus" under his section (a), the points in section (b) warrant comment.

(1) Given a reasonable locality, what superhet on medium waves gives a clear channel either side of Hilversum between Midland Regional and Northern Ireland; and on long waves a clear channel either side of Berlin between Droitwich and Radio Paris? A TRF set of these capabilities is one of our standard range.

(2) The overall amplification of a good TRF set is both uniform and sufficient for practical purposes.

(3) The superhet has more, but not easier, facilities for variable selectivity. On our TRF sets we keep the band width as constant as any superhet.

(4) This is a question of multiple-purpose valves versus others. The characteristics of TRF sets are more constant than superhets with the interchanging of valves.

In summarising, mention must be made of sensitivity. Whilst the superhet has a higher sensitivity, a good TRF set has a sensitivity to three microvolts; this is sufficient under present conditions.

"Reproduction as faithful as can be achieved should be the starting point in design." This has always been in our minds.

We could provide, on mass production, should there be the demand, a TRF set with a better all-round performance and value-for-money for the same price as any superhet in a particular market.

Until the public realise the meaning of efficiency, value and quality as applied to radio theirs will be the lot of "Superhet" and its various evils.

O. B. PINHORN,  
Dynatron Radio, Ltd.

## Observation on S-W Reception

REFERRING to Mr. L. Hipsman's letter in your issue of June 4th and my own in the issue of May 7th, the following may be of interest:—

Occasionally at this time of year we hear signals of very high frequencies (over 40 Mc/s) refracted at short distances of, say, 500-1,000 miles. These signals, we are told, are bent in the E layer when the ionisation is unusually intense. How, therefore, can one differentiate between the intense E causing fade-outs by attenuation and the intense E causing ultra high frequencies to be reflected? If, simultaneously with the failure of longer-distance signals, usually bent by the F layer, high-frequency signals of short distance appeared, we could then say that the failure of the longer-distance circuit was due to unusually strong E layer ionisation causing signals to be refracted back to earth at short distances before they had a chance of reaching the F layer. In this case it will be seen that the F layer

ionisation may remain the same or even be increased, but signals do not reach it, even of very high frequency, because they have all been returned to earth by the E layer.

Until your issue of June 11th appeared I had previously not had any definite instance of the above taking place, but your contributor in "On the Short Waves" states: "There have been a number of Dillinger fade-outs during the past week—there was a very severe one on June 3rd from 06.10-07.00 G.M.T." Now, this is extremely interesting, because on June 3rd at 06.45 G.M.T. I was hearing short-distance signals up to 50 Mc/s (harmonics mostly), including IBE on 48 Mc/s, and at 08.05 G.M.T. I succeeded in transmitting 56 Mc/s signals to YL2CD in Riga, Latvia. (See note later.) This leaves little doubt that the failure of longer-distance signals on June 3rd was due to unusually intense ionisation, presumably by ultra-violet radiation. To say that the signals were completely attenuated in the E layer is rather misleading, rather they were bent back to the earth by the E layer, and thus did not reach the F layer.

In a letter in your issue of June 11th Mr. I. Campbell-Bruce records the reception of a signal on May 18th in the region of 56 Mc/s. There is little doubt that this was a semi-long distance station, and probably a harmonic, as on the morning of May 18th at 08.50 G.M.T. the harmonic of SPW on 41 Mc/s approximately was R6, showing that conditions were suitable for intense E refraction.

Between the months of May and August on certain days signals can be heard up to 60 Mc/s, and contacts would be possible on the amateur 56 Mc/s band if only amateurs would forsake, to some extent, the overcrowded 7 and 14 Mc/s bands and work consistently on 28 and 56 Mc/s.

Already this year, on May 14th and 15th, our American amateur friends made 60 Mc/s contacts from East coast to Middle West. Daily I record the upper frequency limit,



MUSEUM PIECE? The dramatic producer at Milan uses an ordinary speaking tube in preference to its modern electrical counterpart for the purpose of communicating instructions from the control room to his actors in the studios during rehearsals.

and on the following days since the beginning of May this has been over 40 Mc/s: May 17th (morning).—IBE 48 Mc/s rough AC carriers up to 52 Mc/s. May 18th (morning).—SPW 41 Mc/s. May 27th (morning).—SPW 41 Mc/s. June 2nd (morning).—IEM 40 Mc/s, (evening) (19.35 G.M.T.), IBT 49 Mc/s. June 3rd (morning).—IBE 48 Mc/s. June 4th (evening).—IEM 40 Mc/s. June 8th (morning).—IBT 49 Mc/s (evening), unidentified commercial CW signals on 50 Mc/s.

On June 3rd, having observed that conditions were good in the early morning on the UHF, I asked YL2CD, in my 14 Mc/s schedule at 07.00 G.M.T. with him, to change to 28 Mc/s. At 07.50 G.M.T. we contacted on 28 Mc/s. I then asked him to listen on 56.1 Mc/s, and called him from 08.05 to 08.15 G.M.T. He came back on 28 Mc/s and reported my 56 Mc/s signals R5 with some fading. Unfortunately, YL2CD did not have a 56 Mc/s transmitter working, or otherwise we could have made a two-way 56 Mc/s contact. Soon after 08.20 these unusual conditions deteriorated, and the upper frequency limit soon dropped to around 35 Mc/s.

The 56 Mc/s transmitter used here was a simple oscillator of the "long-lines" type with a Mazda ESW501 valve and an input of a little over 50 watts. A long wire aerial  $8\frac{1}{2}$  waves long and end fed was used as a radiator.

D. W. HEIGHTMAN (G6DH).  
Gt. Clacton, Essex.

## Horn-loaded MC Speakers

I AM afraid I must chip in again, though I don't want to. First, in reply to Mr. J. K. Todd. I think he is confused.

Both of Fourier's theorems are propositions in pure mathematics. Hence they are "rigorously applicable" to loud speakers as to anything else if the data are "rigorously" accurate.

Perhaps my first letter was too compressed. What I intended by "other things being equal" was that if in any given device we extend the frequency range without making other changes, such as change of efficiency or power handling capacity, we shall improve the transient response.

His examples to the contrary are singularly unfortunate. In the case of the RC coupling the addition of a suitable choke not only increases the "top" when calculated for sustained notes, but also gives a shortened time-constant from the transient point of view—hence its use in television receivers, which are (or at any rate should be) designed entirely on a time-constant basis.

I can neither agree nor disagree with his statement that headphones, etc., "are really quite good on transients," because this last phrase is meaningless to me. But my experience is that "headphones, loud-speaking telephones, and the older pick-ups" have a most inferior transient response compared with that of a wide-range device such as a good MC speaker, and I think that most of your readers will agree.

Secondly, Mr. Brierley is convinced that to use with a horn a speaker designed for a baffle must give bad results. Has he tried?

It is sad to have to put on record the fact that in loud-speaker work an ounce of practice is worth a ton of such theory as we have, and various customers of my firm have found, beyond any doubt at all, that these speakers at any rate work most excellently in a good horn, though they were designed for the baffle.

P. K. TURNER,  
Hartley Turner Radio, Ltd.  
Isleworth.

IF interest in horns and baffles has not become too attenuated, I should like to suggest an amalgamation. I like Mr. Maggs' idea of using two adjacent walls and the ceiling to form the open end of a horn, but would rather eliminate his acute-angle bend. Of course, the acoustically ideal solution of the problem would be to knock a big hole in the corner and to build out behind it a horn of triangular section, the three sides merging into the walls and ceiling, and the straight centre line passing through the centre of the room. But that is not the architectural ideal—at any rate in Europe.

However, if we choose a corner next to a neighbouring room we may bend our centre line in a gentle curve through about 50° so that two sides of the horn become flat surfaces, continuations of one wall and the ceiling. To do this it is only necessary to knock a few bricks out of a partition wall, build the horn in the adjoining room, which may be a pantry or other uninhabited region, and redecorate. It may be more convenient to use the floor instead of the ceiling or to perforate the ceiling instead of a wall; but in any case it is possible to have a horn, more than good enough to suit Mr. Voigt, which is at the same time an "infinite" baffle to please Mr. Barden, without occupying any space in the listening room.

No, I am not connected with a firm of builders and decorators.

DAVID W. ASHWORTH.

Cam, Glos.

**Measuring RF Resistance**

IN reply to Mr. D. R. Parsons, I must agree that my statement that a bifilar grid winding in the Hartley circuit gets over the resistance difficulty is perhaps subject to qualification. The DC resistance must certainly be studied on the long-wave band; but I am not at all sure that the bifilar method is altogether impracticable in Mr. Parsons' case. He has to provide a good oscillator valve conductance for the highest frequencies, and would probably be able to sacrifice more than 0.1 volt LT on the much easier 150-300 kc/s band. Alternatively, the grid portion of the coil, if tightly coupled, could be made very small; or an iron-cored oscillator coil used, for the same reasons as those given by Mr. Parsons in favour of an iron-cored feed choke.

Referring now to the article by Mr. Pettifor, also in the June 18th issue on the dynatron method of measuring RF resistance, I would confirm that this is capable of excellent accuracy as well as being the easiest to carry out. Mr. Pettifor stresses the latter advantage, as he is dealing with rapid testing of factory products. Looking from the laboratory standpoint, I called attention in an article, "Applications of the Dynatron," in *The Wireless Engineer*, October, 1933, to the accuracy that is obtainable when suitable precautions are taken. I now venture the opinion that the possible accuracy is

better than that of any other known method, and is less dependent on the instruments used. The bridge method of calibration is essential for precise results, and to avoid one small source of error I prefer to connect the bridge permanently in series with the tuned circuit, switching it out by shunting a large condenser across it rather than a change-over, as shown by Mr. Pettifor. Incidentally, the formula for the type of bridge

described should be  $R' = \frac{R_1 R_2}{R_1 - R_2}$ , not as given; and, of course, in his Fig. 1 the 90 v. and 30 v. should be interchanged.

It may be of interest to note that the AC/SG valve mentioned may not be effective at the higher frequencies now in general use; if any difficulty is experienced the AC/Sz valve should be tried. I have had one oscillating at 60 Mc/s, but the practical limit for factory tests is probably more like 20 Mc/s. Even that is enough for present-day ordinary needs.

Another suggestion is that the relay method of controlling the dynatron bias, shown in Figs. 2 and 3, might be replaced by the automatic amplitude control (described in my article mentioned above) as it could be arranged to give an instant and continuous reading without the need for a mechanical relay.

M. G. SCROGGIE.

Bromley, Kent.

**The New Marconiphone Sets**

IN the Model 562 battery transportable we find an entirely new chassis designed to give the highest possible refinement of performance from batteries. The price is 15½ guineas and there has been no attempt to compete with the cheaper battery portables, though the receiver is entirely self-contained. There is a stage of RF amplification preceding the triode hexode frequency changer and the single IF stage works at 124 kc/s. A double-diode-triode occupies the second detector stage, and it is interesting to find that separate pentode valves are employed in the QPP output stage. Bias is automatic and the set may be used for gramophone reproduction, the volume control being operative on both radio and gramophone.

The second receiver (Model 559) in the present issue is a de luxe version of the Model 557 and is a 3-waveband superheterodyne for AC mains. A new type of tuning scale of the rectangular pattern is uniformly illuminated by a long filament lamp, and a cathode-ray tuning indicator occupies the top left-hand corner. The loud speaker is of the latest elliptical type and the price of the Model 559 is 14 guineas.

**Club News**

**Kentish Town and District Radio Society**

**Headquarters:** Holmes Road School, Kentish Town, London, N.W.5.  
**Hon. Sec.:** Mr. R. Pidsley, 27, Herbert Street, Queen's Crescent, N.W.5.

On July 3rd and 4th the Society, in conjunction with the R.S.G.B., are holding a 5-metre field week-end. The transmitter will be situated at the highest point of Dunstable Downs and will work continuously for twenty-four hours, commencing at 8 p.m. on July 3rd. Readers who pick up the transmissions are asked to send in reports, which will be acknowledged. Those who care to visit the transmitter will find much to interest them. The site may be reached by any of the various services to Whipsnade.

**NOTABLE FEATURES of the New ROLA F 742-PM**

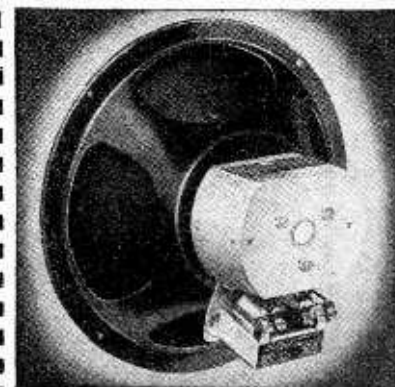

**NEW 'ALNICO' MAGNET MATERIAL GIVES IMPROVED PERFORMANCE**

New magnet material . . . new moisture proof metal and compound shielded transformer . . . new standards of sensitivity with a 9½" diameter speaker—these are some of the special features which distinguish the Rola F742-PM. This remarkable unit has the same flux density as the giant G.12-PM, 11,500 lines per square centimeter and is particularly suitable for battery set or extension speaker use and for all replacement purposes where extreme sensitivity is required. Write to-day for details.



WITHOUT TRANSFORMER 42/-  
OVER 8 MILLION IN USE

**ROLA**

*The World's Finest Reproducers*

**THE BRITISH ROLA CO., LTD.**  
MINERVA ROAD, PARK ROYAL, N.W.10.  
PHONE: WILLESDEN 4322-3-4-5-6.

**Brief descriptions of the more interesting radio devices and improvements issued as patents will be included in this section.**

# Recent Inventions

## CATHODE-RAY TUBES

TO reduce the risk of "implosion"—or collapse due to external air-pressure—the body of a cathode-ray tube is made of metal, with end-pieces of glass. As shown in half-section in the drawing, the body D of the tube is welded to an intermediate tubular section S of metal having the same coefficient of expansion as glass. This, in turn, is fused to a piece of glass G, which forms the bulb end of the tube and carries the fluorescent screen.

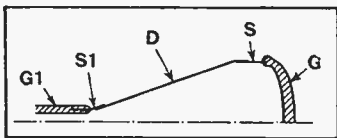

Half-section drawing of CR tube which is made of metal with glass end pieces.

The smaller end of the metal part D is welded or soldered to another section S<sub>1</sub>, similar to the section S, which is fused to a glass strip G<sub>1</sub>, through which the leads to the internal electrodes of the tube are taken. A breakable joint may be provided near this section to allow a new cathode to be inserted, or the tube to be repaired at a fraction of the cost of a new one.

The British Thomson-Houston Co., Ltd., H. W. H. Warren; and W. J. Scott. Application date September 11th, 1935. No. 462600.

## LIGHT-SENSITIVE AMPLIFIERS

TWO light-sensitive electrodes are set at opposite ends of a discharge tube, with a ring-shaped "collector" or anode between them. They are connected across an external circuit which is fed from a high-frequency source, so that their polarity rapidly changes.

One has a central aperture to admit light, which falls upon the opposite electrode, where it produces secondary electrons. These are, in turn, projected towards the opposite electrode, as the latter becomes positive, and so liberate more secondary electrons. Meanwhile a low-frequency potential is applied to the "collector" anode to cause it periodically to draw off from the electron stream a current proportional to the intensity of the light first entering the device.

Baird Television, Ltd., and J. R. H. Forman. Application date September 20th, 1935. No. 463061.

## WIRELESS SETS

FROM the point of view of mass-production, as well as of subsequent "servicing," there is much to be said for replacing

the present wide variety of valves by a so-called "universal" valve. This will have, say, a nine-pin base and be capable, when suitably connected, of performing all the functions required in wireless reception. The possession of one "spare" is then sufficient to allow a listener to replace any disabled valve, no matter at what particular stage in the receiver.

With this object in view, all the valve-holders in the chassis of a set are designed to take a nine-pin valve of the "universal" type, though the external circuit connections are limited to the particular electrodes required from stage to stage. For instance, all the electrodes will be connected up if the valve is to be used as a frequency-changer, whilst if it is to be used as a detector one or more of the electrodes will simply be "dummies."

E. K. Cole, Ltd., and G. Bradford. Application date October 8th, 1935. No. 462991.

## CATHODE-RAY RECEIVERS

THE ordinary method of electrostatic scanning is found to produce a trapezium-shaped picture, instead of a strictly rectilinear one. This is due to the fact that the lines of force tend to spread outwards at the edges of the deflecting plates, instead of keeping strictly perpendicular to the axis of the electron beam, with the result that the scanning spot is accelerated or retarded to a greater or less extent from the normal.

As a remedy it is proposed to fit a guard-ring around each pair of deflecting plates, at the ends near the anode. The rings may be connected to the accelerator anode, or they may be otherwise biased according to the geometry of the electrode system as a whole.

Marconi's Wireless Telegraph Co., Ltd., and A. J. Young. Application date August 31st, 1935. No. 461907.

## SHORT-WAVE AERIALS

IN order to ensure an efficient transfer of energy between a short-wave aerial and a transmission or feed line, it is usual to match the respective impedances by some form of transformer coupling.

The feed-line, which consists of

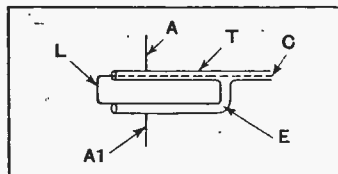

Impedance matching section for a short-wave aerial.

an outer tube T and an inner conductor C, is provided for this purpose with an extension-piece E of the same shape and cross-section as the tube T, and lying parallel to it. Its outer end is connected to the centre conductor C of the feeder by a lead L, as shown. The extension acts partly as an impedance-matching transformer, and

partly as a rejector circuit for interference. The upper and lower limbs A, A<sub>1</sub> of the dipole aerial are connected to the tube T and to the extension E, respectively, at intermediate points, which are selected so as to give the required impedance match.

E. C. Cook and J. L. Pawsey. Application date September 17th, 1935. No. 462911.

## SUPPRESSING "IMAGE" FREQUENCIES

IN a superhet set, any given station can, in theory, be received at two different settings on the tuning scale, one being as far above the local-oscillator frequency as the other is below. In practice, of course, it is highly

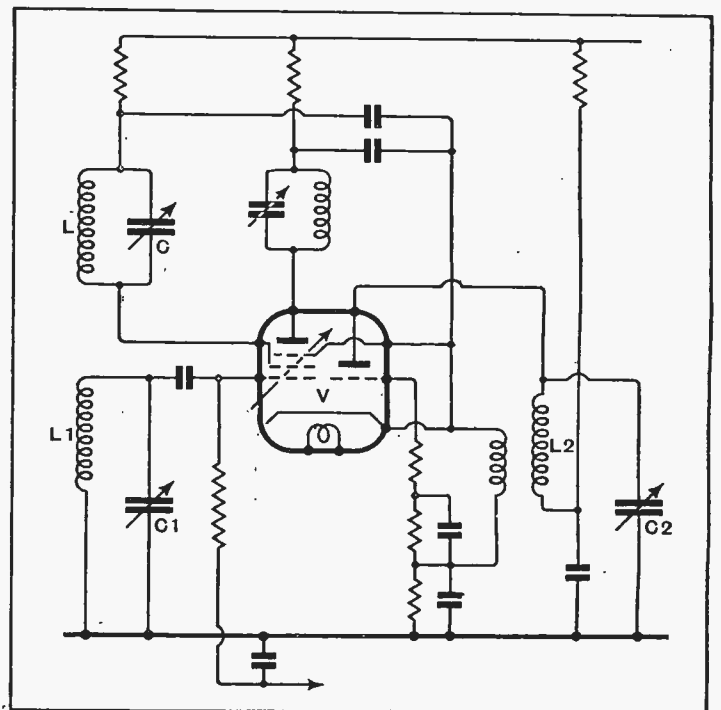

Superheterodyne frequency-changer embodying a tuned image-signal rejector circuit

desirable to cut out one of these "image" signals. This object can be achieved by using a high intermediate frequency, say, 450 kilocycles, which automatically throws the higher "image" frequency outside the tuning range of the set.

Since this particular remedy has certain disadvantages the alternative course of providing a rejector circuit for the undesired signal is sometimes adopted, and the invention consists in ganging such a rejector circuit both to the input circuit and to the local oscillator.

As shown in the figure the "image-rejecting" circuit L, C is connected to one of the grids of the mixing valve V, whilst the

signal input circuit L<sub>1</sub>, C<sub>1</sub> and the local-oscillator circuit L<sub>2</sub>, C<sub>2</sub> are both connected to other grids of the same valve, so that they are electronically coupled. The three circuits are ganged together thus making the rejector equally effective at all settings of the tuning control.

Marconi's Wireless Telegraph Co., Ltd. and A. T. Wilts. Application date September 21st, 1935. No. 463070.

## TELEVISION SYSTEMS

TO avoid the necessity of scanning, and the difficulties associated with synchronisation, the whole of the picture is radiated simultaneously as a complex band of frequencies. A wedge-shaped piezo-electric crystal is used at the transmitter to generate the frequencies required. It is placed between the two plates of a polariser, and, when energised by a thermionic valve, gener-

ates a wide band of frequencies, which vary from point to point over the surface of the crystal.

Light from a projected image will then be modulated by the crystal-and-polariser combination so as to produce a complex band of picture signals, which are handled, at the receiving end, by a similar arrangement. Here the crystal is placed between a pair of polarising plates, as before, and serves to modulate the light received from an arc lamp so as to throw the reconstituted picture upon a viewing screen.

Standard Telephones and Cables, Ltd. (assignees of Le Materiel Telephonique Soc. Anon.). Convention date (France) June 8th, 1935. No. 462877.

The British abstracts published here are prepared with the permission of the Controller of H.M. Stationery Office, from Specifications obtainable at the Patent Office, 25, Southampton Buildings, London, W.C.2, price 1/- each. A selection of patents issued in U.S.A. is also included.



# MISCELLANEOUS ADVERTISEMENTS

## NOTICES

THE CHARGE FOR ADVERTISEMENTS in these columns is

12 words or less, 3/- and 3d. for every additional word.

Each paragraph is charged separately and name and address must be counted.

The proprietors retain the right to refuse or withdraw advertisements at their discretion.

Postal Orders and Cheques sent in payment for advertisements should be made payable to ILLIFFE & SONS, Ltd., and crossed & Co. Notes being untraceable if lost in transit should not be sent as remittances.

## NEW RECEIVERS AND AMPLIFIERS

**A A A**

**DEGALLIERS, Ltd.**, the firm for reliable short-wave radio, have on show in London without exception the largest selection of fully guaranteed brand new all-wave receivers; callers invited to handle these at their leisure without obligation to purchase; all S.W. receivers will get stations on the low bands, including the Americas; let us demonstrate to you; if you live out of town we have satisfied customers in nearly every part of the country, who would probably let you hear these sets in their own homes. Terms, cash with order or c.o.d.; handsomely illustrated catalogues forwarded on receipt of large stamped addressed envelope or 2½d. stamp; our lists give the fullest technical data, with all measurements; each set is complete in cabinet ready to plug in; chassis quoted separately.

**NOTE.**—Marconi royalties are already paid on all Challenger Receivers.

**5/-**—Each American valves, all guaranteed, each a first, no seconds or throwouts, for every known set from 1927-37; metal, metal glass, glass; glass counter-parts, etc.; in ordering just state type and number, we have it; line cords for all Midgets, 4/6 each.

**£3/5**—Midget T.R.F. 4-valve A.C.-D.C., 200-250 volts, in leather cloth or walnut.

**£4**—Midget T.R.F. 5-valve, M. and L. wave, 100-250 volts, A.C.-D.C., calibrated in station names.

**7 Gns.**—Table model 6-valve all-wave superhet, 16½-50, 200-550, 800-2,000 metres, 8in. M.C. speaker, calibrated in station names.

**£10**—Console 8-valve superhet, 3 bands, 17-50, 190-550, 900-2,000 metres, 10in. M.C. speaker.

**CHALLENGER Series Model 800** 8-valve High Fidelity Receivers, A.C. 200-250 volts, 4 distinct bands, 11-32, 27-64, 190-550, 900-2,000 metres, calibrated in metres and station names; available in the following types:

**13 Gns.**—Challenger 800 table model De Luxe, 10in. M.C. speaker.

**£12/18**—800 chassis, valves and 10in. speaker, with all cutchcons, etc.

**£14/18**—800 chassis, valves, and Rola G12 high fidelity P.A. speaker.

**17 Gns.**—Challenger 800 console, 42x12½x24, with G.12 speaker.

**29 Gns.**—Challenger 800 radiogram, with automatic changer, also incorporating the G.12 speaker.

**NOTE.**—The Challenger 800 series are also available in 11-valve A.C.-D.C. 200-250 volts, at a small extra cost.

**14 Gns.**—Challenger 381 table model 8-valve high fidelity receiver, 14-2,060 metres, polychromatic dial scale vision master, beam power output, magic eye, automatic band indicator, high image frequency suppression, magn. dial and second hand; or less cabinet £13/18.

**£50**—24-valve Challenger twin chassis and 2 public address high fidelity speakers, 5-2,000 metres, 60 watts undistorted; or in massive console cabinet, height 4ft. 2in., wide 2ft. 4in., deep 1ft. 3in., £7 extra; this is as supplied to the Navy and Army Canteen Board, therefore ideal for public hall, baths, etc.; carriage and crate 15/-.

**OTHER Receivers in Stock Too Numerous to Mention,** such as Belmont, Ferguson, etc.

**DEGALLIERS, Ltd.**, 18, Connaught St., Marble Arch, London, W.2. Telephones: Paddington 2745 and Bayswater 5732. [4584]

## AIR KING.

**ALL Models Feature Beam Tuning, Magic Eye indicator, gramo. pick-up connections, and special output valves.**

**ALL Sets Fully Guaranteed; H.P. terms available from 3/- per week.**

**WHOLESALE and Trade Enquiries Invited; generous terms.**

**ALL Types of American Vases Stocked; write for lists to**

**AIR KING RADIO, 115, Shaftesbury Av., Cambridge Circus, W.C.2.** Phone: Temple Bar 4875 (2 lines). All receivers assembled in England. [3406]

## ALERT RADIO Co.

**"COMMUNICATION," "Shortwave" and "Allwave" Receivers.**—21, East Rd., N.1. Clerkenwell 4871. [4381]



## ABOUT THE M.A.

### SENSITIVITY

On a good aerial this set brings in all the important stations in Europe, and many of the smaller ones as well.

### SELECTIVITY

Because we do not use "band-pass" tuning, but depend on single-peaked tuning followed by tone-compensation, we get exceptional protection against interference. All intelligible jamming and about two-thirds of the side-band splash are cut out.

(To be continued.)

## HARTLEY TURNER

**RADIO LTD.,**

**THORNBURY ROAD,**

**ISLEWORTH, MIDDLESEX.**

Telephone: HOUnslow 4488

## The 'AVO' Valve Tester

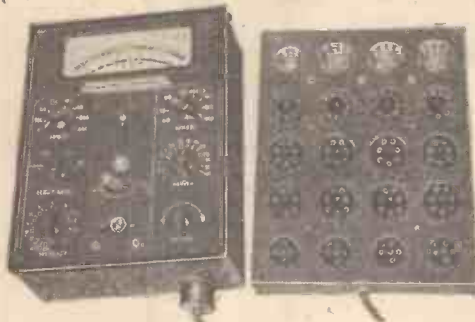

British Made

The "AVO" Valve Tester gives direct readings of Mutual Conductance, this being more reliable than the ordinary emission test. All types of standard valves, English or American, are tested under makers' test conditions. Meter has three scales, one indicating "Good," "Indifferent" or "Replace."

Every test to valves can be made quickly, easily and accurately. No calculations. Operates from A.C. mains. Separate panels for English or American valves.

"THE WIRELESS TRADER" writes:—"... the best of its type we have handled."

Price 11 Gns.

Additional Valve Panel for either English or American Valves 2 Gns. Deferred terms if desired.

Write for pamphlet giving full details.

**THE AUTOMATIC COIL WINDER & ELECTRICAL EQUIPMENT CO. LTD.**

Winder House, Douglas Street, London, S.W.1.

Phone: Victoria 3404/7.

ADVERTISEMENTS for these columns are accepted up to **FIRST POST** on **MONDAY MORNING** (previous to date of issue) at the Head Offices of "The Wireless World," Dorset House, Stamford Street, London, S.E.1, or on **SATURDAY MORNING** at the Branch Offices, 19, Hertford Street, Coventry; Guildhall Buildings, Navigation Street, Birmingham, 2; 260, Deansgate, Manchester, 3; 26a, Renfield Street, Glasgow, C.2.

The proprietors are not responsible for clerical or printers' errors, although every care is taken to avoid mistakes.

For particulars of Box Number Advertisements and Deposit System see previous issues.

## NEW RECEIVERS AND AMPLIFIERS

**A**

**ANGLO-AMERICAN RADIO** Offer the Easiest Purchasing Facilities, and your last opportunity to own one of the finest radio receivers ever made, the 5-band 10 watt Crosley at £11/19/6.

**H.P.**, part exchange, and a 50% saving on the superb Crosley receivers; there will be no better receiver available in this country at under three times the price during the next 12 months.

**LIMITED** Number of the Following Models Only Available; we offer you every advantage and every inducement to purchase now; a large cash saving, and your own choice of the method of payment.

**PLEASE** Note, we offer only brand new goods, every chassis or receiver fully guaranteed 6 months; every receiver accurately checked and aligned on all bands with the latest equipment before despatch; please remember we offer you only goods which will give you lasting satisfaction, and as such unquestionably the finest value that radio has to offer; do not confuse with second-hand, soiled, "job bought" or improperly tested receivers, which are being cleared out at any price by other sources; please note all cabinets supplied by us are copyright by no other firm.

**20%** Deposit with Order Secures Delivery, with undertaking to remit balance over 12 or 18 months to suit your convenience.

**AMAZING** Signal to Noise Ratio is the Keynote to the Phenomenal All-world Reception; there is scarcely a transmission in the world that the 5-band Crosley will not bring in. Mr. Ivor Manley, writing in "The Wireless World" a few weeks back on Spanish broadcasting in the civil war, compiled his article using only one of our Crosley receivers. Over 100 transmissions tuned in from Spain alone! Yes, your new guaranteed Crosley bought from us will do the same, and get you everything on the air.

**£11/19/6**—9-valve high fidelity 5-band (12½-31, 30-80, 75-200, 200-555, 700-2,000 metres), A.C., 97-250 volts, 10 watts undistorted output, R.F. stage all bands, new automatic variable selectivity incorporated, provision gramo. and doublet, accurately calibrated airplane dial and band-spread pointer and subsidiary scale, shadow tuning indicator; your price £11/19/6, or with American Magnavox speaker, £14; Table model, £17; Console, £19; Auto-Radiogram, £34; or 20% deposit with order secures delivery.

**CARRIAGE** Extra: chassis 5/-, table 7/-, Console 10/-, radiogram 15/-.

**BOOK** Your Crosley Now, whilst last stocks remain. Cash, c.o.d., or 20% (4/- in £) deposit secures now. We guarantee your satisfaction.

**4D** Stamps, enclosed with order to cover cost of our comprehensive new radio catalogue, covers every radio requirement, a complete radio buying guide which you will value keeping, fully illustrated.

**BARGAINS.**—See also our display advertisement on page 5 for special guaranteed bargains.

**CAR** Radios.—New consignment in. Will all those customers who have endeavoured to obtain our car radios in the last few weeks, please note that we have a further consignment to hand. These are heavily booked, so please get in touch with us now.

**£5/19/6**—1937 5-valve Superhet. car radio. New suppressorless model, 3 watts output, full A.V.C. volume and tone controls, illuminated dial, large m.c. energised speaker, 3½ amps. consumption only, size only 10in. x 4½in. x 6½in., fits absolutely any car; no finer performance available under £15; 6 months' guarantee; 6-volt model, £5/19/6; 12v., £6/7; carriage 4/-.

**EXTENSIVE** New Showrooms Being Opened Centrally at Albion House; all communications and all callers please note address as below.

**ANGLO-AMERICAN RADIO (AND MOTORS), Ltd.** (Dept. W.24), Albion House, New Oxford St., London, W.C.1. Telephone: Temple Bar 3231 (all departments). [4720]

**A.**

**HILL and PONDER** Offer Brand New Crosley Receivers Under Fullest Comprehensive Guarantee at approx. 70% Below List Price; list available; terms, cash with order or c.o.d.; carriage extra.

**10 Gns.**—"Crosley" high fidelity 9-valve superhet chassis, valves and 8in. M.C. speaker, 5 distinct bands, 12-2,000 metres, Airplane dial calibrated in metres, 10 watts undistorted, Neon tuning device, etc., or with 12in. Magnavox speaker add 20/-; also available in cabinets; table, £12; console, 14 gns.; radiogram with automatic changer, £24.

**HILL and PONDER, 9, Lanchester Mews, London, W.2.** [4713]

# PREMIER SUPPLY STORES

Offer the following Set Manufacturers' Brand New Surplus Goods at a Fraction of the Original Cost; all goods guaranteed perfect; carr. paid over 5/-, under 5/- postage 6d. extra. Orders under 5/- cannot be sent C.O.D.

ALL POST ORDERS TO  
**JUBILEE WORKS,**

**167 LOWER CLAPTON RD., LONDON, E.5**

CALLERS, AS-USUAL TO 165 & 165a, FLEET ST.; E.C.4. (Next door to Anderton's Hotel). Central 2833. New Branch:—50, HIGH STREET, CLAPHAM, S.W.4 (Macaulay 2381).

Have you had our **GIANT ILLUSTRATED CATALOGUE AND VALVE LIST?** Send 4d. in STAMPS FOR THIS BARGAIN LIST.

## FOR AMATEUR TRANSMITTERS!

Self-powered A.C.-D.C. 10 watt. 40 metre, C.W. 3 Tube Transmitter, using Pentode as Crystal Oscillator. Wired and Tested on Metal Chassis, with Meter Tubes, Crystal (please state frequency required) and enclosed holder. With Key. Ready for immediate use - - - - **£4.4.0**

The New "Premier" Short Wave Condensers with Trolitul Insulation. Certified superior to Ceramic. All-brass Construction. 15 mmfd. 1/4; 40 mmfd. 1/7; 100 mmfd. 1/10; 160 mmfd., 250 mmfd. 2/6.

**1937 1-VALVE SHORT-WAVE RECEIVER OR ADAPTOR KIT**, 13 to 86 metres without coil changing. Complete Kit and Circuit, 12/6. **VALVE GIVEN FREE!**  
**DE LUXE MODEL** 14 to 150 metres, complete Kit with Chassis, 4 Coils and all parts, 17/6.  
**1937 SUPERHET CONVERTER KIT, 13/6.**  
**DE LUXE MODEL, 18/6.**  
**S.W. SUPERHET CONVERTER KIT**, for A.C. Mains Receivers, 20/-. A.C. Valve given FREE!  
**1937 2-VALVE S.W. KIT**, 13 to 86 metres without coil changing. Complete Kit and Circuit, 19/6. **VALVES GIVEN FREE.**  
**DE LUXE MODEL**, 14 to 150 metres, complete Kit and Chassis, 4 Coils and all parts, 25/-. **VALVES GIVEN FREE.**  
**3-VALVE S.W. KIT**, S.G. Det. and Pen., 42/-. 13-178 metres **VALVES GIVEN FREE!**  
**MAINS VALVES**, famous Europa 4 v. A.C. types, 4/6 each. H.L., L., S.G., Var.-Mu-S.G., H.F.-Pens., Var.-Mu-H.F. Pens. 1- and 4-watt A.C. directly heated output Pentodes. A.C./D.C. types. 20-volt 18 amp. S.G., Var.-Mu-S.G., H.L., H.L., Power, H.F. Pen. and V.-Mu-H.F. Pen.  
Following types all 5/6 each. Full-wave rectifiers, 850 v. 120 m.a. and 500 v. 120 m.a. 2½-watt indirectly-heated Pens., PX4 type, 6/6. D.D.T., 6/6.  
**BATTERY VALVES**, 2 volts, H.F., L.F., 2/3. Power Super-Power, 2/9. S.G., Var.-Mu-S.G., 4- or 5-pin Pentodes, H.F. Pens., V.-Mu-H.F. Pens., 5/-. Class B, 5/-.  
**AMERICAN VALVES**. Genuine American HYTRON and TRIAD first-grade Valves. 3 months' guarantee. All types in stock, 5/6 each. 210 and 250, 8/6 each. New Metal-Glass Valves, all types, 6/6 each. Genuine American DUOTRON Valves, all types, 3/6 each. Valve holders for all above types, 6d. each. Octal bases, 9d. each.  
**PREMIER MAINS TRANSFORMERS**, wire-end type with screened primaries, tapped 200-250 v. Centre-tapped Filaments. Guaranteed one year. H.T. 8 & 9 or H.T. 10 with 4 v. 4 a. C.T. and 4 v. 1 a. C.T., 8/6. 250-250 v. 60 m.a., or 300-300 v. 60 m.a., 4 v. 1 a., 4 v. 2 a., and 4 v. 4 a., all C.T., 8/6. 350-350 v. 120 m.a., 4 v. 1 a., 4 v. 2 a. and 4 v. 4 a., all C.T., 10/8. Any of these transformers with engraved panel and N.P. terminals, 1/6 extra. 500-500 v. 150 m.a., 4 v. 2-3 a., 4 v. 2-3 a., 4 v. 2-3 a., 4 v. 3-4 a., all C.T., 17/6. Super Model, 19/6. **AUTO TRANSFORMERS**, step up or down, 60 watts, 7/6; 100 watts, 10/-.  
**SPECIAL OFFER OF PHILIPS MAINS TRANSFORMERS. WITH TAPPED PRIMARY, 100-250 v., 500-500 v. 100 m.a., 4 v. 4 a. C.T., 4 v. 4 a. and 4 v. 3 a., 12/6. LIMITED NUMBER ONLY.**  
**MILLIAMETERS**, moving-iron, flush 2½in., all ranges from 0-10 m.a., 5/9. Visual tuning, 6 or 12 m.a., 5/9. Moving-coil meters, 2½in. 0-1 m.a., 18/6; 3½in. 0-1 m.a., 22/6. Multipliers, 1/- each. Ammeters, 0-1, 3, 5, 10 or 20 a., 5/9.  
**ELECTROLYTICS**. U.S.A., 4 or 8 mfd. 530 v. peak, 1/9 each. Dubilier, 4 or 8 mfd. 500 v., 3/-; 50 mfd. 50 v., 1/9; 6 or 10 mfd. 50 v., 6d.; 25 mfd. 25 v., 1/-. T.C.C. 8 mfd. 650 v., 4/-; 15 mfd. 50 or 100 v., 1/-; 50 mfd. 12 v., 1/-. Cardboard Electrolytics, 4 or 8 mfd. 500 v. peak, 1/6 each. Paper Condensers. W.E., 250 v. working 4 mf., 2/-; 2 mf., 1/-. 1 mf. 6d.; 350 v. working 4 mf., 2/6; 2 mf., 1/6. Dubilier 500 v. working 4 mf., 4/-; 800 v. 4 mf., 6/-.  
**P.O. PATTERN "MIKES"**, 3/9. Transverse current Mike 30/-. U.S.A. Crystal Mikes, 23/17/6.  
**SHORT-WAVE COILS**, 4- and 6-pin types. 13-26, 22-47, 41-64, 78-170 metres, 1/9 each, with circuit. Special set of 3-4-Pin S.W. Coils, 14-150 metres, 4/- set, with circuit. Premier 3-band S.W. Coil, 11-25, 10-43, 38-80 metres. Suitable any type circuit, 2/6. **COIL FORMERS**, in finest plastic material, 1½in. low-loss ribbed, 4- or 6-pin, 1/- each.  
**CERAMIC S.W. VALVE HOLDERS**, 4-, 5- or 7-pin. Chassis types, 6d.; B.B. type, 8d. **CLASS AERIAL INSULATORS**, 4d. each. **BEEHIVE STAND-OFF**, 6d. each. **SCREENED FLEX**, single, 3d. yd.; twin, 4d. yd.

**H.F. CHOKES**, S.W., 10-200 metres, 9d. Screened 1/6.  
**ALL-BRASS SLOW-MOTION S.W. CONDENSERS**, .00015 tuning, 3/9; .00015 reaction, 3/3. British Radiophone 2-gang 2X .00016 all-brass S.W. Condensers, 5/6.  
**SPECIAL OFFER. LISSN TWO-GANG SCREENED ALL-WAVE COILS**, 12 to 2,000 metres, complete with switching and wiring diagram, 6/11 per set.  
**BAND-PASS TUNING PACK**, comprising set of Telson 3-gang iron-cored coils with switching, mounted on steel chassis with 3-gang condenser, illuminated disc-drive and 4 valve holders. 25/- the lot. All Mains or Battery circuit FREE!  
**"LUCERNE" SHIELDED IRON-CORED COILS**, 200-2,000 metres. With circuit, 2/- each. **TELSEN Screened Iron-cored Coils**, W.348, 4/- each. Eston Ditto, 2/11.  
**Reliable MORSE KEYS** with Morse Code engraved on bakelite base, 2/- each.  
**Bakelite case BUZZERS**, 1/6; Walnut case. "Loud-tone," 2/6 each.  
**GRAMOPHONE MOTORS**. Collaro Gramophone Unit consisting of A.C. motor, 100-250 v. high quality pick-up and volume control, 45/-; Collaro motor only, 30/-; Collaro Universal Gramophone Motor, 100-250 v. A.C./D.C., with high quality pick-up and volume control, 67/6; Collaro Universal Motor only, 49/6; Edison Bell double-spring motors, including turntable and all fittings, 15/-; Cosmocord Gramo. Unit, comprising A.C. motor, pick-up, and volume control (list 55/-), 35/9. A.C., D.C. Super model, 52/6.  
**MAGNAVOX**. Mains energised M.C. Speakers. '154, 7in. cone, 2,500 ohms, 12/6; '152, 9in. cone, 2,500 ohms, 17/6. '152 Magna, 9in. cone, 2,500 ohms, 37/6. Magnavox P.M.s.—'254, 7in. cone, 16/6; '252, 9in. cone, 22/6.  
**TELSEN P.M.s. with 10 ratio Transformers, 12/6. ROLA** latest type P.M.s. 15/- **B.T.H. ENERGISED MOVING COIL**, 10½in. diam. 1,050 ohms field. Power or Pentode Transformer. (State which). **SPECIAL LINE** at 14/6. Reliable P.M.s. 10/6.  
**W.B. 1935 STENTORIAN SPEAKERS**. Standard model (list, 32/6). Senior model (list, 42/-), 28/6. Brand new in original sealed cartons.  
**3-WATT A.C. AMPLIFIER**, 2-stage for mike or pick-up. Complete kit of parts with 3 valves, 40/-. Wired and tested, 22/15/-.  
**7-WATT A.C./D.C. AMPLIFIER**, 3-stage high-gain, push-pull output. Complete kit of parts with 5 specially matched valves, 24/4/-. Completely Wired and Tested, 25/5/-.  
**10-WATT A.C. KIT**, 25/5/-. Wired and tested, 27/7/-.  
**COSMOCORD PICK-UPS**, with tone arm and volume control, 10/8 each. **PICK-UP HEADS** only, 4/6 each.  
**ORMOND .0005 SLOW-MOTION LOG CONDENSERS**, air spaced, 2/11.  
**LIGHTWEIGHT HEADPHONES**, 3/- pair. Super Quality, 3/9.  
**PREMIER FULL-VISION DIAL**, 10:1 and 150:1, 6/6 Utility 4in. Cursor Micro Dial, 100:1, 6/3.  
**PREMIER L.T. CHARGER KITS** for A.C. mains, including Westinghouse Rectifiers and Tapped Mains Transformers. 8 volts at ½ amp., 14/6; 8 volts 1 a., 17/6; 15 volts 1 a., 19/-; 15 + 15 volts 1 a., 37/6; 15 + 15 + 15 volts 1 a., 50/-; 8 volts 2 a., 29/6.  
**PREMIER H.T. KITS**, all with Westinghouse rectifiers, tapped transformers and adequate smoothing. All Kits absolutely complete. 120 v. 20 m.a., 20/-; with ½ a. L.T. Charger, 28/-; 150 v. 30 m.a., 25/-; with ½ a. L.T. Charger, 31/6. 250 v. 60 m.a., with 4 v. 3 a. C.T., 30/-.  
**ELIMINATOR KITS** for A.C. mains. 120 v. 20 m.a., or 150 v. 25 m.a., 15/-, tapped S.G. det. and utput. Complete kit with long-life valve rectifier (replacement costs only 2/-).

## NEW RECEIVERS AND AMPLIFIERS

**ROYAL RADIO Co.**  
**ALL-WAVE Receivers**, suitable for use on ships, as supplied to officers of many shipping lines.  
**SPECIAL Offer**.—A few all-wave demonstration models, used in showroom, at greatly reduced prices.  
**OUR 8 and 10 Metal Valve All-wave Receivers; 15-2,000 metres**, acknowledged by the trade as the best for range, tone and general performance.  
**LATEST 6-valve Car Radio, A.V.C., remote control**, no suppressors required.  
**A FULL Range of the World Famous Emerson Receivers** for Export.  
**ALL Sets Fully Guaranteed by Ourselves.**  
**ALL Types of American Valves Stocked**, from 5/-.  
**PAY Us a Visit Any Time**, or send for full range catalogue; 1½d. stamp will be appreciated.  
**ROYAL RADIO Co.**, 5, Buckingham Rd., South Woodford, London, E.18. Phone: Buckhurst 2736. [4583]  
**"SERVICE with a Smile."**  
**HENRY FORD RADIO, Ltd.**  
**ELECTRONIC House**, 22, Howland St., Tottenham Court Rd., W.1. Museum 5675. [0511]  
**TRANS-ATLANTIC RADIO Co.** for Finest All-wave Receivers, Midgets and valves.—15, Percy St., W.1. Museum 3096. [4623]  
**ARMSTRONG COMPANY**, Pioneer Firm supplying high grade all-British receivers in chassis form, manufacture models to suit all requirements, incorporating all the latest improvements.  
**ARMSTRONG COMPANY Invite You to Send for Full Particulars.**  
**ARMSTRONG MANUFACTURING COMPANY**, 100, King's Rd., Camden Town, N.W.1. [4615]  
**PILOT**, Ferguson, Belmont, Spartan and Air King all-wave receivers, Grampian public address equipment, wholesale only (send your trade card for list of sets, components and accessories).—Leonard Heys, 36, Henry St., Blackpool. [0530]  
**COMMUNICATION RECEIVERS**, Hammarlund, National, Hallicrafter, R.M.E.69, Tobe-Deutschmann; transmitters, Collins 45A, Peerless DX20, or built to order; American valves, microphones, Eddystone components.—A.C.S. Ltd., 52-4, Widmore Rd., Bromley. Phone: Ravensbourne 0156. [0550]

## RECEIVERS AND AMPLIFIERS CLEARANCE, SURPLUS, ETC.

**PEERLESS Chassis**, 18 watts, 11 valves, 12½" speaker, 5 bands; 10 gns.—Kay, 21, Prince of Wales Rd., Norwich. [4704]  
**1936 Regentone Battery Set**, S.G. Det. and Pent., P.M. speaker, thermometer tuning, list 27/10; 22/10; carriage paid.  
**1937 Regentone Battery Set**, H.F. Pentode, Det. and Pent., P.M. speaker, thermometer tuning, list 26/2/6; 23; carriage paid.  
**1937 Regentone Short-wave Converter**, complete with valves, 6.5 to 80 metres, listed at 24/19/6; 22/12/6; carriage paid.  
**1936 Regentone 5-valve A.C. Console**, thermometer tuning, list 210/10; 24; carriage paid.  
**HENRY'S**, 72, Wellington Av., London, N.15. Stamford Hill 2907. [4709]  
**6-VALVE All-Wave Superheterodyne**, walnut cabinet, speaker, complete as new; 26/10.—32, Robin Hood Lane, S.W.15. Kingston 3856. [4601]  
**DECCA**, Vidor and other 1936-1937 decontrolled receivers in sealed original cartons at amazingly low clearance prices—traders only, write for lists.—Leonard Heys, 36, Henry St., Blackpool. [0527]  
**FERGUSON 366 All-wave 6-valve Universals**, 27/7; Ace 8-valve 4 waveband preslector H.F. stage, 16/16, our price 22/12; current models; cash with order.—Speed, 656, Chester Rd., Erdington, Birmingham. [4687]

## CAR RADIO

**PHILCO Car Radio Sets and Accessories**, wholesale only.—Leonard Heys, 36, Henry St., Blackpool. [0556]  
**PHILCO Repairs and Installations**, trade distributors.—Radiorite, Ltd., Moorfields, Liverpool. Bank 8811. [4456]

## PUBLIC ADDRESS EQUIPMENT

**A SPECIAL Offer!!!**  
**81 Gns. Complete**.—Vortexion portable 15-20 watt 4-stage amplifier, independent mike and pick-up inputs, outputs for 7½ and 15 ohm speakers, weight 25lb.; 4 independent input model, 12/10.  
**12-VOLT, D.C.** or 200-250 A.C. input, combined model consumes only 7 amps. at 12 volts with 20 watts output; chassis complete with valves and converter; 12 gns.  
**HEAVY Duty 20 watt Model**, as fitted to dance halls and cinemas, etc.; 215, complete with valves.  
**60 Watt Model for 6L6s**, with microphone and gramophone independent inputs, and outputs for 5, 7½, 15 or 30 ohm speakers, consumption 150 watts, in ventilated steel carrying case; 224 only! complete with valves less two 6L6s.  
**WHY Not Call and Have a Demonstration.**  
**VORTEXION Ltd.**, 182, The Broadway, Wimbledon, S.W.19. Phone: Lib. 2814. [4672]

**PUBLIC ADDRESS EQUIPMENT**

ALL Types of Public Address Apparatus for Sale or Hire.

WARD, 46, Farringdon St., London, E.C.4. Tel.: Holborn 9703. [0555]

EASCO P.A. Mobiles, large or small, with driver operator.—18w, Brixton Rd., S.W.9. Reliance [0658] 1693.

HOLIDAY and HEMMERDINGER, Dolefield, Bridge Street, Manchester.—Loud-speaker Van for hire; Sports, Fetes, etc. [4642]

PARTRIDGE P.A. Manual, re Standard Handbook; free to trade from: N. Partridge, B.Sc., A.M.I.E.E., King's Buildings, Dean Stanley St., London, S.W.1. [4524]

**USED SETS FOR SALE AND WANTED**

**FERGUSON.**

FERGUSON 378 Console; £15 or offer.—382, Alcester Rd. South, Birmingham, 14. 6.30-7.30 week-days. [4682]

**HARTLEY TURNER**

NEW Hartley Turner SA12 Chassis, perfect, value £27/10, little used; what offers?—Bull, Bond St., Redruth. [4695]

**LUXOR**

LUXOR 12-valve, ten wavebands, 13-2,100 metres; £15/15.—84, Arthur Rd., Southampton. [4707]

**W.W. QUALITY AMPLIFIER**

W.W. Quality Amplifiers, unused, professionally built best materials, Osram valves; £6/17/6: Twentieth Century, George St., Sutton. [4706]

**NEW MAINS EQUIPMENT**

VORTEXION Quality Transformers.

VORTEXION Supply the B.B.C., G.P.O., L.P.T.B., I.C.I., Borough Councils, etc. Why not you?

ALL Fitted Screened Primaries, and tapped 200-250v. with centre tapped filaments, guaranteed one year.

6.3V. and 5v. American Heaters, same price.

W.W. Q.A.425-0-425v. 120-160 m.a., 4v. 5-10a, 4v. 2.5a., 4v. 1-2a., 4v. 1-2a., super shrouded model; 32/-.

500-0-500 150 m.a., 4v. 4a., 4v. 2.5a., 4v. 2a., 4v. 2a., super shrouded model, 2.5% regulation, 35/-; open type, 32/-; 400 or 450v. same price.

350-0-350 120 m.a., 4v. 4a., 4v. 2.5a., 4v. 1-2a., shrouded, 21/-; open type, 18/6; super shrouded, with extra 4v. 6a., 25/-.

350-0-350v. 75 m.a., 4v. 2-4a., 4v. 1-2a., shrouded, 18/-; open type, 16/-.

250-0-250v. 60 m.a., 4v. 2-4a., 4v. 1-2a., shrouded, 15/-; open type, 12/6.

AUTO Transformers, 100-120 to 200-240v.; 80 watts 11/-, 120 watts 14/6, 200 watts 21/-, 500 watts 37/6.

CHOKES.—30h. 60 m.a., 7/6; 7-13h. 120 m.a., 12/6; 30h. 150 m.a., 15/-.

OUTPUT Transformers.—4-10 watt W.W. Q.A., 21/-; 20 watt super shrouded, 30/-.

VORTEXION, Ltd., 182, The Broadway, Wimbledon, London, S.W.19. (Telephone: Liberty 2814.) [4717]

ESSEX TRANSFORMER Co. for Quality Transformers, 276, Hamlet Court Rd., Westcliff-on-Sea. [4680]

TANTALUM for A.C. Chargers, H.T. and L.T.—Blackwell's Metallurgical Works, Ltd., Garston, Liverpool [3984]

**MAINS EQUIPMENT**

**SECOND-HAND, CLEARANCE, SURPLUS, ETC.**

ESSEX TRANSFORMER Co.—Mains transformers, 250-0-250v. 60 m.a., 4v. 1a., 4v. 3-4a. C.T., guaranteed new and unused; 6/-, post free.—276, Hamlet Court Rd., Westcliff-on-Sea. [4681]

**CABINETS**

RADIOGRAM Cabinets, new designs, 30/- to £5/10; inspection invited or photos for selection sent on request.

TABLE Radio Cabinets, undrilled, 6/6 upwards.

SPEAKER Cabinets, 4/6 upwards.

MANUFACTURERS' Clearance.

ULTRA Radiogram Cabinets, undrilled, 33x23x14 or 33x20x15, 30/-.

BURGOYNE "Fury" Radiogram Cabinets (undrilled), 34x22x16½; 49/6.

K.B. De Luxe Walnut Cabinets, undrilled, chromium plated edges and speaker grille, 25in. wide, 14½in. high, 10½in. deep, 18/6; Console model, 42in. high, 21½in. wide, 11½in. deep, 39/6.

HALYCON Radiogram Cabinets (Reconditioned), 33x23x19, 35/-.

H. I. SMITH and Co., Ltd., 287-9, Edgware Rd., London, W.2. Tel.: Pad. 5891. [0485]

No. 45

*Notes*

**on the Suppression of Electrical Interference with Wireless Reception**

Summer is alleged to be with us, and it affects us in many different ways. Most readers will have given up DX work for tennis or the garden, and many will have conveniently forgotten the pledge they made themselves to "do something about the aerial when the fine weather comes." Don't leave such an important matter till the Autumn. That is when aerials blow down where they want to fall; drop them now conveniently in your time, where you want them.

In these days of better and better sets and an ever-increasing electric load supplying all manner of appliances, they are the fortunate few whose listening is not spoilt by electrical interference. If you are one of the multitude, why not seriously consider the installation of an anti-interference aerial, and a mains filter in the set lead to the receiver? The better the set the greater the need.

We do not wish to suggest that you are lazy or that you do not know how to erect such an installation, but we do cater for such readers and make things really easy for them, so everybody reaps the benefit. We have just marketed a complete kit for the critical listener, consisting of an "Eliminoise" installation already connected and wired up to a 75-foot aerial, and 60-foot screened down lead, earth wire, insulators, everything, even to the short length of connection between the type 300 suppressor and the receiver end of the "Eliminoise." This kit includes the new lightning arrestor. We do not consider that any aerial kit is dangerous without an arrestor, but many feel safer with one.



A complete suppressor equipment for the critical listener, £3.18.6.

Send for the book, "Interference Suppression," post free 1s. 2d., or for free copy of "The Eliminoise System" and other relative literature.

\* Trade Mark.



**Belling & Lee Ltd.**  
Cambridge Arterial Road,  
Enfield, Middx.

**DYNAMOS, MOTORS, ETC.**

ALL Types of Rotary Converters in Stock, new and second-hand.

WARD, 46, Farringdon St., London, E.C.4. Telephone: Holborn 9703. [0518]

A.C.-D.C. 1- and 3-phase Motors, all voltages; from 14/9; list free. Repair specialists.—Easco, 18w, Brixton Rd., S.W.9. [0455]

E.D.C. 100 D.C.-230 A.C. 120 watts Cabinet, complete, E.D.C. self exciting alternator, 230 A.C. 240 watts, as new; offers.—Aspinwall, Windermere. [4685]

CRYPTO Rotary Transformer, primary input 220v. D.C., secondary output 30v. 10 amps. D.C., in perfect order; bargain, £2; also ¼h.p. 220v. D.C. motor, with emery wheel, £1.—2, Carlton House Terrace, Halifax. [4684]

**NEW LOUD-SPEAKERS**

BAKER'S Super Quality Triple Speaker.

IDEAL for Use with Quality Amplifiers; A.C. model, £8/15; D.C. model, £7/7; leaflet "Loud Speaker Tailoring" free on request.

BAKER'S Conversions.

THE Next Best Thing to a Baker Super Quality Triple Speaker is a Triple Cone Conversion Assembly; whether your moving coil speaker has a permanent or electro-magnet and no matter what type or make you possess, you can considerably improve frequency response and quality of reproduction by having a triple cone assembly fitted, which comprises main curved cone and dual bakelite and duralumin cones combined, mounted in a 12in. die-cast aluminium frame.

THE Price is 29/6 Complete, including free fitting at our works; there is a special triple cone assembly for owners of Baker's super power speaker, price 25/-, including coil.

BAKER'S Quality Surplus Speakers.

IF You are Requiring Quality Reproduction at Low Cost order one of the following brand new bargain speakers now. The Auditorium models are fitted with latest triple cone comprising main curved cone and bakelite and duralumin cones combined, giving wide and even frequency response, resulting in quality reproduction of speech and music. The Coronation surplus horn models are ideal for reproduction of transients.

39/6 Only, usual price £5.—Auditorium Permanent Magnet Speaker with Alni magnet and die cast frame, large 12in. triple cone giving wide frequency range, complete with large 25 ratio transformer suitable for all outputs, including push-pull and Class B, etc.

59/6 Only, usual price £6.—Auditorium Electro-Magnet Speaker, 1,000, 1,250, 2,000 or 2,500 ohms field, exceptionally large magnet of high permeability steel giving enormous flux density, 2in. moving coil, large triple cone giving wide frequency range, complete with universal transformer, the ideal speaker for use with "Wireless World" and other quality amplifiers.

75/- Only, usual price £9.—As above, but for use on A.C. mains; complete with Westinghouse rectifier and full smoothing equipment.

49/6 Only, usual price £6.—Coronation Surplus Horn Permanent Magnet Moving Coil Speakers, suitable for domestic or public address; the horn is of moderate size and the speaker is therefore ideal for home use where good reproduction of transients is required; can be used separately or in conjunction with baffle board speakers.

15/6 Only.—Permanent Magnet Speaker, Alni magnet 8in. cone, Universal transformer.

12/6 Only.—Permanent Magnet Speaker as above with 7in. cone.

2/9 Only.—Brand new cabinets, 12x10x6.

8/6 Only.—Electro-Magnet Speakers, with 8in. cone, 6,500 ohms field, Universal transformer.

ALL Baker Quality Surplus Speakers are Sold for Cash or o.o.d.

BAKER'S SELHURST RADIO, Ltd., The Pioneer Manufacturers of Moving Coil Speakers, 1925-1937.—75-77, Sussex Rd., South Croydon. (Croydon 3441.) [4522]

VAUXHALL.—Loudspeakers, 1938 range, now available; details see new list.—Vauxhall Utilities, 163a, Strand, Temple Bar 9338. [4609]

**LOUD-SPEAKERS**

**SECOND-HAND, CLEARANCE, SURPLUS, ETC.**

BROWN P.M. Extension Speakers, walnut cabinets, 3 ohm speech coil, without transformer, can be used with any set, 15/-; with volume control, 17/6; worth double.—Sunbeam Wireless Service, 10, The Pavement, Clapham, London. [4648]

**VALVES**

ANDERSON.

AMERICAN Valves, all makes, first grade only; 5/ each.

ANDERSON, 35, Lansdowne Rd., Walthamstow, E.17 Walthamstow 0827. [3351]

BIG and Better Value.

3/- Each All Popular Type American Valves, 6L6, 3/9; 50's, 5/-; 10's, 6/-; 90-day guarantee.

ALL Types Transmitting Tubes in Stock, photo cells, cathode ray tubes, etc.

RADIOGRAPHIC, Ltd., 66, Osborne St., Glasgow, C.1. [4661]

HIVAC, Tungsram, Philco, Raytheon and Arcturus, wholesale only.—Leonard Heys, 36, Henry St., Blackpool. [0557]

AMERICAN Valves, first grade, in all types; trade supplied.—Metropolitan Radio Service Co., 1021, Finchley Rd., N.W.11. Speedwell 3000. [0436]

VALVES

ALL Types of American Valves in Stock of Raytheon, Sylvania, and Arcturus makes, at competitive prices, guaranteed for six months; send for full list; 350 ohms line cords, 2/8.

WARD, 46, Farringdon St., London, E.C.4. Tel.: Holborn 9703. [0452]

BUY Valves Direct, save 50%. 2-volt, H2, L2, 2/3; power LP2, super power P2, 3/-; screens 4/6. H.F. Pentodes 5/6, L.F. Pentodes 5/-. A.C. mains, 4-volt general purpose 4/6, power 5/-. screens and L.F. Pentodes 6/-. H.F. Pentodes 6/6. Full wave rectifiers 4/6. Postage 3d. one valve, 4d. two, 6d. three. Send now.

LUMINOUS ELECTRIC APPLIANCES, Ltd. (Dept. 7), Phoenix Works, Tyburn Rd., Erdington, Birmingham. [4699]

NOTHING Better Available. Six months' guarantee; complete range of battery, A.C. mains, rectifiers, always in stock; 2 volt det., H.F. L.F., 2/3; Power, 2/9; screen grid pentode, H.F. pentode, 5/-; American types, six months' guarantee, 5/6 each, Nos. 18, 24A, 35, 42, 43, 45, 47, 56, 57, 58, 75, 77, 78, 80, 2A5, 2A6, 2A7, 6A7, 2B7, 6B7, 6C6, 6D6, 25Z5, 25Y5.—Write for other prices to Dulci Electrical Co., Devonshire Works, Duke's Av., Chiswick, London, W.4. [0501]

TELEVISION APPARATUS

EDISWAN Type AH Cathode-ray Tube, £7/10; MR-AC1 relay, 25/-; HE-AC1 relay, 25/-; DLS1 delay switch, 5/-; all perfect condition, very little used; cabinet for complete receiver, £23.—Box 2486, c/o The Wireless World. [4705]

METERS, ETC.

FERRANTI Meters, 300 moving coil single and triple range, new boxed discontinued types; approximately 75% off list.—Farnell, 12, Heaton Park Rd., Bradford. [4898]

NEW COMPONENTS

RAYTHEON Valves, all American components; trade. —Zelco, Ltd., 53, Farringdon Rd., E.C.1. [0499]

1/11.—Electric soldering irons, A.C./D.C., 200-250v., post 3d.; popular American valves, 2/3; stamp for lists.—Northwest, 2, Willoughby Rd., Liverpool. [4663]

COMPONENTS

SECOND-HAND, CLEARANCE, SURPLUS, ETC.

RADIO CLEARANCE

ALL Lines Previously Advertised Still Available.

RADIO CLEARANCE, 63, High Holborn, W.C.1. Holborn 4631. [4718]

PREMIER SUPPLY STORES.

PLEASE See Our Displayed Advertisement on page 2. [0488]

AMERICAN Power Transformers, every type in stock at right prices.

GIVE Details When Ordering.

NEW Filtermatic Tone Controls, 7 combinations; 1/9 each.

ELECTROLYTICS, American Midget type, 2in. x 1/2 x 1/2, 8, 16, 20 mfd., 1/9, 2/-, 2/3 each.

SLOW Motion Dials, 156-1; 1/3 each.

80 Watt Resistors, 300 ohms; 1/6 each.

LINECORDS, 350 ohms, 2- and 3-way; £1/9.

1 Watt Resistors, 4/- per dozen; 2 watt resistors, 6/- per dozen.

MICA Condensers, 0.0005 to 0.001; 6/- per dozen.

TUBULAR Condensers, 0.0001 to 0.05; 4/- per dozen.

ROLA F6 Speakers with Transformer, 1,000 or 1,800 ohms; 6/6.

ALL Goods Guaranteed.

RADIOGRAPHIC, Ltd., 66, Osborne St., Glasgow, C.1. [4662]

OLIVERS Offer Erie 1-watt Resistances, 3 1/2 d. each, 3/- dozen, 2/6 dozen in three dozen lots.

CENTRALAB Volume Controls, all values, with switch, 2/- each; line cords, 2/6.

CLASS "B," Q.P.P., Power and pentode speaker transformers, 3/- each; Class "B" and 1 to 4 L.F., 3/6.

ALUMINIUM Chassis, 18 s.w.g., undrilled, 16in. x 10in. x 3in., 5/3; 16 s.w.g. ditto, 7/6; any size to special order.

CARDBOARD Case Electrolytics, B.I., T.C.C., Hunt's, 4 mfd., 1/6, 8 mfd., 1/9, 8 mfd. plus 4 mfd., 2/5, 8 mfd. plus 8 mfd., 2/9, 25 mfd., 25v., 1/-, 50 mfd., 12v., 1/1, 50 mfd., 50v., 1/6.

ROLA G.12, stripped, with push-pull or triode and pentode transformers, 2,500 ohms or 1,500 ohms field; £2/10.

TUBULAR Condensers, .0001 mfd. to .01 mfd., each 4d.; .02 mfd., .05 mfd., each 4 1/2 d.; .1 mfd., .5 mfd., each 5d.; .5 mfd., 6d.

TRIMMERS, .0001 mfd., 9d.; .0003 mfd., 11d.; chassis mounting valve holders, 5-pin 2 1/2 d., 7-pin 3 1/2 d.

OLIVERS, 876, Christchurch Rd., Boscombe, Hants. Orders under 5/6, postage extra. Lists free. [4715]

REMINDER NUMBER ONE

Do excuse us for bringing up the old question of OUTPUT TRANSFORMERS, even if this subject is a bit hackneyed we really must commence our Reminder series of adverts. with some mention of it.

Let us assume that YOU have the finest AMPLIFIER that radio science can produce, the best Loudspeaker obtainable to-day, and a radio frequency circuit which is ultra good. Assuming that you have taken the trouble to verify the excellent response of all these pieces of apparatus the final result will be no better than the OUTPUT TRANSFORMER which you will employ to link the speaker to the rest of the equipment. May we therefore again draw your attention to the fact that our famous 036 type output transformer has a Wireless World certified frequency characteristic which is within 0.5 d.b. from 20 to 20,000 cycles.

Now, quite a number of proprietary speakers on the market are fitted with transformers which definitely are not up to this high standard, and it seems a pity to cramp the style of a thoroughly good outfit when you can substitute the 036 type output transformer and obtain the last ounce from your equipment.

Needless to say all SOUND SALES AMPLIFIERS and DUAL SUSPENSION MOVING COIL SPEAKERS are supplied as standard with 036 transformer, but since such a transformer would be far too good for the average "commercial" radio equipment you cannot blame manufacturers for omitting to use it. There is no reason however why you should be deprived of the excellent results obtainable.

May we send YOU further particulars.

**SOUND SALES**

MARLBOROUGH RD., UPPER HOLLOWAY, LONDON, N.19. LIMITED. Tel.: Archway 1661/2/3  
(Contractors to the G.P.O., etc.)

IT WAS IN JUNE 1935

that "The Wireless World" said:—

"Specimens tested have been found to be particularly smooth and noiseless in action."

RELIANCE ARE SPECIFIED for the Television Receiver. You will need.

RELIANCE POTENTIOMETERS. TYPE "T.W." Wire-wound. Linear. Non-graded, 10,000, 1,000 and 2,000 ohms., 4/6 each. TYPE "S.G." 50,000 ohms. and 2 megohms 4/9 each.

RELIANCE VARIABLE RESISTANCES.

TYPE "S.G." non-tapered 150,000 ohm; and 0.5 megohm, 4/9 each.

Reliance are Reliable, and consistently specified by Leading Technical Journals.

Write for Folder "W.W." Free.

RELIANCE

THE PRODUCT OF SPECIALISED RESEARCH

RELIANCE MANUFACTURING CO (SOUTHWARD) LTD  
WESTBURY ROAD, LONDON E.17.

RECORD

The quality valve in the COMPLETE range

RECORD RADIO LTD., 2/3, Eldon Street, E.C.2

We don't claim to make the cheapest transformers, but we do claim to make



good ones. Most of the professional P.A. men seem to think so, too.

W. BRYAN SAVAGE LTD

Westmoreland Rd., London, N.W.9. Phone: Colindale 7131

COMPONENTS—SECOND-HAND, CLEARANCE, SURPLUS, ETC.

RYALL'S RADIO, 280, High Holborn, London, W.C.1, offer new goods at knock out prices.

AMPLIFIERS, with 6w. push-pull output, 3-stage for AC200/250v., good chassis, complete, with 5v. 50/-

BI Electrolytics, 12x8 ml., 350v., 1/6; NSF 25x26v., 6 3/-; NSF tubular bag ends, 0.15, non-inductive. 750v., 2/6 dozen.

PAIRS Ferranti Screened Coils, 2/6; Ferranti aerial coils, 6 3/6; Ferranti 3-range coils, 1/3; with circuits, chassis types.

FERRANTI Mains Transformers, as used in their commercial sets, 350-0-350v., 70 m.a., 4v. 4-5a. C.T., 4v. 2 1/2a. input, 200/250v., brand new; 6/6. [4464]

VAUXHALL—Standard 1938 components; details, see new free list.—Vauxhall Utilities, 163a, Strand, Temple Bar 9338. [4610]

WARD—For unparalleled bargains in set manufacturers' surplus; all goods are guaranteed unused and perfect; immediate delivery.

BRITISH Radiophone Condensers, fully screened, superhet, or straight type, 3-gang and 2-gang; 7/6.

CENTRALAB Resistances, 1-watt type, 6d.; 2-watt type, 1/2; 3-watt type, 1/9; B.I.C. 8mf. and 4mf. 550 volts peak electrolytic condensers, 3/6.

3,000 Brand New Weairite 110 kc. Pre-tune I.F. Transformers, type O.T.1, O.T.2 and O.T.2F.; 1/6 each, or offer for quantity.

40 mfd. and 24 mfd. 200 Volts Peak Electrolytic Condensers; 3/-.

CLIX Chassis Type Valve Holders, 4- or 5-pin, 6d.; 7- or 9-pin, 6d.; R.C.A. American valve holders, 4s., 6- or 7-pin, 9d.

ASSORTED 1-gross Parcels of 1-watt and 1/2-watt Resistances by N.S.F.; 12/-.

MARCONI Model 25 Pick-ups; 25/-.

CONVERSION Units for Converting D.C. Receivers to A.C. Mains operation up to 110 watts, improved full-wave type; £2/10.

WESTINGHOUSE Rectifiers, L.T.4 or L.T.5, with mains transformer and variable resistance, 22/6; Varley D.P.4 output transformers, 1-1 and 25-1, 9/-.

MAINS Transformers, 350-0-350v. 60 m.a., 4v. 3 amps., 4v. 25 amps., 12/-; 425-0-425v. 120 m.a., 4v. 1 amp., 4v. 1 amp., 4v. 7 amp., 4v. 25 amp., for "W.W." Quality Amplifier, 26/-; L.T. transformers, with two 4v. 3a. C.T. windings or 2.5v. 8a., 5v. 2.5a., 8/6.

VOLUME Controls, with or without switch, by Rotophon, Erie, Electro, and other good makers, any value, 2/6; steel chassis, "Wireless World" Quality Amplifier, 8/6; Partridge 32-watt amplifier, 11/-.

WE Stock All Parts for "Wireless World" Quality Amplifier, Quality Amplifier Receiver, Imperial Short Wave Six, 1936 Monodial Q.A. Super, All-wave Super Seven, etc.

WE Can Supply Correct Equivalents for Any British Type of Valve, including side-contact Universals, H.F. pentodes, double diode triodes, 3-5-watt output pentodes, 500v. indirectly heated rectifiers, octodes, double diodes, single diode tetrodes, etc., at an appreciably lower price.

PHILIPS Amplifiers with 400v. triode in output stage; £2, complete.

300 Jensen P.M. Speakers in Cabinets, with volume control, specially designed for relay company; 14/8 each, or offer for quantity; Bakers super power speakers, £2/5

"CORPACT" Capacity Operated Window Signs; £5.

CARRIAGE Paid, cash with order or c.o.d.; send for list.

WARD, 46, Farringdon St., London, E.C.4. Tel.: Holborn 9703. [0450]

MAINS RADIO DEVELOPMENT CO.'s Astounding Bargains.—Carriage paid; call mornings; 'phone Tudor 4046; stamp for List 205.

N.S.F. 1/2 and 1 watt Carbon Resistors, twelve good sizes. Well assorted, marked values; 50 for 3/6; unrepeatable offer.

CLEARANCE of Mica Tag Condensers, 20 assorted of six good sizes from 0.0002-0.005 mfd.; 1/- while stocks last.

TUBULAR Condensers.—Brand new, wire ends, finest make, 400 volt working, 0.0001-0.002 mfd., 2d.; 0.005, 0.01, 0.02, 0.05, 0.1 mfd., 4d.; 0.25, 0.5 mfd., 6d.

CLIX Latest Chassis Valve Holders unused, 4-pin, 1 1/2 d.; 5-pin, 2 1/2 d.; 7-pin, 4d.; three-valve grey cellulosed metal chassis, 12 1/2 x 6 1/2 x 3in., 1/-.

RESISTORS.—Absolutely finest make, one watt, colour coded wire ends, unused, any size 50 ohms to 5 megohms, 3 1/2 d. each, 2/9 a dozen; your choice; two watt, any size, 6d.

B.I.C. Unused Dry Electrolytics, 8 + 8 mfd., 500 volt, 3/-; 8 mfd. 550 volt, metal can, 2/3.

KNORS.—Black, octagonal bakelite, 1 1/4in. diameter, quarter inch spindle, beautiful appearance; 2 1/2 d. each.

MAINS RADIO DEVELOPMENT CO., 4-6, Muswell Hill Rd., London, N.6. [4691]

FERRANTI AF5CCS, 17/6; sound rales "W.W." F.U.T., 20/-; two PX25A valves, 20/-; all new.—Hewson, 28, Signhills Avenue, Cleethorpes. [4686]

ENQUIRE Our Prices on Mains and Battery Receivers, Europa valves, gramophone units, Telsen coils, Hols speakers, Dipole aerials, etc.; definitely lowest in country.—Standard Radio Supplies, 1, Dantzic St., Manchester. [4708]

FERRANTI AF5, 6/-; OPM11c, 35, 56, 100/1, 5/-; O.P.M.1c, 1/1, 1.6/1, 2.7/1, 5/-; auto transformer, 110/220v., 110v.A, 8/-; West. Rect., 120v. 20 m/a., 5/-; 500v. 200 O/v., 5in. switchboard voltmeter, 12/6; Igranic 10/100 metre coils, 4 for 3/-; Burndipet 0001 variable, 3/-; Igranic L.W. variometers, 5/-; Lotus .0005 condensers with drum gang drive, 8/-.—Box 2487, c/o The Wireless World. [4710]

**PILOT AUTHOR KITS**  
**"WIRELESS WORLD"**  
**TELEVISION**  
**RECEIVER**

EXACT TO SPECIFICATION: build the "W.W." Television Receiver with a genuine PILOT AUTHOR KIT for 100% success. Watch our future announcements for full details of Kits for each unit of the Television Receiver. Send for completely detailed and priced lists of parts.

**VISION RECEIVER**

Described in this issue.

**KIT "A" Cash or C.O.D. £6:8:6**  
 Carriage Paid.

Or Deposit 11/9 and 11 monthly payments of 11/9.

Complete kit of first specified parts for building the Vision Receiver Unit, including B.T.S. ready drilled and stove enamelled steel chassis and 5 B.T.S. Coils, less valves.

\* If required with 7 specified valves, CASH OR C.O.D., Carr. Pd. £11:11:0 or Deposit 21/- and 11 monthly payments of 21/-.

† B.T.S. Air spaced condensers, .000015 mfd. 13s. 0d.

‡ B.T.S. Coils (4) type WW.T.4 (1) Type WW.T.1 10s. 6d.

§ B.T.S. special steel chassis assembly, drilled, grey stove enamelled. 22s. 6d.

**RECEIVER POWER PACK**

Described in this issue.

**KIT "A" Cash or C.O.D. £4:5:0**  
 Carriage Paid.

Or Deposit 7/9 and 11 monthly payments of 7/9.

Complete kit of first specified parts for building the Vision Receiver Power Pack Unit, including B.T.S. ready drilled and stove enamelled chassis, less valves.

\* If required with 2 specified valves, CASH OR C.O.D. £5:13:0 or Deposit 10/6 and 11 monthly payments of 10/6.

† Power Pack Mains transformer, to "W.W." specification 35s. 0d.

‡ B.T.S. ready drilled, and grey stove enamelled steel chassis 10s. 0d.

Please cross P.O.s and register currency.

**PETO-SCOTT** CO. 77 (W.W.32), City Road, London, E.C.1  
 Ltd. 62 (W.W.32), High Holborn, London, W.C.1  
 Est. 1919

**B.T.S. Specifications**  
**"W.W." Television Receiver**

**Vision Receiver**

5 B.T.S. Coils, 4 Type W.W.T.4, 1 Type W.W.T.1 ... the set 10/6

B.T.S. Chassis ... 22/6

**Vision Receiver Power Pack**

B.T.S. Chassis ... 10/-

**Time Base (next week's issue)**

B.T.S. Choke 0.25 Henries, Type W.W.T.2 10/6

From your Dealer or send direct:

**BRITISH TELEVISION SUPPLIES LTD.**  
 Faraday House, 8-10, Charing Cross Road,  
 LONDON, W.C.2.  
 Temple Bar 0134.

**ELECTRADIX BARGAINS**

Everything you want!



Send us your enquiries. Our prices are right.

**ELECTRADIX RADIOS**  
 218, Upper Thames Street, London, E.C.4  
 Telephone: CENTral 4611.

**REPAIRS AND SERVICE**

"SERVICE WITH A SMILE"

**HENRY FORD RADIO Ltd.**—American valves, components, spares, line cords; leading trade repairers; send us your American and British receivers.—Electronic House, 22, Howland St., Tottenham Court Rd., W.1. Museum 5675. [0434]

**HARMONY HOUSE SOUND and SERVICE**, Southport.—Radio repairs for the Trade.—Tel. 8621. [0558]

**METROPOLITAN RADIO SERVICE Co.** for Guaranteed Repairs to American (Midget and Standard and British Receivers).

**CLARION and Majestic Service Depot.**—I.F. and mains transformers rewound. American valves and parts; trade supplied.—Metropolitan Radio Service Co., 1021, Finchley Rd., London, N.W.11. Speedwell 3000. [0435]

**FOR Unusually Good Rewinding of Transformers, chokes, speakers, etc., trade only.**—Gardners Radio, Ltd., West Southbourne, Bournemouth. [0551]

**ESSEX TRANSFORMER Co.** for all Transformer Rewinds; 24-hour service; trade enquiries invited.—276, Hamlet Court Rd., Westcliff-on-Sea. [4679]

**LOUD Speaker Repairs, British, American, etc.;** any make transformer coils rewound: alterations.—Sinclair Speakers, Alma Grove, Copenhagen St., N.1. [4673]

**OUR Technical Department is at your Service.**—Air King Radio, 115, Shaftesbury Av., Cambridge Circus, W.C.2. Phone: Temple Bar 4875 (2 lines). [3963]

**GUARANTEED Repairs.**—Any transformers, choke, motor, armature, converter, dynamo, etc.; keenest prices, immediate quotation, prompt, dependable service.—See below.

**L.T.P. (LONDON TRANSFORMER PRODUCTS, Ltd.)** Willesden, N.W.10. Willesden 6486 (3 lines). [3470]

**MAINS Transformer Service.**—Repairs, rewinds, or constructions to specification of any type; competitive prices and prompt service.—Sturdy Electric Co., Dip-ton, Newcastle-on-Tyne. [0516]

**F. E. GODFREY, A.M.I.R.E.,** qualified to build, repair and convert "Wireless World" sets, etc.; 25 years' experience, prompt service guaranteed.—30, Kemplay Rd., Hampstead. Hampstead 1104. [3509]

**HOLIDAY and HEMMERDINGER, Dolefield, Bridge Street, Manchester.**—Repairs; re-winds. American valves. Service books. Speaker centring gauges, 2/6 set. Speaker dope, 2/- Catalogue free. [4641]

**ENGLISH and American Repair Service, conversions, rebuilds, car radio, public address work; trade and private.**—Warner and Son, Ltd., 201-207, Forest Rd., Walthamstow, E.17. Larkwood 1181. [4712]

**DEGALLIER'S RADIO SERVICE,** repairers of British and American receivers; lowest prices with good workmanship; also speaker repair department; new coils and cones fitted, fields altered, transformers rewound; any transformer, choke, armature, converter, or dynamo re-wound; let us quote.

**DEGALLIER'S RADIO SERVICE, 32, Bathurst Mews, Paddington, London, W.2.** Telephones: Paddington 2745 and Bayswater 5732. [4714]

**REPAIRS to Moving Coil Speakers a Speciality:** cones and coils fitted, fields altered; prices, including eliminators, quoted, loud speakers, 4/-; I.F. and output transformers, 4/-, post free; guaranteed satisfaction; trade invited; estimates free; prompt service.—Loud-Speaker Repair Works, 5, Balham Grove, London. Battersea 1321. [0394]

**TRANSMITTING APPARATUS**

**G5NI.**—The recognised distributors for amateur equipment, National, R.M.E., Thordarson, Hammarlund, McMurda, Hallcrafters, etc.; send 1/4d. stamp for catalogue.—Radiomart, 44, Holloway Head, Birmingham. [0531]

**MISCELLANEOUS**

**CHEAP Printing.**—1,000 billheads, 3/6; sample free.—Creteway Press, 18, Buxted, Sussex. [4719]

**SEND Stamp for Disposal List of Pre-stage, intermediate, and power amplifiers from 10 to 200 watts, rotary converters, P.A. and cinema speakers, horns, 16 m/m and 35 m/m, talkie and projection equipment, etc., etc.**—A. W. Knight, 132, Elgar Av., Tolworth. [4659]

**AMBITIOUS Men.**—To ensure promotion take advantage of The T.I.G.B.'s authoritative home study courses in Radio Engineering and Servicing, Television, Sound Recording, Wireless Communications, etc.; write to-day for "The Engineer's Guide to Success"—free—which gives full particulars—contains the world's widest choice of engineering courses covering all branches—and alone gives the Regulations for qualifications such as A.M.I.E.E., A.M.I.R.E., A.M.I.T.E., A.M.I.W.T., C. & G., etc. Training until successful guaranteed.—The Technological Institute of Great Britain, 5, Temple Bar House, London, E.C.4. (Founded 1917. 20,000 successes.) [4683]

**EXTENDED PAYMENTS**

**LONDON RADIO SUPPLY Co.** (Established 1925), supply on convenient terms, components, accessories and sets, any make, 10% down, balance over 12 months; send for list of requirements.—11, Oat Lane, London, E.C.2. [0337]

**HIRE-PURCHASE.**—Prompt delivery of any radio apparatus on convenient terms.

**WARD, 46, Farringdon St., London, E.C.4.** Tel.: Holborn 9703. [0539]

**RAYMART**  
**CRAFT A CREED**

We have been appointed British  
 Concessionaires for the  
**BASSETT CONCENTRIC FEEDER**

This feeder marks a great technical advance on existing transmission lines and a correctly designed concentric line has long been acknowledged as being far superior to any other method of connecting an aerial to either a transmitter or receiver, with minimum attenuation of all frequencies. This co-axial line has a surge impedance exactly equal to that of the centre of the average doublet aerial. It is absolutely impervious to weather and can be buried in the ground or even taken through water without loss.

Attenuation on the high frequency spectrum is not greater than six-tenths of one db per 100 feet and it can handle up to 2 kilowatts with ease. Accepted and used by all the principal manufacturers of transmitting and television equipment throughout the United States. Low in cost.

TYPE BCF-50, 50 ft. line with connectors ... 50/-  
 TYPE BCF-75, 75 ft. line with connectors ... 65/-  
 TYPE BCF-100, 100 ft. line with connectors ... 85/-  
 Deliveries in strict rotation.

Further technical information on receipt of stamped addressed envelope.

**RAYMART SHORT-WAVE MANUAL.**

48 pages in all, 32 on receivers, transmitters, aerials, circuits, etc., etc., and 16 on short-wave components, 6d., or post free, 7jd. Short-Wave Catalogue, 16 pages, 1jd.

**AMERICAN Mains Transformers.** Heavy Duty 350-350v. 150 m.a. 9.3v. 4a., 5v. 3a., 12/6. GE 350-350 v. 80 m.a., 2.5v. 4.0a., 5v. 2a., 6/11. Majestic, 250-250 2.5v., 5v., 4/11; Pilot 250-250, 2.5 v. C.T., 5 v. C.T., 5/11. Ceramic American Valveholders, 1/- each.

**BRITISH RADIOPHONE .0005** straight or superhet 3-gang fully screened E condensers with trimmers, 4/11; Utility Midget 2-gang ditto, 3/11; S.L. Didd to suit above, 2/11; Utility 2-gang Uniknob .0005 with Dial, 3/11.

**COILFORMS.**—Moulded in RD4 natural loloal material, hollow resilient pins, 1/16 diameter, ribbed; identification disc in top. Four types, 4-pin, 1/6; 6-pin (standard or to fit 7-pin valveholders), 1/9; 7-pin (for handspread tap), 1/10; Machine threading, 2d. extra.

**ELECTROLYTICS.** Huge purchase 500 v. Aluminium Can, 4 mfd., 1/6; 8 mfd., 1/11; 8+8 mfd., 2/6; Block type, 500 v. peak, 4+4 mfd., 1/6; 8+8+4 mfd., 3/-; 60 mfd., 80 v., 1/3; 25 mfd., 25 v., 1/-; Tubular Condensers, 1,500 v. T., all sizes to 0.1 mfd., 6d.; 0.2 to 0.5 mfd., 8d.

**FAMOUS CONTINENTAL A.C. Valves, 4/6;** Battery types from 2/3; American Duotron, etc., all types, 3/6; all types of RCA Licensed first grade tubes, metal and glass, in stock from 5/6.

**HEAVY DUTY Mains Transformer, worth 45/-,** 350-350, 150 m.a., 4 v., 2.5 A., CT, 4 v., 6 A., CT, 12/6; Philips 270-270, 120 m.a., same LT's 6/6; Speaker Transformers, 2/6.

**MICROVARIABLES.**—All brass construction, latest ceramic insulation. The finest condensers made: 15 mmfd., 1/4; 40 mmfd., 1/7; 100 mmfd., 1/10; Transmitting Type.—670m. Spacing, 15 mmfd. (neutralising), 2/9; 40 mmfd. Tuning, 3/6. These are quality.

**PUSHBACK Wire, 6 yds., 6d.;** heavy, 9d.; Resin-cored Solider, 4d. 6d.; Screened Flex, single, 6d. yd.; twin, 9d. yd. Assorted Solides Taps, 6d. packet.

**SHORTWAVE COILS.**—(RD4) CA 11-25, CB 20-45 metres, 2/6. CC 24-100 metres, 2/9. Standard 6-pin types, CA6, CB6, 2/9 each. CC, 3/-; same range as 4-pin.

**SMOOTHING CHOKES, 20 hy., 120 m.a., 3/11;** 200 m.a. swinging chokes, 8/6; Centralab Pots, all sizes, 1/6; switched, 2/-; 20,000 ohm Pots, 1/-; Tubular glass fuses, 2d. Milliammeters, 25 m.a. upwards 5/9; super, 6/9.

**UTILITY 8/6, Microdisc Dials, 3/11;** Radiophone, 0.00016 Shortwaves Condensers, 3/6; Series gap twin, 3/9. Shortwave HF Chokes 5-100 metres, 9d.

**465 KC Litz Wound IP's, 3/11;** Two-speed slow-motion knobs, 1/-; Telsen Ace Transformers, 1/11; Telsen Screened S.W. H.F.C. 1/-; Iron core H.F. chokes, 1/6.

**SPECIAL OFFERS.**—Class B kit, worth 30/-, comprising Driver Transformer, Valve and Holder, 5/-; Doren wire-ended assorted resistors, 1/6. Order 5/- post free. Get our Bargain Catalogue, 1jd. post free. All enquiries and requests for Catalogue must send 1jd. stamp.

**GET THIS NOW**

**G5NI (BIRMINGHAM) LTD.,**  
 44, HOLLOWAY HEAD,  
 BIRMINGHAM TELE: MID. 3254

**5-BAND 10-WATT RADIO**



**YOURS FOR 24'-DOWN.**

Radio's greatest value and biggest bargain to-day. Definitely your last opportunity. Send deposit only, or cash or C.O.D., order now to secure delivery. We guarantee your satisfaction. For full details see our classified advertisement on p. 1. Chassis price £11.19.6. (Value £24.) No finer Radio to compare at under 3 times the price to-day.

If you have not already had your copy of this big new Radio Buying Guide, secure yours to-day. Everything in Radio at wholesale prices. Enclose 4d. stamps to Dept. 6.5.

**ANGLO AMERICAN RADIO**  
 (6 MOTORS) LTD., ALBION HOUSE, NEW OXFORD ST., LONDON, W.1.

**TANNOY**  
 THE SOUND PEOPLE

GUY R. FOUNTAIN LTD.,  
 OR CANTERBURY GROVE, WEST NORWICH,  
 LONDON, S.E.27. (Phone: Str. 4122 (6 lines).  
**SOUND AMPLIFYING EQUIPMENT**

**EXCHANGE**

**I** BUY, sell, exchange good quality receivers, accessories, components; H.P. facilities; promptness, efficiency.—Bostock, 1, Westbourne Terrace, S.E.23. Forest Hill 2236. [0529]

**FINANCIAL PARTNERSHIPS**

**T**ECHNICAL Partner Required, preferably P.M.G. certificate, for radio college; capital £300.—Box 2478, c/o *The Wireless World*. [4700]

**PATENT AND TRADE MARK AGENTS**

**G**EE and Co. (H. T. P. Gee, Mem. R.S.G.B., A.M.I.R.E., Estab. 1905), 51-52, Chancery Lane, London, W.C.2 (2 doors from Government Patent Office). Holborn 4547 (2 lines). Handbook free [0001]

**PATENTS**

**"PRACTICAL Hints on Patents,"** free on application.—The Imperial Patent Service, First Avenue House, High Holborn, W.C.1. Preliminary consultation free. [0481]

**PHOTOGRAPHY**

**P**HOTOGRAPHIC Materials.—Films, plates, papers, postcards, mounts, chemicals, etc., superb quality, economically priced; factory fresh always; money-saving lists free.—"Kimbers," 105, Queen's Rd., Brighton. [4588]

**TUITION**

**R**ADIO Training.—Marine, aircraft, broadcast; prospectus free.—Hull Municipal Technical College. [0523]

**WANTED**

**V**OIGT Twin Cone Bass Chamber Horn, 230 A.C.—Bament, Barrack St., Bridport. [4697]

**W**E Buy for Cash All Types of Modern Second-hand Radio Sets and Accessories, test meters, parts, etc.; we pay more than any other dealer; part exchanges; bring, send, or will call.—University Radio, Ltd., 82, Hampstead Rd., London, N.W.1. Phone: Euston 3810. [4479]

**SITUATIONS VACANT**

**N**ORTHERN Polytechnic, Holloway, London, N.7.

**T**HE Governors of the above Polytechnic have a Vacancy on their Teaching Staff for a Full-time Teacher (Male).

**T**EACHER of Radio Servicing for the Department of Musical Instrument and Radio Technology; at least five years' industrial experience after the age of 21 and some teaching experience are essential; candidates should be capable of lecturing to adults on the theory and practice of modern receiver installation and maintenance.

**T**HE Salary will be in Accordance with the Burnham Scale (£290-£410), less 5% for superannuation.

**O**N Receipt of Stamped Addressed Foolscap Envelope, full particulars and forms of application will be forwarded; the last date for receiving applications will be the 7th July, 1937.—W. M. Macbeth, Clerk. [4665]

**V**ACANCIES Exist For Civilian Laboratory Instructors at the Electrical and Wireless School, Cranwell.

**T**HE Commencing Rate of Pay is £4 per week inclusive, which may be increased to £4/5 after a short period of satisfactory service.

**C**CANDIDATES Must be Capable of Assisting with the Instruction of Laboratory Classes, and should have had experience in the handling, manipulation and maintenance of scientific apparatus, with special reference to electrical and wireless equipment.

**A**N Educational Standard Equivalent to the Matriculation Examination of a University, or the possession of the Higher Education Certificate of the Royal Air Force is desirable.

**A**PPPLICATIONS Should be Addressed to the Principal Education Officer, Electrical and Wireless School, Royal Air Force, Cranwell, Lincs., as soon as possible.

**C**CANDIDATES Will be Required to Appear Before a Selection Board at the School for Interview and Test. [4689]

**W**ANTED Practical and Experimental Service Engineer.—Apply Premier Supply Stores, 167, Lower Clapton Rd., E.5. Amhurst 4723. [4721]

**A**PPRENTICE to Manufacturers of High Quality Amplification and Electro-medical Equipment; South London.—Box 2491, c/o *The Wireless World*. [4711]

**G**UARANTEED Positions in Marconi Service; all successful students placed; separate Morse Classes held.—The Wireless School, 74, Bull St., Birmingham, 4. [4513]

**Y**OUNG Man, age 18 to 20, required for outside demonstration work; must be able to drive small van.—Apply to the Staff Manager, John Barnes and Co., Ltd., Hampstead (next to Finchley Rd. Station). [4696]

**R**ADIO Assembly Foreman, skilled mechanic, with experience of record changers or similar mechanisms.—Send full details of career, stating age and salary required, to Ref. 1/WW, Box 2448, c/o *The Wireless World*. [4693]

**W**IRELESS Operators and Engineers Urgently Required.—Train at Britain's leading colleges; fee after appointment; boarders; prospectus free.—The Wireless College, Colwyn Bay, or The Wireless College, Calmore, Southampton. [0541]

**C**HARGE Hand Wanted for London Factory. Must have had previous experience of testing assembled sets and control of male and female labour; good technical knowledge necessary; give previous employers, work performed, and details of training.—Box 2479, c/o *The Wireless World*. [4701]

**GALPINS ELECTRICAL STORES**

**TELE: 75, LEE HIGH RD., TERMS**  
**LEE CASH**  
**GREEN LEWISHAM, WITH**  
**LONDON, S.E.13. OR C.O.D. ORDER**  
**5240. LONDON, S.E.13. OR C.O.D.**  
All goods sent on 3-days approval against cash.

**A.C. MOTOR,** 2½ h.p., 200/20 v. 50, 1 ph. induction, direct coupled to 110 v. 10A., Dynamo on iron bedplate, complete with starter £10, or separate, Motor and starter £7/10/-; Dynamo £4.

**DYNAMOS,** all fully guaranteed for lighting or charging. 12 volt 8 amp., 15/-; 12 v. 12 a., 17/6; 20 v. 5 a., 25/-; 20 v. 8 a., 32/6; 35 volt 6 a., 27/6; 25 volt 25/35 amp., four pole, compound wound, slow speed, as new, 90/-; 100 v. 10 a., 70/-; 50/75 v. 6 a., 70/- Carriage forward.

**CHARGING RESISTANCES** or Shunt Regulators. Stud, switcharm type, 12/6 each, to suit your requirements.

**C.A.V. AUTOMATIC CHARGING CUT-OUTS,** suit any voltage, 7/6 each.

**MOVING COIL and MOVING IRON Switchboard Meters.** By well-known makers. Various readings, volts and amps., 12/6 and 15/- each.

**WESTINGHOUSE H.T. RECTIFIERS,** output 500 volts 250 mA, ac new, 20/- each.

**MOVING COIL METER MOVEMENTS** for recalibrating into multirange, all-test Meter, 2½ in. dial, by well-known makers, 5/- each.

**EX-G.P.O. MAGNETIC RELAYS,** working current approx. 2 mA., 7/6 each; post 6d. "Sullivan" Moving Coil Relay, in perfect working order, new condition, 45/-.

**ELECTRIC LIGHT CHECK METER,** Kilowatt hour, type, 200/250 volts, 50 cycles, single phase, for subletting garages, etc., in new condition, 6/-; post 1/-.

**SHILLING SLOT ELECTRIC LIGHT CHECK METERS,** 200/250 v. 50 cycles, 5 and 10 amp., 17/6 C/F.

**ROTARY CONVERTERS,** 1,500 Watts, 110 v. D.C. input, 110 v. A.C., 50 cycle single-phase output, 90/-.

**MERCURY VAPOUR LAMPS** for 100/250 v. D.C. as new. List £17/10/-, price to clear £3/10/-.

**MOVING COIL MOVEMENTS,** complete, deflection on four inch scale one milliamp, price 12/6, post 1/-.

**TWO INCH SPARK COILS,** 17/6; X-RAY Tubes, 12/6, new 17/6.

**NEW TWIN FLEX,** 14/36, rubber and braided, red, 36 yds. 4/- or 144 yd. coil 12/6. Post free.



and "THE WIRELESS WORLD TELEVISION RECEIVER"

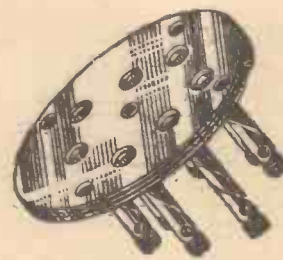

Here is an outstanding example of the faith which modern designers have in CLIX products. No less than 21 CLIX VALVEHOLDERS are specified for the "Wireless World Television Receiver."

FOR THE VISION RECEIVER AND POWER PACK dealt with in this issue, constructors will require the following:

- CLIX VALVEHOLDERS**
- (V.1) Standard Type:
  - Four 4-pin 5d. each.
  - One 5-pin 6d.
- (V.2) Five 7-pin 9d. each.

If supplied with terminal connections the price for each type is 3d. extra on above.

**CLIX SOCKET STRIP**

With terminals and engraved, A.1, A.2, & E. 7d. Valveholders and Strips Leaflet "W" Free.

BRITISH MECHANICAL PRODUCTIONS LTD.

79a, Rochester Row, London, S.W.1.

**SITUATIONS VACANT**

**R**ADIO Receiver Development Engineers Required for Radio Factory, S.W. London. Applicants should have engineering degree or equivalent, with similar experience preferred.—Write, stating experience, age, salary expected and date when free, Box 2480, c/o *The Wireless World*. [4703]

**R**ADIO Engineer, with degree or equivalent and sound knowledge of short wave measurements and/or high quality reproduction; experience of factory test methods desirable.—Send full details of career, with age and salary required, to Ref. 4/W.W., Box 2358, c/o *The Wireless World*. [4651]

**Y**OUNG Man, 22-28, as responsible assistant on production, electrical manufacturing, qualifications machine shop, test room, technical training; able to take charge of section.—State age, precise experience, salary required, to Best Products, Ltd., Felix Works, Felix Rd., Felixstowe. [4688]

**R**ADIO Service Men with Experience of Talkies or Automatic Record Changers or Similar Mechanisms; preference will be given to men with definite mechanical or electrical training.—Send full details of career, stating age and salary required, to Ref. 6/WW, Box 2447, c/o *The Wireless World*. [4692]

**R**ADIC Test Engineer-Charge Hand Required for Western Avenue District, able to design factory test apparatus and control labour; sound technical knowledge essential with organising ability.—Send full details of career and state age and salary required to Ref 2/W.W., Box 2357, c/o *The Wireless World*. [4650]

**V**ACANCIES occur for Thirty Men, aged 18-23, in the Post Office Eng. Dept.; experience is not required, but applicants must be willing to study technical subjects; commencing pay £3/15, rising to £7 per week and upwards, with pension.—For full particulars apply B.I.E.T. (Dept. 574), 17, Stratford Place, W.1. [4716]

**R**ADIO Testers Required, with previous factory experience of modern receiver testing on belt system; good wages and conditions, with regular employment. Call between 9.30 a.m. and 12 noon, or write for appointment (up to 7 p.m. if necessary), with the details of experience.—A. C. Cossor, Ltd., Employment Office, Highbury Grove, N.5. [4702]

**R**ADIO Engineer.—Mitcham Works, Ltd., have a vacancy in their testboard laboratory for a junior engineer having a good grounding in electrical and radio engineering.—Applications to be received not later than 12th July, 1937, must be made in writing to the Labour Supervisor at New Rd., Mitcham Junction, Surrey. Telephoned applications cannot be entertained. [4690]

**P**RODUCTION Engineer Required, experienced in the methods of manufacture and in the control of a large department manufacturing radio component parts and complete receivers. Reply, giving full particulars of firms at which previously employed, capacity in which employed, and reasons for leaving. Also give full particulars of education, age, and salary required.—Box 2339, c/o *The Wireless World*. [4645]

**ENGINEERING OPPORTUNITIES**

**Free!**

268 PAGES

This unique Handbook shows the easy way to secure A.M.I.C.E., A.M.I. Mech. E., A.M.I.E.E., A.M.I.A.E., A.M.I.W.T., A.M.I.R.E., and similar qualifications. **WE GUARANTEE—"NO PASS—NO FEE."** Details are given of over 150 Diploma Courses in all Branches of Civil Mech., Elec., Motor, Aero, Radio and Television Engineering, Building, Government Employment, etc. Write for this enlightening Handbook to-day. **FREE** and post free.

British Institute of Engineering Technology  
387, Shakespeare House, 17-18, Stratford Pl., W.1

**FOR P.A. AT ITS BEST**

**GRAMPIAN**

GRAMPIAN REPRODUCERS LTD.  
Kew Gardens, Surrey

**LEXINGTON VALVE TESTER**

Checks continuity in Coils, Condensers, Transformers, etc. Can be used as D.C. voltmeter. Cannot be over-loaded. Write to-day for full details.

Tests EVERY TYPE of British American valve from 2 volt to 40 volts.

10gms. subject

Lexington Instrument Laboratories Ltd., 155-7, St. Portland Street London, W.1.  
Phone: Langham 3477. "SIMPLIFIED SERVICING."

# SOUND ENGINEERING

— NOW READY —

This entirely new manual devoted to "Sound Engineering" will prove of invaluable assistance to Radio Dealers, Servicemen and amateurs who are interested in sound systems whether for profit or for personal entertainment. "Sound Engineering" is the only manual devoted entirely to the subject of sound systems and associated equipment. This 32-page book, packed with illustrations and useful technical articles will be in great demand. This edition is limited and you are strongly advised to write for your copy immediately.

"Sound Engineering" tells you about :—  
Selling Sound, Components of Sound Systems, Installation of Sound Systems. Carbon, condenser, dynamic, velocity and crystal microphones. Pick-ups, loud speakers and amplifiers. Installation problems. Acoustical levels. How loud is sound. Characteristics of Rochelle Salt Crystals. Sound projection controls.

Send for your copy to-day.  
This edition is limited.

Price 1/-  
post free.

*R.A. Rothermel*

Rothermel House,  
Canterbury Road, High Road, Kilburn, London,  
N.W.6. 'Phone : Maida Vale 6066.

## THE WIRELESS ENGINEER

The Journal of Wireless Research and Progress

"THE WIRELESS ENGINEER" is published in the interests of professional wireless engineers, experimenters, and all keen radio enthusiasts, and is widely read by those who are intimately associated with wireless development.

A valuable monthly feature consists of a summary, under the title of Abstracts and References, of important articles appearing in technical wireless publications throughout the world.

MONTHLY  
2s. 6d. NET  
Subscription:  
32s. per annum,  
post free.

ILIFFE & SONS LTD., DORSET HOUSE, STAMFORD STREET, LONDON, S.E.1

W.W.2

# B.I. RESINKOR SOLDER AND CORALINE PASTE



B.I. Resinkor Solder, which carries its own flux, is supplied in 9-in. sticks, in coils of 1 to 20 S.W.G. weighing up to 28 lbs., and all but the largest sizes can also be supplied on reels. For use with ordinary solder, B.I. Coraline Soldering Paste is excellent. It gives off no spray or fumes, does not run or dry, and is very economical, as only a trace is required. Sold in tins from 1 oz. to 7 lbs.

BRITISH INSULATED CABLES LTD.  
Cable Makers and Electrical Engineers  
PRESCOT, LANCS.

Telephone No. : PRESCOT 6571

London Office : SURREY HOUSE, EMBANKMENT, W.C.2  
Telephone No. : Temple Bar 7722.

## 1937 MIDWEST

Magnificent alike in its conception, design and performance, this the latest Midwest Model X-18 High Fidelity Receiver brings the world to your fire-side. With its 6 TUNING RANGES it gets "Everything on the Air." Its distinctive features in circuit design are not just "talking points," as a comparison will prove, but basic advantages which will assuredly appeal to "Wireless World" readers and all who appreciate Studio or Concert Hall quality of performance in the home.



18 VALVE DE LUXE CHASSIS

FREE ART CATALOGUE DEMONSTRATIONS

40 pages, fully illustrated, giving particulars of Midwest 11, 14, 16, and 18 valve models. at our showrooms Mondays to Saturdays from 9 a.m. to 8 p.m. (except Tuesdays, 9 a.m. to 6 p.m.)

★ THE ONLY ALL-WAVE RECEIVER COVERING 4½ to 2,400 METRES

MIDWEST RADIO Ltd.

Available in Chassis form complete with matched valves and 12" speaker or in Console Cabinet.

Showrooms and Factory:  
16, Old Town, Clapham, London, S.W.4.

FIFTH EDITION

—Revised and Enlarged

## HANDBOOK of TECHNICAL INSTRUCTION for WIRELESS TELEGRAPHISTS

By H. M. DOWSETT, M.I.E.E., F.Inst.P., M.Inst.R.E.

Provides a complete theoretical course for students wishing to qualify for the Postmaster-General's Certificate of proficiency. Additional chapters included in this new edition are those on Echo Sounding Apparatus, Short-Wave Marine Transmission and Reception, Marine Telephony and Band Repeaters—all recent developments which concern the sea-going operator. All sets in general use (Marconi, Siemens, Radio Communication) are also described.

PRICE 15/- net. By post 15/9

Obtainable from all leading booksellers or direct from the publishers ILIFFE & SONS LTD., DORSET HOUSE, STAMFORD STREET, LONDON S.E.1

W.W.90

**JUST PUBLISHED**

# THE COMPLETE 9.5-mm. CINEMATOGRAPHER

By Harold B. Abbott

CLOTH BOARDS  
Size 7½" x 5", 260 pages  
PRICE 5/- net  
By post 5/4

From all leading Booksellers, or  
direct from the Publishers

Because of advances in film technique this book supersedes the author's former successful book "Motion Pictures." The beginner can take it up and find everything he needs to know in order to make successful pictures.

How to choose a 9.5-mm. ciné camera; how to expose correctly; what to take and how to take it; full instructions on developing and printing; methods of planning; editing, titling and trick effects; the art of projection; methods of operation, screen and picture sizes; giving an efficient show; all these are explained in detail.

There are nearly 100 illustrations. The book, packed with useful information, is a comprehensive course of instruction in amateur cinematography.

ILIFFE & SONS LTD., DORSET HOUSE, STAMFORD STREET, LONDON, S.E.1

## FOUNDATIONS of WIRELESS

*A Book of  
First Principles  
for the  
Wireless  
Enthusiast*

PRICE 4/6 NET  
By Post 4/11

Issued in conjunction with  
"THE WIRELESS WORLD"  
and published by the proprietors—

By A. L. M. SOWERBY, M.Sc.

An Elementary Text Book on Wireless Receivers

"Foundations of Wireless," based on a series of articles which appeared in "The Wireless World," covers the whole field of wireless from the simplest electrical phenomena to the construction of a modern set, and all the vital points in receiver design are treated in full detail. Chapters are devoted to direct and alternating currents; typical circuits; the properties of inductance and capacity; the nature of high frequency currents; the tuned circuit; and amplification by the valve.

Eleven of the eighteen chapters of the book deal with the discussion of receivers, in which the whole process of design is reviewed stage by stage to the finished article.

Special attention is paid to the important subject of tuned circuits and band-pass filters, on the correct design of which the performance of every type of set ultimately depends. Moreover, the process of detection, so often imperfectly understood, is clearly explained.

ILIFFE & SONS LTD., DORSET HOUSE, STAMFORD STREET, LONDON, S.E.1



# The Wireless World <sup>4<sup>D</sup></sup>

**THE PRACTICAL RADIO & TELEVISION JOURNAL**

Friday, July 9th, 1937

**free!** Blueprints of splendid sets



Colvern have specially designed two brilliant "up to the minute" sets and blueprints of them are being given away free (except for small postage charge). Using the new

**COLPAK**

(Made under licence from patentee, Hans Vogt)  
 these sets offer the very latest in efficiency, precision and design. Send for blueprints to-day!  
 To COLVERN LTD., Romford, COLPAK CLASS B  
 Essex. Please send me full details and blueprint of the A.C. MAINS SET \*  
 \* Strike out name of blueprint not required.

Name .....

Address .....

.....

If you would like a copy of our Ferrocart booklet, please put a X here. ....

"...but they MUST be **T.C.C. WET ELECTROLYTICS**"

The Telegraph Condenser Co. Ltd., Wales Farm Road, N. Acton, W.3.

CA2200

Everything for **QUALITY RECEPTION**

**HAYNES RADIO**

Everything for the **TELEVISION CONSTRUCTOR**

Duophase amplifier 6-watt, Duophase amplifier 6-watt for P.M. speaker, Duophase amplifier 14-watt, Duophase amplifier 14-watt (constructor's model), Duophone amplifier circuits, Duophase intervalve coupling, gramophone amplifier 6-watt, gramophone amplifier 14-watt, 1-H.F. tuner unit, 2-H.F. tuner unit, all-wave tuner unit, shortwave converter, table model receivers, radiogramophones, schools receivers, baffle boards, loud speakers, volume controls, mains transformers, smoothing and filter chokes, output transformers

Originators of the Quality Receiver and Quality Radiogramophones.

Demonstration night every Friday, 7.30—9.30 p.m.

Time base transformers, time base units, H.T. transformers up to 6,000 volts, heater transformers, smoothing and voltage regulating equipment, high voltage rectifiers, cathode ray tubes and holders with protecting front screen, converter units for speech reception, complete apparatus for vision receiver construction, chassis and special baseplates.

The most attractive development ever presented to the radio enthusiast.

Have you the Haynes Quality Booklet? 1936-37 Edition. Free on request. Howard 1171.

**HAYNES RADIO LIMITED, QUEENSWAY, ENFIELD, MIDDLESEX.**

# "Wireless World" TELEVISION RECEIVER

## Complete PILOT AUTHOR KITS

	KIT "A" <i>less Valves</i>	KIT "B" <i>with Valves</i>
Vision Receiver Unit	£6 . 8 . 6	£11 . 11 . 0
Vision Receiver Power Pack Unit	£4 . 5 . 0	£5 . 13 . 0
Time Base Unit	£7 . 13 . 9	£11 . 13 . 9
Ultra S.W. Quality Receiver Unit	£1 . 7 . 6	£6 . 4 . 0
Sound Receiver Power Pack Unit	£7 . 19 . 9	£9 . 2 . 9
High Voltage Unit	£11 . 14 . 0	£13 . 14 . 0

Ediswan Cathode Ray Tube, Type 12W with Base ... £15 . 15 . 0

Goodman's Speaker with Transformer, W.W.T. ... £3 . 12 . 6

Peto-Scott Cabinet and Chassis Framework in polished Walnut finish with plate glass window for Cathode Ray Tube, as illustrated in "The Wireless World" £4 . 15 . 0

(Carr. 5/- extra if supplied separately).

**COMPLETE KIT "A"** Comprising all above, less Cathode Ray Tube and Valves ... £50 . 16 . 0

**COMPLETE KIT "B"** Comprising all above and including specified Valves and Ediswan Cathode Ray Tube ... £82 . 1 . 0

Convenient Easy Payment Terms on any or all of the above are available.

Send for detailed and priced list of parts.

# THE WORK BEHIND A PILOT AUTHOR KIT

It must have been about twelve years ago when we invented the "Author Kit," and a "Pilot Author Kit" by Peto-Scott is much more than it seems. You can, if you wish, collect the specified parts by going from shop to shop—a little bit here, a little bit there—and it will cost you a lot of trouble. We originated the idea of collecting the parts for you, but we did not let our responsibility cease at that point.

A collection of parts is only useful if each unit works properly. The "Pilot Author Kit" contains the components specified by the designer, but we have tested them to make sure that your completed receiver works, and works well. The holes in the chassis coincide with the holes in the components; the right sizes of screws will be found in the box.

The whole thing comes to you adequately packed—and complete! You just follow the instructions and you have what the designer intended. And it costs you no more than if you did the job yourself. The present example is the "Wireless World" Television Receiver. Television is nothing new to Peto-Scott, and we are more favourably equipped than any other firm to supply your needs for this new development. At the same time, we would particularly draw your attention to the Peto-Scott Television Receiver, with a performance not yet surpassed. Nothing has been scamped in design or materials. For the home constructor it is a value-for-money proposition without equal.

### TELEVISION DEMONSTRATIONS

are given at our West End Branch,

62, HIGH HOLBORN, LONDON, W.C.1

## PETO-SCOTT

Co., Ltd.

77, CITY ROAD, LONDON, E.C.1

Telephone: Clissold 9875-6-7.

62, HIGH HOLBORN, LONDON, W.C.1

Telephone: Holborn 3248.

# Peto-Scott TELEVISION RECEIVER

## Complete HOME CONSTRUCTOR KITS

KIT "A" KIT "B"  
*less Valves with Valves*

Sound and Vision Receiver Unit	£6 . 17 . 6	£15 . 12 . 6
Time Base Unit - Receiver Power Pack Unit	£7 . 15 . 0	£13 . 12 . 6
Time Base Power Pack Unit	£3 . 10 . 0	£4 . 0 . 0
Time Base Power Pack Unit	£3 . 15 . 0	£4 . 10 . 0
Tube Exciter Unit	£4 . 17 . 6	
Ediswan 12in. Cathode Ray Tube, Type 12W	£15 . 15 . 0	
Chassis Framework	£1 . 7 . 6	

(Carr. 3/6 extra if supplied separately.)

**COMPLETE KIT "A"** comprising all above, less Valves and Cathode Ray Tube £28 . 2 . 6  
Set of 22 Valves and Ediswan 12in. Cathode Ray Tube, Type 12W ... £31 . 5 . 0

**COMPLETE KIT "B"** If Complete Kit "B," comprising all above and including 22 Valves and Ediswan 12in. Cathode Ray Tube, Type 12W, with comprehensive instructions, is purchased at once, we deliver for

# 55 GUINEAS

High fidelity Speaker supplied to choice, extra. **READY ASSEMBLED INSTRUMENT**, ex Cabinet only, **60 Gns.**

The Time Base Unit, Receiver Power Pack Unit, and Tube Exciter Unit may be used in conjunction with any design of Sound and Vision Receiver.

Illustrated Literature and Price List free on request.

Convenient Easy Payment Terms are available on all the above items.

Dealers, please write for terms.

EXCLUSIVELY  
SPECIFIED

by the  
**'WIRELESS  
WORLD'**

for their

## Television Receiver

# GOODMANS

Type "W.W.T." P.M. LOUDSPEAKER

Supplied with separate £3 : 12 : 6  
Heavy Duty Transformer inclusive

N.B.—The "W.W.T." Loudspeaker which has been specially designed for the "W.W." Television Receiver to avoid magnetic inter-action with the Cathode Ray tube, should not be confused with GOODMANS Standard 10" Auditorium Reproducer of similar outward appearance.

GOODMANS INDUSTRIES, LTD.

Lancelot Rd., Wembley, Middx. Phone: Wembley 4001 (5 lines)



**FREE ART CATALOGUE** 40 pages, fully illustrated, giving particulars of  
**DEMONSTRATIONS** Midwest 11, 14, 16, and 18 valve models.

at our showrooms Mondays to Saturdays from 9 a.m. to 8 p.m. (except Tuesdays, 9 a.m. to 6 p.m.).

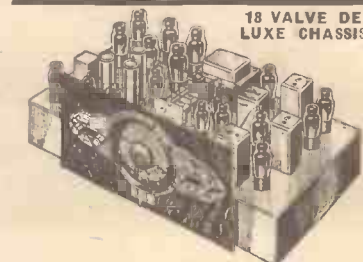

**THE ONLY ALL-WAVE RECEIVER**  
COVERING 4½ to 2,400 METRES  
Available in Chassis form complete with matched valves and 12" speaker or in Console Cabinet.

**MIDWEST RADIO Ltd.**

Showrooms and Factory:  
16, Old Town, Clapham, London, S.W.4.  
Phone: MACaulay 5005.

SECOND EDITION

—Completely Revised

# RADIO DATA CHARTS A SERIES OF ABACS

Providing most of the essential Data required in receiver design.

By R. T. BEATTY, M.A., B.E., D.Sc.

PRICE 4/6 net

BY POST 4/10

From all leading booksellers, or direct from the Publishers.  
Published from the offices of "THE WIRELESS WORLD,"  
DORSET HOUSE, STAMFORD STREET, LONDON, S.E.1  
W.W.93

Mention of "The Wireless World," when writing to advertisers, will ensure prompt attention.

# The Wireless World

THE PRACTICAL RADIO JOURNAL  
27<sup>th</sup> Year of Publication

No. 932.

FRIDAY, JULY 9TH, 1937.

VOL. XLI.

No. 2.

Proprietors: ILIFFE & SONS LTD.

Editor:  
HUGH S. POCOCK.

Editorial,  
Advertising and Publishing Offices:  
DORSET HOUSE, STAMFORD STREET,  
LONDON, S.E.1.

Telephone: Waterloo 3333 (50 lines).  
Telegrams: "Ethaworld, Sedist, London."

COVENTRY: Hertford Street.  
Telegrams: "Autocar, Coventry." Telephone: 5210 Coventry.

BIRMINGHAM:  
Guildhall Buildings, Navigation Street, 2.  
Telegrams: "Autopress, Birmingham." Telephone: 2971 Midland (4 lines).

MANCHESTER: 260, Deansgate, 3.  
Telegrams: "Iliffe, Manchester." Telephone: Blackfriars 4412 (4 lines).

GLASGOW: 26B, Renfield Street, C.2.  
Telegrams: "Iliffe, Glasgow." Telephone: Central 4357.

PUBLISHED WEEKLY. ENTERED AS SECOND-CLASS MATTER AT NEW YORK, N.Y.

Subscription Rates:  
Home, £1 1s. 8d.; Canada, £1 1s. 8d.; other countries, £1 3s. 10d. per annum.

As many of the circuits and apparatus described in these pages are covered by patents, readers are advised, before making use of them, to satisfy themselves that they would not be infringing patents.

## CONTENTS

	Page
Editorial Comment .. .. .	23
The Wireless World Television Receiver—II. Constructing the Time Base .. .. .	24
The Case for Class "B" Restated Unbiased .. .. .	28
Current Topics .. .. .	30
The Evolution of the Phon. . . . .	31
Listeners' Guide for the Week .. .. .	32
Practical Hints and Tips .. .. .	33
Letters to the Editor .. .. .	34
Listening in Europe .. .. .	36
Broadcast Brevities .. .. .	37
On the Short Waves .. .. .	39
Random Radiations .. .. .	40
Television Programmes .. .. .	41
Recent Inventions .. .. .	42

## EDITORIAL COMMENT

### Radio Propaganda

#### Justification for Jamming

**W**E referred briefly last week to the growing concern of the Government over the anti-British propaganda which has for so long been the subject of broadcasts from certain Continental stations.

These broadcasts, as readers are aware, are not confined to the language of the country of origin but are frequently made in languages of the countries to whom the propaganda is being directed. Official representations to the governments concerned may have some effect, but do not seem to produce a satisfactory cessation of the offending transmissions. It cannot be supposed that this country will much longer remain passive in the matter, and whilst we do not for one moment believe that the Government would stoop to indulge in similar offensive propaganda by way of retaliation, we believe that active measures are being taken to provide for accurate news bulletins to reach British territories with a strength at least equal to that of the foreign propaganda, with the object of counteracting its effect.

#### Defence, Not Aggression

If we do not retaliate with reprisals in the form of aggressive propaganda of our own it is simply because it has always been the policy of this country to avoid the use of broadcasting for such purposes and to do all that has been in our power by peaceful persuasion to encourage others to follow this example.

Whilst we may not desire to be

aggressive, however, there is every justification for adopting a defensive attitude. The best means of defence would appear to be to make it impossible for foreign transmitters to invade British territory with unfriendly broadcasts. To do this would necessitate setting up a jamming station in those territories affected. These jamming stations would not be monopolising additional wavelengths; they would be so designed as to maintain their frequencies on the transmission frequencies of the foreign stations, whose transmissions in any case monopolise these wavelengths and make them unserviceable for other purposes in these territories.

#### A Matter for the Government

We recommended this alternative last year and said that this action could only be regarded as defensive and would surely be legitimate in the peculiar circumstances. On that occasion, too, we emphasised that in our view the matter was not one in which it would be fair to ask the B.B.C. to participate, and we questioned whether, in order not to disturb B.B.C. impartiality, it would not be proper for such efforts to be conducted by stations wholly unconnected with the B.B.C. organisation.

That any action of this nature should have to be contemplated is truly deplorable. Broadcasting offers such wonderful opportunities for contributing to a better understanding between nations that to find it being employed as a means of provoking unrest and mistrust is all the more regrettable, and we can only hope it is but a passing phase and that international broadcasting is destined in the future to perform a nobler service to mankind.

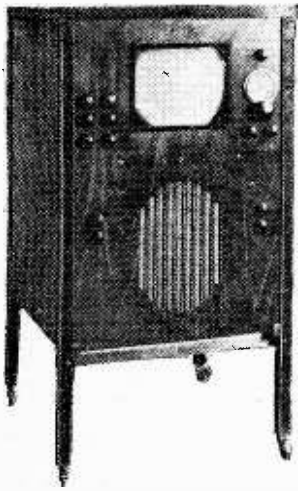

# The Wireless World

# Television

*FULL details were given last week of the vision receiver and its power unit and in this article the time-base is described. It is designed for a tube with electrostatic deflection and has balanced outputs, the saw-tooth oscillators being gas-filled triodes*

## II.—CONSTRUCTING THE DOUBLE TIME - BASE

**S**ECOND in importance only to the receiver is the time-base which must provide suitable voltages for deflecting the beam in the cathode-ray tube and so permit the construction of the raster. The CR tube requires about 1,000 volts between its deflection plates to move the spot from one side of the screen to the other, and the wave form of the time-base output must rise steadily and linearly with time from zero to its maximum in nearly 1/50 second for frame scanning and 1/10,125th second for line scanning, and having reached its maximum value it must fall back to zero in as short a time as possible. The total time of each rise of voltage and its subsequent fall back to zero must be 1/50th second and 1/10,125th second for the frame and line scans respectively.

In general it is not possible to generate a true saw-tooth waveform with a voltage as great as 1,000 volts p-p directly. It is necessary to generate a lower voltage, and then to amplify it and in view of the type

of waveform resistance coupled stages are practically essential. In spite of the saw-tooth wave of each scan being of constant "frequency," the amplifier must be capable of dealing with a wide band of frequencies if distortion is not to be introduced. Actually, to handle a perfect saw-tooth wave with an instantaneous fall from maximum to zero voltage, or "fly-back," the frequency response curve of the amplifier would have to be flat from the frequency of repetition of the wave to infinity, and there would also have to be zero phase distortion over this range.

### Balanced Output

In practice, the fly-back time is finite and of the order of 5 per cent. of the scan time. When this is so the amplifier need be capable of dealing with frequencies from the fundamental time-base frequency to about ten or twenty times this value only. Since phase shift is important this implies a good frequency

characteristic. The frame scanning amplifier must thus deal with frequencies of some 50 c/s to 500/1,000 c/s, and the line scanning amplifier with frequencies of about 10,000 c/s to 100,000/200,000 c/s.

Not only must the amplifier give a large output and handle a wide range of frequencies, but the output must be balanced to earth. With electrostatic deflection severe distortion of the shape of the picture occurs if this condition is not complied with; instead of a rectangular raster being obtained, unbalanced outputs result in a raster shaped like a trapezium. An unbalanced output is obtained when one of the two output terminals is maintained at earth potential, and the potential of the other varies above and below earth. With a balanced output neither output terminal is earthed, and at any instant the two output terminals are at equal and opposite potentials with respect to earth. The familiar push-pull amplifier is an example of a balanced amplifier, and a form of push-pull is actually employed in the time-base output circuits.

The complete time-base circuit appears in Fig. 2, and V4 is the frame scanning oscillator and is a gas-filled triode. The valve is initially non-conductive and the capacity formed by C11 and C12 in series charges through R17 and R18. The voltage across these condensers and hence the anode voltage of V4, consequently rises at a rate dependent upon the HT voltage and the value of R17. When the voltage rises to a certain value, dependent upon the grid bias of V4 and

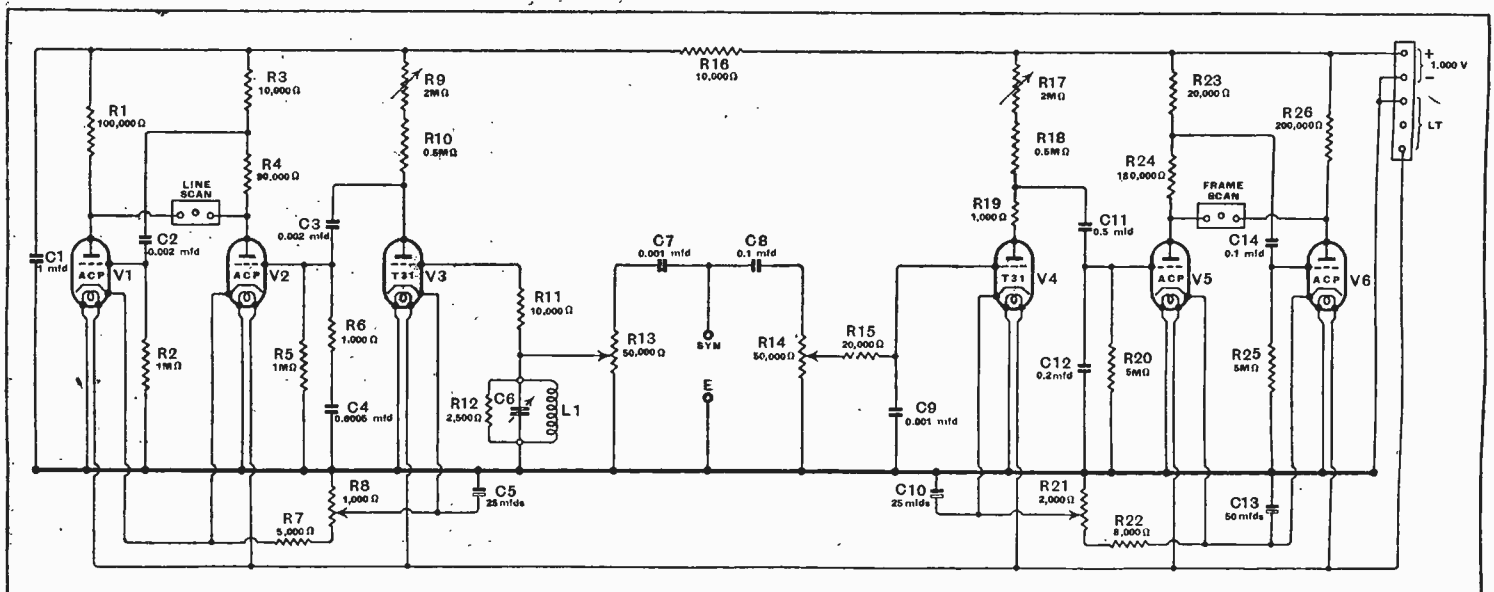
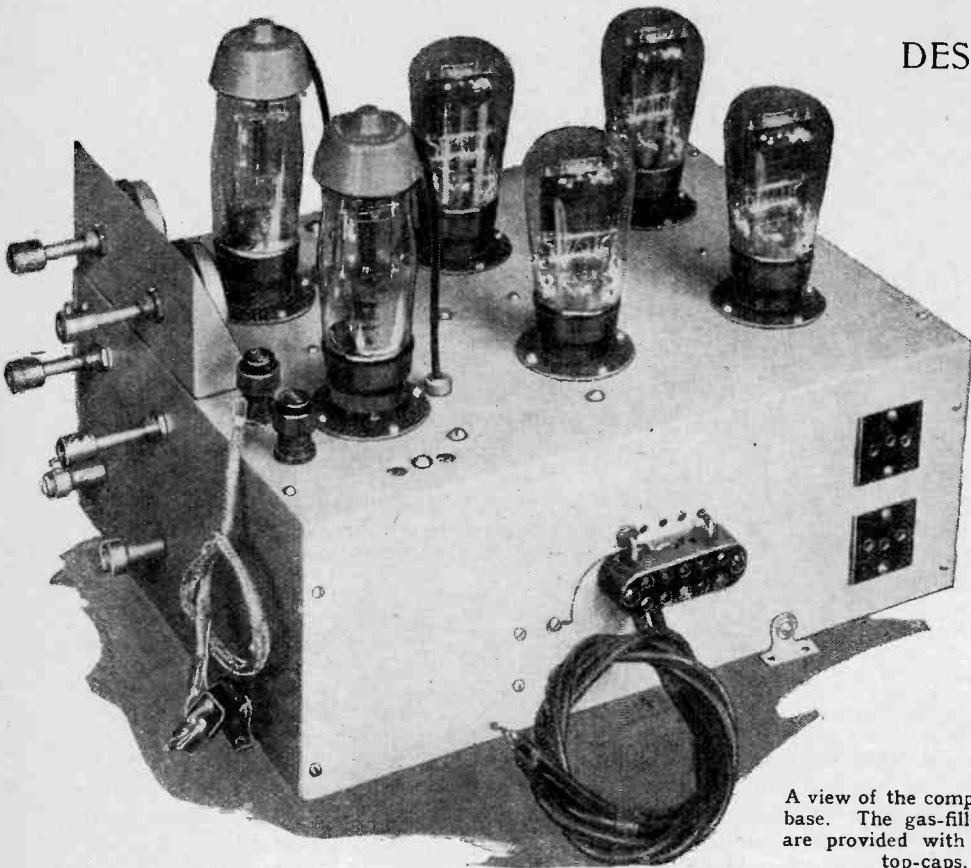

Fig. 2.—The complete circuit diagram of the time-bases is shown here. Each of the two consists of a gas-filled triode oscillator and one triode amplifier with a triode phase-reverser for balanced operation.

DESIGNED BY W. T. COCKING

# Receiver



A view of the complete time-base. The gas-filled triodes are provided with insulated top-caps.

HT supply of some 1,000 volts is needed.

The two amplifier valves are biased by a common cathode resistance comprising R21 and R22. The cathode of the gas-filled triode V4 is returned to the slider on R21, and a portion of the bias of V5 and V6 is used also for V4.

## The Filter Circuit

The line time-base is similar and comprises the gas-filled triode V3, the amplifier V2 and the phase-reverser V1. The resistance R6 is included in series with C4 to accelerate the fly-back speed, and a filter circuit is included in the grid circuit of V3. This assists in the sync separation and appreciably improves the line synchronising, especially when interference is present.

The filter comprises the resistances R11 and R12, and the tuned circuit L1, C6, and it is in reality a crude form of band-pass filter. The main filtering is accomplished by L1 and C6, the circuit being tuned to the line frequency of 10,125 c/s. The resistance R11 is included in order to ensure a fairly high resistance grid circuit for the gas-filled triode V3, since experience shows that if the DC resistance of the grid circuit is too low V3 operates irregu-

determined by the setting of R21, V4 becomes conductive and rapidly discharges the condensers. The resistance R19 is included merely to limit the discharge current to a safe value for the valve.

This is the action without synchronising. In practice, however, synchronising is essential, and the output of the sync separator in the vision receiver is applied to the terminals shown. The mixture of line and frame sync pulses flows through the two parallel circuits C8, R14 and C7, R13, and the desired amplitudes are taken off these potentiometers. A simple filter circuit comprising R15 and C9 is connected between R14 and the grid of V4, so that only the frame sync pulses are applied in any amplitude to the valve.

## The Effect of the Sync Pulses

When in normal operation, the action is now as described above, but while the anode voltage of V4 is still rising, and before it has reached a high enough value to initiate the discharge in V4, the frame sync pulse arrives and drives the grid of V4 positive. This starts the discharge at a definite time. The net result is that the time of each discharge is determined by the frame sync pulses and the oscillator is maintained at the correct frequency. The varying voltage across C12 is applied to the triode amplifier V5 and about 500 volts p-p is developed across its anode resistances R23 and R24, and is applied to one deflecting plate of the CR tube. One-tenth of this voltage, that developed across R23 is applied to the grid of V6 through C14 with the result that a further 500 volts p-p is developed across the coupling resistance R26 and applied to

the other vertical deflecting plate of the tube. Owing to the phase-reversal in this valve, its output is in opposite phase to that of V5, and so the balanced output is secured. The use of this additional valve V6 not only enables balanced operation to be obtained, but it also permits the required output being obtained with about one-half the HT voltage which would otherwise be necessary. Even so, an

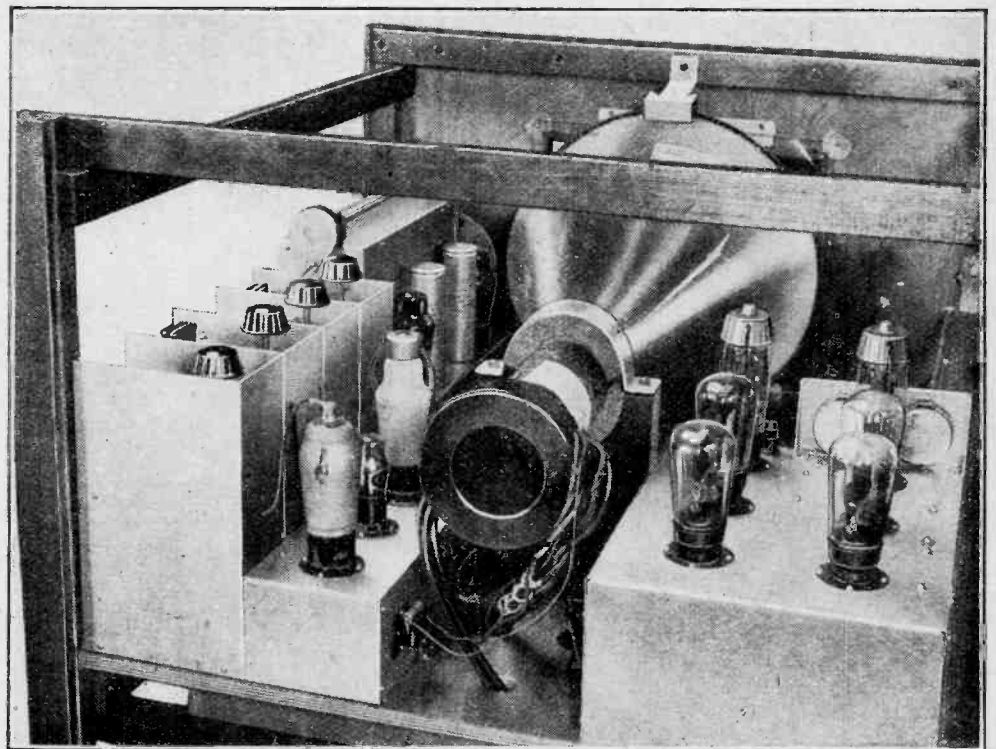

The time-base is shown here to the right of the tube.

The Wireless World Television Receiver—

lary. If the grid circuit resistance is not high enough there is an appreciable variation in the starting times of the lines, and a consequent reduction of the picture definition.

A very important point lies in the shunting resistance R12 to the tuned circuit. This must be of quite low value for a satisfactory performance, low enough, in fact, to make the tuned circuit non-oscillatory. If this resistance has too high a value the tuned circuit is oscillatory, which means that any sudden change in the voltage applied to it makes the circuit oscillate for a few cycles at its natural frequency. This natural frequency is slightly different from the normal resonance frequency determined by the inductance and capacity, for it is affected also by the circuit resistance. Now the sync pulses and also the grid current of V3 are of an ideal form for kicking L1, C6 into oscillation and such oscillation has a very detrimental effect upon the operation of the time-base.

Actually, L1 has an inductance of the order of 0.25 H and C6 is about 0.001µF. In order to make the circuit non-oscillatory, R12 must not be greater than 2,500 ohms. With these values the filter functions very well indeed, and materially improves the stability of synchronisation.

This time-base does not need detailed explanation since it is essentially the same as the frame time-base, the differences

THE LIST OF PARTS FOR THE TIME-BASE

Certain components of other makes but of similar characteristics may be used as alternatives to those given in the following list.

Fixed Condensers:

- 1 0.0005 mfd., mica C4 Dubilier 690W
- 2 0.001 mfd., mica C7, C9 Dubilier 690W
- 2 0.002 mfd., 5,000 volts DC test, C2, C3 Dubilier 680
- 1 0.1 mfd., 1,500 volts working, C14 Dubilier 950A
- 1 0.5 mfd., 1,500 volts working, C11 Dubilier 950A
- 1 1 mfd., 1,000 volts working, C1 Dubilier 950A
- 1 0.1 mfd., tubular, C8 Dubilier 4523
- 1 0.2 mfd., tubular, C12 Dubilier 4425/S
- 2 25 mfd., 25 volts, electrolytic, C5, C10 Dubilier 3016
- 1 50 mfd., 50 volts, electrolytic, C13 Dubilier 3004
- 1 Pre-set double 0.0009 mfd. C6 Hunt's 3288

Resistances:

- 1 2,500 ohms, ½ watt, R12 Erie
- 2 10,000 ohms, ½ watt, R3, R11 Erie
- 2 20,000 ohms, ½ watt, R15, R23 Erie
- 2 1 megohm, ½ watt, R2, R5 Erie
- 2 5 megohms, ½ watt, R20, R25 Erie
- 1 5,000 ohms, 1 watt, R7 Erie
- 1 8,000 ohms, 1 watt, R22 Erie
- 2 0.5 megohm, 1 watt, R10, R18 Erie
- 2 1,000 ohms, 2 watts, R6, R19 Erie

- 1 10,000 ohms, 3 watts, R16 Erie
- 1 90,000 ohms, 3 watts, R4 Erie
- 1 100,000 ohms, 3 watts, R1 Erie
- 1 180,000 ohms, 3 watts, R24 Erie
- 1 200,000 ohms, 3 watts, R26 Erie

Potentiometers, non-graded:

- 1 1,000 ohms, wire-wound, R8 Reliance "TW"
- 1 2,000 ohms, wire-wound, R21 Reliance "TW"
- 2 50,000 ohms, R13, R14 Reliance "SG"
- 2 2 megohms, R9, R17 Reliance "SG"

6 Valve holders, 5-pin (7-pin type fixing) Clix Chassis Mounting Type.

- 2 Extension control outfits Eddystone 1008
- 4 Shaft couplings, ¼ in. Bulgin
- 2 Plugs and sockets, 3-pin Belling-Lee 1119
- 2 Insulated valve top connectors Bulgin P92
- 1 Connector, 5-way Bryce 5C4
- 1 Choke 0.25 H B.T.S.
- 2 Terminals, ebonite shrouded, Syn. E.

Chassis

- Sound Sales
- Miscellaneous: Peto-Scott
- Paxolin bracket and strip, wire, systoflex, screws, etc.

Valves:

- 4 AC/P, 2 T31 Mazda

being merely in the values of components necessitated by the much higher operating frequency. The unit as a whole consumes about 15/20mA. at 1,000 volts for HT and some 8 amperes at 4 volts for LT. The HT supply is taken from the high-

voltage unit which will be described later, but the LT comes from the vision receiver power pack described last week.

Constructionally there is little to say about the time-base, for all components are assembled on the underside of the

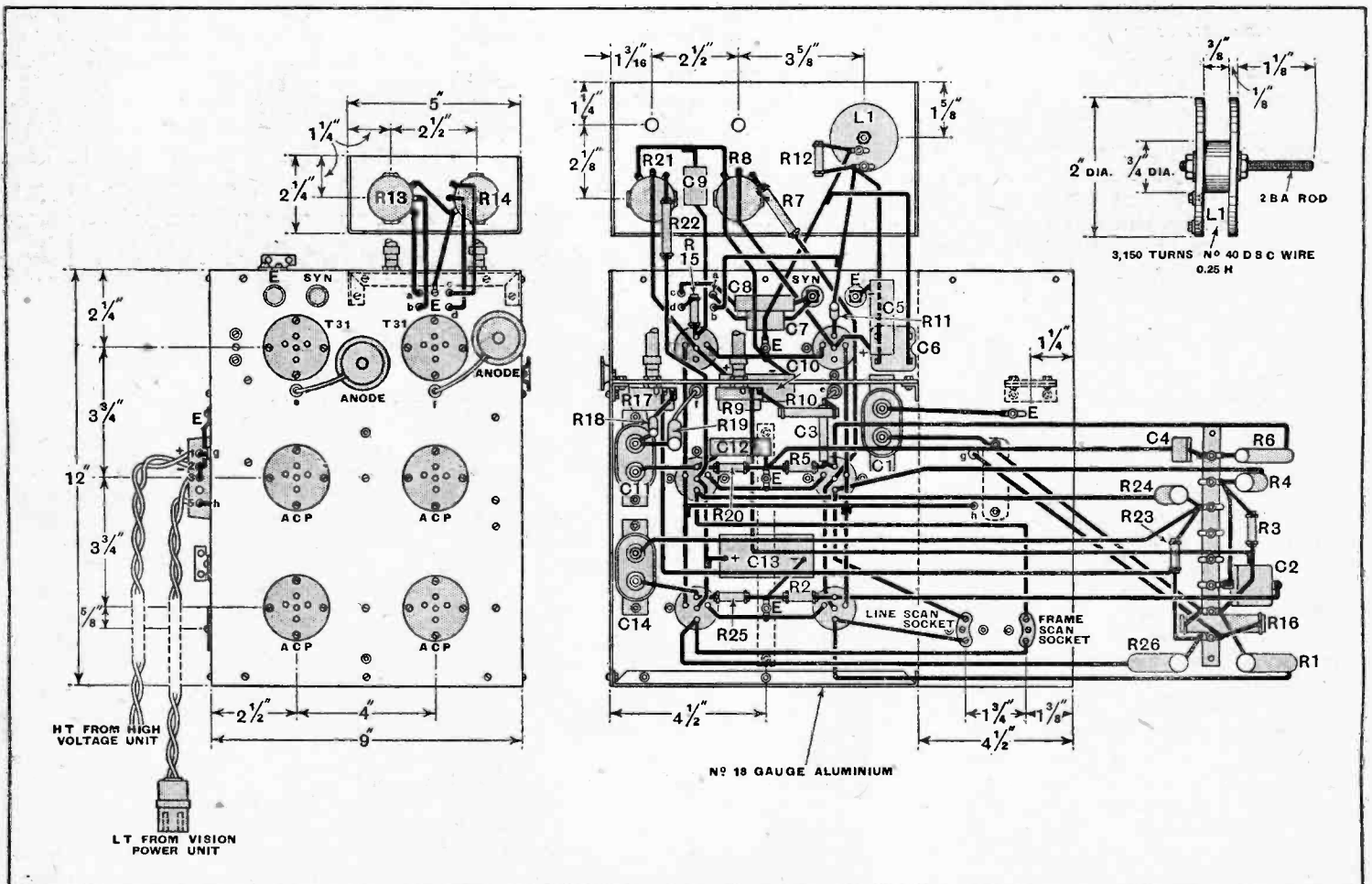

Full constructional and wiring details of the time-base are given here.

The Wireless World Television Receiver—chassis and everything is quite straight-forward. Owing to the high voltage employed, however, care must be taken to see that good insulation is obtained and

picture in the horizontal and vertical directions respectively while R9 and R17 control the time-base frequencies. The remaining controls R13 and R14 enable the amplitudes of the line and frame synchro-

nising pulses to be varied; only very occasional adjustment is needed, and if it were desired to reduce the number of panel controls they could be arranged as pre-set controls adjustable internally.

[In the next instalment the design and construction of the high-voltage unit will be described in detail.]

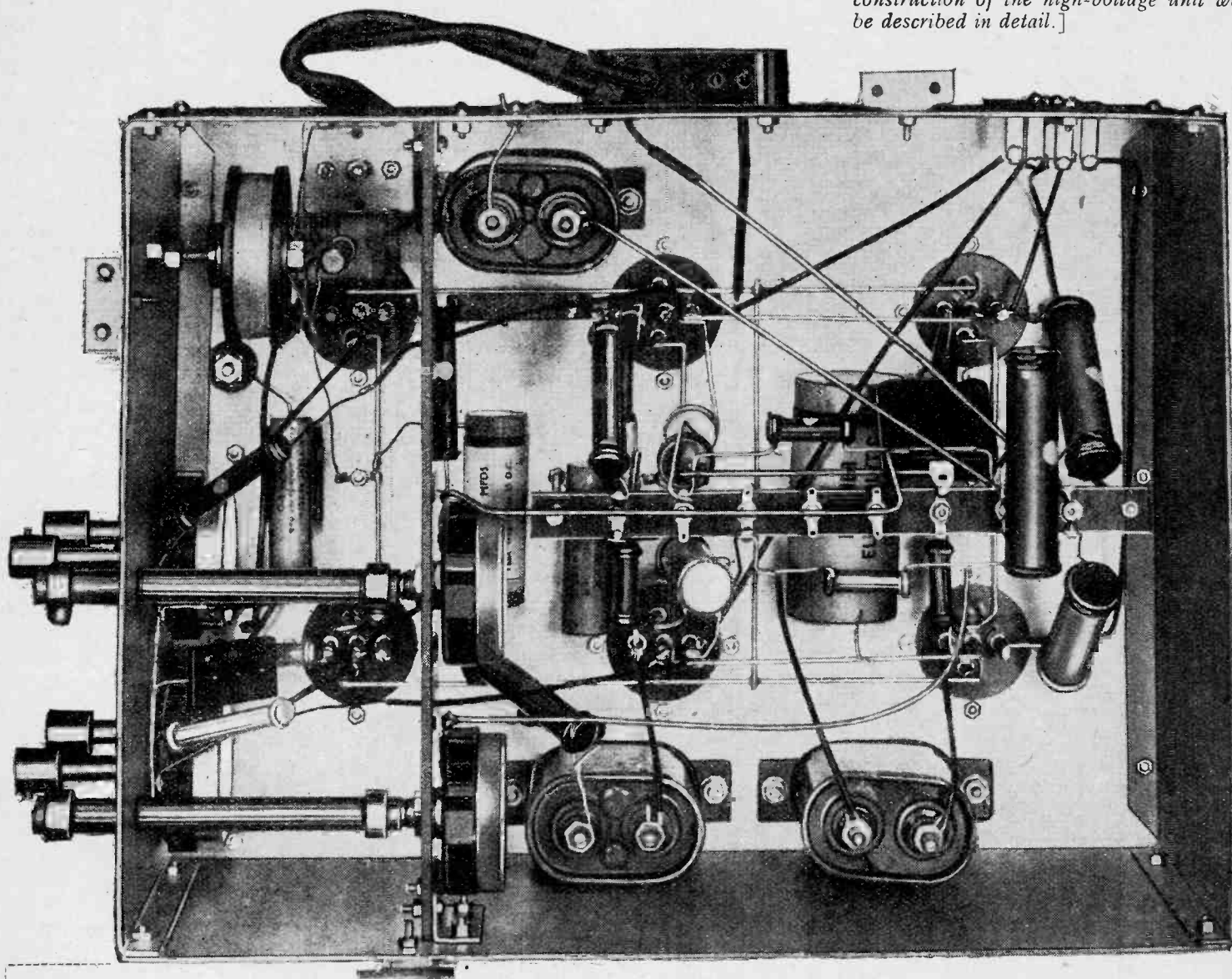

An underview of the chassis showing the insulating strips which carry R9 and R17 and form convenient anchorage points for wiring and resistances.

## AN UNUSUAL METER FAULT

### Beware of Steel Filings

that the clearances between the valve legs and chassis, and output sockets and chassis are adequate. If insufficient clearance is allowed a flash-over may occur. In order to avoid this, the valve holders specified are of a type permitting an unusually large clearance. In the wiring, too, care must be taken in insulation, and it is unwise to rely upon insulating sleeving for the high-voltage circuits. While it may be convenient to use this, it should be as an extra precaution, and not be relied upon for insulation. Run each high-potential wire so that bare wire could be used.

There are six controls on the time-base and they are brought out to the panel by means of extension rods. The potentiometers R8 and R21 control the size of the

A NEW tester, combining milliammeter, voltmeter and ohmmeter, was received from the makers about three months ago. The meter was of the 1,000 ohms per volt type, its readings on the 100-volt, 250-volt and 1,000-volt ranges being on the low side, but just about within the tolerance given in a trade test report. It gave good service until recently, when the indicator began to stick at one particular spot on the dial and eventually would not move past this point. The instrument was removed from its case and an inspection made. The pointer itself appeared to meet no obstruction, and at first no apparent reason could be discovered for the trouble.

A light was then projected through the gap between coil and magnet. On looking very closely, an obstruction could be seen which had the appearance of a minute

hair. Attempts to move it failed at first, as great care was needed to avoid damage to the coil. Acting on the assumption that the obstruction might be a metal filing, a steel pin was inserted in an attempt to attract it. This experiment was successful and the filing, as it turned out to be, came out on the point of the pin.

The pointer was now quite free to move, but on test the readings were now lower than before. Testing with a two-volt accumulator, the reading was now low on the 10-volt range, showing only 1.8 volts. It would appear that this meter had been calibrated with the filing, causing an error but no actual obstruction to cause sticking. A few experiments were then made to correct the calibration, and eventually correct readings were obtained on the 10-volt range and a greater degree of accuracy on the higher ranges. W. G. G.

# The Case for Class "B"

## REFINEMENTS APPLICABLE TO THE NEGATIVELY BIASED SYSTEM

# Restated

By RICHARD H. McCUE

IN the second of two articles dealing with different aspects of push-pull amplification<sup>1</sup> "Cathode Ray" referred to the disadvantages of positive-grid Class "B" amplification, which at one time seemed likely to oust all other systems for giving high output with economy in battery-operated receivers, but which is now almost completely eclipsed by the type of QPP employing two balanced pentodes in a single glass envelope.

Although the present writer agrees that with the earlier types of zero-bias Class "B" valve it was exceedingly difficult to avoid that unpleasant form of distortion which became known as "Class 'B'

several advantages over the double-pentode system.

In the simple circuit shown in the accompanying diagram there are a number of details—all of them important—which perhaps have not been stressed sufficiently in the past. The triode detector valve, besides being adequately decoupled, *must* be parallel-fed to the driver stage. This may seem a dogmatic statement, but it is made as the result of experience. A grid stopper is included to keep any trace of RF from the driver valve. Secondly, it seems that the LP2-

a low-resistance potentiometer across the filament battery for fine adjustment of grid bias on the driver and Class "B" valves. This will allow a continuous variation over a range of two volts—more than sufficient to overlap the tapings on the grid-bias battery. The reason why a low-resistance potentiometer is specified is that it is necessary to keep the ohmic resistance of the Class "B" input circuit as low as possible. A 40- or 50-ohm potentiometer is suitable, and will impose but a light drain on the filament battery. Driver stages in battery-operated Class "B" systems are usually rather over-biased for reasons of economy, and it might be thought that when an LP2-

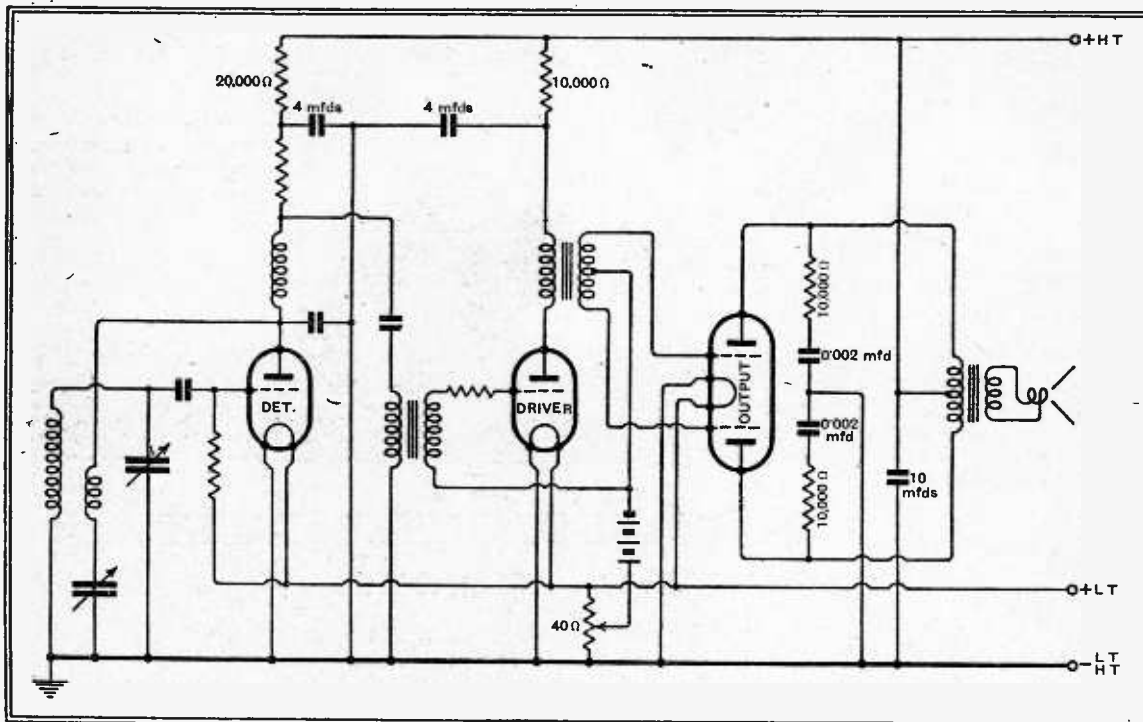

The various details that affect quality of reproduction in a Class "B" circuit are shown in this diagram.

edge" (particularly evident in the reproduction of piano music, and of transients generally), in his opinion the later type of double-triode, operating with a bias of several volts, undeservedly inherited this slur, and, in fact, has not attained the popularity which it merits. This negatively biased type of Class "B" valve is capable of a high standard of reproduction, provided a few simple precautions are taken. To the home constructor, at least, it would appear to offer

<sup>1</sup> "About Push-push," *The Wireless World*, April 23rd, 1937.

type of small power valve under any of its equivalent type-numbers (i.e., the type of small power triode with a short grid-base, low impedance and high mutual-conductance) is always preferable in the driver stage. This valve is also decoupled with a 10,000-ohm resistance and a 4-mfd condenser. It is generally emphasised that the driver transformer is the crux of the whole system. This may be so, but no difficulty has been experienced with any of several good makes; a 1 to 1 ratio is generally satisfactory.

Notice next an important refinement—

It should not now be necessary to use the relatively enormous fixed condensers sometimes shown connected across each half of the Class "B" output transformer—apparently in a last desperate attempt to avoid parasitic oscillation and other distortion. Instead, a simple tone-corrector consisting of a 10,000-ohm resistance in series with a 0.002 or 0.003-mfd. condenser may be connected from each anode to earth. As a final precaution, a 10-mfd. condenser is connected across the HT battery.

Neglecting any RF stages which might be included, such an arrangement of three valves in itself forms a "local station" receiver capable of giving a very satisfying quality of reproduction. It is very flexible and will work well with a low HT voltage—in which case a fine adjustment of grid bias can be obtained with the potentiometer; this is also used to compensate for the HT voltage falling as the battery ages, thus avoiding the "over-bias" distortion so often tolerated by battery-set users when the first bloom of their HT supply has faded. More overall amplification is available than with a QPP pentode stage,



**The Case for Class "B" Restated—**

and much higher maximum output. One last fact, rather beside the point, perhaps, but, nevertheless, of interest to battery-set users. The output of the "Wireless World" or any similar transverse-current microphone, when applied through its appropriate transformer to the first of the three valves shown in the diagram (the grid condenser being disconnected, of course, and the ends of the transformer secondary connected to the grid and to a suitable tapping on the bias battery), is just right for loading the Class "B" valve to full capacity. A similar outfit was used by the writer last summer for "PA" work at a good-sized garden fête. This may sound rather ambitious for a battery-operated amplifier, but with an anode voltage of 160 and a really efficient loud speaker with directional baffle the results were perfectly satisfactory—so much so that the use of the apparatus has been asked for again this year.

**BOOKS**

**The Superheterodyne Receiver.** By Alfred T. Witts. Pp. 182+vii. Third edition. Published by Sir Isaac Pitman and Sons, Ltd., London, W.C.2. Price 3s. 6d.

THE new edition of this book contains the material of its predecessors with extra matter bringing it up to date. The early chapters are devoted to the history of the superheterodyne, and a large section of the book describes, in an accurate and intelligible manner, the mode of operation of this type of receiver.

A number of modern commercial receivers are described in detail and the book concludes with a chapter on the television superheterodyne. This is necessarily somewhat sketchy, for it is almost a subject in itself, and in this chapter one of the few errors occurs. The frequency of the sound transmitter is given as 46.5 Mc/s instead of 41.5 Mc/s. As a result the subsequent remarks, although correct in themselves, are not directly applicable to present conditions. W. T. C.

THE third edition of *Servicing Superheterodynes*, by John F. Rider, is now available. An additional chapter has been included giving data on recent developments, and the list of intermediate frequencies has been brought up to date. The book is obtainable from Holiday and Hemmerdinger,

of Holmer Works, Dalefield, Bridge Street, Manchester, 3, and it is priced at 5s.

**La Radiodiffusion Puissance Mondiale.** By Arno Huth. Pp. 508. Published by Librairie Gallimard, 43, rue de Beaune, Paris.

THIS book is in five parts, of which the first is devoted to the birth and development of broadcasting, while the second deals

with the situation to-day and concludes with a chapter on television.

In the third part broadcasting conditions in the chief countries throughout the world are discussed. In the fourth broadcasting is looked at from the point of view of a public service and its influence from economic and social standpoints investigated. The book concludes with much useful information in tabular form and chapters on television and facsimile.

**Telephone Dial Tuning**

By G. E. CLATWORTHY

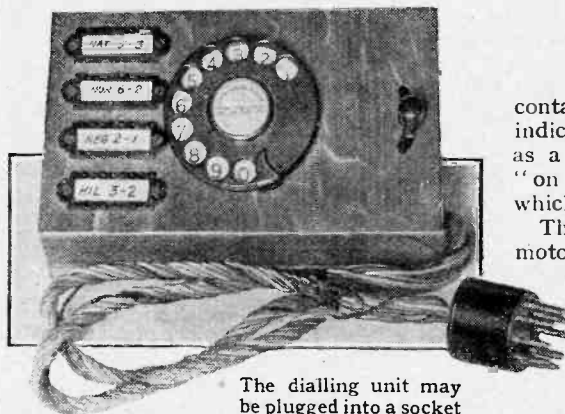

The dialling unit may be plugged into a socket mounted at any point remote from the receiver.

THE writer ventures to think that the following brief account of a system whereby an automatic telephone dial is used to control a receiver may be of interest to some readers of *The Wireless World*. The system is the subject of a provisional patent.

The dial is used to operate a relay consisting of seven banks of twenty-five contacts. The action of the relay is a continuous rotary one, and in this case the contacts are wired in groups of four, making every fifth position an "off" position. This allows for the selection of four stations. Another bank of

contacts are wired to light the appropriate indicator on the control panel which serves as a pilot light to show when the set is "on" besides indicating the station to which the circuits are tuned.

The relay supplies current to an electric motor through a system of metal strips in contact with a common busbar. A station is dialled and the relay supplies current to the motor through the selected strip contact. As the motor runs it moves a "carriage" along the busbar, lifting each contact strip from the busbar until it comes to the one supplying the current. When this is lifted the motor stops, and as the strips are adjusted to coincide with the selected stations, the receiver is thus tuned through a chain of gears to the desired programme.

Dialling an "off" position results in the motor being reversed, the tuning condenser returned to zero, and the receiver switched off.

The receiver in use at present is a two-HF

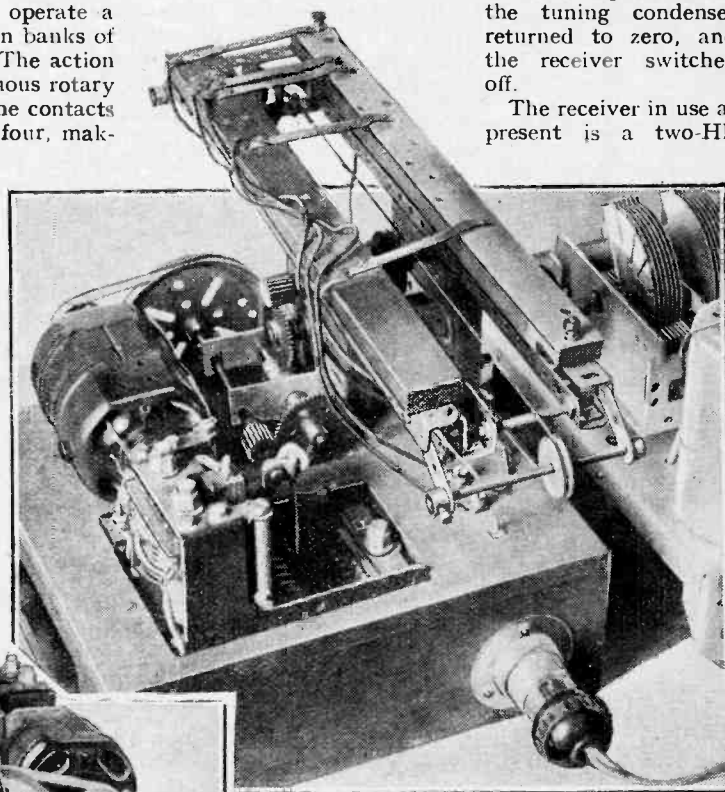

Below is shown the receiver with the remotely controlled mechanism whereby the tuning condenser shaft is rotated; on the right is another view of the actuating mechanism.

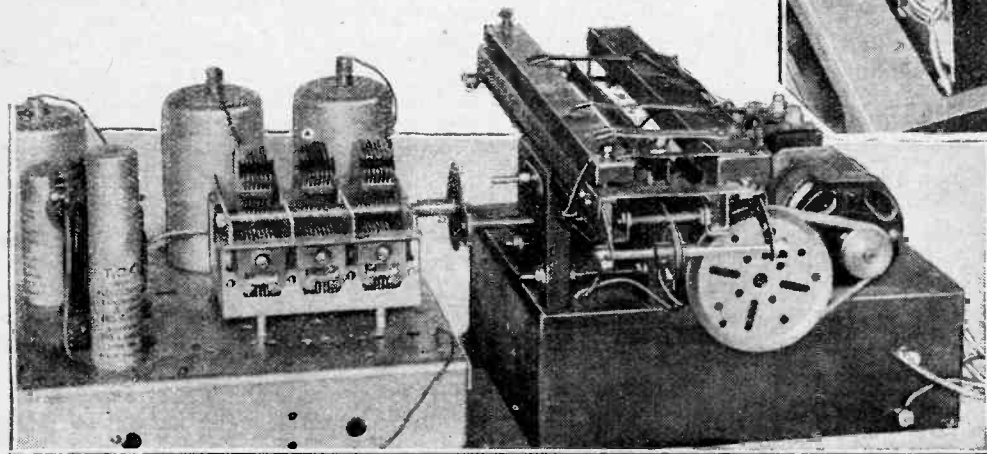

"quality" set, and is "dialled" from any room provided with a socket for the control panel.

From the point of view of convenience, it would appear to be difficult to improve upon this system; by a spin of the dial the desired station may be tuned-in in comfort from one's favourite armchair.

# UNBIASED

## Wireless and the Police

By FREE GRID

IN all probability most people turn automatically, as I do, to the police news as soon as they have finished perusing the racing page of their favourite daily. If so, they cannot help having noticed, from time to time, the apparent backwardness in the education of our legal luminaries who are constantly expressing ignorance of facts known to the ordinary man for years. Only recently a learned judge, who has been married for years, demanded to know, "What is a loud speaker?"

I believe that this strange state of affairs is due to the fact that, as the legal luminaries say, the Law "takes no cognisance of a happening until it is officially informed of it." Until lately, however, I must confess that I never realised that this attitude of mind extended right through our judicial system down to the humblest police constable, but that it *does* do so I have recently had very convincing and personal proof.

It so happened that a few weeks ago I had occasion to visit a London theatre, and, as is my custom, took along a small pocket headphone set with me in order to keep my usual watchful eye—or rather ear—on the doings of the B.B.C. while the play was in progress. The evening was exceedingly oppressive, and after the show was over I took a stroll in one of the London parks for a breather. Needless to say, I still wore my earphones which, being actually of the acorn-sized deaf-aid type,



Hustled along to the nearest police station.

are very inconspicuous, and as I strolled along I put my hand in my trousers pocket and tuned in the National programme.

At that time in the evening, of course, dance music was being served up from the London studio, and, carried away by the rhythm of the waltz, I suppose I must have subconsciously permitted my body to sway and gyrate in time with the melody. I noticed one or two people staring rather

offensively at me, but there was nothing very out of the ordinary in this, and so I took no particular notice of it.

I had, I suppose, been proceeding along for some ten minutes, during which the music, and myself in sympathy with it, had passed from waltz to foxtrot, and from foxtrot to one of those eccentric, new-fangled dances which are all the rage nowadays. Suddenly, without the slightest warning, I was accosted by two police constables, and before I had time to collect my wits I found myself being hustled along to the nearest police station. In spite of my protests, I was subjected to all the indignities of a test for inebriation by a sorely puzzled police surgeon, who was eventually compelled to give me a clean bill of health in this respect, although he rather offensively suggested to the station-sergeant that I be detained for mental observation.

The strangest part of the whole business, however, was that my explanations were completely discounted, even though I persuaded the station-sergeant to don the earphones and listen for himself for a few minutes, the reason he gave being that no official mention of pocket wireless sets was to be found in the Police Regulations. It was indeed fortunate for me that regulations did *not* mention pocket wireless sets, as, had they done so, I learned, I should have been charged under the Sedition Act, owing to the fact that when the station-sergeant listened to it the set happened to be tuned to one of the Continental "propaganda" stations.

### Two to One Bar One.

I SUPPOSE that like myself a good many of you have still got the post-Ascot feeling even though a week or two has elapsed since the meeting. I, personally, have not had such a disastrous time for many a long year but it was comforting to observe that I was far from being the only person of note queuing up, watch and chain in hand, at the entrance to the little portable *mont-de-piété* near the railway station, at the conclusion of the meeting.

Now I don't know about you, but whenever anything goes seriously amiss with my plans, it is my invariable custom to sit quietly down and find out exactly where I've gone wrong. It is an invaluable habit which I learned in my early set-constructing days when I was frequently rewarded by silence from the loudspeaker after many weary hours of toil. Consequently, when all my investments at Ascot, concerning which I had received information from unimpeachable sources, started to go up in smoke, I began to put on my thinking cap.

It was soon clear to me that there must be some unexpected factor at work which I had failed to take into my calculations, and I at once began an ardent search for it. Immediately one very strange and significant fact forced itself on my attention and that was the altogether uncannily accurate fashion with which certain jockeys were timing their "effort."

I suppose that even those of you whose knowledge of racing is confined to the daily sprint for the City train do not imagine that the horses keep going at top speed all the time irrespective of the length of the course. It is one of the secrets of good jockeyship to know when to start going "all out" and it is just as fatal to do this

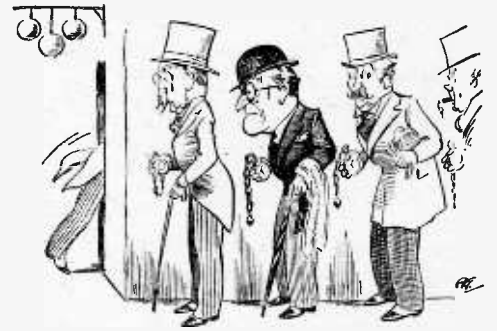

At the conclusion of the meeting.

too soon as to leave it until it is too late. A jockey has to vary the timing of his effort in accordance with many factors, not the least of which is the position of the other horses in the race.

Unfortunately he is, more often than not, in the worst possible position to observe what the others are doing and it has frequently been said that if it were only possible for the trainer from his coign of vantage to convey telepathetically to the jockey his "reading" of the race, it would be as good as won, and this, I discovered, was exactly what was happening except that a far more reliable method than telepathy was being employed.

It did not take me long to prove my theory at the meeting following Ascot, and with very little searching about among the ultra-short waves I soon picked up the particular wavelength being employed, with the result that I have since been reaping a golden harvest at the bookmakers' expense.

Even now, however, I haven't fully solved the mystery for although a flea-power ultra-short wave transmitter and a lapel microphone is easily concealed about the ample clothing of the average trainer and a receiver can easily be distributed about the person of a jockey, some sort of headphones are absolutely essential and I have so far failed to locate through my binoculars the faintest suggestion of even a miniature earpiece.

The only thing I can think of at the moment is that some sort of bone-conduction reproducer is being employed, but surely, even so, it would have to be applied to the skull? Perhaps one of you can get to work and solve the problem in return for my divulging the wavelength.

# Current Topics

## NEWS OF THE WEEK IN BRIEF REVIEW

### Berlin Exhibition

THE German National Radio Exhibition will be held this year between July 30th and August 8th.

### Broadcasting from a Train

THE famous Philadelphia Symphony Orchestra has just completed a broadcasting tour of the U.S.A. It has travelled all over the country in a specially equipped ten-car Pullman train. On one occasion it broadcast a programme while the train was in motion, a specially fitted coach being used as a studio.

### New Lithuanian Station

PLANS have been afoot for some time to erect a national high-power broadcasting station in Lithuania, but financial difficulties have hitherto stood in the way. The Minister of Communications has now announced, however, that at last these difficulties have been disposed of, and tenders are to be invited for the erection of the station. It will probably have a power of 100 kW.

### Car Radio in the U.S.A.

ALTHOUGH there is a popular belief that a very large proportion of the cars in America is fitted with wireless, this is far from being the case. Of the 23 million cars on the road in the U.S.A., rather less than 4 million are equipped with wireless receivers. There are strong rumours, however, that the Chrysler combine are intending to go in seriously for car radio, and to that end are taking over a well-known radio manufacturing concern.

### Television for the Deaf

A SERIES of practical tests is being carried out by the G.E.C. to determine the interest value which television possesses for the totally deaf. A set has been installed at the Tower House Home for deaf and dumb men at Erith, and the results have been very promising. The tests are being continued in order to find out, among other things, whether television will still exercise an appeal after the novelty has worn off, and what type of programme is most suitable for deaf persons. It is probable that a complete report will be sent to the B.B.C. in the hope that they will be able to arrange their programmes so

that each section contains at least one item which does not depend on sound.

### Late Concerts from Poland

DURING July and August the Lwow station is to try the experiment of broadcasting until 1 a.m. every morning.

### Luxemburg's Programmes

ACCORDING to a statement made recently in the House by the Assistant P.M.G., further representations have recently been made to the Luxemburg Government against the broadcasting of advertisements in English on a wavelength not allotted to the Luxemburg station by international agreement.

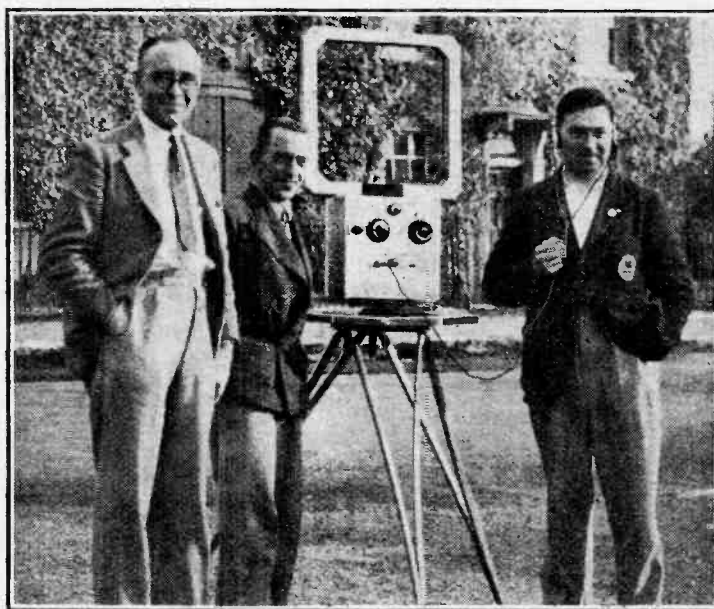

The winners of a recent 40-metre DF contest held by the Southall Radio Society, Mr. H. G. Swann (right) captained the team

### Radio Doctoring

FREE medical advice is now given from Italian broadcasting stations. The scheme is being operated in much the same manner as that adopted by certain newspapers over here, in which the sufferer writes to the paper concerning his symptoms, the question and answer being published for the benefit of readers at large. In the case of the Italian broadcasting service, however, either the post or the telephone can be used to describe the symptoms, the treatment being broadcast at a certain hour of the day which is devoted to this service. Presumably, the identities of patients are not disclosed.

### One Hundred per Cent.

THE Polish village of Helmicamala boasts that it is the only place in the world where all the inhabitants are radio listeners. There are forty-five houses and forty-five wireless licences.

### Folkemottager Influences Licence Figures

THE Norwegian People's Receiver is proving very popular and is having a very marked influence on the number of new licences taken out. There has been a very great increase since this receiver was first marketed.

### Danish Midget

TWO companies are being floated to handle the large-scale production of a midget re-

ators and oscillators as standards of frequency. The presentation will take place at the next meeting of the Physical Society, which will be held at 5.15 p.m. this evening (July 9th) at the Imperial College of Science and Technology, South Kensington.

The Duddell Medal is awarded to "persons who have contributed to the advancement of knowledge by the invention or design of scientific instruments, or by the discovery of materials used in their construction."

### African Chief's Voice Recorded

DURING a visit to the H.M.V. factory, the Alake of Abeokuta, a well-known African potentate, recorded a speech for the benefit of his subjects. Copies of this record are being sent out to Abeokuta.

### Belgian Ship-to-Shore Telephony

IN our issue of June 25th we reported the inauguration of a telephony service via the Blaavandshuk station between ships crossing the North Sea and Denmark. La Société Internationale de TSF, of Brussels, reminds us that similar facilities have been provided on the Belgian Dover-Ostend lines for some time.

### Institute of Public Address Engineers

AT a recent meeting of the Technical Committee it was decided to examine the various means employed for the determination of the audio-frequency output of amplifiers and the harmonic content therein in order to determine the most satisfactory method with a view to its adoption by the Institute as a standard.

The syllabus of the examination paper for associate members was approved. Eight questions (six of which have to be answered) will be set, covering Ohm's Law, Technical Terms, Fault Finding, Application of Valves, Impedance Matching, Lay-outs, Description of Typical Apparatus, and Testing. It is proposed to hold examinations four times a year. Full particulars and entry forms are available on application.

### Technical Catalogues Wanted

THE librarian of the All-Union Arctic Institute, 34, Fontanka, Leningrad, 14, U.S.S.R., asks us to invite British manufacturers of receivers and transmitters to send technical catalogues and other literature for the Institute's library, where they will be studied by engineers engaged in developing the Arctic communication systems.

### Duddell Medal Award

THE Council of the Physical Society has decided to give the fourteenth Duddell Medal award to Walter G. Cady, Professor of Physics at the Wesleyan University, Middletown, Connecticut, U.S.A., for his work on piezo-electric reson-

ceiver produced by Mr. A. Kielsen, a well-known Danish engineer. One company, which has a capital of 100,000 kroner, will handle the home market, while a further company, with a capital of 150,000 kroner, will deal with foreign interests. The Kielsen set is a three-valve battery-operated receiver which will sell at about £4 5s.

# The Evolution of the Phon

## A SUCCESSOR TO THE DECIBEL NOTATION FOR SOUND MEASUREMENT

### MEASUREMENT

By

D. B. FOSTER, M.Sc., Ph.D.

**L**OUNDNESS is the magnitude which the brain assigns to that quality of a sound corresponding to its physical intensity.

Until quite recently the graduations of loudness according to popular conception were represented by about five coarse steps—very loud, loud, medium loud, soft and very soft, corresponding to the musical notations *ff*, *f*, *mf*, *p* and *pp*. Recent research has established that there are more like 200 minimum perceptible increments of loudness between the softest and the loudest sounds which the ear can perceive at the middle of the frequency range.

In early experiments on loudness it was customary to make loudness variations in the sound produced by a telephone receiver held to the ear by varying the electrical power supplied to the receiver from an oscillator. These electrical power changes were expressed in terms of decibels, and so it became customary to express the corresponding loudness changes from the receiver in terms of the same number of decibels, assuming that the receiver had a linear input-output characteristic.

A natural development of the above association was to assign a value of zero decibels to the sound from the receiver which was just audible—that is, to the "threshold of audibility." An increased loudness from this point corresponding to a further electrical power increase through the receiver of *N* decibels was therefore known as a loudness of *N* decibels.

This original association of the decibel and loudness was therefore purely circumstantial, due to the ease of control of loudness from a headphone by means of electrical attenuation or amplification. There were, however, three further good reasons for the popularity of the association, and these were as follows:—

(a) The ear can perceive a maximum loudness change corresponding to a sound intensity of 10,000,000,000:1. The decibel is a logarithmic unit of power ratio, and its use converts the above unwieldy ratio to the more practicable figure of 130 decibels by the formula:—

$$\text{Decibels} = 10 \log_{10} \text{Sound Intensity Ratio.}$$

(b) The Weber-Fechner law suggests that physiological reaction magnitudes such as loudness, brightness or pain are related logarithmically to the associated physical stimulus. This suggested, in other words, that the loudness of a sound was directly proportional to its magnitude in decibels, so that, for example, a sound of

80 decibels would appear to be twice as loud as a sound of 40 decibels. This linear relationship between loudness and its scale of measurement is, of course, a very desirable requirement.

*THE author discusses the shortcomings of the decibel for the numerical evaluation of loudness, and describes the nature of its derivative, the "phon," which has recently been defined by the British Standards Institution and accepted as the unit of loudness*

(c) It had been found by experience that one decibel represented about the minimum loudness change with which one was normally concerned, another eminently desirable requirement.

The first doubts as to the suitability of the decibel as a loudness unit came when comprehensive data became available on the relationship between loudness and sound intensity over the whole audible frequency range. Such a plot of aural characteristics is given in Fig. 1. The horizontal scale represents frequency, the

sound intensity, zero decibels, to correspond to the threshold of audibility at a frequency of 1,000 c/s.

Now, if one tries to reconcile the decibel as a loudness unit with the data in Fig. 1, one finds the following anomalies: Loudness varies with frequency for constant sound intensity in decibels; for example, a sound of 30 decibels at 1,000 c/s is louder than a sound of 30 decibels at 200 c/s, and a sound of 30 decibels at 100 c/s is something less than inaudible!

In a further attempt to overcome this drawback the zero decibels datum was deprived of its constant sound intensity criterion, and was made to correspond to the threshold of audibility curve over the whole frequency range instead of only at 1,000 c/s. This distorted decibel was sometimes given the title of Sensation Unit, but was

clearly unsuitable, since, due to the convergence of the equal loudness contours towards the low frequencies, *N* decibels (above threshold) at 50 c/s corresponded to a greater loudness than *N* decibels (above threshold) at 1,000 c/s.

The next attempt to reconcile the decibel as a loudness unit was to give each equal loudness contour the same number of decibels independent of frequency, and the number of decibels for each contour was made numerically equal to the sound intensity of the contour in decibels at 1,000 c/s. In order to differentiate between the sound intensity decibels at 1,000 c/s and the equal loudness contour decibels, the latter were sometimes given the title of "decibels (1,000 c/s equivalent loudness)."

The original desire to associate the decibel with loudness had therefore produced three successive types of decibels each more closely fitting the loudness data. This co-existence of three types of loudness decibels corresponding to (a) sound intensity, (b) sound intensity above threshold, and (c) 1,000 c/s equivalent loudness, was the chaotic state of affairs when the British Standards Institution met about two years ago to standardise on a loudness unit. They decided, in effect, that, whatever the name to be given to the loudness unit, it should have the same value along any equal loudness contour, and it was agreed that the third type of decibel given above, namely, decibels (1,000 c/s equivalent loudness) represented the type of unit they required. Unless given this full cumbersome title this unit was liable to be confused with sound intensity and electrical power ratio decibels, so the unit was given the new short

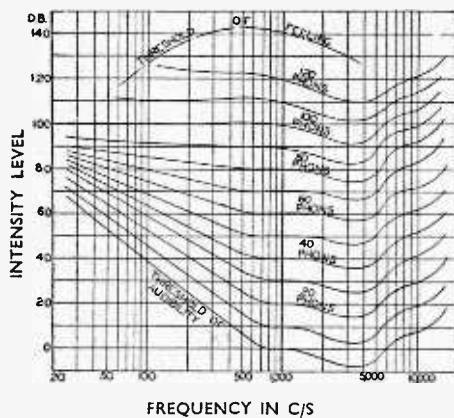

Zero db. at 1,000 c/s = 0.0002 dynes/sq. cm. (RMS.)

Fig. 1.—Aural characteristics: the relationship between loudness (in phons) and sound intensity above threshold (in decibels) over the entire audible frequency scale.

vertical scale represents sound intensity, and the curves are equal loudness contours commencing with the threshold of audibility at the bottom and finishing with the threshold of pain or feeling at the top.

It is customary to assume the datum of

**The Evolution of the Phon—**

title of "phon," and the term decibel was retained for the magnitude of sound intensity above a constant datum. This datum was in the region of threshold of audibility at 1,000 c/s, and was standardised as corresponding to a RMS pressure of 0.0002 dynes per sq. cm.

The loudness of a sound in phons is therefore numerically equal to the sound intensity in decibels of an equally loud 1,000 c/s pure tone. The phon is therefore called a Unit of Equivalent Loudness. Reference to Fig. 1 will show that the equal loudness contours represent equal numbers of phons, and that these contours coincide with the same numbers of sound intensity in decibels at 1,000 c/s.

**Noise Meters**

It will thus be seen that it is simple to make a loudness-measuring meter which will give true results in terms of phons. Such a meter consists of a 1,000 c/s tone from an oscillator fed to a headphone and controlled by an attenuator in decibel steps, the attenuator being engraved zero when the intensity of the tone corresponds to the datum pressure of 0.0002 dynes per sq. cm. In order to measure the loudness of a noise in phons the headphone is held to one ear and the intensity of the reference tone is increased by adjusting the attenuator until the loudness from the headphone at the one ear is judged to be equally loud as the noise entering the uncovered ear. The loudness of the noise in phons is then said to be numerically equal to the intensity of the reference tone in decibels. Thus, if the attenuator had to be turned up 50 decibels from the zero datum to equal the loudness of the noise, then the noise would have a loudness of 50 phons. This type of loudness measurement is known as the Subjective Equality Method, and is the only one by which loudness values can be obtained which are, by definition, accurate in terms of phons. There is a common belief that loudness in phons can be measured by a device, commonly called a "noise meter," consisting of a microphone, amplifier and indicating meter. Such is not the case, although under certain circumstances results can be obtained which are close to the true loudness in phons. This type of objective meter is properly termed a "sound level meter," and the results should be referred to as "sound level in decibels." Such meters may have incorporated a frequency weighting characteristic corresponding to one of the equal loudness contours shown in Fig. 1, but the results obtained are of an arbitrary nature. It is not infrequently found that the results from these meters are of the order of 30 decibels lower than the numerically correct loudness in phons as obtained by the Subjective Equality Method. These errors are based on the inability of a sound level meter to integrate the components of a complex noise according to the manner of aural integration and also on the inability to provide masking allowances.

Returning to the Subjective Equality

Method of noise measurement, it is found in practice that in order to obtain reliable results it is necessary to employ a large number of observers and average their results. Under ideal conditions it is possible to achieve results which are accurate within the limits of plus or minus 5 phons.

The phon has provided us with a loudness unit which is trustworthy, but it has two drawbacks. In the first place, as mentioned in the preceding paragraph, it is practically impossible to obtain precision results to the nearest phon, and in the second place the phon scale of loudness does not linearly represent intuitive judgments of loudness. That is to say, if an observer listening to a radio set producing

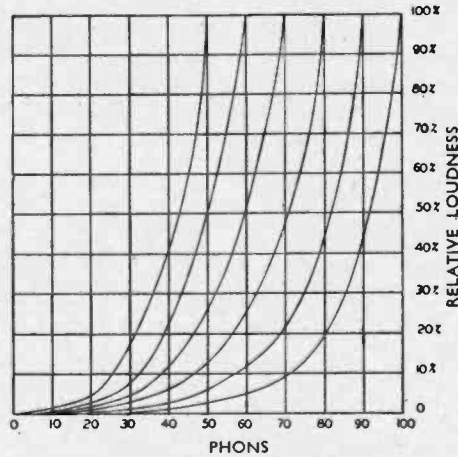

Fig. 2.—Showing the relationship between aurally estimated loudness and the phon scale.

a loudness of 80 phons is asked to turn down the volume control until it is "half as loud," he will not reduce it to 40 phons but probably to something between 65 and 75 phons. This effect is contrary to the statement of the Weber-Fechner law stated earlier. Consequently, an untrained observer has little conception of the loudness change represented by any specified change in the number of phons, nor has he an accurate conception of the absolute loudness represented by any part of the phon scale.

The following table based on practical measurements will give an idea of phon magnitudes:—

No. of phons.	Threshold of feeling or pain.
130	.. Vicinity of aeroplane engine.
110-120	.. Vicinity of pneumatic drill.
105-110	.. Vicinity of loud motor horn.
100-105	.. Interior of tube train, windows open.
90-95	.. Interior of noisy motor vehicle ; loud radio set.
90	.. Interior main-line train, windows open.
80	.. Interior of quiet motor car ; medium radio set.
70	.. Conversation (average to loud)
60-75	.. Suburban residential district.
40-50	.. Quiet country residence.
20-30	.. Threshold of audibility.
0	.. Threshold of audibility.

A number of research workers have recently investigated the relationship between the phon scale and intuitive or "man-in-the-street" loudness judgments, and a typical result of such work is shown in Fig. 2. For example, if the extreme right-hand curve is examined it will be seen that a reduction from 100 per cent. to

50 per cent. ("half as loud") represents a reduction of 8 phons from 100 phons to 92 phons. It would be difficult to memorise all the data represented by this family of curves, but the following values are worth remembering for use with radio reproduction round about a normal loudness of 70-80 phons.

Reduction in phons.	Estimated Loudness Reduction.
1-2	Just perceptible.
3-5	Marked or 25%.
8-10	50% ("half as loud.")
16-20	75% ("quarter as loud.")

The precise loudness of a radio set is, as is well known, a major factor in determining how closely the quality of the reproduction follows the original sound.

Consider that a programme is being broadcast with the loudness following the 70-phon contour in Fig. 1 over the whole frequency range. If no distortion is introduced in any part of the transmission or reproduction the sound will appear identical with the original if reproduced at the same loudness of 70 phons. If, however, the volume control is set 10 decibels above the correct value, the loudness will go up to 80 phons at 1,000 c/s to 83 phons at 200 c/s and to 92 phons at 50 c/s. The original loudness balance will therefore be lost, and the reproduction will become "boomy," due to relative increase of loudness at the lower frequencies. In the same way, if the reproduction is carried on lower than the original loudness, the lower frequencies will be excessively depressed and the quality will lack bass.

With regard to the permanence of the phon as a loudness unit, it is conceivable that as the data on the relationship between intensity and loudness, as given in Fig. 2, becomes more comprehensive it will be replaced by a unit whose magnitude is a direct indication of loudness. Attempts have already been made in this direction in the U.S.A., where a scale of loudness numbers having direct loudness interpretations has been tentatively approved by the Acoustical Society of America.

The tendency of feeling in the responsible body in this country is that, while a direct loudness scale has advantages, the collection and checking of accurate data on which such a scale might be founded have not achieved finality, and it is therefore as well to continue using a unit which, if more difficult to interpret, is quite stable.

**Pilot Model B344**

THIS new battery receiver at 11½ guineas has been produced to meet the demand for a sensitive all-wave set suitable for use at week-end bungalows, on motor cruisers, etc. Its cabinet is conventional in appearance, however, so that it is equally suitable as a permanent domestic receiver in country districts.

A double-pentode output stage gives a rated output of 2 watts, and the 4-valve superheterodyne circuit is designed for reception on 16-52 metres in addition to the usual medium- and long-wave ranges. The standard Pilot circular dial is fitted and there is a tone control as well as provision for a gramophone pick-up.

# Listeners' Guide for

**CAERNARVON CASTLE**, magnificent creation of Edward I, birthplace of the first Prince of Wales, scene of blood, folly and wisdom, will receive the King and Queen on Thursday at the end of their busy two-days' visit to Wales. There will be a ceremonial procession through the Inner and Outer Bailey to the dais, several presentations will be made and Their Majesties will hear an address by the Right Honourable D. Lloyd George, Keeper of the Castle. A B.B.C. observer will describe the scene from the Queen's Gate, before the arrival of the King and Queen, and another will take up the story as the Royal party reaches the Water Gate. Later, as the procession makes its way from the Eagle's Tower, an observer on the King's Gate will continue the story and will describe the scene on the dais.

Listeners will also hear a massed choir of 800 voices singing a traditional Welsh air in the broadcast which begins at 4.5 in the National programme.

To-day the King will unveil a block of Aberdeen granite marking the site of the Empire Exhibition at Bellahouston Park, Glasgow, and listeners to the National programme at 11.50 a.m. will hear a commentary from the scene of action.



A scene from the stage production of "Hay Fever," showing Marie Tempest, who will take part in the broadcast version of the play on Monday and Wednesday

## PERSIAN PICNIC

THE Persian desert was, until last year, practically unexploited by the tourist, but in the summer holidays of 1936 Mr. Everet Barger and a party of twenty British students crossed the Dasht-i-Kavir by car. The 5,000-mile tour through Persia was organised for the National Union of Students of England and Wales.

A description of the careful preparations necessary before the party could make the journey in comfort and security will be broadcast by Mr. Barger, a 26-year-old lecturer on Mediæval History at Bristol University. He will recall many of the thrilling adventures of the party during their eight weeks' tour and give some account of the country they passed through, and of the efforts of an Eastern people to profit from their knowledge of the West. The talk will be given on Monday at 12.30 (Reg.)

## FOLK MUSIC OF ELEVEN COUNTRIES

A COUNTRY'S history is often reflected in its traditional music. Dr. Julius Buerger has collected the folk music of eleven countries — England, Russia, Germany, France, Italy, Czechoslovakia, Poland, Norway, Austria, Spain and Hungary. Entitled "Festival of Folk Music," it is to be pro-

duced as a potpourri on Sunday at 9.5 (Nat.) and again on Monday at 6.0 (Reg.). The programme will, no doubt, appeal to many listeners not only for its intrinsic interest, but because the songs will be given in the language of their origin. The B.B.C. Chorus (Section C) and the B.B.C. Theatre Orchestra will be conducted by Stanford Robinson, who is also responsible for the production.

## NEW STARS

"CAFÉ COLETTE," the mythical *rendezvous* created by A. W. Hanson, the B.B.C. producer, will again be the scene of a broadcast at 8.20 on Tuesday on the National wavelength.

Nicolina, singer of international repute, is coming specially from Paris to take part in the programme, which will also bring to the microphone for his first broadcast here Charles Vadja, the Hungarian singer who sang with Gitta Alpar in C. B. Cochran's "Home and Beauty" revue.

C. Denier Warren, well known for his work with Harry Pepper's "White Coons" and "Kentucky Minstrels," will be heard for the first time as "chef d'orchestre." He played in the Café Colette film.

## HAY FEVER

THE cast of Noel Coward's satirical comedy of week-end manners is now complete. Marie Tempest, who will have her first full-length rôle in a broadcast play, heads a distinguished cast as Judith Bliss.

Frank Cellier, who made a brilliant Quince in the Coronation week production of "Midsummer Night's Dream," will be heard as David Bliss, the part created on the stage by Marie Tempest's husband, the late W. Graham Browne. Other members of the company include Lawrence Hardman, Norman Shelley and Ann Trevor, who will be heard in her original part of Jackie Coryton.

The action of the play is set in the riverside home of Judith Bliss, famous actress, who has recently retired from the stage, her husband, David, and their son and daughter. Each



Yvonne Arnaud in a "still" from a recent television production. She is to give a pianoforte recital on Sunday at 6 (Reg.)

member of the family has asked someone down for the week-end, but, by breakfast time on Sunday, the guests, dazed and exhausted by their hosts' efforts at entertainment, have departed.

The whole play is a masterpiece of satire and wit. There is not a dull moment in the "side-splitting" chain of misadventures which comprise one of the finest comedies written in modern English. "Hay Fever" will be heard at 7.45 on Monday (Nat.) and again on Wednesday at 8.45 (Reg.).

## MAJOR AND MINOR

BECAUSE they were so good when they made their first microphone appearance together not long ago, John Sharman has again booked "Major and Minor" to take part in the Music Hall broadcast to-morrow at 8.

The men behind the name of the act are Alec McGill and Fred Yule, and as entertainers at the piano they have a technique which makes them particularly suitable for radio.

During the same programme listeners will hear Anona Wynn making her first appearance in Music Hall since the pantomime season, and Billy Russell ("on behalf of the working classes").

## BAGPIPES AND ORGAN

PIPE-MAJOR IAIN MACDONALD MURRAY (of Scottish extraction) taught the Duke of Windsor (when he was Prince of Wales) to play the bagpipes, and he is to broadcast with Reginald Foort, who arranged the programme after a recent audition at the B.B.C. Theatre Organ. In commenting on the broadcast, Reginald Foort remarked that, to him, Scottish music had just been Scottish music until he met

# The Week Outstanding Broadcasts at Home and Abroad

Pipe-Major Macdonald Murray; then he discovered to his surprise that it is divided into three distinct types — the Border ballad, Gaelic music and Highland pipers' music.

"Originally," he said, "the pipes were to be accompanied by the Theatre Organ because I can easily get it to imitate bagpipes, but the scale of the two instruments is quite different. That of the pipes is definitely Arabic, proving, I think, that they were of Eastern origin. We shall, therefore, play just one tune together to let listeners hear the strange effect."

During the programme which will be radiated Nationally at 9.35 on Saturday, representative pieces of the three types of music will be played. First a medley of Border ballads, then James McPhee will sing a selection of Gaelic songs, and the pipes will afterwards have a few minutes to themselves.

## MICAH CLARKE

The late Sir Arthur Conan Doyle, though famous for his creations of imagination, wrote several historical stories which adhere very closely to fact.



Louis Levy presents "Music from the Movies" to-day at 8. He is seen here with Robert Ashley, one of his vocalists.

Micah Clarke was one of these, and a broadcast version of it will be heard on the Regional wavelength at 9 on Thursday. The play reconstructs the Battle of Sedgemoor and although it will not be broadcast on the actual anniversary of the battle, it is being presented only ten days afterwards. The production is by Cyril Wood and the play has been adapted by John Hollaway.

## FROM AMERICA

LAST year the experiment was made of relaying through

Caernarvon Castle, which is the scene of a National transmission on Thursday, when the King and Queen will be received there.

the courtesy of the National Broadcasting Corporation of America, on Saturday afternoons, a typical light programme such as was being radiated in America. The programme was given under the title of "Five Hours Back," which is the difference between New York and Greenwich time.

Listeners who like to compare the broadcasting systems of England and America will be interested to hear the first of another series of trans-atlantic broadcasts to-night (Friday) at 7.30, when "Five Hours Back" re-enters British programmes.

The new series will be

broadcast every Friday from 7.30-8 p.m., the last programme being on October 1st.

The National Broadcasting Corporation proposes to introduce as much variety as possible in this series, but it should be borne in mind that it is the ordinary sustaining programme which is being radiated from their own aerials. It is by radio link that the programme comes to us, it being picked up at Tatsfield and thence relayed by land line to London and the transmitters.



Orchestra, conducted by Clifton Helliwell, Eda Kersey will be the soloist on Wednesday in Mario Castelnuovo-Tedesco's violin concerto, at 3.15 (Reg.). At 8.20 on the same day Alex-

## MUSIC

ON Sunday at 9.5 (Reg.) the B.B.C. Midland Orchestra with the B.B.C. Midland Singers, conducted by Eric Warr, will broadcast a programme of music by Vaughan Williams, including the Overture, The Wasps. Arnold Matthews will sing Five Mystical Songs.

Accompanied by the Empire

ander Moskovsky will give a violin recital, also in the Regional programme.

Eileen Joyce will play the solo piano part in a "French Mountain Song" by Vincent d'Indy, with the British Women's Symphony Orchestra, conducted by Boyd Neel at 8 on Tuesday (Reg.).

THE AUDITOR.

## HIGHLIGHTS OF THE WEEK

### FRIDAY, JULY 9th.

Nat., 7.15, In Other Gardens: talk. 7.30, "Five Hours Back." 8, Music from the Movies. ¶London Traffic—reminiscences. Reg., 6, B.B.C. Theatre Organ. 8, Orchestral Concert. ¶Bluebeard. 9.45, Three in Waltz Time.

Abroad.

Paris PTT. 8.30 Symphony Concert from the Casino Vichy.

### SATURDAY, JULY 10th.

Nat., 7.30, A.B.C. 8, Music Hall. 9.20, Monthly Affairs (from America). ¶Orchestre Raymond.

Reg., 6, The Luton Band. 7.30, Frank Merrick (pianoforte). ¶B.B.C. Midland Orchestra.

Abroad.

Milan I, 9, "The Force of Destiny": opera (Verdi).

### SUNDAY, JULY 11th.

Nat., 6, Talk by H. de Vere Stacpoole. 7.55, Service from St. Martin-in-the-Fields: the address by Lord Halifax.

Reg., 6, Yvonne Arnaud (pianoforte). ¶Commodore Grand Orchestra. 10.5, Fred Hartley and his Sextet.

Abroad.

Kalundborg, 8.50, "The Elusive Melody": musical comedy.

### MONDAY, JULY 12th.

Nat., 6.20, Tricks of the Trade.

¶Hay Fever. 9.35, Haigh Marshall String Orchestra. Reg., 6, Folk Music. 8, Geraldo and his Gaucho Tango Orchestra. ¶B.B.C. Scottish Orchestra.

Abroad.

Stuttgart, 9.15, Songs of the German Mountains.

### TUESDAY, JULY 13th

Nat., 6.25, Theatre Organ. 8, British Diarists. ¶Café Colette. 9.40, Chamber Music.

Reg., 6, Eugene Pini and his Tango Orchestra. 9, Swift Serenade.

Abroad.

Munich, 8, "The Dardanelles—Callipoli"—pages from history.

### WEDNESDAY, JULY 14th.

Nat., 6.20, Peter Yorke and his Orchestra. 7.40, Background to Sport. 8.20, Radio Rodeo.

Reg., 6, B.B.C. Scottish Orchestra. 7.30, Stop Dancing!—light music. ¶Hay Fever.

Abroad.

Berlin, 8.10, Military Band Concert.

### THURSDAY, JULY 15th.

Nat., 6.20, They Came to see England: talk by Roger Falford. Piano recital by Susan Slioko. 7.25, Shows from the Seaside, 2.

Reg., 6, B.B.C. Military Band. 8, Radiovue. 9, Micah Clarke: play.

Abroad.

Cologne, 8.10, "The Dance": four centuries of dancing.

# HINTS and TIPS

**A** PART from a rather high-pitched hum which is often experienced where mains input filtering is inadequate, universal AC/DC sets are usually fairly free from mains hum when connected to a DC supply. It sometimes happens, however,

## Hum in AC/DC Sets

that when the supply is changed over to AC, or the owner moves to another district where the supply is AC, there is found to be an unpleasant background of hum which was not present before. Reversing the mains plug in its socket sometimes effects an improvement, but if the set has been in use for some considerable time it is more probable that the cause of the trouble is imperfect insulation between heater and cathode of one or more valves. This is a fault which is apt to develop gradually in use, and although a valve may work quite blamelessly on DC, it may nevertheless be useless on AC on account of hum. This trouble has been particularly common amongst American midget sets, which seems to suggest that heat dissipation may have some connection with it. The valves likely to be affected are detector and AF types in general, and particularly diodes.

**I**N seeking for the cause of "no signals" in any superheterodyne, the logical trouble-tracer, having satisfied himself first that the AF amplifier is functioning normally, will then try to find out whether the frequency-changer valve is oscillating.

## Is it Oscillating?

Unfortunately it is not possible to make certain of this without some kind of meter; the usual method is to connect a milliammeter in the oscillator anode circuit, and then to observe the effect of short-circuiting either the grid or reaction coil. If the valve is oscillating there will be a change in the anode current, and, if not, no change.

An obvious disadvantage of this method is that it is usually far from convenient to break any connections for the purpose of connecting a milliammeter in circuit, particularly when it becomes necessary to remove the set from its cabinet in order to do so. What is wanted is a method of obtaining the vital information without going farther than removing the back of the set.

## Detecting Voltage Changes

The following method, which is used by the majority of busy servicemen and applies to any type of frequency-changing valve, is probably hard to improve upon.

It is based on the foregoing method, but makes use of a voltmeter instead of a milliammeter, an additional advantage

being that either a high or low reading instrument may be used.

Referring to Fig. 1, if we connect a voltmeter between point A and chassis, and proceed to short-circuit the oscillator tuning condenser, the resulting cessation of oscillations should cause a change in voltage to be shown. If there is no movement of the meter needle, it is fairly safe to assume that the valve is not oscillating. Actually the test may be made rather more convincingly by applying the voltmeter to point B or C, as the total anode current (and consequently both the screen and automatic bias voltage) will be affected by the change. In practice it is advisable always to use one or other of these two positions, as in some cases the connection of a voltmeter across the

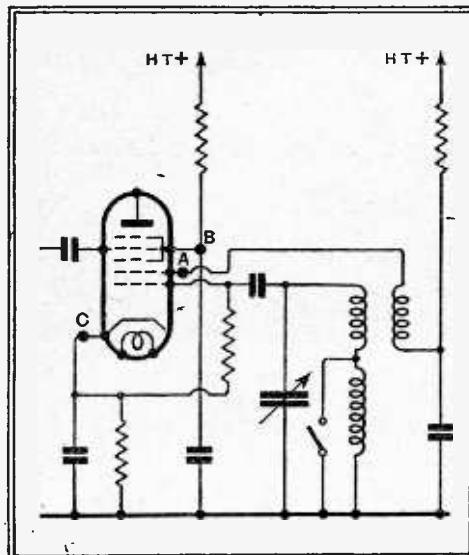

Fig. 1.—Is it oscillating?

oscillator coil itself is sufficient to stop oscillations and so to nullify the test. Both points are conveniently accessible by raising the valve just sufficiently to allow a thin prod to make contact with its pins.

**T**HERE seems to be a general impression that if, either carelessly or intentionally, an attempt is made to investigate the inside of a mains set without first switching off the risk incurred in doing so is far greater than in the case of a humble battery set. This idea is somewhat misleading, because, although the rather obvious risk of shock is undoubtedly more serious with the all-electric set, there is another and more material risk to be considered—that of damage to components—and it would be unfortunate if by comparison the battery set should come to be regarded as not requiring the same respect, and, therefore, as something with which liberties may be taken with im-

## Practical Aids to Better Reception

punity. Actually, nothing could be farther from the truth, and opportunity is taken here to warn readers that a "live" battery set needs to be handled with discretion.

## Fragile Battery Valves

To begin with, the battery type valve is notoriously delicate, and, because its filament can be destroyed by even the briefest short-circuit of HT through it, needs very cautious treatment when compared with the much more robust mains types. Valve burn-outs, however, are less common nowadays, due to the use of practically fool-proof on-off switches and to the more widespread knowledge that accidents of this kind can never occur so long as the LT accumulator remains directly connected to the valves; but it is probably not so widely realised that, in spite of this precaution, it is still possible to do other damage, just as serious and irrevocable, by carelessly short-circuiting points at HT potential to the chassis.

In this case the responsible factor is the particular nature of the power obtained from primary batteries. In a mains set the resistance of the rectifier and smoothing circuits is always large enough to limit the current that can flow in the event of a short-circuit to a fairly low value; for this reason, almost any amount of prodding can be indulged in with a mains set without serious risk of trouble. An HT battery, on the other hand, has only its own internal resistance—a few ohms. Consequently, a direct short may allow a current of several amperes to flow momentarily—enough to do considerable damage, quite apart from its bad effect on the battery itself.

One of the commonest examples of the more serious accidents that can occur is a burning-out of an IF transformer, caused by an uninsulated anode thimble-clip being allowed to touch any part of the chassis; a very few moments is usually sufficient to burn out the primary completely. Similarly, of course, an HF choke, any anode-circuit RF or IF coil, or even an output transformer, is liable to be damaged in the same way, and, even though it should be removed before the damage is obvious, will usually have its efficiency seriously impaired by the overheating.

It should be added that these remarks apply with even greater force to HT accumulators, of which the internal resistance is extremely low. The moral, of course, is "Disconnect the HT First!"

## Battery Power—a Warning



# LETTERS to the EDITOR

## DF Experiment

I AM in process of developing a direction-finding instrument based on a novel principle, but find to my regret that my practical knowledge of construction is too limited to cope with the layout of such things as photo-electric cells, etc. If any one of your readers who is interested in this kind of construction would care to co-operate, I should be very glad to hear from him.

C. G. WILLSON-PEPPER.

"Harbourne," Hawks Hill, Leatherhead.

## Straight v. Superhet

LIKE many other people I was interested in wireless in a casual way from the end of the Great War, and I listened (on very elementary apparatus) to the earliest "broadcasts" from Chelmsford. My electrical knowledge is not deep, and I suppose I was a "constructor" rather than a genuine experimenter. I built crystal, crystal-valve, reflex, and various other circuits that promised great things if only reaction could be controlled. After several neutralised HF affairs I went back to a det. 2LF set for quite a long time, meanwhile realising that the superhet was beyond my knowledge, and anyway could be bought more cheaply than it could be "constructed." Eventually I bought one of most reputable breed, standing somewhat between the production jobs and the individually built regardless-of-cost outfits. And what a life I have had!

Quality, for domestic requirements, was quite nice at first. Then one of its speakers evidently couldn't take the punch it occasionally got and started a whole lot of rattles. The wave-change switch was a curse. So was an extension speaker jack. The IF trimmers appear to unscrew themselves at intervals, and several expensive and amazingly complex valves have gone west. Granted most of these are mechanical faults, but the superhet layout doesn't help one to get at them for easy repair. Now what of the superhet part itself?

It will "get" about 35 to 40 medium-wave stations but only about five programmes, and I should say that of its time in use, it is tuned thus: North Regional, 85 per cent., North National 14 per cent., Midland Regional 0.95 per cent., "listening to Europe" 0.05 per cent. Now, why should I have a superhet? I don't want distance, I don't want short wave, I don't want long wave. Isn't my radio history that of thousands of others? I am fond of good music, but my taste is catholic; Bach, Wagner or Gershwin all have a place. I would rather hear them well from the local than badly from Schenectady, Prague or Peru. I want the news of the day, and I wish to keep pace with the trend of human progress and endeavour—it is part of my job to do so.

Speech and music of good quality, therefore, from the local B.B.C. transmitters are what I need, and the straight set will do all that is necessary. But who makes one at a reasonable price to give good quality of reproduction?

Must I turn constructor again? The negative feed-back amplifier in *The Wireless World*, June 18th, fed by a simple detector should answer my needs. For domestic

listening 3 to 4 watts output is surely enough with a speaker that will avoid boom and provide a reasonably bright "top." Could we not have a constructional article on such an outfit, please?

Manchester DONALD H. SMITH.

## Long-distance Television Reception

I AM enclosing, in the hope that they will be of interest, some snaps of television pictures recently received at Ipswich.

On some the heavy interference experienced here plainly shows. I am using an arrangement for filtering the synchronising pulses that Mr. Tyers kindly sent to me and synchronism is maintained at all times.

These snaps were taken with a Leica camera,  $f/2$  lens,  $\frac{1}{8}$  to  $\frac{1}{4}$  sec. exposure, Kodak Super X panchromatic film.



TELEVISION AT 65 MILES. Allowing for the loss of clarity, incidental to the process of reproduction, these untouched photographs give an excellent idea of the high standard of reproduction attained by Mr. West at Ipswich.



Although not quite as good as the original picture received they indicate pretty well the type of results obtainable here. Ipswich. S. WEST.

## Valve Ratings

IN a letter appearing in *The Wireless World* for May 21st, J. B. rightly draws our attention to the fact that certain valves are rated at  $3\frac{1}{2}$  watts, while another set maker claims for the same valve an output of only  $2\frac{1}{2}$  watts. This naturally raises the question of what the output of a valve really is and when it can truly be called undistorted.

The Editor does not hold himself responsible for the opinions of his correspondents

Some valve makers give their ratings at 5 per cent. total harmonic content, others at 9 per cent., while still others give ratings for 2 per cent. and 10 per cent. These last two are called the undistorted and maximum outputs. This method seems to me the fairest, but few set makers are likely to adopt it; if the valve will give 6 watts output they will claim this, even if the 6 watts is for 30 per cent. distortion.

The audible effect of distortion, however, is not as simple as it seems. Acoustic comparison has been made with various valves, triode, pentode and beam power valves, singly and in push-pull, with and without negative feed-back. It has been found that 5 per cent. second harmonic has no harmful effect, and 10 per cent. is tolerable for reasonable quality. When the even harmonics are balanced out, as by using push-pull, 5 per cent. of third harmonic is annoying and 10 per cent. is really serious. Harmonics of higher order, especially uneven, cannot be tolerated when they exceed 1 per cent.

I would suggest, therefore, the rating of a valve be based upon the audible effect of distortion by using a distortion factor which can be evaluated from a formula which suitably combines the actual amplitudes of the harmonics. For example, the formula might be  $P=a+3b$  when  $P$  is the distortion factor and  $a$  and  $b$  are the amounts of second and third harmonics respectively. The factor 3 by which the third harmonic is multiplied is the amount by which the third harmonic is more objectionable than the same amount of second. Thus, a valve giving a certain output with 3 per cent. second harmonic and 1 per cent. third, would be given a distortion factor of 6, whereas one giving 1 per cent. second and 3 per cent. third harmonic would have  $P=10$ . On the normal method of rating each valve would be given the same distortion of 3.16 per cent.

P. WINKELER, Radio Engineer.  
Antwerp, Belgium.

## Horn-loaded MC Loud Speakers

I WAS very interested to read the letter of Mr. Wykes in your issue of June 18th. The information that he gives is most instructive, but, while I do not wish to dissent from his conclusions, there are several criticisms to be made.

The "well-balanced" jury contained two people "without knowledge or special interest in wireless or music." Such people are notoriously unreliable critics.

A 2ft. 6in. baffle is not large enough for the Goodman unit. Of what material was the baffle made? My Goodman's roin. High Fidelity Auditorium Speaker is mounted on a baffle made of two thicknesses of Celotex. Its area is about 18 sq. ft. and it is secured to a very rigid wooden frame. When the speaker is mounted on a plywood baffle, 2ft. square, the reproduction is decidedly inferior.

I cannot see why gramophone records

were used for the test. The B.B.C. at its best surely gives superior quality.

In view of the great difference in the price of the units under discussion, it is remarkable that they are comparable at all. Fed by a local-station receiver coupled to a modified version of the "W.W." Push-pull Quality Amplifier, the Goodman unit gives superior fidelity to many of the efforts of the B.B.C. The inferior quality of outside broadcast (e.g., the recent broadcast of the Aldershot Tattoo) is unpleasantly apparent, and the distortion in some of the gramophone record programmes is shown to be simply appalling.

I think that Mr. Barden was unwise to challenge the superiority of the Voigt combination, but his firm has certainly made a reproducer of considerable value to many people who cannot afford to buy the more expensive horn-loaded equipment.

I have no connection with either firm.  
Isleworth, Middlesex. D. ROGERS.

### PA Systems

I WAS interested to read the remarks of "Diallist" recently regarding the low intelligibility of the majority of PA systems and the improvement that can be obtained by a low-frequency cut-off.

This is a matter which does not appear to be generally realised, and as a result much money is wasted on microphones which are wholly unsuited to the high-level radiation of speech. The confusion appears to arise from failure to distinguish clearly between the frequency characteristic and the non-linear distortion of microphones. There can be no doubt that high speech intelligibility is best secured by a rising frequency characteristic and a sharp low-frequency cut-off, but, in addition, non-linearity must be reduced to a minimum. In practice, in order to obtain a low value of non-linear distortion, microphones of the so-called "high-quality" type (i.e., moving coil or transverse current carbon) are used, and their relatively flat frequency characteristic gives rise to the low intelligibility of which "Diallist" complains. This flat frequency characteristic, which is not required for PA working, is obtained at the expense of output.

Surely, in the case of those PA systems which are required to radiate speech and music from a pick-up, the reasonable solution is a straight, high-quality amplifier and a microphone which, so far as non-linearity is concerned, is in the high-quality class and yet has a frequency characteristic of the shape required.

J. R. HUGHES.  
London, S.E.7.

### Interference Reports

I CANNOT allow the comments of Mr. Philip W. Crouch, in your issue of May 21st, to pass without a reply, which I hope you can find space to print.

I am not sure of the exact date when I made my complaint and received my visit from the engineers, but it was some time during 1935. For all I knew to the contrary when I wrote on the subject to *Wireless World*, Post Office engineers may drive about in Rolls-Royce saloons nowadays! The fact remains that two years ago they arrived more humbly, and during a thunderstorm, and departed without requesting me to fill in any forms whatever. I still consider that the present method of dealing with interference is too long-winded and clumsy, especially when the interference is intermittent. The only effective cure is to

make such disturbance illegal, both for the manufacturer and also for the user of electrical apparatus who fails to maintain his purchases in good, silent condition.

My set employs a self-contained frame aerial, but I can see no reason why, as a listener. I should be compelled to change or adapt my set. That is putting the cart before the horse, and is as absurd in its own way as it would be to inform the victim of an assault that he shouldn't have been there!

I would suggest that people responsible for broadcasting static should at least be made to take out a transmitting licence!

T. J. E. WARBURTON.

### A Devonian Problem

RECEPTION in the County of Devon is not too glorious at the present, and with the new transmitter to be erected at Start Point we should get better conditions. But will we?

First, we have a very powerful station, Rennes-Bretagne, 120 kW. at 1,040 kc/s. This is liable to cause side-band splash, and is certainly going to ruin the hopes of any local "quality" enthusiasts.

Secondly, what of West Regional or the Welsh, as it will then be? It is 246 kc/s lower than the proposed new transmitter, i.e., twice 123 kc/s. This is a popular intermediate frequency amongst certain manufacturers, and it seems that the Welsh programme is going to suffer from whistles due to second-channel interference.

Some sets have come to my notice that give whistles on "West Regional" due to "Rennes-Bretagne." The outlook for the quality enthusiast and the layman looks formidable. The majority of listeners will still have their sets tuned to their favourite "Fécamp" or "Luxembourg" during most of the day, and will not notice the changes so quickly. They've been inoculated already!

Here's to July 1st and hoping—  
Exeter. A. G. P. MOWER, B.Sc.

### Marine Wireless Gear

NOW I am an old, old man. Indeed, I was an old chap when they disentangled my barnacle-laden beard from the key contacts, assured me that MPD was dead, that Ushant Radio was no longer FFF, that nobody used "gravel cracker" fixed gaps, and that the bulbs blossoming at my elbow were "short-wave onions," after which they gently put me ashore in a baggage sling.

Sitting in my chimney corner I do sometimes mutter about ten-inch coils, and recall the fiendish gurgles, glugs and chuckles of MRA trying to strike his "modern" 10 kW arc—and I am glad they are gone—but—

True, I can corroborate "Operator's" remarks on antiquated gear (I know of several passenger ship stations still functioning on gear at least seventeen years old), and in some respects, too, I can offer the sympathy he seems to need. We who fought and bled with early S/W gear and DF had our soul-searing experiences.

Still, I can't remember anyone trying to calibrate his transmitter by his own receiver. That would have been asking a lot of both sides of the installation (or am I old-fashioned?). There were other ways, even without a wavemeter. But that was long ago; the art may have died.

And because my aged ears (phone caloused though they be) still echo at times to

a "bust in the lug" from MSU's 5 kW spark, I should like it to be known that the enormous improvement of the past twelve years is still adding unto itself. Here, at the river gate of London, it is obvious. Only one of every twenty-five ships passing inwards is audible as she gives GNF her QTP. Outward TR's are scarcer.

However, seeing that the dogs of war have been suitably unleashed on the real culprits and offenders, the shipowners, I will leave the matter to the public-spirited few to further without even saying anything a bit unkind regarding the "little higher technical qualifications" of the poor operator.

I will not dispute that strange and fearful things happen to those who go down to the sea in ships (I remember the weird behaviour of an "11 F" DF under calibration due to three diligent lascars inside the frame), but, for the love of Pete, what kind of ships shift stays and derricks once they are at sea?

Maybe we shall hear something more about it all.

GRANDPA.

Gravesend.

1912—1930.

## The New Philips Car Radio

IN general principle the latest Philips "Motoradio" follows its predecessor, but radical changes have been made in the layout and mechanical design. The six-valve superheterodyne circuit has been produced specially for the conditions of road reception, with special attention to sensitivity

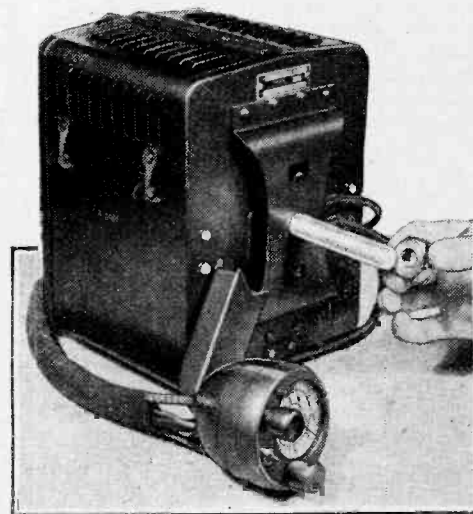

Completely self-contained in a cabinet 9½ × 8 × 7 in. the new Philips "Motoradio" receiver can be fixed in any position by a single bolt.

and efficient AVC. New miniature valves are employed, and a low-pass aerial filter in conjunction with a tuned U-shaped aerial gives effective elimination of ignition interference without resorting to the use of suppressor resistances in the plug leads.

The set is now entirely self-contained with its PM speaker, designed to take into account the acoustics of the average saloon car. A single bolt fixes the complete set to any part of the car and flexible leads from the steering-column control panel are attached to a swivelling junction box, so

that sharp bends are avoided. The colour-illuminated dial for the medium and long wavebands and the electrical locking device are retained, but a new departure is to be found in the wave-change switching, which is now effected by a magnetic relay instead of mechanically as in the earlier model.

Power consumption is rated at 33 watts from a 12-volt system, and the set will work either with a positive or negative earth. HT is derived from a vibratory unit. The price is 14½ guineas and there is a de luxe model with separate loud speaker at 16½ guineas.

# Listening In Europe

## SOME INTERESTING STATISTICS

By A. R. BURROWS

THE year 1936 was notable for the large increase in the number of broadcast listeners in Europe and in the non-European countries bordering the Mediterranean. This increase, which is based on the number of licences issued in the various countries concerned, was 12.8 per cent. over the 1935 figures. The total number of licences in force at the end of 1935 was 24,575,000. By the end of 1936 this had risen to 27,719,925. For obvious reasons the figures for Spain during the past year have not been included. Statistics for the U.S.S.R. are not given for either year.

Allowing an average of four listeners to each licence, the total wireless audience in Europe and the Mediterranean countries on December 31st, 1936, was well over 110 millions. It is noteworthy that Bulgaria alone among European countries showed a decrease in the number of listeners. At the other end of the scale comes Germany where all records were broken, with an increase of

the million mark, while, judging from the increase shown since January, Belgium and Czechoslovakia will probably reach seven figures before December 31st. Among the smaller nations the biggest progress is being made by the Irish Free State, Yugoslavia and Latvia.

In the case of all countries, the biggest

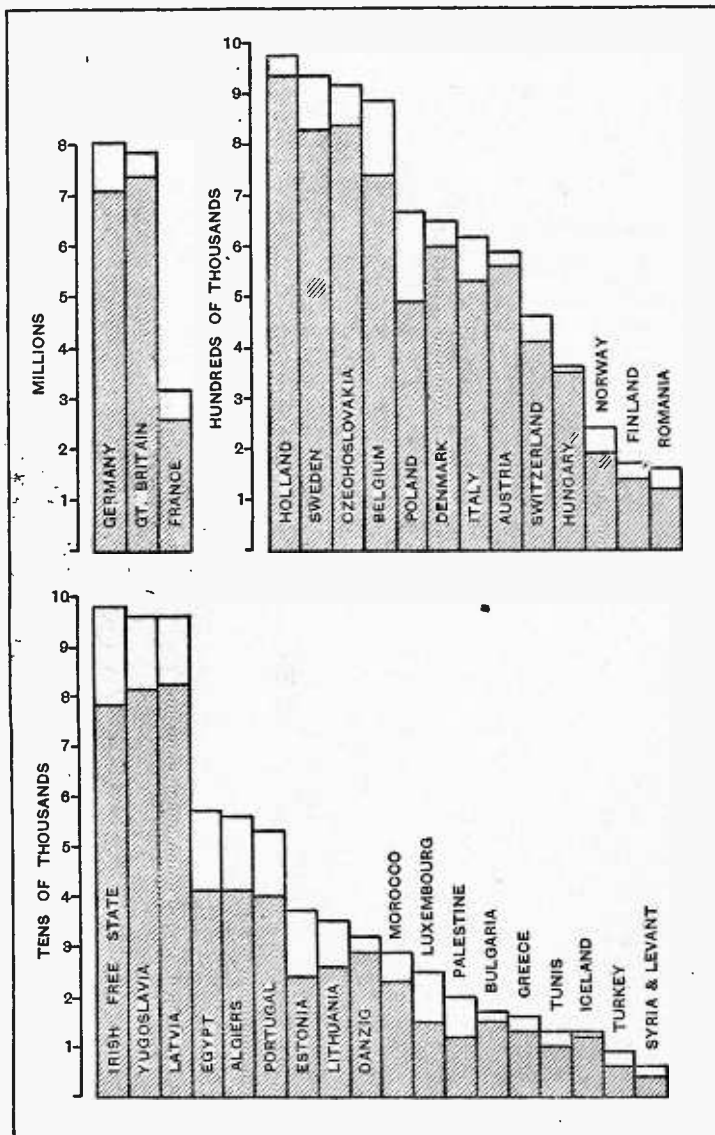

This diagram enables a mental picture to be formed of the distribution of listeners among the various European countries. The shaded portion indicates the position at the end of 1935, the white part representing the increase during 1936.

975,000. In the matter of percentage increase, however, the palm must be awarded to Palestine, the actual figure being 67.11 per cent. Luxembourg was not very far behind with a 66.67 per cent. increase.

Since the beginning of the present year Holland and Switzerland have both passed

increase in the number of licences takes place, as one would expect, during the winter months, but even in the summer relatively good progress is shown so far as the majority are concerned, there being comparatively few instances where a decrease is shown during the proverbially slack season for broadcast listening.



**OUTSTANDING 9-VALVE ALL-WAVE SUPERHET**  
For all-wave reception at its very best

To the all-wave enthusiast, this exceptional receiver offers a number of interesting features, with quite unusual range, and power output. Few receivers at present on the market can claim so high a standard of design and performance.

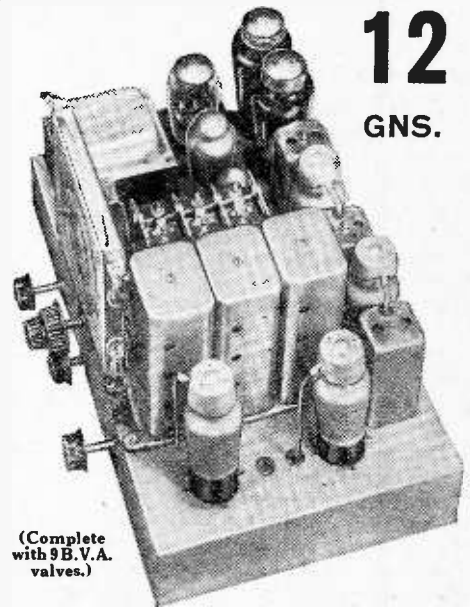

**12 GNS.**

(Complete with 9 B.V.A. valves.)

4 wavebands: 12.8-33, 29-80, 190-550, 800-2000 metres. Illuminated dial with principal station names. Separate coloured lights for each waveband.

**Controls.**—A feature of the receiver is the number of independent controls fitted, making it extremely interesting to operate. These include: sensitivity control (varying bias on R/F stage). Q.A.V.C. with manual muting control, and switch for inter-station noise suppression. Separate potentiometer bias controls for output valves. 5-position wave-change and gramophone switch. Progressive variable tone control operative on radio and gram.

**Circuit in Brief.**—Aerial input to pre-selector circuit radio frequency amplifier, latest type triode-hexode frequency changer, 2 band-pass I.F.T. coupled I.F. amplifiers, double diode detector, L.F. amplifier, parafed transformer-coupled push-pull triode output giving 6 watts. Heavy cadmium-plated steel chassis. Finest components and workmanship throughout.

A.C. models ready for immediately delivery. A.C./D.C. models also in production, and will be available for delivery shortly.

DE LUXE MODEL 14 GNS.

Several additional refinements — full particulars on application.

**IMPORTANT**

The prices at which McCarthy Chassis are advertised include Marconi Royalties. "Wireless World" readers should, for their own protection, make sure before purchasing any receiver that the quoted price includes the Royalty payment.

All McCarthy receivers supplied complete with valves, knobs, pilot lamps, leads, mains cable and plug. 12 months' guarantee.

Deferred terms on application, or through London Radio Supply Co., 11, Oat Lane, E.C.2.

Cash with order on 7 days' approval. Also write for illustrated catalogue of complete range of all McCarthy receivers.

**MCCARTHY RADIO LTD.**

44a, Westbourne Grove, London, W.2

Telephone: Bayswater 3201/2

# Broadcast Brevities

## NEWS FROM PORTLAND PLACE

### Wales and the West

ALTERATIONS entailed in the separation of Wales and the West have involved the re-arrangement of certain wavelengths which can be seen at a glance in the table below.

Plymouth and Bournemouth low-power transmitters, operating on 203.5 metres (1,474 kc/s), will transmit the same programme as the West of England Regional transmitter, except at those times when this transmitter is silent or is radiating the National programme, when they will radiate the London Regional programme.

### Area That Start Point Will Serve

The new arrangement for the West of England is temporary, and when the high-power station near Start Point, in South Devon, is completed (the construction will begin shortly), it will take over the West of England Regional programme from the Washford transmitter, using the wavelength of 285.7 metres. The station is intended to serve the whole of Dorset and most of Devon and Cornwall, but it will not serve Bristol and certain areas in North Devon and Somerset. For that purpose a medium-power relay station is to be erected on a site which has not yet been chosen. It will take over the 203.5 metres wavelength from Bournemouth and Plymouth, whose service areas will be covered by the high-power station at Start Point.

### A Technical Hitch

TEMPORARY suspensions of transmissions are generally stated in the popular Press to be due to "a technical hitch." So much easier on the layman's eye and mind than a full-blown technical explanation, but a cause of amusement to the radio journalist, who assumes that the simpler statement is due to annoying reticence on the part of the B.B.C.

### Supper Table Problems

If, however, Broadcasting House were to go more closely into detail, it is unlikely that

the dailies would print the facts; as, for example, when a shut-down is due to the grid blocking condenser on a particular unit failing, or owing to a blown fuse in the EHT circuit in a modulator panel. What would the ordinary reader make of the "overheating of a right-hand anode closed circuit tuning condenser," or of a "lead-covered grid circuit wire sagging on to HF bus bar in final RF amplifier"? Here is a typical entry in the engineers' log-book: "Array 19 shut down to replace stand-off insulators on array. 18.27.30 power on after temporary repair effected. Changed to array 1 (294 deg.). Power on 18.32.00. 18.46.30 power off to change back to array 19 (160 deg.). After further attempt at repair, repair successful." If that wasn't a technical hitch, what was it?

### Television's Extra Hour

THE extra hour's television transmission announced by the B.B.C. in May last has now been fixed to start on August 23rd, that is, a week after the service is resumed following the three weeks' suspension of all transmissions from Alexandra Palace. Instead, however, of the extra period being from 12.30 to 1.30 p.m., as originally arranged, it will be from 11.30 a.m. to 12.30 p.m., which, for some reason or other, is considered to be more suitable for trade purposes. Perhaps the earlier period is regarded as causing less interference with the trade's luncheon period. The afternoon transmissions, which normally take place between 3 and 4 p.m., will be from 4 to 5 p.m. during the period of the exhibition at Olympia only.

### "For the First Time . . ."

BRITISH television is generally considered to be ten months ahead of other countries. It was demonstrated at Radiolympia in August last; a regular service was inaugurated by the British Postmaster-General in November, 1936, with a flourish of trumpets.

Since then the programmes have been vicariously so-so, good, and marvellous. This is mere history; but alas, the fame of all the activities of Mr. Gerald Cock and his staff at Alexandra Palace seems not yet to have penetrated to America. They are now in the throes of inaugurating a television service in connection with the 1939 New York World's Fair, and in announcing the fact the National Broadcasting Company of America affirms that demonstrations of the "marvels of sound and sight broadcasting" will be brought to visitors "for the first time in radio history" in a building being constructed on the fair-ground in New York City. Lord Selsdon, Sir Noel Ashbridge and their colleagues of the Television Sub-Committee and the B.B.C. may or may not be delighted at the news that America is about to make television history in this way.

### A Family Muirk

WELSH Wales is still in the broadcasting limelight. The B.B.C. announces frequently new appointments to its Welsh staff—it is becoming the most hefty of all regional staffs—and too often the officer appointed is described as "the son of an eminent Welshman." One of these days listeners may expect to hear of the appointment of an eminent Welshman himself.

### Transmitter Synchronisation

IF the feeling of the Summer Meeting at Lausanne of the International Broadcasting Union is any guide to the intentions of the Cairo Conference of next spring, it is a foregone conclusion that the future of broadcasting will be concentrated to an increasing degree on the synchronisation of transmitters for national systems, while the sharing of wavelengths between different countries will assume less importance. The Summer Meeting indicated its belief in this development.

### Long-wave Problem

As to the long waves, no solution could be found under the Lucerne Plan of the serious cases of interference between several stations; this matter will probably have to be dealt with at Cairo; but another meeting of the U.I.R. will be held before then—at Nice in November or December next; and the final plans for the big International Radiocommunications Conference at Cairo will then be drawn up.

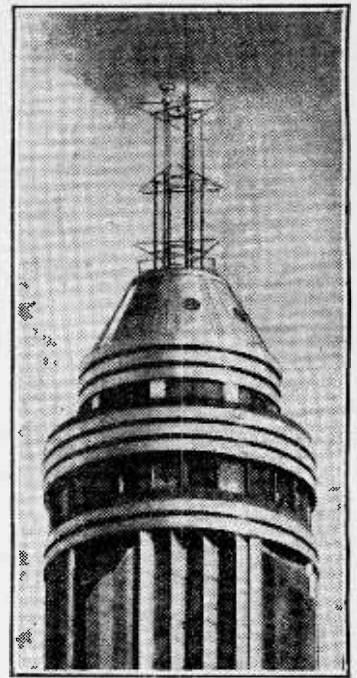

SKY SCRAPER. The television aerial on the top of the Empire State Tower in New York. The range of the transmission is stated by the N.B.C. to be nearly fifty miles.

### New Radio Drama

AS a pendant to the details of the next three months' variety programmes given recently in this page, here is news of the B.B.C.'s second "big pull," as radio drama has been called. Nine new productions will be heard by listeners during July, August and September. Marie Tempest will play the lead in Noel Coward's "Hay Fever"; another play will be "The Lunatic at Large," adapted by Lance Sieveking from the well-known novel by Storer Clouston.

### "Taffrail's" Thriller

Marianne Helweg, one of Sieveking's colleagues on the staff of the Drama Department, has adapted that charming fairy story, "The Little Mermaid," by Hans Andersen, and it will be produced by Val Gielgud, B.B.C. Drama Director. "Taffrail," whose identity was discovered some time ago as that of Capt. Tapprell Dorling, R.N. (retired), has written a new play entitled "S.O.S.," which provides him with a theme from which he can wring the last ounce of drama without destroying the probabilities.

### From the Regions

The regions will have their share of the limelight. "Storm in a Teacup," James Bridie's brilliant adaptation of a German comedy, will come from the Scottish Region, George Eliot's "Mill on the Floss" is Midland Region's offering, while "The Playboy of the Western World," by J. M. Synge, and "Bird in Hand," by John Drinkwater, will be contributed by Northern Ireland and Western regions.

Programme	Transmitter.	Location.	Wavelength.	Frequency.	
Welsh ..	West Regional .. Penmon .. ..	Washford .. Penmon .. ..	} 373.1 metres	804 kc/s.	
West of England	West of England Regional	Washford ..			285.7 metres
National ..	Droitwich National	Droitwich ..	} 1,500 metres	200 kc/s.	
	London National ..	Brookman's Park			} 261.1 metres
	North National .. Scottish National ..	Moorside Edge .. Westerglen ..			

# On The Short Waves

## NOTES FROM A LISTENER'S LOG

DO sunspots give rise to good or bad conditions? I must apologise to readers for once more returning to this question, but so much is now being written generally about sunspots and their associated electro-magnetic manifestation that one would like again to set forth what is believed to be informed English opinion on this subject. There are two schools of thought on the subject. The Americans who believe that sunspots presage poor conditions, and whose opinions are probably followed rather too slavishly by a number of amateurs in this country who illogically assume everything from the U.S.A. to be good, and rarely give a thought to the "prophets" in their own country. Some of the British scientific research group have also inclined to the American view.

A careful study of the situation, however, based on over twelve years' detailed listening below 100 metres and the practical experience of operating world-wide short-wave circuits, leads one to the definite conclusion that sunspots are much more useful to the short-wave engineer than he is prepared to admit.

The average transmission engineer and writer in the popular Press pays far too much attention to occasional or transitory disturbed conditions and fade-outs which naturally occur more frequently during the sunspot maximum years than during the interim periods between the maximum and minimum epochs.

### "Five Hours Back" Relays

A bare two years ago, however, when only a single sunspot was to be seen every three or four weeks, transmission conditions from the U.S.A. were so poor that the B.B.C. could not continue its "Five Hours Back" relays later than 5 p.m., and even then one or two of the relays were quite poor in spite of all the efforts of the modern beam diversity equipment at Tatsfield and the numerous transmitters in operation on the other side.

This year it is proposed to conduct another series of "Five Hours Back" relays round about 11 p.m.!

The point seems to be that the changing ionisation conditions due to the solar cycle demand changes in transmitter technique, in particular the more careful use of the higher frequencies; in daylight during the summer months the optimum band this year ranges from 17 to 21 Mc/s (17 to 14 metres), whilst in the coming winter it will range from 14 to 35 Mc/s (20 to 8 metres), and these figures show only too clearly why the average listener finds conditions poor, at least during the summer.

Most all-wave receivers do not tune above 18 Mc/s (below 16.5 m.) and quite a few above 15 Mc/s (below 19 m.), so that the only distant transmitter which is likely to give a good service until late in the evening now is W<sub>3</sub>XAL on 17.78 Mc/s. Very unfortunately most of the time it transmits with a beam aerial directional on S. America, and we receive only the backwash.

Here it is interesting to look at the current schedule of the B.B.C.'s Empire Station; we find that between 10.42-17.00 G.M.T. they have two transmitters operating in the 21 Mc/s band, GSH directional to Africa and GSJ for Malay and India; and

two transmitters working isochronously on GSG 17.79 Mc/s, one for the Far East and the other for India, Ceylon and Malaya. One of the 17.79 Mc/s transmitters remains in use until midnight B.S.T.

Yet some of the British manufacturers recently advertised in Eastern journals receivers which only tuned down to 19 metres!

I think the conclusion is that if you are prepared to make full use of the 19 Mc/s band, changing to somewhat lower frequencies at night if necessary, but rarely below 10 Mc/s, then on a 24-hour basis short-wave conditions in the sunspot maximum years are much superior to those of the minimum years. If you confine your consideration to certain parts of the day (the transatlantic telephone service may provide an example), then you may be able to discount the very poor night conditions of the minimum years, those blank nights when only 4 Mc/s (70 metres) or long-wave operation is possible.

Finally, it was rather amusing to note rather poor conditions prevailing during the past week-end (June 27th), which on investigation proved most probably to be due to a noticeable fall in solar activity, since in place of the now usual moderate to high activity only one or two sunspots were visible!

With the transatlantic radio-telephone service using WKN and WKF in the 19 Mc/s band, and WLA in the 18 Mc/s band almost exclusively, it is easy to see that 14 Mc/s amateur signals will be poor at present.

Owing to the sunny days (?) little detailed listening has been done during the past fortnight, but it is thought that a few notes on new transmitters and new frequencies for old ones would be helpful.

The station causing the heterodyne on JZK on 15.16 Mc/s is believed to be Stockholm SBG 15.155 Mc/s, but the Mexican transmitter XEWW has also been heard operating on 15.16 Mc/s. The Javanese station YDC at Soerabaja is now working on 9.548 Mc/s, and COBC, a new Cuban transmitter, on 9.34 Mc/s.

Lastly, the Midwest Company in London report good reception of the Berlin television sound transmissions on 42.3 Mc/s between 2.20 and 2.46 p.m. on Thursday afternoon, June 17th; the peak signal was at 2.35 p.m. B.S.T. and the station finally faded out rapidly. Did any other reader hear this? ETHACOMBER.

### The Radio Industry

M.R. Supplies, of 11, New Oxford Street, London, W.C.1, has just issued a new list of microphones, amplifiers and associated PA equipment. An entirely new model of the M.R. Transverse Current Microphone has been introduced at the price of 37s. 6d.

Will Day, Ltd., 19, Lisle Street, Wardour Street, London, W.C., has taken over the assets of Musikon, Ltd., the well-known makers of home and professional recording apparatus, such as trackers and cutting heads, record blanks, turntables, etc.

New G.E.C. sets were announced last Monday. Iron-cored coils are used in all RF and IF circuits.

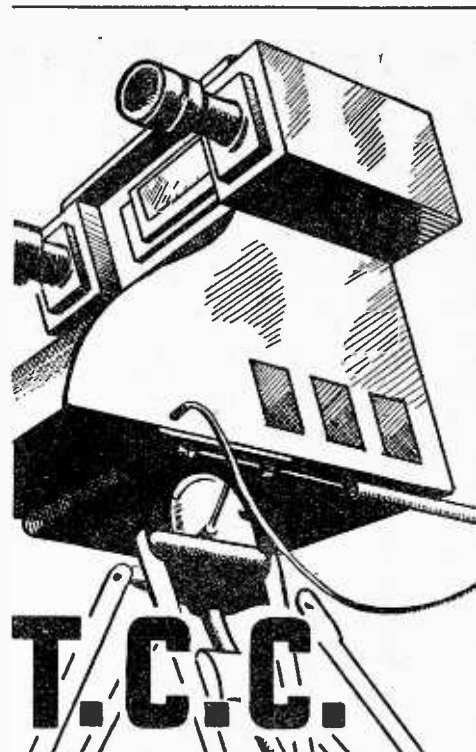

# SPECIFIED

for the  
"Wireless World"

# TELEVISION RECEIVER

## VISION

- 6 0.01 mfd. mica. "M" • Price each 2/-
- 3 0.0005 mfd. mica. "M" Price each 9d.
- 1 500 mfd., 12 volts, Electrolytic. 501. Price 6/-

## SOUND

- 2 0.01 mfd. mica. "M" Price each 2/-
- 1 0.0001 mfd. mica. "M" Price 8d.
- 2 0.0005 mfd. mica. "M" Price each 9d.
- 1 50 mfd., 12 volts, electrolytic. "FT" Price 2/3
- 2 8 mfd., 460 volts peak, electrolytic. 802. Price each 6/-

JUST as in the very first days of Radio—and before—T.C.C. Condensers always featured in outstanding Receivers, so again in Television, where accuracy and reliability are even more vital, do you find the designer specifying T.C.C. So again has T.C.C. dependability prompted the designers' choice.

# T.C.C.

ALL-BRITISH

# CONDENSERS

The Telegraph Condenser Co. Ltd., Wales Farm Rd., N. Acton, W.3

# Random Radiations

By

"DIALLIST"

## Impropaganda

IT'S good that the subject of the violent anti-British propoganda which has been going out from the broadcasting stations of certain countries has been raised in Parliament after an extensive ventilation in the correspondence columns of *The Sunday Times*. Though not the only offender, Italy has been the worst. Highly coloured news bulletins have been sent out from her stations in no fewer than sixteen languages, and, so far as I can make out, the transmissions continue, though their tone does appear to be modified to some extent. Possibly you may have heard some of those in English which emanate from medium-wave stations such as Milan and Bari and from the short-wave station I2RO4. If you haven't, it is worth while tuning them in, the medium-wave stations between seven and eight o'clock in the evening or at about a quarter-past eleven at night, and the short-wave station at 3 p.m. or just after midnight. Those who know Oriental languages such as Arabic may get even bigger surprises than listeners who know English only. The Arabic programme is given each weekday at 6.30 p.m. on 25.4 metres.

## Not Good Enough

Wireless could be and should be one of the greatest factors in the world for promoting international understanding and peace, but, used in this way, it might easily become just the opposite. One hopes that

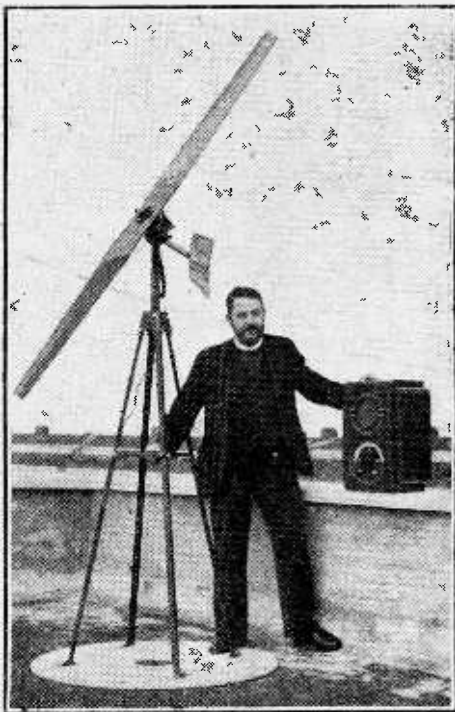

**LOW-TENSION AND HIGH-TENSION FROM THE WIND.**—As announced last week, the Rev. Harold Wilde, chaplain of Tristan da Cunha, has been presented with an Ekco all-wave receiver for the use of the islanders. This photograph shows Mr. Wilde with the windmill generator, which will be used to charge a 4-volt accumulator feeding the filaments directly and also providing HT through the intermediary of a vibratory generator.

the matter will be taken up by the U.I.R. and that at a conference in the near future it may be possible to induce all countries to agree not to indulge in external propoganda. There isn't, of course, the slightest reason why they shouldn't "propagand" as much as ever they like in their own languages for the benefit of people within their frontiers. But when it comes to sending out this embittered stuff in languages which aren't spoken in any of their own dominions it is rather too much of a bad thing.

## Good Commenting

DID you go to the Air Force display at Hendon? If so, you must have been struck by the excellent commentaries wireless from plane to ground by the airmen themselves whilst they did their stuff. It struck me that they were very much superior to the bulk of B.B.C. commentaries; they were fresh, they were alive, they were graphic and they were intimate. One particularly successful commentator was the leader of the Flight Aerobatics, who made you feel almost as if you were taking part yourself in the wonderful show put up by his planes. "Now then, over we go," he cried—and over they went. B.B.C. commentators tend to be just a little too aloof, a little too dry. I hope many of them were at Hendon and realised from what they heard the airmen do how very good the rather less formal type of commentary can be.

## A Television Problem

SPEAKING of commentaries brings to mind one rather queer effect which accompanied the B.B.C.'s first attempt to televise Wimbledon tennis. When the first trial was made they "married" the commentary intended for National broadcasting to the television transmission. If you happened to be looking-in, the result was rather extraordinary. The commentator seemed to lag always nearly a stroke behind the actual play as you saw it. It doesn't, of course, matter a bit for sound broadcasting alone if his remarks are made a second or two after the event described has taken place; but it emphatically does matter for a television running commentary, and it seems that a different technique altogether is going to be needed when sporting broadcasts by television become more general.

## A Battery Tragedy

THOUGH many battery receiving sets are designed for use with special HTBs, there's no question that the 120-volt standard capacity battery is the one that the man in the street has come to regard as the normal and proper source of plate current for his receiving set. He is offered everywhere batteries of this kind priced at five or six shillings and he buys them, though the proper replacement unit for his set may cost two or three times as much—or perhaps I should say *because* it costs two or three times as much. The saddest part of the whole business is that not a few makers of battery sets are finding themselves forced by popular demand to turn out re-

ceivers which will work in some kind of way with a high-tension battery that registers a voltage of about 120 when new and perhaps 70 or 80 after it has been used for a few weeks. Most British battery valves are at their best when the plate voltage is in the neighbourhood of 150; hence their performances are a long way below what they should be when the battery voltage is 120, and become very poor indeed when it drops from 40 to 50 volts below that. I do blame both set manufacturers and battery manufacturers for failing to instil into the great body of listeners that the battery set of to-day can be very nearly as good as the mains set if only they will use an adequate source of high-tension supply, and, secondly, that batteries which seem very cheap on account of their low initial cost are often a very poor investment owing to their short life.

## Facts and Figures

IT happens to me quite often to hear from some user of small cheap batteries that he has a set which draws, say, ten milliamperes when the HTB is up to its nominal 120 volts, that he uses it not less than six hours a day, and that he obtains fine performance and perfect reproduction for six or seven months from each new HTB. It's no good telling such a fellow that the thing is theoretically impossible. Even will he close his eyes and his ears to hard, cold practical facts. He is so anxious to believe in his own cleverness in securing a bargain that he will put up with almost incredible distortion and thoroughly bad performance in every way rather than admit that his cheap battery is no longer doing its job. Laboratory tests show the real facts and figures, but if you quote them to him or show him test records in graph form they no more sink in than does water poured upon a duck's back!

## Better Tuning Dials

ONE of the outstanding features of many of the new season's wireless sets that I have seen is the big all-round improvement that has been made in tuning dials. In these columns I have long waged war against the small tuning dial with station names on the medium- and long-wave bands that are difficult to read, a cramped and not too well marked scale of metres or megacycles on the short-wave range and the pointer about as thick as a poker. An idea firmly fixed in the minds of the big men of some firms was that any kind of large dial must be unsightly and that the ordinary user much preferred a small dial to one that was open and easily legible. That obsession seems now to have been removed, for one finds semicircular dials six or seven inches in diameter and rectangular ones of similar goodly dimensions.

Sometimes, I think, there is a tendency to crowd in rather too many station names, which may mean that small type has to be used for them. Those who design dials should remember that not everybody has

first-rate eyesight, and that it can be a bit of a bore to have to put on glasses whenever you want to change from one station to another.

**Co-Axials and Valves**

WHAT a big difference the co-axial cable is going to make to communications in this country! Quite close to my home there was until recently a huge array of overhead wires borne on the Siamese-twin type of telegraph post. These were the main London-Birmingham lines. Now they have all come down. The posts remain for the moment, gaunt and hideous in their nakedness (it's amazing how naked a line of telegraph poles can look without any wires!) and the underground co-axial cable lies snugly tucked away, safe from gales and snowstorms. The co-axial cable could never have been made to serve any useful purpose if it hadn't been for the wireless valve. Now it carries in its slim self telegraphy and telephony and before long it will be carrying television, too. Only those who remember the telephone in its earlier days can realise what a change the valve has made. It used to take hours to put through a trunk call for which now you're bidden to hold the line. And if the distance was more than 40 or 50 miles you shouted at your correspondent and heard a muzzy whispering from him.

**Television at Radiolympia**

IT is good to see that television is to have a real chance at this year's Radiolympia, the B.B.C. co-operating with the organisers to make it a real success. The programmes are to be altered during the run of the Exhibition so as to make it possible for a very large number of people to see complete items. With this end in view they will be divided into three fifteen-minute periods, each complete in itself, with intervals of five minutes between items to give time for one audience to leave the booth and another to come in. There are going to be at least fifteen or sixteen booths, and I see it is suggested that each of them will accommodate about thirty people. If that is so it will be possible to let between 1,300 and 1,400 people "look-in" during each pro-

**Ferranti "1137"**

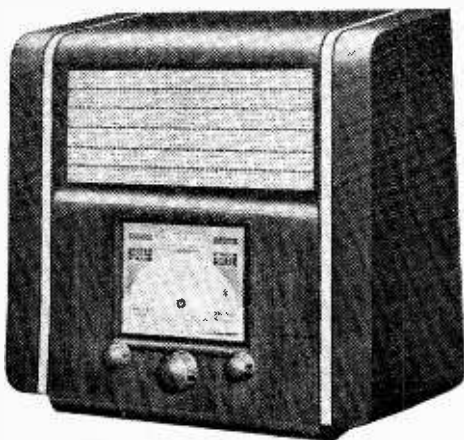

BASED on the Model 837, recently reviewed in these pages, this set is housed in a new type of cabinet and is fitted with the redesigned "Magnascopic" scale for accurate tuning on short waves. The price of the new set is 11 guineas.

gramme transmission. I am inclined to wonder, though, whether it is wise to try to get so large an audience into a viewing booth. It is rather important to give audiences the best possible impression of what television can do.

I find that some apology is due to the Museum authorities for my last week's remarks concerning the lack of information at the Television Exhibition. I must have been unlucky at my earlier visit; the facts are that one of the official Guide-Lecturers makes frequent tours of the Exhibition and also those in charge of the demonstration receivers are able and willing to answer any technical enquiry.

**Television  
Programmes**

Transmissions are from 3-4 and 9-10 daily.

Vision: 45 Mc/s. Sound: 41.5 Mc/s.

**FRIDAY, JULY 9th.**

3, The Raft: an interlude by Stephen Leacock. Scene—Lost in the Caribbean Sea. 3.15, Sculpture; making a plaster cast. 3.25, British Movietonews. 3.35, Douanes, with Valerie Hobson, Ernst and Lotte Berk and Eric Wild and his Tea-Timers.

9, Pyramus and Thisbe: Shakespeare comedy, produced by Jan Bussell. 9.15, Gaumont-British News. 9.25, Repetition of 3.15 programme. 9.35, Ad Lib. Revue.

**SATURDAY, JULY 10th.**

3, In Our Garden, by C. H. Middleton. 3.15, The Hogarth Puppet Cabaret. 3.30, Gaumont-British News. 3.40, Plus la Change—light entertainment.

9, Repetition of 3.40 p.m. programme. 9.20, Summer Gardening: C. H. Middleton. 9.30, British Movietonews. 9.40, Variety, with the Hobart Trio, Collinson and Dean and the B.B.C. Television Orchestra.

**MONDAY, JULY 12th.**

3, Recital by Lisa Minghetti (violin) and Marita Farell (soprano) accompanied by Cyril Belcher. 3.15, Film: Building a Building. 3.25, Two Diminutive Dramas. 3.50, Gaumont-British News.

9, Repetition of 3 p.m. programme. 9.5, Film: Deep Sea Thrills. 9.15, Discussion on Salads between M. Marcel Boulestin and C. H. Middleton. 9.30, British Movietonews. 9.40, Television Follies.

**TUESDAY, JULY 13th.**

3, An O.B. 3.10, Fashion Parade, arranged by H. E. Plaister and G. R. Kenward-Eggar. 3.25, British Movietonews. 3.35, Mizzen Cross Trees.

9, Repetition of 3 p.m. programme. 9.15, Film: Building a Building. 9.25, Damon and Phyllida, a one-act opera. 9.50, Gaumont-British News.

**WEDNESDAY, JULY 14th.**

3, Pyramus and Thisbe: Shakespeare comedy, produced by Jan Bussell. 3.15, Film: Deep Sea Thrills. 3.25, Revue. 3.50, Gaumont-British News.

9, Recital by Marita Farell (soprano) accompanied by Cyril Belcher. 9.10, Excavations at Maiden Castle in Dorset. 9.25, British Movietonews. 9.35, Two Diminutive Dramas.

**THURSDAY, JULY 15th.**

3, Dancer. 3.15, Waxworks demonstration by Bernard Tussaud. 3.25, British Movietonews. 3.35, Revue.

9, Repetition of 3 p.m. programme. 9.10, The Raft: an interlude by Stephen Leacock. 9.25, Gaumont-British News. 9.35, Mizzen Cross Trees.

**POINTS OF  
IMPORTANCE  
in the Rola  
G.12**

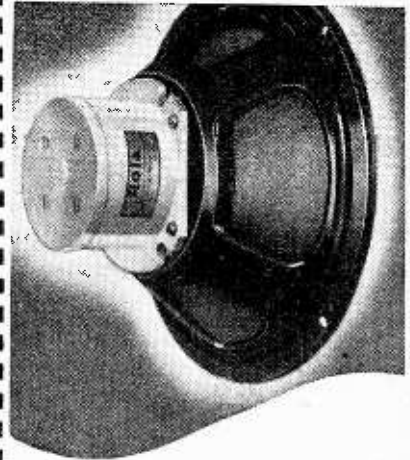

**THE SPEAKER  
SELLS THE SET**

So widely has the phenomenal performance of the Rola G.12 become recognised that it is true to say that it is a speaker that sells the set. Once you have heard the remarkable fidelity of this unit you will be content with no receiver that is not G.12 equipped. You will discover too, that the mere presence of a G.12 in a radio receiver affords proof of its quality, for it would pay no manufacturer to install this unit in a set that was not able to do full justice to such a reproducer. Ask your dealer to demonstrate a Rola G.12 and let your own ear confirm our claims.

G.12 P.M. (as illustrated) less Transformer	£4 16 0
G.12 P.M. with Transformer	£5 5 0
G.12 D.C. Complete with Transformer, Mounting Stand, Handle and Base	£5 5 0
G.12 D.C. with Mounting Stand, Handle and Base, but without Transformer	£4 16 0
G.12 D.C. Stripped, but with Transformer	£4 4 0
G.12 D.C. Stripped and without Transformer	£3 15 0

(When ordering please state Field Resistance and Impedance of Transformer required.)

For Public Address work both the P.M. and Energised Models can be supplied with a 15 ohm Voice Coil at an additional charge of 3/-.

Write for Folder A.

**OVER 8 MILLION IN USE**

**ROLA**

*The World's Finest Reproducers*

**THE BRITISH ROLA CO. LTD.**  
MINERVA ROAD, PARK ROYAL, N.W. 10.  
PHONE: WILLES DEN 4322-3-4-5-6.

# Recent Inventions

**Brief descriptions of the more interesting radio devices and improvements issued as patents will be included in this section**

## FLUORESCENT SCREENS

**F**LUORESCENT material is sprinkled upon a 10 per cent. solution of caustic soda which has been spread over a backing-plate of soda-glass. The matrix is then baked. This is stated to prevent the fluorescent crystals from being dislodged from their setting by mechanical vibration, and also avoids any loss in sensitivity due to the screening action of the usual water-glass binding.

*Ferranti, Ltd. and M. K. Taylor. Application date October 3rd, 1935. No. 463642.*

## CATHODE-RAY TUBES

**A**DVANTAGE is taken of the peaked impulses applied to the deflecting coils of a cathode-ray television receiver to obtain "free" DC voltage for biasing the second anode of the tube.

The deflecting coils are shunted by a circuit including a variable resistance, in series with a rectifier valve and a condenser. The rectifier is inoperative during the forward stroke of each scanning line, but comes into action during the "flyback" period, to charge up the series condenser. This is shunted by a potentiometer from which a supply of DC voltage is tapped off to the second anode of the tube.

*Marconi's Wireless Telegraph Co., Ltd. (Assignees of A. W. Vance). Convention date (U.S.A.) September 29th, 1934. No. 463253.*

**W**HEN external magnetic coils are used for deflecting the stream inside a cathode-ray tube, there is a tendency for part of the field to stray out of its proper path, and, by affecting the electron stream, to produce distortion of the picture.

According to the invention the ferro-magnetic core of the deflecting coil is provided with extra pole-pieces, which are adjustable relatively to each other so as to offset or prevent the passage of stray fields into any part of the tube where they may produce undesirable results.

*A. H. Gilbert; L. R. Merdler; and Baird Television, Ltd. Application date September 12th, 1935. No. 462684.*

## MAINS-SUPPLY UNIT

**A** HIGH-TENSION unit is designed for use with either 110 or 220 volts on either AC or DC mains, and to deliver a higher rectified voltage than that supplied by the mains, even in the case of a DC supply. The step-up is secured by means of an auxiliary valve, which is connected across the supply trans-

former so that it generates continuous oscillations and feeds them into the primary winding. The higher voltage induced in the secondary winding is then fed to a rectifier valve and smoothing circuit. The auxiliary valve is, of course, switched out of operation when the device is coupled to an AC supply.

*The British Thomson-Houston Co., Ltd. Convention date (Belgium) August 25th, 1934. No. 463410.*

## "DIELECTRIC GUIDES"

**U**LTRA-SHORT waves, of the order of 2,000 megacycles are transmitted from point to point through a "dielectric guide" consisting of a cylindrical body of air or other dielectric, enclosed by a metallic sheath 5in. in diameter. The wave travels through this guide in much the same way as it would travel through open space, except that it is strictly localised inside the metallic sheath.

The invention is concerned with various ways and means of impressing telephonic or other signals upon such a carrier wave, and of demodulating or rectifying the signals at the distant end.

*Standard Telephones and Cables, Ltd. (Assignees of G. C. Southworth and A. P. King). Convention date (U.S.A.) October 12th, 1935. No. 463238.*

## RF COUPLINGS

**T**HE "selectivity" response of the ordinary two-tuned circuit varies from the peaked curve A, Fig. 1, which corresponds to

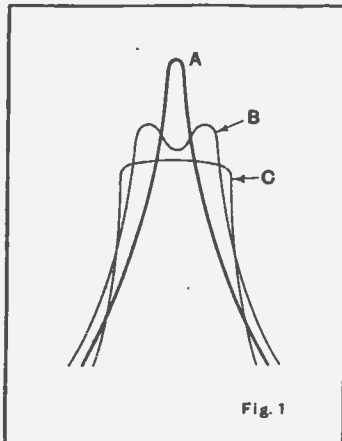

Fig. 1.—Typical response curves of a two-circuit coupling are shown by curves A and B with loose and tight coupling respectively. Curve C is that of the three-circuit coupling unit described.

loose coupling to the double-humped curve B produced by tight coupling. The object of the invention is to vary the selectivity of a set from curve A to curve C, which has a broad and substantially flat top and steep sides.

Fig. 2 shows a three-circuit coupling designed for this purpose. Each of the units A, B, C consists of a coil fitted with a powdered-iron core, and a small variable

capacity K, K1, K2 mounted at the base. The Unit A may, for instance, be inserted in the plate circuit of an intermediate-frequency valve, and the unit C in the grid circuit of the following valve, the unit B then serving as a coupling link between the other two. The coils of the units A and C are set at right angles to each other and at a definite distance apart. The coupling is varied by swinging the coil of the unit B about the pivot P by means of a handle (not shown) embracing the yoke Y.

*Johnson Laboratories Inc. (Assignees of A. Crossley and H. E. Meinema). Convention date (U.S.A.) August 10th, 1935. No. 463202.*

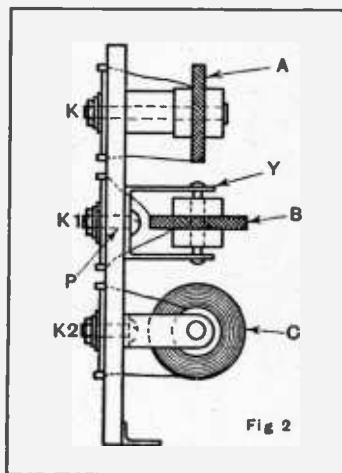

Fig. 2.—Method of mounting the coils and condensers in the three-circuit coupling unit.

## TUNING COILS

**A** HIGH-FREQUENCY coil is designed so that the inherent capacity between its windings is sufficient to tune it over an extended range of frequencies. A small variable condenser may be added for trimming purposes, but the selective action of the coil depends mainly on the fixed capacity between its windings plus the variation in inductance due to a movable powdered-iron core.

The coils are preferably wound in a single layer. A separate movable core may be provided at each end to allow of tuning over two different wavelength ranges.

*S. G. Brown. Application date August 30th, 1935. No. 463724.*

## FEEDBACK AMPLIFIERS

**T**HE output from an amplifier V is fed back through a condenser C and a coil L connected, as shown, to a band-pass input circuit. A resistance R in the input circuit to the grid introduces a 90 deg. phase-shift, which produces regeneration in both cir-

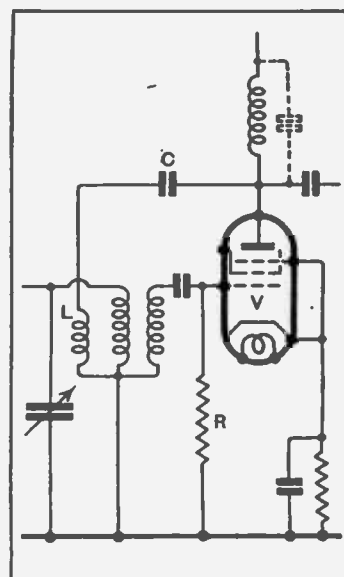

Method of increasing gain and selectivity in an amplifier with a band-pass input circuit.

uits, and so increases both the gain and selectivity of the set. Without this resistance, when both band-pass circuits are exactly in resonance, the phase conditions are such that no regeneration occurs.

The output from the amplifier can also be rectified and used to provide automatic volume control. Automatic selectivity control is similarly obtained by varying the bias on the grid of the valve, and, therefore, the amount of feedback.

*Marconi's Wireless Telegraph Co., Ltd. (Assignees of J. Pleban-ski). Convention date (Poland) October 7th, 1935. No. 463233.*

## MICROPHONES

**T**HE carbon-granule type of microphone, when used for public address systems or for broadcasting, has a pronounced directional effect, which makes it necessary to set several instruments at different angles in order to secure a correctly balanced pick-up, say, from a large orchestra or choir.

According to the invention the microphone is fitted with a curved diaphragm, circular in cross-section, and a number of carbon "cells" are mounted around the periphery over, say, an angle of 180 deg. The cells may all be connected in parallel, or certain of them may be coupled to a separate amplifier. A single instrument of this type will receive equally sound-waves coming either from a point directly in front of it or at wide angles of divergence, and will give a correctly balanced output.

Instead of being circular in cross-section, the diaphragm may be curved at one part of its periphery and flat at another.

*The British Thomson-Houston Co., Ltd., and L. B. Ault. Application date October 3rd, 1935. No. 463649.*

The British abstracts published here are prepared with the permission of the Controller of H.M. Stationery Office, from Specifications obtainable at the Patent Office, 25, Southampton Buildings, London, W.C.2, price 1/- each. A selection of patents issued in U.S.A. is also included



# MISCELLANEOUS ADVERTISEMENTS

### NOTICES

THE CHARGE FOR ADVERTISEMENTS in these columns is

12 words or less, 3/- and 3d. for every additional word.

Each paragraph is charged separately and name and address must be counted.

SERIES DISCOUNTS are allowed to Trade Advertisers as follows on orders for consecutive insertions, provided a contract is placed in advance, and in the absence of fresh instructions the entire "copy" is repeated from the previous issue: 13 consecutive insertions 5%; 26 consecutive, 10%; 52 consecutive, 15%.

ADVERTISEMENTS for these columns are accepted up to FIRST POST on MONDAY MORNING (previous to date of issue) at the Head Offices of "The Wireless World," Dorset House, Stamford Street, London, S.E.1, or on SATURDAY MORNING at the Branch Offices, 19, Hertford Street, Coventry; Guildhall Buildings, Navigation Street, Birmingham, 2; 260, Deansgate, Manchester, 3; 26a, Renfield Street, Glasgow, C.2.

Advertisements that arrive too late for a particular issue will automatically be inserted in the following issue unless accompanied by instructions to the contrary. All advertisements in this section must be strictly prepaid.

The proprietors retain the right to refuse or withdraw advertisements at their discretion.

Postal Orders and Cheques sent in payment for advertisements should be made payable to **LILFFE & SONS Ltd.**, and crossed **& Co.** Notes being untraceable if lost in transit should not be sent as remittances.

All letters relating to advertisements should quote the number which is printed at the end of each advertisement and the date of the issue in which it appeared.

The proprietors are not responsible for clerical or printers' errors, although every care is taken to avoid mistakes.

## ABOUT THE M.A.

(Continued.)

### FREQUENCY RESPONSE

For the reasons quoted last week, the response is exceptionally good. By using the tone-control, the output can be maintained up to 8-9,000 c/s, even at maximum selectivity, though if (under very bad conditions) side-band splash comes through, it can be "cut" to 5,000 c/s.

### DISTORTION

This is negligible. The output stage gives 7 or 14 watts according to type, and special care is taken to avoid detector distortion due to A.V.C. The output is pure even to deep modulation.

(To be continued.)

## HARTLEY TURNER RADIO LTD.,

THORNBURY ROAD,  
ISLEWORTH, MIDDLESEX.  
Telephone: HOUNslow 4488.

### NUMBERED ADDRESSES

For the convenience of private advertisers, letters may be addressed to numbers at "The Wireless World" Office. When this is desired, the sum of 6d. to defray the cost of registration and to cover postage on replies must be added to the advertisement charge, which must include the words Box 000, c/o "The Wireless World." All replies should be addressed to the Box number shown in the advertisement, c/o "The Wireless World," Dorset House, Stamford Street, London, S.E.1. Readers who reply to Box No. advertisements are warned against sending remittance through the post except in registered envelopes; in all such cases the use of the Deposit System is recommended, and the envelope should be clearly marked "Deposit Department."

### DEPOSIT SYSTEM

Readers who hesitate to send money to advertisers in these columns may deal in perfect safety by availing themselves of our Deposit System. If the money be deposited with "The Wireless World," both parties are advised of its receipt.

The time allowed for decision is three days, counting from receipt of goods, after which period, if buyer decides not to retain goods, they must be returned to sender. If a sale is effected, buyer instructs us to remit amount to seller, but if not, seller instructs us to return amount to depositor. Carriage is paid by the buyer, but in the event of no sale, and subject to there being no different arrangement between buyer and seller, each pays carriage one way. The seller takes the risk of loss or damage in transit, for which we take no responsibility. For all transactions up to £10, a deposit fee of 1/- is charged; on transactions over £10 and under £50, the fee is 2/6; over £50, 5/-. All deposit matters are dealt with at Dorset House, Stamford Street, London, S.E.1, and cheques and money orders should be made payable to Lilffe & Sons Limited.

SPECIAL NOTE.—Readers who reply to advertisements and receive no answer to their enquiries are requested to regard the silence as an indication that the goods advertised have already been disposed of. Advertisers often receive so many enquiries that it is quite impossible to reply to each one by post. When sending remittances direct to an advertiser, stamp for return should also be included for use in the event of the application proving unsuccessful.

### NEW RECEIVERS AND AMPLIFIERS

**DEGALLIERS, Ltd.**—Still we grow. Note new address below.

**DEGALLIERS, Ltd.**, the firm for reliable short-wave radio, have on show in London without exception the largest selection of fully guaranteed brand new all-wave receivers; callers invited to handle these at their leisure without obligation to purchase; all S.W. receivers will get stations on the low bands, including the Americas; let us demonstrate to you; if you live out of town we have satisfied customers in nearly every part of the country, who would probably let you hear these sets in their own homes. Terms, cash with order or c.o.d.; handsomely illustrated catalogues forwarded on receipt of large stamped addressed envelope or 2½d. stamp; our lists give the fullest technical data, with all measurements; each set is complete in cabinet ready to plug in; chassis quoted separately.

NOTE.—Marconi royalties are already paid on all Challenger Receivers.

5/- Each, American valves, all guaranteed, each a first, no seconds or throwouts, for every known set from 1927-37; metal, metal glass, glass; glass counter-parts, etc.; in ordering just state type and number, we have it; line cords for all Midgets, 4/6 each.

£3/5—Midget T.R.F. 4-valve A.C.-D.C., 200-250 volts, in leather cloth or walnut.

£4—Midget T.R.F. 5-valve, M. and L. wave, 100-250 volts, A.C.-D.C., calibrated in station names.

7 Gns.—Table model 6-valve all-wave superhet, 16½-50, 200-550, 800-2,000 metres, 8in. M.C. speaker, calibrated in station names.

CHALLENGER Series Model 800 8-valve High Fidelity Receivers, A.C. 200-250 volts, 4 distinct bands, 11-32, 27-64, 190-550, 900-2,000 metres, calibrated in metres and station names; available in the following types:

13 Gns.—Challenger 800 table model De Luxe, 10in. M.C. speaker.

£12/18—800 chassis, valves and 10in. speaker, with all escutcheons, etc.

£14/18—800 chassis, valves, and Rola G12 high fidelity P.A. speaker.

17 Gns.—Challenger 800 console, 42x12½x24, with G.12 speaker.

29 Gns.—Challenger 800 radiogram, with automatic changer, also incorporating the G.12 speaker.

NOTE.—The Challenger 800 series are also available in 11-valve A.C.-D.C. 200-250 volts, at a small extra cost.

14 Gns.—Challenger 381 table model 8-valve high fidelity receiver, 14-2,060 metres, polychromatic dial scale vision master, beam power output, magic eye, automatic band indicator, high image frequency suppression, magn. dial and second hand; or less cabinet £13/18.

(This advertisement continued in third column.)

## ELECTRADIX BARGAINS

TELEPHONES for HOUSE, OFFICE, GARAGE, and Field Sports. Table, Wall and Waterproof Portable, from 10/-. Headphones for short-wave radio, etc. 2/9 pair. Telephone wire cheap.

SWITCHES. We have some super grade; ultra-short switches. Contacts on ribbed pedestal. D.P.C.O. 7/6. Resistance Box (Switch Panels) boxbase R.I. 8-way arm, 7/6. Larger type with two sets of mounted 10-way studs and arms, 9/-. Light duty switches for Wave-change and Semi-rotary D.P.C.O., 6d. R.A.F. Switch Boxes for 3 circuits, rocker type, 1/2. 6-way Rocker-toggle, 2/- 8-way ditto, 3/6. Yaxley and Rex Wavechange D.P., 3-way, roller contact, new, 1/3. Bulgin 3-point Wave-change, 9d. Tunwell 8-P. on-off semi-rotary, 8d.

STUD SWITCHES. 20-way Stud Switches on panel, two contact arms and ring for 10 amps. 5/6. 7-way Stud Switches on 2½in. panel, in and out sets, 1/8. 10-way D.P. ebony mounted, 8 amps. Automatic. 2 to 4 amps. 7/6; 6 amps. 10/-; 10 amps. 12/-; 1 amp., 14/-; 20 amps. 16/-.

PRECISION MICRO-AMMETERS for Valve Voltmeters, etc. 0 to 50 microamps full scale, 5 mV. moving coil, flush panel, 2½in. dial. Reads direct signal strength on crystal, 1,000 ohms., 40/-.

Genuine Weston model 354. Central zero 1 to 15 amps., pot. metal, 25-0-25 m.a., 10/- Weston, 0 to 30 m.a. mov. coil milliammeters, 17/6.

MEGGERs AND OHM-METERS. 1,000 ohms. to 100 megs., from £5/10/-.

ELECTRIC WATER PUMPS. A.C. or D.C., 6lt. del. 100 galls. per hour, 67/6; larger sizes motor engine driven supplied. Electric Blowers or Fume Exhausters, D.C. 220-v. 3in. outlet, 65/-; 1½-v. ditto, 45/-.

Electric Compressors for Inflation and Spray Painting, £5/15/- to £12.

Disc Home Recording with the all-gear FEIGH Electric Recorder, Ball Bearing centre gear-box and traverse rod is the lowest price electric home recorder

that will fit any gram. The set with Tracking Gear, Pick-up and tone arm with diamond, 37/6.

ACOUSTIC RECORDERS. Lasting Interest. Cost is low. New MIVONCE acoustic sets, complete outfits in carton, de luxe, 18/-. No. 2 10/6. Junior, 5/6. 6in. blank all discs 4/- doz.

Send for latest Bargain List "W."

**ELECTRADIX RADIOS**  
218, Upper Thames Street, London, E.C.1.  
Phone: Central 4611

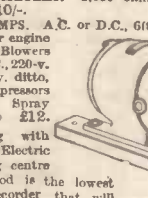
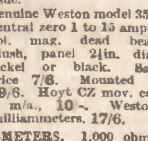
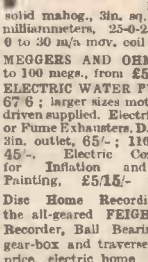
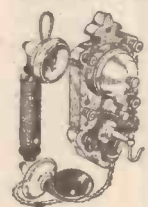

### NEW RECEIVERS AND AMPLIFIERS

(This advertisement continued from first column.)

£50—24-valve Challenger twin chassis and 2 public address high fidelity speakers, 5-2,000 metres, 60 watts undistorted; or in massive console cabinet, height 4ft. 2in., wide 2ft. 4in., deep 1ft. 3in., £7 extra; this is as supplied to the Navy and Army Canteen Board, therefore ideal for public hall, baths, etc.; carriage and crate 15/-.

OTHER Receivers in Stock Too Numerous to Mention, such as Belmont, Ferguson, etc.

NEAREST Stations "Underground" Lancaster Gate, Edgware Rd., and Praed St. Buses passing within 100 yds.: 6, 7, 8, 15, 16, 36, 60, 92, 291, 294, 12, 17, 32, 86, 136, 27a. Map enclosed with all applications for catalogues showing all routes and main line stations.

DEGALLIER'S, Ltd., 32, Bathurst Mews, Paddington, London, W.2. Telephones: Paddington 2745 and Bayswater 5732. [4584]

HILL and PONDER Offer Brand New Crosley Receivers Under Fullest Comprehensive Guarantee at approx. 70% Below List Price; list available; terms, cash with order or c.o.d.; carriage extra.

10 Gns.—"Crosley" high fidelity 9-valve superhet chassis, valves and 8in. M.C. speaker, 5 distinct bands, 12-2,000 metres, Airplane dial calibrated in metres, 10 watts undistorted, Neon tuning device, etc., or with Rola G12 High Fidelity speaker add 20/-; also available in cabinets; table, £12; console, 14 gns.; radiogram with automatic changer, £24.

HILL and PONDER, 9, Lancaster Mews, London, W.2. [4713]

ALERT RADIO Co. "COMMUNICATION," "Shortwave" and "Allwave" Receivers.—21, East Rd., N.1. Clerkenwell 4871. [4381]

"SERVICE with a Smile."

HENRY FORD Radio, Ltd.

ELECTRONIC House, 22, Howland St., Tottenham Court Rd., W.1. Museum 5675. [0511]

TRANS-ATLANTIC RADIO Co. for Finest All-wave Receivers, Midgets and Valves.—15, Percy St., W.1. Museum 3096 [4623]

ROYAL RADIO Co., 5, Buckingham Rd., E.18.—Send for catalogue of all the latest short wave receivers and car radio. [4741]

ARMSTRONG COMPANY, Pioneer Firm supplying high grade all-British receivers in chassis form, manufacture models to suit all requirements, incorporating all the latest improvements.

ARMSTRONG COMPANY Invite You to Send for Full Particulars.

ARMSTRONG MANUFACTURING COMPANY, 100, King's Rd., Camden Town, N.W.1. [4615]

# PREMIER SUPPLY STORES

Offer the following Set Manufacturers' Brand New Surplus Goods at a Fraction of the Original Cost; all goods guaranteed perfect; carr. paid over 5/-; under 5/- postage 6d. extra. Orders under 5/- cannot be sent C.O.D.

ALL POST ORDERS TO

JUBILEE WORKS,

167, LOWER CLAPTON RD., LONDON, E.5

CALLERS, AS USUAL, TO 20-22, HIGH ST., CLAPHAM, S.W.4 (Macaulay 2382) 'Phone: Amherst 4723  
New Branch:—50, HIGH STREET, CLAPHAM, S.W.4 (Macaulay 2381).

And 165 & 165a, FLEET ST., E.C.4 (Next door to Anderton's Hotel). Central 2833.

Have you had our GIANT ILLUSTRATED CATALOGUE AND VALVE LIST? Send 4d. in STAMPS FOR THIS BARGAIN LIST.

**MAINS VALVES**, famous Europa 4 v. A.C. types, 4/6 each. HL., L., S.G., Var.-Mu-S.G., H.F.-Pens., Var.-Mu-H.F. Pens. 1, 3 and 4-watt A.C. directly heated output Pentodes A.C./D.C. types. 20-volt .18 amp. S.G., Var.-Mu-S.G., H., HL., Power.

Following types all 5/8 each. Full-wave rectifiers, 350 v. 120 m.a. and 500 v. 120 m.a. 2½ watt indirectly-heated Pentodes, Octode, Frequency Changers.

**BATTERY VALVES**. 2 volts, H.F., L.F., 2/3. Power, Super-Power, 2/9. S.G., Var.-Mu-S.G., 4- or 5-pin Pentodes, H.F. Pens., V.-Mu-H.F. Pens. 5/-. Class B, 3/6.

**AMERICAN VALVES**. Genuine American HYTRON and TRIAD first-grade Valves. 3 months' guarantee. All types in stock, 5/6 each. 210 and 250, 8/6 each. New Metal-Glass Valves, all types, 6/6 each. Genuine American DUOTRON Valves, all types, 3/6 each. Valve holders for all above types, 6d. each. Octal bases, 9d. each.

**SHORT-WAVE COILS**, 4- and 6-pin types, 13-26, 22-47, 41-94, 78-170 metres, 1/9 each, with circuit. Special set of 3-4-Pin S.W. Coils, 14-150 metres, 4/- set, with circuit. Premier 4-pin 3-band S.W. Coil, 11-25, 19-43, 38-86 metres. Suitable any type circuit, 2/6. **COIL FORMERS**, in finest plastic material, 1½ in. low-loss ribbed, 4- or 6-pin, 1/- each.

**H.F. CHOKES**, S.W., 10-200 metres, 9d.; S.W. screened, 1/6; standard screened, 180-2,000 metres, 1/6.

**ELECTROLYTICS**. U.S.A., 4, 8 mfd. 530 v. peak, 1/9 each. Dubilier, 4 or 8 mfd. 500 v., 3/-; 50 mfd. 50 v., 1/9; 10 mfd. 50 v., 6d.; 25 mfd. 25 v., 1/-; T.C.C., 8 mfd. 650 v., 4/-; 15 mfd. 60 or 100 v., 1/-; 50 mfd. 12 v., 1/-. Paper Condensers. W.E., 250 v. working 4 mf., 2/-; 2 mf. 1/-; 1 mf. 6d.; 350 v. working 4 mf., 2/6; 2 mf., 1/6. Dubilier 500 v. working 4 mf., 4/-; 800 v. 4 mf., 6/-.

**GOSMOCORD PICK-UPS**, with tonearm and volume control, 19/6 each. **PICK-UP HEADS** only, 4/6 each.

**PREMIER MAINS TRANSFORMERS**, wire-end type with screened primaries, tapped 200-250v. Centre-tapped Filaments. Guaranteed one year. H.T. 8 & 9 or H.T. 10 with 4 v. 4 a. C.T. and 4 v. 1 a. C.T., 8/6. 250-250 v. 60 m.a., or 300-300 v. 60 m.a., 4 v. 1 a., 4 v. 2 a. and 4 v. 4 a., all C.T., 8/6. 350-350 v. 120 m.a. 4 v. 1 a., 4 v. 2 a. and 4 v. 4 a., all C.T., 10/6. Any of these transformers with engraved panel and N.P. terminals, 1/6 extra. 500-500 v. 150 m.a., 4 v. 2-3 a., 4 v. 2-3 a., 4 v. 3-4 a., all C.T., 17/6. Super Model 19/6. **AUTO TRANSFORMERS**, step up or down, 60 watts, 7/6; 100 watts, 10/-. **SMOOTHING CHOKES**, 25 m.a., 2/9; 40 m.a., 4/-; 60 m.a., 5/6; 150 m.a., 10/6. 2,500 ohms, 60 m.a. Speaker Replacement Chokes, 5/6.

**SPECIAL OFFER OF PHILIPS MAINS TRANSFORMERS**. 250-250 v. or 300-300 v. 80 m.a. 4 v. 5 a. C.T. & 4 v. 1 a. 6/11.

**LARGER MODEL WITH TAPPED PRIMARY**, 100-250 v. 450-450 v. 150 m.a. 4 v. 4 a. C.T., 4 v. 4 a. and 4 v. 3 a. and 500-500 v. 100 m.a., 4 v. 4 a. C.T., 4 v. 4 a. and 4 v. 3 a., 12/6. **LIMITED NUMBER ONLY.**

**MILLIAMMETERS**, moving-iron, flush 2½ in., all ranges from 0-10 m.a., 5/9. Visual tuning, 6 or 12 m.a., 5/9. Moving-coil meters, 2½ in. 0-1 m.a., 18/6; 3½ in. 0-1 m.a., 22/6. Multipliers, 1/- each. Ammeters, 0-1, 3, 5, 10 or 20 a., 5/9.

**TRANSFORMERS**, latest type Telsen R.G.4 (list 12/6), 2/9. Lissen Hypermik Q.P.P. (list 12/6), 3/6.

**OUTPUT TRANSFORMERS** for Power or Pentode, 2/6; Multi-Ratio, 4/6.

**ELIMINATOR KITS** for A.C. Mains. 120 v. 20 m.a., or 150 v. 25 m.a., 15/-, tapped S.G. det. and output. Complete Kit with long-life valve rectifier (replacement cost only 2/-)

**PREMIER L.T. CHARGER KITS** for A.C. mains, including Westinghouse Rectifiers and Tapped Mains Transformers, 8 volts at ½ amp., 14/6; 8 volts 1 a., 17/6; 15 volts 1 a., 19/-; 8 volts 2 a., 29/6.

**TELSEN** iron-cored screened coils, W.349, 4/- each.

Electric **SOLDERING IRONS**, 200-250 v., A.C./D.C., 2/3. **NEW 1937 1-VALVE SHORT-WAVE RECEIVER OR ADAPTOR KIT**, 13 to 86 metres without coil changing. Complete Kit and Circuit, 12/6. **VALVE GIVEN FREE!**

**DE LUXE MODEL** 14 to 150 metres, complete Kit with Chassis, 4 Coils and all parts, 17/6.

**1937 SUPERHET CONVERTER KIT**, 13/6.

**DE LUXE MODEL**, 18/6

**S.W. SUPERHET CONVERTER**, for A.C. Mains Receivers, 20/-; A.C. Valve given FREE!

**NEW 1937 2-VALVE S.W. KIT**, 13 to 86 metres without coil changing. Complete Kit and Circuit, 19/6. **VALVES GIVEN FREE.** **DE LUXE MODEL**, 14 to 150 metres, complete Kit and Chassis, 4 Coils and all parts, 25/-; **VALVES GIVEN FREE.** **3-VALVE S.W. KIT**, S.G., Det. and Pen., 42/-; **VALVES GIVEN FREE!**

**BAND-PASS TUNING PACK**, comprising set of Telsen 3-gang iron-cored coils with switching, mounted on steel chassis with 3-gang condenser, illuminated disc-drive and 4 valve holders, 25/- the lot. All Mains or Battery circuit. **FREE!**

**SPECIAL OFFER. LISSÉN TWO-GANG SCREENED ALL-WAVE COILS**, 12 to 2,000 metres, complete with switching and wiring diagram, 6/11 per set.

**MAGNAVOX**. Mains energised M.C. Speakers. '154', 7in cone, 2,500 ohms, 12/6; '152', 9in. cone, 2,500 ohms, 17/6; '152 Magna', 9in. cone, 2,500 ohms, 37/6. Magnavox P.M.s.—'254', 7in. cone, 16/6; '252', 9in. cone, 22/6. Reliable P.M.s., 19/6. **TELSEN** P.M.s. with 10 ratio Transformers, 12/6. **TELSEN** Speaker Units, 2/6. **ROLA** latest type P.M.s., 15/-; **B.T.H. ENERGISED MOVING COIL**, 10in. diam., 1,650 ohms field. Power or Pentode Transformer. (State which.) **SPECIAL LINE** at 14/6.

**W.B. 1936 STANDARD STENTORIAN** (list 32/6), 21/-, brand new in sealed cartons.

**Potentiometers** by well-known makers. All values up to 1 meg., 2/-; with switch, 2/6.

**TUBULAR CONDENSERS**, non-inductive, all values up to .5 mfd., 6d. each.

Wire-end **RESISTORS**, any value, 1 watt, 6d.; 4 watts, 1/-; 8 watts, 1/6; 15 watts, 2/-; 25 watts, 2/6 each.

Reliable **MORSE KEYS** with Morse Code engraved on bakelite base, 2/- each.

Bakelite case **BUZZERS**, 1/6; Walnut case "Loud-tone," 2/6 each.

Super Quality lightweight **HEADPHONES**, 3/9 pair.

**PREMIER FILAMENT TRANSFORMERS**, 4v. 3a., C.T., 7/6; 4 v. 5 a., C.T., 8/6; 5 v. 3 a., 7/6; 6.3 v. 3 a., 7/6; 7.5 v. 3 a., 7/6; 2.5 v. 8 a., 8/6.

Self-powered **A.C./D.C. 10-watt 40-metre C.W. 3-Tube TRANSMITTER**, Pentode Crystal Oscillator, with meter, tubes, crystal (please state frequency required) and enclosed holder, with key, ready for immediate use, 24 4s.

The New "Premier" **SHORT-WAVE CONDENSERS**, with Trolitul Insulation; certified superior to Ceramic; all-brass construction, 15 mmfd., 1/4; 40 mmfd., 1/7; 100 mmfd., 1/10; 160 mmfd., 250 mmfd., 2/6.

**PREMIER HIGH-FIDELITY P.A. AMPLIFIER KITS**, 2/6 and 15/6.

**3-WATT A.C. 2-stage AMPLIFIER** for Mike or Pick-up. Complete Kit of Parts with 3 valves, 40/-.

**7-WATT A.C./D.C. 3-stage AMPLIFIER**. High-Gain. Push-Pull output. Complete Kit of Parts with 5 matched valves, 24 4s.

**10-WATT A.C. 3-stage AMPLIFIER** incorporating Phase-Inversion and Push-Pull Triodes. Enormous gain and straight line reproduction. Complete Kit of Parts, including 5 matched valves, 25 5s.

## NEW RECEIVERS AND AMPLIFIERS

**ANGLO-AMERICAN RADIO** Offer the Easiest Purchasing Facilities, and your last opportunity to own one of the finest radio receivers ever made, the genuine 5-band 10 watt Crosley at £11/19/6. H.P., part exchange, and a 50% saving on the superb Crosley receivers; there will be no better receiver available in this country at under three times the price during the next 12 months.

**LIMITED** Number of the Following Models Only Available; we offer you every advantage and every inducement to purchase now; a large cash saving, and your own choice of the method of payment.

**PLEASE** Note, we offer only brand new goods, every chassis or receiver fully guaranteed 6 months; every receiver accurately checked and aligned on all bands with the latest equipment before despatch; please remember we offer you only goods which will give you lasting satisfaction. And as such unquestionably the finest value that radio has to offer; do not confuse with second-hand, soiled, "job bought," or improperly tested receivers, which are being cleared out at any price by other sources; please note all cabinets supplied by us are copyright by no other firm.

**10% or 20%** With Order to Suit Your Convenience **Secures** Delivery, with undertaking to remit balance over 12 or 18 months.

**AMAZING** Signal to Noise Ratio is the Keynote to the Phenomenal All-world Reception; there is scarcely a transmission in the world that the 5-band Crosley will not bring in; Mr. Ivor Manley, writing in "The Wireless World" a few weeks back on Spanish broadcasting in the civil war, compiled his article using only one of our Crosley receivers; over 100 transmissions tuned in from Spain alone! Yes, your new guaranteed Crosley bought from us will do the same, and get you everything on the air.

**£11/19/6**.—9-valve high fidelity 5-band (12½-31, 30-80, 75-200, 200-555, 700-2,000 metres), A.C., 97-250 volts, 10 watts undistorted output, R.F. stage all bands, new automatic variable selectivity incorporated, provision grammo. and doublet, accurately calibrated airplane dial and band-spread pointer and subsidiary scale, shadow tuning indicator; your price £11/19/6, or with American Magnavox speaker, £14; Table model, £17; Console, £19; Auto-Radiogram, £34; or 20% deposit with order secures delivery.

**CARRIAGE** Extra: chassis 5/-, Table 7/-, Console 10/-, Radiogram 15/-.

**BOOK** Your Crosley Now, whilst last stocks remain; we guarantee your satisfaction.

**£6/14/6**.—8-valve all-wave AC/DC Superhet, 16-2, 100 metres, new 5½ in. multi-indication airplane dial, full A.V.C., wonderful all-wave performance; those on D.C. mains will never regret acquiring this outstanding receiver; chassis £6/14/6, with speaker £7/6/6; table model £7/19/6 (list 14 gns.) or deposit secures now; terms as above.

**CAR** Radios.—New consignment in; will all those customers who have endeavoured to obtain our car radios in the last few weeks please note that we have a further consignment to hand; these are heavily booked, so please get in touch with us now.

**£5/19/6**.—1937 5-valve Superhet. car radio, new sup. volume and tone controls, illuminated dial, large m.c. energised speaker, 3½ amps. consumption only, size only 10in. x 4½ in. x 6½ in., fits absolutely any car, no finer performance available under £15; 6 months' guarantee; 6-volt model, £5/19/6; 12v., £6/7; carriage 4/-.

**4D** Stamps, enclosed with order to cover cost of our comprehensive new radio catalogue, covers every radio requirement, a complete radio buying guide which you will value keeping, fully illustrated.

**EXTENSIVE** New Showrooms Now Opened Centrally at Albion House; all communications and all callers please note address as below.

**IF** You Cannot Call, order through the post with confidence; we specialise in postal orders, and have served customers all over the British Isles; you are assured of a square deal and satisfaction.

**ANGLO-AMERICAN RADIO (AND MOTORS), Ltd.** (Dept. W.25), Albion House, New Oxford St., London, W.C.1. Telephone: Temple Bar 3231 (all departments). [4758]

**COMMUNICATION** Receivers, Hammarlund, National, Hallicatcers, R.M.E.69, Tobe-Deutschmann; transmitters, Collins 45A, Peerless DX20, or built to order; American valves, microphones, Eddystone components.—A.C.S., Ltd., 52-4, Widmore Rd., Bromley. 'Phone: Ravensbourne 0156. [0550]

## RECEIVERS AND AMPLIFIERS CLEARANCE, SURPLUS, ETC.

**PEERLESS** Chassis, 18 watts, 11 valves, 12½" speaker, 5 bands; 10 gns.—Kay, 21, Prince of Wales Rd., Norwich. [4704]

**1936** Regentone Battery Set, S.G. Det. and Pent., P.M. speaker, thermometer tuning, list 27/10; £2/10; carriage paid.

**1937** Regentone Battery Set, H.F. Pentode, Det. and Pent., P.M. speaker, thermometer tuning, list 26/2/6; £3; carriage paid.

**1937** Regentone Short-wave Converter, complete with valves, 6.5 to 80 metres, listed at 24/19/6; £2/12/6; carriage paid.

**1936** Regentone 5-valve A.C. Console, thermometer tuning, list 210/10; £4; carriage paid.

**HENRY'S**, 72, Wellington Av., London, N.15. Stamford Hill 2907. [4709]

**6-VALVE** All-wave Superheterodyne, walnut cabinet, speaker, complete as new; 26/10.—32, Robin Hood Lane, S.W.15. Kingston 3856. [4601]

**FERGUSON** 366 All-wave 6-valve Universals, £7/7; Ace 8-valve 4 waveband preselector H.F. stage, £16/16, our price £12/12; current models; cash with order.—Speed, 656, Chester Rd., Erdington, Birmingham. [4687]

## CAR RADIO

**PHILCO** Repairs and Installations, trade distributors.—Radiorite, Ltd., Moorfields, Liverpool. Bank 8811 [4456]

All Goods advertised previously still available.

**PUBLIC ADDRESS EQUIPMENT**

**SPECIAL Offer!!!**  
**81** Gns. Complete.—Vortexion portable 15-20 watt 4-stage amplifier, independent mike and pick-up inputs, outputs for 7½ and 15 ohm speakers, weight 25lb.; 4 independent input model, £10.  
**12** -VOLT, D.C. or 200-250 A.O. input, combined model consumes only 7 amps. at 12 volts with 20 watts output; chassis complete with valves and convertor; 12 gns.  
**HEAVY** Duty 20 watt Model, as fitted to dance halls and cinemas, etc.; £15, complete with valves.  
**60** Watt Model for 6L6s, with microphone and gramophone independent inputs, and outputs for 5, 7½, 15 or 30 ohm speakers, consumption 150 watts, in ventilated steel carrying case; £24 only complete with valves less two 6L6s.  
**WHY** Not Call and Have a Demonstration.  
**VORTEXION** Ltd., 182, The Broadway, Wimbledon, S.W.19. Phone: Lib. 2814. [4672]  
**ALL** Types of Public Address Apparatus for Sale or Hire.  
**WARD**, 46, Farringdon St., London, E.C.4. Tel.: Holborn 9703. [0555]  
**EASCO** P.A. Mables, large or small, with driver operator.—18w, Brixton Rd., S.W.9. Reliance 1695. [0658]  
**HOLIDAY** and **HEMMERDINGER**, Dolefield, Bridge Street, Manchester.—Loud-speaker Van for hire; Sports, Fetes, etc. [4642]  
**PARTRIDGE** P.A. Manual, re Standard Handbook; free to trade from: N. Partridge, B.Sc. A.M.I.E.E., King's Buildings, Dean Stanley St., London; S.W.1. [4524]

**USED SETS FOR SALE AND WANTED**

**FERGUSON.**

**£15/15**—Ferguson 8-valve all-wave receiver, 4-band, perfect order, used few times only; accept £9.—Walbro Cycle Co., Saffron Walden. Phone: 45. [4736]

**G.E.C.**

**GENERAL** Electric "Fidelity" All-wave Eight, with set spare valves; offers requested.—Shepherd, Rowlands Castle, Hants. [4735]

**MARCONI**

**MARCONI** 42 D.C., complete, little used; 25/-.—Brown Leaves, Broad Ave., Bournemouth. [4731]  
**A** S Brand New, Marconi Model 239, used for one week only; £16.—Box 2449, c/o The Wireless World. [4694]

**POWERTONE**

**PORTABLE** Powertone, Class B, M.C. speaker, new condition; 70/-.—Wanted, test oscillator.—MacLachlan, Strathyre. [4743]

**MISCELLANEOUS**

**MIDWEST** 1937 Model Chassis and Speaker, in absolutely new condition; £24.  
**"WIRELESS** World" Imperial Short-Wave Six Receiver Unit, to specification; £12/10, carriage paid.  
**WARD**, 46, Farringdon St., London, E.C.4. Tel.: Hol. 9703. [4754]

**EXCHANGE OR WANTED**

**WANTED**—G.E.C. Fidelity A.C. 5 or Fidelity Short-wave 5, in new condition.—Napiers, 60, Alloway St., Ayr. [4723]

**NEW MAINS EQUIPMENT**

**ALL** Transformers as Last Week's Prices.  
**VORTEXION** Ltd., 182, The Broadway, Wimbledon, London, S.W.19. (Telephone: Liberty 2814.) [4753]  
**TANTALUM** for A.C. Chargers, H.T. and L.T.—Blackwell's Metallurgical Works, Ltd., Garston, Liverpool. [3984]  
**ESSEX** TRANSFORMER Co.—Television transformer to "W.W." specification, 350-0-350v., 75 m.a., 4v. 2.5 a., 4v. 8 a., 4v. 8 a., 2v. 1.5 a., C.T.; 32/6, post free.—275, Hamlet Court Rd., Westcliff-on-Sea. [4745]  
**NEW** Mains Transformers, heavy cores, fitted screened primaries, tapped 200-250v. centre, filaments shrouded; 450-0-450v. 160 m.a., 4v. 2.5 a., 2.5-2.5, fine job, 22/- each; 500-0-500v. 150 m.a., 4v. 2 a. 2 a. 2.5 a., very large, 27/- each; chokes, 14.7 H. 150 am., 12/6 each.—Osborne, 17, Martins Rd., Shortlands, Kent. Cash only. [4756]

**CABINETS**

**RADIOGRAM** Cabinets, new designs, 30/- to £5/10; inspection invited or photos for selection sent on request.  
**TABLE** Radio Cabinets, undrilled, 6/6 upwards.  
**SPEAKER** Cabinets, 4/6 upwards.  
**MANUFACTURERS'** Clearance.  
**ULTRA** Radiogram Cabinets, undrilled, 33x23x14 or 33x20x15, 30/-.  
**BURGOYNE** "Fury" Radiogram Cabinets (undrilled), 34x22x16½; 49/6.  
**K.B. De Luxe** Walnut Cabinets, undrilled, chromium plated edges and speaker grille, 25in. wide, 14½in. high, 10½in. deep, 18/6; Console model, 42in. high, 21½in. wide, 11½in. deep, 39/6.  
**HALYCON** Radiogram Cabinets (Reconditioned), 33x23x19, 35/-.  
**H. L. SMITH** and Co., Ltd., 287-9, Edgware Rd., London, W.2. Tel.: Pad. 5891. [0485]

No. 46

*Notes*

**on the Suppression of Electrical Interference with Wireless Reception**

REPORT OF INVESTIGATION carried out on behalf of

**A LARGE DRAPERY STORE**

**OBJECT OF INVESTIGATION.** To eliminate interference in Radio Showroom receivers caused by Tabulating Machines in Accounts Department.

**DETAILS of Plant under test.**—Receivers working off "Eliminoise" aerial systems. Interference from two tabulating machines running off a separate generator supply. Main switch, fuses, generator control and voltage regulator in tabulating room. Generator in special chamber some distance away in another part of building. Belling-Lee mains filter on mains side of generator. Severe interference on any receiver being demonstrated in Radio Showroom when either of the tabulating machines in use. It was found that a filter of German manufacture had previously been fitted and had given satisfactory suppression, but that this had burned out after having been in use for some time.

A Belling-Lee filter had been advised by the makers of the tabulating machines and had been fitted by the House electricians to replace the faulty unit, but had very little effect on interference.

The German suppressor was, however, of a semi-portable type and had been fitted in the mains lead of one of the machines (the largest and the chief cause of interference), whereas the Belling-Lee filter had been inserted on the mains side of the generator, at a considerable distance from the source of interference.

**TESTS MADE.** A standard mains filter, consisting of chokes and condensers, was fitted in the mains lead in the tabulating room, from which point both machines were fed, and it was found on testing in the Radio Showroom that adequate suppression had been obtained for either machine. (These tests were carried out with the generator filter disconnected.) It was arranged for the electrician to refit this filter at the mains switch in the tabulating room, and that if any generator noise was present on a powerful receiver tuned to a distant station, a \*type 1118 condenser unit should be fitted across the brushes.

Apart from this form of interference, which will disappear when the filter has been properly fitted, it was noted that there is a considerable background of noise due to signal lights, lifts, hairdressing equipment, and other electrical apparatus in use in the building, and it is advised that a 5-amp. mains filter be fitted in the circuit supplying the receivers on the stand. (These are fed from a separate plug which is readily accessible). Further relief will also follow if one or more "Eliminoise" extensions are wired here instead of extending the aerial from a transformer by about 20ft. of flex. By means of suitably disposed points (3-pin, wired with "Eliminoise" cable), one "Eliminoise" receiver will serve the whole stand, the transformer being plugged in for any receiver it is desired to demonstrate.

† "Eliminoise" (Trade Mark) Anti-interference Aerial 35s.  
 "C" type Screened Cable, extra, per yard ... 10d.  
 Additional Receiver Transformers, each ... 17s. 6d.  
 \* Condenser Suppressor, 1118, each ... 10s. 6d.  
 Send for the book, "Interference Suppression," post free 1s. 2d., or for free copy of "The Eliminoise System" and other relative literature.



**Belling & Lee Ltd.**  
 Cambridge Arterial Road, Enfield, Middx.

**DYNAMOS, MOTORS, ETC.**

**ALL** Types of Rotary Converters in Stock, new and second-hand.  
**WARD**, 46, Farringdon St.; London, E.C.4. Telephone: Holborn 9703. [0518]  
**WANTED**, rotary converter, 6 or 12 volts input to 500 D.C. at 120 mill. approx.—Miller's Radio, Millford Haven. [4730]  
**A.C.-D.C.** 1- and 3-phase Motors, all voltages; from 14/9; list free. Repair specialists.—Easco, 18w, Brixton Rd., S.W.9. [0455]  
**E.D.C.** Converter, 210v. D.C.-230v. A.C., 90 w., A.W. filter, silence cabinet, brand new; £10/10.—Write, 7, Bexhill Rd., Mortlake, S.W.14. [4742]

**NEW LOUD-SPEAKERS**

**BAKER'S** Super Quality Triple Speaker.  
**IDEAL** for Use with Quality Amplifiers; A.C. model, £8/15; D.C. model, £7/7; leaflet "Loud Speaker Tailoring" free on request.  
**BAKER'S** Conversions.  
**THE** Next Best Thing to a Baker Super Quality Triple Speaker is a Triple Cone Conversion Assembly; whether your moving coil speaker has a permanent or electro-magnet and no matter what type or make you possess, you can considerably improve frequency response and quality of reproduction by having a triple cone assembly fitted, which comprises main curved cone and dual bakelite and duralumin cones combined, mounted in a 12in. die-cast aluminium frame.  
**THE** Price is 29/6 Complete, including free fitting at our works; there is a special triple cone assembly for owners of Baker's super power speaker, price 25/- including coil.  
**BAKER'S** Quality Surplus Speakers.

**IF** You are Requiring Quality Reproduction at Low Cost order one of the following brand new bargain speakers now. The Auditorium models are fitted with latest triple cone comprising main curved cone and bakelite and duralumin cones combined, giving wide and even frequency response, resulting in quality reproduction of speech and music. The Coronation surplus horn models are ideal for reproduction of transients.  
**39/6** Only, usual price £5.—Auditorium Permanent Magnet Speaker with Alni magnet and die cast frame, large 12in. triple cone giving wide frequency range, complete with large 25 ratio transformer suitable for all outputs, including push-pull and Class B, etc.  
**59/6** Only, usual price £6.—Auditorium Electro-Magnet Speaker, 1,000, 1,250, 2,000 or 2,500 ohms field, exceptionally large magnet of high permeability steel giving enormous flux density, 2in. moving coil, large triple cone giving wide frequency range, complete with universal transformer, the ideal speaker for use with "Wireless World" and other quality amplifiers.

**75/-** Only, usual price £9.—As above, but for use on A.C. mains; complete with Westinghouse rectifier and full smoothing equipment.  
**49/6** Only, usual price £6.—Coronation Surplus Horn Permanent Magnet Moving Coil Speakers, suitable for domestic or public address; the horn is of moderate size and the speaker is therefore ideal for home use where good reproduction of transients is required; can be used separately or in conjunction with baffle board speakers.  
**15/6** Only.—Permanent Magnet Speaker, Alni magnet, 8in. cone, Universal transformer.  
**12/6** Only.—Permanent Magnet Speaker as above with 7in. cone.  
**2/9** Only.—Brand new cabinets, 12x10x6.  
**8/6** Only.—Electro-Magnet Speakers, with 8in. cone, 6,500 ohms field, Universal transformer.

**ALL** Baker Quality Surplus Speakers are Sold for Cash or c.o.d.  
**BAKER'S SELHURST** RADIO, Ltd., The Pioneer Manufacturers of Moving Coil Speakers, 1925-1937.—75-77, Sussex Rd.; South Croydon. (Croydon 3441.) [4552]  
**VAUXHALL**—Loudspeakers, 1938 range, now available; details see new list.—Vauxhall Utilities, 163A, Strand, Temple Bar 9338. [4609]

**LOUD-SPEAKERS**

**SECOND-HAND, CLEARANCE, SURPLUS, ETC.**  
**NEW** Magnavox "Duode," 1,250 field, massive "Sound Sales" push-pull output transformer, 9 K/c whistle filter; nearest £4; separate.—Pysden, 20, Lansdown Rd., Canterbury. [4729]

**VALVES**

**ANDERSON.**  
**AMERICAN** Valves, all makes, first grade only; 5/- each.  
**ANDERSON**, 35, Lansdowne Rd., Walthamstow, E.17. Walthamstow 0827. [3351]  
**BIG** and Better Value.  
**3/-** Each All Popular Type American Valves, 6L6, 3/9; 50's, 5/-; 10's, 6/-; 90-day guarantee.  
**ALL** Types Transmitting Tubes in Stock, photo cells, cathode ray tubes, etc.  
**RADIOGRAPHIC**, Ltd., 66, Osborne St., Glasgow, O.1. [4661]  
**AMERICAN** Valves, first grade, in all types; trade supplied.—Metropolitan Radio Service Co., 1021, Finchley Rd., N.W.11. Speedwell 3000. [0436]  
**ALL** Types of American Valves in Stock of Raytheon, Sylvania, and Arcturus makes, at competitive prices, guaranteed for six months; send for full list; 350 ohms line cords, 2/8.  
**WARD**, 46, Farringdon St., London, E.C.4. Tel.: Holborn 9703. [0452]  
**NOTHING** Better Available. Six months' guarantee; complete range of battery, A.C. mains, rectifiers, always in stock; 2 volt det., H.F., L.F., 2/3; Power, 2/9; screen grid pentode, H.F. pentode, 5/-; American types, six months' guarantee, 5/6 each, Nos. 18, 24A, 35, 42, 43, 45, 47, 56, 57, 58, 75, 77, 78, 80, 2A5, 2A6, 2A7, 6A7, 2B7, 6B7, 6C6, 6D6, 25Z5, 25Y5.—Write for other prices to Dulci Electrical Co., Devonshire Works, Duke's Av., Chiswick, London, W.4. [0501]

METERS, ETC.

NEW Universal Avominor; 60/-, or exchange all-wave test oscillator, microammeter. — MacLachlan, Strathyre. [4744]

FERRANTI Meters, 300 moving coil single and triple range, new boxed discontinued types; approximately 75% off list.—Farnell, 12, Heaton Park Rd., Bradford. [4698]

"E.M.I." Insulation Tester, in carrying case, £5; also "E.M.I." output meter, 55/-; "Hunts" capacity and resistance bridge, type C.L.R., £2; all brand new; "Weston" 665 analyser and 692 oscillator, in combined carrying case, complete with all adaptors and extras as listed, hardly used, perfect condition and appearance, £17.—Box 2577, c/o The Wireless World. [4755]

NEW COMPONENTS

RAYTHEON Valves, all American components; trade.—Zelco, Ltd., 53, Farringdon Rd., E.C.1. [0499]

COMPONENTS

SECOND-HAND, CLEARANCE, SURPLUS, ETC.

RADIO CLEARANCE.

ALL Lines Previously Advertised Still Available.

RADIO CLEARANCE, 63, High Holborn, W.C.1. Holborn 4631. [4718]

PREMIER SUPPLY STORES.

PLEASE See Our Displayed Advertisement on page 2. [0488]

AMERICAN Power Transformers, every type in stock at right prices.

GIVE Details When Ordering.

NEW Filtermatic Tone Controls, 7 combinations; 1/9 each.

ELECTROLYTICS, American Midget type, 2in. x 1/2 x 1/2, 8, 16, 20 mfd., 1/9, 2/-, 2/3 each.

SLOW Motion Dials, 156-1; 1/3 each.

80 Watt Resistors, 300 ohms; 1/6 each.

LINECORDS, 350 ohms, 2- and 3-way, £1/9.

1 Watt Resistors, 4/- per dozen; 2 watt resistors, 6/- per dozen.

MICA Condensers, 0.0005 to 0.001; 6/- per dozen.

TUBULAR Condensers, 0.0001 to 0.05; 4/- per dozen.

ROLA F6 Speakers with Transformer, 1,000 or 1,800 ohms; 6/6.

ALL Goods Guaranteed.

RADIOGRAPHIC, Ltd., 66, Osborne St., Glasgow, C.1. [4662]

RYALL'S RADIO, 280, High Holborn, London, W.C.1. offer new goods at knock out prices.

AMPLIFIERS.—7 watt A.C. outputs, pair triodes in a push-pull coupled correct type Varley transformer, 3-stage, for 200-250v. A.C., good chassis, complete with 5v. and Rola G.12 speaker, £7; transverse mike on plated stand, 25/-.

BI Electrolytics, 12x8 mt., 350v.; 1/6; NSF 25x26v., 6 3/-; NSF tubular bag ends, 0.15, non-inductive, 750v., 2/6 dozen.

PAIRS Ferranti Screened Coils, 2/6; Ferranti aerial coils, 6 3/6; Ferranti 3-range coils, 1/3; with circuits, chassis types.

FERRANTI Mains Transformers, as used in their commercial sets, 350-0-350v., 70 m.a., 4v. 4.5a. C.T., 4v. 2 1/2a. input, 200/250v., brand new; 6/6. [4748]

OLIVERS Offer Erie 1-watt Resistances, colour coded, 3/4d. each, 3/- dozen, 2/6 dozen in 3 dozen lots.

CARDBOARD Case Electrolytics.—Hunt's, B.I. T.C.C., 4 mfd., 1/6; 8 mfd., 1/9; 8 mfd.+4 mfd., 2/5; 8 mfd.+8 mfd., 2/9; 1 mfd., 1/-; 50 mfd. 50v., 1/6; 25 mfd. 25v., 1/-; 50 mfd. 12v., 1/1.

ROLA Speaker, G.12, stripped but complete with transformer for push-pull, triode or pentode, 2,500 ohms and 1,250 ohms field; £2/19.

LINE Cords, 2/6; speaker transformers, 3/- each, types power and pentode, Class "B", push-pull; L.F. transformers, 3/6 each, types Class "B"; Q.P.P. 1.4 straight.

RESIN Cored Solder, 1d. foot; push-back wire, 9 yards 6d.; aerial wire, bare copper 100ft. 1/9, insulated 1/6.

TUBULAR Condensers.—0.0001 mfd.-0.002 mfd., 4d. each; 0.05 mfd., 0.01 mfd., 4 1/2d. each; 0.1 mfd., 0.25 mfd., 6d. each; 0.5 mfd., 6d. each.

CHASSIS Mounting Valve Holders, 5-pin 2 1/2d., 7-pin 3 1/2d.; Octal base types, 6d.; American types, 6d.

OLIVERS, 676, Christchurch Rd., Boscombe, Hants. Enquiries invited. Orders under 5/6 postage extra. [4746]

VAUXHALL.—Standard 1938 components; details, see new free list.—Vauxhall Utilities, 163a. Strand, Temple Bar 9338. [4610]

MEGGER.—Evershed and Vignoles 20 meg., 500 volts, cost £8/15; £4, nearly new; transmitting valve, cost £5/5; £2.—Ross, 2, Walford Rd., Stoke Newington. [4725]

A MATEUR Discontinuing Hobby Wishes to Dispose, cheaply, of large stock of modern components, L.S., etc.—Forcellini, 25, Fairmount Rd., Brixton, S.W.2. [4724]

STANDARD RADIO SUPPLIES.—Definitely lowest prices in country on Europa, Hivac, valves, speakers, gramophone motors, Telsen coils; send for list.—1, Dantzic St., Manchester. [4752]

SPECIAL Offer.—Plessey moving coil speakers in high class walnut cabinet, with volume control complete, 14/9. in sealed cartons; Philips moving coil speakers, in high class cabinet, 17/6, complete; large quantity of electrolytic condensers and resistances to clear.—R.T., Ltd., 103, Vallance Rd., London, E. Phone: Bis. 8543. [4739]

FRIENDS, ROMANS, COUNTRYMEN,  
LEND ME YOUR EARS.

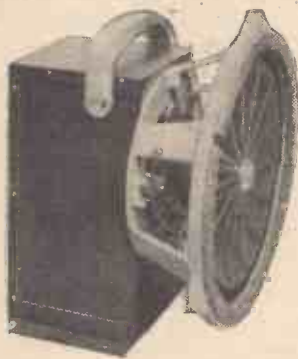

Five minutes' demonstration is better than hours of technical argument. Let the Sound Speaker prove to you that by reason of its special construction it can, and does, produce outstandingly good results, especially on high power quality amplifiers.

A claim substantiated by "The Wireless World" Test Report, on January 8th, 1937.

**SOUND SALES**  
MARLBOROUGH RD., LONDON, N.19. UPPER HOLLOWAY, LIMITED. Tel.: Archway 1661/2/3  
(Contractors to the G.P.O., etc.)

AMERICAN  
SET OWNERS  
INSIST ON

THE  
WORLD'S  
STANDARD  
VALVE



The Standard Valve for Standard Sets  
**FOR RELIABLE  
CONSISTENT  
PERFORMANCE**

UNIVERSAL RADIO DISTRIBUTORS LTD.  
14, FITZROY SQUARE, LONDON, W.1.

COMPONENTS—SECOND-HAND,  
CLEARANCE, SURPLUS, ETC.

MAINS RADIO DEVELOPMENT CO.'s Astounding Bargains.—Carriage paid; call mornings; phone Tudor 4046; stamp for List 205.

N.S.F. 1/2 and 1 watt Carbon Resistors, twelve good sizes, well assorted, marked values; 50 for 3/6; unrepeatable offer.

CLEARANCE of Mica Tag Condensers, 20 assorted of six good sizes from 0.0002-0.005 mfd.; 1/- while stocks last.

TUBULAR Condensers.—Brand new, wire ends, fine-t make, 400 volt working, 0.001-0.002 mfd., 2d.; 0.005, 0.01, 0.02, 0.05, 0.1 mfd., 4d.; 0.25, 0.5 mfd., 6d.

CLIX Latest Chassis Valve Holders unused, 4-pin, 1 1/2d.; 5-pin, 2 1/2d.; 7-pin, 4d.; three-valve grey cellulosed metal chassis, 1 1/2 x 6 1/2 x 3in., 1/-.

RESISTORS.—Absolutely finest make, one watt, colour coded wire ends, unused, any size 50 ohms to 5 megohms, 3 1/2d. each, 2/9 a dozen; your choice; two watt, any size, 6d.

B.I.C. Unused Dry Electrolytics, 8 + 8 mfd., 500 volt, 3/-; 8 mfd. 550 volt, metal can, 2/3.

KNOBS.—Black, octagonal bakelite, 1 1/4in. diameter, quarter inch spindle, beautiful appearance; 2 1/2d. each.

MAINS RADIO DEVELOPMENT CO., 4-6, Muswell Hill Rd., London, N.6. [4691]

DEGALLIER'S RADIO SERVICE, repairers of British and American receivers; lowest prices with good workmanship; also speaker repair department; new coils and cones fitted, fields altered, transformers rewound; any transformer, choke, armature, converter, or dynamo rewound; let us quote.

DEGALLIER'S RADIO SERVICE, 32, Bathurst Mews, Paddington, London, W.2. Telephones: Paddington 2745 and Bayswater 5732. [4714]

AS New, Wego condensers, 4 mfd., 600v. working, 3/- each; T.C.C. 200v. N1 0.5 1 mfd., 1/- each; 0.0001-0.002-0.0003 mfd., 6d. each; 350v.w. 0.1 wire ends, 5d. each; S.W. condensers (brass), 0.00016, 2/- each; Wearite driver transformers, 2/9 each; epicyclic slow motion drives, 10:1 ratio, fit 1/4 spindle, 2/6 each; short wave converters, 3 valves, A.C. mains, less valves, 55/- each. Ferranti meters, 0-15 and 0-50 m.a., 16/- each. Cash only.—Osborne, 17, Martin's Rd., Shortlands, Kent. [4757]

TRANSMITTING APPARATUS

HAMS Interested in Fone Should Send for Details of our 60 Watt Modulator, complete with power pack; quality modulation, competitive price.—G6JQ, Fox Radio, Thrusington, Leicester. [4738]

G5N1.—The recognised distributors for amateur equipment, National, R.M.E., Thordarson, Hammarlund, McMurda, Hallcrafters, etc.; send 1 1/2d. stamp for catalogue.—Radiomart, 44, Holloway Head, Birmingham. [0531]

MISCELLANEOUS

CHEAP Printing.—1,000 billheads, 3/6; sample free.—Creteway Press, 18, Buxted, Sussex. [4719]

UNCHALLENGED.—Revolutionary detection theory, system, circuits; post anywhere, 1/1.—D'Arcy Ford, Gandy St., Exeter. [4754]

SEND Stamp for Disposal List of Pre-stage, intermediate, and power amplifiers from 10 to 200 watts, rotary converters, P.A. and cinema speakers, horns, 16 m/m and 35 m/m, talkie and projection equipment, etc., etc.—A. W. Knight, 132, Elgar Av., Tolworth. [4659]

EXTENDED PAYMENTS

LONDON RADIO SUPPLY Co. (Established 1925). supply on convenient terms, components, accessories and sets, any make, 10% down, balance over 12 months; send for list of requirements.—11, Oat Lane, London, E.C.2. [0337]

HIRE-PURCHASE.—Prompt delivery of any radio apparatus on convenient terms.

WARD, 46, Farringdon St., London, E.C.4. Tel.: Holborn 9703. [0539]

EXCHANGE

I BUY, sell, exchange good quality receivers, accessories, components; H.P. facilities; promptness, efficiency.—Bostock, 1, Westbourne Terrace, S.E.23. Forest Hill 2236. [0529]

FINANCIAL PARTNERSHIPS

TECHNICAL Partner Required, preferably P.M.G. certificate, for radio college; capital £300.—Box 2478, c/o The Wireless World. [4750]

PATENT AND TRADE MARK  
AGENTS

GEE and Co. (H. T. P. Gee, Mem. R.S.G.B., A.M.I.E.E., Estab. 1905), 51-52, Chancery Lane, London, W.C.2 (2 doors from Government Patent Office). Holborn 4547 (2 lines). Handbook free [0001]

TUITION

RADIO Training.—Marine, aircraft, broadcast; prospectus free.—Hull Municipal Technical College. [0523]

RADIO Engineering.—Theory and practice thoroughly taught by postal course; 350 positions obtained for students in four years; recognised as a training institution by radio manufacturers; also instruction at college.—Apply British Radio Engineering College, 179, Clapham Rd., London, S.W.9. (Brixton 3487.) [4722]

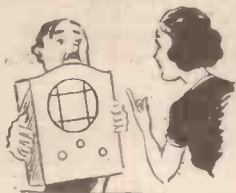

"I think I'll revive the old set,"  
Said Smith; and his wife  
replied "Pet  
If you'd wired it right  
At first, with FLUXITE,  
You'd have saved your-  
self trouble, I'll bet."

See that FLUXITE is always by you—in the house—garage—workshop—wherever speedy soldering is needed. Used for 30 years in Government works and by leading engineers and manufacturers. Of Ironmongers—in tins, 4d., 8d., 1/4 and 2/8. Ask to see the FLUXITE SMALL-SPACE SOLDERING SET—compact but substantial—Complete with full instructions, 7/6. Write for Free Book on the art of 'SOFT' SOLDERING—and ask for leaflet on CASE-HARDENING STEEL and TEMPERING TOOLS with FLUXITE.

TO CYCLISTS! Your wheels will NOT keep round and true unless the spokes are tied with fine wire at the crossings AND SOLDERED. This makes a much stronger wheel. It's simple—with FLUXITE—but IMPORTANT.

## THE FLUXITE GUN

is always ready to put Fluxite on the soldering job instantly. A little pressure places the right quantity on the right spot and one charging lasts for ages.  
Price 1/6.



ALL MECHANICS WILL HAVE

# FLUXITE

IT SIMPLIFIES ALL SOLDERING

FLUXITE LTD., Dept. W.W., DRAGON WORKS, BERMONDSEY ST., S.E.1

*From*  
**OTHER LIPS**

DEALERS are invited to send for full particulars of our service

**GARDNERS RADIO LTD**  
Carbery Works W. Southbourne  
BOURNEMOUTH

**HIRE PURCHASE**

We can supply any Radio and Electrical Apparatus on HIRE PURCHASE having a value of over £3 at convenient terms, including Midwest, Spartan, Challenger, Armstrong, Scientific Supplies and other receivers. Spartan Refrigerators, "Easy" Washing Machines, etc., etc.

**CHAS. F. WARD,** 46, Farringdon Street, LONDON, E.C.4. Tel.: Holborn 9703.

## REPAIRS AND SERVICE

"SERVICE WITH A SMILE."

**HENRY FORD RADIO LTD.**—American valves, components, spares, line cords; leading trade repairers; send us your American and British receivers.—Electronic House, 22, Howland St., Tottenham Court Rd., W.1. Museum 5675. [0434]

**HARMONY HOUSE SOUND and SERVICE.** Southport.—Radio repairs for the Trade.—Tel. 8621. [0558]

**ANY Transformer Repaired or Made to Specification;** 15 years' experience.—Fel-Electric, Garden St., Sheffield. [0561]

**METROPOLITAN RADIO SERVICE Co.** for Guaranteed Repairs to American (Midget and Standard and British Receivers).

**CLARION and Majestic Service Depot.**—I.F. and mains transformers rewound. American valves and parts; trade supplied.—Metropolitan Radio Service Co., 1621, Finchley Rd., London, N.W.11. Speedwell 3000. [0435]

**FOR Unusually Good Rewinding of Transformers, chokes, speakers, etc., trade only.**—Gardners Radio, Ltd., West Southbourne, Bournemouth. [0551]

**LOUD Speaker Repairs, British, American, etc.;** any make transformer coils rewound; alterations.—Sinclair Speakers, Alma Grove, Copenhagen St., N.1. [4673]

**GUARANTEED Repairs.**—Any transformers, choke, motor, armature, converter, dynamo, etc.; keenest prices, immediate quotation, prompt, dependable service.—See below.

**L.T.P. (LONDON TRANSFORMER PRODUCTS, Ltd.),** Willesden, N.W.10. Willesden 6486 (3 lines). [3470]

**MAINS Transformer Service.**—Repairs, rewinds, or constructions to specification of any type; competitive prices and prompt service.—Sturdy Electric Co., Dip-ton, Newcastle-on-Tyne. [0516]

**ZETAVOX, Zenith, repairs, conversions; specialists in** installation and repairs car radio; trade service; public address, coil winding, sets designed.—Zetavox, 4, Colebrook Place, Islington, Can. 1172. [4740]

**HOLIDAY and HEMMERDINGER, Dolefield, Bridge Street, Manchester.**—Repairs; re-winds. American valves. Service books. Speaker centring gauges, 2/6 set. Speaker Jope, 2/-. Catalogue free. [4641]

**REPAIRS to Moving Coil Speakers a Speciality;** cones and coils fitted, fields altered; prices, including eliminators, quoted, loud speakers, 4/-; L.F. and output transformers, 4/-, post free; guaranteed satisfaction; trade invited; estimates free; prompt service.—Loud-Speaker Repair Works, 5, Balham Grove, London, Battersea 1321. [0594]

## WANTED

**THE Publishers Will Pay 2/6 for Copies of "Wireless Engineer,"** dated October, 1923, and January, 1924.—Address copies to the Publisher, Dorset House, Stamford St., London, S.E.1. [4759]

**WANTED, Ferranti and Weston milliammeters,** also clean surplus components and bankrupt stocks; best prices paid.—Newport Surplus Stores, 24a, Newport Court, Charing Cross Rd., W.C.2. Ger. 2791. [4747]

**WE Buy for Cash All Types of Modern Second-hand** Radio Sets and Accessories, test meters, parts, etc.; we pay more than any other dealer; part exchanges; bring, send, or will call.—University Radio, Ltd., 82, Hampstead, Rd., London, N.W.1. Phone: Euston, 3810. [4749]

## BUSINESSES AND PROPERTY FOR SALE, TO BE LET, OR WANTED

**RADIO Supplies and Accumulator Service to the Trade** with Connection Over North London, established 10 years, for sale, with equipment (cost £200) and van; accept £775 or near offer; equipment and s.a.v.; long lease or freehold available.—Write Box 2582, c/o The Wireless World. [4760]

## SITUATIONS VACANT

**WAR Department.**

**APPLICATIONS** Are Invited for Appointments as Assistant III in the Signals Experimental Establishment at Woolwich.

**CANDIDATES** Should Possess a Sound Knowledge of the Theory of Wireless, and should preferably have had training to the standard of a university degree in physics or electrical engineering; laboratory or works experience in communication engineering is very desirable. **COMMENCING Salary** up to £202 may be offered, according to age, qualifications and experience, and in this connection possession of a university degree will be taken into consideration; the salary scale proceeds by annual increments of £12 from the rate on entry, to a maximum of £310 (efficiency bar at £214).

**APPLICATIONS To Be Made on a Form to be Obtained** from the Superintendent, Signals Experimental Establishment, Woolwich Common, S.E.18, and to be lodged not later than 19th July, 1937. [4751]

**GUARANTEED Positions in Marconi Service;** all successful students placed; separate Morse Classes held.—The Wireless School, 74, Bull St., Birmingham, 4. [4513]

**WIRELESS Valves and Cathode Ray Tubes, experienced** staff required for technical and production work in London. Reply with details of experience, age, etc., Box 2525, c/o The Wireless World. [4726]

**EXPERIENCED Representatives Required,** with car, to sell cathode ray instruments; salary and car allowance; technical knowledge essential.—Write full particulars, Box 2569, c/o The Wireless World. [4737]

**RADIO Assembly Foreman, skilled mechanic, with ex-**perience of record changers or similar mechanisms.—Send full details of career, stating age and salary required, to Ref. 1/VW, Box 2448, c/o The Wireless World. [4693]

**JUNIOR for General Work in High-class Amplifier** Workshop; progressive position for keen worker.—Apply by letter only, stating age, to Henri Selmer (Tru-voice Dept.), 114-116, Charing Cross Rd., W.C.2. [4733]

# RAYMART

CRAFT A CREED

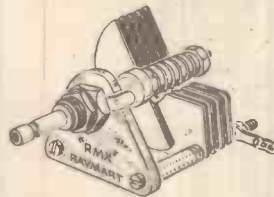

**CERAMIC MICRO-VARIABLES for Receiving and Transmitting.**

We stress the word CERAMIC in the heading of this advertisement because, in comparison with other dielectric constants, "RMX" (the latest product of the laboratories), which is exclusively used in these condensers, shows a marked improvement in overall efficiency when working on the higher radio frequencies.

These micro-variables are of all-brass construction with heavy gauge vanes, the whole being rigidly mounted on one "RMX" Ceramic plate. Smooth in operation. All receiving types can be ganged.

Type	RECEIVING.	Type	TRANSMITTING.
VC15X	15 mmfd. 1/4	NC15	Neutralising:
VC40X	40 mmfd. 1/7	VC100X	150 mmfd., spacing .07" ... 2/0
VC100X	100 mmfd. 1/10	VC180X	180 mmfd. 2/3
VC180X	180 mmfd. 2/3	VC250X	250 mmfd. 2/6
VC250X	250 mmfd. 2/6	TC40	Tuning: 40 mmfd., spacing .07" ... 3/6

## FOUR RAYMART MICRO-VARIABLES

ARE SPECIFIED FOR THE  
"Wireless World" Television Receiver  
TYPE VC15X. 15 mmfd. 1/4 each.

**AMERICAN Mains Transformers.** Heavy Duty 350-350v. 150 m.a., 5.3v. 4a., 5v. 3a., 12/8. GE 350-350 v. 80 m.a., 2.5v., 4.5a., 5v. 2a., 6/11. Majestic, 250-250 2.5v., 5v., 4/11. Pilot 250-250, 2.5 v. C.T., 5 v. C.T., 5/11. Ceramic American Valveholders, 1/- each.

**BRITISH RADIOPHONE 0005** straight or superhet 3-gang fully screened condensers with trimmers, 4/11; Utility Midget 2-gang ditto, 3/11; S.L. Dial to suit above, 2/11; Utility 2-gang Uniknob .0005 with Dial, 3/11.

**COILFORMS.**—Wound in RD4 natural lousa material, hollow resinimpregnated, 1/4in. diameter, ribbed; identification die in top. Four types, 4-pin, 1/6; 6-pin (standard or to fit 7-pin valveholders), 1/9; 7-pin (for bandspread tap), 1/10; Machine threading, 2d. extra.

**ELECTROLYTICS.** Huge purchase 500 v. Aluminium Cap. 4 mf., 1/6; 8 mf., 1/11; 8-8 mf., 2/6; Block type, 500 v. peak, 4+4 mf., 1/8; 8+8+4 mf., 3/-; 50 mf., 50 v., 1/3; 25 mf., 25 v., 1/-; Tubular Condensers, 1,500 v. T., all sizes to 0.1 mf., 6/-; 0.2 to 0.5 mf., 3d.

**FAMOUS CONTINENTAL A.C. Valves, 4/6;** Battery types from 2/3; American Duotron, etc., all types, 3/6; all types of RCA Licensed first grade tubes, metal aud. glass, in stock from 5/6.

**HEAVY DUTY Mains Transformer, worth 45/-,** 350-350, 150 m.a., 4 v., 2.25 A., C.T., 4 v., 1 A., C.T., 12/8; Philips 270-270, 120 m.a., same L.T. 6/6; Speaker Transformers, 2/6.

**PUSHBACK Wire, 6 yds., 6d.; heavy, 9d.;** Resin-cored Solder, 6ft., 6d.; Screened Flex, single, 6d. yd.; twin, 9d. yd. Assorted Solder Tags, 6d. packet.

**SHORTWAVE COILS.**—RD4, CA 11-25, CB 20-45 metres, 2/6. CC 14-100 metres, 2/6. Standard, 6-pin types, CA6, CB6, 2/0 each; CC6, 3/-; same range as 4-pin.

**SMOOTHING CHOKES, 20 yd., 120 m.a., 3/11;** 200 m.a. swinging chokes, 8/6; Centratab Pots, all sizes, 1/6; switched, 2/-; 20,000 ohm Pots, 1/-; Tubular glass tubes 24. Milliammeters, 25 m.a. upwards 5/9; super, 6/9.

**UTILITY 88, Microdisc Dials, 3/11;** Radiophone, 0.00016 Shortwave Condensers, 3/6. Series gap 1win. 3/9. Shortwave HF Chokes 5-100 metres, 9d.

**465 KC Litz Wound I.F.'s, 3/11;** Two-speed slow-motion knobs, 1/-; Telsen Ace Transformers, 1/11; Telsen Screened S.W. H.F.C. 1/-; Iron core H.F. chokes, 1/-.

**SPECIAL OFFERS.** Chas B Kit, worth 30/-, comprising Driver Transformer, Valve and Holder, 5/-; Dozen wire-ended assorted resistors, 1/6. Order 5/- post free. Get our Bargain Catalogue, 1/6d. post free. All enquiries and requests for Catalogue must send 1/4d. stamp.

**RAYMART SHORT-WAVE MANUAL.** 48 pages in all, 32 on receivers, transmitters, aerials, circuits, etc., etc., and 16 on short-wave components, 6d., or post free, 7/4d. Short-Wave Catalogue, 16 pages, 1/4d.

**G5NI (BIRMINGHAM) LTD.**  
44, HOLLOWAY HEAD,  
BIRMINGHAM TELE: MID 3254

**BTH SOUND AMPLIFYING EQUIPMENT**

Including the:—  
Latest Development in Moving Coil and Metal Diaphragm Horn Type Speakers.

THE FINEST TONAL QUALITY IN THE WORLD

**BTH RUGBY**  
THE BRITISH THOMSON-HOUSTON COMPANY LIMITED, RUGBY, ENGLAND.



# 57 ERIE RESISTORS

*Specified exclusively*  
for the  
**WIRELESS WORLD  
TELEVISION  
RECEIVER**

The stability of resistors is even more important in Television than in radio. For in Television a faulty resistance means visual as well as sound distortion. Hence, the 'Wireless World' specified Eries. A special impregnation process gives them unrivalled stability. Hand Tested. Guaranteed. Colour coded.

All values - - 1/- per watt.

Write for Erie Colour Code Chart with helpful technical data.  
**RADIO RESISTOR CO., LTD.**  
1, Golden Square, Piccadilly, London, W.1.

*The Key to your  
Rectification Problems*

**WESTINGHOUSE  
METAL  
RECTIFIERS**

WESTINGHOUSE BRAKE & SIGNAL CO. LTD. 82 YORK RD. KING'S CROSS, N.1.

**TANNOY**  
THE SOUND PEOPLE

GUY E. FOUNTAIN LTD.,  
CANTERBURY GROVE, WEST NORWOOD,  
LONDON, S.E.27. Phone: Str. 4122 (6 lines).

**SOUND AMPLIFYING EQUIPMENT**

**BOOKS on WIRELESS**  
Write for complete list to  
**ILIFFE & SONS LTD.**  
Dorset House, Stamford St., London, S.E.1 W.W.1

**SITUATIONS VACANT**

**WIRELESS Operators and Engineers Urgently Required.**  
—Train at Britain's leading colleges; fee after appointment; boarders; prospectus free.—The Wireless College, Colwyn Bay, or The Wireless College, Calmore, Southampton. [0541]

**TEST and Development Engineer Required by Manufacturers of A.F. Amplifiers and Public Address Equipment.**—Write in confidence, stating experience, age, previous employer and salary required, to K., Box 2543, c/o The Wireless World. [4728]

**RADIO Service Instrument Designers Required with Good Knowledge of H.F. Circuits and S.W. Radio work;** applications should give full details of training, (including degrees), experience, age and salary required. —Box 2526, c/o The Wireless World. [4727]

**RADIO Engineer, with degree or equivalent and sound knowledge of short wave measurements and/or high quality reproduction;** experience of factory test methods desirable.—Send full details of career, with age and salary required, to Ref. 4/W.W., Box 2358, c/o The Wireless World. [4651]

**AMPLIFIERS.**—Wanted, first-class wiremen-assemblers for portable P.A. equipment, good soldering essential; progressive positions for the right men.—Apply by letter only stating age, experience and salary required, to Henri Selmer (Truviso Dept.), 114-116, Charing Cross Rd., W.C.2. [4732]

**RADIO Service Men with Experience of Talkies or Automatic Record Changers or Similar Mechanisms;** preference will be given to men with definite mechanical or electrical training.—Send full details of career, stating age and salary required, to Ref. 6/W.W. Box 2447, c/o The Wireless World. [4692]

**VACANCIES occur for Thirty Men, aged 18-23, in the Post Office Eng. Dept.;** experience is not required, but applicants must be willing to study technical subjects; commencing pay £3/15, rising to £7 per week and upwards, with pension.—For full particulars apply B.I.E.T. (Dept. 574), 17, Stratford Place, W.1. [4716]

**RADIO Engineer.—Mitsam Works Ltd.,** have a vacancy in their testboard laboratory for a junior engineer having a good grounding in electrical and radio engineering.—Applications to be received not later than 12th July 1937, must be made in writing to the Labour Supervisor at New Rd., Mitcham Junction, Surrey. Telephoned applications cannot be entertained. [4690]

**FREED-EISEMANN 69/6**  
2-Wave band Universal AC-DC SET.  
Transportable 100-250 volts. 200-550 and 900-2,000 metres. Attractive dial calibrated in metres.  
Superb Tone. Self-contained Aerial. Raytheon Valves. No earth required. Cabinet covered with washable Fabrikoid Leather.  
**FULLY GUARANTEED.**  
Special Terms to the Trade for quantities.  
**LEONARD HEYS** Parady House, Henry Street, BLACKPOOL.

We don't claim to make the cheapest transformers, but we do claim to make good ones. Most of the professional P.A. men seem to think so, too.

**W. BRYAN SAVAGE LTD**  
Westmoreland Rd., London, N.W.9. Phone: Colindale 7131

**WEARITE CONDENSER ANALYSER**  
A new instrument of the latest design for carrying out rapid complete tests of radio condensers. Electrolytic, Mica, Paper, Trimmer and Tuning condensers may now be tested for Capacity, Insulation, Power Factor, Open Short and Intermittence. This unit is portable entirely A.C. mains operated.  
**PRICE - £9.9.0**  
Full particulars upon request to:  
**WRIGHT & WEAIRE LTD.,**  
740, High Road, Tottenham, London, N.17.

**PRECISION RESISTORS**  
Extreme accuracy, a Bulgin passport, has been applied extensively in these precision resistors. Accurate to a declared percentage, constant and everlasting. Wound non-inductively with finest enameled nickel-iron wire and shrouded with protective cover. With insulated terminals.  
List Nos.:  
FROM R.10, 0.1 ohm. at 7/-  
TO R.29, 100,000 Ω at 14/6

**A.F. BULGIN & Co. Ltd.** SHOWROOMS: 64 HOLBORN VIADUCT, LONDON E.C.1.  
ABBEY RD. BARKING, ESSEX. Tel. RIPPLEWAY 3474 (3 LINES)

**P.A. at its Best**  
**GRAMPIAN**  
PUBLIC ADDRESS EQUIPMENT  
GRAMPIAN REPRODUCERS LTD.  
New Gardens Surrey

**5-BAND 10-WATT RADIO** **YOURS FOR 24/- DOWN.**  
Radio's greatest value and biggest bargain to-day. Definitely your last opportunity. Send deposit only, or cash or C.O.D., order now to secure delivery. We guarantee your satisfaction. For full details see our classified advertisement on p. 2. Chassis price £11.19.6. (Value £24.) No finer Radio to compare at under 3 times the price to-day.

If you have not already had your copy of this big new Radio Buying Guide, secure yours to-day. Everything in Radio at wholesale prices. Enclose 4d. stamps to Dept. C.6.

**GET THIS NOW**

**ANGLO AMERICAN RADIO**  
16 MOTORS LTD. ALBION HOUSE, NEW FORD ST. LONDON, W.C.1.

**"ENGINEERING OPPORTUNITIES"**  
This unique Handbook shows the easy way to secure A.M.I.C.E., A.M.I. Mech. E., A.M.I.E.E., A.M.I.A.E., A.M.I.W.T., A.M.I.R.E., and similar qualifications.  
**WE GUARANTEE—"NO PASS—NO FEE."**  
Details are given of over 150 Diploma Courses in all branches of Civil, Mech., Elec., Motor, Aero, Radio and Television Engineering, Building, Government Employment, etc. Write for this enlightening Handbook to-day FREE and post free.  
**British Institute of Engineering Technology**  
387, Shakespeare House, 17, 18, 19, Stratford Pl., W.1.

**FREE 268 PAGES**

**INDEX TO ADVERTISEMENTS**

	PAGE
All-power Transformers, Ltd.	
Anglo-American Radio (and Motors), Ltd.	6
Automatic Coil Winder Co., Ltd.	
Baker's Selhurst Radio	
Belling-Lee, Ltd.	3
Birmingham Radiomart G5N1	5
British Institute of Engineering Technology	6
British Insulated Cables, Ltd.	
British Rola Co., Ltd.	Edit. 43
British Thomson-Houston Co., Ltd.	5
Bulgin, A. S., & Co., Ltd.	6
C.A.V.	
Colvern, Ltd.	Front Cover
Cossor, A. C., Ltd.	
"Drydex"	
Dubilier Condenser Co. (1928), Ltd.	
Electradix Radios	1

	PAGE
Fluxite	5
Forbat, Eugene J.	
Galpin's Electrical Stores	
Gardners Radio, Ltd.	5
Goodmans Industries, Ltd.	Inside Front Cover
Gramplan Reproducers, Ltd.	6
Hartley Turner Radio, Ltd.	1
Haynes Radio	Front Cover
Heys, Leonard	6
H.M.V.	
Institute of Wireless Technology	
McCarthy Radio, Ltd.	Edit. 39
Midwest Radio, Ltd.	Inside Front Cover
M.P.R. Electrical Co.	
M.R. Supplies	
New Times Sales Co.	

	PAGE
Parmeko, Ltd.	
Peto-Scott, Ltd.	Inside Front Cover
Player's Cigarettes	
Postlethwaite Bros.	
Premier Supply Stores	2
Radio Resistor Co., Ltd.	6
Savage, W. Bryan	6
Scott Sessions, Ltd.	
Sound Sales, Ltd.	4
Stern, S.	
Tannoy Products	6
Telegraph Condenser Co., Ltd.	Front Cover, Edit. 41
Universal Radio Distributors, Ltd.	
Varley (Oliver Pell Control, Ltd.)	4
Ward, C. F.	5
Westinghouse Brake & Signal Co.	6
Wright & Weaire, Ltd.	6

Printed in England for the Publishers, ILIFFE AND SONS LTD., Dorset House, Stamford Street, London, S.E.1, by The Cornwall Press Ltd., Paris Garden, Stamford Street, London, S.E.1. "The Wireless World" can be obtained abroad from the following: FRANCE: W. H. Smith & Son, 248, Rue Rivoli, Paris; Hachette et Cie, Réaumur, Paris, and branches. BELGIUM: W. H. Smith & Son, 74-75, Boulevard Adolphe Max, Brussels. AUSTRALIA: Gordon & Gotch, Ltd., Melbourne (Victoria), Sydney (N.S.W.), Brisbane (Queensland), Adelaide (S.A.), Perth (W.A.), and Launceston (Tasmania). NEW ZEALAND: Gordon & Gotch, Ltd., Wellington, Auckland, Christchurch and Dunedin. INDIA: A. H. Wheeler & Co., Bombay, Allahabad and Calcutta. CANADA: Imperial News Co., Toronto, Winnipeg and Vancouver; Benjamin News Co., Montreal; Gordon & Gotch, Ltd., Toronto. SOUTH AFRICA: Central News Agency, Ltd. UNITED STATES: The International News Co., New York.



PRICE 2/6 net  
By post 2/9

From all leading Booksellers, or direct  
from the Publishers

*NOW READY—A new book which will help you to get the best results with your camera!*

# Brighter Photography

by DAVID CHARLES, F.R.P.S.

This handy book reveals in a clear, attractive way the secrets of successful photography. Though primarily intended for the novice, it is invaluable to every keen camera user.

The carefully arranged chapters cover the whole field from the choosing of a camera to developing and printing the finished picture. Details of the various photographic materials on the market are given, and there are important sections dealing with Focusing, Aiming the Camera, Photographic Groups, Lighting and Exposing.

In addition there are over one hundred and sixty illustrations, each numbered and each conveying a really useful hint. By simple cross references these illustrations provide a series of clear, concise lessons in the art of making better pictures.

ILIFFE & SONS LTD., DORSET HOUSE, STAMFORD STREET, LONDON, S.E.1

THE  
**WIRELESS  
ENGINEER**  
*The Journal of Wireless Research  
and Progress*

"THE WIRELESS ENGINEER" is published in the interests of professional wireless engineers, experimenters, and all keen radio enthusiasts, and is widely read by those who are intimately associated with wireless development.

A valuable monthly feature consists of a summary, under the title of Abstracts and References, of important articles appearing in technical wireless publications throughout the world.

MONTHLY  
2s. 6d. NET

Subscription  
32s. per annum,  
post free.

ILIFFE & SONS LTD., DORSET HOUSE, STAMFORD STREET, LONDON, S.E.1

W.W.2

*A Book of First Principles for the  
Wireless Enthusiast*

# FOUNDATIONS of WIRELESS

By A. L. M. SOWERBY, M.Sc.

An Elementary Text Book on  
Wireless Receivers

Covers the whole field from the simplest electrical phenomena to the construction of a modern set, and all the vital points in receiver-design are treated in full detail. Eleven of the eighteen chapters of the book deal with the discussion of receivers in which the whole process of design is reviewed stage by stage to the finished article. Special attention is paid to the important subject of tuned circuits and band-pass filters, on the correct design of which the performance of every type of set ultimately depends. Moreover, the process of detection, so often imperfectly understood, is clearly explained.

Bound in Cloth Boards  
Size 7½ ins. x 5 ins. 272 Pages

PRICE 4/6 NET. By Post 4/11

Issued in conjunction with "THE WIRELESS WORLD" and published by the Proprietors—

ILIFFE & SONS LTD., DORSET HOUSE, STAMFORD STREET, LONDON, S.E.1

W.W.45

Mention of "The Wireless World," when writing to advertisers, will ensure prompt attention.

**JUST PUBLISHED**

# THE COMPLETE 9.5-mm. CINEMATOGRAPHER

By Harold B. Abbott

Because of advances in film technique this book supersedes the author's former successful book "Motion Pictures." The beginner can take it up and find everything he needs to know in order to make successful pictures.

How to choose a 9.5-mm. cine camera; how to expose correctly; what to take and how to take it; full instructions on developing and printing; methods of planning; editing, titling and trick effects; the art of projection; methods of operation, screen and picture sizes; giving an efficient show; all these are explained in detail.

There are nearly 100 illustrations. The book, packed with useful information, is a comprehensive course of instruction in amateur cinematography.

CLOTH BOARDS  
Size 7½" × 5", 260 pages  
PRICE 5/- net  
By post 5/4

From all leading Booksellers, or  
direct from the Publishers

ILIFFE & SONS LTD., DORSET HOUSE, STAMFORD STREET, LONDON, S.E.1

SECOND EDITION

—THOROUGHLY REVISED

## WIRELESS SERVICING MANUAL

By W. T. COCKING

(of "The Wireless World")

The first complete book of reference of its kind. A reliable practical guide for amateur and professional.

The demand for this book was so great that the first edition was sold out in the short space of a very few months. A second edition containing additional material is now on sale. The "Wireless Servicing Manual" deals fully with Testing Apparatus and explains the methods of locating and curing faults in receiving equipment.

Ganging, Automatic Volume Control, Instability, Distortion, Mains Hum, Whistles and Local Interference are all separately treated.

The new edition contains much additional information on short-wave receivers, and on methods of operating extension loud speakers, the reference material including base-connections for British, Continental and American Valves and the various colour codes for components has been extended and brought up to date.

BOUND IN CLOTH BOARDS

SIZE 7½ ins. × 5 ins.

231 PAGES

PRICE 5/- net. By post 5/4

Issued in conjunction with "THE WIRELESS WORLD" and Published by the Proprietors:—

ILIFFE & SONS LTD., DORSET HOUSE, STAMFORD STREET, LONDON, S.E.1



# The Wireless World

4<sup>D</sup>

## THE PRACTICAL RADIO & TELEVISION JOURNAL

Friday, July 16th, 1937

### Exclusively Good!

The "WIRELESS WORLD" again pin their faith exclusively on **SOUND SALES** for **TRANSFORMERS** in their first complete **TELEVISION RECEIVER**. (A SOUND choice of course in more senses than one).



**MARLBOROUGH RD. LONDON, N.19.** **UPPER HOLLOWAY LIMITED.** Tel.: ARChway 1661/2/3  
(Contractors to the G.P.O., War Office, Air Ministry, etc.)

### EVERY Radio TEST with ONE Meter

For servicing and laboratory work an accurate multi-range meter is essential. The Model 7 Avometer provides unique facilities for all radio tests. It is an A.C./D.C. meter, having 46 ranges. Measures A.C. and D.C. amperes and volts, also resistance, capacity audio-frequency power, and decibels. No external shunts or series resistances. Extremely low current consumption ensures great accuracy. Meter protected against damage through overload by an automatic cut-out. Conforms to B.S. 1st grade requirements.



BRITISH MADE  
16 Gns.

Resistance Range Extension Unit (for measurements down to 1/100th ohm) . . . 10/- extra.  
The 36-range Universal Avometer, 13 Gns.  
29-range D.C. Avometer, 9 Gns.  
Carrying Cases, 5/1.  
Deferred Terms if desired.

★ Write for descriptive pamphlet. THE AUTOMATIC COIL WINDER & ELECTRICAL EQUIPMENT CO. LTD., Winder House, Douglas Street, London, S.W.1. \*Phone: Y10. 3404/7

The 46-RANGE UNIVERSAL AVOMETER 7 MODEL  
Regd. Trade Mark

## HAYNES QUALITY RECEIVERS

Demonstration night—every Friday, 7.30—9.30 p.m.

Originators of the Quality Receiver.

**HAYNES RADIO** Have you the Haynes Quality Booklet? 1936-37 Edition.  
QUEENSWAY, ENFIELD, MIDDLESEX. Enfield 2726

Central London area Agent, London Radio Supply Company, 11, Oat Lane, E.C.2. Hire purchase arranged.

## CAV DRY BATTERIES



60 VOLTS 3/9  
99 VOLTS 6/3  
108 VOLTS 6/9  
120 VOLTS 7/6

The Finest British Battery of Standard Capacity

C. A. VANDERVELL LTD. WELL ST., BIRMINGHAM

# WIDE ANGLE DIFFUSION from ONE P.A. Speaker



**DUPLEX  
HORN P.A.  
LOUD-  
SPEAKER**

**£4. 10**

List

Power Handling Capacity 12 watts  
Peak A.C. Speech Coil Impedance 15ohms.  
Length of Horn 2' 10"  
Width of Horn 2' 11"  
Finish — Battle-ship Grey.

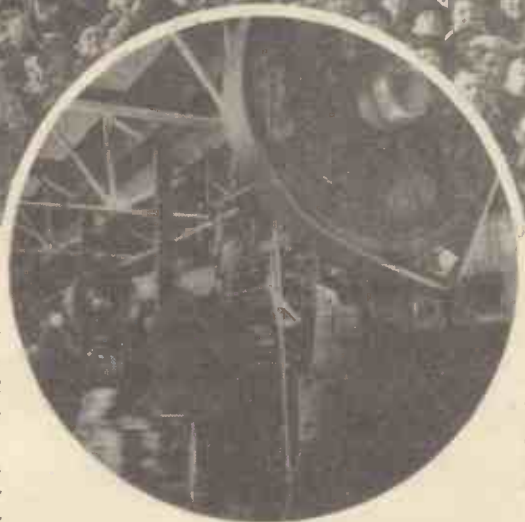

**TESTIMONY**  
from user:—  
“... We are very pleased with the results and have pleasure in placing our definite order for three more Speakers.”

*Drawing Loud-speaker Chassis, at GOODMAN'S Wembley Factory.*

## GOODMANS DUPLEX HORN P.A. SPEAKER

GOODMANS' Duplex Horn P.A. Loudspeaker provides the effect hitherto obtainable only with two P.A. Speakers. On test, this Speaker has proved superior to other P.A. Projection Horn Speakers selling at much higher prices. Noteworthy points regarding the design are:—

1. The Duplex horizontal type directional horn, with vertical centre partition. This design virtually constitutes two horns set at an angle to each other—giving an extremely wide angle of diffusion at all frequencies.
2. The totally enclosed unit—giving enormously increased loading, and reducing the risk of damage to the diaphragm in the event of over-loading.
3. The specially developed diaphragm which, combined with the extremely high flux permanent magnet incorporated, produces an excellent response for Public Address Work.

**POST this COUPON**

Please send leaflet describing Duplex Horn P.A. Loudspeaker, also literature describing High Fidelity Auditorium Loudspeakers.

GOODMANS INDUSTRIES LTD.,  
Lancelot Rd., Wembley, Middx.

Name.....  
Address.....

GOODMANS INDUSTRIES, LTD., LANCELOT RD., WEMBLEY, MIDDX. Phone: Wembley 4001-5 (5 lines)

# B.I. CONDENSERS

for  
**RADIO & GENERAL USE**

B.I. CONDENSERS for Radio Receivers, Battery Eliminators, Smoothing Circuits, etc., are made in several different types to suit the various uses for which Condensers are required in connection with Wireless circuits.

These Condensers are the result of 36 years' experience in the manufacture of all kinds of Condensers from the smallest sizes up to those weighing more than 2 tons.

In addition to the Standard Types, B.I. Condensers can be supplied in special forms to suit manufacturers' requirements.

The illustration shows Type 212 recommended for use with eliminators.



**BRITISH INSULATED CABLES LTD.**

Cable Makers and Electrical Engineers

**PRESCOT, LANCS.**

Telephone No.: PRESCOT 6571.

London Office: SURREY HOUSE, EMBANKMENT, W.C.2

Telephone No.: Temple Bar 7722.

## They're pleasing more smokers all the time



Increasing sales show that more and more smokers are saying "Player's Please"—convincing proof that the great majority realise and appreciate the truth of the Player maxim "IT'S THE TOBACCO THAT COUNTS"

PLAYER'S MILD NAVY CUT CIGARETTES are not so well known as the popular Medium Navy Cut Cigarettes, but if your taste is for a mild and very smooth smoke, ask for Player's "MILD." An old established brand, the prices are the same as for "Medium" 10-8d, 20-11+d.

PLAIN OR CORK TIPPED



PLAYER'S 'MEDIUM' NAVY CUT CIGARETTES

NCC-386A

# The Wireless World

THE  
PRACTICAL RADIO  
JOURNAL  
27<sup>th</sup> Year of Publication

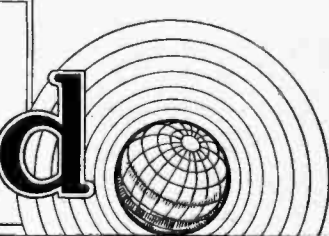
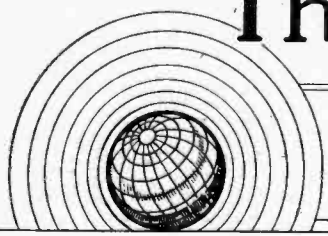

No. 933.

FRIDAY, JULY 16TH, 1937.

VOL. XLI. No. 3.

Proprietors: ILIFFE & SONS LTD.

Editor:  
HUGH S. POCKOCK.

Editorial,  
Advertising and Publishing Offices:  
DORSET HOUSE, STAMFORD STREET,  
LONDON, S.E.1.

Telephone: Waterloo 3333 (50 lines).  
Telegrams: "Ethaworld, Sedist, London."

COVENTRY: Hertford Street.

Telegrams: "Autocar, Coventry." Telephone: 5210 Coventry.

BIRMINGHAM:

Guildhall Buildings, Navigation Street, 2.  
Telegrams: "Autopress, Birmingham." Telephone: 2971 Midland (4 lines).

MANCHESTER: 260, Deansgate, 3.

Telegrams: "Hiffe, Manchester." Telephone: Blackfriars 4412 (4 lines).

GLASGOW: 26B, Renfield Street, C.2.

Telegrams: "Hiffe, Glasgow." Telephone: Central 4857.

PUBLISHED WEEKLY. ENTERED AS SECOND-CLASS MATTER AT NEW YORK, N.Y.

Subscription Rates:

Home, £1 1s. 8d.; Canada, £1 1s. 8d.; other countries, £1 3s. 10d. per annum.

As many of the circuits and apparatus described in these pages are covered by patents, readers are advised, before making use of them, to satisfy themselves that they would not be infringing patents.

## CONTENTS

	Page
Editorial Comment .. .. .	45
The Wireless World Television Receiver—III. Constructing the Mains Units .. .. .	46
Television in the Making .. .. .	50
Unbiased .. .. .	52
Broadcast Brevities .. .. .	53
Random Radiations .. .. .	54
Frequency Modulation .. .. .	55
Current Topics .. .. .	57
Listeners' Guide for the Week .. .. .	58
Letters to the Editor .. .. .	60
An Ideal Valve Voltmeter .. .. .	62
Imperial Model AD45 Receiver .. .. .	64
Recent Inventions .. .. .	66

## EDITORIAL COMMENT

### Transatlantic Experiment

#### Wireless and Air Navigation

IT is gratifying to learn that the carefully organised wireless services contributed so much to the successful outcome of the transatlantic test flights recently carried out by the *Caledonia* and the American flying boat. Though there has undoubtedly been some exaggerated talk as to the navigators' dependence on radio bearings, it is certain that the normal direction-finding technique and, above all, the successful application of the Marconi-Adcock principle to the obtaining of reliable bearings on short waves at great distances have together been more than valuable, and helped the navigators to maintain such good courses that fast times could be made.

The topography of the Northern transatlantic route is unfortunately such that existing D.F. stations (including those specially established at each of the terminal points) do not give good wide-angle bearings for the exact determination of position of an aircraft in mid-ocean. However, if the long-distance short-wave system of direction-finding has indeed come up to expectation as fully as we believe, it may be thought worth while to make a serious attempt to overcome the many and obvious difficulties in the way of erecting a third installation in Greenland. A station in the neighbourhood of Cape Farewell should, in conjunction with the existing terminal stations, provide right-angle "fixes" over the crucial part of the route.

In any case, Imperial Airways is to be congratulated on having taken wireless so seriously; would that the same could be said of all others responsible for long-distance flights, even

after making allowances for different circumstances. Too often the wireless apparatus is put on board as a mere afterthought, and, worst of all, none of the personnel of the aircraft is sufficiently skilled in its operation. Things happen quickly in the air where operating and technical standards should, if anything, be higher, rather than lower, than in the marine service. The wild rumours current about Mrs. Putnam's fate would almost certainly never have been circulated had her machine been even half as elaborately equipped and well manned wirelessly as was the *Caledonia*.

### National "Quality" Listening

#### Effect of the New B.B.C. Arrangements

**S**URPRISINGLY little comment and, so far as can be judged at present, few complaints have been made on the B.B.C.'s decision to close down the London and North National medium-wave transmitters during the daytime. This change is incidental to the provision of a separate Regional programme for Wales.

As a result, those who are accustomed to listen during the daytime to the National programmes through the stations in question have now no alternative to the long-wave transmitter at Droitwich. Good as is the quality of that station, there are inherent reasons why it cannot reach the general standard of the now-silent medium-wave Nationals. Here is a strong additional argument for the early inauguration of the ultra-short-wave service for which "quality" enthusiasts have so long been waiting and for which we have so long pleaded.

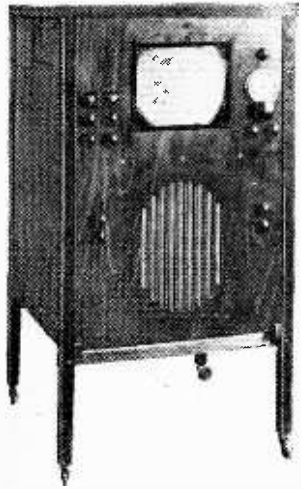

# The Wireless World Television Receiver

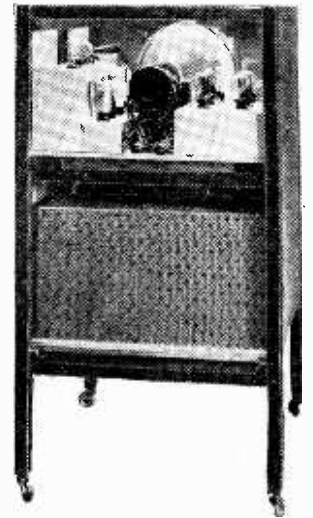

## III.—CONSTRUCTING THE HIGH-VOLTAGE SUPPLY

### UNIT AND THE SOUND POWER STAGE DESIGNED BY W. T. COCKING

**I**N the preceding articles the vision receiver time-base, and the vision receiver power pack have been described, and the high-voltage unit, which supplies HT for both tube and time-base, must now be dealt with. The circuit diagram appears in Fig. 3 and the mains input voltage is derived from the vision receiver power pack in which the delay switch is included. The mains transformer has two secondaries rated at 4 volts 1 ampere, for the filaments of the two U17 valves, and a winding rated at 30 mA. at 1,750 volts.

The two rectifiers are connected in the voltage-doubler circuit with condensers C1 and C2 of 0.1  $\mu$ F. and 1.0  $\mu$ F. respectively. A current of some 20 mA. at 2,000 volts is withdrawn from the junction of these condensers and is used for operating the time-base. It is dropped to 1,000 volts by means of R2 and R3 which also provide smoothing in conjunction with C3 and C4.

The voltage across C1 and C2 is about 4,500 volts and is used for the cathode-ray tube HT supply. The tube current consumption is very small, and the total current is substantially that consumed by the voltage divider—about 1 mA. Smoothing is effected by the resistance R1 and the following condensers. These condensers are connected across the tapping points of the voltage-divider, and so also tend to maintain the tube electrodes at cathode potential for alternating currents.

The two potentiometers R4 and R5 are termed the horizontal and vertical shift controls respectively, since they permit the picture to be moved sideways or up and down on the screen of the tube and so to be centred accurately. The potentiometer R9 enables the second anode voltage to be varied so that the light spot can be focused on the screen. These three controls are brought out to the panel for convenience, but as they only require occasional adjustment it would be quite permissible to make them internally adjustable. The fourth control on this unit is the brilliancy control; it is R13 and varies the grid bias of the tube.

Owing to the high voltages, special care has been taken in the design of this part of the equipment, not only to provide ade-

*A CATHODE-RAY tube demands an HT supply of several thousand volts, but quite a small current is needed. Components must consequently be built to withstand much greater voltages than is usual in receiving equipment and the apparatus must be adequately protected. The peak voltages are reduced by using the voltage-doubler rectifier, and this is economical in permitting the time-base HT supply to be derived from the same equipment.*

sheet of aluminium so that all components can be earthed by their contact with it. Before screwing down the condensers it is wise to scrape off the paint beneath the fixing flanges so that a good contact is ensured. Incidentally, in the case of the condensers C5, C6, C7, C8 and C9, which are all in a single container, the case is actually the connection to one side of C9 and it is accordingly fitted with an earthing screw.

The two valveholders are carried on a Paxolin strip supported above the base by wooden blocks in order that adequate insulation may be obtained. Similarly the fixed and variable resistances and the output terminals are mounted on another Paxolin panel. All this will be clear from the drawings, as also will be the wiring.

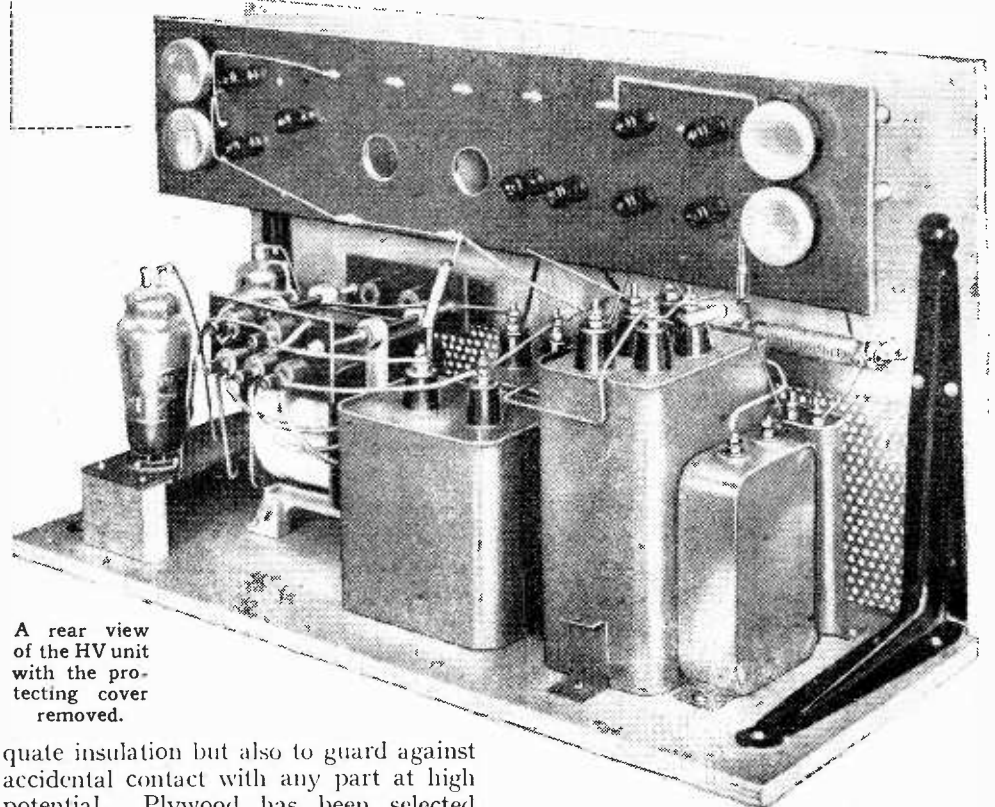

A rear view of the HV unit with the protecting cover removed.

quate insulation but also to guard against accidental contact with any part at high potential. Plywood has been selected for the base and is faced with a thin

CONSTRUCTIONAL DETAILS OF THE HIGH-VOLTAGE UNIT

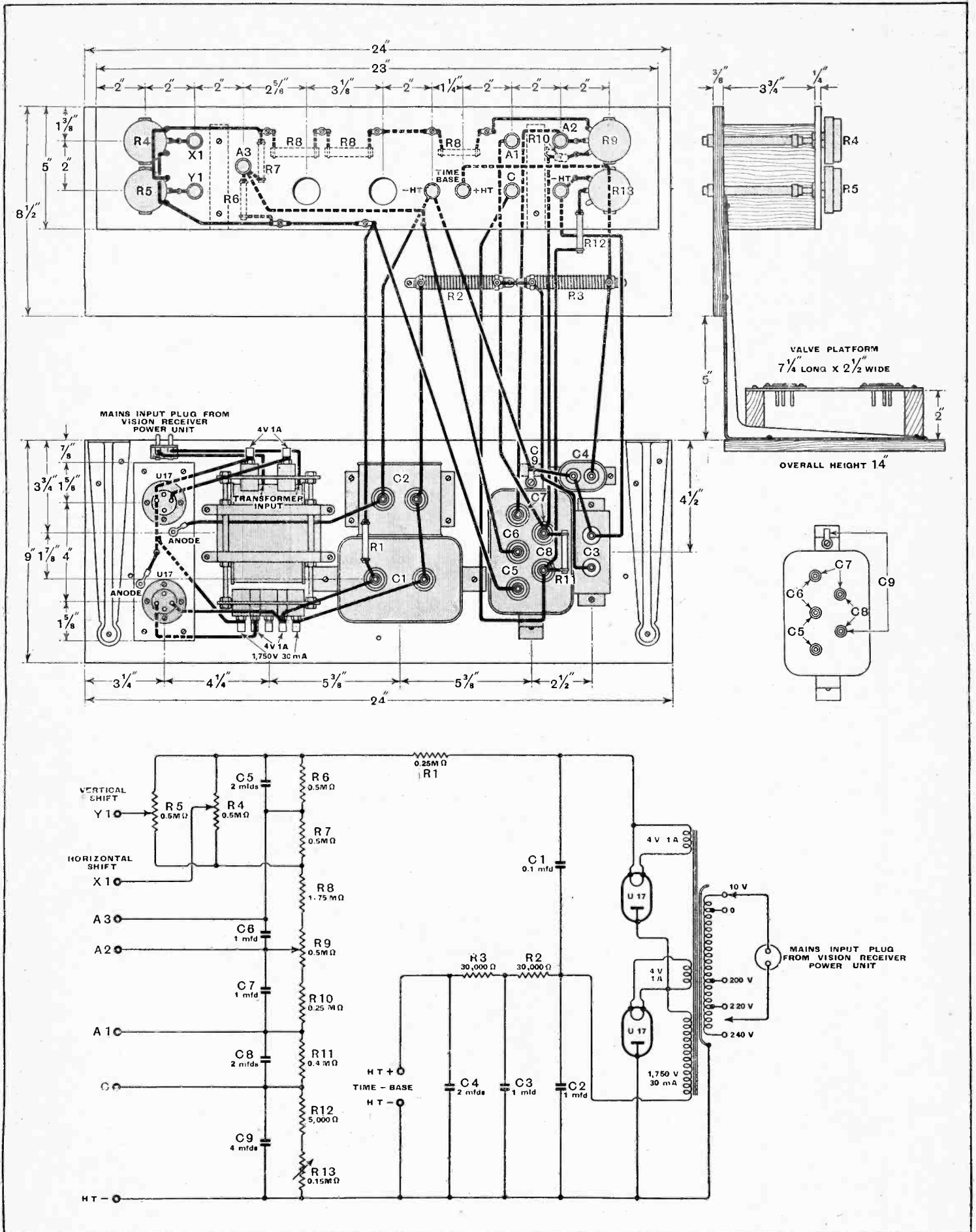

Fig. 3.—The theoretical circuit diagram is shown here as well as the practical wiring diagram.

**"The Wireless World" Television Receiver—**

No reliance can be placed on insulating sleeving at high voltages, of course, and every high-voltage wire should be spaced by half an inch or so from other wires or components. No. 18 or even 16 gauge wire stretched straight is the most convenient on account of its rigidity. Especial care must be taken in the construction and wiring of this unit. Although the variable resistances have "dead" spindles, no reliance is placed in their insulation, and insulating couplers are provided for the couplings to the extension control shafts. These couplers are of the type used in short-wave apparatus for the avoidance of hand-capacity effects and consist of a length of insulating tubing with a set-screw at each end. When connecting up remember to insert the extension shaft only far enough for the set-screw to grip properly. The couplers are hollow and it would be possible to push a shaft through so far that it could butt up against the end of the potentiometer spindle. To do this would completely defeat the end in view and would be asking for trouble.

**Enclosing the HV Unit**

A screen of perforated zinc covers the unit, and when it is in position it is impossible to come into contact with any high-voltage part. Although it is not essential to the working of the apparatus, it is a safety device the use of which is strongly recommended.

Suitably insulated wire must be used for the external connections to this unit. Ordinary good quality lighting flex can be used for the -HT and cathode leads; heavily insulated cable similar to motor-car ignition cable is adopted for the high-voltage connections.

Before passing on to the tube connections, inter-unit connections and cabinet, it may be as well to deal with the sound equipment. The receiver has already been dealt with in *The Wireless World*<sup>1</sup> under the title of The Ultra-Short-Wave Quality

<sup>1</sup> *The Wireless World*, April 23rd, 1937.

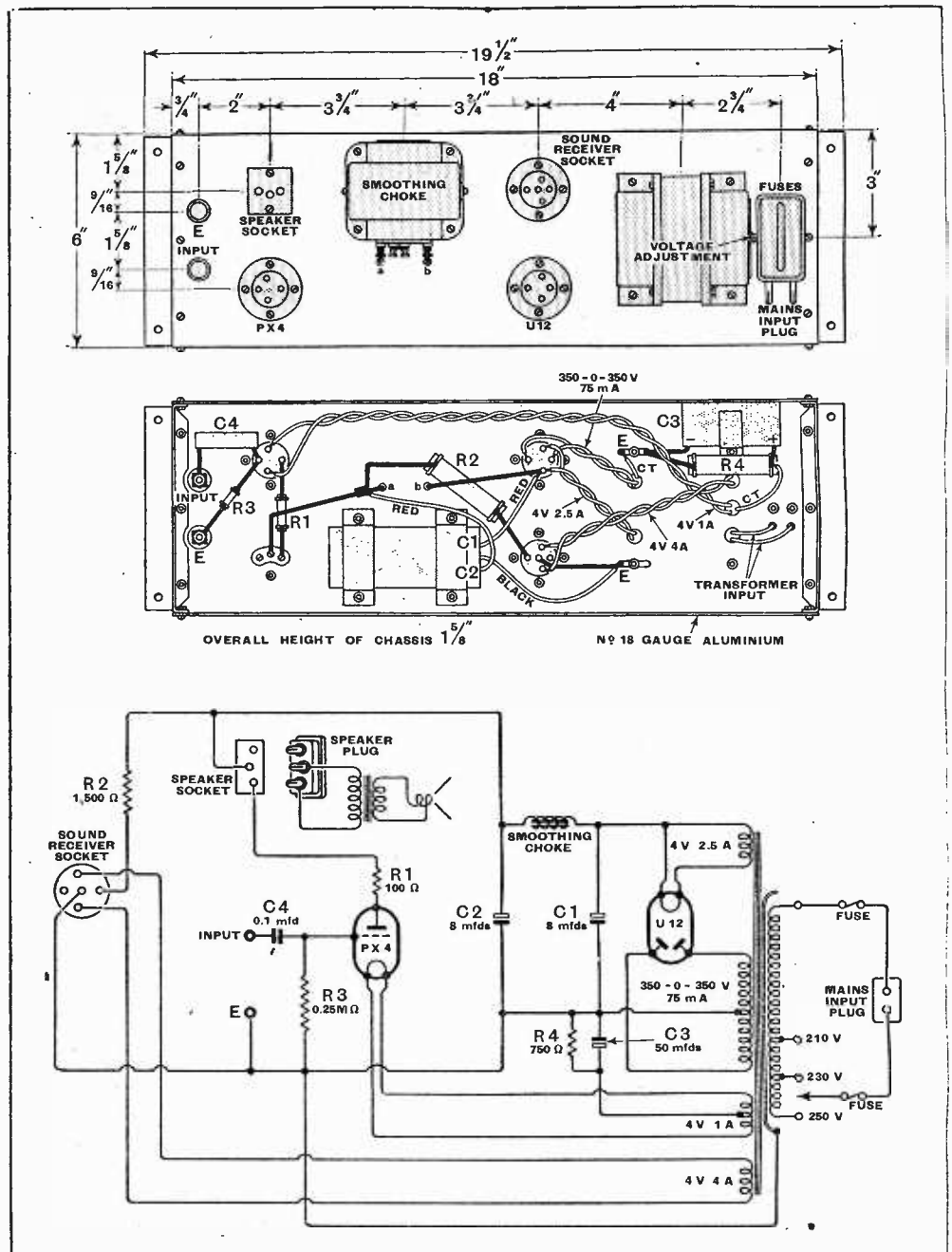
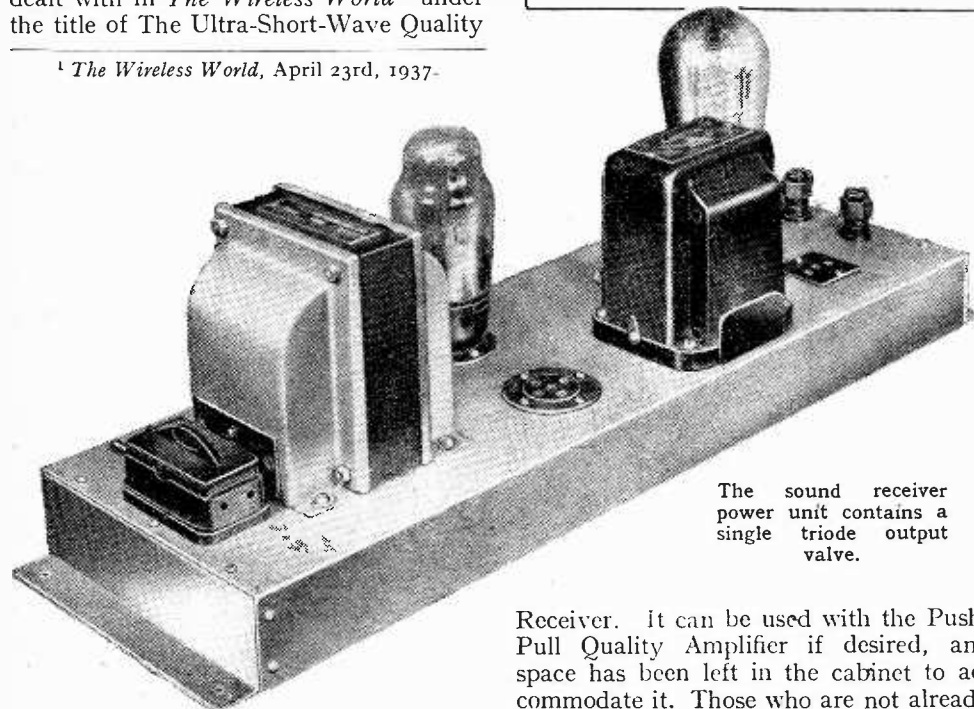

Fig. 4.—Full details are given here of a simple power unit for the sound receiver.



The sound receiver power unit contains a single triode output valve.

Receiver. It can be used with the Push-Pull Quality Amplifier if desired, and space has been left in the cabinet to accommodate it. Those who are not already

in possession of this amplifier, however, will need an output stage and mains equipment, and a small unit has been designed for this purpose. The circuit diagram appears in Fig. 4, and it will be seen that a single PX4 output valve is employed with resistance coupling, while the mains equipment is of the simplest type. The output of such a valve is entirely adequate for television purposes, for experience shows that appreciably lower volume is needed than for ordinary broadcast reproduction. This is undoubtedly partly because one listens more attentively when one has vision as well as sound, but it is also due to the size of the picture. For optimum results, the picture size and sound volume must be correctly balanced.

The construction of the sound power unit is entirely straightforward and calls for no comment. When it is used, however, the Ultra-Short-Wave Quality Re-

"The Wireless World" Television Receiver—ceiver must be altered in one particular—the resistance R10 in the receiver must be short-circuited and only the "+Output" terminal employed. It is also important to use a metallised detector valve or to fit a valve screen over a plain detector; if this is not done the valve will pick up the scanning voltages by electrostatic induction from the tube since it is mounted immediately alongside its end.

A single 5-way cable in which four wires only are employed serves to convey power to the sound receiver, and a single screened lead carries the AF output to the power unit.

A permanent-magnet type loud speaker having very good characteristics has been selected and has proved very satisfactory. In this connection it must not be forgotten that the stray field of the magnet is important and may distort the picture. Excessive field will distort the rectangular picture into a trapezium. In order to avoid this effect the speaker has been carefully chosen and has been mounted as far as possible from the tube.

The assembly of the various units will be described next week.

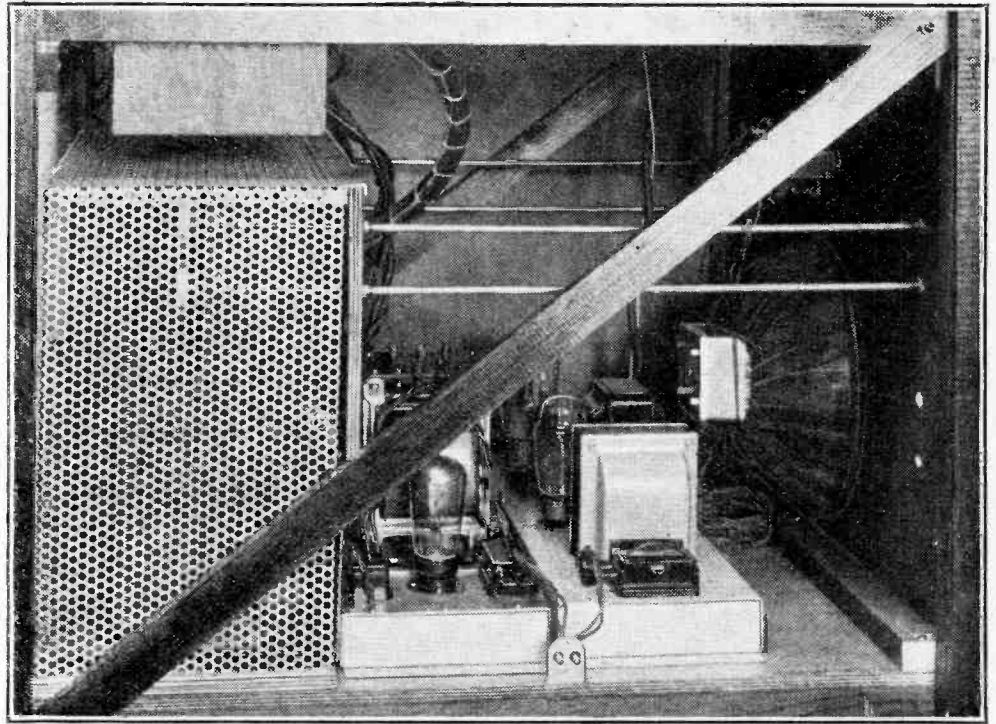

A side view of the lower deck of the apparatus; from left to right the units are the HV supply equipment, the vision receiver power pack, and the sound receiver power pack.

**THE LIST OF PARTS USED**

Certain components of other makes but of similar characteristics may be used as alternatives to those given in the following list.

**HIGH-VOLTAGE UNIT**

1 Mains transformer, Primary: 200-250 volts, 50 c/s; Secondaries: 1,750 volts 30 m/A., 4 volts 1 amp., 4 volts 1 amp.

Sound Sales TEL/EHT

**Resistances:**

- 1 5,000 ohms, 1/2 watt, R12 Erie
- 3 250,000 ohms, 1 watt, R1, R8, R10 Erie
- 1 400,000 ohms, 1 watt, R11 Erie
- 2 0.5 megohm, 1 watt, R6, R7 Erie
- 2 0.75 megohm, 2 watts, R8 Erie

2 30,000 ohms, 40 watts, R2, R3 Bulgin PR39  
(R8 = 2 x 0.75MΩ + 1 x 0.25MΩ)

Resistances Variable, non-tapered.  
1 150,000 ohms, R13 Reliance "SG"  
3 0.5 megohm, R4, R5, R9 Reliance "SG"

**Fixed Condensers:**

- 1 0.1 mfd., 7,000 volts, oil-immersed, C1 Dubilier 951
- 1 1 mfd., 2,000 volts, oil-immersed, C3 Dubilier 951B
- 1 1 mfd., 3,000 volts, oil-immersed, C2 Dubilier 951C
- 1 2 mfd., 1,000 volts, oil-immersed, C4 Dubilier 950A

1 10 mfd. (multiple block), C5, C6, C7, C8, C9 Dubilier BE526

2 Valve holders 4-pin (without terminals) Clix Chassis Mounting Standard Type V1

2 Plug-top valve connectors, Belling-Lee 1175

1 Mains connector, 2-way Bulgin P33

9 Terminals, ebonite shrouded, HT+, HT- (2), A1, A2, A3, C, X, Y Belling-Lee "B"

4 Extension control outfits Eddystone 1008

Miscellaneous: Peto-Scott  
Paxolin sheet, baseboard, perforated zinc, wire, sistoflex, screws, etc.

Valves:  
2 U17 Osram

**SOUND RECEIVER POWER PACK**

1 Mains transformer, Primary: 200/250 volts, 50 c/s; Secondaries: 350-0-350 volts 75 m/A., 4 volts 2.5 amps., 4 volts 4 amps., 4 volts 1 amp., C.T. Bryce 5VT28

1 Smoothing Choke Varley Dual DP11

Fixed Condensers:  
1 0.1 mfd., 350 volts, tubular, C4 T.C.C. 250  
1 8+8 mfd., 450 volts, electrolytic, C1, C2 T.C.C. 702H/3c  
1 50 mfd., 50 volts, electrolytic, C3 Dubilier 3004

Resistances:  
1 100 ohms, 1/2 watt, R1 Erie  
1 250,000 ohms, 1/2 watt, R3 Erie  
1 750 ohms, 3 watts, R4 Erie  
1 1,500 ohms, 3 watts, R2 Erie

2 Valve holders, 4-pin (without terminals), Clix Chassis Mounting Standard Type V1

1 Valve holder, 5-pin (without terminals) Clix Chassis Mounting Standard Type V1

1 Fused mains input connector with 1 amp. fuses Belling-Lee 1114

1 Plug and socket, 3-pin Belling-Lee 1119

2 Terminals, ebonite shrouded, E, Input Belling-Lee "B"

1 Loud speaker with transformer Goodman's WWT Auditorium

Chassis Sound Sales  
Miscellaneous: Peto-Scott  
Wire, sistoflex, screws, etc.

Valves:  
1 U12, 1 PX4 Osram

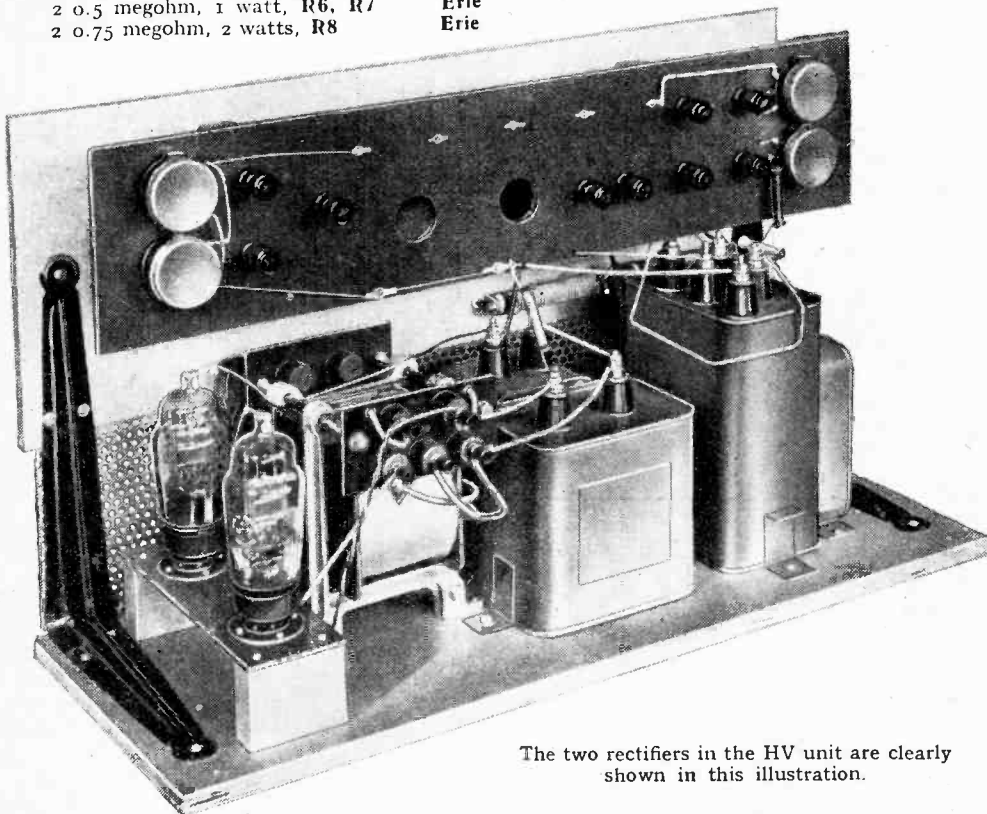

The two rectifiers in the HV unit are clearly shown in this illustration.

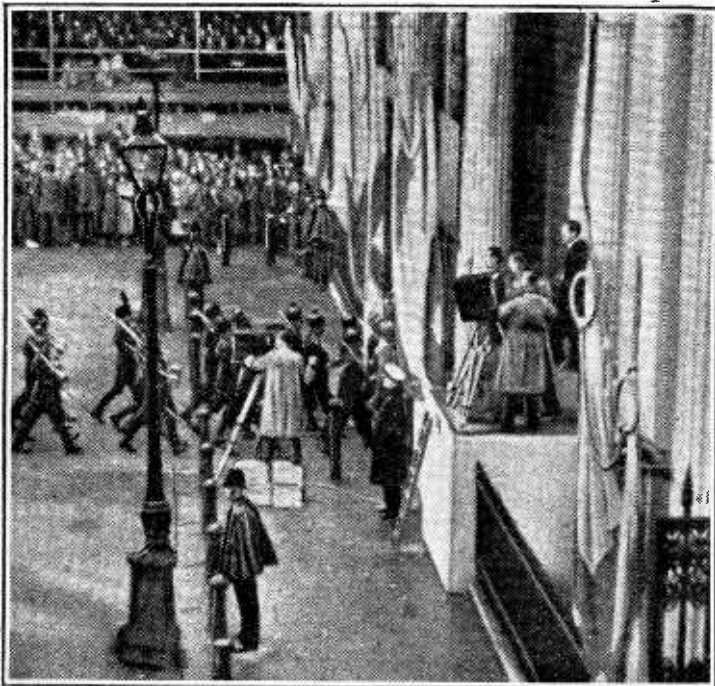

The televising of the Coronation procession at Apsley Gate, Hyde Park Corner, was undoubtedly television's greatest fillip.

Photo by courtesy of British Pictorial Productions, Ltd.

the idea is placed on the knees of the gods at the next programme meeting. If the gods smile, the producer may or may not be a happy man, depending upon how many

other programmes are absorbing all his waking hours.

Let us assume that "Hotel Cosmopolitan"—a brisk singing and dancing show—has been duly tabled for presentation a month hence. Cecil Madden, the Programme Organiser, must find the right niche for this super production, his task being to achieve programme balance and avoid awkward clashes. The guiding principle is to please as many viewers as possible in sixty minutes of varied entertainment. The Television Orchestra, conducted by the indefatigable Hyam Greenbaum, will be required, so "Hotel Cosmopolitan" will come up for discussion at the music meeting, which follows on after the programme discussion.

When a date has been found for "Hotel Cosmopolitan," the programme is allotted a space in the elaborate time-table of the Productions Department, which is

**T**AKE an oblong of frosted glass 10in. x 8in. and a loud speaker. To fill the one with a living picture, the other with concordant sound, for 120 minutes a day for six days a week, and let it be a good picture and good sound." This, briefly, is the task entrusted to Mr. Gerald Cock, B.B.C. Director of Television. Is it easy?

If you have doubts ask a stage producer whether he would choose to turn out "something new" every day; whether, instead of rehearsing for three weeks and then settling down for a steady run, he would prefer the deliciously varied job of putting on fresh material every night. If he deigns to reply, and if you still have lingering doubts, put the question to a film director who works feverishly all day, rehearses his artistes line by line and shot by shot, is mortified a dozen times in as many hours by having to "cut" and start again, and whose daily output of screen time is . . . perhaps two minutes. His reply is a foregone conclusion.

### Achievement

And still television *lives*. Animated images have been thrown on the opalescent screen for more than 450 hours since November 2nd last year. Drama, variety, ballet, musical comedy, talks, outside broadcasts, orchestral works, recitals—all these have been presented, and although the programmes are, of course, open to all the winds of criticism, it is generally conceded that production has reached a stage of *finesse* which justifies the serious consideration of entertainment lovers.

How does a programme evolve from an idea to a finished production?

The story of any particular production begins just about five weeks before it springs to life on the screen. Someone on the programme side is visited by an idea—Dallas Bower thinks of "Pasquinade," George More O'Ferrall of "Hassan," Stephen Thomas of "Derby Day"—and

# Television in

## BEHIND THE SCENES

presided over by D. H. Munro. It is the Productions Department that "pulls the strings," attending to studio management and contriving that, as far as is humanly possible, the producer's ideas are translated into reality.

Meanwhile, the producer has found time to consult with Peter Bax, the scenery expert, and already he is designing the dummy revolving door of the "Hotel," and it is now taking shape in the carpenter's shop. The scene painters are at work in their rather flat medium of black, grey and white, to supply the background of the "Hotel" lounge. But "Hotel Cosmopolitan" only becomes really interesting when the artistes are assembled and rehearsals have begun, so we may pass over such severely practical details as booking the artistes, reducing the script to continuity form, and cutting it to fill, say, thirty minutes.

### Rehearsal Problems

If a genius could invent a means to obviate the learning of lines, television rehearsal time could be cut down considerably. In the case of a production with speaking parts a good deal of dogged rehearsing must be gone through before it can be tried out before the cameras. Often the preliminary rehearsals are carried out at Broadcasting House. Once in the television studio the show is treated as if it were actually on the air; the producer, after a brief period on the floor with the

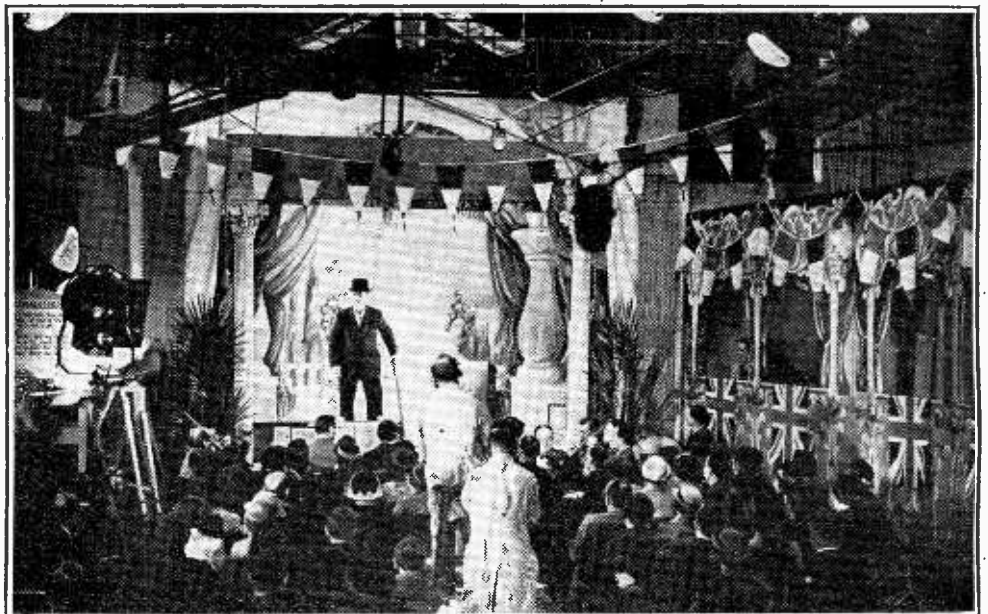

The stage is set. By the judicious use of scenery Peter Bax creates atmosphere in the studio. This photograph was taken during Harry Pringle's show "Music Hall Cavalcade," which was produced in May.



# the Making

T ALEXANDRA PALACE

By  
E. C. THOMSON

artistes, leaves that side of the business to the studio manager, and takes his seat at the producer's window high up at the back of the studio. There, so far as his own show is concerned, he is monarch of all he surveys. Facing him are two monitor tubes, one showing the picture which, if transmission were on, would actually be radiated, and the other giving a choice of pictures from the other cameras in the studio. At the "word of command" the sound and vision control engineers supply any combination of picture and sound that

Instruction in golf in Alexandra Park was one of the first O.B.s attempted by the television staff. Here Miss Poppy Wingate is seen demonstrating a shot before the camera in June.

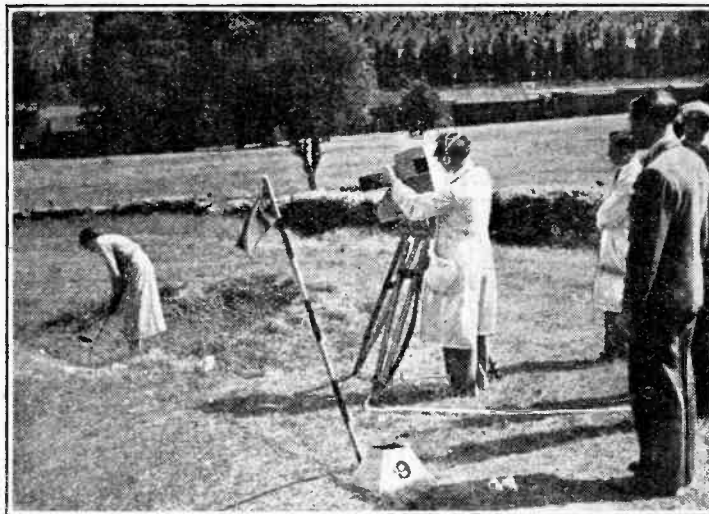

mopolitan." After three hours' rehearsal on the morning of the day itself, including a final run-through timed by the studio manager's stop-watch, all is ready for transmission at, say, 3.25. As the time draws near the producer gives a last anxious look round the studio and then ascends to his uneasy chair to watch the closing shot in the preceding news reel, which, incidentally, has been timed to the split second in the Film Viewing Room. "Two minutes to go" he signals to his studio manager, who blows the warning whistle. People in the studio talk in whispers. A make-up assistant dashes on to the set to powder a nasal high light . . . an

with "Revolving Door," the opening chorus.

Meanwhile, the producer has his hands full. Following "continuity" he has faded from the caption card to the tele-cine circuit for a film loop showing the bustle and excitement outside a large hotel, and is now bringing down the gain control on orchestra for the announcer's opening sentences. Back to full volume on orchestra, he fades out the film loop and brings in Camera 1 on the Cosmopolitan Choristers gyrating around the revolving door.

The show is on.

### O.B. Technique

Outside broadcasts are controlled in just the same way, the only difference being that the producer is denied a direct view of what is happening, and must rely on what he sees in the monitor and on messages received by field telephone from his "studio" manager. He is, of course, in constant touch with camera and microphone squads by means of headphones. Starting cues are usually given by the camera man on instructions from the control desk.

"And that, ladies and gentlemen, concludes our television transmission for today" says the announcer at the end of the



In the first of these three photographs the camera man is seen focusing on the players on the Centre Court at Wimbledon during the tennis championships. He is kept in touch with the control van by means of the headphones he is wearing. The middle picture shows the tele-

the producer may require. During rehearsals the producer uses a "talk back" speaker, but this, of course, cannot be employed during actual transmission; but he can still communicate with the studio by visual signals, through headphones worn by the camera and microphone operators, and by telephone to the studio manager. Cue lights are also used, and are invaluable to the announcers and the conductor of the orchestra.

### Improved lighting and make-up

Although make-up is rarely required for rehearsal, Miss Mary Allen, in charge of make-up and wardrobe, or one of her assistants, is present to observe whether certain faces are likely to need special attention, and each artiste is watched on the floor and on the studio monitoring receiver. Nowadays, since improved lighting has been made possible, a very light make-up is required.

The stage is set, then, for "Hotel Cos-

vision cable, among a number of others, leaving the commentator's box to be carried, as shown in the third picture, to the van which was stationed a quarter of a mile away.

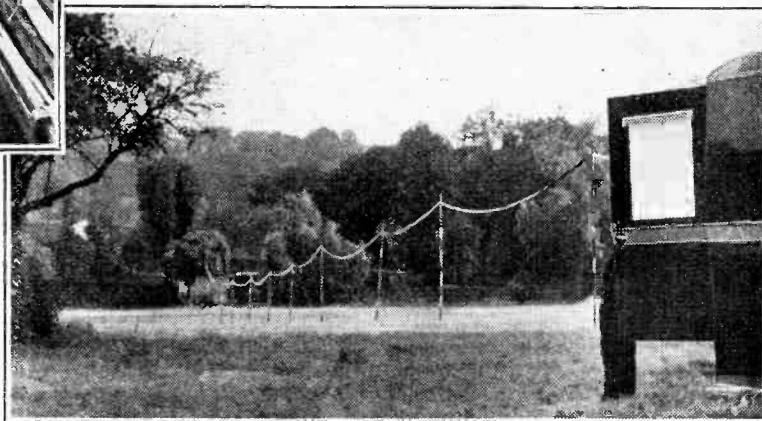

announcer does smiling practice before camera 3 . . . the senior studio engineer moves a lamp a few degrees. Then another whistle, and the red indicator registers "Sound on, Vision on." A green cue light flashes and the orchestra strikes up

day's programme. Staff and artistes go home. "Hotel Cosmopolitan" and all the effort it involved will soon be forgotten, for to-morrow a fresh band of artistes will arrive to give the public "something new."



# UNBIASED

By  
FREE GRID

Another well-known and respected figure.

## Inferior Electricity

A GOOD many of you will no doubt recollect the great howl of indignation which went up throughout the land some years ago when the various gas companies started to charge by the therm instead of by the good old cubic foot. Everybody started to moan that they were being cheated and couldn't understand why one company gave more cubic feet to the inch than others; in fact, those companies whose gas was so good that it required less feet to make a therm than others were accused of swindling, just as though they had been trying to supply cubic feet containing fewer than twelve cubic inches.

Although Mr. Therm is now quite a well-known and respected figure in the community, I do not think that the average man really understands his relationship to the cubic foot even now, as only last week, when paying a visit to an old acquaintance who has recently moved to a new abode, the indifferent performance of his mains radiogram was excused on account of the "poor quality of the current supplied." When I asked the reason for this astounding statement my friend justified it on the grounds that it was obvious that it must be so as all other explanations of the set's poor performance had been exhausted, and, furthermore, the cost per unit was cheaper than in the last district in which he lived, this being "similar to the case of gas, the cost of a cubic foot of which is also less when the quality is inferior."

I naturally laughed his explanation to scorn, and after trying my best to make him understand that the cost of gas didn't depend on its quality, I pointed out that in any case the "quality" in the case of electricity could not possibly vary. I must confess, however, that after hearing all the evidence I am not feeling quite so cocksure about the matter as I am at a complete loss for an explanation of the set's wretched performance.

My friend's new house is in the next street to his old one, and the two gardens actually back on to each other. The two houses are, however, in different boroughs and receive their electricity supply from different undertakings, although the voltage and periodicity is the same in both cases. The set is a conventional AC model which has given perfectly good results in my friend's old house.

Naturally, when the move had taken place and the set went off colour all sorts of things such as local screening was suspected, but these were discounted by the fact that the performance of an old battery receiver which my friend possessed was quite as good in the new house as in the old.

The AC set was thoroughly overhauled without improvement, and finally it occurred to my friend to make the acquaintance of the tenant of his old dwelling and arrange for the mains connections from his set to be passed over the garden wall to one of the lighting sockets of his old house. At once the set behaved normally, and, naturally, this was immediately taken to indicate that the fault was in the mains. Accordingly, the voltage was tested by means of a borrowed AC voltmeter and the periodicity checked with a stroboscope on the gramophone turntable, the stroboscope being one which he had used in his old residence. In both cases all was found in order.

The net results of all this is that my friend is quite satisfied that his indifferent reception is solely due to what he alleges to be the "poor quality" of the current supplied to him, and unless I can find a better explanation very quickly he is going to the expense of having a permanent cable laid from his old house, he having come to the necessary financial arrangement with the tenant. If, therefore, any of you power station wallahs can give me a helping hand in the matter I shall be very grateful indeed, as my technical reputation is at stake.

## Debunking Psychology

LIKE myself I suppose that you fellows often get tired of the sentimental slush offered for our mental recreation by the bookstalls, and yearn for some more ennobling literature. Whenever this sort of feeling comes over me more strongly than usual I almost invariably repair to H.M. Stationery Office and seek to elevate my mind by some of the soul-stirring works which they publish.

I always find that, among other things, the termination of the stories published by the Stationery Office is totally unexpected which is so unlike the case of the average cheap novelette where anybody, with any gumption at all can detect right from the very first chapter who it was that murdered the old squire and stuffed his body into the refrigerator. As an instance of what I mean I may mention that quite recently I finished an exciting volume entitled "Causes of Mortality in the Mercantile Marine," and found that the principal cause is not, as I should have thought, fire or tempest, nor is it what you think either—but I will not

spoil the enjoyment of the book by giving the dénouement away.

During the past few days my attention has been devoted to an enthralling work on "Occupational Diseases," and I have been learning all about such things as Housemaid's Knee, Writer's Cramp, and Commercial Traveller's Conscience. The best part of the book, however, is that which tells of the curious psychological symptoms brought about by certain activities. Who would have thought, for instance, that persistent working in the Lost Property Office would result in the development of absent-mindedness and memory weakness. The most interesting of all these curious psychological effects, however, is that which has been noticed in connection with wireless servicemen.

According to the report they invariably appear to develop habits of unpunctuality after they have been in this occupation for some little time. Strangely enough this curious "disease" has also been observed to be prevalent among what the report terms "Amateur Wireless Servicemen" by which, I take it, is meant people who repair their friends' sets, and, possibly, home constructors also. Apparently medical science is completely baffled by this strange effect, and can suggest neither the cause nor the cure.

To my mind this attitude on the part



Hints and Tips—Simple de-magnetisation of one's time-piece.

of the medical men is merely another instance of the objectionable habit of scientific men generally of seeking long-winded and elaborate explanations of quite simple and straightforward effects and overlooking the obvious and simple causes which lie right under their noses. It seems quite clear to me, for instance, that the cause of unpunctuality among wireless servicemen is merely that their watches are slow due to the gradually increasing retarding effect brought about by the magnetising of their "innards," which is inevitable among people who are constantly messing about in the vicinity of powerful loud speaker magnets. The cure is as simple as the cause, namely, to hold the watch for a few moments each day in the vicinity of a powerful AC dynamo. Any power station engineer will be only too happy to oblige if approached in the right way.

# BROADCAST BREVITIES

## Propaganda

WHILE one marks a growing restlessness in many quarters over the amount of propaganda which is being put on the air in various languages by German and Italian broadcasting stations, the Government and the B.B.C. preserve an unruffled serenity. The most that can be drawn from Government spokesmen in reply to questions in the House of Commons is that the matter is receiving consideration.

## Other Methods

The delay in announcing what steps, if any, are to be taken to counter foreign propaganda is due to several causes; the most important being that while the B.B.C. is fully aware that its machinery is available and may some day be commandeered for engaging in the game of vocal pyrotechnics, other propaganda methods are at Great Britain's command. For example, through the ruling princes, whose lightest word is law in their own domain, she can influence India's millions; through the leaders of native races themselves, living beneath the British flag in other Dominions, colonies and protectorates, she can reach those to whom she desires that the facts shall be known.

Foreign Office wireless, or "British Official," is also available for disseminating news. Thus Portland Place does not expect to be asked, at present at all events, to give up programme time to foreign language broadcasts whose effectiveness is doubtful.

## Round Pegs in Round Holes

LIKE an ever-rolling stream, life in Broadcasting House is constantly on the move, always changing. Since the beginning of the year considerably more than two hundred alterations in staff have taken place, consisting of new appointments, transfers and cessations; and in general the object has been to get the round pegs into round holes and to prevent them from being kept too long in square holes. In many cases transfers are asked for by members of the staff themselves, and one may assume that these are anxious to avoid stagnating in one job year in, year out.

## General Post

The list of transfers is an imposing one, for it includes Station Directors and junior

## NEWS FROM PORTLAND PLACE

cashiers, control room engineers and announcers. In the Talks Department Mr. Roger Wilson was translated from London to Manchester, while Mr. I. Cox performed the journey in the opposite direction. Mr. T. Dornier, the Chief Cashier, resigned on attaining the age limit, his place being taken by Mr. J. S. Dawbarn, who was originally a receptionist.

Mr. G. C. Beadle, chief of the Staff Training College, applied for the post of West of England Regional Director, and got it. He takes up his duties in October. Mr. H. M. Fitch, who was Assistant Regional Director in Manchester, is now Acting Regional Director in place of Mr. E. G. D. Liveing, resigned.

## Transferred to Television

To television came Mr. R. A. Rendall, after organising the Palestine Broadcasting Company; Mr. Jan Bussell, transferred from a Producership at Manchester; and Mrs. Mary Adams, from the Talks Department at B.H.

## Restless Occupation

Paul Askew, formerly Dance Bands executive, is off to Bristol as Studio Executive there. B. Walton O'Donnell, conductor of the B.B.C. Military Band, becomes Music Director at Belfast. "Freddie" Grisewood has left the announcing staff at headquarters for the wider field of O.Bs.—and so the tale goes on.

Broadcasting is a restless occupation, and rightly so. To "settle down" would mean stagnation.

## Bouquets for Empire Station

SINCE the new Empire transmitters at Daventry took the air some of the hard-boiled critics in the Antipodes have paid handsome tribute to the changed conditions. Says *Wireless Weekly* (Australia): "It would be difficult to imagine broadcasts of a better type than can now be heard from Daventry. . . . The stations on the 19-metre band provide a wonderful entertainment. On 19 metres GSO is the most consistent transmitter."

South Africa is just as pleased. Says the *Cape Argus*: "Reception has never been better from the B.B.C. studios. If any listener is dissatisfied let him speak now, or for ever hold his tongue."

## To Be Seen, but . . .

BALANCE and control engineers in St. George's Hall have been wearing a worried expression of late, the reason being that their little cubicle to the right of the stage is not soundproof. All sorts of canny attempts to keep out the sounds from the stage and auditorium failed, until the other day a genius suggested the use of special sound-excluding 'phones. Several pairs of these, which are of the moving-coil type, have now been provided, and it is understood that one could drop a Mills bomb within six feet of the engineers and they would still maintain their balance and control.

## Mr. Beadle Speaks

JUST what do the Regions want that the National programme cannot give them? This question is not easily answered, and some of the doughtiest champions of local talent in broadcasting become tongue-tied when pressed to explain.

But Mr. G. C. Beadle, who has just been appointed West of England Regional Director, has definite views on the point.

## Where the Artiste Comes In

"It is easy enough," he says, "to broadcast concerts, dance

## Creating Authentic Atmosphere

This is a knock at the farm-yard school which thinks that you have only to bring an honest-to-goodness countryman to the "mike" in order to provide the authentic atmosphere of the locality. There has been a little too much of this sort of thing in the past. The man-in-the-street is a good fellow, but . . . well, let us leave it at that. Mr. Beadle's aim, and it might well be copied in some of the other regions, will be to employ local talent at all times, so long as it is talent.

## A Cairo Canard

IT is time to nip in the bud certain rumours anent the meeting of the international telegraph and telephone delegates at Cairo in 1938. Suggestions have been made that the agenda includes discussion on questions of broadcast propaganda and jamming reprisals. Actually, the conference will be concerned exclusively with the technical aspects of electrical communication, of which broadcasting is a part, but only a part.

## Murder in Television Studio

TELEVISION programmes from Alexandra Palace in the autumn are to include more original material than at present, and script writers are now getting busy on plays specially suited to the television medium.

One play in preparation deals with a murder in the studio;



INTEREST IN TELEVISION. Over 48,000 persons visited the Television Exhibition at the Science Museum, South Kensington, during the first three weeks. This flashlight photograph shows a part of the crowd watching demonstrations of two of the eight commercial receivers that are being shown in operation.

bands and all forms of ready-made entertainment, but these by themselves are not enough. The important side of regional broadcasting is not to be found ready made; it has to be created afresh every time."

Mr. Beadle considers that real regional entertainment consists of creating sound pictures in speech or music of regional affairs, present or past, and presenting these pictures to the audience with a degree of finesse which is only found in the artiste.

another centres round the discovery of chloroform in 1847 and the dramatic moment when half a dozen doctors, led by James Simpson, nearly killed themselves while experimenting with the new anaesthetic.

But perhaps the most vivid programme in store for viewers will be that built around all the ceremony of the arrival and departure of an Atlantic liner. Some of the scenes will be filmed in advance at Southampton, and the film interspersed appropriately in the programme.

# RANDOM RADIATIONS

## The Welsh Regionals

NOW that Wales has achieved not just one, but two Regional transmitters of its very own, its long-standing grouse against the B.B.C. should be removed once and for all. The old arrangement of trying to satisfy both Welshmen and West Countrymen with the same Regional programme obviously couldn't work. Whatever happened, the Welshmen complained that there wasn't half enough Welsh in the programmes, whilst the men of Devon and Somerset and Cornwall were equally certain that there was far too much. And you can't be surprised. Welsh folk love their own language, which is as unintelligible as Swahili to the great majority of people living south of the Bristol Channel. In fact, you can't really imagine two more dissimilar regions in language, music, thought and outlook than Wales and West. They are far more unlike in many respects than London and North Scottish; for one thing, the Scots have no desire for the bulk of their programmes to be transmitted in Gaelic.

## Will Wales Respond ?

The next question is whether, now that the B.B.C. has done its bit by giving Wales all the Welsh programmes that it can possibly want, Welsh folk will play up by becoming more interested in radio? At the end of last year Wales showed the poorest figure but one for the ratio of licences to "estimated number of households." That estimate was made by taking the average number of persons in a family for the whole of Great Britain. In Wales, though, large families are not uncommon and I'd be inclined to think that on this account the real number of households is possibly less than the 659,660 shown in the B.B.C. report. It is, perhaps, rather remarkable that though even last year the Washford Cross Regional programmes were so largely in Welsh, West Region showed a percentage of 66 of licences to households, as against 53 for Wales. So far, the increase produced by the opening of Penmon has been distinctly disappointing. One hopes that now that Wales has also a 70-kilowatt Regional on the very favourable wavelength of 373.1 metres there may be a rapid and continuous rise in the licence figures.

## National Reception

I can't help wondering how some parts of the West Country will fare during the time that they are deprived of a "local National" station (what a queer contradiction in terms those words are!) until the Start Point transmitter gets to work and the non-Welsh station at Washford Cross resumes its National status. I know that the "Luxemburg effect" is pretty pronounced in some places, whilst in others Droitwich fades very badly. However, I hope to be able to write ere long from first-hand knowledge, for I am expecting to take the holiday that I feel is so richly deserved—curious how difficult it is to convince others that you're overworked—at a place in Mount's Bay, which is reputed to be exceedingly bad from the Home broadcasting point of view. Naturally, it'll be a busman's holiday, for I shall take at least one wireless set with me. I am wondering just how much it will be possible to hear of the home programmes, particularly the National.

## By "DIALLIST"

### Plywood and Boom

IN the old days when wireless sets were expensive, the cabinets that contained their works were often made of good thick wood, cut from the solid plank. Nowadays, when the aim of so many manufacturers seems to be to turn out something rather cheaper than the next man's, the plywood cabinet—and, it may be, not very thick plywood at that—seems to have come to stay. Plywood has, of course, much to recommend it, for it can be obtained with all kinds of beautiful veneers and it lends itself to original and striking designs. But I can't help thinking that a good deal of the boominess, about which many listeners complain, is due to the use of plywood. I wonder if any maker of moderately priced receivers will be bold enough to try the experiment of offering the same chassis in a de luxe cabinet of solid wood at a somewhat higher price? I have an idea that the experiment might be rather successful if the cabinet were particularly designed to avoid boominess. Anyhow, it might be worth trying. I don't mean that the more expensive set should be the only one offered; my idea is that it should be there as an alternative to the standard model.

### Superhets and Sensitivity

TOUCHING recently on the much vexed question of the superhet versus the straight set, I mentioned that one of the drawbacks of the former was that if you made use of anything like the full sensitivity available in order to hear a weak signal you were apt to obtain a most unsatisfactory

noise-to-signal ratio. Just how bad this can be, with a small superhet, at any rate, has been brought home to me rather strikingly of late. Wanting (partly out of sheer curiosity, and partly because I had a man staying with me who knows several oriental languages) to hear what the Italian programmes for the Far East were like, I tried several times to tune-in the Rome transmissions on 25.4 metres at intervals between 3 o'clock and 4.30 in the afternoons. The station apparently uses some kind of directional aerial for these, for signal strength here is considerably below normal. If any reader cares to try for himself, he will find that he has to turn the wicks right up, with the result that background noises make much of the programmes exceedingly hard to follow. Some of the noise is undoubtedly due to mush, which any kind of set would bring in, but the greater part of it seems to me to be peculiar to the superhet.

### Queer Languages

Still, there are times when these transmissions to the Far East come in pretty well, and when you happen to strike respectable conditions you can spend some interesting moments in discovering how queer some languages can sound. One of the strangest that I have come across so far is Chinese, which gives you the impression that it consists entirely of questions, owing to its peculiar rhythm and the way in which the speaker's voice runs up and down the musical scale! There is no difficulty about telling which language is being used, for the announcer always gives out in English that the talk will be in such and such a tongue. The talks in Eastern languages always seem to come on at about 4 o'clock, after the news and the musical programme. Try it for yourself and you will get some idea of the extraordinary variety of noises that the human animal makes in different parts of the world in order to communicate its thoughts to its fellows.

## Television Programmes

Transmissions are from 3-4 and 9-10 daily

Vision 45 Mc/s.

Sound 41.5 Mc/s

FRIDAY, JULY 16th.

3, Freddie Dosh—Comedy Impressions. 3.5, Friends from the Zoo—first Zoo O.B. 3.20, Film—"Casting Animals." 3.30, Television Follies, presented by Gordon Crier. 3.50, Gaumont-British News.

9, Friends from the Zoo, by Alan Best. 9.15, Film—"Wayward Canary." 9.25, "A Review of Revues," presented by Dallas Bower. 9.50, British Movietone news.

SATURDAY, JULY 17th.

3, "Swings and Roundabouts"—an O.B. from the Fair in Alexandra Park. 3.15, Film—"Wayward Canary." 3.25, "Have You Forgotten?"—Remembered by Jean Colin, Monti Ryan, Richard Murdock and Percival Mackey and his Band. 3.50, British Movietone news.

9, Reine Paulet, in French Songs. 9.5, Film—"Casting Animals." 9.15, Freddie Dosh—Comedy Impressions. 9.25, Gaumont-British News. 9.35, Repetition of 3.25 p.m. programme.

MONDAY, JULY 19th.

3, Film—"Lobsters." 3.10, Derby Day. Comic Opera by A. P. Herbert. 3.50, British Movietone news.

*The programme will be interrupted during this afternoon and tomorrow afternoon for short relays from the Inter-Zone Final of the Davis Cup at Wimbledon.*

9, Film—"Ladybirds." 9.10, Repetition of 3.10 p.m. programme. 9.35, Gaumont-British News.

TUESDAY, JULY 20th.

3, "The Man with a Flower in His Mouth"—a Dialogue by Luigi Pirandello. 3.15, Film—"Ladybirds." 3.25, Eric Coates conducts the B.B.C. Television Orchestra—solo saxophone, Ken Gray. 3.50, Gaumont-British News.

9, The John Carr Jacquard Puppets. 9.15, Film—"Lobsters." 9.25, Cabaret, with Eric Wild and his Tea-Timers. 9.50, British Movietone news.

WEDNESDAY, JULY 21st.

3, Ernest Mills, Cartoonist. 3.10, "Boys and Girls Come Out to Play."—O.B. from Alexandra Park. 3.25, British Movietone news. 3.35, Ad Lib.—Revue by Herbert Farjeon.

9, Marie Eve in Continental Songs. 9.10, Repetition of 3 p.m. programme. 9.25, Gaumont British News. 9.35, "Mizzen Cross Trees"—Revue of Nautical Songs and Dances.

THURSDAY, JULY 22nd.

3, "Starlight"—Elsie Carlisle, accompanied by Ronald Aldrich and Freddie Aspinall. 3.10, Talk by Myfanwy Evans—"Expedition on a Bicycle." 3.25, Gaumont-British News. 3.35, Repetition of Tuesday's 9.25 p.m. programme.

9, Repetition of Tuesday's 3.0 p.m. programme. 9.15, Film—"Mickey's Pal Pluto." 9.25, Repetition of 3.35 p.m. programme. 9.50, British Movietone news.

# Frequency Modulation

## A POSSIBLE SOLUTION OF SOME DIFFICULTIES

By  
"CATHODE RAY"

**T**HERE are two serious obstructions in the way of radio communication. A little while ago I wrote about one of them—Noise\*—as the limiting factor in the range of reception. Long before the limit of amplification possible with modern technique is reached noise steps in and makes it useless to go any farther.

The other obstruction—crowding of wavelengths—limits the number and quality of transmissions that can be put out. If half the stations in Europe were eliminated, the other half could be received much better.

In the article on noise I referred rather sketchily to the Armstrong frequency-modulation system which has been proved by practical experiment to be capable of things that were thought impossible; such, for instance, as better reception under severe conditions of atmospherics, etc., from a 2-kilowatt transmitter 85 miles away than from the regular 50-kilowatt broadcaster at only 20 miles. Unhappily, the system is very complex and inapplicable to the ordinary broadcast waveband because the superiority as regards signal/noise ratio depends on using a wide frequency band such as 100 kilocycles, which occupies the room of eleven ordinary stations, and so must be relegated to the ultra-short waveband.

Thus, if the Armstrong system successfully presses back one of our two obstructions, it does so only by yielding ground to the other.

Frequency modulation means that the programme is impressed on the carrier wave by causing its frequency to oscillate around the normal instead of by varying its amplitude as in the ordinary system.

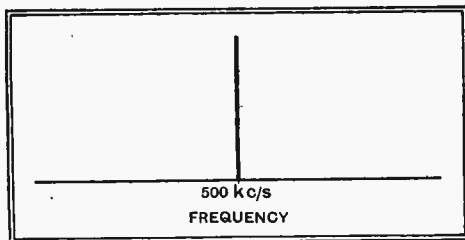

Fig. 1.—An unmodulated carrier wave might be represented like this.

Some readers may not be quite clear about this distinction, because they know perfectly well that the ordinary or amplitude-modulation system causes the frequency of a transmitter to spread out by the formation of sidebands.

But this spreading is really quite different from frequency modulation. When a single audible programme frequency, such as a 1-kc/s tuning note, is impressed on a carrier wave of 500 kc/s, the carrier remains there, but is supplemented by side frequencies of  $500 \pm 1$  kc/s, which are also of fixed frequency so long as that note is being transmitted (Fig. 2). The strength of the tuning note, or depth of modulation, is represented by the strength of the side frequencies relative to the carrier wave. Of course, in a musical or speech programme these side-frequencies are very numerous, and occupy a more or less continuous band each side of the carrier wave (Fig. 3). If the tuning note were being transmitted by a frequency-modulated transmitter the carrier wave itself would shift up and down at a frequency of 1 kc/s, and the width of the frequency band covered by it in this process would have nothing to do with the frequency of the programme but would be a measure of its strength. In the Armstrong system 100 kc/s might be taken to correspond to 100 per cent.

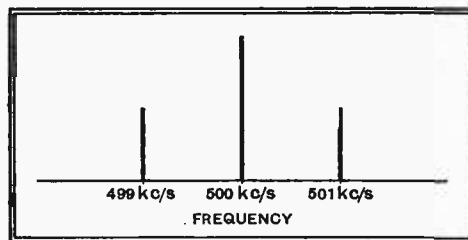

Fig. 2.—The simplest possible programme—a note of one constant frequency—would then be represented like this on the ordinary amplitude-modulation system.

modulation. But if the anti-noise properties are sacrificed it is quite possible to obtain full modulation by a frequency shift of perhaps only 0.1 kc/s. No doubt you will say, "Oh yes! This means that broadcast stations could be packed only 0.2 kc/s or so apart if they were frequency-modulated, instead of the present 9 kc/s (which even so is inadequate)." Well, as a matter of fact it doesn't; for even a narrowly frequency-modulated carrier covers a frequency band just as wide as any other, though this may not be obvious without mathematical proof. But there is one way in which it might be possible to attack the problem of overcrowding. It consists in modulating the transmitter both ways at once and so impressing two programmes on it simultaneously. The success of this idea obviously depends on

the receiver being capable of selecting either of them without interference from the other. Assuming it is technically practicable, it is thus possible either to double the number of programmes in a given waveband or (preferably) to double the band-width of each, and so to improve the quality and ease of separation.

Although I have no definite information on the point it does appear that an ordinary broadcasting station with narrow

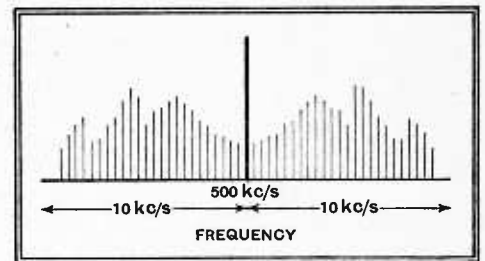

Fig. 3.—Or a complex programme like this, where the single side frequencies spread out into sidebands.

frequency modulation superimposed would continue to give the same service as at present to owners of ordinary receiving sets, and listeners who cared to use special receivers would be able in addition to switch over to the alternative programme. Such a scheme would make it absolutely essential that the two sorts of modulation should not be mixed up at all. In the type of transmitter in which the modulator acts directly on the oscillator valve, still used in many amateur stations, amplitude modulation is accompanied by frequency modulation, and the same programme would be heard however the receiver were arranged. Of course, modern broadcasting stations set a very high standard, and the chief burden falls on the receiver. It is not at all easy to design a reasonably simple receiver capable of separating two programmes from even a perfect transmitter.

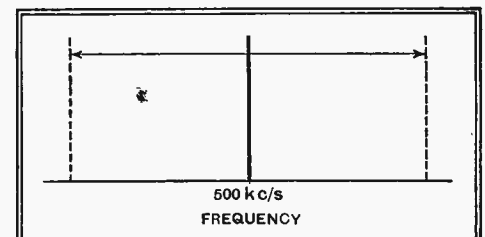

Fig. 4.—A frequency-modulated transmission consists of a carrier wave vibrating in frequency over a range dependent not on the frequency but the strength of the programme.

\* Noise, Jan. 15th, 1937.

**Frequency Modulation—**

J. R. Woodyard, in the *Proceedings of the I.R.E.* (May, 1937), has given some idea of how it might be done. Anybody who has possessed a receiver with reaction control, and who has even been so unscrupulous as to allow it to oscillate when receiving a station, knows that the beat-note or howl obtained in this way falls in pitch the more closely the receiver is tuned to the carrier wave. The frequency of the note is, in fact, equal to the difference in frequency between the receiver oscillation and the carrier wave, and so it ought to be possible to make it as low as one likes. In practice it falls quite steadily to a certain pitch and then disappears completely, and there is a small tuning range over which no beat note is heard, before it reappears the other side of exact tuning. The cause of this result is that the carrier wave pulls the receiver into step with itself, and the stronger it is the wider is the silent space. Under certain conditions of coupling between signal, local oscillation, and detection the detector response is unaffected by the strength of the incoming signal, but is affected by the frequency within the silent space. In other words, it responds to frequency modulation but not to amplitude modulation. Fig. 5 illustrates the type of result described by Mr. Woodyard; the diagonal line shows how the detector response depends uniformly on the signal frequency within the silent space, which usually covers only a few hundred cycles at most. If the signal is

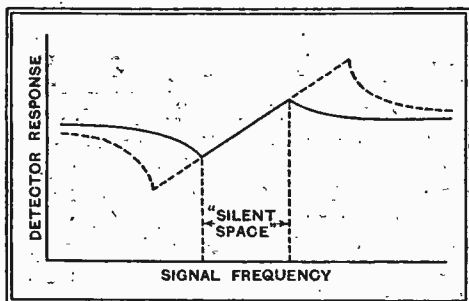

Fig. 5.—Showing the curious sort of response given by a receiver detector to a signal on which a local oscillation is superimposed when conditions are suitably adjusted.

made stronger the silent space is widened out, as shown by the dotted line, but the original diagonal part is entirely unaffected. Theoretically, therefore, an amplitude-modulated programme would be inaudible, and a frequency-modulated programme heard; and by switching off the local oscillator the situation would be reversed (assuming the receiver tuning to be flat-topped within the limits of frequency modulation).

This sounds so remarkable that I did a little investigating on my own. The elementary circuit given by Woodyard is shown in Fig. 6, in which A, B, and C indicate the couplings on which the proper action depends; but he points out that to avoid separate adjustment of these circuits for each station this process would

in practice be established at the second detector of a superhet. So I started on those lines, loosely coupling the IF valve to the diode detector, and coupling both to a local oscillator. These couplings had to be rather carefully adjusted to get the Fig. 5 type of result at all, but when at last it was obtained there was a very marked suppression of the programme

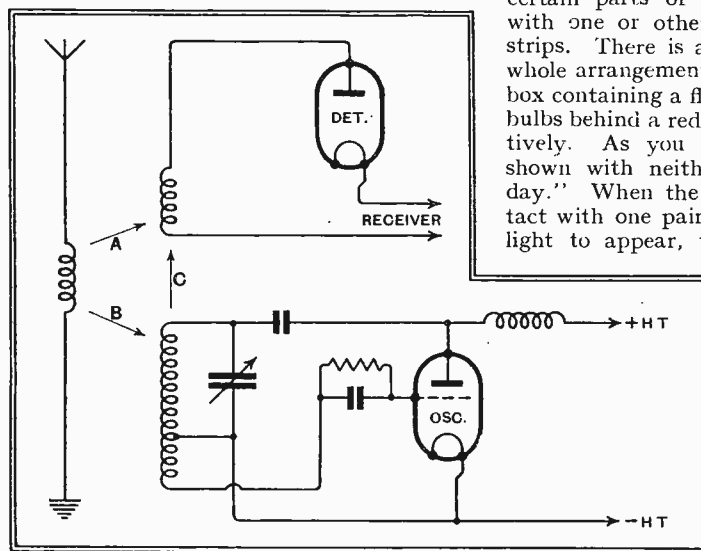

Fig. 6.—Circuit diagram (due to J. R. Woodyard, *Proc. I.R.E.*, May, 1937) illustrating the method of getting the result shown in Fig. 5.

over the middle portion of the silent space. I never managed to get anything approaching complete suppression, but the experiment was rather rough and the circuits unshielded. It was very noticeable that the lower audible frequencies were suppressed much more completely than the higher. Mr. Woodyard claims to have achieved separation of two programmes complete enough for listening purposes.

Apart from the objection that broadcasters would risk causing interference by trying it, the receiver would be very tricky to adjust, and, of course, to-day's trend is all in the direction of making things very simple for the listener. Still, a receiver to do all the things a very up-to-date model now does would have seemed to a 1927 engineer to have to be excessively tricky. But in 1937 it is the manufacturer who has performed all the tricks and the listener has practically nothing to think about—or that is the intention, anyway.

## DISTANT RECEPTION NOTES

**M**Y best thanks to those readers who have been kind enough to send me suggestions for overcoming the difficulty of ascertaining the local time in distant countries and for remembering, once you've found the hour, whether it's yesterday, to-day or to-morrow. Actually, I have a time-chart and use it to some extent but it isn't a very satisfactory one. I feel sure that, like myself, fellow D.X.'ers would wel-

come some simple contrivance that was easy to use and easy to read.

One idea put up by a reader is so ingenious that I feel an urge to make it up if I can find the time to do so.\* Briefly, it consists of a fixed disc surrounded by one that is movable.

The movable disc is marked off into hours; the fixed one into degrees of longitude and the names of key stations. The outer disc carries a metal arm, which, over certain parts of its travel makes contact with one or other of two pairs of copper strips. There is also a fixed pointer. The whole arrangement is mounted on a shallow box containing a flash-lamp battery and two bulbs behind a red and green window respectively. As you turn the disc, all times shown with neither bulb alight are "to-day." When the pointer, by making contact with one pair of strips, causes a green light to appear, the hour reading is "to-

morrow." Similarly the appearance of a red light indicates that the hour is "yesterday."

It would take a bit of working out, but it might prove a very useful gadget for long-distance work.

Another most handy adjunct for the D.X.'ers table is the great circle projection map of the world published by

*The Wireless World*. It enables you to obtain the distance and the true bearing of any station that you may pick up in a brace of shakes with the aid of an ordinary foot rule marked off into tenths of an inch—one-tenth equals 100 miles.

I've had mine mounted in linen and sectioned so that it folds up compactly. The sectioning, of course, very slightly impairs its accuracy, but not so much as to make any enormous difference. And, in any case, if you want measurements or bearings of precision it's easy enough to allow for the gaps caused by the sectioning.

There have been reports that Moscow No. 1, on 1744 metres, has been deliberately interfered with of late. I've tuned in to this station several times lately when programmes in various foreign languages have been going on and so far I have not come across any sign of attempts to jam the transmissions, except the German talk.

Japanese medium-wave stations have been heard, and heard strongly, in this country; but has any one ever succeeded in picking up any of the stations in Australia, New Zealand, Hawaii, China and other places in the Far East and in the region of the Antipodes? Many of these stations are pretty well heard in America, but they don't seem to reach us. The most favourable time for trying for them is a little before daybreak—perhaps that's why we don't have more success with them. D. EXER.

## HARTLEY TURNER M12 RECEIVER

**I**N the circuit diagram of this receiver which appeared in our issue of June 25th, condensers were omitted from the leads from the diodes to the IF output filter and from the lead joining the "Earthing" end of the first tuned circuit in the aerial input filter to the coupling coils. A complete circuit, including the output and rectifier stages, is available from Hartley Turner Radio, Ltd., Thornbury Road, Isleworth, Middlesex.

# Current Topics

## EVENTS OF THE WEEK IN BRIEF REVIEW

### Television at Ninety Miles

A COMPLETE programme from the Alexandra Palace has been successfully received at the G.E.C. works at Coventry. Although brief extracts have been received on previous occasions, it has not hitherto been possible to "hold" the transmission through the entire period of the programme. A standard receiver was employed in conjunction with a special high-efficiency valve in one part of the circuit.

### Indian Wireless Trade Figures

THE imports of wireless apparatus into India show a steady yearly rise. In 1934-35 the value of the imports was 1,600,000 rupees. This increased to 2,600,000 rupees in 1935-36, and to 3,500,000 in 1936-37. A further large increase is expected for the year 1937-38. The largest share of the trade was taken by the U.S.A., which exported wireless goods to the value of 1,602,354 rupees to India during the past year. The United Kingdom exported 1,262,625 rupees' worth. Holland despatched to India radio goods valued at 438,660 rupees, the share of the trade captured by other countries being 236,432 rupees.

### European Listeners

THERE are now over three-quarters of a million licences issued in Poland, the actual figure being 773,470. A large increase is expected when the various new transmitters which are projected are put into service.

On May 1st there were 922,814 listeners in Belgium, and 972,694 in Czechoslovakia. On June 1st France had 3,926,902, and Germany 8,372,848 listeners.

### France Decries Uplift Programmes

A RESOLUTION has been passed by the Congress of the French National Federation of Broadcasting demanding that programmes of an educative and informative character appealing only to a limited section of

listeners should not be radiated during normal broadcasting hours, but should be sent only at a special time of the day. An alternative suggestion is that special "talks" stations should be provided, working on an exclusive wavelength.

### An Interesting Russian Experiment

A TRIANGULAR conversation has recently taken place between people travelling by land, water, and air. It was arranged for experimental purposes by the Soviet Army authorities, and very successful results were obtained. The travellers by water were in a submarine, the land travellers being in a fast-moving car.

### Swedish Broadcasting Dispute Settled

THE recent difference of opinion between the Swedish broadcasting authorities and the leading football clubs concerning the question of payment for broadcast running commentaries on important

tions of any important matches they choose. A similar arrangement has been made in the neighbouring country of Finland.

### Scandinavia Encourages Tourists

IN future, foreign visitors to Denmark are to be permitted to use wireless receivers for two weeks without being called upon to pay for a licence. After this they must pay the equivalent of 9s. for an ordinary annual licence. In Norway visitors are to be allowed to use sets for eight weeks free of charge.

### Radio Rowdies

THE increasing degree of annoyance caused to neighbours in certain quarters of Paris by the habit indulged in by many thoughtless listeners of operating loud speakers at full volume all day and far into the night is having some unforeseen consequences. Certain sufferers, exasperated at having been unable to obtain relief by legal means, have been deliberately causing etheric interference by

### Wireless and Whales

MANY experts are prophesying the rapid extermination of the whale, owing to the fact that now the New Zealand whale-fishing companies are reported to have equipped their fleets and depots with wireless telephony in order that rapid information can be transmitted concerning the movements of whales. It is thought that it will not be long before most whaling fleets in other parts of the world are similarly equipped.

### Chinese School Broadcasting

THE Minister of Education in China has decided to equip a further 5,000 schools with receiving sets. There are at present 2,000 provided with sets. All schools receivers are made in the State factory in Shanghai.

### Sponsored Programmes

AS is well known, American broadcasting programmes are not paid for out of licence fees as is the case in this country, but by various commercial concerns who sponsor programmes for the purpose of interlarding them with advertising announcements. Drug firms are by far the largest users of radio advertising, they being responsible for no less than 33

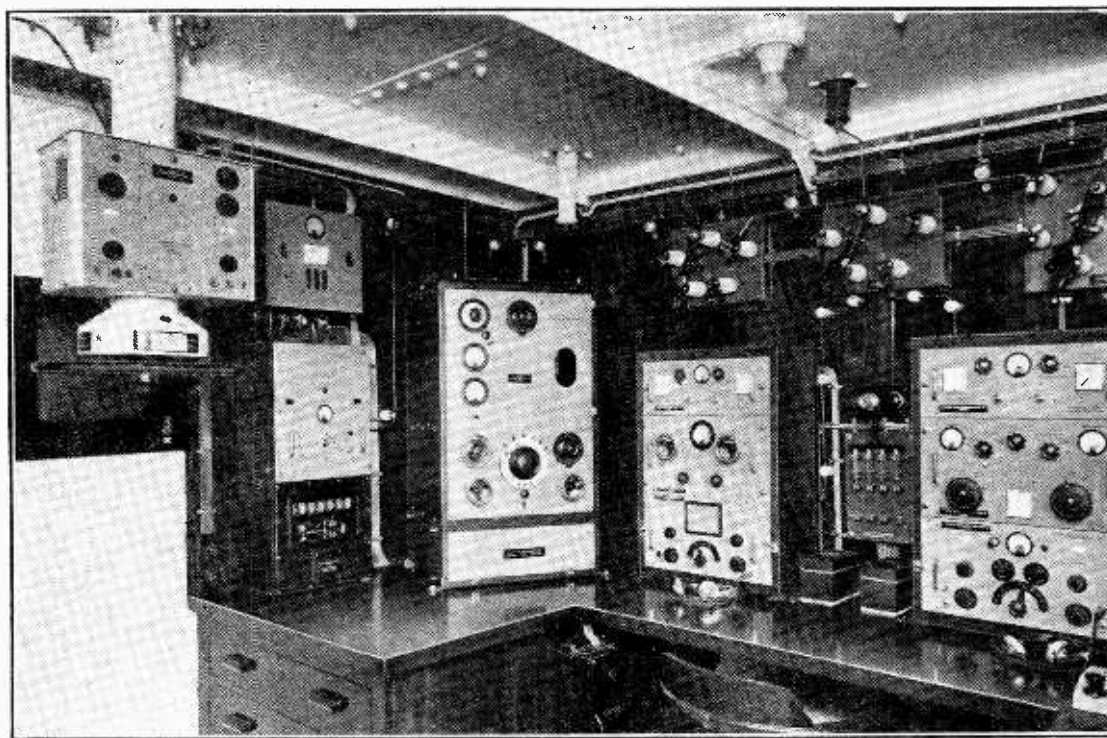

COMPREHENSIVE CARGO BOAT INSTALLATION. The S.S. *Malancha*, which ran her trials last week, has, in addition to a 600/800-metre ICW/CW installation, by Gambrell Radio Communications, a short-wave transmitter, auto alarm and direction finder by the same firm. The capacity of the independent emergency gear greatly exceeds B.O.T. and international requirements.

matches has now been settled in a satisfactory manner. In future the broadcasting authorities will pay a fixed amount annually to the association of clubs, and this will give them the right to broadcast descrip-

the use of various pieces of apparatus such as violet-ray generators. The operation of such devices makes reception impossible over a wide area and causes the innocent to suffer with the guilty.

per cent. of the income of one leading broadcasting company. Foodstuff firms come second, they accounting for 27 per cent. of the income. Motor manufacturers, who contribute 10 per cent., occupy third place.

LONDON is featured twice in this week's programmes. On Saturday, at 9.20 (Nat.), will be presented the first of a weekly series of seven entertaining and topical broadcasts, "Summer over the British Isles." The series, to which each of the Regions will contribute, will portray, by means of recorded shots and studio scenes, the work and pleasure of the peoples in different parts of the British Isles. In the programme on Saturday, Laurence

# Listeners' Guide for

years a point of attraction to emigrants from all over the world. The contrasting reasons why people from other lands have made London their home will be brought out. Typical "squatters" will tell how London has affected their life stories.

Grisewood will give running commentaries from Wimbledon on the first day's play in the Inter-zone final for the Davis Cup between America and Germany. On Monday and Tuesday afternoons, also, he will give commentaries from Wimbledon. The motor cycling



**TYPICALLY LONDON.** This aerial view of part of the great metropolis with St. Paul's, which is symbolic of London, in the foreground shows the Thames winding towards Westminster. Twice this week London is featured in the programmes.

Gilliam will present "Summer in London." The second of this series of broadcasts will be given on Wednesday at 10.30 (Nat.) and will be "Summer in Scotland." This will emphasise the pleasures and beauties of long summer days in the remote highlands of the outer islands.

The second occasion on which London will be the theme of a programme is on Sunday at 9.5 (Reg.) when listeners will hear "Why London?" The idea behind this programme, which has been prepared by Berthe Grossbard and will be produced by Felix Felton, is to present London as Cosmopolis and to show that it has been for many, many

## SATURDAY SPORT

EACH succeeding Saturday seems to surpass the last in the matter of abundance and variety of sporting broadcasts. Stay-at-home sportsmen will have a good afternoon of listening this Saturday, for from 3.15-5.15 (Nat.) athletics, rifle shooting, tennis, and motor cycling will be described for their benefit. At 3.15 and 4.20 H. M. Abrahams will tell listeners of the progress of events at the A.A.A. championships at the White City. From 3.30 to 4 Capt. J. V. Jackson and Capt. E. H. Robinson, the well-known wireless correspondent, will be at Bisley to describe the shooting for the King's Cup. At 4 and 5 F. H.

broadcasts on Saturday come from Donington Park, where at 4.15 and 4.45 C. R. Hodgson and George A. Allan will describe the closing stages in the International Six Days Motor Cycle Trial.

## MOVIE MUSIC

LOUIS LEVY and his Symphony come to the end of the present series of "Music from the Movies" with the fifteenth programme on Wednesday at 7.30 (Reg.), their penultimate broadcast will be given to-night (Friday) at 8 (Reg.). For his choice of numbers for the final programme, Louis Levy is being guided entirely by the letters received from listeners requesting repetitions.

## HIGHLIGHTS OF THE WEEK

FRIDAY, JULY 16th.  
Nat., 7.30, "Five Hours Back"—II.  
8.30, The Rocky Mountaineers.  
Reg., 8.30, Jelly D'Aranyi (violin) and Myra Hess (piano). 9.20, "Ladies and Gentlemen of the Chorus."

### Abroad.

Munich, 6.35, Mozart's "Don Giovanni" from the Residenz-theater.

SATURDAY, JULY 17th.  
Nat., 3.15-5.15, Saturday's Sport.  
8, "Palace of Varieties." 9.20, "Summer in London."  
Reg., 6, British Legion Band. 8 and 8.40, Bruckner Festival Concert from the Festival Hall, Linz (Upper Austria).

### Abroad.

Budapest, 8, "Soldiers on the Stage": dances from old and new operettas.

SUNDAY, JULY 18th.  
Nat., 2.50, Service for the Merchant Navy and Fishing Fleet in Southampton Docks. 9.5, Stanford Robinson conducts the Theatre Orchestra. 9.50, The London Mozart Orchestra.  
Reg., 6.30, B.B.C. Military Band and Dennis Noble. 9.5 "Why London?"

### Abroad.

Rome, 9, Gigli in Donizetti's "L'elisir d'amore."

MONDAY, JULY 19th.  
Nat., The Song is Ended—1. A reminiscent programme of dance music. 9.35, Almonds and Raisins: a Jewish Review.  
Reg., 8, "The Lunatic at Large": an exhilarating farce of the '90's.

### Abroad.

Bordeaux, 8.30, Messenger's operetta "Véronique."

TUESDAY, JULY 20th.  
Nat., 6.50, "The Lunatic at Large." 9.40, "Follow-on": a revue in miniature. 10, Ina Souez and the Theatre Orchestra.

Reg., 7.30, Tzigane music from Budapest. 8, Variety from the Hippodrome, Boscombe. 9.40, Pianoforte recital, Angus Morrison.

### Abroad.

Radio Paris, 9, "La Vivandière": operetta (Godard).

WEDNESDAY, JULY 21st.  
Nat., 8, "Nikki Makes News": a new radio burlesque. 10.30, "Summer in Scotland."

Reg., 3.30, Polo commentary from Hurlingham. 7.30, Music from the Movies. 9, Commentary on Speedway racing.

### Abroad.

Warsaw, 9, Recita' of Chopin's polonaises.

THURSDAY, JULY 22nd.  
Nat., 8 Entertainment tour of Blackpool. 9.20, A Saint-Saëns programme, by the B.B.C. Orchestra (C).

Reg., 8, "Why August?": discussion on spread-over holidays. 9, "Nikki Makes News."

### Abroad.

Munich, 7, Operetta melodies from Strauss to Lehár.



# e Week

## nding Broadcasts ome and Abroad

### GOING, GOING . . .

HENRY HALL will direct the B.B.C. Dance Orchestra for the last time in a broadcast on Saturday night. It is fitting that this programme should be the popular Henry Hall's Hour followed by Midnight Music. As announced in May, the orchestra is to be disbanded as from August 7th. From Saturday until that date the members will be on their annual holiday. Although virtually it is the end of the B.B.C. Dance Orchestra as such, Saturday will not, in fact, be the last time its members and director will be heard. For on their return from holidaying, Henry Hall will assemble a band of his own which will be employed by the B.B.C. in a full time capacity until September 25th, when Henry Hall's resignation from the B.B.C. takes effect. This orchestra, which will include the greater part of the personnel of the B.B.C. Dance Orchestra plus five or six newcomers, will be known to listeners as Henry Hall and his Dance Orchestra.

### THE MELODY GIRL

DURING her first visit to England since she was six years old, Vera Guilaroff, daughter of a former English diplomat, is to broadcast from

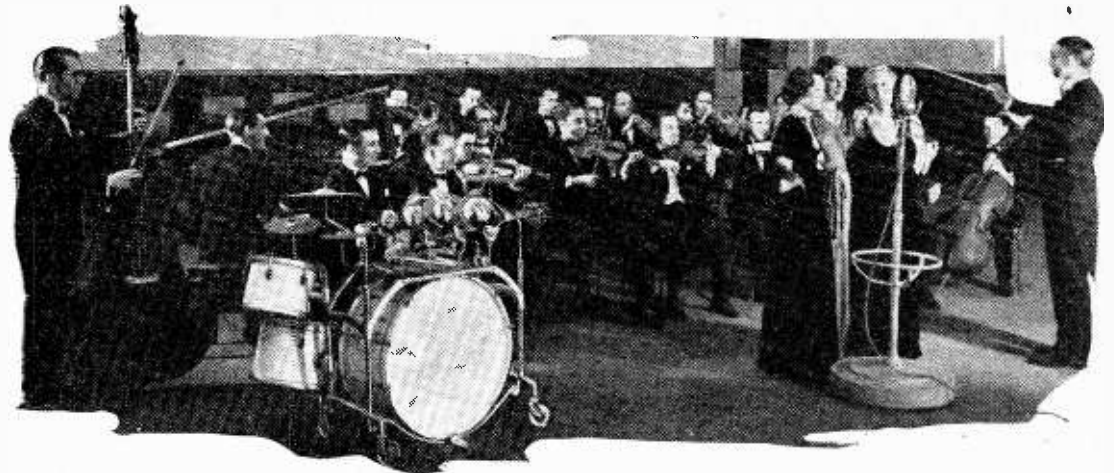

HENRY HALL with members of the B.B.C. Dance Orchestra, which is being disbanded and will be heard for the last time on Saturday.

Canada as "The Melody Girl."

She will play the piano, accompanied by Reginald Foort at the B.B.C. Theatre Organ.

### "PALACE OF VARIETIES"

BERTHA RICARDO, who recently made her first radio appearance in an Ernest Longstaffe production, is to accompany Ralph Truman—as his fiancée—to radio's mythical music hall, the "Palace of Varieties," for the seventh broadcast which comes in the National programme on Saturday at 8.

Sitting in the stalls, their conversation between the acts, picked up by an eavesdropping microphone, will serve as a commentary on the turns which they are seeing.

Artistes booked for the programme include Charles Penrose, in one of his "laughing" songs; Suzette Tarri—one of Ernest Longstaffe's "discoveries"; G. H. Elliott, the original Chocolate Coloured Coon, singing some of his older

numbers; Monsewer Eddie Gray—"fugitive from the Crazy Gang,"

WITH THE MICROPHONE in hand Harold Abrahams congratulates a winner at a recent A.A.A. meeting. He will be commenting at the White City on Saturday.



her native London on Thursday at 7.30 (Reg.) in a programme of the kind that has made her known throughout

who, introduced by Eddie Windsor, will be making his first broadcast in this country; and Bransby Williams.

### THE CHORUS

LISTENERS' memories will, by the new production "Ladies and Gentlemen of the Chorus," be whisked back over the years to the days when chorus girls did little else on the stage than put one foot gracefully before the other and smile sweetly. This programme is dedicated to both the old and new style of chorus. Broadcasts have already been written in honour of stars of the stage, and now it is the turn of the chorus which is often called the backbone of the stage. It will remind listeners of artistes who started in the chorus and who later found stardom.

Bryan Michie, who is producing the show, has persuaded George Graves, of "Merry Widow" fame, to act as compère. The show, which has been written by Gale Pedrick, will include scenes typical of the stage door.

### AT LARGE

A NEW radio play by Lance Sieveking, based on J. Storer Clouston's celebrated novel, "The Lunatic at Large," which has been selling regularly since its appearance in 1900, will be broadcast twice this week—on Monday at 8 (Reg.) and on Tuesday at 6.50 (Nat.).

The adaptation was a happy thought, for this exhilarating farce lends itself admirably to microphone treatment. The two principal characters, Mandell Essington, the aristocratic lunatic, who is wandering through England in the '90's not having any idea as to who he is, and the Baron Rudolph von Blitzenberg, jolly, old-fashioned German tourist, make excellent comedy in all their encounters. Naunton

Wayne, the comedian, will play the part of the lunatic.

### OPERA

LORTZING'S "Waffenschmied," from Berlin at 8.10, is the least familiar of Friday evening's opera. First produced in Vienna in 1846, it is among the less popular of the composer's dozen or so operas. Saturday's least familiar work is the Zandonai opera, "I cavalieri di Ekebù," which is based on a story of the veteran Swedish writer, Selma Lagerlöf. Zandonai is one of the most esteemed of living Italian composers. Born in 1883, he would seem to be at the height of his powers.

Althone is making a new departure in spreading Verdi's "Aida" over four evenings. Acts I-IV being given on Sunday at 5.30, Monday at 7.15, Tuesday at 7.0, and Wednesday at 7.0 respectively. Three hours of Verdi's "big guns" would be rather a stiff dose for a listening public not yet inured to opera.

The big thing on the French stations on Wednesday is the Radio Paris 8.30 performance of "La reine Fiammette" by Xavier Leroux, a composer who, though born in the Papal States, was French of the French.

Thursday's big event is the production at the Salle Gaveau of Félix Raugel's new arrangement of Handel's "The Messiah," which Radio Paris relays at 8.30. This supreme masterpiece was written in 24 days, in the autumn of 1741, and received its *première*, strangely enough, in Dublin. The programme of "The Messiah," by "Mr." Handel, is still to be seen in the Library of Trinity College, Dublin.

THE AUDITOR.

# Letters to the Editor

The Editor does not hold himself responsible for the opinions of his correspondents

## Components

AS my company has been specialising in the needs of home constructors for something like eighteen years, your editorial comments on the unsatisfactory position of component supplies is not without interest to us.

For ourselves, we are unable to agree that an adequate range of components is not available to experimenters. Whilst we pay particular attention to "Author kits," we are also able to offer odd components for constructor sets which have been described in the technical papers during the last five years; and the wide range of every sort and condition of component is sometimes, if we may confess it, the despair of the management and storekeeper alike.

We do not think that any mass-production set or component manufacturer would entertain the idea of reopening the component market for one moment, for the very good reason that they have not got the organisation for the supply and distribution of such lines. The average radio dealer can hardly be expected to stock a necessarily widely varied range of small articles against a problematical market; and the manufacturer, with his trade distribution and specialised production planning, would find it much more bother and expense than was worth while to sell these components direct to the public.

In spite of the fact that we ourselves are singularly well placed to cater for the needs of the experimenter, we sometimes wonder if it is worth while developing this side of our business. We would be prepared to extend our activities if we could be reasonably sure of fair support; but we have a feeling that the market is not large enough to justify the extra effort required.

It has to be realised that, for every keen and knowledgeable reader of *The Wireless World*, there probably exist 400 or 500 listeners who are not in the least interested in home construction. The temptation to cater for the larger market is obvious.

Your readers' comments on the foregoing would be of real interest and value.

London, E.C.1. H. A. HARTLEY,  
Peto Scott Co., Ltd.

## HT Battery Connections

I REALLY must comment upon a few things which "Diallist" has said in his interesting notes recently, and will do so as briefly as possible.

With regard to battery connections, it seems to me that simplicity, while an admirable goal to aim for, can be carried to too great extremes. With only two connections to the HTB there is thereby abolished flexibility in adjustment, which, as the battery runs down, becomes more and more desirable. I am not talking about grid bias, which should be automatic in every case where it is possible, but about those other intermediate connections which enable one to obtain a variety of results. Regarding my own set, there are seven connections. While two of these are to the GB section of the HTB, once they are plugged in no further adjustment is needed during the whole life of the battery. Of the remaining

five connections, two are connected to the positive and negative terminals, and two go to the "Delay" section, while the last plug allows for necessary adjustment at various periods during the life of the HTB. I don't see how any of these can be sacrificed without some loss in adaptability to voltage decline. Thanks to all these *very plainly marked* connections I am enabled to obtain the very last usable volt from my HTBs.

Backs to all sets, battery as well as mains, are absolutely necessary in my opinion. Prevention is far better than cure, and far better is it to exclude dust in the first place than to try dangerously to remove it later on. My "Pye" set has a back which is easily opened, and which, being nearly all *dust-proof* (but not sound-proof) fabric, does not cause "boom."

T. J. E. WARBURTON.

East Molesey, Surrey.

## Straight v. Superhet Receivers

UP to this present time of writing six letters, excluding my own, have appeared in *The Wireless World*, and since the various writers are apparently fairly representative of the manufacturer, wireless repairer and interested amateur classes, an analysis of their remarks is indicated.

Mr. Pinhorn, of Dyratron Radio, makes some very definite statements, and I agree with him entirely. It is interesting to observe his firm have specialised in straight receivers for many years. The fact that it continues to do so seems to indicate a select market provides their customers. Mr. H. J. Dix represents the second class, and to this gentleman I would quote a humorous story as an analogy to his creed.

"A certain man was lecturing a class of first-year engineering students, and in describing an ordinary engineer's steel 12in. rule, said: 'The longest vertical marks are the inch divisions, the next longest are the half-inch divisions, and the shorter ones you need not trouble about.'"

This same attitude seems to be the creed of most repairers I have met. Perhaps I have been unlucky. Section 3 is in two parts, and perhaps Mr. Foley is best representative of the real keen amateur class. However, my letter published in your issue of June 18th, 1937, should show the fallacy of believing pre-HF amplification in superhets. to be the absolute cure for all the evils of this type. Also, this is what I manage to do very successfully with a TRF set. Single tuned circuit preceding first RF followed by band-pass to second RF followed by a second band-pass stage to third RF, then a single-tuned circuit before a diode detector, one AF stage feeding a push-pull pair of triodes. Rectifier, subsidiary circuit. A triode operating as a quartz crystal oscillator at 50 kc/s, harmonics of which are used for gauging purposes. The 30th harmonic is weak and is very useful for tuning up the tuned circuits. AVC is not employed, as I believe in adequate metering at all crucial positions. However, here are 10 valves. Messrs. Hewson, Curtis, and "J. W. B." are obviously keen listeners with some constructive ability and favour the TRF, principally on manipu-

lative grounds. Perhaps the veriest tyro of the public might do likewise.

I would like to draw the attention of readers to the new IF system employing Rochelle Salt Crystals and a steel bar as a controlling element (and which savours somewhat of magnetostriction principles), developed by the Brush Development Co., and described in *Q.S.T.* for April and June, 1937, by J. J. Lamb. The idea is not new, and cannot truly be compared with wide-band quartz crystal filters as mentioned in my letter of June 18, 1937. It is better than normal LC circuits, though.

Until crystal filters are obtainable at a reasonable price, I still plump for TRF.  
Portsmouth. "NAUTICUS."

I HAVE read with much interest the comments concerning the respective merits of superhet and straight set. I notice that not one of your correspondents has mentioned the straight set using untuned RF transformers. Much of the difficulty of designing a really high-gain straight set lies in the fact that stable amplification with over three tuned RF stages is practically impossible, to say nothing of the wide variation of band width over each waveband which would occur with such an arrangement. It is not realised that a well-designed untuned transformer will give constant band width and nearly constant amplification over the whole of the MW band, and could be switched for dual-wave use. With a band-pass aerial circuit, a band-pass filter between first and second RF stages, and two or three stages of untuned RF amplification using low-impedance pentodes, followed by a negative feedback anode-bend detector, a gain as high as, and a consistency of band width as good as, the best superhet could be obtained, with none of the disadvantages of the superhet. While the selectivity would not be so good as the equivalent superhet, this does not matter so much in a high-fidelity set, which, incidentally, would be able to make full use of the wider band width present with lower selectivity.

Smethwick.

B. J. BRETTELL.

## The Radio Industry

PHILCO RADIO announces that the Philco-Phone, an audio-frequency inter-room communication system, will be on the market towards the end of August.

Important extensions have been made to the Great Eastern Street premises of Brown Bros., Ltd., the well-known distributors.

The address of the Philips' Liverpool branch is now 47a-49, Tithebarn Street, Liverpool, 2.

"Sound Engineering" is the title of a useful publication (price 1s.) just issued by R. A. Rothermel, Ltd., Canterbury Road, London, N.W.6. It deals at length with the problems of commercial PA, and contains much information on piezo-electric appliances.

Telsen Electric Co. (1935), Ltd., have recently taken over the manufacture and sale of the instruments and appliances formerly made by Lystan Products, Ltd., of Lytham. An extensive range of instruments will be added to the present Lystan series, which now includes valve testers, suppressor safety plugs and adaptors.

A scheme for the insurance of cathode-ray tubes has been put into operation by Arthurs, Gray House, 150, Charing Cross Road, London, W.C.2.

# NEW VALVES—Marconi and Osram Output Tetrodes and the International Series

THE pentode was originally developed as an output valve and grew out of the earlier screen-grid tetrode. At that time the tetrode was unsatisfactory when called upon to deal with any large amount of power because the presence of the negative-resistance bends in its characteristics prevented the attainment of large power output without severe distortion. A suppressor grid was consequently introduced between the screen grid and anode to remove the effects of secondary emission and the valve became the well-known pentode.

Means have now been found of obtaining pentode-type characteristics with a tetrode construction; in other words, it is now possible to remove the bad effects of secondary emission from a tetrode without having to introduce a suppressor grid. This leads to a simpler electrode assembly and often to some improvement in performance.

Several methods of preventing the negative-resistance bends in the valve curves are known, and in the new Marconi and Osram types earthed metal plates are fitted near the anode. These assist in the formation of a cloud of electrons between screen and anode, and this cloud repels secondary electrons which may be emitted from the anode.

The first of the new valves is the KT2, which has characteristics similar to those of the well-known PT2, with which it is interchangeable. In the AC range the KT42 is the equivalent of the N42 which it replaces.

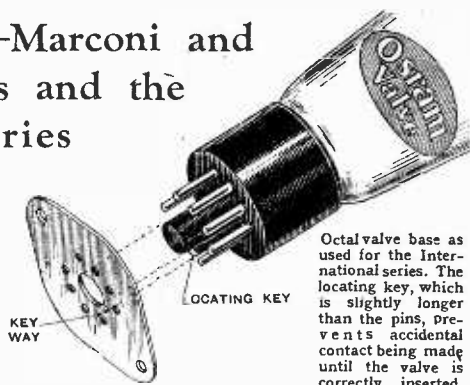

Octal valve base as used for the International series. The locating key, which is slightly longer than the pins, prevents accidental contact being made until the valve is correctly inserted.

The International Series also contains tetrodes, the KT63 and KT66. The valves in this series are fitted with the American Octal bases, and are the equivalent in characteristics of American types. With the exception of the rectifier, the heaters are all rated at 6.3 volts, and, apart from the two output tetrodes, consume 0.3 ampere. The X63, W63, and Z63 are equivalents of the 6A8G, 6K7G, and 6J7G, and no alteration other than the readjustment of trimming is needed; the H63, D63, DH63, KT63, and KT66 are equivalents of the 6F5G, 6H6G, 6Q7G, and 6L6, and may be substituted for them without alteration.

The rectifier is the U50, and is the equivalent of the 5Y3; it is of the full-wave, 500 volt, 120 mA. type, and its filament is rated at 5 volts 2 amperes. The range is completed by the Y63 cathode-ray tuning indicator.

For use in AC-DC sets, the N30/G, N31, and U30 are recommended for the output stage and rectifier. These valves consume 0.3 ampere at 13/26 volts, according to type.

## AIRCRAFT WIRELESS

### Equipment of the "Caledonia"

THE radio installation which has been fitted in the "Caledonia" and her sister ship, the "Cambria," was carried out by the Marconi Co. There are two transmitters, the first of which is for CW only and is intended for long-distance work. It covers the 16.5 to 75-metre waveband. The second transmitter operates on CW, ICW, or telephony, and is used on the 95-185-metre band for long-distance and approach work on the American side. When nearing the European side it is operated on the 500-1,000-metre band. Both transmitters are independent of each other, but operate from a common source of supply, consisting of a motor-generator driven by the aircraft accumulators. A light-weight petrol engine is carried for use if the accumulators are out of commission.

The main receiver works on 15-100 metres, 183 metres, and 600-2,000 metres, DF circuits being incorporated in the latter band. There is a second receiver provided for use as a standby, and it covers the 180-2,000-metre band. It can be used for ordinary reception or for both aural and visual DF work.

There are three aerials—a trailing one for long-distance work, a fixed aerial running along the length of the machine, and a rotatable frame. The latter enables the operator to take cross-bearings on various land and ship stations, and can be withdrawn into the hull of the machine when not in use, in order to reduce drag and so increase the speed of the boat.

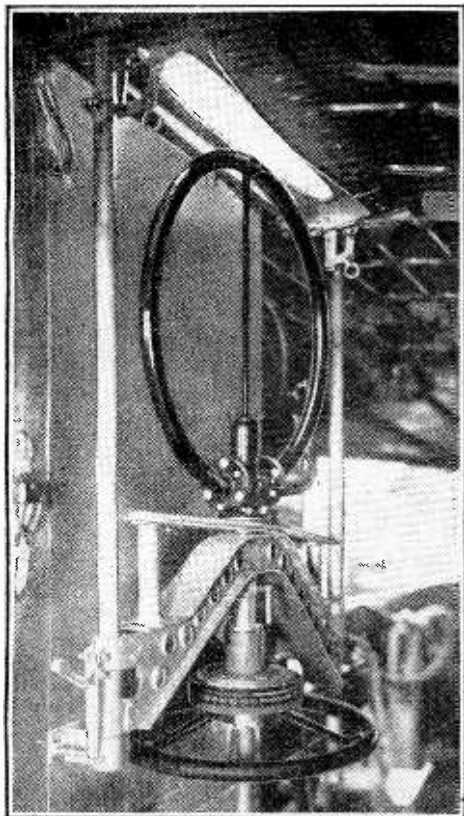

The Marconi retractable loop aerial as fitted to the "Caledonia" and similar flying boats. When not in use it is withdrawn into the hull to reduce drag.



## OUTSTANDING 9-VALVE ALL-WAVE SUPERHET For all-wave reception at its very best

To the all-wave enthusiast, this exceptional receiver offers a number of interesting features, with quite unusual range, and power output. Few receivers at present on the market can claim so high a standard of design and performance.

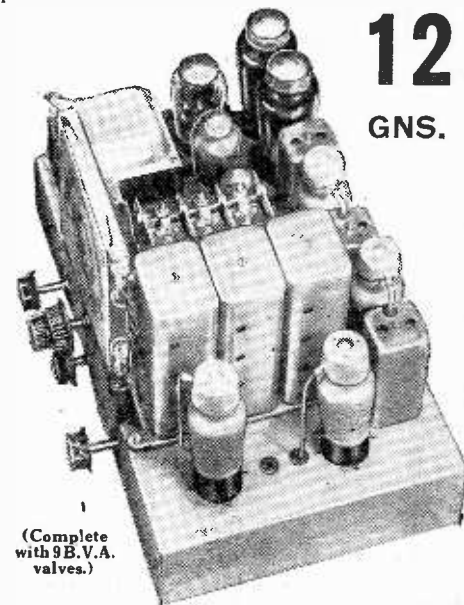

12 GNS.

(Complete with 9 E.V.A. valves.)

4 wavebands: 12.8-33, 29-80, 190-550, 800-2000 metres. Illuminated dial with principal station names. Separate coloured lights for each waveband.

**Controls.**—A feature of the receiver is the number of independent controls fitted, making it extremely interesting to operate. These include: sensitivity control (varying bias on R/F stage). Q.A.V.C. with manual muting control, and switch for inter-station noise suppression. Separate potentiometer bias controls for output valves. 5-position wave-change and gramophone switch. Progressive variable tone control operative on radio and gram.

**Circuit in Brief.**—Aerial input to pre-selector circuit radio frequency amplifier, latest type triode-hexode frequency changer, 2 band-pass I.F.T. coupled I.F. amplifiers, double diode detector, L.F. amplifier, parafeed transformer-coupled push-pull triode output giving 6 watts. Heavy cadmium-plated steel chassis. Finest components and workmanship throughout.

A.C. models ready for immediately delivery. A.C./D.C. models also in production, and will be available for delivery shortly.

DE LUXE MODEL 14 GNS. Several additional refinements—full particulars on application.

### IMPORTANT

The prices at which McCarthy Chassis are advertised include Marconi Royalties. "Wireless World" readers should, for their own protection, make sure before purchasing any receiver that the quoted price includes the Royalty payment

All McCarthy receivers supplied complete with valves, knobs, pilot lamps, leads, mains cable and plug. 12 months' guarantee.

Deferred terms on application, or through London Radio Supply Co., 11, Oat Lane, E.C.2.

Cash with order on 7 days' approval. Also write for illustrated catalogue of complete range of all McCarthy receivers.

**MCCARTHY RADIO LTD.**

44a, Westbourne Grove, London, W.2

Telephone: Bayswater 3201/2.

# An Ideal Valve Voltmeter

## METER WHICH AVOIDS MANY SHORTCOMINGS OF THE CONVENTIONAL INSTRUMENT

**W**HILE the valve voltmeter should be one of the most useful of laboratory instruments, the limited range, the necessity for expensive and fragile microammeters, and the fact that most instruments of this type have been designed for battery operation greatly limit their usefulness to experimenters and servicemen. The high-tension batteries used with such an instrument have a definite shelf life, and when used occasionally it will be found that the batteries may have run down just when most needed! Also, the use of delicate indicating instruments with the valve voltmeter places a great strain on the average experimenter. A single lapse of memory or attention with regard to the backing off voltage, or an "open" grid circuit, may result in a damaged instrument. This not only postpones the experiment but also hurts the pocket-book severely.

A recent innovation in American voltmeters is one in which all the shortcomings of the conventional instrument have been eliminated: no batteries; wide range—0.1 to 200 volts, AC and DC; and no indicating instruments (microammeters or milliammeters), greatly reducing cost of components, and upkeep!

As shown in Fig. 1, this perfect valve voltmeter employs a metal 6F5 valve ( $\mu = 100$ ;  $R_a = 65,000$  ohms—at  $E_a = 250$  volts and  $E_g = -2$  volts) which operates as a linear automatic-biased rectifier of the anode bend type. (This method of operation was named "reflex" by early English experimenters in this field.) This valve,

*AT all but audio frequencies the measurement of AC voltage demands the use of a valve voltmeter, and in many cases this instrument is also the best at quite low frequencies. In this article a simple voltmeter is described which has a wide range and does not necessitate the use of any meter.*

ence and short leads in high-frequency measurements. In most cases it should be possible to make the "hot" lead less than 1in. in length, as it is usually convenient to "hang" the valve by its grid clip. Between the grid and earth is connected a resistance of 5 to 10 megohms. The latter value will result in the absorption of less power by the voltmeter input circuit, but can only be used with gas-free valves. However, of 15 valves checked for this purpose none was affected by the use of the high resistance, proving that it should be possible to obtain satisfactory valves. Of course, it is permissible to use the voltmeter without an input resistance when no DC appears across the source of AC which it is desired to check.

### Supply Circuits

Proceeding to the power unit, a transformer and rectifier supply 300 to 350 volts at 10 to 15 milliamperes; a single-section resistance-capacity filter as shown

between cathode and earth, while the second is between anode and earth (the second filter condenser). These two condensers are essential in providing paths of low impedance across the anode and cathode resistors at low frequencies, while the 100-m-mfd. mica condensers mounted at the 6F5 socket (in parallel to the 8-mfd. electrolytic units) prove equally effective at high frequencies. Thorough test of this instrument in the Application Laboratories of the Hygrade Sylvania Corporation indicated that a calibration made at 60 c/s held for

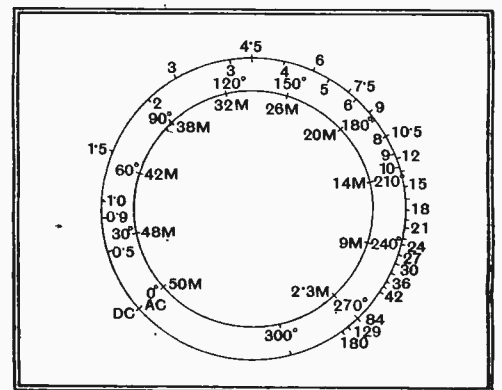

Fig. 2.—A sample calibration scale for the variable resistance  $R_2$  is shown here.

frequencies from 30 c/s to above 60 Mc/s. The high-frequency calibration was checked against a Ferris signal generator, and held to the high-frequency limit of the generator. In addition to assuring calibration free from frequency errors, the two mica by-pass condensers serve to keep high-frequency currents out of the cable, thus giving stability without resorting to a shielded cable. At this point it may be well to state that the shell of the 6F5 is also earthed.

After discussing the prod and power supplies, the calibrated resistor,  $R_2$ , and the 6E5 cathode-ray indicator must be treated.

### Direct Calibration

$R_2$  is a wire-wound potentiometer of 50,000-ohms resistance which serves as the bias resistor for the 6F5. The 6E5 grid is connected to the slider on this resistor, having applied to it a sufficient voltage to close its shadow. In operation the 6F5 input is connected across the unknown voltage. The slider on  $R_2$  is then varied until the 6E5 shadow just closes, or perhaps it may be more accurate to adjust for a "hair line" separation between the two shadow edges.  $R_2$  is equipped with a dial or scale of at least

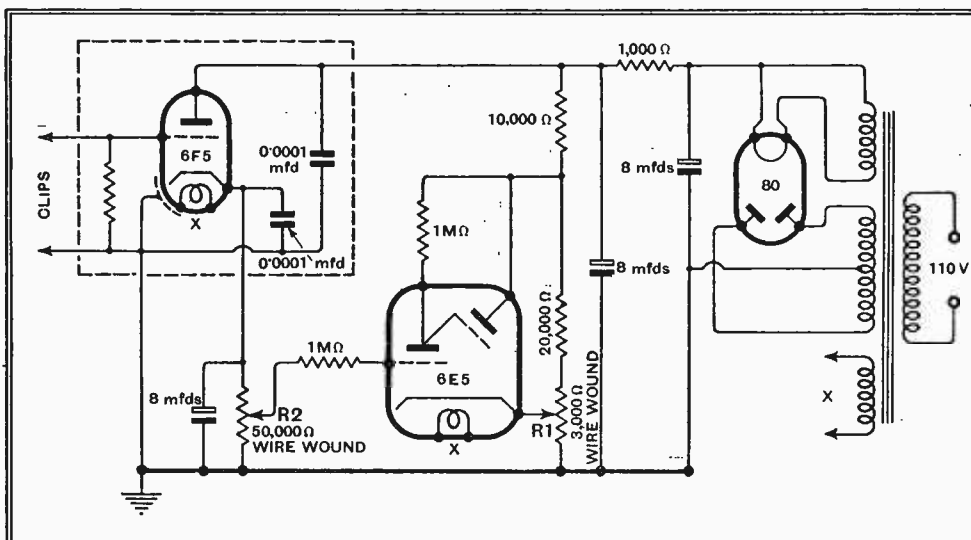

Fig. 1.—The circuit of the voltmeter is shown here. It is completely mains-operated and an inexpensive cathode-ray tuning indicator is employed instead of a milliammeter.

with two mica by-pass condensers of 100 m-mfd. capacity, is mounted on the end of a cable 18in. to 2ft. in length for conveni-

is satisfactory. It will be seen that in this unit are two additional by-pass condensers of 8 mfd. One is connected

**An Ideal Valve Voltmeter—**

6in. diameter, and is calibrated directly in voltage. Two scales are necessary—one for AC of any frequency, and one for DC. A sample scale (actual) is shown in Fig. 2. After setting R2 all that remains is the reading of the voltage impressed on the 6F5. It will be realised that the operation of this instrument leaves little to desire in simplicity or dependability.

In some cases it may be worth while to decrease the 6E5 target and plate voltage from 250 to approximately 150 volts (above earth), as this valve is more sensitive to small changes in grid voltage (greater deflection of shadow for a given grid voltage) under this condition—although the target does not glow so brilliantly at the lower voltage.

When first setting up the voltmeter for calibration, R1 is adjusted so that the 6E5 shadow just closes with no signal, and with the arm of R2 at its cathode or positive end. This control will seldom require adjustment—unless the mains voltage undergoes a marked change.

After calibration, the operation requires only the adjustment of R2 until the shadow nearly closes—an adjustment which will be found very definite and easy of duplication—at which point the voltage is read directly from the scale. It may be advisable to point out that the accuracy of the voltmeter depends in large measure on the size of the scale. Both calibration and reading are much more difficult with a small dial.

Valves have little effect on the accuracy of calibration, as 15 6F5s were substituted for the one for which the instrument was calibrated, with no readable error.

**Stability**

In a preliminary model of this voltmeter three neon lamps in series were connected (with the proper series resistance) across the high-voltage anode supply. This was done to minimise the change in calibration with shifts in mains voltage, but it was later decided to eliminate this feature in the interest of economy and simplicity. However, in locations where the mains voltage varies over a wide range, and in cases where the maximum accuracy is desired, it will be advisable to employ a neon bank, Stabilovolt, or a variable resistance in series with the transformer primary. An AC voltmeter may be connected across the transformer primary, or a low-voltage meter may be used by connecting it across a filament or heater winding.

Where a DC voltage is superimposed on the unknown AC voltage, a blocking condenser of 0.01 mfd. may be connected between the 6F5 grid and the high side of the voltage to be measured.

This meter was developed by Mr. George C. Connor, New York sales engineer for the Hygrade Sylvania Corporation, makers of Sylvania valves. In addition to checks by the Sylvania laboratories, a number of these instruments were built by servicemen, and are giving satisfactory performance.

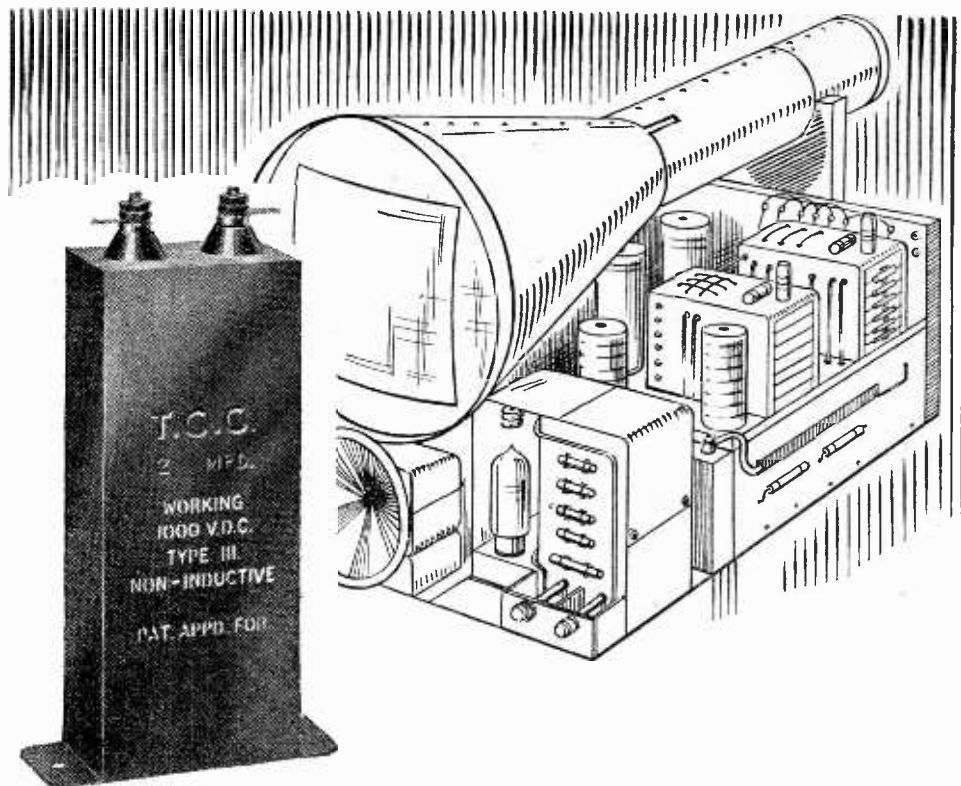

... for the **HIGHER VOLTAGES**

**LONGER LIFE**  
**NO "CREEPING"**

Television and 'Quality Output' gear call for voltages much in excess of those previously encountered... Again T.C.C. provide the right condensers for these exacting demands, with

**SAFER AGAINST**  
**BREAKDOWN**  
**NO FREE LIQUID**

**PETROLEUM JELLY-IMPREGNATED PAPER CONDENSERS**

**NO LEAKAGE**  
**SMALL SIZE**

Built on entirely new principles they are specially designed for Television, etc. They work up to 2,500 V.D.C. Jelly-impregnated, there is **NO FREE LIQUID**—thus having all the advantages of oil but without risk of leakage or "creeping." Wherever high voltages and high **temperatures** are involved—play for safety—and use these "specialist-built" condensers.

**TEMPERATURES**  
**UP TO 140 F.**  
**PERMISSIBLE**

Capacity	Type 111 1,000 V.D.C. Working		Type 121B 1,500 V.D.C. Working		Type 131 2,000 V.D.C. Working		Type 141B 2,500 V.D.C. Working		<b>FOR STILL HIGHER VOLTAGES</b> the following types are available in all capacities, prices on application.  Type 161/C 3,000 v. D.C. working " 171 4,000 v. " " 191 5,000 v. " " 201/C 6,000 v. " " 221/C 7,500 v. "
	s.	d.	s.	d.	s.	d.	s.	d.	
0.1	3	6	4	3	5	0	10	0	
0.25	4	0	6	3	7	6	11	6	
0.5	4	6	6	9	8	0	14	0	
1	6	0	8	6	10	0	20	0	
2	8	3	12	0	15	0	35	0	
4	14	6	18	6	21	0	60	0	
5	18	0	24	0	—	—	—	—	
6	21	0	29	6	33	0	94	0	
8	32	0	39	0	43	0	115	0	
10	40	0	48	0	54	0	150	0	

**T.C.C.**  
**ALL-BRITISH**  
**CONDENSERS**

The Telegraph Condenser Co., Ltd.,  
Wales Farm Road, N. Acton, W.3.

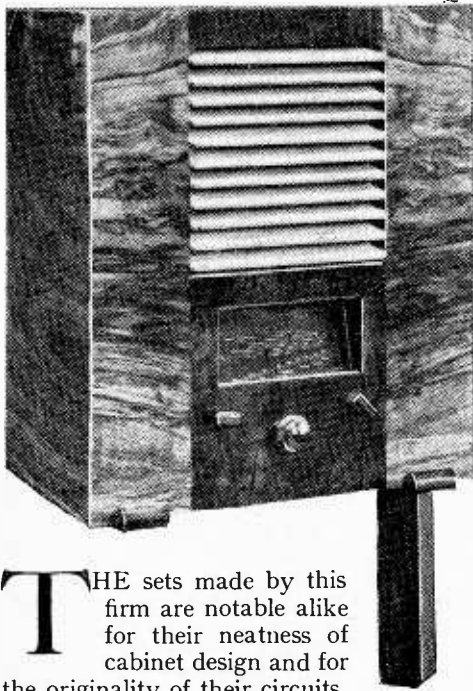

# Imperial

MODEL AD45

## A SELF-CONTAINED FIRESIDE RECEIVER FOR AC OR DC MAINS



**T**HE sets made by this firm are notable alike for their neatness of cabinet design and for the originality of their circuits. In many ways the AD45 may be regarded as a grown-up mains version of the Model P23 "Baby" battery transportable reviewed in our issue of December 18th, 1936. It has the same style of cabinet, with louvred loud speaker fret, and the circuit is reflexed.

Separate frame aerials are used for medium and long waves, and the signal is first amplified at radio frequency by a pentode amplifier with tuned grid coupling to the octode frequency changer which follows. The usual IF transformer is connected in the anode circuit of this valve, both primary and secondary being tuned. No IF amplifier valve is, however, employed, but increased sensitivity is obtained by reaction from the second detector stage.

The valve employed for this purpose is a triode in which the grid functions as a

diode anode. The plate of the valve is supplied with HT from a potentiometer through a decoupling resistance, and is tied to earth as far as RF currents are concerned by a suitable by-pass condenser. An electron coupling circuit is thus formed, giving regeneration additional to that provided by the cathode coupling coil and providing a sensitive control. In the earth return circuit of the IF transformer secondary there is the usual diode load resistance across which are developed the AVC and rectified AF volts.

AVC is supplied to both the frequency-changer and the RF amplifier, but the constants of the filtering circuits differ so that the AF output is applied only to the grid of the first valve in the circuit. After amplification by this stage the AF voltage

**FEATURES.** *Type.*—Self-contained transportable for AC or DC mains. *Circuit.*—Var.-mu pentode RF/AF amplifier—heptode frequency-changer—triode second detector with reaction—pentode output valve. *Half-wave valve rectifier.* *Controls.*—(1) Tuning. (2) Wavrange. (3) Volume and on-off switch. (4) Tone. (5) Sensitivity (IF reaction). *Price.*—12½ guineas. *Stand* 31s. 6d. extra. *Makers.*—Betterset Radio Ltd., Clarendon Works, Montague Street, Worthing.

is passed to the grid of the pentode output valve through a resistance-capacity coupling circuit. Beyond this point the circuit follows conventional practice with a variable tone control across the primary of the output transformer and the usual diode rectifier and smoothing circuit for the HT supply.

As in the case of the "Baby" battery portable, the chassis unit carries also the loud speaker and the frame aerials. These are mounted parallel to the sides of the cabinet and at right angles to their more usual position so that with the mass of the loud speaker further removed from the field of the coils an appreciable improvement in circuit efficiency is to be expected.

The set is entirely self-contained, and measures 15in. × 19in. × 11in. When used in conjunction with the special stand which has been designed for it, it makes an admirable fireside receiver for easy operation from the comfort of an armchair. The three principal controls of tuning, wavrange, and volume are the only ones

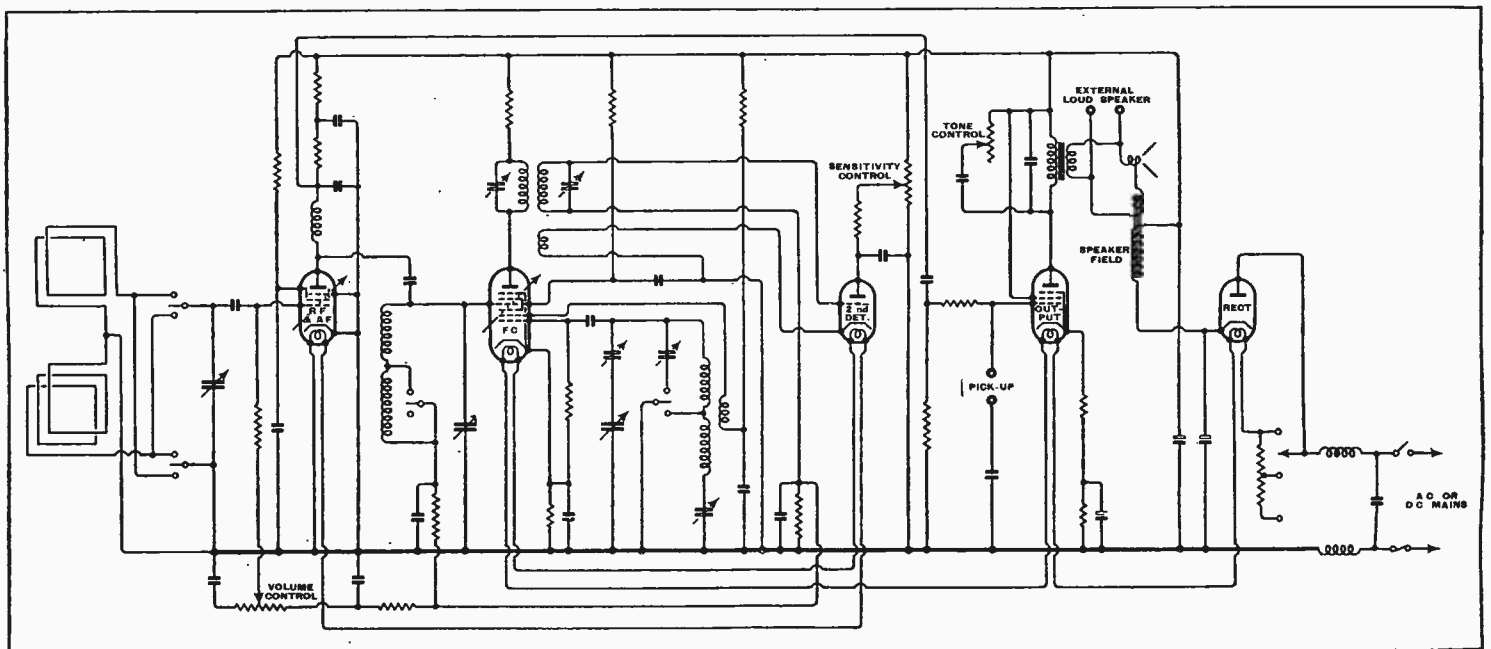

A reflexed input stage and a triode second detector arranged to give diode rectification with reaction, are unusual features of the superheterodyne circuit.

**Imperial Model AD45—**

accessible from the front of the cabinet. A neat rectangular tuning scale carries station names arranged on diagonal lines, and the shadow of the tuning point is

useful programme value in daylight. On the South Coast, of course, all these stations would rank automatically as first selection stations.

The directional properties of the frame

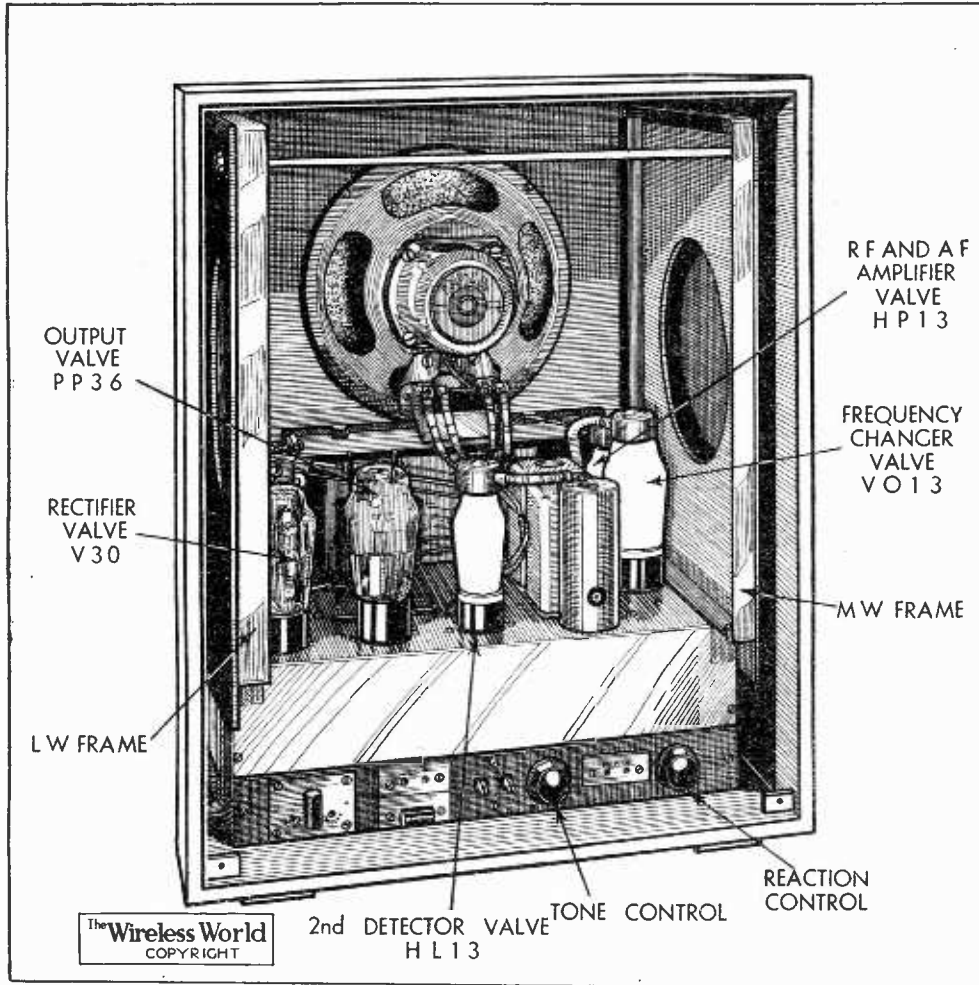

Loud speaker, frame aeriels and chassis form a self-contained unit easily removed from the cabinet.

thrown on to the scale by a pilot light which travels with the pointer.

At the back of the set there are two controls, one for reaction on the IF transformer, which need only be used when pushing the set to its limits on distant stations, and the other a tone control, which, when adjusted to the taste of the listener's requirements, needs no further attention.

Excellent results as regards quality of reproduction were obtained with the tone control anywhere from the half-way mark to the position of greatest high-note response. There is plenty of real bass response unmarred by cabinet resonances, and tone in general is of a type which in a violin would be described as free playing. The volume can be increased well above the level normally required from a set of this type without any suggestion of overloading, and the input to the last stage from the principal continental broadcasts such as Fécamp, Luxembourg, and Radio-Paris is more than adequate to give the full output of which the set is capable. Stations such as Hilversum on the long waves and Cologne on the medium waves required some help from the sensitivity control before they could be regarded as of

aerial, due to the efficient AVC, are not very marked, so that help from this property cannot be relied upon as an aid to selectivity. On the other hand, it is gratifying to know that one need not necessarily orientate the set every time a fresh station is received, although a turntable is provided for this purpose. On long waves comfortable separation was possible between Radio-Paris and Droitwich, and on the medium waveband between two and three channels were lost on either side of the London Regional transmitter when using the set in Central London.

Without the advantage of the high signal-to-noise ratio which an outdoor aerial gives one generally expects to find a comparatively high level of background noise and switch clicks entering through the mains leads; but it will be seen from the circuit that filtering chokes have been included in both mains leads, and it is safe to say that the set is as quiet as this type of receiver can be made.

Provision is made for the attachment of a gramophone pick-up, but as the input is made directly to the grid of the output stage the high voltage output from a crystal type pick-up would seem to be called for.

**NOTABLE  
FEATURES  
of the New  
ROLA F 742-PM**

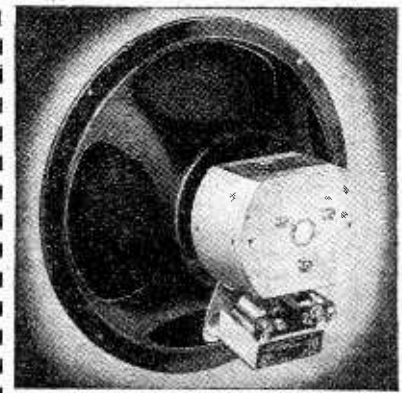

**FLUX DENSITY  
EQUALS THE  
ROLA G.12-PM**

Comparison between this 9 3/4" diameter speaker selling at 49/6 and the giant Rola G.12-PM may at first sight appear rather preposterous. Yet when space and price are serious considerations this new Rola unit is the ideal substitute for its famous companion. Like the G.12-PM it possesses a flux density of 11,500 lines per square centimetre. It is super sensitive and therefore ideal for Battery set and Extension speaker use. Special features include the use of a new magnet material 'Alnico' and a moisture proof transformer, metal and compound shielded. No better value in reproducers is obtainable to-day. Please write for full particulars.

*Model*  
**F 742-PM** 49/6

WITHOUT TRANSFORMER 42/-  
**OVER 8 MILLION IN USE**

**ROLA**

*The World's Finest Reproducers*

**THE BRITISH ROLA CO., LTD.**  
MINERVA ROAD, PARK ROYAL, N.W.10.  
PHONE: WILLESDEN 4322-3-4-5-6.

# Recent Inventions

**Brief descriptions of the more interesting radio devices and improvements issued as patents will be included in this section.**

## SCREENING POTS

THE action of the ordinary metal case, used to screen, say, a high-frequency coil, is due to the fact that primary currents in the coil induce eddy currents in the metal screen. The eddy currents, by the laws of induction, have such a direction that they oppose the passage of those lines of force which tend to spread outwards from the coil.

But, in addition, the coil induces other Foucault currents in the screen which tend to flow in a circular path around the metal in a plane at right-angles to the axis of the HF coil. These have an undesirable damping effect, and tend to increase the inherent capacity of the coil.

In order to suppress them, the screening pot is divided longitudinally by a slit, the edges of which are "seamed" together around a suitable insulating material so that the circular path of the undesired currents is broken.

G. Fodor; J. Toutain; and M. Bloch. Convention date (France) October 17th, 1935. No. 463676.

## SHORT-WAVE OSCILLATORS

INSTEAD of using ordinary Lecher-wires to take the output from a short-wave valve of the magnetron type, the tuned circuit consists of an outer tube R and an inner conductor C forming a concentric "transmission line." The two ends of the outer tube R are cut away as shown, and enclosed inside a glass vessel V to form the usual "split" anode of this type of oscillator. The filament F is mounted between the two inner conductors C.

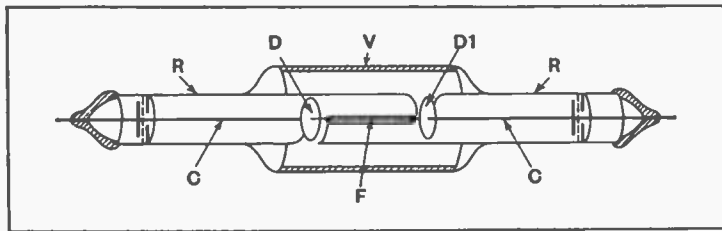

Constructional details of ultra-short wave magnetron valve.

The arrangement allows the impedance of the resonant circuit to be more accurately matched with that of the valve, whilst the uniformly distributed capacity of the concentric arrangement is not disturbed by the valve electrodes. Discs D, D1 collect the electrons, as they move axially under the external magnetic field applied to the valve.

Telefunken Ges. fur drahtlose Telegraphie M.b.H. Convention date (Germany) August 15th, 1935. No. 463236.

## ELECTRON MULTIPLIERS

TWO photo-sensitive cathodes C, C1 are set opposite each other, rather like the two halves of an open cylinder. They are both perforated and coated with a layer of caesium on silver. Outside them are mounted two "collector" electrodes B, B1 connected to leads L, L1, whilst in the centre of the bulb is a spiral-wire anode A carrying a high positive voltage.

When light strikes against one or other of the sensitised cathodes, the electrons set free are accelerated towards the central anode. Some of them pass through to the opposite cathode, where they produce other electrons by secondary emission. If we suppose the cathodes to be solid plates, instead

coated with a metallic layer deposited, say, from a colloidal suspension of gold in lavender oil, upon which a sensitive layer of zinc selenide is applied by spraying or by being allowed to settle from a suspension in liquid.

When the tube is in operation an electrode which collects the electrons emitted from the screen is given a positive bias of from 5 to 10 volts. This is stated to increase the sensitivity of the screen and to reduce any lag in response. It also avoids the so-called "tilting" effect, which is usually manifested in the picture by a gradually increasing brightness along a scanning line which should be of uniform illumination.

H. Miller. Application date, September 24th, 1935. No. 463297.

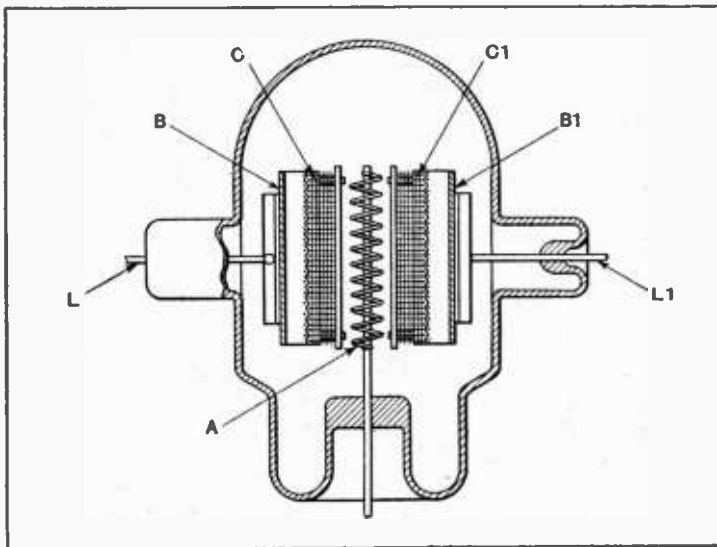

Arrangement of the elements in the electron multiplier described in Patent No. 463514.

of being perforated, the electrons would surge to and fro between them. But because of the perforations, a certain proportion of the electrons pass through on to the collectors B, B1. If the latter are

## TIME-BASE CIRCUITS

A GENERATOR of saw-toothed oscillations, used for scanning in television, consists of a screen-grid valve with its anode-cathode circuit back-coupled to the grid. A condenser C in the grid circuit is connected through a resistance R to a source of say 240 volts. The grid current first charges up the condenser to "block" the valve, and then the charge leaks away through the resistance R. This creates a rectilinear or saw-toothed voltage across the condenser plates, which is drawn off at the terminals T and used for scanning. Synchronising impulses are applied at S to "trigger" the valve, and are effective even though of very small amplitude.

Another series of square-topped negative pulses are simultaneously produced in the screen-grid circuit, and are tapped off at S and used to suppress the cathode-ray beam

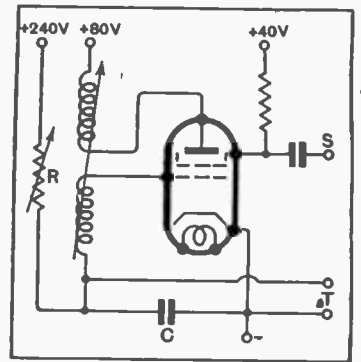

Method of generating saw-toothed oscillations for scanning in television apparatus.

during the so-called "fly-back" period of scanning.

Marconi's Wireless Telegraph Co., Ltd. and G. B. Banks. Application date August 2nd, 1935. No. 463625.

## "DIELECTRIC" GUIDE LINES

CENTIMETRE waves are fed into a "dielectric guide" which may consist of a rod of fused quartz, or of a rod of some other dielectric sheathed in copper, or of a hollow conductor enclosing a core of air. The waves travel through the dielectric as "displacement" currents, there being no return circuit in the ordinary sense of the term. The energy is strictly localised inside the guide line and does not set up any external field, providing the diameter of the "guide" is properly related to the wavelength it is called upon to handle.

The invention is particularly concerned with a guide line of this character in which one or more partitions are provided to keep each of a number of separate frequencies distinct from the rest, so that the line can be used for multiplex working.

Standard Telephones and Cables, Ltd. (assignees of S. A. Schelkunoff). Convention date (U.S.A.) December 31st, 1935. (Addition to Patent No. 420447). No. 464185.

## WIRELESS FOR MOTOR CARS

TO prevent radiation from the ignition system of a motor car, such as is likely to cause interference to wireless reception, it has already been proposed to insert suppressor resistances of the Spaghetti type between the sparking plugs and their leads.

According to the invention these are replaced by a flexible core of pure silk which has been coated or impregnated with graphite to the degree necessary to provide a resistance of the required value. The prepared core is then enclosed in an outer rubber covering. The result is a stable "suppressor" of constant resistance, having considerable flexibility and tensile strength.

F. R. F. Ramsay. Application date October 10th, 1935. No. 464278.

## PHOTO-SENSITIVE SCREENS

THE photo-electric screen of a cathode-ray television transmitter consists of a sheet of mica

The British abstracts published here are prepared with the permission of the Controller of H.M. Stationery Office, from Specifications obtainable at the Patent Office, 25, Southampton Buildings, London, W.C.2, price 1/- each. A selection of patents issued in U.S.A. is also included.



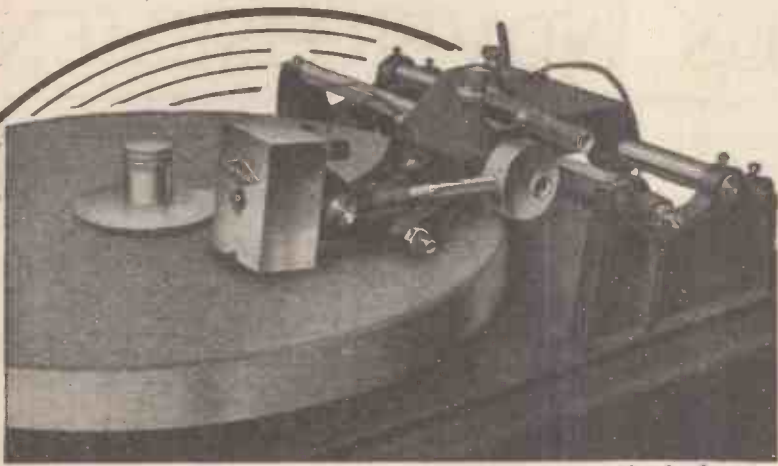

# RECORDING EQUIPMENT built by



**T**HIS "Parmeko" model gives you the quickest, most satisfactory and least costly sound record that it is possible to produce. The model is used for all sound on disc recording where first class results are required and when it is necessary to obtain an immediate play back.

The "Parmeko" is being used by Broadcast Stations, Film Studios and Private Record Studios all over the world—it is named by users "the incomparable Parmeko."

FOR FULL PARTICULARS AND PRICES PLEASE GET IN TOUCH WITH—PARMEKO LIMITED, Percy Road, Aylestone Park, LEICESTER

FOR P.A. AT ITS BEST  
**GRAMPIAN**  
 GRAMPIAN REPRODUCERS LTD.  
 Kew Gardens, Surrey.

## DICTIONARY of WIRELESS TECHNICAL TERMS

Compiled by S. O. PEARSON, B.Sc., A.M.I.E.E. and issued in conjunction with "THE WIRELESS WORLD"

Second Edition. Completely revised and brought up to date

This handy volume is very much more than a Dictionary. It not only takes the technical terms of wireless and explains their meaning, but in doing so it concentrates into a small space a large amount of information on wireless subjects. It has become, in fact, a compendium of wireless knowledge, and an invaluable handbook for all who are interested in wireless transmission and reception. Diagrams and illustrations are freely interspersed throughout the book to amplify the explanations of the text.

272 pp., bound in cloth boards  
 Size 5 by 3 inches

Price 2/- net. By post 2/2

From all leading booksellers or direct from Publishers.

ILIFFE & SONS LTD.  
 Dorset House, Stamford Street, London, S.E.1

W.W.48

# CLIX

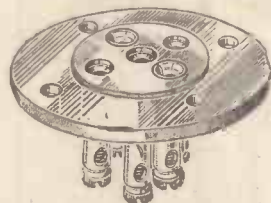

Specified for the TELEVISION RECEIVER

**21 Clix Valveholders are specified** and for the High Voltage Unit and Sound Receiver Pack described in this issue you need the following:—

- 4 Type V.I. 4-pin 5d. each
- 1 Type V.I. 5-pin 6d. each (without terminals as specified).

**For the Time Base described last week you require 6 Type V.I. 5-pin at 6d. each fitted with plate as used in Type V.2.**



A.1., A.2 & E...7d.

This Clix Strip and 10 other Clix Valveholders are specified for the Vlsion Receiver and Power Pack.

# CLIX

BRITISH MECHANICAL PRODUCTIONS LTD.  
 79a, ROCHESTER ROW, LONDON, S.W.1

## ELECTRADIX BARGAINS

H.M.V. MAINS TRANSFORMERS, 100/250 v. to 700 C.T. 60 m/a. 4 v. 1 a. 4 v. 2 a., 10 G. 30 Hy. Chokes, 50 m/a., 4/-, 1 amp. Chokes, 10/-.

POCKET HEADPHONES, W.D., all leather headband, strap and cord, 2/6 pair. Wireless type with aluminum headbands, 2/9. Portable valve set kits assembled in suitcase, partly wired, speaker, aerial, and all parts, less valves, 21/-. Metal Rectifiers, chassis type, 180 v. 30 m/a. output, 5/-. Lightning Arrestors—make serials safe in summer storms, 1/- ea.

VALVE BARGAINS. Mains Universal 7-pin Freq. Converter, 4/6. A.C. ditto, 4/6. Universal H.F. 7-pin Pentode, 4/6. Power Valves: Ediswan VT13B 30-watt, Ph. 6 v., 1,500 v., Mag. 35, under half price, 22/6. T50 25 valves, 7 v., Ph. 1,500 v., P. Mag. 30, 22/6. AT40, 10 watt, 6 v., Ph. 4/-.

H.T. Rectifiers up to 10,000 v. N12, 5 v. Fil., 250 watts, 35/-. 100 watt T2A, 40/-. Half-wave W.D. Rectifier, 200/1,000 v. 50 m/a., 2/6.

SPEAKER BARGAINS in high grade M.C. Speakers. All offered at less than half price. Finest quality reproduction.

D.C. ENERGISED 9" Celestion M.C. 2,500 ohm field, speech trans., as new, 7/6. R. & A. 8" 2,500 ohms, "wired trans.", 7/-. Magnavox 6" No. 144, 2,500 ohms, 12/6.

A.C. SPEAKERS with rectifier, 100/250 v., 11" dia. with trans., 25/-. Jensen, 220 v., 7" dia. and trans., 22/6. 100 volt ditta, 7" 18/6. 100 v., 8" dia. with trans., 19/-. BATTERY SPEAKERS, Brown 6/12 volts 11" dia., 14/6.

P.M. SPEAKERS, Sonochorde Class B with trans., 20/-. P.M. in Cabinets: Hyra, Oak, 12x12, 25/-. Heavy Duty 5/8 watt with trans., 38/-. A.C. Rect. Speaker, 200/250, 5 watts with trans., 60/-. Small Cone Speakers for extension: Siemens magnet table, 6/-. H.M.V. Cone Units 2/6. Brown's plain, 12" cones, 1/-.

PUBLIC ADDRESS SPEAKERS, M.C. Horn Unit, large, 8 ohms 10 watts, 27. Trix 5 watts, 28/10/-. Trix, large, 10 watts, 27/10/-. Brown's Unit, for horn, 7 watts, 50/-. M.C. Vitavox 6 v. Units, 15 watt size, 30/-. Brown's Horn Speaker, 36" 70/-. P.M. Horn Speaker, 10 watts, 28. Short Horn P.M. 5 watt Speaker, 70/-. Brown's Cabinet 7 watt Speaker, 24. Siemens Giant Grille Speaker, 25/-. COILS, 8/W Coils, plug-in, 1/6 ea. L.W. 2-pin, 1/- Reaction, various, 9d. Philips Superhet, set of three in carton, 3/-. Cosor 3- and 4-pin Coils, 1/-. Interference cutting H.F. Twin Chokes, 2/-. Spark Transmitter shortwave sets (or model boat remote control), 17/-. CONDENSERS. Variable lowloss F type, 0005, 1/9. J.B. 0003, 2/- Reaction varia., 1/3. Eye 0003 with S.M. dial, 5/-. 2-rang varia., all aluminium, 3/- only. Fixed Condensers, 2 mfd. 250 v., 10d., or 6 for 4/-, 4,000 v. 1 mfd., 6/-. etc. FRACTIONAL H.P. MOTORS.—300 in stock. A.C. and D.C., 1/50 h.p. to 1 h.p., 6 v. to 230 v. A.C. or D.C. from 12/6. CRYSTAL SETS. Are great fun. No battery or valves wanted. Quiet and efficient reception. 500 shop-sold sets cheap. Enclosed type, 5/6 and 7/6 each. Headphones, 4/6 pair. AN A.C. PLUS-A-GRAM PEDESTAL, sliding motor turntable and pick-up with record cabinet under. As new, 24. SOUND RECORDING at home on your own gram. with 4d. discs. The FEIGE centre gear record costs 37/6 still. MICROPHONE PICK-UPS. Brown's Microbox Tone Arm with button mike reproducer, 10/6. DRILLS FOR CONSTRUCTORS. Hand geared drills to 1", 1/3. Ceramic S/W lead-in, brass stem, 8d. 3" stand-off insulators, 6d. PARCELS of experimental odd balls, magnets, wire, chokes, condensers, switches, terminals, etc., post free, 10 lbs., 7/-; 7 lbs., 5/-. 1,000 other Bargains in large Illustrated Sale List "W."



## ELECTRADIX RADIOS

218, UPPER THAMES STREET, LONDON, E.C.4  
 Telephone: Central 4611

Mention of "The Wireless World," when writing to advertisers, will ensure prompt attention.

# MISCELLANEOUS ADVERTISEMENTS

## NOTICES

THE CHARGE FOR ADVERTISEMENTS in these columns is

12 words or less, 3/- and 3d. for every additional word.

Each paragraph is charged separately and name and address must be counted.

SERIES DISCOUNTS are allowed to Trade Advertisers as follows on orders for consecutive insertions, provided a contract is placed in advance, and in the absence of fresh instructions the entire "copy" is repeated from the previous issue: 13 consecutive insertions 5%; 26 consecutive, 10%; 52 consecutive, 15%.

ADVERTISEMENTS for these columns are accepted up to FIRST POST on MONDAY MORNING (previous to date of issue) at the Head Offices of "The Wireless World," Dorset House, Stamford Street, London, S.E.1, or on SATURDAY MORNING at the Branch Offices, 19, Hertford Street, Coventry; Guildhall Buildings, Navigation Street, Birmingham, 2; 260, Deansgate, Manchester, 3; 26a, Renfield Street, Glasgow, C.2.

Advertisements that arrive too late for a particular issue will automatically be inserted in the following issue unless accompanied by instructions to the contrary. All advertisements in this section must be strictly prepaid.

The proprietors retain the right to refuse or withdraw advertisements at their discretion.

Postal Orders and Cheques sent in payment for advertisements should be made payable to **ILLIFFE & SONS Ltd.**, and crossed **& Co.** Notes being untraceable if lost in transit should not be sent as remittances.

All letters relating to advertisements should quote the number which is printed at the end of each advertisement and the date of the issue in which it appeared.

The proprietors are not responsible for clerical or printers' errors, although every care is taken to avoid mistakes.

## NEW RECEIVERS AND AMPLIFIERS

**DEGALLIERS, Ltd.**—Still we grow. Note new address below.

**DEGALLIERS, Ltd.**, the firm for reliable short-wave radio, have on show in London without exception the largest selection of fully guaranteed brand new all-wave receivers; callers invited to handle these at their leisure without obligation to purchase; all S.W. receivers will get stations on the low bands, including the Americas; let us demonstrate to you; if you live out of town we have satisfied customers in nearly every part of the country, who would probably let you hear these sets in their own homes. Terms, cash with order or c.o.d.; handsomely illustrated catalogues forwarded on receipt of large stamped addressed envelope or 2½d. stamp; our lists give the fullest technical data, with all measurements; each set is complete in cabinet ready to plug in; chassis quoted separately.

NOTE.—Marconi royalties are already paid on all Challenger Receivers.

5/- Each, American valves, all guaranteed, each a first, no seconds or throwouts, for every known set from 1927-37; metal, metal glass, glass; glass counter-parts, etc.; in ordering just state type and number, we have it; line cords for all Midgets, 4/6 each.

£3/5.—Midget T.R.F. 4-valve A.C.-D.C., 200-250 volts, in leather cloth or walnut.

£4.—Midget T.R.F. 5-valve, M. and L. wave, 100-250 volts, A.C.-D.C., calibrated in station names.

7 Gns.—Table model 6-valve all-wave superhet, A.C.-D.C., 200-250 volts, 16½-50, 200-550, 800-2,000 metres, 8in. M.C. speaker, calibrated in station names.

£9/9.—7-valve all-wave superhet, 3 bands, 15-2,100 metres, multi-coloured oval dial, cathode ray magic eye, Octal valves, 21in. long, 10¼in. deep, 12in. high, A.C. 200-250 volts; carriage 5/-; also available in 8-valve for A.C.-D.C. 100-250 volts at 9½gns.

CHALLENGER Series Model 800 8-valve High Fidelity Receivers, A.C. 200-250 volts, 4 distinct bands, 11-32, 27-64, 190-550, 900-2,000 metres, calibrated in metres and station names; available in the following types:

13 Gns.—Challenger 800 table model De Luxe, 10in. M.C. speaker.

£12/18.—800 chassis, valves and 10in. speaker, with all escutcheons, etc.

£14/18.—800 chassis, valves, and Rola G12 high fidelity P.A. speaker.

17 Gns.—Challenger 800 console, 42x12½x24, with G.12 speaker.

29 Gns.—Challenger 800 radiogram, with automatic changer, also incorporating the G.12 speaker.

14 Gns.—Challenger 381 table model 8-valve high fidelity receiver, 14-2,060 metres, polychromatic dial scale vision master, beam power output, magic eye, automatic band indicator, high image frequency suppression, magn. dial and second hand; or less cabinet £13/18.

OTHER Receivers in Stock Too Numerous to Mention, such as Belmont, Ferguson, etc.

(This advertisement continued in third column.)



## ABOUT THE M.A.

(Continued.)

### REMOVING WHISTLES

With a high-note response such as ours, heterodyne-whistles become an annoyance. So our "Balance Filter" type of whistle-rejector is built into the M.A. set. It gives a "cut" of over 50 dB on a whistle without perceptible loss of programme.

### TONE CORRECTION

This gives a true "tilt" to the response-curve. Provided mainly to compensate for the effect of the tuned circuits, it may also be used to modify the response to suit the acoustics of the room.

## HARTLEY TURNER RADIO LTD.,

THORNBURY ROAD, ISLEWORTH, MIDDLESEX.

Telephone: HOUnslow 4488

## GALPINS ELECTRICAL STORES

TELE: 75, LEE HIGH RD., LEE GREEN 5240. TERMS CASH WITH ORDER OR C.O.D.

All goods sent on 3-days approval against cash.

CAR RADIO Generators, 12 V. input, 200V., 40 M/A output, 2 H.T. tappings, complete in case with full smoothing equipment, new and unused, price 42/6.

TRANSFORMER, 2½ KILOWATT, 100/120 V. to 200/250 V. Step up or down, 50 cycle single phase. Guaranteed, £3-10-0.

SLIDER RESISTANCE, high grade, 21 in. by 3 in. by 3 in., resistance 10 ohms to carry 15 amps., price 35/-.

A.E. MOTOR, 2½ H.P., with starter induction, 200/220 V., 50 cycles, 1 P.H. £7-10-0.

PLEASE see advertisement in issue of 'Wireless World,' dated July 2nd, for other bargains.

## ENGINEERS! ARE YOU EARNING LESS THAN £10 PER WEEK?

If so, you cannot afford to carry on without reading our 268-page Handbook. The book explains clearly and definitely many ways of carving out a successful career. Among other things, it explains the Services of our unique Appointments Department; outlines Home-Study Courses in all branches of Civil, Mechanical, Electrical, Motor, Aero, Wireless, "Talkie," Engineering, Building, Govt. Employment, etc., and gives details of B.Sc., A.M.I.C.E., A.M.I.E.E., A.M.I.Mech.E., A.M.I.A.E., A.M.I.W.T., A.M.I.R.E., G.P.O., M.A.T.R.I.C., and all Exams. We Guarantee "NO PASS—NO FEE." Whether you be an old hand or a budding apprentice, get this book to-day—FREE and POST FREE.

BRITISH INSTITUTE OF ENGINEERING TECHNOLOGY  
387 Shakespeare House, 17/19, Stratford Place, London, W.1.

## NUMBERED ADDRESSES

For the convenience of private advertisers, letters may be addressed to numbers at "The Wireless World" Office. When this is desired, the sum of 6d. to defray the cost of registration and to cover postage on replies must be added to the advertisement charge, which must include the words Box 000, c/o "The Wireless World." All replies should be addressed to the Box number shown in the advertisement, c/o "The Wireless World," Dorset House, Stamford Street, London, S.E.1. Readers who reply to Box No. advertisements are warned against sending remittance through the post except in registered envelopes: in all such cases the use of the Deposit System is recommended, and the envelope should be clearly marked "Deposit Department."

## DEPOSIT SYSTEM

Readers who hesitate to send money to advertisers in these columns may deal in perfect safety by availing themselves of our Deposit System. If the money be deposited with "The Wireless World," both parties are advised of its receipt.

The time allowed for decision is three days, counting from receipt of goods, after which period, if buyer decides not to retain goods, they must be returned to sender. If a sale is effected, buyer instructs us to remit amount to seller, but if not, seller instructs us to return amount to depositor. Carriage is paid by the buyer, but in the event of no sale, and subject to there being no different arrangement between buyer and seller, each pays carriage one way. The seller takes the risk of loss or damage in transit, for which we take no responsibility. For all transactions up to £10, a deposit fee of 1/- is charged; on transactions over £10 and under £50, the fee is 2/6; over £50, 5/-. All deposit matters are dealt with at Dorset House, Stamford Street, London, S.E.1, and cheques and money orders should be made payable to Illiffe & Sons Limited.

SPECIAL NOTE.—Readers who reply to advertisements and receive no answer to their enquiries are requested to regard the silence as an indication that the goods advertised have already been disposed of. Advertisers often receive so many enquiries that it is quite impossible to reply to each one by post. When sending remittances direct to an advertiser, stamp for return should also be included for use in the event of the application proving unsuccessful.

## NEW RECEIVERS AND AMPLIFIERS

(This advertisement continued from first column.)

NEAREST Stations "Underground" Lancaster Gate, Edgware Rd., and Praed St. Buses passing within 100 yds.: 6, 7, 8, 15, 16, 36, 60, 92, 291, 294, 12, 17, 32, 88, 136, 27a. Map enclosed with all applications for catalogues showing all routes and main line stations.

SPECIAL Summer Offer, available until the 15th September only.—To enable out-of-town patrons to visit us, on purchasing goods at 13gns. or over, we will pay up to 20/- towards the fare or petrol used on production of the railway ticket or garage account. To mail order customers ordering through the post, who are unable to get to London during this period, we will include with each order a set of replacement valves gratis.

DEGALLIER'S, Ltd., 32, Bathurst Mews, Paddington, London, W.2. Telephones: Paddington 2745 and Bayswater 5732. [4584]

ALERT RADIO Co.

"COMMUNICATION," "Shortwave" and "Allwave" Receivers.—21, East Rd., N.1. Clerkenwell 4871. [4381]

"SERVICE with a Smile."

HENRY FORD RADIO, Ltd.

ELECTRONIC House, 22, Howland St., Tottenham Court Rd., W.1. Museum 5675. [0511]

ROYAL RADIO Co., 5, Buckingham Rd., E.18.—Send for catalogue of all the latest short wave receivers and car radio. [4741]

TRANS-ATLANTIC RADIO Co. for Finest All-wave Receivers, Midgets and valves.—15, Percy St., W.1. Museum 3096. [4623]

HILL and PONDER Offer Brand New Crosley Receivers Under Fullest Comprehensive Guarantee at approx. 70% Below List Price; list available; terms, cash with order or c.o.d.; carriage extra.

10 Gns.—"Crosley" high fidelity 9-valve superhet chassis, 12-2,000 metres, Airplane dial calibrated in metres, 10 watts undistorted, Neon tuning device, etc., or with Rola G12 High Fidelity speaker add 20/-; also available in cabinets; table, £12; console, 14 gns.; radiogram with automatic changer, £24.

HILL and PONDER, 9, Lancaster Mews, London, W.2. [4713]

ARMSTRONG COMPANY, Pioneer Firm supplying high grade all-British receivers in chassis form, manufacture models to suit all requirements, incorporating all the latest improvements.

ARMSTRONG COMPANY Invite You to Send for Full Particulars.

ARMSTRONG MANUFACTURING COMPANY, 100, King's Rd., Camden Town, N.W.1. [4615]

COMMUNICATION Receivers, Hammarlund, National, Hallcrafters, R.M.E.69, Tobe-Deutschmann; transmitters, Collins 45A, Peerless DX20, or built to order; American valves, microphones. Edystone components.—A.C.S., Ltd., 52-4, Widmore Rd., Bromley. 'Phone: Ravensbourne 0156. [0550]

NEW RECEIVERS AND AMPLIFIERS.

**ANGLO-AMERICAN RADIO** Offer the Easiest Purchasing Facilities, and your last opportunity to own one of the finest radio receivers ever made, the genuine 5-band 10 watt Crosley at £11/19/6

H.P. part exchange, and a 50% saving on the superb Crosley receivers; there will be no better receiver available in this country at under three times the price during the next 12 months.

**LIMITED** Number of the Following Models Only Available; we offer you every advantage and every inducement to purchase now; a large cash saving, and your own choice of the method of payment.

**PLEASE** Note, we offer only brand new goods, every chassis or receiver fully guaranteed 6 months; every receiver accurately checked and aligned on all bands with the latest equipment before despatch; please remember we offer you only goods which will give you lasting satisfaction, and as such unquestionably the finest value that radio has to offer; do not confuse with second-hand, "job bought," or improperly tested receivers, which are being cleared out at any price by other sources; please note all cabinets supplied by us are copyright by no other firm.

**10% or 20%** With Order to Suit your Convenience Secures Delivery, with undertaking to remit balance over 12 or 18 months.

**AMAZING** Signal to Noise Ratio is the Keynote to the Phenomenal All-world Reception; there is scarcely a transmission in the world that the 5-band Crosley will not bring in; Mr. Ivor Manley, writing in "The Wireless World" a few weeks back on Spanish broadcasting in the civil war, compiled his article using only one of our Crosley receivers; over 100 transmissions tuned in from Spain alone! Yes, your new guaranteed Crosley brought from us will do the same, and get you everything on the air.

**£11/19/6**—9-valve high fidelity 5-band (12½-31.30-90, 75-200, 200-555, 700-2,000 metres), A.C., 97-250 volts, 10 watts undistorted output, R.F. stage all bands, new automatic variable selectivity incorporated, provision gramophone, and doublet, accurately calibrated airplane dial and band-spread pointer and subsidiary scale, shadow tuning indicator; your price £11/19/6, or with American Magnavox speaker, £14; Table model, £17; Console, £19; Auto-Radiogram, £34; or small deposit as above with order secures delivery.

**CARRIAGE** Extra: Chassis 5/-; Table 7/-; Console 10/-; radiogram 15/-.

**BOOK** your Crosley Now, whilst last stocks remain; cash, c.o.d., or small deposit (see above) secures now. We guarantee your satisfaction.

**£6/14/6**—8-valve all-wave A.C./D.C. Superhet, 16-2, 100 metres, new 5½in. multi-indication airplane dial, full A.V.C., wonderful all-wave performance; those on D.C. mains will never regret acquiring this outstanding receiver; chassis £6/14/6, with speaker £7/6/6; table model £7/19/6 (list 14 gns.) or deposit secures now; terms as above.

**£5/19/6**—1937 5-valve Superhet, car radio, new suppressorless model, 3 watts output, full A.V.C. volume and tone controls, illuminated dial, large m.c. energised speaker, ¾ amps. consumption only, size only 10in. X4½in. X6½in., fits absolutely any car, no finer performance available under £15; 6 months' guarantee; 6-volt model, £5/19/6; 12v., £6/7/; carriage 4/-.

**4D** Stamps, enclosed with order to cover cost of our comprehensive new radio catalogue, covers every radio requirement, a complete radio buying guide which you will value keeping, fully illustrated.

**EXTENSIVE** New Showrooms Now Opened Centrally at Albion House; all communications and all callers please note address as below.

**If You Cannot Call**, order through the post with confidence; we specialise in postal orders, and have served customers all over the British Isles; you are assured of a square deal and satisfaction.

**ANGLO-AMERICAN RADIO (AND MOTORS), Ltd.** (Dept. W.26), Albion House, New Oxford St., London, W.C.1. Telephone: Temple Bar 3231 (all departments). [4793]

RECEIVERS AND AMPLIFIERS CLEARANCE, SURPLUS, ETC.

ALL Lines Previously Advertised Still Available.

**HENRY'S**, 72, Wellington Ave., N.15. Stamford Hill 2907. [4791]

**PEERLESS** Chassis, 18 watts, 11 valves, 12½ speaker, 5 bands; 10 gns.—Kay, 21, Prince of Wales Rd., Norwich. [4704]

PUBLIC ADDRESS EQUIPMENT

**CUSTOMER** Writes re our 20-watt Amplifier—

"I am Amazed at the Quality and Power Output, which appears to be quite, if not more than, you claim. I have been in the P.A. line since 1927, and have never heard anything to compare with it.—A. Anderson."

**12** VOLT D.C. or 200-250 A.C. input, combined model consumes only 7 amps. at 12 volts with 20 watts output; chassis complete with valves and converter; 12 gns.

**VENTILATED** Steel case, 12/6 extra.

**20** WATT Model for 200-250 A.C. Only 8½ gns; case, 10/6 extra; 4 input model, 1½ gns. extra.

**HEAVY** Duty 20 Watt Model, as fitted to dance halls and cinemas, etc.; £15, complete with valves.

ALL Above have Outputs for 4, 7½, and 15 ohm speakers and independent mike and pick-up inputs.

**OLA** Speakers, Piezo pick-ups, Reslo microphones in stock.

**HAVE** a Demonstration Without Obligation.

**VORTEXION, Ltd.**, 182, The Broadway, Wimbledon, S.W.19. Phone: Lib. 2814. [4783]

ALL Types of Public Address Apparatus for Sale or Hire.

**WARD**, 46, Farringdon St., London, E.C.4. Tel.: Holborn 9703. [0555]

**M.R. SUPPLIES** Offer Some Interesting Material in the Components Column of This Issue. [4769]

**EASCO** P.A. Mobiles, large or small, with driver operator.—18w, Brixton Rd., S.W.9. Reliance 1693. [0558]

No. 47

Notes on the Suppression of Electrical Interference with Wireless Reception

REPORT OF INVESTIGATION carried out on behalf of THE AGENTS ON BOARD THE "CACHALOT," BRIXHAM, DEVON

OBJECT OF INVESTIGATION. Interference on long, medium and short waves on two receivers.

DETAILS OF Plant under test.

1. 50 v. D.C. charging plant. This was not tested or touched as orders have been given that the radios are not to be played when plant is in operation, and a special switch is provided in the engine-room so that radios cannot be operated when plant is operating. (Note: Two sets had been burnt out in the past.)
2. 2 DC/AC Rotary Convertors—one was a spare, the other fitted with suppression gear.
3. Engine-room ventilating fan (fixture).
4. Galley fan (fixture).
5. 3 portable desk fans.

CONDITIONS OF TESTS. With both sets operating on a vertical aerial—mast head cross-trees to deck—and all above plant operating with exception of No. 1 (Convertors tested separately).

TESTS MADE.

Both sets on main converter:—

- Set (a) 4 wavebands .. 2,000—800 m.  
500—200 m.  
50—30 m.  
30—17 m.

Set (b) 5 wavebands .. As (a) with one extra band 180—70 m.

Both sets had interference peaks at about 380 m.—250 m., and 150—90 m. in the case of set (b), also a fair amount of noise present on both S.W. bands.

(The main converter had been suppressed by someone else by means of one No. 1211† suppressor, three No. 1118‡ suppressors, eight 0.1 and 0.5 condensers and six special hand wound chokes.) Also screened in earthed metal box.

By fitting one No. 300\* Set Lead Suppressor all interference from converter was stopped, leaving this installation as above with the exception of slight noise about 140 m. in the case of set (b). Set (a) no noise.

The spare converter which had no suppression gear fitted was suppressed by means of two No. 1118 suppressors in input and output sides, and four .01 condensers between brushes and frame; and two small hand wound chokes in D.C. side. This gave exactly the same results as the mains converter.

In the case of fans, these were tested and suppressed one by one.

No. 3—with the No. 300 fitted this gave no trouble.

No. 4—gave bad interference on L and M bands, but was suppressed by means of one No. 1118.

No. 5—were cured by fitting 0.01 condensers across brushes to earth.

When all were finished a demonstration, in which all appliances were operated, was given to the ship's engineer, and the service engineer to the agent, with the result that on Set (a) there was no noise on any band on one of the receivers, while on Set (b) slight noise at about 140 m., which was well below tolerable level.

† Set Lead Suppressor (mains filter, type 1211), price 17s. 6d.  
‡ Condenser Suppressor, type 1118 .. price 10s. 6d.  
\* Set Lead Suppressor (mains filter, type 300) price 21s. 0d.

Send for the book, "Interference Suppression," post free 1s. 2d., or for free copy of "The Eliminoise System" and other relative literature.

**BELLING-LEE SUPPRESSION SERVICE**

**Belling & Lee Ltd.**  
Cambridge Arterial Road, Enfield, Middx.

PUBLIC ADDRESS EQUIPMENT

**HOLIDAY** and HEMMERDINGER, Dolefield, Bridge Street, Manchester.—Loud-speaker Van for hire; Sports, Fetes, etc. [4642]

**PARTRIDGE** P.A. Manual, re Standard Handbook; free to trade from: N. Partridge, B.Sc., A.M.I.E.E., King's Buildings, Dean Stanley St., London, S.W.1. [4524]

**B.T.H.** 36in. Horn P.A. Speakers.—A.C.-D.C., 200-250, two only; bargain, £5 each. 20-watt (undistorted) amplifier, 200-250 A.C., by Partridge, £15.—Nicholas, Chinnor, Oxon. [4794]

CAR RADIO

**PILCO** Repairs and Installations, trade distributors.—Radioprite, Ltd., Moorfields, Liverpool. Bank 8811. [4456]

USED SETS FOR SALE AND WANTED

ELDECO

**ELDECO** Stenode Superhet, 200-220 A.C., table model. Walnut cabinet, Magnavox speaker, needs small repairs; first 40/- to Radio, 10, Aberdeen Park, N.5. [4763]

DOMINION

**DOMINION** 8-valve Short-wave Special Superhet. Chassis, five bands, 8.8-550 metres, A.C., Magnavox L.S.; see report "W.W." Jan. 17, 1936; very little used; cost £35; what offers?—Phone: Putney 4186, or write Box 2635, c/o The Wireless World. [4768]

W.W. SUPER SEVEN

"WIRELESS World" Super Seven Receiver, chassis, ganged, Scott Sessions; £6/10.—28, Clovelly Av., Hendon, N.W.9. [4765]

W.W. QUALITY AMPLIFIER

W.W. Quality Amplifiers, complete, valves, £6/17/6; various feeders available.—Twentieth Century, George St., Sutton. [4780]

EXCHANGE OR WANTED

WANTED, "W.W." Quality amplifier, Q.A. receiver, Avomitor.—Kellaway, Thorverton, Devon. [4779]

NEW MAINS EQUIPMENT

V

V

**VORTEXION** Quality Transformers.

**VORTEXION** Supply the B.B.C. G.P.O., L.P.T.B., I.C.I., Borough Councils, etc. Why not you

**ALL** Fitted Screened Primaries, and tapped 200-250v. with centre tapped filaments, guaranteed one year. W.W. Television Transformer; 30/-.

**6.3** V. and 5v. American Heaters, same price.

**W.W.** Q.A.425-0.425v. 120-160 m.a., 4v. 5-10a., 4v. 2.5a., 4v. 1-2a., 4v. 1-2a., super shrouded model; 32/-.

**500**—0-500 150 m.a., 4v. 4a., 4v. 2.5a., 4v. 2a., 4v. 2a., 4v. 2a., super shrouded model, 2.5% regulation 35/-; open type, 32/-; 400 or 450v. same price.

**350**—0-350 120 m.a., 4v. 4a., 4v. 2.5a., 4v. 1-2a., shrouded, 21/-; open type, 18/6; super shrouded with extra 4v. 6a.; 25/-.

**350**—0-350v. 75 m.a., 4v. 2-4a., 4v. 1-2a., shrouded, 18/-; open type, 16/-.

**250**—0-250v. 60 m.a., 4v. 2-4a., 4v. 1-2a., shrouded, 15/-; open type, 12/6.

**AUTO** Transformers, 100-120 to 200-240v.; 80 watts 11/-; 120 watts 14/6, 200 watts 21/-, 500 watts 37/6.

**CHOKES**—30h. 60 m.a., 7/6; 7-13h. 120 m.a., 12/6; 30h. 150 m.a., 15/-.

**OUTPUT** Transformers.—4-10 watt W.W. Q.A., 21/-; 20 watt super shrouded, 30/-.

**VORTEXION, Ltd.**, 182, The Broadway, Wimbledon, London, S.W.19. (Telephone: Liberty 2814.) [4784]

**TANTALUM** for A.C. Chargers, H.T. and L.T.—Blackwell's Metallurgical Works, Ltd., Garston, Liverpool. [5984]

CABINETS

**RADIOGRAM** Cabinets, new designs, 30/- to £5/10; inspection invited or photos for selection sent on request.

**TABLE** Radio Cabinets, undrilled, 6/6 upwards.

**SPEAKER** Cabinets, 4/6 upwards.

**MANUFACTURERS'** Clearance.

**ULTRA** Radiogram Cabinets, undrilled, 33x23x14 or 33x20x15, 50/-.

**BURGOYNE** "Fury," Radiogram Cabinets (undrilled), 34x22x16½; 49/6.

**K**. De Luxe Walnut Cabinets, undrilled, chromium plated edges and speaker grille, 25in. wide, 14½in. high, 10½in. deep, 18/6; Console model, 42in. high, 21½in. wide, 11½in. deep, 39/6.

**HALYCON** Radiogram Cabinets (Reconditioned), 33x23x19; 35/-.

**H. L. SMITH** and Co., Ltd., 287-9, Edgware Rd., London, W.2. Tel.: Pad. 5891. [0485]

DYNAMOS, MOTORS, ETC.

ALL Types of Rotary Converters in Stock, new and second-hand.

**WARD**, 46, Farringdon St., London, E.C.4. Telephone: Holborn 9703. [0518]

A.C.-D.C. 1- and 3-phase Motors, all voltages; from 14/9; list free. Repair specialists.—Easco, 18w, Brixton Rd., S.W.9. [0455]

**G.E.C.** Rotary Converter, 110-volt D.C. to 220-volt A.C., 50 cycles, 200 watt, complete with smoothing-in steel silence cabinet, cost £28; accept 6 gns.; other converters, alternators, etc., cheap.—Johnson, 86, Great Portland St., W.1. Museum 7852. [4789]

# PREMIER SUPPLY STORES

Offer the following Set Manufacturers' Brand New Surplus Goods at a Fraction of the Original Cost; all goods guaranteed perfect; carr. paid over 5/-; under 5/- postage 6d. extra. Orders under 5/- cannot be sent C.O.D.

ALL POST ORDERS TO  
**JUBILEE WORKS,**

**167, LOWER CLAPTON RD., LONDON, E.5**

CALLERS, AS USUAL, TO 20-22, HIGH ST., CLAPHAM, S.W.4 (Macaulay 2382) 'Phone: Amherst 4723  
New Branch:—50, HIGH STREET, CLAPHAM, S.W.4 (Macaulay 2381).

And 165 & 165a, FLEET ST., E.C.4 (Next door to Anderton's Hotel). Central 2833.

Have you had our **GIANT ILLUSTRATED CATALOGUE AND VALVE LIST?** Send 4d. in STAMPS FOR THIS BARGAIN LIST.

**MAINS VALVES**, famous Europa 4 v. A.C. types, 4/6 each. H.L., L., S.G., Var.-Mu-S.G., H.F.-Pens., Var.-Mu-H.F. Pens. 1, 3 and 4-watt A.C. directly heated output Pentodes A.C./D.C. types. 20-watt 18 amp. S.G., Var.-Mu-S.G., H.L., Power.

Following types all 5/6 each. Full-wave rectifiers, 350 v. 120 m.a. and 500 v. 120 m.a. 2½ watt indirectly-heated Pentodes, Octode, Frequency Changers.

**BATTERY VALVES**. 2 volts, H.F., L.P., 2/3. Power, Super-Power, 2/9. S.G., Var.-Mu-S.G., 4- or 5-pin Pentodes. H.F. Pens., V.-Mu-H.F. Pens., 5/- Class B, 3/6.

**AMERICAN VALVES**. Genuine American HYTRON and TRIAD first-grade Valves. 3 months' guarantee. All types in stock, 5/6 each. 210 and 250, 8/6 each. New Metal-Glass Valves, all types, 6/6 each. Genuine American DUOTRON Valves, all types, 3/6 each. Valve holders for all above types, 6d. each. Octal bases, 9d. each.

**SHORT-WAVE COILS**, 4- and 6-pin types, 13-26, 22-47, 41-94, 78-170 metres, 1/9 each, with circuit. Special set of 3-4 Pin S.W. Coils, 14-150 metres, 4/- set, with circuit. Premier 4-pin 3-band S.W. Coil, 11-25, 19-43, 38-86 metres. Suitable any type circuit, 2/6. **COIL FORMERS**, in finest plastic material, 1½ in. low-loss ribbed, 4- or 6-pin, 1/- each.

**H.F. CHOKES**, S.W., 10-200 metres, 9d.; S.W. screened, 1/6; standard screened, 130-2,000 metres, 1/6.

**ELECTROLYTICS**. U.S.A., 4, 8 mfd. 530 v. peak, 1/9 each. Dubilier, 4 or 8 mfd. 500 v., 3/-; 50 mfd. 50 v., 1/9; 10 mfd. 50 v., 6d.; 25 mfd. 25 v., 1/-; T.C.C., 8 mfd. 650 v., 4/-; 15 mfd. 50 or 100 v., 1/-; 50 mfd. 12 v., 1/-; Paper Condensers, W.E., 250 v. working 4 mf., 2/-; 2 mf. 1/-; 1 mf. 6d.; 350 v. working 4 mf., 2/6; 2 mf., 1/6. Dubilier 500 v. working 4 mf., 4/-; 800 v. 4 mf., 6/-.

**COSMOCORD PICK-UPS**, with tonearm and volume control, 10/6 each. **PICK-UP HEADS** only, 4/6 each.

**PREMIER MAINS TRANSFORMERS**, wire-end type with screened primaries, tapped 200-250v. Centre-tapped Filaments. Guaranteed one year. H.T. 8 & 9 or H.T. 10 with 4 v. 4 a.C.T. and 4 v. 1 a.C.T., 8/6. 250-250 v. 60 m.a., or 300-300 v. 60 m.a., 4 v. 1 a., 4 v. 2 a. and 4 v. 4 a., all C.T., 8/6. 350-350 v. 120 m.a. 4 v. 1 a., 4 v. 2 a. and 4 v. 4 a., all C.T., 10/6. Any of these transformers with engraved panel and N.P. terminals, 1/6 extra. 500-500 v. 150 m.a., 4 v. 2-3 a., 4 v. 2-3 a., 4 v. 2-3 a., 4 v. 3-4 a., all C.T., 17/6. Super Model 19/6. **AUTO TRANSFORMERS**, step up or down, 60 watts, 7/6; 100 watts, 10/-. **SMOOTHING CHOKES**, 25 m.a., 2/9; 40 m.a., 4/-; 60 m.a., 5/6; 150 m.a., 10/6. 2,500 ohms, 60 m.a. Speaker Replacement Chokes, 5/6.

**SPECIAL OFFER OF PHILIPS MAINS TRANSFORMERS**. 250-250 v. or 300-300 v. 80 m.a. 4 v. 5 a. C.T. & 4 v. 1 a. 6/11.

**LARGER MODEL WITH TAPPED PRIMARY**, 100-250 v. 450-450 v. 150 m.a. 4 v. 4 a. C.T., 4 v. 4 a. and 4 v. 3 a. and 500-500 v. 100 m.a., 4 v. 4 a. C.T., 4 v. 4 a. and 4 v. 3 a., 12/6. **LIMITED NUMBER ONLY.**

**MILLIAMMETERS**, moving-iron, flush 2½ in., all ranges from 0-10 m.a., 5/9. Visual tuning, 6 or 12 m.a., 5/9. Moving-coil meters, 2½ in. 0-1 m.a., 18/6; 3½ in. 0-1 m.a., 22/6. Multipliers, 1/- each. Ammeters, 0-1, 3, 5, 10 or 20 a., 5/9.

**TRANSFORMERS**, latest type Telsen R.G.4 (list 12/6), 2/9. Lissen Hypernik Q.P.P. (list 12/6), 3/6.

**OUTPUT TRANSFORMERS** for Power or Pentode, 2/6; Multi-Ratio, 4/6.

**ELIMINATOR KITS** for A.C. Mains. 120 v. 20 m.a., or 150 v. 25 m.a., 15/-, tapped S.G. det. and output. Complete Kit with long-life valve rectifier (replacement cost only 2/-)

**PREMIER L.T. CHARGER KITS** for A.C. mains, including Westinghouse Rectifiers and Tapped Mains Transformers, 8 volts at ½ amp., 14/6; 8 volts 1 a., 17/6; 15 volts 1 a., 19/-; 8 volts 2 a., 29/6.

**TELSEN** iron-cored screened coils, W.349, 4/- each.

Electric **SOLDERING IRONS**, 200-250 v. A.C./D.C., 2/3. **NEW 1937 1-VALVE SHORT-WAVE RECEIVER OR ADAPTOR KIT**, 13 to 86 metres without coil changing. Complete Kit and Circuit, 12/6. **VALVE GIVEN FREE!**

**DE LUXE MODEL 14** to 150 metres, complete Kit with Chassis, 4 Coils and all parts, 17/6.

**1937 SUPERHET CONVERTER KIT**, 13/6.

**DE LUXE MODEL**, 18/6

**S.W. SUPERHET CONVERTER**, for A.C. Mains Receivers, 20/- A.C. Valve given FREE!

**NEW 1937 2-VALVE S.W. KIT**, 13 to 86 metres without coil changing. Complete Kit and Circuit, 19/6. **VALVES GIVEN FREE.** **DE LUXE MODEL**, 14 to 150 metres, complete Kit and Chassis, 4 Coils and all parts, 25/- **VALVES GIVEN FREE.** **3-VALVE S.W. KIT**, S.G., Det. and Pen., 42/- **VALVES GIVEN FREE!**

**BAND-PASS TUNING PACK**, comprising set of Telsen 3-gang iron-cored coils with switching, mounted on steel chassis with 3-gang condenser, illuminated disc-drive and 4 valve holders, 25/- the lot. All Mains or Battery circuit. **FREE!**

**SPECIAL OFFER. LISSSEN TWO-GANG SCREENED ALL-WAVE COILS**, 12 to 2,000 metres, complete with switching and wiring diagram, 6/11 per set.

**MAGNAVOX**. Mains energised M.C. Speakers. '154', 7in. cone, 2,500 ohms, 12/6; '152', 9in. cone, 2,500 ohms, 17/6; '152 Magna', 9in. cone, 2,500 ohms, 37/6. **Magnavox P.M.s.—'254'**, 7in. cone, 16/6; '252', 9in. cone, 22/6. Reliable P.M.s. 10/6. **TELSEN P.M.s.** with 10 ratio Transformers, 12/6. **TELSEN Speaker Units**, 2/6. **ROLA** latest type P.M.s, 15/- **B.T.H. ENERGISED MOVING COIL**, 10½ in. diam. 1,650 ohms field. Power or Pentode Transformer. (State which.) **SPECIAL LINE** at 14/6.

**W.B. 1936 STANDARD STENTORIAN** (list 32/6) 21/-, brand new in sealed cartons.

**Potentiometers** by well-known makers. All values up to 1 meg. 2/-; with switch, 2/6.

**TUBULAR CONDENSERS**, non-inductive, all values up to .5 mfd., 6d. each.

**Wire-end RESISTORS**, any value, 1 watt, 6d.; 4 watts, 1/-; 8 watts, 1/6; 15 watts, 2/-; 25 watts, 2/6 each.

**Reliable MORSE KEYS** with Morse Code engraved on bakelite base, 2/- each.

Bakelite case **BUZZERS**, 1/6; Walnut case "Loud-tone," 2/6 each.

Super Quality lightweight **HEADPHONES**, 3/9 pair.

**PREMIER FILAMENT TRANSFORMERS**, 4v. 3a., C.T., 7/6; 4 v. 5 a., C.T., 8/6; 5 v. 3 a., 7/6; 6.3 v. 3 a., 7/6; 7.5 v. 3 a., 7/6; 2.5 v. 8 a., 8/6.

**Self-powered A.C./D.C. 10-watt 40-metre C.W. 3-Tube TRANSMITTER**, Pentode Crystal Oscillator, with meter, tubes, crystal (please state frequency required) and enclosed holder, with key, ready for immediate use, 24 4s.

The New "Premier" **SHORT-WAVE CONDENSERS**, with Trolitol Insulation; certified superior to Ceramic; all-brass construction, 15 mfd., 1/4; 40 mfd., 1/7; 100 mfd., 1/10; 160 mfd., 250 mfd., 2/6.

**PREMIER HIGH-FIDELITY P.A. AMPLIFIER KITS**, 2/6 and 15/6.

**3-WATT A.C. 2-stage AMPLIFIER** for Mike or Pick-up. Complete Kit of Parts with 3 valves, 40/-.

**7-WATT A.C./D.C. 3-stage AMPLIFIER**. High-Gain. Push-Pull output. Complete Kit of Parts with 5 matched valves, 24 4s.

**10-WATT A.C. 3-stage AMPLIFIER** incorporating Phase-Inversion and Push-Pull Triodes. Enormous gain and straight line reproduction. Complete Kit of Parts, including 5 matched valves, 25 5s.

## NEW LOUD-SPEAKERS

**BAKER'S** Super Quality Triple Speaker.

**I**DEAL for Use with Quality Amplifiers; A.C. model, £8/15; D.C. model, £7/7; leadnet "Loud Speaker Tailoring" free on request.

**BAKER'S** Conversions.

**T**HE Next Best Thing to a Baker Super Quality Triple Speaker is a Triple Cone Conversion Assembly; whether your moving coil speaker has a permanent or electro-magnet and no matter what type or make you possess, you can considerably improve frequency response and quality of reproduction by having a triple cone assembly fitted, which comprises main curved cone and dual bakelite and duralumin cones combined, mounted in a 12in. die-cast aluminium frame.

**T**HE Price is 29/6 Complete, including free fitting at our works; there is a special triple cone assembly for owners of Baker's super power speaker, price 25/- including coil.

The following testimonial is typical of many recently received: To-day I received back my speaker less old cone but with your Triple Cone Conversion Assembly. I have given the speaker a thorough test and find that the peak responses are delightfully less and reproduction greatly improved in quality. I strongly advise all with a good speaker magnet to have the Triple Cone Assembly. It is a very sound investment.—Herbert Hart, Managing Partner, Uwins' Orthopedic Centre, 1, Kensington, Bath.

**BAKER'S** Quality Surplus Speakers.

**I**F You are Requiring Quality Reproduction at Low Cost order one of the following brand new bargain speakers now. The Auditorium models are fitted with latest triple cone comprising main curved cone and bakelite and duralumin cones combined, giving wide and even frequency response, resulting in quality reproduction of speech and music. The Coronation surplus horn models are ideal for reproduction of transients.

**39/6** Only, usual price 25.—Auditorium Permanent Magnet Speaker with Alni magnet and die cast frame, large 12in. triple cone giving wide frequency range, complete with large 25 ratio transformer suitable for all outputs, including push-pull and Class B, etc.

**59/6** Only, usual price £6.—Auditorium Electro-Magnet Speaker, 1,000, 1,250, 2,000 or 2,500 ohms field, exceptionally large magnet of high permeability steel giving enormous flux density, 2in. moving coil, large triple cone giving wide frequency range, complete with universal transformer, the ideal speaker for use with "Wireless World" and other quality amplifiers.

**75/-** Only, usual price £9.—As above, but for use on A.C. mains; complete with Westinghouse rectifier and full smoothing equipment.

**49/6** Only, usual price £6.—Coronation Surplus Horn Permanent Magnet Moving Coil Speakers, suitable for domestic or public address; the horn is of moderate size and the speaker is therefore ideal for home use where good reproduction of transients is required; can be used separately or in conjunction with baffle board speakers.

**15/6** Only.—Permanent Magnet Speaker, Alni magnet, 8in. cone, Universal transformer.

**12/6** Only.—Permanent Magnet Speaker as above with 7in. cone.

**2/9** Only.—Brand new cabinets, 12x10x6.

**8/6** Only.—Electro-Magnet Speakers, with 8in. cone, 6,500 ohms field, Universal transformer.

**A**LL Baker Quality Surplus Speakers are Sold for Cash or c.o.d.

**BAKER'S SELHURST RADIO**, Ltd., The Pioneer Manufacturers of Moving Coil Speakers, 1925-1937.—75-77, Sussex Rd., South Croydon. (Croydon 3441.) [4790]

**VAUXHALL**—Loudspeakers. 1938 range, now available: details see new list.—Vauxhall Utilities, 163a Strand, Temple Bar 9338. [4609]

## LOUD-SPEAKERS

**SECOND-HAND, CLEARANCE, SURPLUS, ETC.**

**VOIGT** Unit, cost £14/10, perfect bargain; 25/-

toft. Harvey. "Normandene," Normanston Drive, Lowestoft. [4764]

## VALVES

**A**NDERSON.

**A**MERICAN Valves, all makes, first grade only; 5/- each.

**A**NDERSON, 55, Lansdowne Rd., Walthamstow, E.17. Walthamstow 0827. [1351]

**B**IG and Better Value.

**3/-** Each All Popular Type American Valves, 61.6 3/9; 50's. 5/-; 10's. 6/-; 90-day guarantee.

**A**LL Types Transmitting Tubes in Stock, photo cells, cathode ray tubes, etc.

**R**ADIOGRAPHIC, Ltd., 66, Osborne St., Glasgow, C.1. [4661]

**A**MERICAN Valves, first grade, in all types; trade supplied.—Metropolitan Radio Service Co., 1021, Finchley Rd., N.W.11. Speedwell 3000. [0436]

**A**LL Types of American Valves in Stock of Raytheon, Sylvania, and Arcturus makes, at competitive prices, guaranteed for six months; send for full list; 350 ohms line cords, 2/8.

**W**ARD, 46, Farringdon St., London, E.C.4. Tel.: Holborn 9703. [0452]

## METERS, ETC.

**F**ERRANTI Meters, 300 moving coil single and triple range, new boxed discontinued types; approximately 75% off list.—Farnell, 12, Heaton Park Rd., Bradford. [4698]

**H**UNTS Capacity and Resistance Bridge, Type C.L.R.: 26 (printed incorrectly as £2 last issue); brand new.—Box 2577, c/o The Wireless World. [4785]

## TESTING EQUIPMENT

**W**ESTON Analyser for Disposal, with several adapters and Manual; £8/10.—Box 2679, c/o The Wireless World. [4788]

All Goods advertised previously still available.

NEW COMPONENTS

RAYTHEON Valves, all American components; trade. -Zelco, Ltd., 53, Farringdon Rd., E.C.1. [0499]

COMPONENTS

SECOND-HAND, CLEARANCE, SURPLUS, ETC.

RADIO CLEARANCE

ALL Lines Previously Advertised Still Available.

RADIO CLEARANCE, 63, High Holborn, W.C.1. Holborn 4631. [4718]

PREMIER SUPPLY STORES.

PLEASE See Our Displayed Advertisement on page 4. [0488]

RYALL'S RADIO, 280, High Holborn, London, W.C.1, offer new goods at knock out prices.

AMPLIFIERS.—7 watt A.C. outputs, pair triodes in push-pull coupled correct type Varley transformer, 3-stage, for 200-250v. A.C., good chassis, complete with 5v. and Rola G.12 speaker, £7; transverse mike on plated stand, 25/-.

BI Electrolytics, 12x8 mf., 350v., 1/6; NSF 25x26v., 6 3/4; NSF tubular bag ends, 0.15, non-inductive, 750v., 2/6 dozen.

PAIRS Ferranti Screened Coils, 2/6; Ferranti aerial coils, 6 3/6; Ferranti 3-range coils, 1/3; with circuit chassis types.

FERRANTI Mains Transformers, as used in their commercial sets, 350-0-350v., 70 m.a., 4v. 4-5a. C.T., 4v. 2 1/2a. input, 200/250v., brand new; 6/6. [4748]

M.R. SUPPLIES Offer only Exclusive and High-class Bargains; please read carefully and order with confidence.

M.R. SUPPLIES.—Last few G.E.C. portable amplifying equipments, all brand new; output for large outdoor assemblies; battery model, with batteries and Osram valves, in oak case, £8/17/6; 12-volt car battery model with built-in H.T. generator, Osram valves, £11/17/6; further details on immediate request; G.E.C. 19-guinea car radios (12-volt), most efficient, 200-2,000 metres, remote control flex coupled, complete, in maker's packing, £8/17/6.

M.R. SUPPLIES.—G.E.C. microphone preliminary amplifiers for all carbon mikes, with auto-energising, sturdy closed chassis form; suit any main amplifier, diagram supplied, with Osram valve, 42/6; G.E.C. heavy tripod mike stands (extending), 27/6; Truvox, Racon, etc. M/coil projector horn units, 6v. field, 15-ohm coil, all perfect, handling 20-watts, 38/6; horns to suit, Truvox, 42in., 47/6; all metal 42in., 45/6; 40in., 39/6.

M.R. SUPPLIES.—G.E.C. super-cinema M/coil speakers handling 15-watts, field 2,000 ohms, 8-ohm coil, weight 41lb., 50/-; massive oak cabinet to suit, 22/6; Wright deoester P.M. speakers, paracurve, with multi transformer, 12in. dia., 29/6; Rothermel R.155 Tweeters (crystal), 12/6; heavy duty output transformers, exact "W.W." spec., no-loss, all-ratio 1/1 to 75/1 with C.T. for P.P., weight 7 1/2lb., 26/-; G.E.C. choke-filter speaker coupling units, stabilising long speaker extension lines, 5/-.

M.R. SUPPLIES.—Mains transformers (liquidated contract) best London maker, 400/400 120 m.a., 4v. 7/8 and 4v. 2 1/2, selector switch primary, shielded, 11/6; sliding rheostats, slate former, fine action, 40 watts, 35 ohms 1 amp., 150 ohms 1/2 amp., 475 ohms 1/4 amp., 7/11; also 600 ohms 1/2 amp. (150 watts), 11/6; also 225 ohms 1 amp. (225 watts), 13/11; and others; time switches, breaking 3 amps., 21/-; also 8-day ditto breaking 10 amps., 42/-; also ditto, with synchronous electric clock, with two on-off periods per journal, breaking 10 amps., 65/-; synchronous clock movements, our ever popular offer, driving up to 15in. hands, cut gears, very well made, 16/6.

M.R. SUPPLIES.—Weston 301 panel meters, 2 1/2in. reading 0-250 volts, D.C., 12/6; reading 0-10 amps, 10/6; Raytheon valves (firsts, new), 6A7, 25Z5, 43, 42 and others, any one, 3/11; mains bells, 200-250v. A.C., self-contained, by largest British maker, 5/6.

M.R. SUPPLIES Enjoy an Excellent Reputation for Fair Dealing; get our public address and microphone lists—free on request.—11, New Oxford St., London, W.C.1. (Holborn 7058). [4770]

Vauxhall.—Standard 1938 components; details, see new free list.—Vauxhall Utilities, 163a, Strand, Temple Bar 9338. [4610]

QUANTITY New and Second-hand Sets, speakers, components; bargain prices; list free, stamp.—Barnell, 143, Ashburnham Rd., Northampton. [4778]

STANDARD RADIO SUPPLIES.—Definitely lowest prices in country on Europa, Hivac, valves, speakers, gramophone motors, Telsen coils; send for list.—1, Dantzic St., Manchester. [4752]

OLIVERS Offer Cardboard Case Electrolytics, B.I. T.C.C. Hunt's, 4 mfd., 1/6, 8mfd. 1/9, 50 mfd. 50v. 1/6; 8mfd.+4 mfd. 2/5; 8 mfd.+8 mfd. 2/9; 4 mfd.+4 mfd. 2/-; 4 mfd.+4 mfd.+4 mfd. 3/-; 1 mfd. 1/-; 25 mfd. 25v. 1/2, 50 mfd. 1/1.

ALUMINIUM Chassis, 16in.x10in.x3in., 18 gauge, 5/3; ditto, 16 gauge, 7/6; any size to special order; quotations upon request; drilled to any specification; components fitted; 6 B.A. brass nuts and bolts, 5d. dozen.

COPPER Ariel Wire, 7/22 bare, 100ft. 1/9. insulated 1/6; push-back, 9 yards 6d.; resin cored solder, 1d. foot.

SPEAKER Transformers, 3/- each; power and Pentode, "Class B," push-pull.

VALVE HOLDERS. 5-pin 2 1/4d., 7-pin 3 1/4d.; Octal base holders, 6d.; American valveholders, 6d.

CENTRALAB Volume Controls, with switch, 2/- each; valves, non-ring and American types, all guaranteed, best discounts.

A.C./D.C. Receiver Twin Mains Filter Coils, on base, 6d.; dial lampholder and bracket, 1 1/2d.; all by world-famous manufacturer.

OLIVERS, 676, Christchurch Rd., Boscombe, Hants. All goods guaranteed. Orders under 5/6 postage extra, C.O.D. extra. Lists and all quotations free. [4782]

RAYMART CRAFT A CREED

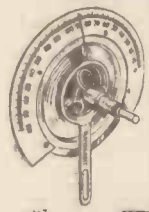

MICRODISC DIAL

The famous Utility micro movement is incorporated in these dials and they provide the finest drive for smooth operation, with freedom from backlash. Their high standard of efficiency is fully acknowledged by leading receiver manufacturers. Fitted with fast and slow motion, controlled by concentric knobs. Beveled scales are provided for easy reading.



REDUCTION DRIVE

We can strongly recommend our epicyclic reduction drive for fitting to all 1 1/2 shafts and providing, when used direct, a 6-1 reduction. When used with a 12-1 dial a slow motion ratio of 72 to 1 is obtained. This reduction drive is admirable for controlling fierce reaction, and for vernier tuning. The movement prevents all possibility of slip.

Type SMD 3/11.

Type ERD 2/3.

FOUR RAYMART MICRO-VARIABLES ARE SPECIFIED FOR THE

"Wireless World" Television Receiver

TYPE VC15X. 15 mmfd. 1/4 each.

AMERICAN Mains Transformers. Heavy Duty 350-350v. 150 m.a., 6.3v. 4a., 5v. 3a., 12/6. GE 350-350 v. 60 m.a., 2.5v., 4.5a., 5v. 2a., 6/11. Majestic, 250-250 2.5v., 6v., 4/11; Pilot 250-250, 2.5 v. C.T., 5 v. C.T., 5/11. Ceramic American Valveholders, 1/- each. BRITISH RADIOPHONE 0005 straight or superhet 3-gang fully screened condensers with trimmers, 4/11; Utility Midjet 2-gang ditto, 3/11; S.L. Dial to suit above, 2/11; Utility 2-gang Unluok .0005 with Dial, 3/11.

COLIFORMS.—Moulded in RD4 natural holose material, hollow resilient plastic, 1 1/4in. diameter, ribbed. Rectification disc in top. Four types, 4-pin, 1 1/8; 6-pin (standard or to fit 7-pin valveholder), 1/9; 7-pin (for bandspread tap), 1/10; Machine threading, 2d. extra.

ELECTROLYTICS. Huge purchase 500 v. Aluminium Can, 4 mf., 1/6; 8 mf., 1/11; 8+8 mf., 2/6; Block type, 500 v. Peak, 4+4 mf., 1/6; 8+8+4 mf., 3/-; 50 mf. 50 v., 1/3; 25 mf. 25 v., 1/3; Tubular Condensers, 1,500 v. T., all sizes to 0.1 mf., 6d., 0.2 to 0.5 mf., 8d.

HEAVY DUTY Mains Transformer, worth 45/-, 350-350, 150 m.a., 4 v., 2.5 A., CT, 4 v., 6 A., CT, 12 1/2; Philips 270-270, 120 m.a., same LT's 6/6; Speaker Transformers, 2/6.

MICROVARIABLES.—All brass construction, latest ceramic insulation. The finest condensers made, 15 mmfd., 1/4; 40 mmfd., 1/7; 100 mmfd., 1/10. Transmitting type.—.070in. spacing, 15 mmfd. (neutralising), 2/9. 40 mmfd. Tuning, 3/6. These are quality.

PUSHBACK Wire, 6 yds. 6d.; heavy, 9d.; Resin-cored Solder, 6d. 6d.; Screened Flex, single, 6d. yd.; twin, 9d. yd. Assorted Solder Tags, 6d. packet.

SHORT-WAVE COILS.—(RD4), CA 11-25, CB 20-45, 2/6. CO 44-100 metres, 2/9. Standard 6-pin types, CA6, CBS, 2/9 each; CO6, 3/-; same range as 4-pin.

SMOOTHING CHOKES, 20 hv., 120 m.a., 3/11; 900 m.a. winding chokes, 3/6; Centralab Pots, all sizes, 1/8; switched 2/-; 30,000 ohm Pots, 1/-; Tubular glass fuses, 2d. Milliammeters, 25 m.a. upwards 5/9; super, 6/9.

UTILITY 8/6, Microdisc Dials, 3/11; Radiophone, 0.00016 Shortwave Condensers, 3/6. Series gap twin, 3/9. Shortwave HF Chokes 5-100 metres, 9d. KD Litt Wound LF's, 3/11; Two-speed slow-motion knobs, 1/-.

465 Telsen Ace Transformers, 1/11; Telsen Screened S.W. H.F.C., 1/-; Iron core H.F. chokes, 1/-.

SPECIAL OFFERS. Class B Kit, worth 3/6, comprising Drive Transformer, Valve and Holder, 5/-; Dozen wire-ended assorted resistors, 1/6. Order 5/- post free. Get our Bargain Catalogue, 11d. post free. All enquiries and requests for Catalogue must send 11d. stamp.

RAYMART SHORT-WAVE MANUAL

48 pages in all, 32 on receivers, transmitters, aerials, circuits, etc., etc., and 16 on short-wave components, 6d., or post free, 7d. Short-Wave Catalogue, 16 pages, 1/4.

G5NI (BIRMINGHAM) LTD. 44, HOLLOWAY HEAD, BIRMINGHAM TELE: MID. 3254

Specified for 'THE WIRELESS WORLD' TELEVISION RECEIVER. One Mains Transformer, Type 5T.23, Price 32/6. One Bakelite Connector, Block Type 5C2, Price 1/9. One Bakelite Connector Type 5C5, Price 2/3. W. ANDREW BRYCE & CO., North Road, Burnt Oak, Edgware, Middlesex.

We do quite a lot of business making up transformers to customers own specifications; but we have a standard list. May we send you a copy? W. BRYAN SAVAGE LTD Westmoreland Rd., London, N.W.9. 'Phone: Colindale 7131

COMPONENTS—SECOND-HAND, CLEARANCE, SURPLUS, ETC.

WARD.—For unparalleled bargains in set manufacturers' surplus; all goods are guaranteed unused and perfect; immediate delivery.

BRITISH Radiophone Condensers, fully screened, superhet, or straight type, 3-gang and 2-gang; 7/6.

CENTRALAB Resistances, 1-watt type, 6d.; 2-watt type, 1/2; 3-watt type, 1/9; B.I.C. 8mf. and 4mf. 550 volts peak electrolytic condensers, 3/5.

3,000 Brand New Weirite 110 kc. Pre-tune I.F. Transformers, type O.T.1, O.T.2 and O.T.2F; 1/6 each, or offer for quantity.

40 mfd. and 24 mfd. 200 Volts Peak Electrolytic Condensers; 3/-.

CLIX Chassis Type Valve Holders, 4- or 5-pin, 6d.; 7- or 9-pin, 6d.; R.C.A. American valve holders, 4-5-, 6- or 7-pin, 9d.

ASSORTED 1-gross Parcels of 1-watt and 1/2-watt Resistances by N.S.F.; 12/-.

MARCONI Model 25 Pick-ups; 25/-.

CONVERSION Units for Converting D.C. Receivers to A.C. Mains operating up to 110 watts, improved full-wave type; £2/10.

WESTINGHOUSE Rectifiers, L.T.4 or L.T.5, with mains transformer and variable resistance, 22/6; Varley D.P.4 output transformers, 1-1 and 25-1, 9/-.

MAINS Transformers, 350-0-350v. 60 m.a., 4v. 3 amps., 4v. 25 amps., 12/-; 425-0-425v. 120 m.a., 4v. 1 amp., 4v. 1 amp., 4v. 7 amp., 4v. 25 amp., for "W.W." Quality Amplifier, 26/-; L.T. transformers, with two 4v. 3a. C.T., windings or 2.5a. 8a., 5v. 2.5a., 8/6.

VOLUME Controls, with or without switch, by Rotavohm, Erie, Electrad, and other good makers, any value, 2/6; steel chassis, "Wireless World" Quality Amplifier, 8/6; Partridge 32-watt amplifier, 11/-.

WE Stock All Parts for "Wireless World" Quality Amplifier. Quality Amplifier Receiver, Imperial Short Wave Six, 1936 Monodial Q.A. Super. All-wave Super Seven, etc.

WE Can Supply Correct Equivalents for Any British Type of Valve, including side-contact Universals, I.F. pentodes, double diode triodes, 3-5-watt output pentodes, 500v. indirectly heated rectifiers, octodes, double diodes, single diode tetrodes, etc., at an appreciably lower price.

PHILIPS Amplifiers with 400v. triode in output stage; £2, complete.

300 Jensen P.M. Speakers in Cabinets, with volume control, specially designed for relay company; 14/6 each or offer for quantity; Bakers super power speakers, £2/5.

"CORPACT" Capacity Operated Window Signs; £5.

CARRIAGE Paid, cash with order or c.o.d.; send for list.

WARD, 46, Farringdon St., London, E.C.4. Tel.: Holborn 9703. [0450]

MAINS RADIO DEVELOPMENT CO.'s Astounding Bargains.—Carriage paid; call mornings; phone: Tudor 4046; stamp for List 205.

N.S.F. 1/2 and 1 watt Carbon Resistors, twelve good sizes, well assorted, marked values; 50 for 3/6; unrepeatable offer.

CLEARANCE of Mica Tag Condensers, 20 assorted of six good sizes from 0.0002-0.005 mfd.; 1/- while stocks last.

TUBULAR Condensers.—Brand new, wire ends, finest make, 400 volt working, 0.0001-0.002 mfd., 2d.; 0.005, 0.01, 0.02, 0.05, 0.1 mfd., 4d.; 0.25, 0.5 mfd., 6d.

CLIX Latest Chassis Valve Holders, unused, 4-pin, 1 1/4d.; 5-pin, 2 1/4d.; 7-pin, 4d.; three-valve grey cellulosed metal chassis, 12 1/2 x 6 1/2 x 5 1/2 in., 1/-.

RESISTORS.—Absolutely finest make, one watt, colour R coded wire ends, unused, any size 50 ohms to 5 megohms, 3 1/4d. each, 2/9 a dozen; your choice; two watt, any size, 6d.

B.I.C. Unused Dry Electrolytics, 8+8 mfd., 500 volt, 3/-; 8 mfd. 550 volt, metal can, 2/3.

KNOBBS.—Black, octagonal bakelite, 1 1/4in. diameter, 1/4 quarter inch spindle, beautiful appearance; 2 1/2d. each.

MAINS RADIO DEVELOPMENT CO., 4-6, Muswell Hill Rd., London, N.6. [4774]

TRANSMITTING APPARATUS G5NI.—The recognised distributors for amateur equipment, National, R.M.E., Thordarson, Hammarlund, McMurda, Hallicrafters, etc.; send 1 1/4d. stamp for catalogue.—G5NI (Birmingham), Ltd., 44, Holloway Head, Birmingham. [0531]

MISCELLANEOUS CHEAP Printing.—1,000 billheads 3/6; sample free.—Creteaway Press, 18, Buxted, Sussex. [4719]

AMBITIOUS Men. To ensure promotion take advantage of the T.I.G.B.'s authoritative home study courses in Radio Engineering and Servicing, Television, Sound Recording, Wireless Communications, etc.; write to-day for "The Engineer's Guide to Success"—free—which gives full particulars—contains the world's widest choice of engineering courses covering all branches—and alone gives the Regulations for qualifications such as A.M.I.E.E., A.M.I.R.E., A.M.I.T.E., A.M.I.W.T.C. & G., etc. Training until successful guaranteed.—The Technological Institute of Great Britain, 5 Temple Bar House, London, E.C.4 (Founded 1917. 20,000 successes.) [4688]

EXTENDED PAYMENTS LONDON RADIO SUPPLY Co. (Established 1925), supply on convenient terms, components, accessories and sets, any make, 10% down, balance over 12 months; send for list of requirements.—11, Oat Lane, London, E.C.2. [0337]

HIRE-PURCHASE.—Prompt delivery of any radio apparatus on convenient terms. WARD, 46, Farringdon St., London, E.C.4. Tel.: Holborn 9703. [0539]

EXCHANGE WESTON Selective Analyser, type E665 (new), for good film camera, miniature preferred.—Write Box 2628, c/o The Wireless World. [4762]

I BUY, sell, exchange good quality receivers, accessories, components; H.P. facilities; promptness, efficiency.—Bostock, 1, Westbourne Terrace, S.E.23, Forest Hill 2236. [0529]

REPAIRS AND SERVICE

"SERVICE WITH A SMILE."

HENRY FORD RADIO LTD.—American valves, components, spares, line cords; leading trade repairers; send us your American and British receivers.—Electronic House, 22, Howland St., Tottenham Court Rd., W.1. Museum 5675. [0434

HARMONY HOUSE SOUND and SERVICE, Southport.—Radio repairs for the Trade.—Tel. 8621. [0558

ANY Transformer Repaired or Made to Specification; 15 years' experience.—Fel-Electric, Garden St., Sheffield. [0561

METROPOLITAN RADIO SERVICE Co. for Guaranteed Repairs to American (Midget and Standard and British Receivers).

CLARION and Majestic Service Depot.—I.F. and mains transformers rewound, American valves and parts; trade supplied.—Metropolitan Radio Service Co., 1021, Finchley Rd., London, N.W.11. Speedwell 3000. [0435

FOR Unusually Good Rewinding of Transformers, chokes, speakers, etc., trade only.—Gardners Radio, Ltd., West Southbourne, Bournemouth. [0551

LOUD Speaker Repairs, British, American, etc.; any make transformer coils rewound; alterations.—Sinclair Speakers, Alma Grove, Copenhagen St., N.1. [4673

GUARANTEED Repairs.—Any transformers, choke, motor, armature, converter, dynamo, etc.; keenest prices, immediate quotation, prompt, dependable service.—See below.

L.T.P. (LONDON TRANSFORMER PRODUCTS, Ltd.), Willesden, N.W.10. Willesden 6486 (3 lines). [3470

MAINS Transformer Service.—Repairs, rewinds, or constructions to specification of any type; competitive prices and prompt service.—Sturdy Electric Co., Dip-ton, Newcastle-on-Tyne. [0516

F. E. GODFREY, A.M.I.R.E., qualified to build, repair and convert "Wireless World" sets, etc.; 25 years' experience, prompt service guaranteed.—30, Kemplay Rd., Hampstead, Hampstead 1104. [4767

HOLIDAY and HEMMERDINGER, Dolefield, Bridge Street, Manchester.—Repairs; re-winds. American valves. Service books. Speaker centring gauges, 2/6 set. Speaker dope, 2/-. Catalogue free. [4641

DEGALLIER'S RADIO SERVICE, repairers of British and American receivers; lowest prices with good workmanship; also speaker repair department; new coils and cones fitted, fields altered, transformers rewound, any transformer, choke, armature, converter, or dynamo rewound; let us quote

DEGALLIER'S RADIO SERVICE, 32, Bathurst Mews, Paddington, London, W.2. Telephones: Paddington 2745 and Bayswater 5732. [4714

REPAIRS to Moving Coil Speakers a Specialty; cones and coils fitted, fields altered; prices, including eliminators, quoted, loud speakers, 4/-; L.F. and output transformers, 4/-, post free; guaranteed satisfaction; trade invited; estimates free; prompt service.—Loud Speaker Repair Works, 5, Balham Grove, London, Battersea 1321. [0394

PATENT AND TRADE MARK AGENTS

"PRACTICAL Hints on Patents," free on application.—The Imperial Patent Service, First Avenue House, High Holborn, W.C.1. Preliminary consultation free.

GEE and Co. (H. T. P. Gee, Mem. R.S.G.B., A.M.I.R.E., Estab. 1905), 51-52, Chancery Lane, London, W.C.2. (2 doors from Government Patent Office). Holborn 4547 (12 lines). Handbook free. [0001

TUITION

RADIO Training.—Marine, aircraft, broadcast; prospectus free.—Hull Municipal Technical College. [0523

RADIO Engineering.—Theory and practice thoroughly taught by postal course; 350 positions obtained for students in four years; recognised as a training institution by radio manufacturers; also instruction at college.—Apply British Radio Engineering College, 179, Clapham Rd., London, S.W.9. (Brixton 3487). [4722

WANTED

S.W. Converter ("W.W." design preferred) Wanted; also Piezo-crystal pick-up.—12, Kensington Rd., Gosport. [4777

WE Buy for Cash All Types of Modern Second-hand Radio Sets and Accessories, test meters, parts, etc.; we pay more than any other dealer; part exchanges; bring, send, or will call.—University Radio, Ltd., 82, Hampstead Rd., London, N.W.1. Phone: Euston 3810. [4749

SITUATIONS VACANT

AIR MINISTRY.

CIVILIAN Wireless Instructors Required.

VACANCIES Exist for Civilian Wireless Instructors at the Electrical and Wireless School, Royal Air Force, Cranwell, Lincs. The commencing rate of pay is £4 a week inclusive, which may be increased to £4/5 a week after a short period of satisfactory service.

CANDIDATES Must be Capable of Lecturing, and must have a sound knowledge of electrical principles and their application to radio and low-power electrical engineering.

APPLICATIONS Should be Addressed to the Commanding Officer, Electrical and Wireless School, Cranwell, Lincs, giving full particulars as to previous experience, age, etc.

CANDIDATES Will be Required to Appear Before a Selection Board at the School for Interview and Test. The test will include the giving of a lecture on any subject which may be chosen by the candidate, involving the principles of modern radio. Lecturing sequence and style are most important. [4773

AIR MINISTRY.

CIVILIAN Instrument Maker Instructors Required.

VACANCIES Exist for Civilian Instrument Maker Instructors at the Electrical and Wireless School, Royal Air Force, Cranwell, Lincs. The commencing rate of pay is £4 a week inclusive, which may be increased to £4/5 a week after a short period of satisfactory service.

CANDIDATES Must be Capable of Lecturing, and must have a sound knowledge of the principles, action and construction of aircraft instruments.

APPLICATIONS Should be Addressed to the Commanding Officer, Electrical and Wireless School, Royal Air Force, Cranwell, Lincs, giving full particulars as to previous experience, age, etc.

CANDIDATES will be required to appear before a Selection Board at the School for Interview and Test. The test will include the giving of a lecture on any subject which may be chosen by the candidate, involving the principles or construction of modern aircraft instruments. Lecturing sequence and style are most important. [4772

SERVICE Engineer.—Thoroughly capable all-round man; permanency and good money for suitable applicant.—Box 2667, c/o The Wireless World. [4776

A VACANCY Exists for a Test Foreman in London Radio Factory; recent experience of test work on modern broadcast receivers and control of male and female labour essential; applications are invited from senior men possessing the suitable technical knowledge, experience and ability, giving (in confidence) complete details of present and past employers, positions held, technical training, age and salary required.—Box 2658, c/o The Wireless World. [4775

RADIOGRAPHIC ARE SPECIALISTS

TRY US FOR TRANSMITTING GEAR TUBES, COMMUNICATION RECEIVERS, P.A. AMPLIFIERS, MICROPHONES, IN FACT ANY DARNED THING! O.K. FOR PRICE AND QUALITY.

66 OSBORNE STREET, GLASGOW, C.I.

LEXINGTON VALVE TESTER. Checks continuity in Coils, Condensers, Transformers, etc. Can be used as D.C. voltmeter. Cannot be overloaded. Write to-day for full details. 10 gns. subject. Lexington Instrument Laboratories Ltd., 155-7, Gt. Portland Street, London, W.1. Phone: Langham 3477. "SIMPLIFIED SERVICING."

SITUATIONS VACANT

AIR MINISTRY.

DIRECTORATE of Technical Development.

APPLICATIONS are Invited for Appointments as Technical Officer (Ref. No. 5261) at the Royal Aircraft Establishment, South Farnborough, Hants, for radio development work.

CANDIDATES Should Possess a B.Sc. Degree in Physics or Electrical Engineering, or education to an equivalent technical standard. Experience in radio or communications engineering is desirable. Specialist knowledge of design of small transmitters, or receivers, or direction finding equipment, or the like, would be an advantage.

THE Scale of Salary is £275-£18-£455-£25-£580 a year, with an efficiency bar at £455 a year. Commencing salary will be determined with reference to selected candidate's qualifications and experience. Promotion to the higher grade of senior technical officer (£680-£800) and above is governed by merit as and when vacancies occur.

THE Appointments will be Non-pensionable, but entrants will be eligible for consideration for appointments to pensionable posts in the event of vacancies arising on the permanent establishment.

APPLICATIONS Should be Made on a Form to be Obtained (quoting Ref. 5261) from the Chief Superintendent, Royal Aircraft Establishment, South Farnborough, Hants, to whom it should be returned not later than 24th July, 1937. [4771

WELL Educated Young Men Required Immediately as Apprentice, to learn theory and practice.—Write R.T.I. Radio Service, 40, Earl's Court Rd., W.8. [4781

GUARANTEED Positions in Marconi Service; all successful students placed; separate Morse Classes held.—The Wireless School, 74, Bull St., Birmingham, 4. [4513

RADIO Service Engineers Required in Devonshire, London, Essex, etc.; permanency for first class men; to work at test bench only.—Full particulars and rate to Box 2624, c/o The Wireless World. [4761

JUNIOR for General Work in High-class Amplifier Workshop; progressive position for keen worker.—Apply by letter only, stating age, to Henri Selmer (Truvoice Dept.), 114-116, Charing Cross Rd., W.O.2. [4787

RADIO Assembly Foreman, skilled mechanic, with experience of record changers or similar mechanisms.—Send full details of career, stating age and salary required, to Ref. 1/W.W. Box 2448, c/o The Wireless World. [4693

WIRELESS Operators and Engineers Urgently Required.—Train at Britain's leading colleges; fee after appointment; boarders; prospectus free.—The Wireless College, Colwyn Bay, or The Wireless College, Calmore, Southampton. [0541

AMPLIFIERS.—Wanted, first-class wiremen-assemblers for portable P.A. equipment, good soldering essential; progressive positions for the right men.—Apply by letter only stating age, experience and salary required, to Henri Selmer (Truvoice Dept.), 114-116, Charing Cross Rd., W.C.2. [4786

RADIO Service Men with Experience of Talkies or Automatic Record Changers or Similar Mechanisms; preference will be given to men with definite mechanical or electrical training.—Send full details of career, stating age and salary required to Ref. 6/W.W. Box 2447, c/o The Wireless World. [4692

VACANCIES occur for Thirty Men, aged 18-23, in the Post Office Eng. Dept.; experience is not required, but applicants must be willing to study technical subjects; commencing pay £3/15, rising to £7 per week and upwards, with pension.—For full particulars apply B.I.E.T. (Dept. 574), 17, Stratford Place, W.1. [4716

EXPERIENCED Radio Engineers Required for the Alignment of Modern All-wave Superhets; commencing rates up to 1/6 per hour, according to previous experience and ability, with annual service increases of 10%; call 8.30 to 11.30 a.m. or write for appointment (up to 7 p.m. if necessary), with details of experience.—Employment Office, A. C. Cossor, Ltd., Highbury Grove, N.5. [4766

REQUIRED, junior assistant, sales technical department, must be experienced in office routine and have a knowledge of low frequency, amplifiers, high power, output valves and apparatus.—Write, stating age, qualifications and salary required to Reference F.W.C., Technical Department, Messrs. Tungsram Electric Lamp Works (Great Britain), Ltd., Tungsram House, 82-84, Theobalds Rd., W.C.1. [4792

INDEX TO ADVERTISEMENTS

Armstrong Mfg. Co. PAGE Front Cover
Automatic Coil Winder Co., Ltd. Front Cover
Bakers Selhurst Radio 3
Belling-Lee, Ltd. 5
Birmingham Radiomart G5N1 5
British Institute of Engineering Technology 2
British Insulated Cables, Ltd. Inside Front Cover
British Mechanical Productions, Ltd. 1
British Pix 1
British Rola Co., Ltd. Edit. 65
British Sound Recording 1
British Thomson-Houston Co., Ltd. 5
Bryce, W. A., Ltd. 5
Bulgin, A. F., & Co., Ltd. 5
C.A.V. Front Cover
Colvern, Ltd. Front Cover
Denco
Dubilier Condenser Co. (1925), Ltd.
Ediswan, Ltd.
Electradix Radios 1
Exide, Ltd.

Film Industries, Ltd. PAGE
Fluxite
Forbat, Eugene J. 2
Galpins 2
Gardners Radio, Ltd.
German Radio Exhibition Inside Back Cover
Goodman's Industries, Ltd. Inside Front Cover
Grampian Reproducers, Ltd. 1
Hartley Turner Radio, Ltd. 2
Haynes Radio Front Cover
High Vacuum Valve Co., Ltd.
Institute of Wireless Technology
Lexington Instrument Laboratories, Ltd. 6
Linguaphone, Ltd.
McCarthy Radio, Ltd. Edit. 61
Midwest Radio, Ltd. Inside Back Cover
M.P.R. Electrical Co.
M.R. Supplies
Parmeko, Ltd. 1
Peto Scott, Ltd.

Pitman, Sir Isaac, & Son, Ltd. PAGE
Player's Cigarettes Inside Front Cover
Postlethwaite Bros. 4
Premier Supply Stores 4
Prism Manufacturing Co.
Radio Development Co.
Radiographic, Ltd. 6
Record Radio, Ltd.
R.G.D.
Savage, W. Bryan 5
Sound Sales, Ltd. Front Cover
Tannoy Products
Telegraph Condenser Co. Edit. 63
Universal Radio Distributors, Ltd.
Voigt Patents, Ltd.
Ward, C. F.
Webb's Radio
Westinghouse Brake & Signal Co., Ltd.
Wingrove & Rogers, Ltd.
Wright & Weaire, Ltd.

Printed in England for the Publishers, LITTLE AND SONS LTD., Dorset House, Stamford Street, London, S.E.1, by The Cornwall Press Ltd., Paris Garden, Stamford Street, London, S.E.1.
The Wireless World can be obtained abroad from the BELGIUM: W. H. Smith & Son, 74-75, Boulevard Adolphe.
ADELAIDE (S.A.): Perth (W.A.), and LAUNCESTON (Tasmania).
NEW ZEALAND: Gordon & Gotch, Ltd., Wellington, Auckland, Christchurch and Dunedin.
INDIA: A. H. Wheeler & Co., Bombay, Allahabad and Calcutta.
CANADA: Imperial News Co., Toronto, Winnipeg and Vancouver; Benjamin News Co., Montreal; Gordon & Gotch, Ltd., Toronto.
CENTRAL NEWS AGENCY, LTD. UNITED STATES: The International News Co., New York.

## MIDWEST

Magnificent alike in its conception, design and performance, this the latest Midwest Model X-18 High Fidelity Receiver brings the world to your fire-side. With its 6 TUNING RANGES it gets "Everything on the Air." Its distinctive features in circuit design are not just "talking points," as a comparison will prove, but basic advantages which will assuredly appeal to "Wireless World" readers and all who appreciate Studio or Concert Hall quality of performance in the home.

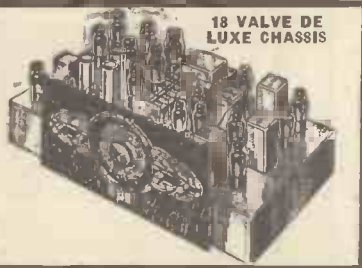

**FREE ART CATALOGUE DEMONSTRATIONS**

40 pages, fully illustrated, giving particulars of Midwest 11, 14, 16, and 18 valve models. at our showrooms Mondays to Saturdays from 9 a.m. to 8 p.m. (except Tuesdays, 9 a.m. to 6 p.m.)

★ **THE ONLY ALL-WAVE RECEIVER COVERING 4½ to 2,400 METRES** **MIDWEST RADIO Ltd.**  
Available in Chassis form complete with matched valves and 12" speaker or in Console Cabinet. Showrooms and Factory: 16, Old Town, Clapham, London, S.W.4.

SECOND EDITION — Completely Revised

# RADIO DATA CHARTS

A SERIES OF ABACS

Providing most of the essential Data required in receiver design.

By R. T. BEATTY, M.A., B.E., D.Sc.

PRICE 4/6 net BY POST 4/10

From all leading booksellers, or direct from the Publishers. Published from the offices of "THE WIRELESS WORLD." DORSET HOUSE, STAMFORD STREET, LONDON S.E.1 W.W.16

Second Edition— Thoroughly Revised

# WIRELESS SERVICING MANUAL

By W. T. COCKING  
*(of "The Wireless World")*

The first complete book of reference of its kind. A reliable practical guide for amateur and professional.

The first edition of this book was sold out in a very few months and a second edition, with additional material, is now on sale.

The "Wireless Servicing Manual" deals fully with Testing Apparatus, and explains the methods of locating and curing faults in receiving equipment.

Ganging, Automatic Volume Control, Instability, Distortion, Mains Hum, Whistles and Local interference, are all separately treated.

Information on short-wave receivers, and on methods of operating extension loud speakers, has been added. The reference material, including base-connections for British, Continental and American valves, and the various colour codes for components, has been extended and brought up to date.

BOUND IN CLOTH BOARDS. SIZE 7½ ins. x 5 ins. 231 PAGES

**NOW ON SALE**

5/- net By post 5/4

Issued in conjunction with "THE WIRELESS WORLD" and Published by the proprietors:—

ILIFFE & SONS LTD., DORSET HOUSE, STAMFORD ST., LONDON, S.E.1

W.W. 20



## 14th Great German Radio Exhibition Berlin 1937 July 30 to Aug. 8

Visitors to the Great German Radio Exhibition will be granted a reduction in fare of 60% on the German Railways Company's lines.

All information through the Ausstellungsleitung, Berlin-Charlottenburg 9, and the travelling offices.

# THE WIRELESS ENGINEER

The Journal of Wireless Research and Progress

"THE WIRELESS ENGINEER" is published in the interests of professional wireless engineers, experimenters, and all keen radio enthusiasts, and is widely read by those who are intimately associated with wireless development.

A valuable monthly feature consists of a summary, under the title of Abstracts and References, of important articles appearing in technical wireless publications throughout the world.

MONTHLY 2s. 6d. NET

Subscription: 32s. per annum, post free.

ILIFFE & SONS LTD., DORSET HOUSE, STAMFORD STREET, LONDON, S.E.1

W.W.2

Mention of "The Wireless World," when writing to advertisers, will ensure prompt attention.

**JUST PUBLISHED**

# THE COMPLETE 9.5-mm. CINEMATOGRAPHER

By Harold B. Abbott

Because of advances in film technique this book supersedes the author's former successful book "Motion Pictures." The beginner can take it up and find everything he needs to know in order to make successful pictures.

How to choose a 9.5-mm. cine camera; how to expose correctly; what to take and how to take it; full instructions on developing and printing; methods of planning; editing, titling and trick effects; the art of projection; methods of operation, screen and picture sizes; giving an efficient show; all these are explained in detail.

There are nearly 100 illustrations. The book, packed with useful information, is a comprehensive course of instruction in amateur cinematography.

CLOTH BOARDS  
Size 7½" × 5", 260 pages  
PRICE 5/- net  
By post 5/4

From all leading Booksellers, or  
direct from the Publishers

ILIFFE &amp; SONS LTD., DORSET HOUSE, STAMFORD STREET, LONDON, S.E.1

## FOUNDATIONS of WIRELESS

*A Book of  
First Principles  
for the  
Wireless  
Enthusiast*

PRICE 4/6 NET  
By Post 4/11

Issued in conjunction with  
"THE WIRELESS WORLD"  
and published by the proprietors—

By A. L. M. SOWERBY, M.Sc.

An Elementary Text Book on Wireless Receivers

"Foundations of Wireless," based on a series of articles which appeared in "The Wireless World," covers the whole field of wireless from the simplest electrical phenomena to the construction of a modern set, and all the vital points in receiver design are treated in full detail. Chapters are devoted to direct and alternating currents; typical circuits; the properties of inductance and capacity; the nature of high frequency currents; the tuned circuit; and amplification by the valve.

Eleven of the eighteen chapters of the book deal with the discussion of receivers, in which the whole process of design is reviewed stage by stage to the finished article.

Special attention is paid to the important subject of tuned circuits and band-pass filters, on the correct design of which the performance of every type of set ultimately depends. Moreover, the process of detection, so often imperfectly understood, is clearly explained.

ILIFFE &amp; SONS LTD., DORSET HOUSE, STAMFORD STREET, LONDON, S.E.1



# The Wireless World <sup>4<sup>D</sup></sup>

## THE PRACTICAL RADIO & TELEVISION JOURNAL

Friday, July 23rd, 1937

See the new McCarthy models first!

The new range of McCarthy all-wave receivers include many improved features, giving still better performance. Prices include Marconi Royalties.

There are also several exceptionally interesting new models of an advanced type. Write for the McCarthy Catalogue, containing illustrations, full specifications, circuit diagrams, also details of loud speakers, cabinets, etc., to:—



**MCCARTHY**  
RADIO LTD.

44a, Westbourne Grove, London, W.2  
Telephone: Bayswater 3201/2.

SEE ADVERTISEMENT INSIDE →

**MOULDED MICA CONDENSERS**

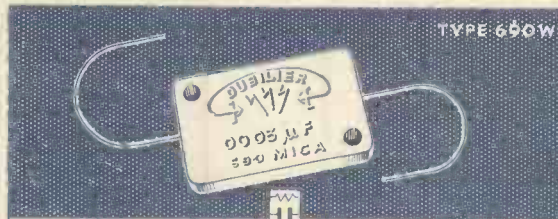

CAPACITY $\mu$ F	PRICE EACH
.00005 - .0003	8d.
.0005 -	9d.
.001 and .002	1/-
350v. D.C. PEAK WORKING.	750v. A.C. TEST

You will find the wire terminals to these condensers a great help. They increase the speed and ease of assembly considerably.

**DUBILIER**

Dubilier Condenser Co. (1925) Ltd., Ducon Works, Victoria Rd., North Acton, London, W.3. C. K. Casson 10

Everything for

**QUALITY RECEPTION**

**HAYNES**  
RADIO

Everything for the

**TELEVISION CONSTRUCTOR**

Duophase amplifier 6-watt, Duophase amplifier 6-watt for P.M. speaker, Duophase amplifier 14-watt, Duophase amplifier 14-watt (constructor's model), Duophase amplifier circuits, Duophase intervalve coupling, gramophone amplifier 6-watt, gramophone amplifier 14-watt, 1-H.F. tuner unit, 2-H.F. tuner unit, all-wave tuner unit, shortwave converter, table model receivers, radiogramophones, schools receivers, baffle boards, loud speakers, volume controls, mains transformers, smoothing and filter chokes, output transformers.

Originators of the Quality Receiver and Quality Radiogramophones.

Demonstration night every Friday, 7.30—9.30 p.m.

Time base transformers, time base units, H.T. transformers up to 6,000 volts, heater transformers, smoothing and voltage regulating equipment, high voltage rectifiers, cathode ray tubes and holders with protecting front screen, converter units for speech reception, complete apparatus for vision receiver construction, chassis and special baseplates.

The most attractive development ever presented to the radio enthusiast.

Have you the Haynes Quality Booklet? 1936-37 Edition. Free on request. Howard 1171.

**HAYNES RADIO LIMITED, QUEENSWAY, ENFIELD, MIDDLESEX.**

# COSSOR



Lead again with a

## COMPLETE SERIES OF OUTPUT TETRODES



**BIGGER VOLUME • BETTER  
TOP NOTE RESPONSE • SIMPLY  
REPLACES EQUIVALENT PENTODE**

Cossor again demonstrate their leadership in valve development with the introduction of a complete range of Output Tetrodes. These new valves have the normal characteristics of output pentodes but, due to a lower grid-anode capacity and a lower impedance, they reduce the attenuation of the higher audio frequencies and also minimise bass resonance. The result is, naturally, crisper tone, greater fidelity, and an entire absence of the "boomy" bass so frequently associated with some types of Moving Coil speakers. The 220 O.T. and 42 O.T. simply plug-in in place of the existing pentodes—no alteration to wiring needed. Ask your dealer for full details.

**BATTERY TETRODE - - - 220. O.T.**  
 Filament Volts - - - - 2.0  
 Filament Amps. - - - - 0.2  
 Anode Volts (Max.) - - - - 150  
 Auxiliary Grid Vol'ts (Max.) - - - - 150  
 Mutual Conductance at Va-100, Vag-100,  
 Vg-0 - - - - 2.5 ma/V. **Price 11/-**

**A.C. MAINS TETRODE (4 volt Series) 42. O.T.**  
 Heater Voltage - - - - 4.0  
 Heater Current (Amps) - - - - 2.0  
 Maximum Anode Voltage - - - - 250  
 Maximum Auxiliary Grid Voltage - - - - 250  
 Mutual Conductance at Va-100, Vag-100,  
 Vg-0 - - - - 7.0 ma/V. **Price 13/6**

**D.C./A.C. MAINS TETRODE (.2 Amp Series) 402. O.T.**  
 Heater Voltage - - - - 40  
 Heater Current (Amps) - - - - 0.2  
 Maximum Anode Voltage - - - - 250  
 Maximum Auxiliary Grid Voltage - - - - 250  
 Mutual Conductance at Va-100, Vag-100,  
 Vg-0 - - - - 7.0 ma/V. **Price 13/6**

N.B.—The Control Grid of this valve is connected to the top cap.

British Made by A. C. COSSOR LTD., Highbury Grove, London, N.5. Depots at Birmingham, Bristol, Cardiff, Glasgow, Newcastle, Leeds, Liverpool, Manchester, Nottingham, Belfast & Dublin.

# The Wireless World

THE PRACTICAL RADIO JOURNAL  
27<sup>th</sup> Year of Publication

No. 934.

FRIDAY, JULY 23RD, 1937.

VOL. XLI. No. 4.

Proprietors: ILIFFE & SONS LTD.

Editor:  
HUGH S. POCOCK.

Editorial,  
Advertising and Publishing Offices:  
DORSET HOUSE, STAMFORD STREET,  
LONDON, S.E.1.

Telephone: Waterloo 3333 (50 lines).  
Telegrams: "Ethaworld, Sedist, London."

COVENTRY: Hertford Street.  
Telegrams: "Autocar, Coventry." Telephone: 5210 Coventry.

BIRMINGHAM:  
Guildhall Buildings, Navigation Street, 2.  
Telegrams: "Autopress, Birmingham." Telephone: 2971 Midland (4 lines).

MANCHESTER: 260, Deansgate, 3.  
Telegrams: "Iliffe, Manchester." Telephone: Blackfriars 4412 (4 lines).

GLASGOW: 26B, Renfield Street, C.2.  
Telegrams: "Iliffe, Glasgow." Telephone: Central 4857.

PUBLISHED WEEKLY. ENTERED AS SECOND-  
CLASS MATTER AT NEW YORK, N.Y.

Subscription Rates:  
Home, £1 1s. 8d.; Canada, £1 1s. 8d.; other  
countries, £1 3s. 10d. per annum.

*As many of the circuits and apparatus described in these  
pages are covered by patents, readers are advised, before  
making use of them, to satisfy themselves that they would  
not be infringing patents.*

## CONTENTS

	Page
Editorial Comment. . . . .	67
The Wireless World Television Re- ceiver—IV. Framework and Unit Assembly . . . . .	68
Broadcast Brevities . . . . .	73
40-Metre Working . . . . .	74
Current Topics . . . . .	75
Belmont Model 700 Reviewed . . . . .	76
On the Short Waves . . . . .	77
New Apparatus Reviewed. . . . .	79
Listeners' Guide for the Week . . . . .	80
Decoupling . . . . .	82
The Modern Noise Meter. . . . .	84
Random Radiations . . . . .	86
Recent Inventions . . . . .	88

## EDITORIAL COMMENT

### Aerials

#### The Penalty of Neglect

**I**N discussing the effect of the station changes in the West of England and South Wales which took place recently the B.B.C. specially directs the attention of listeners to the question of aerials.

It is well that from time to time the matter of aerials should be made a subject for discussion because far too little attention is paid to this important aspect of reception to-day.

Because receivers have improved in efficiency there is a steadily growing tendency to minimise the importance of the aerial and be content with a very small one or an indoor aerial trailing around the house. The direct result of a poor aerial is that the receiver is operated at a more sensitive position, thereby making it responsive to interference which is also picked up easily on the small aerial because of its proximity to buildings or to the house wiring.

#### Few Exceptions

Only when using an unselective set in close proximity to a powerful transmitter is there a good reason for reducing the size of the aerial. In all other cases the aerial should be high, placed as far as possible away from likely sources of interference—the downlead should be direct and, if necessary, of the anti-interference type.

The service area of transmitters does not, from experience, appear to increase with power as much as theory would predict. Is not this probably due to the present tendency to neglect the aerial and to expect satisfactory reception from the very poorest forms of collector? In the early days of broadcasting transmitting authorities could base their estimates on reasonably

good aerials for reception, but that is no longer the case to-day.

A campaign for better aerials would, we believe, do much to improve the general standard of reception and reduce complaints of local interference.

#### Absurd Prejudice

It is not easy to determine whether the small number of effective aerials to be seen during a day's journey through the countryside is due to public indifference or some stronger feeling amounting almost to antipathy. It is certain, however, that many people regard a prominent aerial as an eyesore—and it must be freely admitted that far too many of the crazy erections that are seen leave much to be desired on aesthetic grounds.

As to whether it is possible to instal a good aerial on a picturesque old house without spoiling its appearance we will not hazard an opinion, but it should be easy enough for the architect of a modernistic type of building to make proper provision for an aerial without in any way detracting from the appearance. One or two serious attempts have apparently been made to do so, but we should like to see more of them.

#### Good Sets—Bad Aerials

The indifference of the listening public to the aerial question is reflected in the fact that there are few firms to-day to whom one can turn for the erection of an efficient mast and aerial. For a local radio salesman to suggest a good aerial would often be taken to-day as a reflection on the capabilities of the set merely because, for some unaccountable reason, the public have been permitted to come to the conclusion that the efficiency of a receiver can be measured in terms of its ability to dispense with aerial efficiency.

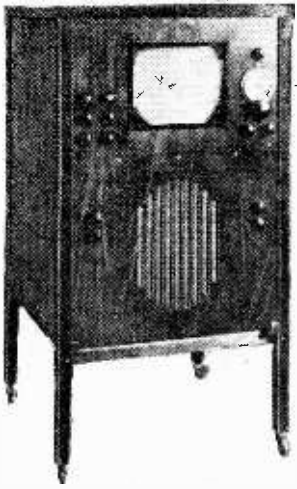

# The Wireless World Television

## IV.—THE FRAMEWORK AND THE ASSEMBLY OF UNITS

**T**HE construction of the various units which comprise the sound and vision receivers has been dealt with in the preceding articles, and, before going on to discuss the operation and adjustment, their inter-connection and housing must be dealt with. Unless the equipment is operated in darkness some form of container is necessary in order to keep light from the back of the tube; it is, however, inconvenient to fit the units into a cabinet of normal design, for they would be inaccessible.

The method of housing adopted is one which enables all units to be got at readily and it consists really of a special form of cabinet construction. It consists of a framework made of the four corner posts suitably braced and carrying two shelves for the gear. These posts are grooved and sliding panels are used for the sides and front. The latter must be considered a fixture since the various control shafts pass through it, but the two sides and back can be slid out at a moment's notice. The details of the construction will be clear from the drawings and it will be noticed that small wheels in a swivel mounting are fitted to the legs. Naturally it is a matter of individual preference whether these are adopted or not, but they are recommended in view of the weight of the apparatus since they enable it to be readily moved.

A sheet of  $\frac{1}{4}$ -in. plate glass is fitted in the viewing window to protect the tube from accidental damage. In this connection, it must be remembered that a large cathode-ray tube is somewhat fragile and must be handled with care; it is electrically robust, but mechanically delicate and care must be taken to see that it is never knocked. Remember that the external air pressure is several tons; the glass is built to withstand this, but it is folly to increase the strain on it by rough handling.

### The Tube Mounting

The tube is supported at the front end on two small blocks of sponge rubber and at the other by a cradle, rubber cushioning again being adopted. The tube base fits on the end and is supported entirely by the tube.

*DETAILS are given in this article of the method of assembly of the various units which comprise the television receiver, and the framework which houses them is described. The sound receiver is also briefly redescribed.*

The sound and vision receiver chassis are screwed on the right-hand side of the upper shelf and the time-base on the left-hand side at the rear. Between these and immediately beneath the tube base are mounted the two 0.01 mfd. high-voltage condensers for the line deflecting plates. The two 0.1  $\mu$ F. condensers for the frame deflecting plates and the four 5-megohm resistances are contained in a small wooden box and screwed underneath the shelf under the time-base. These components are fitted in a box to guard against accidental contact with any of the connections for many of these are at high voltage. The connections to the 0.01  $\mu$ F. condensers are

necessarily made outside the box and the joins should consequently be carefully wrapped with rubber insulating tape, many layers being used.

### The Connections to the Tube

The theoretical circuit of the tube and its immediately associated equipment, which must be considered a part of the framework, is given in Fig. 5 and the practical wiring plan will be found among the other drawings which also show the way in which the various units are interconnected. There are many connections and great care should be taken to see that no

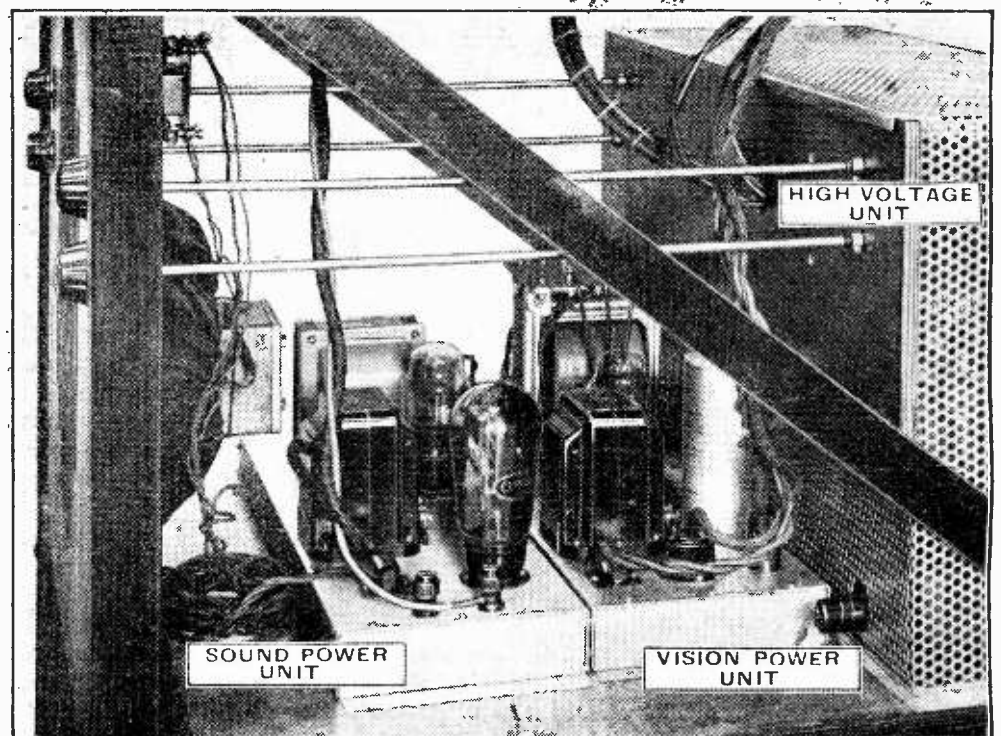

A side view of the lower shelf showing the power units.

DESIGNED BY W. T. COCKING

# Receiver

This box, mounted under the time-base, contains the condensers C3 and C4 and four resistances.

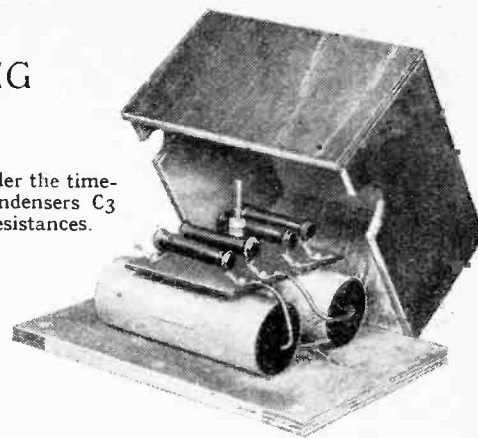

mistakes are made. The deflection plate connections may be a little confusing but no damage will result if an error is made. If the connections to the Y-plates are reversed the picture will appear upside

down. The deflection plate connections may be a little confusing but no damage will result if an error is made. If the connections to the Y-plates are reversed the picture will appear upside

distance from the Alexandra Palace. In the writer's experience the best results are secured from a centre-fed half-wave dipole mounted vertically and with a reflector behind it. Details regarding various types of aerial were given in a recent issue of *The Wireless World*,<sup>1</sup> and from the data given there it is easy to obtain the dimensions and method of construction of a suitable type.

## The Aerial System

Within two or three miles of the transmitter good results can be secured with almost any aerial, even the ordinary broadcast aerial. At greater distances a dipole is to be recommended, and at eight miles or more the addition of a reflector is strongly to be advised since it doubles the signal strength as well as greatly reducing interference which originates to the rear of the array.

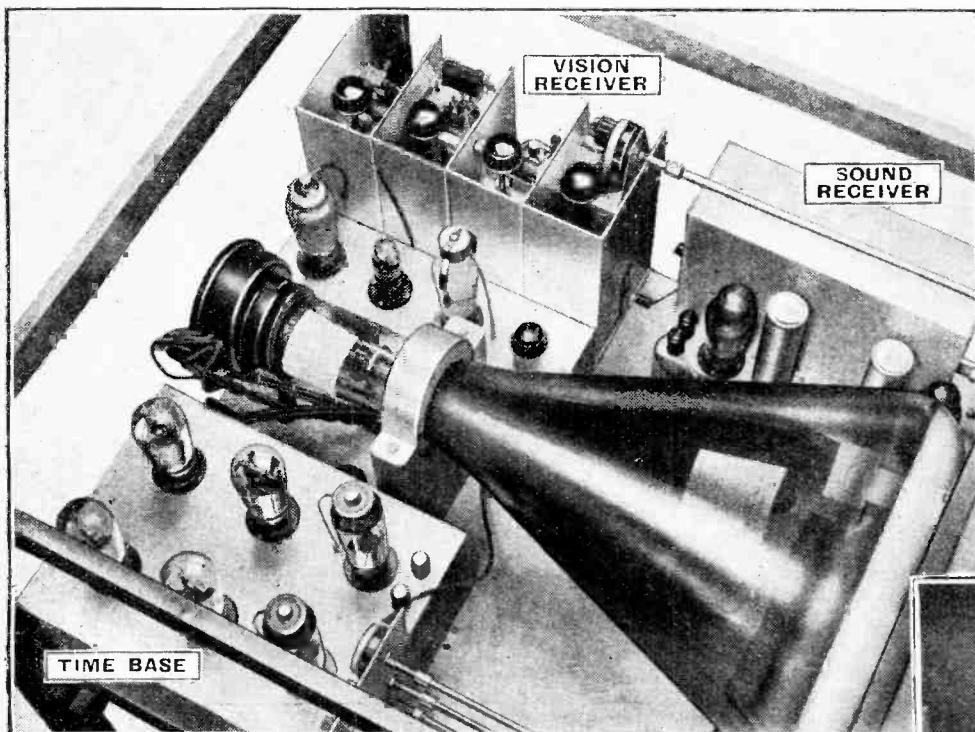

The receivers, time-base, and tube are clearly shown in this illustration.

down, while a reversal of the leads to the X-plates will reverse the picture from left to right. The remedy is obvious, but it should be pointed out that should such a misconnection occur, it can be put right either by reversing the leads on the tube socket or on the appropriate time-base plug.

## The Sound Receiver

The power units are all mounted on the lower shelf and the connections pass through holes in the upper shelf. Except in the case of the high-voltage unit, plug and socket connectors are used throughout. The AF connection between the sound receiver and its power unit is screened, as is also the lead between the vision receiver and time-base.

Although the sound receiver has been already described, the circuit diagram is repeated here for convenience of reference. It will be seen from Fig. 7 that a single

This photograph shows the condensers C1 and C2 beneath the tube base.

ated by a single control knob. Following the detector, for which a metallised valve must be used, comes another triode. When the Push-Pull Quality Amplifier is employed this valve acts as a phase-splitter and gives little gain. When the smaller amplifier described last week is employed, however, the resistance R10 is short-circuited and the valve acts as an amplifier giving good gain and an output adequate to load a PX4-type valve.

It will be seen from the drawings that the two aerial coils of the sound and vision receivers are connected in series and joined to the aerial. The type of aerial used is of considerable importance, especially when the equipment is used at any great

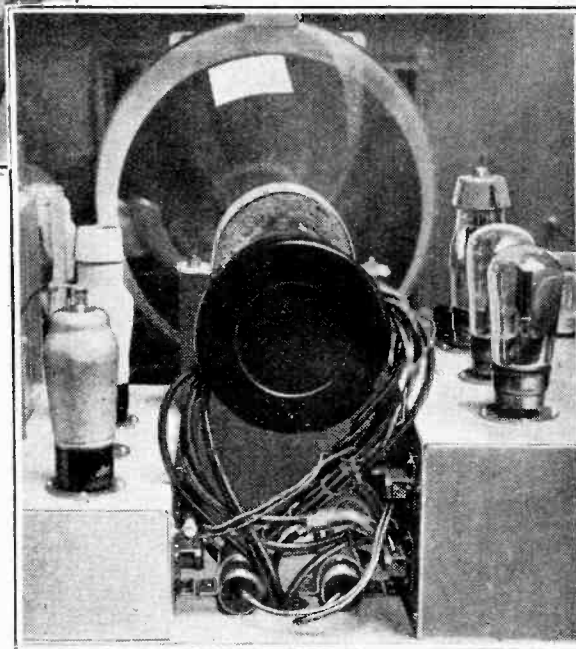

Whatever aerial system is used it should be erected as high as possible and away from metalwork such as drain pipes and gutters. In particular, it should be kept away from any metalwork which is a multiple of a half-wave in length. A drain

<sup>1</sup> *The Wireless World*, May 28th, 1937.

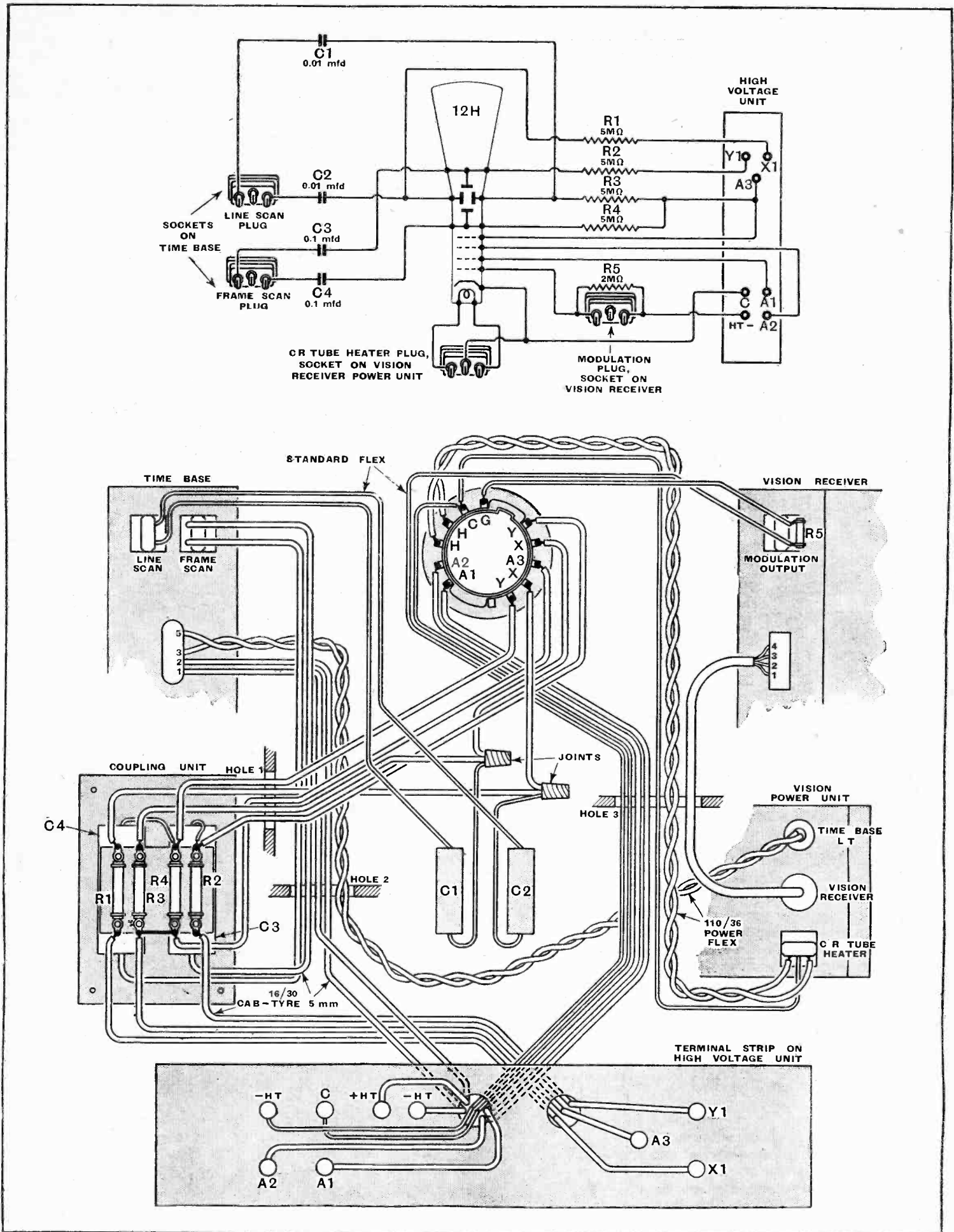
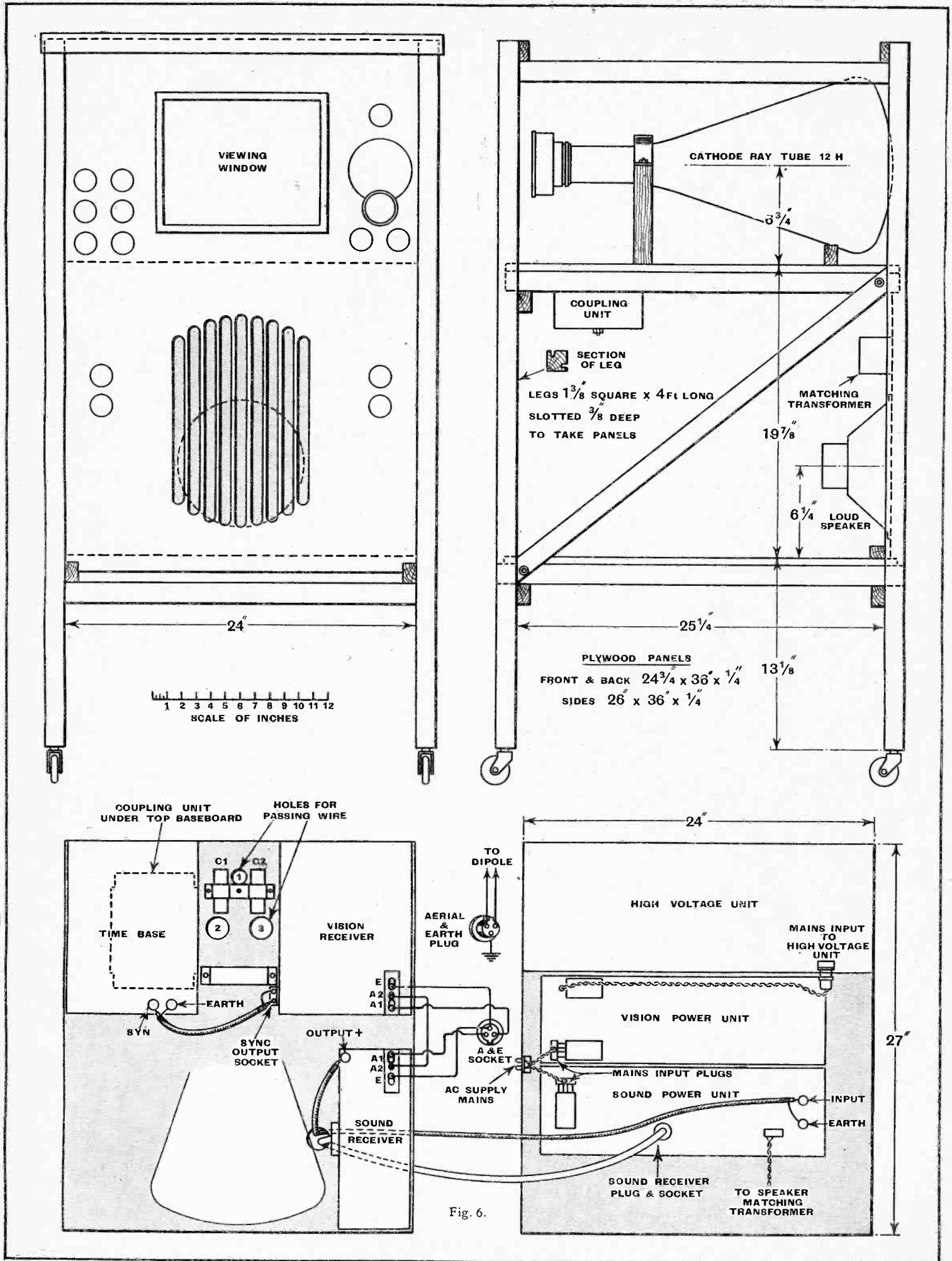

Fig. 5. Circuit diagram and practical wiring plan of the cathode-ray tube and connections to its associated units. The coupling unit should be wired before the high-voltage unit is inserted in the cabinet. On the opposite page, Fig. 6 shows suggested cabinet and layout; also wiring of terminal strips and inter-unit connectors.



**The Wireless World Television Receiver IV—** pipe of 11ft., 22ft., 33ft. in length will resonate at the wavelength of the vision signal and if it is close to the aerial, within 11ft. or so, it is likely greatly to reduce the efficiency.

Whether a reflector is used or not, the dipole must be joined to the receiver by a feeder of definite impedance (some 72 ohms). Special feeder cable in 60ft.

**LIST OF PARTS FOR FRAMEWORK AND ASSEMBLY OF UNITS**

- 1 Cathode Ray tube Ediswan 12H
- 1 Tube base (G.E.C. type) Bulgin CR10
- Fixed Condensers:**
- 2 0.1 mfd., 5,000 volts, tubular, C3, C4 Dubilier
- 2 0.01 mfd., 5,000 volts, tubular, C1, C2 Dubilier
- Resistances:**
- 1 2 megohms, 1/2 watt, R Erie
- 4 5 megohms, 2 watts R1, R2, R3, R4 Erie
- 11 Extension rods, 1/4 in., two 15 1/4 in., five 14 in., four 18 1/2 in. Bulgin
- Miscellaneous:** Peto-Scott
- Wood, glass, screws, sistoflex, wire, etc.

jects and so does not need any special attention in the way of spacing from walls. It should, however, be run tidily and in such a way that it is not subjected to mechanical strain, otherwise a broken conductor will sooner or later interfere with reception.

*The operation of the equipment and the necessary initial adjustments will be described in next week's instalment.*

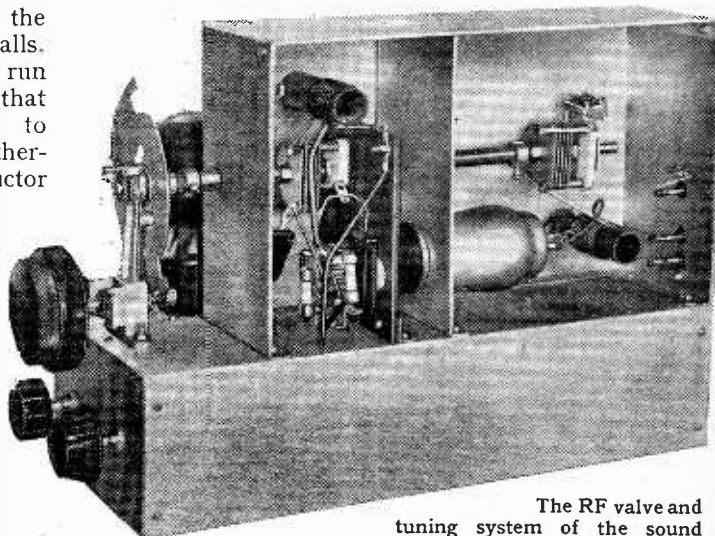

The RF valve and tuning system of the sound receiver are clearly shown here.

**LIST OF PARTS USED FOR THE SOUND RECEIVER**

*Certain components of other makes but of similar characteristics may be used as alternatives to those given in the following list.*

- 2 Variable condensers, 40 mmfds., C1, C5 Bulgin SW95
- "Apex Economy" Webb's Radio
- 14, Soho St., W.I.
- 1 Variable condenser, 15 mmfds., C6 Eddystone 1070
- "Apex Economy" Webb's Radio
- 1 Dial, dual ratio Eddystone 1070
- Condensers:**
- 2 0.01 mfd., mica, C3, C10 T.C.C. "M"
- 1 0.0001 mfd., mica, C7 T.C.C. "M"
- 2 0.0005 mfd., mica, C4, C8 T.C.C. "M"
- 1 50 mfd., 12 volts, electrolytic, C11 T.C.C. "FT"
- 2 8 mfd., 460 volts peak, electrolytic, C9, C12 T.C.C. 802
- 1 Trimmer, C2 Bulgin SW95
- 2 Coils
- 3 Extension control outfits Eddystone 1008
- 1 Valve holder, 7-pin (without terminals) Clix Chassis Mounting SW Type V5
- 1 Valve holder, 5-pin (without terminals) Clix Chassis Mounting SW Type V5
- 1 Valve holder, 7-pin (without terminals) Clix Chassis Mounting SW Type V5
- 1 Socket strip Clix "C"
- 2 Terminals, ebonite shrouded, output +, - Belling-Lee "B"
- 1 Group board, 10-way Bulgin C32
- 1 Plug top valve connector Belling-Lee 1175

lengths is available from Belling and Lee and is to be recommended. The loss in the feeder naturally increases with length but in any reasonable quantity is negligible. There is, consequently, no need to choose

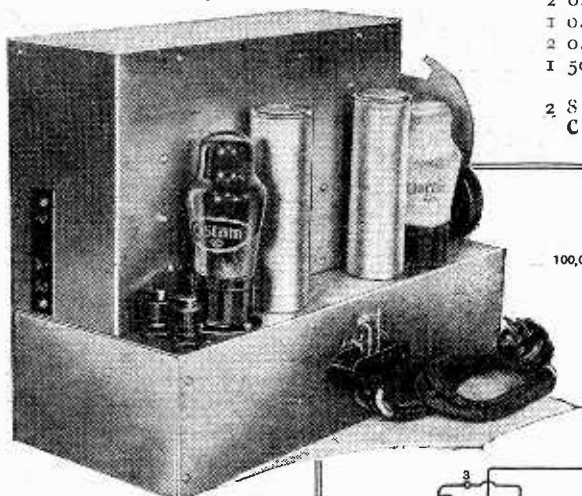

The sound receiver, showing the detector and AF valves.

(Right) Fig. 7.—The complete circuit of the sound receiver is shown here for the Push-Pull Quality Amplifier. When used with the smaller power unit R10 should be short-circuited.

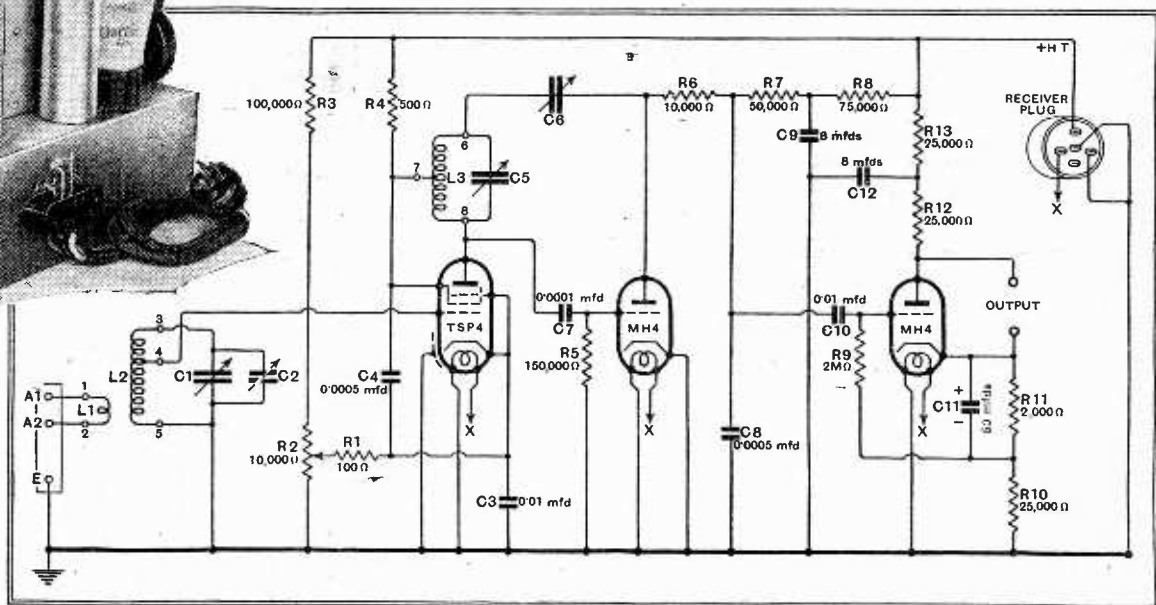

the aerial position for a short lead-in and it can be selected solely on its merits for reception. If the attainment of an extra five feet in aerial height involves an increase in feeder length of twenty feet or more by virtue of a different aerial position, the change will probably be well worth while.

The feeder itself consists of two wires embedded in insulating material and it is unlikely to pick up interference to any serious degree. It is "dead" to external ob-

- Resistances:**
- 1 100 ohms, 1/2 watt, R1 Dubilier F 1/2
- 1 500 ohms, 1/2 watt, R4 Dubilier F 1/2
- 1 2,000 ohms, 1/2 watt, R11 Dubilier F 1/2
- 1 10,000 ohms, 1/2 watt, R6 Dubilier F 1/2
- 3 25,000 ohms, 1/2 watt, R10, R12, R13 Dubilier F 1/2
- 1 50,000 ohms, 1/2 watt, R7 Dubilier F 1/2
- 1 75,000 ohms, 1/2 watt, R8 Dubilier F 1/2
- 1 150,000 ohms, 1/2 watt, R5 Dubilier F 1/2
- 1 2 megohms, 1/2 watt, R9 Dubilier F 1/2
- 1 100,000 ohms, 2 watts, R3 Dubilier F2
- 1 Potentiometer, 10,000 ohms, wire-wound, R2 Haynes Radio

- 1 Connector, 5-way Bryce
- 1 Cable, 5-way, with twin 70/36 leads and 5-pin plug Goltone
- Chassis** B.T.S.
- Miscellaneous:** Peto-Scott
- 2 Lengths Systoflex, 1 oz. No. 18 tinned copper wire, aluminium for brackets, etc. Screws: 48 6BA 1/4 in. R/hd.; 2 4BA 3/4 in. R/hd.; 2 6BA 1 in. R/hd.; all with nuts and washers.
- Valves:**
- 1 TSP4, metallised Mullard
- 1 MH4, plain Osram
- 1 Mf14, metallised Osram



# Broadcast Brevities

## NEWS FROM PORTLAND PLACE

### Human Wants of the Empire

WHILE Portland Place is spending sleepless nights—and days—in puzzling out what mental pabulum to provide for the heterogeneous masses who go to make the Empire what it is, those same masses have their own idea of their broadcasting wants. And very human are their needs.

### Big Ben Makes the Running

In writing to the B.B.C. Empire listeners still put Big Ben at the top of the list of what they want to hear, with news bulletins a close second. Talks must have an Empire flavour, e.g., the "Responsibilities of Empire" series, or must be about the English countryside. "In Town To-night," with its characteristic London atmosphere, is another favourite feature.

### Technical Hitches: Some Inner History

THE "technical hitches" which cause shut-downs involve a multitude of major and minor mishaps difficult to explain to the public at large. Many radio amateurs, however, would often be grateful for more information, and if some of the transmission logs were published the B.B.C. engineers might win a good deal of sympathy from the people who understand something of the difficulties involved.

### Nightmare at Daventry

Here is the cold-blooded record of a real nightmare at Daventry a fortnight ago:—

"GSI.S.6 shut down from 23.21.30 to the end of the transmission (41 minutes 30 seconds) and from 00.17.00 to 00.24.00 due to (a) suspected rocky point on gap 5 with CAM 4 and 5 grid meters and grid resistances burnt out, (b) failure of drive due to unreliable plate coil connections in amplifier No. 1, (c) fault on control circuit preventing closing of A.C.B."

### When the Hook Parted

Next day there were three more spots of bother:—

"GSI.S.3 shut down from 03.00.00 to 03.12.00 due to failure of right-hand anode tuning condenser in demountable valve unit.

"GSI.S.3 shut down from 04.50.00 for the last 10 minutes of transmission 6. Overheating of anode condenser in demount-

able valve unit which had been inserted at 03.12.00.

"GSO.S.3 shut down from 07.01.00 to 07.07.30 due to array selector switch 'C' parted on hook."

The Daventry log-book is a masterpiece of literary restraint.

### Victoria Regina

PEOPLE have been wondering whether the B.B.C. has overlooked the splendid broadcasting material in Mr. Laurence Housman's now famous series of plays, *Victoria Regina*. Actually, the Corporation is now considering a series of broadcasts incorporating not only the *Victoria Regina* plays but several original plays by Mr. Housman on the same theme.

Look out for an interesting announcement.

### High Jinks on the South Coast

CAR radio will perform a new role on August 12, when Harry Pepper produces his "Round the Fol-de-Rols" programme, in which different companies at Eastbourne, Llandudno, Sandown and Hastings will broadcast in quick succession in order to provide National listeners with one continuous seventy-minute show.

Harry Pepper will make his opening announcement at Eastbourne; then, when the show is under way, he will dash off by car to Hastings to give the closing announcement there. While *en route* he will listen to the show on his car radio.

### Cues by Radio

To guard against breakdown a second car will follow, also fitted with radio.

Incidentally, the Fol-de-Rols at the different seaside towns will listen to each other's performances and will take their cues by radio. Harry Pepper will have one assistant and two OB engineers at each point. At least twelve microphones will be used.

### Queen's Hall Alterations

WILL the new decorations and seating arrangements in the Queen's Hall be noticeable by listeners to the "Proms"? Such a thing is just possible, for the alterations have included new seating arrangements and an improved system of ventilation. Everyone knows that the size of an audience affects the acoustics of a building, but perhaps attention has not been given to the effect of an audience's shape. The new seats are so luxurious

that the occupants sink into them, and, although only the select few get a seat at the "Proms," it is quite likely that their characteristic curves in the new seats may set up unexpected resonances. Anyhow, we shall hear.

And, of course, a new ventilation system may play the deuce with the sound waves.

### Sir Henry's Forty-third

The "Proms" programmes for 1937 follow the well-tryed model. Mondays will, as always, be dedicated to Wagner; Wednesdays will oscillate between Bach, Brahms, and Handel; Fridays will be sacred to Beethoven; and Saturdays will be "popular" nights.

Every night, however, will be Sir Henry Wood's night. The G.O.M. of British music will be

record (Big Ben is now relayed direct). At the close of the evening television transmission the man at control placed the needle in the wrong groove. Viewers were surprised by the yapping of a terrier.

### Truth About the Sync Signal

NO drastic overhaul of the apparatus at Alexandra Palace will take place during the "shut down," one excellent reason being that the transmitters will be functioning on most days during that period.

But the gear will be "tidied up," to use the engineers' own expression, and during the process special attention will be given to the synchronisation pulses, but they will not be increased in power.

### Resumption

After the "shut-down" period transmissions from August 16th to 21st will be at the normal hours, 3-4 and 9-10.

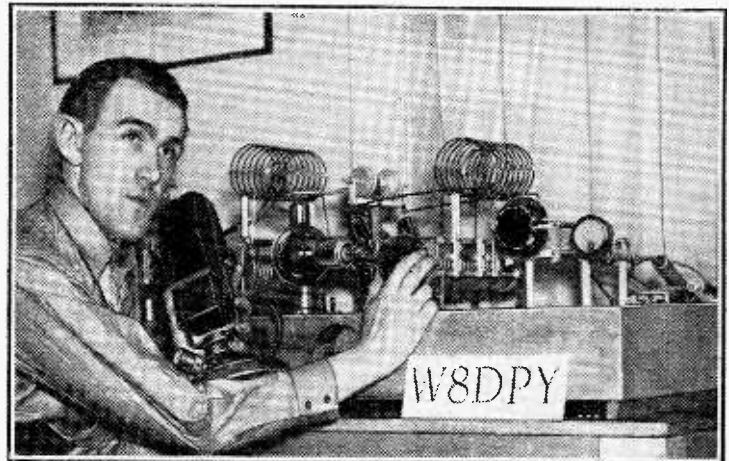

DURING THE U.S.A. FLOODS last March, Walter Stiles, jun., after spending all night handling emergency messages, received a desperate call for help from a township 70 miles distant. Stiles, who is here seen with his apparatus, set out on an all-night journey with the relief party, taking with him his portable transmitting gear with which he handled traffic continuously for 24 hours, until relieved by two other operators. For a total of 160 hours his station formed the sole link between the stricken town and the outside world. For his work in this emergency Stiles received the first annual William S. Paley award, and the presentation ceremony was broadcast on the Columbia Network.

conducting his forty-third Promenade season.

### Syncopating Big Ben

NO listener seems to have noticed that Big Ben appeared to strike two at teatime one day last week. The engineer controlling the National transmission inadvertently switched out the Westminster chime after the first stroke of five; then, realising the mistake, he plugged back again, but only in time to get the last stroke.

### A Dog Barked

A worse mistake occurred at Alexandra Palace a few weeks ago, when clock chimes were taken from a gramophone

On August 23rd and 24th, the two days prior to the opening of the Radio Show at Olympia, there will be three hours' transmission of film, with sound announcements, the additional period being from 11.30 a.m.-12.30 p.m.

During the show, from August 25th to September 4th, there will be three one-hour transmissions daily. These will be given from 11.30 a.m. to 12.30 p.m. (film) and from 4-5 and 9-10 (actuality).

After the exhibition normal programme times will be resumed, with an additional morning period for trade purposes, made up as follows: 10.30-11 a.m., cruciform pattern with tone, and 11 a.m.-12 noon, magazine sound films.

# 40-Metre Working

MODIFYING THE SIMPLE TWO-  
VALVE TRANSMITTER FOR 7 MC/S OPERATION

By

AUSTIN FORSYTH

G6FO

**M**ANY readers have enquired if the 1.7 Mc/s transmitter described in *The Wireless World* dated June 11th can be modified for working on 40 metres by altering the values and substituting a 7 Mc/s crystal.

The answer is that it can and it can't! In anticipation of such enquiries, tests have been made to check performance on 7 Mc/s—though the set was originally intended only for 160 metres, as explained in the article—and it has been found that in the hands of a competent operator the transmitter will actually give results on any band.

The difficulties are not so much with CW as in telephony working, due to the fact that with such a simple arrangement—a directly controlled power oscillator—frequency modulation is almost inevitable when speech is being used. With proper adjustment this is not evident on 1.7 Mc/s, but it becomes so on the much higher frequency of 7 Mc/s. Further, as implied in the article, ordinary crystals will not generally stand such hard treatment, direct excitation and keying, as they will on 1.7 or 3.5 Mc/s, hence the fact that this point also introduces a difficulty.

However, in view of the interest shown in this question of 40 m. working, the circuit has been modified slightly, as given with values in Fig. 1. The crystal is now loose-coupled to the grid circuit, thus reducing the crystal load while retaining the essential feature of frequency control by the crystal. Tuning and adjustment are the same as before.

## Checking Frequency

It should be noted that the transmitter is much more tricky on 7 than on 1.7 Mc/s, and it will be very necessary when tuning on to the crystal frequency for the first time to have a monitor available so that after the grid and plate circuits have been resonated the crystal frequency can be found correctly. Though the point at which the crystal takes control can be seen by a double-dip on the plate milliammeter, a monitor on which the right frequency can be located is almost essential for correct adjustment. An additional reason for this is that crystals, when directly excited in circuits of this type, exhibit curious properties. They appear to have a number of resonant frequencies, far removed from the fundamental, on any of which some degree of control is possible. This in spite of the fact that when used in the ordinary way only one resonant point occurs—the fundamental. The writer believes that through the medium of the transmitter described

in the original article he has found the answer to every amateur's prayer—the perfect "rubber crystal"! At all events, two otherwise normal specimens give between them varying depths of control on upwards of thirty points in the 1.7 Mc/s band. Several other crystals on different bands behave in the same way when directly excited, and the phenomenon is now being investigated; it was first observed by the writer about seven years ago, but was then put down as being due to poor manufacture.

## The Circuit

Reverting to Fig. 1, it is evident that the circuit is actually a tuned-plate-and-grid with crystal lock, and the performance depends entirely upon the efficiency of the

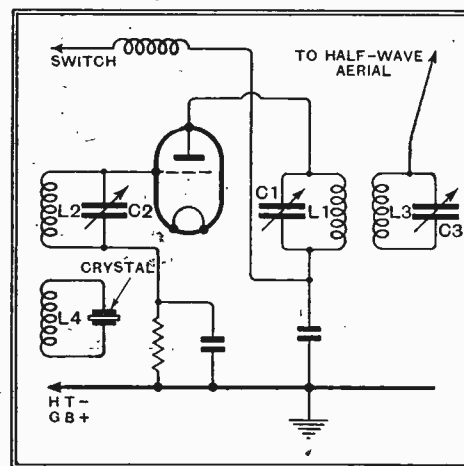

Fig. 1.—Modification to oscillator circuit for 7 Mc/s operation. A power-type crystal should be used, loose-coupled as shown. Values for 7 Mc/s are: L1, L3, twelve turns No. 12 enamelled, 3in. dia. spaced about  $\frac{1}{4}$ in. between turns. L2, thirteen turns No. 18 enamelled, slightly spaced on valve-base or similar former (1 $\frac{1}{4}$ in. diameter approximately). L4, three or four turns closely coupled to and on same former as L2. All other values as given in the issue dated June 11th.

lock. If it is made too great, the crystal is over-loaded, as it would be when direct-coupled; if it is too loose, there is not enough control and the transmitter output is unstable. A 7 Mc/s power crystal should be used, and as the degree of coupling required varies with different crystals, some alteration of the turns of L4 may be necessary.

A further point is with regard to the aerial circuit; on 40 metres a half-wave wire is usually possible (66ft. long approximately), and this should be coupled as shown. The same aerial can be tapped

direct to L1—varying the coupling by moving the clip up or down the coil—but this method, though simple, is not advisable. The loose-coupled arrangement is better in every way, and tuning is perfectly simple: with the tank circuit L1-C1 at resonance (minimum plate current) the coupling between L1 and L3 is set at several inches and, with the aerial connected, C3 is rotated till that circuit tunes, indicated by a slight rise in plate current. The coupling is then increased and both condensers C1 and C3 brought to resonance—the circuits L1-C1 and L3-C3 react on one another more and more as the coupling is tightened, this process being continued till the valve is drawing the required plate current. If the no-load current is about 10-15 mA, the best transfer will usually be when the coupling is adjusted to produce about 30 mA "draw."

While the modified circuit will give satisfactory CW performance on 7 Mc/s, some trouble may be experienced on 'phone for the reason already mentioned, and therefore when modulating on this band the depth of control must be kept low, not more than 50 per cent. or so on peaks.

To sum up, then, it can be said that the transmitter will work well when modified and carefully adjusted, but those who are unfamiliar with this type of circuit would be well advised to carry out some preliminary tests with an "artificial aerial" before going on the air with the set.

## AMERICAN THREE- CIRCUIT INTER- MEDIATE- FREQUENCY TRANSFORMER.

The latest type of 465-kc/s IF coupling developed by Aladdin Radio Industries, Inc., of Chicago. Primary, secondary and intermediate circuits are all tuned by trimmers mounted at the top of the assembly. The resonance curve has a broad flat top about 8 kc/s wide, with steep sides.

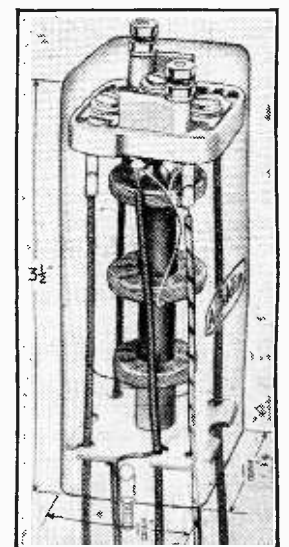

## Television Expenditure

IN reply to a question in the House, the P.M.G. has stated that his Department is considering the question of whether the B.B.C.'s income is adequate for it to conduct efficiently the services entrusted to it. The question of the expenditure on television is the subject of special consideration.

## Russian Television

A TELEVISION exhibition is to be held in Moscow during the autumn in connection with the celebrations attending the twentieth anniversary of the Soviet régime.

## Brussels Rejects Relays

IN view of the strong protests which have been made by Belgian manufacturers and traders, the various Communes forming Greater Brussels have decided to abandon their project of instituting an inter-communal wireless relaying system for distributing programmes.

## Pirate Transmissions

MANY short-wave enthusiasts are reporting reception of signals on the 7 Mc/s (40-metre) band from G6SL. This call-sign is allotted to the experimental station at the Eddystone works of Stratton and Co., Ltd. This station is at present in the process of reconstruction, and in any case confines its activities to the 56 Mc/s (5-metre) band. The transmissions must therefore be coming from an unlicensed station which is illicitly using this call-sign.

## Lazy Man's Tuning

SPASMATIC attempts have been made from time to time in this country to produce sets of the so-called "automatic" type in which any given station can be tuned in by using a dialling arrangement similar to that used in the case of the automatic telephone system. Similar arrangements have also appeared in the U.S.A., but it now seems that the Americans are taking these automatic tuning systems really seriously, as a large number of receivers embodying these arrangements in some form or other are being produced for the coming season. These and similar systems are known in America by the somewhat appropriate description of Lazy Man's Tuning.

## The Oriental Mind

IN Japan, talks and educational programmes are far more numerous than those intended for entertainment, and it is reported that, owing to the peculiar psychological make-up

# Current Topics

NEWS OF THE  
WEEK IN  
BRIEF REVIEW

of the Japanese people, they are actually more popular. Educational broadcasts are now divided into three categories, there being a special Kindergarten hour and a "Higher Education" hour, in addition to the ordinary transmissions for schools. Over 3,000 schools are now provided with wireless sets.

## N.R.E.A.

THE 1937 Western Area examinations for the Fellowship of the National Radio Engineers' Association will take place at Bristol next Wednesday (July 28th). The chief examiner will be Mr. A. R. Twiss, F.R.E.A., M.I.E.E. Applications should be made not later than to-morrow (July 24th) to Mr. G. E. Palmer, Western Area secretary, 3, Two-Mile Hill, Kingswood, Bristol. Tel.: Kingswood 73218.

## An Important Legal Decision

THE French Court of Cassation has upheld the decision of the Court of Appeal and the Lower Court in an action brought by a wireless trader against a doctor. The action was in respect of the grave prejudice caused to the business of the wireless trader by the doctor's electro-therapeutic apparatus. The trader alleged that the doctor's apparatus caused serious interference with the listening of his customers, this having, indirectly, an adverse effect on his business. The two Lower Courts decided in favour of the trader, and the Court of Cassation has agreed with them.

## New Ceylon Station

THE new 5 kW. Colombo station was designed by the Ceylon Radio Department and, to a large extent, was constructed on the island. The relatively few parts of the transmitter which are of external origin were ordered from England. An entirely new studio has also been built.

## The Theatrophone

THE new Beaujon Hospital in Paris claims to have the most up-to-date wireless installation in existence. There are forty loud speakers and nine hundred pairs of headphones.

Each pair of headphones is provided with a separate volume control which the patient can adjust to suit his particular needs. The patients can not only be supplied with broadcasting programmes or with gramophone recitals and concerts originated within the hospital, but they can be connected by landline with any of the Paris theatres by means of the Theatrophone service.

## American Trade Figures

ACCORDING to the latest figures available, there are approximately 60 firms solely devoted to the manufacture of wireless sets, and 40 valve-makers. The manufacturers of PA systems are said to number

are put out by French sponsored-programme stations. They are demanding that, if these stations are to continue, their programmes will have to be raised to a much greater artistic level, the name of the sponsoring firm being announced once only at the beginning and again at the ending of the programme.

## Italy and Radio Advertising

ALTHOUGH the Italian Minister of Popular Culture is said to have come to a decision to suppress radio advertising, it does not necessarily mean the disappearance of the sponsored programme. Provided that a complete programme of real artistic merit is prepared it will not be illegal for a firm to make it known that they are responsible for it. Apparently, however, advertising of the coarse and blatant type, likely to offend against refined taste, will no longer be tolerated.

## French High-power Station

THE two transmitters at the French national station now being built at Allouis will each be capable of transmitting with a power of 500 kW. The

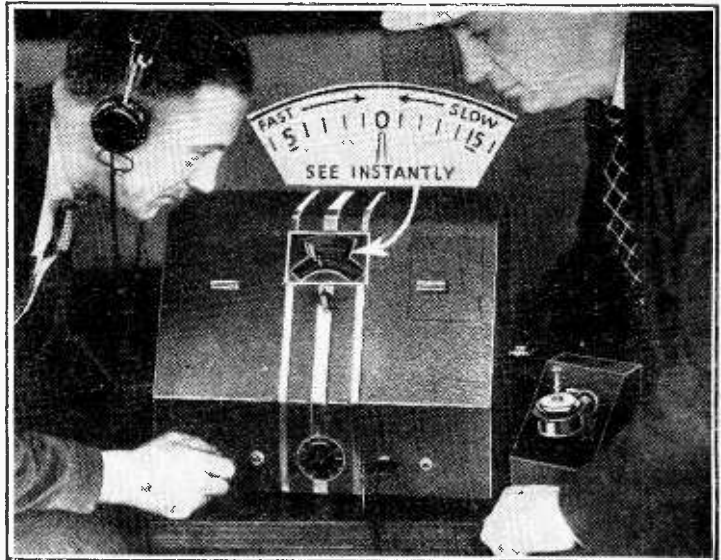

**AMPLIFIER FOR WATCH REPAIRERS.** The watch is placed on the microphone to the right, and is compared with a standard clock in the instrument so rapidly that it can be regulated in three or four minutes. In addition, provision is made for using the amplifier as an aid to the location of defects; it is stated that a cracked jewel, a bent balance wheel or a worn pinion each produces a distinctive sound in the headphones

no fewer than 150, but it must be remembered in America this includes many firms who make nothing but loud-speaking inter-office communication systems. There are no reliable figures available concerning radio component manufacturers.

## Boring Programmes

IT is stated the French listeners are becoming rather satiated with the indifferent programmes, interlarded with false facetiousness and cheap witticisms, which

work of installing the apparatus is expected to commence almost immediately.

## Miscellaneous Advertisements for August 6th Issue

WITH the approach of the August Bank Holiday slight alterations are necessary in our printing arrangements. Miscellaneous advertisements intended for the issue of August 6th must be received not later than first post on Friday, July 30th.

# Belmont MODEL 700

## High Sensitivity and Good Quality in a Compact Table Model

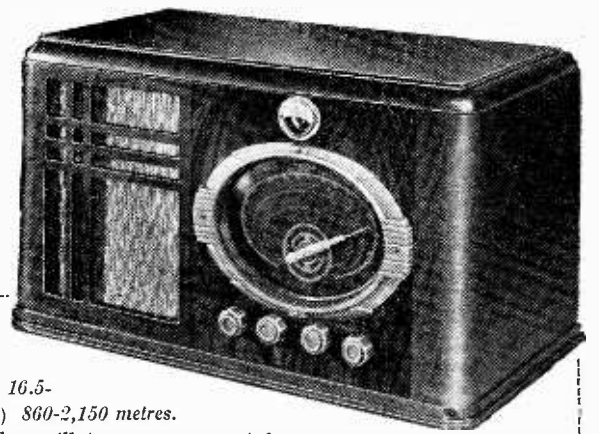

As the result of arrangements which have recently been completed, sets of this make are now being manufactured in this country. The Model 700 is a worthy representative of the range and has many points, both in cabinet design and performance, which cannot fail to earn for it a good reputation.

The large oval dial is distinctive, and if we may disagree with the arrangement of scales in which the greatest length goes to the long-wave range, which needs it least, there is no denying the lucidity of the station calibrations and the convenience of the indicator showing the setting of the waverange switch.

Immediately above the tuning scale is the cathode-ray tuning indicator. This is provided with a shade so that the glow is still easily distinguishable in bright light. Tuning controls are four in number and are arranged in a row immediately below the oval dial. They are not identified by any form of lettering, but one soon learns to memorise the order which, from left to right, is as follows: Volume control and on-off switch, tone, tuning, waverange switch. A separate switch at the back of the chassis is used to change over from radio to gramophone, and it should be noted that the volume control operates only for radio reception, and that a pick-up incorporating a separate volume control will be required.

From the moment of switching on there can be no doubts of the outstanding sensitivity of this receiver. This is a property

**FEATURES.**—Table model super-heterodyne for AC mains. (190-280 volts, 50 cycles). **Waveranges.**—(1) 16.5-56.5 metres. (2) 187-588 metres. (3) 860-2,150 metres. **Circuit.**—Heptode mixing valve—triode oscillator—var-mu pentode IF amplifier—double-diode triode second detector—pentode output valve. Full-wave valve rectifier. **Controls.**—(1) Tuning. (2) Volume and on-off switch. (3) Tone. (4) Waverange. (5) Radiogram. switch. **Price.**—13 guineas. **Makers.**—British Belmont Radio Ltd., Belmont House, 4/5, Ridgmount Street, London, W.C.1.

which is not shared by one waveband alone, nor is there any obvious falling-off at the ends of each range. In daylight the medium-wave range is crowded with stations, and the majority of the long-wave transmissions are fully loading the loud speaker before the volume control reaches the half-way mark. The short-wave performance is no less convincing, and so far as sensitivity is concerned the reception of American transmissions will be effortless whenever conditions in the ionosphere permit a signal to get across. There is room for improvement, however, in the ratio of the slow motion control for this range, and a certain delicacy of touch is necessary when making the final adjustment of tuning.

### Signal-to-Noise Ratio

High sensitivity brings its own special problems, and before it can be allowed full rein a set must be cleaned up so far as background noise and whistles are con-

cerned. This precaution has been taken in the Model 700, and there is nothing to complain of in the set's behaviour while the pointer is traversing the short gaps between useful stations. The high intermediate frequency (465 kc/s) compensates to some extent for the fact that there is only one stage of preselection on short waves, and second-channel repetition points for stations have to be carefully searched for to be found.

On the medium-wave range, for which a band-pass filter is provided, the selectivity is sufficient to give clear reception outside 1½ channels on either side of the power local stations and on long waves, where there is a single tuned circuit instead of the band-pass filter, station separation though adequate is not quite sufficient to give Deutschlandsender clear of Droitwich and Radio-Paris in London.

No less impressive than the high sensitivity is the quality of reproduction which provides ample justification for those who maintain that an off-set speaker in a

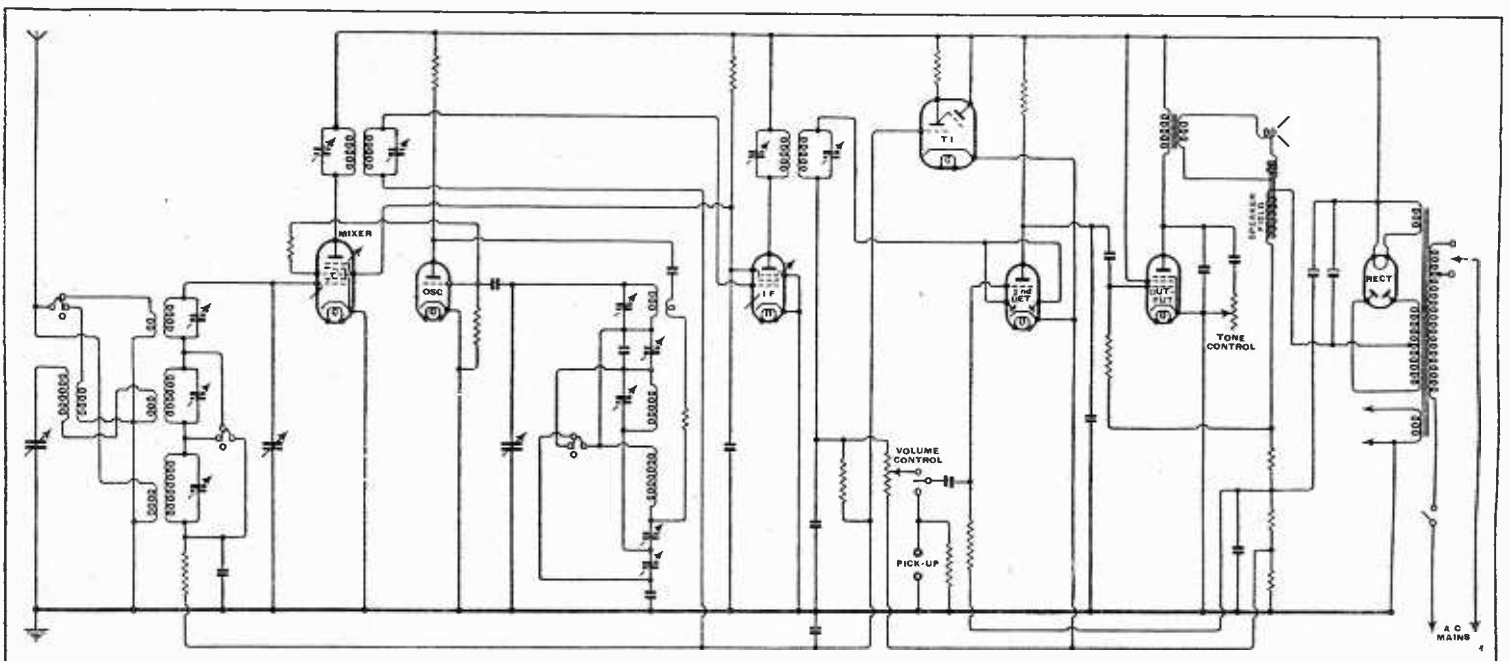

A band-pass filter is used on medium waves and single tuned circuits on the short- and long-wave ranges. Separate valves are used for the oscillator and mixing functions of the frequency-changer.

**Belmont Model 700—**

cabinet of a horizontal type is an effective method of steering clear of cabinet resonances and the peaks and troughs which a symmetrical arrangement gives. Certainly there is in this set a wide and mobile bass response, and the top register is crystal clear with no trace of the 2,500-cycle peaks which so often set a limit to the volume which can be tolerated.

At all events, no reduction of high-note response seems to be called for under any

using a separate oscillator in conjunction with a heptode mixing valve has been adopted. Apart from this and the fact that band-pass tuning is used only on the medium waveband, the circuit follows the usual layout with a var.-mu. pentode IF amplifier, double-diode-triode second detector and pentode output valve.

The chassis as a whole is neat and compact, and a good feature is the protection of the mains voltage adjustment by an easily detachable cover plate. The

reception of W2XE on 21.52 Mc/s seems to have been strongest on the second (typical) day, a result which bears out the evening performance.

These results, of course, quite definitely point to a fall in F layer ionisation on polar routes when the sunspot activity is excessive or of a particular kind, but to a steady increase in the F layer levels on equatorial or non-polar routes.

The important point, to which I have previously drawn attention in these notes, is that the agent responsible for the fall in

ionisation is able to distinguish between polar and non-polar routes. This is a well-known property of charged particles.

During the second Polar Year observations at Tromso in 1932-3<sup>1</sup>, the Radio Research Board reported that a complete cessation of echoes was often noted on their layer-height measuring equipment, the fade-out being complete on all available frequencies for vertical incidence pulses.

The explanation advanced to account for these phenomena was that they were due to severe attenuation of the signals caused by an increase in E (or lower layer) ionisation.

During the sunspot minimum years we often experienced magnetic storm activity when the F layer levels fell, following a decline in sunspot activity to zero. An analysis of the Polar year magnetic records also shows this effect, i.e., a magnetic storm accompanied the fade-outs, which also seems to be due to a fall in F layer ionisation.

It is not safe to draw hard-and-fast conclusions, but the inference is obvious.

This idea of a neutralising radiation from the sun seems to be quite recent, but is obviously worth further consideration.

Incidentally, it should not be implied from the foregoing that I retreat from the contention that on the whole sunspots are beneficial to short-wave propagation!

There was an error in my last notes. The "Five Hours Back" series is, of course, running from 7.30-8.0 p.m. on Fridays. It is the "America Dances" broadcasts taken at Tatsfield, via W2XE, of the Columbia system, which occur at 11.30 p.m.

Turning to more definite things one hears rumours of intended or actual increases in power of many of the Western stations. The Mexican transmitter XEWW on 15.16 and 9.5 Mc/s, for example, has a 10 kW (output) transmitter similar to W2XE, and TGW Guatemala City will also have one of this power shortly. Power increases are also rumoured for W2XAD and W2XAF.

Judging by the signal strength of GSG 17.79 Mc/s in London in the early evening, the Daventry Empire station is now pumping out some useful power.

On July 2nd sunspot activity was quite low, only one small group being visible, and in the late evening, at 10.50 p.m., W3XAL was fairly good, but W2XAD was very

<sup>1</sup> Appleton, Naismith and Ingram (Miss), Trans. Royal Society, Series A, 764, Vol. 236, 1937.

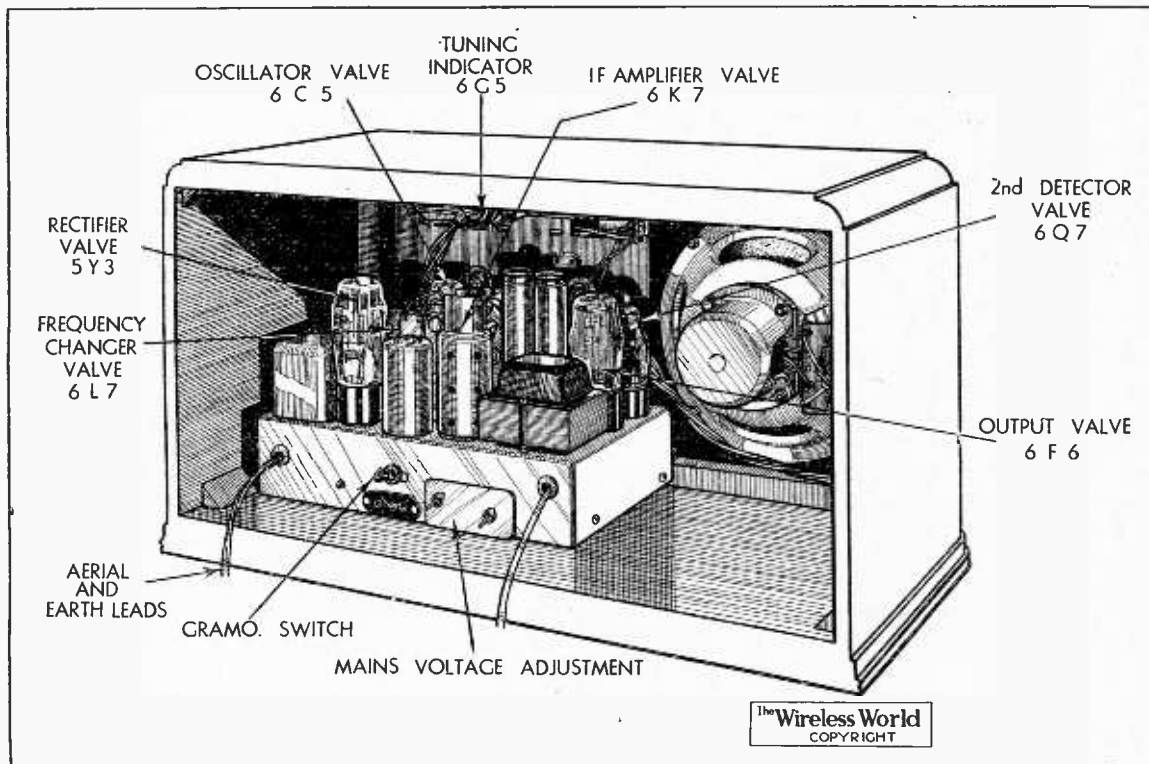

The change-over from radio to gramophone is effected by a separate switch at the back of the chassis. Extension loud speaker connections must be made directly to the terminal panel of the internal loud speaker unit.

conditions of operation, so that the fact that the range of the tone control is rather crowded towards the lower end does not amount to a serious criticism.

In the arrangement of the frequency-changing circuits the American practice of

cathode-ray tuning indicator, generally the least accessible of valves, is in this case not only the easiest to replace, but is mounted in a special clip with a detachable socket on flexible leads so that the image can be easily adjusted for angle.

# On The Short Waves

## NOTES FROM A LISTENER'S LOG

**T**HE past week has fortunately given one a further opportunity to study the effect of a high degree of solar activity in some detail.

From July 10th there has been an amazing increase in the number of spots, a total of forty or so having been counted on July 14th.

During this period careful observations were made during the late evening, when the effect of daylight, at least on the E layer, had largely worn off, on the U.S. and the easterly circuits, taking care to select signals in pairs, one of the pair having travelled via the poles (to a greater or lesser degree), and the other over a sensibly equatorial or non-polar path.

A most remarkable effect was noted on the first day of the increased activity: the optimum frequency increased on all the cir-

cuits, coupled with a general improvement in signal strengths.

The same effect was noted on the second day, although the hoped-for further improvement did not seem to materialise in case of the U.S. and Japanese signals.

On the third day, when an additional increase in activity was noted, a general deterioration took place in the high-frequency signals, about 16 Mc/s and higher, from the U.S. and Japan, the optimum frequency decreasing to between 13 and 15 Mc/s or so, but in the case of the Eastern (non-polar) signals the optimum frequency, as far as it was possible to judge, again increased and very high signal strengths were encountered on 18 Mc/s, and higher even over completely night paths.

No reliable comparisons are available in respect of daylight reception except that

**On the Short Waves—**

good indeed, and, as would be expected, excellent reception was also obtained on this occasion from W1XAL on 11.79 Mc/s.

The Japanese beam telegraph transmitters JNG-C-B, ranging from 19 to 13 Mc/s, were all good on Saturday afternoon, July 3rd, JNG on the highest frequency being easily the strongest.

A rather surprising round-the-world echo was heard on GSG at 10.30 p.m. on Sunday, and good conditions seemed prevalent.

Strong signals were intercepted from SPW, Warsaw, at 6.45 p.m. on Friday, July 9th, and good results were obtained in

the evening from those stations received regularly.

An interesting record was played at PCJ 9.59 Mc/s at 7.40 p.m. on Tuesday, July 13th. This record was composed of eight or nine separate recordings of the reception of various short-wave stations on a well-known commercial receiver.

Excerpts from the programmes of the following stations were heard: (1) W1XAZ Boston, (2) RNE Moscow, (3) LRX Buenos Aires, (4) W2XAD/F Schenectady, (5) PRF5 Rio, (6) I2RO Rome, (7) HVJ Vatican, and (8) VK3LR Melbourne.

Quite a bag! ETHACOMBER.

## Scophony Television System

### High-definition Pictures Projected on Large Screens

PERHAPS the most interesting feature of the Scophony system of television, of which a special demonstration was given to us recently, is that the picture is projected by means of a special optical system on to an external screen. The problem of adequately illuminating comparatively large screens has also been overcome by a new development known as the Supersonic Light Control. This differs from the usual method of scanning in that one whole line containing all the picture elements in that line is thrown on the screen at a time. It is claimed that by this means far brighter illumination is obtained than if the picture were scanned by a spot of light only. It is largely due to this development that screens of some 20 square feet in area can be employed and adequately illuminated with a standard cinema arc lamp.

The scanning portion of the Scophony high-definition home receiver is very compact and can be accommodated in a space approximately 30in. cube.

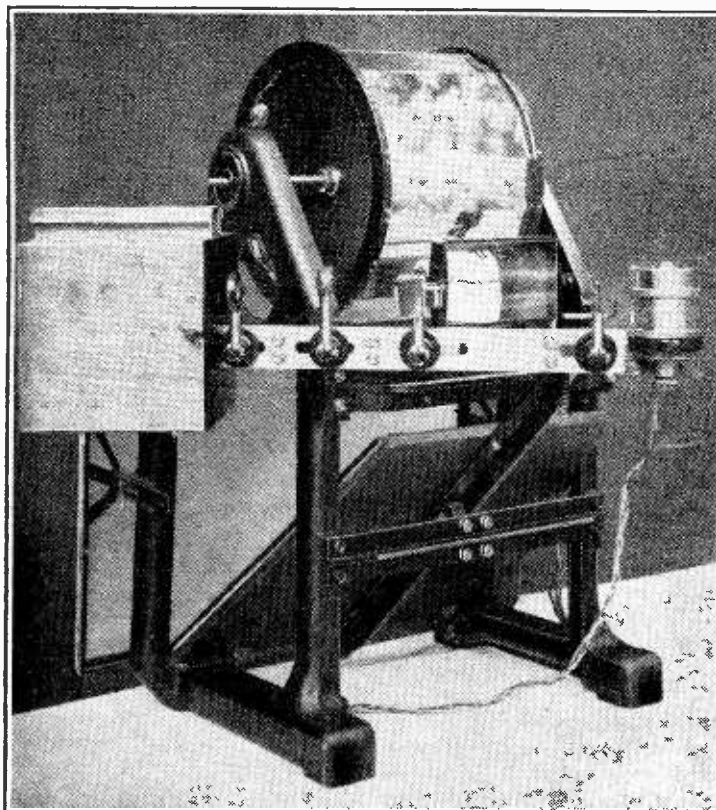

In a home model, for which a screen 2ft. by 1ft. 10in. is employed, the light source is a specially developed mercury lamp consuming 3½ amperes at 70 volts DC, or 250 watts approximately.

Needless to say, it is a high-definition system, and although at the demonstration at their Campden Hill laboratories only the 240-line 25-frame apparatus was shown working, we were told sets for use on the present 405-line B.B.C. transmissions, with interlaced scanning had been developed and would be available as soon as the B.B.C. have made a promised improvement in the regularity of the synchronising signal from Alexandra Palace.

The subjects demonstrated (films in this case) were chosen for the vast amount of detail they contained, and were admittedly difficult subjects to televise. Nevertheless, the reproduced pictures were very good, both in definition and steadiness, the synchronising holding perfectly throughout. Apart from the 25-picture flicker the results compared very favourably in all respects with contemporary systems.

A point of interest regarding the Scophony apparatus is that the highest voltage used in any of the receivers, home or public hall models, is 350, and it is understood that the former can even be operated successfully on 250 volts or so.

## Television Programmes

Vision 45 Mc/s. Sound 41.5 Mc/s.

FRIDAY, JULY 23rd.

3, "Pyramus and Thisbe." A most lamentable comedy by William Shakespeare. 3.15, Film—Mickey's Pal Pluto. 3.25, Mizzen Cross Trees. 3.50, British Movietone news.

9, "The Raft"—an Interlude by Stephen Leacock. 9.15, Film—"Bugle from Blue Grass." 9.25, "Ad Lib"—Revue by Herbert Farjeon. 9.50, Gaumont-British News.

SATURDAY, JULY 24th.

2.30, Relays from Wimbledon. In addition, programmes will be interrupted between 3 and 4 p.m. for short relays from the Challenge Round of the Davis Cup at Wimbledon. 3, In Our Garden—Another practical talk by C. H. Middleton from the garden in Alexandra Park. 3.15, The John Carr Jacquard Puppets. 3.25, Gaumont-British News. 3.35, "Review of Revues": cast includes Adèle Dixon, Valerie Hobson and Cyril Pritchard; production by Dallas Bower.

9, Starlight: Elsie Carlisle in Comedy Songs. 9.10, Summer Gardening VII—by C. H. Middleton. 9.25, British Movietone news. 9.35, Repetition of 3.35 p.m. programme.

DURING the television "close-down period" from Monday, July 26 to Saturday, August 14 inclusive, there will be two test transmissions daily, with the exception of Saturdays, when the morning transmission alone will be given. These will be solely for the benefit of the radio industry. There will be no transmission on Sundays or on Saturday, July 31, or Monday, August 2. The transmissions will be radiated from 11.0 a.m. to 12.0 noon and from 2.0 to 3.0 p.m., and will consist of the television demonstration film, short magazine films and news reels, accompanied by sound, and exterior shots from the balcony with gramophone records, all of which will be interspersed with periods of cruciform pattern with tone on the sound transmitter. In addition, the Davis Cup Challenge Round match will be relayed from Wimbledon between 3.0 and 4.0 p.m. on Monday and Tuesday next, July 26 and 27.

## The Radio Industry

CELESTION loud speakers will be found this year at Radiolympia on Stand 26, and the new season's models will include extension speakers and "Auditorium" chassis models ranging in price from 22s. 6d. to £22 1s. As in previous years the retail distributing side of the business will be in the hands of Cyril French, 29, High Street, Hampton Wick, Kingston-on-Thames.

Mr. I. T. Watkins has been appointed as Midlands area representative of the Westinghouse Brake and Signal Co., Ltd. His address is, 26, Featherstone Road, King's Heath, Birmingham.

Batwin Electrical Appliances, Ltd., 138, Southwark Street, London, S.E.1, have sent us a pamphlet describing the Cetron photo-cell, for which the firm holds an agency. The associated firm of U.S. Radio, Ltd., of the same address, has also issued catalogues and leaflets giving particulars of American Arcturus valves.

The Alma Grove (London, N.1) factory of Sinclair Speakers will be closed for the annual holidays from Saturday, July 31st, until Monday, August 9th.

Acting on instructions received from H.M. Office of Works, the British Thomson-Houston Co., installed the sound amplifying equipment for use during the recent visit of the King to Caernarvon Castle.

# New Apparatus Reviewed

## Recent Products of the Manufacturers

### WEARITE CONDENSER ANALYSER

**T**HIS test set has been developed by Wright and Weaire, Ltd., 740, High Road, Tottenham, London, N.17, mainly for the use of service engineers and radio dealers requiring a compact, self-contained instrument for the measurement of capacity and for generally testing condensers of all kinds. Though this is its primary function, it also provides the means for measuring resistances, since a bridge circuit that functions on the principle of balancing one impedance against another can with very little change be made to serve equally well for resistance only.

The two functions, viz., capacity and resistance measurement, are, therefore, embodied in this one instrument.

In addition, a test circuit is included for ascertaining the condition of a condenser. Leakage and short-circuits are determined by applying voltages of from 100 to 500 across the condenser and observing the effect on a neon lamp.

Though not provided with a scale or a calibration for insulation resistance, an approximate idea of the state of the condenser, or other component tested on this circuit, can be had by noting the period of flashing in the neon lamp.

The method of ascertaining the approximate leakage resistance is dealt with fully in the operating instructions.

Three capacity and two resistance scales calibrated directly in microfarads and ohms respectively are provided. They are marked C<sub>1</sub>, C<sub>2</sub>, C<sub>3</sub>, R<sub>1</sub>, and R<sub>2</sub>. Range C<sub>1</sub> takes in capacities of from 0.00001 to 0.004 mfd.; C<sub>2</sub> covers 0.001 to 0.4 mfd., and C<sub>3</sub> 0.1 mfd. to 40 mfd. The two resistance ranges cover 100 to 40,000 ohms and 10,000 ohms to 4 megohms respectively.

All kinds of condensers, including the electrolytic variety, can be tested and measured on this bridge, which will give



Wearite capacity and resistance measuring set.

also a measurement of power factor. A visual indication of balance is employed, the indicator being a miniature cathode-ray tube.

The accuracy of this test set is far better than the ordinary tolerance of condensers and resistances, so that it will adequately meet the requirements of service engineers and radio dealers. It is simple to handle and is operated entirely from the AC mains.

The price complete with testing leads is £9 9s.

### WARD CAR-RADIO AERIAL

**A**MONG the various problems that arise in installing radio in a motor car is that of arranging for an efficient aerial system. For in the restricted space available only very short aerials can be employed, added to which they are usually required to be inconspicuous, must not interfere with the entry and egress of driver and passengers, yet be required to effect good reception under all conditions.

From the technician's point of view the obvious place for an aerial is on the roof of the car, and if properly mounted and shaped to conform with the lines of the car's body, it should not impair the appearance.

That an outside aerial can combine the attributes of efficiency and attractiveness is exemplified by the recently introduced Ward Car Aerial, obtainable from Wireless

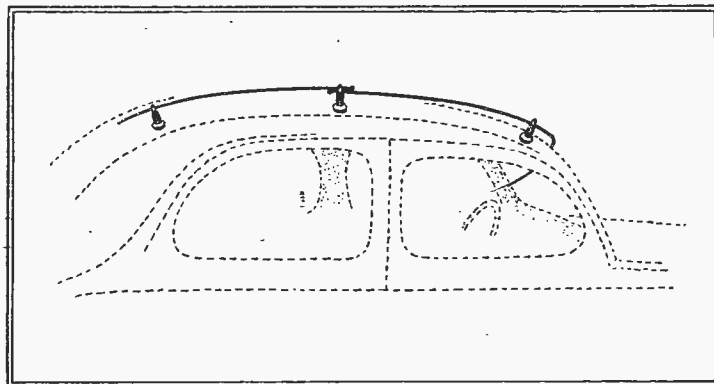

Ward Streamline aerial for fitting on the roof of a car.

Supplies Unlimited, 278-282, High Street, Stratford, London, E.15.

It consists of two chromium-plated rods each 3ft. 7in. long and mounted on black stand-off insulators which raise the aerial 3in. above the roof. If assembled in line an aerial just over 7ft. 6in. long can be obtained, for a few inches has to be allowed for overlap at the centre.

Alternatively, the two rods can be mounted in the form of a V with the diverging arms towards the back of the car.

It is quite unnecessary to drill holes in the roof for mounting the aerial as the insulators are securely fixed in position by a special cement in conjunction with a suction cup which is on the base of each insulator. The only hole needed is in the windscreen pillar to bring the downlead into the car and so to the receiver. As the insulators provide a long leakage path the efficiency of the aerial will not be impaired in wet weather.

This model costs 22s. 6d. There are various other types available for fitting to sports cars, tourers and open two-seaters.

### BERCO POWER POTENTIOMETERS

**T**HE BRITISH ELECTRICAL RESISTANCE CO., LTD., Queensway, Ponders End, Middlesex, have for long specialised in the manufacture of high-grade variable and fixed resistances.

Among their products is a range of toroidal-wound potentiometers designed to

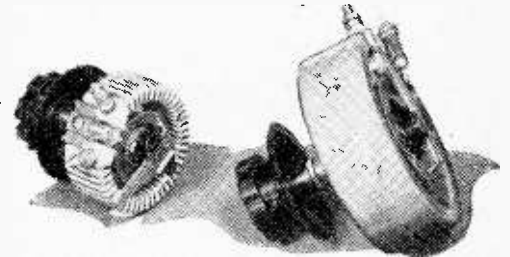

Berco heavy-duty potentiometers; the large model is a 300-ohm 100-watt type.

handle comparatively high power, and they are consequently particularly well suited for use in public address equipment and relay installations.

The Type T, as these power resistances are described, are made in 50- and 100-watt sizes. In order to provide adequate ventilation the resistance wire is wound on a large porcelain former which allows free access of air to all parts of the winding.

The laminated contact arm is constructed of nickel and phosphor-bronze, and to it is fitted a contact brush of a copper and graphite mixture. An extension of the contact arm bears against a collector ring.

The spindle, contact arm and collector ring are insulated from the spindle, the insulation being adequate to withstand 3,000 volts. The resistances can therefore

be mounted on metal panels even though they be used in high-voltage circuits.

These resistances are delightfully smooth, and they are quite silent in use. Some tests were made with a 100-watt model having a resistance of 300 ohms, its rated maximum current being 580 mA. Though not tested with the full load a sufficient lead was employed to enable an opinion to be reached regarding its ability to handle the rated power. No trace of loosening of the winding was observed, while the good ventilation allowed for rapid dissipation of the heat generated.

The former on this model measured 3½ in. in diameter, 1¼ in. deep and ¾ in. wide. Considering the fine workmanship exhibited and the power rating the prices of these potentiometers are very reasonable. The 300-ohm 100-watt type costs 22s. In this size the resistance values range from 3 to 17,000 ohms and prices from 21s. to 24s.

In the 50-watt series resistances of from 3 to 7,800 ohms are made and their prices range from 15s. to 17s. 6d.

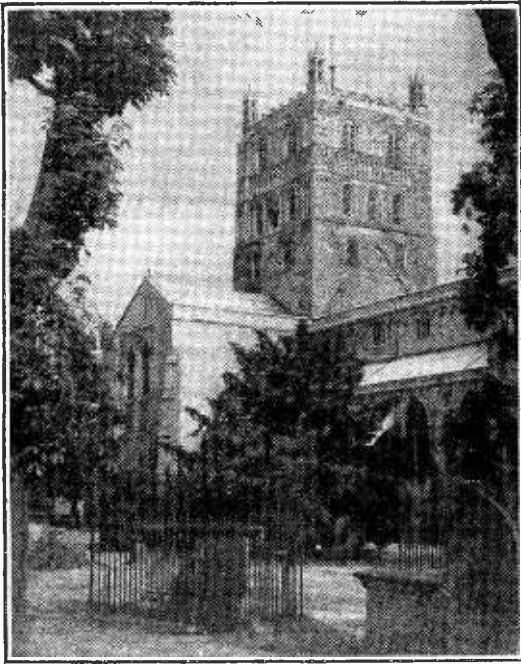

# Listeners' Guide

## Outstanding Broadcasts at Home and Abroad

**TEWKESBURY ABBEY**, from which will be heard part of Eliot's "Murder in the Cathedral," to-night at 9.40.

published will take part in this programme, among them being Violet

Lorraine, singing "Dear Old Saturday Night"; G. H. Elliott, singing "I Used to Sigh for the Silvery Moon," and Ellaline Terriss, who will sing the first song Darewski wrote, namely, "Au Revoir, My Little Hyacinth." Lola Shari and Morgan Davies will be heard in this programme, and so will Captain Bruce Bairnsfather, for whose wartime show, "The Better 'Ole," Herman Darewski wrote the music.

### WATERMEN

More and more use is being made by the B.B.C. of recordings of special events which take place early in the day for inclusion in the evening's programme. This allows for a greater number of listeners to hear the broadcast than would be the case if the transmission took place at the actual time of the event. A case in point is the occasion of Their Majesties' visit to Northern Ireland on Wednesday. Throughout the day the B.B.C. Mobile Recording van and its crew of engineers will be present at various ceremonies which are to take place. Records will be made of the actual ceremonies, together with descriptions, and these will be broadcast in the National programme at 6.20.

A similar instance occurs on the following day (Thursday) when King Farouk is crowned King of Egypt. It is hoped to record a description of the actual ceremony as it takes place at 8.30 a.m., and to include this in the evening's National programme at 9.20.

### "THE MAN BEHIND THE MELODIES"

This is the apt title given to a programme to be broadcast by the National transmitter on Tuesday at 8, when Herman Darewski recalls many of his musical memories. The programme will be produced by an old friend of his, Max Kester, of the B.B.C. Variety Department. Many of the well-known people who were the first to sing Herman Darewski's songs when they were

Drama Festival is being held in aid of the fund for the repair of the Norman Abbey of Tewkesbury. Listeners will hear excerpts from the final scenes of E. Martin Browne's production of "Murder in the Cathedral," by T. S. Eliot, which is one of the plays being performed in the open air against the west front of the Abbey. If it is wet it will be produced inside the Abbey. This will be broadcast at 9.40 in the Regional programme to-night (Friday).

### SUMMER

Listeners are to have impressions in the third of the series, "Summer Over the British Isles," of a tour of the romantic coast-line and quiet rivers of Devon and Cornwall, where thousands of visitors from all over the British Isles are spending their summer holiday. This will be broadcast Regionally on Sunday at 9.45, and should prove interesting and enjoyable for the thousands of listeners who have been awestruck as they have gazed on the rugged rocks and relentless lashing of the Atlantic breakers.

### SEASIDE SHOWS

The third and fourth broadcasts in the series, "Shows from the Seaside," will be heard this week. To-night (Friday) at 6.25, Harry Pepper and Davy Burnaby will introduce "Dazzle," from Pierrot Land, Bognor. On Thursday, 6.25 (Reg.), listeners will be taken over to the Bandstand Pavilion, Littlehampton, for an excerpt from "Summer Revellers."

Another broadcast from a holiday resort comes from the West on Monday, relayed in the Regional programme at 8, when "Show of Shows, 1937 Edition," will be broadcast from Knightstone Pavilion, Weston-super-Mare.

### CRICKET, TENNIS AND POLO

The second Test Match between England and New Zealand at Old Trafford, Man-

chester, will provide many commentaries for National listeners on Saturday, Monday, and Tuesday. P. G. H. Fender will be the commentator, and the times of transmission will vary from day to day.

Between 2.30 and 5 on Saturday, National listeners will be lookers-on, through the eyes of B.B.C. commentators, at the Davis Cup Challenge Round matches at Wimbledon and the Ireland v. Hurlingham polo match for the Empire Cup at Hurlingham. No times of individual relays are given, as they will largely depend upon the progress of each event. Listeners will, however, be kept in touch with each match by short running commentaries.

The play at Wimbledon on Monday will also be commented upon at intervals during the afternoon, as will also the third day's play—that is, if the match does not finish in two days.

### DANCING.

With the departure of the B.B.C. Dance Orchestra listeners are to hear a variety of dance bands during the coming weeks. Among those broadcasting during the evening programmes this week are Al Collins and his Dance Orchestra (Friday, 8.30, Nat.); Dave Frost and his Band, who are presenting



LARRY ADLER, the American wizard of the harmonica, will be heard during Saturday's "Music Hall," as will also Turner Layton and Gus Chevalier.



# For the Week

"When You and I Were Dancing—Tunes of Yesterday" at 8 (Reg.) to-night (Friday); Nat Gonella and his Georgians (Saturday, 5.15, Reg.); Victor Silvester and his Ballroom Orchestra (Tuesday, 7.30, Reg.); Jack Payne and his Band, who will present "Favourites of the Famous" at 6.50 (Nat.) on Wednesday and Carroll Gibbons and the Savoy Hotel Orpheans, who will be heard on Thursday at 8 (Nat.).

## HERO WORSHIP

THE inescapable penalty of fame in any walk of life is that of having ardent fans besieging the hero or heroine wherever they are getatable. Gladiators and Olympian athletes doubtless had their fans, but they were harmless compared with those of to-day, when autograph hunting is the mildest form of fan-worship. It

**SALZBURG.** A view of the city the Festival of which will frequently feature in the programmes during the next week or two.



was left to Lewis Waller to inspire the first organised band of fans; these were known as the "K.O.W.s," or "Keen Order of Wallerites."

Since those days, with the coming of films and radio, fan-worship has become more and more popular.

The idea of the broadcast "Fan," which will be heard on Thursday at 8.30 (Reg.), is to show that fan-worship can be sincere as well as sinister, and that in its most genuine form it affords relief in drab lives by bringing a star into close contact with the admirer. It will conjure up a scene in a gallery at a first night and deal with the phenomenon of fan-mail.

## OPERA RELAYS.

WE are to have a fair sprinkling of opera in the home programmes this week, the reason being that the Salzburg and

Bayreuth Festivals are in progress, and relays from these two great musical events will be given on three occasions.

On Saturday at 8.45 (Reg.) the third Act of Wagner's "Lohengrin" will be relayed from the Festspielhaus, Bayreuth, the capital of Franconia.

From Salzburg, on Monday, come two relays of Verdi's "Falstaff," which is being conducted by the great Toscanini. At 8 (Nat.) will be heard Act II, followed at 9.30 (Reg.) by Act III.

For next week, arrangements have been made to relay from Salzburg the second Acts of

Colonel" is an opera-bouffe, like his own "Esther de Carpentras," but has a military background. Both of these will be heard in this transmission.

Those who wish to hear the whole of "Falstaff," and not Acts II and III only, should tune in to Lyons at 7 on Monday.

On Tuesday at 7, Radio Paris is relaying Richard Strauss' "Der Rosenkavalier," of which G. Bernard Shaw is the librettist, from the Salzburg Festival. It will, by the way, be the 81st birthday anniversary of G.B.S. on this day.

## MILITARY BANDS GALORE.

FOR those who like military band music, there is a treat in store if they will tune in to the wavelength of Brussels I at

"The Magic Flute," "Don Giovanni" and "Die Meistersingers."

In the programmes from abroad there is little opera other than the relays from the two festivals referred to above. Munich and all German stations are taking from Bayreuth Wagner's "Lohengrin" in its entirety from 4—10. During the interval from 7.45—8.45 a visit will be made to Wagner's House, Villa Wahnfried, where solos will be played on the great composer's own piano.

Admirers of the ultra-modern in French music will doubtless be pleased by the Milhaud and Sauguet operas which form Saturday's *émission commune* from Paris PTT, Marseilles and Alpes-Grenoble at 8. Recently Milhaud referred in the most complimentary terms to Sauguet whose "Plume du

8.30 to-night (Friday). This station is relaying, from the Grand Palais du Centenaire, a gala benefit concert for War Disabled, which includes a French military band, Band of the 2nd Batt. Somerset Light Infantry, Band of the Royal Carabineers of Italy, Band of the Royal Romanian Guard and a Belgian military band.

## MISCELLANY

SOME of the best known of Carl Michael Bellman's songs will be heard in a special commemorative programme to be given by Swedish stations on Monday at 9.5.

An all-Norwegian programme of old and new church music will be given by augmented choirs in the ancient cathedral of Trondheim, on Thursday at 8, which will be relayed by Oslo.

THE AUDITOR.

## HIGHLIGHTS OF THE WEEK

### FRIDAY, JULY 23rd.

Nat., 7.30, Five Hours Back. 9.40, Robb Wilton as Mr. Muddlecombe, J.P. Reg., 11.15 a.m., Commentary on the race for "Doggett's Coat and Badge." 6.25, Shows from the Seaside. 9.40, Tewkesbury Drama Festival.

### Abroad.

Brussels I, 8.30, Gala Benefit Concert for the War Disabled.

### SATURDAY, JULY 24th.

Nat., 2.30—5, Commentaries from Wimbledon and Hurlingham. 8, Act II "Lohengrin" 9.20, Description of the Paris Exhibition by M. Stéphan, from Paris.

Reg., 6, Callender's senior band and the St. David's Singers. 8.45, Act III "Lohengrin."

### Abroad.

Munich, and all German stations, 4—10, "Lohengrin" from Bayreuth.

### SUNDAY, JULY 25th.

Nat., 7.55, Service from the Temple Church. 9.5, Victorian Melodies—16. 9.45, Margate Municipal Orchestra.

Reg., 5, Light Concert from Berlin. 6.30, Recital: Oda Slobodskaya. 9.45, Summer Over the British Isles—3.

### Abroad.

Vienna, 8.35, Salzburg festival relay of Cathedral Concert.

### MONDAY, JULY 26th.

Nat., 7, Monday at Seven. 9.35, Hachem Khan (baritone) and the Theatre Orchestra.

Reg., 8, "Show of Shows—1937 edition," from Weston-Super-Mare. 8.45, Billy Thorburn and his music. 9.30, Act III "Falstaff" from Salzburg.

### Abroad.

Radio Paris, 8.45, Symphony Concert from the Casino, Vichy.

### TUESDAY, JULY 27th.

Nat., 8, Darewski—the man behind the melodies. 9.20, America To-day—talk on literature.

Reg., 6.30, Recital—Gueda Waller and Vera Maconochie (songs and duets) and William Busch (piano). 9, Walter Widdop and the Military Band.

### Abroad.

Radio Paris, 7, "Der Rosenkavalier" (Richard Strauss) from Salzburg.

### WEDNESDAY, JULY 28th.

Nat., 6.20, Recorded impressions of Their Majesties' visit to Northern Ireland. 6.50, Jack Payne and his band. 10, "Rhythm on the Roof," American cabaret.

Reg., 8, Variety from the Argyle Theatre, Birkenhead. 8.45, "The Romantic Young Lady"—Spanish Play.

### Abroad.

Breslau, 8.10, Dances old and new.

### THURSDAY, JULY 29th.

Nat., 6.40, "The Romantic Young Lady." 9.20, Recital: Lisa Minghetti (violin) and Adolph Hallis (piano).

Reg., 6, Medvedeff's Balalaika orchestra. 6.25, Shows from the Seaside—4; 8.30, "Fan." 9, "Dorothy": comedy opera.

### Abroad.

Radio Paris, 8, "The Mastersingers" (Wagner) from Vichy.

# Decoupling

By  
"CATHODE RAY"

## Separating the Various Kinds of Current

THE problems of the radio circuit designer are very similar to those that confront the Minister of Transport. Both are obliged to legislate for routes that carry different classes of traffic at the same time, and are expected to arrange things so that, as far as possible, each can move without injuring or interfering with the others. The radio designer has the advantage that his electric traffic obeys known laws, and he can measure very accurately the resistance of each path to current of any frequency. The Minister of Transport has to rely on very imperfect machinery for ascertaining in advance the resistance of, say, a certain cycle track, and may consequently be quite a lot out in his results. He may find an unexpectedly strong current of cyclists flowing in part of a route supposed to be confined to faster traffic.

In the same way, certain paths in a receiver are intended for steady currents, some for low frequencies and some for high; and if they are allowed to run riot along a single route there is likely to be trouble. So we have chokes, "stoppers," blocking and by-pass condensers, and so forth. It is easy enough to keep DC out of a path intended for AC—a condenser is a complete block to DC, and if of sufficient capacity offers negligible obstruction to

is needed; for 50-cycle current large iron-core coils are required.

It is sound psychology not to control people only by restrictions, but for each barrier to provide also a legitimate outlet for energy. It is also sound radio engineering. For straining out one sort of current from a circuit it is wise to provide at least two components—one to bar and the other to by-pass.

V1 in Fig. 1 is a detector valve, and therefore has in its anode circuit three

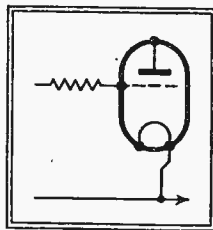

Fig. 2.—This works as a separator only because the valve acts as a condenser.

sorts of current—the original radio-frequency signal in amplified form, the low frequency resulting from the detection process, and the DC necessary to feed the valve. The first of these is a sort of waste by-product, and unless it is utilised for reaction, it should be short-circuited away from other paths by means of the condenser C1. The capacity of C1 must be chosen to be as attractive as possible to the radio-frequency currents, but not so large as to waste an appreciable proportion of the low frequencies. These are wanted at the grid of the next valve, whither they are led by a condenser C2; and to keep them from finding a short-circuit through the battery the high-inductance choke L2 is inserted. A direct connection to the grid of V2 would let the HT battery voltage get there, whereas so far as DC is concerned the grid needs to be negative, and is supplied from the grid battery through a resistance high enough to cause very little leakage of audio-frequency signals.

### Resistance-capacity Filtering

A resistance, if it is nothing more, looks the same to DC and AC of all frequencies; and a correspondent is not clear how it can be useful for separating. By itself it certainly is completely ineffective. If there is only a single railway carriage on the train it must be used by passengers of all sorts. But if another marked "Non-smoking" is available, the first immediately becomes less attractive to some people and more attractive to others, although it has undergone no change, and thus it exercises a discriminating influence.

As a resistance discriminates between different sorts of current only in this indirect manner, it is not so effective as a choke coil, but it has the merits of being

cheaper, more compact, and incapable of inductive coupling with other components.

Fig. 2 looks like an exception. A resistance is often connected as shown with the object of stopping RF. Here the valve itself is the discriminating component, for between grid and cathode it is, in effect, a small condenser, probably about 10  $\mu\mu\text{F}$ . Suppose the resistance is half a megohm. This seems quite high, but to DC the valve is virtually infinity, and by comparison the resistance in the grid lead is negligible, and whatever bias is applied to the resistance finds its way to the grid. At even the highest audio-frequencies the valve is several megohms, and receives the greater part of any signal that is applied; but at 470 kc/s (for example) the valve is only a little over 30,000  $\Omega$ , and most of a signal of that frequency is lost in the resistance.

The decouplers normally included in anode circuits require a relatively large capacity in order to be effective for two reasons: (1) Such a high resistance as  $\frac{1}{2}$  M $\Omega$  would waste a large part of the HT because the anode-to-cathode path is certainly *not* an infinite resistance, and (2) it is normally designed to stop not only radio-frequencies but also the very low frequencies of "motor-boating." Fig. 3 is an example. Although DC does not particularly like going through resistance it is obliged to pass through R1, R2, and R3, simply because there is no alternative. Radio-frequency currents from the valve go straight back again through C1; audio-frequencies find C1 too small, but go through C2 to the next valve, while circuits of any frequencies at all that may

try to work back from the next valve (where the currents are very much stronger) are by-passed safely by C3, and are unable to get via C2 to the grid of the next valve. Suppose the voltage between the points A and E is varying, due to currents in later stages of the amplifier, the proportion of such voltages

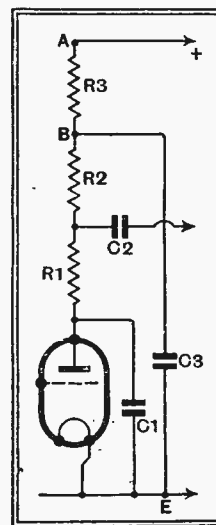

Fig. 3.—Example of the usual type of decoupling.

appearing at the point B depends on the proportion of the total impedance that exists from B to E. That proportion can

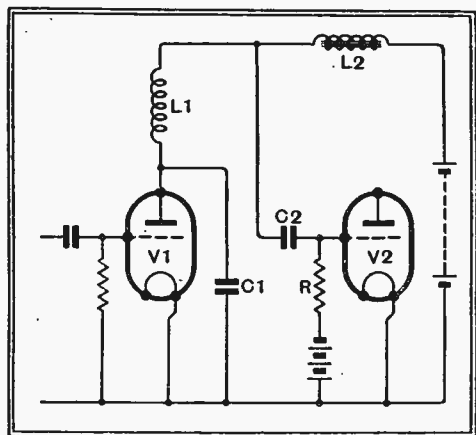

Fig. 1.—Example of how the different currents present in a single circuit are separated out.

AC. Taking advantage of the fact that the obstruction proportionately grows less as the frequency increases, a condenser is often used to separate low- from high-frequency AC, but, of course, the separation is never complete.

There is no component that can be used to pass DC freely and block AC completely, but a suitable choke coil comes near to this specification. The lower the frequency the greater the inductance that



# The Modern Noise Meter

A Versatile Instrument with Many Applications

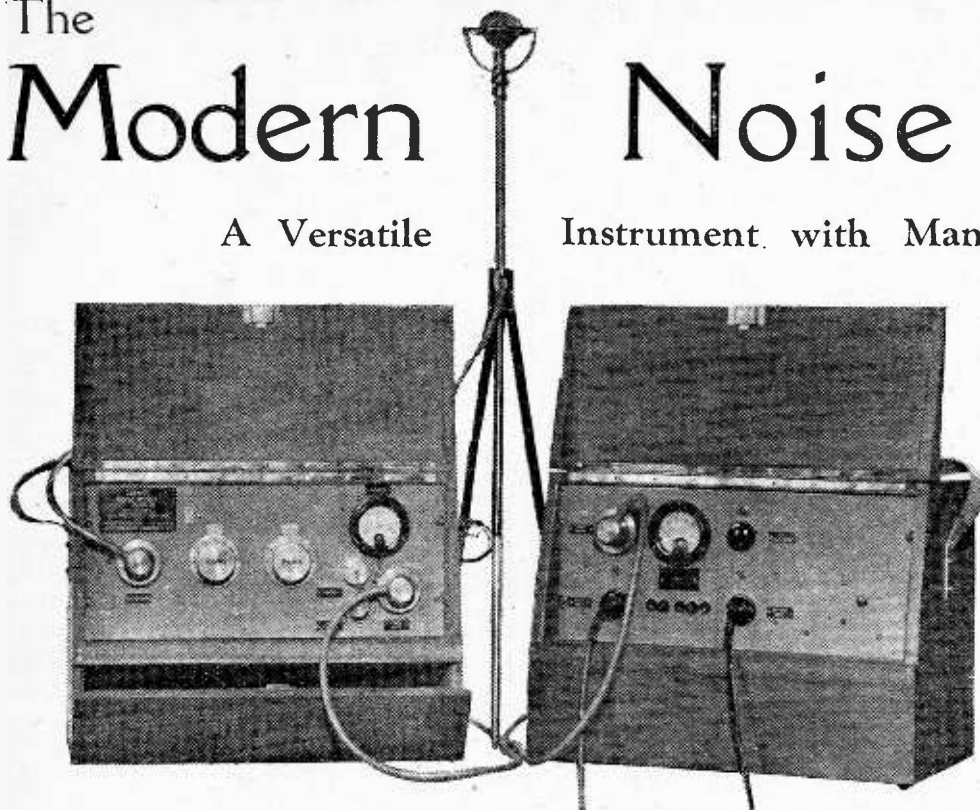

RECENT proposed regulations of the Ministry of Transport regarding the maximum noise which will be tolerated from motor vehicles have refocused attention upon instruments which can be relied upon to give scientifically accurate meter readings as a basis for comparison. The equipment adopted for preliminary investigations is the Tannoy Noise Meter manufactured in collaboration with the National Physical Laboratory.

Like other instruments of its type, it consists essentially of a microphone amplifier suitably "weighted" to reproduce the characteristics of the ear, and an indicating meter in association with an attenuator. Every instrument is issued with an N.P.L. certificate and is calibrated directly to read in phons. On steady tones it gives results which agree closely with other recognised standard instruments, but on short impulse sounds, which, after all, are those generally described as noise, there is a fundamental difference. Whereas most noise meters tend to average the sound energy of a discontinuous noise, the Tannoy meter gives a peak reading which is very close to the level of any individual impulse, and is not seriously affected by the frequency with which those impulses occur. As a result the Tannoy meter gives a more accurate assessment of noises, such as a motor cycle exhaust, and one which is closer to the truth as far as the noise value of the sound is concerned.

Up to the rectifier stage the circuit is straightforward. Three stages of resistance-coupled LF amplification using H30 non-microphonic valves are used to amplify the output from the non-directional piezo-electric microphone. The characteristics of the ear are simulated by two tone-correction circuits, one in each of the interval couplings, and the frequency

curve chosen is that of the average ear at a level of 75 phons. This falls approximately in the middle of the range of levels generally met with in practice. Volume controls are included in the grid circuits of the second and third stages and are calibrated directly in phons as coarse and fine adjustments. The third stage also includes a correction network for the microphone, and one of the first steps in testing the instrument is to adjust this correction with the "weighting" networks out of circuit until a flat response is obtained.

It is in the rectifier and its associated meter that the chief interest is to be found. The meter is of the high-speed type, but even so, it is not quick enough in action to give an accurate reading on the short-impulse sounds which constitute the subject of most of the measurements which have to be made. Accordingly, a time-constant circuit is introduced which stores the energy during the impulse and feeds it to the meter after the impulse has passed. The values are so adjusted that the steady reading of the meter falls very little short of the peak value of the sound impulse, and the important thing to note is that for impulses of equal strength the meter reading is not increased, even though the time interval between the pulses may be considerably reduced.

In Fig. 1 the action of the metering circuits is shown diagrammatically. The shaded portion represents an impulse of short duration and the curve shows the deflection of the meter pointer. It will be seen that by the time the impulse has ceased the meter has only reached about 45 per cent. of its final deflection, which occurs some time after the impulse has ceased. Nevertheless, the full reading is reached very quickly, but the return is slower, so that the eye is able to concen-

trate on the maximum readings more easily.

As a matter of interest, a sound of 100 milliseconds duration gives a deflection which is only 2 db. less than that given by a continuous note of the same frequency and intensity, and for a duration of 25 milliseconds the reduction is not more than 4 db.

Another useful feature of the Tannoy meter is that it has right-hand zero, and the biasing arrangements are such that a sudden increase of sound while giving a left to right deflection actually reduces the current in the meter. There is thus no possibility of damage from mishandling of the apparatus.

The standard instrument is housed in two teak cases measuring approximately  $20 \times 14 \times 8\frac{1}{2}$  in. One of these is devoted to the power supply with suitable adjustments and monitoring meter, and contains in the case of the battery-operated model a rotary converter designed to run off a 12-volt car battery. There are also models for AC mains only and for AC mains or battery operation. It is understood that a more compact edition is in course of preparation, and that when completed this will be available for operation from a 2-volt LT battery supply.

Apart from its application to the legal aspect of motor car noise, the noise meter is finding innumerable applications in industry. The motor car manufacturers, for instance, are using these instruments to investigate body resonances and panel drumming, while the tyre manufacturers have found them invaluable in their search

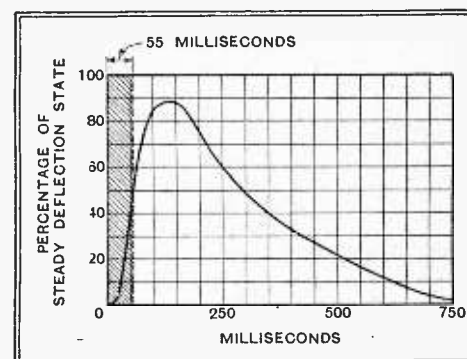

Fig. 1.—Diagram showing rise and fall of meter needle for a sound impulse of short duration.

for a silent tread. Manufacturers of domestic appliances, such as refrigerators, sewing machines and electric fans are finding that exact information regarding the amount of noise emitted is being demanded by buyers. Gas burners, particularly those of the high-pressure type, are being redesigned with the aid of the noise

**The Modern Noise Meter—**

meter to reduce the amount of hiss, and in the electrical engineering industry the instrument is being used to investigate transformer lamination hum and the running noise of rotary machinery. The industrial psychologist regards it as one of his most important aids, for noise level in factories is one of the most prominent factors determining fatigue. In banks and other offices where counting machines and typewriters are in use the question of noise is also important.

To return nearer home, the manufacturers of the meter have found it useful in another branch of their activity, namely, PA work, and it has been the means of obtaining useful data regarding the distribution and covering power of loud speaker units of different types. With this exact information at their disposal the PA engineers have been able to predict the layout of

Many applications have been found for the noise meter in industry. Here it is seen in use for measuring the noise emitted by ventilating fans and domestic refrigerating apparatus.

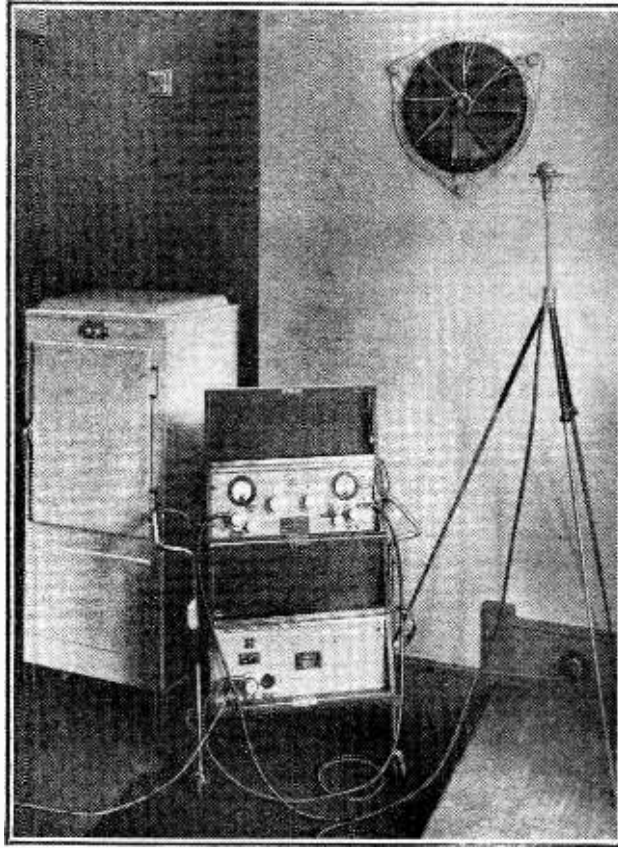

the loud speakers required to cover any event if they are provided with a plan of the ground beforehand. Experience has shown very little discrepancy between the estimates and the results.

**“TELEVISOR” —Name Now Decontrolled**

**B**AIRD TELEVISION, LTD., desires to inform the public and their friends in the trade that in future all their goods will be marketed under the trade-mark “Baird,” which has already been largely used by the company.

As is generally known, the company is the registered proprietor of the trade-mark “Televisor,” but this word, which was originally invented by Mr. Baird in 1925 and registered by him as a trade-mark, has now become in the United States the generally recognised word for describing television apparatus, and although the company has taken the necessary steps to protect its rights in this country it has become apparent to them that to continue doing so would be likely to result in the necessity for unfriendly action on their part against competitors and others without any counterbalancing advantage. Television apparatus is still, comparatively speaking, in its infancy, and the company considers that it would be right to use as its trade-marks words which will be regarded by all as distinctive of its goods rather than a word which many contend should be available for the use of all as a descriptive word for any kind of television apparatus. Accordingly, Baird Television, Ltd., announces that it is abandoning its registration of the word “Televisor” as a trade-mark, and that this word will in future be free, so far as they are concerned, for all to use as a word descriptive of television apparatus generally.

The above announcement does not in any

way affect the rights of the company in respect of its other registered trade-marks, which it will continue to use and defend if occasion arises.

**Valve Price Reductions in Germany**

**B**Y restricting the number of types to be manufactured and by restricting the number of new types for this season to one, the German valve industry have been able to reduce prices of radio valves generally by 25-30 per cent. The reductions take effect from July 15th. Notably the prices of new valves now employed in modern receivers have been reduced, whereas the reduction on older types is only about 10 per cent. These older types now only account for about one-fifth of the total German valve sales.

As the cost of the valves for a medium-sized receiver was about £5 in Germany, a reduction of 25 per cent. means a considerable saving. Roughly speaking, no German valve now costs more than Rm. 15 (15/- at par or 25/- at present rate of exchange).

Here are some examples: ACH1, formerly Rm. 17.50, now Rm. 13; BCH1 from Rm. 19 to Rm. 15; CH1 from Rm. 14 to Rm. 12.50; CL2 from Rm. 18 to Rm. 15. Of fourteen types of 4-volt A.C. valves eleven types have been brought down in price. Whereas of forty-one old-fashioned types only eleven have come down.

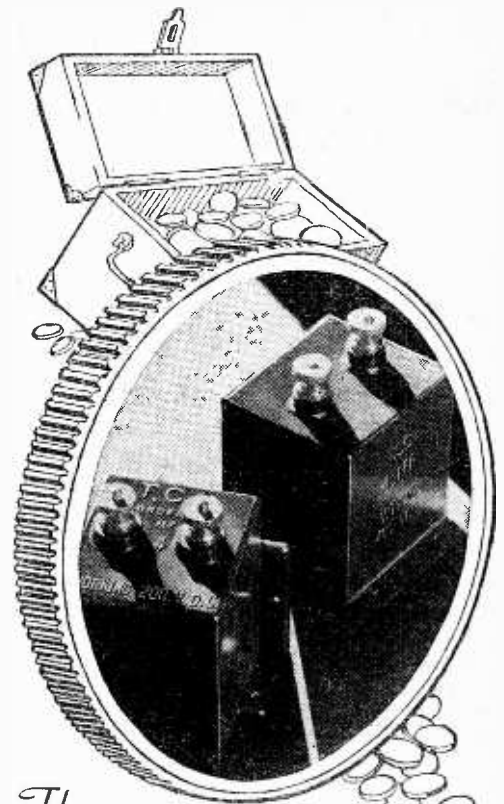

*The*  
**STAMP of**  
**A NAME**

— that stands for recognised  
**DEPENDABILITY**

FOR over 28 years T.C.C. have specialised in the design and manufacture of the one product—condensers and condensers alone. As a result T.C.C. have brought first to the world of cables, second to Radio and now to Television a standard of dependability which only specialisation can give. Look back over the years, almost invariably wherever a vital step forward in condenser design has been made, that step has been made by T.C.C. . . . Little wonder “T.C.C.” means **DEPENDABILITY.**

The illustration shows two T.C.C. Paper Condensers. Left a Type 50 non-inductive 4 mfd. tested to 400 V.D.C. for 200 v. working, and right a Type 80 non-inductive 8 mfd. tested to 800 V.D.C. for 400 v. working

**T.C.C.**  
**ALL-BRITISH**  
**CONDENSERS**

The Telegraph Condenser Co. Ltd., Wales Farm Rd., N. Acton, W.3

# Random Radiations

By "DIALLIST"

## A Big Improvement

ITALY'S friendly gesture in toning down the news bulletins and the propaganda talks sent out by her medium-wave and short-wave stations should not go unnoticed amongst wireless folk. Let's hope that she will keep it up and that other countries will follow her excellent lead. Personally, I am more than glad that we have not succumbed to the temptation to use the Empire transmitters for counter-propaganda. So far we have kept the party clean, and I trust we shall go on doing so. Probably our best way of showing the world how to keep external politics and propaganda out of wireless is to develop first-rate broadcasting systems in every part of the Empire. Give people good propaganda-free programmes from their local stations and they won't worry very much about those that come in from outside.

## Not from Daventry

In any event, it would be an almost impossible task for the Daventry short-wave station to endeavour to broadcast even once a week in their own languages or dialects to all the inhabitants of this Empire of ours. Comparatively few people realise the magnitude of the problem. Were you to transmit to India alone in Urdu, Punjabi, Eastern Hindi, Western Hindi, Pushtu, Baluchi, Gujerati, Marathi, Sindhi, Bengali, Oriya, Telugu, Kanarese, Tamil and Malayalam there would still be millions of inhabitants of the Indian sub-continent who wouldn't understand a word that was said. To cover the whole Empire thoroughly from Daventry short-wave station we should require broadcasts in hundreds of different languages, and any such thing is clearly quite outside the bounds of possibility. That's why I think we'd best stick to English in our broadcasts and leave it to the local authorities to supply programmes intelligible by their local people.



## Kilocycles or Metres?

SOME time ago I asked in these notes whether it was now too late to induce the man in the street to think in kilocycles rather than in metres. An East Barnet reader sends a very interesting comment. You will never induce the man in the street to think in kilocycles, he suggests, so long as a clockwise movement of his tuning dial decreases the number of cycles. He has become accustomed to a steady increase in metres as he tunes "higher." If you want to educate him to think in terms of frequencies all that you have to do is to persuade manufacturers to supply tuning condensers whose capacity decreases as the knob is turned clockwise. Low-frequency signals will then be received at low condenser settings and high-frequency signals at high dial readings—which is, after all, the logical arrangement.

There is a good deal in that, for with the usual type of tuning condenser the ordinary listener cannot see why, when it comes to frequencies, it should be a case of the higher you go the fewer. But it wouldn't be enough just to turn the tuning arrangements

inside out, so to speak, for the aforementioned ordinary listener would then kick at having to tune higher in order to obtain a station of a lower place in the published lists. The reform would have to be a double one: it would be necessary to reverse the order of the list of stations so as to make them show the stations with the highest frequencies at the top. That would be a terrific upheaval, when you come to think of it, and I very much doubt whether it will ever come to pass.

## Is It a Possibility?

All difficulties would, of course, be swept away were it possible for the International Broadcasting Union to adopt a ten-kilocycle basis for its next European Plan. We should then be in the same happy position as our cousins in the United States, who number their broadcasting channels (they use the medium waves only) from 53, which is 530 kilocycles, to 155, which is 1,550. On the face of it, the adoption of a ten-kilocycle basis on this side of the Atlantic seems utterly impossible, since so many stations have to be fitted in. The long waveband we needn't bother about, for it seems to be already past praying for; but is a ten-kilocycle plan for the medium waveband quite out of the question? At the I.B.U.'s meeting in June the Technical Committee stressed strongly the advantages shown in practical working of synchronised transmissions in national systems. It is just on the cards that in view of the big gains in many directions that would result if there were a ten-kilocycle basis British and Continental authorities might be persuaded to facilitate its adoption by increasing the number of synchronised stations and thus making fewer channels necessary to provide for Europe's requirements.

## Short-wave Crowding

Anyone who listens to short-wave transmissions, and that means pretty well every owner of a wireless set nowadays, must realise how badly overcrowded the more important broadcasting belts have become. The situation is growing worse and worse as time goes on. The Technical Committee of the I.B.U. is hard at work now trying to find some solution, and the matter will be fully thrashed out at next year's conference at Cairo. The main trouble is that what we loosely call the short waveband isn't one band at all; it consists of at least six—the 13-metre, the 16-metre, the 19-metre, the 25-metre, the 31-metre, and the 49-metre—each of which has its own special characteristics, which vary from hour to hour, from season to season, and from year to year. Any country which hopes to conduct a satisfactory world-broadcasting service, therefore, needs a considerable number of different wavelengths for its transmitters. It isn't going to be easy to obtain international agreement for any plan put forward, and the longer such a plan is delayed the more difficult will it be to obtain its acceptance. Stations which have dug themselves firmly in on this wavelength or that don't give it up very readily.

## How Many Controls?

IT'S curious to notice how often the pendulum swings in matters wireless. Fifteen or more years ago, when the bulk of those who held receiving licences knew something about the technical side and wanted to get the very utmost from their sets, control knobs and switches increased in number and variety, sprouting on the panels like mushrooms in an autumn field. Cast your mind back and you'll remember that we often had three RF circuits tuned by separate condensers, as well as the reaction coupling control. There was usually a rheostat for each valve, and many of us went in for such things as variable grid leaks and variable anode resistances in resistance-coupled circuits. Then there were switches doing a multiplicity of jobs. As popular interest in broadcasting increased makers strove hard to reduce the number of controls, putting the one-knob set before themselves as the ideal. Now there are distinct signs of a breakaway from the minimum possible number of controls, and it will be interesting to see what developments there are in this direction this season.

## Simplicity and Performance

You can't very well reduce the number of controls below four—main tuning, on-off switch, volume control, wave-change—though this number can be brought down to three by combining the on-off switch with the volume control. In the better-class receiver most people nowadays probably insist upon tone control in the audio-frequency circuits, and there's no question of the advantage of having selectivity control as well. Many will go further and ask for other means of adjusting the various circuits of a set from the panel. I observe that some of the big American sets are going in for quite large numbers of knobs. One with thirty valves has seven manual controls; another, with eleven valves, has a dozen. I don't think we'll go quite as far as that, but I have an idea that in the bigger sets that we shall see this year makers won't be afraid of adding a knob or two to the conventional number if their presence really aids performance. One receiver that has just appeared has an aerial trimmer for use on the short wavebands. I handled that set a month or two ago whilst it was still in laboratory form, and the aerial trimmer certainly made a world of different to short-wave results.



## The Bathroom Again

ANOTHER case of a fatal electric shock received in a bathroom was reported recently. The victim this time was found dead in her bath with a small mains portable resting on her body. Part of the mains leads were burnt out, showing that a very heavy current must have passed through them. Presumably, the insulation of the flex leads was defective, and the victim touched them with a wet hand. Though well-designed mains sets and other electrical apparatus are completely safe in the ordinary way, there is one room in the house which is emphatically not suitable for them, and that's the bathroom. The wise course is not to take your wireless set in your bath with you and to put the light switch—which should certainly not be of the metal type—in a place where it cannot be reached by anyone who is actually in the bath. The best and safest of all positions for the set is outside the bathroom.

# First of the New G.E.C. Sets

TWO BATTERY MODELS AND AN AC MAINS RECEIVER

A COMPLETE list of G.E.C. receivers for the 1937-38 season has been prepared, and three of the sets, an AC and two battery models, are now ready for release.

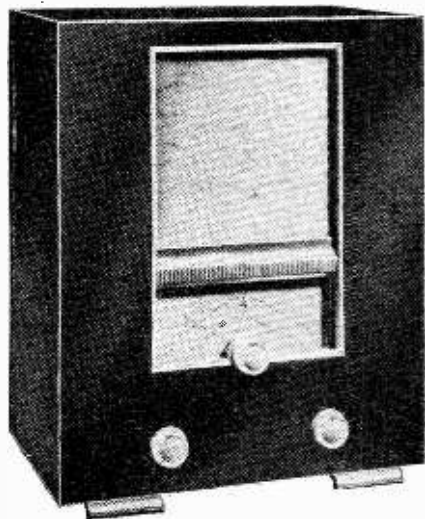

G.E.C. "Battery SP<sub>3</sub>" in new cellulosed cabinet.

In the "Battery SP<sub>3</sub>"—a two-waveband, three-valve straight set—special attention has been given to economy in maintenance as well as in first cost. The station-calibrated dial carries a visual switching indicator, and the set is housed in a distinctive brown cellulosed cabinet. Including valves and batteries the price is £6 15s.

A superheterodyne circuit covering 16-50

metres, in addition to the two normal broadcast bands, is employed in the "Battery All-Wave 4" at £10 10s. This receiver is equipped with the new G.E.C. "Chromoscopic" dial, automatic two-speed tuning and a "touch-lighting" control for dial illumination while the set is being tuned.

The "Chromoscopic" dial in which the coloured station names are edge illuminated against a black background, is a feature of the new "All-Wave 5" for AC mains which in common with all the new G.E.C. mains receivers is fitted with a noise shield to guard against power line interference. This set, which costs £9 19s. 6d., includes a 16-50 metre range, and is housed in a polished walnut cabinet with sloping tuning panel.

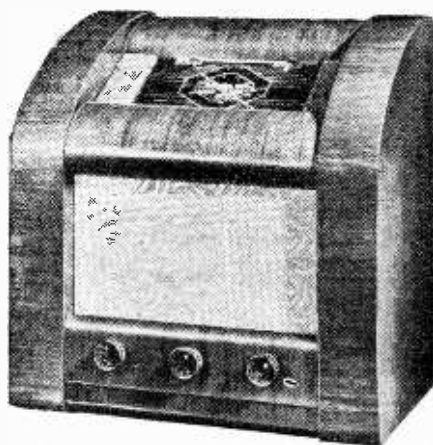

A sloping tuning dial with indirect lighting is a feature of the "All-Wave 5" and other G.E.C. table models.

## News from the Clubs

### Wirral Amateur Transmitting and Short-wave Club

**Headquarters:** King's Square Café, Birkenhead.  
**Meetings:** Last Wednesday evening in each month.  
**Hon. Sec.:** Mr. J. R. Williamson, 49, Neville Road, Bromborough, Birkenhead.

At the last monthly meeting Mr. W. Rogers (G80C) gave a talk on the application of the electronic oscillator to detection in SW receivers. A description of a successful 3-valve receiver embodying this principle was given, together with diagrams and coil specifications.

### Bradford Short-wave Club

**Headquarters:** Bradford Moor Council School, Leeds Road, Bradford.  
**Meetings:** Fridays at 7.30 p.m.  
**Hon. Sec.:** Mr. G. Walker, 33, Napier Road, Thornbury, Bradford, Yorks.

The Morse practice classes will be resumed this evening (July 23rd) as Mr. K. Abbott, the instructor, is returning to the club.

### Newcastle Radio Society

**Headquarters:** 2, Duke Street, Newcastle-on-Tyne.  
**Meetings:** Sundays at 6 p.m. and Thursdays at 7 p.m.  
**Hon. Sec.:** Mr. G. C. Castle, 10, Henry Street, Gosforth, Newcastle-on-Tyne, 3.

A programme has been got together for newcomers to radio which is so arranged that it also forms a refresher course for the experienced. Practical constructional work is followed by a talk on theory and design. Morse instruction is given in the final half-hour of every meeting.

A visit to the Newcastle station and transmitter is shortly to be arranged.

### Southend and District Radio and Scientific Society

**Hon. Sec.:** Mr. F. S. Adams, "Chippenham," 27, Eastern Avenue, Southend-on-Sea.

The society recently held a very successful DF contest when twenty-three members scoured Essex with portable receivers in an endeavour to trace a hidden transmitter operating on a wavelength of 155.8 metres. Only one competitor, Mr. M. Tapson, G61F, succeeded in finding it.

A series of similar events will be held throughout the summer as well as many indoor meetings. The full programme of lectures will be resumed in September.

### Leicester Amateur Radio Society

**Headquarters:** Winn's Café, Granby Street, Leicester.  
**Hon. Sec.:** Mr. T. Cribb, 53, Knighton Drive, Leicester.

At the recently-held annual general meeting, after the election of officers and committee, there was a discussion on the question of reducing the amount of the subscription for members under 20 years of age, and it was finally decided to do so. The following items were arranged for the summer:

July 24th or 25th.—Visit to the Borough Hill Transmitting Station.

August 22nd.—Social outing for members and their womenfolk.

September 5th.—Visit to the South Kensington Science Museum.

September 7th.—Meeting at H.Q. to check apparatus and arrange for field day.

September 12th.—160-metre DF field day, using a portable station.

NOTABLE  
FEATURES  
of the *New*  
ROLA F 742-PM

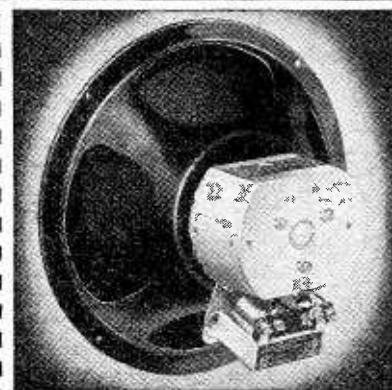

FLUX DENSITY  
EQUALS THE  
ROLA G.12-PM

Comparison between this 9½" diameter speaker selling at 49/6 and the giant Rola G.12-PM may at first sight appear rather preposterous. Yet when space and price are serious considerations this new Rola unit is the ideal substitute for its famous companion. Like the G.12-PM it possesses a flux density of 11,500 lines per square centimetre. It is super sensitive and therefore ideal for Battery set and Extension speaker use. Special features include the use of a new magnet material 'Alnico' and a moisture proof transformer, metal and compound shielded. No better value in reproducers is obtainable to-day. Please write for full particulars.

Model  
F 742-  
PM 49/6

WITHOUT TRANSFORMER 42/-  
OVER 8 MILLION IN USE

ROLA

The World's Finest Reproducers

THE BRITISH ROLA CO., LTD.  
MINERVA ROAD, PARK ROYAL, N.W.10.  
PHONE WILLESDEN 4322-3-4-5-6.

# Recent Inventions

The British abstracts published here are prepared with the permission of the Controller of H.M. Stationery Office, from Specifications obtainable at the Patent Office, 25, Southampton Buildings, London, W.C.2, price 1/- each. A selection of patents issued in U.S.A. is also included.

## TUNING UNITS

THE drawing shows a self-contained tuning unit for mounting on a wireless receiver. An air-cored long-wave coil L and an iron-cored medium-wave coil L<sub>1</sub> are both carried by a two-part former F, the upper portion of which contains the powdered-iron core K. A trimming condenser C,

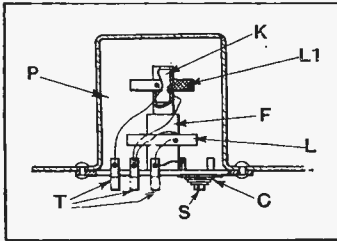

Medium- and long-wave coil unit for use in broadcast receivers.

fixed underneath the panel, consists of two metal plates separated by a mica spacer, one of the plates being bent or dished outwards, so that the effective capacity can be altered by turning the screw S.

The various leads are taken out to tags T, as shown, and the tuning coils are covered by a screening pot P. The condenser C is connected across the coils L, L<sub>1</sub> and is adjusted to compensate for inherent and other "stray" capacities.

*The General Electric Co., Ltd., and R. W. Speirs. Application date November 26th, 1936. No. 463393.*

## TELEVISION SYSTEMS

BOTH the picture and synchronising signals are derived from a single photo-electric cell, the synchronising impulses being of such amplitude as to reduce the carrier-wave to zero. The adjustment of the transmission level then becomes purely optical, with the following advantages:—

(a) The intensity of the synchronising impulses remains constant.

(b) The amplitude remains constant, in spite of other fluctuations, because it is definitely determined by the "vanishing" of the current from the final output stage of the amplifier.

(c) The amplifier can be set to strict linearity, so that the half-tones of the picture are accurately reproduced irrespective of any automatic regulation that may be necessary.

*Radio-Akt. D. S. Loewe. Convention date (Germany) October 25th, 1934. No. 464483.*

## CATHODE-RAY TUBES

ONE of the anodes of a cathode-ray tube usually consists of a metallic surface of silver deposited on the inside surface of the glass. A disadvantage is that the silver, being highly reflecting, throws light on to the fluorescent screen, and this may affect the tone contrasts of the received picture. The use of graphite, as an

## Brief descriptions of the more interesting radio devices and improvements issued as patents will be included in this section.

alternative, is open to the objection that it contains substances, which, during the subsequent baking and pumping processes, may contaminate the fluorescent material of the screen.

To overcome these difficulties, the anode is formed upon the glass wall of the tube by applying a dilute aqueous solution of lead salt, which is then converted into the black lead-sulphide by the action of an alkaline solution of thio-carbamide or thiourea.

*S. T. Henderson. Application date October 9th, 1935. No. 464105.*

## LOUD SPEAKERS.

THE tone quality of a high-powered speaker, suitable for use in a cinema or for public address purposes, is improved by inserting a rotating vane or screw inside the main diaphragm. As shown in the figure, a small

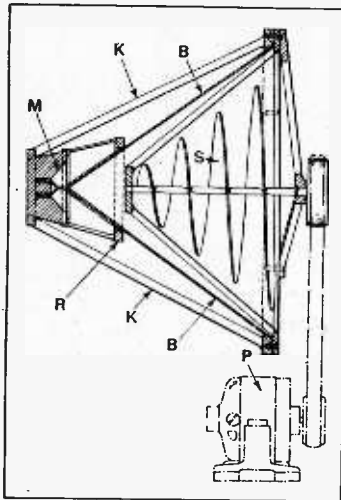

Rotating helical screw mounted inside diaphragm of loud speaker to improve quality of reproduction.

driving cone is energised from an electromagnetic movement M, and, in turn, drives a larger cone B, which fits inside a ring R. The large end of the cone B is rigidly held by the arms K. Inside is a shaft carrying a helical screw S, which is rotated at a speed of from 1,200-2,200 revolutions per minute by an induction motor P.

The useful effect of the screw S is due to the fact that it varies the air pressure in the vicinity of the vibrating surface of the cone B, causing the latter to approximate more closely to the ideal "piston-like" action.

*R. R. Glen. Application date October 4th, 1935. No. 463734.*

## TELEVISION RECEIVERS

THE fluorescent screen of a cathode-ray receiver is set obliquely to the main axis of the tube instead of at right-angles to it. This allows the image to be

enlarged by lenses which can be directed on to the positive or "impact" side of the screen, where the resulting fluorescence is brightest.

The difficulty of keeping the scanning stream always in focus, as it moves to and fro over the inclined surface of the screen, is overcome by using an auxiliary control field. This is derived from the current passing through the ordinary deflecting coils, so that its intensity varies in proportion to the angle of deflection. Alternatively, the deflecting coils may be inclined to the main axis of the cathode-ray tube so as to ensure the required correction.

*P. T. Farnsworth. Application date February 28th, 1936. No. 463896.*

THE same source of current is used to supply (a) the anode of a valve used to amplify the received picture signals, (b) the modulating electrode of the cathode-ray tube, and (c) an external focusing coil for the electron stream flowing through the tube.

The anode of the amplifier valve is connected directly to the grid of the cathode-ray tube through a series resistance, whilst the anode of the CR tube is connected directly to the common source of supply. The external focusing coil is connected across the common source of supply in series with a variable resistance. One advantage of the arrangement is that should the source of supply fail, leaving the CR tube with no bias, the electron stream is simultaneously defocused or scattered so that it does not burn the fluorescent screen.

*Baird Television, Ltd., and L. R. Mendler. Application date October 8th, 1935. No. 463973.*

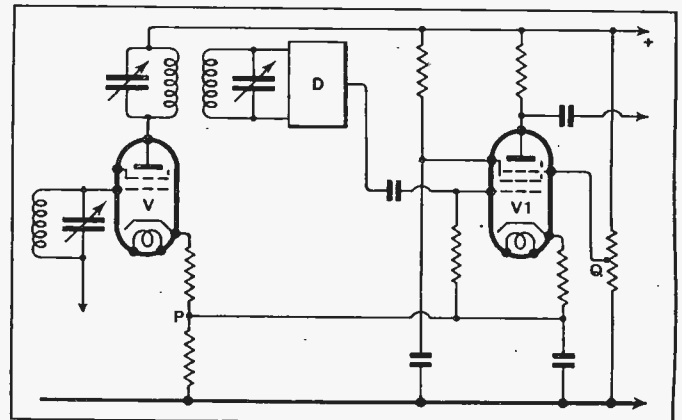

Muting circuit for a superheterodyne receiver.

## SOUND AND PICTURE RECEIVERS

A SET designed to receive television signals on one carrier frequency, and sound signals on an adjacent carrier, is designed to

allow the two carriers to have a minimum "guard band" or safety gap between them, so as to economise ether space.

Both sets or signals are received on a broadly tuned input circuit and are passed to a common local oscillator and a common frequency-changer. From the latter the intermediate amplifiers for the sound and picture signals are branched off as separate channels across a common coupling. The latter is so arranged that the channel input which "accepts" the picture signals acts as a rejector circuit for the sound signals, and vice versa.

*Marconi's Wireless Telegraph Co., Ltd. (assignees of C. D. Kentner). Convention date (U.S.A.) October 31st, 1934. No. 464286.*

## AMPLIFIERS

TO improve the fidelity and power of a push-pull amplifier, a part of the output circuit is designed to produce even harmonics, which are then combined with the fundamental and odd harmonics in such a way as to diminish distortion.

*Standard Telephones and Cables, Ltd. (assignees of V. M. Cousins). Convention date (U.S.A.) May 1st, 1935. No. 464231.*

## MUTING CIRCUITS.

THE intermediate-frequency amplifier V of a superhet receiver is coupled through the second detector (shown diagrammatically at D) to the control grid of a low-frequency amplifying valve VI. The cathode of VI is tapped to a point P in the anode-cathode circuit of the valve V, whilst the suppressor grid is tapped to a point Q on a potentiometer shunting the valve V.

The valve V is subject to automatic volume control. Therefore, at a certain predetermined level of signal strength, the potential of the point P becomes equal to, or lower than, the point Q, and the pentode VI will then pass signals through to the loud speaker. For

signals below this "threshold" value the pentode is "blocked" and the set automatically muted.

*E. K. Cole, Ltd., and A. W. Martin. Application date December 12th, 1935. No. 463748.*



# MISCELLANEOUS ADVERTISEMENTS

## NOTICES

THE CHARGE FOR ADVERTISEMENTS in these columns is

12 words or less, 3/- and 3d. for every additional word.

Each paragraph is charged separately and name and address must be counted.

SERIES DISCOUNTS are allowed to Trade Advertisers as follows on orders for consecutive insertions, provided a contract is placed in advance, and in the absence of fresh instructions the entire "copy" is repeated from the previous issue: 13 consecutive insertions 5%; 28 consecutive, 10%; 52 consecutive, 15%.

ADVERTISEMENTS for these columns are accepted up to FIRST POST on MONDAY MORNING (previous to date of issue) at the Head Offices of "The Wireless World," Dorset House, Stamford Street, London, S.E.1, or on SATURDAY MORNING at the Branch Offices, 19, Hertford Street, Coventry; Guildhall Buildings, Navigation Street, Birmingham, 2; 260, Deansgate, Manchester, 3; 26a, Renfield Street, Glasgow, C.2.

Advertisements that arrive too late for a particular issue will automatically be inserted in the following issue unless accompanied by instructions to the contrary. All advertisements in this section must be strictly prepaid.

The proprietors retain the right to refuse or withdraw advertisements at their discretion.

Postal Orders and Cheques sent in payment for advertisements should be made payable to LILFEE & SONS Ltd., and crossed & Co. Notes being untraceable if lost in transit should not be sent as remittances.

All letters relating to advertisements should quote the number which is printed at the end of each advertisement and the date of the issue in which it appeared.

The proprietors are not responsible for clerical or printers' errors, although every care is taken to avoid mistakes.

## IMPORTANT NOTICE.

Owing to the August Bank Holiday, the issue of "THE WIRELESS WORLD" for August 6th must be closed for press earlier than usual.

MISCELLANEOUS ADVERTISEMENTS for insertion in that issue can be accepted up to

FIRST POST, FRIDAY, JULY 30th.

## NEW RECEIVERS AND AMPLIFIERS

**A**  
**A**  
**A**  
**D**EGALLIERS, Ltd.—Still we grow. Note new address below.  
**D**EGALLIERS, Ltd., the firm for reliable short-wave radio, have on show in London without exception the largest selection of fully guaranteed brand new all-wave receivers; callers invited to handle these at their leisure without obligation to purchase; all S.W. receivers will get stations on the low bands, including the Americas; let us demonstrate to you; if you live out of town we have satisfied customers in nearly every part of the country, who would probably let you hear these sets in their own homes. Terms, cash with order or c.o.d.; carriage extra; handsomely illustrated catalogues forwarded on receipt of large stamped addressed envelope or 2½d. stamp; our lists give the fullest technical data, with all measurements; each set is complete in cabinet ready to plug in; chassis quoted separately.

NOTE.—Marconi royalties are already paid on all Challenger Receivers.

5/- Each, American valves, all guaranteed, each a first, no seconds or throwouts, for every known set from 1927-37; metal, metal glass, glass; glass counter-parts, etc.; in ordering just state type and number, we have it; line cords for all Midgets, 4/6 each.

£3/5.—Midget T.R.F. 4-valve A.C.-D.C. 200-250 volts, in leather cloth or walnut.

£4.—Midget T.R.F. 5-valve, M. and L. wave, 100-250 volts, A.C.-D.C., calibrated in station names.

7 Gns.—Table model 6-valve all-wave superhet, A.C.-D.C., 200-250 volts, 16½-50, 200-550, 800-2,000 metres, 8in. M.C. speaker, calibrated in station names.

£9/9.—7-valve all-wave superhet, 3 bands, 15-2,100 metres, multi-coloured oval dial, cathode ray magic eye, Octal valves, 21in. long, 10½in. deep, 12in. high, A.C. 200-250 volts; carriage 5/-; also available in 8-valve for A.C.-D.C. 100-250 volts at 9½gns.

(This advertisement continued in third column.)



## "THE WIRELESS WORLD" AGREES

When we produced the M.A. receiver, we claimed no miracles for it. We know that the performance of any receiver depends on the local conditions. What we *did* claim was that, for any particular set of conditions as regards interference, etc., the M.A. would definitely give a much better musical performance than the normal type of "band-pass" receiver. And here is what *The Wireless World* test department says:—"... there can be no possible doubt that for a given set of conditions the M.A. receiver provides a much superior performance from the point of view of quality".

COME AND HEAR IT.

Demonstrations on Wednesdays till 10.30 p.m.

**HARTLEY TURNER RADIO LTD.,**  
THORNBURY ROAD,  
ISLEWORTH, MIDDLESEX.  
Telephone: HOUnslow 4488

## IT WAS IN JUNE 1935

that "The Wireless World" said:—

"Specimens tested have been found to be particularly smooth and noiseless in action."

RELIANCE ARE SPECIFIED FOR THE TELEVISION RECEIVER. You will need RELIANCE POTENTIOMETERS. TYPE "T.W." Wire-wound. Linear. Non-graded, 10,000, 1,000 and 2,000 ohms, 4/6 each. TYPE "S.G." 50,000 ohms and 2 megohms, 4/9 each.

RELIANCE VARIABLE RESISTANCES. TYPE "S.G." non-tapered 150,000 ohms and 0.5 megohm, 4/9 each. Reliance are Reliable, and consistently specified by Leading Technical Journals.

Write for Folder "W.W." Free.

RELIANCE MANUFACTURING CO. (SOUTHWARK) LTD.  
WESTBURY ROAD, LONDON E 17



WESTINGHOUSE BRAKE & SIGNAL CO. LTD, 82 YORK RD, KING'S CROSS, N.1

## HIRE PURCHASE

We can supply any Radio and Electrical Apparatus on HIRE PURCHASE having a value of over £3 at convenient terms, including Midwest, Spartan, Challenger, Armstrong, Scientific Supplies and other receivers. Spartan Refrigerators, "Easy" Washing Machines, etc., etc.

CHAS. F. WARD, 46, Farringdon Street, LONDON E.C.4. Tel.: Holborn 9703.

## NUMBERED ADDRESSES

For the convenience of private advertisers, letters may be addressed to numbers at "The Wireless World" Office. When this is desired, the sum of 6d. to defray the cost of registration and to cover postage on replies must be added to the advertisement charge, which must include the words Box 000, c/o "The Wireless World." All replies should be addressed to the Box number shown in the advertisement, c/o "The Wireless World," Dorset House, Stamford Street, London, S.E.1. Readers who reply to Box No. advertisements are warned against sending remittance through the post except in registered envelopes: in all such cases the use of the Deposit System is recommended, and the envelope should be clearly marked "Deposit Department."

## DEPOSIT SYSTEM

Readers who hesitate to send money to advertisers in these columns may deal in perfect safety by availing themselves of our Deposit System. If the money be deposited with "The Wireless World," both parties are advised of its receipt.

The time allowed for decision is three days, counting from receipt of goods, after which period, if buyer decides not to retain goods, they must be returned to sender. If a sale is effected, buyer instructs us to remit amount to seller, but if not, seller instructs us to return amount to depositor. Carriage is paid by the buyer, but in the event of no sale, and subject to there being no different arrangement between buyer and seller, each pays carriage one way. The seller takes the risk of loss or damage in transit, for which we take no responsibility. For all transactions up to £10, a deposit fee of 1/- is charged; on transactions over £10 and under £50, the fee is 2/6; over £50, 5/-. All deposit matters are dealt with at Dorset House, Stamford Street, London, S.E.1, and cheques and money orders should be made payable to Lilfee & Sons Limited.

SPECIAL NOTE.—Readers who reply to advertisements and receive no answer to their enquiries are requested to regard the silence as an indication that the goods advertised have already been disposed of. Advertisers often receive so many enquiries that it is quite impossible to reply to each one by post. When sending remittances direct to an advertiser, stamp for return should also be included for use in the event of the application proving unsuccessful.

## NEW RECEIVERS AND AMPLIFIERS

(This advertisement continued from first column.)

CHALLENGER Series Model 800 8-valve High Fidelity Receivers, A.C. 200-250 volts, 4 distinct bands, 11-32, 27-64, 190-550, 900-2,000 metres, calibrated in metres and station names; available in the following types:

13 Gns.—Challenger 800 table model De Luxe, 10in. M.C. speaker.

£12/18.—800 chassis, valves and 10in. speaker, with all escutcheons, etc.

£14/18.—800 chassis, valves, and Rola G12 high fidelity P.A. speaker.

17 Gns.—Challenger 800 console, 42x12½x24, with G.12 speaker.

29 Gns.—Challenger 800 radiogram, with automatic changer, also incorporating the G.12 speaker.

14 Gns.—Challenger 381 table model 8-valve high fidelity receiver, 14-2,060 metres, polychromatic dial scale vision master, beam power output, magic eye, automatic band indicator, high image frequency suppression, magn. dial and second hand; or less cabinet £13/18.

OTHER Receivers in Stock Too Numerous to Mention, such as Belmont, Ferguson, etc.

NEAREST Stations "Underground" Lancaster Gate, Edgware Rd., and Praed St. Buses passing within 100 yds.: 6, 7, 8, 15, 16, 36, 60, 92, 291, 294, 12, 17, 32, 88, 136, 27A. Map enclosed with all applications for catalogues showing all routes and main line stations.

SPECIAL Summer Offer, available until the 15th September only.—To enable out-of-town patrons to visit us, on purchasing goods at 13gns. or over, we will pay up to 20/- towards the fare or petrol used on production of the railway ticket or garage account. To mail order customers ordering through the post, who are unable to get to London during this period, we will include with each order a set of replacement valves gratis.

DEGALLIER'S, Ltd., 32, Bathurst Mews, Paddington, London, W.2. Telephones: Paddington 2745 and Bayswater 5732. [4584]

ALERT RADIO Co.

"COMMUNICATION," "Shortwave" and "Allwave" Receivers.—21, East Rd., N.1. Clerkenwell 4871. [4381]

"SERVICE with a Smile."

HENRY FORD RADIO, Ltd.

ELECTRONIC House, 22, Howland St., Tottenham Court Rd., W.1. Museum 5675. [0511]

TRANS-ATLANTIC RADIO Co. for Finest All-wave Receivers, Midgets and valves.—15, Percy St., W.1. Museum 3096. [4623]

ROYAL RADIO Co., 5, Buckingham Rd., E.18.—Send for catalogue of all the latest short wave receivers and car radio. [4741]

CAR Radios, 6 and 12 volt, top aerial and accessories; all-wave A.C./D.C. Midgets, etc.; wholesale only.—A.D.E.E. RADIO, 9, Cosdach Ave., Wallington, Surrey. [4819]

# PREMIER SUPPLY STORES

Offer the following Set Manufacturers' Brand-New Surplus Goods at a Fraction of the Original Cost; all goods guaranteed perfect; carr. paid over 5/-; under 5/- postage 6d. extra. Orders under 5/- cannot be sent C.O.D.

ALL POST ORDERS TO

JUBILEE WORKS,

167, LOWER CLAPTON RD., LONDON, E.5

CALLERS, AS USUAL, TO 20-22, HIGH ST., CLAPHAM, S.W.4 (Macaulay 2382) 'Phone: Amherst 4723  
New Branch:—50, HIGH STREET, CLAPHAM, S.W.4 (Macaulay 2381).

And 165 & 165a, FLEET ST., E.C.4 (Next door to Anderton's Hotel). Central 2833.

Have you had our GIANT ILLUSTRATED CATALOGUE AND VALVE LIST? Send 4d. in STAMPS FOR THIS BARGAIN LIST.

The New "Premier" SHORT-WAVE CONDENSERS with Trolitul Insulation; certified superior to Ceramic; all-brass construction, 15 mmfd., 1/4; 40 mmfd., 1/7; 100 mmfd., 1/10; 160 mmfd., 250 mmfd., 2/6.

Self-powered A.C./D.C. 10-watt 40-metre C.W. 3-Tube TRANSMITTER, Pentode Crystal Oscillator, with meter, tubes, crystal (please state frequency required) and enclosed holder, with key, ready for immediate use, £4 4s.

SHORT-WAVE COILS, 4- and 6-pin types, 13-26, 22-47, 41-94, 78-170 metres, 1/9 each, with circuit. Special set of 3-4 Pin S.W. Coils, 14-150 metres, 4/- set, with circuit, Premier 4-pin 3-band S.W. Coil, 11-25, 19-43, 38-86 metres. Suitable any type circuit, 2/6. COIL FORMERS, in finest plastic material, 1 1/2 in. low-less ribbed, 4- or 6-pin, 1/- each.

SPECIAL OFFER. LISSEN TWO-GANG SCREENED ALL-WAVE COILS, 12 to 2,000 metres, complete with switching and wiring diagram, 6/11 per set.

MILLIAMMETERS, moving-iron, flush 2 1/2 in., all ranges from 0-10 m.a., 5/9. Visual tuning, 6 or 12 m.a., 5/9. Moving-coil meters, 2 1/2 in. 0-1 m.a., 18/6; 3 1/2 in. 0-1 m.a., 22/6. Multipliers, 1/- each. Ampmeters, 0-1, 3, 5, 10 or 20 a., 5/9.

COSMOCORD PICK-UPS, with tonearm and volume control, 10/6 each. PICK-UP HEADS only, 4/6 each.

NEW 1937 1-VALVE SHORT-WAVE RECEIVER OR ADAPTOR KIT, 13 to 86 metres without coil changing. Complete Kit and Circuit, 12/6. VALVE GIVEN FREE!

DE LUXE MODEL, 14 to 150 metres, complete Kit with Chassis, 4 Coils and all parts, 17/6.

1937 SUPERHET CONVERTER KIT, 13/6.

DE LUXE MODEL, 18 6 S.W. SUPERHET CONVERTER, for A.C. Mains Receivers, 20/- A.C. Valve given FREE!

NEW 1937 2-VALVE S.W. KIT, 13 to 86 metres without coil changing. Complete Kit and Circuit, 19/6. VALVES GIVEN FREE.

DE LUXE MODEL, 14 to 150 metres, complete Kit and Chassis, 4 Coils and all parts, 25/-. VALVES GIVEN FREE. 3-VALVE S.W. KIT, S.G. Det. and Pen., 42/-. VALVES GIVEN FREE! Metal Cabinet 10/6 extra.

CERAMIC S.W. VALVE HOLDERS, 4-, 5- or 7-pin. Chassis types, 6d.; B.B. type, 8d. GLASS ARIEL INSULATORS, 4d. each. BEEHIVE STAND-OFF, 6d. each. SCREENED FLEX, single, 3d. yd.; twin, 4d. yd.

H.F. CHOKES, S.W., 10-200 metres, 9d.; Screened, 1/6.

ALL-BRASS SLOW-MOTION S.W. CONDENSERS, .00015 tuning, 3/9; .00015 reaction, 3/3. British Radiophone 2-gang 2X .00016 all-brass S.W. Condensers, 5/6.

**SPECIAL OFFER. Ferranti All-Wave Receivers. "Parva" All-Wave A.C.4 (list 9 gns.) £6.6.0. "Nova" All-Wave A.C. Superhet (list 12 gns.) £8.15.0. All brand new in sealed cartons. Full Guarantee.**

MAINS VALVES, famous Europa 4 v. A.C. types, 4/6 each. H.L., L., S.G., Var-Mu-S.G., H.F. Pens., Var-Mu-H.F. Pens., 1, 3 and 4-watt A.C. directly heated output Pentodes A.C./D.C. types. 20-volt .18 amp. S.G., Var-Mu-S.G., H., H.L., Power.

Following types all 5/6 each. Full-wave rectifiers, 350 v. 120 m.a. and 500 v. 120 m.a. 2 1/2 watt indirectly-heated Pentodes, Octode, Frequency Changers.

BATTERY VALVES. 2 volts, H.F., L.F., 2/3. Power, Super-Power, 2/9. S.G., Var-Mu-S.G., 4- or 5-pin Pentodes, H.F. Pens., V-Mu-H.F. Pens., 5/- Class B, 3/6.

AMERICAN VALVES. Genuine American HYTRON and TRIAD first-grade Valves. 3 months' guarantee. All types in stock, 5/6 each. 210 and 250, 8/6 each. New Metal-Glass Valves, all types, 6/6 each. Genuine American DUOTRON Valves, all types, 3/6 each. Valve holders for all above types, 6d. each. Octal bases, 9d. each.

PREMIER HIGH-FIDELITY P.A. AMPLIFIER KITS, 3-WATT A.C. 2-stage AMPLIFIER for Mike or Pick-up. Complete Kit of Parts with 3 valves, 40/-.

7-WATT A.C./D.C. 3-stage AMPLIFIER. High-Gain. Push-Pull output. Complete Kit of Parts with 5 matched valves, £4 4s.

10-WATT A.C. 3-stage AMPLIFIER incorporating Phase-Inversion and Push-Pull Triodes. Enormous gain and straight line reproduction. Complete Kit of Parts, including 5 matched valves, £5 5s.

ELIMINATOR KITS for A.C. Mains. 120 v. 20 m.a., or 150 v. 25 m.a., 15/-, tapped S.G. det. and output. Complete Kit with long-life valve rectifier (replacement cost only 2/-)

PREMIER MAINS TRANSFORMERS, wire-end type with screened primaries, tapped 200-250v. Centre-tapped Filaments. Guaranteed one year. H.T. 3 & 9 or H.T. 10 with 4 v. 4 a. C.T. and 4 v. 1 a. C.T., 8/6. 250-250 v. 60 m.a., or 300-300 v. 60 m.a., 4 v. 1 a., 4 v. 2 a. and 4 v. 4 a., all C.T., 8/6. 350-350 v. 120 m.a. 4 v. 1 a., 4 v. 2 a. and 4 v. 4 a., all C.T., 10/6. Any of these transformers with engraved panel and N.P. terminals, 1/6 extra. 500-500 v. 150 m.a., 4 v. 2-3 a., 4 v. 2-3 a., 4 v. 2-3 a. 4 v. 3-4 a., all C.T., 17/6. Super Model 19/6. AUTO TRANSFORMERS, step up or down, 60 watts, 7/6; 100 watts, 10/-. SMOOTHING CHOKES, 25 m.a., 2/9; 40 m.a., 4/-; 60 m.a., 5/6; 150 m.a., 10/6. 2,500 ohms, 60 m.a. Speaker Replacement Chokes, 5/6.

PREMIER L.T. CHARGER KITS for A.C. mains, including Westinghouse Rectifiers and Tapped Mains-Transformers, 8 volts at 1 amp., 14/6; 8 volts 1 a., 17/6; 15 volts 1 a., 19/-; 8 volts 2 a., 29/6.

TRANSFORMERS, latest type Telsen R.G.4 (list 12/6), 2/9. Lissen Hypernik Q.P.P. (list 12/6), 3/6.

OUTPUT TRANSFORMERS for Power or Pentode, 2/6; Multi-Ratio, 4/6.

PHILIPS MAINS TRANSFORMERS, PRIMARY, 100-250 v. 450-450 v. 150 m.a., 4 v. 4 a. C.T., 4 v. 4 a. and 4 v. 3 a. and 500-500 v. 100 m.a., 4 v. 4 a. C.T., 4 v. 4 a. and 4 v. 3 a., 12/6. LIMITED NUMBER ONLY.

MAGNAVOX. Mains energised M.C. Speakers. '154', 7in cone, 2,500 ohms, 12/6; '152', 9in. cone, 2,500 ohms, 17/6; '152 Magna', 9in. cone, 2,500 ohms, 37/6. Magnavox P.M.s.—'254', 7in. cone, 16/6; '252', 9in. cone, 22/6. Reliable P.M.s., 10/6. TELSEN P.M.s., with 10 ratio Transformers, 12/6. TELSEN Speaker Units, 2/6. ROLA latest type P.M.s., 15/-. B.T.H. ENERGISED MOVING COIL, 10 1/2 in. diam. 1,650 ohms field. Power or Pentode Transformer. (State which.) SPECIAL LINE at 14/6.

W.B. 1936 STANDARD STENTORIAN (list 32/6) 21/-, brand new in sealed cartons.

Potentiometers by well-known makers. All values up to 1 meg. 2/-; with switch, 2/6.

Wire-end RESISTORS, any value, 1 watt, 6d.; 4 watts 1/-; 8 watts, 1/6; 15 watts, 2/-; 25 watts, 2/6 each.

Reliable MORSE KEYS with Morse Code engraved on bakelite base, 2/- each.

Bakelite case BUZZERS, 1/6; Walnut case "Loud-tone," 2/6 each.

Super Quality lightweight HEADPHONES, 3/9 pair.

PREMIER FILAMENT TRANSFORMERS, 4v. 3a., C.T., 7/6; 4v. 5a., C.T., 8/6; 5v. 3a., 7/6; 6.3v. 3a., 7/6; 7.5v. 3a., 7/6; 2.5v. 8a., 8/6.

GRAMOPHONE MOTORS. Collara Gramophone Unit consisting of A.C. motor, 100-250 v. high quality pick-up and volume control, 45/-; Collara motor only, 30/-; Collara Universal Gramophone Motor, 100-250v. A.C./D.C. with high quality pick-up and volume control, 67/6; Collara Universal Motor only, 49/6; Edison Bell double-spring motors including turntable and all fittings, 15/-; Cosmocord Gramo. Unit, comprising A.C. motor, pick-up, and volume control (list 55/-), 35/9. A.C. D.C. Super model, 52/6.

## NEW RECEIVERS AND AMPLIFIERS

**A** NGLO-AMERICAN RADIO Offer the Easiest Purchasing Facilities, and your last opportunity to own one of the finest radio receivers ever made, the genuine 5-band 10 watt Crosley at £11/19/6.

**H**.P. part exchange, and a 50% saving on the superb Crosley receivers; there will be no better receiver available in this country at under three times the price during the next 12 months.

**L**IMITED Number of the Following Models Only Available; we offer you every advantage and every inducement to purchase now; a large cash saving, and your own choice of the method of payment.

**P**LEASE Note, we offer only brand new goods, every chassis or receiver fully guaranteed 6 months; every receiver accurately checked and aligned on all bands with the latest equipment before despatch; please remember we offer you only goods which will give you lasting satisfaction, and as such unquestionably the finest value that radio has to offer; do not confuse with second-hand, soiled, "job bought," or improperly tested receivers, which are being cleared out at any price by other sources; please note all cabinets supplied by us are copyright by no other firm.

**10%** or 20% With Order to Suit your Convenience balance over 12 or 18 months.

**A**MAZING Signal to Noise Ratio is the Keynote to the Phenomenal All-world Reception; there is scarcely a transmission in the world that the 5-band Crosley will not bring in; Mr. Ivor Manley, writing in "The Wireless World" a few weeks back on Spanish broadcasting in the civil war, compiled his article using only one of our Crosley receivers; over 100 transmissions tuned in from Spain alone! Yes, your new guaranteed Crosley bought from us will do the same, and get you everything on the air.

**24/-** With Order or £11/19/6 Cash.—9-valve high fidelity 5-band (12 1/2-31, 30-80, 75-200, 200-555, 700-2,000 metres), A.C., 97-250 volts, 10 watts undistorted output, R.F. stage all bands, new automatic variable selectivity incorporated, provision grammo, and doublet, accurately calibrated airplane dial and band-spread pointer and subsidiary scale, shadow tuning indicator; your price £11/19/6, or with American Magnavox speaker, £14; Table model, £17; Console, £19; Auto-Radiogram, £24; or small deposit as above with order secures delivery.

**C**ARRIAGE Extra: Chassis 5/-, Table 7/-, Console 10/-, radiogram 15/-.

**B**OOK your Crosley Now, whilst last stocks remain; cash, c.o.d., or small deposit (see above) secures now. We guarantee your satisfaction.

**13/6** With Order or £6/14/6 Cash.—8-valve all-wave AC/DC Superhet, 16-2, 100 metres, new 5 1/2 in. multi-indication airplane dial, full A.V.C., wonderful all-wave performance; those on D.C. mains will never regret acquiring this outstanding receiver; chassis £6/14/6, with speaker £7/6/6; table model £7/19/6 (list 14 gns.) or deposit secures now; terms as above.

**22/-** With Order or 10 1/2 Gns. Cash.—De Luxe new 17 gn. model 6-valve Car Radio receiver, R.F. stage, 3-4 watts output, extreme sensitivity and magnificent performance, easily fitted to any car; full instructions; distributor suppressor only used; illuminated remote control; a superb instrument at a bargain price direct from importers; order now; cash, c.o.d. or 22/- first payment secures now, balance over 12 or 13 months as required.

**4**d. Stamps, enclosed with order to cover cost of our comprehensive new radio catalogue, covers every radio requirement, a complete radio buying guide which you will value keeping, fully illustrated.

**E**XTENSIVE New Showrooms Now Opened Centrally at Albion House; all communications and all callers please note address as below.

**N**EAREST Stations: Tottenham Court Rd. (100 yds.), Holborn (2 minutes), Central London, Edgware and Piccadilly lines. Hours: 9.0-6.30. Saturday 1.30 p.m.

**I**F You Cannot Call, order through the post with confidence; we specialise in postal orders, and have served customers all over the British Isles; you are assured of a square deal and satisfaction.

**A**NGLO-AMERICAN RADIO (AND MOTORS), Ltd. (Dept. W.27), Albion House, New Oxford-St., London, W.C.1. Telephone: Temple Bar 3251. [4823]

**H**ILL and PONDER Offer Brand New Crosley Receivers Under Fullest Comprehensive Guarantee at approx. 70% Below List Price; list available; terms, cash with order or c.o.d.; carriage extra.

**10** Gns.—"Crosley" high fidelity 9-valve superhet chassis, valves and 8in. M.C. speaker, 5 distinct bands, 12-2,000 metres. Airplane dial calibrated in metres, 10 watts undistorted. Neon tuning device, etc., or supplied with alternative speakers at an extra cost. 10in. Rola, 10/-; 12in. Magnavox, 20/-; or the 4 gns. Rola High Fidelity G12 12in. P.A. 30/-; also available in cabinets; table, £12; console, 14 gns.; radiogram with automatic changer, £24.

**H**ILL and PONDER, 9, Lancaster Mews, London, W.2. [4713]

**A**RMSTRONG COMPANY. Pioneer Firm supplying high grade all-British receivers in chassis form, manufacture models to suit all requirements, incorporating all the latest improvements.

**A**RMSTRONG COMPANY Invite You to Send for Full Particulars.

**A**RMSTRONG MANUFACTURING COMPANY, 100, King's Rd., Camden Town, N.W.1. [4615]

**C**OMMUNICATION Receivers, Hammarlund, National, Hallicrafters, R.M.E.69, Tobe-Deutschmann; transmitters, Collins 45A, Peerless DX20, or built to order; American valves, microphones, Eddystone components.—A.C.S., Ltd., 52-4, Widmore Rd., Bromley. 'Phone: Ravensbourne 0156. [0550]

**RECEIVERS AND AMPLIFIERS  
CLEARANCE, SURPLUS, ETC.**

**A**LL Lines, Previously Advertised Still Available.  
**H**ENRY'S, 72, Wellington Ave., N.15, Stamford Hill 2907. [4791]  
**P**ERLESS Chassis, 18 watts, 11 valves, 12 1/2 speaker, 5 bands; 10 gns.—Kay, 21, Prince of Wales Rd., Norwich. [4704]

**PUBLIC ADDRESS EQUIPMENT**

**A****C**USTOMER Writes re our 20-watt Amplifier:—  
"I am Amazed at the Quality and Power Output, which appears to be quite, if not more than, you claim. I have been in the P.A. line since 1927, and have never heard anything to compare with it.—A. Anderson."

**12**-VOLT D.C. or 200-250 A.C. input, combined model consumes only 7 amps. at 12 volts with 20 watts output; chassis complete with valves, and converter; 12 gns.

**V**ENTILATED Steel case, 12/6 extra.

**20**-WATT Model for 200-250 A.C. Only 8 1/2 gns; case, 10/6 extra; 4 input model, 1 1/2 gns. extra.

**H**EAVY Duty 20 Watt Model, as fitted to dance halls and cinemas, etc.; £15, complete with valves.

**A**LL Above have Outputs for 4, 7 1/2, and 15 ohm speakers and independent mike and pick-up inputs.

**R**OLA Speakers, Piezo pick-ups, Reslo microphones in stock.

**H**AVE a Demonstration Without Obligation.

**V**ORTEXION, Ltd., 182, The Broadway, Wimbledon, S.W.19. Phone: Lib. 2814. [4783]

**A**LL Types of Public Address Apparatus for Sale or Hire.

**W**ARD, 46, Farringdon St., London, E.C.4. Tel.: Holborn 9703. [0555]

**E**ASCO P.A. Mables, large or small, with driver operator.—18w, Brixton Rd., S.W.9. Reliance 1693. [0558]

**P**ARTRIDGE P.A. Manual, re Standard Handbook; free to trade from: N. Partridge, B.Sc. A.M.I.E.E., King's Buildings, Deau Stanley St., London, S.W.1. [4524]

**CAR RADIO**

**P**HILCO Repairs and Installations, trade distributors.—Radiorite, Ltd., Moorfields, Liverpool. Bank 8811. [4456]

**USED SETS FOR SALE  
AND WANTED**

**EDDYSTONE**

**E**DDYSTONE All World Two, complete batteries, phones, 5 coils; what offers.—Box 2727, c/o The Wireless World. [4799]

**R.G.D.**

**V**ERY Special Offer (owner exchanging for radiogram).—1937 (May) R.G.D. 625 A.C. receiver, 6 valve 8 stage superhet, with triode output, 4 wave bands and cathode ray tuning, as brand new and fully covered by makers' guarantee; 19 gns., cost £26/5; may be viewed any time by appointment.—Box 2766, c/o The Wireless World. [4807]

**EXCHANGE OR WANTED**

**Q**.A. Receiver, £3, subject test.—Bradshaw, Mill House, Prestwood, Great Missenden. [4821]

**W**ANTED, clearance, surplus, or good used car radios.—Anchor Motor Company, The Newgate, Chester. [4804]

**NEW MAINS EQUIPMENT**

**V**.  
**A**LL Transformers as Last Week's Prices.

**V**ORTEXION, Ltd., 182, The Broadway, Wimbledon, London, S.W.19. (Telephone: Liberty 2814.) [4820]

**T**ANTALUM for A.C. Chargers, H.T. and L.T.—Blackwell's Metallurgical Works, Ltd., Garston, Liverpool. [3984]

**CABINETS**

**R**ADIOGRAM Cabinets, new designs, 30/- to £5/10; inspection invited or photos for selection sent on request.

**T**ABLE Radio Cabinets, undrilled, 6/6 upwards.

**S**PEAKER Cabinets, 4/6 upwards.

**M**ANUFACTURERS' Clearance.

**U**LTRA Radiogram Cabinets, undrilled, 33x23x14 or 33x20x15, 30/-.

**B**URGOYNE "Fury" Radiogram Cabinets (undrilled), 34x22x16 1/2; 49/6.

**K**.B. De Luxe Walnut Cabinets, undrilled, chromium plated edges and speaker grille, 25in. wide, 14 1/2in. high, 10 1/2in. deep, 18/6; Console model, 42in. high, 21 1/2in. wide, 11 1/2in. deep, 39/6.

**H**ALYCON Radiogram Cabinets (Reconditioned), 33x23x19; 35/-.

**H**.L. SMITH and Co., Ltd., 287-9, Edgware Rd., London, W.2. Tel.: Pad. 5891. [0485]

*Notes* on certain No. 48 components used in The "Wireless World" Television Receiver.

To a very considerable number of readers this series of constructional articles will rank among the most interesting that have appeared for a long time. The issues in which the Receiver is described may well be called "special" and the authors have taken, if possible, even more than usual care to ensure a really satisfactory design and have specified only components and accessories that have been well and truly tried.

For several months past, while "The Wireless World" have been developing this receiver, we have been privileged to be in consultation regarding safe working voltages and current-carrying capacities of components, noise levels, etc.

A few of the smaller but nevertheless important links in the chain of success are illustrated and described below.



The specification calls for two fused mains input connectors, illustrated above. This component comprises a bakelite moulding designed for safety and efficiency. In use it is impossible to touch the fuses. With cover removed the fuses are accessible and disconnected from mains, and receiver, eliminator or other apparatus is dead. The moulded flex part carrying mains is entirely shrouded; the sockets and plugs conform to B.S.S. 5 amp. standard. Takes two 1 1/4" standard fuses, nominally fitted with 1 amp. rating (B.S.S. 646b) No. 1114, price 4/3.

The only twin safety fuseholder required is very similar to the connector described above, but without the plug and socket feature—No. 1033, price 2/9.

In all, six of these three-pin plugs and sockets are specified, and are used as follows, Line Scan, Frame Scan, Synchronising Input, Modulation, Speaker and L.T. Supply to C.R. Tube. The connector is non-reversible and the construction of the pins ensures a reliable electrical contact. The Plug Handle is bakelite—No. 1119 price each 1/3.

Six Plug Top Valve Connectors are required—No. 1175, price each 1d.

The "B" Type insulated and lettered terminal is too well known to W.W. readers to require description here. Thirteen are needed for the complete equipment, lettered Syn. E., E input (2), HT+, HT- (2), A1, A2, A.C., C.X.Y. each 8d.

Constructors and designers will appreciate our book, "Radio and Electrical Accessories," containing 150 illustrations, including 75 blue-prints of curves, diagrams and constructional details, and specifications of all our standard products in the accessory class. Send 8d. for a copy Post Free. Free literature also available on request.



**Belling & Lee Ltd.**  
Cambridge Arterial Road, Enfield, Middx.

**DYNAMOS, MOTORS, ETC.**

**A**LL Types of Rotary Converters in Stock, new and second-hand.

**W**ARD, 46, Farringdon St., London, E.C.4. Telephone: Holborn 9703. [0518]

**A**.C.-D.C. 1- and 3-phase Motors, all voltages; from 14/9; list free. Repair specialists.—Easco, 18w, Brixton Rd., S.W.9. [0455]

**NEW LOUD-SPEAKERS**

**B**AKER'S Super Quality Triple Speaker.

**I**DEAL for Use with Quality Amplifiers; A.C. model, £8/15; D.C. model, £7/7; leaflet "Loud Speaker Tailoring" free on request.

**B**AKER'S Conversions.

**T**HE Next Best Thing to a Baker Super Quality Triple Speaker is a Triple Cone Conversion Assembly; whether your moving coil speaker has a permanent or electro-magnet and no matter what type or make you possess, you can considerably improve frequency response and quality of reproduction by having a triple cone assembly fitted, which comprises main curved cone and dual bakelite and duralumin cones combined, mounted in a 12in. die-cast aluminium frame.

**T**HE Price is 29/6 Complete, including free fitting at our works; there is a special triple cone assembly for owners of Baker's super power speaker, price 25/-, including coil.

**B**AKER'S Quality Surplus Speakers.

**I**F You are Requiring Quality Reproduction at Low Cost order one of the following brand new bargain speakers now. The Auditorium models are fitted with latest triple cone comprising main curved cone and bakelite and duralumin cones combined, giving wide and even frequency response, resulting in quality reproduction of speech and music. The Coronation surplus horn models are ideal for reproduction of transients.

**39/6** Only, usual price £5.—Auditorium Permanent Magnet Speaker with Alni magnet and die cast frame, large 12in. triple cone giving wide frequency range, complete with large 25 ratio transformer suitable for all outputs, including push-pull and Class B, etc.

**59/6** Only, usual price £6.—Auditorium Electro-Magnet Speaker, 1,000, 1,250, 2,000 or 2,500 ohms field, exceptionally large magnet of high permeability steel giving enormous flux density, 2in. moving coil, large triple cone giving wide frequency range, complete with universal transformer, the ideal speaker for use with "Wireless World" and other quality amplifiers.

**75/-** Only, usual price £9.—As above, but for use on A.C. mains; complete with Westinghouse rectifier and full smoothing equipment.

**49/6** Only, usual price £6.—Coronation Surplus Horn Permanent Magnet Moving Coil Speakers, suitable for domestic or public address; the horn is of moderate size and the speaker is therefore ideal for home use where good reproduction of transients is required; can be used separately or in conjunction with baffle board speakers.

**15/6** Only.—Permanent Magnet Speaker, Alni magnet, 8in. cone, Universal transformer.

**12/6** Only.—Permanent Magnet Speaker as above with 7in. cone.

**2/9** Only.—Brand new cabinets, 12x10x6.

**8/6** Only.—Electro-Magnet Speakers, with 8in. cone, 6,500 ohms field, Universal transformer.

**A**LL Baker Quality Surplus Speakers are Sold for Cash or C.O.D.

**B**AKER'S SELHURST RADIO, Ltd., The Pioneer Manufacturers of Moving Coil Speakers, 1925-1937.—75-77, Sussex Rd., South Croydon. (Croydon 3441.) [4790]

**V**AUXHALL.—Loudspeakers, 1938 range, now available; details see new list.—Vauxhall Utilities, 163a, Strand, Temple Bar 9338. [4609]

**LOUD-SPEAKERS**

**SECOND-HAND, CLEARANCE, SURPLUS, ETC.**

**G**OODMANS 10in. High Fidelity Auditorium Speaker, with transformer; £2; perfect.—Vemey, Rumsam, Barnstaple. [4795]

**VALVES**

**A**NDERSON.

**A**MERICAN Valves, all makes, first grade only; 5/- each.

**A**NDERSON, 35, Lansdowne Rd., Walthamstow, E.17. Walthamstow 0827. [3351]

**B**IGGER and Better Value in American Valves.

**3/-** Any Popular Type; 6/- each 210, 250 and 81, variety of Octal Base Tubes, 3/- to 4/-.

**A**LL Types Transmitting Tubes in Stock; Majestic and Spartan types, 4/6 each.

**R**ADIOGRAPHIC, Ltd., 66, Osborne St., Glasgow, C.1. Bell 848. [4816]

**A**MERICAN Valves, first grade, in all types; trade supplied.—Metropolitan Radio Service Co., 1021, Finchley Rd., N.W.11. Speedwell 3000. [0436]

**A**LL Types of American Valves in Stock of Raytheon, Sylvania, and Arcturus makes, at competitive prices, guaranteed for six months; send for full list; 350 ohm line cords, 2/8.

**W**ARD, 46, Farringdon St., London, E.C.4. Tel.: Holborn 9703. [0452]

# FOR HE'S A JOLLY GOOD FELLOW!

We wonder how many people realise the enormous amount of work entailed in producing a design, perhaps it would be giving away secrets if we mentioned how long "The Wireless World" had spent in the most careful and thorough investigation of Television before producing their present design.

We feel just a little proud that we were finally selected to take care of the vital question of TRANSFORMERS, and it is very nice to think that you will be able not only to hear but to see how good SOUND SALES products really are—that is, of course, if you fit the specified components. Anyway, it is not a bad idea to support the jolly good Fellows who have worked so hard to perfect a design.

### SPECIFIED TRANSFORMERS.

Type TEL/EHT.....Price £2.18.6  
Type TEL/350.....Price £1.15.0

### SPECIFIED CHASSIS.

SOUND RECEIVER POWER PACK Chassis, Price 11/0  
SOUND RECEIVER POWER PACK Chassis, with Valve Holders.....Price 12/0  
TIME BASE Chassis.....Price 16/0  
TIME BASE Chassis, but fitted with Valve Holders.....Price 20/0

The above are 18 gauge steel, sprayed finish.

May we send YOU further particulars of SOUND SALES Products?



**SOUND SALES**  
MARLBOROUGH RD., LONDON, N.19.  
UPPER HOLLOWAY, LIMITED. Tel.: ARChway 1661/2/3  
(Contractors to the G.P.O., War Office, Air Ministry, etc.)

## PRINTER'S ERROR

In our advertisement on Page 2 of July 9th issue, owing to a printer's error, the figures 2/6 and 15/6 appeared under the heading

### PREMIER HIGH FIDELITY P.A. AMPLIFIER KITS,

although the price of each kit was clearly mentioned. Unfortunately the issue of July 16th had gone to press before the error was noticed, resulting in its being repeated. We sincerely regret any inconvenience caused to our clients.

## PREMIER SUPPLY STORES,

Jubilee Works,  
167, Lower Clapton Rd., London, E.5.



**TANNOY**  
THE SOUND PEOPLE  
GUY R. FOUNTAIN LTD.  
CANTERBURY GROVE, WEST NORWOOD,  
LONDON, S.E.27. 'Phons: Str. 4122 (5 lines).  
SOUND AMPLIFYING EQUIPMENT

## METERS, ETC.

CAMBRIDGE, 35 micromap, 288 ohm, no scale; 50/-  
—Harris, 50, Blessington Rd., Lewisham. [4798]

AVOMETER, universal, complete in case with accessories, new condition; cost £5, accept 55/-, or near offer.—Box 2770, c/o The Wireless World. [4811]

FERRANTI Meters, 150 moving coil single and triple range, new boxed discontinued types; 10/- to 17/6 each.—Farnell, 12, Heaton Park Rd., Bradford. [4806]

## NEW COMPONENTS

CONDENSERS, fixed paper, in metal containers.

1,000 Volt Working, 1 mfd., 2/6; 2 mfd., 4/9; 4 mfd., 7/6; 8 mfd., 10/6; bakelite tubulars, 1,000 volt working, 1 mfd., 2/6; 0.5 mfd., 2/-; 0.25 mfd., 1/9; 0.1 mfd., 1/3; 0.01 mfd., 9d.

THE STATIC CONDENSER Co., 11, Eden St., Hampstead Rd., London, N.W.1. "Makers of Good Condensers." [4808]

RAYTHEON Valves, all American components; trade; —Zelco, Ltd., 53, Farringdon Rd., E.C.1. [0499]

## COMPONENTS

SECOND-HAND, CLEARANCE, SURPLUS, ETC.

SPECIAL Summer Sale Now Proceeding at Our Holborn Premises.  
ALL Lines Previously Advertised Still in Stock.

RADIO CLEARANCE, 63, High Holborn, W.C.1. Holborn 4631. [4818]

### PREMIER SUPPLY STORES.

PLEASE See Our Displayed Advertisement on Page 2. [0488]

OLIVERS Offer Centralab Volume Controls, with switch, all values; 2/- each.

CHASSIS Mounting Valve Holders, 5-pin, 2 1/2d.; 7-pin, 3 1/2d.; octal base, 6d.; American, 6d.

ERIE 1-watt Colour Coded Resistances; 3 1/2d. each, 3/- dozen; 2/6 dozen in 3-dozen lots.

B.I.T.C.C. and Hunt's Cardboard Case Electrolytics, 4 mfd., 1/6; 8 mfd., 1/9; 50 mfd. 50v., 1/6; 8 mfd. + 4 mfd., 2/5; 8 mfd. + 8 mfd., 2/9; 4 mfd. + 4 mfd., 2/-; 4 mfd. + 4 mfd. + 4 mfd., 3/-; 1 mfd., 1/-; 25 mfd. 25v., 1/1; 50 mfd. 12v., 1/-.

ALUMINIUM Chassis, 18 gauge, 16in. x 10in. x 3in., 5/3; 16 gauge ditto, 7/6; drilled to any specifications, any size, quotations upon receipt information; panels and boxes a speciality.

AMERICAN and Non-ring Valves, all guaranteed, brand new; best discounts off list prices; write for lists; together with quotations.

ENQUIRIES invited; quotations and lists free; components of all descriptions which we are unable to advertise will be quoted for upon request.

OLIVERS, 676, Christchurch Rd., Boscombe, Hants. Orders under 5/6 postage extra; c.o.d. extra. [4813]

RYALLS RADIO, 280, High Holborn, London, W.C.1, offer new goods at knock out prices.

AMPLIFIERS.—7 watt A.C. outputs, pair triodes in push-pull coupled correct type Varley transformer, 3-stage, for 200-250v. A.C., good chassis, complete with 5v. and Rola G.12 speaker, 27; transverse mike on plated stand, 25/-.

BI Electrolytics, 12x8 mfd., 350v., 1/6; NSF 25x26v., 6 3/4; NSF tubular bag ends, 0.15, non-inductive; 750v., 2/6 dozen.

PAIRS Ferranti Screened Coils, 2/6; Ferranti aerial coils, 6 3/8; Ferranti 3-range coils, 1/3; with circuits, chassis types.

FERRANTI Mains Transformers, as used in their commercial sets, 350-0-350v., 70 m.a., 4v. 4-5a. C.T., 4v. 2 1/2a. input, 200/250v., brand new; 6/6. [4748]

VAUXHALL—Standard 1938 components; details, see new free list.—Vauxhall Utilities, 163a, Strand, Temple Bar 9338. [4610]

MAINS RADIO DEVELOPMENT CO.'s Astounding Bargains.—Carriage paid; call mornings; 'phone: Tudor 4046; stamp for List 205.

N.S.F. 1/2 and 1 watt Carbon Resistors, twelve good sizes, well assorted, marked values; 50 for 3/6; unrepeatable offer.

CLEARANCE of Mica Tag Condensers, 20 assorted of six good sizes from 0.0002-0.005 mfd.; 1/- while stocks last.

TUBULAR Condensers.—Brand new, wire ends, finest make, 400 volt working, 0.0001-0.002 mfd., 2d.; 0.005, 0.01, 0.02, 0.05, 0.1 mfd., 4d.; 0.25, 0.5 mfd., 6d.; 5-pin, 2 1/2d.; 7-pin, 4d.; three-valve grey cellulosed metal chassis, 12 1/2 x 6 1/2 x 3in., 1/-.

RESISTORS.—Absolutely finest make, one watt, colour coded wire ends, unused, any size 50 ohms to 5 megohms, 3 1/2d. each, 2/9 a dozen; your choice; two watt, any size, 6d.

B.I.C. Unused Dry Electrolytics, 8+8 mfd., 500 volt, 3/-; 8 mfd. 550 volt, metal can, 2/3.

KNOBS.—Black, octagonal bakelite, 1 1/4in. diameter, quarter inch spindle, beautiful appearance; 2 1/2d. each.

FERRANTI Twin H.F. Choke Mains Interference Filter Units. Must be cleared, 1/- Extraordinarily effective.

MAINS RADIO DEVELOPMENT CO., 4-6, Muswell Hill Rd., London, N.6. [4774]

STANDARD RADIO SUPPLIES.—Definitely lowest prices in country on Europa, Hivac, valves, speakers, gramophone motors, Telsen coils; send for list.—1, Dantzic St., Manchester. [4752]

FERRANTI A.C./D.C. Test Meter, £3/10, list £6/6; E.M.I. oscillator, as new, £3/8; Radiometers valve tester, £5/5; 0-1 A.C. n/a meter, Weston, 40/-; 0-5 Weston A.C. voltmeter, 12/6; Savage carbon microphone, 15/-; Philco all-purpose tester, £8.—Grosier, 451, Seven Sisters Rd., N.15. [4824]

## ELECTRADIX BARGAINS

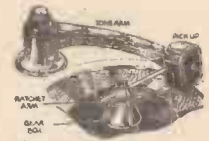

ELECTRIC HOME RECORDERS. Our prices are unbeatable, as factory cost was twice our sale price. The FEIGH RECORDER fits any Radiogram and is positive drive by 37/6 METERS. For fault finding, etc. Bargain line in portable moving coil by Everett Edgecombe, 40 to 240 v., 25-. A £15 A.C./D.C. Type "8" Radio Tester, as new, £5/17/6.

120 volts for home conversion to multi-range, 21/8. Western flush panel milliammeters, 0-30 or 0-100, 17/6 each. E.E. voltmeters, A.C., 240 v., 25-. A £15 A.C./D.C. Type "8" Radio Tester, as new, £5/17/6. PANELS. Aluminium 16- and 18-gauge one side enamelled. Paxolin and Ebonite, any size, from 2 1/2in. x 2 1/2in. at low prices. CONDENSERS. 2-gang variable, 0.005, new, 2/8; single, 1/6. COILS, Phillips Superhet set of 3 in makers carton, 3/- set. 8-W coils plug-in, 1/8. Ribbed formers, 9d. Long-wave and B.C. 2-pin, 1/- Reaction tuners, 9d. H.F. twin chokes, mains, 9d. Rugby and other coils in stock. All wavelengths in 2-pin, 1/3. Brownie dual-range 200/2,000, 1/8. M.I.C. concert coils, set of 4, 2/6; aerial, react., long, short and multiple, 1/8; 8/W Formers ribbed and slotted, 4d. RESISTANCES. I.M.V. in glass tube, wire ends, 10,000, 25,000, 50,000, 100,000, 500,000 ohms and 1 meg., 1/8 set of 6. CRYSTAL SETS. Still the best Radio Receiver. No battery or valves wanted. Quiet and efficient reception. 500 shop-soiled sets, cheap. Enclosed type, 5/6 and 7/6 each.

HEADPHONES. Light weight, 2,000 ohms, 4/6. Single high res. earpieces, 2/6. Sullivan 120 ohm W.D. model. Aluminium body and headbands. Maker's price to-day 15/-. Our price 2/0 per pair. 3d. postage. DOUBLE CURRENT GENERATORS, D.C., 0-60 volts 100 m.a., and 6 volts, 3 amps., 32/6. X-RAY TUBES. As illus. previous issues. Brand new W.O. Hospital Surplus. Pin. dia. bulb big tungsten electrodes. Full emission. Cost £5. Sale 15/- Packing, 2/6.

SPARK COILS. 1in., 1 1/2in. and 1in. gap, with condensers, 10/6. Large 7in. coils in mahog. case, £7/10/0. Short wave spark transmitters for boat model control, 17/-. SOLENOIDS. 6-volt, for model work or distance switch, core travel 1in. 1 1/2oz., 3/3. A.C. Magnets, 230 volts, 30 m.a., 14 ozs., 12t, 2/6. FLEX CORDS. 3-way 6ft. long, 6d. 4-way, 12t, 1/- 4-way 6ft. with plug and socket, 1/6. Govt. 6ft. telephone cords, with plug, 1/-.

LIGHT AND RAY CELLS.—Selenium Raycraft, 21/-; Kingston, 15/-. Raycraft outfit with relay and amplifier, 45/-; Photocells, for sound on Film, Television and Ray Work. R.C.A., 25/-; G.E.C., £3 10/-. Beck Angle Prisms, mounted in carrier, 5/6. Micrometer adjusters for lens, 1/-; Eye-pieces with prisms and lenses for photocell inspection, 12/6. Selenium Cells, 5/- and 7/6. Raw Selenium, 1/- piece. MIRRORS.—5 1/2in. dia., 20/-; 20in., 25/-; 24in., 30/-. Carr. fwd. Neon Lamps, 2/6 and 3/- each, with holder. Miniature Neons, 2/6.

TELEPHONES for House, Office, Garage and Field Sports. Wall type, Fig. 1, as illustrated, 15/-. Other Wall and Table models cheap. Send for lists.

NOTE SELECTOR RELAY SWITCHES, 6 gangs of 25 ways, magnet operated, 8/6.

MAGNETIC TRIP SWITCHES, 1 to 1 amp. A.C. or D.C. 5v. to 500 volts, bakelite cover, ideal circuit protectors, 6/6.

TRANSMITTERS, MORSE AND SIGNAL KEYS, Royal Air Force model, balanced action, solid brass bar, tunnel contacts, indicator lamp, Type K881; a guinea key for 7/6. Learner's outfit complete, 4/9. Ask for special illustrated Key List "K.W."

## ELECTRADIX RADIOS

218, UPPER THAME STREET, LONDON, E.C.4  
Telephone: Central 4611



**"ENGINEERING OPPORTUNITIES" FREE!**  
This unique Handbook shows easy way to secure  
A.M.I.C.E., A.M.I.Mech.E.,  
A.M.I.E.E., A.M.I.A.E.,  
A.M.I.W.T., A.M.I.R.E.,  
and similar qualifications.  
WE GUARANTEE  
"NO PASS—NO FEE."  
Details are given of over 150  
Diploma Courses in all  
branches of Civil, Mech., Elec.,  
Motor, Aero., Radio and  
Television, Engineering,  
Building, Government  
Employment, etc. Write for  
this enlightening Handbook FREE and post free.  
BRITISH INSTITUTE OF ENGINEERING TECHNOLOGY,  
387, Shakespeare House, 17, 18, 19, Stratford Place W.1



**LEXINGTON VALVE TESTER**  
Checks continuity in Coil, Condensers, Transformers, etc. Can be used as D.C. voltmeter. Cannot be overloaded. Write to-day for full details.  
Tests EVERY TYPE of British or American valve on 2 volts to 100 volts.  
10 gns. subject  
Lexington Instrument Laboratories Ltd.,  
155-7, St. Portland Street London, W.1.  
'Phone: Langham 3477. "SIMPLIFIED SERVICING."



*The Autocar*  
The Leading Motoring Paper  
EVERY FRIDAY 4d. W.W 16

# RAYMART

CRAFT A CREED

## SHORT-WAVE AND SERIES GAP CONDENSERS

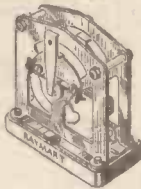

Short-wave Type V.C.1. The use of extension brackets is obviated in the construction of these highly efficient all brass condensers, the whole assembly is fitted on a steatite base, no other insulation being used. Noiseless operation is secured through pig-tail connection being taken to point of lowest potential.

**TYPE V.C.1.**  
·00015 mfd.,  
4/6.

**TYPE V.C.2.**  
·00015 mfd.,  
5/-.

Series Gap Type V.C.2. These condensers may be used at 1,000 volts or as split stator at 500 volts, they may also be employed as two gang ·00015 (Bridged Matched).

**FOUR RAYMART MICRO-VARIABLES  
ARE SPECIFIED FOR THE  
"Wireless World" Television Receiver  
TYPE V.C.15X. 15 mmfd. 1/4 each.**

**AMERICAN MAINS TRANSFORMERS.** Heavy Duty 350-350 v. 150 m.a., 4.5v. 4s. 5v. 3a., 12.6. GE 350-350 v. 80 m.a., 2.5v. 4.5a. 5v. 2a. 5/11. Majestic 250-250, 2.5v., 5v., 4/11. Pilot 250-250, 2.5 v. C.T. 5 v. C.T. 5/11. Ceramic American Valveholders, 1/-, 2.5 v. C.T. 5/11. **BRITISH RADIOPHONE** ·0005 straight or superhet 3-gang fully screened condensers with trimmers, 4/11; Utility Midget 2-gang ditto, 3/11; S.L. Dial to suit above, 2/11; Utility 2-gang Uniknob ·0005 with Dial, 3/11. **COLIFORMS**—Moulded in RD4 natural loloal material, hollow resilient cups, 1 1/2 in. diameter, ribbed; identification disc in top. Four types, 4-pin, 1/8; 6-pin (standard or to fit 7-pin valveholders), 1/9; 7-pin (for handspread tap), 1/10; Machine threading, 2d. extra. **ELECTROLYTICS.** Huge purchase 500 v. Aluminium Can, 4 mf., 1/8; 8 mf., 1/11; 8+8 mf., 2/6; Block type, 500 v. peak, 4+4 mf., 1/6; 8+8+4 mf., 3/-; 50 mf., 50 v., 1/3; 25 mf., 25 v., 1/-; Tubular Condensers, 1,500 v. T., all sizes to 61 mf., 81. 0.2 to 0.5 mf., 8d. **FAMOUS CONTINENTAL A.C. VALVES, 4/6;** Battery types from 2/3; American Duotron, etc., all types, 3/6; all types of RCA Licensed first grade tubes, metal and glass, in stock from 5/8. **HEAVY DUTY MAINS TRANSFORMER,** worth 45/-, 350-350, 150 m.a., 2 v., 2.5 A. C.T. 4 v., 6 A. C.T. 12/6; Philips 270-270, 120 m.a., same LT's 6/6; Speaker Transformers, 2/8. **MICROVARIABLES.**—All brass construction, latest ceramic insulation. The finest condensers made: 15 mmfd., 1/4; 40 mmfd., 1/7; 100 mmfd., 1/10. Transmitting Type—·070 in. spacing, 15 mmfd. (neutralising), 2/8; 40 mmfd. Tuning, 3/6. These are quality. **PUSHBACK WIRE,** 6 yds., 6d.; heavy 9d.; Resin-coated Solder, 6s., 6d.; Screened Flex, single, 6d. yd.; twin, 8d. yd. Assorted Solder Tags, 6d. packet. **SHORTWAVE COILS.**—(RD4), CA 11-25, CB 30-45 metres, 2/6. OC 44-100 metres, 2/8. Standard 4-pin types, CA8, CB6, 2/9 each. **OCN,** 3/-, same range as 4-pin. **SMOOTHING CHOKES,** 20 hy., 120 m.a., 3/11; 200 m.a. swinging chokes, 8/6; Centralab Pots, all sizes, 1/8; switched, 2/-; 20,000 ohm Pots, 1/-; Tubular glass fuses, 2d. Milliameters, 25 m.a. upwards 5/9; super, 6/9. **UTILITY** 8/6, Microdisc Diats, 3/11; Radiophone, 0.00015 Shortwave Condensers, 3/8; Series gap twin, 3/8. Shortwave HF Chokes 6-100 metres, 2d. **465 KC Litz Wound IF's,** 3/11; Two-speed slow-motion knobs, 1/-; Telsen Ace Transformers, 1/11; Telsen Screened S.W. H.F.C., 1/-; Iron core H.F. chokes, 1/-.

**SPECIAL OFFERS.** Class B Kit, worth 30/-, comprising Driver Transformer, Valve and Holder, 5/-; Dozen wire-ended assorted resistors, 1/8. Order 6/- post free. Get our Bargain Catalogue, 1yd. post free. All enquiries and requests for Catalogue must acid 1yd. stamp.

**RAYMART SHORT-WAVE MANUAL**  
48 pages in all, 32 on receivers, transmitters, aeriels, circuits, etc., etc., and 16 on short-wave components, 6d., or post free. 7d. Short-Wave Catalogue, 16 pages, 1/6d.

**G5NI (BIRMINGHAM) LTD.**  
44, HOLLOWAY HEAD,  
BIRMINGHAM TELE: MID 3254

**THE ORIGINAL CARDED LINES**

A neat selection of valve connectors. Item wanted is seen at a glance. Clean firm contact without looseness and "crackles."

**CARD No. 31. Price 10/-.**

DISPLAY CARDS

**BULGIN**  
BRITISH MADE

TOP QUALITY ADAPTORS

**CONNECTORS**

DISPLAY CARDS

**A. F. BULGIN & CO., LTD.**  
ABBEY ROAD, BARKING, ESSEX

## REPAIRS AND SERVICE

"SERVICE WITH A SMILE."

**HENRY FORD RADIO** Ltd.—American valves, components, spares, line cords; leading trade repairers; send us your American and British receivers.—Electronic House, 22, Howland St., Tottenham Court Rd., W.1. Museum 5675. [0434]

**HARMONY HOUSE SOUND and SERVICE,** Southport.—Radio repairs for the Trade.—Tel. 8621. [0558]

**D.C. Sets Converted to A.C. Operation;** £2/5 inclusive.—Champion, 42, Howitt Rd., N.W.3. Primrose 6791. [4796]

**ANY Transformer Repaired or Made to Specification;** 15 years' experience.—Fel-Electric, Garden St., Sheffield. [0561]

**METROPOLITAN RADIO SERVICE** Co. for Guaranteed Repairs to American (Midget and Standard and British Receivers).

**CLARION and Majestic Service Depot.**—I.F. and mains transformers rewound. American valves and parts; trade supplied.—Metropolitan Radio Service Co., 1021, Finchley Rd., London, N.W.11. Speedwell 3000. [0435]

**FOR Unusually Good Rewinding of Transformers, chokes, speakers, etc., trade only.**—Gardners Radio, Ltd., West Southbourne, Bournemouth. [0551]

**GUARANTEED Repairs.**—Any transformers, choke, motor, armature, converter, dynamo, etc.; keenest prices, immediate quotation, prompt, dependable service.—See below.

**L.T.P. (LONDON TRANSFORMER PRODUCTS, Ltd.)** Willesden, N.W.10. Willesden 6486 (3 lines). [3470]

**MAINS Transformer Service.**—Repairs, rewinds, or constructions to specification of any type; competitive prices and prompt service.—Sturdy Electric Co., Dip-ton, Newcastle-on-Tyne. [0516]

**F. E. GODFREY, A.M.I.R.E.,** qualified to build, repair and convert "Wireless World" sets, etc.; 25 years' experience, prompt service guaranteed.—30, Kemplav Rd., Hampstead. Hampstead 1104. [4767]

**DEGALLIER'S RADIO SERVICE,** repairers of British and American receivers; lowest prices with good workmanship; also speaker repair department; new coils and cones fitted, fields altered, transformers rewound, any transformer, choke, armature, converter, or dynamo re-wound; let us quote.

**DEGALLIER'S RADIO SERVICE,** 32, Bathurst Mews, Paddington, London, W.2. Telephones: Paddington 2745 and Bayswater 5732. [4714]

**REPAIRS to Moving Coil Speakers a Speciality;** cones and coils fitted, fields altered; prices, including eliminators, quoted, loud speakers, 4/-; L.F. and output transformers, 4/-, post free; guaranteed satisfaction; trade invited; estimates free; prompt service.—Loud-Speaker Repair Works, 5, Balham Grove, London. Battersea 1321. [0394]

## TRANSMITTING APPARATUS

**3.5 M.C. X-cut Crystals,** 5/-; A.T.-cut, 7/6.—GETZ, 85, Hermitage Rd., Coventry. [4810]

**G5N1.**—The recognised distributors for amateur equipment, National, B.M.E., Thordarson, Hammarlund, McMurda, Hallcrafters, etc.; send 1/2d. stamp for catalogue.—G5N1 (Birmingham), Ltd., 44, Holloway Head, Birmingham. [0531]

## MISCELLANEOUS

**CHEAP Printing.**—1,000 billheads, 3/6; sample free.—Creteway Press, 18, Buxted, Sussex. [4719]

**WHEATSTONE Bridges,** fitted 17 plugs and key, new, by high class makers, weight 6lb.; 20/-; postage 9d.—Beaton's Stores, 63, Chalk Farm Rd., N.W.1. [4812]

## EXTENDED PAYMENTS

**LONDON RADIO SUPPLY** Co. (Established 1925), supply on convenient terms, components, accessories and sets, any make, 10% down, balance over 12 months; send for list of requirements.—11, Oat Lane, London, E.C.2. [0337]

**HIRE-PURCHASE.**—Prompt delivery of any radio apparatus on convenient terms.

**WARD,** 46, Farringdon St., London, E.C.4. Tel.: Holborn 9703. [0539]

## EXCHANGE

**I BUY, sell, exchange** good quality receivers, accessories, components; H.F. facilities; promptness, efficiency.—Bostock, 1, Westbourne Terrace, S.E.25. Forest Hill 2236. [0529]

## PATENT AND TRADE MARK AGENTS

**GEE and Co. (H. T. Gee, Mem. R.S.G.B., A.M.I.R.E.,** Estab. 1905), 51-52, Chancery Lane, London, W.C.2 (2 doors from Government Patent Office). Holborn 4547 (2 lines). Handbook free [0001]

## TUITION

**RADIO Training.**—Marine, aircraft, broadcast; prospectus free.—Hull Municipal Technical College. [0523]

**RADIO Engineering.**—Theory and practice thoroughly taught by postal course; 330 positions obtained for students in four years; recognised as a training institution by radio manufacturers; also instruction at college.—Apply British Radio Engineering College, 179, Clapham Rd., London, S.W.9, (Brixton 3487.) [4722]

## WANTED

**WE Buy for Cash All Types of Modern Second-hand** Radio Sets and Accessories, test meters, parts, etc.; we pay more than any other dealer; part exchanges; bring, send, or will call.—University Radio, Ltd., 82, Hampstead, Rd., London, N.W.1. Phone: Euston 3810. [4749]

# HIRE a VOIGT SPEAKER

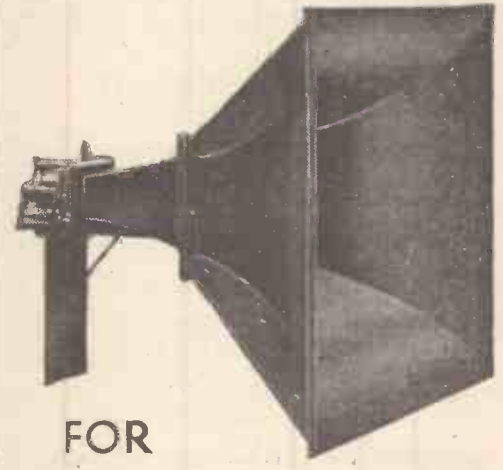

## FOR THAT BIG P.A. JOB

In order to give P.A. experts the opportunity of testing out a Voigt speaker under their own conditions we have allocated a few straight horns and units for hire work.

**CONDITIONS OF HIRE:**  
Hirer supplies references or deposit, and afterwards a report of performance.  
**FEE** First week: 1 guinea, plus transport; Additional weeks: 1/2 guinea per week  
This fee is waived if hirer purchases.

**EARLY APPLICATION ADVISABLE.**

**WRITE NOW**



**THE COURTS · SILVERDALE · SYDENHAM · S.E.26**  
Tel.: SYDenham 6666

Regd. Office: 22 Castle Street, E.C.1

Radiolympia

We hope to hire premises near Radiolympia again this year.

Full details will be published as soon as possible.

V.P.L.

WANTED

**THE Publishers Will Pay 2/8 per Copy for Copies of**  
 "The Wireless Engineer," dated January, 1924; February, March, July, 1929; January, February, March, August, 1930; January, February, March, May, 1931; April, May, June, November, 1935; January, February, 1935.—Address Publishers, Dorset House, Stamford St., London, S.E.1. [4822]

**BUSINESSES AND PROPERTY FOR SALE, TO BE LET, OR WANTED**

**PUBLIC Address Outfit, consisting of two coaches, three equipments, nine speakers, 3 "mikes," cable, batteries, converters, etc; bargain price; to be sold as going concern with engagements.—Box 2623, c/o The Wireless World. [4797]**

**SITUATIONS VACANT**

**AIR MINISTRY.**

**DIRECTORATE of Technical Development.**

**VACANCIES for Draughtsmen, Grade I, at the Royal Aircraft Establishment, South Farnborough, Hants:—**

**DRAUGHTSMEN, Grade I, for work in connection with the design of wireless apparatus. Candidates should have had good technical training in electrical engineering and drawing office and workshops experience on radio, telephone, or scientific instruments work, or on work of an allied character.**

**SALARY Scale:**

**£220** a year, rising by annual increments of £10 to £260 and thence by £12 to £330 a year. There is an efficiency bar at £260 a year.

**THE Commencing Salary will be Fixed According to Qualifications and Experience.**

**THE Appointments will be Non-pensionable, but entrants will be eligible for consideration for appointment to pensionable posts in the event of vacancies arising on the permanent establishment.**

**APPLY (Quoting Reference Number 357D.), and stating age, qualifications and experience, to the Chief Superintendent, Royal Aircraft Establishment, South Farnborough, Hants.**

**CLOSING Date for the Receipt of Applications is July 30th. [4801]**

**WELL Educated Young Men Required Immediately as Apprentices to learn theory and practice.—Write R.T.I. Radio Service, 40, Earl's Court Rd., W.8. [4781]**

**GUARANTEED Positions in Marconi Service; all successful students placed; separate Morse Classes held.—The Wireless School, 74, Bull St., Birmingham. 4. [4513]**

**FIFTH EDITION— Revised and Enlarged**

**HANDBOOK of TECHNICAL INSTRUCTION for WIRELESS TELEGRAPHERS**

**By H. M. DOWSETT, M.I.E.E., F.Inst.P., M.Inst.R.E.**

Author of "Wireless Telegraphy & Telephony," "Wireless Telegraphy & Broadcasting."

**PROVIDES a complete theoretical course for students wishing to qualify for the Postmaster-General's Certificate of proficiency. Additional chapters included in this new edition are those on Echo Sounding Apparatus, Short-Wave Marine Transmission and Reception, Marine Telephony and Band Repeaters—all recent developments which concern the sea-going operator. All sets in general use (Marconi, Siemens, Radio Communication) are also described. A chapter on Direction-finding includes information on laying-off bearings, specially drawn direction-finding charts and methods of calculating great-circle distances.**

**Demy 8vo 570 pages 525 diagrams and illustrations**

**PRICE 15/- net By post 15/9**

*Obtainable from all leading booksellers or direct from the publishers*

**ILIFFE & SONS LTD.**

**DORSET HOUSE, STAMFORD ST., LONDON, S.E.1**  
 W.W.96

**SITUATIONS VACANT**

**LONDON COUNTY COUNCIL.**

**INSTRUCTOR for Radio Service Work (Wednesdays, 7.30 to 10 p.m.), required at Norwood Technical Institute, Knight's Hill, S.E.27; responsible service experience with all types of receivers necessary; some P.A. work desirable; teaching experience an advantage; fee 22/- an attendance, including payment for any duties beyond teaching period; forms from Education Officer (T.1), County Hall, S.E.1 (stamped addressed foolscap envelope necessary), to be returned by 14th August; canvassing disqualifies. [4809]**

**WIRELESS Operators and Engineers Urgently Required.**  
 —Train at Britain's leading colleges; fee after appointment; boarders; prospectus free.—The Wireless College, Colwyn Bay, or The Wireless College, Calmore, Southampton. [0541]

**RADIO Service Engineer-Salesman, thoroughly qualified, able use test gear and handle all repairs, smart, efficient, and absolutely honest, able drive, good post and prospects for right man; enclose photograph.—Blythe Marden, 26, Croydon Rd., Caterham, Surrey. [4814]**

**MANUFACTURERS of Public Address Equipment Require First Class Representative to Commence About 31st August, proven London and provincial connections essential, excellent prospects for the right man.—Fullest particulars, with proposed salary and commission, to Box 2740, c/o The Wireless World. [4800]**

**VACANCIES occur for Thirty Men, aged 18-23, in the Post Office Eng. Dept.; experience is not required, but applicants must be willing to study technical subjects; commencing pay £3/15, rising to £7 per week and upwards, with pension.—For full particulars apply B.I.E.T. (Dept. 574), 17, Stratford Place, W.1. [4716]**

**RADIO Production Superintendent Required, to take control of large departments manufacturing components and complete receivers, must have sound technical knowledge, and experience in up-to-date mass production methods.—Apply in writing to Employment Office, A. C. Cosser, Ltd., Highbury Grove, giving full particulars in chronological order of age, experience, and salary required. [4815]**

**SITUATIONS WANTED**

**ENGINEER, A.M.I.E.E., seeks position, radio and P.A. used to control, own car, etc.—Box 46, Cummins Library, Muswell Hill. [4803]**

**BOOKS, INSTRUCTION, ETC.**

**"WIRELESS WORLD," 1933-1936, unbound, 1931 from June, 1932 from March; offers.—105, Clements Rd., East Ham. [4805]**

**"WIRELESS WORLD" From 1927 to Current Number, few missing; price 10/- the lot, plus carriage and advertising.—Bradshaw, 113, Clarence Avenue, Northampton. [4802]**

**INDEX TO ADVERTISEMENTS**

All-power Transformers, Ltd.	PAGE
Automatic Coil Winder Co., Ltd.	
Baker's Selhurst Radio	
Belling-Lee, Ltd.	3
Birmingham Radiomart G5N1	5
British Institute of Engineering Technology	4
British Insulated Cables, Ltd.	
British Mechanical Productions, Ltd.	
British Pix	
British Radiogram Co., Ltd.	
British Rola Co., Ltd.	Edit. 87
British Sound Reproducers, Ltd.	
British Thomson-Houston Co., Ltd.	Inside Back Cover
Bulgin, A. S., & Co., Ltd.	5
C.A.V.	
Colvern, Ltd.	
Cosser, A. C. Ltd.	Inside Front Cover
"Drydex"	
Dubilier Condenser Co. (1925), Ltd.	Front Cover
Edison Swan Electric Co., Ltd.	
Electradix Radios	4
Exide, Ltd.	

Fluxite	PAGE
Forbat, Eugene J.	Inside Back Cover
Galpin's Electrical Stores	
Gardners Radio, Ltd.	
Goodmans, Ltd.	Inside Back Cover
Grampian Reproducers, Ltd.	Inside Back Cover
Hartley Turner Radio, Ltd.	1
Haynes Radio	Front Cover
Henley's W.T. Cable & Wireless Works	
H.M.V.	
Institute of Wireless Technology	
Ismay Distributors, Ltd. (Halcyon)	
Lexington Instrument Laboratories, Ltd.	4
Marconi's Wireless Telegraph Co.	Inside Back Cover
McCarthy Radio, Ltd.	Front Cover, Edit 83
Midwest Radio, Ltd.	Front Cover, 6
M.P.R. Electrical Co.	
M.R. Supplies	
Parmeko, Ltd.	

Peto-Scott, Ltd.	PAGE
Player's Cigarettes	
Polytechnic Institute	Inside Back Cover
Postlethwaite Bros.	2, 6
Premier Supply Stores	
Record Radio, Ltd.	
Reliance Mfg. Co.	1
Savage, W. Bryan	Inside Back Cover
Scott Sessions, Ltd.	
Shafesbury Microphone	
Sound Sales, Ltd.	4
Stern, S.	
Tannoy Products	4
Telegraph Condenser Co., Ltd.	Edit. 85
Universal Radio Distributors, Ltd.	
Voigt Patents, Ltd.	5
Ward, C. F.	1
Webb's Radio	
Westinghouse Brake & Signal Co.	1
Wright & Weaire, Ltd.	Inside Back Cover

**FREE ART CATALOGUE DEMONSTRATIONS** 40 pages, fully illustrated, giving particulars of Midwest 11, 14, 16, and 18 valve models, at our showrooms Mondays to Saturdays from 9 a.m. to 8 p.m. (except Tuesdays, 9 a.m. to 6 p.m.)

**MIDWEST**

Magnificent alike in its conception, design and performance, this latest Midwest Model X-18 High Fidelity Receiver brings the world to your fire-side. With its 6 TUNING RANGES it gets "Everything on the Air." Its distinctive features in circuit design are not just "talking points," as a comparison will prove, but basic advantages which will assuredly appeal to "Wireless World" readers and all who appreciate Studio or Concert Hall quality of performance in the home.

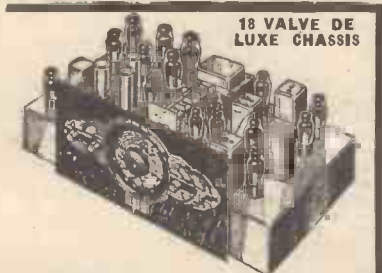

**MIDWEST RADIO Ltd.**

Showrooms and Factory:  
 16, Old Town, Clapham, London, S.W.4.  
 Phone: MA0945 5005.

**THE ONLY ALL-WAVE RECEIVER COVERING 4½ to 2,400 METRES**

Available in Chassis form complete with matched valves and 12" speaker or in Console Cabinet.

**SECOND EDITION**

—Completely Revised

**RADIO DATA CHARTS A SERIES OF ABACS**

Providing most of the essential Data required in receiver design.

By **R. T. BEATTY, M.A., B.E., D.Sc.**

**PRICE 4/6 net BY POST 4/10**

From all leading booksellers, or direct from the Publishers. Published from the offices of "THE WIRELESS WORLD," **DORSET HOUSE, STAMFORD STREET, LONDON S.E.1** W.W.93



**STABILOVOLT**

THE SOLUTION TO UNSTABLE SUPPLY VOLTAGE

The Stabilovolt tube is a voltage dividing potentiometer and voltage regulator. The voltages tapped are independent to a precision of about .1% from the supply voltage variations, 1-2% from the varying current intensities tapped, .01% from one another. Currents up to 200 mA, voltages of unlimited values subdivided into parts of 70 volts each. Light in weight, small in size, simple and safe in operation.

**MARCONI'S**

Prices: Stabilovolt tubes from £1.16.0 to £62. Iron Barretters, for use with above, from 16s. to £1.7.6. Full particulars from:

MARCONI'S WIRELESS TELEGRAPH CO., LTD., Electra House, Victoria Embankment.



EXCLUSIVELY SPECIFIED

by the  
**'WIRELESS WORLD'**  
for their

**Television Receiver**

**GOODMANS**

Type "W.W.T." P.M. LOUDSPEAKER

Supplied with separate £3 : 12 : 6  
Heavy Duty Transformer Inclusive

N.B.—The "W.W.T." Loudspeaker which has been specially designed for the "W.W." Television Receiver to avoid magnetic inter-action with the Cathode Ray tube, should not be confused with GOODMANS Standard 10" Auditorium Reproducer of similar outward appearance.

**GOODMANS INDUSTRIES, LTD.**  
Lancelot Rd., Wembley, Middx. Phone: Wembley 4001 (5 lines)

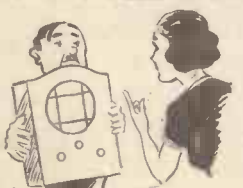

"I think I'll revive the old set,"  
Said Smith; and his wife  
replied "Pet  
If you'd wired it right  
At first, with FLUXITE,  
You'd have saved your-  
self trouble, I'll bet."

See that FLUXITE is always by you—in the house—garage—workshop—wherever speedy soldering is needed. Used for 30 years in Government works and by leading engineers and manufacturers. Of Ironmongers—in tins, 4d., 8d., 1/4 and 2/3. Ask to see the FLUXITE SMALL-SPACE SOLDERING SET—compact but substantial—Complete with full instructions, 7/6. Write for Free Book on the art of "SOFT" SOLDERING—and ask for leaflet on CASE-HARDENING STEEL and TEMPERING TOOLS with FLUXITE.

TO CYCLISTS! Your wheels will NOT keep round and true unless the spokes are tied with fine wire at the crossings AND SOLDERED. This makes a much stronger wheel. It's simple—with FLUXITE—but IMPORTANT

**THE FLUXITE GUN**

is always ready to put Fluxite on the soldering job instantly. A little pressure places the right quantity on the right spot and one charging lasts for ages.  
Price 1/6.

**ALL MECHANICS WILL HAVE**

**FLUXITE**

**IT SIMPLIFIES ALL SOLDERING.**

FLUXITE LTD., Dept. W.W., DRAGON WORKS, BERMONDSEY ST., S.E.1

**THE POLYTECHNIC**  
309, REGENT STREET, W.1.

**SCHOOL OF ENGINEERING**

Head of School:  
PHILIP KEMP, M.Sc.Tech., M.I.E.E., A.I.Mech.E.;  
Mem.A.I.E.E.

**Radio Engineering**

A full-time day course in tele-communications, extending over a period of three years, preparing for all recognised examinations and for the radio, television and telephone industries.

School re-opens 21st September.  
Prospectus on application to Director of Education.

FOR P.A. AT ITS BEST



**GRAMPHIAN**

GRAMPHIAN REPRODUCERS LTD.  
Kew Gardens, Surrey.



**SOUND AMPLIFYING EQUIPMENT**

THE FINEST TONAL QUALITY IN THE WORLD

BTH Equipment is used for the largest and most comprehensive Sound Amplifying Systems in this country.

**BTH RUGBY**  
THE BRITISH THOMSON-HOUSTON COMPANY LIMITED, RUGBY, ENGLAND.  
A 2319



We don't claim to make the cheapest transformers but we do claim to make good ones. Most of the professional P.A. men seem to think so, too.

**W. BRYAN SAVAGE LTD.**  
Westmoreland Rd., London, N.W.9. Phone: Colindale 7131

**WEARITE CONDENSER ANALYSER**

A new instrument of the latest design for carrying out rapid complete tests of radio condensers. Electrolytic, Mica, Paper, Trimmer and Tuning condensers may now be tested for Capacity, Insulation, Power Factor, Open Short and Intermittence. This unit is portable entirely A.C. mains operated.

**PRICE - £9.9.0**

Full particulars upon request to:  
**WRIGHT & WEARE LTD.,**  
740, High Road, Tottenham, London, N.17.

Mention of "The Wireless World," when writing to advertisers, will ensure prompt attention.

**JUST PUBLISHED**

# THE COMPLETE 9.5-mm. CINEMATOGRAPHER

By Harold B. Abbott

Because of advances in film technique this book supersedes the author's former successful book "Motion Pictures." The beginner can take it up and find everything he needs to know in order to make successful pictures.

How to choose a 9.5-mm. cine camera; how to expose correctly; what to take and how to take it; full instructions on developing and printing; methods of planning; editing, titling and trick effects; the art of projection; methods of operation, screen and picture sizes; giving an efficient show; all these are explained in detail.

There are nearly 100 illustrations. The book, packed with useful information, is a comprehensive course of instruction in amateur cinematography.

CLOTH BOARDS  
Size 7½" x 5", 260 pages  
PRICE 5/- net  
By post 5/4

From all leading Booksellers, or  
direct from the Publishers

ILIFFE &amp; SONS LTD., DORSET HOUSE, STAMFORD STREET, LONDON, S.E.1

## THE WIRELESS ENGINEER

*The Journal of Wireless Research  
and Progress*

"THE WIRELESS ENGINEER" is published in the interests of professional wireless engineers, experimenters, and all keen radio enthusiasts, and is widely read by those who are intimately associated with wireless development.

A valuable monthly feature consists of a summary, under the title of Abstracts and References, of important articles appearing in technical wireless publications throughout the world.

MONTHLY  
2s. 6d. NET  
Subscript on-  
32s. per annum,  
post free.

ILIFFE &amp; SONS LTD., DORSET HOUSE, STAMFORD STREET, LONDON, S.E.1

W.W.2

Second Edition—

Thoroughly Revised

## WIRELESS SERVICING MANUAL

By W. T. COCKING

*(of "The Wireless World")*

The first complete book of reference of its kind. A reliable practical guide for amateur and professional.

The first edition of this book was sold out in a very few months and a second edition, with additional material, is now on sale.

The "Wireless Servicing Manual" deals fully with Testing Apparatus and explains the methods of locating and curing faults in receiving equipment.

Ganging, Automatic Volume Control, Instability, Distortion, Mains Hum, Whistles and Local interference, all are separately treated.

Information on short-wave receivers, and on methods of operating extension loud speakers, has been added. The reference material, including base-connections for British, Continental and American valves and the various colour codes for components has been extended and brought up to date.

BOUND IN CLOTH BOARDS, SIZE 7½ ins. x 5 ins.  
231 PAGES

NOW ON SALE

5/- net By post 5/4

Issued in conjunction with "THE WIRELESS WORLD"  
and Published by the proprietors:—

ILIFFE &amp; SONS LTD., DORSET HOUSE, STAMFORD ST., LONDON, S.E.1



# The Wireless World

**4<sup>D</sup>**

*THE  
PRACTICAL  
RADIO & TELEVISION JOURNAL*

Friday, July 30th, 1937

## New MAZDA VALVES FOR TELEVISION

**FOR THE RECEIVER**

**AC/S.P.3.** A high - slope H.F. pentode specially designed for use in video receivers.

**D.I.** A special low-capacity indirectly heated diode for the detector stage.

**AC/4 Pen.** A "beam power" output valve for the sound receiver, giving up to 8 watts A.F. output.

**FOR THE SCANNING CIRCUIT**

**T.3I.** A gas-filled thyatron for use in electrostatic deflection circuits in conjunction with the

**AC/P.4.** A special output triode for amplification of scanning potentials.

**T.2I.** Gas - filled thyatron with lower internal voltage drop for use with magnetic deflection circuits.

**M.U.2.** Mercury vapour directly heated half-wave rectifier for high voltage supply to both cathode ray tube and time base circuits.

Ask for full information about these and other valves in the MAZDA range at the **EDISWAN STAND AT OLYMPIA**, or send your enquiry to the address below.

*Mazda Radio Valves are manufactured in Great Britain for the British Thomson-Houston Co. Ltd., London and Rugby, and distributed by:*

**THE EDISON SWAN ELECTRIC CO. LTD., 155 CHARING CROSS RD., LONDON, W.C.2**



RM316

# Are you investing wisely?

Are you investing in a valve tester that does the job efficiently and accurately?

The method of testing which positively reveals the condition of a valve is the measurement of mutual conductance. The "AVO" Valve Tester provides readings for mutual conductance of all types of valves—triodes, pentodes, tetrodes and the individual sections of multi-type valves. It also tests heater-cathode insulation, and provides for emission tests for all rectifier valves, RF diodes and the diodes of multi-electrode valves.

In fact, this is the instrument you must have for effective valve testing.

A USER WRITES:—"We congratulate you on what is probably the best and most versatile commercial valve tester on the market."

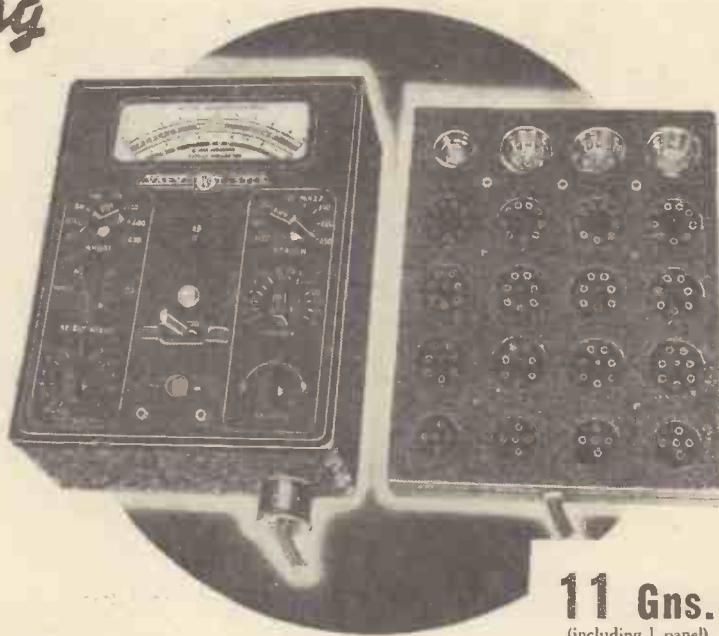

## SIX FEATURES

- 1 Tests valves in accordance with laboratory methods.
- 2 Gives mutual conductance readings, accurate to within a few per cent., at voltages corresponding to the maker's test conditions.
- 3 Indicates condition of valves to customers by means of scale marked "Good," "Indifferent" and "Replace."
- 4 A second scale is calibrated in mA/V, and a third scale gives readings of heater-cathode insulation in megohms when valve is hot.
- 5 Tests filament continuity and inter-electrode "leakage." All sections of multi-type valves tested without removing valve from socket.
- 6 No calculations. Operated from A.C. mains. Valve panels are separate—ensuring that instrument will never become out of date.

**11 Gns.**  
(including 1 panel)  
Additional valve panels (for either English or American valves), price: 2 gns.

British Made

# The 'AVO' VALVE TESTER

REGD. TRADE MARK

Write for illustrated pamphlet giving full details.

THE AUTOMATIC COIL WINDER & ELECTRICAL EQUIPMENT CO. LTD.  
Winder House, Douglas Street, London, S.W.1. Phone: Victoria 3404/7

# B.I. HIGH VOLTAGE CONDENSERS



for  
RADIO and TELEVISION

We can offer a complete range of High Voltage Condensers in all capacities and for all working conditions met with in Radio and Television Sets.

In accordance with our standard practice these are impregnated with a special Petroleum Jelly.

The insulated terminals have ample creeping surface, and we recommend these condensers with the utmost confidence.

**BRITISH INSULATED CABLES LTD.**

Cablemakers and Electrical Engineers

PRESCOT—Lancs.

Telephone No.: PRESCOT 6571

London Office: Surrey House, Embankment, W.C.2

Tel. No.: Temple Bar 7722

# MIDWEST

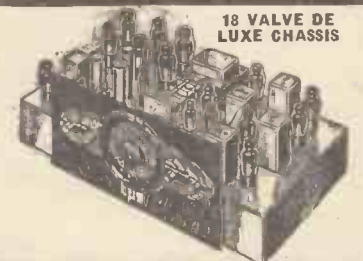

18 VALVE DE LUXE CHASSIS

Magnificent alike in its conception, design and performance, this latest Midwest Model X-18 High Fidelity Receiver brings the world to your fire-side. With its 6 TUNING RANGES it gets "Everything on the Air." Its distinctive features in circuit design are not just "talking points," as a comparison will prove, but basic advantages which will assuredly appeal to "Wireless World" readers and all who appreciate Studio or Concert Hall quality of performance in the home.

**FREE ART CATALOGUE DEMONSTRATIONS** 40 pages, fully illustrated, giving particulars of Midwest 11, 14, 16, and 18 valve models. at our showrooms Mondays to Saturdays from 9 a.m. to 8 p.m. (except Tuesdays, 9 a.m. to 6 p.m.)

★ **THE ONLY ALL-WAVE RECEIVER COVERING 4½ to 2,400 METRES** **MIDWEST RADIO Ltd.**  
Available in Chassis form complete with matched valves and 12" speaker or in Console Cabinet. Showrooms and Factory: 16, Old Town, Clapham, London, S.W.4.

## The ELEMENTARY PRINCIPLES of WIRELESS TELEGRAPHY and TELEPHONY

by R. D. BANGAY

Third Edition (1930) Revised by O. F. Brown, B.Sc.

The standard book of instruction for wireless students. Deals thoroughly with modern developments. Leaflet with full particulars and synopsis of chapters sent on request.

**PRICE**  
7/6 by post 8/-

From all leading Booksellers or Direct from the Publishers

**LILFE & SONS LTD., Dorset House, Stamford St., London, S.E.1**

w.w.97

# The Wireless World

THE  
PRACTICAL RADIO  
JOURNAL  
27<sup>th</sup> Year of Publication

No. 935.

FRIDAY, JULY 30TH, 1937.

VOL. XLI. No. 5.

Proprietors: ILIFFE & SONS LTD.

Editor:  
HUGH S. POCOCK.

Editorial,  
Advertising and Publishing Offices:  
DORSET HOUSE, STAMFORD STREET,  
LONDON, S.E.1.

Telephone: Waterloo 3333 (50 lines).  
Telegrams: "Ethaworld, Sedist, London."

COVENTRY: Hertford Street.

Telegrams: "Autocar, Coventry." Telephone: 5210 Coventry.

BIRMINGHAM:

Guildhall Buildings, Navigation Street, 2.

Telegrams: "Autopress, Birmingham." Telephone: 2971 Midland (4 lines).

MANCHESTER: 260, Deansgate, 3.

Telegrams: "Iliffe, Manchester." Telephone: Blackfriars 4412 (4 lines).

GLASGOW: 26B, Renfield Street, C.2.

Telegrams: "Iliffe, Glasgow." Telephone: Central 4857.

PUBLISHED WEEKLY. ENTERED AS SECOND-CLASS MATTER AT NEW YORK, N.Y.

Subscription Rates:

Home, £1 1s. 8d.; Canada, £1 1s. 8d.; other countries, £1 3s. 10d. per annum.

As many of the circuits and apparatus described in these pages are covered by patents, readers are advised, before making use of them, to satisfy themselves that they would not be infringing patents.

## CONTENTS

	Page
Editorial Comment .. ..	89
Transient Response .. ..	90
Straight Set versus Superheterodyne	93
Unbiased .. ..	96
Current Topics .. ..	97
The Wireless World Television Receiver V—Adjustment and Operation .. ..	98
Broadcast Brevities .. ..	101
Listeners' Guide for the Week ..	102
Letters to the Editor .. ..	104
New Apparatus Reviewed .. ..	105
Little Princess Portable .. ..	106
Random Radiations .. ..	108
Recent Inventions .. ..	110

## EDITORIAL COMMENT

### Television

#### What Is the Public Waiting For?

THE Television Exhibition is proving to be one of the biggest draws that the Science Museum at South Kensington has ever had in the way of a special show. A daily attendance of over 2,000 is reported. There is no question that the public in general is eager to know as much as possible about television, wants to see demonstrations of reception, and having seen them, is loud in its praises of the clearness and the steadiness of the images. Why then is it that television sets are not selling more rapidly? At Olympia last year many people estimated that within six months some ten-thousand television receivers would be in use, yet to-day probably less than half that number have been sold.

Actually the service area of the Alexandra Palace transmitter has turned out to be very much greater than was originally anticipated, thereby increasing the number of potential purchasers of television receivers. Many people who could well afford to buy receivers and would like to have them are waiting, it would seem, to see whether there will be any big new development at this year's Exhibition. Such an attitude seems entirely unjustified by the facts.

The early story of "sound" broadcasting is quite different from that of television, for two main reasons. The original "sound" transmitters were very crude in their lack of fidelity and old receiving sets were perhaps cruder still. As improvements were made in transmission, receiving sets became out of date because their performance was not sufficiently good to keep pace with them; the receiver could not reproduce what the transmitter was sending out unless it was up to date.

Television transmissions, on the other hand, started on a very high level; the receivers were designed to do them full justice and so far as one can see those made at present will continue to do so for a long time to come. The second big difference is that in "sound" broadcasting, increases in output power and in the numbers of stations made a higher and higher degree of selectivity essential. Receiving sets, in other words, became out of date because their selectivity was insufficient. On the television waves there is no likelihood of any such happening to an extent where mutual interference would occur.

### Stealing Electricity

#### Problem for the German P.O.

OUR correspondent in Germany reports that the use of wireless energy radiated from the Hamburg station to provide light for their bungalows has brought a group of local dwellers before the Hamburg court. Their bungalows, it seems, are in the immediate vicinity of Hamburg's 100 kW aerial. By fixing electric bulbs to a simple circuit these people have enjoyed free electric light supplied by the energy radiated from the transmitter.

The owners of the station, the German Post Office, sued them for stealing wireless energy which would otherwise go to listeners. The accused contended that they were using energy floating in the air which would otherwise go to waste. The judge has requested the Post Office to supply definite proof of the weakening of Hamburg's signals caused by the house owners "sucking off" the energy for lighting purposes. It will be interesting to learn how the P.O. authorities succeed in demonstrating this to the satisfaction of the judge.

# Transient Response

REAL AND FICTITIOUS TRANSIENTS IN RELATION TO  
LOUD SPEAKER DESIGN By P. G. A. H. VOIGT, B.Sc., A.M.I.E.E.

*IN this article the author challenges the prevailing idea that wideness of frequency response is the sole factor of importance in the reproduction of transients. He gives reasons for his belief that a considerable proportion of transients normally encountered do not contain extremes of frequency. Later he describes an imaginary loud speaker having an infinitely wide frequency response, and shows that it might, nevertheless, be incapable of reproducing even the simplest of transients satisfactorily*

ONCE upon a time, there were clever mathematicians who realised that vibrations, etc., did not consist only of unmodulated combinations of sine waves, but might also involve changes. Any such change can be described by that general word, a "transient." As is the way with mathematicians, they examined the subject mathematically and found that to study the multitude of different possible transients would have been a superhuman task. The task was, therefore, simplified by deciding to study one transient only, and this simplification was justified by picking such a nasty transient that, in solving its problems, the general process for solving all others would have been mapped out.

The transient selected happens, on paper, to look particularly innocent, and is by now very famous. It is in fact our old friend the square-topped pressure wave (only the rising front of it), together with its complementary pressure wave which comprises a single impulse in one direction only. According to the analysis this simple-looking wave includes all frequencies from zero to infinity, a conclusion so easy, and even to the non-mathe-

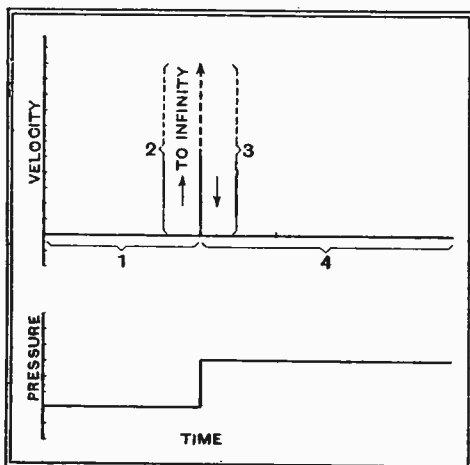

Fig. 1.—The mathematicians' ideal transient—a square-topped pressure wave with vertical rising front.

matician so obvious, that everybody (even the writer!) believes it.

Now humans resemble sheep in a most extraordinary manner, and because the clever mathematicians analysed this most difficult transient and *proved* that it contained all frequencies, a lot of not quite so clever technicians ask no further questions and assume that this result necessarily applies to *all* transients regardless of their waveform. Tut, tut! Truly a little learning is a dangerous thing! Thus has grown up an accepted idea that to reproduce transients (presumably any transient), an infinitely wide frequency response is desirable.

## Practical Considerations

STOP! Let us consider whether the very special transient selected by the mathematicians ever occurs in nature. Does it? Its electrical counterpart is easily produced, but I can think of only one way of making an actual sound which gets even remotely near it—and for that I require an electric spark—so this sound is hardly to be expected from the average orchestral broadcast. Actually, natural sounds are not nearly so complex, and it should be interesting to examine a transient of the kind more likely to be generated naturally.

Let us begin by considering what is wrong with the mathematicians' transient from a practical point of view. For investigation this can be considered in the four sections marked respectively 1, 2, 3, and 4 in Fig. 1. What do these sections involve?

(1) Air particle at rest. (No difficulty here.)

(2) Air particle accelerated instantaneously to an infinitely high velocity. (This involves infinitely high acceleration forces, and is therefore impossible in practice.)

(3) Air particle instantly decelerated and brought to rest. (Just as impossible as 2.)

(4) Air particle remains at rest in its new position.

The fact that infinite forces can never be available in a natural sound limits the acceleration force. This limitation causes both a rounding of the corners and a time period for the duration of the transient. The fact that infinite velocities are also impossible is likewise taken care of by the existence of the duration time, since with finite time, the velocity is also finite. Fig. 2 shows the modification produced by these factors.

If we consider our air particle as being located on the envelope of an imaginary balloon with the source of the transient impulse at the centre, section 4 implies that the "balloon" is now of different diameter. The air pressure within it considered as a whole has therefore changed, and although this gives us the correct complementary square-topped pressure

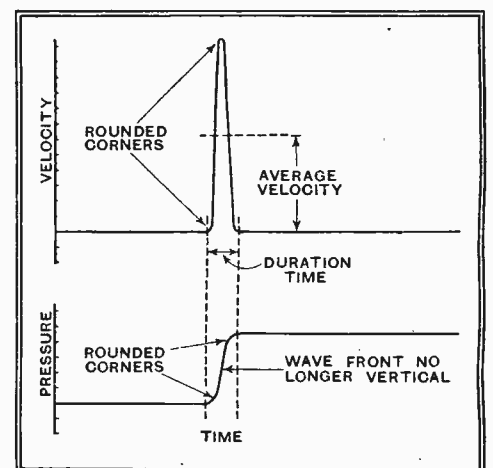

Fig. 2.—In practice the infinitely high velocity and acceleration implied by the ideal square-topped transient cannot be attained and the nearest approach is that depicted above. It should be noted that only in the case of a sine (or cosine) wave are the pressure curve and complementary velocity curve of similar shape.

wave, Nature, objecting to unbalanced pressures, will promptly push (or pull) the "balloon" back to its correct diameter, thus restoring atmospheric pressure.

In the practical case, therefore, this transient is not self-supporting, and cannot end with section 4. It *must* be followed by a restoration period whose waveform depends upon circumstances. Whatever these are the average velocity must be in the reverse direction, and in order that the finishing point shall coincide with the starting point, the area above the zero line of the velocity/time curve must

**Transient Response—**

equal the area below it. The necessity for this recovery period adds a further modification to the original transient, and one of many possible shapes for the recovery period can be seen in the complete curve of Fig. 3.

Having shown that natural conditions tend to remove the violent extremes from the mathematicians' transient, let us invent one for ourselves which shall be as simple as possible, and at the same time be practical.

Such a one is shown in Fig. 4, and consists of a combination of two curves. One is one cycle only of a 300-cycle cosine curve wave amplitude +1 with centre line displaced downwards by 1, and the other is one cycle only of a 600-cycle cosine curve amplitude -2 with centre line displaced upwards by 2, the two curves being phased so that the crest of one occurs simultaneously with the trough of the other. By making one curve of shorter time interval, but bigger amplitude numerically than the other, it is possible to make their areas equal. By displacing the curves on opposite sides of the centre line they can be made to balance, and by using the cosine curve instead of the sine curve sharp corners are avoided.

This transient, by avoiding sharp corners, avoids high accelerating forces. The areas above and below the zero line are equal; the final position of the air particle is therefore the same as the starting position. The transient is consequently complete and self-supporting and could easily occur in practice.

**Damping**

I am no mathematician, and cannot express this curve in its correct Fourier analysis formula without looking up maths. I have forgotten long ago. I would be very surprised, however, if the analysis contains any frequencies other than 300 and 600 cycles. Also, for that reason, I do not expect the reproduction of that transient to be affected in the slightest degree by the addition of either a "tweeter" or a "woofer" speaker. I do, however, expect that critical damping at both 300 and 600 cycles is essential if the waveshape is to be retained. Also, I anticipate that if there is a time delay in the loud speaker, i.e., as the wave is propagated along the diaphragm or horn (if any), this time delay should be identical at both frequencies.

It is believed that the ear has large tolerances in connection with such time delay differences (usually called phase),

and it would be interesting to know whether the sound of Fig. 5 can be distinguished by ear from that of Fig. 4, and if not, how far can the waves A and B be separated before the ear does perceive the difference. I fancy that altering the

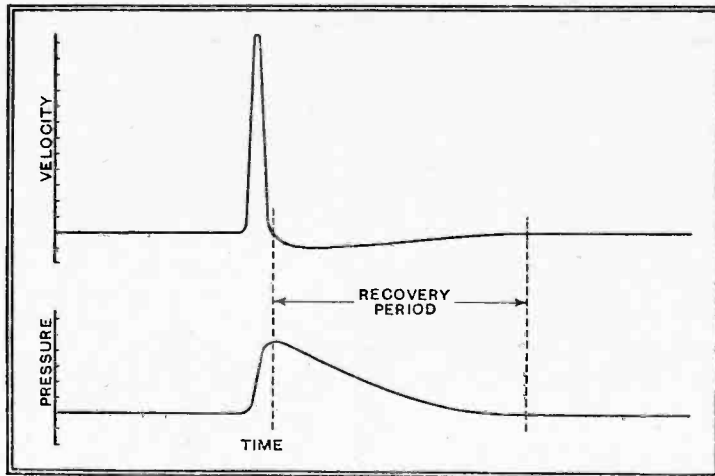

Fig. 3.—The waveform of the transient of Fig. 2 is quite practicable in the movement of a sound emitting surface, but the sustained increase of pressure cannot exist in free air and a recovery period will follow.

relative position of waves A and B as above immediately brings into the Fourier analysis additional terms depending upon the amount of displacement between the waves.

It will be seen from the above that for the majority of possible kinds of transients, i.e., all the ones without sharp corners (which includes most speech transients except sibilants), damping is likely to be more important than frequency range.

**Experimental Verification**

Of this I have had experimental verification in two different ways. First, with a commercial baffle speaker mounted in an infinite baffle, the result was good as regards response, and no serious resonances or other faults could be identified; the result, however, sounded "loud-speakerish." A short horn (mouth and taper suitable for 200 cycles upwards) was then held in front of the diaphragm.

Immediately the response seemed restricted, especially as regards the lower end of the scale. The actual sound heard, however, became more lifelike, and the choir and orchestra seemed to sort itself out, and instead of coming through as a confused mass of sound, each section stood out separately. This test has often been repeated, always with the same result, i.e., greater separation in spite of the slight reduction in "apparent" frequency range. The more complex the sound, the more marked is the effect.

The second verification occurred in the

early days when I was searching for simple ways of augmenting the ends of the scale with reference to the middle. I knew from the impedance curves of the horn speaker with which I was experimenting that at the top the impedance rose owing to the inductance of the speech coil, while in the bass it rose in the horn cut-off region owing to reduction of loading which permitted increased diaphragm velocity. A fixed resistance in series with the speech coil, while reducing the magnetic damping, should reduce the two ends of the scale only a little and the main part considerably. This was therefore tried, the volume control being readjusted to make good the general loss of volume. As expected, the frequency response was wider, and with this improvement the "quality" (which includes transients) should have been better. But was it? For a moment, yes. It seemed that there had been an improvement, but on listening for a while doubts cropped up. The bass seemed to have lost its incisiveness and become "flabby," the string, drum and brass bass no longer having their clear-cut differences of character. Also the top was peaky, and other detail defects too small to be singled out caused the definite decision that the overall result as heard by ear was better without the series resistance, i.e., with reduced frequency response but improved magnetic damping.

**Reverberation**

From considerations and experiments such as these I am convinced that, although very sharp transients undoubtedly require reproduction of high frequencies, there are many simple transients in which this is not the case.

There is no doubt that perfect reproduction of the mathematicians' transient involves all frequencies from zero to infinity. According to the common idea, therefore, it is only a matter of designing a speaker capable of this range of frequencies, and—hey presto!—the transient in question can be perfectly reproduced. I wonder! Is this necessarily right?

For example, I can visualise an imaginary speaker with a perfectly even

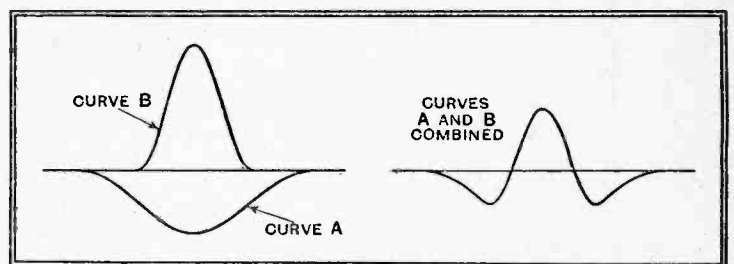

Fig. 4.—Synthesis of a self-supporting transient which might easily occur in practice.

response from zero to infinity which will deal perfectly with any sustained note, and spoil every transient so completely as to be quite useless for any practical listening.

Has blind acceptance of specialised mathematical analysis caused the overlooking of something outside that analysis,

**Transient Response—**

but, nevertheless, vital to the reproduction of transients?

I will now describe this extraordinary imaginary speaker. Immediately it is described you will say—"But no one in his senses would dream of constructing such a speaker," and no doubt you will

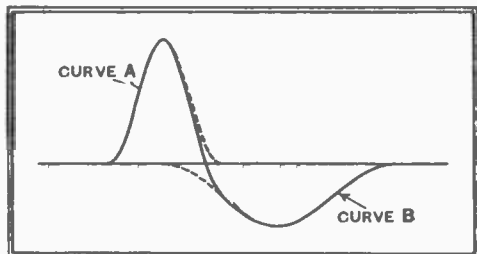

Fig. 5.—Synthesised transient with a phase difference between the 300- and 600-cycle components. The family likeness with the curve of Fig. 3 should be noted.

be perfectly correct, but it is often useful to examine in imagination something hopelessly fantastic in order to realise something very obvious.

Let us imagine first an echo room with walls of 100 per cent. reflection efficiency, and of such irregular construction that it has no natural frequencies of its own. Let this room have an opening of such size that substantially all the sound energy is passed out in a fixed time, say 1 sec., into the open air where the listener is situated. Providing that none of the energy re-enters the "echo-room" loud speaker, this gives the sound in effect a reverberation of 1 sec. at all frequencies.

Now assume that a perfectly "aperiodic" loud speaker had been invented of infinite frequency range which responded instantly and without distortion to any wave fed into it (such a masterpiece of course would reproduce any and every transient perfectly), and that this loud speaker was situated inside the echo chamber. The "mouth" of my fantastic loud speaker would be the opening of the echo chamber.

**Frequency Calibration**

Let us hang a calibrating microphone near the mouth and consider what happens. We feed to our loud speaker a low note. The sound in the echo room builds up for 1 sec. to its steady value which is measured by the microphone and plotted. Switch off, the sound dies away for 1 sec., and we go on to the next note, and so on. In each case, since the originating loud speaker is perfect, the response builds up to the same value from the lowest to the highest frequency. In other words, this arrangement has a perfectly smooth response from zero to infinity. But what happens to a transient? Will the change it represents not be stretched out for one whole second, no matter how sudden it may have been to start with?

You may well claim that no one in his senses will ever have an echo chamber like this connected to his loud speaker.

No, perhaps not, but more than 99.99 per cent. of the loud speakers ever made have moving parts which, in relation to their damping, are much too heavy not to store energy and do something of this kind at one or more points in the scale.

Under such conditions can a level frequency response be a guarantee of perfect transient performance? I doubt it.

Now you theoreticians, get busy and prove me wrong. Show us that the simple transient invented for Fig. 3 contains all frequencies from zero to infinity. Show us that the fantastic speaker just described can, for example, deal with the "transient" produced when the player of a tin whistle covers one of its holes so as to change the pitch of the note being emitted. But please translate the results of your work into intelligible word pictures. I have forgotten my maths., and no doubt many "W.W." readers are in a similar position.

Show us that transient response as distinct from frequency response is a myth!

**Guglielmo Marconi****World-wide Tributes**

THROUGHOUT the world warm tributes have been paid to the memory of the Marchese Marconi. The initiative which he showed in the early days, when at first his ideas were by no means enthusiastically received, enabled him to achieve successes which eventually paved the way for the development of radio communication as we know it to-day.

In much of the subsequent progress he took an active part, his enthusiasm stimulating the work of those he gathered round him as collaborators, whilst throughout his life his interest in everything connected with wireless development never tired. His life's work will remain a permanent monument to his genius.

**BOOK REVIEW**

**Alternating Current Measurements.** By David Owen, B.A., D.Sc., F.Inst.P. 120 pages, 80 diagrams. Methuen and Co., Ltd., 36, Essex Street, London, W.C.2. Price 3s. 6d.

THIS is one of an extensive series of monographs within the field of physics, and "is intended to supply readers of average scientific attainment with a compact statement of the modern position in each subject."

Estimates of the level of scientific attainment that constitutes an average may differ, but anybody who is likely to be interested in the subject of AC measurements at all need have no fear of being unable without mathematical ability to make good use of the little volume by Dr. Owen. Neither need *Wireless World* readers suppose that it is likely to waste their time with such problems as the measurement of power in three-phase systems. The book is limited to the measurements of inductance, capacitance, resistance and frequency; and they are tackled from a conspicuously "wireless" aspect.

The first chapter runs through essential AC theory, from fundamentals to the principles underlying bridge networks, finishing with two examples of deriving the conditions of balance in bridges. The remaining chapters are devoted to practical methods of measurements; the last, on radio frequency work, comprises two-thirds of the book. One chapter deals with the conditions of accuracy in low-frequency bridge measurements, and another draws attention to the rather neglected merits of the AC potentiometer.

The low-frequency bridge chapters can be highly recommended to those who want a much briefer treatment than that of Hague's standard textbook. The great practical importance of conditions for balance being independent of one another is fully emphasised, and illustrative examples give the reader some idea of the magnitude of the standards used and the accuracy to be expected. The formulæ for working out the results are expressed clearly, with the adjustable quantities distinguished by an "arrow" notation.

The index might with advantage be fuller; one expects such an item as "inductance" to be included.

The radio-frequency chapter is of particular interest, though the reviewer considers that the use of a valve voltmeter shown in so many diagrams for the adjustment of a circuit to resonance is generally less convenient than one or other of the beat-note methods, and introduces complications due to its shunt impedance. Such complications are needlessly aggravated in Fig. 6r, where the voltmeter ought to be across the coil. The possible sources of error seem also to be less clearly pointed out than in the audio-frequency chapters. For example, the circuit diagram of a wavemeter (or frequency meter) shows terminals for an indefinite coupling coil right in the calibrated tuned circuit, and a variable by-pass condenser across 'phones in series with it. The use of the term "first harmonic" for that double the frequency of the fundamental is, we had supposed, obsolete and liable to cause confusion.

Nevertheless, in the limited space available the chapter gives a useful indication of radio-frequency measurement technique. The book, as a whole, is concise, clear and practical, and can be recommended.

M. G. S.



# Straight Set versus Superheterodyne

**L**ETTERS which have recently appeared in the correspondence columns of *The Wireless World* have revealed that in spite of the popularity of the superheterodyne there are still many who remain faithful to the straight set. The number who favour this type of receiver is indeed rather surprising when it is remembered that for several years few such sets have been available. Various reasons have been advanced in support of individual preferences and at first sight some of these appear contradictory; a closer investigation, however, often reveals that the conflicting arguments are conflicting only because they are based on different premises.

It should be self-evident that there is no such thing as the best receiver, there is only the best receiver for a particular purpose. One man wants a set which will tune from 5 metres to 2,000 metres, and give him extreme sensitivity and selectivity, and he is right in saying that the superheterodyne is better than the straight set—for his particular requirements in the matter of performance. Another only wants to be able to receive his two local stations and naturally prefers the straight set. Neither type of set can truly be said to be better than the other without taking into account the conditions under which it will be used and the performance expected.

In view of this it is a matter of some importance to examine impartially the merits and defects of the two types of receiver. With a clear idea of their respective characteristics it naturally becomes easier to make a choice between them, always bearing in mind that the choice does not depend on the receiver's characteristics alone, but on those characteristics in relation to individual conditions and requirements.

## Sensitivity

In the matter of sensitivity there is no difference between the two receivers, for it is possible to build a straight set which is as sensitive as the most sensitive superheterodyne. It is not quite so easy to do so, however, for as the amplification is all obtained at signal frequency, instead of being split and obtained partly at signal frequency and partly at intermediate fre-

quency, more thorough screening is needed to maintain stability. Moreover, the mechanical difficulties of screening are somewhat more difficult than in the superheterodyne because of the need for variable condensers and wave-change switches in each stage. These difficulties are by no means insuperable, however, especially if several RF stages are used. This may seem rather surprising, but it is nevertheless a fact that it is easier to obtain a given amplification with stability from several low gain stages than from one or two each giving a high gain. Moreover,

## Factors Which Affect Design

the apparatus is then much less critical and a greater tolerance for variations in values of components can be allowed.

Turning now to the question of background noise, most advocates of the straight set bring against the superheterodyne the charge of noise. Actually, this is unjustified, for it is not in accordance with the facts. If a comparison be made between the two types it will be found that there is nothing to choose in the matter of the signal/noise ratio, provided that the two sets have the same sensitivity, the same overall modulation frequency response, and the same degree of internal regeneration, and provided that the superheterodyne includes an effective RF amplifier. When considering signal/noise ratio, one must be careful to distinguish between two different types of superheterodyne. Sets in which the first valve is the frequency-changer are almost invariably noisier than straight sets of the same sensitivity, but they are also noisier than the better class of superheterodyne in which the frequency-changer is preceded by an RF amplifier.

Much of the criticism of the superheterodyne in the matter of noise is really due to an unfair comparison. Most superheterodynes give the impression of being noisy because they are much more sensitive than the average straight set. If the comparison be made fairly, however, by tuning each set to the same signal, then there is very little to choose between them.

The next point to be considered is selectivity, and it is here that the superheter-

odyne scores, for there is no doubt whatever that it is much easier to secure high selectivity with it than with the straight set. It is difficult to use more than four tuned circuits in a straight set, because condensers with more than four sections are not available. Of course, one can go up to eight circuits if one does not object to two tuning controls. The mechanical linking of two separate condensers to obtain the equivalent of a six- or eight-gang condenser has certain difficulties connected with the matching of the sections. In the superheterodyne, however, it is possible to use any number of tuned circuits at the intermediate frequency, and up to three at signal frequency.

It appears, however, that the full possibilities of the straight set in the matter of selectivity have not been exploited. Development in these receivers almost ceased with the reintroduction of the superheterodyne some five years ago, but recent work has shown it to be capable of giving surprisingly high selectivity in spite of the limitation of four tuned circuits only. It is not, of course, as good as a large superheterodyne with eight or more tuned circuits, but on the medium waveband there is little to choose between it and the smaller superheterodynes, and on the long waveband it is better.

This brings us to another point on which the straight set is at a disadvantage as

*THE controversy on the relative merits of the straight set and the superheterodyne, which raged some years ago, appeared to have been settled in favour of the superheterodyne, but it has been revived in recent months and the issue now appears somewhat doubtful. Modern design technique has greatly improved the performance of the straight set and there is now much to be said for it. The characteristics of both types of receiver are discussed in this article and the pros and cons of each are carefully weighed up.*

compared with the superheterodyne. With the latter the selectivity is nearly independent of the wavelength to which the set is tuned, but the selectivity of the straight set varies very considerably over the waveband, increasing with wavelength. Moreover, it is much more difficult to devise a good variable selectivity system with such sets.

**Straight Set versus Superheterodyne—**

These remarks apply to the normal broadcast bands. On short waves very high selectivity is necessary and it cannot be obtained with the straight set, although this type of receiver is quite suitable, perhaps more so than the superheterodyne, for the ultra-short waves where high selectivity is at present unnecessary. For good short-wave reception the superheterodyne has no rival.

In spite of the high selectivity of the superheterodyne this receiver suffers from a liability to certain types of interference from which the straight set is quite free. The best known of these special forms of interference is second channel or image interference, but there are many other kinds which have similar audible results, and which normally manifest themselves as whistles, the pitch of which varies with the setting of the tuning control. In a badly designed or badly adjusted receiver it is quite possible for a whistle to appear on every station in the medium waveband; on the other hand, in a well-designed and properly adjusted receiver it is normally possible to keep the whistles down to two or three or ever to eliminate them entirely. Much depends on local conditions, however, and upon whether the receiver is used in close proximity to a powerful broadcasting station.

valve or the frequency-changer is overloaded. Experience shows that under average conditions a receiver including an RF stage usually develops a greater number of whistles than one which does not. Unless an RF stage is included, however, the signal/noise ratio is lower than it can be. The reason why an RF stage increases whistle production is that by its amplification it so increases the input to the frequency-changer from a local station that this valve is overloaded, and this in spite of the fact that the signal-frequency circuits may be appreciably mistuned from the local station. The remedy is, of course, better preselection.

**Ganging**

In view of these points the early stages of a superheterodyne call for very careful design. In general an RF stage should be used, but for the best performance its gain should be no higher than is necessary to attain the maximum signal/noise ratio, and the preselection should be as high as possible. In this connection, it is worthy of notice that the results are greatly affected by the aerial. Any increase in the aerial efficiency will be reflected in an improved signal/noise ratio and with a good aerial it is quite possible for a superheterodyne without an RF

correctly designed. The conventional aerial coupling gives neither the best efficiency nor the best ganging.

The adjustment of ganging demands merely the setting of trimmers for maximum response and can be carried out without any source of known frequency. A test oscillator is naturally convenient, but the ganging can be performed just as easily and just as accurately on a signal.

Now in the superheterodyne the IF amplifier must be aligned by means of its trimmers, and while it is easy enough to make all circuits tune to the same frequency it is by no means easy to make sure that this frequency is the correct one unless an accurately calibrated test oscillator is available. It is very important that the intermediate frequency used should be the one for which the receiver is designed, for if it is not large errors in the ganging of signal and oscillator circuits are inevitable.

In the ganging proper, the signal-frequency circuits follow the same rules as those of a straight set, but the oscillator must always be tuned to a frequency higher than the signal by the intermediate frequency. With the usual "padding" system of ganging it is only possible to secure correct ganging at three points in the tuning range. Two of these points are normally 1,400 kc/s and 600 kc/s

**The Characteristics of Straight Set and Superheterodyne**

ATTRIBUTE.	STRAIGHT SET.	SUPERHETERODYNE.
Sensitivity ... ..	No limit	No limit.
Signal/Noise Ratio ... ..	Set by thermal agitation in first tuned circuit	Set by thermal agitation in first tuned circuit if the receiver includes an RF stage.
Adjacent Channel Selectivity ... ..	In practice limited, because it is rarely possible to use more than four tuned circuits.	No limit.
Whistles ... ..	None	The avoidance of whistles demands careful design and precise adjustment of the receiver.
Modulation Frequency Response... ..	Liabile to vary over the waveband. A good compromise between selectivity and quality is not easy. A form of variable selectivity is necessary in a selective set.	Substantially independent of wavelength. A good compromise between selectivity and quality can readily be secured. Continuously variable selectivity can be arranged fairly easily.
General Distortion... ..	Can be kept very small	Can be kept very small.
Adjustments ... ..	Ganging can readily and accurately be carried out without instruments. Defects which cause ganging errors are easily traced.	Correct ganging necessitates the use of an accurately calibrated oscillator. Defects which cause ganging errors are not always easy to locate.

There are two main causes of whistles. Many can be produced by the feed-back of harmonics of the intermediate frequency to the early circuits and their avoidance demands very thorough screening. In fact, as much screening is needed in a superheterodyne for the avoidance of whistles as in a straight set for the maintenance of stability. The other chief cause of whistles is a lack of selectivity at signal frequency. It is necessary to provide quite a high degree of selectivity before the frequency-changer for the avoidance of second-channel and kindred forms of interference, especially when the set is used within a few miles of a broadcasting station.

The question of an RF stage also introduces difficulties because the liability of a receiver to produce whistles is enormously increased if either the RF

stage to be quieter than a set with such a stage, or a straight set, used with a poor aerial. Within the service area of a transmitter, however, any increase in aerial efficiency increases the liability to whistles, so that for any given superheterodyne in any given locality there is actually an optimum figure for the aerial efficiency which gives the best compromise between the conflicting factors.

We have now to consider the questions of ganging and its adjustment. In the straight set all tuned circuits are similar and except for the aerial circuit it is only necessary to use tuning coils of identical inductance and a gang condenser with identical sections for perfect ganging to be secured. Perfect ganging of the aerial circuit is theoretically impossible, but in practice the errors can be made extremely small provided that the circuit is

and adjustments, must be carried out at these frequencies, so that a test oscillator again becomes necessary. The third correct point is settled in the design of the receiver and if everything is in order its position falls automatically at about 900 kc/s, the frequencies of maximum error in ganging being about 1,500 kc/s, 1,120 kc/s, 730 kc/s and 550 kc/s.

The magnitude of the errors is not very large, but is greater with a high intermediate frequency than with a low. It is especially important to note, however, that if the IF circuits are adjusted to a frequency differing only slightly from the correct one the ganging errors are greatly increased. It will still be possible to adjust the early circuits so that correct ganging is secured at 1,400 kc/s and 600 kc/s, but the third point will no longer be 900 kc/s. It may shift to 800 kc/s



**Straight Set versus Superheterodyne—**

and this will reduce the errors at lower frequencies but increase them at higher, and the errors in tuning at 1,000 kc/s may become very large.

As the selectivity is determined chiefly by the IF amplifier, the dial settings depend on the oscillator circuit, and the result of the ganging errors is to make the signal-frequency circuits the ones which are mistuned. The result is that the errors are effective in reducing the preselection and consequently increase the liability of the receiver to whistles and reduce the signal/noise ratio. It is probably true to say that 80 per cent. of the whistles present in modern superheterodynes are caused by ganging errors and that of these errors half are due to the use of the wrong intermediate frequency and half to insufficiently accurate matching of coils and condensers.

The matter of quality has yet to receive consideration and here there is theoretically nothing to choose between the straight set and the superheterodyne. There is little doubt, however, that it is easier to obtain freedom from amplitude distortion with the straight set, although the reason for this is not very clear. As regards frequency distortion, however, the superheterodyne is likely to be the better, especially if the selectivity is fixed. Because the selectivity is obtained at a fixed frequency it is possible to use many tuned circuits in coupled pairs and so obtain an approach to the ideal square-topped resonance curve. This course is not practicable in a straight set with its limited number of circuits, for it is necessary to make the most of each circuit if reasonable selectivity is to be secured. In consequence it is not so easy to obtain a good compromise between selectivity and quality in a straight set as in a superhet-

erodyne and some form of variable selectivity becomes essential.

The main attributes of the two types of receiver are listed in the table for ready comparison and it will be clear that the straight set has two points very definitely in its favour—namely, the absence of whistles and the much greater ease of ganging. This latter point is one which will carry great weight with amateurs who as a rule have little in the way of test apparatus. It is, in fact, clear that the only way in which the superheterodyne is unquestionably superior is in the ease of obtaining very high adjacent channel selectivity. If it is possible to obtain, not necessarily as high selectivity as that of the superheterodyne, but adequate selectivity for present-day broadcasting conditions with the straight set, it is obvious that it has much in its favour and many will be justified in preferring it.

Since the number of tuned circuits is limited to four, it is clear that the maximum of selectivity must be obtained from each. Efficient coils must be used, therefore, and must be so connected in circuit that a minimum of damping is imposed upon them. Furthermore, every effort must be made to secure accurate ganging if the inherent selectivity of the individual circuits is to be combined properly to realise its theoretical maximum.

In practice, the greatest ganging errors occur through mismatching of the coils. It is not difficult, however, completely to eliminate this source of error by employing coils of adjustable inductance so that they can be matched by the user while they are in the set. This does not increase the difficulty of ganging, it only makes the process a little longer. Actually, ganging involves tuning in a

low wavelength station and adjusting each trimmer on the gang condenser for maximum response; then tuning in a station at the other end of the waveband and repeating the process, this time using the inductance trimmers. For the most accurate results this should be followed by a check on the settings of the capacity trimmers at a low wavelength, but there is nothing at all difficult about the process and no test oscillator is needed.

The arrangement of the circuits is a matter of importance. With four tuned circuits it has become conventional to use two RF stages so that the circuits are arranged as two single-tuned circuits and one coupled pair. This entails an appreciable reduction in selectivity, however, unless the coupling is made so loose that the sensitivity is seriously impaired. The maximum selectivity is secured with three RF stages and it is then easy to secure high gain. It is necessary to limit the gain per stage in the interests of both stability and selectivity and this is best done by a combination of two ways. The grid bias of the valves is increased above the normal minimum, thus reducing the mutual conductance and increasing the AC resistance, and the circuits are coupled very loosely to the valves so that a minimum of damping is imposed.

In this way it is easy to secure good amplification and a degree of selectivity which is in practice adequate for most requirements. The selectivity is, in fact, so high that a very considerable degree of sideband cutting occurs and means for reducing it for high quality reception of powerful signals must be included. On the long waveband, for instance, it is readily possible to receive Deutschlandsender with no more than a certain amount of sideband splash from Droitwich and Radio Paris.

**Bass Reflex Baffle**

**I**N this cabinet baffle developed for use with the American Jensen 18-inch loud speaker, the apertures in the back panel are designed to bring the output from the back in phase with the front wave. A response uniform down to 30 cycles is claimed.

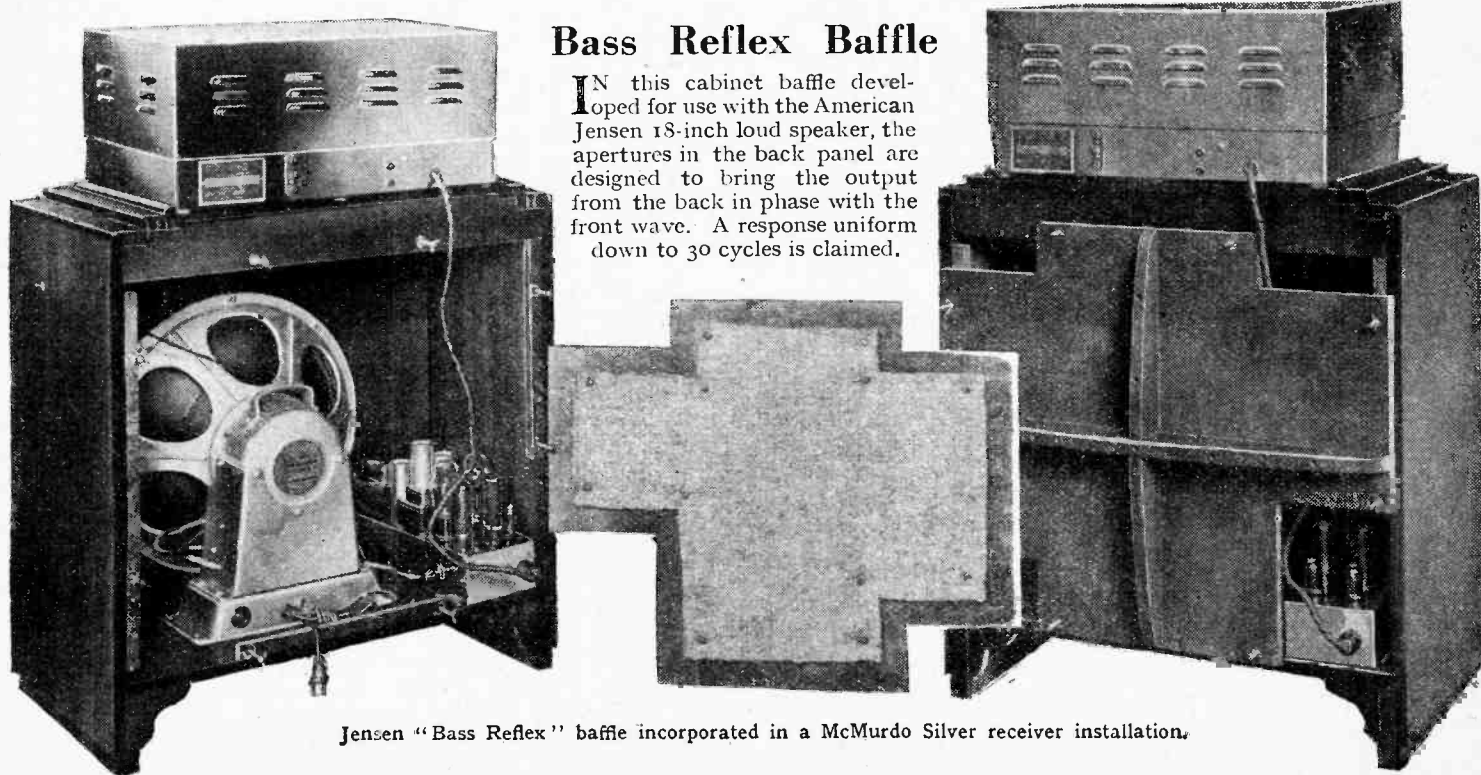

Jensen "Bass Reflex" baffle incorporated in a McMurdo Silver receiver installation.

# UNBIASED

## A Cinevision

IN nearly all of us there is a strong vein of avariciousness which is apt to cause us to cast about for any and every means whereby we can save money and, like the man who, to save the railway fare, walked from London to Scotland and later had to foot a heavy doctor's bill, we are usually so blinded by some obvious saving that we are apt to overlook the fact that in many cases our so-called economy may mean far greater expenditure later on. One of the most striking instances of this sort of thing that has ever been brought to my notice came my way the other day.

I happened to be enjoying a peaceful half-hour at home, as Mrs. Free Grid had been unexpectedly called to the bedside of a sick friend, when I was disturbed from my rest by a seedy-looking individual whom I at first took to be a wireless manufacturer who, poor souls, are always hard put to it to stave off the wolf which ever menaces the door of their humble cottages. I was soon enlightened as to the reason of his visit as he sought to interest me financially in a new company which, he informed me, was being floated for the purpose of building a chain of cinemas in the suburbs.

Now, as I pointed out to him, in my opinion this sort of thing is already overdone, and there does not seem much room for a new venture of this kind. He at once informed me that the proposed company would be able to offer the same comfort as an ordinary cinema but at far cheaper rates, since it was intended to effect a drastic cut in costs by using only one projector for the whole chain of cinemas.



... asking if I felt better.

In response to my request as to how it was proposed to carry out this apparent impossibility he explained that there would be one central cinema equipped with a first-class projector and the pictures would be transmitted to all the satellite cinemas by means of a low-powered television transmitter, the afore-mentioned satellites each being fitted with a number of television receivers dotted about the auditorium, one receiver to each half-dozen members of the audience. I was just about to reach for my cheque-book

## By FREE GRID

when I was suddenly conscious of a radiantly beautiful nurse bending over me and asking me if I felt better. It was, I suppose, the result of the pickled cabbage. I have been warned about it before.

## Radio Rowdies

WE wireless people seem to be so busy denouncing those who interfere with our reception by means of "unsuppressed" electrical apparatus, and in demanding that laws be passed to suppress both them and their wretched apparatus, that we are apt to overlook the rising tide of indignation at the interference with the ordinary amenities of life caused by many wireless listeners. I refer, of course, to the ever-increasing menace of the over-loud speaker next door which bellows unceasingly day and night.

At one time a complaint of such interference, only arose during the summer when people took the loud speaker into the garden or placed it near an open window. Nowadays, however, the volume at which loud speakers are operated has risen to such a pitch that in many cases they can be heard two or three houses away. Now to my mind the only way to remove this menace of noisy loud speakers is to take away the cause of it. The question is, of course, what is the cause, and I flatter myself that I have unearthed both the cause and the cure as the result of my very diligent application to the problem.

The whole trouble is, I find, due to the fact that nowadays people are getting so used to the wireless set as a background to their daily activities, that they cannot do without it. Now most people have only one wireless set, while extension loud speakers are still a comparative rarity in the average family. Consequently, when any member of the household is in a part of the house other than the room in which the loud speaker is installed, he or she demands that it be run at excessive volume in order to be able to follow the programme.

In the case of households where the fort is held all day by a woman, you will nearly always notice that the set is run at very great volume when she is pottering about the different parts of the house doing what she dignifies by the name of work. The remedy is an obvious one, namely, to have all houses permanently wired for loud speakers and to have an extension instrument fitted to every room. I have long used this arrangement at home, and consequently nobody in my household, no matter even if they be in the coal cellar, has to call for the family set to be run at excessive volume.

I have actually proved my theory to be correct by approaching one or two



... noisy loud speakers ...

notorious disturbers of the peace in a well-known London suburb and arranging temporarily to fit their dwellings with a loud speaker in every room. In each case so far, the complaints from the neighbours have ceased instantly, and, what is more to the point, the inhabitants of the erstwhile noisy households, have themselves appreciated the comfort of the arrangement to such an extent that they have at once bought a set of loud speakers for themselves.

## Inferior Electricity

I GREATLY fear that some of the remarks which I made under the above title the other week have been twisted, turned and torn out of their context by many people to make it appear as though I were ignorant of the elementary fact that there are 1,728 cubic inches to a cubic foot. I feel now that I can at last understand what Kipling was driving at when he wrote his famous lines:—

*"If you can bear to hear the truth you've spoken,  
Twisted by knaves to make a trap for fools."*

I have been overwhelmed by letters purporting to show that I stated that there were only 12 cubic inches to a cubic foot. Needless to say, I said no such thing as anybody who cares to read my remarks carefully can prove for themselves. What I said was, "just as though they had been trying to supply cubic feet containing fewer than 12 cubic inches," which is quite a different thing. Undoubtedly it was, and is, perfectly correct for me to imply that it would be swindling to supply cubic feet containing fewer than 12 cubic inches, so I cannot see that my remarks constituted an error. It is true that it would be equally as much swindling to supply a cubic foot containing 13 cubic inches, but I quite fail to see where I have said it would not. So that's that.

With regard to the actual question of the inferior performance of the set, the most likely explanation that I have received is to the effect that it is due to a poor power factor associated with the particular mains concerned, although one reader states that he came across a similar trouble in a house where the electric light wiring consisted of unsheathed rubber-covered cable, the usual metal conduit or lead covering being absent.

# Current Topics

## EVENTS OF THE WEEK IN BRIEF REVIEW

### 729-line Television

IT has been announced by the Fernseh Company that at the Berlin Radio Show, which opens to-day (July 30th) they will be demonstrating 729-line television.

### Wireless Booming

SO great has been the demand for the Norwegian "People's Receiver" that manufacturers are finding it extremely difficult to keep abreast of orders. So far, 18,200 have been sold, 14,600 of these being of the AC type. A further 5,800 sets are on order.

### Bergen Exhibition

A WIRELESS exhibition will be opened in Bergen on August 7th and will remain in being until September 5th. A studio with glass walls is being erected inside the exhibition in order to give people some idea of how broadcasting is carried out. Special "amateur nights" are being arranged in which the public will be invited to broadcast from the studio.

### Amateur Movement Spreading

AN amateur radio society known as the "Experimental Radio Society of Egypt" has been founded in the Land of the Pharaohs. The first President is Mr. W. E. Marsh, owner of the Egyptian amateur station, SU1WM.

### Amateur Award

THE annual Maxim award for the most outstanding record of amateur radio achievements during the year has been won by Victor Clark, owner of station W6KFC, for his work during 1936. The award was established as a memorial to their father by the children of the late Hiram Percy Maxim, founder and president of the American Radio Relay League, and is given annually to the amateur who, in the opinion of the judges, has the most noteworthy record of work and achievement.

### The America's Cup Commentary

EVERY possible means, including the use of aeroplanes and blimps, will be employed by the N.B.C. commentators in their endeavour to convey to listeners a vivid word-picture of the various races for the America's Cup, which commence to-morrow (July 31st). For the benefit of listeners in

this country the B.B.C. will make frequent relays of the N.B.C. commentaries.

### Danish Radio Chief Dies

MR. Kay Christiansen, the engineer-in-chief of the Danish Post Office and technical head of Danish broadcasting, has died at the early age of forty-six. Mr. Christiansen was for two years assistant to Professor Pedersen and later spent some time in America. In 1931 he presided over the International Radio Convention at Copenhagen, and in 1932-3 was the official advisor in telegraphic and telephonic matters to the League of Nations.

### GW Calling

WHEN the prefix GM came into use for Scottish amateur transmitting stations a few months ago it was mentioned that Wales was the only country of the United Kingdom not possessing its own prefix. This deficiency has now been remedied, the G.P.O. having recently sanctioned the use of the prefix, GW, by Welsh amateur stations.

### Wireless Operators Wanted

THE R.A.F. will be requiring four hundred boy entrants in September for training in the trades of Armourer, Photographer and Wireless Operator. Candidates must be not less than 15½ and not more than 17½ years of age on September 1st, 1937. The initial period of engagement is for nine years after attaining the age of 18. Full particulars are contained in Air Ministry Pamphlet No. 54, which may be had free of charge from the Inspector of Recruiting, Royal Air Force, Victory House, Kingsway, London, W.C.2.

### Mid-Ocean Concerts

IT is reported that at the request of the owners of the French liner *Normandie* the N.B.C. has been carrying out an inspection of the ship's wireless facilities with a view to relaying concerts from the liner over the U.S. radio network on these occasions when prominent radio artists are among the passengers. Considerable attention, it is said, has been devoted to the question of a suitable room for a studio. If the broadcasts are successful it is probable that the Cunard-White Star liner *Queen Mary* will be similarly equipped.

Mr. Montague M. MacQueen who, as chairman of the Radio Manufacturers' Association, will influence the policy of the industry this season and direct the organisation of the Radio Show. Mr. MacQueen is manager of the wireless section of the G.E.C.



### All About France

ON Mondays, Wednesdays and Saturdays from 6.45 p.m. until 7 p.m. listeners who tune in Rennes or Lille will be able to pick up special talks broadcast in English giving official information concerning conditions in France. On Mondays these talks will be devoted to setting forth what France is trying to do in the social domain, extracts being given concerning town planning, housing conditions, education reform, etc. Wednesday's talks will deal more with the events of the day while, on Saturdays, descriptive travel talks will be given and points such as hotel prices, which would interest the intending visitor, will be given.

### B.E.R.U. Trophy Contest

AN Australian amateur, Mr. Ivan Millar, VK3EG, has succeeded in obtaining first place in the high-power section of the amateur transmitting contest organised by the British Empire Radio Union. In the low-power section, which is limited to amateurs employing not more than 25 watts, first place has been gained by a Londoner, Mr. R. Holmes, G6RH. Actually this contest, which is an annual event, was held last February, and the lapse of a few months in announcing the results is inevitable, as entries are received from the remotest parts of the Empire, every one of which has to be carefully checked.

### U.I.R. Meeting

AT the conclusion of its summer meeting the International Broadcasting Union presented an electric clock to Vice-Admiral Sir Charles Cappendale, Deputy-Director of the B.B.C., in recognition of his services as President of the Union during its first ten years.

The chief business of the meeting was in connection with the ever-growing problems of waveband congestion, more especially on the short waves. The technical committee has prepared a programme of tests, involving the close collaboration

of American stations, which will take place during the next few months, so that the results obtained may be used by the 1938 Cairo Conference in the preparation of a world plan for the allocation of short waves.

### Foreign Broadcasting Policy

WHEN discussing the question of "propaganda" broadcasting we are apt to think that it is confined to just a few countries. It is somewhat surprising to learn, therefore, that according to a statement made the other day no fewer than twenty-one countries are broadcasting special programmes for listeners outside their borders and are using foreign languages for the purpose.

### Smith, Jones or Jensen

AMONG the unusual items planned by the Programme Department of the Danish Broadcasting Service for the near future is a special "Jensen Day." On this day it is hoped that every item broadcast will either be written or performed by somebody bearing the name of Jensen, which is fully as common as is Johnson in this country. The day will be opened by the new chief of broadcasting who bears this name.

### Spoken Letters

THE latest application of the thermionic valve appears to be in connection with the "spoken letter" service inaugurated by the Dutch Post Office. Outside the G.P.O. in Amsterdam, The Hague, and other large towns, are installed special automatic recording machines. The user inserts a coin into the slot and then proceeds to speak about 150 words into a microphone mounted on the instrument. By means of a valve amplifier and other apparatus his words are duly recorded on a disc, which is then delivered by the machine, complete with a special envelope ready for despatch to a friend. The reverse side of the disc is available for spoken advertising.

# The Wireless World Television

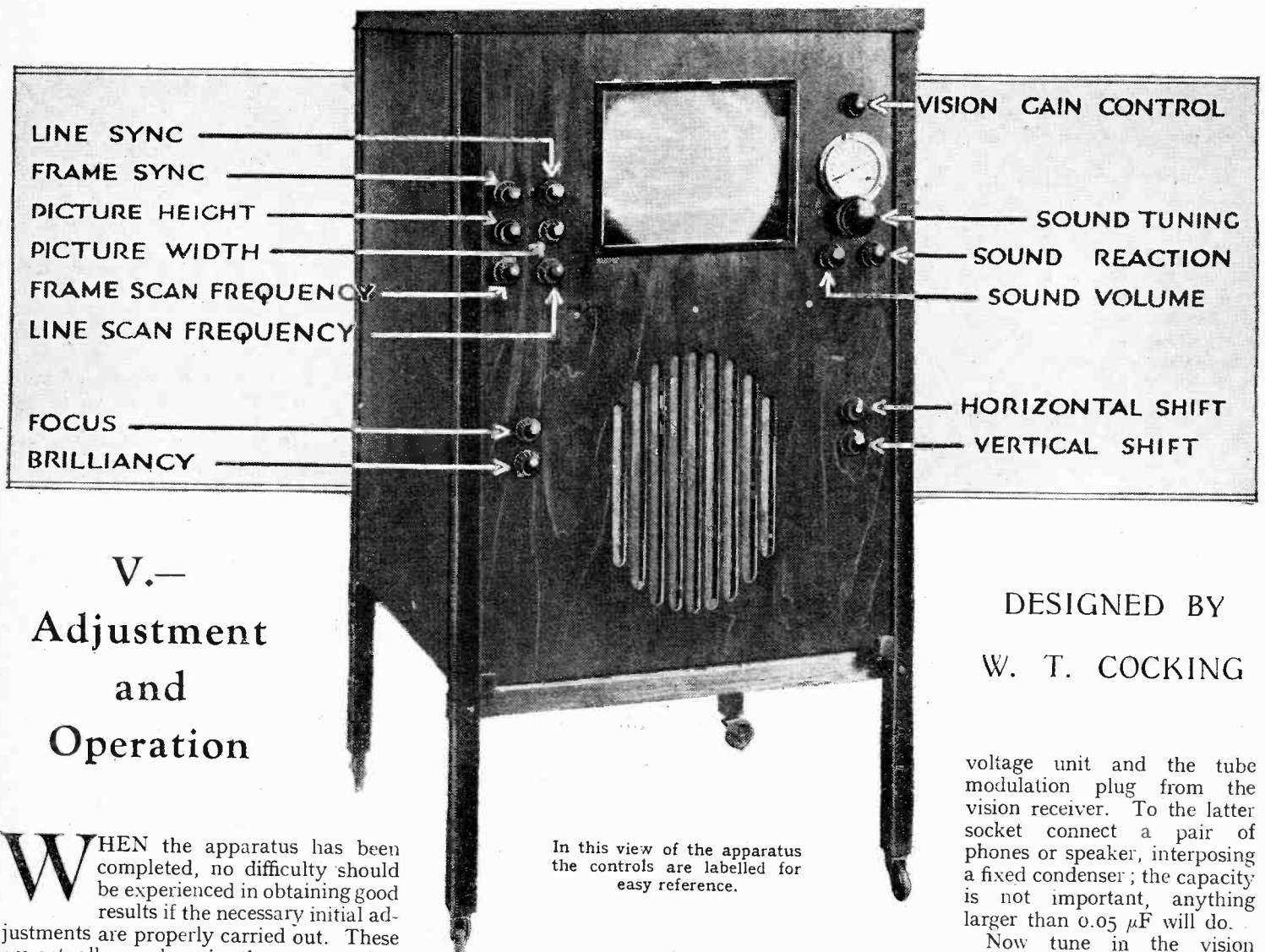

## V.— Adjustment and Operation

**W**HEN the apparatus has been completed, no difficulty should be experienced in obtaining good results if the necessary initial adjustments are properly carried out. These are actually much easier than may at first appear, and any apparent complexity is due largely to their unfamiliarity. The adjustments will consequently be described in some considerable detail.

Except at the shortest distances from Alexandra Palace a resonant aerial should be used and at any considerable distance a centre-fed half-wave aerial with reflector is strongly recommended. Not only does this type give greater signal strength, but it is directional and will in consequence often reduce interference.

A good earth is essential, not for reception, but for safety. If the equipment is not properly earthed, the screens and metal work generally can become charged to quite a high voltage. It is wise, therefore, not only to install a good earth, but to arrange it so that it cannot easily become disconnected.

The sound and vision receivers are entirely separate and can consequently be tested separately. Test the sound receiver first; this may be done by pulling out the

mains plug on the vision receiver power pack. For precise details regarding initial adjustments to the sound receiver, the constructor is referred to the article in which this set appeared.<sup>1</sup> The tuning control, reaction and sound volume control are the only controls which affect it, and it should readily be possible to tune in the sound transmissions at good volume. In the original receiver the dial setting was about 14 and the vision signal could be heard near zero.

### Tuning the Vision Receiver

Turning now to the vision side, all adjustments can be carried out by watching the effect on the tube, but it is generally more convenient to tune the receiver first with the aid of a pair of phones or even a loud speaker. To do this remove the mains plug from the high-

<sup>1</sup> *The Wireless World*, April 23rd, 1937

voltage unit and the tube modulation plug from the vision receiver. To the latter socket connect a pair of phones or speaker, interposing a fixed condenser; the capacity is not important, anything larger than 0.05  $\mu$ F will do.

Now tune in the vision signal, adjusting each of the four trimmers for maximum response. In general the first three trimmers will be near their minimum capacity, and the last about one-third in. It should be possible to obtain very loud phone signals, or rather weak loud speaker signals, from the sync pulses, and until these are obtained there is little use in proceeding further.

There should be no difficulty in obtaining such signals, and the HV unit can now be switched on. Before doing so, make sure that the tube and all valves in the time-base are alight. The heaters can all be clearly seen except in the case of the T31 valves. With these it may be necessary to remove the top-caps for inspection.

Before switching on, make sure that the brilliancy control is turned fully anti-clockwise, the focusing control and the six controls on the left-hand side of the window are set about half-way round their travels.

Then push the mains plug on the HV

DESIGNED BY  
W. T. COCKING

# Receiver

*FULL constructional details of the television equipment have appeared in the earlier articles in this series and it now remains to describe the adjustments necessary for the attainment of a good performance. It will be seen that these adjustments are by no means complex and are, in fact, easier than those needed by many modern broadcast sets.*

unit. This will function immediately for the delay switch in the vision receiver power unit will have been closed for some time since it has been in operation during the testing of the vision receiver.

Turn the gain control right down and then slowly turn up the brilliancy control. An illuminated rectangle should appear on the end of the tube. Leave the control set at moderate brilliancy so that the rectangle is clearly visible. Then centre the raster with the panel opening by the two shift controls on the right of the speaker fret.

## The Time-base Controls

The next step is to adjust the raster to approximately the right size. This is done by the centre pair of knobs to the left of the window; the left-hand knob controls the picture height and the right hand the picture width. These should be adjusted so that the raster is about the size of the window. Now focus the spot on the screen by means of the upper of the two knobs on the left of the speaker fret. Adjust this slowly for maximum sharpness of the horizontal lines which build up the raster. It is essential to turn this knob slowly for there is a small time lag between its movement and a change on the tube. At this stage the lines are unlikely to be steady for there is as yet no sync being applied.

The next step is to apply the signal by turning up the vision gain control until black and white marks appear on the picture. Then turn the sync separator bias control (R20 on the vision receiver) fully anti-clockwise and then back about one-quarter of its travel.

Set the frame sync amplitude control (top left-hand knob) fully anti-clockwise, and slowly turn the frame frequency control. A horizontal black line will be observed moving vertically across the tube, but as the frame frequency control is turned its speed of movement will vary. If it increases, turn the knob the other way. The speed will then slow down and a point will be found at which the black line stops. When it does, turn up the frame sync amplitude control about half-way. The black line will now probably be moving across the screen in a jumpy manner; readjust the frame frequency control, and a point will be found at which it will lock in at the top of the raster and become invisible. The setting of the frame frequency control is not critical with a good amplitude of sync pulse, and may be varied appreciably without visible effect.

The line must now be adjusted and this

is best done by turning the line sync amplitude control fully clockwise and turning the line frequency control. As this is rotated the various black marks on the picture will change and at some points become lines which swing round through the vertical. At one point, the picture will suddenly appear with a black edge on the right-hand side which will lock in on the extreme right. The setting of the line frequency control is more critical than that of the frame, but is not unduly so. In fact, the setting of no control is nearly as critical as the tuning of an ordinary broadcast set!

The picture should now be steady and recognisable, but will probably be of the wrong shape, for the size of the picture depends not only on the settings of the height and width controls, but also upon the frequency controls. If the picture is not wide enough, turn the picture width control clockwise, at the same time turning the line frequency control in the same direction so that the sync is not upset. Then adjust the height by simultaneously turning the height and frame frequency controls in the same direction.

## Final Adjustments

Now inspect the picture closely. It will probably be found that the lines are wandering slightly up and down, and this can be corrected by more careful setting of the frame frequency control. The next step is to adjust the focus precisely for maximum sharpness of the lines and this is now easily done for the lines are perfectly steady and not wandering.

Turn down the gain control so that the picture disappears and turn down the brilliancy so that the raster just disappears. Then turn up the gain control so that a very faint picture appears. This will probably be unsteady, so adjust the sync separator control for maximum stability. On turning up the gain control farther a good steady picture should be obtained, but it may be a bit fuzzy for the tuning has not yet been properly adjusted. This is the next step and should be carried out with a fairly bright picture.

The tuned circuits should, after the preliminary tuning, be all in resonance with one another, and although this condition gives the greater sensitivity it does not give the best picture. The circuits must be mistuned slightly for the best results, and this condition must be found experimentally, since the precise settings will vary with different receivers. In the original model the best results were obtained with the first and third circuits tuned to resonance, the second trimmer

set at zero, and the last with somewhat more capacity than the optimum for signal strength. As these circuits are varied the gain control should be altered simultaneously so that the picture brilliancy remains constant.

At certain settings of the controls it will be found that on the right-hand edge (viewing the tube from the front) of a black object there appears a band of white or on the edge of a white object a band of black. This indicates that the circuits are so tuned that frequency distortion is occurring.

During the adjustment of the circuits, settings will probably be found at which interference from the sound occurs, and these must naturally be avoided. The interference manifests itself as a horizontal dark shadow across the picture which varies with the sound modulation; it may also affect the sync. On the tuning signal a regular wobble of the lines, so that while "B.B.C." is moving sideways to the left, "Tuning Signal" is moving to the right, is a definite indication of interference from the sound signal. When such interference is not due to the vision receiver being incorrectly tuned, it will be found that the cause is misadjustment of the aerial circuit trimmer on the sound receiver.

When satisfied with the picture definition it is only necessary to adjust the contrast. This is done by varying the brilliancy and vision gain controls for the best results. In general, an increase in brilliancy will give better detail in dark parts of the picture, but may be accompanied by a loss of detail in light parts. The two controls should thus be adjusted for the best effect.

## Precautions

These adjustments are, of course, carried out when initially setting up the receiver, and in normal use only the gain controls and brilliancy need attention. Before switching off always turn the brilliancy control fully anti-clockwise and before switching on always make sure that it is in this position. If this is not done there is a risk of the screen being burnt, for the time-base HT voltage falls more rapidly than the tube voltage when switching off. If the brilliancy control is not turned down, therefore, the raster collapses and leaves a bright spot in the centre of the tube.

When switching on, do not turn up the brilliancy control until the delay switch closes. This will usually be audible as a clatter in the speaker; if it is not heard, allow two minutes before turning up the control. After switching off, do not

**The Wireless World Television Receiver—V—** switch on again within five minutes, otherwise the delay switch may not have opened, and will not afford any protection to the condensers.

The best results are naturally secured when the equipment is operated in a dark room, but complete darkness is by no means essential. At night good results are obtainable with ordinary room lighting, and in the afternoon it is normally necessary only to draw the curtains in the room. The most important point is to prevent so far as possible light from falling on the end of the tube, and in general the receiver is consequently best placed with its back to the window.

In darkness, the brilliancy obtainable is amply sufficient, and, indeed, it is usually necessary to work with less than full brilliancy to avoid dazzle. Some people

#### REFERENCE TO EARLIER INSTALMENTS

- July 2nd - The Vision Units
- July 9th - The Time Base
- July 16th - The Mains Units
- July 23rd - Framework and Assembly—  
The Sound Receiver

A model of the complete receiver will be shown on "The Wireless World" stand during the Olympia Radio Show.

It will normally be found that the synchronising holds the time-bases in step over long periods without adjustment. The stability of operation, however, is affected in some degree by temperature, and there may be a slight drift during the first quarter of an hour or so after the gear is switched on. For a short time,

therefore, occasional readjustment of the line frequency control may prove necessary.

### Radio Amateur Call Book

THE summer edition, 1937, of the *Radio Amateur Call Book Magazine* is now available and can be obtained from F. L. Postlethwaite, 41, Kinfauns Road, Goodmayes, Ilford, Essex. The price is 6s. post free.

In addition to the call signs of amateur stations throughout the world, there is much information of value to the short-wave listener. For example, there is a list of commercial stations that transmit weather and press news on the short waves, and another of stations operating regularly in proximity to the amateur bands which can be used for the purpose of frequency calibration.

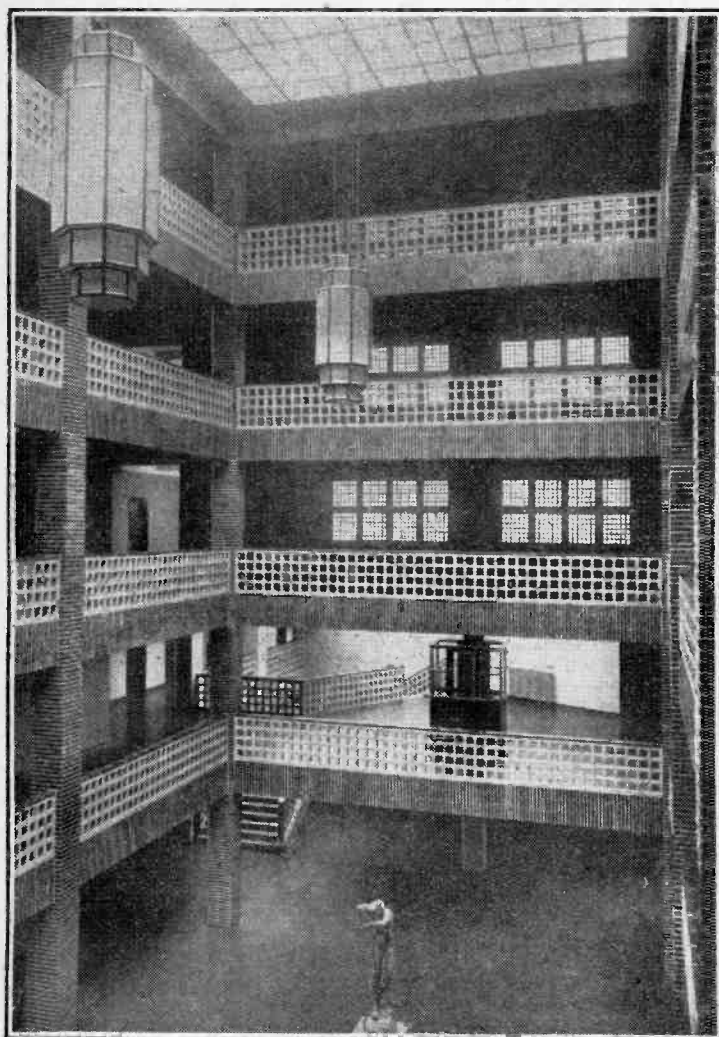

## "Haus des Rundfunks"

### THE HEADQUARTERS OF GERMAN BROADCASTING

UNLIKE Broadcasting House in London, the headquarters of German broadcasting in Berlin form the focal point of a complete entertainment centre, where are held various fairs and exhibitions, and in particular the Radio Exhibition. Adjacent also to the actual broadcasting house is the five-hundred-foot "Funkturn," which, somewhat like the much older Eiffel Tower, supports a restaurant in addition to wireless aerials.

The actual broadcasting house itself is of unusual design, the outer buildings resembling the letter D, the vertical portion of the letter forming the front, which is about 450ft. long. Inside the outer ring of buildings are three wings radiating from a common point, where there is a large light well passing through all four floors, and from which entrance is gained to all studios. Apart from a large number of studios and apparatus rooms, the entire administrative machinery of the State broadcasting company, as well as that of the two companies which operate the Deutschlandsender and the Berlin national transmitter, is contained inside the building. E. K.

The light well of the Berlin Broadcasting House passes through all four floors and from it access is gained to the various studios. The view below, taken from the Funkturn, shows clearly the three inner wings surrounded by the D-shaped outer building.

prefer subdued room lighting while viewing the pictures, and the brilliancy obtainable is entirely adequate. When working with a large amount of room light, however, it will be found that there is a limit to the brilliancy and this is set by defocusing of the spot in white parts of the picture. Such defocusing causes a loss of detail, and the best results are consequently secured when the room is dark enough to permit the attainment of a bright picture without excessively high settings of either the brilliancy control or the vision gain control.



# BROADCAST BREVITIES

## Clearing Up the Dance Band Muddle

LIKE the poor, the "dance band situation" is always with us, but John Watt has gone a long way towards alleviating certain asperities by outlining the clearest-cut scheme the B.B.C. has yet evolved for pleasing everybody concerned.

### Self-expression

Every type of dance band fan should be pleased, every resident in Tin Pan Alley should be gratified, and even the dance band leaders themselves should find scope for that self-expression which they look upon as their birthright.

### John Watt's Plans

In a heart-to-heart talk with three representatives of the dance band fraternity, namely, Mr. Jack Payne, Mr. Jay Wilbur, and Mr. Lou Preager, the new Variety Director has explained that three types of dance programmes are to be featured. The first, appealing to the largest class, will be devoted purely to entertainment, and will consist of comedy songs, concert arrangements, novelities and symphonic effects. "Vocals" will not be restricted in any way so long as they are good. Eight programmes of this kind will be given each week.

### For People Who Dance

The second type of dance band programme will be intended for people who actually want to dance. In spite of the ceaseless outpouring of rhythm it is strange, but true, that comparatively few listeners do dance to radio. Therefore, only four of these programmes will be radiated weekly. No vocalists will be tolerated, the intention being to provide strict rhythm.

### For Connoisseurs

The third type of programme—twice a week—will be reserved for dance connoisseurs. The fare will be carefully selected not only from the British bands but from some of the best Continentals relayed direct, and gramophone records.

### "An Hour to Play"

The dancing week will follow a well-ordered rhythm. Tuesdays will be notable for "B.B.C. Ballroom," Wednesdays for "Siesta" and "Hill-Billy" programmes in alternate weeks, and Thursdays for "Thé Dan-sant" in the afternoon and comedy numbers at night. Fridays will be devoted to "symphonic" dance music, while Saturdays will offer a full hour

## NEWS FROM PORTLAND PLACE

each week entitled "An Hour to Play, specialising in the individual presentation methods of the various dance band leaders.

### B.B.C. at Radiolympia

EMPIRE broadcasting is to be the main feature of the B.B.C. display at Radiolympia.

Most people have a hazy notion of when and how the various parts of the Empire pick up their programmes from the Mother Country, so the whole intricate process is to be made clear by flashing signs (well shielded, one hopes) showing the areas covered by the six transmissions.

### Six-colour Scheme

Three large circular displays are being arranged. The first will deal with the transmission's number and the countries served by that transmission; a second display will show the time at which a transmission takes place; and the third will show, by means of a giant map on a special projection of the world, the areas covered by the transmissions. The various sections will be illuminated by neon lights in six colours, each transmission being outlined separately by a time-switch system.

### Hands Across the Sea

THE B.B.C. may broadcast greetings to a new neighbour when the projected short-wave station at the Irish Free State begins radiating to Irishmen abroad before the end of next year. Constructional work is to be started almost immediately.

### Those B.B.C. Vowels

THE limelight has been turned on last week's agony advertisement for a young man with a command of B.B.C. vowels.

Actually, a large number of people seem anxious to talk B.B.C. English, to judge from the applications for copies of the booklet issued by the Advisory Committee on Spoken English. The Committee's recommendations are primarily for the enlightenment of B.B.C. announcers, who must necessarily follow a regulation standard, and the Corporation is anxious not to foist its own rules on the general public.

Nevertheless, the man with a copy of the "recommendations" in his pocket is a formidable conversationalist.

### Homage to Wireless . . .

B.B.C. staff are hoping that the Corporation will emulate the example of South America in ordaining that September 21 shall be regarded as "Wireless Day." The occa-

### NEARING COMPLETION.

A considerable advance has been made on the construction of the North-east Regional Station at Stagshaw, near Newcastle. It is expected that the station will be ready to take over the 267.4 metre transmissions early in October.

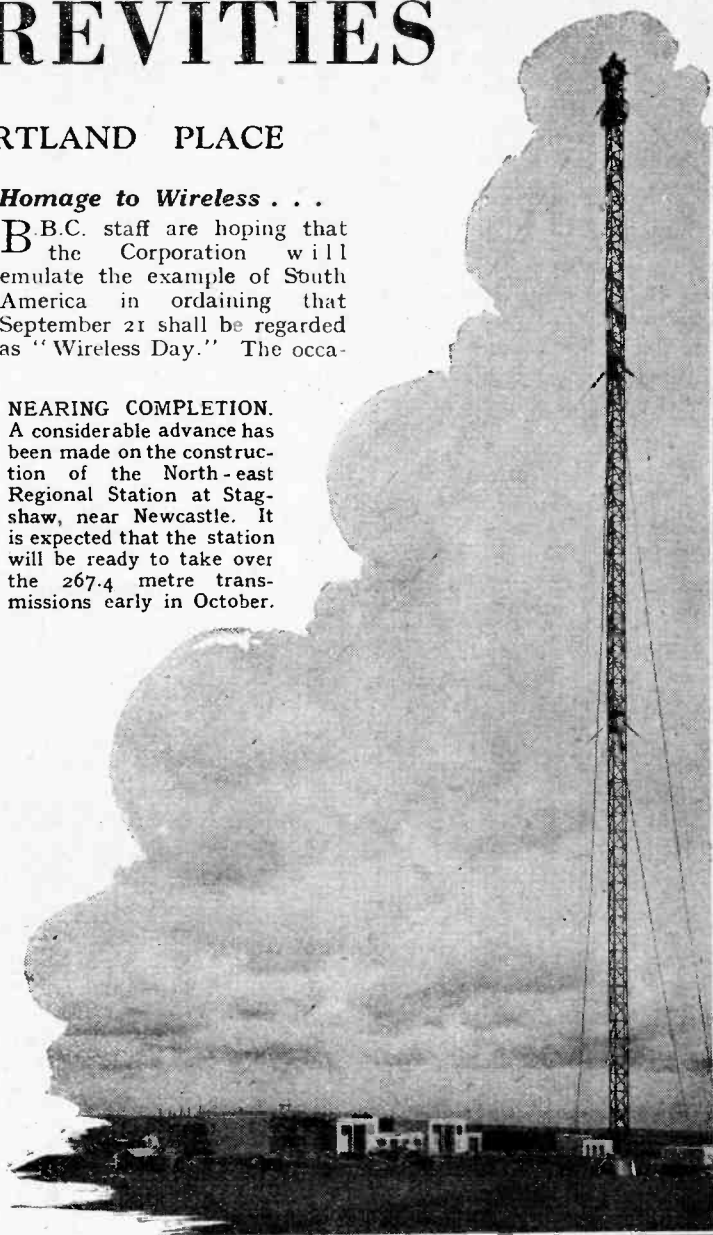

sion will be observed in curious fashion; instead of proclaiming the fact from the mast tops, the stations will remain in "complete silence in homage to wireless."

The staff of Portland Place have such a deep veneration for wireless that they feel one day would hardly be enough. A week at least is recommended.

### . . . And to Television

At Alexandra Palace they are paying three weeks' homage to television.

### Duck's Back Effect for Television?

HARRY PRINGLE, whose "Cabaret Cruises" have got nearer to realism than most other television shows, has been wondering whether the good ship "Sunshine" could weather a storm. Word got around that he was considering how to produce a real deluge without soaking the artists. As a result, a letter arrived at Alexandra Palace a few days ago from an

enterprising firm offering to submit the artists' clothing to a special process which would make the water trickle off in little globules in "duck's back" fashion.

Oddly enough, the umbrella manufacturers have not troubled to write.

### Neck to Neck

IS Germany leading Great Britain in the matter of wireless licences? The B.B.C. denies it, although the June figures—Germany, 8,511,000; Britain, 8,234,000—suggest that the Fatherland leads by a short head.

In point of fact, practically half a million German licences are issued free to war veterans, bringing the total of paid licence fees down to eight million. In this country free licences are issued only to blind persons, of whom there are 47,000 on the licence registers. Thus it will be seen that in paid licences Britain leads by approximately 150,000.

**A**LTHOUGH the week under review includes Bank Holiday Monday the programmes are not outstanding, the reason being, no doubt, that the programme planners realise that as many people as possible get out into the wide open spaces during this, the last holiday week-end of the summer, and are therefore not likely to be listening in.

For those, however, who by desire or necessity are at home on Monday, there is one highlight, namely a broadcast from Plymouth during the

# Listeners' Guide for Outstanding Broadcasts at Home

## TIDWORTH TATTOO

FROM the Southern Command Tattoo at Tidworth comes two relays in the National programme on Saturday. At 9.45 the massed bands of the Southern Command will be heard for fifteen minutes. Then from 11.5 to 11.45 will be heard the Musical Drive of the 2nd Brigade of the Royal Horse

## COUNTY CRICKET

EARLIER this year I stated that Mr. S. J. de Lotbinière was hoping this season to make cricket broadcasts as popular here as in Australia. He is certainly making a good effort to do so. This week-end he has arranged for commentaries on two matches

He will relate in this series of talks the misery and adventures that befell him on the road. He feels too strongly about it all to try to turn it into an exciting narrative, and too grateful to those who helped him during that period to belittle their efforts by pretending that he enjoyed his adventures. His story will, therefore, be absolutely authentic, and should prove truly enthralling to all listeners. The first talk will be given at 12.45 (Reg.) on Saturday.

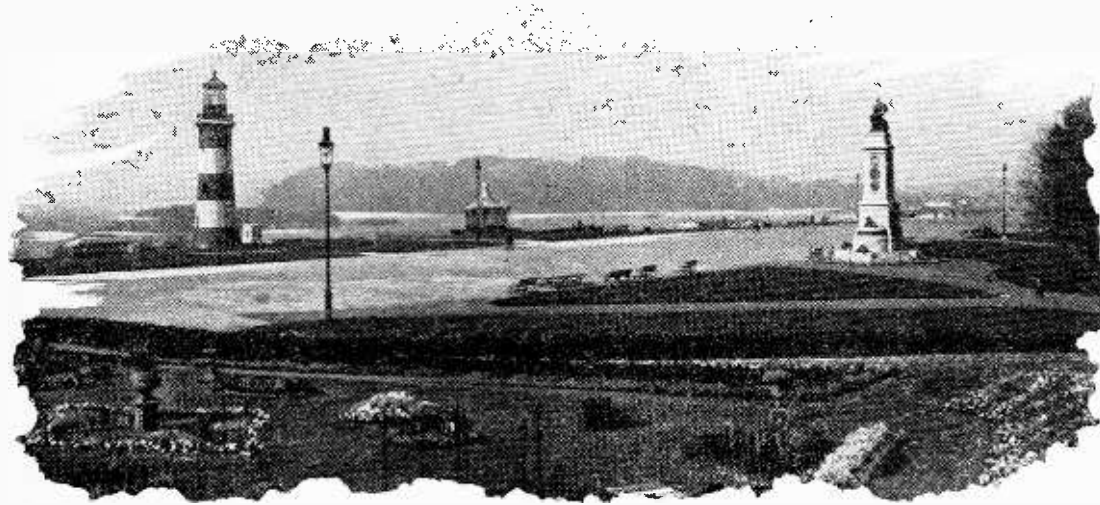

PLYMOUTH HOE with Smeaton Tower to the left of the picture from which, during the broadcast on Bank Holiday Monday at 6.35 (Nat.), the commentator will describe the scenes of merriment. In the distance behind the tower can be seen Drake's Island.

## WEST COUNTRY

THE late John Drinkwater's three-act, West Country comedy, "Bird in Hand," has been adapted for broadcasting by Cyril Wood and will be heard by National listeners on Tuesday at 7 and Regionally on Thursday at 8.45. The scenes for each of the three acts are set in the Gloucestershire inn, "The Bird in Hand." Although not a dialect play in the strict sense, for there are several contrasted types of visitors to the countryside, authentic dialect will be spoken by the actors taking Gloucestershire parts.

## HIGH SPEED

ERNEST LONGSTAFFE, who always manages to introduce a novel twist in his variety programmes, will produce "Next, Please," a high-speed variety show for National listeners on Wednesday at 8. The programme, which can be truly termed "lightning variety," will form a mosaic, each item blending into the next, and for this reason there will be no studio audience present, so that applause will not interfere with the maintaining of speed.

Among those taking part are Haig and Escoe, who will be broadcasting for the first time; Cecil Johnson, giving a burlesque talk on physical training; Tollefsen, the wizard of the accordion; Scott and Whaley, the celebrated Kolooured Komedy Kings; and Chick Endor and Charlie Farrell, America's popular songsters.

Wilfrid Parry will be at the

Navy Week celebrations which open to-morrow (Saturday, July 31st). The broadcast, which begins at 6.35, will provide National listeners with an impression of the gaiety at this naval port. It will commence with a description of the scenes on the Hoe from Smeaton Tower, next comes a bird's eye view from an aeroplane, given by J. Best. For this a short-wave link will be used.

Following this comes a commentary on the ancient ceremony of "crossing the line," which will take place in the Royal Naval Dockyard. And finally, listeners will be switched over to the Alhambra, Devonport, when they will hear the harmonica band of H.M.S. Rodney.

In the afternoon commentaries on the International Athletic Meeting at the White City will be given by H. M. Abrahams and Jack Lovelock between 4 and 5.20 (Nat.). During this period also, the second day's play in the two county cricket matches, referred to later, will provide commentaries

Artillery accompanied by four Cavalry and two Infantry bands. This will be followed by the finale, which will conclude with the singing of the National Anthem by all present. During the Tattoo no fewer than nineteen bands with one thousand performers will be taking part. An observer will set the scene before each broadcast, thereby helping listeners to visualise the splendour of this military pageant.

## SALZBURG RELAYS

As mentioned last week, we are to hear three relays from the great musical festival at Salzburg this week. Toscanini will be the conductor to-night (Friday), when at 8.35 (Reg.) comes the second act of Mozart's "The Magic Flute," and again on Thursday at 7 (Nat.), when Act 2 of Wagner's "Die Meistersinger" is relayed. On Monday Bruno Walter will be conductor when the second act of Mozart's "Don Giovanni" is heard at 8.55 (Reg.).

which will be in progress; Yorkshire v. Lancashire at Bramall Lane, Sheffield, and Kent v Hampshire at St. Lawrence Ground, Canterbury. The first will be commented upon by P. G. H. Fender and the second by Howard Marshall. It is proposed to broadcast from both of these matches during each of the three days' play; on Saturday at 1.10 and 5, on Monday between 4 and 5.20, and again on Tuesday at 1.10 and 5. All the commentaries will be given in the National programme.

## "I WAS A TRAMP"

A SERIES of talks under this heading will be given during the next few weeks by a young journalist who will, however, remain anonymous. At the age of twenty-two he found himself without a job, or any immediate prospect of obtaining one, and with only a few shillings between him and starvation. He decided to tramp the country, not because of any romantic notion, but that there seemed at the moment nothing else to do.



# the Week and Abroad

piano, and Bram Martin and his dance orchestra will play several interpolated features and a concluding number. Bram Martin, who was associated for some time with the Holborn Restaurant, has now taken to the stage with a new combination, and this will be its first radio appearance.

## “PAST, PRESENT AND FUTURE”

JACK Hylton and Eddie Pola are to present the first of their programmes under this heading on Saturday at 8 (Nat.). In this series they will introduce stars and events of yesterday and to-day, and stars possibly of to-morrow. Among those who will be heard this week include Vesta Victoria, Marriott Edgar, George Elrick and Frances Day. The music will be played by Jack Hylton and his band with Eddie Pola acting as compère.

## FROM THE NORTH

AN interesting cross-section of the North at play may be anticipated when the fourth programme in the series, “Summer Over the British Isles,” is broadcast on Monday at 8.30 (Nat.). A comprehensive impression of summer in such a vast area as the North of England means only a few moments of music or speech from each place or

WALTER GIESEKING, the celebrated German pianist who will be heard from *Deutschlandsender* on Monday at 9.15, photographed with the composer, Professor Pfitzner (left)



## EXCHANGE

ON Monday at 10.30 (Nat.) the B.B.C. Symphony Orchestra will be conducted by Hans Adolf Winter, premier conductor of the Munich broadcasting station. An exchange visit will be paid to Munich by Clarence Raybould, a B.B.C. staff conductor, who has been invited by the German broadcasting authorities to conduct a concert for them.

## BERLIN RADIO SHOW

FROM Sunday until Saturday, August 7th, the evening programmes from the German stations are almost entirely devoted to relays from the Berlin Radio Show. An arrangement has been made whereby each regional station will be responsible for the entertainment on the great stage of the show for one evening.

## DUBLIN HORSE SHOW

THIS horse show, which is reckoned to be the biggest in the world, takes place this year from August 3rd to the 7th. On Wednesday, at 5.30, Athlone broadcasts interviews with officers of the various foreign jumping teams and also an interview with the judge of the

monly known as Ladies' Day, will be the occasion of another broadcast at 5.30, when the judges of the hunter and pony classes will be interviewed.

## AMERICAN MEMORIAL

FROM 3—4.15 on Sunday Radio Paris will relay the ceremony of the unveiling of the American War Memorial at Montfauçon-d'Argonne. The broadcast will include addresses by President Lebrun, General Pershing, Marshal Pétain and the American Ambassador. President Roosevelt's address, broadcast from Washington, will also be relayed by Radio Paris.

## OPERA

THE idea of giving an act per evening from Athlone seems to have become a settled policy of that station, for this evening at 8.15 and to-morrow (Saturday) at 8.25 comes the third and fourth acts of Verdi's “Othello.”

There is no mention of the Salzburg festival in the German programmes. Listeners must tune-in to Vienna, Radio Paris or Sottens if they wish to hear the operas in full. These stations will be relaying

at 7.5 to-night (Friday) “The Magic Flute,” and “Don Giovanni” on Monday at 7.

From the Residence Theatre, Munich, will be

CROWDS gather nightly about the entrance to the great Festspielhaus, Salzburg, to get a glimpse of some of the great opera singers arriving for the festival. Three relays from Salzburg come into the English programmes this week.

relayed Mozart's “Figaro” by Munich at 7.5 to-night (Friday).

THE AUDITOR.

## HIGHLIGHTS OF THE WEEK

### FRIDAY, JULY 30th.

Nat., 7.35, Five Hours Back. 8, “Dorothy”: comedy opera.  
Reg., 8, Recital: Frederick Sharp (baritone) and Thelma Reiss (cello). 8.35, Salzburg relay.  
Abroad.  
Vienna, etc., 7.5, “The Magic Flute,” from Salzburg.

### SATURDAY, JULY 31st.

Nat., 8, “Past, Present and Future”: Eddie Pola and Jack Hylton. 9.45 and 11.5, Tidworth Tattoo. 10, Jan van der Gucht and the Theatre Orchestra.  
Reg., 7.30, Old Swedish Dance Music from Stockholm. 9, “Four Meetings” from the short story by Henry James.  
Abroad.  
Radio Mediteranee, 9.10, Symphony Concert from the Casino, Monte Carlo.

### SUNDAY, AUGUST 1st.

Nat., 6.45, Robert Easton and the Theatre Orchestra. 7.55, Scottish Service from Dunblane Cathedral. 9.50, Concert from the Knocke Casino.  
Reg., 6.35, Tatiana Makushina (soprano) and the Modern Wind Quartet. 9.5, “Hereward”: adaptation of Jefferson Farjeon's stage play.  
Abroad.  
Kalundborg, 4, Open Air Band Concert (seventy performers).

### MONDAY, AUGUST 2nd.

Nat., 4-5.20, Athletics and County Cricket. 6.35, Relays from Plymouth. 8.30, Summer Over the British Isles: IV—The North.  
Reg., 6.35, Dale Smith and Stern-dale Bennett in songs for two. 7.30, “The Song is Ended”: reminiscent programme of popular songs. 8.55, Salzburg relay.  
Abroad.  
Radio Toulouse 9.10, Selections from Lohar's “Frasquita.”

### TUESDAY, AUGUST 3rd.

Nat., 7, “Bird in Hand”: West Country comedy. 9.40, “Late Night Final”—a news revue.  
Reg., 7.30, Sullivan-German programme: the Military Band. 9, Variety from the Theatre Royal, Worcester.

Abroad.  
Brussels I, 8.30, French version of two plays from Laurence Housman's “Victoria Regina.”

### WEDNESDAY, AUGUST 4th.

Nat., 8, “Next Please”: high-speed variety. 9.20, “Tonight, Twenty-three Years Ago”: Harold Nicolson, M.P.

Reg., 8.20, Cello and pianoforte duets: Nikolai Graudan and Hansi Fraudberg. 9, “Murder in the Embassy”: thriller by Francis Durbidge.

Abroad.  
Vienna, 8, Richard Strauss Concert from the Salzburg Festival.

### THURSDAY, AUGUST 5th.

Nat., 7, Salzburg relay. 8, “Murder in the Embassy.” 9.30, The Richard Crean Orchestra.  
Reg., 6.25, Shows from the Seaside: 5—Brighton Follies. 8.45, “Bird in Hand.”

Abroad.  
Munich, 8.10, The Magic of the Voice: a concert with famous soloists.

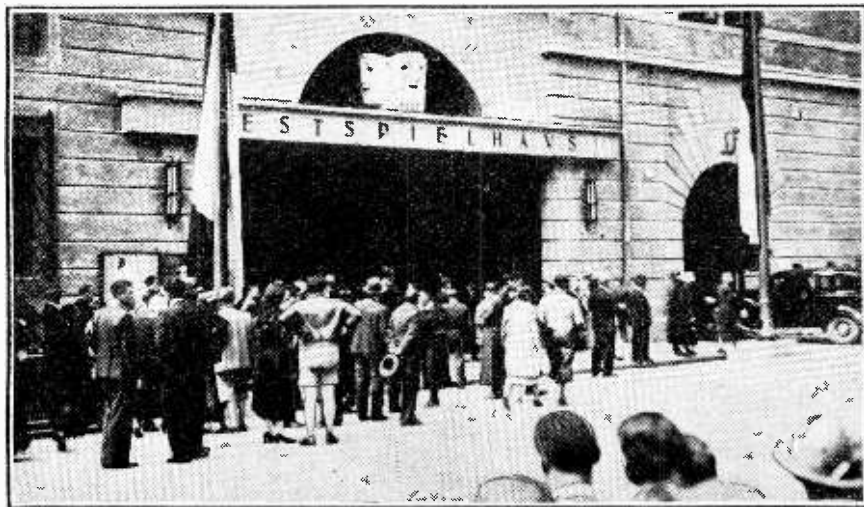

person, but listeners will hear something of the entertainments to which Northern holiday-makers are flocking.

inter-hunt competition. During this broadcast army bands will provide music in the show grounds. Thursday, com-

# Letters to the Editor

## Synchronising Film and Disc

IT is generally accepted that high-quality sound recording on direct play-back blanks is now being obtained regularly by amateur and professional recordists possessing good-class apparatus and sufficient operating experience, and so the experimenter naturally turns his attention to other related unsolved problems, for, like many scientists, the true experimenter tends to lose interest when all the difficulties have been overcome.

One of the remaining problems of great importance is that of synchronising amateur sub-standard films, *i.e.*, 16 mm. or 9.5 mm.,

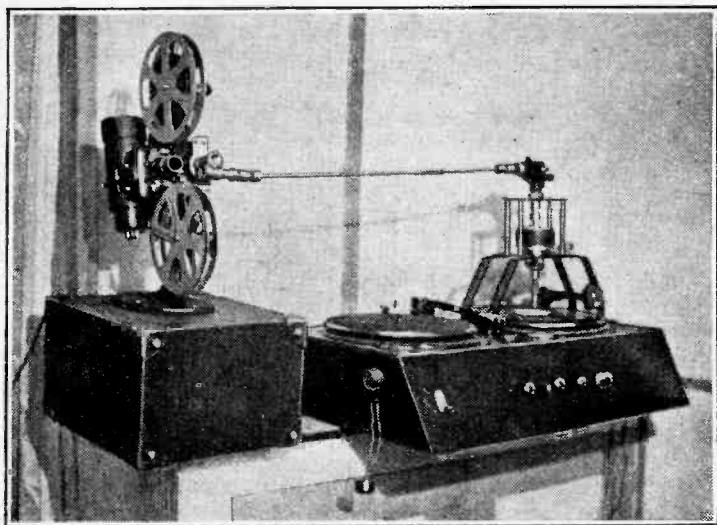

The Editor does not hold himself responsible for the opinions of his correspondents

“lead” or “lag” to be corrected instantly. It may be observed that almost all methods of synchronising consist of flexible shafts (although the projector-to-turntable coupling can with advantage be rigid), *i.e.*, mechanical connections, which, of course, have the disadvantage that free movement of the camera over a large area is restricted, as much more than six feet of shafting is not permissible. The professional method is to employ what is known as “electrical interlock,” which provides exact synchronism and does not necessitate the camera being very near to the recording apparatus. (There is no space available to explain what “electrical interlock” is, and those desiring information should refer to a good technical film book, *e.g.*,

“lead” or “lag” to be corrected instantly. It may be observed that almost all methods of synchronising consist of flexible shafts (although the projector-to-turntable coupling can with advantage be rigid), *i.e.*, mechanical connections, which, of course, have the disadvantage that free movement of the camera over a large area is restricted, as much more than six feet of shafting is not permissible. The professional method is to employ what is known as “electrical interlock,” which provides exact synchronism and does not necessitate the camera being very near to the recording apparatus. (There is no space available to explain what “electrical interlock” is, and those desiring information should refer to a good technical film book, *e.g.*,

A successful method of coupling the home cine projector to sound-on-disc recorder is described in the accompanying letter.

with sound-on-disc recording. (The problems and expense of recording sound on sub-standard film cannot usually be faced by the average amateur, and so will not be discussed, although it may be worth while to mention that RCA has recently released a 16 mm. sound-on-film camera for amateur use at £95, which price compares very favourably with the cost of a professional 35 mm. sound-recording camera, namely, £1,500!)

Many attempts have been made by individual workers and by members of amateur cine societies to produce a cheap and effective synchronising mechanism for recording and play-back on discs, but apparently few have been really successful for little information has been published on the subject.

However, two members of the Eltham Cine Society, Messrs. D. C. Pruden and J. F. Shore, have succeeded in devising a suitable picture-camera-to-sound recorder coupling and synchronising mechanism between projector and play-back turn-table. They have very kindly given me permission to state some particulars of their device. The camera-to-recorder coupling is not the major difficulty, as is often thought, provided a common drive is employed; a powerful recording motor coupled by a 3:2 ratio gear box and an old car speedometer drive to the camera are used in this instance. The outstanding difficulty is the synchronising mechanism between projector and turn-table, and this has been overcome by a special gear box design (epicyclic gears), with a novel feature of “adjustable coupling” which enables, whilst the film is actually running, sound

Lester Cowan's *Recording Sound for Motion Pictures.*)

Here, then, is an opportunity for experimenters to display their ingenuity in developing (1) a simple system of “electrical interlock” for use on time- (frequency) controlled AC mains, or (2) some mechanical method of synchronising.

This letter has been written in the hope that it will stimulate experimenters to make public their efforts in synchronised SOD films, and I feel sure that you will be generous enough to open these columns to short letters giving details of various methods of synchronism. DONALD W. ALDOUS.

Ilford, Essex.

## Straight Set v. Superhet.

I HAVE read with interest the various letters in your recent issues on the above subject, but it seems to me that in many cases the writers have not really grasped the design problem.

First of all, so far as I can see, none of them has referred to the complete difference in design called for in (a) a set designed for home construction and use by the intelligent amateur and (b) one for factory construction and adjustment with elaborate apparatus, but for use by the unskilled.

Second, the crux of the whole design of a quality set at present is to get “top” without interference, and so long as stations are spaced only 9 kc/s apart and we want up to 9 kc/s of audio response this must be the first consideration; as you know, my own opinion is that for this requirement all “band-pass” circuits are fundamentally unsatisfactory.

Replying in particular to the letter of “Nauticus” in the issue of June 25th I do not think his detailed comparison is sound. I have always taken it as an axiom that in a superonic receiver the IF amplifier should provide all the selectivity against “neighbouring” stations in the wave-band, while the RF side looks after “distant” interference such as second-channel, breakthrough of extremely near stations, etc. Consequently, in spite of what I have said above, band-pass circuits may be used in the RF side provided that the band is always quite wide—say 20-25 kc/s overall. In practice there is no serious difficulty in keeping the band-width reasonably constant over the working range.

His point of “drift” in the tuned circuits of the IF amplifier is not one that has given us any serious difficulty at all, though a set using “single-peaked” tuning might be expected to be extra-sensitive to this.

In fact, though I respect the serious thought that “Nauticus” has given to the matter, I am forced by practical experience of designing and selling sets designed for real faithfulness, to disagree with nearly all the points of his design. P. K. TURNER.

Isleworth. Hartley Turner Radio, Ltd.

## Numerical Condenser Symbols

I HAVE not seen any suggestion regarding the graphical indication of condenser values on circuit diagrams, but feel that your readers would welcome such an innovation. My suggestion is that the conventional symbol representing a condenser of any value should be replaced by one drawn in accordance with the system shown in the sketch.

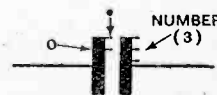

Short lines added to the left-hand element of the conventional symbol indicate the decimal point, while further lines give the number of ciphers. Similar lines added to the right-hand element indicate the number.

- |                 |                       |
|-----------------|-----------------------|
| —  — = 1 mfd    | —  — = 0.001 mfd      |
| —  — = 2 mfd    | —  — = 0.004 mfd      |
| —  — = 0.1 mfd  | —  — = 0.0001 mfd     |
| —  — = 0.2 mfd  | —  — = 0.0005 mfd etc |
| —  — = 0.01 mfd |                       |
| —  — = 0.03 mfd |                       |
- Condenser values by graphical symbols.

The application of the system will be made clear by the accompanying examples. Kidderminster. F. J. CLARKE.

## Are Cheaper Valves Coming?

ARE we going to see at long last a really big reduction in British-made valve prices this year? There are, I think, certain signs that something of the sort may happen. One of them is the announcement of one firm that its new receivers are to be fitted with valves and valve-sockets of the international range. This must mean that unless our own valves are to be substantially cheaper, the replacement market for them will be very considerably narrowed. One would require a very special brand of patriotism to resist the temptation of buying a replacement valve of overseas origin rather than its British counterpart at, perhaps, three times the price.

Barnet. GEOFFREY McNEIL.

# New Apparatus Reviewed

Recent Products  
of the Manufacturers

## WAVEMASTER MICA TRIMMING CONDENSERS

THE Webb Condenser Co., Ltd., 32, Hatton Garden, London, E.C.1, have introduced a new range of miniature mica dielectric trimming condensers with a nominal maximum capacity of 35 m-mfds.

Some are assembled on bakelite plates of very good quality, and the Type 100, as this style is described, is available as single condensers measuring only  $\frac{3}{4}$  in.  $\times$   $\frac{3}{8}$  in., and in banks of two, three, and four separate condensers assembled on a strip of bakelite  $\frac{3}{4}$  in. wide.

The single models are intended to be suspended in the wiring or joined across the soldering lugs on coil formers, and in view of their very small size this method of fixing is very convenient. Holes are provided in the end tags, however, to allow for alternative methods of fixing.

In the case of the multi-bank models there are fixing holes at each end of the bakelite strips.

The majority of the samples tested were actually slightly larger in capacity than the figure quoted, the values obtained varying from 43 m-mfds. to 48 m-mfds. at maximum. Their minimum capacities are very low indeed, being of the order of 1.5 to 2 m-mfds.

Not only are these condensers very well made but high quality material is used throughout, and their prices are most reasonable.

In the bakelite series (Type 100) the single condenser costs only 4d. For the multi-bank types the price is 4d. for each condenser; thus a two-bank costs 8d., a three-bank 1s., and a four-bank 1s. 4d.

There is also another style available, in which the condenser is assembled on a frequentite base. These are described as the Type 101 Postage Stamp Trimmer condensers. In this style, apparently, only single condensers are available, the size and the method of construction being the same

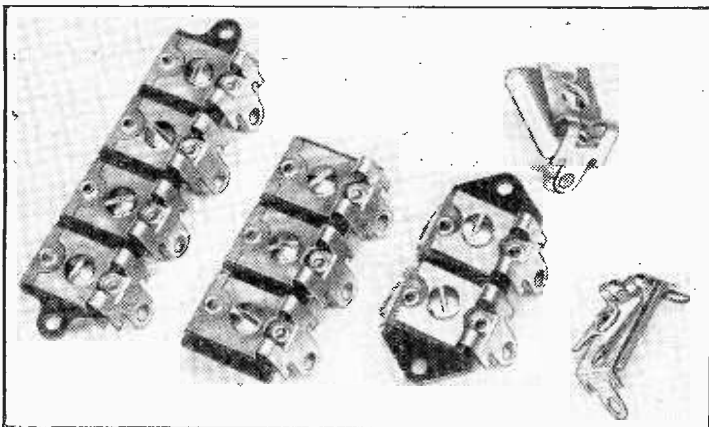

as that of the single model in the 101 series. One sample was tested, its minimum and maximum capacities being 2 and 34.5 m-mfds. respectively. It costs 6d.

## BULGIN VIBRATOR HT SUPPLY EQUIPMENT

THOUGH this vibrator unit was developed primarily to provide the HT for operating car radio receivers, its usefulness is not necessarily restricted to this one function. Experimenters requiring a con-

venient source of HT for a mobile transmitter or receiver might well consider its merits, for it will provide 250 volts at 60 mA after smoothing, and it takes its power from a 6-volt battery.

One of these units was used on a recent occasion for this purpose, and it proved very satisfactory indeed.

From tests made, the overall efficiency is of the order of 50 per cent. when delivering between 40 and 50 mA of DC after smoothing and at a voltage of just over 250. It thus compares very favourably indeed with

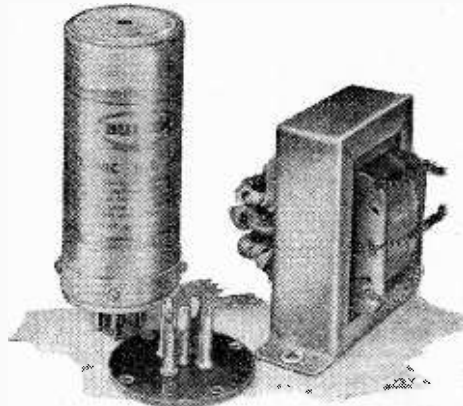

Bulgin "Electronic" HT vibrator generator rectifier Type HTV.1, and the MT.5 transformer.

most other forms of HT supply devices that operate from a low-voltage accumulator.

On light loads the voltage is inclined to rise to high levels; for example, with but 20 mA flowing, 400 volts were obtained; with 40 mA there were 325 volts, and with 60 mA the voltage was 240.

The Bulgin vibrator generator is a self-rectifying device, and the only additional parts needed are the transformer, smoothing choke, and several condensers. A low-resistance smoothing choke was used in order to obtain the high output voltages given, that used being the Bulgin No. F185 of 320 ohms resistance.

This is a 10-henry choke, but for a sensitive receiver more smoothing will be required. However, there are ample volts available, so that a larger inductance can be used even though

Wavemaster miniature trimming condensers; single- and multi-type are shown.

this may require a choke of higher DC resistance.

When taking measurements the Bulgin MT. 5 transformer giving an output of 250 volts was employed, but when lower voltages will suffice, the MT. 2 model can be used, its output being 150 volts (smoothed) at 60 mA. The combined HT vibrator generator and rectifier is described as the Type HTV. 1, and it costs 23s. 4d. The price of the Type MT. 5 transformer is 14s. 7d., and of MT. 2 model 11s. 9d.



# MCCARTHY

## SPECIAL 9-VALVE FOUR-WAVE SUPERHET DE LUXE

The De Luxe Model of this exceptional receiver includes many interesting features, and combines unusual sensitivity with great flexibility of control. Only receivers now on the market at very much higher prices can claim so high a standard of design and performance.

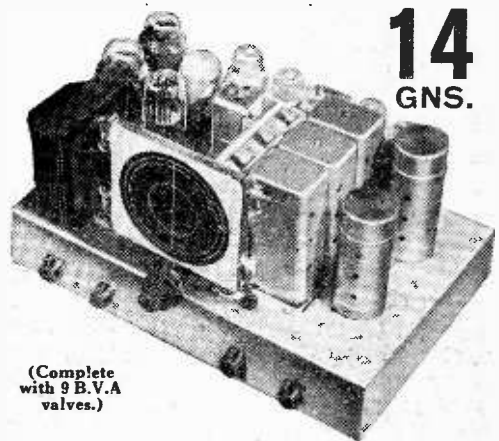

(Complete with 9 B.V.A valves.)

4 wavebands: 12.8-33, 79-80, 190-550, 800-2000 metres. Illuminated dial with principal station names. Separate coloured lights for each waveband.

**Controls.**—A feature of the receiver is the number of independent controls fitted, making it extremely interesting to operate. These include: sensitivity control (varying bias on R/F stage). Q.A.V.C. with manual muting control, and switch for inter-station noise suppression. 5-position wave-change and gramophone switch. Progressive variable tone control operative on radio and gram.

**Circuit in Brief.**—Aerial input to pre-selector circuit, radio frequency amplifier, latest type triode-hexode frequency changer, 2 band-pass I.F.T. coupled I.F. amplifiers, double diode detector, L.F. amplifier and special push-pull pentode output stage. Heavy cadmium-plated steel chassis. Finest components and workmanship throughout.

A.C. models ready for immediate delivery. A.C./D.C. models also in production, and will be available for delivery shortly.

### STANDARD MODEL 12 GNS.

as above, but with triode push-pull output, and fewer controls fitted.

### IMPORTANT

The prices at which McCarthy Chassis are advertised include Marconi Royalties. "Wireless World" readers should, for their own protection, make sure before purchasing any receiver that the quoted price includes the Royalty payment.

All McCarthy receivers supplied complete with valves, knobs, pilot lamps, leads, mains cable and plug. 12 months' guarantee.

Deferred terms on application, or through London Radio Supply Co., 11., Oat Lane, E.C.2.

Cash with order on 7 days' approval. Also write for illustrated catalogue of complete range of all McCarthy receivers.

## MCCARTHY RADIO LTD.

44a, Westbourne Grove, London, W.2

Telephone: Bayswater 3201/2.

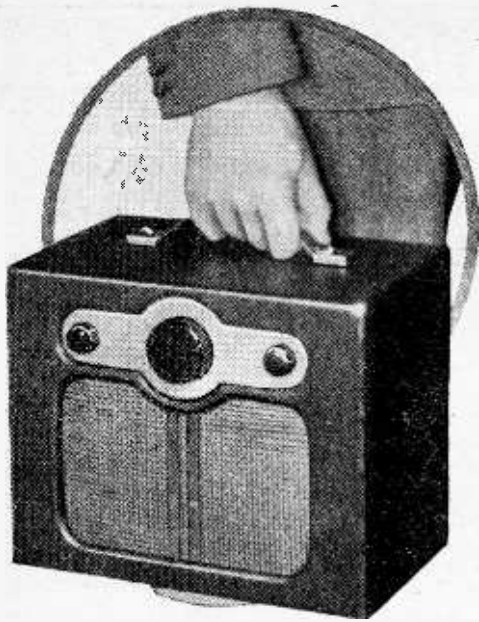

**A**LTHOUGH in general specification the circuit will be familiar to those who have made a comparative study of the various receivers comprising the small portable class, there are one or two differences which ensure that this receiver will not be treated as "just another portable."

Most important of these, in our opinion, is the choice of a Hivac-Harries output tetrode valve in place of the usual battery output pentode. Although the anode current consumption of this valve is appreciably higher than that of the so-called "economy" pentode, there can be little doubt in the mind of anyone who has listened to this set that the increased current results in more than a proportional increase in volume and reduction in harmonic distortion. As the volume control is turned up and the limits of the ordinary portable are passed and left well behind it is difficult to believe that one is not handling a first-class table model battery receiver or even a small mains set. Not only does the reproduction carry "punch," but it has the correct balance for conditions in the open air, and there need be no excuse for breaking up a picnic party to crowd round the loud speaker when an item calling for attentive listening crops up.

### Sensitivity

Guaranteed reception of twenty-five stations is mentioned in the maker's literature, and, judging from the sensitivity, they should have no difficulty in substantiating this claim, though a little care may be required in tuning, say, the last half a dozen required to complete the list. In Central London good programmes were tuned-in without difficulty from Fécamp, Cologne, Paris PTT and Brussels No. 1. The excellent strength of the latter station confirms the impression that the sensitivity is well maintained at the top end of the medium waveband. The same applies to the long-wave range and the volume from Huizen is well above the average. The volume control requires to be turned down

# "Little Princess" Portable

## HIGH UNDISTORTED OUTPUT FROM A PORTABLE OF SMALL DIMENSIONS

on Luxembourg to avoid overloading on the output valve, and all the usual long-wave transmissions are capable of working the set at or very near full volume.

Careful screening of the set as a whole, and in particular of the RF coupling coils, leaves a very clean minimum in the pick-up from the frame aerial, so that its directional properties are of real value as an aid to selectivity when an appreciable angle exists between the directions of the wanted and unwanted stations. Using this method, the Deutschlandsender was successfully received clear of Droitwich, though the effort required in tuning is not one which, in the ordinary way of listening, one would have the necessary energy to indulge in.

A sharp minimum, of course, is not

coupled to the grid detector valve by a tuned anode circuit to which reaction is applied by the usual capacity-controlled circuit. An intermediate bias between + and - LT is provided by the well-known expedient of using two grid leaks, one returned to each of the LT leads. The detector is followed by a first stage of AF amplification using a triode valve. This is resistance-coupled to the detector and transformer-coupled to the output valve, a volume control being provided by a variable resistance across the primary.

### Combined Volume Control

The AF volume control and the reaction control are combined in a single component of rather interesting design. It consists of a solid-dielectric variable condenser in which the fixed vanes occupy a quadrant of 90 degrees. At the back of the condenser and operated by the same spindle is a carbon track resistance with a triple contact brush arm. For nearly three-quarters of the range of the control the reaction condenser is at its minimum, and only the AF volume control is in action. In the last quarter, reaction and AF amplification are increased simultaneously, and the point at which oscillation starts is adjusted to be near the end of the control so that useful gain at low frequency shall not be lost.

The anode circuit of the output valve is provided with a telephone jack and special high-sensitivity headphones are available from the manufacturers for those who may be tempted by the performance of the set to go in for really ambitious long-distance reception.

The cabinet design is neat with the controls fitted on a sunk panel which brings them practically flush with the outside of the case. The long, narrow receiver chassis is mounted close to the

**FEATURES.** *Type.*—Self-contained battery portable. *Circuit.*—Pentode RF amplifier—triode grid detector with reaction—triode first AF amplifier—tetrode output valve. *Controls.*—(1) Tuning. (2) Volume. (3) Waverange and on-off switch. *Price.*—7 guineas. *Makers.*—Peto Scott Electrical Instruments (Holdings) Ltd., Pilot House, Church Street, Stoke Newington N.16.

without its disadvantages, and when in search of distant stations one must keep in mind the approximate bearing of the station to avoid trying to tune it on its minimum. Also, a few degrees of rotation near the position of maximum pick-up may make all the difference between success and failure in receiving a station near the limits of the range of the set. Terminals are provided for the addition of an aerial or earth, but ample variety of fare is provided without calling in their aid.

The pentode RF amplifier which takes the output from the frame aerial is

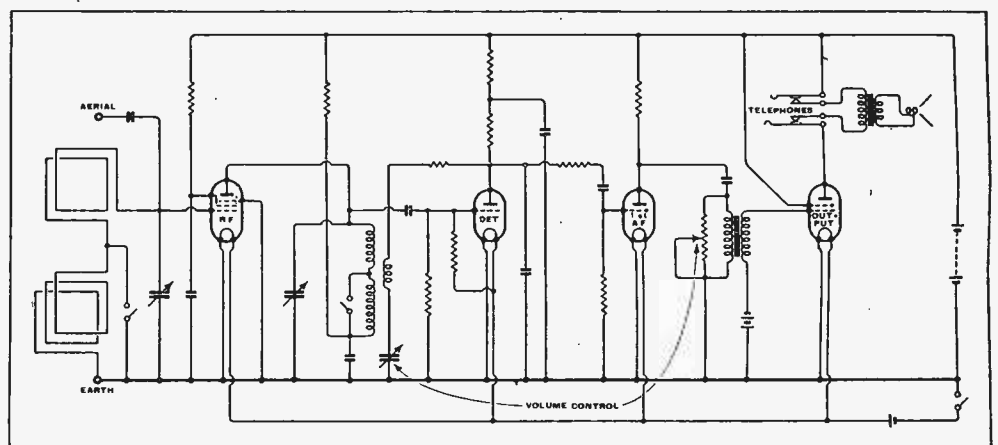

Complete circuit diagram. A Hivac-Harries tetrode is used in the output stage.

"Little Princess" Portable—top of the cabinet, leaving ample space for the 90-volt HT battery and the 17-amp.-hour jelly electrolyte 2-volt accumulator. A total HT current consumption of 6½ mA is mentioned as an average value in the maker's literature, but in the case of the receiver tested the consumption at 90 v. with -3 v. bias was 10.5 mA. At 60 v. with the same bias the current fell to 4.5 mA, but there was a considerable falling-off in the liveliness of the set. On special occasions, when greater volume

they apply to the Corporation for the necessary facilities, which are readily granted. In the case of the Little Bardfield event Mr. Murrow, C.B.S. representative in England, seeing in this little village the possibilities for a broadcast to America, asked the B.B.C. to arrange matters for him. This necessitates the rental of a Post Office line and the supplying of B.B.C. engineers, microphones and transmitting gear at the scene of the broadcast. The transmission is then sent by line to Broadcasting House and thence by line to Rugby, where it is transmitted to America.

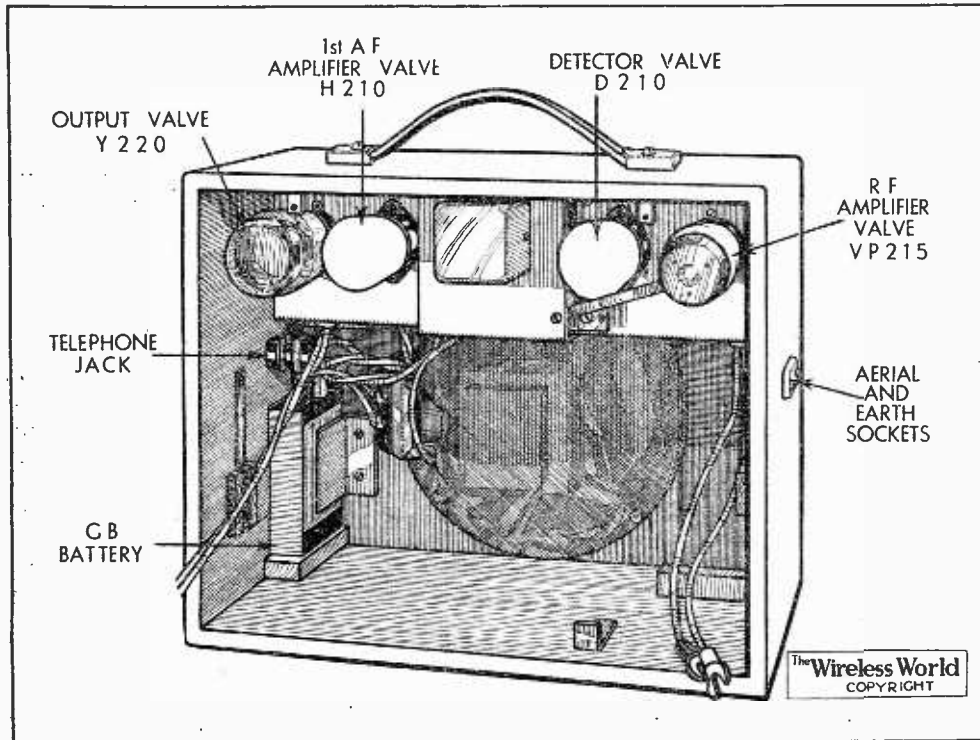

A 7-inch permanent-magnet moving coil loud speaker makes good use of the output from the tetrode valve in the final stage of the circuit. The grid bias battery is a separate unit and should not be overlooked when making replacements.

is required and extra expenditure of HT seems justified, the bias may be reduced to -1.5 v., when a 40 per cent. increase of current may be expected. Incidentally, the measured LT current for the set as a whole was 0.53 amp. The set is of convenient size, and measures only 9½ in. high, 11¼ in. wide and 7½ in. deep. The weight is 18½ lb., and the collapsible carrying handle is well placed from the point of view of balance.

## English—American Broadcasts

### A Reciprocal Arrangement

THE fact that the B.B.C. arranged a broadcast from the Essex village of Little Bardfield for the Columbia Broadcasting System of America and yet did not include the item in their own programmes caused a certain amount of adverse criticism at the time. Upon enquiry at Broadcasting House, it was learned that this broadcast was only one of a number of such transmissions, the arrangement being that if the C.B.S. or N.B.C. wish to broadcast an event taking place in this country, whether it is being broadcast by the B.B.C. or not,

Not only was the fact that the item was not heard by British listeners criticised, but many must have asked who pays for all the arrangements. It is difficult to say why the Programme Department did not avail themselves of the material at hand, but, as to the cost, this is borne entirely by the B.B.C. In the same way, when the B.B.C.'s American representative, Felix Greene, asks the N.B.C. or C.B.S. for facilities to broadcast a special item to England, they are immediately forthcoming with no charge whatever to the B.B.C. It is, however, true that we do not include American items in our programmes to anything like the degree that the Americans do those from the English side, but the arrangement remains, and it may well be that the balance will one day swing over on our side of the scale.

### The Radio Industry

W. Andrew Bryce and Co., Ltd., of North Road, Burnt Oak, Edgware, Middx, sends us a leaflet containing a reprint of an N.P.L. report on the Bryce multiple connector blocks. The connectors withstood voltages up to 5,900 applied between adjacent "ways," while the inserts carried a current of 20 amperes for four hours with a mean temperature rise of only 10 deg. C.

During the annual Philco holidays (July 31st to August 9th) the works will be closed down so far as production is concerned, but new machinery and assembly lines will be installed.

## ACHIEVEMENT



OBSTACLES ARE OVERCOME — THE HEIGHTS ATTAINED — ONLY THROUGH HIGH INTENT. TENACITY OF PURPOSE AND A STEADFAST WILL TO ACHIEVE

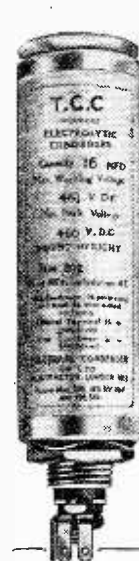

THROUGH more than 28 years T.C.C. have always had but a single goal—the attainment of perfection in the manufacture of condensers. From that original intent—to concentrate on the one product alone, T.C.C. have never deviated. Passing time has brought it problems, demands have varied and T.C.C. have invariably been the first to solve the difficulty. A case in point is the T.C.C. Wet Electrolytics. Introduced to this country by T.C.C. these voltage regulators have played the biggest possible part in making the A.C. Receiver a DEPENDABLE instrument. The inherent SURGE VOLT danger to components has been eliminated. For safety sake—use these T.C.C. Wets in your A.C. Receiver.

### FOUR STANDARD TYPES

Type	Capacity	Continuous Working Volts
802	16 mfd.	440 volts Peak
602	8 mfd.	440 volts Peak
805	8 mfd.	500 volts Peak
809	32 mfd.	320 volts Peak

Special types are available to meet the stringent conditions found in A.C./D.C. Receivers. Write for full details.

# T.C.C.

## SURGE-PROOF WET ELECTROLYTICS

THE TELEGRAPH CONDENSER CO., LTD., WALES FARM ROAD, NORTH ACION, W.3.

# Random Radiations

By  
"DIALLIST"

## Tuning Made Difficult

IN just one or two of the new season's receiving sets that I have handled I notice a defect which calls for immediate remedy. The tuning knob is distinctly stiff and heavy to move, particularly when the "fast" drive is in use. There is nothing that makes tuning more difficult or more unpleasant than a stiff drive. It becomes real hard work to spend half an hour or so with the set in search of foreign stations, and if, as is sometimes the case, the knob itself is small, your fingers can be made quite sore. You should be able to move without effort from one end to the other of any tuning range, and it is especially important for short-wave work that the slow-motion drive should be as light as a feather. If it isn't, you'll keep on jumping past the exact resonance point, and it's the dickins and all to tune-in any rather feeble transmission.

■ ■ ■

## PA Woomphs

FROM a reader who is interested in the making of public-address apparatus I have a letter referring to my recent paragraphs on the poor intelligibility of many of the outfits that one hears. After much experimenting he is in complete agreement with me that not every manufacturer realises the very real need that there is for PA equipment to be provided with a bass cut-off control. He is also of opinion that a good deal of trouble arises from the use of unsuitable microphones. Of course it isn't a bit of good designing a first-rate amplifier if you're going to use it with a microphone whose response is poor to the most important parts of the scale of frequencies from the intelligibility point of view. My correspondent makes another point which is of very great importance. The human element, he says, cannot be overlooked. Many people take it for granted that their microphone voices are everything that they should be and will endeavour to use PA apparatus without any preliminary instruction.

## The Acid Test

This I can bear out from personal experience. Not long ago I was running a gymkhana and a very good PA outfit was hired for the day so that announcements could be made. One man insisted on taking on the job of announcer and airily brushed aside all suggestions that he should have a trial run on the morning before the show started. When he got to work he gabbled so fast and pitched his voice so low that literally only a word here and there could be understood by anyone. He was quite indignant when, as a result of protests, the committee had to substitute a more satisfactory speaker.

I had just written the above when a PA van went slowly past my house. A good deal of noise was coming from the loud speakers on its roof but, honestly, I couldn't make out a word. I gathered that it was advertising some meeting or other, for a car following the van was displaying a selection of posters. But what came from the loud speakers was just noise and nothing more.

## HT Battery Connections

I WAS rather surprised at some criticisms of my remarks about simplifying the HT connections in battery sets which appeared in a recent letter in the correspondence columns of *The Wireless World*. One remark of the writer's about his own set I cannot follow at all. He mentions that by using five HT connections, plus two for GB, he is able to obtain the very last usable volt from his HTB. That's all very well, but he also says that the grid-bias leads are plugged into the GB section of the HTB, and "once they are plugged-in no further adjustment is needed during the whole life of the battery." As it is, or should be, under no load, the GB section of a battery may show almost its full nominal voltage when the rest of the battery, having supplied current for a more or less lengthy period, makes no very good showing on the voltmeter. In other words, the writer is apparently using approximately the same negative biasing voltage on the grids of his low-frequency valves when his HT battery has run down to, say, 80 volts as he was when its EMF was 150 in its first youth.

## Treating 'em all Alike.

One great point about having automatic grid-bias and only two HT connections is that every part of the battery is always under an exactly equal load. To see what this means, take the simple case of a set using a battery with a GB section and having leads for HT- cum GB+, HT+1, HT+2 and GB-. Suppose that HT+1 serves various screening or priming grids and that their circuits require a current of 3 milliamperes, while HT+2 supplies the plate circuits, which draw between them 9 milliamperes. Then the total load on the section of the battery between HT- and HT+1 is 12 milliamperes, that on the section between HT+1 and HT+2, 9 milliamperes, and that on the section between GB+ and GB-, nil.

It follows that with its 33½ per cent. greater load the section between HT- and HT+1 wears out a good deal more rapidly than that between HT+1 and HT+2. The GB section, on the other hand, remains unaffected, save by the effects of "shelf life." With a well-designed voltage divider all parts of the battery run down equally fast, and something like a proper balance between plate, screening-grid and control-grid voltages is maintained automatically. You thus get the "last usable volt" without any trouble.

■ ■ ■

## Marconi

THE writer of practically every obituary notice which has appeared about Marconi has dwelt at length upon the famous "S" signals by which wireless first spanned the Atlantic on December 12th, 1901, but none of them seems to be aware of the reason why Marconi chose this particular letter instead of the more customary "V" which was in almost universal use for test purposes by land-line telegraphists and was later adopted for the same purpose by wireless operators. Indeed, the choice of "S" must seem, on the face of it, to be a singularly unwise one, since a letter consisting solely of dots is far harder to distinguish through atmospheric and background noises generally than one containing dashes, irrespective of whether headphones or a morse inker are employed.

The reason is a simple one but of considerable technical interest. In the great effort to span the Atlantic the Poldhu transmitter was being worked "all out," and there was a very great likelihood of the dielectric of the main condenser breaking down under the strain, thus short-circuiting and burning out the power transformer. Test signals had to be kept up over a period of many days, and it was considered that a series of short signals—or, in other words, dots—would impose far less strain on the condenser than even a few signals of greater



The winner of the 40 metre field-day contest held by the Thames Valley Amateur Radio and Television Society, Mr. A. F. E. Bott (G5VB), is here shown operating his transmitter. On the left, adjusting the receiver, is Mr. L. Cooper (G5LC). Power was limited to 5 watts, supplied from batteries. Scoring was based on points awarded according to the distance covered.

length; hence the choice of a letter containing no dashes.

Comparatively few newspapers seemed to have called to mind the fact that one of the earliest occasions on which the superiority of wireless over the land-line, under adverse meteorological conditions, was dramatically proved occurred as early as 1898. In the winter of that year, when Press telegrams were on the point of being dispatched announcing the arrival of Mr. Gladstone at Bournemouth—a visit paid just before his death—an exceptionally heavy snowstorm brought down all the telegraph and telephone wires in the neighbourhood. The town would have been completely isolated from a telegraphic point of view had it not been for the fact that Marconi was there at the time conducting experiments across the Solent to Totland Bay, and when he got into touch with his colleagues there he found comparatively good weather prevailing, so that the telegraph lines in the Isle of Wight were undamaged.

By a curious coincidence, the death of Marconi occurred on the fortieth anniversary of the founding of the firm which bore his name. When it came into being on July 20th, 1897, it was called the "Wireless Telegraph and Signal Company," the name being changed to Marconi's Wireless Telegraph Company in 1900.

## Television

### New German Standard

THE German authorities have announced their decision to adopt for the future the international television standard for all public television work in Germany. The standard, which has already been accepted in America, is 441 lines, 25 frames, interlaced scanning. It is thought that this standard will soon be followed by France and Britain. The question of mains frequency would, however, have to be taken into consideration.

The new standard of television definition is considered, in Germany, to be the present optimum, and that it will remain so for a long period of years. To further increase the number of lines would bring new and difficult technical problems without much gain in picture quality. At the moment the Berlin television service is still operating on the previous German standard, 180 lines, 25 frames. This will be discontinued shortly after the close of the forthcoming Radio Exhibition. New studio premises for television have already been completed.

It will be remembered that last year Germany seemed to favour the adoption of a 375-line standard. It is thought better, however, to follow the international trend and to increase the number of lines for scanning to the present technical optimum.

441-line pictures by wire and wireless will be a feature of the German Radio Exhibition which opens to-day (July 30th). The new transmitters on the Brocken and on the Feldberg will open with the new number of lines in autumn. Sets are expected to be available at 60-65 Rm.

### Distant Reception Notes

THE whole civilised world was shocked to hear of the death of the Marchese Marconi at the comparatively early age of sixty-three. It was through his genius, his energy and his persistence that wireless

telegraphy came into being and the foundations were laid for broadcasting, which is undoubtedly one of the most important developments in the history of mankind.

DX enthusiasts must look upon him as the founder of their craft, for he was the earliest of all long-distance men. That simple signal received across the Atlantic thirty-six years ago was the first piece of DX work. We who have experienced the thrills of capturing some almost absurdly tiny and distant station can realise something of what he felt when those groups of dots were received; but only something, for to him they meant the triumphant vindication of the inventions upon which he had worked so long and so patiently.

For those who are fond of the more difficult feats of reception, quite a number of out-of-the-way little stations are waiting on the medium-wave band. I don't mean members of big common-wave groups; those that I have in mind are the small fry which either possess individual wavelengths or are to be found working on their own if you try for them at the right times.

At the very top of the band, on 587.1 metres, there is the Estonian Tartu, rated at 0.5 kilowatt. As it has no other station within 8 kilocycles of it, the station should be receivable when conditions are good. I have never yet logged it, but that is possibly due to the fact that there is a good deal of interference in my neighbourhood on wavelengths above about 560 metres.

A tempting little station is the 100-watt Egyptian-Assiout. Nominally it shares a wavelength with Madrid EAJ<sub>2</sub> and Seville (410.4 m.), but the Spanish stations seem to work very irregularly just now. Assiout has, I know, been recorded by several enthusiasts.

Zagreb (0.7 kilowatt, 276.2 metres) used not to be difficult to receive, but I have not heard it for a long time now. It has a wavelength partner in Falun, so that one's only real chance is when the Swedish station closes down early.

Down towards the bottom of the band there are two smallish Hungarian stations, Magyaróver and Miskole, each of which has its own wavelength. Both are rated at 1.25 kilowatts. The former works on 227.1 metres, the latter on 208.6. Miskole I have heard, though Magyaróver has so far escaped my net—at any rate, I have not identified it.

Binche, the Belgian 0.1-kilowatt station on 201.7 metres, is often not difficult to pick up, and the 0.2-kilowatt Karlskrona (Sweden) may be heard on 196 metres if your set will tune down low enough. I am using one just now that goes down to a little below 170 metres, but so far I have not found the Latvian Liepaja, which works on 173 metres and is rated at 100 watts.

There are two much bigger stations which are teasers. One is Belgrade, rated at 2.5 kilowatts, which, working on 437.3 metres, is sandwiched between the 100-kilowatt Sottens and the 120-kilowatt Paris P.T.T. The other is Stara-Zagora, the Bulgarian station on 214 metres, whose rating is 2 kW.

Two wavelength changes are announced from Italy. It has been found that Radio Marconi's 50 kilowatts cannot do themselves justice on 245.5 metres, and the station is to replace Genoa on 304.3. Genoa, which, like Trieste, relays the Turin No. 1 programmes, is to go to 263.2 metres. Turin No. 1, Trieste and Genoa will be synchronised. It is rather interesting that two synchronised groups of three stations apiece will be working on adjacent channels, for the British Nationals on 261.1 metres are next door to the Italians. D. EXER.

# POINTS OF IMPORTANCE

*in the Rola*  
**G.12**

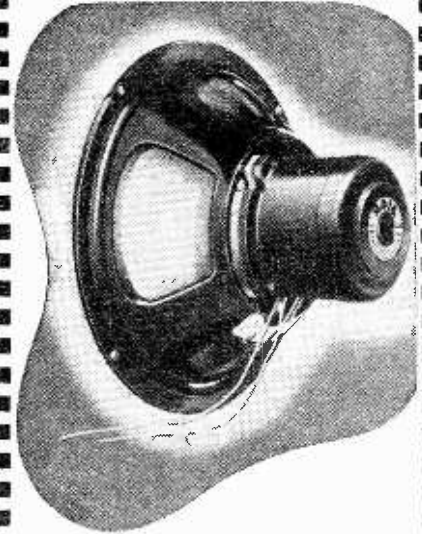

## THE BEST RECEIVERS ARE G.12 EQUIPPED

Glance inside the cabinet of any receiver in the "de Luxe" class and nine times out of ten you will find a Rola G.12. Any manufacturer could tell you the reason. The fact is that the Rola G.12 has achieved such a unique reputation for supreme quality that it pays them to pay the little more that a G.12 costs, and secure the thousands of additional sales that its installation ensures. For this reason the G.12 is in itself a guarantee of the quality of the set in which it is found. Make sure that your set is G.12 equipped and enjoy radio entertainment in its most perfect form.

G.12 D.C. (as illustrated) Stripped and without Transformer	£3 15 0
G.12 D.C. Complete with Transformer, Mounting Stand, Handle and Base	£5 5 0
G.12 D.C. with Mounting Stand, Handle and Base, but without Transformer	£4 16 0
G.12 D.C. Stripped, but with Transformer	£4 4 0
(When ordering please state Field Resistance and Impedance of Transformer required.)	
G.12 P.M. less Transformer	£4 16 0
G.12 P.M. with Transformer	£5 5 0

For Public Address work both the P.M. and Energised Models can be supplied with a 15 ohm Voice Coil at an additional charge of 3/-.

Write for Folder A.

OVER 8 MILLION IN USE

# ROLA

*The World's Finest Reproducers*

**THE BRITISH ROLA CO., LTD.**  
MINERVA ROAD, PARK ROYAL, N.W. 10.  
PHONE WILLES DEN 4322-3-4-5-6.

# Recent Inventions

## SHORT-WAVE AERIALS

IT is desirable to keep the total impedance of a short-wave transmitting aerial, over a range of frequencies, substantially equal to the resistance of the aerial at the carrier frequency to which it is tuned.

With this object the main feed-line C, O is coupled to the aerial A, A<sub>1</sub> through a "dummy" line consisting of a centre conductor D and an outer sheath D<sub>1</sub>. The centre conductor C of the feed line is connected to the outer sheath

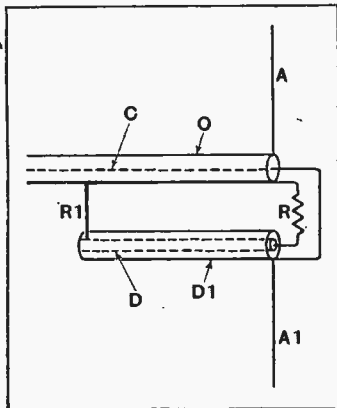

Feeder and coupling system to broaden response of a dipole aerial.

D<sub>1</sub> of the "dummy," and vice versa, whilst reciprocal connections are made at R and R<sub>1</sub>. The upper and lower limbs A, A<sub>1</sub> of the aerial are directly joined to the two outer sheaths. The arrange-

**Brief descriptions of the more interesting radio devices and improvements issued as patents will be included in this section.**

down to the so-called zero frequency, which represents the "average illumination" of the transmitted picture.

To do this the incoming signals are first passed through a pair of valves in order to suppress the DC or zero-frequency component. At the same time a modulating frequency is applied so as to produce pulses of recurrent peaks and crests in the output. The DC component is afterwards restored by rectifying the pulses, and the effect of the deliberately-introduced modulation is removed by suitable filter-circuits. Alternatively, the pulses may be arranged to occur at relatively unimportant times, e.g., when the margins of the picture are being scanned.

*Baird Television, Ltd. and P. W. Willans. Application date October 23rd, 1935. No. 464979.*

## TIME-BASE CIRCUITS

SAW - TOOTHED oscillations, suitable for scanning in television, are derived from a screen-grid or pentode valve in which back-coupling between the screening grid and the anode is utilised to improve the shape of the waveform, and in particular to shorten the "fly-back" or idle stroke.

Oscillations from a previous back-coupled valve are applied to the grid of a triode V, and are

way as to shorten the fly-back period.

*Ferranti, Ltd. and J. C. Wilson. Application date October 29th, 1935. No. 464141.*

## DIRECTION FINDING

THE so-called "night effect" in direction-finding is due to a rotation of the plane of polarisation of the transmitted wave, as it is reflected from the Heaviside layer, and tends to mask the true direction of the transmitting beacon.

According to the invention, the disturbing effect, as manifested in the frame aerial F, is offset by the pick-up voltage from a horizontal dipole aerial D, both voltages being combined in a circuit C, which is coupled to the receiver. The currents in the two aerials are brought into correct relation, before being combined, by means of a phasing resistance R inserted either in the frame aerial, as

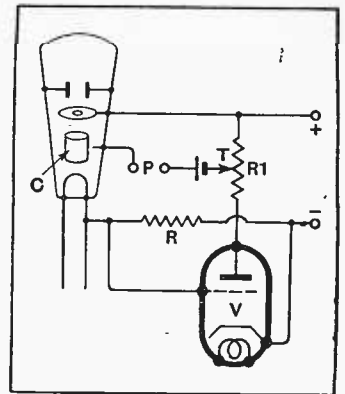

Method of applying regeneration to a CR tube.

stance R<sub>1</sub> in the anode circuit of that valve, from which they are fed back by a tapping T to the control grid of the CR tube.

The degree of feed-back is controlled by a suitable choice of the resistance R and the tapping point T. Because of the resistance coupling the feed-back voltage is kept in phase with the original signals. The method is applicable over a wide range of frequencies, and requires no special or auxiliary electrode in the cathode-ray tube.

*E. Michaelis. Convention date (Germany) June 22nd, 1935. No. 464064.*

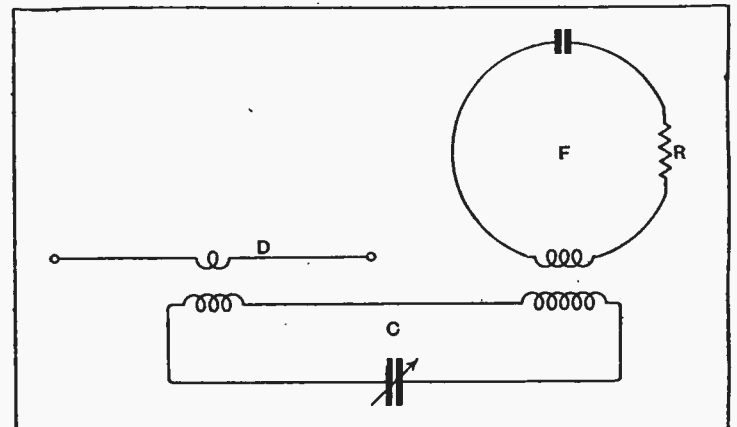

Combination of frame and dipole aerials to counteract "night effect."

shown, or in the dipole. When the arrangement is used for waves of 100 metres or more, both aerials should be located at least one-third times the square root of the working wavelength above ground.

*Telefunken ges für drahtlose Telegraphie m.b.h. Convention date (Germany) August 7th, 1935. No. 464075.*

## APPLYING REACTION TO A CR TUBE

THE sensitivity of a cathode-ray tube is increased by means of the regenerative circuit shown in the figure. Picture signals applied at P to the control electrode C produce voltages across the cathode resistance R. These are fed to the grid of an auxiliary valve V, and reappear across a re-

## AERIALS FOR AIRCRAFT

AN aerial suitable for use on an aeroplane consists of a length of wire which is normally wound up on a spring reel enclosed in a suitable housing. To bring the aerial into use, the wire is pulled out against the spring of the roller, until a button near the end of the wire can be slipped into a bayonet slot. This locks it in the extended position. When no longer required, the button is withdrawn from the slots, and the extended wire is then automatically rewound by the spring of the roller. A second wire, similarly arranged, can be used as a counter-

*K. Schuchter. Convention date (Austria) September 12th, 1935. No. 464769.*

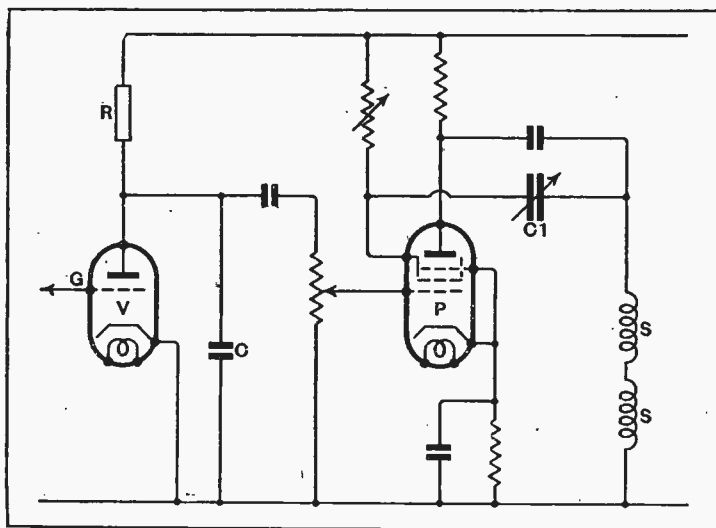

Method of shortening the fly-back stroke in a saw-toothed oscillation generator.

ment is particularly suitable for the transmission of television signals.

*A. D. Blumlein; E. C. Cork; and J. L. Pawsey. Application dates October 19th, 1935 and July 10th, 1936. No. 464443.*

## TELEVISION AMPLIFIERS

IN a television receiver it is necessary to amplify a wide band of frequencies, extending

used to time the discharge of a condenser C, which is recharged through a suitable resistance R, such as a saturated diode.

The resulting imperfect impulses are fed to the grid of the pentode P and produce scanning voltages across the coils S. The anode is back-coupled to the screening grid through a condenser C<sub>1</sub>, whereby the impulses are made to react on their own generation in such a

The British abstracts published here are prepared with the permission of the Controller of H.M. Stationery Office, from Specifications obtainable at the Patent Office, 25, Southampton Buildings, London, W.C.2, price 1/- each. A selection of patents issued in U.S.A. is also included.



# HIGH QUALITY

at a  
**LOW PRICE**



**DUPLEX HORN P.A. LOUD-SPEAKER**  
**£4. 10**

Power handling capacity 12 watts Peak A.C. Speech Coil Impedance 15 ohms. Length of horn 2 ft. 10 in. Width of horn 2 ft. 11 in. Finish: Battleship grey.

GOODMANS Duplex Horn P.A. Loudspeaker is extremely efficient, yet low in price. Tests have proved that the performance of this speaker is superior to other Projector type P.A. Loudspeakers of much higher price.

**Unsolicited Testimonials from Users:—**

"We find that the two Duplex Speakers will take all that my 28 watt amplifier can give. Actually we tried ONE speaker on alone and gave it full volume. Your claim that this speaker will handle 13 watts is therefore only 'Half a truth.' I shall scrap my other speakers and substitute yours."

"We have just had the opportunity of trying out the Duplex

Loudspeaker, and we must congratulate you on a very excellent job—especially at the very moderate price. We enclose cheque and would ask you to forward another Duplex at your very earliest.

"We are extremely pleased with the results, and shall be glad if you will deliver two of these speakers at the earliest possible date. In the near future we hope to place a further order with you."

"I am very pleased with the Duplex Horn P.A. Loudspeaker received from you just before the Coronation, and think it excellent value for money. Please send me another of these splendid Loudspeakers before Saturday next.

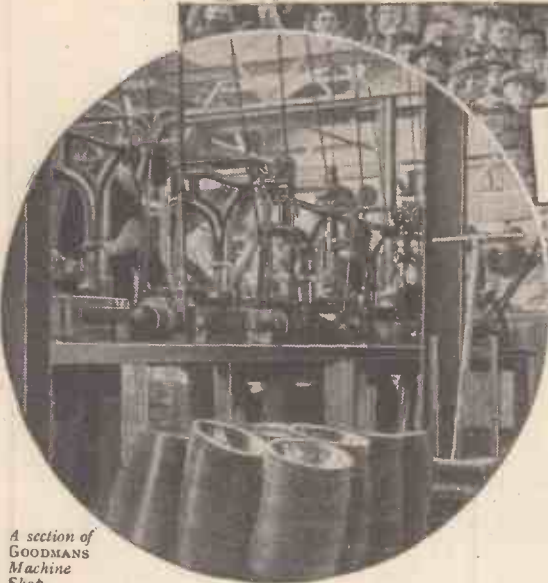

A section of GOODMANS Machine Shop.

**POST this COUPON**

Please send leaflet describing Duplex Horn P.A. Loudspeaker, also literature describing High Fidelity Auditorium Loudspeakers.

GOODMANS INDUSTRIES, LTD., Lancelot Rd., Wembley, Middx.

Name.....  
Address.....

## GOODMANS

### DUPLEX HORN P.A. SPEAKER

GOODMANS INDUSTRIES, LTD., LANCELOT ROAD, WEMBLEY, MIDDX.  
Telephone: Wembley 4001 (5 lines).



57

## ERIE RESISTORS

Specified exclusively for the WIRELESS WORLD TELEVISION RECEIVER

The stability of resistors is even more important in Television than in radio. For in Television a faulty resistance means visual as well as sound distortion. Hence, the 'Wireless World' specified Eries. A special impregnation process gives them unrivalled stability. Hand Tested. Guaranteed. Colour coded. All values - - 1/- per watt.

Write for Erie Colour Code Chart with helpful technical data.  
**RADIO RESISTOR CO., LTD.**  
1, Golden Square, Piccadilly, London, W.1.

## AMERICAN SET OWNERS INSIST ON

THE WORLD'S STANDARD VALVE



The Standard Valve for Standard Sets  
**FOR RELIABLE CONSISTENT PERFORMANCE**

UNIVERSAL RADIO DISTRIBUTORS, LTD.  
24, FITZROY SQUARE, LONDON, W.1.

## A COMPLETE LIST OF

# CLIX

### SPECIFICATIONS FOR THE "TELEVISION RECEIVER"

For the Vision Receiver and Power Pack constructors will require the following:

- CLIX VALVEHOLDERS**  
(V.1) Standard Type:  
Four 4-pin .. 5d. each.  
One 5-pin .. 6d.  
(V.2) Five 7-pin .. 9d. each.

**CLIX SOCKET STRIP**  
With terminals and engraved, A.1, A.2, & E. 7d.

- For the Time Base you will require:  
**CLIX VALVEHOLDERS**  
(V.1) Standard Type:  
Six 5-pin .. 6d. each.  
Fitted with plate as used in Type V.2.

For the High Voltage Unit and Sound Receiver Pack you need the following:

- CLIX VALVEHOLDERS**  
(V.1) Standard Type:  
Four 4-pin .. 5d. each.  
One 5-pin .. 6d.

TAKE THIS LIST TO YOUR DEALER.

BRITISH MECHANICAL PRODUCTIONS LTD.  
**CLIX**  
79a, ROCHESTER ROW, LONDON, S.W.1

# MISCELLANEOUS ADVERTISEMENTS

## NOTICES

THE CHARGE FOR ADVERTISEMENTS in these columns is

12 words or less, 3/- and 3d. for every additional word.

Each paragraph is charged separately and name and address must be counted.

**SERIES DISCOUNTS** are allowed to Trade Advertisers as follows on orders for consecutive insertions, provided a contract is placed in advance, and in the absence of fresh instructions the entire "copy" is repeated from the previous issue: 13 consecutive insertions 5%; 26 consecutive, 10%; 52 consecutive, 15%.

**ADVERTISEMENTS** for these columns are accepted up to **FIRST POST ON MONDAY MORNING** (previous to date of issue) at the Head Offices of "The Wireless World," Dorset House, Stamford Street, London, S.E.1, or on **SATURDAY MORNING** at the Branch Offices, 19, Hertford Street, Coventry; Guildhall Buildings, Navigation Street, Birmingham, 2; 280, Deansgate, Manchester, 3; 26a, Renfield Street, Glasgow, C.2.

Advertisements that arrive too late for a particular issue will automatically be inserted in the following issue unless accompanied by instructions to the contrary. All advertisements in this section must be strictly prepaid.

The proprietors retain the right to refuse or withdraw advertisements at their discretion.

Postal Orders and Cheques sent in payment for advertisements should be made payable to **ILIFFE & SONS Ltd.**, and crossed **& Co.** Notes being untraceable if lost in transit should not be sent as remittances.

All letters relating to advertisements should quote the number which is printed at the end of each advertisement and the date of the issue in which it appeared.

The proprietors are not responsible for clerical or printers' errors, although every care is taken to avoid mistakes.

## IMPORTANT NOTICE.

Owing to the August Bank Holiday, the next issue of "THE WIRELESS WORLD" (dated August 6th) is closing for press earlier than usual.

In accordance with the Notice that appeared last week, the latest date upon which Miscellaneous Advertisements could be accepted for the above issue was **FIRST POST, FRIDAY, July 30th.**

## NEW RECEIVERS AND AMPLIFIERS

**A. DEGALLIER'S, Ltd.**, the leading firm for reliable, fully guaranteed short wave radio, have without exception the largest selection on view in their new London showroom; callers are invited to handle these receivers at their leisure, without any obligation to purchase; all sets are brand new in sealed cartons and are guaranteed to get the Americas, etc., on the low bands; following are a few examples only of the wonderful value Degallier's are offering: a 4-valve T.R.F. Midget, in walnut or fabric, for A.C. or A.C./D.C., 200-250 volts, at £3 5s.; a 7-valve superhet all-wave covering from 15-2,000 metres, complete in cabinet, for £9 9s., or the same model, using 8 valves, in A.C./D.C., at £9/19/6; the famous 8-valve Challenger table model, with 4 wavebands, covering from 12-2,000 metres, including 10 in M.C. speaker, at 13 gns.; in handsome Console, with Rola G12 speaker, 17 gns., or as a radiogram, with auto changer, 29 gns.; a 9-valve chassis G12 speaker, 5 wavebands, for £12; this goes on right up to a 24-valve twin chassis with 2 speakers at £50; why not visit the showrooms or send 2d. in stamps for a beautifully illustrated catalogue; any American valve at 5/- each; to enable customers to come and see for themselves, until September 15th Degallier's will allow up to £1 towards expenses on production of return half of railway ticket or garage account, to all purchasers of goods at 13 gns. or over; to those ordering by post a spare set of valves gratis.

**NOTE** New Address: Degallier's, Ltd., 32, Bathurst Mews, Paddington, London, W.2. 'Phone: Paddington 2745 and Bayswater 5732. [4839]

**A LERT RADIO Co.**

"COMMUNICATION." "Shortwave" and "Allwave" Receivers.—21, East Rd., N.1. Clerkenwell 4871. [4381]

"SERVICE with a Smile."

**HENRY FORD RADIO, Ltd.**

**ELECTRONIC House**, 22, Howland St., Tottenham Court Rd., W.1. Museum 5675. [0511]

**ROYAL RADIO Co.**, 5, Buckingham Rd., E.18.—Send for catalogue of all the latest short wave receivers and car radio. [4741]



## HOLIDAYS

We have had ours—our staff had to be complete again by now, to be ready for the autumn rush.

And what a pity that rush is!

Our five main lines for the winter season are all out already—the M.A. receivers, the S.A. receivers, G.A. 12S amplifiers, P.M. speakers and Duode-luxe speakers. When we have new lines ready, we announce them at once, irrespective of season.

Yet we know that many customers who might order now will wait: they will order all at once in a month or two's time; and then they will be displeased at delay in delivery!

Why not order NOW?

Don't forget we keep **OPEN HOUSE** for demonstration every **WEDNESDAY**—even through the summer.

## HARTLEY TURNER RADIO LTD.

THORNBURY ROAD, ISLEWORTH, MIDDLESEX.

Telephone: HOUnslow 4488

## IT WAS IN JUNE 1935

that "The Wireless World" said:—  
Specimens tested have been found to be particularly smooth and noiseless in action.

**RELIANCE ARE SPECIFIED FOR THE TELEVISION RECEIVER.** You will need

**RELIANCE POTENTIOMETERS. TYPE "T.W."** Wire-wound. Linear. 10,000, 1,000 and 2,000 ohms ... 4/6 each.

**TYPE "S.G."** Composition. Linear. 50,000 ohms and 2 megohms ... 4/9 each.

**RELIANCE VARIABLE RESISTANCES.**

**TYPE "8.Q."** Composition Linear. 150,000 ohms and 0.5 megohm, 4/9 each.

Reliance are Reliable, and consistently specified by Leading Technical Journals.

Write for Folder "W.W." Free.



THE PRODUCT OF SPECIALISED RESEARCH

**RELIANCE MANUFACTURING CO. (SOUTHWARK) LTD.**  
WESTBURY ROAD, LONDON, E.17



## ENGINEERING OPPORTUNITIES

This unique Handbook shows the easy way to secure A.M.I.C.E., A.M.I.Mech.E., A.M.I.E.E., A.M.I.A.E., A.M.I.W.T., A.M.I.R.E., and similar qualifications.

**WE GUARANTEE—"NO PASS—NO FEE."**

Details are given of over 150 Diploma Courses in all branches of Civil, Mech., Elec., Motor, Aero, Radio and Television Engineering, Building, Government Employment, etc. Write for this enlightening Handbook to-day FREE and post free.

British Institute of Engineering Technology, 387, Shakespeare House, 17, 18, Stratford Pl., W.1.

## NUMBERED ADDRESSES

For the convenience of private advertisers, letters may be addressed to numbers at "The Wireless World" Office. When this is desired, the sum of 6d. to defray the cost of registration and to cover postage on replies must be added to the advertisement charge, which must include the words Box 000, c/o "The Wireless World." All replies should be addressed to the Box number shown in the advertisement, c/o "The Wireless World," Dorset House, Stamford Street, London, S.E.1. Readers who reply to Box No. advertisements are warned against sending remittance through the post except in registered envelopes; in all such cases the use of the Deposit System is recommended, and the envelope should be clearly marked "Deposit Department."

## DEPOSIT SYSTEM

Readers who hesitate to send money to advertisers in these columns may deal in perfect safety by availing themselves of our Deposit System. If the money be deposited with "The Wireless World," both parties are advised of its receipt.

The time allowed for decision is three days, counting from receipt of goods, after which period, if buyer decides not to retain goods, they must be returned to sender. If a sale is effected, buyer instructs us to remit amount to seller, but if not, seller instructs us to return amount to depositor. Carriage is paid by the buyer, but in the event of no sale, and subject to there being no different arrangement between buyer and seller, each pays carriage one way. The seller takes the risk of loss or damage in transit, for which we take no responsibility. For all transactions up to £10, a deposit fee of 1/- is charged; on transactions over £10 and under £50, the fee is 2/6; over £50, 5/-. All deposit matters are dealt with at Dorset House, Stamford Street, London, S.E.1, and cheques and money orders should be made payable to Iliffe & Sons Limited.

**SPECIAL NOTE.**—Readers who reply to advertisements and receive no answer to their enquiries are requested to regard the silence as an indication that the goods advertised have already been disposed of. Advertisers often receive so many enquiries that it is quite impossible to reply to each one by post. When sending remittances direct to an advertiser, stamp for return should also be included for use in the event of the application proving unsuccessful.

## NEW RECEIVERS AND AMPLIFIERS

**ANGLO-AMERICAN RADIO** Offer the Easiest Purchasing Facilities, and your last opportunity to own one of the finest radio receivers ever made, the genuine 5-band 10-watt Crosley at £11/19/6.

**H.P.**, part exchange, and a 50% saving on the superb Crosley receivers; there will be no better receiver available in this country at under three times the price during the next 12 months.

**30** Only Left Now. We offer you every advantage and every inducement to purchase now; a large cash saving, and your own choice of the method of payment.

**PLEASE** Note, we offer only brand new goods, every chassis or receiver fully guaranteed 6 months; every receiver accurately checked and aligned on all bands with the latest equipment before despatch; please remember we offer you only goods which will give you lasting satisfaction, and as such unquestionably the finest value that radio has to offer; do not confuse with second-hand, soiled, "job bought," or improperly tested receivers, which are being cleared out at any price by other sources; please note all cabinets supplied by us are copyright by no other firm.

**10% or 20%** With Order to Suit Your Convenience Secures Delivery, with undertaking to remit balance over 12 or 18 months.

**AMAZING** Signal to Noise Ratio is the Keynote to the Phenomenal All-world Reception; there is scarcely a transmission in the world that the 5-band Crosley will not bring in; Mr. Ivor Manley, writing in "The Wireless World" a few weeks back on Spanish broadcasting in the civil war, compiled his article using only one of our Crosley receivers; over 100 transmissions tuned in from Spain alone! Yes, your new guaranteed Crosley bought from us will do the same, and get you everything on the air.

**24/-** With Order or £11/19/6 Cash.—9-valve high fidelity 5-band (12½-31, 30-80, 75-200, 200-555, 700-2,000 metres), A.C., 97-250 volts, 10 watts undistorted output, R.F. stage all bands, new automatic variable selectivity incorporated, provision grammo, and doublet, accurately calibrated airplane dial and band-spread pointer and subsidiary scale, shadow tuning indicator; your price £11/19/6 or with American Magnavox speaker, £14; Table model, £17; Console, £19; Auto-Radiogram, £34; or small deposit as above with order secures delivery.

**CARRIAGE** Extra: Chassis 5/-. Table 7/-. Console 10/-. radiogram 15/-.

**BOOK** Your Crosley Now Whilst Last Stocks Remain; cash, c.o.d., or small deposit (see above) secures now. We guarantee your satisfaction.

**13/6** With Order to £6/14/6 Cash.—8-valve all-wave AC/DC Superhet, 16-2, 100 metres, new 5½ in. multi-indication airplane dial, full A.V.C., wonderful all-wave performance; those on D.C. mains will never regret acquiring this outstanding receiver; chassis £6/14/6, with speaker £7/6/6; table model £7/19/6 (list 14 gns.), or deposit secures now; terms as above.

This advertisement continued on next page.)

NEW RECEIVERS AND AMPLIFIERS

(This advertisement continued from previous page.)

**22/-** With Order or 10½ Gns. Cash.—De Luxe new 17 gn. model 6-valve Car Radio receiver, R.F. stage, 3-4 watts output, extreme sensitivity and magnificent performance, easily fitted to any car; full instructions; distributor suppressor only used; illuminated remote control; a superb instrument at a bargain price direct from importers; order now; cash, c.o.d. or 22/- first payment secures now, balance over 12 or 18 months as required.

**TWO** Unprecedented Bargains Offered at Fraction of Usual Value, order now (post 1/-).

**50/-**—Multi-band (7-2,000 metres) Junior Communications outfit, for battery operation, 8in. speaker, metal shivel cabinet, 7in. band-spread dial, short-wave, station names and listening times marked, also includes headphones and world rotating globe; complete outfit with 8-page instruction booklet, cash or c.o.d. 50/- or 5/- with order and 12 monthly payments of 4/6.

**21/-**—Superheterodyne short-wave converter, 7-200 metres, 5in. dial with band-spread, operates in front of any superhet or H.F. receiver, mains or battery, complete with valves and black shivel finished cabinets, aerial tested and guaranteed; cash or c.o.d.

**4D** Stamps.—Send to-day for our comprehensive radio catalogue, covers every radio requirement, at the lowest cash and deferred terms prices in the country; a complete radio buying guide.

**EXTENSIVE** New Showrooms Now Opened Centrally at Albion House; all communications and all callers please note address as below.

**NEAREST** Stations: Tottenham Court Rd. (100 yds.), Holborn (2 minutes), Central London, Edgware and Piccadilly lines. Hours: 9.0-6.30, Saturday 1.30 p.m.

**IF** You Cannot Call, order through the post with confidence; we specialise in postal orders, and have served customers all over the British Isles; you are assured of a square deal and satisfaction.

**ANGLO-AMERICAN RADIO (AND MOTORS), Ltd.** (Dept. W:28), Albion House, New Oxford St., London, W.C.1. Telephone: Temple Bar 3231. [4851]

**TRANS-ATLANTIC RADIO Co.** for Finest All-wave Receivers, Midgets and valves.—15, Percy St., W.1. Museum 3096. [4623]

**CAR** Radios, 6 and 12 volt, top aerial and accessories; all-wave A.C./D.C., Midgets, etc.; wholesale only.—**A.D.E.E. RADIO**, 9, Cosdach Ave., Wallington, Surrey. [4819]

**ARMSTRONG COMPANY**, Pioneer Firm supplying high grade all-British receivers in chassis form, manufacture models to suit all requirements, incorporating all the latest improvements.

**ARMSTRONG COMPANY** Invite You to Send for Full Particulars.

**ARMSTRONG MANUFACTURING COMPANY**, 100, King's Rd., Camden Town, N.W.1. [4615]

**COMMUNICATION** Receivers, Hammarlund, National, Hallicrafters, R.M.E.69, Tobe-Deutschmann; transmitters, Collins 45A, Peerless DX20, or built to order; American valves, microphones. Eddystone components.—**A.C.S., Ltd.**, 52-4, Widmore Rd., Bromley. Phone: Ravensbourne 0156. [0550]

RECEIVERS AND AMPLIFIERS CLEARANCE, SURPLUS, ETC.

**ALL** Lines Previously Advertised Still Available.

**HENRY'S**, 72, Wellington Ave., N.15. Stamford Hill 2907. [4791]

**PEERLESS** Chassis, 18 watts, 11 valves, 12½ speaker, 5 bands; 10 gns.—**Kay**, 21, Prince of Wales Rd., Norwich. [4704]

PUBLIC ADDRESS EQUIPMENT

**A** **CUSTOMER** Writes re our 20-watt Amplifier:—

"I am Amazed at the Quality and Power Output, which appears to be quite, if not more than, you claim. I have been in the P.A. line since 1927, and have never heard anything to compare with it.—A. Anderson."

**12-VOLT** D.C. or 200-250 A.C. input, combined model consumes only 7 amps. at 12 volts with 20 watts output; chassis complete with valves and converter; 12 gns.

**VENTILATED** Steel case, 12/6 extra.

**20-WATT** Model for 200-250 A.C. Only 8½ gns; case, 10/6 extra; 4 input model, 1½ gns. extra.

**HEAVY** Duty 20 Watt Model, as fitted to dance halls and cinemas, etc.; £15. complete with valves.

**ALL** Above have Outputs for 4, 7½, and 15 ohm speakers and independent mike and pick-up inputs.

**ROLA** Speakers, Piezo pick-ups, Reslo microphones in stock.

**HAVE** a Demonstration Without Obligation.

**VORTEXION, Ltd.**, 182, The Broadway, Wimbledon, S.W.19. Phone: Lib. 2814. [4783]

**ALL** Types of Public Address Apparatus for Sale or Hire.

**WARD**, 46, Farringdon St., London, E.C.4. Tel.: Holborn 9703. [0555]

**RASCO P.A.** Mobiles, large or small, with driver operator.—18w, Brixton Rd., S.W.9. Reliance 1693. [0558]

**MICROPHONES**—Jenkins Adaire condenser microphone, 59/6; Siemens ribbon microphone, 7 gns.—G2LP, 152, Elgar Av., Tolworth, Surbiton. [4833]

**PARTRIDGE P.A.** Manual, re Standard Handbook; free to trade from: N. Partridge, B.Sc., A.M.I.E.E., King's Buildings, Dean Stanley St., London, S.W.1. [4524]

No. 49

Notes on the Suppression of Electrical Interference with Wireless Reception

WHAT YOU CAN EXPECT FROM THE LAW

There is an interesting B.B.C. handbook on "Receiving Aerials and Electrical Interference" which gives the result of an International survey which was carried out on existing receiving aerials and sources of interference in various countries. The result shows that aerials are on the whole so poor and are so closely coupled to electric wiring that to achieve the low level of interference envisaged by the B.B.C. handbook, suppressors on appliances would have to be so elaborate that in many cases they would cost almost as much as the appliance, and be unreasonably bulky. It is obvious that there must be a compromise, and listeners must improve their aerials so that they will enjoy relief if electrical machines are suppressed to a level which can be obtained in most cases at reasonable cost.

There are still a large number of broadcast listeners who take umbrage at the mere suggestion that they should do anything to suppress electrical interference with their listening. With the progress of civilisation it becomes increasingly evident that one must pay for its amenities. We have to pay towards the cleaning of the streets even if we ourselves do not scatter the litter, and we shall have to pay towards radio free from crackling even though we do nothing to create the crackles. But it should be—and will be—illegal for anyone to run an electrical appliance capable of producing more than a predetermined level of interference. As this level is determined by the sensitivity of the receiver, a man with an expensive sensitive set will have to do more at his end to obtain tolerable reception, than the man with the cheap set. He might have to use an anti-interference aerial and probably "mains filtration, whereas the man with the small set, content with local broadcasts, will probably get away with the necessity of a reasonably efficient outdoor aerial. Legislation is not providing for the man who wants to listen to foreign programmes, and whose who so desire will have to fit anti-interference aerials or mains filters, or both.

† The "Eliminoise" (Trade Mark) anti-interference aerial, efficient on all broadcast bands, 10-2,000 metres ... 35/-  
Screened Cable, extra, per yard ... 10d.  
\* Set Lead Suppressor (mains filter, type 300) ... 21/-  
Technical book on "Interference Suppression" 72 pages with diagrams, etc. Post free, 1/2. Also free publications, "Wireless Without Crackle," "The Eliminoise System," etc.



Belling & Lee Ltd.  
Cambridge Arterial Road, Enfield, Middx.

CAR RADIO

**AUTO RADIO**—Newest models, best makes, supplied at keenest prices; correctly fitted for optimum performance; first class service and repair to any make, whether bought from us or not, at very reasonable charges.—Wireless Supplies Unlimited, 278-280-282, High St., Stratford, E.15. [4831]

**LATEST** American Type Top Car Aerials; streamlined for beauty, engineered for 100% efficiency; positively better signal strength, more stations, less fading, higher signal-to-noise ratio; quickly fitted without drilling roof, elegant form and finish enhance car's appearance; for saloons, fixed or sunshine, 22/6, complete; also under-running-board model, best of their kind, completely rubber covered, easily fixed, 22/6 pair; top-car type better, of course; every dealer, service station, doing good business with this line; more than selling aerials, it sells radios; are you in on it? If not, come and see quickly.—Wireless Supplies Unlimited, Distributors, 278-280-282, High St., Stratford, E.15. [4832]

USED SETS FOR SALE AND WANTED

G.E.C.

**G.E.C.** A.C. Overseas Short Wave 6, teak cabinet, 3 wavebands, perfect order, nearest £5/10.—Alred, 838, Manchester Road, Bradford. [4828]

R.G.D.

**R.G.D.** 6 valve chassis with Mazda valves. All O.K. from £85. Radiogram First £25 genuine speaker for above Heavy Rola Auditorium. Listed £12 when purchased, £3.—137, Grange Rd., Kings Heath. [4829]

NATIONAL

**NATIONAL F.B.X.A.**, as new, four sets coils, speaker and power pack complete; £18 or offer.—Box 2849, c/o The Wireless World. [4845]

WIRELESS WORLD P.A. AMPLIFIER

"**WIRELESS WORLD**" 12 Watt P.A. Amplifier and Feeder Unit, list brand new parts as specified by author, drilled chassis; all valves, blue prints, never been opened, £10; Epoch speaker for above, Domino model type, 1C1½, brand new, £4.—Box 2836, c/o The Wireless World. [4837]

EXCHANGE OR WANTED

**WANTED**, clearance, surplus, or good used car radios.—Anchor Motor Company, The Newgate, Chester. [4827]

NEW MAINS EQUIPMENT

**V.** ALL Transformers as Last Week's Prices.  
**VORTEXION, Ltd.**, 182, The Broadway, Wimbledon, London, S.W.19. (Telephone: Liberty 2814.) [4820]  
**TANTALUM** for A.C. Chargers, H.T. and L.T.—Blackwell's Metallurgical Works, Ltd., Garston, Liverpool. [3984]

CABINETS

**RADIOGRAM** Cabinets, new designs, 30/- to £5/10; inspection invited or photos for selection sent on request.  
**TABLE** Radio Cabinets, undrilled, 6/6 upwards.  
**SPEAKER** Cabinets, 4/6 upwards.  
**MANUFACTURERS'** Clearance.  
**ULTRA** Radiogram Cabinets, undrilled, 33x23x14 or 33x20x15, 30/-.  
**BURGOYNE "Fury"** Radiogram Cabinets (undrilled), 34x22x16½; 49/6.  
**K.B. De Luxe** Walnut Cabinets, undrilled, chromium plated edges and speaker grille, 25in. wide, 14½in. high, 10½in. deep, 18/6; Console model, 42in. high, 21½in. wide, 11½in. deep, 39/6.  
**HALYCON** Radiogram Cabinets (Reconditioned), 33x23x19; 35/-.  
**H.L. SMITH** and Co., Ltd., 287-9, Edgware Rd., London, W.2. Tel.: Pad. 5891. [0485]

VALVES

**A** **NDERSON**.  
**A** **ERICAN** Valves, all makes, first grade only; 5/- each.  
**A** **NDERSON**, 35, Lansdowne Rd., Walthamstow, E.17. Walthamstow 0827. [3551]  
**B** **IGGER** and Better Value in American Valves.  
**3/-** Any Popula; Type; 6/- each 210, 250 and 81. variety of Octal Base Tubes, 3/- to 4/-.  
**A** **LL** Types Transmitting Tubes in Stock; Majestic and Spartan types, 4/6 each.  
**R** **ADIOGRAPHIC, Ltd.**, 66, Osborne St., Glasgow, C.1. Bell 848. [4816]  
**2/3**—American valves, 2A5, 2A7, 89, and all popular types; 6L6G, 3/9; guaranteed; lists.—Northwest Sales, 2, Willoughby Rd., Liverpool, 22. [4843]  
**A** **ERICAN** Valves, first grade, in all types; trade supplied.—Metropolitan Radio Service Co., 1021, Finchley Rd., N.W.11. Speedwell 3000. [0436]  
**A** **LL** Types of American Valves in Stock of Raytheon, A. Sylvania, and Arcturus makes, at competitive prices, guaranteed for six months; send for full list: 350 ohms line cords, 2/8.  
**W** **ARD**, 46, Farringdon St., London, E.C.4. Tel.: Holborn 9703. [0452]

**DYNAMOS, MOTORS, ETC.**

ALL Types of Rotary Converters in Stock, new and second-hand.

WARD, 46, Farringdon St., London, E.C.4. Telephone: Holborn 9703. [0518]

A.C.-D.C. 1- and 3-phase Motors, all voltages; from 14/9; list free. Repair specialists.—Easco, 18w, Brixton Rd., S.W.9. [0455]

**NEW LOUD-SPEAKERS**

BAKER'S Super Quality Triple Speaker.

IDEAL for Use with Quality Amplifiers; A.O. model, £8/15; D.C. model, £7/7; leaflet "Loud Speaker Tailoring" free on request.

BAKER'S Conversions.

THE Next Best Thing to a Baker Super Quality Triple Speaker is a Triple Cone Conversion Assembly; whether your moving coil speaker has a permanent or electro-magnet and no matter what type or make you possess, you can considerably improve frequency response and quality of reproduction by having a triple cone assembly fitted, which comprises main curved cone and dual bakelite and duralumin cones combined, mounted in a 12in. die-cast aluminium frame.

THE Price is 29/6 Complete, including free fitting at our works; there is a special triple cone assembly for owners of Baker's super power speaker, price 25/-, including coil.

BAKER'S Quality Surplus Speakers.

IF You are Requiring Quality Reproduction at Low Cost order one of the following brand new bargain speakers now. The Auditorium models are fitted with latest triple cone comprising main curved cone and bakelite and duralumin cones combined, giving wide and even frequency response, resulting in quality reproduction of speech and music. The Coronation surplus horn models are ideal for reproduction of transients.

39/6 Only, usual price £5.—Auditorium Permanent Magnet Speaker with Alni magnet and die cast frame, large 12in. triple cone giving wide frequency range, complete with large 25 ratio transformer suitable for all outputs, including push-pull and Class B, etc.

59/6 Only, usual price £6.—Auditorium Electro-Magnet Speaker, 1,000, 1,250, 2,000 or 2,500 ohms field, exceptionally large magnet of high permeability steel giving enormous flux density, 2in. moving coil, large triple cone giving wide frequency range, complete with universal transformer, the ideal speaker for use with "Wireless World" and other quality amplifiers.

75/- Only, usual price £9.—As above, but for use on A.C. mains; complete with Westinghouse rectifier and full smoothing equipment.

49/6 Only, usual price £6.—Coronation Surplus Horn Permanent Magnet Moving Coil Speakers, suitable for domestic or public address; the horn is of moderate size and the speaker is therefore ideal for home use where good reproduction of transients is required; can be used separately or in conjunction with baffle board speakers.

15/6 Only.—Permanent Magnet Speaker. Alni magnet, 8in. cone, Universal transformer.

12/6 Only.—Permanent Magnet Speaker as above with 7in. cone.

2/9 Only.—Brand new cabinets, 12x10x6.

8/6 Only.—Electro-Magnet Speakers, with 8in. cone, 6,500 ohms field, Universal transformer.

ALL Baker Quality Surplus Speakers are Sold for Cash or c.o.d.

BAKER'S SELHURST RADIO. Ltd. The Pioneer Manufacturers of Moving Coil Speakers, 1925-1937.—75-77, Sussex Rd., South Croydon. (Croydon 3441.) [4790]

VAUXHALL.—Loudspeakers, 1938 range, now available; details see new list.—Vauxhall Utilities, 163a, Strand. Temple Bar 9338. [4609]

**LOUD-SPEAKERS**

SECOND-HAND, CLEARANCE, SURPLUS, ETC.

HARTLEY-TURNER Twin Diaphragm, 1,250 ohm field with push-pull transformer; £4/4.—Darnton, Sissinghurst Court, Cranbrook. [4852]

**METERS, ETC.**

AVOMINOR D.C. in case, 25/-, perfect order.—Sutton, Wong, Horncastle, Lincs. [4835]

UNIVERSAL 36 Range Avometer, 8 gns.; Avo oscillator, 3 gns.—Darnton, Sissinghurst Court, Cranbrook. [4853]

FERRANTI Meters, 150 moving coil single and triple range, new boxed discontinued types; 10/- to 17/6 each.—Farnell, 12, Heaton Park Rd., Bradford. [4806]

**TESTING EQUIPMENT**

WESTON Analyser, with various adaptors and manual for disposal, £8/10.—Box 2851, c/o The Wireless World. [4840]

**NEW COMPONENTS**

RAYTHEON Valves, all American components; trade. R.—Zelco, Ltd., 53, Farringdon Rd., E.C.1. [0499]

**COMPONENTS**

SECOND-HAND, CLEARANCE, SURPLUS, ETC.

SPECIAL Summer Sale Now Proceeding at Our Holborn Premises.

ALL Lines Previously Advertised Still in Stock.

RADIO CLEARANCE, 63, High Holborn, W.C.1. Holborn 4631. [4818]

In our opinion no space is wasted in any advertisement if it brings us YOUR enquiry.

**SOUND SALES LTD.**

manufacturers of high grade Quality Amplifiers, Custom Built Radio, Transformers, Chokes and Loudspeakers. Contractors to the War Office, Air Ministry, G.P.O., etc. MARLBOROUGH ROAD UPPER HOLLOWAY LONDON, N.19 Archway 1661 (3 lines)

**ONE WEEK ONLY!**  
**DO NOT BE LATE**

You may miss the bargain of a lifetime.

The Radio Development Co. wish to dispose of a number of end of season lines to make way for coming stocks.

These end of season bargains consist of LOUDSPEAKERS of all types and sizes, both P.M. and energised,

SHORT WAVE COMPONENTS of every description. All goods are brand new at prices far below cost. Definitely limited quantities. Cannot be repeated at prices offered.

CALL AT ALDWYCH HOUSE and inspect these bargains or send a stamped addressed envelope for lists.

An opportunity not to be missed

**RADIO DEVELOPMENT CO.**

(Props.: Epoch Reproducers Ltd.) Aldwych House, Aldwych, London, W.C.2 Tel.: Holborn 9111

**JULY 30th.-AUGUST 7th.**  
**ONLY**

**COMPONENTS—SECOND-HAND, CLEARANCE, SURPLUS, ETC.**

PREMIER SUPPLY STORES.

PLEASE See Our Displayed Advertisement on Page 5. [0488]

RYALL'S RADIO, 280, High Holborn, London, W.C.1. offer new goods at knock out prices.

AMPLIFIERS.—7 watt A.C. outputs, pair triodes in push-pull coupled correct type Varley transformer. 3-stage, for 200-250v. A.C., good chassis, complete with 6v. and Rola G.12 speaker, £7; transverse mike on plated stand, 25/-.

BI Electrolytics, 12x8 ml., 350v., 1/6; NSF 25x26v., 6 3/-; NSF tubular bag ends, 0.15, non-inductive, 2/6 dozen.

PAIRS Ferranti Screened Coils, 2/6; Ferranti aerial coils, 6 3/6; Ferranti 3-range coils, 1/3; with circuits, chassis types.

FERRANTI Mains Transformers, as used in their commercial sets. 350-0-350v., 70 m.a., 4v. 4-5a. C.T., 4v. 2 1/2a. input, 200/250v., brand new; 6/6. [4748]

VAUXHALL.—Standard 1938 components; details, see new free list.—Vauxhall Utilities, 163a, Strand. Temple Bar 9338. [4610]

WARD.—For unparalleled bargains in set manufacturers' surplus; all goods are guaranteed unused and perfect; immediate delivery.

BRITISH Radiophone Condensers, fully screened, super-het; or straight type, 3-gang and 2-gang; 7/6.

CENTRALAB Resistances, 1-watt type, 6d.; 2-watt type, 1/2; 3-watt type, 1/9; B.I.C. 8mf and 4mf. 550 volts peak electrolytic condensers, 3/3.

3,000 Brand New Wearite 110 kc. Pre-tune I.F. Transformers, type O.T.1, O.T.2 and O.T.2F.; 1/6 each, or offer for quantity.

40 mfd. and 24 mfd. 200 Volts Peak Electrolytic Condensers; 3/-.

CLIX Chassis Type Valve Holders, 4- or 5-pin, 6d.; 7- or 9-pin, 6d.; R.C.A. American valve holders, 4-, 5-, 6- or 7-pin, 9d.

ASSORTED 1-gross Parcels of 1-watt and 1/2-watt Resistances by N.F.S.; 12/-.

MARCONI Model 25 Pick-ups; 25/-.

CONVERSION Units for Converting D.C. Receivers to A.C. Mains operation up to 110 watts, improved full-wave type; £2/10.

WESTINGHOUSE Rectifiers, L.T.4 or L.T.5, with mains transformer and variable resistance, 22/6; Varley D.P.4 output transformers, 1-1 and 25-1, 9/-.

MAINS Transformers, 350-0-350v. 60 m.a., 4v. 3 amps., 4v. 25 amps., 12/-; 425-0-425v. 120 m.a., 4v. 1 amp., 4v. 1 amp., 4v. 7 amp., 4v. 25 amp. for "W.W." Quality Amplifier, 26/-; L.T. transformers with two 4v. 3a. C.T. windings or 2.5v. 8a., 5v. 2.5a., 8/6.

VOLUME Controls, with or without switch, by Rotor-ohm, Erie, Electrad, and other good makers, any value, 2/6; steel chassis, "Wireless World" Quality Amplifier, 8/6; Partridge 32-watt amplifier, 11/-.

WE Stock All Parts for "Wireless World" Quality Amplifier, Quality Amplifier Receiver, Imperial Short Wave Six, 1936 Monodial Q.A. Super, All-wave Super Seven, etc.

WE Can Supply Correct Equivalents for Any British Type of Valve, including side-contact Universals, H.F. pentodes, double diode triodes, 3-5 watt output pentodes, 500v. indirectly heated rectifiers, octodes, double diodes, single diode tetrodes, etc., at an appreciably lower price.

PHILLIPS Amplifiers with 400v. triode in output stage; £2, complete.

BAKERS Super Power Speakers; £2/5.

"CORPACT" Capacity Operated Window Signs; £5.

CARRIAGE Paid, cash with order or c.o.d.; send for list.

WARD, 46, Farringdon St., London, E.C.4. Tel.: Holborn 9703. [0450]

MAINS RADIO DEVELOPMENT CO.'s Astounding Bargains.—Carriage paid; call mornings; phone: Tudor 4046; stamp for list 20s.

N.S.F. 1/2 and 1 watt Carbon Resistors, twelve good sizes, well assorted, marked values; 50 for 3/6; unrepeatable offer.

CLEARANCE of Mica Tag Condensers, 20 assorted of six good sizes; from 0.0002-0.005 mfd.; 1/- while stocks last.

TUBULAR Condensers.—Brand new, wire ends, finest make, 400 volt working, 0.0001-0.002 mfd., 2d.; 0.005, 0.01, 0.02, 0.05, 0.1 mfd., 4d.; 0.25, 0.5 mfd., 6d.

CLIX Latest Chassis Valve Holders, unused, 4-pin, 1 1/4d.; 5-pin, 2 1/4d.; 7-pin, 4d.; three-valve grey cellulosed metal chassis, 12 1/2 x 6 1/2 x 3in., 1/-.

RESISTORS.—Absolutely finest make, one watt, colour coded wire ends, unused, any size 50 ohms to 5 megohms, 3 1/2d. each, 2/9 a dozen; your choice; two watt, any size, 6d.

B.I.C. Unused Dry Electrolytics, 8+8 mfd., 500 volt. 3/-; 8 mfd. 550 volt, metal can, 2/3.

KNOBS.—Black, octagonal bakelite, 1 1/4in. diameter, quarter inch spindle, beautiful appearance; 2 1/2d. each.

FERRANTI Twin H.F. Choke Mains Interference Filter Units. Must be cleared, 1/- Extraordinarily effective.

MAINS RADIO DEVELOPMENT CO., 4-6, Muswell Hill Rd., London, N.6. [4774]

STANDARD RADIO SUPPLIES.—Definitely lowest prices in country on Europa, Hivac, valves, speakers, gramophone motors, Telsen coils; send for list.—1, Dantzic St., Manchester. [4752]

COMPONENTS—SECOND-HAND,  
CLEARANCE, SURPLUS, ETC.

**OLIVERS** Offer Garrard Record Changer Units, 200-250v., 40-60 cycles A.C., plays eight 10in. or 12in. records, complete with super pick-up, rejection switch, unit plate 14in. x 16in., highly polished bronze, etc.; £5/10.

**ROLA** G.12 Speakers, stripped but complete with transformer for push-pull, triode or pentode, 2,500 ohms and 1,250 ohms field; £2/19.

**SPEAKER** Transformers, 3/-, types power and pentode; class "B." push-pull L.F. transformers, 3/6, types class "B." Q.P.P., 1-4 straight; transformers of any type supplied to special order; re-winding a speciality, write for quotations.

**RESIN** Core Solder, 1d. per foot; insulating sleeving, 1 and 1½ mm., 1½d. yard; 12 yards, 1/2; 2 mm., 2d. yard; 12 yards, 1/4; assorted colours, best quality.

**CARDBOARD** Case Electrolytics, B.I., T.C.C., Hunt's, 8 mfd., 1/9; 4 mfd., 1/6; 50 mfd., 50v., 1/6; 8 mfd. +4 mfd., 2/5; 8 mfd. +8 mfd., 2/9; 4 mfd. +4 mfd., 2/-; 4 mfd. +4 mfd. +4 mfd., 3/-; 1 mfd., 1/-; 25 mfd., 25v., 1/-; 50 mfd., 12v., 1/1.

**ALUMINIUM** Chassis, 16in. x 10in. x 3in., 18 gauge undrilled, 5/3; 16 gauge drilled, 7/6; other sizes pro rata.

**FERRANTI** A.C./D.C. Receiver Twin Mains Filter Coils, on base, 6d.; dial lamp holder and bracket, 1½d.

**OLIVERS**, 676, Christchurch Rd., Boscombe, Hants. Enquiries invited. Quotations and lists free. Orders under 5/6 postage extra, c.o.d. extra. [4847

TRANSMITTING APPARATUS

**G5N1**—The recognised distributors for amateur equipment, National, R.M.E., Thordarson, Hammarlund, McMurda, Hallicrafters, etc.; send 1½d. stamp for catalogue.—G5N1 (Birmingham), Ltd., 44, Holloway Head, Birmingham. [0531

MISCELLANEOUS

**CHEAP** Printing.—1,000 billheads, 3/6; sample free.—Creteway Press, 18, Buxted, Sussex. [4825

**AMPMETER**, hot wire, ½ amp., 7/6, postage 3d.; Wheelstone bridges, 17 plugs, new, 20/-, postage 9d.—Beaton's Stores, 63, Chalk Farm Rd., N.W.1. [4842

**VACANCIES** occur for Thirty Men, aged 18-23, in the Post Office Eng. Dept.; experience is not required, but applicants must be willing to study technical subjects; commencing pay £3/15, rising to £7 per week and upwards, with pension.—For full particulars apply B.I.E.T. (Dept. 574), 17, Stratford Place, W.1. [4716

EXTENDED PAYMENTS

**LONDON RADIO SUPPLY** Co. (Established 1925). supply on convenient terms, components, accessories and sets, any make, 10% down, balance over 12 months; send for list of requirements.—11, Oat Lane, London, E.C.2. [0337

**HIRE-PURCHASE**—Prompt delivery of any radio apparatus on convenient terms.  
**WARD**, 46, Farringdon St., London, E.C.4. Tel.: Holborn, 9703. [0539

EXCHANGE

**I** BUY, sell, exchange good quality receivers, accessories, components; H.P. facilities; promptness, efficiency.—Bostock, 1, Westbourne Terrace, S.E.23. Forest Hill 2236. [0529

PATENTS

**BRITISH** Patent No. 407704.—Device for converting or translating acoustic energy into electric energy and vice versa.

**THE** Proprietor of the Above British Patent is Desirous of Arranging, by way of licence or otherwise, for the working of the invention on a commercial scale in this and Francis, Chartered Patent Agents, 88-90, Chancery country.—For particulars write to Stanley, Popplewell Lane, London, W.C.2. [4850

**"PRACTICAL** Hints on Patents," free on application.—The Imperial Patent Service, First Avenue House, High Holborn, W.C.1. Preliminary consultation free. [0481

TUITION

**RADIO** Training.—Marine, aircraft, broadcast; prospectus free.—Hull Municipal Technical College. [0523

**RADIO** Engineering.—Theory and practice thoroughly taught by postal course; 350 positions obtained for students in four years; recognised as a training institution by radio manufacturers; also instruction at college.—Apply British Radio Engineering College, 173, Clapham Rd., London, S.W.9. (Brixton 3487.) [4722

WANTED

**WANTED**, test oscillator, cheap.—Box 2848, c/o The Wireless World. [4844

**WANTED**, amplifier or public address outfit; state make and price.—Box 2835, c/o The Wireless World. [4836

**WE** Buy for Cash All Types of Modern Second-hand Radio Sets and Accessories, test meters, parts, etc.; we pay more than any other dealer; part exchanges; bring, send, or will call.—University Radio, Ltd., 82, Hampstead Rd., London, N.W.1. Phone: Euston 3810. [4749

# PREMIER SUPPLY STORES

Offer the following Set Manufacturers' Brand New Surplus Goods at a Fraction of the Original Cost; all goods guaranteed perfect; carr. paid over 5/-; under 5/- postage 6d. extra. Orders under 5/- cannot be sent C.O.D.

ALL POST ORDERS TO  
**JUBILEE WORKS,**

**167, LOWER CLAPTON RD., LONDON, E.5**

Phone: Amherst 4723

CALLERS, AS USUAL, TO 50, HIGH STREET, GLAPHAM, S.W.4 (Macaulay 2381).

And 165 & 165a, FLEET ST., E.C.4 (Next door to Anderton's Hotel). Central 2833.

Have you had our **GIANT ILLUSTRATED CATALOGUE AND VALVE LIST**? Send 4d. in STAMPS FOR THIS BARGAIN LIST.

The New "Premier" **SHORT-WAVE CONDENSERS** with Trolit insulation; certified superior to Ceramic; all-brass construction, 15 mmd., 1/4; 40 mmd., 1/7; 100 mmd., 1/10; 160 mmd., 250 mmd., 2/6.

Self-powered A.C./D.C. 10-watt 40-metre C.W. 3-Tube TRANSMITTER, Pentode Crystal Oscillator, with meter, tubes, crystal (please state frequency required) and enclosed holder, with key, ready for immediate use, £4 4s.

**SHORT-WAVE COILS**, 4- and 6-pin types, 13-26, 22-47, 41-94, 78-170 metres, 1/9 each, with circuit. Special set of 3-4-Pin S.W. Coils, 14-150 metres, 4/- set, with circuit. Premier 4-pin 3-band S.W. Coil, 11-25, 19-43, 38-86 metres. Suitable any type circuit, 2/6. **COIL FORMERS**, in finest plastic material, 1½in. low-loss ribbed, 4- or 6-pin, 1/- each.

**SPECIAL OFFER. LISSÉN TWO-GANG SCREENED ALL-WAVE COILS**, 12 to 2,000 metres, complete with switching and wiring diagram, 6/11 per set.

**MILLIAMMETERS**, moving-iron, flush 2½in., all ranges from 0-10 m.a., 5/9. Visual tuning, 6 or 12 m.a., 5/9. Moving-coil meters, 2½in. 0-1 m.a., 18 6; 3½in. 0-1 m.a., 22/6. Multipliers, 1/- each. Ammeters, 0-1, 3, 5, 10 or 20 a., 5/9.

**COSMOCORD PICK-UPS**, with tonearm and volume control, 10/6 each. **PICK-UP HEADS** only, 4/6 each.

**NEW 1937 1-VALVE SHORT-WAVE RECEIVER OR ADAPTOR KIT**, 13 to 86 metres without coil changing. Complete Kit and Circuit, 12/6. **VALVE GIVEN FREE!**

**DE LUXE MODEL**, 14 to 150 metres, complete Kit with Chassis, 4 Coils and all parts, 17/6.  
**1937 SUPERHET CONVERTER KIT**, 13/6.

**DE LUXE MODEL**, 18/6  
**S.W. SUPERNET CONVERTER**, for A.C. Mains Receivers. 20/-. A.C. Valve given FREE!

**NEW 1937 2-VALVE S.W. KIT**, 13 to 86 metres without coil changing. Complete Kit and Circuit, 19/6. **VALVES GIVEN FREE!**

**DE LUXE MODEL**, 14 to 150 metres, complete Kit and Chassis, 4 Coils and all parts, 25/-.  
**VALVES GIVEN FREE!** Metal Cabinet 10/6 extra.

**CERAMIC S.W. VALVE HOLDERS**, 4-, 5- or 7-pin. Chassis types, 6d.; B.B. type, 8d. **GLASS ARIEL INSULATORS**, 4d. each. **BEEHIVE STAND-OFF**, 6d. each. **SCREENED FLEX**, single, 3d. yd.; twin, 4d. yd.

**H.F. CHOKES**, S.W., 10-200 metres, 9d.; Screened, 1/6.  
**ALL-BRASS SLOW-MOTION S.W. CONDENSERS**, .00015 tuning, 3/9; .00015 reaction, 3/3. British Radiophone 2-gang 2X .00010 all-brass S.W. Condensers, 5/8.

**SPECIAL OFFER. Ferranti All-Wave Receivers. "Parva" All-Wave A.C.4 (list 9 gns.) £6.6.0. "Nova" All-Wave A.C. Superhet (list 12 gns.) £8.15.0.** All brand new in sealed cartons. Full Guarantee.

**MAINS VALVES**, famous Europa 4 v. A.C. types, 4/6 each. H.L., L. S.G., Var.-Mu-S.G., H.F.-Pens., Var.-Mu-H.F. Pens., 1, 3 and 4-watt A.C. directly heated output Pentodes A.C./D.C. types. 20-volt .18 amp. S.G., Var.-Mu-S.G., H. H.L., Power.

Following types all 5/6 each. Full-wave rectifiers, 350 v. 120 m.a. and 500 v. 120 m.a. 2½ watt indirectly-heated Pentodes, Octode, Frequency Changers.

**BATTERY VALVES**, 2 volts, H.F., L.F., 2/3. Power, Super-Power, 2/9. S.G., Var.-Mu-S.G., 4- or 5-pin Pentodes, H.F. Pens., V.-Mu-H.F. Pens., 5/- Class B, 3/6.

**AMERICAN VALVES**. Genuine American HYTRON and TRIAD first-grade Valves, 3 months' guarantee. All types in stock, 5/6 each. 210 and 250, 8/6 each. New Metal-Glass Valves, all types, 6/6 each. Genuine American DUOTRON Valves, all types, 3/6 each. Valve holders for all above types, 6d. each. Octal bases, 9d. each.

**PREMIER HIGH-FIDELITY P.A. AMPLIFIER KITS**, 3-WATT A.C. 2-stage AMPLIFIER for Mike or Pick-up. Complete Kit of Parts with 3 valves, 40/-.

**7-WATT A.C./D.C. 3-stage AMPLIFIER**. High-Gain. Push-Pull output. Complete Kit of Parts with 5 matched valves, 24 4s.

**10-WATT A.C. 3-stage AMPLIFIER** incorporating Phase-Inversion and Push-Pull Triodes. Enormous gain and straight line reproduction. Complete Kit of Parts, including 5 matched valves, 25 5s.

**ELIMINATOR KITS** for A.C. Mains. 120 v. 20 m.a., or 150 v. 25 m.a., 18/-, tapped S.G. det. and output. Complete Kit with long-life valve rectifier (replacement cost only 2/-)

**PREMIER MAINS TRANSFORMERS**, wire-end type with screened primaries, tapped 200-250v. Centre-tapped Filaments. Guaranteed one year. H.T. 8 & 9 or H.T. 10 with 4 v. 4 a. C.T. and 4 v. 1 a. C.T., 8/6. 250-250 v. 60 m.a., or 300-300 v. 60 m.a., 4 v. 1 a., 4 v. 2 a. and 4 v. 4 a., all C.T., 8/6. 350-350 v. 120 m.a., 4 v. 1 a., 4 v. 2 a. and 4 v. 4 a., all C.T., 11/-.

Any of these transformers with engraved panel and N.P. terminals, 1/6 extra. 500-500 v. 150 m.a., 4 v. 2-3 a., 4 v. 2-3 a., 4 v. 2-3 a. 4 v. 3-4 a., all C.T., 17/6. Super Model 19/6. **AUTO TRANSFORMERS**, step up or down, 60 watts, 7/6; 100 watts, 10/-.

**SMOOTHING CHOKES**, 25 m.a., 2/9; 40 m.a., 4/-; 60 m.a., 5/6; 150 m.a., 10/6. 2,500 ohms, 60 m.a. Speaker Replacement Chokes, 5/6.

**PREMIER L.T. CHARGER KITS** for A.C. mains, including Westinghouse Rectifiers and Tapped Mains Transformers, 8 volts at ½ amp., 14/6; 8 volts 1 a., 17/6; 15 volts 1 a., 19/-; 8 volts 2 a., 29/6.

**TRANSFORMERS**, latest type Telsen R.G.4 (list 12/6), 2/9. Lissen Hypernik Q.P.P. (list 12/6), 3/6.

**OUTPUT TRANSFORMERS** for Power or Pentode, 2/6; Multi-Ratio, 4/6.

**PHILIPS MAINS TRANSFORMERS, PRIMARY**, 100-250 v. 450-450 v. 150 m.a. 4 v. 4 a. C.T., 4 v. 4 a. and 4 v. 3 a. and 500-500 v. 100 m.a., 4 v. 4 a. C.T., 4 v. 4 a. and 4 v. 3 a., 12/6. **LIMITED NUMBER ONLY.**

**MAGNAVOX**. Mains energised M.C. Speakers. '154', 7in. cone, 2,500 ohms, 12/6; '152', 9in. cone, 2,500 ohms, 17/6; '152 Magna', 9in. cone, 2,500 ohms, 37/6. Magnavox P.M.s.—'254', 7in. cone, 16 6; '252', 9in. cone, 22/6. Reliable P.M.s., 10/6. **TELSEN P.M.s.** with 10 ratio Transformers, 12/6. **TELSEN** Speaker Units, 2/6. **ROLA** latest type P.M.s., 15/-.

**B.T.H. ENERGISED MOVING COIL**, 10½in. diam., 1,650 ohms field. Power or Pentode Transformer. (State which.) **SPECIAL LINE** at 14/6.

**W.B. 1936 STANDARD STENTORIAN** (list 32/6) 21/-, brand new in sealed cartons.

**Potentiometers** by well-known makers. All values up to 1 meg., 2/-; with switch, 2/6.

**Wire-end RESISTORS**, any value, 1 watt, 6d.; 4 watts 1/-; 8 watts, 1/6; 15 watts, 2/-; 25 watts, 2/6 each.

Reliable **MORSE KEYS** with Morse Code engraved on bakelite base, 2/- each.

Bakelite case **BUZZERS**, 1/6; Walnut case "Loud-tone," 2/6 each.

Super Quality lightweight **HEADPHONES**, 3/9 pair.

**PREMIER FILAMENT TRANSFORMERS**, 4v. 3a., C.T., 7/6; 4v. 5a., C.T., 8/6; 5v. 3a., 7/6; 6.3v. 3a., 7/6; 7.5v. 3a., 7/6; 2.5v. 8a., 8/6.

**GRAMOPHONE MOTORS**. Collaro Gramophone Unit consisting of A.C. motor, 100-250 v. high quality pick-up and volume control, 45/-; Collaro motor only, 30/-; Collaro Universal Gramophone Motor, 100-250v. A.C. D.C. with high quality pick-up and volume control, 67/6; Collaro Universal Motor only, 49/6; Edison Bell double-spring motors including turntable and all fittings, 15/-; Cosmocord Gramo. Unit, comprising A.C. motor, pick-up, and volume control (list 55/-), 35/9. A.C., D.C. Super model, 52/6.

# RAYMART

CRAFT A CREED

**FULL RANGE OF ABOVE  
SPECIALISED SHORT-WAVE  
COMPONENTS ALWAYS IN STOCK**

Sole Distributors for Bliley, Thordarson, Taylor Tubes, RME, National, Bassett Concentric Cable, Hoyt Meters, etc., etc.

**JOHNSON Q ANTENNAE:** 20-metre, 39/6; 10-metre, 26/6; 5-metre, 27/6. Full range Bassett Concentric Feeders In stock.

**COMMUNICATION Equipment:** Send 1/4d. stamp for latest bargain list. It will save you pounds.

**LATEST 3-GANG** low minimum all wave condensers, fitted airplane dial, 8 & 80: 1, 8/6; Yaxley 3-gang 3-band switches, 2/11; ditto, 4-gang 4-band, 3/11.

**MOVING COIL SPEAKERS,** 8in., by famous maker, 1,200 ohm field with transformer, 6/11; M.C. Speaker Transformers, 1/11.

**FOUR RAYMART MICRO-VARIABLES  
ARE SPECIFIED FOR THE  
"Wireless World" Television Receiver  
TYPE V.G.15X. 15 mmfd. 1/4 each.**

**AMERICAN Mains Transformers.** Heavy Duty 350-350 v. 150 m.a., 6.3v. 4a., 5v. 3a., 12/6. GE 350-350 v. 80 m.a., 2.5v. 5a., 5v. 2a., 6/11. Majestic, 250-250, 2.5v., 5v., 4/11; Pilot 260-260, 2.5v. C.T. 5v. C.T., 5/11. Ceramic American Valveholders, 1/- each.

**BRITISH RADIOPHONE.** .0005 straight or superb 3-gang fully screened condensers with trimmers 4/11; Utility Midget 2-gang ditto, 3/11; S.L. Dial to suit above, 2/11; Utility 2-gang Ukroln .0005 with Dial, 3/11; 2-speed 4in. bakelite microphone, 1/6.

**COLIFORMS.**—Moulded in RD4 natural hollow material, hollow resilient pins, 1 1/4in. diameter, ribbed; identification disc in top. Four types, 4-pin, 1/6; 6-pin (standard or fit 7-pin valveholders), 1/9; 7-pin (for bandspread tap), 1/10; Machine threading, 2d. extra.

**ELECTROLYTICS.** Huge purchase 500 v. Aluminium Can, 4 mf., 1/6; 8 mf., 1/11; 8+8 mf., 2/6; Block type, 500 v. peak, 4+4 mf., 1/6; 3+8+4 mf., 3/-; 50 mf. 50 v., 1/3; 25 mf. 25 v., 1/-; Tubular Condensers, 1,500 v. T., all sizes to 0.1 mf., 6d.; 0.2 to 0.5 mf., 8d.

**FAMOUS CONTINENTAL A.C. Valves,** 4/6; Battery types from 2/3; American Duotron, etc., all types, 3/6; all types of RCA Licensed first grade tubes, metal and glass, in stock from 5/6.

**HEAVY DUTY Mains Transformer,** worth 45/-, 350-350, 150 m.a., 4 v., 2.5 a., C.T., 4v. 6A., C.T. 12/6; Phillips 270-270, 120 m.a., same L.T.s., 6/6; Speaker Transformers, 2/6.

**MICROVARIABLES.**—All brass construction, latest ceramic insulation. The finest condensers made: 15 mmfd., 1/4; 40 mmfd., 1/7; 100 mmfd., 1/10. Transmuting Type,—.070in. spacing, 15 mmfd. (neutralising), 2/9; 40 mmfd. Tuning, 3/6. These are quality.

**PULSEBACK Wire,** 6 yds., 6d.; heavy, 9d.; Resin-cored Solder, 6ft., 6d.; Screened Flex, single, 6d. yd.; twin, 9d. yd. Assorted Solder Tags, 6d. packet. Humdimmers, 6d. each.

**SHORTWAVE COILS.**—(RD-4), CA 11-25, CB 20-45 metres, 2/6. CO 14-100 metres, 2/9. Standard 6-pin types, CA6, CB6, 2/9 each; CO6 3/-; same range as 4-pin.

**SMOOTHING CHOKES** 15 hy., 60 m.A., 1/11; 20 hy., 120 m.A., 3/11; 200 m.A., Swinging Chokes, 8/6; Central Pot, all sizes, 1/6; switched, 2/-; 20,000 ohm Pots, 1/-; Tubular Glass Pots, 2d.; Millimeters, 25 m.A. upwards, 5/9; Super, 8/9.

**UTILITY 8/6, Microdisc Dial,** 3/11; Radiophone, 0.00016 shortwave Condensers, 3/6. Series gap twin, 3/9. Shortwave HF Chokes 5-100 metres, 9d.

**465 KC Litz Wound I.F.s,** 3/11; Two-speed slow-motion knobs, 1/-; Telsen Ace Transformers, 1/11; Telsen Screened S.W. H.F.C., 1/-; Iron Core H.F. Chokes, 1/-; Famous 1 watt Resistors, 6d.

**SPECIAL OFFERS.** Class B Kit, worth 30/-, comprising Driver Transformer, Valve and Holder, 5/-; Dozen wire-ended assorted resistors, 1/6. Order 5/- post free. Get our Bargain Catalogue, 1/4d. post free. All enquiries and requests for Catalogue must send 1/4d. stamp.

### RAYMART SHORT-WAVE MANUAL,

48 pages in all, 32 on receivers, transmitters, aerials, circuits, etc., etc., and 16 on short-wave components, 6d., or post free, 7/6. Short-Wave Catalogue, 16 pages, 1/4d.

**G5NI (BIRMINGHAM) LTD.  
44, HOLLOWAY HEAD,  
BIRMINGHAM TELE: MID. 3254**

## REPAIRS AND SERVICE

"SERVICE WITH A SMILE."

**HENRY FORD RADIO, Ltd.**—American valves, components, spares, line cords; leading trade repairers; send us your American and British receivers.—Electronic House, 22, Howland St., Tottenham Court Rd., W.1. Museum 5675. [0434

**HARMONY HOUSE SOUND AND SERVICE.** Southport.—Radio repairs for the Trade.—Tel. 8621. [0558

**METROPOLITAN RADIO SERVICE Co.** for Guaranteed Repairs to American (Midget and Standard and British Receivers). [0435

**CLARION and Majestic Service Depot.**—I.F. and mains transformers rewound. American valves and parts; trade supplied.—Metropolitan Radio Service Co., 1021, Finchley Rd., London, N.W.11. Speedwell 3000. [0435

**FOR Unusually Good Rewinding of Transformers,** chokes, speakers, etc., trade only.—Gardners Radio, Ltd., West Southbourne, Bournemouth. [0551

**GUARANTEED Repairs.**—Any transformers, choke, motor, armature, converter, dynamo, etc.; keenest prices, immediate quotation, prompt, dependable service.—See below.

**L.T.P. (LONDON TRANSFORMER PRODUCTS, Ltd.),** Willesden, N.W.10. Willesden 6486 (3 lines). [3470

**MAINS Transformer Service.**—Repairs, rewinds, or constructions to specification of any type; competitive prices and prompt service.—Sturdy Electric Co., Dip-ton, Newcastle-on-Tyne. [0516

**F. E. GODFREY, A.M.I.R.E.,** qualified to build, repair and convert "Wireless World" sets, etc.; 25 years' experience, prompt service guaranteed.—30, Keimplay Rd., Hampstead, Hampstead 1104. [4767

**HOLIDAY and HEMMERDINGER, Dolefield, Bridge St.,** Manchester.—Repairs, re-winds; American valves; service books; speaker centring gauges, 2/6 set; speaker dope, 2/-; catalogue free. [4838

**WE Specialise in Majestic and American Radio Repairs,** and stock components and valves at low prices; get real service from International Majestic, 173-5, Farringdon Rd., E.C.1. Terminus 2256. [4834

**REPAIRS to Moving Coil Speakers** a Speciality; cones and coils fitted, fields altered; prices, including eliminators, quoted, loud speakers, 4/-; L.F. and output transformers, 4/-, post free; guaranteed satisfaction; trade invited; estimates free; prompt service.—Loud-Speaker Repair Works, 5, Balham Grove, London, Battersea 1321. [0394

## SITUATIONS VACANT

**AIR MINISTRY.**

**DIRECTORATE of Scientific Research.**

**LABORATORY Assistants** required at Bawdsey Research Station, Bawdsey Manor, Woodbridge, Suffolk. Candidates should have a good general education with theoretical training in electricity. Practical experience of wireless receivers or of electrical testing is desirable. **SALARY** 40/- (at age 19) rising to a normal maximum of 70/- a week.

**APPLY** by letter quoting reference No. B508 to the Superintendent, Bawdsey Research Station, Bawdsey Manor, Woodbridge, Suffolk, stating age, training and experience. Closing date for receipt of applications is 13th August, 1937. [4830

**JUNIOR Service Engineer** Required; previous experience unnecessary.—Phonart, High St., Walsall. [4826

**MECHANICAL Designers** Required for Small Apparatus Development Work.—Apply by letter to Murphy Radio, Ltd., Welwyn Garden City, Herts. [4849

**GUARANTEED Positions in Marconi Service;** all successful students placed; separate Morse Classes held.—The Wireless School, 74, Bull St., Birmingham, 4. [4513

**RADIO Service Engineer-Salesman** Required, quick fault-finding experience, all battery, D.C. and universal receivers essential.—Henry's, 54, High St., Margate. [4841

**DRAFTSMAN** Required by well-known West London Radio Manufacturers, reply stating full particulars, age and salary required.—Box 2864, c/o The Wireless World. [4854

**TECHNICAL Supervisor** to First Class Wireless Relay Company, one accustomed to control of outside staff, also with experience of high power amplifiers; state age, wage, and experience to Box 2847, c/o The Wireless World. [4848

**WIRELESS Operators and Engineers** Urgently Required.—Train at Britain's leading colleges; fee after appointment; boarders; prospectus free.—The Wireless College, Colwyn Bay, or The Wireless College, Calmore, Southampton. [0541

## SITUATIONS WANTED

**RADIO Service Engineer,** experienced all British, American receivers, P.A., etc., seeks new position.—Box 2850, c/o The Wireless World. [4846

## ELECTRADIX BARGAINS

**MOTORS.** A.C. Start on full load, 1/60 h.p. with pulley, Type 50, 1,500 revs., 18/6. 1/25 h.p., Type 36.G, 3,500 revs., 27/6. 1/4 h.p., 2,000 revs., 25/-. Squirrel Cage 1/10 h.p. Motors, 2,500 revs., 35/-. **D.C. MOTORS.** 1/40 h.p., 110 or 220 volts, series, Type K.B., 1,750 revs., 15/-. Type G, 1/35 h.p., 2,000 revs., 16/-. 1/12 h.p. Type C, 110 or 220 v. shunt, 1,700 revs., 30/-. Tiny Motors, 6 v., 12/6. 50 v., 14/-, 100 v., 15/-. 12 volts 1/4 h.p. compound, 40/- Electric Water Pumps, 67/6. Compressor Spray Set, 37/6.

**MOTOR GENS.** 220 v. A.C. to 100 v. 1 amp. D.C., 60/-. Big stock all sizes to 2 kW.

**E.M.V. MAINS Transformers,** 100/250 v. to 700 C.T. 60 m/a. 4 v. 1 a., 4 v. 2 a., 10/6. 30 Hy. Chokes, 50 m/a., 4/-, 1 amp. Chokes, 10/-. **POCKET HEADPHONES, W.D.,** all leather headband, strap and cords, 2/9 pair. Wireless type with aluminium headbands, 2/9. 4,000 ohms, 4/6. House, Office and Field Telephones, wall and table.

**DECK FANS,** 15 volts, 100 v. and 220 volts, 12/6. **CONSTRUCTORS.** Hand geared drills to 1", 1/3. Ceramic 8/W lead-in, brass stem, 8d. 3' stand-off 8/W insulators, 6d. Portable valve set kits assembled in suitcase, partly wired, speaker, aerial, and all parts, less valves, 21/-. Metal Rectifiers, chassis type. 180 v. 30 m/a. output, 5/-. Lightning Arrestors, make aerials safe in summer storms, 1/- ea.

**VALVE BARGAINS.** Mains Universal 7-pin Freq. Changers, 4/6. A.C. ditto, 4/6. Universal H.F. 7-pin Pentode, 4/6. Power Valves: Edison VT13B 30-watt, Fil. 6 v., 1,500 v., Mag. 35, under half price, 10/6. T50 45 valves, 7 v., Fil. 1,500 v., P. Mag. 30, 22/6. AT40, 10 watt, 6 v., Fil., 4/-. H.T. Rectifiers up to 10,000 v. ND2, 5 v. Fil., 250 watts, 35/-. 100 watt T2A, 40/-, Half-wave W.D. Rectifier, 200/1,000 v., 50 m/a., 2/6.

**COILS.** 8/W Coils, plug-in, L.V. 2-pin, 1/-, Reaction, various, 9d. Philips Superhet, set of three in carton, 3/-. Cosor 3 and 4-pin Coils, 1/-. Interference cutting H.F. Twin Chokes, 2/-. Spark Transmitter shortwave sets for model boat remote control, 17/-. **CONDENSERS.** Variable lowloss P type, .0005, 1/9. J.B. .0003, 2/-. Reaction vari., 1/3. Pye .0003 with 8.3 dia., 5/-, 2-gang vari., all aluminium, 3/- only. Fixed Condensers, 2 mfd. 250 v., 10d., or 6 for 4-4,000 v. 1/4 mfd., 6/-, etc.

**CRYSTAL SETS.** Are great fun. No battery or valves wanted. Quiet and efficient reception. 500 shop-sold sets cheap. Enclosed type, 5/6 and 7/6 each.

**AN A.C. PLUS-A-GRAM FEDESTAL,** sliding motor turntable and pick-up with record cabinet under. As new, 24.

**SOUND RECORDING** at home on your own grammo, with 4d. discs. The FEIGH centre geared recorder costs 37/6 still.

**MICROPHONE PICK-UPS.** Brown's Microbox Tone Arm with button mike reproducer, 10/6.

**SPEAKER BARGAINS** in high grade M.C. Speakers. All offered at less than half price. Finest quality reproduction.

**D.C. ENERGISED 9"** Celestion M.C., 2,500 ohm field, speech transf., as new, 7/6. R. & A. 6" 2,500 ohms, with transf., 7/-. Magnavox 6" No. 144, 2,500 ohms, 12/6.

**A.C. SPEAKERS** with rectifier, 100/250 v., 11" dia. with transf., 25/-. Jensen, 220 v., 7" dia. and transf., 22/6. 100 volt ditto, 7" 18/6. 100 v., 8" with transf., 19/-. **BATTERY SPEAKERS.** Brown 6/12 volts 11" dia., 14/6.

**P.M. SPEAKERS,** Sonocobor Class B with transf., 20/-. P.M. in Cabinets: Hyra, Oak, 12 x 12, 25/-. Heavy Duty 5/8 watt with transf., 38/-. A.C. Rect. Speaker, 200/350, 3 watts with transf., 60/-. Small Cone Speakers for extension: Siemens magnet table, 5/-. H.M.V. Cone Units, 2/6. Brown's plan, 12" cones, 1/-.

**PUBLIC ADDRESS SPEAKERS,** M.C. Horn Unit, large 8 ohms 10 watts, 27. Trix 5 watts, 26/10/-. Trix, large, 10 watts, 27/10/-. Brown's Unit, for horn, 7 watts, 50/-. M.C. Vitavox 5 v. Units, 15 watt size, 30/-. Brown's Horn Speaker, 200/350, P.M. Horn Speaker, 10 watts, 28. Short Horn P.M. 5 watt Speaker, 70/-. Brown's Cabinet 7 watt Speaker, 24. Siemens Giant Grille Speaker, 25/-.

**PARCELS** of experimental odd coils, magnets, wire, chokes, condensers switches, terminal, etc., post free, 10 lbs., 7/-; 7 lbs., 5/-. 1,000 other Bargains in large Illustrated Sale List "W".

**ELECTRADIX RADIOS**  
218, UPPER THAMES STREET, LONDON, E.C.4  
Telephone: Central 4611

## DICTIONARY of WIRELESS TECHNICAL TERMS

—SECOND EDITION

Compiled by S. O. PEARSON, B.Sc., A.M.I.E.E. and issued in conjunction with "THE WIRELESS WORLD"

272 pp., bound in cloth boards. Size 5 by 3 inches

Price 2/- net. By post 2/2

From all leading booksellers or direct from Publishers. ILIFF & SONS LTD. Dorset House, Stamford Street, London, S.E.1

W.W.48

## INDEX TO ADVERTISEMENTS

	PAGE
All-power Transformers, Ltd.	
Automatic Coil Winder Co., Ltd.	Inside Front Cover
Baker's Selhurst Radio	
Belling-Lee, Ltd.	3
Birmingham Radiomart G5NI	6
British Institute of Engineering Technology	2
British Insulated Cables, Ltd.	Inside Front Cover
British Mechanical Productions, Ltd.	1
British Pix	
British Radiogram Co., Ltd.	
British Rola Co., Ltd.	Edit. 109
British Sound Reproducers, Ltd.	
British Thomson-Houston Co., Ltd.	
Bulgin, A. S., & Co., Ltd.	
C.A.V.	
Colvern, Ltd.	
Cosser, A. C., Ltd.	
"Drydex"	
Dubilier Condenser Co. (1925), Ltd.	
Edison Swan Electric Co., Ltd.	Front Cover
Electradix Radios	6

	PAGE
Exide, Ltd.	
Fluxite	
Forbat, Eugene J.	
Galpin's Electrical Stores	
Gardners Radio, Ltd.	
Goodmans, Ltd.	1
Gramplan Reproducers, Ltd.	Inside Back Cover
Hartley Turner Radio, Ltd.	2
Haynes Radio	
H.M.V.	
Institute of Wireless Technology	
Ismay Distributors, Ltd. (Halcyon)	
Lexington Instrument Laboratories, Ltd.	
Marconi's Wireless Telegraph Co.	
McCarthy Radio, Ltd.	Edit. 105
Midwest Radio, Ltd.	Inside Front Cover
M.P.R. Electrical Co.	
M.R. Supplies	
Parmeko, Ltd.	
Peto-Scott, Ltd.	
Player's Cigarettes	

	PAGE
Polytechnic Institute	
Postlethwaite Bros.	
Prancer Supp. B. Stegs	5
Radio Development Co.	4
Radio Resistor Co.	1
Record Radio, Ltd.	
Reliance Mfg. Co.	2
Savage, W. Bryan	Inside Back Cover
Scott Sessions, Ltd.	
Shaftesbury Microphone	
Sound Sales, Ltd.	4
Stern, S.	
Tannoy Products	Inside Back Cover
Telegraph Condenser Co., Ltd.	Edit. 107
Universal Radio Distributors, Ltd.	1
Varley, Ltd.	Inside Back Cover
Veigt Patents, Ltd.	
Ward, C. F.	
Webb's Radio	
Westinghouse Brake & Signal Co.	
Wright & Weaire, Ltd.	

Printed in England for the Publishers, ILIFF AND SONS LTD., Dorset House Stamford Street, London, S.E.1, by The Cornwall Press, Ltd., Paris Garden, Stamford Street, London, S.E.1 "The Wireless World" can be obtained abroad from the following: FRANCE: W. H. Smith & Son, 248, Rue Rivoli, Paris; Hachette et Cie, Réaumur Paris, and branches. BELGIUM: W. H. Smith & Son, 74-75, Boulevard Adolphe Max, Brussels. AUSTRIA: Gordon & Gotch, Ltd., Melbourne (Victoria), Sydney (N.S.W.), Brisbane (Queensland), Adelaide (S.A.), Perth (W.A.), and Launceston (Tasmania). NEW ZEALAND: Gordon & Gotch Ltd., Wellington, Auckland, Christchurch, and Dunedin. INDIA: A. H. Wheeler & Co., Bombay, Allahabad and Calcutta. CANADA: Imperial News Co., Toronto, Winnipeg and Vancouver; Benjamin News Co., Montreal; Gordon & Gotch, Ltd., Toronto. SOUTH AFRICA: Central News Agency, Ltd. UNITED STATES: The International News Co., New York.



## NICORE COIL UNITS

Build an efficient Battery or Mains Set with one of the famous Nicore Coil Units. These ganged units are giving excellent results with the following:—  
 No. 1 (BP 111) Mains Superhet (110 k.c., I.F.)  
 No. 2 (BP 112) Battery Superhet (465 k.c., I.F.)  
 No. 3 (BP 113) 3-valve Mains receiver with band-pass tuning. One H.F. valve.  
 No. 4 (BP 114) S.G. Battery 3 with Pentode Output valve.

Write for circuit blueprints of the above sets, 6d. each (BP 114 is 3d.) POST FREE.

VARLEY (OLIVER PELL CONTROL LTD.), BLOOMFIELD ROAD, WOOLWICH, S.E.18 Tel: Woolwich 2345

*We do quite a lot of business making up transformers to customers' own specifications: but we have a standard list. May we send you a copy?*

**W. BRYAN**  
WESTMORELAND R.D. LONDON N.W.9

**SAVAGE LTD**  
PHONE, COLINDALE 7131

*P.A. at its Best*

**GRAMPIAN**

PUBLIC ADDRESS EQUIPMENT  
 GRAMPIAN REPRODUCERS LTD.  
 Kew Gardens, Surrey

**TANNOY**  
THE SOUND PEOPLE

GUY R. FOUNTAIN LTD.  
 FOR ALL CANTERBURY GROVE, WEST NORWOOD, LONDON, S.E.27. Phone: Str. 4122 (6 lines).  
 SOUND AMPLIFYING EQUIPMENT

THE  
**WIRELESS ENGINEER**  
*The Journal of Wireless Research and Progress*

"THE WIRELESS ENGINEER" is published in the interests of professional wireless engineers, experimenters, and all keen radio enthusiasts, and is widely read by those who are intimately associated with wireless development.

A valuable monthly feature consists of a summary, under the title of Abstracts and References, of important articles appearing in technical wireless publications throughout the world.

MONTHLY  
 2s. 6d. NET  
 Subscriptions:  
 32s. per annum  
 post free.

ILIFFE & SONS LTD., DORSET HOUSE, STAMFORD STREET, LONDON, S.E.1  
 W.W.2

Second Edition—

**RADIO DATA CHARTS**

A SERIES OF ABACS  
 providing most of the essential Data required in Receiver Design.

By **R. T. BEATTY, M.A., B.E., D.Sc.**

Published from the Offices of  
 "THE WIRELESS WORLD"

"Radio Data Charts" provide designers of wireless apparatus with a ready and convenient means of solving problems without having recourse to complicated formulæ and mathematics.

By the use of the new "Radio Data Charts" such abstruse problems as the design of tuning coils are solved almost as easily as the simple application of Ohm's Law.

Price 4/6 net By post 4/10

From leading booksellers or direct from the publishers:

ILIFFE & SONS LTD.  
 Dorset House, Stamford Street, London, S.E.1  
 W.W.93

NOW READY!

Second Edition—Thoroughly Revised

**WIRELESS SERVICING MANUAL**

By **W. T. COCKING** (of "The Wireless World")

The first complete book of reference of its kind, A reliable practical guide for amateur and professional. The first edition of this book was sold out in a very few months and a second edition, with additional material, is now on sale.

The "Wireless Servicing Manual" deals fully with Testing Apparatus, and explains the methods of locating and curing faults in receiving equipment. Ganging, Automatic Volume Control, Instability, Distortion, Mains Hum, Whistles and Local Interference are all separately treated.

Fresh information on short-wave receivers, and on methods of operating extension loud speakers, has been added. The reference material including base-connections for British, Continental and American valves, and the various colour codes for components has been extended and brought up to date.

Cloth Boards.  
 Size 7½ ins. x 5 ins.  
 231 Pages

5/- net  
 By post 5/4

Issued in conjunction with "THE WIRELESS WORLD" and Published by the Proprietors:—  
 ILIFFE & SONS LTD., DORSET HOUSE, STAMFORD STREET, LONDON, S.E.1



PRICE 2/6 net  
By post 2/9

From all Leading Booksellers, or direct  
from the Publishers

*A new book which will help you to get the  
best results with your camera!*

## Brighter Photography

by DAVID CHARLES, F.R.P.S.

This handy book reveals in a clear, attractive way the secrets of successful photography. Though primarily intended for the novice, it is invaluable to every keen camera user.

The carefully arranged chapters cover the whole field from the choosing of a camera to developing and printing the finished picture. Details of the various photographic materials on the market are given, and there are important sections dealing with Focusing, Aiming the Camera, Photographic Groups, Lighting and Exposing.

In addition there are over one hundred and sixty illustrations, each numbered and each conveying a really useful hint. By simple cross references these illustrations provide a series of clear, concise lessons in the art of making better pictures.

ILIFFE & SONS LTD., DORSET HOUSE, STAMFORD STREET, LONDON, S.E.1

W.W.40

## FOUNDATIONS of WIRELESS

*A Book of  
First Principles  
for the  
Wireless  
Enthusiast*

PRICE 4/6 NET  
By Post 4/11

Issued in conjunction with  
"THE WIRELESS WORLD"  
and published by the proprietors—

By A. L. M. SOWERBY, M.Sc.

An Elementary Text Book on Wireless Receivers

"Foundations of Wireless," based on a series of articles which appeared in "The Wireless World," covers the whole field of wireless from the simplest electrical phenomena to the construction of a modern set, and all the vital points in receiver design are treated in full detail. Chapters are devoted to direct and alternating currents; typical circuits; the properties of inductance and capacity; the nature of high frequency currents; the tuned circuit; and amplification by the valve.

Eleven of the eighteen chapters of the book deal with the discussion of receivers, in which the whole process of design is reviewed stage by stage to the finished article.

Special attention is paid to the important subject of tuned circuits and band-pass filters, on the correct design of which the performance of every type of set ultimately depends. Moreover, the process of detection, so often imperfectly understood, is clearly explained.

ILIFFE & SONS LTD., DORSET HOUSE, STAMFORD STREET, LONDON, S.E.1