

4^D



The Wireless World

THE PRACTICAL RADIO & TELEVISION JOURNAL

Friday, May 7th, 1937.

THE NEW

MAZDA

TUNING

INDICATOR

Type

AC.ME

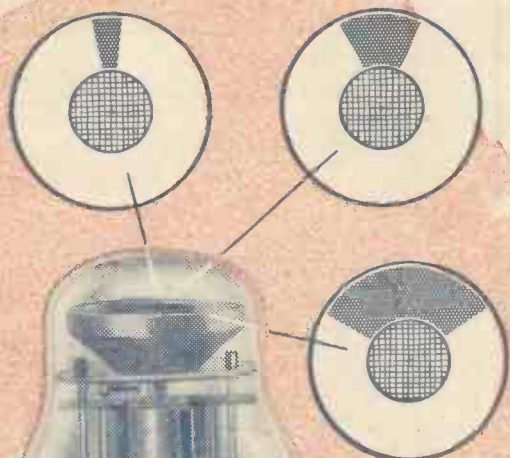

The Mazda AC.ME enables exceedingly accurate tuning of a receiver to be obtained by purely electrical means. It consists of an electrode system surmounted by a target coated with a fluorescent material. The area of glow on the target is controlled by the bias applied to the control grid of the electrode structure.

The AC.ME is suitable for use in circuits employing diode detection.

For AC/DC receivers type ME.920 should be used. This has characteristics identical with the AC.ME with a 9-volt .2 amp. heater.

CHARACTERISTICS

Heater Volts	4
Heater Current5
Max. Anode Volts	250
Max. Target Volts	250
Grid Volts for zero shadow	22
Anode Current24

BASE CONNEXIONS

Pin No. 1	—
" " 2	GI
" " 3	Target
" " 4	Heater
" " 5	Heater
" " 6	Cathode
" " 7	Anode

The AC.ME is fitted with a standard 7-pin base.

PRICE 10/6

Mazda Radio Valves are manufactured in Great Britain for The British Thomson-Houston Co. Ltd., London and Rugby and distributed by

THE EDISON SWAN ELECTRIC CO. LTD., 155 CHARING CROSS RD., LONDON, W.C.2





We've taken protective measures

We have protected our B.T. Insulated Metallised Resistances against the dangers of short circuiting by moulding them in bakelite. Actually, we are the only manufacturers to give resistances complete insulation in this way. The advantages are obvious. They can be mounted at such close quarters, that it is frequently possible to reduce the size, simplify the design and lower the cost of apparatus in which the resistances are used.

There are also many interesting points about our Type B.W. Wire Wound Resistances (also moulded in bakelite), our Type F Metallised Resistances and our Metallised Volume Controls. We have no space here to do justice to their numerous advantages, but we have done our best to detail them in our Catalogues. Perhaps you would like a copy. There are two catalogues—one for constructors and one for manufacturers.

DUBILIER

CONDENSERS

DUBILIER CONDENSER CO. (1925) LTD., DUCON WORKS, VICTORIA ROAD, NORTH ACTON, LONDON, W.3



C. R. Casson 121

Mention of "The Wireless World," when writing to advertisers, will ensure prompt attention.

The Wireless World

THE
PRACTICAL RADIO
JOURNAL
27th Year of Publication

No. 923

FRIDAY, MAY 7TH, 1937.

VOL. XL

No. 19.

Proprietors: ILIFFE & SONS LTD.

Editor:
HUGH S. POCOCK.

Editorial,
Advertising and Publishing Offices:
DORSET HOUSE, STAMFORD STREET,
LONDON, S.E.1.

Telephone: Waterloo 3333 (50 lines).
Telegrams: "Ethaworld, Sedist, London."

COVENTRY: Hertford Street.

Telegrams: "Autocar, Coventry." Telephone: 5210 Coventry.

BIRMINGHAM:

Guildhall Buildings, Navigation Street, 2.
Telegrams: "Autopress, Birmingham." Telephone: 2971 Midland (4 lines).

MANCHESTER: 260, Deansgate, 3.

Telegrams: "Iliffe, Manchester." Telephone: Blackfriars 4412 (4 lines).

GLASGOW: 26B, Renfield Street, C.2.

Telegrams: "Iliffe, Glasgow." Telephone: Central 4857.

PUBLISHED WEEKLY. ENTERED AS SECOND
CLASS MATTER AT NEW YORK, N.Y.

Subscription Rates:

Home, £1 1s. 8d.; Canada, £1 1s. 8d.; other
countries, £1 3s. 10d. per annum.

*As many of the circuits and apparatus described in these
pages are covered by patents, readers are advised, before
making use of them, to satisfy themselves that they would
not be infringing patents.*

CONTENTS

	Page
Editorial Comment	437
5 to 15 Metre Reception—A Three- valve Battery Set	438
The Royal Week—A Guide to the Principal Broadcasting Events	442
Why the Triode-Hexode? I	446
Broadcast Brevities	449
Current Topics	450
New Apparatus Reviewed	451
Principal Broadcasting Stations	452
Anti-Interference Filters. I	454
Random Radiations	456
Letters to the Editor	458
Recent Inventions.. ..	460

EDITORIAL COMMENT

The Coronation

World-Wide Broadcasts

DENSE as will be the crowds lining the route of the Coronation procession and participating directly in this great occasion, the numbers are small by comparison with the vast communities who will be brought into touch with all that is happening in London through the medium of broadcasting in this country, Empire transmissions to the Dominions and Colonies, and commentaries arranged by foreign countries which will be put out over the networks of their own broadcasting services.

Months have been spent in completing the organisation and for weeks past Post Office and B.B.C. engineers have been engaged on the task of installing the necessary microphones and linking them up to the control points and amplifiers required. It is stated that a total of no fewer than fifty-eight microphones will be used during the day, thirty-two for the actual ceremony within the Abbey and the remainder for commentaries on the progress of the procession and for obtaining "effects" along the route.

Every precaution has been taken to ensure that the preparations will stand up to the most exacting requirements of the occasion.

The responsibility which rests upon those entrusted with the task of broadcasting the Coronation is great because it can be said that the whole world will be listening, and the event will be one to be remembered in millions of homes and to go down in history as the first occasion when, through the medium of broadcasting, so vast an audience could participate in a ceremony, local geographically, but which, nevertheless, is world-wide in significance.

To a restricted audience the B.B.C.

television station will extend the range of sight as well as sound, with the arrangements to televise the procession from Hyde Park Corner.

Some details of all these Coronation arrangements are given elsewhere in this issue.

In addition to broadcasting and television programmes mention should be made of the elaborate planning of loud speakers and amplifiers along the processional route, as well as in centres throughout the country, which will be primarily used to reproduce the Abbey ceremony to those outside. The whole organisation is one which commands admiration and we believe that the success of these arrangements will prove a full reward to all those who have been associated with them.

Short Waves

Remarkable Vicissitudes

AN account is given in this issue of the recent extraordinary behaviour of long-distance short-wave transmissions. The most surprising and prolonged interruptions of short-wave communication between East and West which have yet been encountered in the history of these wavelengths have occurred during the past week or so. In our report some explanations are given as to why these conditions have developed, but the explanations tend to increase rather than diminish the scientific interest which these peculiar happenings arouse. One cannot help contemplating what an extraordinary upheaval in our modern civilisation might be caused if physical changes of this nature affecting short waves were not confined to these bands; but it must be left to a Jules Verne or H. G. Wells to tell the story of what might happen if the ether suddenly failed us as a medium for radio transmission.

5-15 Metre

THREE-VALVE BATTERY SET FOR THE EXPERIMENTER

By D. W. HEIGHTMAN

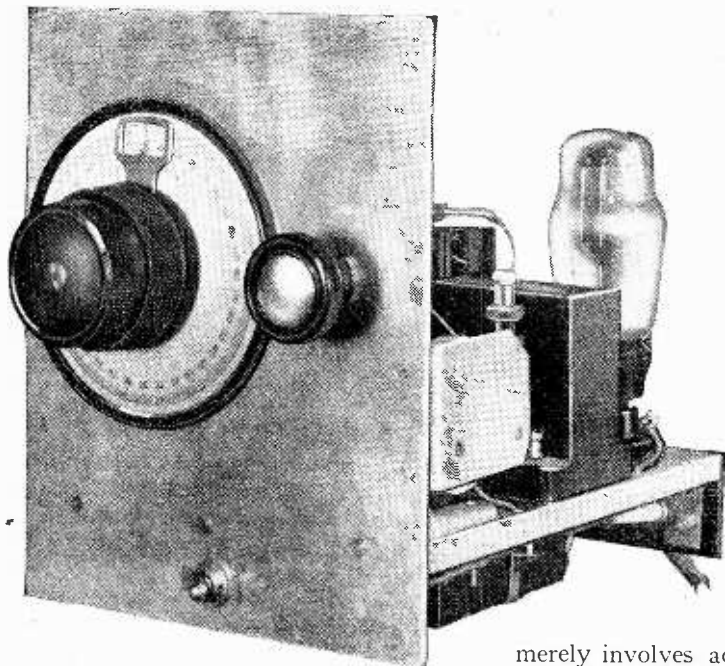

THE ultra high frequencies are daily providing more of interest for listeners and for the outlay of a modest sum it is possible to build a receiver which will give many hours of extra radio enjoyment. With this fact in view the set has been designed to provide an inexpensive, simple yet efficient receiver, primarily for frequencies between 20 and 60 Mc/s and suitable for 'phone or C.W. reception. At the same time, with suitable coils, it gives an excellent performance on frequencies down to 5 Mc/s and is extremely easy to handle. Being battery operated and compact, the set can be used for portable work.

Provided it is properly designed and handled, the "straight two" type of receiver is capable of giving excellent results, but suffers from the great disadvantage that the aerial has a most undesirable effect on the detector stage of causing instability of the received signals (unless the aerial is rock-steady), and poor reaction—i.e., dead spots on certain sections of the tuning range. It was therefore decided that a radio frequency stage, prior to the detector, would be essential.

The next question was to find a valve suitable for this stage, as most SG valves, far from amplifying, produce a considerable loss in signal strength on frequencies above 25 Mc/s. Obviously, the acorn type of valve was the best for this position, but its use was ruled out on a question of cost! Fortunately, the special Hivac SG220SW was found to be suitable for the purpose. This valve has the grid connection on top, is fitted with a ceramic base, and, as will be seen later, allows an excellent layout to be obtained, also no noticeable loss in signal strength is produced up to 60 Mc/s, while some gain is obtained lower than about 35 Mc/s.

Inspection of the circuit in Fig. 1 will show it to be quite conventional. As in all ultra high-frequency receivers, the orthodox circuits work well, provided extreme care is exercised in the layout of components, and it is remembered that small capacities, leads, etc., while being

negligible on lower frequencies, are certainly not so on these frequencies. In fact, the design of such a receiver

merely involves adapting a conventional circuit for ultra high frequencies and finding a suitable layout and the choice of the right components.

It was decided to use a tuned grid circuit for the RF stage, as the aperiodic RF choke, commonly used in this position, often causes false signals. Since the tuning of such a stage is comparatively broad the tuning condenser can satisfactorily be ganged to the detector stage condenser.

The tuning condensers have a capacity of 40 mmfd. In view of the wide frequency band to be covered, this value was decided upon as being the most suitable, since smaller condensers necessitate so many coil changes to completely cover a range of 20-60 Mc/s. If a good slow-motion dial is fitted no difficulty is experienced in tuning with the 40 mmfd. condensers, even at the highest frequency of the tuning range. Those requiring only a limited frequency range (for example, the 56 and 28 Mc/s

amateur bands) could substitute 15 mmfds. in place of the larger condensers.

As the grid connection of the SG valve is brought out on top, the tuned grid circuit of this valve can be sufficiently isolated from the detector tuned circuit, without screening, to prevent self oscillation in the RF stage, thus simplifying construction.

The aerial is coupled by L_1 and either the ordinary inverted L or a twin feeder type may be used. In the former case one end of L_1 is connected to the chassis and in the latter one feeder is connected to either end of L_1 . An earth will not generally be found necessary.

The RF stage is coupled to the detector by means of the condenser C_3 , a 30 mmfd. mica trimmer with a ceramic base, and the choke $Ch.1$, which should be of a good section wound type. Besides acting as a coupling condenser C_3 is useful for matching up the RF and detector tuned circuits,

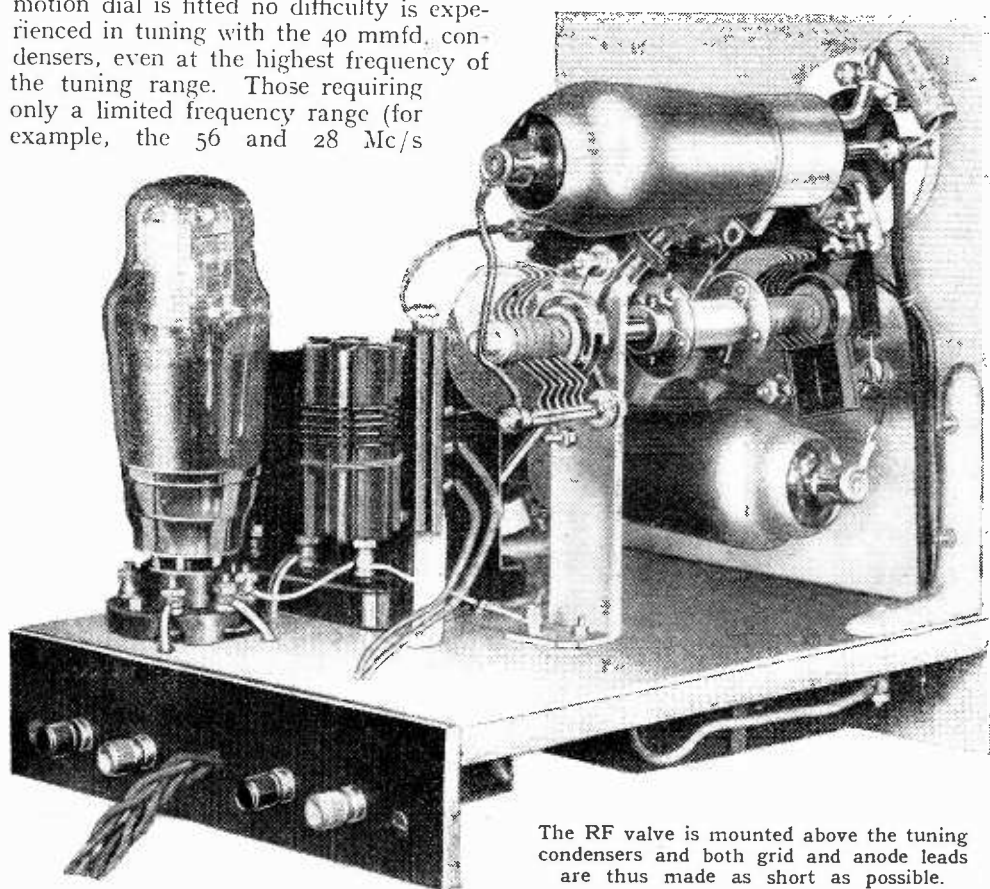

The RF valve is mounted above the tuning condensers and both grid and anode leads are thus made as short as possible.

Reception

THE ultra-short wave receiver described in this article will provide a new interest for the amateur experimenter since it covers a waveband below that of the average short wave set. It is well suited also for the more experienced ultra-short wave worker, for every care has been taken to make the set as efficient as possible.

as varying the capacity of this condenser alters the amount of stray capacity across the detector circuit.

As the signals to be received usually have low values of strength, reaction has been relied upon as the only volume control necessary, but, if desired, other forms of control could, of course, be fitted.

The Hivac D210SW has been chosen as the detector valve as this type has been found to oscillate more readily at UHF than most battery triodes, and the fact that the grid connection is on top also simplifies and improves the layout of the set. Grid leak and condenser values for the detector have been chosen, after test, as giving the best rectification and also smooth reaction control. It should be noted that the grid leak is taken to the positive side of the filament circuit.

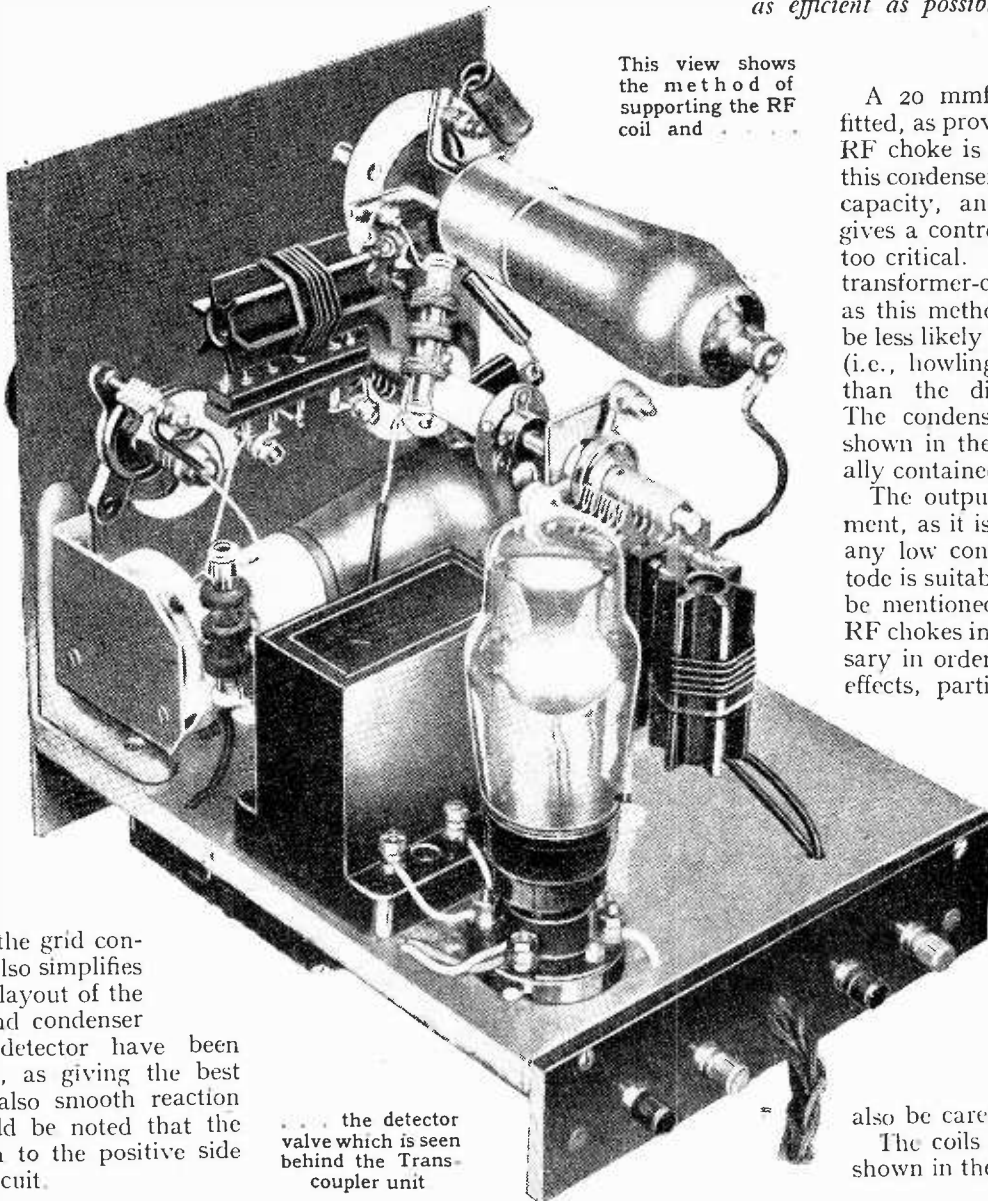

This view shows the method of supporting the RF coil and

the detector valve which is seen behind the Transcoupler unit

A 20 mmfds. reaction condenser is fitted, as provided a good section wound RF choke is used in the detector stage this condenser is found to have sufficient capacity, and, being small in value, gives a control of reaction which is not too critical. The detector is resistance-transformer-coupled to the output stage as this method of coupling is found to be less likely to cause "threshold howl" (i.e., howling on the edge of reaction) than the direct transformer method. The condenser C7 and resistance R2 shown in the circuit diagram are actually contained in the Transcoupler unit.

The output circuit requires no comment, as it is quite straightforward and any low consumption high gain pentode is suitable for this stage. It should be mentioned, however, that the small RF chokes in the output leads are necessary in order to prevent body capacity effects, particularly when using headphones.

It is recommended that all the makes of components specified for the RF and detector stages be adhered to, as a change in the type of a component is liable to have a considerable effect on the performance of the receiver. The layout depicted in the drawings and photographs should also be carefully followed.

The coils for various frequencies are shown in the illustrations, and they can

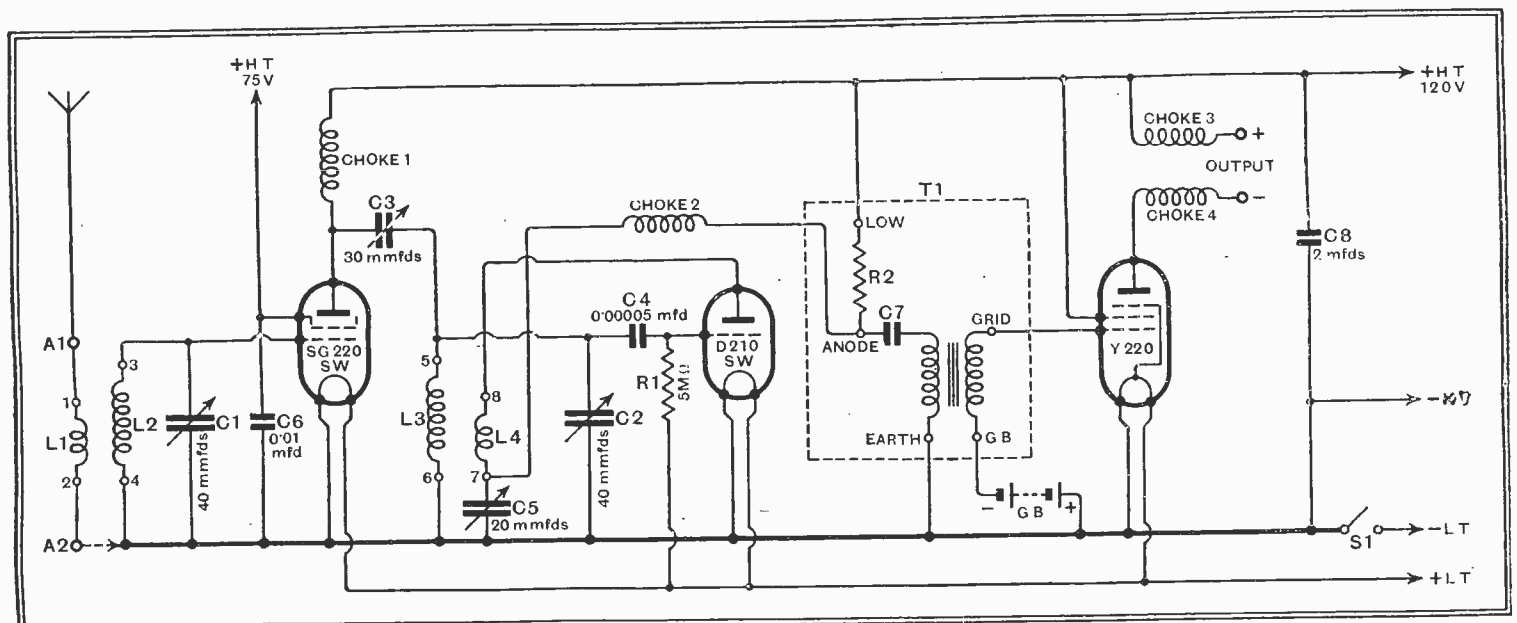

Fig. 1.—Theoretical circuit diagram of the ultra-short wave receiver.

5-15 Metre Reception—

be obtained from Messrs. Denco, .59, Burrs Road, Clacton, Essex. These coils were designed specially for this receiver as the few types at present on the market are difficult to adapt for an efficient layout. By being mounted close to the condensers they allow a minimum length of connecting leads to be used both on the formers and in the receiver.

or brass. It is cut to the size given in the drawings, and the brackets for supporting the detector-valve holder and RF tuning condenser are made from the same material. The base of the set is preferably made of aluminium-covered plywood $\frac{3}{8}$ in. thick, known as Plymax, and the panel is fixed to it by means of small brackets. At the rear of the base the ebonite strip is also held by two brackets,

these condensers the detector coil base is supported by means of 14 gauge thick wire connections, as will be seen in the photograph, thus the connecting leads are reduced to a minimum length.

The Eddystone Frequentite valve-holders should now be mounted; that for the detector being supported by a bracket held in position by the panel bracket bolts. After the RF tuning con-

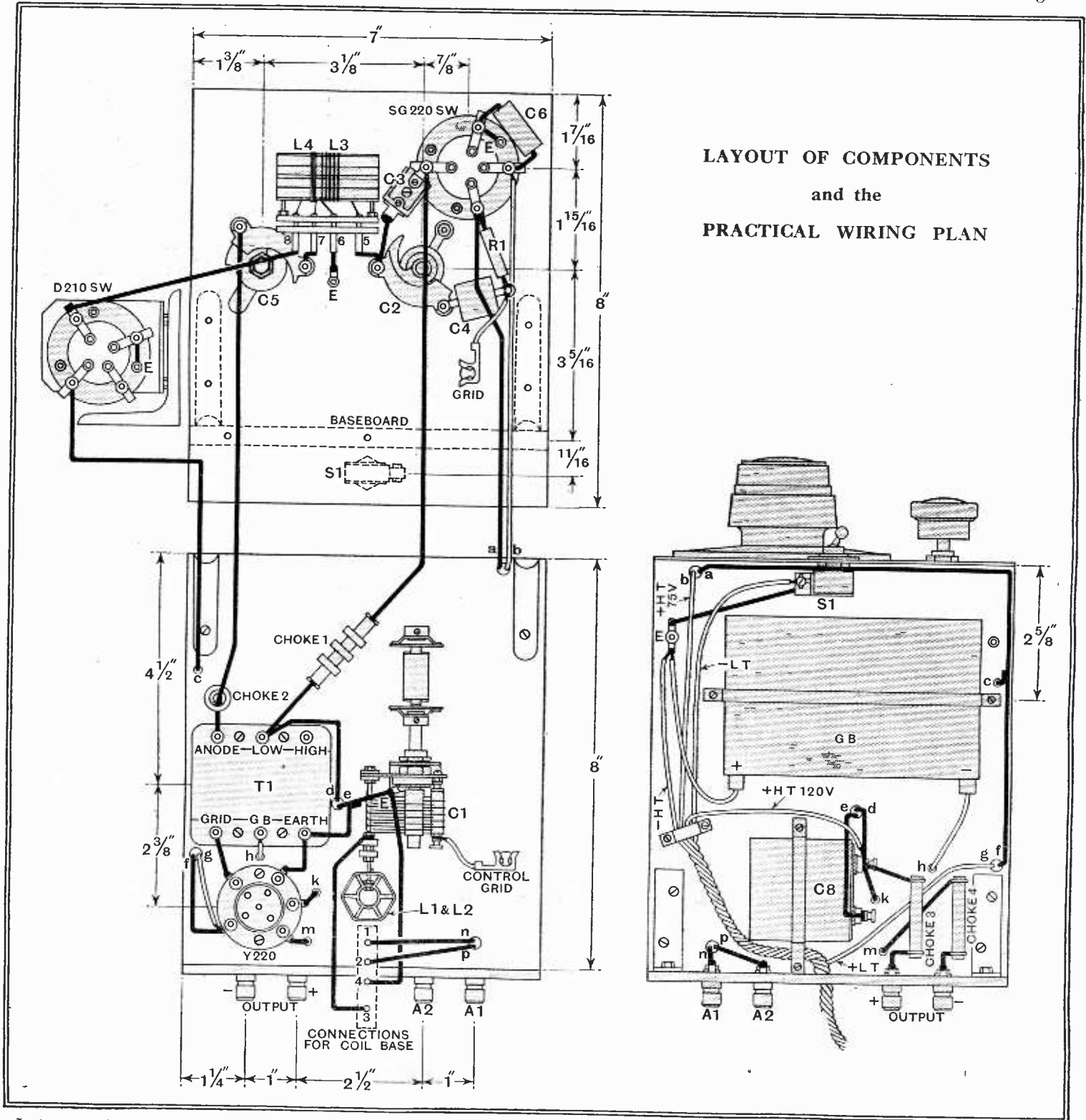

LAYOUT OF COMPONENTS and the PRACTICAL WIRING PLAN

It is essential that everything be made rigid and vibrationless otherwise trouble will be experienced with "wobble" on the received signals. For this reason the panel should be at least 1/16th inch thick and it can be made of aluminium, copper

which can be made by bending up small pieces of the aluminium used for the panel. This strip carries two aerial terminals and two phone terminals. The tuning and reaction condensers should first be put in position on the panel. On

denser and coil base have been mounted the rest of the construction and wiring can be carried out in any order the constructor prefers. It is advisable first, however, to put the GB battery and the HT reservoir condenser C8 in their posi-

5-15 Metre Reception—

tions under the baseboard so that sufficient space is left for them when wiring. Most of the wiring can be done under the base, thus adding to the neatness of the set, and the battery leads are brought out through a hole in the rear terminal strip. The on-off switch breaks the LT negative lead, one side being taken direct to the panel. All baseline connections are taken to the nearest point on the chassis; for instance, the negative filament terminals on the valveholders are taken to the bolts securing the holders. When connecting up the Bulgin transcoupler the HT positive is taken to the *low* resistance terminal. It should not be overlooked that the HT positive SG connection is taken to what is usually the grid pin on the SG220SW valve. When fixing the slow motion dial the maker's instructions should be carefully followed.

On completion no difficulty should be experienced in getting the set to operate as there are practically no initial adjustments. An HT voltage of about 120 volts gives best results with 75 volts on the SG of the RF valve, but the set will work quite satisfactorily with HT batteries as low as 75 volts. C3 is set with its screw about half undone. If the layout and wiring shown in the drawings have been adhered to the ganging of the two tuning condensers should be correct without further adjustment, but in order to check whether this is so or not the following procedure should be carried out. After having tuned in a fairly strong signal with the dial at about 90 degrees, preferably with the lower-frequency coils in position, loosen the grub screw on the flexible coupler so that the spindle of the RF tuning condenser C1 can be rotated independently of the detector tuning condenser C2. C1 is then varied so as to bring the signal up to a maximum. If it is found that less capacity is required on C1 to bring the RF circuit into tune C3 should be slightly increased. This will mean that C2 has to be reduced to receive the signal, and after having retuned this condenser the above procedure is repeated until the signal is received with the moving plates of both tuning condensers in the same position. If it is found that C1

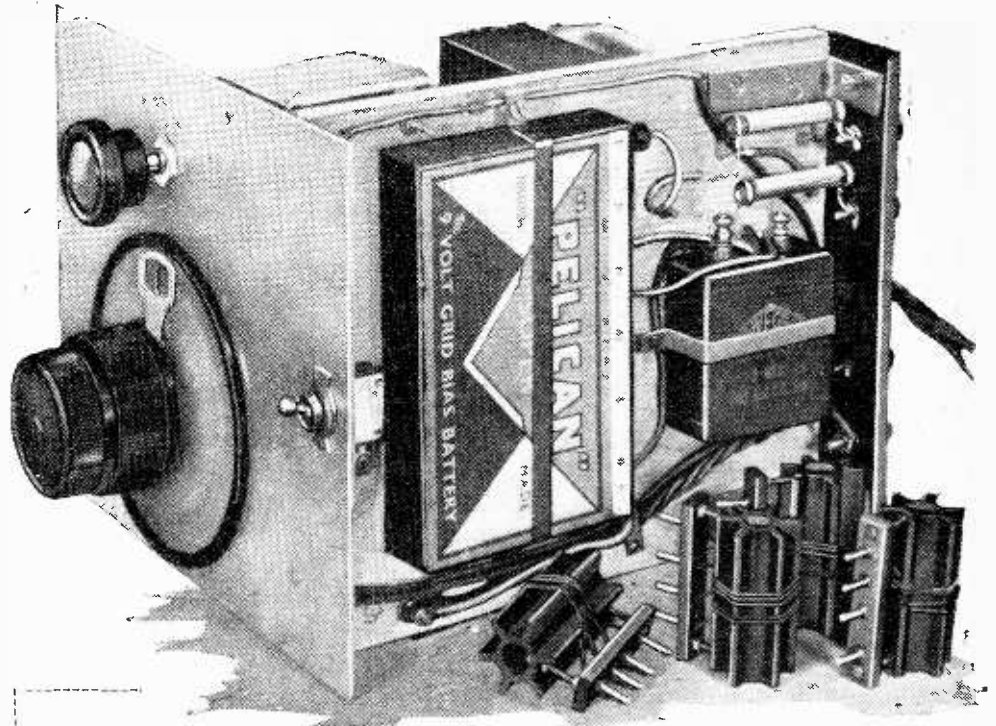

The grid battery, telephone RF chokes, condenser C8, filament and HT wiring are all accommodated below the base-board.

has to be increased for peak tuning C3 should, of course, be decreased in value.

The following ranges and dial readings are those covered by the various coils. For the highest frequency range the two-turn coils are used and the coverage is approximately 62 to 42 Mc/s. The 56 Mc/s amateur band is centred about 50 degrees on the scale. The next range, three-turn coils in this case, covers 48 to 32 Mc/s and the 41.5 Mc/s television sound transmissions tune in at about 70 on the scale. For the lowest range four-turn coils are employed, and these give a coverage of 34 to 21 Mc/s and bring in the 28 Mc/s amateurs round about 70 on the scale.

In conclusion it may be as well to remind those new to ultra-high frequency listening not to be disappointed if no signals are heard on any particular day,

especially with the approach of the summer months. However, those within 80 miles or so (in most directions) of Alexandra Palace will be able to test on the television transmissions when conditions for longer distances are poor.

The Radio Industry

According to the official organ of the Industrial Development Association of Wolverhampton, the local firm of Reproducers and Amplifiers, Ltd., has secured contracts in New Zealand and Estonia in the face of heavy competition from America and Germany respectively.

A system of controlling traffic by loud speakers—believed to be the first of its kind—is being installed by the G.E.C. at the newly opened Kincardine-on-Forth Bridge. The controller will be stationed in a cabin on the crown of the bridge; a projection speaker is mounted at each end.

Two hundred and twenty Philco receivers have been supplied to the education authorities of Uruguay for use in the State schools of that country.

The new edition (price 6d.) of a booklet issued by the V.G. Manufacturing Co., Ltd., Gorst Road, Park Royal, London, N.W.10, describes at length the Simplat system of home recording.

Recent additions to the range of test apparatus produced by Marconi-Ekco Instruments, Ltd., comprise an ultra-short-wave signal generator, a valve inter-electrode capacity tester (0.0001 to 1.0 mmfd.) and a resonance test set. Leaflets describing these instruments are available. Address: Electra House, Victoria Embankment, London, W.C.2.

A. Barson and Co., Ltd., have issued a leaflet describing a universal saw set; the saws should be useful to wireless constructors as well as for general purposes. Messrs. Barson's new address is: Lysian Buildings, 111, City Road, London, E.C.1.

The price of £3 19s. 6d. for the Reid "Pocketphone" receiver, quoted last week, does not include the case; leather and canvas cases cost respectively 12s. 6d. and 5s. 6d. extra.

LIST OF PARTS.

Certain components of other makes but of similar characteristics may be used as alternatives to those given in the following list.

- | | | |
|---|---|-----------------------------|
| Condensers: | 1 Switch, QMB on/off, S1 | Bulgin S80 |
| Variable | 1 Transcoupler, T1 | Bulgin LF10 |
| 2 40 mmfds., C1, C2 | 2 Valve holders, 4-pin | Eddystone "Frequentite" 949 |
| Eddystone "Microdenser" 900/40 | | W.B. Rigid Type |
| 1 20 mmfds., C5 | 1 Valve holder, 5-pin | Bulgin BC3 |
| Eddystone "Microdenser" 900/20 | 1 Battery cable, 5-way | Ealex |
| 1 30 mmfds. mica, C3 | 4 Terminals | Ealex |
| Fixed | 5 Wander plugs | Ealex |
| 1 0.00005 mfd. mica, C4 | 2 Spade ends | Belling-Lee 1175 |
| 1 0.01 mfd. non-inductive, tubular, C6 | 2 Plug-top valve connectors | |
| Dubilier 4421/E | 1 Grid Bias battery, 9 volts | Bulgin K44 |
| 1 2 mfd. 700 volts test, C8 | 1 Knob for reaction condenser | Peto-Scott |
| 1 Dial, slow motion | Plymax base, 7x8x3/8 in. | |
| Utility "Micro-dial" W181 | Aluminium panel 7x8x1/8 in. and 2 brackets for RF condenser and detector valve holder | |
| 1 Flexible coupler | Miscellaneous: | Peto-Scott |
| Bulgin EH12 | Small quantity wire, screws, nuts, bolts, ebonite strip 7x1 1/2 x 1/4 in., two small panel brackets, etc. | |
| 1 Resistance, 5 megohms, 1/2 watt, R1 | Valves: | Hivac |
| Dubilier | 1 SG220SW, 1 D210SW, 1 Y220. | |
| 2 Section-wound SW chokes, Ch1, Ch2 | | |
| Denco | | |
| 2 Small RF 'phone chokes, Ch3, Ch4 | | |
| Denco | | |
| 1 Set of 6 coils (3 ranges) and 2 bases | | |
| Denco | | |

The



HIS MAJESTY at his desk in Buckingham Palace whence he will speak to his people at 8 o'clock on Coronation Day.

Copyright, "The Times"

THE focal point of the week's broadcast programmes is, of course, the ceremony of the Coronation of Their Majesties King George VI and Queen Elizabeth on Wednesday next, May 12th. This great national event will be outstanding in many respects, not the least of these being the enormous part broadcasting will play in this, the first coronation of an English monarch since its inception. Much has already been written both in *The Wireless World* and in the daily Press on what will be broadcast during Coronation Week, which heralds what promises to be the most brilliant season in the last quarter of a century. From all this it is obvious that the B.B.C. Programme Planning Department has gone "all-out" to provide listeners with the best possible entertainments and have ensured that the solemnity of the occasion is fittingly portrayed by services, commentaries, and talks.

REX IMPERATOR

ON the all-important day all B.B.C. transmitters will be "on the air" at 9.30, when, until 10.15, they will give the usual morning weather forecast, etc., followed by a summary of Coronation news. At 10.15 they will be switched over to an observation post some 30ft. high erected above the stands in the Green Park overlooking the forecourt of Buckingham Palace. From

here John Snagge will describe the scenes as the procession starts down the Mall. Then George Blake, from one of the observation boxes above Middlesex Guildhall facing Westminster Abbey, will portray the arrival at the Abbey of the peers, commoners, and Dominion delegates.

At Buckingham Palace

From the inner courtyard of Buckingham Palace, Harman Grisewood will describe the first appearance in public of Their Majesties on Coronation Day, when at 10.34 they leave the Palace. From his position Harman Grisewood will have an unimpeded view of them entering the ancient gilded State coach, and will be able to depict the scene as the Royal procession forms and moves away. By means of microphones placed over the arch of the palace doorway, sounds will be superimposed on his narrative, thereby enhancing the realism of his story.

As the State coach begins its journey down the Mall, John Snagge will again take up the story. Whilst the procession is journeying towards the Abbey, Howard Marshall, from the triforium, will picture the scene inside the Abbey as everybody awaits the arrival of the King and Queen. Michael Standing, from the Abbey annexe, will continue this pre-view of the scene which awaits Their Majesties.

Harold Abrahams will then be heard from his observation post outside the Ministry of Labour in Whitehall, where he will describe the scene as the State coach approaches and passes the Cenotaph and goes on to Parliament Square. George Blake will then resume his story from Middlesex Guildhall in time to picture the arrival of Their Majesties at 11 o'clock.

The Coronation Ceremony

As they move into the Abbey annexe, Michael Standing will tell of the marshalling of the Great Proceeding and of the memorable scene as the procession moves slowly up the carpeted aisle. Some thirty-eight microphones in the Abbey will convey to listeners the service. Occasionally the B.B.C. Director of Religion, the Rev. F. A. Iremonger, Chaplain to the King, stationed alongside Howard Marshall, will read and, where necessary, explain the rubrics. The only part of the service which will not be broadcast is that from the end of the Sanctus (the Ascription "Holy, holy, holy, Lord God of hosts,") to the beginning of the Lord's Prayer. This includes the administration of the Sacrament to the King and Queen. During this break in the broadcast the hymn "Let all mortal flesh keep silence" will be broadcast by the B.B.C. Singers

from St. Margaret's Church, Westminster. At the conclusion of the service Howard Marshall and Michael Standing will co-operate in describing the final scenes in the Abbey and its annexe.

The Return Journey: A Sound Picture

Their Majesties' drive in state to Buckingham Palace is expected to begin at approximately 1.40. George Blake will depict the scene as the cheering crowds, pealing bells, and barking guns proclaim the newly crowned King and Queen of England. On the return journey, instead of observers, four "atmosphere" microphones will tell the story by reproducing the sounds as the procession passes. These will be placed at approximately eight-minute intervals—the first at the Victoria Embankment end of Horse Guards Avenue, the second in Trafalgar Square, close to the statue of King Charles I, the third on the roof of St. James's Palace, and the fourth on the balcony of a building in Piccadilly Circus. The sounds thus picked up will be interpreted by S. J. de Lotbinière, the Outside Broadcasts Director, as each microphone is brought into circuit.

As the procession nears Constitution Hill, Thomas Woodroffe, from his observation post by the Quadriga—the four-horse statue surmounting Wellington Arch—will have a wide view of the approaching cavalcade. He will, as it passes beneath him, be the only commentator to have the opportunity of describing the two-mile-long procession from beginning to end.

John Snagge, from his post, will picture the scene as Their Majesties, at approximately 3.10, arrive at the Palace and, as is expected, appear on the balcony.

A Masterpiece of Organisation

To ensure the smooth running of such a complicated and intricately timed O.B., an elaborate series of cue sentences has been arranged so that each observer will be able to indicate that his description is finished, thus enabling the next commentator to continue without a break.

Royal Week—A Guide to the Principal Broadcasting Events

—BY THE AUDITOR

Each observation point will be fed with the whole broadcast programme so as to maintain continuity.

At the conclusion of such a masterpiece of organisation I am sure we will one and all be thankful that we have been enabled to take part in the service and celebrations via the ether whether having heard the broadcast along the route or in our own homes.

GREETINGS

KING GEORGE V was, in a special way, endeared to the hearts of his people. This was undoubtedly largely due to his regular Christmas Day broadcasts to the peoples of the British Empire, through which he seemed to have a personal link with his subjects. His Majesty King George VI will speak to his Empire from a room in Buckingham Palace at 8 o'clock on the day of his Coronation. It will be a unique and historic occasion—the first on which a King, through the medium of broadcasting, has spoken to his subjects throughout the world within a few hours of his Coronation.

Preceding His Majesty's talk will come, for forty minutes from 7.20, "The Empire's Homage." Listeners will be taken westward round the world as they hear a chain of greetings from the peoples of the Empire to their newly crowned King. From Bermuda the Governor, Lt.-Gen. Sir Reginald Hildyard, will be heard. The Vice-Chairman of the Newfoundland Commission of Government, Mr. W. R. Howley, will speak from London, as will also the Prime Ministers of Canada, Mr. W. L. Mackenzie King; of New Zealand, Mr. M. J. Savage; of Australia, Mr. J. A. Lyons; and the Chief Minister

of Burma, Dr. Da Maw. Next will be heard the Viceroy of India, Lord Linlithgow, speaking from India. The Prime Ministers of Southern Rhodesia, Dr. G. M. Huggins, and of S. Africa, General J. B. M. Hertzog, will next be heard from London.

The programme will also embody some of the features which have become part of the Christmas Day broadcasts. For, in addition to the official greetings, representative citizens will be heard speaking from Canada, New Zealand, Australia, and S. Africa, as well as spokesmen of the King's people in the British Isles.

The greetings will be brought to a fitting conclusion by the Prime Minister of the United Kingdom, Mr. Stanley Baldwin, speaking from his residence in Downing Street. Fanfares to introduce the Dominion greetings have been composed by Arthur Bliss and will be played by the B.B.C. Military Band.

IN PREPARATION

THERE have been a number of programmes arranged which bear either on the historic or spiritual aspect of the Coronation, not the least important of these being the service in preparation for the Coronation, which will be broadcast from the Concert Hall, Broadcasting House, at 7.55 on Sunday. His Grace the Lord Archbishop of Canterbury will give the address; the Thanksgiving will be said by the Rev. M. E. Aubrey, M.A., Moderator of the Federal Council of Evangelical Free Churches; and the prayers by the Rt. Rev. Professor Daniel Lamont, D.D., Moderator of the Church of Scotland. The final hymn, the National Anthem, and a solemn fanfare will be broadcast from under the Dome of St. Paul's Cathedral, where members of the Coronation Choir, together with delegate singers from the Dominions,

Scotland, Wales, Ireland, and London, will be assembled. For this broadcast the B.B.C. is issuing a special souvenir order of service.

SYMBOLISM

ALL regular features and talks series have been suspended for this week, special programmes having been arranged to help listeners to realise the true significance and solemnity of the centuries-old ceremony of the Crowning of a King.

On Sunday, in the National programme, at 5, comes a talk entitled "What Mean Ye by this Service?" which is to be given by Laurence E. Tanner. In it he will emphasise the religious significance of the Coronation. Mr. Tanner, who is Keeper of the Muniments and sub-librarian at Westminster Abbey, has also written a history of the Coronation Chair. This will be broadcast at 4.30 (Reg.)



THE STATE COACH bearing Their Majesties King Edward VII and Queen Alexandra in the Coronation Procession on August 9th, 1902. The celebrations of this year will be recalled in "Scrapbook for 1902."

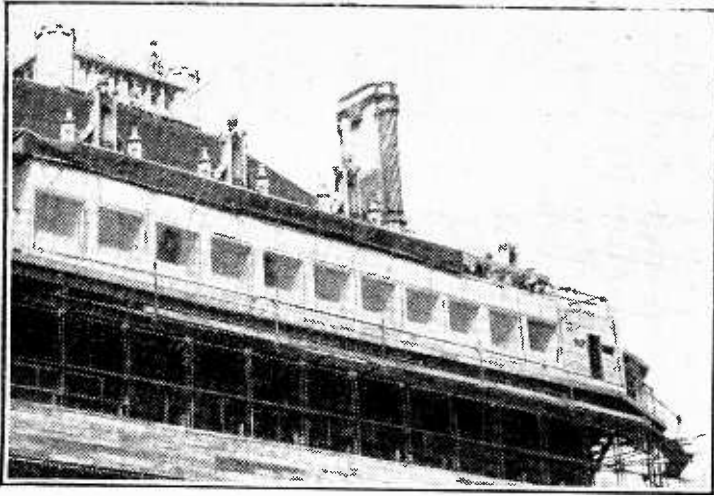

OBSERVATION BOXES erected above the stands at the Middlesex Guildhall. From these the commentators of many countries will see . . .

on Sunday, headed "The King's Chair." In it he will trace the history of the chair from its installation in the Abbey by King Edward I to the present time. Although intended for the children, this broadcast will doubtless prove interesting to adult listeners also.

Later on Sunday, at 9.20 (Reg.), Felix Felton will produce a feature programme which he has compiled, entitled "The King's Anointing." It will trace the continuity of Kingship and the story of the Coronation through the centuries. An adaptation of this programme will be broadcast for children on Coronation Day at 5.15 (Reg.).

THIRTY-FIVE YEARS AGO

ADDED interest will be given to the broadcast of the next Scrapbook, compiled by Charles Brewer and Leslie Baily, which will be broadcast to-night (Friday) at 8 (Nat.) and on Saturday at 6 (Reg.), since it covers the year 1902, which included the Coronation of King Edward VII. The similarities and differences between the two periods of festivity will be brought out by the collaborators in this programme. It is hoped that personalities in various walks of life who have memories of the ceremonies of 1902 will recall their impressions of the events. Among these will be Captain W. A. Featherstone, who was one of the State trumpeters at the Coronation.

Another important happening of the year was the end of the Boer War. Cecil Rhodes did not live to know of this, for he died on March 26th.

The entertainment world, as

was to be expected in a Coronation Year, was full of activity, and this will be suitably portrayed.

CORONATION PARTY

A TOPICAL counterpart of the now well-established Christmas Radio Party will represent radio's contribution to the jollifications of Coronation Day. Charles Brewer, who is in charge, has invited the following well-known artistes, who have all intimated their intention of being present: Elsie and Doris Waters, Jeanne de Casalis, Clapham and Dwyer, the Two Leslies, Leonard Henry, Davy Burnaby and Michael North. Bryan Lawrence, Jan van der Gucht, Raymond Newell and Stuart Robertson, four vocalists well known to listeners, will, as a quartet, sing humorous part-songs. The Revue Chorus and the Theatre Or-

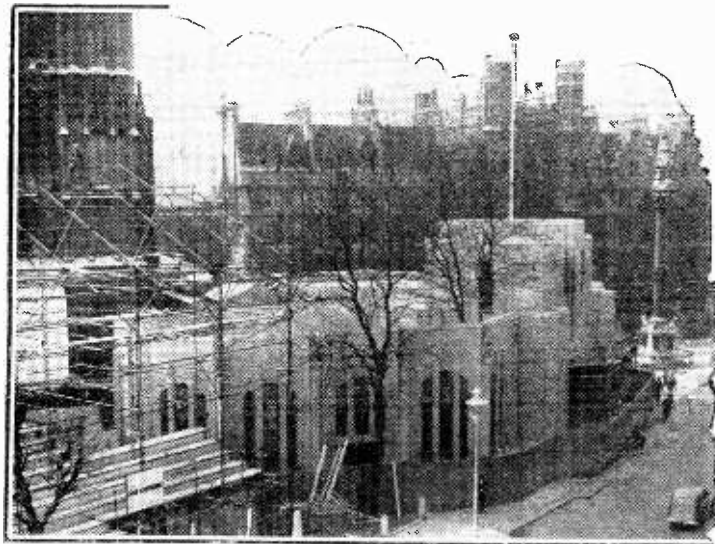

. . . THE ABBEY ANNEXE as the people arrive. This view was taken by a *Wireless World* photographer from one of the boxes before the hoarding around the annexe had been removed. The scaffolding on the left is for the stands.

chestra will be in attendance. The party, which is due to begin at 8.15 (Nat.), will run for 75 minutes.

GALA REVUE

THE Coronation Gala Radio Revue, which is to be broadcast twice during this week, on Tuesday at 8 (Nat.) and on Thursday at 7.30 (Reg.), will be produced by Harry S. Pepper and John Watt. The book has been specially written by Douglas Furber, his first work for the B.B.C. He is, however, well known to theatre-goers as the author and part-author of many successful West End shows, numbering more than fifty. His songs, ranging from "The Bells of St. Mary's" to "Limehouse Blues," have sold in thousands.

George Robey will take the part of a waiter, Wilson Hallett will be an exceptionally unpleasant child and Mabel Constanduros will be mother. The cast also includes Sir Frank Lawton, Cecily Courtneidge, Leslie Hutchinson ("Hutch"), Wynne Ajello and the Western Brothers.

Reginald Foort will be at the Theatre Organ, Harry Pepper and Doris Arnold at two pianos, and pipers will be under the direction of Pipe-Major McIntosh. The Variety Orchestra and a chorus of 16 voices will be conducted by Mark H. Lubbock.

"MERRIE ENGLAND"

SPECIAL arrangements have been made for the production of Sir Edward German's "Merrie England" in the

National programme on Sunday at 9.20 and Regionally on Monday at 7.30, so that it will be thoroughly coherent in its radio version, although bereft of its spectacular stage pageantry.

Mere narration would destroy the 16th-century atmosphere, and in place of a narrator three imaginary 16th-century players have been substituted. These are Walter Wilkins, who is supposed to have written the piece; Jill Purtle, who is cast for a leading rôle; and Silas Simkins, a second-rate comedian who wants to play all the male parts. In the conversation and wrangling between the three of them, the story of



N.B.C. Photograph

FROM AMERICA. Rudy Valee, the well-known American band leader and crooner, who will be heard with guest artistes in the National programme on Saturday at 8.

"Merrie England" will be told, whilst the music will be rendered by singers, the B.B.C. Revue Chorus, and Theatre Orchestra. Stanford Robinson is returning from Italy to conduct this production, which will be heard in St. George's Hall.

VISITORS TO LONDON

FIVE continents will be represented by interesting personalities who will come to the microphone during the week's broadcasts of "In Town Tonight." The producer, A. W. Hanson, will choose from the multitude of visitors to the metropolis representatives of Europe, Africa, Asia, America and Oceania, thus bringing to listeners a unique picture of life in all parts of the world. Who they will be, however, must remain a secret until they broadcast. "In Town Tonight" will be heard in the National programme at 7.40

from Monday to Saturday of Coronation Week with the exception of Wednesday.

BRITAIN DANCES

THE dance music highlight of the week will occur on Coronation night, when, from 10.15 until 1 the following morning, a programme entitled

HIGHLIGHTS OF THE WEEK

FRIDAY, MAY 7th.

Nat., 6.25, Sullivan programme: B.B.C. Orchestra (E). 8, Scrapbook for 1902.

Reg., 7.30, The King's Health—History of health drinking and toasting. 9.5, "Aida".

Abroad.

Rome, 9, Gomez festival programme from La Scala, Milan.

SATURDAY, MAY 8th.

Nat., 3.45, Rugby League Cup Final. 8, Rudy Vallee.

Reg., 6, Scrapbook for 1902. 8.15, Debate: "This Planning Business."

Abroad.

Kalundborg, 8, Act I of "The Count of Luxembourg." (Léhar).

SUNDAY, MAY 9th.

Nat., 3.30, Viennese Music relayed from Vienna. 7.55, Service in preparation for the Coronation. 9.20, "Merrie England."

Reg., 5, Stiles Allen (soprano) and the B.B.C. Military Band. 9.20, "The King's Anointing." 10, Purcell's "Sound the Trumpet."

Abroad.

Stuttgart, 7.30, Verdi's "Tosca."

MONDAY, MAY 10th.

Nat., 8, Sir James Barrie's "Dear Brutus."

Reg., 7.30, "Merrie England." 8.35, Ystalyfera and District Choral Society and the Band of H.M. Welsh Guards.

Abroad.

Kalundborg, 9.25, Concert version of "The Mikado."

TUESDAY, MAY 11th.

Nat., 8, Gala Radio Revue. 9.50, Memories of the Coronation of King George V.

Reg., 6.45, Talk "Playing for England," by Patsy Hendren. 7.30, "Dear Brutus." 9.10, "Carmen."

Abroad.

Paris PTT, 8.30, Reynaldo Hahn conducting a concert of his music.

WEDNESDAY, MAY 12th.

Nat., 10.15-3.30, Coronation Broadcast. 7.20, The Empire's Homage. 8, His Majesty the King. 8.15, Coronation Party.

Reg., 10.15-3.30 and 7.20-8.15 National programme. 8.45, "King's Post." Letters from kings and queens. 10.15, Britain Dances.

Abroad.

Radio Paris, 8.30, Famous lovers in opera and operetta.

THURSDAY, MAY 13th.

Nat., 6.30, Band of H. M. Coldstream Guards. 8, Choral and Orchestral concert. 10.25, Albert Hall Costume Ball.

Reg., 7.30, Gala Radio Revue. 9, "Gradelly Folk," programme on rural areas of the North.

Abroad.

Lyons PTT, 8.30, Operetta music.

"Britain Dances" will be transmitted. In this, dance bands from all over the country will co-operate in a chain of fifteen-minute programmes linked together by and alternating with the B.B.C. Dance Orchestra. The bands have been chosen as representative of the areas from which they will be broadcasting, and they will thus furnish a sound picture of Britain celebrating in dance the crowning of the King.

PROCESSION ROUTE IN MUSIC

A DESCRIPTION in music of the Royal Procession route to and from Westminster Abbey will be broadcast by the Variety Orchestra in the National programme on Sunday afternoon. Composers have written many popular works on the sights of London, and most of the important thoroughfares have been portrayed in music. The programme will include a Coronation march, "Royal Cavalcade," specially written by Albert Ketelby.

THE CORONATION ABROAD

THE great day will be duly celebrated abroad in the broadcast programmes of the five continents. The B.B.C. has provided ten observation boxes at the Middlesex Guildhall and



four in Green Park near Buckingham Palace for commentators to broadcast descriptions of the scenes to their respective countries. It has been necessary to make these soundproof in order to ensure there is no interference from adjacent commentaries. The effects, therefore, are being provided by outside microphones. In addition to the commentaries in

English, for the U.S.A., the following languages will be used:—Czech, Danish, Dutch, Finnish, Flemish, French, German, Hungarian, Japanese, Norwegian, Spanish (for the Argentine) Swedish and Yugoslavian.

Many stations will be relaying the address of His Majesty in the evening.

In compliment to England, a number of European stations are incorporating English music in their programmes for Wednesday. Kalundborg at 8.5 gives a Henry Purcell orchestral concert, and at 10.25 a programme of light English music. The same station, at 9.35, will radiate a speech by the Danish Foreign Minister, M. P. Munch, expressing his country's congratulations to our King and his people.

From Radio Luxembourg on Tuesday at 6.30 the Rt. Hon. Winston Churchill will give a talk on the Coronation in French and English.

OPERA

Two relays from the Royal Opera House grace the programmes again this week. The first is to-night (Friday) at 9.5 (Reg.), when the second act of Verdi's "Aida," with Martinelli as Radames and Gina Cigna in the name part, with a mainly Italian cast. The action takes place at Memphis and Thebes in the time of the Pharaohs. The second is on Tuesday, when Act 2 of Bizet's "Carmen" will be heard at 9.10 (Reg.). Sir Thomas Beecham will be conducting and there will

PETER DAWSON, the world-famous Australian singer, with Miss Vera Buck, an Australian composer. He will be singing one of her songs, "Reminiscence," in his broadcast recital on Wednesday at 6.45 (Reg.).

be a new Carmen in the person of Renée Gilly, who is the daughter of the well-known baritone, Dinh Gilly, while Don José will be sung by the famous French tenor, Georges Thill.

The week is also rich in opera from abroad. To-night (Friday) we have that perennial delight, "Figaro," relayed from Romania's Royal

Opera House by Bucharest at 7.35, and something less familiar, Mussorgsky's five-act "Khovanschina," from Budapest No. 1 at 8.15. Mussorgsky's colourful music drama is something as intensely and touchingly national as any Russian music we know. The scene opens with dawn on the river Moskva, and as the sun rises the gathering light reveals the



COMMENTATOR for the N.B.C. Coronation broadcasts. Blevins Davis, Yale University authority on British history, studying imitations of the Crown Jewels.

Holy of Holies to all Russians—the Red Square in Moscow. The action takes place in the time of Peter the Great. The opera, on which the composer worked for many years yet left only in a provisional rough draft at his premature death at the age of forty-two, was overhauled and finished by his friend, Rimsky-Korsakov.

On Saturday at 9, Milan gives "Il deserto tentato," the work of a contemporary Italian composer of first rank, Casella, as well as the seldom-heard comic opera by Rossini, "Il Signor Bruschino." Both of these will be relayed from the Teatro Comunale, Florence. These two operas will also be heard from Rome on Wednesday at 9. Sullivan's immortal "Mikado" comes from Munich on Saturday at 8.10 and from Kalundborg on Monday at 9.25. "Tosca," with a particularly fine cast, comes from Stuttgart on Sunday at 7.30. On that evening also "Tiefand," the masterpiece of that dynamic Glasgow-born genius, Eugen d'Albert, comes from Frankfurt at 8. Thursday brings us the three-act comic opera, "Die drei Pintos," by the king of German romantic composers, Weber.

Why the Triode-Hexode ?

PART I.—DEVELOPMENT OF THE 1ST-DETECTOR TYPE OF FREQUENCY CHANGER

IN this introductory article the author traces the development of the superheterodyne frequency changer, and provides graphical explanations of the difficulties encountered with early frequency changers and the reasons for the development and present popularity of the triode-hexode.

EVER since the invention of the superheterodyne method of reception in 1917, frequency changing has been the ever-present problem. Every development, though hailed as the final solution, has been found to bring new difficulties in its train.

In the early days, two valves were invariably required for changing frequency, one valve functioning as an oscillator while in the other the mixing of the desired

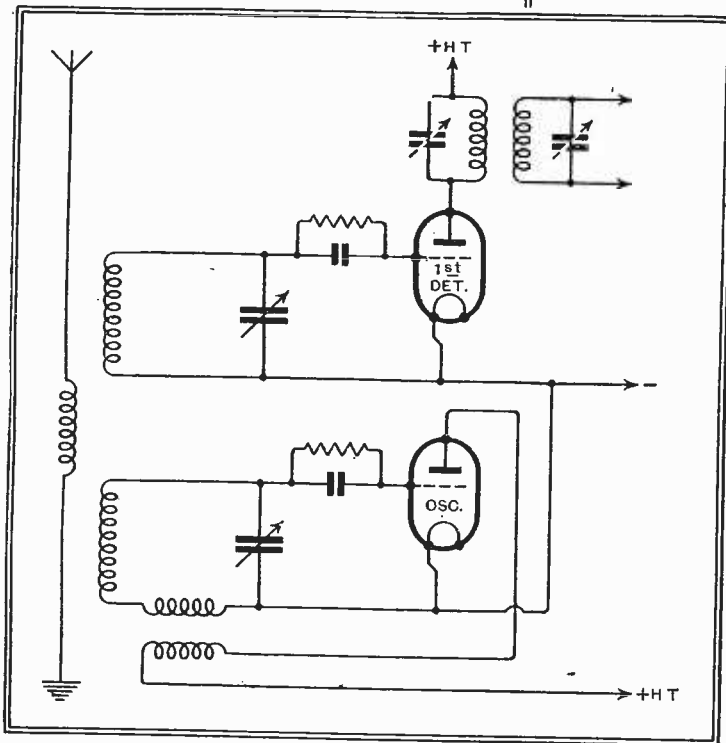

Fig. 1.—The classical frequency-changing circuit.

signal frequency with that of the oscillator took place, and so was produced a third frequency, the so-called intermediate frequency, to which the anode circuit of the mixer was tuned. As it was found that, in those early mixers, a larger IF output was obtained when the incoming signal was rectified, it was assumed that this

By J. A. SZABADI
(Technical Department, Tungsum Electric Lamp Works).

valve had to be a detector, and hence it was called the first detector. The actual demodulator which turned the radio frequency into audio frequency, and which

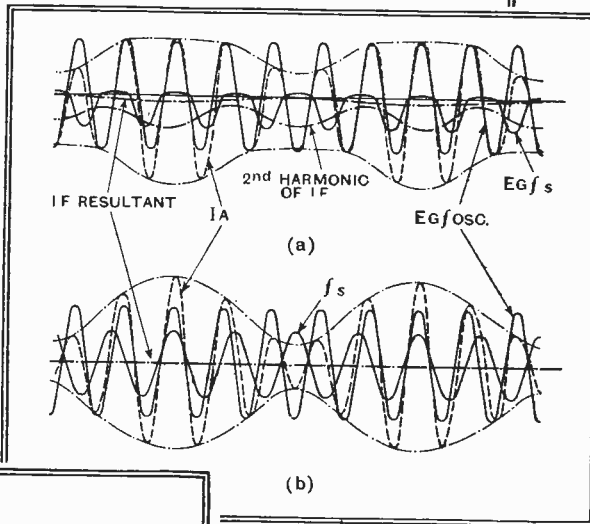

Fig. 2.—Diagram (a) shows additive mixing in grid-rectifying 1st detector; no beat-frequency is produced by additive mixing when rectification is absent as in diagram (b).

was situated after the IF amplifier, naturally became the second detector. We now know that this early rectification is by no means

essential or axiomatic, and was only a consequence of the type of mixing used in those early days, and, in fact, it will be shown that rectification in the mixer in modern valves is actually to be avoided at all costs, as its presence is responsible for nearly all the troubles which caused the superheterodyne set to be shunned by many of the early enthusiasts.

The Levy-Armstrong mixer circuit (Fig. 1) was a pure additive mixer, i.e., the amplitudes of the input signal and the oscillator wave were added together arithmetically. If we examine Fig. 2b, it will be seen that the resultant IF amplitude of pure addition is zero, and it is only when rectification is present, as in Fig. 2a, that a resultant IF amplitude is produced. It will be readily appreciated that it does not matter which frequency is rectified, whether the signal frequency or the oscillator frequency, or both, for in

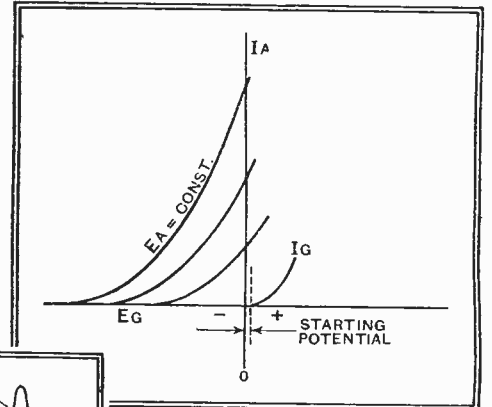

Fig. 3.—The starting potential in early valves was generally in the positive region of grid potentials.

essential or axiomatic, and was only a consequence of the type of mixing used in those early days, and, in fact, it will be shown that rectification in the mixer in modern valves is actually to be avoided at all costs, as its presence is responsible for nearly all the troubles which caused the superheterodyne set to be shunned by many of the early enthusiasts.

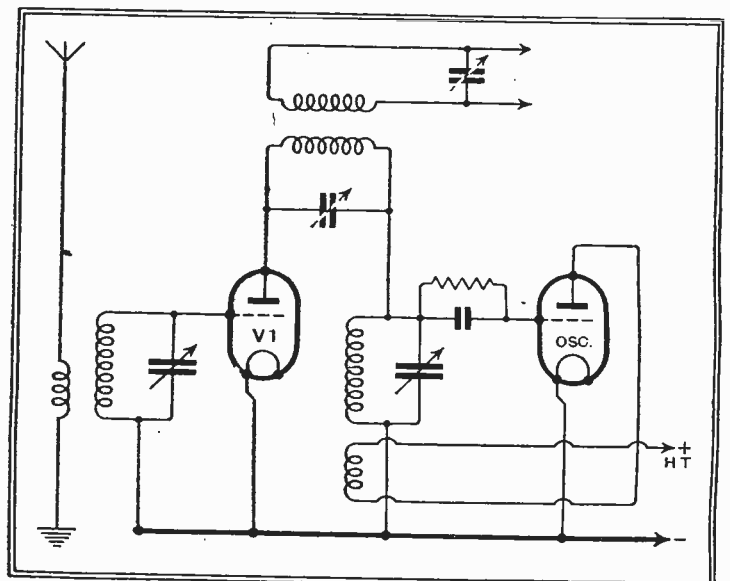

Fig. 4.—“Ultra-dyne” circuit in which V1 is not a grid detector, but virtually an RF amplifier with anode rectification of the oscillator voltage, which is applied in place of the usual steady HT voltage.

Why the Triode-Hexode?—

either case beat notes are produced. Levy and Armstrong both used this method, and hence they introduced the term first detector.

Even the early experimenters recognised the serious limitation of this method; the sensitivity of the whole receiver was limited by the threshold value of the grid leak rectifier. Practically all valves in those days had their grid current

starting potential in the positive region, which meant that unless the grid bias was very critically adjusted the detector would only respond to a signal larger than this limiting value (Fig. 3). In modern terminology, the receiver squelched all signals below a certain value. This was very inconvenient because in those days all stations were very weak, and such a limitation was looked upon as a very serious handicap.

In the early twenties a great advance

bias, the valve passed no grid current, and thus acted quite well as an RF amplifier of very small signals. Fig. 5 shows the actual sequence in time. (As this type of mixing very closely resembles a strobo-

was different, being mainly additive. In this arrangement the oscillator frequency is rectified by space-charge grid action, the first grid having a slight positive potential. The second grid—the modulator electrode in this case—does not directly affect the cathode space charge, and acts only as an amplifier control grid; it should

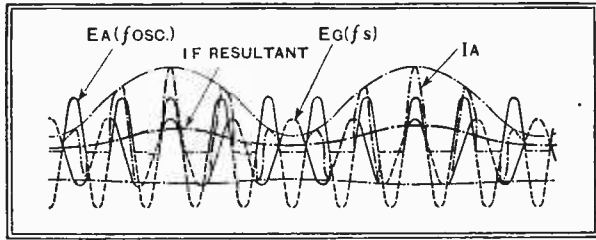

Fig. 5.—Showing additive mixing in "Ultra-dyne" circuit.

scopic action it was later called "Strobodyne" in America.)

At about the same time an entirely new type of mixer circuit made its appearance on the Continent. Only one double-grid valve was required

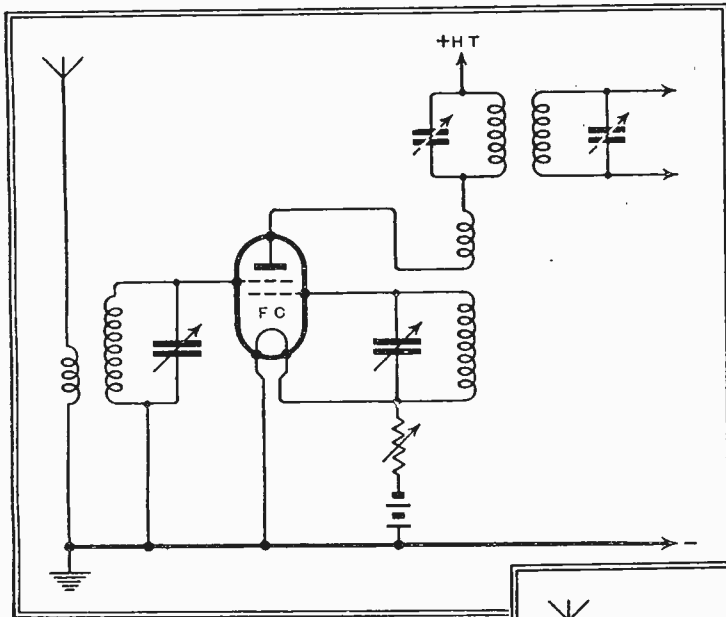

Fig. 6.—(Above). The first single-valve mixer circuit, as widely used on the Continent. Fig. 7.—(Right). Cathode injection mixer, made practicable by the introduction of the indirectly-heated SG valve.

was made when, in the so-called "Ultra-dyne" circuit, grid rectification in the first detector stage was dropped in favour of anode rectification (not anode-bend) of the large-amplitude oscillator frequency while letting in the minute signals from the weak distant stations in an uninterrupted unrectified condition.

It will be seen from Fig. 4 that from the point of view of the incoming signal, the mixer valve is really an RF amplifier, whose anode voltage is varying continuously, it being supplied by the oscillator and not by an HT battery. The slightly positive starting potential of early valves actually favoured this circuit, as, with zero

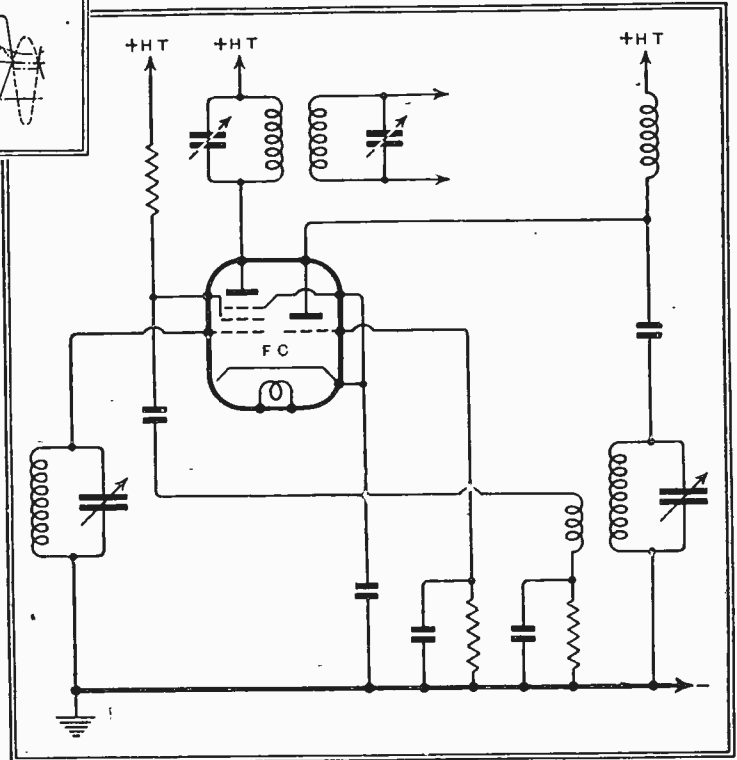

Fig. 8.—Cathode-coupled circuit with triode-pentode valve.

to perform the combined functions of oscillating and mixing (Fig. 6). Although this circuit closely resembles that used with more recent multigrad converters, its action

be slightly negative with respect to the grid current starting potential.

The mixer action in this case is also mainly additive, and very similar to that shown in Fig. 2a. The more asymmetrically the valve oscillates, due to the positive space-charge grid, the greater is the IF output.

About 1929 the Americans produced their first mains-operated screen-grid valve, Type 24. They no doubt tried to use this four-electrode valve in a circuit similar to Fig. 6, but could not have been very successful, due to the entirely different construction of this valve, and very soon a special circuit suited particularly to this type of valve was evolved (Fig. 7). This was generally called the cathode injection mixer circuit, and in it the input signal is rectified by anode-bend detection.

This one-valve frequency changer,

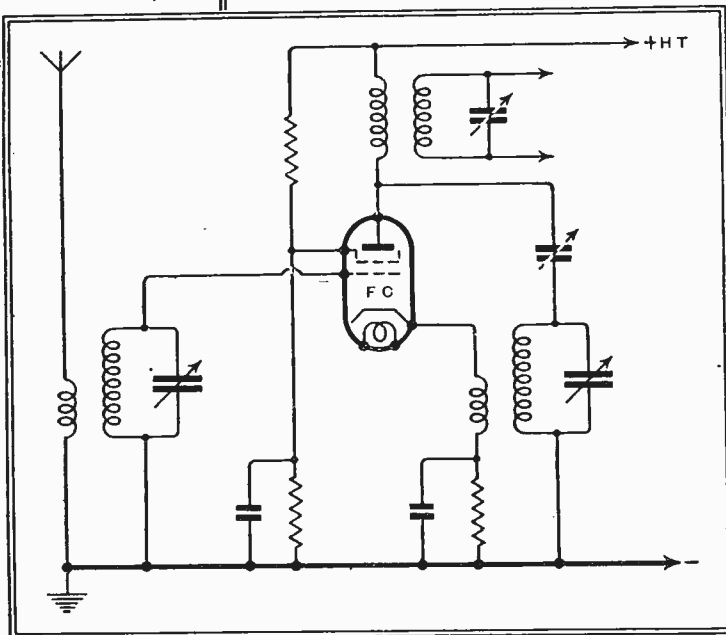

Why the Triode-Hexode?—

though very efficient, had all the disadvantages of the additive method, which were mainly whistles and cross-modulation. These troubles were even more pronounced, because overall sensitivities were now much greater. An additional shortcoming was a considerable variation in sensitivity over the tuning range, due to the difficulty of designing a suitable stable oscillator system which would not "squeg."

In 1933 attempts were made in this country to use the same circuit, but with an output pentode in place of the screened tetrode. This arrangement was superseded in 1934 by the Mazda cathode-coupled triode-pentode (Fig. 8).

This circuit was a considerable improvement on previous types, and can be said to have been the best of all the additive mixer systems. Cross-modulation was greatly reduced, but due to the cathode coupling there were still inherent faults, namely, a tendency towards cross-modulation on strong signals and pulling or interlocking on weak stations or on shorter wavelengths; also, the possibility of modulation hum, particularly in AC/DC sets, was increased, due to the floating cathode.

Abnormal Short-Wave Conditions

Complete Interruption at Times

DURING the past fortnight there has taken place one of the most extensive failures of short-wave communication to Canada and the U.S.A. on record.

The disturbance started abruptly at 21.00 G.M.T. on Saturday, April 24th, as far as short-wave communication was concerned, but the magnetic traces at Abinger first began to show signs of disturbance at 11.00 G.M.T. on the same day. It was not surprising, therefore, to see reported in the correspondence columns of *The Times* for April 27th that a bright auroral display had been witnessed during the early morning of April 25th from the Chilterns between Tring and Dunstable. The auroral arch was bluish-green in colour with three nearly equidistant shafts of shimmering reddish light which extended high into the heavens.

Halifax, Nova Scotia, in a more northerly latitude, reported that on the night of April 27th the aurora was so brilliant as almost to floodlight the town!

Whilst writing these notes one learns that short-wave communication with Canada is still disrupted, whilst in the case of the U.S.A. conditions are very erratic and reception alternates from 21-17-15 or 9 Mc/s.

Reception from the south and south-west has, however, been relatively unaffected, but conditions to the west have at times been quite poor, though not disturbed to the extent of wholesale dislocation.

Even the cable circuits have had unworkable periods due to earth currents.

The cause of all this trouble has probably been an active sunspot group, comprising three major spots of area 1,750, 900, 700 millionths of the sun's hemisphere respectively.

This group is at the moment disappearing over the west limb, but it is possible that

the "storm" is due to another smaller region which appeared over the east limb near the time of the start of the short-wave disturbance. The larger spots do not always appear to be the most active. Finally, one remarkable feature is that during the very poor conditions on Saturday 28 Mc/s signals suddenly came in in fine fettle from India! Was this E region bending?

Distant Reception Notes

AS I write, the Conference summoned at the instance of Holland is still discussing the state of the long wave band and endeavouring to find some means of cleaning things up a little. Hilversum No. 1 seems at last to have realised that it cannot go on holding on to the wavelength of 1,875 metres, which was allotted under the Lucerne Plan to Brasov. In June, 1933, when the plan was drawn up, the Romanian transmitter was rated at only 1 kilowatt. Huizen, as Holland's long wave was then known, refused the wavelength of 1,345 metres offered to it and, feeling sure that it could shout down the feeble Brasov, grabbed the 1,875-metre channel on the plea that it had established a right to it by long use.

Since Brasov, now known as Radio Roumania, went up to 150 kilowatts the Dutch station's transmissions have been badly interfered with even in Holland. It is interesting to note that of late Hilversum No. 1 has been heard testing after programme hours on 1,186 metres. Under the Lucerne Plan this wavelength belongs to Norway, and it is actually used by Vigra, or Aalesund, to give it its better-known name.

Norway, however, is entitled to only one long wave channel, though at present it has Oslo working on 1,153.8 metres (a channel that does not appear in the original Lucerne Plan), as well as Aalesund on 1,186. The latter is only a 10-kilowatt station and Norway might be induced to give up the wavelength, synchronising Aalesund with one or more of her other stations.

Would Hilversum find the 1,186 metre channel acceptable? The corresponding frequency is 253 kcs. The next door neighbours in Europe are Kiev on 248 kcs. and Oslo on 260; there is thus a frequency separation of 5 kilocycles on one side and 7 on the other. This makes rather a tight fit, but it should be a good deal better than having a station right on your wavelength. There is also Tashkent, only 3.4 kilocycles away; but Tashkent, rated at 25 kilowatts, is in distant Turkestan and would probably cause no trouble.

The Inter-American Conference, which meets towards the end of the year, will have some knotty problems to deal with. Canada and the United States arrived years ago at a *modus vivendi*, both countries agreeing to organise their distributions on a 10-kilocycle basis and each recognising the other's exclusive right to certain channels. All went well until broadcasting began to grow by leaps and bounds in Central and South America.

You don't realise how many separate countries there are in that part of the world till you examine an atlas—over twenty of them are to take part in the Autumn Conference. No wonder the problem of interference between stations in different countries has become serious.

After a good deal of experimental work,

the Indian broadcasting authorities have come to the conclusion that the lower medium wavelengths are going to give the best results in most places. I have not yet heard the reason officially given for this, but it may be because reception on such wavelengths is found to suffer less from atmospheric interference. Atmospherics can be poisonous in many parts of India.

Be that as it may, seven out of nine of the wavelengths now announced are below 300 metres. The remaining two are Delhi, 340 metres, and Trichinopoly, 397.

The first of the new transmitters is expected to be at work in August, and the remainder should all be in action within less than a year from then. D. EXER.

Television Programmes

Transmissions are from 3-4 and 9-10 daily (except May 12th).

Vision:	Sound:
45 Mc/s.	41.5 Mc/s.

FRIDAY, MAY 7th.

3, Starlight: Dances by Vera Zorina, star of "On Your Toes" at the Coliseum. 3.15, Friends from the Zoo. 3.30, Gaumont-British News. 3.40, Theatre Parade; Flora Robson in Act II of "Anna Christie" as produced at the Westminster Theatre. 9, Clifford Stanton in impressions. 9.10, Repetition of 3.15 programme. 9.25, British Movietonews. 9.35, "Vauxhall": a masque of Vauxhall Gardens.

SATURDAY, MAY 8th.

3, For the Children—Paul Leyssac reading two of Hans Andersen's stories. 3.10, Bruce Bairnsfather, creator of "Old Bill" Cartoons. 3.20, British Movietonews. 3.30, Cabaret with Hildergarde, Rudi Grasl and the Metaxa Girls. 9, Wynne Ajello (songs). 9.10, "The 'ole in the Road"; sketch by Seamark. 9.25, Gaumont-British News. 9.35, Scenes from John Drinkwater's play, "Abraham Lincoln."

MONDAY, MAY 10th.

3, Starlight: Jane Carr. 3.10, The World of Women (III)—Anything New? 3.25, British Movietonews. 3.35, Cabaret Parade. 9, Starlight: Phyllis Robins (songs). 9.10, Repetition of 3.10 programme. 9.25, Gaumont-British News. 9.35, Repetition of 3.35 programme.

TUESDAY, MAY 11th.

3, The Markova-Dolin ballet. 3.15, Gaumont-British News. 3.20, Arrangements for televising the Coronation Procession explained by the Director of Television. 3.30, Fifty-third Picture Page. 3.55, Gaumont-British News. 9, Irene Scharrer (piano). 9.15, Repetition of 3.20 programme. 9.25, British Movietonews. 9.35, Fifty-fourth Picture Page.

WEDNESDAY, MAY 12th.

Transmission starts at 2. Part I providing views of the park and the crowds and Part II the complete procession. Transmission ends approximately at 3. 9, The Poet Laureate will read his Coronation Ode. 9.5, Music Hall Cavalcade. 9.50, Gaumont-British News.

THURSDAY, MAY 13th.

3, Screen Scene. 3.10, Masks through the Ages—IV (conclusion). 3.25, Gaumont-British News. 3.35, Harry Roy and his band with his wife, Princess Pearl. 9, Starlight: Clapham and Dwyer. 9.10, Coronation cartoons: Nicholas Bentley will draw what he saw in the Coronation crowds. 9.25, British Movietonews. 9.35, Some Visitors to London: Personalities in London for the Coronation. 9.45, "Rhythm in the Dawn"; first performance of a modern rhapsody by Ord Hamilton.

Broadcast Brevities

NEWS FROM
PORTLAND PLACE

No "Royal" Microphone

ALTHOUGH special microphone cases will be used when the King gives the Royal Message to the Empire on the evening of Coronation Day, it should be emphasised that the microphone itself will, as always, be taken from stock. Thus it may happen that the "mike" which has featured in the biggest broadcast in history may subsequently be used by the humblest "In Town Tonightner."

Two microphones will be placed in the royal study in Buckingham Palace in new cases made of Australian oak and standing fourteen inches high. Each will be in two sections, the lower and larger housing the amplifiers, the microphone itself being contained in the smaller compartment above. Between the microphone cases will stand a small wooden framework for the red light which will remain "on" while His Majesty is speaking.

Inscribed for Posterity

The microphones will not be visible, being concealed behind a small screen of about four inches diameter. After the Coronation speech the microphone cases will be suitably inscribed and will be reserved for use in all subsequent broadcasts by the King.

That Family Spirit

CRITICS of the B.B.C. once suggested that there should be more of the family spirit at Broadcasting House; then the pendulum swung the other way, it being alleged that the family spirit was declaring itself to such an extent that producers were bringing in their sisters and their cousins, their uncles and their aunts to make up the casts of drama and variety shows.

The Lucky Outsider

Now, however, the family spirit has been summarily exorcised by an edict just issued, which requires that relatives of B.B.C. staff must not receive preferential treatment. The golden rule must always be that artists are engaged purely for their programme value, and the regulations even hint that, if an outsider and a producer's mother-in-law are equally promising, the outsider wins.

Radio Repertory

IS the B.B.C. returning to the idea of a repertory company for radio drama? This question has been recently asked, as the names of certain artists have

been recurring quite a lot in the programmes of the last few months. Nevertheless, the answer is no.

New Talent

In recent weeks more than twenty artists new to broadcasting have been booked for radio drama, among them being Arthur Sinclair, Ellen Pollock, Margaret Rawlings,

is attended by a B.B.C. sleuth—who, by the way, pays for his seat—and if the haul is not always a large one, that is not the fault of these striving officials.

B.B.C. sleuths can usually be recognised by their square jaws and air of disillusionment.

Tricks of the Trade

THE B.B.C. Talks Department is taking a leaf out of the "O.B." Department in the late summer by probing the country at large for "actuality" material.

The first experiment will be in the direction of a new talks series dealing with Tricks of the

will take listeners out to sea on an eel-fishing expedition.

In the Shadow

"SO near and yet so far" sums up a tragedy of Coronation Day in which the principal actors are Leslie Woodgate, the popular B.B.C. conductor, and a group of the B.B.C. Singers. For they are to spend ten hours of Coronation Day, from 6 a.m. onwards, in the church of St. Margaret's, Westminster, seeing nothing and hearing very little of the pomp and ceremony enacted just outside.

Their mission is an unusual one. During the most sacred portion of the Coronation Service there will be an intermission in the broadcast from the Abbey and during this brief period the B.B.C. Singers in St. Margaret's will render one short anthem.

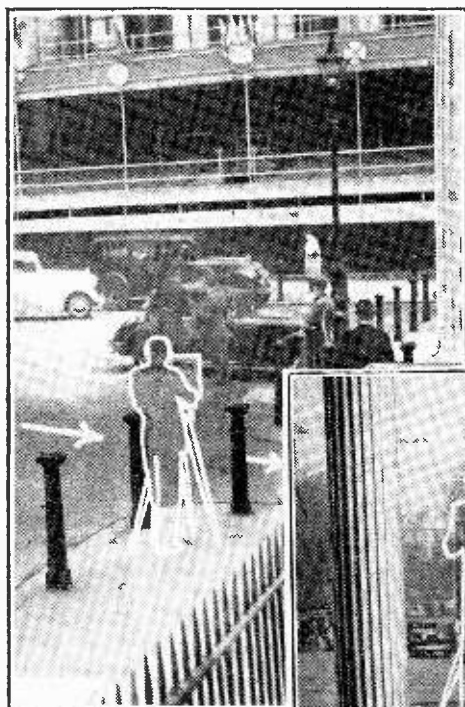

TELEVISION THE CORONATION PROCESSION. The positions of the three cameras which are to televise the passing pageantry from Apsley Gate, Hyde Park, are indicated on these "Wireless World" photos. The nearness of the pavement camera to the route of the passing Royal coach indicates the prospects of an excellent close-up of Their Majesties. The first actual tests, which were carried out at midday on Monday last, from the selected position, proved entirely satisfactory. Scenes from Hyde Park were conveyed to the transmitter at Alexandra Palace by the coaxial cable recently laid down for the purpose.

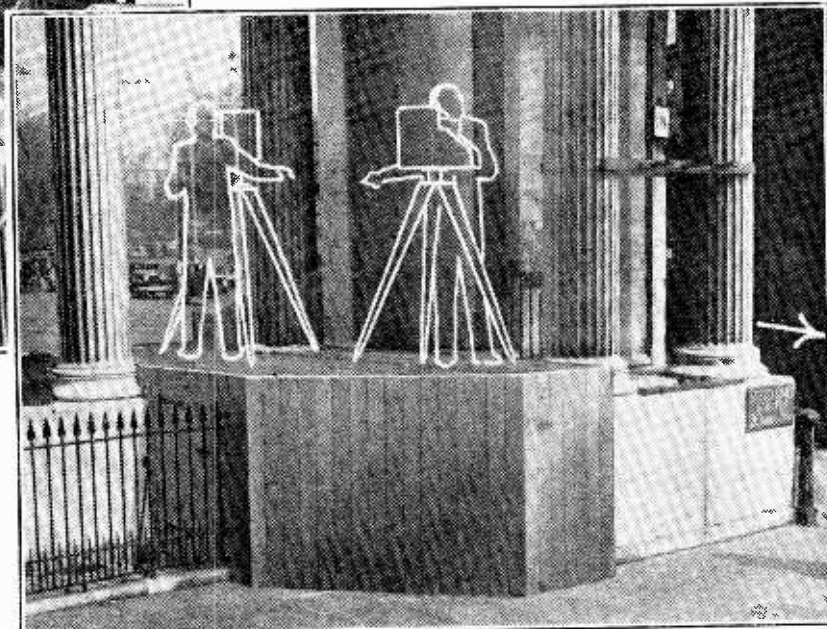

Trade, in which local industries will be described by the craftsmen themselves direct from the scene of their labours.

Although the arrangements are all somewhat tentative, it is understood that all the B.B.C. regions will come into the picture. Scotland may provide a yacht-building feature. Midlanders will describe and illustrate bell-founding, and Welshwomen may tell the world how clogs are made.

London, of all unexpected places, may offer a roof thatching programme, besides dealing with rowing boats, while the manufacturer of quill pens may be portrayed by the West of England Region. Cutlery is an obvious choice for a North of England broadcast, and it is expected that Northern Ireland

Known by Their Call-signs

WHEN the B.B.C. abandoned station call-signs they transferred them to individuals, and nowadays nearly everyone in the Corporation is so saddled with initials that their own mothers would hardly recognise them. N.I.R.D., for example, cloaks the identity of the Northern Ireland Regional Director; O.E.I.D., the genial chief of the Overseas and Engineering Information Department; A.C.E., the Assistant Chief Engineer, and so on. And now, down in Wales, they are calling the august Corporation the "Bee Bee Eck." At Portland Place people are searching for Gaelic dictionaries to find whether this is a compliment or the other thing.

Current Topics

EVENTS OF THE WEEK IN BRIEF REVIEW

A Bigger Exhibition

THE wireless section of the Foire de Paris, which will be held from May 15th to the 31st, occupies double the space it did last year.

Programmes from Greece

IT is reported that at last a start has been made with the building of a transmitter at Athens. It will have a power of 15 kW but will be capable of easy conversion to 100 kW.

Balkan Plans

THE official building programme of the Yugoslavian broadcasting authorities provides for the erection of a 100-kW station in Belgrade, a 20-kW station in Zagreb, and smaller stations in Split, Skoplje, and Sarajevo.

Another High-Power Station

THE new Czechoslovakian transmitter now being erected at Melnik will, it is hoped, be completed by the end of the year. Official details concerning its power are not yet available, but it will probably be between 60 and 100 kW.

Moscow's Broadcasting House

WHAT is claimed will be the finest broadcasting headquarters in the world is to be commenced in Moscow during the present month. The main studio will be approximately 30 feet high and have an area of 600 square yards. It will accommodate an orchestra of 250 performers, together with an audience of 350.

Prison for a Pirate

AN inmate of a Berlin prison situated a few yards from one of the broadcasting transmitters has just received an extra month on his sentence for operating a wireless set without a licence. An earphone and a crystal smuggled into the prison gave him excellent signals when connected to the ironwork of his bed.

French Coronation Broadcasting

VERY complete arrangements are being made in France for the broadcasting of the Coronation ceremony. The broadcast will commence with the description of the arrival of the main procession by two well-known French commenta-

tors who will be stationed outside the Abbey. The same commentators will describe the departure after the service, which will also be broadcast to French listeners. Another French commentator will be stationed outside Buckingham Palace to describe the return from the Abbey.

A Stunt Programme

AN unusual programme was recently broadcast in New York. In the script 50,000 words were used in which the letter E, the most used in the English language, did not occur once.

Standardisation of Components

THE Radio Component Manufacturers Federation has now issued further supplements to its Standardisation Report. The present supplement deals with mechanical and electrical details of potentiometers, variable resistances and fixed resistances. Copies are obtainable for 1s. 6d. from the Secretary, 83, Cannon Street, London, E.C.4.

Broadcasting in Esperanto

THE number of items broadcast more or less regularly in Esperanto is showing a steady increase. Apart from the transmissions of Prague and Brno, the well-known Hilversum station is to continue providing programmes in that language.

Some Interesting Figures

DURING the period from 1932 to the end of 1936 the proportion of musical items in German broadcasting rose from 64 per cent. to 74 per cent., and during the same period talks fell from 32 per cent. to 19 per cent.

Anti-Interference Campaigns

OTHER countries apart from our own are carrying on an active campaign against electrical interference. During the past year 355 complaints were investigated by the Polish authorities and a cure was effected in 79 of them. The authorities in Rumania have now decided to begin an official campaign against interference. Although monthly reports are no longer published in France, concerning the work of the official static hunters, steady progress is believed to be the order of the day.

A Newspaper Substitute

LOUD speakers have been established at fifteen different places in Addis Ababa, and at noon every day they are used to disseminate news in the local dialect. Most of the citizens are illiterate.

Sounding the Stratosphere

A RADIO-EQUIPPED balloon recently sent up by the French National Meteorological Office reached a height of 25,500 metres. The balloon was fitted with an automatic radio transmitter to signal to the ground its height and the reading of the self-registering meteorological apparatus which it contained. These balloons which are sent up from time to time are equipped with a parachute which brings the apparatus safely to earth. Twenty-five francs is paid to the finder of the apparatus.

A Pirate Transmitter

THE authorities in Italy are said to be greatly troubled by a secret wireless station which is frequently to be heard between midnight and 7 a.m. Its chief broadcasts consist of anti-Government propaganda. It works on 21 and 42 metres as well as on the medium wave-band.

Television Exhibition

MEMBERS of the Wireless Section of the I.E.E. are to have a private view of the Television Exhibition which is to be opened by Lord Selsdon at the Science Museum, South Kensington, on June 10th. The private view will be held from 5 p.m. to 8 p.m. on the opening day. This exhibition, to which the public will be admitted free of charge, will be open on Mondays, Tuesdays and Wednesdays, from 10 a.m. to 6 p.m. The closing time will be two hours later on Thursdays, Fridays and Saturdays, and on Sundays it will be open from 2.30 p.m. to 6 p.m. It will last for approximately three months. Specimens of single-core co-axial cable, as laid between Broadcasting House and Alexandra Palace, and the 4-core cable laid between London and Birmingham will be on view.

Dud American Valves

HITHERTO valve makers in the U.S.A. have endeavoured to reduce manufacturing costs by maintaining a special department to deal with



IN THE MALL. Film Industries speakers installed on a lamp standard.

valves which have some slight mechanical defect. In this manner it has been possible to reduce very considerably the daily number of rejects. One of the most important companies has, however, recently adopted the policy of destroying all defective valves, no matter how slight the fault. This has actually had the effect of reducing the number of duds, since it has inspired factory operatives to exercise greater care owing to the fact that wages vary according to the number of rejects.

Indian Activities

AN interesting paper entitled "The Propagation of Radio Waves Through the Ionosphere," was submitted by Dr. Saha and Mr. R. N. Rai, of Allahabad University, at the last meeting of the National Institute of Sciences (India).

PA Assists Strikers

IN the recent sit-down strike at several large automobile manufacturing works in the U.S.A. the men's leaders made use of PA vans to communicate instructions to the strikers. Since the sit-down strikers were inside the factory and the leaders outside, this was the only method of letting them know what was going on in the outside world.

Miscellaneous Advertisements for May 21st Issue

WITH the approach of the Whitsun Bank Holiday slight alterations are necessary in our printing arrangements. Miscellaneous advertisements intended for the issue of May 21st must be received not later than first post on Friday, May 14th.

New Apparatus Reviewed

Recent Products of
the Manufacturers

"AVO" VALVE TESTER

IT is generally agreed that unless facilities are available for making a comprehensive test on a valve, the one measurement that reveals more than any other the state of the valve is that of mutual conductance.

The new "Avo" Valve Tester provides this information in a simple and straightforward manner, at least so far as its actual operation and handling are concerned.

In addition to giving a figure for mutual conductance of triodes, pentodes, tetrodes and the individual sections of multi-type

It obviates a lengthy explanation of mutual conductance and what it signifies, and if the pointer comes to rest on that part of the scale marked "Replace," it is very convincing proof that the valve is faulty.

Filament volts from 2 to 40 can be selected, and provision is made for screen voltages of 60 to 250 in suitable steps, while anode voltages of from 80 to 250 are provided.

This very useful valve tester forms a valuable addition to the range of test equipment made by the Automatic Coil Winder

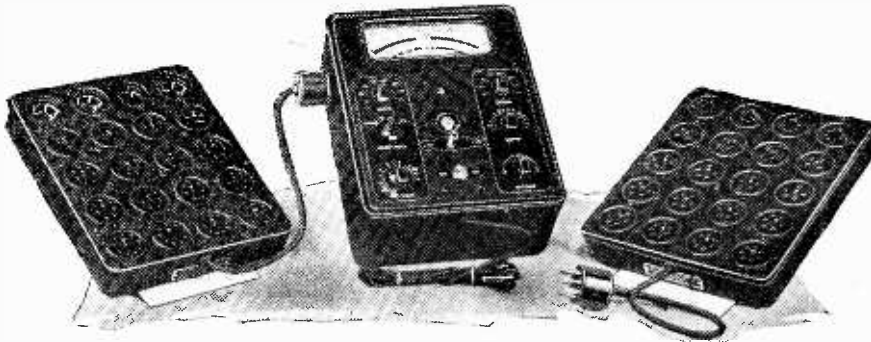

New "Avo" Valve Tester and the two valve panels now available.

valves, provision is made for heater-cathode insulation tests, while for all rectifier valves, including RF diodes and the diodes in multi-electrode valves, an emission test is made.

The test set comprises two units, the main tester contains the meter, switching for the various electrode voltages and all controls, also the power supply unit. The operating power, incidentally, is taken from the AC mains and no batteries are used in the instrument.

The other unit is a valve-holder panel, and this can be supplied fitted and wired for either British or American valves. It is connected to the main test unit by a cable and nine-pin plug. With the two valve-holder panels the instrument provides facilities for testing almost every valve now in general use.

It is not proposed to give a detailed description of the method of operating the tester since this is very fully explained in the instructional leaflet. It will suffice to say that its operation is extremely simple for what is a comparatively complicated measurement, and one that, as a rule, only laboratory-type apparatus provides.

All that need be done is to refer to the valve charts supplied, transfer to the switching the voltage values given, and on pressing a lever to the left, the actual mutual conductance value is read off direct from the meter's scale. Nothing could be simpler.

Actually there are three scales on the meter, one calibrated directly in mutual conductance in mA/V, another for heater-cathode resistance measured in megohms, and one other divided into three differently coloured sections, marked "Replace" and "Good," with an intervening space indicating poor or indifferent.

The last scale is really for the benefit of non-technical users, and also to enable dealers and servicemen to show their customers in a way easy to comprehend the actual state of any valve submitted to them for test.

and Electrical Equipment Co., Ltd., Winder House, Douglas Street, London, S.W.1, and its price, including one valve panel, is £11 11s. The extra valve panel costs £2 2s.

SIMPLAK ACCUMULATOR

A WELL-MADE 2-volt accumulator that combines some of the features of the very slow-discharge type, but is quite capable of delivering one ampere on continuous discharge, is made by Simplak Batteries, Ltd., British Industries House, Marble Arch, London, W.1. Known as the Type M5, it measures $4\frac{3}{4} \times 3\frac{1}{2} \times 6\frac{7}{8}$ in. total height, and is fitted with a permanently attached carrying handle.

The capacity is given as 70 hours at $\frac{1}{2}$ amp. and 30 hours at 1 amp. discharge rates respectively. Two positive and three negative plates are used with a comparatively wide spacing between them, which

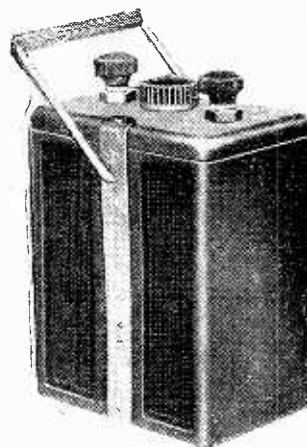

Simplak two-volt accumulator Type M5.

space is occupied solely by electrolyte, as spacers are not employed. The positive and one of the negative plates are each $\frac{1}{4}$ in. thick, while the two outside negative ones

are approximately half this thickness. The usual accumulator acid is used with a specific gravity of 1.250 when fully charged.

A moulded bakelite case is used, and in one end is a small glass window. This is a most useful feature, as with most batteries with opaque cases it is necessary to remove the filler plug to examine the acid level. In the case of the Simplak battery the acid level can be seen through the window.

In addition to the positive and negative terminals being of different colours, they are also fitted with a different size of shank, so are thus non-interchangeable.

The price of this battery is 12s. 6d.

BELLING-LEE FLAT-PIN PLUGS

FOR obvious reasons it is most desirable that no confusion should arise between loud speaker extension points and electric supply mains lighting or power points, since both are often mounted on the skirting-board in a room.

Dissimilar types of fittings for the two services are most essential for relay systems, hospitals, and all public buildings equipped with radio, and particularly is this necessary when headphones are employed.

Belling and Lee, Ltd., Cambridge Arterial Road, Enfield, Middlesex, have now introduced special flat-pin plugs and sockets for all radio extension points. They are made in two- and three-pin types, and the socket fittings can be supplied for flush or surface

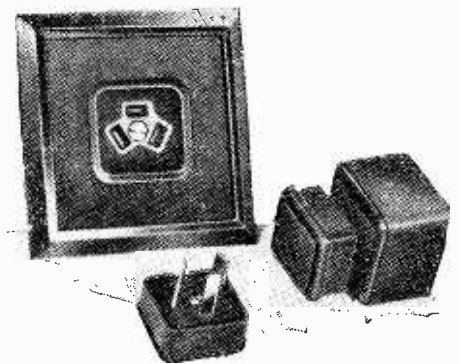

New Belling-Lee flat-pin fittings for radio extension points.

mounting, the flush type being fitted with a bakelite plate measuring 3 in. square.

These fittings are designed for radio speech circuits up to 50 watts with a nominal maximum current handling capacity of 5 amps. RMS.

These fittings can be used for any radio purpose other than the mains supply, and they would accordingly come in useful for microphone extension points, etc. Both two- and three-pin types are non-reversible and they cost 2s. 4d. for a two-pin plug and socket and 2s. 8d. for a three-pin variety. Flush or surface mounting patterns in each style cost the same.

There are no exposed metal parts in any of the fittings, and the whole is well protected by bakelite mouldings. The standard patterns are in brown bakelite but cream bakelite fittings are available, and these cost 10d. more in each case.

PRINCIPAL BROADCASTING STATIONS OF EUROPE

Arranged in Order of Frequency and Wavelength

(This list is included in the first issue of each month. Stations with an Aerial Power of 50 kW. and above in heavy type)

Station.	kc/s.	Tuning Positions.	Metres.	kW.	Station.	kc/s.	Tuning Positions.	Metres.	kW.
Ankara (Turkey)	152		1973.5	5	Leipzig (Germany)	785		382.2	120
Kaunas (Lithuania)	153		1961	7	Barcelona, EAJ1 (Spain)	795		377.4	7.5
Radio Romania (Brasov) Romania	160		1875	150	Lwow (Poland)	795		377.4	50
Hilversum No. 1 (Holland) (10 kW. till 1840)	160		1875	150	North Welsh Regional (Penmon)	804		373.1	5
Lahti (Finland)	166		1807	150	West Regional (Washford Cross)	804		373.1	70
Moscow, No. 1, RW1 (Komintern) (U.S.S.R.)	172		1744	500	Milan, No. 1 (Italy)	814		368.6	50
Paris (Radio Paris) (France)	182		1648	80	Bucharest (Romania)	823		364.5	12
Istanbul (Turkey)	185		1622	5	Kiev No. 2, RW9 (U.S.S.R.)	832		360.6	35
Irkutsk (U.S.S.R.)	187.5		1600	20	Agen (France)	832		360.6	0.5
Deutschlandsender (Germany)	191		1571	60	Berlin (Germany)	841		356.7	100
Droitwich	200		1500	150	Sofia (Bulgaria)	847.5		354	0.75
Minsk, RW10 (U.S.S.R.)	208		1442	35	Norwegian Relay Stations	850		352.9	—
Reykjavik (Iceland)	208		1442	16	Valencia (Spain)	850		352.9	3
Motala (Sweden)	216		1389	150	Simferopol, RW52 (U.S.S.R.)	859		349.2	10
Novosibirsk, RW76 (U.S.S.R.)	217.5		1379	100	Strasbourg (France)	859		349.2	100
Warsaw, No. 1 (Poland)	224		1339	120	Poznan (Poland)	868		345.6	16
Luxembourg	232		1293	150	London Regional (Brookmans Park)	877		342.1	70
Leningrad, No. 1 RW53 (Kolpino) (U.S.S.R.)	232		1293	100	Linz (Austria)	886		338.6	15
Kalundborg (Denmark)	240		1250	60	Graz (Austria)	886		338.6	15
Vienna, No. 2 (Austria)	240		1250	0.5	Helsinki (Finland)	895		335.2	10
Kiev No. 1 (U.S.S.R.)	248		1209.6	100	Limoges, P.T.T. (France)	895		335.2	1.5
Vigra (Aalesund) (Norway)	253		1186	10	Hamburg (Germany)	904		331.9	100
Tashkent, RW11 (U.S.S.R.)	256.4		1170	25	Dnepropetrovsk (U.S.S.R.)	913		328.6	10
Oslo (Norway)	260		1153.8	60	Toulouse (Radio Toulouse) (France)	913		328.6	60
Moscow, No. 2, RW49 (Stelkovo) (U.S.S.R.)	271		1107	100	Brno (Czechoslovakia)	922		325.4	32
Tromsø (Norway)	282		1065	10	Brussels, No. 2 (Belgium)	932		321.9	15
Tiflis, RW7 (U.S.S.R.)	283		1060	35	Algiers (Algeria)	941		318.8	12
Saratov (U.S.S.R.)	340		882.3	20	Göteborg (Sweden)	941		318.8	10
Finmark (Norway)	347		864	10	Breslau (Germany)	950		315.8	100
Archangel (U.S.S.R.)	350		857.1	10	Paris (Poste Parisien) (France)	959		312.8	60
Rostov-on-Don, RW12 (U.S.S.R.)	355		845.1	20	Bordeaux-Sud-Ouest (France)	968		309.9	30
Budapest, No. 2 (Hungary)	359.5		834.5	18	Odessa (U.S.S.R.)	968		309.9	10
Sverdlovsk, RW5 (U.S.S.R.)	375		800	40	Northern Ireland Regional (Lisburn)	977		307.1	100
Voroneje, RW25 (U.S.S.R.)	390		769	10	Genoa (Italy)	986		304.3	10
Boden (Sweden)	392		765	0.6	Torun (Poland)	986		304.3	24
Banska-Bystrica (Czechoslovakia) (15 kW. after 1700)	392		765	30	Hilversum No. 2 (Holland). (15 kW. till 1840)	995		301.5	60
Geneva (Switzerland)	401		748	1.3	Bratislava (Czechoslovakia)	1004		298.8	13.5
Moscow, No. 3 (RCZ) (U.S.S.R.)	413.5		726	100	Midland Regional (Droitwich)	1013		296.2	70
Ostersund (Sweden)	413.5		726	0.6	Chernigov (U.S.S.R.)	1013		296.2	4
Oulu (Finland)	431		696	10	Barcelona, EAJ15 (Spain)	1022		293.5	3
Tartu (Estonia)	511		587.1	0.5	Cracow (Poland)	1022		293.5	2
Hamar (Norway)	519		578	0.7	Oviedo (Spain)	1022		293.5	0.7
Innsbruck (Austria)	519		578	1	Königsberg No. 1 (Heilsberg) (Germany)	1031		291	100
Ljubljana (Yugoslavia)	527		569.3	6.3	Paredo (Portugal)	1031		291	5
Viiuri (Finland)	527		569.3	10	Leningrad, No. 2, RW70 (U.S.S.R.)	1040		288.5	10
Bolzano (Italy)	536		559.7	10	Rennes-Bretagne (France)	1040		288.5	120
Wilno (Poland)	536		559.7	50	Scottish National (Falkirk)	1050		285.7	50
Budapest, No. 1 (Hungary)	546		549.5	120	Bari No. 1 (Italy)	1059		283.3	20
Beromünster (Switzerland)	556		539.6	100	Paris (Radio Cité) (France)	1068		280.9	0.8
Athlone (Irish Free State)	565		531	100	Tiraspol, RW57 (U.S.S.R.)	1068		280.9	10
Klaipeda (Lithuania)	565		531	10	Bordeaux-Lafayette (France)	1077		278.6	12
Palermo (Italy)	565		531	3	Zagreb (Yugoslavia)	1086		276.2	0.7
Stuttgart (Germany)	574		522.6	100	Falun (Sweden)	1086		276.2	2
Alpes-Grenoble, P.T.T. (France)	583		514.6	15	Madrid, EAJ7 (Spain)	1095		274	5
Madona (Latvia)	583		514.6	50	Vinnitsa (U.S.S.R.)	1095		274	10
Vienna No. 1 (Austria)	592		506.8	100	Kuldiga (Latvia)	1104		271.7	50
Rabat (Morocco)	601		499.2	25	Naples (Italy)	1104		271.7	1.5
Sundsvall (Sweden)	601		499.2	10	Moravska-Ostrava (Czechoslovakia)	1113		269.5	11.2
Florence (Italy)	610		491.8	20	Radio Normandie (Fécamp) (France)	1113		269.5	10
Cairo, No. 1 (Egypt)	620		483.9	20	Alexandria, No. 1 (Egypt)	1122		267.4	0.25
Brussels, No. 1 (Belgium)	620		483.9	15	Newcastle	1122		267.4	1
Lisbon (Portugal)	629		476.9	15	Nyiregyhaza (Hungary)	1122		267.4	6.25
Trøndelag (Norway)	629		476.9	20	Hörby (Sweden)	1131		265.3	10
Christiansand (Norway)	629		476.9	20	Turin, No. 1 (Italy)	1140		263.2	7
Prague, No. 1 (Czechoslovakia)	638		470.2	120	Trieste (Italy)	1140		263.2	10
Lyons, P.T.T. (France)	648		463	100	London National (Brookmans Park)	1149		261.1	20
Petrozavodsk (U.S.S.R.)	648		463	10	North National (Slaithwaite)	1149		261.1	20
Cologne (Germany)	658		455.9	100	West National (Washford Cross)	1149		261.1	20
North Regional (Slaithwaite)	668		449.1	70	Kosice (Czechoslovakia)	1158		259.1	10
Jerusalem (Palestine)	668		449.1	20	Monte Ceneri (Switzerland)	1167		257.1	15
Sottens (Switzerland)	677		443.1	100	Copenhagen (Denmark)	1176		255.1	10
Belgrade (Yugoslavia)	686		437.3	2.5	Nice-Corse (France)	1185		253.2	60
Paris, P.T.T. (France)	695		431.7	120	Frankfurt (and Relays) (Germany)	1195		251	25
Stockholm (Sweden)	704		426.1	55	Prague, No. 2 (Czechoslovakia)	1204		249.2	5
Rome, No. 1 (Italy)	713		420.8	50	Lille, P.T.T. (France)	1213		247.3	60
Kharkov, No. 1, RW20 (U.S.S.R.)	722		415.4	10	Bologna (Radio Marconi) (Italy)	1222		245.5	50
Fredrikstad (Norway)	722		415.4	1	Gleiwitz (Germany)	1231		243.7	5
Tallinn (Estonia)	731		410.4	20	Cork (Irish Free State)	1235		242.9	1
Madrid, EAJ2 (Spain)	731		410.4	3	Saarbrücken (Germany)	1249		240.2	17
Seville (Spain)	731		410.4	5.5	Riga (Latvia)	1258		238.5	10
Munich (Germany)	740		405.4	100	Rome, No. 3 (Italy)	1258		238.5	1
Marseilles, P.T.T. (France)	749		400.5	120	Bilbao, EAJ8 (Spain)	1258		238.5	1
Pori (Finland)	749		400.5	1	Nürnberg (Germany)	1267		236.8	2
Katowice (Poland)	758		395.8	12	Radio Méditerranée (Juan-les-Pins) (France)	1276		235.1	27
Scottish Regional (Falkirk)	767		391.1	70	Dresden (Germany)	1285		233.5	0.25
North Scottish Regional (Burghhead)	767		391.1	60	Aberdeen	1285		233.5	1
Stalino (U.S.S.R.)	776		386.6	10	Klagenfurt (Austria)	1294		231.8	5
Toulouse P.T.T. (France)	776		386.6	120	Vorarlberg (Austria)	1294		231.8	5
					Danzig	1303		230.2	0.5

Station.	kc/s.	Tuning Positions.	Metres.	kW.	Station.	kc/s.	Tuning Positions.	Metres.	kW.
Swedish Relay Stations	1312		228.7	—	Vaasa-Vasa (Finland)	1420		211.3	0.5
Magyarovar (Hungary)	1321		227.1	1.25	Alexandria, No. 2 (Egypt)	1429		209.9	0.5
German Relay Stations	1330		225.6	—	Turku (Finland)	1429		209.9	0.5
Montpellier, P.T.T. (France)	1339		224	1.2	Miskolc (Hungary)	1438		208.6	1.25
Lodz (Poland)	1339		224	2	Paris (Eiffel Tower) (France)	1456		206	5
Dublin (Irish Free State)	1348		222.6	0.5	Pees (Hungary)	1465		204.8	1.25
Rjukan (Norway)	1348		222.6	0.15	Belgian Relay Stations	1465		204.8	0.1
Salzburg (Austria)	1348		222.6	2	Bournemouth	1474		203.5	1
Tampere (Finland)	1348		222.6	0.7	Plymouth	1474		203.5	0.3
Cairo No. 2 (Egypt)	1348		222.6	0.5	Binche (Belgium)	1487		201.7	0.1
Königsberg (Germany)	1348		222.6	2	Belgian Relay Stations	1492		201.1	0.1
Nottoden (Norway)	1357		221.1	0.15	Nimes (France)	1492		201.1	0.7
Italian Relay Stations	1357		221.1	—	Albacete (Spain)	1492		201.1	0.2
L'île de France (France)	1366		219.6	0.7	Santiago (Spain)	1492		201.1	0.5
Basle (Switzerland)	1375		218.2	0.5	Belgian Relay Stations	1500		200	0.1
Berne (Switzerland)	1375		218.2	0.5	Pietarsaari (Finland)	1500		200	0.25
Warsaw, No. 2 (Poland)	1384		216.8	7	Radio Alcalá (Spain)	1500		200	0.2
Lyons (Radio Lyons) (France)	1393		215.4	25	Karlskrona (Sweden)	1530		196	0.2
Stara-Zagora (Bulgaria)	1402		214	2	Liepāja (Latvia)	1734		173	0.1

SHORT-WAVE STATIONS OF THE WORLD

Station.	Call Sign.	kc/s.	Tuning Positions.	Metres.	kW.	Station.	Call Sign.	kc/s.	Tuning Positions.	Metres.	kW.
Batavia (Java)	YDA	3,040		93.88	10	Lisbon (Portugal)	CT1AA	9,655		31.09	2
Kharbarovsk (Russia)	RV15	4,273		70.20	20	Buenos Aires (Argentina)	LRX	9,660		31.06	5
Caracas (Venezuela)	YV5RH	5,800		51.72	1	Lisbon (Portugal)	CTICT	9,680		31.00	0.5
San Jose (Costa Rica)	TIGPH	5,820		51.52	0.5	Madrid (Spain)	EAQ	9,860		30.43	20
Vatican City (Vatican State)	HVJ	5,970		50.26	10	Lisbon (Portugal)	CSW	9,940		30.18	5
Mexico City (Mexico)	XEBT	6,000		50.00	1	Bandoeng (Java)	PMN	10,260		29.24	3
Moscow (Russia)	RW59	6,000		50.00	20	Ruysslede (Belgium)	ORK	10,330		29.04	9
Montreal (Canada)	CFCX	6,005		49.96	—	Buenos Aires (Argentina)	LSX	10,350		28.99	12
Havana (Cuba)	COCO	6,010		49.92	0.5	Teneriffe (Canary Isles)	EAJ43	10,360		29.94	4
Prague (Podebrady) (Czechoslovakia)	OLR	6,010		49.92	30	Tokio (Japan)	JVM	10,740		27.93	20
Bogota (Colombia)	HJ3ABH	6,018		49.90	1	Bandoeng (Java)	PLP	11,010		27.25	3
Zeesen (Germany)	DJC	6,020		49.83	50	Lisbon (Portugal)	CSW	11,040		27.17	5
Boston (U.S.A.)	W1XAL	6,040		49.67	10	Motala (Sweden)	SBG	11,700		25.63	1
Miami (U.S.A.)	W4XB	6,040		49.67	2.5	Winnipeg (Canada)	CJRX	11,720		25.60	2
Daventry (Gt. Britain)	GSA	6,050		49.59	15	Paris (Radio-Colonial) (France)	TPA4	11,720		25.60	12
Cincinnati (U.S.A.)	W8XAL	6,060		49.50	10	Daventry (Gt. Britain)	GSD	11,750		25.53	15
Philadelphia (U.S.A.)	W3XAU	6,060		49.50	10	Zeesen (Germany)	DJD	11,770		25.49	50
Skamlebaek (Denmark)	OXY	6,060		49.50	0.5	Boston (U.S.A.)	W1XAL	11,790		25.45	10
Motala (Sweden)	SBG	6,060		49.50	1	Tokio (Japan)	ZJZ	11,800		25.42	20
Chicago (U.S.A.)	W9XAA	6,080		49.34	0.5	Vienna (Austria)	OFR2	11,800		25.42	1.5
Nairobi (Kenya)	VQ7LO	6,083		49.31	0.5	Rome (Italy)	I2RO	11,810		25.40	25
Bowmanville (Canada)	CRGX	6,090		49.26	0.5	Daventry (Gt. Britain)	GSN	11,820		25.38	15
Hong Kong (China)	ZBW2	6,090		49.26	2	Wayne (U.S.A.)	W2XE	11,830		25.36	10
Johannesburg (South Africa)	ZTJ	6,100		49.20	5	Lisbon (Portugal)	CT1AA	11,830		25.36	2
Bound Brook (U.S.A.)	W3XAL	6,100		49.18	35	Zeesen (Germany)	DJP	11,850		25.31	50
Chicago (U.S.A.)	W9XF	6,100		49.18	10	Prague (Podebrady) (Czechoslovakia)	OLR	11,840		25.34	30
Belgrade (Yugoslavia)		6,100		49.18	1	Daventry (Gt. Britain)	GSE	11,860		25.29	15
Manizales (Colombia)	HJ4ABB	6,105		49.12	1	Pittsburgh (U.S.A.)	W8XK	11,870		25.27	40
Daventry (Gt. Britain)	GSL	6,110		49.10	15	Paris (Radio-Colonial) (France)	TPA3	11,880		25.23	12
Calcutta (India)	VUC	6,110		49.10	0.5	Moscow (Russia)	RNE	12,000		25.00	20
Wayne (U.S.A.)	W2XE	6,120		49.02	10	Lisbon (Portugal)	CTICT	12,082		24.83	0.5
Havana (Cuba)	COCID	6,120		48.93	0.25	Reykjavik (Iceland)	TFJ	12,235		24.52	7.5
Pittsburgh (U.S.A.)	W8XK	6,140		48.86	40	Paredo (Portugal)	CTIGO	12,400		24.20	0.35
Winnipeg (Canada)	CJRO	6,150		48.78	2	Warsaw (Poland)	SPW	13,635		22.00	10
Lisbon (Portugal)	CSL	6,150		48.78	0.50	Amateurs		14,000		21.42	0.01
Caracas (Venezuela)	YV5RD	6,150		48.78	1			to		to	
Paredo (Portugal)	CTIGO	6,200		48.40	5			14,400		20.84	
San Jose (Costa Rica)	TIGP	6,410		46.80	0.5	Sofia (Bulgaria)	LZA	14,970		20.04	1.5
Barranquilla (Colombia)	HJ1ABB	6,450		46.52	1	Zeesen (Germany)	DJL	15,111		19.85	50
Valencia (Colombia)	YV4RV	6,520		46.00	0.5	Vatican City (Vatican State)	HVJ	15,123		19.84	10
Riobamba (Ecuador)	PRADO	6,620		45.31	2	Daventry (Gt. Britain)	GSF	15,140		19.82	10
Amateurs		7,000		42.86	0.01	Bandoeng (Java)	YDC	15,160		19.80	3
		to		to		Daventry (Gt. Britain)	GSO	15,180		19.76	10
		7,300		41.10		Hongkong (China)	ZBW4	15,190		19.75	2
Moscow (U.S.S.R.)	RV96	7,520		38.89	25	Zeesen (Germany)	DJB	15,200		19.74	50
Prangins (Radio-Nations) (Switz'l'd)	HBP	7,780		38.48	20	Pittsburgh (U.S.A.)	W8XK	15,210		19.72	40
Suva (Fiji)	VPD2	8,720		34.40	3	Huizen (Holland)	PCJ	15,220		19.71	20
Budapest (Hungary)	HAT4	9,125		32.88	5	Prague (Podebrady) (Czechoslovakia)	OLR	15,230		19.70	30
Bangkok (Siam)	HS8PJ	9,350		32.09	20	Paris (Radio-Colonial) (France)	TPA2	15,243		19.68	12
Madrid (Spain)	EAQ2	9,480		31.65	20	Daventry (Gt. Britain)	GSI	15,260		19.66	10
Rio de Janeiro (Brazil)	PRF5	9,500		31.58	5	Wayne (U.S.A.)	W2XE	15,270		19.65	10
Daventry (Gt. Britain)	GSB	9,510		31.55	15	Zeesen (Germany)	DJQ	15,280		19.63	50
Melbourne (Australia)	VK3ME	9,510		31.55	1.5	Buenos Aires (Argentina)	LRU	15,290		19.62	5
Hongkong (China)	ZBW3	9,520		31.49	2	Daventry (Gt. Britain)	GSP	15,310		19.60	10
Jeløy (Norway)	LKJ1	9,520		31.49	1.5	Schenectady (U.S.A.)	W2XAD	15,330		19.57	18
Schenectady (U.S.A.)	W2XAF	9,530		31.48	30	Zeesen (Germany)	DJR	15,340		19.53	50
Zeesen (Germany)	DJN	9,540		31.45	50	Budapest (Szekesfehervar) (Hungary)	HAS3	15,370		19.52	20
Prague (Podebrady) (Czechoslovakia)	OLR	9,550		31.41	30	Hongkong (China)	ZBW5	17,750		16.90	2
Zeesen (Germany)	DJA	9,560		31.38	50	Zeesen (Germany)	DJE	17,760		16.89	50
Bombay (India)	VUB	9,565		31.36	4.5	Wayne (U.S.A.)	W2XE	17,760		16.89	10
Millis (U.S.A.)	W1XK	9,570		31.35	10	Huizen (Holland)	PHI	17,770		16.88	23
Daventry (Gt. Britain)	GSC	9,580		31.32	15	Bound Brook (U.S.A.)	W3XAL	17,780		16.87	35
Lyndhurst (Australia)	VK3LR	9,580		31.32	1	Daventry (Gt. Britain)	GSG	17,790		16.86	10
Philadelphia (U.S.A.)	W3XAU	9,590		31.28	10	Bandoeng (Java)	PLE	18,830		15.93	60
Sydney (Australia)	VK2ME	9,590		31.28	20	Bangkok (Siam)	HS8P	19,020		15.77	20
Huizen (Holland)	PCJ	9,590		31.28	20	Bandoeng (Java)	PMA	19,350		15.50	60
Prangins (Radio-Nations) (Switz'l'd)	HBL	9,595		31.27	20	Daventry (Gt. Britain)	GSH	21,470		13.97	10
Moscow (Russia)	RAN	9,600		31.25	20	Wayne (U.S.A.)	W2XE	21,520		13.94	10
Rome (Italy)	I2RO	9,635		31.13	25	Daventry (Gt. Britain)	GSJ	21,530		13.93	10
Sourabaya (Java)	YDB	9,650		31.09	1	Pittsburgh (U.S.A.)	W8XK	21,540		13.93	40

Anti-Interference Filters

By F. R. W. STRAFFORD

(Research Dept. : Belling and Lee, Ltd.)

ONE of the many annoying forms in which electrical interference with broadcast reception manifests itself is associated with the main electric supply to the house wiring.

Electrical disturbances due to impulses of current from some commutating or intermittent circuit such as a motor or flashing sign, perhaps several hundred yards distant, may travel along the mains supply and be picked up by the receiver.

Such forms of interference are characterised by the harsh crackling noises which they produce in the loud speaker, and generally by their untunable nature. They may be picked up in two ways: first, the interfering current superimposed upon the mains supply may enter the receiver via its mains connecting lead. Secondly, the interfering currents may produce an appreciable radiated magnetic field in the close vicinity of the aerial lead-in where it joins the receiver, and in such a case the interference is injected through the aerial circuit.

It is obvious in the latter case that the means for suppressing the interference should be located at a point at least a few feet from the receiver itself so that the mains lead carrying the supply voltage to the receiver should be free from the disturbance where it runs close to the lead-in to the receiver itself.

How Interference is Generated

One is apt to talk a little glibly about electrical interference without a fundamental understanding as to its production and propagation along the mains supply wires. Electrical interference is normally characterised by the presence of myriads of individual components covering a very wide band of frequencies which extends from the audio- into the radio-frequency spectrum. Thus a certain type of electrical interference may cause annoyance to the user of a sensitive AF amplifier, while a neighbouring broadcast receiver may be practically immune. In this instance the frequency components of the interfering spectrum are mainly located at audio-frequencies. The reverse may occur, when the amplifier is immune but the broadcast receiver is badly affected. In this case most of the interfering frequencies are located in the radio-frequency spectrum.

Finally, the frequency distribution of the electrical interference may cover such a wide range as to adversely affect both radio receivers and audio amplifier at the same time.

The reason for these variations in the

frequency electrical interference must be fully understood before a real knowledge of suppression may be attained, and it is proposed to devote a little time in elucidating the fundamental theory.

Consider Fig. 1 (a), which depicts a simple DC circuit in which is inserted a rotating contact which rhythmically makes and breaks the current flow through R.

When the switch is closed a current flows and a voltage E appears across R. When the switch is opened the voltage instantly falls to zero.

If the switch is rhythmically opened and closed by means of a motor, the curve of voltage across R with respect to time T is clearly shown in Fig. 1 (b).

This indicates a square-topped wave form and is a typical example of the wave form of current which may be expected when an electric flashing sign is operated on DC mains. Why (in terms of this square-topped wave occurring at a rate of possibly ten times per second) should this produce a harsh untunable crackle in a broadcast receiver?

The answer is very clear to mathematicians and invariably hopelessly complicated to laymen. Without going into any details of the famous Fourier trigonometrical series, Fig. 1 (b) may be replaced by Fig. 2 (a), in which the wave is replaced by a number of sinusoidal waves.

By suitably selecting the amplitude and phases of each of the sinusoidal waves it should not be difficult for the veriest layman to imagine that the addition of all

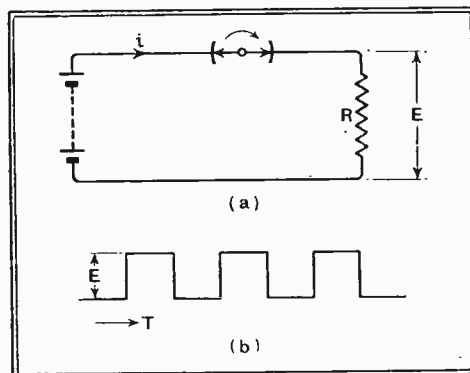

Fig. 1.—Artificially generated interference: operation of the rotary switch in diagram (a) produces a square-topped wave form represented by curve (b).

these components would make up a wave as depicted now in Fig. 2 (b), which is very similar to that shown in Fig. 1 (b).

If sufficient sinusoidal waves are taken it should then be possible exactly to re-

BY way of introduction to his subject, the author explains in this instalment how an apparently simple electro-mechanical operation, such as the recurrent interruption of a DC circuit, may produce impulses capable of causing interference over a wide band of frequencies.

produce the original square-topped wave shown in Fig. 1 (a).

The foregoing discussion shows (it is hoped) that any rhythmic impulses of current or voltage may be considered as composed of a vast number of individual sinusoidal components of differing frequencies and magnitudes which, when acting together, result in the original shape of the impulse. Thus, our ten-cycle-per-second impulses of square-topped form may have sinusoidal frequency components at 1,000,000, 1,000,010, 1,000,020 cycles per second, etc., extending right over the tuning range of a broadcast receiver.

It may also be assumed that a sharply defined wave having very steep sides, as in Fig. 1 (b), will extend over a much wider frequency range and with much greater uniformity of amplitude. In other words, it will be quite untunable over a very wide wave range on the receiver. But if the interfering wave is rather rounded, as for example in Fig. 2 (c), less sinusoidal components will be required to build up this shape, and thus the interference may fall off quite rapidly at the higher frequencies. In this case greater interference would appear at long waves, less at medium, and possibly little or nothing on the short waves.

In the extreme case when the interfering currents become a pure sinusoid, the interference will only be produced at one frequency, and may or may not be tunable by the receiver.

Wide Frequency Range

We should now know something of the mechanism of electrical interference, for we have seen that every sudden electrical impulse must be regarded as a vast number of individual frequency components whose lowest frequency is determined by the rhythmic period of the disturbance itself, and whose higher frequencies have magnitudes dependent upon the steepness of the curve of the impulse with respect to time.

Actually it does not matter whether the impulse is rhythmic or not. The mere process of closing an electric light switch produces a sudden variation in the current distribution through the mains circuit, and

Anti-Interference Filters—

this one impulse contains myriads of alternating frequency components covering a vast spectrum, and accounts for the clicks heard from most loud speakers when a neighbouring light is switched on or off. The mathematical analysis in this case is even more profound.

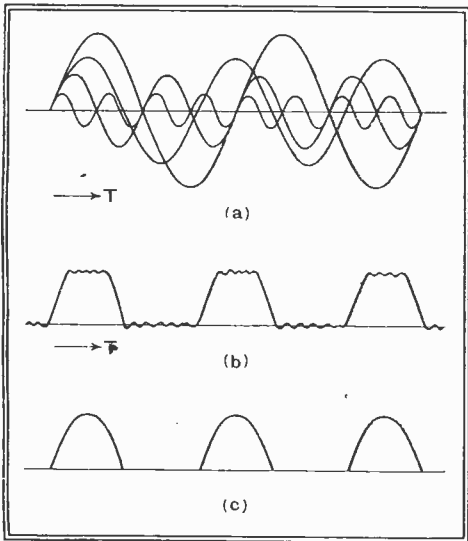

Fig. 2.—From the point of view of interference, the simple square-topped wave form of Fig. 1 (b) may be replaced by the complex curves of diagrams (a) and (b). The rounded wave form of diagram (c) would cause interference mainly with long-wave reception.

The next instalment will deal with the manner in which electrical interfering impulses are propagated along the mains wiring, and it will be shown how their effect upon a broadcast receiver may be materially reduced.

News from the Clubs

Croydon Radio Society

Headquarters: St. Peter's Hall, Ledbury Road, South Croydon.
Meetings: Tuesdays at 8 p.m.
Hon. Pub. Sec.: Mr. E. L. Cumbers, 14, Campden Road, South Croydon.

The final meeting of the session was devoted to a musical programme derived from gramophone records. Mr. L. F. Marshall was elected to the position of Secretary in place of Mr. H. G. Salter.

Thames Valley Amateur Radio and Television Society

Headquarters: The Albany Hotel, Station Yard, Twickenham, Middlesex.
Meetings: Wednesdays at 8.15 p.m.
Hon. Sec.: Mr. J. N. Roe, 19a, The Barons, St. Margarets-on-Thames, Middlesex.

The annual subscription to the Society is 3s. 6d. per year. All those interested in amateur short-wave work will be welcomed. The Society has prepared the following activities for the summer, full details of which can be obtained from the Hon. Sec.:

- May 9th.—10-metre field-day competition.
- May 26th.—Lecture and demonstration of short-wave components and apparatus by Mr. E. Cholot, of Lissen, Ltd.
- June 5th and 6th.—The Society will operate an 80-metre portable station for District 15 in the R.S.G.B. National Field-day Competition.
- June 30th.—Lecture on 10-metre work by Mr. H. Wilkins, G6WN.
- July 4th.—20-metre Field-day Competition.

Exeter and District Wireless Society

Headquarters: Y.W.C.A., 3, Dix's Field, Southernhay, Exeter.
Meetings: Mondays at 8 p.m.
Hon. Sec.: Mr. W. J. Ching, 9, Sivel Place, Heavitree, Exeter.

At a recent meeting an interesting lecture was given by Mr. Mays on electrical interference and methods of curing it. A selection of gramophone records, on which were recorded almost every type of electrical interference, was played.

Bideford and District Short-Wave Society

Headquarters: Mignonette Walk, Bideford.
Hon. Sec.: Mr. E. K. Jensen, 5, Furzebeam Terrace, Bideford.

In view of the interest shown in amateur transmissions it has recently been decided that alternate meetings, which are held fortnightly, should be devoted to this subject. The club subscription has been fixed at 1s. per fortnight. The Society now possesses its own short-wave receiving apparatus.

A large attendance of members witnessed the first transmitting demonstration by the chairman when contact was made with four amateur stations on the 1.7 megacycle band.

Golders Green and Hendon Radio Scientific Society

Headquarters and Hon. Sec.: 60, Pattison Road, Hampstead, N.W.2.

Interest in the Society's recent visit to the Marconiphone television demonstration theatre was so great that several people had to be disappointed. Preceding the demonstration Mr. A. S. Radford gave an explanatory talk on the system of transmission employed and a brief description of the Marconiphone television receivers. The Society has prepared the following activities for the summer, full details of which may be obtained from the Hon. Sec.:

- May 23rd.—Coronation direction-finding competition on 80 metres near St. Albans, Herts. Tea at 4.30 p.m., followed by conference.
- June 2nd, July 11th and September 12th.—5-metre field-day competition.

Radio Society of Northern Ireland

Headquarters: Y.M.C.A. Radio Club, Wellington Place, Belfast.
Meetings: The first Wednesday of each month.
Hon. Sec.: Mr. F. A. Robb, 46, Victoria Avenue, Sydenham, Belfast, N.I.

The Morse practice class which is held every Wednesday is very well attended, and the Club now possesses twelve operators for its transmitter G16YM. The transmitting members hold a QSO party at midnight every Saturday on the 14-megacycle waveband. The contest for the R.S.N.I. Leonard Trophy, full details of which appeared in the April 30th issue of *The Wireless World*, is taking place during the week-ends of May.

K.B. MODEL 630

A New All-Wave AC Mains Superheterodyne

AN unusual feature of the circuit of this receiver, just released by Kolster Brandes, Ltd., is that two IF stages are employed. They follow a triode-hexode frequency-changer, which is the first valve in the set, and automatic volume control is applied to all three stages. AVC is derived from a double-diode second detector and the output stage is a pentode.

There are three waveranges as follows: 16.5 to 52 metres, 195 to 565 metres, 970 to 2,300 metres. Station names on the "Alphadex" dial are grouped alphabetically, and the tuning is effected through a two-speed drive with ratios of 8:1 and 48:1.

Provision is made for gramophone reproduction, and the price is 12 guineas.



MCCARTHY

6-valve all-wave Superhet with Radio Frequency Stage

- 8 stages.
- 8 tuned circuits.
- 3 wavebands.

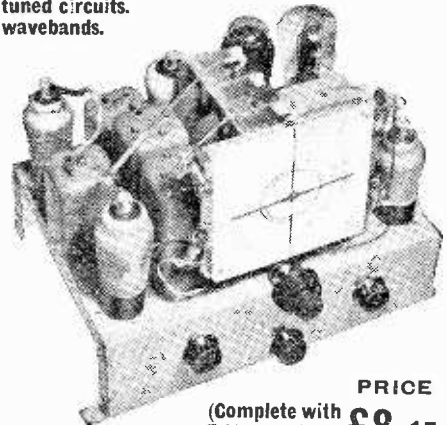

PRICE
(Complete with B.V.A. valves) **£8.17.6**

Performance (made possible by use of multi-electrode valves) equal to that of many receivers employing 8 valves or more. Brief specification includes: Large "Airplane" dial, with different coloured lights automatically switched on for each wave-range. Micro-vernier 2-speed drive. 4-point wave-change and gramophone switch. Volume control and variable tone control also operative on gramophone. Reinforced heavy-gauge steel chassis. Covers 19-2,000 metres. Circuit comprises: Preselector circuit, radio frequency amplifier (operative on all 3 wavebands), triode-hexode frequency changer, double band-pass I.F.T. coupled I.F. amplifier, double diode-triode detector and L.F. amplifier. D.A.V.C. applied to 3 preceding valves. 3-watt pentode output.

Special

6-VALVE BAND-PASS SUPERHETERODYNE

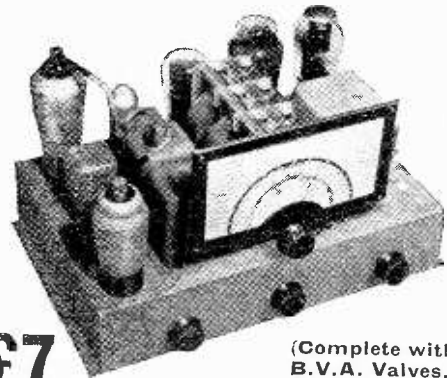

£7 (Complete with B.V.A. Valves.)

Specially designed and built for high quality radio gram work. **SPECIAL FEATURES:** Reinforced stout steel chassis. High class components by well-known makers of acknowledged reputation used throughout. Fitted with attractive and specially large full-vision dial, glass fronted, and supplied complete with escutcheon and fittings. Separate illumination automatically switched in for radio/gramophone.

CIRCUIT DETAILS: Inductively coupled band-pass filter, triode-hexode frequency changer, band-pass I.F.T. coupled I.F. amplifier, I.F.T. coupled to diode detector. D.A.V.C. applied to preceding valves. L.F. amplifier capacity coupled to output pentode 3-3½ watts undistorted. Variable tone control and volume control operate on both radio and gramophone.

ALTERNATIVE TRIODE OUTPUT
All McCarthy receivers supplied complete with valves, knobs, pilot lamps, leads, mains cable and plug. 12 months' guarantee. Deferred terms on application, or through London Radio Supply Co., 11, Oat Lane, E.C.2. Cash with order on 7 days' approval. Also write for illustrated catalogue of complete range of all McCarthy receivers

MCCARTHY RADIO LTD.
44a, Westbourne Grove, London, W.2
Telephone: Bayswater 3201/2.

Random Radiations

By
"DIALLIST"

The Short-wave Range

I'M glad to see considerable improvements in the short-wave departments of some of the new sets. One of these is to divide the short-wave bands covered into at least two ranges instead of trying to go from about 15 to 60 metres in one sweep of the condenser vanes. With two or more ranges tuning is far easier, and the wavebands can be provided with metre or megacycle scales that aren't nearly so hard on the eyes. Then I observed a tendency, worthy of all praise, to take in the 13-metre band, which was omitted in many of the older models. The optimum wavelength is growing steadily shorter and shorter, and is likely to go on doing so for the best part of the next two years from now. The B.B.C. now makes no regular transmissions at all from the Empire Station on wavelengths above 31.55 metres (GSB), and recommends that all receivers intended for Empire use should be capable of tuning down at least to 13.93 metres, the wavelength of GSJ. Don't grab pen and paper to tell me that GSA is still shown in the short-wave lists with a wavelength of 49.59 metres. I know it is; but if you examine the details of the six regular Empire transmissions you'll find that GSA is not now shown for any of them. I believe, though, that it is occasionally used under certain exceptional conditions.

The Best of Luck!

THE B.B.C. deserves to have every success with next Wednesday's Coronation broadcast, for so far as is humanly possible nothing has been left to chance. An immense amount of preliminary work has been done in all kinds of directions. It was necessary, for instance, to find by surveys of the Abbey and of the route taken by the procession and by experiment the most suitable positions for each of the 58 microphones that will be in use. The best places for the control rooms had to be found, and once this was done the G.P.O. co-operated with the B.B.C. in carrying out the 472 miles of wiring required. An imposing array of special apparatus was built for the control rooms to enable them to handle the incoming transmissions from 32 points within the Abbey, from "effects" microphones along the route and from the commentators' boxes, and to pass these on to Broadcasting House for home and Empire services, or to the International Trunk Exchange for relaying to foreign countries:

Television, Too!

A stupendous piece of organisation! Every listener will, one hopes, realise the hard work that has been put into the preparations and will wish the O.B. department the best of luck when Wednesday sees them carrying out the biggest job that they have yet undertaken.

Success, too, to the television engineers, who will be undertaking their first genuine O.B.—outside the Alexandra Palace grounds, that is. A co-axial cable has been laid from Broadcasting House (already connected by one to A.P.) to Apsley Gate, Hyde Park. Here there will be three Emitron cameras, with a mobile control van. Vision will be transmitted over the co-axial

cables; sound, over ordinary telephone lines. Given the fine day for which we are all praying, television will make history on Wednesday. I shan't be able to "look in" because my ear will be more or less glued to the loud speaker of my own medium-wave set; but I hope to be able to tell you how my neighbour receives the television broadcast.

A Suggestion

That last sentence engenders an idea which I pass on to the B.B.C. with my blessing. There will be numbers of owners of television sets who won't want to miss anything of either the commentaries or the "televews." Why not relay the whole of the spoken commentary from inside and

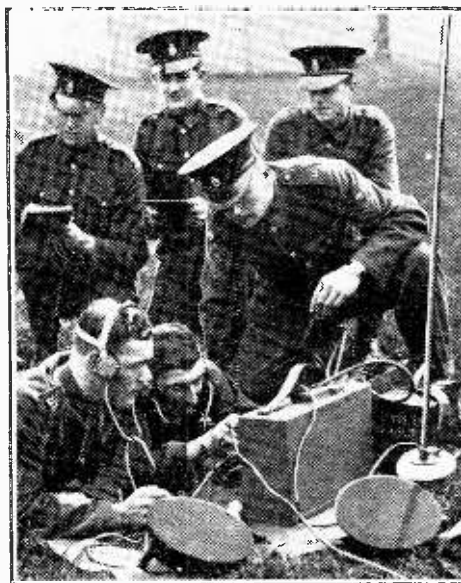

KEEPING IN TOUCH. Signallers of the Life Guards will maintain one of a number of portable wireless stations for the transmission of official messages from different points on the Processional route on Coronation day.

outside the Abbey on the ultra-short sound wavelength, just breaking it during the time when the television images with their special commentary are being sent out? It should be simple enough to do that, and if it can be managed I'm sure that it will be greatly appreciated by those who have television receivers. Otherwise, they'll have to keep a medium-wave receiver going, or to switch over from the ultra-shorts to the medium waves if the television set has an "all-wave" sound department.

Should the B.B.C. Borrow?

FROM a Birmingham reader I have a neat criticism of my suggestion that the B.B.C. should, if possible, avoid borrowing to meet the cost of television development. He puts it something like this. A is an old stager who has held a receiving licence since 1922. B is a newcomer who took out his first licence this year. Out of each ten shillings that A has paid a proportion—say two shillings—has been spent on building studios, plant, offices and so on, as well as in buying furniture, musical instruments and goodness knows what else that make up

the B.B.C.'s general equipment. A and his fellows have, in fact, built up the B.B.C.'s assets that now run to nearly four million pounds. B, on the other hand, has not paid a penny towards all this, though he comes in on the same ten-shilling basis. But B will henceforth have to shell out year by year, so long as the B.B.C. spends part of its revenue on similar things, for the benefit of C, who buys his first licence in 1947.

Not a Club

If we take this reader's view, the purchase of one's first wireless licence is rather like joining a club. The new member finds the club-house with all its furniture and other amenities ready waiting for him, and the entrance fee that he pays is his contribution towards their cost. That is very right and proper. But broadcasting isn't on the same footing. It has already been pointed out in *The Wireless World* that your receiving licence merely entitles you to use a radio receiver, just as a game licence makes you free to shoot game. It is not an undertaking to provide you with broadcasting to listen to any more than the game licence is an undertaking to provide you with game to shoot. Broadcasting is run by means of Government grants, and in practice these are worked out in proportion to the amount received from licence fees.

Posterity

"We do a lot for posterity," sighs my correspondent, "but what has posterity done for us?" Well, I suppose one might say that it's only because we have one eye on the future that we keep on bringing things up to date. If it weren't for posterity we might not have nearly such a good broadcasting system as we now have—and we probably shouldn't be so keen on developing television, to come back to the main theme of the argument. I am all in favour of borrowing when borrowing is necessary, but my reason for hoping that television expenditure during the next few years will be met by a bigger Government grant rather than by raising the wind is this. The B.B.C. is already faced by a huge programme of new building and rebuilding in its "sound" broadcasting sphere, and so far as one can see this kind of broadcasting is going to be the main fare of the great mass of wireless users for some little time. By its charter the B.B.C. can borrow only a certain limited amount. This may well be needed for the proper development of "sound" broadcasting; wouldn't it, therefore, be as well to avoid borrowing for television purposes if it is at all possible to do so? I can't help feeling that it would.

Televising the Coronation Procession

UNDCUBTEDLY the televising of the Coronation Procession will give an added fillip to television. It is an ambitious undertaking and the first big O.B. attempted. From the results of the rehearsal which the engineers had last Monday, it is certain to be a milestone in the history of television. In Broadcast

Brevities it has already been stated that three cameras will be used. On another page in this issue will be found photographs of Apsley Gate, Hyde Park Corner, giving the positions of these cameras.

It is necessary to provide control room apparatus at the scene of the television broadcast, and to enable this to be carried out the B.B.C. will be using the three-unit mobile transmitter, recently purchased. The control room is installed in one of these vehicles, which is about the size of a Green Line motor coach, the apparatus being mounted on two rows of racks along the sides of the vehicle. The operators are able to see the televised picture on a tube fitted into the compartment over the driver's head. In addition, it is equipped as a small sound control room with all the necessary faders and amplifiers to deal with the four microphones which will pick up the voice of the commentator and the sound effects. This motor will be parked behind the park-keeper's lodge on the west side of the gate, three multiple cables connecting the cameras will run from it to the top of the gate, across which they will pass to the plinth erected for the Emitron cameras. The cables are about 1½ inches in diameter and contain twenty-seven insulated cables, two of which are of low capacity to carry the VF signals.

The second vehicle, the ultra-short-wave transmitter, will be parked alongside the other and will radiate the vision signals on

a wavelength of about 3 metres from a directional aerial. These signals will be picked up at Alexandra Palace on an aerial mounted at the top of the main transmitting mast. The third motor contains the power plant which will generate the sync pulses and the scanning voltages for the cameras.

The engineers will use the recently laid coaxial cable to transmit the vision frequencies to Alexandra Palace. They will probably use at the same time the ultra-short-wave transmitting van, so that the engineers at the Alexandra Palace can take their choice and use the better of the two transmissions.

At 2 o'clock the transmission will begin by giving crowd scenes around Hyde Park Corner, then a camera, trained on East Carriage Drive, will give views of the approaching cavalcade. The camera on the pavement, which will be within about six feet of the passing Procession, will give close-up views of the Royal Coach and other important parts of the Procession as it passes through the gate. The third camera, which will face Wellington Arch, will intersperse views of the disappearing pageant. Thus, until the last horseman passes the gate, viewers will, it is hoped, receive a complete picture of the Procession. Frederick H. Grisewood, the announcer who was recently appointed Staff Reporter, stationed alongside the cameras, will give a continuous commentary.

The Norwegian Folkemottager

IMPRESSED by the success attended by the marketing of Germany's famous "Volksempfänger," many other countries of Europe are now attempting to follow her lead in this respect. The latest

three valves instead of two pentodes plus rectifier, as in the case of the mains set.

This receiver is sold for little over £4, there being a vast gap between this and the ordinary mains set, which sells for from £12 to £15. The set proved popular immediately it was marketed, and it was not long before the first batch made—16,000 sets—was sold out. The preliminary batch was produced by two well-known Oslo manufacturers, special arrangements being made with patent holders for reduced payments in respect of these sets. It is expected that before very long the other

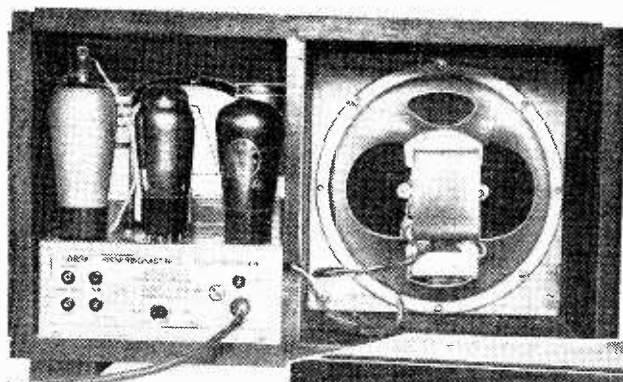

The mains model is designed to operate from two pentode valves.

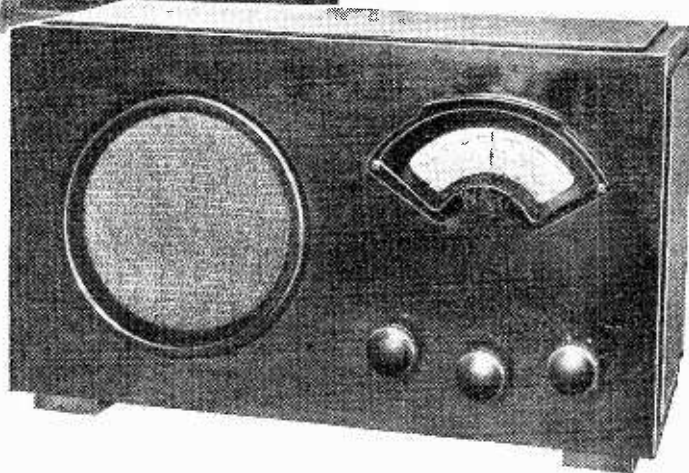

country to do so is Norway.

The Norwegian "Folkemottager," or "People's Receiver," is available in two models, for mains and battery operation. In both cases tuning arrangements are similar, but whereas the mains set uses an RF pentode valve as a leaky grid detector, the battery set employs a triode. In both cases the detector is followed by a resistance coupling. Triodes are used in the battery set throughout, and consequently there is a total of

Scandinavian countries will follow the lead of Norway and market special receivers of this type. No definite announcement has yet been made, but there would seem little need to depart from the Norwegian design.



CONFUCIUS
551-478 B.C.

So asked Confucius two thousand years ago. A far cry from ancient China to modern radio but to-day, as of old, that which "bringeth surcease from care" is no less a jewel. And it needs not the philosophy of Confucius to appreciate its value.

Setmakers, Designers and Constructors too, have found in T.C.C. Wet Electrolytics a real remedy for trouble in A.C. Receivers.

The momentary building up of HIGH SURGE VOLTS when switching on is the most prolific cause of breakdown. Maybe just a condenser, maybe valves or even a transformer burnt out. Free yourself of this ever present possibility—Fit T.C.C. 'Wets,' and condensers and components are safe against damage. 'No lead' surges cannot develop—normal working conditions are constantly maintained.



FIT T.C.C. 'WETS' AND END CONDENSER WORRIES

FOUR TYPICAL TYPES

Type	Capacity	Continuous Working Volts
802	16 mfd.	440 volts Peak
602	8 mfd.	440 volts Peak
805	8 mfd.	500 volts Peak
809	32 mfd.	320 volts Peak

Special types are available to meet the stringent conditions found in A.C./D.C. Receivers. Write for full details.

T.C.C.
VOLTAGE REGULATING
WET ELECTROLYTICS

THE TELEGRAPH CONDENSER CO., LTD.,
WALES FARM ROAD, NORTH ACTON, W.3.

Letters to the Editor

The Editor does not hold himself responsible for the opinions of his correspondents

Sunspots and Short Waves

REFERRING to the article "Sunspots and the Short-wave Listener" in your issue of April 23rd, and particularly the remarks regarding sudden fade-outs, I note that it is stated that these fade-outs are caused by sudden excessive rise in ionisation resulting in complete attenuation of high-frequency signals, and am wondering if this fact has been definitely proved. My experience on frequencies above 20 Mc/s would go to show that the opposite is the case and that the fade-outs are caused by decreased ionisation.

Some time ago, in a letter to you, I pointed out the reception from time to time of a peculiar "hiss" occurring during daylight hours on frequencies between 10 and 40 Mc/s and generally peaking about 25 Mc/s. It has since been noted that on the days when this hiss has been heard fade-outs have often been reported, so also have magnetic storms, and there appears to be some connection with the aurora borealis. The nature of the agent causing the hiss is not clear, but it is suggested that it is a shower of particles shot off from the sun, particularly during high sun-spot activity. Apparently the particles are attracted by the earth's magnetic poles and tend to follow its magnetic field. If this shower possesses the power of neutralising the ionisation (due to ultra-violet light) it will be seen that here we have an explanation of the fade-outs, as obviously the neutralising effect would be greatest on the outer layers.

The hiss has been very active lately, and on April 25th the writer and others had a particularly good example of the co-relation of it and fade-outs. In the early morning of this day the hiss was observed to be unusually continuous and loud, and on reaching the G.P.O. receiving station at Baldock we found that they had had a complete fade-out on U.S.A., etc., circuits for about three hours and were just getting through again at 11.30.

Although I can only speak from observations on frequencies above 20 Mc/s, it has always been found that fade-outs occur first on circuits north of east or west, while circuits in southerly directions are the last to go out—if they go at all. This supports the fact that the neutralising agent is attracted to the poles, as obviously its effects would be greatest on the layers over the polar regions and nil, or practically nil, on those over the equator.

Going one step farther, it seems to me that in the above there may possibly be an explanation of the fact that communication over long distances east and west (and, of course, north of both) is not possible during summer months on the ultra-high frequencies. If it is assumed that there is always, to some extent, an emission of this neutralising shower from the sun, then during the summer months, since the North Pole is nearer the sun, we should expect the greater part of the shower to be attracted to this pole and the neutralising effect on the layers in the northern hemisphere would be much greater than during the winter months. Therefore, although the effect of the ultra-violet radiation is greater in summer, the effect of the shower is still greater and the nett ionisation less.

The present explanation of poor summer

conditions is that expansion of the F layer, due to heating, causes less nett ionisation density during the summer. It would seem that something is lacking in this theory, because on frequencies above 20 Mc/s long-distance communication over the Equator (i.e., north-south) is consistent throughout the year, while parallel to the Equator, in the northern or southern hemisphere, it is only consistent during the winter months, becoming erratic in spring and nil during the summer. For example, on the 28 Mc/s amateur band South Africa can be contacted very consistently throughout the year, while U.S.A. on one side and Russia on the other can only be contacted erratically in spring and autumn and consistently during winter. In the southern hemisphere the same thing applies, i.e., Africans can contact us throughout the year, but can only work Australia and South America consistently during their winter (i.e., summer here, of course). If the expansion theory were true we should expect the nett ionisation over the Equator to be less than elsewhere and, therefore, trans-Equator contacts on ultra-high frequencies not possible or erratic.

D. W. HEIGHTMAN.

Gt. Clacton, Essex.

Horn-Loaded M.C. Speakers

THIS is someone else's private fight, and I ought not really to butt in; but I cannot let Mr. Todd's letter pass. He refers to transient response, which is good, for that is a most important point. But he implies that it is more or less independent of frequency response.

He cites "Fourier's Analysis" as having no bearing on transients. Presumably he means "Fourier's Theorem." But has he not overlooked "Fourier's Integral Theorem"? This *does* cover transients, and indicates that, *other things being equal*, every increase in frequency response improves fidelity on transients.

There is as yet no generally accepted and rigorous analysis of the transient problem in loud speakers; but experience indicates that the two main desiderata are:

- (1) Wide frequency response.
- (2) Absence of sharp resonances.

Given equal brains in design, the question of horn loading or baffle does not seem to affect this point.

P. K. TURNER,
Hartley-Turner Radio, Ltd.

Isleworth.

I WAS interested to read that Mr. Voigt, in his letter of March 26th, agrees with me that a horn type of loud speaker capable of reproduction down to frequencies of 40 c/s is impracticable for average domestic use.

Mr. Voigt has gone to a considerable amount of trouble to show why a horn-loaded speaker "down to its cut-off frequency" is superior to a baffle speaker. As I pointed out in my original letter, I am entirely in agreement with this. My query was, is there any relative advantage in a horn speaker, operating below its cut-off frequency, over a baffle speaker, bearing in mind the fact that the baffle speaker has an additional advantage in that it can be arranged to have a considerably lower cut-off without

becoming too unwieldy. For his calculations for the baffle speaker Mr. Voigt actually uses a frequency of 50 c/s as a basis, and compares the results with those for a horn speaker working within its frequency range of efficient loading.

It is an interesting fact that the principal manufacturers of sound film reproducing equipment, both in this country and the U.S.A., use a large baffle speaker for reproduction of the lower register. I believe I am correct in stating that the reason is the enormous difficulty of building a horn that would be capable of efficient working at low frequencies, as compared with a comparatively simple but efficient large-diaphragm baffle speaker.

Dealing once more with the question of air loading, if Mr. Voigt will refer to his original advertisement he will find that he uses the words "with a baffle, the loading is a maximum for wavelengths so small . . ." and *not* "with baffle speakers. . ." The difference is subtle but very important. Mr. Voigt's statement, to be correct, would necessitate the removal of the speaker from its baffle. Surely, then, it ceases to be a baffle speaker? The same argument might be raised for a horn unit, and would not be any more irrelevant.

Finally, may I take this opportunity of expressing my appreciation of Mr. Voigt's efforts towards the development of better loud speakers, while maintaining that friendly discussions of this nature react for the good of the industry in general?

For Goodmans Industries, Ltd.,
G. A. BARDEN.

Wembley,
Middlesex.

Reflections on "Random Radiations"

AT the risk of taking up your space, I will comment briefly upon a few of the points raised by "Diallist" in the issue dated April 2nd. Thus:

Playing Up.—Besides the intermittent fault in a set, what about the tip-and-run kind of interference? You complain about a noise like that of an American gangster film—in other words, a sound like a machine gun—and in due course (perhaps overdue is the better word) Post Office engineers arrive on their motor bikes (in my case they arrived during a thunderstorm!). You switch on the set and—provided there's no thunderstorm—not a sound is to be heard except the sweet music of somebody's quintet. No machine-guns at all. Nothing but harmony. The engineers' pleasant manner perceptibly freezes, and soon they depart, obviously thinking hard to themselves that you're not quite all there. Immediately they have left, the offender starts up his drill again, and you switch off, feeling incapable of summoning the busy fellows again in case the same thing happens as before! Why don't local post offices have their own listening departments?

Piracy.—I agree thoroughly with "Diallist's" remarks thereon. Very often the people who cheat the B.B.C. and their listeners are people who can well afford the

ros. licence. I know of someone myself who steals his entertainment, but all the same I'm not going to send one of those anonymous postcards exposing him! There are probably many more pirates than is generally realised. And, as "Diallist" points out, piracy could easily be eradicated.

Chain Listening.—That's where we battery folk gain. The possessor of a set working off expensive HTB's simply cannot, unless he's a millionaire, keep it on all day. Besides, even the best HTB would rebel against such treatment. So, therefore, to avoid expensive and frequent replacements one chooses items one really wants to hear, and that, whatever the items may be, is "good listening"! T. J. E. WARBURTON, East Molesey, Surrey.

P.A. Along Coronation Route

WITH reference to your Editorial on the use of P.A. equipment along the Coronation route, we should like to point out that a precedent was set during the passing of King George V's funeral. We were then officially advised to fade out when the procession came into view, in our case some three-quarter-mile away. The same stipulation has been made for the Coronation procession.

We strongly agree with your suggestions for a rehearsal, as in some instances the procession will come into view only a hundred yards or so away from loud-speaker positions, and it will be noted that nearly all the speakers are necessarily of the directional-horn type, capable of carrying considerable distances. Furthermore, many have been erected pointing towards the oncoming procession.

N. J. LEAK.

London, W.6. For H. J. Leak and Co.

Coronation PA Contracts

AMPLIFIERS giving an undistorted output of 480 watts with thirty projector speakers are being installed on stands in Whitehall by B.T.-H. Other important installations are being carried out at Blackpool and Bath.

Grampian PA equipment is being installed at about thirty sites on the Coronation route. A radio input via land lines is being taken from a central receiving station outside the central London area.

Marconiphone apparatus is being installed in the Mall, on all the stands round the Houses of Parliament, St. Margaret's stand adjoining Westminster Abbey, all the stands round St. George's Hospital, and at many other important points.

Trix Sound Equipment is to be installed for official use inside the new annexe at Westminster Abbey; three complete installations with sixteen speakers will be used. Other Trix equipment is being fitted on the official stands at the Horse Guards, Treasury and Admiralty buildings.

Many dealers have been supplied with Vortexion 20-watt amplifiers for use during Coronation celebrations.

It is anticipated that the permanent Voigt installation at the Royal Empire Society building will be temporarily extended for the Coronation.

"Cellophane"

IN a letter from Mr. W. A. Richardson on the subject of recording, published in *The Wireless World* of April 23rd, the use of "Cellophane" was recommended.

"Cellophane" is the registered trade mark of British Cellophane, Ltd., applied to their products, and the name, therefore, should not be used in reference to transparent cellulose sheeting generally.

PHILCO PHONE

New Intercommunication System for Private Installations

THE Philco Phone, a new system of instant, private, two-way communication, is to be introduced into England in the near future by Philco Radio. The instrument has been developed in the United States, where it has been installed in private homes, business houses, restaurants, doctors' offices, amusement places and many other buildings.

Philco Phone provides two-way communication between a master control unit and one, two, three or four remote units. The system can be used between distant points in homes, offices, stores, hotels, factories, theatres, garages, hospitals or similar places. It is an inexpensive but efficient communication system. The price will, in all probability, be of the order of £20 with one remote unit, additional remote units costing about £2 each.

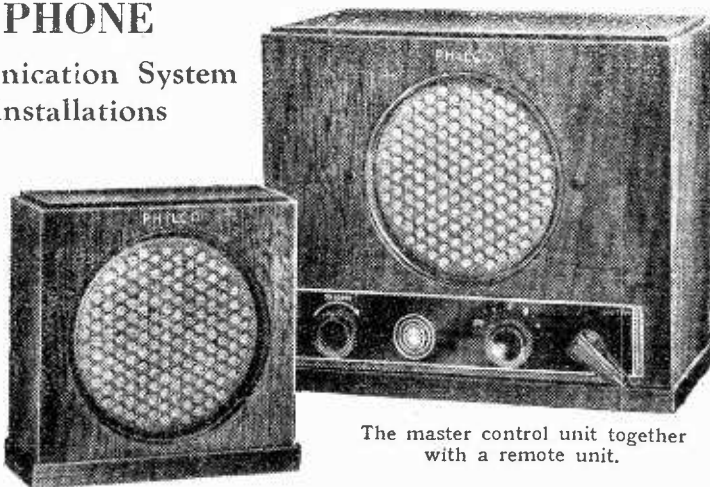

The master control unit together with a remote unit.

The equipment is built of all Philco standard components, and it can be used on either AC or DC supplies. It can be installed anywhere within a few minutes.

The master control unit is encased in a compact, attractive walnut cabinet. Combination speaker-microphone permits instant conversation with one or all remote points at will. A turn of the volume knob sends the voice to the remote units as loud or as low as desired. A red signal light on the master unit shows when the system is in operation.

NOTABLE FEATURES of the New ROLA F 742-PM

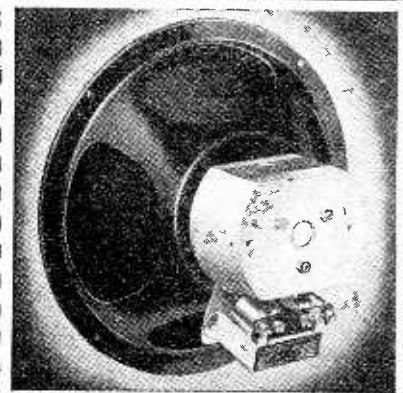

A 9 1/2" DIAMETER SPEAKER WITH 12" PERFORMANCE

It is no exaggeration to say that the new Rola F742-PM has a performance equal to the majority of 12" speakers. It isn't as good as the giant Rola G.12-P.M., of course, but the flux density is the same and it gives you super-sensitivity at a very much lower price. A new magnet material "Alnico" is used with this model, and another special feature is the new metal and compound shielded universal transformer, not only dust-proof but moisture-proof, a further instance of Rola technicians' care. For battery sets or for that weak short-wave station, as Extension Speakers or under any conditions where extreme sensitivity is a requisite, the Rola F742-PM is the ideal speaker to specify.

Write to-day for leaflet AB.

Model F 742-PM 49/6

WITHOUT TRANSFORMER 42/-
OVER £8 MILLION IN USE

ROLA

The World's Finest Reproducers

THE BRITISH ROLA CO., LTD.
MINERVA ROAD, PARK ROYAL, N.W. 10.
PHONE: WILLESDEN 4322-3-4-5-6.

Brief descriptions of the more interesting radio devices and improvements issued as patents will be included in this section.

Recent Inventions

AUTOMATIC SELECTIVITY CONTROL

THE selectivity of a wireless receiver can be automatically controlled so that it is highest for weak or distant signals and lowest for strong signals. According to the invention, the control is secured by causing the incoming signals to vary the effective linkage between the primary and secondary windings of a band-pass coupling.

As shown, the primary winding P and the secondary winding S form part of a band-pass coupling between the two radio frequency or intermediate-frequency amplifiers V and V₁. Associated with the windings P and S are auxiliary windings P₁ and S₁, which are wound in such a way that they tend to oppose the effective coupling between the coils P and S.

The winding P and S are originally over-coupled so as to give a wide band-pass effect, but so long as only a weak signal is being received the link circuit P₁, S₁ serves to neutralise the original

INTERLACED SCANNING

WHEN the rate of picture-repetition is lower than the frequency of the mains supply—which in America is 60 cycles—it is difficult to keep the AC component out of the picture. Its presence is manifested by what is known as "flag waving," or periodic changes of light and shade, which greatly increase the apparent flicker.

If, however, the rate of picture-repetition is made equal to the fundamental AC frequency, these difficulties at once disappear. According to the invention, a sufficiently high repetition-rate is used in combination with a system of interlaced scanning, in which the ordinary saw-toothed oscillations are combined with a series of square-topped waves; on two series of saw-toothed waves may be used, provided the "line" and "frame" oscillators are interlocked.

Farnsworth Television Inc. Convention date (U.S.A.) November 5th, 1931. No. 459400.

"DETECTIVE" VALVES

A PAIR of valves are reciprocally coupled so as to form a multi-vibrator circuit in which the period of oscillation is determined by the values of the coupling resistances and capacities.

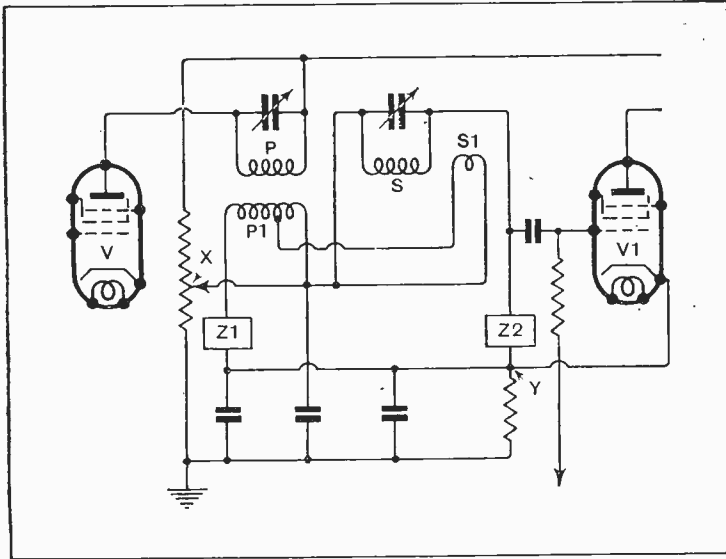

Circuit arrangement for automatic selectivity control.

setting and to produce only a narrow band-pass or highly selective coupling. However, when a strong signal comes in, the AVC voltage applied to the grid of the valve V₁ reduces the output current from that valve, so that the point Y falls below the potential of the point X. Current then flows through the Thyrite elements Z₁, Z₂, and reduces their resistance, so that Z₁ short-circuits the winding P₁, whilst Z₂ damps the winding S₁. This cancels the effect of the reverse coupling-link P₁, S₁ and restores the original wide band-pass effect.

E. K. Cole, Ltd.; G. Bradfield; and F. A. Inship. Application date July 1st, 1935. No. 459209.

The combination is then utilised to detect the approach of a body or person towards a protected area. The capacity of the intruding body is added to that of the circuits, and the resulting change in the period of oscillation is used to operate a relay or to sound an alarm.

The device may be used, say, to guard the approach to a strong-room or safe, or to open or close a door automatically, or to record the passage of vehicles over a bridge or through a tunnel, or to light up a particular object on the approach of a customer, or for advertising purposes generally.

A. C. Alexandra. Application date July 25th, 1935. No. 460297.

"SECRET" SIGNALING

A FREQUENCY "wobble" is imparted to the carrier wave, in order to impart a measure of secrecy, by using a piezo-electric crystal as the master control, and so mounting it that its natural frequency constantly varies. As shown, the crystal Q is circular in shape, and is mounted to roll

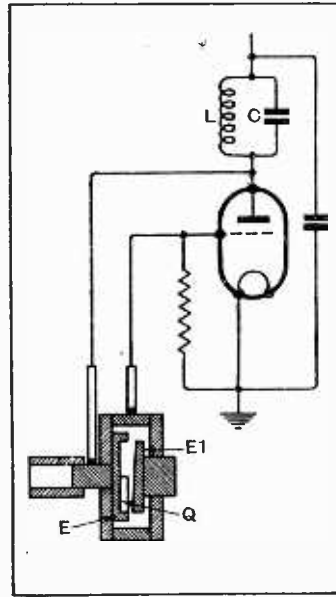

Method of mounting a piezo-electric crystal to "wobble" the frequency of a master oscillator stage.

freely in a recess in the face of a rotating electrode E.

A second electrode E₁ is set at a slight angle to the first, so that the effective spacing between the crystal and its pair of electrodes is constantly changing. This causes the carrier frequency generated in the circuit L, C to vary in a cyclic fashion. In addition the speech currents are "inverted," so that the high frequencies are transformed into low, and vice versa, before they are applied to the modulator valve.

Marconi's Wireless Telegraph Co., Ltd., and T. D. Parkin. Application date July 5th, 1935. No. 459303.

TELEVISION SYSTEMS

THE object is scanned by the apparatus shown in Fig. 1 which consists of a tube T (shown more clearly in Fig. 2) containing a slotted cylinder C mounted on a transverse axis. The tube T is formed with a slot S at one end, and has a ground-glass viewing-screen V at the other end. The cylinder C is pierced by a series of slots K set in a spiral, and it contains a photo-electric cell connected to brush contacts, B, B₁.

In operation the tube T and the

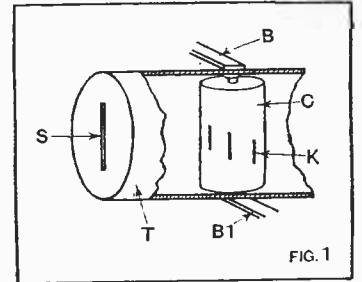

Assembly of the two cylinders in a television scanning system.

contained cylinder C are both rotated about the longitudinal axis of the latter. The result, it is stated, is to throw, not a true image of the object on the screen V, but persistence of vision in the eye of the observer causes the continually changing groups of luminous lines actually projected on the screen to appear as a picture of the object presented to the slot S.

The arrangement is also used to record on a cinema film a series of markings, which, although not recognisable at sight as the picture scanned, will reproduce the

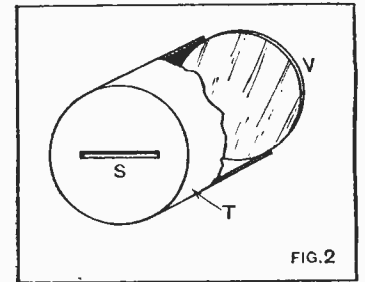

The outside cylinder has a slot at one end and a viewing screen at the other.

original picture when projected on to a viewing screen through apparatus similar to that already described.

H. Vierl. Convention dates (Germany) March 27th and October 11th, 1934. No. 459042.

SUPER-REGENERATIVE AMPLIFIERS

IN order to get the best results from a super-regenerative amplifier the quenching oscillations should be adjusted until the valve is very close to the threshold of self-oscillation. In practice it is difficult to secure a sufficiently elastic control over the quenching, so that the valve is often worked considerably below the optimum coupling.

According to the invention a fine control over the quenching is obtained by using a capacitance impedance to vary the amount of feed-back from plate to grid. Actually a variable condenser is arranged in series between the usual back-coupled grid inductance and the anode.

L. M. Merdler, M. Scott and Baird Television, Ltd. Application date July 5th, 1935. No. 459300.

The British Abstracts published here are prepared with the permission of the Controller of H.M. Stationery Office, from Specifications obtainable at the Patent Office, 25, Southampton Buildings, London, W.C.2, price 1/- each. A selection of patents issued in U.S.A. is also included.

URGENT & IMPORTANT
to all interested in P.A.



This offer applies to two of the most popular and efficient Portable Outfits available in this country to-day and represents a really remarkable opportunity which will not recur. These are current models, several hundreds of each type having been sold this year at full list price to highly satisfied users. The output is ample for large assemblies either indoors or outdoors, entirely independent of any mains supply. We are confident that the demand will exceed the supply at these special prices and we have to advise immediate reservation.

ANOTHER EXCLUSIVE OFFER BY
M.R. SUPPLIES
65 ONLY BRAND NEW **G.E.C.**

PORTABLE AMPLIFYING EQUIPMENTS
to be cleared at **SPECIAL BARGAIN CASH PRICES!**

G.E.C. BATTERY OPERATED PORTABLE AMPLIFYING EQUIPMENT, comprising Amplifier in oak portable case 18in. by 9in. by 10in., for microphone or pick-up, class "B" Output, with all valves and batteries, Moving Coil Microphone and Telescopic Floor/Table Stand (as illustrated). Current list price £28 5 0.

35 only of this model at £12 18 6 each, carriage paid.
G.E.C. 12-VOLTS CAR AMPLIFIER EQUIPMENT, comprising Amplifier (as illustrated) with built-in H.T. Generator and all valves in oak portable case 12in. by 8in. by 10in., for operation from 12-volt car battery (consumption only 3 amps.) and microphone or pick-up input, Moving Coil Microphone and Telescopic Floor/Table Stand. Current list price £34 5 0.

30 only of this model at £17 each, carriage paid. The output impedance of either of the above is 15-ohms and any speaker of that impedance is suitable. We have a very limited number of G.E.C. 1591 Portable Projector Speakers, brand new, 18in. by 14in. by 14in. with carrying handle, containing 56in. folded horn and fitted powerful P.M. Moving Coil Unit, at 87 6 each. Also a few brand new Truvox 8-watt P.M. Horn Units at 85/- and 42in. Straight Projector Horns to suit at 42/-.

Further details gladly sent in response to immediate request, but these fine outfits can be ordered with every assurance of complete satisfaction.
OTHER SPECIAL OFFERS.
Good news for those who responded too late to our offer in "W.W." of 16th April of G.E.C. "Overseas 7" Superhet Receivers. We have just acquired 16 only of these same sets in Chassis Form, tuning 11 to 555 metres (5-bands), 3-watts undistorted output, with senior G.E.C. Energised M/Coil Speaker which plugs on to chassis, seven Osram Valves, brand new. Mains 100-250v. A.C. The ideal radio-grain unit. Price only £7 10 0 complete.

Crosley All-wave Chassis, 12 to 2,000 metres in 5 bands, 9-valve superhet complete with 12in. energised Magnavox Speaker ready-assembled and all valves, £11 15 0.

G.E.C. Speaker Coupling Units (special choke filter) recommended for use with extension speakers of any type, assisting matching and overcoming instability on long lines (listed 19/6). Special offer of 300 at 5/- each.

Truvox and Racon M/Coil Horn Units, 15-ohms speech, 6-volt field, handling up to 20-watts, all maker-reconditioned, 38/6 each. (Suitable for G.E.C. Portable Equipments.)

G.E.C. Microphone Preliminary Amplifiers, suitable for use with any main amplifier, energising carbon mike and giving very high gain. Very well made, thorough smoothing, complete with Osram valve, and ready for use. List £9. Brand new 42/6. Circuit diagram with each.

G.E.C. Cabinet M/Coil P.M. Speakers with 6-ratio centre-tapped transformer suitable for matching to any set. Well made hand-painted cabinet 18in. by 12in. by 6in. Perfect for extension or relay systems. Brand new—boxed, 28 6 each. £13 per dozen. We have 200 of these and will accept reasonable offer for lot.

Weston M/Coil Model 301 Meters, dia. 3in. flush mtgs., 0-3 m.a., 0-30 u.a., or 0-200 m.a., either 25/-, Also same model, 0-250 volts, 14/6. Also 0-10 amps, 10/6.

G.E.C. Portable Gramophone Playing Desks with high-quality pick-up and spring motor in strong carrying case with record storage. Ideal for use with the G.E.C. Portable Equipments. Brand-new 58/6.

Electric Clock Movements, 200-250 v. A.C. (synchronous) finest movement extant, drive up to 15in. hands. 2in. dia. 16 6

Heavy Duty Output Transformers exact "W.W." spec., 11 ratios from 11/1 to 75/1 with C.T. for P.P., weight 7 1/2 lb. (usually 55/-). Exact matching, minimum loss, 28/-.

G.E.C. Super-Cinema M/Coil Speakers, 2,000 ohm id. Handle 20-watts, massive construction, weight 4 1/2 lb., 70/-, Solid Oak Cabinets to suit, 20in. by 20in. by 14in., 20/-.

List 1436 describes the range of popular M.R. Microphones, Portable Amplifiers, etc.

M.R. SUPPLIES, 11, New Oxford St., London, W.C.1

Telephone: Holborn 7058.



5 TO 15 METRES

Just one year ago Hivac produced three special short-wave valves which were designed to meet the definite needs of short-wave enthusiasts.

These valves have been greatly appreciated and extensively used by leading designers and many well-known experimenters in short-wave work.

The valves are of most rigid construction, therefore their excellence of performance is consistently maintained.

THREE HIVAC VALVES ARE SPECIFIED FOR THE 5-15 METRE BATTERY SET DESCRIBED IN THIS ISSUE.

- ★ SG220 SW - - 12/6
- ★ D210 SW - - 5/6
- Y220 - - - - 9/6

Obtainable through all Dealers.

HIGH VACUUM VALVE CO., LTD.
111-117, Farringdon Rd., London, E.C.1



Note the Top Grid connection and Frequentite base as employed in the special range of Hivac valves for Short-wave work.

LISTEN TO THE CORONATION BROADCASTS on **1937 MIDWEST**

ENGLAND • THE EMPIRE • THE WORLD

In fact "Everything on the Air" is obtainable with this latest Midwest Model X-18 High Fidelity Receiver. Its 6 TUNING RANGES not only bring the broadcasts of the World into your home, but it brings them with a quality which is equalled only by the original performance. Its distinctive features in circuit design are not just talking points, as a comparison will speedily prove, but basic quality, which will assuredly appeal to "Wireless World" readers and all music lovers,

THE ONLY ALL-WAVE RECEIVER COVERING 4 1/2 - 2,400 METRES

FREE

ART CATALOGUE
40 pages, fully illustrated, giving particulars of Midwest 11, 14, 16, and 18 valve models.

DEMONSTRATIONS
at our showrooms Mondays to Saturdays from 9 a.m. to 8 p.m. (except Tuesdays, 9 a.m. to 6 p.m.).

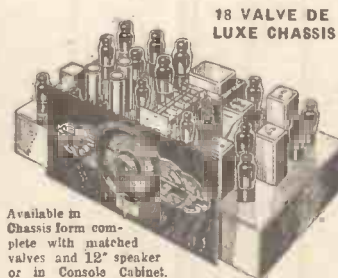

Available in Chassis form complete with matched valves and 12" speaker or in Console Cabinet.

MIDWEST RADIO LTD.

Showrooms and Factory:
16, OLD TOWN, CLAPHAM, LONDON, S.W.4.

Phone: MAnclay 5005.

Mention of "The Wireless World," when writing to advertisers, will ensure prompt attention.

MISCELLANEOUS ADVERTISEMENTS

NOTICES

THE CHARGE FOR ADVERTISEMENTS in these columns is

12 words or less, 3/- and 3d. for every additional word.

Each paragraph is charged separately and name and address must be counted.

SERIES DISCOUNTS are allowed to Trade Advertisers as follows on orders for consecutive insertions, provided a contract is placed in advance, and in the absence of fresh instructions the entire "copy" is repeated from the previous issue: 13 consecutive insertions 5%; 26 consecutive, 10%; 52 consecutive, 15%.

ADVERTISEMENTS for these columns are accepted up to **FIRST POST** on **MONDAY MORNING** (previous to date of issue) at the **Head Offices** of "The Wireless World," Dorset House, Stamford Street, London, S.E.1, or on **SATURDAY MORNING** at the **Branch Offices**, 19, Hertford Street, Coventry; Guildhall Buildings, Navigation Street, Birmingham, 2; 260, Deansgate, Manchester, 3; 26a, Renfield Street, Glasgow, G.2.

Advertisements that arrive too late for a particular issue will automatically be inserted in the following issue unless accompanied by instructions to the contrary. All advertisements in this section must be strictly prepaid.

The proprietors retain the right to refuse or withdraw advertisements at their discretion.

Postal Orders and Cheques sent in payment for advertisements should be made payable to **HLIFFE & SONS Ltd.**, and crossed **& Co.** Notes being untraceable if lost in transit should not be sent as remittances.

All letters relating to advertisements should quote the number which is printed at the end of each advertisement and the date of the issue in which it appeared.

The proprietors are not responsible for clerical or printers' errors, although every care is taken to avoid mistakes.

IMPORTANT NOTICE.

Owing to the Coronation and Whitsun Holidays, the issue of "THE WIRELESS WORLD" for **MAY 21** must be closed for press earlier than usual.

MISCELLANEOUS ADVERTISEMENTS for insertion in that issue can be accepted up to **FIRST POST FRIDAY, MAY 14.**

NEW RECEIVERS AND AMPLIFIERS

A.

A.

DECALLIER'S, Ltd., the firm for reliable short wave radio, have on show in London the largest selection of fully guaranteed brand new all-wave receivers; callers invited to handle all these at their leisure without obligation to purchase; all S.W. receivers will get stations on the low bands, including the Americas, etc. Closed all day Mondays. All goods cash with order or c.o.d. Handsomely illustrated catalogues forwarded on receipt of large stamped addressed envelope or stamp 2½d. Our models receive American transmissions at full programme strength; demonstrations daily after 4.30.

6/6 Each.—Valves for American receivers, all guaranteed, each a first, no seconds or throw-outs; for every known set from 1927-37; metal, metal glass, glass counterparts, and glass; in ordering just state type and number, we have it, all post paid; line cords for all midgets, 4/6 each.

£3/10—T.R.F. Midget receiver. "The smallest of its type in the world," medium and long wavebands, moving coil speaker, 2 watts output, no earth required, compact and transportable, leather cloth covered, obtainable in various colours; carriage 1/-.
£7/7—Table model six-valve all-wave superhet, tuning 16½-50, 200-250, 800-2,000 metres, high efficiency resistance-capacit. circuit with A.V.C. station calibrated dial, 8in. moving coil speaker, cabinet of handsome appearance and super acoustic, 17x13x9½, operates on A.C. or D.C. mains, 200-250 volts; never before such tone from a D.C. receiver, carriage 4/6.

13 Gns.—The new Challenger 8 (type 800) table model De Luxe, 22x18x12, high fidelity 8-valve superhet, A.C. 200-250 volts, waveband coverage 11-32, 27-65, 190-550, 900-2,000 metres, simplified centralised tuning, super slow motion vernier slow-fast tuning dial calibrated in metres, with station names, self contained control panel, perfect tone quality at low volume, new type, M.C. 10in. speaker, from a whisper to 8 watts pure undistorted tone, no overloading at full volume, oscillator fundamental without use of harmonics, persistent oscillator of highest output, isolating filters eliminate oscillation and motor boating, fully delayed A.V.C., P.U. terminals (switching and volume control incorporated in the front panel), absolute minimum of noise, sensitivity con-

(This advertisement continued in third column.)



OUR A.F. COUPLING UNIT

has had a steady sale ever since we made it available as a separate component.

But we have had some complaints that it is unduly bulky for modern ideas.

So we are producing a new design—just the same inside, but in an enamelled steel "can" instead of the present bakelite case, and considerably smaller.

This has enabled us to reduce the price—a welcome change. The present prices are, for standard types, 30/- and for high-power, 45/-, plus 10 per cent. in each case, making 33/- and 49/6. We have now decreased the base prices to 25/- and 40/-, which with the 10 per cent. increase on all our goods makes a final figure of 27/6 and 44/- nett.

Six types, to suit different circuits, as before: write for the special leaflet describing them.

REMINDER

Open House on Wednesday evenings only, until further notice.



HARTLEY TURNER RADIO LTD.,

THORNBURY ROAD,
ISLEWORTH, MIDDLESEX.
Telephone: HOUNslow 4488

RECORD

The quality valve in the COMPLETE range

RECORD RADIO LTD., 2/3, Eldon Street, E.C.2

M.P.R. 3 WATT BATTERY PUSH-PULL AMPLIFIER.

For Cafes, Dances, Socials, etc. Amazing volume, with excellent quality. Supplied complete with 3 British Valves, and Volume Control, ready for connecting to pick-up, etc. Complete Amplifier (less batteries) Price 45/- or £1 deposit and 3 payments 10/- Matched MC Speaker 20/- extra. Send for full details, also AC 7 watt model, 105/- Car Portable Model 120/- Phone: Romford 338. M.P.R. ELECTRICAL CO., 252, Victoria Road, ROMFORD, Essex.



NUMBERED ADDRESSES

For the convenience of private advertisers, letters may be addressed to numbers at "The Wireless World" Office. When this is desired, the sum of 6d. to defray the cost of registration and to cover postage on replies must be added to the advertisement charge, which must include the words Box 000, c/o "The Wireless World." All replies should be addressed to the Box number shown in the advertisement, c/o "The Wireless World," Dorset House, Stamford Street, London, S.E.1. Readers who reply to Box No. advertisements are warned against sending remittance through the post except in registered envelopes: in all such cases the use of the Deposit System is recommended, and the envelope should be clearly marked "Deposit Department."

DEPOSIT SYSTEM

Readers who hesitate to send money to advertisers in these columns may deal in perfect safety by availing themselves of our Deposit System. If the money be deposited with "The Wireless World," both parties are advised of its receipt.

The time allowed for decision is three days, counting from receipt of goods, after which period, if buyer decides not to retain goods, they must be returned to sender. If a sale is effected, buyer instructs us to remit amount to seller, but if not, seller instructs us to return amount to depositor. Carriage is paid by the buyer, but in the event of no sale, and subject to there being no different arrangement between buyer and seller, each pays carriage one way. The seller takes the risk of loss or damage in transit, for which we take no responsibility. For all transactions up to £10, a deposit fee of 1/- is charged; on transactions over £10 and under £50, the fee is 2/6; over £50, 5/-. All deposit matters are dealt with at Dorset House, Stamford Street, London, S.E.1, and cheques and money orders should be made payable to Hliffe & Sons Limited.

SPECIAL NOTE.—Readers who reply to advertisements and receive no answer to their enquiries are requested to regard the silence as an indication that the goods advertised have already been disposed of. Advertisers often receive so many enquiries that it is quite impossible to reply to each one by post. When sending remittances direct to an advertiser, stamp for return should also be included for use in the event of the application proving unsuccessful.

NEW RECEIVERS AND AMPLIFIERS

(This advertisement continued from first column.)

control for noise suppression. Reinforced capacitors prevent drift, pre-aged intermediate frequency transformers, I.F. barrier discs, anchor coil leads, plug-in loudspeaker, moisture resisted out by tropical zone impregnation, self healing electrolytic condensers. One complete chassis of dreadnought construction, moderate voltages assure full valve life, economical to operate, 75 watts consumption, correct valve selection, no compromise, no hum, full weight transformers, true push-pull, stabilised H.T. supply, stabilised biases, ceramic coil insulation, fully loaded plate coils give maximum gain, pre-balanced coil assembly, sealed insulation, thin laminations of special silico steel, 7 k.c. selectivity, fractional microvolt sensitivity, shielded switching permits high gain, positive silver plated contacts eliminates switch noises, audio frequency range 30-8,000 cycles, diode detection, Prizmatone high fidelity, R.F. selector stages on all bands; carriage 5/6.

£12/18—"800" chassis valves and 10in. speaker with all escutcheons, etc.; carriage 4/-.

£14/18—"800" chassis-valves and G.12 12in. Rola high fidelity speaker; carriage 6/-.

£17/17—Challenger "800C" Console, height 3ft. 6in., width 24in., depth 12½in.; this is the 800 chassis with G.12 Rola; carriage and crate 10/-.

NOTE.—The Challenger 800 is available in 11-valve A.C./D.C. 200-250 volts, at an additional cost of 20/- on each model.

29 Gns.—Challenger "800RG" radiogram, with automatic changer "Garrard"; this job also incorporates the G.12 high fidelity Rola, carriage and crate 15/- A.C./D.C. model £2 extra.

14 Gns.—Challenger 381 8-valve 14-2,060 metres. Polychromatic dial scale, improved vision master, beam power output, band spread Magna dial and second-hand magic eye tuning, automatic band indicator, high image frequency suppression, hair line selectivity, 5 k.c. separation; carriage 5/6; less cabinet, £13/18; carriage 4/-.

THE Following Bargains Cannot be Repeated, owing to the fact that they are samples; these are also covered by the usual guarantee in Great Britain against faulty workmanship and materials; owing to the weight and difficulty in packing, these are available to callers only, and a visit to our showrooms will be well worth while.

£37/10—Six only 1937 24-valve Garod receivers, speakers, 5 wavebands covering 5-2,000 metres, 60 watts undistorted output; this chassis is also available in Console form at £7 extra, this cabinet alone cost to make over £15.

£35—Three only 24-valve Lafayette twin chassis and 2 speakers, 5 wavebands, 8-2,000 metres, 30 watts undistorted; also 1 Console at £41/10, and a radiogram with record changer at £50.

DECALLIER'S, Ltd., 18, Connaught St., Marble Arch, London, W.2. Paddington 2745. [4223]

PILOT, Ferguson, Spanton, American transportable, car radio, and others; traders; lists.—Perseus Co., W.W., Burton-on-Trent. [4264]

NEW RECEIVERS AND AMPLIFIERS

ANGLO AMERICAN RADIO, Ltd., introduce the following magnificent range of Crosley chassis for the Coronation.

CROSLEY'S Reputation and Unsurpassed Standard of Workmanship is Your Guarantee of Satisfaction. **C**ROSLEY Superheterodynes to Suit Every Need, from the unsurpassed 10-valve all-wave 5-band to the 6-valve short and medium wave 3-band; our Coronation cash prices save you 40-50% now.

£12/19/6—10-valve High Fidelity 5-band (13-31, 30-80, 75-200, 200-555, 750-2,000 metres), A.C. 97-240 volts, 10 watts undistorted output, metal valves, pre-H.F. stage on all bands, provision grammo and doublet push-pull output, super A.V.C., band-spread pointer, metre calibration of airplane dial; side by side tests prove that this receiver outperforms multi-valve sets with double the number of valves; you cannot buy a better set; the all-world reception is a revelation; the tonal quality from a whisper to the full 10 watts is magnificent; to-day's value £25, your price £12/19/6; with 12in. American Magnavox speaker, £15.

£11/19/6—9-valve, 5-band, A.C. 10 watts, as above but employing glass valves; with Magnavox speaker, £14.

£9/19/6—8-valve, 5-band, A.C., as above, but with modified output stage only, giving 4 watts undistorted; with 12in. Magnavox speaker, £12.

£8/19/6—8-valve, A.C. 3-band, 2 models; (1) 17.5-50, 200-555, 750-2,000 metres, 4 watts undistorted output, provision grammo, and doublet, pre-H.F. on all bands; with matched Magnavox speaker, £9/15.

£6/19/6—6-valve, A.C. 3-band, 2 models, as above, 4 watts output, A.V.C., no pre-H.F. stage, grammo, doublet, large 7in. colour airplane dial; with Magnavox speaker, £7/15.

ORDER with Confidence.—These Crosley radios bring nothing but unbounded satisfaction on all sides; whichever model you choose you know you simply cannot buy a better job in its class at double or treble the price.

49/6—2-valve A.C./D.C. short-wave superheterodyne converter, 10-200 metres, employs H.F. Pentode and own power supply, operates in front of any receiver with single connection, A.C./D.C. 100-240v., large dial with band-spread control, complete in attractive metal cabinet, an unprecedented bargain; secure yours to-day.

TERMS: Cash or cheque with order or c.o.d.; send your order now before the Coronation rush.

4 D. Stamps Post Free.—Advance applications now being received for our wonder new radio catalogue; covers every radio need; receivers, communication sets, accessories, short-wave gear, etc., in colours and illustrated.

ANGLO AMERICAN RADIO (AND MOTORS), Ltd., Dept. W.16, Albion House, New Oxford St., London, W.C.1. (Showrooms: 53, New Oxford St.) Telephone: Temple Bar 3231, 9821. [4361]

AIR KING.

ALL Models Feature Beam Tuning, Magic Eye indicator, grammo, pick-up connections, and special output valves.

ALL Sets Fully Guaranteed; H.P. terms available from 3/- per week.

WHOLESALE and Trade Enquiries Invited; generous terms.

ALL Types of American Valves Stocked; write for lists to

AIR KING RADIO, 115, Shaftesbury Av., Cambridge Circus, W.C.2. Phone: Temple Bar 4875 (2 lines). All receivers assembled in England. [3406]

ALERT RADIO Co.

"COMMUNICATION," "Shortwave" and "Allwave" Receivers.—21, East Rd., N.1. Clerkenwell 4871. [4381]

ROYAL RADIO Co.

ALL-WAVE Receivers, suitable for use on ships, as supplied to officers of many shipping lines.

OUR 8 and 10 Metal Valve All-wave Receivers; 15-2,000 metres, acknowledged by the trade as the best for range, tone, and general performance.

LATEST 6-valve Car Radio, A.V.C., remote control, no suppressors required.

A FULL Range of the World Famous Ferguson and Pilot Models Stocked.

ALL Sets Fully Guaranteed by Ourselves.

ALL Types of American Valves Stocked.

PAY Us a Visit Any Time, or send for full range catalogue; 1/6d. stamp will be appreciated.

ROYAL RADIO Co., 5, Buckingham Rd., South Woodford, London, E.18. Phone: Buckhurst 2736. [4350]

"SERVICE With a Smile."

HENRY FORD RADIO, Ltd.

ELECTRONIC House, 22, Howland St., Tottenham Court Rd., W.1. Museum 5675. [0511]

HARMAUR RADIO for Wireless Receivers from £3/3; Raytheon glass and metal valves and all components; trade enquiries.

THE HARMAUR RADIO Co., Ltd., 8, Clifford St., New Bond St., London, W.1. [0499]

£7/5.—Six-valve all-wave chassis with 8in. Rola, B.V.A. valves, royalties paid, twelve months' guarantee.—Coulphone, Hutton, Preston. [4229]

TRANS-ATLANTIC RADIO for the Finest All-wave Sets and Compacts; agents for Ferguson, Philco, etc.; radio service specialists.—Trans-Atlantic Radio Co., 15, Percy St., W.1. Museum 3096. [4353]

PILOT, Ferguson, Belmont, Pegasus, and Air King all-waves lead the field, our deliveries are prompt in original cartons, with full guarantees; your trade card will bring our wholesale catalogue from the authorised distributors.—Leonard Heys, 36, Henry St., Blackpool. [0530]

Notes

No. 37.

on the Suppression of Electrical Interference with Broadcast Reception

Sometimes in writing these notes we feel that the reader may trace a certain monotonous theme running through the series. By far the greater majority of cases dealt with are suppression at the listener's end, either with an "Eliminoise" aerial, a mains filter or both. Yet our work is anything but monotonous. Very few readers are in a position to appreciate the ramifications of the subject, and we think they might be as interested as we are in the variety of cases dealt with.

We have had to suppress the electrical equipment on speed boats down to 12 metres with engines running; there was an auxiliary motor and generator for search lights, etc., and no loss of power could be tolerated.

Electrical equipment for arctic expeditions comes to us to be suppressed before being taken aboard.

A ship looks like being held up at the docks in London because a new smoke indicator is preventing the wireless operator from using his short wave receivers. We send an engineer to suppress it and the ship sails to time.

Gyroscope compasses and their repeaters, are notoriously bad in certain cases.

We have suppressed country house equipments where the cost has amounted to £50 instead of the usual guinea or two, and where there have been passenger and service lifts, organs with double consols, to say nothing of turnip choppers, etc.

How many readers realise that the basement of the usual modern block of flats contains a power plant of no mean proportions. Often their own water is pumped from a well. In any case the water both hot and cold is pumped around the building, and there is probably either automatic stoking or thermostatically controlled oil furnaces for heating. There are blocks that have cold storage laid on, as it were, with huge compressors down below stairs, and sometimes great fans for air conditioning, and all this in addition to lifts for passengers and service.

We send engineers to Fleet Street to suppress newspaper offices and cable companies, and we have teleprinters to deal with.

We have suppressed Army cars so that very high frequency high gain receivers can be used on board.

Belling-Lee suppressors have been fitted to vessels of all sizes from the Queen Mary to little pleasure cruisers, to all kinds of road vehicles, to all sorts of factories, to telescope motors (why we don't know) and aerodrome beacons and police stations.

No, life is not dull to our engineers; they never know what is coming next.

* "Eliminoise" (Trade Mark) All-wave Anti-interference Aerial. Transformers for one aerial installation 35s.

"C" type Shielded Cable, extra per yard, 10d.

† Type 300 Mains Filter, for set lead, 10 to 2,000 metres.

Send for the book, "Interference Suppression," post free 1s. 2d., or for free copy of "The Eliminoise System" and other relative literature.



Belling & Lee Ltd.
Cambridge Arterial Road,
Enfield, Middx.
Telephone: Enfield 3322.

NEW RECEIVERS AND AMPLIFIERS

MCCARTHY New Series of A.C. Universal, Battery, All-wave and other receivers, many refinements, several interesting new models.

IMPORTANT!—All prices quoted for McCarthy chassis include Marconi royalty payments.

MCCARTHY All-wave Battery Superhet with R/F Stage; £7; separate triode oscillator, L.F. stage, pentode output, ext. speaker and gram. sockets, etc., equals mains performance.

MCCARTHY 6-valve All-wave Superhet with R/F Stage; £8/5; A.C. or Universal, iron-cored I.F. coils, Litz-wound tuning coils, illuminated "Airplane" dial, triode-hexode frequency changer, double band-pass coupled I.F. amplifier, L.F. stage, pentode output, D.A.V.C. tone control, ext. speaker and gram. sockets, etc., etc.; performance equals many 8-valve receivers.

MCCARTHY Super 9-valve All-wave with Push-pull Triode Output; £12/12; a set for the connoisseur! McCarthy special 7-valve all-wave with R/F stage, four wave-bands, many interesting new features; £10/10; full particulars on application.

ALL McCarthy Receivers on Heavy Cadmium-plated Steel chassis; quality components and B.V.A. valves throughout.

SEE McCarthy Advertisement on Page 455 for Other McCarthy models; also write for complete catalogue. **M**CCARTHY RADIO, Ltd., 44a, Westbourne Grove, London, W.2. [4379]

THE Greatest Value in "Ham" Sets.—Halli-crafter Sky-buddy, £9; incorporates B.F.O., phone jack, A.V.C. on-off switch, pitch control, mechanical bandspread, Audio gain control, R.F. control, built-in speaker, 5 Raytheon tubes, all-metal cabinet, a real performer; all other models in stock.

RADIOGRAPHIC, Ltd., 66, Osborne St., Glasgow, C.1. Bell 848. [4386]

COMMUNICATION Receivers, Hammarlund, National, Halli-crafter, B.M.E.69, Tobe-Deutschmann; transmitters, Collins 45A, Peerless DX20, or built to order; American valves, microphones, Eddy-stone components.—A.C.S., Ltd., 52/4, Widmore Rd., Bromley. Phone: Ravensbourne 0156. [0550]

RECEIVERS AND AMPLIFIERS CLEARANCE, SURPLUS, ETC.

HENRY'S.

1937 Regentone De Luxe Model A.C. 200-250 3-waveband Superhet, 5 valves, 17.5 to 2,000 metres, handsome cabinet; list 12½ gns., our price £7.

1937 Regentone 3 Waveband A.C. 200-250, 17.5 to 2,000 metres, thermometer tuning; list 9 gns., £4/10.

1936 Regentone 5-valve Consolette, A.C. 200-250, thermometer tuning; list £10/10, £4.

1937 Regentone 3-valve Battery Set, H.F. pentode, det., and pentode output, moving coil speaker, thermometer tuning; list £6/2/6, £3.

FARREX Short Wave Units for A.C. Mains or Battery Sets; list £3/3, only a few left for 30/-.

HENRY'S, 72, Wellington Ave., London, N.15. Stamford Hill 2907. [4360]

CLEARANCE List (Trade Only).—Write Leonard Heys, 36; Henry St., Blackpool. [0527]

ARMSTRONG Co. Have a Further Few Soiled but Genuine Brand New Radio Chassis for Disposal at Considerably Less Than Cost Price, described hereunder.

ARMSTRONG 1937 9-stage Radio-gramophone Chassis, covering 4 wavebands from 12.9 metres, circuit H.F. Pentode as radio frequency amplifier, tuned H.F. transformer coupled to hexode triode, detector oscillator, 2 band-pass coupled I.F. amplifier stages, double diode triode, detector and L.F. amplifier, push-pull output stage capable of handling 6 watts, highest grade components used throughout. "Airplane" multi radio drive, all wavebands calibrated station names, tone control works on both radio and gramophone, provision for extension speaker, etc.

SEVERAL Chassis as Above, brand new, but chassis slightly marked, price complete with Mullard valves, 9 gns.; an exceptional opportunity.

ARMSTRONG Co. Also Offer Few Genuine 1937 Armstrong 6v. All-wave Superheterodyne Radiogram Chassis, brand new but cellulose slightly marked, complete with new full size Rola moving coil speaker and 6 new and fully guaranteed Marconi or Mullard valves; these chassis are the well known 3BPT models containing high grade British components, are ganged and aerial tested, and ready to switch on; price £6/10, complete.

ARMSTRONG Co. Have Technical Data Sheets Available.

ARMSTRONG Co. Will Willingly Send Above Chassis on 7 Days' Trial, carriage and packing free.

ARMSTRONG MANUFACTURING Co., 100, King's Rd., Camden Town, N.W.1. [4343]

CAR RADIO

PHILCO Repairs and Installations, trade distributors.—Radiorite, Ltd., Moorfields, Liverpool. Bank 8811. [4321]

SPECIAL Clearance Offer.—New Marconi car radios, S listed £21; net cash £7/10; carriage paid; in unopened cartons.—Bowe, Arcadia, Chester-le-Street. [4382]

PUBLIC ADDRESS EQUIPMENT

SPECIAL Offer!!!

81 Gns. Complete.—Vortexion portable 15-20 watt 4-82 stage amplifier, independent mike and pick-up inputs, outputs for 7½ and 15 ohm speakers, weight 25lb., 4 independent input model, £10.

HEAVY Duty 20 watt model, as fitted to dance halls and cinemas, etc.; £15, complete with valves.

60 Watt Model for 6L6s, with microphone and gramophone independent inputs, and outputs for 4, 7½, 15 and 30 ohm speakers, consumption 150 watts, in ventilated steel carrying case; £24 only! complete with valves less two 6L6s.

WHY Not Call and Have a Demonstration.

VORTEXION, Ltd., 182, The Broadway, Wimbledon, S.W.19. Phone: Lib. 2814. [4254]

PUBLIC ADDRESS EQUIPMENT

ALL Types of Public Address Apparatus for Sale or Hire.

WARD, 46, Farringdon St., London, E.C.4. Tel.: Holborn 9703. [0555]

TRADERS, write for our lists; all best makes equipment supplied.—Perseus Co., W.W., Burton-on-Trent. [4266]

HARMONY HOUSE SOUND SERVICE, Southport.—Beam power amplifiers, 14 watts output; £13/10 (subject); send for lists. [0546]

EASCO 1937 Super Mobile P.A. Van, available for engagements Coronation Week, with operator driver.—Reliance 1693. Easco, 18w, Brixton Rd., S.W.3. [0544]

BROWN'S 30W. Public Address Outfit with Two Speakers, microphone, engine and dynamo, complete in trailer van; £35.—B. Moffat, Egremont, Cumberland. [4385]

"F.I." Loudspeakers, £6/15; B.T.H. microphones, £3/5; E.D.C.C. rotary transformer, input 12 volts, output 400 volts, £6/10; amplifier, £5/15.—Sound Amplifiers, Verrill Place, Cheltenham. [4334]

AMPLIFIED Speech and Music for Fetes, sports meetings, etc., using our public address mobile equipments, also smaller equipments for dinners, dances, conferences, etc.—Harmony House Sound Service, Southport. [0548]

ARMSTRONG Latest Coronation 30-watt Public Address Amplifier, incorporating 3 input circuits and self contained Fader system; both microphone stages have a total gain of 97db. and are electron coupled; this apparatus is particularly suitable where large output is required; price complete, 16 gns.; British throughout.

ARMSTRONG 10-watt High Fidelity Amplifier, suitable for indoor public address or gramophone reproduction, two inputs, controlled by self contained Fader unit, tone control working on both inputs, Class A push-pull output; British throughout; price complete with valves, etc., 9 gns.

ARMSTRONG, 100, King's Rd., Camden Town, N.W.1. Phone: Gulliver 3105. [4384]

USED SETS FOR SALE AND WANTED

FERGUSON CAR RADIO

FERGUSON Car Radio, 5v., 12v., chromium plated, complete, plug suppressors, condenser, new; £5, or nearest.—Baker, 26, Grafton Rd., Acton, W.3. [4325]

MIDWEST

MIDWEST—18 valves, 1936 model, chassis, speaker, valves; £18, near offer.—Phone: Hop 1091. [4392]

PHILIPS

PHILIPS 8349 Super Induction, D.C.; £5.—Calkin, 81, Kingsley Way, London, N.2. [4395]

W.W. ALL-WAVE SEVEN

"WIRELESS WORLD All-Wave Seven"; £8/8.—Box 1791, c/o The Wireless World. [4394]

NEW MAINS EQUIPMENT

VORTEXION Quality Transformers.

VORTEXION Supply the B.B.C., G.P.O., L.P.T.B., I.C.L., Borough Councils, etc. Why not you?

ALL Fitted Screened Primaries, and tapped 200-250v. with centre tapped filaments, guaranteed one year.

W.W. Q.A., 425-0-425v. 120-160 m.a., 4v. 5-10a., 4v. 2.5a., 4v. 1-2a., 4v. 1-2a., super shrouded model; 32/-

500-0-500v. 150 m.a., 4v. 4a., 4v. 2.5a., 4v. 2a., 4v. 2a., 4v. 2a., super shrouded model, 2.5% regulation, 35/-; open type, 32/-; 400 or 450v. same price.

350-0-350v. 120 m.a., 4v. 2-6a., 4v. 2-4a., 4v. 1a., 4v. 1a., super shrouded, 25/-; normal shrouded, 21/-; open type, 18/6.

350-0-350v. 75 m.a., 4v. 2-4a., 4v. 1-2a., shrouded, 18/-; open type, 16/-

250-0-250v. 60 m.a., 4v. 2-4a., 4v. 1-2a., shrouded, 15/-; open type, 12/6.

AUTO Transformers, 100-120 to 200-240v.; 80 watts 11/-, 120 watts 14/6, 200 watts 21/-, 500 watts 37/6.

CHOKES.—30h. 60 m.a., 7/6; 7-13h. 120 m.a., 12/6; 30h. 150 m.a., 15/-.

OUTPUT Transformers—4-10 watt W.W. Q.A., 21/-; 20 watt super shrouded, 30/-.

VORTEXION, Ltd., 182, The Broadway, Wimbledon, London, S.W.19. (Telephone: Liberty 2814.) [3951]

TANTALUM for A.C. Chargers, H.T. and L.T.—Blackwell's Metallurgical Works, Ltd., Garston, Liverpool. [3984]

PARTRIDGE Transformers for P.A., radio, relay, transmitting, recording, talkies, television, etc.—N. Partridge, B.9., A.M.I.E.E., King's Buildings, Dean Stanley St. London, S.W.1. [4372]

Still — they — come!

As most of our readers will realise, we do not spend a lot of money on advertising.

Whilst we could easily fill this entire column in eulogising the products of our brain and factory, we prefer to put every ounce of energy and surplus money (if any) into the "goods" to make them "THE GOODS."

This policy is amply repaid by the number of encouraging letters we receive from satisfied owners.

Here is an extract:—

"... My quest for a quality outfit has ended, both the finish, battleship construction, and the quality of the output is all that one could desire..."

Incidentally, this applies not only to Amplifiers for home use like the famous 4-12 watt and the new 4-6 watt models but to the 14 watt P.A. and the 30 watt P.A. Amplifiers.

May we have the pleasure of hearing further from YOU?

SOUND SALES
MARLBOROUGH RD., UPPER HOLLOWAY, LONDON, N.19. (Contractors to the G.P.O., etc.)
LIMITED. Tel.: Archway 1661/2/3

The 'AVO' CAPACITY METER
BRITISH MADE
Reg. Trade Mark



£23
Deferred Terms if desired.

A simple and accurate capacity meter, reading capacities directly from a calibrated dial. Provides a degree of accuracy obtained hitherto with only extremely costly apparatus. Six ranges; measurements can be made from a few mmfd. to 0.1 mfd. (100,000 mmfd.) correct to within an error of less than 1%. Measurements carried out by a resonance method, the unknown condenser being introduced into a tuned circuit coupled to a radio frequency oscillator. A meter gives visual indication of resonance, length of meter deflection gives a comparative measure of losses of condenser under test. Suitable for mass production testing of condensers.

Write for descriptive pamphlet:—
The Automatic Coil Winder & Electrical Equipment Co., Ltd., Winder House, Douglas Street, London, S.W.1.
Phone: VICTORIA 3404/7.

CABINETS

RADIOGRAM Cabinets, new designs, 30/- to £5/10; inspection invited or photos for selection sent on request.

TABLE Radio Cabinets, undrilled, 6/6 upwards.

SPEAKER Cabinets, 4/6 upwards.

MANUFACTURERS' Clearance.

ULTRA Radiogram Cabinets, undrilled, 33x23x14 or 33x20x15, 30/-.

BURGOYNE "Fury" Radiogram Cabinets (undrilled), 34x22x16½; 49/6.

K.B. De Luxe Walnut Cabinets, undrilled, chromium plated edges and speaker grille. 25in. wide, 14½in. high, 10½in. deep, 18/6; Console model, 42in. high, 21½in. wide, 11½in. deep, 39/6.

HALYCON Radiogram Cabinets (Reconditioned), 33x23x19, 35/-.

H. L. SMITH and Co., Ltd., 287-9, Edgware Rd., London, W.2. Tel.: Pad. 5891. [0485]

DYNAMOS, MOTORS, ETC.

ALL Types of Rotary Converters in Stock, new and second-hand.

WARD, 46, Farringdon St., London, E.C.4. Telephone: Holborn 9703. [0518]

CONVERTER E.D.C.C., 240 D.C. to 230 A.C., 90 watts, £12.—Calkin, 81, Kingsley Way, London, N.2. [4396]

ELECTRO-DYNAMIC Rotary Converter, D.C. 230 volts—A.C. 210 volts, 90 watts, perfect running order; £6.—Box 1784, c/o The Wireless World. [4378]

NEW LOUD-SPEAKERS

BAKER'S Quality Surplus Speakers.

HITHERTO Baker's Surplus Speakers Have Been Sold Through Agents; quality enthusiasts in search of a bargain can now obtain these speakers direct from our works. The following speakers are all brand new 1935-1936 models, and are offered at considerably under half list prices. If you are requiring Quality Reproduction at low cost, order one of the following exceptional bargains now. You will be amazed at the value obtained.

THE Auditorium Models are Fitted With Latest Triple Cone, comprising main curved cone and bakelite and duralumin cones combined, giving wide and even frequency response resulting in quality reproduction of both speech and music.

39/6 Only, usual price £5.—Auditorium Permanent Magnet Speaker, with Alni magnet and die cast frame, large 12in. triple cone giving wide frequency range, complete with large 25 radio transformer suitable for all outputs, including push-pull and Class B, etc.

59/6 Only, usual price £6.—Auditorium Electro-Magnet Speaker, 1,000, 1,250, 2,000 or 2,500 ohms field exceptionally large magnet of high permeability steel giving enormous flux density, 2in. moving coil, large triple cone giving wide frequency range, complete with universal transformer. The ideal speaker for use with "Wireless World" and other quality amplifiers.

75/- Only, usual price £9.—As above, but for use on A.C. mains; complete with Westinghouse rectifier and full smoothing equipment.

24/- Only.—Permanent Magnet Speaker, Alni magnet, die cast frame, 10in. cone, Universal transformer.

15/6 Only.—Permanent Magnet Speaker, Alni magnet, 8in. cone, Universal transformer.

12/6 Only.—Permanent Magnet Speaker as above, with 7in. cone.

2/9 Only.—Brand new cabinets, 12x10x6.

8/6 Only.—Electro-Magnet Speakers, with 8in. cone, 6,500 ohms field, Universal transformer.

ALL Baker Quality Surplus Speakers are Sold for Cash or C.O.D.

BAKER'S SELHURST RADIO, Ltd., The Pioneer Manufacturers of Moving Coil Speakers, 1925-1937.—75-77, Sussex Rd., South Croydon. (Croydon 3441.) [4347]

VAUXHALL.—Best quality speakers; see below.—Vauxhall Utilities, 163a, Strand. [4401]

GIANT P.A. Speakers for Sale; no horn or baffle required, entirely non-directional, two sizes; Junior, to handle 50-100 watts, single unit; Senior, 100-200 watts, single unit; require output matching of 240 ohms.; awarded first prize for best speakers at Aldershot.—Switchit Service, Brighton. [4365]

LOUD-SPEAKERS

SECOND-HAND, CLEARANCE, SURPLUS, ETC.

VAUXHALL.—Magnavox mains energised, 2,500 or 6,500 field coil, 10in. cone, 17/6; 7in. cone, 12/6.

VAUXHALL.—Magnavox permanent magnets, universal, suitable for Class "B" power or pentode, 7in. cone, 16/6; 10in. cone, 22/-.

VAUXHALL.—American Rolas, 2,500, 8in., 15/-; 9½in., 19/6; permanent magnets, 8in., 19/6; 9½in., 24/6.

VAUXHALL.—Above, fully guaranteed, complete with humbucking coils; state power or pentode transformer; unused manufacturers' stock.

VAUXHALL.—Immediate delivery, carriage paid; lists free; cash with order or c.o.d.—Vauxhall Utilities, 163a, Strand, W.C.2. Temple Bar 9338. [4400]

CELESTION Senior Auditorium A.C.38, 40-watt field, 200-250v. A.C., listed 18 gns.; £8, or nearest; also 2 A.F.58, 7/6 each.—103, Oakland St., Widnes, Lancs. [4366]

TESTING EQUIPMENT

RADIOLAB 21-range Universal Test Meter, unused, £3/18; Ferranti 0-50 m.a., 18/6; 0-100 m.a., 18/6; cash or c.o.d.—Grigg, 70, Peel Rd., Weststone, Middlesex. [4391]

VALVES

ANDERSON.
AMERICAN Valves, all makes, first grade only; 5/- each.
ANDERSON, 35, Lansdowne Rd., Walthamstow, E.17. Walthamstow 0827. [3351]
6L6, 3/9; all other popular types American valves, 3/-; 90-day guarantee.
EIMAC, Taylor, Raytheon and R.C.A. in stock.
RADIOGRAPHIC, Ltd., 66, Osborne St., Glasgow, C.1. Bell 848. [4387]
TRADERS, write for lists, cheap and best American and replacement mains and battery valves; lists.—Perseus Co., Burton-on-Trent. [4265]
AMERICAN Valves, first grade, in all types; trade supplied.—Metropolitan Radio Service Co., 1021, Finchley Rd., N.W.11. Speedwell 3000. [0436]

ALL Types of American Valves in Stock of Raytheon, Sylvania, and Arcturus makes, at competitive prices, guaranteed for six months; send for full list; 350 ohms line cords, 2/8.
WARD, 46, Farringdon St., London, E.C.4. Tel.: Holborn 9703. [0452]

NOTHING Better Available. Six months' guarantee, complete range of battery, A.C. mains, rectifiers, always in stock, 2 volt det., H.F., L.F., 2/3; Power, 2/9; screen grid pentode, H.F., pentode, 5/-; American types, six months' guarantee, 5/6 each, Nos. 18, 24A, 35, 42, 43, 45, 47, 56, 57, 58, 75, 77, 78, 80, 2A5, 2A6, 2A7, 6A7, 2B7, 6B7, 6C6, 6D6, 25Z5, 25Y5.—Write for other prices to Dulci Electrical Co., Devonshire Works, Duke's Av., Chiswick, London, W.4. [0501]

METERS, ETC.

UNIVERSAL Radio Meter, Philco Model O25, perfect condition; what offers?—Gladstone 3692. [4376]

NEW COMPONENTS

MICROPHONES.—With much regret, owing to increased material costs, prices of our microphone kits must now be original 9/6, improved, 11/-. De Luxe 13/6.

HOME Recording.—Cellophone, as proposed, p. 411, April 23rd issue; 2/- per dozen, 12-inch.

A HINDERLICH, 2, Bridge Rd., London, N.W.10. [4337]

COMPONENTS

SECOND-HAND, CLEARANCE, SURPLUS, ETC.

RADIO CLEARANCE.

ALL Lines Previously Advertised Still Available.

RADIO CLEARANCE, 63, High Holborn, W.C.1. Holborn 4631. [4398]

PREMIER SUPPLY STORES.

PLEASE See Our Displayed Advertisement on this page. [0488]

OLIVERS' Offer:—Centralab volume controls, with switch, all values; 2/- each.

ERIE 1-watt Resistances, colour coded, all values, 3/4d. each, 3/- per dozen; 2/6 per dozen in 3 dozen lots.

CARDBOARD Case Electrolytics, 4 mfd., 1/6; 8 mfd., 1/9; 4 mfd.+4 mfd., 2/-; 8 mfd.+4 mfd., 2/5; 8 mfd.+8 mfd., 2/9.

TUBULAR and Tag Condensers.—0.0001 mfd. to 0.02 mfd., 4d. each; 0.05 mfd. and 0.01 mfd., 4 1/2d. each; 0.1 mfd. and 0.25 mfd., 5d. each; 0.5 mfd., 6d. each.

HYTRON, Triade, Arcturus, and other types American valves, all types, 5/3 each; metal types from 5/-.

ALUMINIUM Chassis, 18 gauge, undrilled, 16in. x 10in. x 3in., 5/3; 16 gauge ditto, 7/6; all sizes made to specifications; prices upon request.

CHASSIS Mounting Valve Holders.—5-pin, 2 1/4d.; 7-pin, 3 1/2d.; speaker transformers, 3/- each, either power and pentode, Class "B" or push-pull.

"MAGIC EYE" Tuning Indicator Unit, easily fitted to any A.C. receiver with A.V.C.; complete tube, transformer, full instructions, 12/6; tube only, 7/- each.

ROLA G.12 Speakers, stripped but complete with transformer, for push-pull, triode or pentode, 2,500 ohms and 1,250 ohms field; £2/19.

OLIVERS, 676, Christchurch Rd., Boscombe, Hants. Enquiries invited. Lists free. Orders under 5/6 postage extra. [4389]

RYALL'S RADIO, 280, High Holborn, London, W.C.1, offer new goods at knock-out prices.

AMPLIFIER, with 6-watt output, 3-stage, for A.C. 200-250v., splendid chassis, Ferranti transformer, complete with 5 valves; 50/-.

T.C.C. Electrolytics, tubular can type, dry, 16x8 mfd., 450v., 1/7; 4x4 ditto, post extra on this line.

N.S.F. 0.1 Tubular Non-inductive 1,000v. Test Condensers, 2/6 dozen, tag ends; 0.01 ditto N.S.F. 25x25 mfd., six for 3/-. tubular, wire ends.

PAIRS Matched Ferranti Screened Coils, aerial and H.F., with reaction, sensitive and selective; 2/6 per pair, chassis type.

FERRANTI Mains Transformers, as used in their own commercial receivers, 350-0-350v., 70 m.a., 4v. 2 1/2a., 4v. 4-5a., C.T. input 200-250v., brand new; 6/6 each. [4402]

FOR Sale; two high fidelity speakers, pick-up, amplifier chassis, valves, etc.—Write Advertiser, 96, Queen's Rd., W.2. [4397]

PREMIER SUPPLY STORES

Offer the following Set Manufacturers' Brand New Surplus Goods at a Fraction of the Original Cost; all goods guaranteed perfect; carr. paid over 5/-; under 5/- postage 6d. extra. Orders under 5/- cannot be sent C.O.D. ALL POST ORDERS TO

JUBILEE WORKS, 167 LOWER CLAPTON RD., LONDON, E.5
CALLERS, AS USUAL, TO 165 & 165a, FLEET ST., E.G.4 (Next door to Anderton's Hotel). Central 2833. New Branch:—50, HIGH STREET, CLAPHAM, S.W.4 (Macaulay 2381).

Have you had our **GIANT ILLUSTRATED CATALOGUE AND VALVE LIST**? Send 4d. in STAMPS FOR THIS BARGAIN LIST.

MAINS VALVES, famous Europa 4 v. A.C. types, 4/6 each. H.L., L., S.G., Var.-Mu-S.G., H.F.-Pens., Var.-Mu-H.F. Pens. 1- and 4-watt A.C. directly heated output Pentodes. A.C./D.C. types. 20-volt 18 amp. S.G., Var.-Mu-S.G., H.L., Power, Pen, H.F. Pen and V.-Mu-H.F. Pen.

Following types all 5/6 each. Full-wave rectifiers, 350 v. 120 m.a. and 500 v. 120 m.a. 2 1/2-watt indirectly-heated Pentodes, Octode Frequency Changers.

BATTERY VALVES, 2 volts, H.F., L.F., 2/3. Power Super-Power, 2/9. S.G., Var.-Mu-S.G., 4- or 5-pin Pentodes, H.F. Pens., V.-Mu-H.F. Pens, 5/- Class B, 5/-.

AMERICAN VALVES. Genuine American HYTRON and TRIAD first-grade Valves. 3 months' guarantee. All types in stock, 5/6 each. 210 and 250, 3/6 each. New Metal-Glass Valves, all types, 6/6 each. Genuine American DUOTRON Valves, all types, 3/6 each. Valve holders for all above types, 6d. each. Octal bases, 9d. each.

SHORT-WAVE COILS, 4- and 6-pin types. 13-26, 22-47, 41-94, 78-170 metres, 1/9 each, with circuit. Special set of 3-4-Pin S.W. Coils, 14-150 metres, 4/- set, with circuit. Premier 4-pin 3-band S.W. Coil, 11-25, 19-43, 38-86 metres. Suitable any type circuit, 2/6. COIL FORMERS, in finest plastic material, 1 1/2in. low-loss ribbed, 4- or 6-pin, 1/- each.

SUPER CERAMIC CONDENSERS, S.L.F., .0001G, .0001, 2/9 each; double-spaced, .00005, .00025, .000015, 3/- each. All brass with integral slow motion, .00015 tuning, 3/9; .00015 reaction, 2/9.

CERAMIC S.W. VALVE HOLDERS, 4-, 5- or 7-pin. Chassis types, 6d.; B.B. type, 8d. GLASS AERIAL INSULATORS, 4d. each. BEEHIVE STAND-OFF, 6d. each. SCREENED FLEX, single, 3d. yd.; twin, 4d. yd.

H.F. CHOKES, S.W., 10-200 metres, 9d. ELECTROLYTICS. U.S.A., 4 or 8 mfd. 530 v. peak, 1/9 each. Dubilier, 4 or 8 mfd. 500 v., 3/-; 50 mfd. 50 v., 1/9; 10 mfd. 50 v., 6d.; 25 mfd. 25 v., 1/-. T.C.C. 8 mfd. 650 v., 4/-; 15 mfd. 50 or 100 v., 1/-; 50 mfd. 12 v., 1/-. Paper Condensers. W.E., 250 v. working 4 mf., 2/-; 2 mf. 1/-, 1 mf. 6d.; 350 v. working 4 mf., 2/6; 2 mf., 1/6. Dubilier 500 v. working 4 mf., 4/-; 800 v. 4 mf., 6/-.

COSMOCORD PICK-UPS, with tonearm and volume control, 10/6 each. PICK-UP HEADS only, 4/6 each.

PREMIER MAINS TRANSFORMERS, wire-end type with screened primaries, tapped 200-250 v. Centre-tapped Filaments. Guaranteed one year. H.T. 8 & 9 or H.T. 10 with 4 v. 4 a. C.T. and 4 v. 1 a. C.T., 8/6. 250-250 v. 60 m.a., or 300-300 v. 60 m.a., 4 v. 1 a., 4 v. 2 a., and 4 v. 4 a., all C.T., 9/6. 250-350 v. 120 m.a., 4 v. 1 a., 4 v. 2 a. and 4 v. 4 a., all C.T., 10/6. Any of these transformers with engraved panel and N.P. terminals, 1/6 extra. 500-500 v. 150 m.a., 4 v. 2-3 a., 4 v. 2-3 a., 4 v. 2-3 a., 4 v. 3-4 a., all C.T., 17/6. Super Model, 19/6. AUTO TRANSFORMERS, step up or down, 60 watts, 7/6; 100 watts, 10/-. SMOOTHING CHOKES, 25 m.a., 2/9; 40 m.a., 4/-; 60 m.a., 5/6; 150 m.a., 10/6. 2,500 ohms 60 m.a. Speaker Replacement Chokes, 5/6.

SPECIAL OFFER OF PHILIPS MAINS TRANSFORMERS. 250-250 v. or 300-300 v. 80 m.a., 4 v. 5 a. C.T. & 4 v. 1 a., 6/11.

LARGER MODEL WITH TAPPED PRIMARY, 100-250 v., 450-450 v. 150 m.a., 4 v. 4 a. C.T., 4 v. 4 a. and 4 v. 3 a. and 500-500 v. 100 m.a., 4 v. 4 a. C.T., 4 v. 4 a. and 4 v. 3 a., 12/6. LIMITED NUMBER ONLY.

MILLIAMMETERS, moving-iron, flush 2 1/2in., all ranges from 0-10 m.a., 5/9. Visual tuning, 6 or 12 m.a., 5/9. Moving-coil meters, 2 1/2in. 0-1 m.a., 18/6; 3 1/2in. 0-1 m.a., 22/6. Multipliers, 1/- each. Ampmeters, 0-1, 3, 5, 10 or 20 a., 5/9.

TRANSFORMERS, latest type Telsen R.G.4 (list 12/6), 2/9. Lissen Hypernik Q.P.P. (list 12/6), 3/6.

OUTPUT TRANSFORMERS for Power or Pentode, 2/6; Multi-Ratio, 4/6; Push-Pull Input Transformers, by prominent manufacturer, 4/6 each.

PREMIER L.T. CHARGER KITS for A.C. mains, including Westinghouse Rectifiers and Tapped Mains Transformers, 8 volts at 1 amp., 14/6; 8 volts 1 a., 17/6; 15 volts 1 a., 19/-; 8 volts 2 a., 29/6.

TELSEN iron-cored screened coils, W.349, 4/- each. Electric SOLDERING IRONS, 200-250 v., A.C./D.C., 2/3.

NEW 1937 1-VALVE SHORT-WAVE RECEIVER OR ADAPTOR KIT, 13 to 86 metres without coil changing. Complete Kit and Circuit, 12/6. VALVE GIVEN FREE!

DE LUXE MODEL 14 to 150 metres, complete Kit with Chassis, 4 Coils and all parts, 17/6. 1937 SUPERHET CONVERTER KIT, 13/6.

DE LUXE MODEL, 18/6. S.W. SUPERHET CONVERTER KIT, for A.C. Mains Receivers, 20/-. A.C. Valve given FREE!

NEW 1937 2-VALVE S.W. KIT, 13 to 86 metres without coil changing. Complete Kit and Circuit, 19/6. VALVES GIVEN FREE. DE LUXE MODEL, 14 to 150 metres, complete Kit and Chassis, 4 Coils and all parts, 25/-. VALVES GIVEN FREE.

3-VALVE S.W. KIT, S.G. Det. and Pen., 32/- VALVES GIVEN FREE!

BAND-PASS TUNING PACK, comprising set of 3 Telsen iron-cored coils with switching, mounted on steel chassis with 3-gang condenser, illuminated disc-drive and 4 valve holders, 25/- the lot. All Mains or Battery circuit. FREE!

SPECIAL OFFER. LISSEN TWO-GANG SCREENED ALL-WAVE COILS, 12 to 2,000 metres, complete with switching and wiring diagram, 6/11 per set.

3 VALVE BAND-PASS KIT, 200-2,000 metres. Complete kit of parts, including chassis, all components, valves, M.C. speaker and wiring diagram. Battery Model, 50/- A.C. Mains Model, 70/-.

MAGNAVOX. Mains energised M.C. Speakers. '154', 7in. cone, 2,500 ohms, 12/6; '152', 9in. cone, 2,500 ohms, 17/6; '152 Magna', 9in. cone, 2,500 ohms, 37/6. Magnavox P.M.s.—'254', 7in. cone, 16/6; '252', 9in. cone, 22/6. Reliable P.M.s., 10/6. TELSEN P.M.s. with 10 ratio Transformers, 12/6. ROLA latest type P.M.s., 15/-.

GOODMANS' 8in. mains energised 1,000 ohms field, 10/6 each. Jensen P.M.s., 10/6. B.T.H. ENERGISED MOVING COIL, 10 1/2in. diam. 1,650 ohms field. Power or Pentode Transformer. (State which.) SPECIAL LINE at 14/6.

Potentiometers by well-known makers. All values up to 1 meg., 2/-; with switch, 2/6. GRAMOPHONE MOTORS. Collaro Gramophone Unit consisting of A.C. motor, 100-250 v. high quality pick-up and volume control, 45/-; Collaro motor only, 30/-; Collaro Universal Gramophone Motor, 100-250 v. A.C./D.C., with high quality pick-up and volume control, 67/6; Collaro Universal Motor only, 49/6; Edison Bell double-spring motors, including turntable and all fittings, 15/-; Cosmocord Gramo. unit, comprising A.C. motor pick-up and volume control (list 55/-), 35/9.

TUBULAR CONDENSERS, non-inductive, all values up to 5 mfd., 6d. each.

Wire-end RESISTORS, any value, 1 watt, 6d.; 4 watts, 1/-; 8 watts, 1/6; 15 watts, 2/-; 25 watts, 2/6 each.

Reliable MORSE KEYS with Morse Code engraved on bakelite base, 2/- each.

Bakelite case BUZZERS, 1/6; Walnut case, "Loud-tone," 2/6 each.

Super Quality lightweight HEADPHONES, 3/9 pair.

UTILITY 2-GANG MICA DIELECTRIC CONDENSERS (2 x .0005) with Uniknob Trimmers and disc drive, 3/6.

POLA STAR 3-GANG (3 x .005) with Trimmers, fully screened, 5/6.

PREMIER FILAMENT TRANSFORMERS, 4 v. 3 a., C.T., 7/6; 4 v. 5 a., C.T., 9/6; 5 v. 3 a., 7/6; 6.3 v. 3 a., 7/6; 7.5 v. 3 a., 7/6; 2.5 v. 8 a., 8/6.

P.A at its Best
GRAMPIAN
 PUBLIC ADDRESS EQUIPMENT
 GRAMPIAN REPRODUCERS LTD.
 Kew Gardens Surrey

TANNOY
 THE SOUND PEOPLE
 GUY B. FOUNTAIN LTD.
 FOR CANTERBURY GROVE, WEST NORWOOD,
 ALL LONDON, S.E.27. *Phone: Str. 4122 (6 lines).
 SOUND AMPLIFYING EQUIPMENT

WEARITE CONDENSER ANALYSER
 A new instrument of the latest design for carrying out rapid complete tests of radio condensers. Electrolytic, Mica, Paper, Trimmer and Tuning condensers may now be tested for Capacity, Insulation, Power Factor, Open Short and Intermittence. This unit is portable entirely A.C. mains operated.
PRICE - £9.9.0
 Full particulars upon request to:
WRIGHT & WEARE LTD.,
 740, High Road, Tottenham, London, N.17.

ELECTRADIX BARGAINS



SELECTOR SWITCHES. As illus. 8 arms of 25 ways each. Relay solenoid operated for distant control. As used in Tote and Auto 'phone exchange. 7/6 and 10/-. Overload Trip Switches, any amps., 7/6.

SWITCHBOARDS.—Auto-cut-out and in, field reg. switch, meter, fuses, etc., from 22/6. Let us quote you for other types and sizes.



ALTERNATORS. 200 Watt Midget Alternators, Type 52A.—The most perfectly made little generator used, gives 500 cycles 10 volts 20 amps., weight 7 1/2 lb., in aluminium cover. Belt or motor driven, and fully guaranteed. With quite a small transformer, any H.T. voltage up to 2,000 volts may be obtained, smoothed and rectified for plate H.T. Cost £30, and are given away at £23 10s., cash with order.

SWITCHGEAR. SELECTOR SWITCHES.—We stock a large quantity for any purpose and make a lot more. 20 stud Regulator Rheos. 200 ohm 1 amp. for television control, speed reg. field res. dimming, etc. Ironclad. Special bargain, 10/6.

STUD SWITCHES.—Plate panel 5in. x 5in., with 20 studs, two contact arms, ring and knob, 5/6. 7-stud on ebonite with plug. 1/9. Yaxley wave change, 2-gang with knob. one hole. 1/2. Reyrolle Power Plugs, 15 amp., shrouded panel wall, two pairs on iron box, unused, 10/-.

MORSE RECORDING OF WIRELESS SIGNALS.—For receiving and recording wireless signals. These well-known service recorders are simple in use, reliable, and enable messages on any wavelength to be received and recorded at a speed too high for most to read direct. The tape record can be comfortably read at leisure. Recorders add enormously to interest in wireless. Magnificent British work, all brass case on mahogany, drawer containing tape reel. Such apparatus, costing £40, is rarely obtainable, and is the last of the surplus. All instruments are carefully inspected and guaranteed in working order. £6 10s. each. The finest bargain offered.

PETROL OR GAS ENGINES with Dynamos 150 watts to 4 kW. EDISON Steel Storage Cells. DYNAMOS and Switchboards from 50 watts to 6 kW. Several hundreds to select from. Morse chains and wheels, 25/- set. Sawgear boxes 1 h.p., 10/-. Gear boxes, 2-1 for 1 h.p., 4/6. Electric Clutch 6 volt, 7/6. Electric Governors, 7/6. Bowden R.A.F. Remote Controls, 18 points, 7/6.

7/6 COMMUTATORS for 2/-

For Motors and Dynamos 5 to 500 volts. Very solidly built-up Copper Segments, mica insulated, pressure assembled on tubular centre, to slip on to armature shaft. 24 Segments, 1 1/2 in. dia., 1 1/2 in. long, 1/4 in. bore. 30 Segments, 1 1/2 in. dia., 1 1/2 in. long, 7/16 in. bore. 2/-.



CRYSTAL SETS for crystal pure reception. Desk type B, all bakelite, full B.B.C. range. 7/6. Headphones, 4/6.



LIGHT AND RAY CELLS. Selenium Raycraft, 21/-; Kingston, 15/-; Raycraft outfit with relay and amplifier, 45/-; Photocells, for sound on Film, Television and Ray Work. R.C.A., 25/-; G.E.C., £3 10s. Beck Angle Pisms, mounted in carrier, 5/6. Micrometer adjusters for lens, 1/-; Eyepieces with prism and lenses for photocell inspection, 12/6. New X-Ray Tubes, 10/-.

MIRRORS.—5 1/2 in. dia., Heli or Television, 1/6. Parabolic Concave, 10in., 20/-; 20in., 25/-; 24in., 30/-. Carr. fwd. Neon Lamps, 2/6 and 3/- each, with holder. Invention Neons, 2/6.

PUBLIC ADDRESS OUTFITS.—Mobile Type, complete with batteries and converter in case, mike and P.A. horn speaker. 6 watt D.C. mains P.A. Amplifier; outfit and speaker complete. 10 and 20 watt A.C. Vertical 50 watt 6in. panels, unitted, 35/-.

PORTABLE FIELD TELEPHONES.

ARMY TYPE in pigskin case for speech or code. No skill required. No. X 135, 60/-. 1 mile D2 cable, 50/-.

BATTERY SUPERSEDERS.

Provide H.T. from your L.T. 2-volt battery, rectified and smoothed. 3 tappings. A boon to those who are not on the mains. Reduced from £3 15s. New and Guaranteed, 37/6.

Switchgear and boards, Rheostats, Regulators, Meters, Relays, Cut-outs, etc. Send us your enquiries.

ELECTRADIX RADIOS

218, UPPER THAMES STREET, LONDON, E.C.4.

Telephone: Central 4611

TELEVISION

TECHNICAL TERMS AND DEFINITIONS.

By E. J. G. Lewis. An up-to-date, comprehensive work of reference, containing over 1,000 detailed explanations of technical terms used in television, as well as a number of illustrations. It is an invaluable book for all who are interested in television. 108 pages. 5/- net (by post 5/3).

"A very useful guide and reference."—TELEVISION AND RADIO BULLETIN.

PITMAN,

FARKER STREET, KINGSWAY, LONDON, W.C.2



We don't claim to make the cheapest transformers but we do claim to make good ones. Most of the professional P.A. men seem to think so, too.

W. BRYAN SAVAGE LTD.

Westmoreland Rd., London, N.W.9. Phone: Colindale 7131

COMPONENTS—SECOND-HAND, CLEARANCE, SURPLUS, ETC.

SOUTHERN RADIO'S Wireless Bargains; all goods guaranteed and sent post paid.

RECEIVERS.—Vidor 3-oval battery portable receivers, complete with 3 Osram valves, special Vidor long life batteries and accumulator; moving coil speaker, brand new, in sealed cartons; £3/17/6.

LUCILLE 5-valve American Midget Sets, complete with 5 valves, moving coil speaker, ready for use on any mains, 100-250 volts A.C./D.C., long and medium waves; £3/15, new, in sealed cartons.

RECORD CHANGERS.—Garrard Model R.C.4, plays automatically and changes eight 10in. or 12in. records of any kind, new, in sealed cartons; £6.

GRAMOPHONE MOTORS.—Collaro electric radiogram units, for A.C. or D.C. mains, 100-250 volts, fully auto stop, complete with pick-ups, can be used on any mains, brand new, in sealed cartons, 57/-; Collaro spring gramophone motors, with 10in. turntable, complete with all accessories, 11/-; all Collaro motors are brand new, in sealed cartons.

SPEAKERS.—Celestion Soundex, permanent magnet, 10/-; Telsen permanent magnet, with 10-ratio transformer, to suit any receiver, 12/6; Telsen loud speaker units, 2/6; all brand new and boxed.

COILS.—Telsen iron core W349 (Midget size), 4/-; type W478 (twin), 9/- pair; type W477 (triple), 16/- per set; type W476 (triple superhet, selector and oscillator), 16/- per set; Telsen short wave coils, matched set of three, 4-pin bases, 12-26, 22-47, 41-84 metres, 5/- per set; Telsen dual range H.F. transformer and aerial coils, type W154, 3/- each; all ganged coils complete on base with switch; Telsen I.F. transformer coils, 110 k.c., 5/-; Telsen dual range coils, with aerial series condenser incorporated, type W76, 4/-; Telsen aerial condensers, with shorting switch, 2/-; all Telsen components brand new, in sealed cartons.

AMERICAN VALVES.—A full range of valves for all American receivers; 6/- each.

MISCELLANEOUS BARGAINS.—All brand new, in original sealed cartons; Telsen A.C./D.C. multi-meters, test anything, radio or electrical, 8/6; Telsen 2-range voltmeters, 3/-; 5-range meters, including milliamps, 4/-; Ace (P.O.) microphones, with transformer, ready for use with any receiver, 4/6; Bell transformers, 200-250 volts input, 3, 5, or 8 volts output, 3/6; Morse signal units, incorporating buzzer, tapper and flash, with international code, complete with batteries and bulb, 3/9 each; lightweight headphones, double-pole, 4,000 ohms each earpiece, 3/- pair.

REGENTONE Eliminators, A.C. 200-250 volts, type W5a, with trickle charger; 37/6.

SOUTHERN RADIO.—Branches at 271-275, High Rd., Willesden Green, N.W.10; 46, Lisle St., London, W.C.2. All mail orders to 323, Euston Rd., London, N.W.1.

SOUTHERN RADIO, 323, Euston Rd., London, N.W.1 (near Warren St. Tube). Phone: Euston 3775. [4192]

WARD.—for unparalleled bargains in set manufacturers' surplus; all goods are guaranteed unused and perfect; immediate delivery.

BRITISH Radiophone Condensers, fully screened, superhet, or straight types, 3-gang and 2-gang; 7/6.

CENTRALAB Resistances, 1-watt type, 6d.; 2-watt type, 1/2; 3-watt type, 1/9; B.I.C. 8mf. and 4mf. 550 volts peak electrolytic condensers, 3/3.

3,000 Brand New Wearite 110 kc. Pre-tune I.F. Transformers, type O.T.1, O.T.2 and O.T.2F; 1/6 each, or offer for quantity.

40 mfd. and 24 mfd. 200 Volts Peak Electrolytic Condensers; 3/-.

CLIX Chassis Type Valve Holders, 4- or 5-pin, 6d.; 7- or 9-pin, 6d.; R.C.A. American valve holders, 4-, 5-, 6-, or 7-pin, 9d.

ASSORTED 1-gross Parcels of 1-watt and 1/2-watt Resistances by N.S.P.; 12/-.

MARCONI Model 25 Pick-ups; 25/-.

CONVERSION Units for Converting D.C. Receivers to A.C. Mains operation up to 110 watts, improved full-wave type; £2/10.

WESTINGHOUSE Rectifiers, L.T.4 or L.T.5, with mains transformer and variable resistance, 22/6; Varley D.P.4 output transformers, 1-1 and 25-1, 9/-.

MAINS Transformers, 350-0-350v. 60 ma., 4v. 3 amps. 4v. 25 amps., 12/-; 425-0-425v. 120 ma., 4v. 1 amp. av. 1 amp., 4v. 7 amp., 4v. 25 amp., for "W.W." Quality Amplifier, 26/-; I.T. transformers, with two 4v. 5a. C.T. windings or 2.5v. 8a., 5v. 2.5a., 8/6.

VOLUME Controls, with or without switch, by Rotor-ohm, Erie, Electrad, and other good makers, any value, 2/6; steel chassis, "Wireless World" Quality Amplifier, 8/6; Partridge 32-watt amplifier, 11/-.

WE Stock All Parts for "Wireless World" Quality Amplifier, Quality Amplifier Receiver, Imperial Short Wave Six, 1936 Monodial Q.A. Super, All-wave Super Seven, etc.

WE Can Supply Correct Equivalents for Any British Type of Valve, including side-contact Universals, H.F. pentodes, double diode triodes, 3-5-watt output pentodes, 500v. indirectly heated rectifiers, octodes, double diodes, single diode tetrodes, etc., at an appreciably lower price.

PHILIPS Amplifiers with 400v. triode in output stage; £2, complete.

CARRIAGE Paid, cash with order or c.o.d.; send for list.

WARD, 46, Farringdon St., London, E.C.4. Tel.: Holborn 9703. [0450]

PETO-SCOTT

THE ONLY FIRM with 18 YEARS' EXPERIENCE supplying the specialised needs of the constructor

"Wireless World" 5-15 metre

3 valve BATTERY SET

KIT "A" CASH OR C.O.D. £4:12:6

Carriage Paid

Or 8/6 down and 11 monthly payments 8/6.

Complete Kit of Parts as specified by "Wireless World," but with B.T.S. Coils, Coil Bases and H.F. Chokes. Includes Peto-Scott ready-drilled Aluminium Panel, Plymax Baseboard, and all screws, nuts, wire and brackets, less valves only.

KIT "B" As above, but with 3 specified valves. £6:0:0

Cash or C.O.D. Carriage Paid

Or 11/- down and 11 monthly payments 11/-.

KIT-BITS You pay the Postman. We pay post charges on all orders over 10/-—GT. BRITAIN ONLY.

Peto-Scott Aluminium Panel, ready-drilled, swirled and lacquered	4/6
Peto-Scott Plymax Baseboard	2/6
Set of 6 B.T.S. Coils and 2 Coil Bases (5-15 metres)	per set 19/6
2 B.T.S. Section Wound Chokes	per pair 5/-
2 B.T.S. H.F. Phone Chokes	per pair 1/6
Utility Micro Dial Type W181	7/6
Bulgin Transcuser Type L.F.10	12/6

FINISHED INSTRUMENT

Peto-Scott Version

Assembled, wired, and tested by Peto-Scott technicians, employing highest-grade components as specified in above Kits and complete with all Coils, Valves and G. B. Battery, but less cabinet. Cash or C.O.D. £6:6:0 Years for 11/6 DOWN

Carriage Paid and 11 monthly payments 11/6

"Wireless World" A. C. Mains SHORT WAVE CONVERTER

FINISHED INSTRUMENT

Peto-Scott Version

Assembled and tested by Peto-Scott technicians, employing B.T.S., Cydon, Erie and Peto-Scott components to exact values as specified by "Wireless World," and complete with 2 valves, less cabinet. Cash or C.O.D. £7:19:6 Years for 15/- DOWN

Carriage Paid and 11 monthly payments 14/6.

If B.T.S. Cabinet for Converter only required add 18/6 to cash price or 19/- to deposit and each monthly payment.

For Prices of Kits see our adverts in April 9th and 16th issues.

All Postal Orders must be crossed and currency registered.

PETO-SCOTT Co. Ltd., Established 1919

77 (W.W.25), City Road, London, E.C.1

62 (W.W.25), High Holborn, London, W.C.1.

AMERICAN

SET OWNERS

INSIST ON

THE

WORLD'S

STANDARD

VALVE



The Standard Valve for Standard Sets

FOR RELIABLE

CONSISTENT

PERFORMANCE

UNIVERSAL RADIO DISTRIBUTORS LTD.

14, FITZROY SQUARE, LONDON, W.1.

"Foundations of Wireless" Post free 4/11

COMPONENTS—SECOND-HAND, CLEARANCE, SURPLUS, ETC.

STANDARD RADIO SUPPLIES, 1, Dantzic St., Manchester.—Note our very low prices.

RECEIVERS.—Vidor band pass all-wave battery set, moving coil speaker, wave bands 17.51, 185-550, 750-2,150 metres; circuit, band pass input to VMHF pentode, triode detector, pentode output.

GRAMOPHONE Motors.—Garrard 202 AC7, comprising AC motor and pick-up, list 4 gns.; £2.

VALVES.—Famous Europa AC types, HL, SG, VMSG, ACPen, 5-pin, HFPen, VMHF Pen, FW rectifiers, 300v., all at 4/-; at 5/3 each, FC4 type, Pen. 4VB type, FW350/120 m.a.; at 6/3, PM24M type, also full range of Hivac valves at full trade discounts.

AMERICAN Valves.—No. 1 makes, in most numbers, 5/-; good second quality tubes at 3/-.

COILS.—Telsen iron core, W349 (midget size), 3/9; W478 (twin), 8/6; W477 (triple), 15/-; W476, 15/-; IF transformers, W482, 4/9.

TELSEN AC/DC Multimeter, 8/-; tubular condensers and T.C.C. condensers advertised last week still available.

ALL Orders Value 5/- Post Free; under 5/- postage extra; no c.o.d. orders under 5/-.

STANDARD RADIO SUPPLIES.—Every article sold is guaranteed.—1, Dantzic St., Manchester. [4393]

ALL Goods Previously Advertised are Standard Lines, still available; post card for list free.

VAUXHALL UTILITIES, 163a, Strand, W.C.2. Over Denny's the Booksellers. Temple Bar 9338. [4399]

TRANSFORMERS.—D.C. rotary, H.T.8, Ferranti; other bargains, lists free.—Austin, 33, Fitzroy Rd., Whitstable. [4388]

EXPERIMENTER'S Surplus; A.F.58, 11/6; B.2, 10/6; A.F.38, O.P.I.S., B.I.S., 7/6.—Cairns, South Erskine Park, Bearsden, Glasgow. [4383]

1934 Monodial, A.C. chassis, speaker, extra smoothing, valves, amplifier, 2 1/2 watt, £6; amplifying ditto, extra smoothing, valves, 50/-.

MAGNAVOX Magna, 142, 2,500 ohms, 30/-; Rothermel Piezo speaker, R.95, new, £1; Baker's P.M.M.C. speaker, 9in., 17/6.

FERRANTI A.F.5 Cs., 14/-; O.P.3C., 11/-; O.P.M.4C., 11/-; A.F.3, 5/-; Colvern 110 I.F., 4/6.

ELIMINATORS, Atlas A.2, 10/6; Regentone, W.I.C., 15/-; W.I.D., 10/6; must sell; best offers accepted.—Ashton, Byass Av. Bridlington. [4376]

MAINS RADIO DEVELOPMENT COMPANY Offer Guaranteed Bargains; carriage paid, call mornings.—Phone: Tudor 4046. Stamp for new list 203.

MAGNUM Fully Screened Three-wave Band Superhet. Coils, and I.F. transformers, surplus to set maker; latest type grey cellulose cans, trimmers on all wave bands, 15-52, 190-560, 800-2,200 metres; aerial (for pro H.F.), H.F. and oscillator (465 kc); three coils, two 465 kc I.F.'s, and three-gang Vaxley type switching; complete kit, with circuit diagram, 25/-; without I.F. transformer, 17/6.

ERIE Surplus Quarter Watt Resistors, unused, colour coded, wire ends, two each of six good sizes, our choice; 1/- dozen.

SATOR Metal Cased Condensers, 400 volt working, 1 mfd., 7/2d., 2 mfd., 10d., 4 mfd., 1/8.

CENTRALAB Unused Potentiometers, 500,000 ohms, 1/-; 10,000 ohms, 1/3; Cosor 50,000 ohms, 1/3; Rotorohm, 10,000 ohms with switch, 1/6; Centralab, 500,000 ohms with switch, 1/9; any other size in Centralab, with or without switch, 2/3.

B.I.C. 8 mfd., 550 volt dry, metal can electrolytics, 2/3; ten other sizes on list.

PYE 20h., 120 m/a., boxed L.F. chokes, 4/6; Arco steatite short, wave condensers, 0.00016 mfd., 1/6.

TUBULAR Condensers, very best make, wire ends, 400 volt working, 0.0001, 0.002 mfd., 3d.; 0.005, 0.05 mfd., 5d.; 0.25, 0.5 mfd., 7d.; special 0.1 mfd., 450 volt working, 5d.

CLIX Latest Unused Chassis Valve Holders, 4-pin, 1 1/4d.; 5-pin, 2 1/4d.; 7-pin, 4d.; chassis, grey cellulosed metal, three valve, 12 1/2 x 6 1/2 x 3in., 1/- (9-pin, 6d.).

RESISTORS, absolutely finest make, one watt, colour coded, wire ends, unused, 50 ohms to 5 megohms, any size, your choice, 3 1/4d.; 2/9 dozen; two watt, any size, 6d.

MAINS RADIO DEVELOPMENT COMPANY, 4-6, Muswell Hill Rd., London, N.6. [4318]

TRANSMITTING APPARATUS

G5NI.—The recognised distributors for amateur equipment, National, R.M.E., Thordarson, Hammarlund, McMurda, Hallcrafters, etc.; send 1/4d. stamp for catalogue.—Radiomart, 44, Holloway Head, Birmingham. [0531]

EXTENDED PAYMENTS

LONDON RADIO SUPPLY Co. (Established 1925) supply on convenient terms, components, accessories and sets, any make, 10% down, balance over 12 months; send for list of requirements.—11, Oat Lane, London, E.C.2. [0537]

HIRE-PURCHASE.—Prompt delivery of any radio apparatus on convenient terms.

WARD, 46, Farringdon St., London, E.C.4. Tel.: Holborn 9703. [0539]

RAYMART CRAFT A CREED MICRODISC DIAL

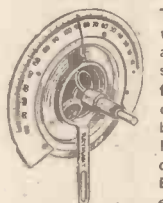

The famous Utility micro movement is incorporated in these dials and they provide the finest drive for smooth operation, with freedom from backlash. Their high standard of efficiency is fully acknowledged by leading receiver manufacturers. Fitted with fast and slow motion, controlled by concentric knobs. Bevelled scales are provided for easy reading.

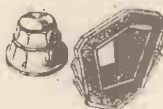

Type SMD 3/11.

REDUCTION DRIVE

We can strongly recommend our epicyclic reduction drive for fitting to all 1/2" shafts and providing, when used direct, a 6:1 reduction. When used with a 12-1 dial a slow motion ratio of 72 to 1 is obtained. This reduction drive is admirable for controlling fierce reaction, and for vernier tuning. The movement prevents all possibility of slip.

Type ERD 2/3.

OUR SHORTWAVE MANUAL AND CATALOGUE, 48 pages in all, 32 on receivers, transmitters, aerials circuits, etc., and 16 on a splendid range of short-wave components, 6d., or post free 7d. 16 p. Short-wave Catalogue only, 1 1/4d.

MICROVARIABLES.—All brass construction, latest ceramic insulation. The finest condensers made: 15 mmfd., 1/4; 40 mmfd., 1/7; 100 mmfd., 1/10; Transmitter Type.—0.70in. spacing, 15 mmfd. (neutralising), 2/9. 40 mmfd. Tuning, 3/6. These are quality.

SHORTWAVE COILS.—(R.D.) CA, 11-25; CB, 20-45 metres, 2/6. CC 45-100 metres, 2/9. Standard 6-pin types, CA8, CB6, 2/6 each; CC6, 3/- same range as 4-pin.

COILFORMS.—Moulded in R.D. natural lous material, hollow resilient pins, 1 1/4in. diameter, ribbed; identification disc in top. Four types, 4-pin, 1/6; 6-pin (standard or to fit 7-pin valveholders), 1/8; 7-pin (for bandspread tap), 1/10; Machine threading, 2d. extra.

AMERICAN Mains Transformers, Heavy Duty 350/350v. 150 m/a, 6.3v. 4a., 5v. 3a., 12/6. GE 360/350 v. 80 m/a, 2.5v. 4.5a, 5v. 2a, 6/11. Majestic, 200-250 2.5 v. 5 v. 4/11. Pilot 260-260, 2.5 v. C.T., 5 v. C.T., 5/11. Ceramic American Valveholders, 1/- each.

HEAVY DUTY Mains Transformer, worth 35/-, 350-350, 150 m/a, 4 v., 2.5 A., C.T., 4 v., 6 A C.T., 12/6; Philips 270-270, 120 m/a., same I.T., 6/6; Speaker Transformers, 2/6.

UTILITY 8/6, Microdisc Dials, 3/11; Radiophone, 0.00016 Shortwave Condensers, 3/6; Series gap twin, 3/9. Shortwave HF Chokes 5-100 metres, 9d.

465 KG Litz Wound IF's, 3/11; Two-speed slow-motion knobs, 1/-; Telsen Ace Transformers, 1/11; Telsen Screened S.W. H.P.C., 1/-; Iron core H.F. chokes, 1/-.

ELECTROLYTICS. Huge purchase 500 v. Aluminium Can, 4 mf., 1/6; 8 mf., 1/11; 8+8 mf., 2/6; Block type, 500 v. peak, 4+4 mf., 1/6; 8+8+4 mf., 3/-; 50 mf. 50 v., 1/3; 25 mf. 25 v., 1/-; Tubular Condensers, 1500 v. T., all sizes to 0.1 mf., 6d.; 0.2 to 0.5 mf., 8d.

FAMOUS CONTINENTAL A.C. Valves, 4/6; Battery types from 2/3; American Duotron, etc., all types, 3/6; All types of RCA Licensed first grade tubes, metal and glass, in stock from 5/6.

BRITISH RADIOPHONE 00005 straight or superhet 3-gang fully screened condensers with trimmers, 4/11; Utility Midget 2-gang ditto, 3/11; S.L. Dial to suit above, 2/11; Utility 2-gang Uniknob 00005 with Dial, 3/11.

PUSHBACK Wire, 6 yds., 6d.; heavy, 9d.; Resin-cored Solder, 6ft., 6d.; Screened Flex, single, 6d. yd.; twin, 9d. yd. Assorted Solder Tags, 6d. packet.

SMOOTHING CHOKES, 20 h., 120 m.a., 3/11; 200 m.a. swinging chokes, 8/6; Centralab Pots, all sizes, 1/6; switched, 2/-; 20,000 ohm Pots, 1/-; Tubular glass fuses, 2d. Milliamperes, 25 m.a. upwards, 5/9; super, 6/9.

SPECIAL OFFERS. Class B Kit, worth 30/-, comprising Driver Transformer, Valve and Holder, 5/-; Dozen wire-ended assorted resistors, 1/6. Order 5/- post free. Get our Bargain Catalogue, 1/1d. post free. All enquiries and requests for Catalogue must send 1/1d. stamp.

BIRMINGHAM RADIAMART (G5NI) 44, HOLLOWAY HEAD, BIRMINGHAM. TELE: MID. 3254

44, HOLLOWAY HEAD, BIRMINGHAM. TELE: MID. 3254

44, HOLLOWAY HEAD, BIRMINGHAM. TELE: MID. 3254

44, HOLLOWAY HEAD, BIRMINGHAM. TELE: MID. 3254

44, HOLLOWAY HEAD, BIRMINGHAM. TELE: MID. 3254

44, HOLLOWAY HEAD, BIRMINGHAM. TELE: MID. 3254

44, HOLLOWAY HEAD, BIRMINGHAM. TELE: MID. 3254

44, HOLLOWAY HEAD, BIRMINGHAM. TELE: MID. 3254

44, HOLLOWAY HEAD, BIRMINGHAM. TELE: MID. 3254

44, HOLLOWAY HEAD, BIRMINGHAM. TELE: MID. 3254

44, HOLLOWAY HEAD, BIRMINGHAM. TELE: MID. 3254

44, HOLLOWAY HEAD, BIRMINGHAM. TELE: MID. 3254

44, HOLLOWAY HEAD, BIRMINGHAM. TELE: MID. 3254

44, HOLLOWAY HEAD, BIRMINGHAM. TELE: MID. 3254

44, HOLLOWAY HEAD, BIRMINGHAM. TELE: MID. 3254

44, HOLLOWAY HEAD, BIRMINGHAM. TELE: MID. 3254

44, HOLLOWAY HEAD, BIRMINGHAM. TELE: MID. 3254

44, HOLLOWAY HEAD, BIRMINGHAM. TELE: MID. 3254

44, HOLLOWAY HEAD, BIRMINGHAM. TELE: MID. 3254

44, HOLLOWAY HEAD, BIRMINGHAM. TELE: MID. 3254

44, HOLLOWAY HEAD, BIRMINGHAM. TELE: MID. 3254

44, HOLLOWAY HEAD, BIRMINGHAM. TELE: MID. 3254

44, HOLLOWAY HEAD, BIRMINGHAM. TELE: MID. 3254

44, HOLLOWAY HEAD, BIRMINGHAM. TELE: MID. 3254

44, HOLLOWAY HEAD, BIRMINGHAM. TELE: MID. 3254

44, HOLLOWAY HEAD, BIRMINGHAM. TELE: MID. 3254

44, HOLLOWAY HEAD, BIRMINGHAM. TELE: MID. 3254

44, HOLLOWAY HEAD, BIRMINGHAM. TELE: MID. 3254

44, HOLLOWAY HEAD, BIRMINGHAM. TELE: MID. 3254

44, HOLLOWAY HEAD, BIRMINGHAM. TELE: MID. 3254

44, HOLLOWAY HEAD, BIRMINGHAM. TELE: MID. 3254

REPAIRS AND SERVICE

GRAHAM'S.

GRAHAM'S Radio, Repair and Rewinding Service; 24 hours' service guaranteed.—See below.

ALL Moving Iron Loud Speakers, L.F. transformers, or pick-ups, from 2/6. output transformers from 4/-; postage extra; mains transformers, moving coils, electric clocks quoted, trade discounts.—Graham's Repairs, 194-Tolworth Rise, Kingston By-pass, Surrey. Phone: Derwent 2060. [4367]

DISTAVOX SERVICE.

GUARANTEED Service.—All makes of English and American receivers; quotation by return.

REWINDING.—Mains, L.F. and output transformers, speakers, headphones, etc.; keenest terms for contracts.

DISTAVOX RADIO SERVICE Co., 119, Bunhill Row, London, E.C.1. Phone: National 8589. [4363]

SCOTT SESSIONS and Co.,

ALL British or American Sets Repaired or Modernised by Qualified Engineers; satisfied customers throughout the world are your guarantee; send to-day for free estimate; free collection 10 miles radius of London.—Scott-Sessions and Co., Exchange Works, Dukes Av., Muswell Hill, London, N.10. Phone: Tudor 4101. [0552]

"SERVICE WITH A SMILE."

HENRY FORD RADIO, Ltd.—American valves, components, spares, line cords; leading trade repairers; send us your American and British receivers.—Electronic House, 22, Howland St., Tottenham Court Rd., W.1. Museum 5675. [0434]

METROPOLITAN RADIO SERVICE Co., for Guaranteed Repairs to American (Midget and Standard and British Receivers).

CLARION and Majestic Service Depot.—I.F. and mains transformers rewound. American valves and parts; trade supplied.—Metropolitan Radio Service Co., 1021, Finchley Rd., London, N.W.11. Speedwell 3000. [0435]

REPAIRS, rewinds, and construction, any size transformers, chokes, etc., to trade.—Electric, Garden St., Sheffield, 1. [3915]

FOR Unusually Good Rewinding of Transformers, chokes, speakers, etc., trade only.—Gardners Radio, Ltd., West Southbourne, Bournemouth. [0551]

OUR Technical Department is at your Service.—Air King Radio, 115, Shaftesbury Av.; Cambridge Circus, W.C.2. Phone: Temple Bar 4875 (2 lines). [3963]

LOUD Speaker Repairs, British, American, etc.; any make transformer coils rewound; alterations.—Sinclair Speakers, Alma Grove, Copenhagen St., N.1. [4030]

NATIONAL RADIO and TELEVISION SERVICE Co., Leading Service Engineers and Car Radio Experts, 155-157, Great Portland St., W.1. Phone: Langham 3477. [3911]

GUARANTEED Repairs.—Any transformers, choke, motor, armature, converter, dynamo, etc.; keenest prices; immediate quotation; prompt, dependable service.—See below.

L.T.P. (LONDON TRANSFORMER PRODUCTS, Ltd.), Willesden, N.W.10. Willesden 6486 (3 lines). [3470]

POULTNEY and PURVIS, British and American Service, trade or private; "W.W." sets a speciality; free collection, estimates.—147, Pitsanger Lane, Ealing, W.5. Perivale 3765. [4362]

MAINS Transformer Service.—Repairs, rewinds, or constructions to specification of any type; competitive prices and prompt service.—Sturdy Electric Co., Dip-ton, Newcastle-on-Tyne. [0516]

F. E. GODFREY, A.M.I.R.E., qualified to build, repair and convert "Wireless World" sets, etc.; 25 years' experience, prompt service guaranteed.—30, Kemplay Rd., Hampstead, Hampstead 1104. [3509]

ZETAVOX, Zenith, repairs, conversions; specialists in installation and repairs car radio; trade service; public address; coil winding; sets designed.—Zetavox, 4, Colebrooke Place, Islington. Can. 1172. [4390]

REPAIRS to Moving Coil Speakers a Speciality; cones and coils fitted, fields altered; prices, including eliminators, quoted, loud speakers, 4/-; L.F. and output transformers, 4/-, post free; guaranteed satisfaction; trade invited; estimates free; prompt service.—Loud-Speaker Repair Works, 5, Balham Grove, London. Battersea 1321. [0394]

MISCELLANEOUS

CHEAP Printing.—1,000 billheads, 3/6; sample free.—Cretaway Press, 18, Buxted, Sussex. [4312]

G.P.O. Engineering Dept. (no experience required). Commencing £3/13 per week; age 18-23; excellent prospects.—Free details of entrance exam. from B.I.E.T. (Dept. 574), 17-19, Stratford Place, London, W.1. [4371]

AMBITIOUS Men.—To ensure promotion take advantage of The T.I.G.B.'s authoritative home study courses in Radio Engineering and Servicing, Television, Sound Recording, Wireless Communications, etc.; write to-day for "The Engineer's Guide to Success"—free—which gives full particulars—contains the world's widest choice of engineering courses covering all branches—and alone gives the Regulations for qualifications such as A.M.I.E.E., A.M.I.R.E., A.M.I.T.E., A.M.I.W.T. C. & G., etc. Training until successful guaranteed.—The Technological Institute of Great Britain, 5, Temple Bar House, London, E.C.4. (Founded 1917. 20,000 successes.) [4370]

Advertisement for 'ENGINEERS! ARE YOU EARNING LESS THAN £10 PER WEEK?' featuring a book '268 PAGES Free' and contact information for the British Institute of Engineering Technology at 387 Shakespeare House, London, W.1.

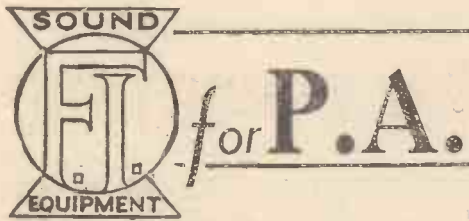

• CORONATION •

Among the contracts which F.I. efficiency has brought are included:

● TRAFALGAR SQUARE

● THE ADMIRALTY ARCH
THE MALL
VICTORIA MEMORIAL
GARDENS (EAST SIDE)

● CONSTITUTION HILL

● HYDE PARK CORNER

● MARBLE ARCH

● PICCADILLY CIRCUS

● Whatever your P.A. problem, consult the country's leading P.A. Engineers—F.I.:

FILM INDUSTRIES LTD.

60, Paddington Street, W.1

'Phone: Welbeck 2293/4—2385/6

Scottish Office—229, St. Vincent] St., Glasgow

ELECTRIC CLOCKS

SMITHS and Ferranti Electric Clocks, Waltham and Russell watches and clocks; traders' enquiries invited. —Leonard Heys, 36, Henry St., Blackpool. [0526]

EXCHANGE

EXCHANGE 200 "Wireless Worlds," 1932-1936, clean, for amateur-built receivers for breaking up S.W. gear, etc.; what offers?—Lambert-Clear, Sturminster-Newton, Dorset. [4364]

I BUY, sell, exchange good quality receivers, accessories, components; I.P. facilities; promptness, efficiency.—Bostock, 1, Westbourne Terrace, S.E.23, Forest Hill 2236. [0529]

PATENT AND TRADE MARK AGENTS

GEE and Co. (H. T. P. Gee, Mem. R.S.G.B., A.M.I.R.E., Estab. 1905), 51-52, Chancery Lane, London, W.C.2 (2 doors from Government Patent Office), Holborn 4547 (2 lines). Handbook free. [0001]

PATENTS

"PRACTICAL Hints on Patents," free on application. The Imperial Patent Service, First Avenue House, High Holborn, W.C.1. Preliminary consultation free. [0431]

TUITION

RADIO Training.—Marine, aircraft, broadcast; prospectus free.—Hull Municipal Technical College. [0523]

PRACTICAL Radio and Television, private or postal training; particulars free.—R.T.I., 39-47, Earl's Court Rd., W.8. Western 6917. [3758]

WANTED

WANTED, Philco oscillator, Universal Avometer or similar.—19, Hanover St., Newcastle, Staffs. [4374]

WANTED for Cash, McMichael transportables, types CF or C, with moving iron (cone) speaker.—Matheson, Fishmarket, Aberdeen. [4375]

WANTED, amplifier and speakers for 600-seater cinema; would consider complete outfit; London preferred; send full particulars to Lowney, Clonakilty, Cork. [4380]

WE Buy for Cash All Types of Modern Second-hand Radio Sets and Accessories, test meters, parts, etc.; we pay more than any other dealer; part exchanges; bring, send, or will call.—University Radio, Ltd., 82, Hampstead Rd., London, N.W.1. 'Phone: Euston 3810 [4193]

SITUATIONS VACANT

AIR MINISTRY.
CIVILIAN Wireless Instructors Required.
VACANCIES Exist for Civilian Wireless Instructors at the Electrical and Wireless School, Royal Air Force, Cranwell, Lincs; the commencing rate of pay is £4 a week inclusive, which may be increased to £4/5 a week after a short period of satisfactory service.
CANDIDATES must be Capable of Lecturing, and must have a sound knowledge of electrical principles and their application to radio and low-power electrical engineering; applications should be addressed to the Commanding Officer, Electrical and Wireless School, Royal Air Force, Cranwell, Lincs, giving full particulars as to previous experience, age, etc.; candidates will be required to appear before a Selection Board at the school for interview and test; the test will include the giving of a lecture on any subject which may be chosen by the candidate involving the principles of modern radio; lecturing sequence and style are most important. [4373]

SITUATIONS VACANT

CROWN Agents for the Colonies.
COLONIAL GOVERNMENT APPOINTMENTS.

APPLICATIONS from Qualified Candidates are Invited for the Following Post:—

ASSISTANT Engineer Required for the Posts and Telegraphs Department of Kenya, Uganda and Tanganyika, for one tour of 24-28 months. Salary £600-£30-£720 a year. Free passages, quarters, and liberal leave on full salary. Candidates, aged 25-35, must be of good education, and have obtained a degree or diploma in Wireless Engineering of some recognised University or College. Associate Membership of the Institution of Electrical Engineers would be an additional qualification. They must be capable of designing, installing, and maintaining short- and medium-wave wireless stations, and a knowledge of direction finding would be an advantage.

APPLY at once by Letter, stating age, whether married or single, and full particulars of qualifications and experience, and mentioning this paper, to the Crown Agents for the Colonies, 4, Millbank, London, S.W.1. quoting M/4931. [4403]

RADIO Engineer Required, B.Sc. standard; must have good knowledge of R.F. and A.F. measurements and instruments; state age, experience and salary.—Pye Radio, Ltd., Dept. 44/WW/RE, Cambridge. [4369]

WIRELESS Operators and Engineers Urgently Required.—Train at Britain's leading colleges; fee after appointment; boarders; prospectus free.—The Wireless College, Colwyn Bay, or The Wireless College, Calmore, Southampton. [0541]

BOOKS, INSTRUCTION, ETC.

"WIRELESS Worlds," 1927 to 1935 inclusive; offer wanted.—Box 1764, c/o The Wireless World. [4368]

Specified for the ULTRA SHORT WAVE QUALITY RECEIVER

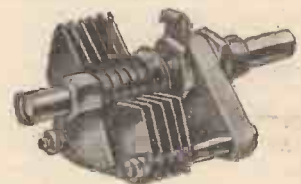

'APEX ECONOMY' CONDENSERS

15 mmfd 1/6. 40 mmfd 1/9
All other parts in stock

WEBB'S RADIO

The recognised London Suppliers to AMATEUR EXPERIMENTERS

14, Soho Street, Oxford Street, London, W.1.
Telephone: GER. 2089

INDEX TO ADVERTISEMENTS

	PAGE		PAGE
Armstrong Mfg. Co.		Institute of Wireless Technology	PAGE 2
Automatic Coil Winder Co., Ltd.	4	Linguaphone, Ltd.	
Bakers Selhurst Radio		McCarthy Radio, Ltd.	Edit. 455
Belling-Lee, Ltd.	3	Midwest Radio, Ltd.	1
Birmingham Radiomart G5N1	7	M.I. Supplies	1
British Institute of Engineering Technology	7	M.P.R. Electrical Co.	2
British Insulated Cables, Ltd.	Inside Back Cover	Parmeko, Ltd.	
British Mechanical Productions, Ltd.		Peto Scott, Ltd.	6
British Ptx		Pitman, Sir Isaac, & Son, Ltd.	6
British Rola Co., Ltd.	Edit. 459	Postlethwaite Bros.	
British Sound Recording		Premier Supply Stores	5
British Thomson-Houston Co., Ltd.		Prism Manufacturing Co.	
Bulgin, A. F., & Co., Ltd.		Radio Development Co.	
C.A.V.		Radiographic, Ltd.	
Colvern, Ltd.		Record Radio, Ltd.	2
Denco	Inside Back Cover	R.G.B.	
Dubilier Condenser Co. (1925), Ltd.	Inside Front Cover	Savage, W. Bryan	6
Ediswan, Ltd.	Front Cover	Sound Sales, Ltd.	4
Electradix Radios	6	Tannoy Products	5
Exide, Ltd.	6	Telegraph Condenser Co.	Edit. 457
Film Industries, Ltd.	8	Universal Radio Distributors, Ltd.	6
Fluxite		Voigt Patents, Ltd.	Inside Back Cover
Forbat, Eugene J.		Ward, C. F.	
Galpins		Westinghouse Brake & Signal Co., Ltd.	
Gardners Radio, Ltd.		Webb's Radio	8
Goodman's Industries, Ltd.		Wingrove & Rogers, Ltd.	
Gramphon Reproducers, Ltd.	5	Wright & Weaire, Ltd.	5
Hartley Turner Radio, Ltd.	2		
Haynes Radio			
High Vacuum Valve Co., Ltd.	1		

B.I. CONDENSERS

for
RADIO & GENERAL USE

B.I. CONDENSERS for Radio Receivers, Battery Eliminators, Smoothing Circuits, etc., are made in several different types to suit the various uses for which Condensers are required in connection with Wireless circuits.

These Condensers are the result of 36 years' experience in the manufacture of all kinds of Condensers from the smallest sizes up to those weighing more than 2 tons.

In addition to the Standard Types, B.I. Condensers can be supplied in special forms to suit manufacturers' requirements.

The illustration shows Type 212 recommended for use with eliminators.



BRITISH INSULATED CABLES LTD.

Cable Makers and Electrical Engineers

PRESCOT, LANCS.

Telephone No. : PRESCOT 6571.

London Office: **SURREY HOUSE, EMBANKMENT, W.C.2**

Telephone No. Temple Bar 7722.

SPEECH COIL STRUCTURE

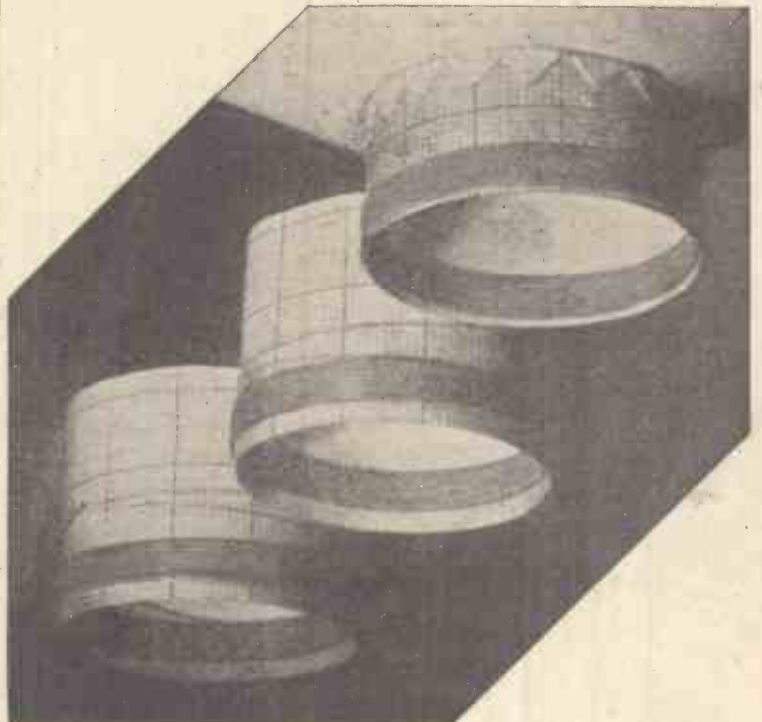

The orthodox speech coil structure consists of a tube on to which the speech coil is wound. The tube must be strong enough to withstand the crushing effect of the winding, and often requires additional reinforcement on each side of the winding.

In the case of Voigt speakers, the speech winding is divided

into two parts, one part being on the outside of the speech coil tube in the normal manner, and the other being inside.

The picture above shows this clearly. We have developed the technique for producing this structure, and readers may amuse themselves by puzzling out how it is done.—No prizes offered!

ADVANTAGES

FIRST The structure permits the use of a much lighter speech coil tube. This is because the crushing effect of the outer winding is balanced by the outward reaction of the inner one, so that the speech coil tube is in radial equilibrium.

The necessary strength being now determined only by its function as a transmitter of speech energy, we are enabled to use a material about three times lighter than aluminium and thinner than $\frac{5}{1,000}$. The advantage from the point of view of high note response and sharp transients will be obvious.

SECOND The heat generated, owing to I.R. drop in the speech winding, can escape in all directions instead of outwards only as in the normal case. Volume compression

and response changes due to change in ohmic resistance when handling loud passages, therefore become negligible.

THIRD Under normal conditions, adhesion between the winding and the tube is spread over twice the area. The shearing force (per unit area) is therefore halved, and twice the current, i.e., 4 times the speech watts, would be required to stress the adhesive to the same extent. The safety factor for high power work is therefore four times greater.

When it is recalled that with a Voigt speaker on a straight horn, the sound pressure generated with only 5 watts input is enough for the average 1,000 seater talkie theatre, the need for detailed attention to safety factors will be appreciated.

VOIGT SPEAKERS ARE DESIGNED

★ For that extra specially important P.A. job, remember we have a certain number of horns and units available for hire. (Early application advisable.)

**THE COURTS,
SILVERDALE,
LONDON,
S.E.26**



Telephone :
Sydenham 6666

Redg. Office :
22, Castle St., E.C.1

VOIGT PATENTS LTD

SPECIFIED FOR THE

5-15 METRE Battery Receiver

- DENCO LOW LOSS U.H.F. COILS . . . 17/6 per set of six or 3/- each
- DENCO S.W. Section Wound R.F. CHOKES 2/6
- COMPLETE KIT of Components and Valves as specified £5 CASH or C.O.D.

DENCO, 59, BURRS ROAD, CLACTON, ESSEX

RADIO RECEIVER MEASUREMENTS

By Roy M. Barnard, B.Sc., A.M.I.R.E. (1934)

Complete with fifty-three illustrations and diagrams, summaries of method, four appendices and a general index.

PRICE 4/6 net
By post 4/9

From all booksellers or direct from the Publishers.

ILIFFE & SONS LTD., DORSET HOUSE, STAMFORD STREET, LONDON, S.E.1

Of practical value to the radio service engineer and the amateur experimenter. Measurements of sensitivity, selectivity and fidelity are explained at length and the interpretation in estimating receiver performance is carefully set out.

Details are given of methods of receiver testing with full descriptions of commercial signal generators and their application to the adjustment of superheterodynes and "straight" receivers.

W.W.10.

Mention of "The Wireless World," when writing to advertisers, will ensure prompt attention.

SECOND EDITION

—THOROUGHLY REVISED

WIRELESS SERVICING MANUALBy **W. T. COCKING***(of "The Wireless World")***The first complete book of reference of its kind. A reliable practical guide for amateur and professional.**

The demand for this book was so great that the first edition was sold out in the short space of a very few months. A second edition containing additional material is now on sale. The "Wireless Servicing Manual" deals fully with Testing Apparatus and explains the methods of locating and curing faults in receiving equipment.

Ganging, Automatic Volume Control, Instability, Distortion, Mains Hum, Whistles and Local Interference are all separately treated.

The new edition contains much additional information on short-wave receivers, and on methods of operating extension loud speakers, the reference material including base-connections for British, Continental and American Valves and the various colour codes for components has been extended and brought up to date

BOUND IN CLOTH BOARDS

SIZE 7½ ins. x 5 ins.

231 PAGES

PRICE 5/- net. By post 5/4

Issued in conjunction with "THE WIRELESS WORLD" and Published by the Proprietors:—

ILIFFE & SONS LTD., DORSET HOUSE, STAMFORD STREET, LONDON, S.E.1

W.W. 20

**FOUNDATIONS
of WIRELESS**

*A Book of
First Principles
for the
Wireless
Enthusiast*

PRICE 4/6 NET

By Post 4/11

Issued in conjunction with
"THE WIRELESS WORLD"
and published by the Proprietors—

By **A. L. M. SOWERBY, M.Sc.**

An Elementary Text Book on Wireless Receivers

"Foundations of Wireless," based on a series of articles which appeared in "The Wireless World," covers the whole field of wireless from the simplest electrical phenomena to the construction of a modern set, and all the vital points in receiver design are treated in full detail. Chapters are devoted to direct and alternating currents; typical circuits; the properties of inductance and capacity; the nature of high frequency currents; the tuned circuit; and amplification by the valve.

Eleven of the eighteen chapters of the book deal with the discussion of receivers, in which the whole process of design is reviewed stage by stage to the finished article.

Special attention is paid to the important subject of tuned circuits and band-pass filters, on the correct design of which the performance of every type of set ultimately depends. Moreover, the process of detection, so often imperfectly understood, is clearly explained.

ILIFFE & SONS LTD., DORSET HOUSE, STAMFORD STREET, LONDON, S.E.1



4^D

The Wireless World

THE PRACTICAL RADIO & TELEVISION JOURNAL

Friday, May 14th, 1937.

free!

Blueprints of splendid sets



Colvern have specially designed two brilliant "up to the minute" sets and blueprints of them are being given away free (except for small postage charge). Using the new

COLPAK

(Made under licence from patentee, Hans Vogt)

these sets offer the very latest in efficiency, precision and design. Send for blueprints to-day!

To COLVERN LTD., Romford, { COLPAK CLASS B Essex. Please send me full details and blueprint of the { A.C. MAINS SET

Stamps value 3d. to cover postage are enclosed.

* Strike out name of blueprint not required.

Name

Address

If you would like a copy of our Ferrocart booklet, please put a X here

"WHEN WE FIND T.C.C. CONDENSERS WE LOOK FOR THE TROUBLE SOMEWHERE ELSE"



T.C.C.
ALL-BRITISH
CONDENSERS

So said a service engineer to us recently. The mere fact that T.C.C. Condensers are in a Receiver, tells him straight away that at least a dozen possible breakdown points can be eliminated.

The Telegraph Condenser Co., Ltd., Wales Farm Road, N. Acton, W.3.

CA 1814

Everything for
QUALITY RECEPTION

HAYNES
RADIO

Everything for the
TELEVISION CONSTRUCTOR

Duophase amplifier 6-watt, Duophase amplifier 6-watt for P.M. speaker, Duophase amplifier 14-watt, Duophase amplifier 14-watt (constructor's model), Duophase amplifier circuits, Duophase intervalve coupling, gramophone amplifier 6-watt, gramophone amplifier 14-watt, 1-H.F. tuner unit, 2-H.F. tuner unit, all-wave tuner unit, shortwave converter, table model receivers, radiogramophones, school receivers, baffle boards, loud speakers, volume controls, mains transformers, smoothing and filter chokes, output transformers

Originators of the Quality Receiver and Quality Radiogramophones.

Demonstration night every Friday, 7.30-9.30 p.m.

Time base transformers, time base units, H.T. transformers up to 6,000 volts, heater transformers, smoothing and voltage regulating equipment, high voltage rectifiers, cathode ray tubes and holders with protecting front screen, converter units for speech reception, complete apparatus for vision receiver construction, chassis and special baseplates.

The most attractive development ever presented to the radio enthusiast.

Have you the Haynes Quality Booklet? 1936-37 Edition. Free on request. Howard 1171.

HAYNES RADIO LIMITED, QUEENSWAY, ENFIELD, MIDDLESEX.

TX4

for ALL-WAVE & TELEVISION

Price 15/-

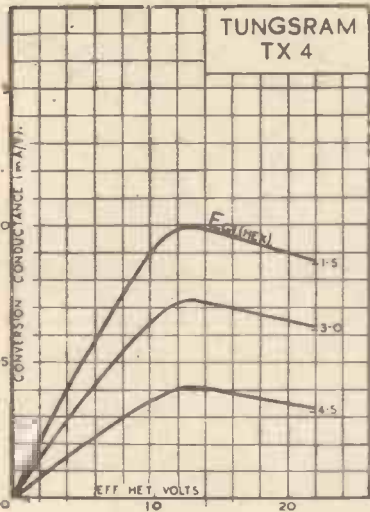
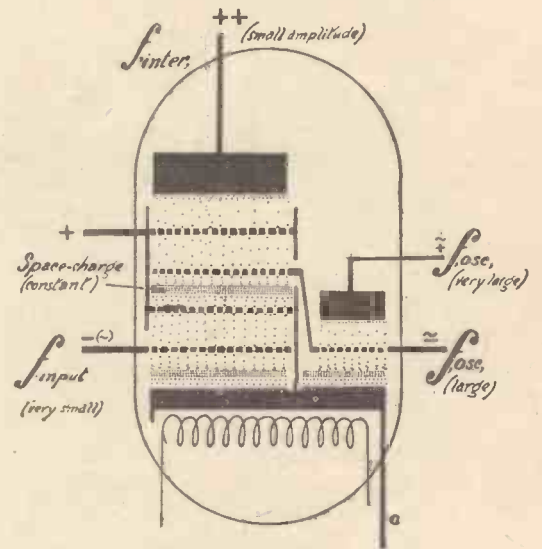

TUNGSRAM

MANUFACTURED IN
TOTTENHAM, LONDON

Barium VALVES

THE VALVE WITH THE NAME BEHIND IT!

TUNGSRAM ELECTRIC LAMP WORKS (GREAT BRITAIN) LTD., 82 THEOBALDS ROAD, LONDON W.C.1. PHONE HOL. 3563

Second Edition—

Completely Revised

RADIO DATA CHARTS

A SERIES OF ABACS

providing most of the essential Data required in Receiving Design

By R. T. BEATTY, M.A., B.E., D.Sc.

Published from the Offices of "THE WIRELESS WORLD."

RADIO DATA CHARTS provide designers of wireless apparatus with a ready, convenient means of solving all the more familiar problems connected with the design of modern radio apparatus without having recourse to complicated formulæ and mathematics.

In order to keep abreast of the great advances in wireless communications since the first edition of "Radio Data Charts" appeared, obsolete abacs have been omitted in this second edition and important fresh material added.

By the use of the present edition of "Radio Data Charts," such abstruse problems as the design of tuning coils are solved almost as easily as the simple application of Ohm's Law.

Price 4/6 net By post 4/10

(37 CHARTS and 46 Diagrams)

From all leading booksellers or direct from the Offices of

"THE WIRELESS WORLD," Dorset House, Stamford Street, London, S.E.1

The Wireless World

THE
PRACTICAL RADIO
JOURNAL
27th Year of Publication

No. 924.

FRIDAY, MAY 14TH, 1937.

VOL. XL. No. 20.

Proprietors: ILIFFE & SONS LTD.

Editor:
HUGH S. POCOCK.

Editorial,
Advertising and Publishing Offices:
DORSET HOUSE, STAMFORD STREET,
LONDON, S.E.1.

Telephone: Waterloo 3333 (50 lines).
Telegrams: "Ethaworld, Sedist, London."

COVENTRY: Hertford Street.
Telegrams: "Autocar, Coventry." Telephone: 5210 Coventry.

BIRMINGHAM:
Guildhall Buildings, Navigation Street, 2.
Telegrams: "Autopress, Birmingham." Telephone: 2971 Midland (4 lines).

MANCHESTER: 260, Deansgate, 3.
Telegrams: "Iliffe, Manchester." Telephone: Blackfriars 4412 (4 lines).

GLASGOW: 26B, Renfield Street, C.2.
Telegrams: "Iliffe, Glasgow." Telephone: Central 4857.

PUBLISHED WEEKLY. ENTERED AS SECOND
CLASS MATTER AT NEW YORK, N.Y.

Subscription Rates:
Home, £1 1s. 8d.; Canada, £1 1s. 8d.; other
countries, £1 3s. 10d. per annum.

As many of the circuits and apparatus described in these
pages are covered by patents, readers are advised, before
making use of them, to satisfy themselves that they would
not be infringing patents.

CONTENTS

	Page
Editorial Comment	461
Building Sets to Last!	462
Resistance-Coupled AF Oscillator	465
Broadcast Brevities	467
Anti-Interference Filters. II ..	468
Listeners' Guide for the Week. ..	470
Why the Triode-Hexode? II ..	472
The Television Receiver. IX ..	475
Unbiased	478
Current Topics	480
Letters to the Editor	481
Recent Inventions	482

EDITORIAL COMMENT

The Superhet

Finality in Receiver Design?

RECEIVERS employing the superheterodyne principle have grown in popularity throughout the world to such an extent that we are inclined to ignore claims of any other receiver principle to a point where anything which is not a superhet is looked upon as obsolescent. The American Radio Manufacturers' Association last year, in recommendations to the Federal Communication Commission, pointed out that the present popularity of the superheterodyne was likely to continue because technically and economically it offered big advantages over the straight set, but that it still had the disadvantage that it was liable to interference when transmitters worked on a frequency close to the intermediate frequency chosen for the superheterodyne. The Association suggested that if a value should be standardised by designers for the intermediate frequency of sets, then this frequency might be kept clear by the Federal Communication Commission by declining to allot this frequency to transmitters.

A year or two ago such a proposal as this would not have found favour because designers, even in America, were not prepared to concede then that the superheterodyne represented finality, or that its advantages were so great as to eclipse the prospects of a return to favour of the straight set.

If now the superheterodyne is to become the universally standardised receiver, then it would be well to consider whether in Europe, too, it might be possible to adopt one intermediate frequency and keep this frequency clear of transmitting stations. But there would be no purpose in starting an elaborate campaign to achieve this

result in Europe, unless designers were entirely satisfied that the superheterodyne would remain the last word in receivers. To succeed in getting a clear channel in Europe for the benefit of the superheterodyne receiver, only to find that the pendulum had by then swung back in favour of straight sets, would be farcical.

We believe that it would be extremely useful to have the views of readers of *The Wireless World*, both in this country and abroad, on the question of whether the superheterodyne principle should now be accepted so widely, or whether the neglected straight set still has advantages over the superheterodyne which justify its retention and development, especially in the light of recent progress.

Although we have only touched on the subject, we feel that enough has been said to stimulate correspondence from readers whose technical knowledge or practical experience puts them in the position of being able to contribute usefully to a discussion.

Reliability

Care In Set Manufacture

IN the scramble to obtain the utmost performance from their receivers there has been in the past a tendency on the part of manufacturers to pay insufficient attention to the matter of reliability.

Breakdowns and service troubles, however, taught their lesson, and to-day the most stringent precautions are taken to avoid breakdowns due to faults in the manufacture of the better types of receiver.

An interesting account is given in this issue of how some of these tests of reliability of component parts and the assembled sets are conducted. This information should do much to increase confidence in the dependability of modern receivers.

Building Sets

POINTS WHICH MAKE FOR RELIABILITY

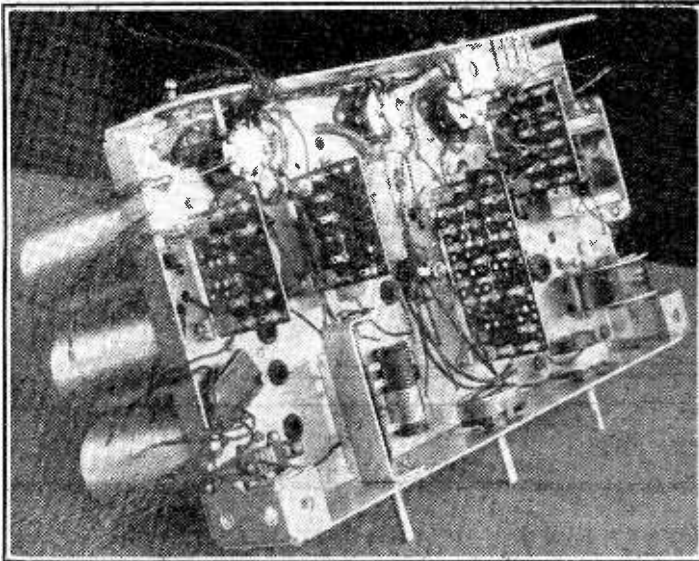

Underside of chassis in course of wiring, showing liberal use of sub-assembly panels. Note paper washers under soldered joints on valveholders near top edge of chassis.

THE very essence of any public service is reliability. In the sphere of broadcasting the responsibility for the maintenance of an uninterrupted service is shared by the B.B.C. and by the manufacturers who supply the public with receivers. Inevitably the receiving end will be more vulnerable than the transmitter, for few people can afford to duplicate their equipment or pay for the large margins of safety which are the rule at the transmitting end. On the other hand, no one is going to buy a set which will be liable to expire with the termination of the maker's guarantee period, for although in a rapidly developing art a new set every year would be a good principle, in practice most of us stick to the sets in which we have invested our hard-earned cash until they are conspicuously inefficient by comparison with current models.

Common ground is reached by both maker and user when the question of cost is considered. Reliability is an essential factor of "value for money," which in the long run is the manufacturer's best weapon in a competitive market, and is the all-embracing figure of merit by which the wise purchaser arrives at a final choice. But there is an economic limit to the money which can be spent in providing reliability, and the decision as to how far this object can be pursued must vary according to circumstances.

For instance, a manufacturer who brings out sets which, from a technical point of view, are in advance of current designs, must expect those sets to be kept in service for a longer period than the products of firms hunting in the rear of the pack.

Fortunately, there are many ways in which reliability can be achieved without adding a penny to the cost of a set. It takes just as long to make a bad-soldered joint as a good one, and in the case of components it often happens that a less costly design turns out in the long run to be the more reliable. There are, of

It is instructive to make a tour of a works like that of Murphy Radio, Ltd., where reliability has for many years been established as a creed, and to see the hundred-and-one details and operations which are concerned, either directly or indirectly, with ensuring the permanence of the sets.

Much has already been done by sheer forethought before the plans have left the drawing office. Take the case of the waverange switch fitted to some of the two-waveband models. A rigid frame ensures that strains shall not permit movements which might introduce noises, while a very small diameter cam, formed by a flat surface milled in the switch spindle itself, reduces the torque required to produce the necessary contact pressure. The cam does not rub on the springs themselves, but works in a trough of stainless steel, which has good wearing properties and is, of course, above sus-

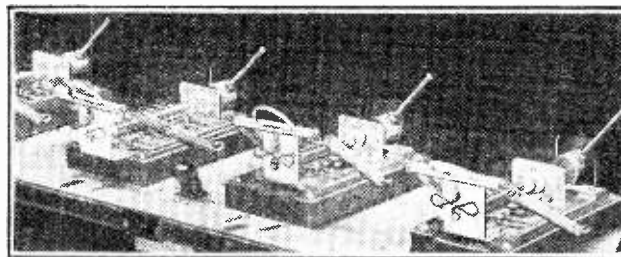

(Above) A bank of waverange switches being "run in" by a special machine. (Right) Checking contact pressure with calibrated spring tongs. Contact, which must be maintained against the opening force of the test tongs, is indicated by the meter in the background.

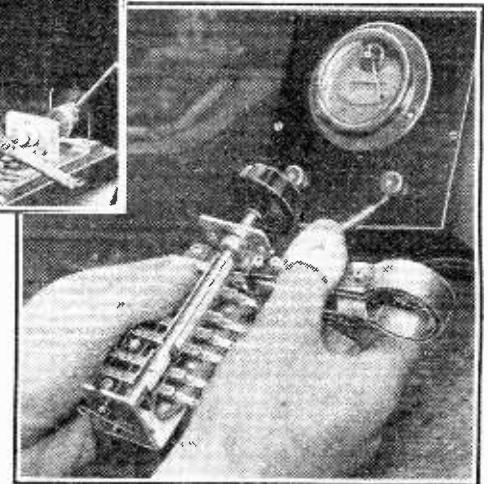

course, vital points where the best materials regardless of cost must be used, but for the most part the reliability of a receiver will depend upon the skill and experience of its designer and the vigilance and proper organisation of the works' testing department.

Stainless steel is also used for the roller in the locating device, and is kept in contact with the indents by a steel spring dipped in a special rust-proofing solution. The main bearing of the switch is quite free from any side thrust due to this spring, as the tension is applied between the roller and the spindle, and is independent of the frame of the switch.

Simplification is a powerful ally of reliability. For instance, by designing an aerial filter circuit with magnetic coupling, both primary and secondary coils can be wound on a single former, and separate screening cans, coupling condensers, and numerous additional connections are eliminated. Much can be done by the

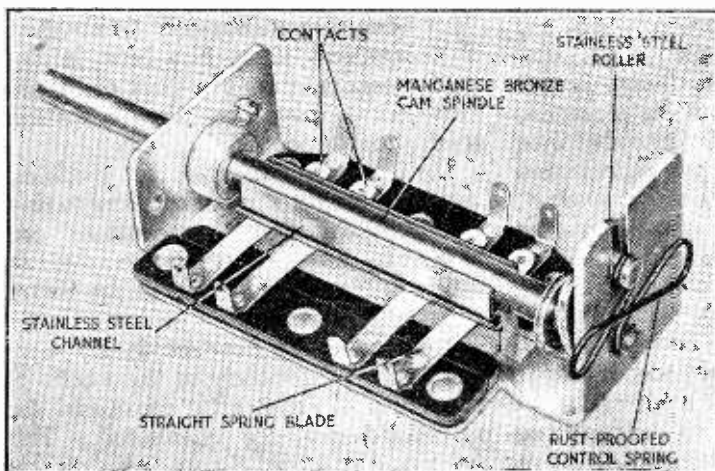

Mechanical and electrical reliability are of equal importance in the waverange switch, a component which, like the volume control and on-off switch, is subjected to hard wear.

to Last

HIGH performance in a receiver is of little value unless it is maintained. The factors contributing to reliability are discussed and illustrated by points observed in a tour of the works of Murphy Radio Ltd.

use of sub-assemblies for decoupling resistances, by-pass condensers, etc. Testing and inspection in the early stages narrows the search for faults which may be detected in the final assembly, and, as most of the soldering is done while the parts are accessible, it is increasingly difficult for an operative to make a bad joint.

In passing through the component assembly section it was observed that a wire covered with both enamel and silk was being used for the primary and high-

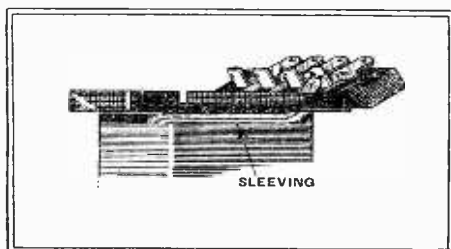

Breakdowns in output transformers are reduced to a minimum by the use of sleeving made from a transparent plastic substance for leading out the inner end of the primary winding.

voltage windings of mains transformers—a vital component where only the best materials are good enough. It was also interesting to learn that random winding in output transformers has proved more reliable than layer windings interleaved with paper, which has shown a tendency to absorb acids from the air. The designers are fully alive to the possibilities of new chemical products, and sleeving of a transparent plastic material has proved ideal for leading out the inner wire of output transformer primaries.

Soldering flux has naturally come in for

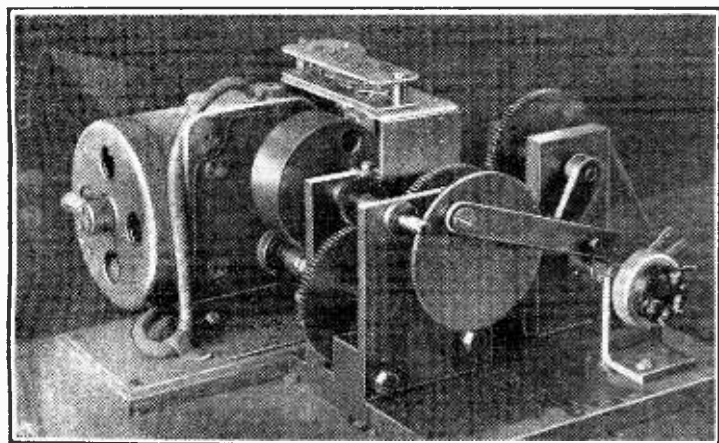

Life tests of volume controls and on-off switches are carried out with this reciprocating mechanism. The machine runs day and night and a counter at the top records the number of movements made.

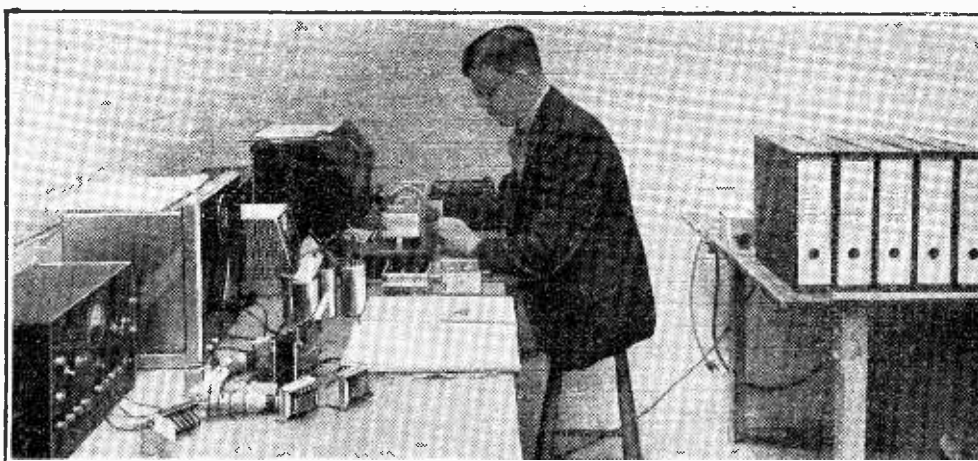

A corner of the Reject Analysis Department where cases of faulty construction are investigated.

a good deal of searching inquiry, and the fluid used is made up to the works' own specification. But good flux may give rise to nearly as much trouble because of its insulating properties as bad flux does from corrosion, so valve-holders are fitted with absorbent paper discs to prevent excess flux from flowing into the sockets. The paper is, of course, removed after the soldering has been completed.

The testing department, which superficially might be regarded as being concerned only with the production at the end of the assembly lines of a receiver uniform in performance and up to the required standard, proved on closer enquiry to be one of the most important guarantors of permanence. Gang condensers, for instance, are aligned in two stages, the first being a close approximation, after which they are aged to allow time for strains and fatigue in the metal to settle down before the accurate adjustment to the final limits is made. This question of permanence of alignment is an important one, for although an abrupt failure of the set may give rise to acute annoyance, a steady deterioration is the more serious, as it may well escape detection by anyone accustomed to listening to the set from day to day. It goes without saying that the accuracy and permanence of the modulated oscillators used for the final adjustment of the completed receiver will be reflected in the uniformity of the product, which is yet another interpretation of the term "reliability." Each of the fourteen separate transmitters

supplying different checking points on the medium and long wavebands is crystal-controlled, and has AVC on both output and modulation depth.

All test apparatus is checked daily against sub-standards, and the sensitivity in most cases is at least ten times that of the tolerance allowed in the component. Special attention is paid to the output from all mains transformer windings, since the life of valve cathodes and other components is directly affected.

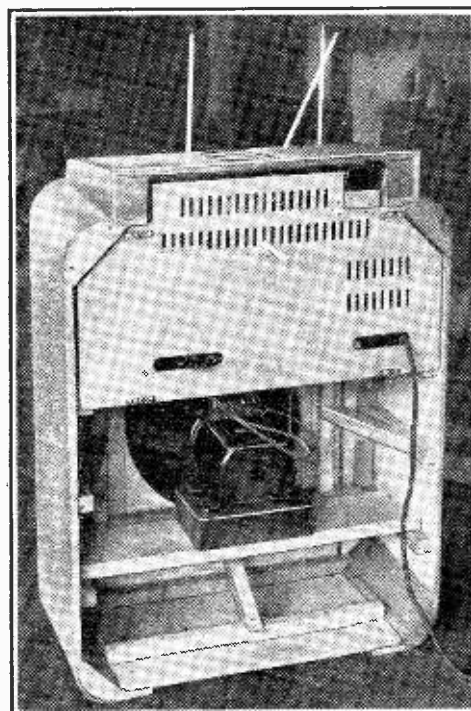

Testing an experimental layout in one of the latest console cabinets for heat distribution. The thermometers indicate the temperature in the vicinity of the oscillator coils, the gang condenser, the electrolytic smoothing condensers and the mains transformer.

A very complete system of records is kept by the test department. Every part bears a code number by which the name of the employee responsible for a given operation can be traced at any future date. Apart from the use of such records in supplying information for future designs, their moral value in the interests of conscientious workmanship can hardly be overestimated. There is also a section whose sole function is the analysis of reject parts, first with the object of identifying and reducing the causes of excessive waste, and again with indirect

Building Sets to Last—

bearing on future reliability, for the smaller the percentage of failures arriving at any given test point, the less chance there will be of parts with incipient faults filtering through into the final product.

Periodically, a component is pounced upon at random by the Engineering Department and subjected to the same type of destructive test as was devised originally to prove its suitability for inclusion. Here a staff of scientific torturers devises instruments to compress into a few weeks a lifetime's wear of volume controls,

dealer, for it is realised that by so doing he is helping to improve the breed. The information revealed by the analysis of these records, which go back to the very first sets produced by the company, provides the answer to countless minor problems of design, and is drawn upon by all sections of the organisation.

Thus we see that the initial reliability of a firm's products will depend primarily on the experience and imagination of the designers. Thereafter it becomes an organic growth to which all branches of the firm make their own special contri-

Nairobi, VQG; Canada, Drummondville, PQ, CGA; and in S. America, at Hurlingham, LSL, and Monte Grande, LSY, both near Buenos Aires.

The Bermuda service is routed via New York.

Conditions during the past few weeks have been very poor, especially during the last week in April, and this particular period was dealt with in a special note in last week's issue, since it was thought that readers would appreciate early information on the very bad conditions which prevailed.

Failure of Canadian Signals

There seems to be little doubt that charged particles ejected by the sun were responsible for this particularly continuous failure of the signals from and to the north-west, the Canadian services having been even more affected than the American ones.

These particles are gathered up by the earth's magnetic field and concentrated at the poles, so that the maximum disturbance is to be expected on those circuits, such as the Canadian ones, whose great circle paths traverse the polar regions.

This type of disturbance should not be confused with those due to bright hydrogen eruptions and the abnormal emission of ultra-violet light by the sun, which are much more transitory in character.

In fact, the rapidity with which conditions return to normal after this type of fade-out suggests (according to Prof. Appleton) that the region affected is probably the D and not the E region.

Only at the lower height of the D region is the gas pressure sufficient to bring about the rapid recombination of electrons and ions which will fit the observed rate of restoration of normality after the fade-out.

In fact, the general tendency now seems to be to attribute to the D and C layers the attenuating properties which were previously thought to be the main property of the E region as far as the short waves are concerned.

Reception Reports

Owing to the poor conditions which have prevailed there is not a great deal of worthwhile reception to report.

Good reception of W9XAZ on 26.4 Mc/s was, nevertheless, experienced for a short while at 9.30 p.m. on Friday, April 23rd, and W2XE on 15.27 Mc/s and W3XAL on 17.78 Mc/s were both quite good during the evening.

A mystery morse transmission, GWW de GTZ, was also heard on 33 Mc/s about 6.40 p.m. at good strength. Conditions this evening were quite good.

From Saturday, April 24th, to Thursday, April 29th, conditions from the U.S.A. were very poor indeed.

After Thursday conditions improved, but they have not yet reached excellent again.

Some interesting signals have been OXY, Skamlebäk, on 9.52 Mc/s between GSB and LKJ1, and the second harmonic of Rabat, CNR, on 25.66 Mc/s (11.7 m.) at 7.35 p.m. on Friday, April 30th.

Conditions were definitely good, however, on May 1st, with W2XE (new transmitter?), W2XAD and W3XAL all performing well.

In general, the higher frequencies seem to behave well on some days and the lower ones on others—but an especially consistent signal, although of no programme value, has been PMC, the Javanese multiplex transmitter, on 18.135 Mc/s.

ETHACOMBER.



Records play an important part in the progression towards complete reliability. The case history of every set is filed and statistics are prepared for the information of all sections of the works.

wavering switches, and other mechanical details. Electrolytic condensers are given long-period standing voltage and recurring surge tests, and even pilot lights are investigated to find their effective life at various degrees of brilliance. The amount of heat that tuning scales will withstand without distortion is known, and all other components likely to be affected by the temperatures met with, say, in DC/AC sets are investigated. When a new cabinet design is evolved, the interior layout is adjusted until a satisfactory temperature distribution is obtained, and the cabinet itself is observed for signs of distortion or deterioration of finish. Other long-period researches undertaken in this department include the comparison of various types of plating and enamels for chassis plates—tested in all weathers out of doors.

Enough has been given to show that everything possible "by taking thought" has been done to add to the potential life of a new receiver before the first model is sold to the public. It is the service department who will pass final judgment on efficacy or otherwise of the measures which have been taken. Full records are kept of every service job; not only those undertaken at the works, but minor repairs and adjustments carried out by dealers. Reports on special forms are regularly sent to head office by the

department. Above everything else, pride in, and enthusiasm for, the good name of the firm and the keeping of proper records are indispensable.

On the Short-wave

NOTES FROM A LISTENER'S LOG

ONE must start these notes by apologising for an error in phrasing which crept into my last notes.

In dealing with the B.B.C.'s short-wave broadcasts which came via the G.P.O. radio-telephone services I implied, accidentally, that relays from Australia and India were transmitted via New York.

This is not the case of course, since the transmitting terminal for Australia is Sydney, VLK, and for India, Kirkee, VWY (near Poona); all are received, however, at Baldock.

The other transmitting terminals of the G.P.O. circuits are situated as follows: Africa, Klipheuveel, Capetown, ZSS; Kenya,

Resistance-Coupled AF Oscillator

A MODIFIED "MULTI-VIBRATOR" CIRCUIT

By T. A. LEDWARD, Assoc.I.E.E.

DESCRIBING a simple and inexpensive audio-frequency oscillator primarily designed to cover a range from 150 to 10,000 cycles per second.

AUDIO-FREQUENCY oscillators of the beat-frequency type, while having the advantage of being continuously adjustable over a wide band of frequencies by means of a single control, are somewhat in the nature of a luxury for the average amateur, and are not very easy to construct in a simple and reliable form. The oscillator circuit to be described, while not possessing the single control feature of a good beat-frequency instrument, has the merit of sim-

manner. Violent oscillations are produced in such a circuit, and the output at terminals T1, T2 is fairly considerable, but the wave form is such that it is useless for any test purposes until it has passed through filters. It is

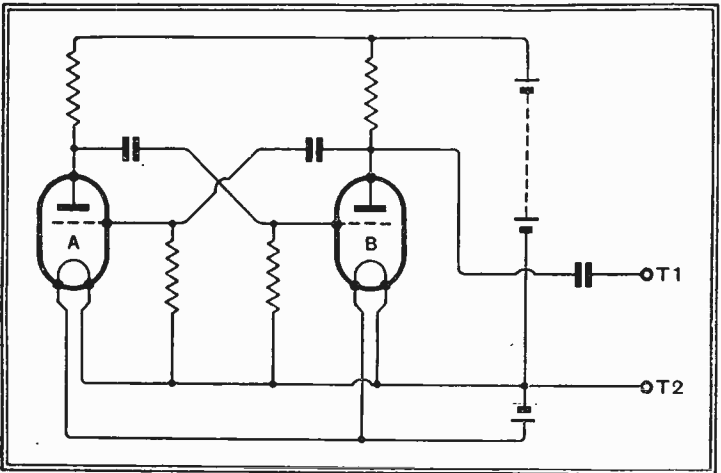

Fig. 2.—A multi-vibrator circuit giving an output of better wave form.

extremely rich in harmonics, and a large number of test frequencies may, therefore, be obtained from the output terminals by interposing suitable filters. This makes it a valuable arrangement for certain laboratory tests, but the complication of filters

renders it not so useful to the average wireless amateur.

If we can arrange that the output at the terminals shall have a good wave form, then filters will be unnecessary. Variation of frequency may then be made by varying one or other of the coupling components. The circuit shown in Fig. 2 indicates one way of attaining this result. Here it will be seen that the output from valve B is fed back to A through a potentiometer R. The feed-back is thus controllable, and by suitably limiting the feed-back an excellent wave form may be

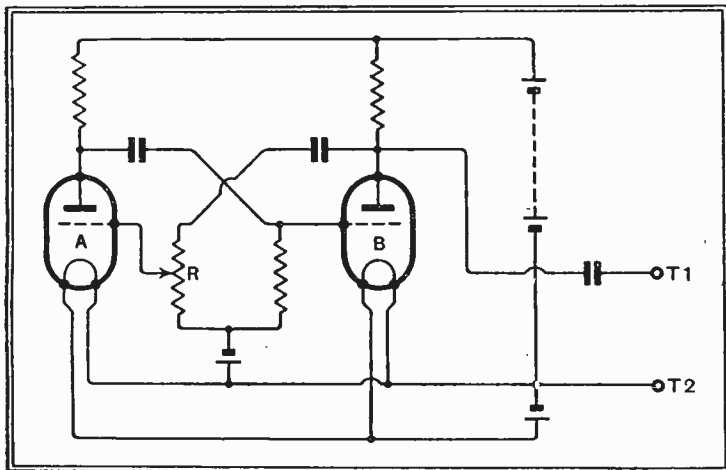

Fig. 1.—The simple "multi-vibrator" generator.

plicity. Also the resulting wave form is very good, and an appreciable output is obtained.

The oscillator proper requires only two ordinary triode valves, and the other components are simply fixed and variable resistances and condensers. The principle of operation will be best understood by referring first of all to Fig. 1, which shows the circuit of what is known as a "multi-vibrator." It will be seen that in this arrangement the first valve A is coupled to the second valve B by means of a normal form of resistance-capacity coupling, while the second valve B is coupled back to the first valve A in a similar

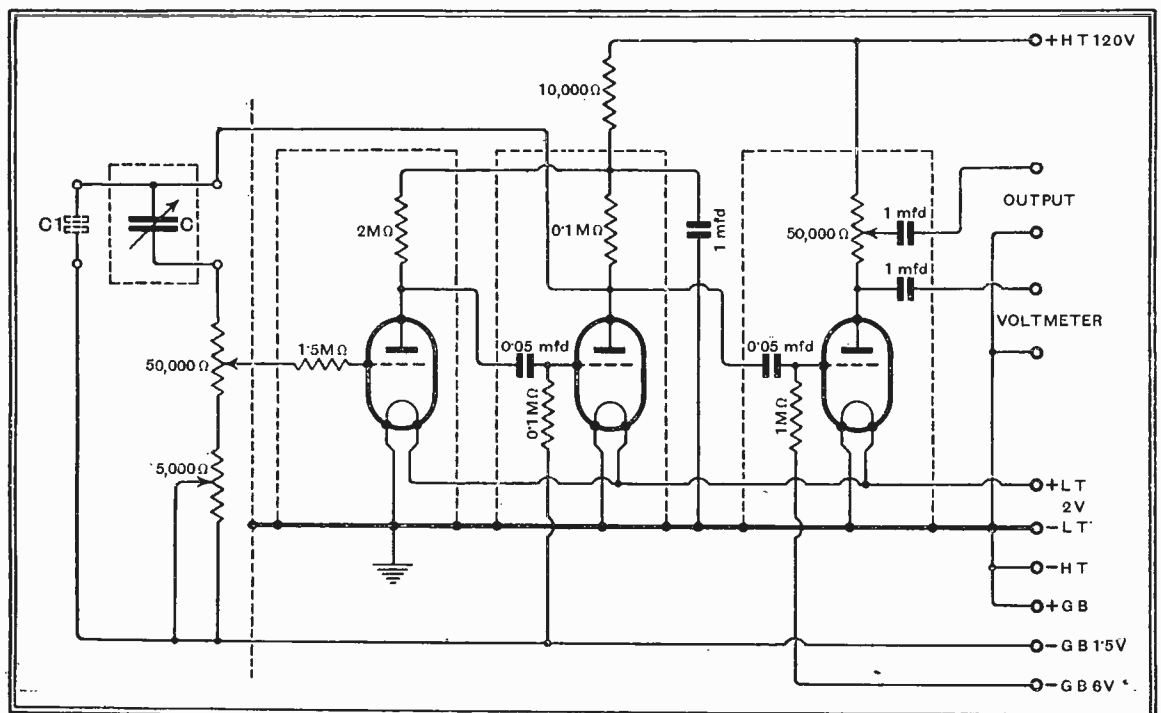

Fig. 3.—Circuit of a practical oscillator; the extra valve provides isolation between the output terminals and the oscillator proper.

Resistance-coupled A.F. Oscillator—obtained. The frequency may now be altered by changing the condenser C.

In order to obtain satisfactory results over a wide band of frequencies it is important that suitable values of coupling components should be used. Also, the resistance R is preferably divided into two variable parts, giving coarse and fine adjustments, and a third valve is added, principally for the purpose of isolating the output terminals from the oscillator circuit and thus avoiding trouble due to capacities of connecting leads, etc. At the same time, of course, this valve acts as an amplifier and increases the output. A further requirement is that each stage should be enclosed in an earthed screen.

A practical circuit, which has been found to give very satisfactory results from about 25 to about 10,000 cycles, is shown in Fig. 3. The resistances R₁ and R₂ give very smooth control of the amplitude of oscillation. R₁ is arranged as a potentiometer and gives a comparatively coarse adjustment, while R₂, which is a variable resistance, gives a fine adjustment. In operating the oscillator, R₂ should first be set to the short-circuited position and R₁ ad-

justed until oscillation commences. R₁ should then be re-adjusted until oscillation just ceases and R₂ can then be used to start oscillation and will give smooth and easy control of amplitude. With all the other components of fixed values the frequency is determined by the value of the condenser C, and is not appreciably affected by quite large variations of battery voltage or by adjustment of the amplitude controls.

For the range of frequencies from 150 to 10,000 cycles, a number of fixed condensers ranging from 0.001 mfd. to 0.5 mfd. are required, and a variable 0.001 mfd. condenser is desirable for frequencies requiring lower condenser values, and for fine adjustments in

conjunction with the fixed condensers. The following table indicates approximate values of condenser C for different frequencies.

C/s	150	400	750	1,000	5,000	10,000
Mfds	0.5	0.03	0.008	0.005	0.00015	0.00005

It will be seen that for frequencies above 400 the capacity is approximately proportional to the inverse square of the frequency. At the lower end of the frequency scale this relationship is not maintained, and any increase of C above 0.5 mfd. has comparatively little effect on the frequency.

If it is desired to extend the frequency range below 150 cycles, this may be done by adding condenser C₁, connected as shown. For instance, with C=0.5 mfd. and C₁=0.1 mfd., the frequency will be about 50 cycles. If C₁ is increased to 0.56 mfd. the frequency will be 25 cycles.

The wave form at these lower frequencies, although quite good, is somewhat inferior to that obtained at the higher frequencies. Fig. 4 indicates the wave forms as shown on a cathode-ray oscillograph at (a) 150, (b) 50, and (c) 25 cycles. At all frequencies above 150 the wave form is equal to Fig. 4 (a).

The valves used in the test circuit were three small power valves. The values of the anode resistance and grid leak in the first stage are, of course, totally unsuitable for an ordinary RC amplifier, but they were found to give the most satisfactory control in this circuit.

It will be noted that the output terminals are shown connected to a potentiometer in the anode circuit of the last valve, while voltmeter terminals are provided and are so connected that the full voltage output is always applied to these terminals irrespective of the potentiometer setting. These features are not essentials, but they are useful refinements. The voltmeter should be a high-resistance rectifier type. If the oscillation amplitude is always adjusted to give the same reading on the voltmeter, and this reading is such that the valves are not overloaded, then a good

wave form is assured and the output potentiometer may be calibrated in volts.

It is of interest to note that the circuit may be used for providing audio-frequency reaction without oscillation, but the effect will be to boost up particular frequencies depending upon the values of the components used.

Television Programmes

Transmissions are from 3-4 and 9-10 daily.

Vision : 45 Mc/s.
Sound : 41.5 Mc/s.

FRIDAY, MAY 14th.

3, Jack Hylton and his band. 3.35, British Movietonews. 3.45, Theatre Parade: Leslie Henson with Fred Emney and Richard Hearne in scenes from "Swing Along."

9, Albert Sammons (violin). 9.10, Artists and their work: talk by Frank Salisbury, L.L.D. 9.20, Gaumont-British News. 9.30, Theatre Parade: Tyrone Guthrie's Globe Theatre production of "Love, and how to cure it."

SATURDAY, MAY 15th.

3-4, Tour of the London Television Station, with Leslie Mitchell as guide and George Robey as the visitor. Viewers will see Gaumont-British News, and meet C. H. Middleton and Clapham and Dwyer.

9-10, Repetition of the tour. Viewers will see British Movietonews and a variety from the Empire, including Flotsam and Jetsam (Australia), Rosette (New Zealand), Oliver Wakefield (S. Africa), and The Seven Hindustans (India).

MONDAY, MAY 17th.

3, Alexandra Park on Bank Holiday. 3.10 Ernest Mills (cartoons). 3.20, Gaumont-British News. 3.30, The White Coons Concert Party.

9, Captain C. R. W. Knight introduces his African eagle and will show extracts from his film "African Adventure." 9.20, British Movietonews. 9.30, Repetition of 3-30 programme.

TUESDAY, MAY 18th.

3, Starlight: Steve Geray and Magda Kun. 3.10, Cart Horse Parade: some competitors from the Whit-Monday Parade held in Regents Park. 3.25, "The Beggar's Opera." 3.55, British Movietonews.

9, The Future of Television: the third personality to give their views. 9.10, Dog Show: exhibits from show to be held at Olympia on the 19th. 9.25, Repetition of 3-25 programme. 9.55, Gaumont-British News.

WEDNESDAY, MAY 19th.

3, Captain Knight and his African Eagle. 3.20, Fifty-fifth Picture Page. 3.50, Gaumont-British News.

9, Play Parade: scenes from "The School of Scandal." 9.20, British Movietonews. 9.30, Fifty-sixth Picture Page.

THURSDAY, May 20th.

3, Fashion Parade: London—Paris—New York. 3.15, Architecture—IV. 3.35, British Movietonews. 3.45, Students' Songs: impressions of a German beer garden.

9, Repetition of 3-45 programme. 9.15, Repetition of 3-15 programme. 9.35, Gaumont-British News. 9.45, Repetition of 3 programme.

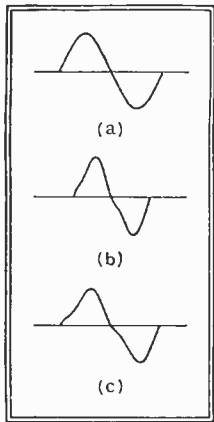
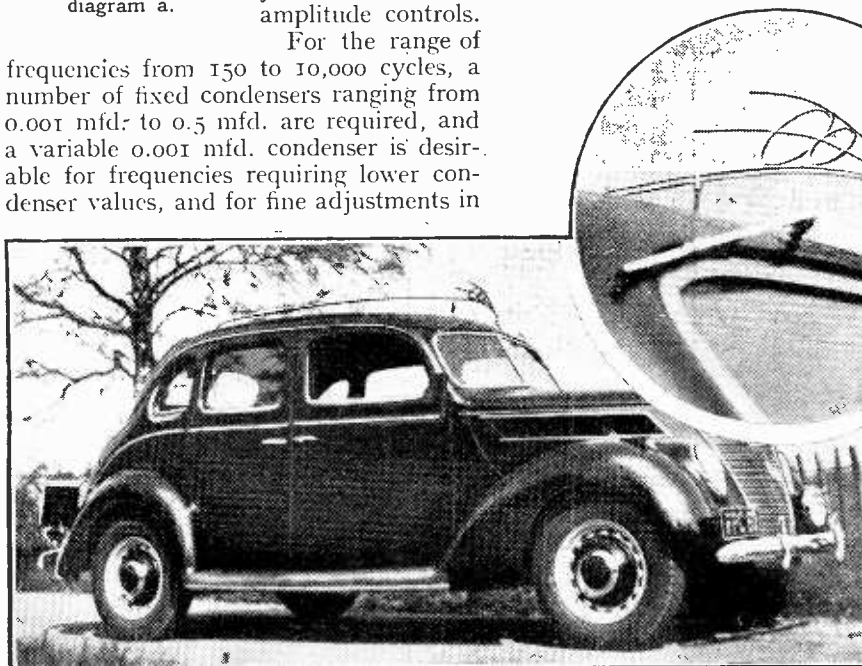

Fig. 4.—The wave form of the oscillator at frequencies above 150 c/s is as good as indicated by diagram a.



SYMBOLICAL AERIAL.—A Ford car fitted with an aerial taking the form of the familiar "V8" device. The external aerial, more effective and conducive to a better signal-to-noise ratio than the concealed type, is gradually coming into use on cars fitted with broadcast receivers.

Broadcast Brevities

NEWS FROM PORTLAND PLACE

Television Cable

TELEVISION is full of surprises, and one of them has been the disclosure by the B.B.C. engineers that short-distance "O.B." work in the London area can be satisfactorily carried out with a twin-wire balanced cable, of an inch in diameter, which contains only two internal leads and is protected by an external lead sheathing.

One of the fundamental differences between the operation of this cable and "co-axial" is that "co-axial" works with a modulated carrier wave; twin-wire does not.

Co-axial for Long Distances

The new cable is being used to link the mobile unit with London's television "belt," also composed of twin-wire cable, which pursues a tortuous route down Regent Street, through Piccadilly Circus to Whitehall, Westminster and Victoria, returning to Broadcasting House via Hyde Park Corner, Park Lane, Marble Arch and Oxford

HIS MAJESTY before the microphone which he used when addressing his people last Wednesday. The case between the two microphones contains the cue light.

broadcast in the Concert Hall at Broadcasting House would be announced in French, German and Italian. It has been stated that this multi-lingual innovation would be introduced for the sake of the Continental delegates in the Hall, who represented the International Association for Testing Materials.

Happily, or unhappily, the B.B.C. remembered, at the last moment, a three-year-old agreement with the International Broadcasting Union.

The Occasional Exception

Under this agreement the Corporation undertakes not to announce in foreign languages.

Thus, in these days of radio propaganda, the B.B.C. adheres strictly to the principle of isolation, while a dozen Continental stations appear to use any language but their own.

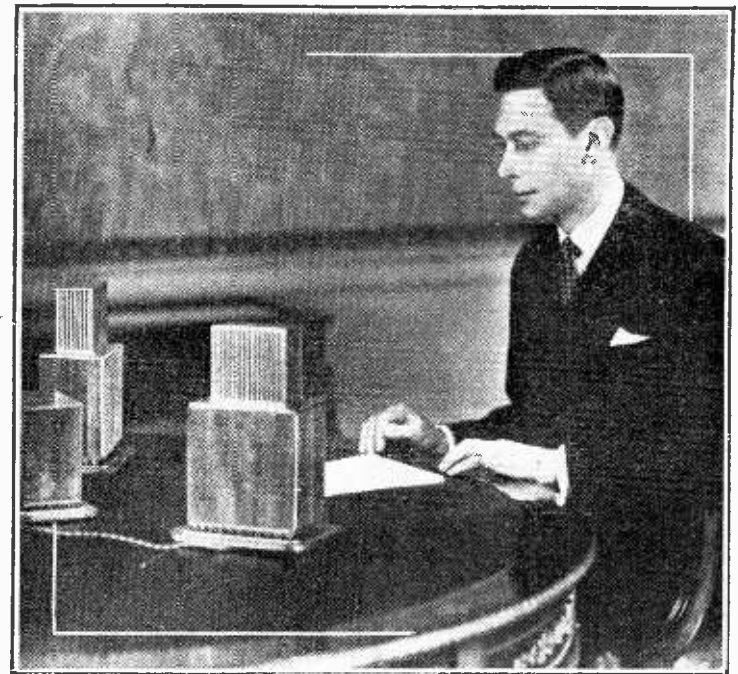

Welsh Independence Day

JULY 4th is America's Independence Day, but from 1937 onwards it may also be known as Welsh Independence Day, for from that date the Welsh Region will be finally severed from the West of England Region.

The existing National transmitter at Washford will then take over the Scottish National wavelength of 285.7 metres and will radiate an exclusively West of England programme, while the Washford Regional transmitter, on 373 metres, will go "All-Welsh"

Scottish National will be synchronised with the London and North Nationals on 261.1 metres.

the Regional chair; in fact, Percy Edgar is already in command in Bristol, and is now combining his West of England duties with his work as Midland Regional Director.

Pioneer

Mr. Edgar is the doyen of Regional Directors, for he was appointed Director of the old Birmingham station in 1922 and has been the most prominent figure in Midland broadcasting ever since. He is immensely popular. When it was rumoured some years ago that he might be transferred to London there was a local outcry.

It was Percy Edgar who in 1922 inaugurated the "Radio Circle"—the first "Children's Hour."

Surprise for B.B.C. Man

"FAN mail" on the grand scale, so everybody thinks, exists only in America, where radio and film stars are bombarded with the most trivial communications from people they have never seen and hope never to see.

Felix Greene, the B.B.C. North American representative, had a surprise the other day when he dropped in at the Commodore Hotel in New York and found Tommy Dorsey, the dance band leader, with a tableful of letters from English fans who had heard his broadcast relay from America.

The Fan Germ

The correspondence showed that the English listener, if the fan germ really gets him, can beat the Americans at their own game. Among the letters were three proposals of marriage addressed to Mr. Dorsey's vocalist, Edythe Wright, who was on the air for not more than two and a half minutes.

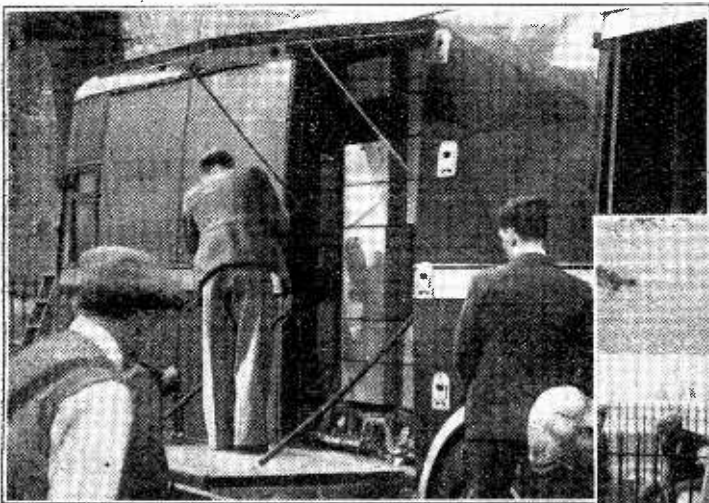

IN THE NEWS.—The two cuttings from last week's Pathé Gazette news reel show the television control van and one of the three cameras that were used on Wednesday last at Apsley Gate, Hyde Park Corner. The side of the van is in six sections, two of which are shown open, to allow easy access to the backs of the various control panels.



Street. Between Portland Place and Alexandra Palace both co-axial and twin-wire cable are installed.

It is expected that for the long-distance relays of the future co-axial cable will be used.

No Foreign Announcements

DISAPPOINTMENT awaited European listeners who expected that Jack Payne's recent

Occasionally the B.B.C. relaxes its attitude, but programme producers have strict orders not to depart from English without first consulting the Programme Controller. And permission to do so is given only in emergencies, as in the case of SOS messages or when a foreign language is desirable from the artistic or programme point of view.

Percy Edgar and the West

It is an honour for the West of England Region to have Mr. Percy Edgar as temporary Regional Director, pending the choice of Mr. E. R. Appleton's successor. Mr. Appleton's period of service with the Corporation does not expire officially until June; but he is now enjoying two months' holiday, and will not again occupy

Anti-Interference Filters

PART II.—MAINS-BORNE IMPULSES AND THEIR SUPPRESSION

IN the first part of this article it was shown that any sudden fluctuation in the normal supply current from the electric mains may be separated into a vast number of individual sinusoidal components covering an infinitely wide frequency spectrum. It was also shown that the relative amplitudes of these components is a function of the shape of the initial impulse.

Consideration must now be given to the propagation of these interference currents

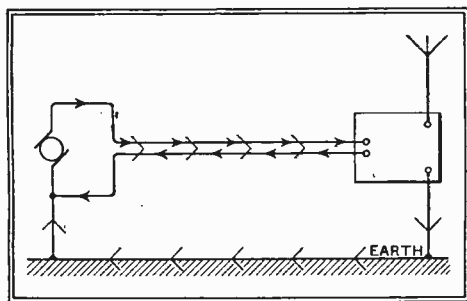

Fig. 1.—The passage of interfering impulses along supply leads.

along the electric mains, and how the behaviour of the mains to high frequencies is vastly different from its normal functioning conditions to DC or 50-cycle AC.

In Fig. 1 a dynamo is supplying current to a broadcast receiver by means of a pair of wires (i.e., the electric mains). Interfering impulses will be created by the commutation of the dynamo, and will appear as random sinusoidal frequencies covering a vast frequency range. These may be propagated along the electric mains via two distinct paths, and it is necessary to distinguish very carefully between these two paths.

First, the interference may be propagated along a path shown by the small arrowheads. The components of interference thus conveyed to the receiver are termed the "symmetrical components." On the other hand, the interfering currents may use the pair of supply wires as one path, the return path being through the earth back to the generator. These are shown by the large arrowheads, and the components thus conveyed are termed the "asymmetrical components."

Two highly important points immediately become evident. In the case of symmetrical interference, the go and return paths of the interfering currents are very close (i.e., the electric supply wires are adjacent). Because of this there can be no radiation of electric force from the mains, so that the symmetrical component is only capable of bringing the interference directly into the receiver, and cannot in-

duce interference into the aerial or other adjacent wiring.

On the other hand, since the two wires comprising the electric mains carry the asymmetrical component in one direction only (the return path being via earth), electric fields will be created, and the interference will be radiated in all directions. In general it must be obvious that the asymmetrical components of interference are the worst offenders, since their suppression at the mains input to the receiver cannot possibly affect the radiated components which may reach part or whole of the aerial system and thus be transferred to the receiver.

Mains as a Transmission Line

The suppression of the symmetrical component (go and return through mains) is a relatively simple matter, as it is only necessary to connect a condenser of approximately 0.1 mfd. across the mains input to the receiver in order to reduce the interfering voltage to a negligible value. At first sight one would think that the capacity between the pair of wires constituting the electric mains would be so large as to make the effect of an additional 0.1 mfd. quite negligible.

It must be remembered, however, that one is now dealing with broadcast frequencies, and at these frequencies the effective capacity of the mains, as viewed at the wall socket of lampholder, is by no means the same as the capacity at, say, 50 cycles.

This, of course, is because the electric mains is behaving as a high-frequency transmission line, in which it must be remembered that not only has the mains a distributed capacity over its length, but in addition a distributed series inductance

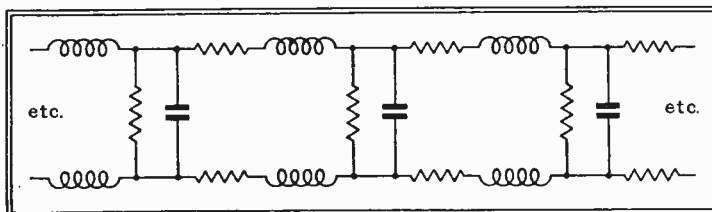

Fig. 2.—So far as their behaviour to radio-frequency currents is concerned, a pair of mains leads may be represented as in this diagram.

and resistance. In fact, the circuit of the two-wire electric mains is as depicted in Fig. 2.

Statistical evidence obtained by many measurements indicates that the average impedance of the electric mains between the two wires of any outlet is of the order of 150 ohms at broadcast frequencies.

*I*N this instalment the author describes the two main divisions into which mains-borne interference may be classified, and discusses the appropriate types of preventive filters with particular reference to the value of condensers used on AC supplies

By F. R. W. STRAFFORD

(Research Dept., Belling and Lee, Ltd.)

Now the reactance of a 0.1 mfd. condenser at 150 kc/s (2,000 metres) is only 10.6 ohms, while at 1,500 kc/s (200 metres) it is 1.06 ohms, both values of which are quite small compared with the mains impedance of 150 ohms. Hence the suppression of the symmetrical component of interference can be effected by the use of a capacity of 0.1 mfd. across the mains input to the receiver, shown in Fig. 3. Similarly the suppression may be effected at the source by connecting the 0.1 mfd. condensers across the outgoing pair of wires from the dynamo.

In actual practice the addition of series

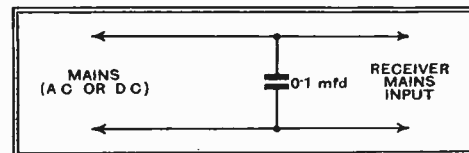

Fig. 3.—Simple suppressor circuit for the elimination of symmetrical component of mains-borne interference.

chokes in the mains leads is often necessary, as the suppression afforded by a 0.1 mfd. condenser is sometimes insufficient in cases of acute interference. The same effect would have been obtained, however, by increasing the capacity of the parallel condensers. For DC supplies this

is the more economical proposition, since no current passes through the condensers, but, on AC, condensers of large capacity may possibly operate the wattmeter at the supply intake. Although the condenser current is theoretically watt-

less, it must be remembered that a poor power factor for the condenser, or a fairly high wiring circuit resistance, will dissipate energy as the result of any additional wattless current flowing round the circuit. Large capacities of the order of 1 mfd. or more have been known to cause indications on AC wattmeters. The use of chokes

Anti-Interference Filters—

is, therefore, advised when a condenser not greater than 0.25 mfd. is not sufficiently effective for the suppression of the symmetrical component of interference.

Actually, the chokes may ultimately be necessary in any case, because of their ability to suppress asymmetrical interference, so that they do assist in suppressing the two forms at the same time.

It is thus necessary to consider now the general questions of the suppression of asymmetrical interference (go via mains, return via earth).

Since the interfering voltage now appears between the pair of mains wires as one common connection, and earth as the other, a condenser from one side of the mains to earth provides a reduction similar to that effected by the mains parallel condenser in the case of symmetrical interference.

Unfortunately, the size of this condenser from mains to earth is important from a safety viewpoint, as will now be explained.

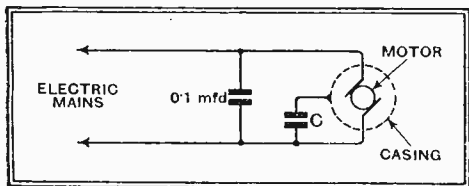

Fig. 4.—Explaining the need for caution in fitting a suppressor to a non-earthed electrical appliance.

In practically every AC or DC electrical supply undertaking in this country one pole of the supply mains is earthed. In the case of DC supplies, the earthing is effected at the supply station only, the use of additional earths being deprecated on the grounds of electrolysis and hum effects. Most AC systems are three-phase, in which the neutral is earthed at the supply and at each sub-station.

If a voltmeter is connected between the neutral lead of the electric mains and a local "earth," a very small voltage will be measured. This is due to the small ohmic resistance of the neutral lead and the total current passing through it, the combined effect producing a small PD to earth.

Protection from Shock

Unfortunately, however, there is no hard-and-fast rule regarding the disposition of the neutral lead when connected to any socket or lampholder outlet, and the consumer does not know which is the live or neutral lead. It is thus an even chance whether he obtains a severe shock or not when touching one of the two supply leads and earth at the same time.

Consider an appliance such as an electric hair dryer. Electrically, this consists of a small motor encased in a metallic frame but insulated therefrom. Suppression of the symmetrical component of interference may be readily achieved by connecting a 0.1 mfd. condenser across the input leads as already described. In order to reduce the asymmetrical component, a

low-impedance path must be provided between the metal casing and one side of the supply. Such a path is provided by the condenser C in Fig. 4.

Now it is an even chance whether the plug is inserted in such a manner that the

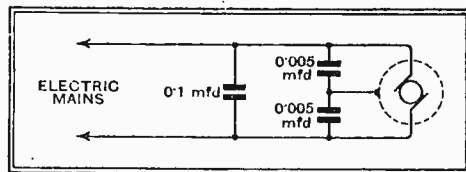

Fig. 5.—Another method of suppressing interference from a device of which the metallic casing (dotted lines) is unearthed.

condenser C is connected to the neutral line. It is an even chance, therefore, that the condenser is connected to the live mains, and the metallic case thus takes up the mains potential with respect to ground. The voltage which would appear between the case and ground when completed by a resistive circuit such as the human body depends first upon the size of the condenser C, and secondly upon the circuit resistance to ground. Statistical evidence shows that a condenser of greater value than 0.01 mfd. may give an unpleasant shock to the average person wearing leather soles and standing upon a plain stone floor or damp boards.

In Fig. 5 an alternative method of connection is depicted, in which a pair of 0.005 condensers are centre-tapped to the casing.

From a suppression viewpoint the effective capacity is still 0.01 mfd. (0.005 + 0.005), but the effective voltage to ground is now halved, and less shock is thus experienced. In this case, however, it is possible to obtain a shock no matter which way the plug is connected, while in the case of Fig. 4 this is only possible in one position.

A further restriction to the size of the earth condenser (apart from the question of shock) must now be considered in terms of Fig. 6), which depicts a popular type of mains filter which is applicable to AC or DC working.

From a DC viewpoint, the size of the condensers incorporated in this unit may be increased without restriction, since no current can flow through them. On AC, however, the input condenser is restricted to 0.1 mfd., since it is possible for larger values to show on the wattmeter at the supply intake for reasons already discussed.

Since the centre-tapped condensers are definitely earthed by a low-resistance path, it might be argued that the absence of the possibilities of electrical shock would permit these to be increased to at least 0.1 mfd.

This is not so, because the resistance

of the earth from the consumer's earth point to the power station or sub-station may average 100 ohms, so that the wattless current flowing through the condenser may produce sufficient power dissipation in the resistance of the earth path to record on the intake wattmeter. Although the amount recorded may be quite small, it is cumulative, particularly if the switching on the receiver is arranged to follow instead of precede the suppression filter, which is the normal practice.

If such a filter is embodied in a receiver the centre-tapped condenser may be increased, since the switching is then performed from the intake, but it must be remembered that the fitting of suppressors inside the receiver cabinet does not materially reduce the asymmetrical component of interference, because the radiating mains wire is brought right to the receiver chassis, and may easily couple to the aerial input circuit.

The correct position for such a suppressor is at least 4ft. from the receiver, in which case the cord from the receiver to the suppressor is now free from radiation, and far better suppression thereby results.

BOOK REVIEW

The Decibel Notation. By Alfred Morris, A.R.C.Sc., D.I.C., M.I.E.E. Pp. 57. Published by Dorling and Co. (Epsom), Ltd., Station Road, Epsom, Surrey. Price 2s. 6d.

INTENDED primarily for students of communication engineering, this little handbook should do much to remove the many misconceptions which, by general usage, are in danger of becoming permanently associated with "the decibel." Its identity is clearly established as a conventional notation and not as a unit. Strictly speaking,

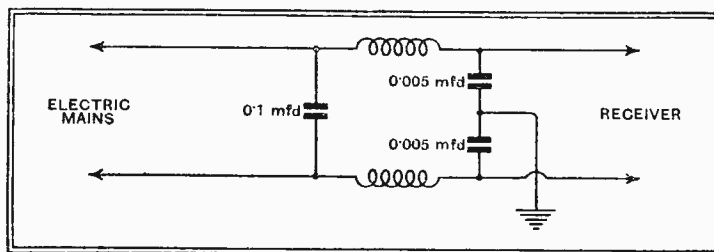
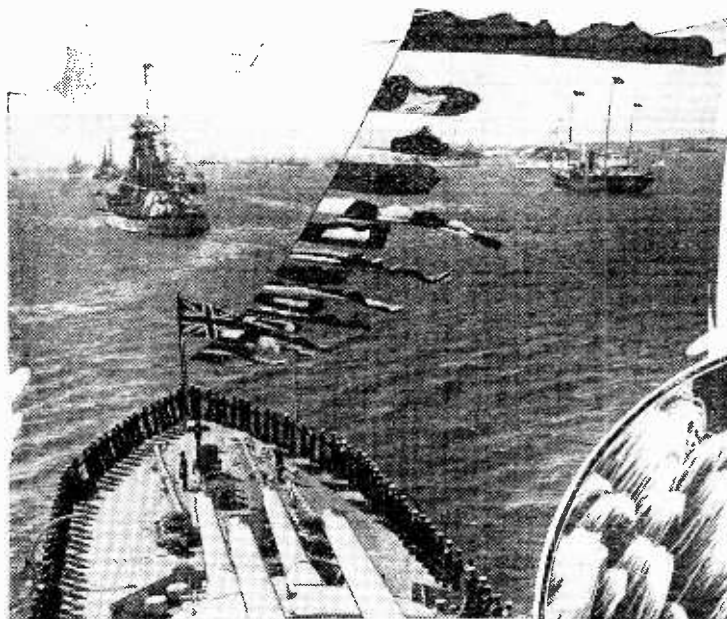

Fig. 6.—A choke-condenser filter applicable to general use.

therefore, reference to "the decibel" or "a decibel" is inadmissible.

The text is singularly free from "padding" and the author plunges directly into the theory of indices and logarithms. Although the treatment is concentrated, the student's task is lightened by a liberal use of worked-out examples, and through these he is given facility in expressing in the decibel notation the power relationships which are commonly met with in practice. In dealing with voltage ratios the author places no special emphasis on the necessity for equal resistances for input and output loads though, as most of the examples deal with telephone engineering practice, this condition is tacitly assumed.

There is a good leavening of examples taken from allied subjects, and the book should prove of value to the junior staffs of sound-recording studios, control rooms and telephone repeater stations. F. L. D.



REVIEWING THE FLEET. The *Victoria* and *Albert* passing between the lines during the 1935 Jubilee review. B.B.C. commentaries on Thursday's review will be broadcast Nationally. An impression of the sight as the rockets are fired from the ships' decks can be gained from the picture on the right. Will the commentator be able to describe this scene?

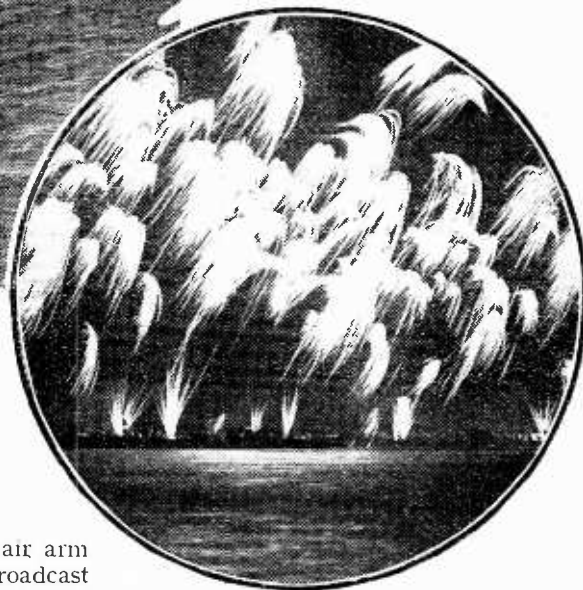

CORONATION festivities continue to grace the broadcast programmes again this week. The highlight of the week is His Majesty's review of the Fleet at Spithead. No fewer than five times the microphone will break-in on the scene and convey to listeners impressions and sound shots of the proceedings. The review is to be held on Thursday, and the first impression will be conveyed to listeners at 8.45 (Nat.) on Wednesday, when Lt. Com. T. Woodrooffe will describe the scene as at sunset His Majesty's ships haul down the ensign. He will be stationed on H.M.S. *Nelson* and, in the ten minutes allotted him, will endeavour to portray sunset from the Fleet, whilst "effects" microphones pick-up the bugle sounding "Attention" and "Sunset."

On the actual day of the review an observer stationed on the South railway jetty will at 2.50 describe the scenes at the jetty and the departure of His Majesty's yacht *Victoria and Albert* from Portsmouth Dockyard. Listeners will then hear the Royal Salute of 21 guns from the Fleet as the Royal yacht approaches the head of the lines. At 4.50, as the yacht returns down the lines, Lt. Com. Woodrooffe will describe the scenes and listeners will hear the cheers of the ship's ratings. The fly past of

the Fleet's air arm will be broadcast at 5.35. For these broadcasts two observers will be on the *Nelson*, Lt. Com. Woodrooffe in the foretop and Com. D. A. Stride in the fore-castle, whilst the observer on the jetty will be Lt. Com. G. V. Knight.

The commentaries from the *Nelson* will be transmitted on ultra-shorts and picked up at a B.B.C. receiving station at Southsea Castle whence they will be sent by land line to Broadcasting House.

The last flash from Spithead will describe for listeners the inspiring sight of the Fleet illuminated and the sky stabbed by hundreds of searchlights. Woodrooffe will again be in position in the foretop on H.M.S. *Nelson* and will thus have an unimpeded view of the panorama of the illuminated ships.

CORONATION MUSIC HALL

THE last variety production of Coronation Week which will be broadcast on Saturday at 8 (Nat.) will last for ninety minutes. John Sharman, producer, has booked notable artistes for this great occasion. Matheson Lang, Irene Vanbrugh and Victoria Hopper and Company will be heard in an excerpt from "Drake," specially arranged for broadcasting. Flanagan and Allen, Will Fyffe, Bertha Willmott,

Listeners' Guide

Florence Desmond, Elsie Carlisle and Billy Caryll and Hilda Munday are also billed. Nearly two hundred Boy Scouts, the biggest cast ever to

in the National programme on Monday at 3.30. Major G. Phipps-Hornby will comment upon the last five chukkas of the match.

EMPIRE'S YOUTH

A SPECIAL Empire service of youth to be held in Westminster Abbey on Wednesday afternoon will be relayed in the National programme at 4. To this service will come youth representing all parts of the Empire, including a contingent of some three hundred students from Canada. The address will be given by the Archbishop of Canterbury.

On the previous evening, Tuesday, an Empire rally of youth will be held at the Albert Hall, and the speeches by the Prime Minister and Mr. Alfred Noyes will be broadcast in the National programme at 8.10.

HOCKEY ON ROLLER SKATES

IN his new capacity of radio reporter, Freddie Grisewood will be heard in the Regional programme on Tuesday at 9.40 giving a running commentary with Charles Whitcroft on the second half of the International Rink Hockey Match between England and Germany. This will be played at the Pier Pavilion, Herne Bay. It is the first of its kind to be broadcast, and should prove a novelty O.B.

take part in a single act in St. George's Hall, will conclude the programme. They are all members of "The Gang Show," which is produced by Ralph Reader.

SPORTS

ON Saturday afternoon cricket and athletics will provide commentaries for National listeners. From Lord's, T. Woodrooffe will comment on the Middlesex versus Sussex match, after which A. E. Lawton, from Old Trafford, will describe the match between Lancashire and Yorkshire. The Universities Athletic Union Championships at the White City Stadium will be described by H. M. Abrahams.

The polo match between Australia and the Army, at Hurlingham, will provide a 45-minute commentary

THEIR MAJESTIES the King and Queen of Denmark and Iceland. Their Silver Jubilee Thanksgiving Service will be broadcast Nationally on Saturday.



de for the Week Outstanding Broadcasts at Home and Abroad

BLACKPOOL BY NIGHT

A TOUR of Blackpool's palaces of entertainment will be conducted by "Our Albert" for Regional listeners at 8 on Monday. During the tour the Tower ballroom will be visited, where Reginald Dixon will be heard at the organ, also Norman Newman and the Tower Band. At the Palace Theatre Charlie Kunz will be at the piano, and from the South Pier listeners will be given an excerpt from the Arcadian Follies.

DANCING THROUGH

GERALDO'S popular series, "Dancing Through," is coming to National listeners on Friday at 8 in a special edition to celebrate the Coronation. It will be a one-hour's non-stop pot-pourri of dance music and light music covering the period 1901-1937, presenting a cavalcade of music of two reigns. In fact, every tune will recall an episode during that period. It is expected that the record of 162 tunes featured in the last edition will be exceeded in this present one.

DANISH SILVER JUBILEE

THE outstanding broadcast abroad is undoubtedly Denmark's programmes on Saturday to celebrate the completion of twenty-five years' reign of Their Majesties King Christian X and Queen Alexandrine. National listeners at 10.25 a.m. will hear the Thanksgiving Service in Copenhagen's Cathedral, Vor Frue Kirke. Prior to and after the service a B.B.C. commentator will describe the animated scenes outside the Cathedral.

The Danish programmes throughout the day are of a jubilant nature consisting mostly of Outside Broadcasts. At 7.50 a.m., the Royal Guards parade on Amalienborg Castle Square will be broadcast. Then at 9, from the same square, comes a "Singers' Homage" to His Majesty.

In the evening, at about 6.15, King Christian will address his people.

At 9 a gala concert will be relayed from the Tivoli Concert Hall, Copenhagen. At 9.45, the concert will be switched out for a short time to relay a running commentary on the Students' Torch Procession to

Christiansborg Palace, their songs from the forecourt, and His Majesty's talk to the students from the Palace balcony.

NORWEGIAN FESTIVITIES

THE week under review will, in addition to the Jubilee in Denmark, include another Scandinavian National festival, namely Norway's celebration of its Independence Day on Monday. Some of the more

brings two rather unfamiliar operas. The first, from Budapest No. 1 at 7.30, is "The Queen of Sheba," by Goldmark, a Hungarian Jewish composer who died in 1915. This opera, which is a brilliant and colourful piece of work, was first produced at the Court Opera in Vienna, in 1875. The other, at 8.55 from Hilversum No. 1, is "Doktor und Apotheker," a lively, soundly constructed, but rather rough



RALPH READER and some of the Scouts in the film "The Gang Show" by Herbert Wilcox Productions. Two hundred members of the cast will be heard on Saturday evening in the gala variety.

interesting events for British listeners are a concert by the Students' Choir from the Aula of the Oslo University at 12 noon and a gala programme at 7.30.

OPERA

WE are to have another relay from the Royal Opera House this week. It comes to National listeners at 10.15 on Monday and will consist of Act III of Wagner's "Die Walküre." The opening night of the season at the Opera House, Glyndebourne, Sussex, will provide another opera broadcast. This will be on Wednesday, when at 8.25 listeners will hear Act II of Mozart's "Don Giovanni."

From abroad Friday evening

comic opera by the 18th century Viennese composer, Karl von Dittersdorf.

Monday brings a choice of two Verdi operas, "Aida" from Leipzig at 7, and "Rigoletto" from Berlin at 8.

Wednesday is certainly a Haydn day. Hamburg at 9 gives a performance of his "La Canterina" a comic opera rarely heard nowadays. At 9.45 Vienna gives a rare treat—incidental music to Shakespeare's "King Lear." This was recently discovered at Esterhazy Castle near the little town of Eisenstadt, where Haydn lived as Kappelmeister for many years. This programme will also be given by a number of other stations.

THE AUDITOR.

HIGHLIGHTS OF THE WEEK

FRIDAY, MAY 14th.

Nat., 6.20, Talk by Hugh Walpole, "Families in Fiction." 7.40, "In Town To-night." 8, Dancing Through. 9, Pianoforte recital: Myra Hess. Reg., 6.40, Recital: Isobel Baillie (soprano). 8.15, The River Clyde: feature programme. 9, A. J. Alan

Abroad.

Rome, 9, Lchar's "The Count of Luxembourg."

SATURDAY, MAY 15th.

Nat., 10.25 a.m., Silver Jubilee of Their Majesties the King and Queen of Denmark. 3, Sports commentaries. 7.30, "In Town To-night." 8, Gale Variety. 10.30, A. J. Alan.

Reg., 7.30, Recital: Maggie Teyte. 9, Coronation Concert from the Town Hall, Birmingham

Abroad.

Kalundborg, Special programmes throughout the day for Silver Jubilee celebrations

SUNDAY, MAY 16th.

Nat., 4.55, British Legion Memorial Service at the Cenotaph.

Reg., 5.20, B.B.C. Orchestra (D) and Harry Wendon (tenor). 9.5, Scenes from Shakespeare's "A Midsummer Night's Dream"

Abroad.

Vienna, 8.35, Elisabeth Schumann singing Scottish and Sacred songs.

MONDAY, MAY 17th.

Nat., 3.30, Polo commentary. 6.40, From the London Theatre: excerpt from Henry V. 7, "Monday at Seven."

Reg., 7.30, Whit Week Customs. 8, Entertainment Tour of Blackpool. 9, Mark Hambourg

Abroad.

Leipzig, 7, "Aida" with Margarete Teschemascher in the name part

TUESDAY, MAY 18th.

Nat., 6.30, Musical Comedy: "A Twelvemonth and a Day." 8.10, Albert Hall Rally of Empire Youth.

Reg., 6.30, Recital: W. H. Squire (cello). 9.40, Hockey on roller skates.

Abroad.

Radio Paris, 8.30, Pau. Dukas commemoration concert.

WEDNESDAY, MAY 19th.

Nat., 7.50, Gracie Fields from Rochdale. 8.45, Sunset from the Fleet: relay from Spithead. 9.20, Discussion: "Should Blood Sports be Prohibited?"

Reg., 8.25, Glyndebourne opening night. 11, Song of the nightingale.

Abroad.

Vienna, 9.45 Music to "King Lear."

THURSDAY, MAY 20th.

Nat., 2.50, 4.50 and 5.35, Relays from Spithead. 7.40, Palace of Varieties.

Reg., 8, Danish European Concert. 9, "A Twelvemonth and a Day." 10.25, Illuminations of the Fleet: relay from Spithead.

Abroad.

Deutschlandsender, 8.10, Romantic opera music.

Why the Triode-Hexode?

PART II.—DEVELOPMENT OF THE ELECTRON-COUPLED MIXER

AFTER having described the development of the classical rectifying frequency changer in an earlier instalment, the author goes on to explain the modern electron-coupled system, with multiplicative mixing.

if it had its own cathode, with the exception that this virtual cathode is not a constant source of electrons and has no inertia. The quantity of electrons in this space charge is not constant but instantaneously

A NEW mixer technique was being evolved independently in America and on the Continent during 1932 and 1933. Efforts were being directed towards the elimination of the serious disadvantages associated with additive mixing and with the need for rectification in the mixer. This new frequency-changing technique, known as electron coupled or multiplicative mixing, solved most of the problems that up to now had been troubling the superhet. It can be considered as the most important step in making the superheterodyne the most popular circuit in the world, and one which enabled designers to obtain good quality and stable reception with great ease and simplicity of design.

In America RCA developed the pentagrid, while Telefunken in Germany, working on different lines, developed the hexode. These were followed somewhat later by numerous heptodes (basically the same as pentagrids) in this country and on the Continent, which were very soon superseded by octodes developed by Philips in Holland and Tungram in Hungary. The former had a negative sixth grid (providing suppressor action), the latter, a positive sixth grid termed the velogrid (providing accelerator action).

The Two Basic Types

All these multiplicative mixers can be divided into two groups: (a) Valves in which the oscillator grid is the one nearest the cathode: pentagrid (heptodes) and both kinds of octodes (Fig. 9, a, b, and c respectively). (Fig. 10 shows the differences between these three types, the octodes causing the least IF shunt-loss, as their impedance is highest.)

By J. A. SZABADI

(Technical Department, Tungram Electric Lamp Works)

Fig. 11.—Showing IF resultant produced by multiplicative mixing without recourse to rectification.

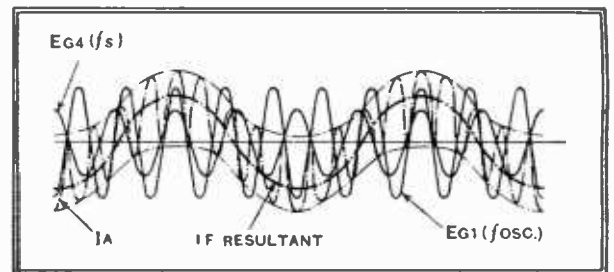

(b) Valves in which the first grid is the signal input grid: Hexodes (Fig. 9d). (These did not attain great popularity as, due to the oscillator section deriving its electrons from the virtual cathode, AVC could not be applied as the oscillator

varying. As the anode current depends on the mutual conductance of the second control grid to anode system, which, deriving its electrons from the virtual cathode, is itself a function of the first control grid voltage, it follows that

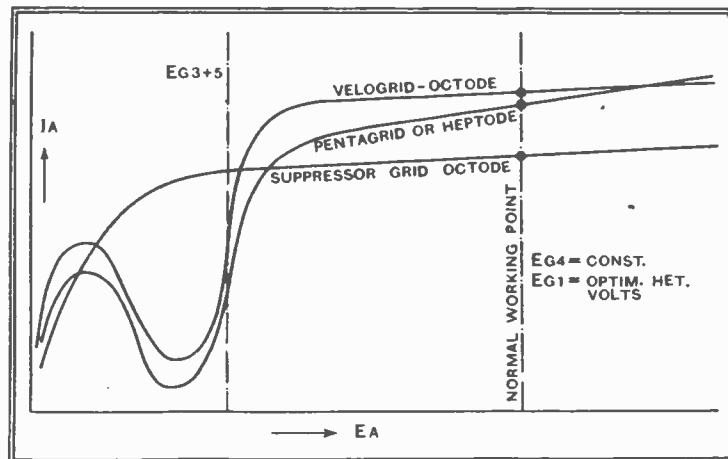

Fig. 10.—General characteristics of mixers in group a; note the higher anode impedance of the octodes.

the anode current must be proportional to both, i.e., to the multiple of the input and oscillator signal amplitudes:—

$$I_{aIF} = \frac{1}{2} a_1 E_1 \cos(\omega_1 - \omega_i) t$$

where a_1 = amplitude on g_1
 E_1 = modulator grid volts
 ω_1 = $2\pi f$ OSC
 ω_i = $2\pi f$ MOD

would stop oscillating.) Both groups have the common feature of having a second space charge in which (or close to which) a second control grid operates. The second control grid operates just as

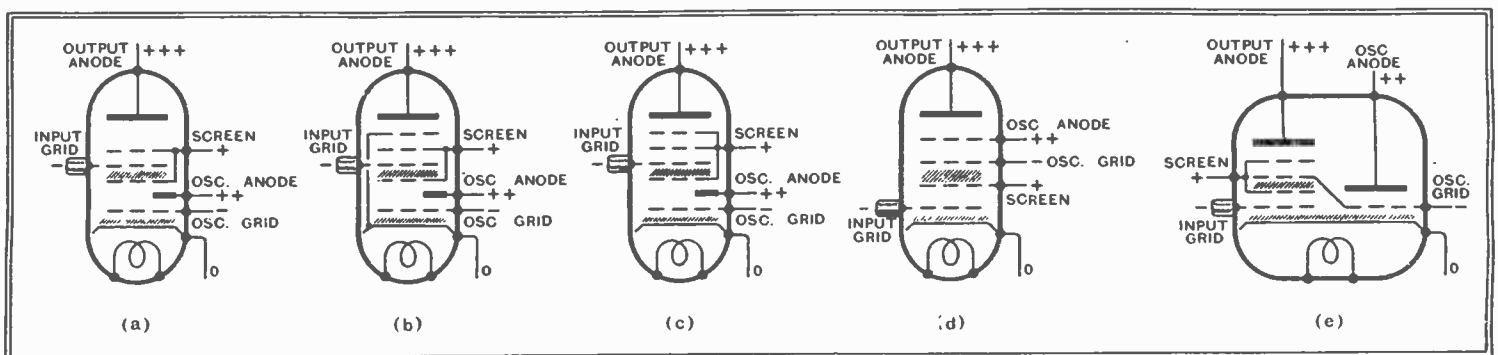

Fig. 9.—Showing relative potentials and functions of pentagrids (heptodes), suppressor grid octodes, velogrid octodes and hexodes. Shaded areas indicate space charges; the normal cathode space charge occupies the area nearest the cathode, while the area between the first positive screening grid and the second negative control grid comprises the virtual cathode space charge.

Why the Triode-Hexode?

Thus it will be seen that in order to produce an IF beat note rectification will not be required, as the resultant is produced by pure multiplication as shown graphically in Fig. 11.

As these various multiplicative mixers do not require rectification it is obvious that the tendency to cross-modulation will

Fig. 12.—Variation of conversion conductance with frequency, showing beneficial effect of neutralising condenser between points X and Y (see Fig. 13).

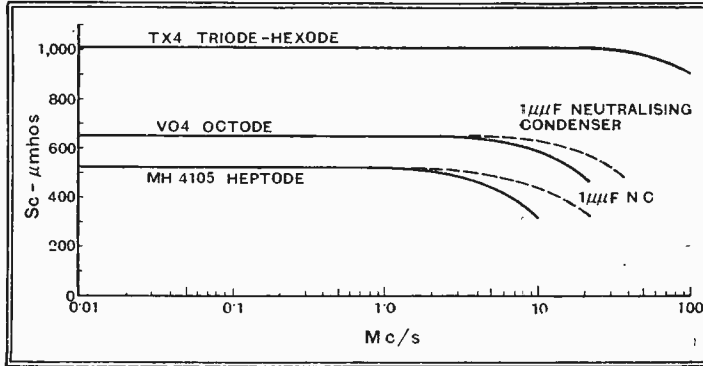

be substantially reduced. If the I_a/EG_4 curve is a perfect exponential curve (so-called anti-cross curve) this trouble can be even further reduced. With the progress of valve-making technique generally, even the relative inefficiency of the early multiplicative mixers could have been overcome, and it really appeared that one or

tween the two control grids, which I shall endeavour to elucidate. Fig. 13 shows a diagrammatic representation of a heptode as well as a representation of a section through its structure (Fig. 14) with shaded

ing to illustrate the instantaneous density of electrons. The accompanying table gives an explanation of the function of the electrodes as well as their potentials relative to cathode.

The characteristic in Fig. 15 shows the quantity of electrons in the virtual cathode space charge as a function of the voltage on the first grid.

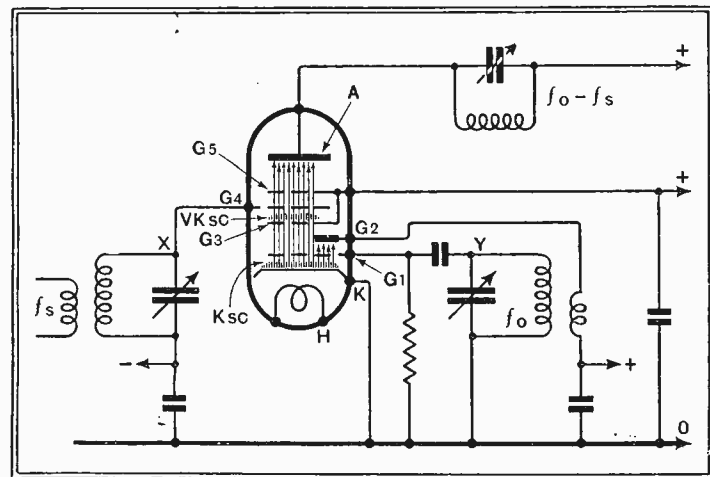

As the voltage on G_1 approaches zero so the quantity of electrons increases and takes up a larger space, the centre of gravity of this space being near to G_4 . When G_1 becomes

Fig. 13.—Showing the virtual cathode space charge between first positive screen and second control grid. The oscillator frequency is transferred to G_4 by virtue of influence.

charge and the rubbed glass rod brought near an electroscope. The electroscope will indicate a charge when the rod is approached, which will disappear again when the rod is taken away.

If we do the same thing to a long conductive rod an instantaneous current will flow in it until equilibrium is established, and the current will flow in the reverse direction when the influence is withdrawn. Exactly the same thing happens in an electronic mixer valve of Group (a) between the oscillating space charge and the input grid G_4 , an influence current flowing in and out of this grid. This is called the space-charge coupling effect.

It is clear that, due to the input circuit impedance, an oscillator frequency voltage will be built up on the input grid G_4 . The oscillator frequency voltage on G_4 will be greatest when the difference between the oscillator frequency and the resonant frequency of the input circuit is

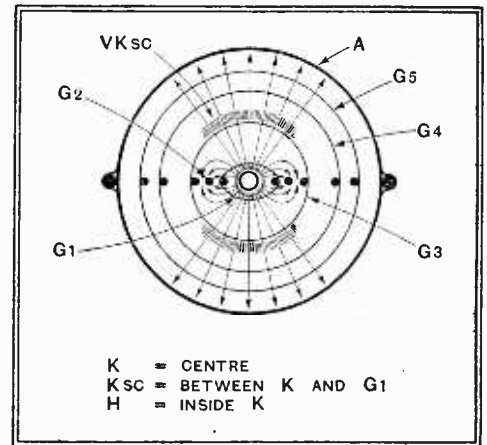

Fig. 14.—Representation of a section through a heptode.

other of the octodes would become the final mixer valve. However, there was one further serious trouble, and this only really came into prominence in 1935-36, when short-wave reception was being asked for in receiving sets; this trouble, as shown in Fig. 12, is due to a falling-off in conversion conductance towards the shorter wavelengths.

This falling-off is due to an inherent factor, namely, space-charge coupling be-

more negative, on the other hand, the quantity of electrons decreases and the centre of gravity recedes nearer to G_3 . It is due to this shifting of virtual cathode that the slope of the mixer portion of the valve changes from a maximum to a minimum, and produces the IF by the normal multiplicative mixing, as was shown in Fig. 11.

So far we have regarded the negatively biased input grid (G_4) and its attached

circuit as entirely independent of the flow of electronic discharge passing through it. Unfortunately, this assumption is not justified. If we remember the classical demonstration of "influence" from our schooldays we shall readily see the similarity between this approaching and receding space

small. Furthermore, this voltage on G_4 will be in phase with G_1 if the input circuit is inductive with respect to F_{osc} , and will be 180° out of phase if the input circuit is capacitive.

If the oscillator frequency is greater than the resonant frequency of the input circuit, the influence voltage will be 180° out of phase and the conversion conductance will decrease, while in the opposite case it will increase.

In most commercial superhets. the frequency of the oscillator is greater than that of the signal, and we find, as shown in Fig. 12, that the conversion gain drops

Symbol.	Description.	Potential.	Remarks.
H	Heater	—	Indirectly heated.
K	Cathode	0	
Ksc	Cathode space charge.	Slightly negative ≈ 0	Substantially constant.
G_1	Oscillator grid ...	From about -50 V. to +1 V. or so.	Oscillates.
G_2	Oscillator anode...	From about +250 V. to +20 V.	Oscillates.
G_3	First screen grid...	+100 V.	Constant.
VKsc	Virtual cathode space charge.	Slightly negative ≈ 0	Space charge quantity varies.
G_4	Modulator grid ...	Input signal... ..	Also -3 to -50 V. vari-mu control.
G_5	2nd screen grid ...	+100 V.	Constant.
A	Anode	From about +150 to +350 V.	Signal output oscillation.

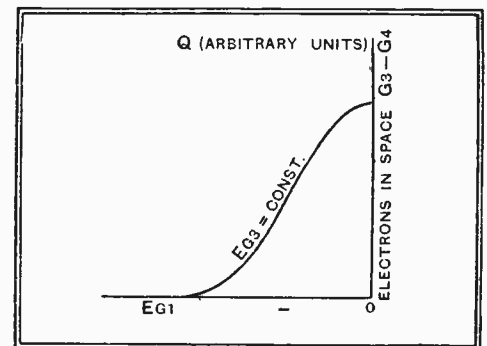

Fig. 15.—Distribution of electrons in the virtual cathode space charge as a function of the voltage on the first grid.

Why the Triode-Hexode?—

off below 5 Mc/s, though the drop is not really appreciable until we get down to about 10 Mc/s. One can partially neutralise space-charge coupling by inserting a small condenser between points marked X and Y in Fig. 13. The condenser value in most practical cases will be approximately $1 \mu\mu\text{F}$. As is shown in Fig. 12, quite an appreciable extension of the useful part of the conversion conductance curve is possible by this means.

However, it is equally clear that neutralising the space-charge coupling is only a partial remedy. The main diffi-

curve in Fig. 12 shows the relative immunity of the triode-hexode from this space-charge coupling trouble; it is thus the frequency changer par-excellence for all-wave superhets., with practically linear response to all frequencies.

A further advantage of the triode-hexode over all other mixer valves, and one which is again of particular interest on short waves, is the considerably reduced tendency to frequency-pulling with AVC.

The pentagrids, heptodes, and both kinds of octodes suffer considerably from pulling on short waves. This is due to the

to the hexode does not alter the triode anode current at all.

Fig. 16 shows a typical modern five-waveband frequency-changer stage using a triode-hexode with AVC applied. In this circuit, in order to obtain absolutely linear response within each tuning range, a Colpitts oscillator circuit is adopted for the triode section. Due to decrease of L/C ratio in the input circuits towards the lower frequency end of each tuning range, there would be a drop in response, and the increased reaction coupling given by this Colpitts circuit at the lower frequencies results in an increase of the

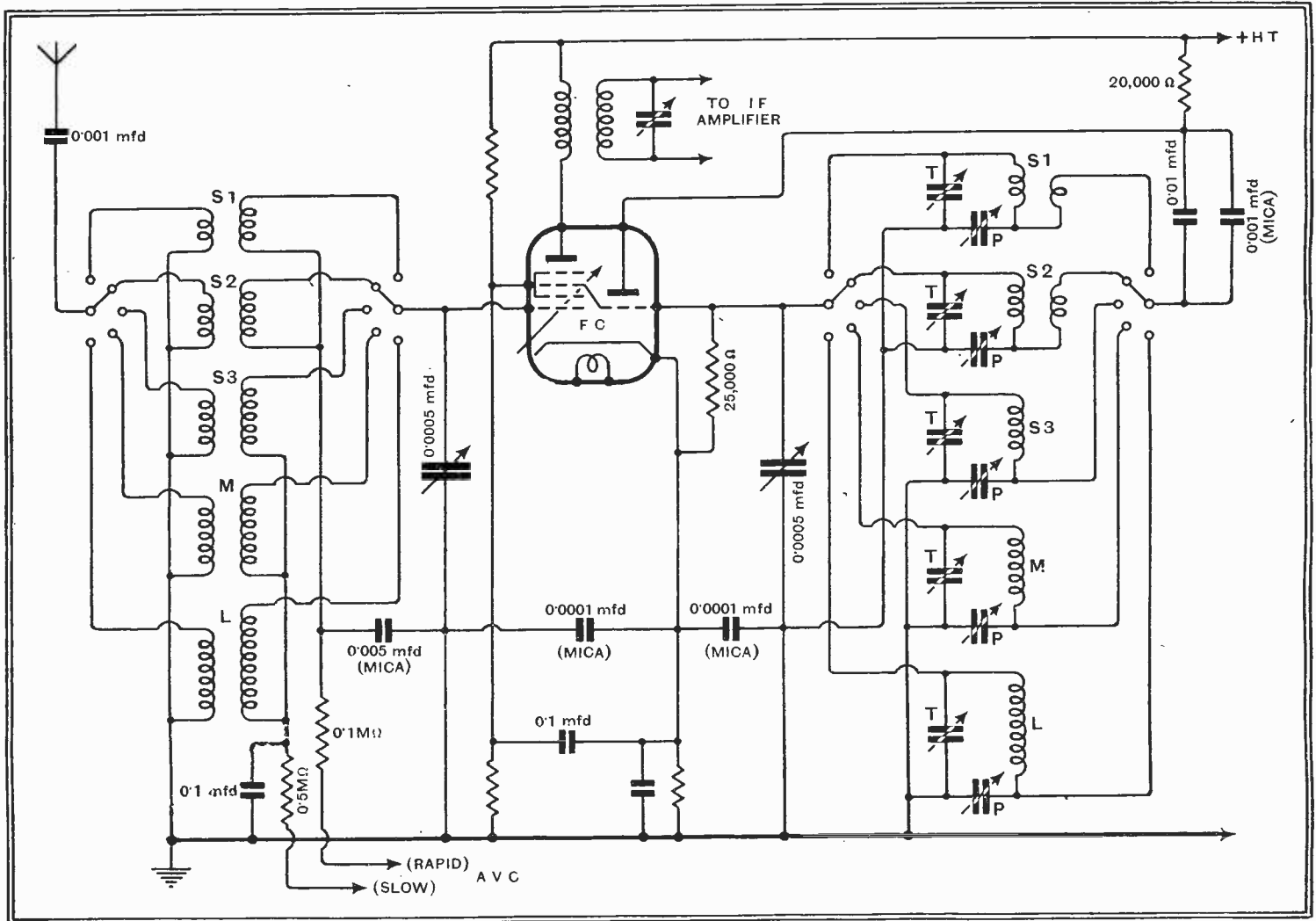

Fig. 16.—A modern frequency-changing circuit for a five-waveband receiver. The non-inductive properties of the mica condensers as shown are important on the shorter wavebands.

culty is, of course, that the amplitude of oscillations transferred to the input grid *via* influence is very large compared with the amplitude of most short-wave signals. If only one could reverse matters all would be well. This is exactly what takes place in the hexode and triode-hexode. We make the first grid the signal input grid, while the oscillator frequency is applied to G3.

Though space-charge coupling does still occur its effect is negligible, as the voltage being transferred from the input grid to the oscillating grid is negligible. Furthermore, in the triode-hexode the injector grid is linked to a powerful triode oscillator, and thus the minute influence voltages lose all importance. The top

fact that as the AVC voltage applied to the input grid G4 becomes more negative so the virtual cathode space charge is partially forced back through the meshes of the first positive screen (G3) and causes the oscillator anode current (IG2) to increase. As this increase is not produced by an increase in oscillator anode voltage (EG2), it means that the anode conductance of the triode oscillator has increased, but, as this altered conductance, or its reciprocal resistance, is coupled to the oscillator tuned circuit *via* the reaction coil, it follows that as this changes so does the oscillator frequency. This serious trouble is not encountered in the triode-hexode as the oscillator triode is a totally independent unit, and the AVC applied

heterodyne voltage to compensate for the decreased response of the input circuits. It is therefore advisable to design this oscillator circuit so that when the tuning condensers are at maximum capacity the heterodyne voltage is optimum; as the tuning capacity decreases the heterodyne voltage drops while the L/C ratio of the input circuits improves, thus keeping the response substantially linear.

What of the future; is the triode-hexode the last word? It would, of course, be absurd to answer this question in the unqualified affirmative, but it can be said with some confidence that, unless broadcast reception descends below 3 metres, the triode-hexode has come to stay, though it may be improved in detail.

The Television Receiver

IX.—SYNC SEPARATION WITH VF AMPLIFICATION

By W. T. COCKING

THE use of vision-frequency amplification leads to some further problems in synchronising. The reason for these is explained in this article, and their solution is given.

IT has been shown in earlier articles in this series that the real objection to the use of vision-frequency amplification is that it increases the difficulty of synchronising. Types of amplitude filter suitable for sync separation were dealt with in a previous article in *The Wireless World*,¹ and it was shown that the most suitable of the types described is an RF pentode operating with an RF or IF input. The valve is operated with about 6 volts HT only, some 40 volts screen potential, and about -3 volts grid bias, with the result that a characteristic similar to that of Fig. 18

flat top of the curve, so that it is only the sync pulses which cause a change in the anode current of the valve.

Now this same sync separator can also be used with a VF input, and when the CR tube is fed directly from a diode detector we can adopt the system of Fig. 19, which shows both detector and sync separator. The detector output which is developed across R1 is applied

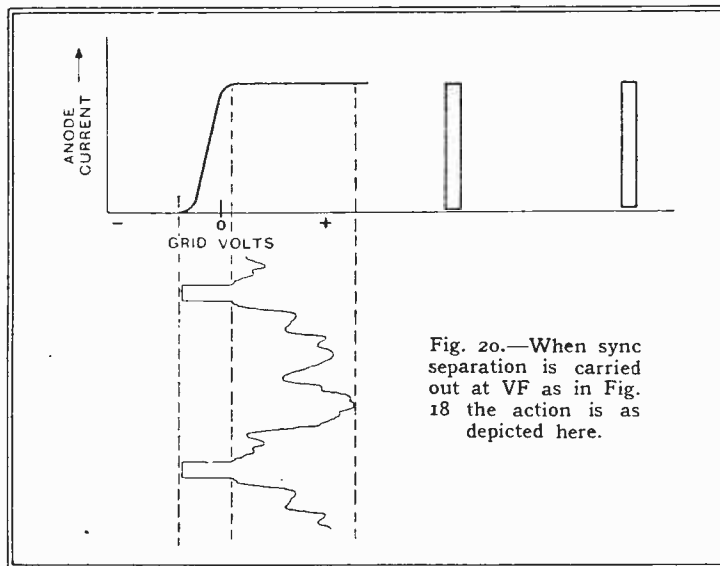

Fig. 20.—When sync separation is carried out at VF as in Fig. 18 the action is as depicted here.

to the grid of the sync separator through R2, with the result that the operating conditions are as pictured in Fig. 20. Actually, in this case the lower bend in the valve characteristic is not really necessary, but its presence does no harm and is of some advantage when interference is present.

The presence of the resistance R2, which may have a value of some 50,000 ohms, is essential.

It will be seen that over the range of picture signal voltages the sync separator operates with a positive grid, with the result that grid current flows and this valve has a low input impedance. If it were connected directly across R1 it would largely short-circuit the diode load resistance and prevent the proper voltages being developed across it. The inclusion of R2 renders the shunting effect of the sync separator negligible, and it also improves the amplitude filter by making it no longer necessary for the valve to have a flat-topped characteristic over a wide range of positive voltages. Actually, on the picture signal R2 and the input resistance of V2 form a potentiometer across R1 so that only a small proportion of the voltage across R1 is applied to the valve.

On the sync pulses, however, the grid of V2 is negative and grid current no longer flows. The valve then has a very high input resistance, and R2 causes a negligible drop of voltage. This effect is so marked that it is

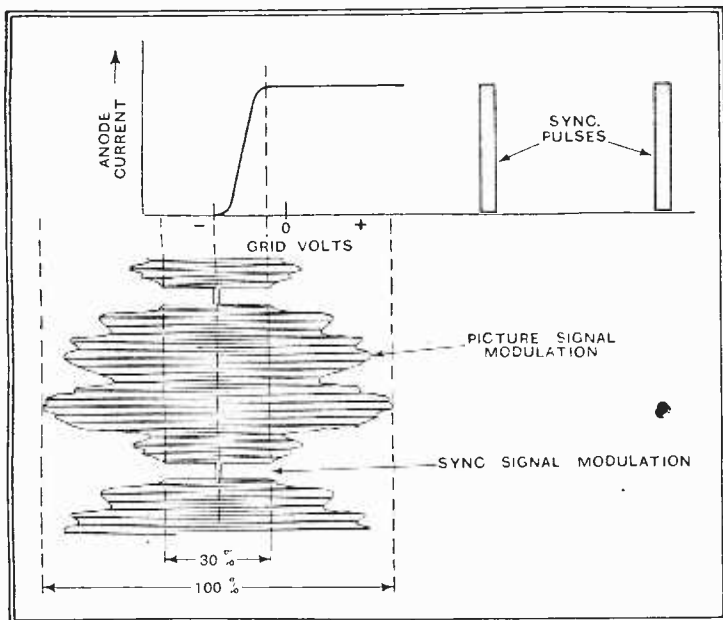

Fig. 18.—The operation of an amplitude filter operating on the modulated carrier is shown here, and it is readily seen how only the sync pulses can affect the output.

is obtained. In this illustration the manner in which the RF input is applied is also shown, and it can be seen that the negative carrier voltage changes all fall beyond the point of anode current cut-off and so do not affect the output. Furthermore, the positive portion of the picture signal modulation falls upon the

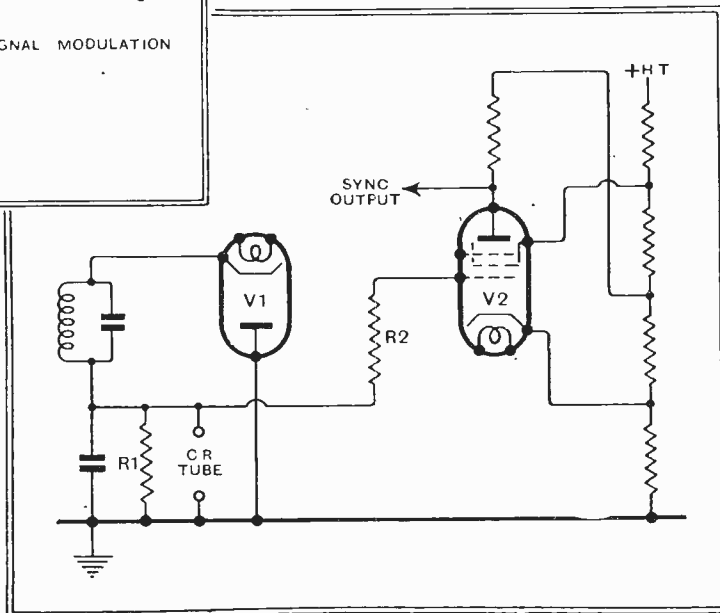

Fig. 19.—Sync separation can be carried out on the VF signal across the diode load resistance R1; the separator valve is V2.

¹ *The Wireless World*, January 22nd, 1937.

The Television Receiver—

quite possible to obtain good sync separation by it alone, and V2 can be a diode; R2 must then be increased to 0.5 megohm, however, and as the phase of the output is wrong some form of phase reversal must follow.

Now although this circuit enables practically perfect synchronising to be obtained, it is by no means easy to use it following a VF amplifier, even if we retain the DC component. Theoretically, it would be possible to use the circuit of Fig. 21, in which V1 is the output valve and V2 the amplitude filter. The values of resistances in the voltage divider are so chosen that in the absence of a signal the cathode of V2 is about 3 volts positive with respect to the anode of V1, and the screen and anode of V2 are about 40 v. and 6 v. positive with respect to its own cathode.

There is no doubt that the system would be entirely satisfactory if it were possible to maintain these potentials. In practice,

conditions to obtain moderate stability of synchronising, but it is never very good. Experience shows that the best results are obtained with a capacity of 0.1 μ F. for C, a resistance of 50,000 ohms for R2, and 10,000 ohms for R3; the grid bias should be zero or slightly positive.

The difficulty is brought about by the absence of the DC component in the signals applied to V2. When the DC component is present the waveform of the output of the receiver is of the form shown in Fig. 23 (a), where the signals corresponding to a nor-

signals tend to settle down across the zero line in such manner that the contour lines enclose an equal area on either side. It is clear from this illustration that we cannot

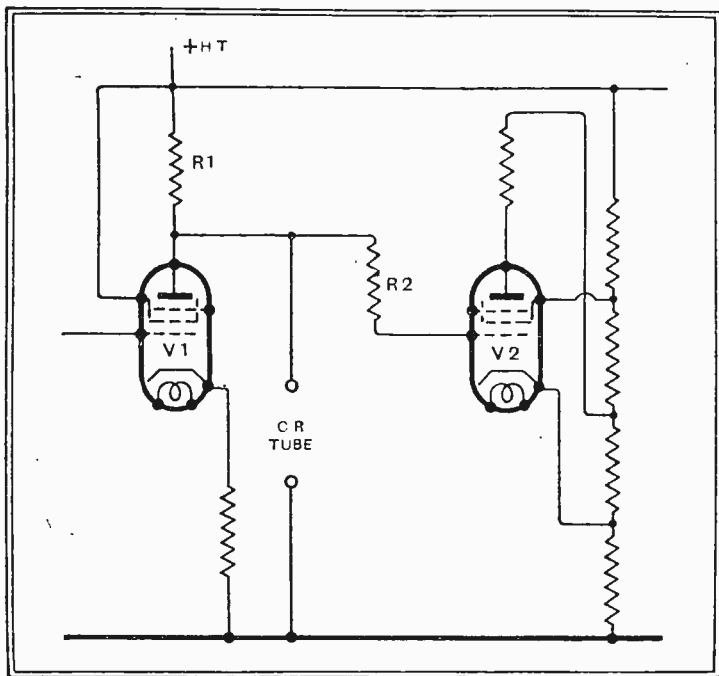

Fig. 21.—This circuit operates in a similar manner to that of Fig. 18, but is impracticable because small voltage variations in the HT supply upset the operation.

however, it is not. For correct operation the grid potential of V2 must be kept constant within about 0.5 volt; the anode potential of V1, however, may vary by as much as 20 volts in some cases through mains voltage fluctuations and through poor regulation of the mains equipment when the gain control is varied. As the grid of V2 is joined to the anode of V1 through a resistance, its potential will suffer similar variations.

Now if we adopt resistance-capacity coupling in the obvious manner shown in Fig. 22, we shall find it exceedingly difficult to secure any reasonable approach to good synchronising. This circuit is essentially the same as that of Fig. 21 save for the inclusion of the coupling condenser C and the grid-leak R3, but its performance is very different. It is possible by very careful adjustment of the operating con-

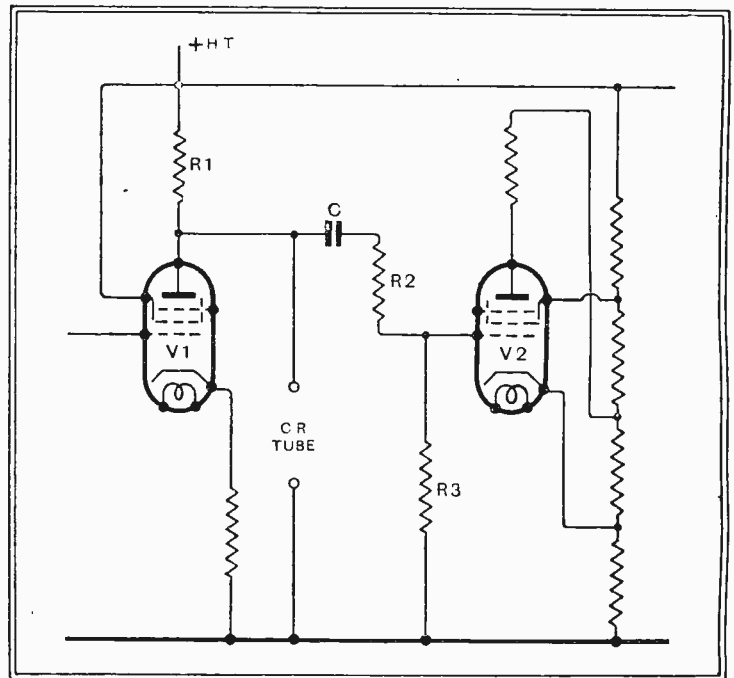

Fig. 22.—This circuit is the same as that of Fig. 21 save for the insertion of the condenser C. This removes the trouble of inconsistent operation, but proper synchronisation cannot be obtained because the condenser removes the DC component of the signal.

mal picture line, a black line, and a white line, are shown all resting on the same base line. It is also clear that we can draw a line (dotted) through these signals such that below it the sync pulses are all identical; if the signals above this line are cut off by the sync separator we are left with a uniform series of sync pulses which are quite independent of the magnitude and form

separate any series of pulses of constant amplitude from signals of this nature, for it is not possible to draw across these signals a pair of parallel lines, representing the upper and lower bends in the valve V2, which will cut through identical signals in every case.

What are we to do then? We cannot retain the DC component and yet we cannot do without it. At first sight it appears as though we cannot use VF amplification. Fortunately, there is a way out of the difficulty. If we apply the waveform of Fig. 23 (b) to a rectifier which is adjusted to pass current on the negative peaks of the sync pulses, we can obtain a voltage which is nearly equal to the amount by which the signal extends below the base line. If this voltage is then applied to the sync separator in series with the signal, it acts in such a way that it pushes the signals upwards so that they all rest on the same base line just as if the DC component had been retained.

This sounds very complicated, but the circuit is actually very simple indeed. It is shown in Fig. 24, and the diode V2 performs the magic function of restoring

of the picture signal modulation.

Now when the DC component is removed the signals tend to the form shown at (b). The changes of voltage are reproduced practically perfectly, but the bottoms of the sync pulses no longer stand on the same base line. Instead, the

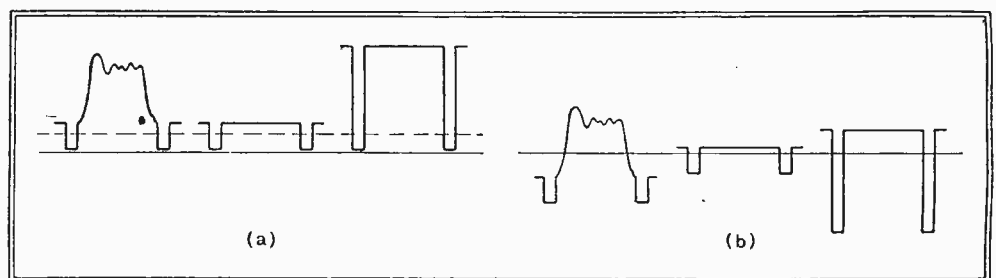

Fig. 23.—Three typical signals are shown at (a), the first corresponding to a normal line, the second to a black line, and the third to a white line. The same signals are shown at (b) with the DC component removed.

The Television Receiver—

the DC component. When the voltage across R3 swings so that the anode of V2 is positive with respect to the cathode, as it does on each sync pulse, the diode conducts and charges the condenser C positively with respect to earth. The condenser can charge quickly through the low resistance of the diode, but during the following line signal it can only discharge slowly through the high resistance R3, so

load resistance in the manner of Fig. 19. The circuit is in no way critical and functions admirably.

Not only does this restoration of DC enable the sync separator to function, but it restores it also as far as the CR tube is concerned, and it is no longer necessary to retain it throughout the amplifier. This permits us to connect the tube at the point shown in Fig. 24, and so avoid applying the HT of the receiver to it. We are also

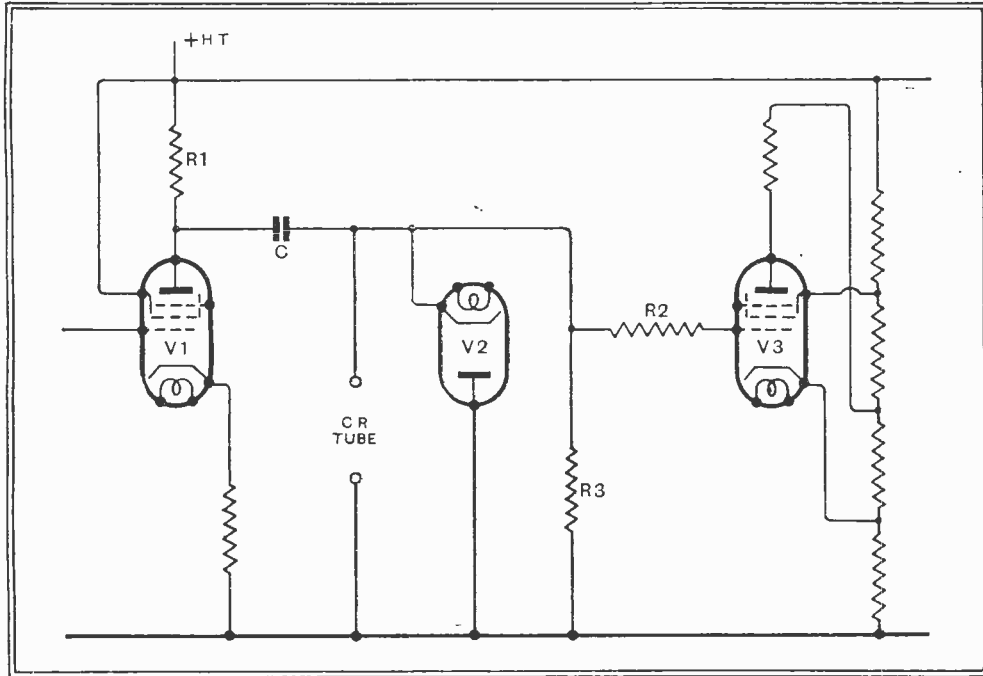

Fig. 24.—In this circuit the DC component is lost because of the condenser C, but is restored artificially by the diode V2. This arrangement is quite practicable and gives very good synchronising.

that the line signal is added to the condenser voltage.

In practice R3 can be 0.1 megohm and R2 500,000 ohms, with C=0.1 μF., and the difficulties of synchronising are completely removed. The performance of the following amplitude filter V3 is just as good as if it were connected to the diode

no longer restricted to the use of a single VF stage, for we can use normal LF-type couplings and ignore the DC component, since we are able to restore it in the output circuit.

Lest it be thought that this restoration of the DC component is liable to cause distortion, it should be remembered that the DC component in the transmitted signal is actually produced in this way. In the transmitter circuits a very large amount of VF amplification is employed, and it is out of the question to employ DC amplifiers. Consequently, no attempt is made to retain the DC component, and it is re-inserted at a suitable late stage in a manner similar to that just described.

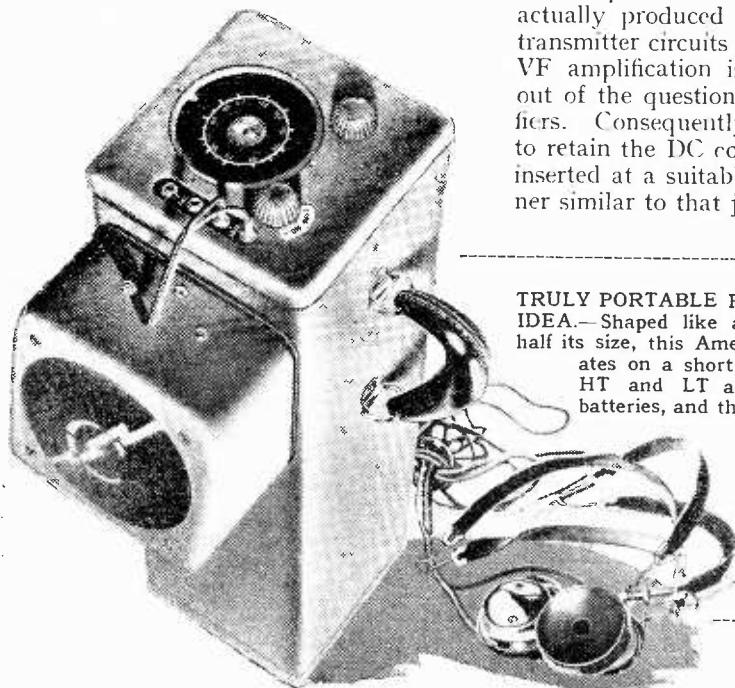

TRULY PORTABLE RECEIVERS: A NEW IDEA.—Shaped like a golf bag, but about half its size, this American Crosley set operates on a short trailing aerial. Both HT and LT are obtained from dry batteries, and the total weight is given as 18 lb. The circuit employs five valves, plus a barretter which presumably provides automatic regulation of filament current in spite of voltage variations.



6-valve all-wave Superhet with Radio Frequency Stage

8 stages.
8 tuned circuits.
3 wavebands.

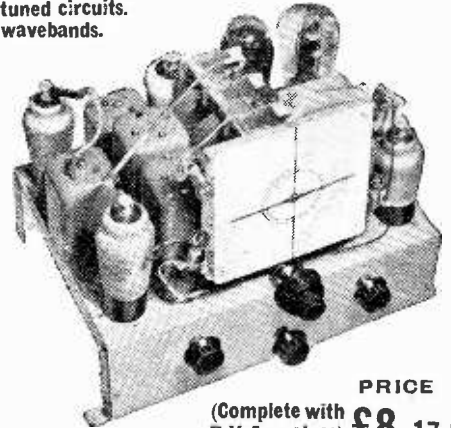

PRICE
(Complete with B.V.A. valves) **£8.17.6**

Performance (made possible by use of multi-electrode valves) equal to that of many receivers employing 8 valves or more. Brief specification includes: Large "Airplane" dial, with different coloured lights automatically switched on for each wave-range. Micro-vernier 2-speed drive. 4-point wave-change and gramophone switch. Volume control and variable tone control also operative on gramophone. Reinforced heavy-gauge steel chassis. Covers 19-2,000 metres. Circuit comprises: Preselector circuit, radio frequency amplifier (operative on all 3 wavebands), triode-hexode frequency changer, double band-pass I.F.T. coupled I.F. amplifier, double diode-triode detector and L.F. amplifier. D.A.V.C. applied to 3 preceding valves. 3-watt pentode output.

Special

6-VALVE BAND-PASS SUPERHETERODYNE



£7 (Complete with B.V.A. Valves.)

Specially designed and built for high quality radio/gram work. **SPECIAL FEATURES:** Reinforced stout steel chassis. High class components by well-known makers of acknowledged reputation used throughout. Fitted with attractive and specially large full-vision dial, glass fronted, and supplied complete with escutcheon and fittings. Separate illumination automatically switched in for radio/gramophone.

CIRCUIT DETAILS: Inductively coupled band-pass filter, triode-hexode frequency changer, band-pass I.F.T. coupled I.F. amplifier, I.F.T. coupled to diode detector. D.A.V.C. applied to preceding valves. L.F. amplifier capacity coupled to output pentode 3-3½ watts undistorted. Variable tone control and volume control operate on both radio and gramophone.

ALTERNATIVE TRIODE OUTPUT
All McCarthy receivers supplied complete with valves, knobs, pilot lamps, leads, mains cable and plug. 12 months' guarantee.

Deferred terms on application, or through London Radio Supply Co., 11, Oat Lane, E.C.2. Cash with order on 7 days' approval. Also write for illustrated catalogue of complete range of all McCarthy receivers.

MCCARTHY RADIO LTD.
44a, Westbourne Grove, London, W.2

Telephone: Bayswater 3201/2.

UNBIASED

Seeing Double at the Coronation

NOW that the shouting and the tumult has died, and the Captains and the Kings are taking their departure from London, we can take stock of the casualties sustained by those of use who were foolish enough to try to fight our way to the front of the crowd on Coronation Day. For my part I was extremely lucky, and got off very lightly. Apart from having my hat knocked over my eyes, my coat torn off my back and nearly losing my trousers in the scrum, I sustained no great damage. If it had not been for the great blessing of television and ordinary broadcasting, I should neither have seen nor heard anything, whereas, as it was, I did quite a lot of both and finished off the day as His Majesty's guest.

Like yourselves, of course, nearly all my spare cash goes in buying hats for Mrs. Free Grid, and so I hadn't any hope of being able to pay the extortionate price that was being demanded for seats in the stands; not that I would have paid the price even if I had possessed the money, as it is against my principles to pay for anything unnecessarily. At first I was in some doubt as to whether I should see the Coronation at all, as I well remember the fierce fight I had to get to the front of the crowd in 1902 and again in 1911. The only alternative is to take up your stand on the kerbside the previous night, but, unfortunately, I am no longer as young and active as I was at the time of former coronations. It was absolutely essential, therefore, to bring science to my aid.

H.T. from the Bank

I quickly made up my mind that I would get as near to the front of the multitude as I could and take my television set with me by the simple expedient of mounting it on the chassis of a tea-waggon and trundling it in front of me. When I had completed my preparations there were one or two small snags, one of which was the question of HT supply. The maximum voltage requirements of a television set are 6,000 volts, but fortunately the current demands are only 1/20th of a milliampere, and so there was no need to go to the expense of connecting up a whole string of HT batteries in series. I made up a very simple HT battery by building a straightforward Voltaic pile consisting of a large number of pennies and half-crowns and electrolyte-soaked cloth discs, each having a hole bored through the centre and threaded on a string in the proper sequential order, and finally hung round my neck like a mayoral chain. My local bank manager, of course, lent me the necessary coinage for the occasion,

By FREE GRID

so my HT supply cost me nothing. Accumulators were arranged to take care of the LT supply, in the ordinary manner.

When I had finally completed the building of my HT battery, and the installation of the set on the tea-waggon, I commenced my preliminary tests and speedily came across one very important omission which prevented me from seeing anything at all: I had neglected to provide an aerial. Unfortunately, this placed me in a very awkward predicament, since it would be impossible for me to erect any form of telescopic aerial which could be reared above the tops of the houses until it had an uninterrupted line of sight to the Alexandra Palace. I did for a time toy with the idea of hiring a telescopic fire escape from the local fire brigade, but eventually abandoned it, for I came to the conclusion that the police would raise silly objections. Unfortunately, aerial-less reception of television in London streets is practically impossible owing to the screening effect of steel-framed buildings.

Had it not been for a fatuous remark made by Mrs. Free Grid, who suggested a periscope on the roof top to divert the

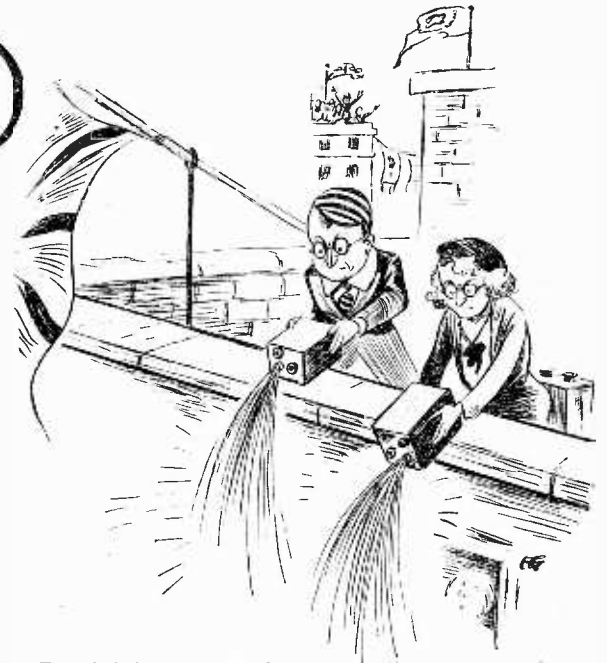

Emptied the contents of their accumulators . . .

stages of this they are fed out again, without any rectification or other nonsense, to the second aerial, which re-radiates them in greatly magnified form. Owing to the small dimensions of the aerial used for ultra-short-wave work, it is a perfectly simple matter to screen them from each other so that they do not interact and produce a sort of self-oscillation effect. The thing is, in fact, analogous to the G.P.O. valve repeaters on their so-called wired-wireless circuit, and I expect that the B.B.C. originally cribbed it from them.

It did not take long to enter into negotiations with the owners of the shop in Regent Street near which I hoped to take up my stand. I managed to hire a bit of roof space very cheaply owing to the fact that Mrs. Free Grid spends the greater part of my income there, and naturally the proprietors did not wish to risk losing her custom. The negotiations for the site completed, I soon had my installation rigged up and arranged for it to be in the charge of a couple of the little Grid Leaks, cutting short their objections that they wouldn't be able to see the procession themselves by pointing out that as they were very young they stood a good chance of seeing future coronations long after I had found a final resting place in the Abbey.

On the great day in question I set forth early with my impedimenta, the relaying party having gone the previous night. I eventually fought my way to a fairly favourable position near an imposing-looking grandstand. I attracted considerable attention, not only from those in my immediate vicinity but also from several plutocrats in neighbouring stands. Some of the latter, whom I realised by the look on their faces must be readers of *The Wireless World*, were so keen that they went so far as to surrender their seats



. . . on the crowd below.

television rays downwards, I should have been compelled to abandon the whole idea. Although, of course, Mrs. Free Grid was obviously talking through her new Coronation hat, I determined to adopt an idea for which I am indirectly indebted to the B.B.C. This is to use two aerials for the Alexandra Palace straight to the grid circuit of an HF valve. After one or two

Unbiased—

to others, saying that they would rather do this than miss such an opportunity of improving their technical knowledge.

All would have gone well had I not overlooked the fact in my calculations that the B.B.C. would probably use an ultra-short wave link as well as a coaxial cable between Hyde Park Corner and Alexandra Palace. At any rate, I can explain subsequent happenings on no other basis, and I am not shaken in my opinion by any foolish denials on the part of the B.B.C., which bitter experience has long since taught me to discount. Although you would scarcely think that the B.B.C. would be so foolish as to use the same wavelength for the wireless link as for the main transmitter at the Alexandra Palace, yet they must at any rate have at least employed a harmonic of it, as otherwise the regrettable events which occurred would never have taken place.

It will be obvious to you that the little Grid Leaks in their roof-top cyrie and myself in the street below were about half a mile from the B.B.C. at Hyde Park Corner and some ten times that distance from the Alexandra Palace. A simple arithmetical calculation will enable you to realise that this unfortunate circumstance meant that the direct signals from Hyde Park were reaching me a tiny fraction of a second earlier than the main ones from Alexandra Palace, with the result that I got pictures of the same event from two different sources, but—and here was the snag—owing to the difference in the distances from which the two pictures were coming, one was just about half a line behind the other.

This resulted, of course, in certain parts of the picture showing white where they should have been black and *vice versa*, although in many instances all was well momentarily as, for example, when two parts of the picture separated from each other by half a line happened for a fraction of a second to be of more or less the same tone. Thus at times the picture was perfectly recognisable and as good as one

could wish for, and the crowd around me cheered vociferously, and at others it resembled nothing so much as a scene from Dante's Inferno and the crowd reacted accordingly. Needless to say, those who had given up their seats in the stand in the hope of having a first-class television view began to get a little restless.

At first I thought that the little Grid Leaks had got the sound and vision wavelengths mixed up, and it was only after a lot of feverish semaphoring to them that the bitter truth dawned on me. By this time, however, the crowd was getting thoroughly out of hand, and there were open murmurings by certain malcontents concerning what they alleged were my subversive political activities, and some even went so far as to say that I was probably in the pay of some foreign power. It only needed a spark to set into open conflagration the undercurrent of hysteria and lynch-lust which is for ever latent in the minds of crowds on these occasions, and the suave voice of the B.B.C. announcer telling us what a wonderful television broadcast it had been provided it.

Had it not been for the prompt action on the part of the little Grid Leaks up aloft, who emptied the contents of their accumulators on the crowd, I hesitate to say what would have happened. Even as it was, I spent the night as one of the many guests which His Majesty entertained at Vine Street and elsewhere on that memorable occasion.

My friends in the suburbs are of the opinion that the *contretemps* was due solely to technical incompetence on my part, as they tell me that the results on their television receivers were all that could be desired. It is quite obvious, however, that in their case they were well outside the range of the comparatively feeble emanations of the B.B.C.'s Hyde Park transmitter, whereas I was not only within a mile of it, but was getting its signals together with those of the Alexandra Palace boosted up by a directional relaying system.



VISION



VISION has always been a highly prized asset. Over 28 years ago T.C.C., gifted with their facility to

visualise the needs of tomorrow, planned and built for the future.

A far-sighted policy, ever insistent on the use of the finest materials, the highest skilled labour and the best brains available has justified the extra care, trouble and expense it involved . . . today T.C.C. are dominant in the field of condenser design and practice. Dominant because every worthwhile condenser development has emanated from T.C.C. . . . dominant because Setmaker, Designer, and Constructor alike has learned to trust T.C.C. . . . the "condenser that never lets you down."

T.C.C.

ALL-BRITISH
CONDENSERS

The Telegraph Condenser Co. Ltd., Wales Farm Road,
N. Acton, W.3.

© 1813

TUNING AID FOR THE BLIND

STATION names are grouped on geographical basis in the tuning scale of the German "Siemens - Standard." There are also two additional scales with raised dots for the use of the blind.

These are situated on the lower edge of the frame surrounding the dial and a projecting pointer indicates the setting of the tuning condenser. The top line of type carries the

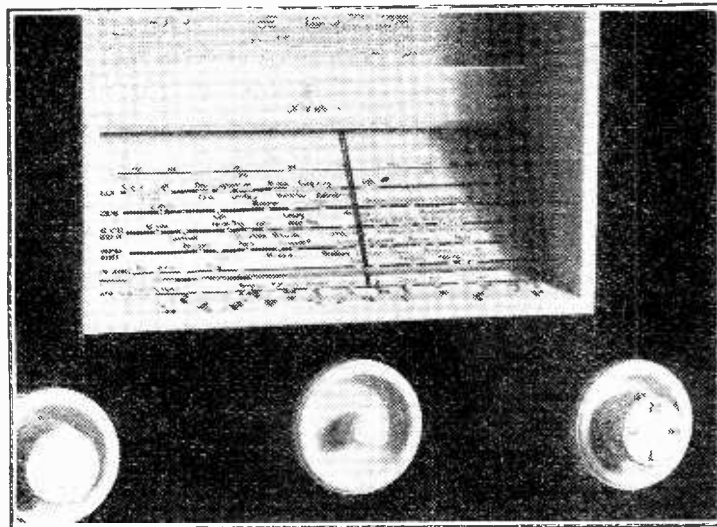

initial letters of the principal German stations and the lower line a selection of foreign stations. In all, there is a choice of 22 alternative transmissions.

CURRENT TOPICS

Paris Exhibition Postponed

THE opening of the Foire de Paris has been postponed until May 22nd. It will remain open until June 7th. Its period of opening will thus coincide with the first two weeks of the Paris International Exhibition, which opens on May 24th. The availability of the special cheap travel tickets from this country has been altered to coincide with the new date of opening.

New Commercial Stations

THE Norwegian Post Office is to erect a 10-kilowatt coast station near Ostre Hauge (Lista) to replace the existing Flekkeroy station, which is out of date. At the same time, the Swedish P.O. is building a new commercial receiving station at Enköping to replace the present one at Kungsbacka. The cost will be 645,000 Swedish Kroner.

A Wireless Strike?

DANISH radio operators, who intended to come out on strike on May 7th, following a breakdown in the negotiations for better conditions, have agreed to remain at their posts pending an investigation of their claim by the Public Conciliator. Apart from questions of salary increases, one of the chief points in the dispute is in regard to automatic call devices on ships. These devices, according to the operators, are unreliable.

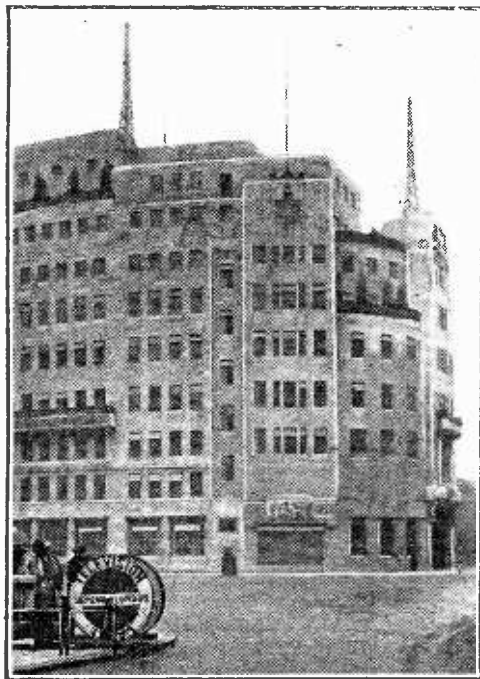

THE LINK.

A network of special twin wire cable for television purposes, linking up Broadcasting House and Alexandra Palace with several prominent points in the West End of London, has recently been laid by the Post Office. The cable was made by Siemens.

Amateurs Celebrate

THE World Friendship Society of Radio Amateurs has just celebrated its second anniversary. It held a birthday party on the other in which all its transmitting members took part.

Station Closes Down

THE broadcasting station which the Government of Iraq opened some months ago at Baghdad has closed down owing to the difficulty of obtaining artistes.

Preparing for 1940

JAPAN has already commenced to make preparations for the Olympic Games, which will be held in Tokio in 1940. Sixteen short-wave telephonic transmitters are to be built at a cost of approximately 1 million sterling in order that the commentaries will be really world-wide.

An Historic PA Undertaking

ALTHOUGH the public address system installed in Westminster Abbey for the Coronation was not exceptionally large as installations go nowadays, the undertaking is surely the most important ever carried out in this country.

According to engineers of Standard Telephones and Cables, the firm which undertook the work, acoustic conditions in the Abbey are not unfavourable—in fact, they are distinctly better than those usually obtaining in similar buildings. Five amplifiers of 30 watts were used, with 120 cabinet loud speakers fitted with small auxiliary diaphragms for high-note reproduction and a phasing arrangement for bass reinforcement.

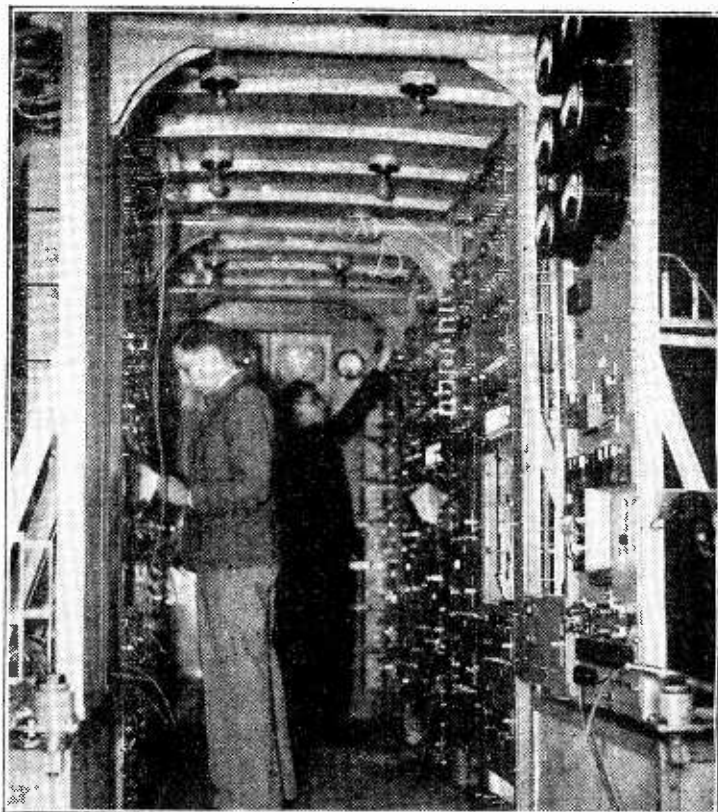

TELEVISION NERVE CENTRE. The interior of the control van which was used for the television broadcast of the Coronation Procession. At the far end of the van can be seen the two monitoring tubes on which the control engineer sees the picture as transmitted. Each tube is connected to a separate camera.

A Record?

THE most radio-minded family in the world is said to live at Brisbane. Paterfamilias Mackenzie is the owner of station VK4GK, his daughter, Madeleine, operates her own station, VK4YL, at the same address, while a third transmitter, VK4HJ, is the property of the eldest son. Two younger sons, aged nine and ten respectively, are both fully qualified Morse experts. The daughter obtained her transmitting licence when she was only twelve years old.

Beverage Aerial and Interference

OWING to severe interference from Moscow, the Uleaborg station in the East of Finland has been compelled to abandon for the time being the use of a wireless link in relaying the Lahti transmissions. At the moment a cable connection, which is said to be very costly, is being employed, but the engineers at Uleaborg are experimenting with a Beverage aerial over a mile long. They are said to have high hopes of this device solving the problem.

New Ray Discoveries

PROFESSOR FREUD is stated to have made an important communication to the Vienna Society of Medicine, in which he alleges the discovery of a ray similar to X-rays, but occupying a different part of the spectrum. The new ray is said to reveal

growths in the human body which are quite invisible with X-rays. At the same time, Dr. Korner, a member of the Austrian Biophysical Society, has been experimenting with the application of short waves to cheese, and is stated to have had remarkable results in the matter of improving its vitamin content.

Historic Building Changes Hands

MARCONI HOUSE, which was the headquarters of Marconi's Wireless Telegraph Co., Ltd., and its associated companies from 1912 to 1933, has been taken over by the Air Ministry and renamed Ariel House. This building, which was built in 1903, was originally the Gaiety Hotel. It will probably be best remembered as the original home of both transmitter and studios of 2LO, which commenced regular broadcasting on November 14th, 1922. The studios were moved to Savoy Hill on May 1st, 1923, but the transmitter was used until February, 1925, when it was transferred to the roof of Selfridges in Oxford Street.

5-15 Metre Reception

In the circuit diagram of this receiver, which was described last week, the Hivac Y220 output valve should not have been indicated as a pentode but as a tetrode.

Letters to the Editor

"Distortionless" Driver

IN your issue of April 30th, Mr. W. N. Weeden describes a method for reducing driver distortion in Class AB circuits by the introduction of negative feedback round the driver stage itself. He also points out the advantages of degeneration in the output stage if pentodes are used, but complains that this increases the demand on the driver.

This difficulty can be avoided if the negative feedback connection is taken from the output load of the amplifier to the input circuit of the driver; and, although some care must be taken to prevent the occurrence of positive feedback conditions at very high frequencies, this arrangement transfers the demand for increased signal voltage to the pre-driver stage, where it may be met without any difficulty. Moreover, the frequency and phase characteristics of the amplifier as a whole will be more nearly perfect, due to the inclusion of the coupling between the driver and output stage in the feedback scheme.

The accompanying oscillograms, obtained with a pair of 6L6 valves driven by a para-phase combination, show results obtained under conditions of uniform output (a) without degeneration and (b) when degeneration is added in the manner described above. A test signal was applied direct to the X plates of the oscillograph and also through an attenuator to the input of the amplifier. The output voltage was applied to the Y plates and adjusted by means of the attenuator to give a figure at 45 degrees to the X and Y axes. It is evident that in the

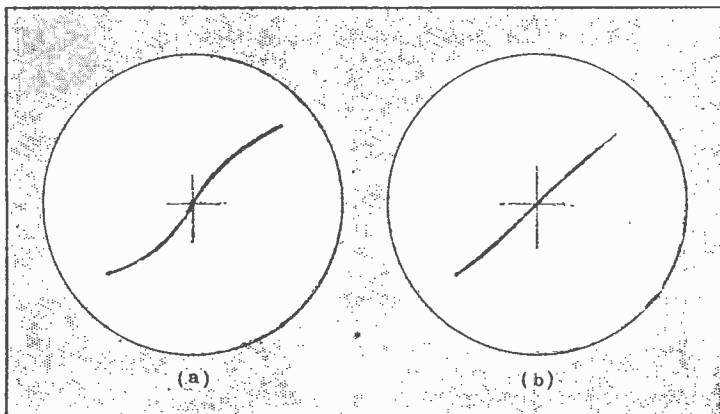

Cathode-ray figures obtained from amplifier. (a) Without degeneration, (b) with degeneration.

absence of amplitude and phase distortion this figure will be a straight line, while any other figure may be analysed graphically to determine the amount of phase shift and harmonic content. In this way we have measured the percentage of second and third harmonic in the two cases illustrated. For the amplifier with negative feedback they are 0.44 per cent. and 3.13 per cent. respectively. Without feedback the second harmonic remained at a very low value, but the third harmonic rose to 14.7 per cent.

London, S.W.1. R. P. G. DENMAN.
E. S. L. BEALE.

"Flutter"

I AM interested in the letters now appearing in your valuable weekly on the subject of "Flutter."

Whilst your correspondent, Mr. G. H. Bradbury, appears to have formulated a more convincing theory than that proffered by Mr. R. G. Young, I do not feel satisfied in my own mind that either of the views expressed is the precise interpretation of the cause of the phenomenon.

The Editor does not hold himself responsible for the opinions of his correspondents

Recently, the writer, dissatisfied with the performance of the AVC system of his receiver (a commercial superhet 7), which produced only 3.75 volts bias on the three variable-mu valves even when tuned to Droitwich, decided that conversion to amplified AVC was easily practicable. The alteration was therefore effected, and an immense improvement was immediately noticeable both in background noise and diminution of fading. The bias had jumped up to 18.8 volts on Droitwich, and I feel that every ounce is not now being squeezed out of the valves to provide sufficient bias.

It immediately became apparent, however, that a symptom I now know as "flutter" had made its appearance. As my experiences in this connection are at variance with those of your previous correspondents, I give them hereunder:—

- (1) Flutter can be provoked on any fairly powerful carrier *whether it is being modulated or not.*
- (2) Flutter occurs only at *minimum* setting of the volume control.
- (3) Flutter occurs at frequency of one per second at zero volume (observed by watching neon tuning indicator), and increases as

VC is advanced, and finally disappears at ordinary listening volume.

(4) Flutter occurs at above 9 Mc/s, since either Schenectady or Zeesen on 19 Mc/s will start it on my receiver.

(5) It has been completely eradicated by (a) reducing delay; (b) reducing resistance in triode-cathode circuit; (c) increasing negative voltage to which diode is connected.

All three, of course, amount to the same thing, and are much cheaper than the other methods advocated.

I trust the above is of sufficient interest to warrant inclusion in your columns.

Fareham, Hants. HAROLD STRIPE.

The Radio Industry

THE Dubilier factory, which closed down for the Coronation holidays on May 11th, will reopen on Tuesday morning, May 18th. Employees are being paid for the holiday period.

Four Grampian C377 amplifiers were used for crowd control, etc., for the Cup Final at Wembley

NOTABLE FEATURES of the New ROLA F 742-PM

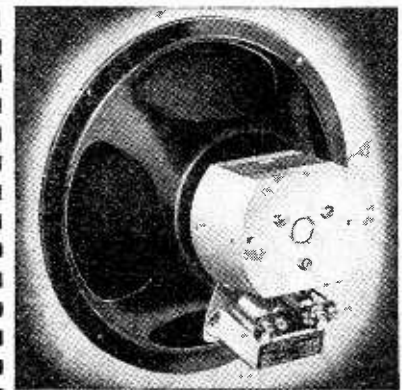

AN IDEAL UNIT FOR BATTERY SET USE

Only a very sensitive speaker will get the best results from a battery set. But very sensitive speakers are frequently very high in price. Here at last is a new 9" PM unit with a flux density equal to the big Rola G.12-PM selling at only 49/6. It is an excellent speaker for use with any receiver, but for a battery set, as an Extension speaker, or under any operating conditions where extreme sensitivity is required, it is absolutely ideal. The new Rola F742-PM makes use of the new magnet material "Alnico" and is equipped with a newly designed metal and compound shielded universal transformer, impervious to moisture—just another Rola refinement.

Write to-day for leaflet AB.

Model F 742-PM 49/6

WITHOUT TRANSFORMER 42/-

OVER 8 MILLION IN USE

ROLA

The World's Finest Reproducers

THE BRITISH ROLA CO., LTD.
MINERVA ROAD, PARK ROYAL, N.W.10.
PHONE: WILLESDEN 4322-3-4-5-6

Brief descriptions of the more interesting radio devices and improvements issued as patents will be included in this section.

Recent Inventions

INTERVALVE COUPLINGS

THE circuit shows a valve coupling suitable for amplifying a wide band of signals, such as are used in television, without discriminating between the high frequencies and the low. The anode to screen-grid capacity of the amplifier V1 can be represented by the condenser C1, since the screen-grid is at fixed or "earthy" potential. Similarly the condenser C2 represents the grid-cathode shunt capacity of the amplifier V2.

These are both in series with two inductances, L1, L2, the midpoint of which is connected through a resistance to the high-tension supply. The capacity C2 should be greater than twice, or less than half, the value of the capacity C1. A mathematical analysis of the frequency-charac-

pulses occurring in the intervals between two successive trains of picture signals—it is possible to apply the former at an earlier point in the chain of amplification than the latter without any risk of intermodulation.

According to the invention this is done, the picture signals in a 40 kW transmitter accounting for 60 per cent. of the modulation and the synchronising impulses 40 per cent. The method simplifies the operation of "mixing" at high voltage levels, and allows either phase or amplitude distortion in either type of signal to be corrected independently.

A. J. Brown and Baird Television, Ltd. Application date July 23rd, 1935. No. 460222.

AUTOMATIC TUNING CONTROL

TUNING is effected by hand in the first instance, and advantage is then taken of a characteristic change which occurs in a "working current" of the receiver, on the approach of resonance, to set the circuits auto-

magnetising current through the powdered-iron core of an inductance, and hence the tuning of associated circuits.

British Thomson-Houston Co., Ltd. Convention date (France) June 7th, 1934. No. 459658.

SUPERHET. RECEIVERS

A DIODE valve is used as the first detector in a superhet. set, and at the same time means are provided to prevent reradiation of the local oscillations from the aerial. The incoming signals are applied to a circuit A, whilst

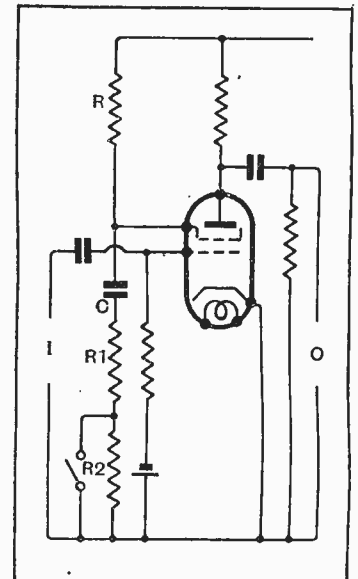

Amplifier for television signals to maintain correct phase relation in input and output circuits.

stage is designed so that the output remains in phase with the input. As shown, the input voltage is applied at I across the control grid and the cathode. The screen grid is connected to HT through a resistance R, and to the cathode through a large capacity C in series with resistances R1, R2. This causes its voltage to swing in phase-opposition to that of the control grid. The anode voltage, in turn, is in phase opposition to that of the screen grid, which brings it into line with the control grid. The output is taken from the terminals marked O.

T. H. Bridgewater. Application date September 26th, 1935. No. 460673.

FLUORESCENT SCREENS

A FLUORESCENT screen giving a brilliant response, closely approximating to pure white, is made by mixing zinc borate—which requires a slight content of an activating substance such as manganese dioxide—with chemically pure zinc sulphide. A water-suspension is first made of the mixture, and after this has been dried out the fine powder is sprayed over the inside surface of the bulb-end of a cathode-ray tube.

The subsequent processing of the tube must be carried out at a temperature not exceeding 300-400 deg. C., so as to avoid any chemical reaction between the pure sulphide and the dioxide used as an activating agent for the borate. Although the light response of the mixture is a more "natural" colour than either of the two ingredients, taken separately, the time-lag effect is no greater than that normally exhibited by zinc borate.

Farnsworth Television Inc. Convention date (U.S.A.) March 13th, 1935. No. 460479.

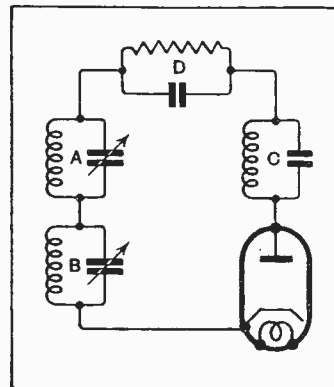

Non-radiating first detector stage for a superheterodyne receiver

local oscillations are fed to a circuit B, the resulting intermediate frequency being collected in the circuit C. A circuit D, comprising a resistance shunted by a condenser, is inserted in series with the anode and cathode of the diode as shown.

Because of the series arrangement only a small proportion of the voltage existing in the local-oscillator circuit B will appear across the input circuit A, so that there is practically no radiation from the aerial.

N. V. Philips Gloeilampenfabrieken. Convention date (Germany) August 19th, 1935. No. 460408.

VALVE AMPLIFIERS

IN most amplifiers, particularly if resistance-capacity coupled, each stage introduces a phase-change of 180 deg., so that an even number of stages must be used if the phase of the output is to agree with that of the signal input. In the case of a television receiver it is important that this phase coincidence should be preserved, since otherwise signals corresponding to a positive picture appear as a negative image on the screen. Accordingly, one may be forced to use a four-stage amplifier, when, in fact, three stages would be sufficient.

To overcome this difficulty each

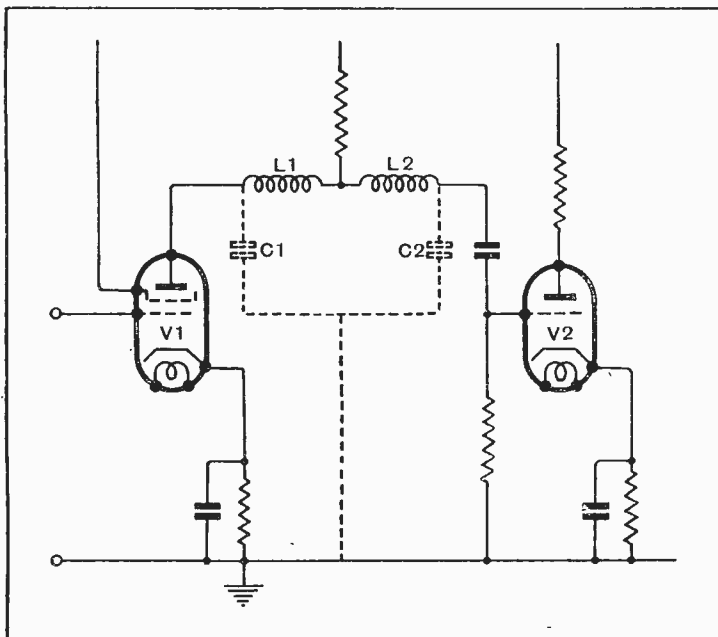

Circuit for amplifier with wide-band frequency response

teristics of the circuit is given in the specification, together with the electrical values of the various circuit components.

J. Hardwick and E. L. C. White. Application date July 9th, 1935. No. 459581.

TELEVISION SIGNALS

IN transmission, picture signals are usually applied to modulate the outgoing carrier-wave at the same point in the chain of amplifiers as the synchronising impulses. This means that the latter must be of comparatively large amplitude. But since the two types of signals are not present at the same moment of time in the radiated wave—the synchronising im-

matically to the exact tuning point. A "working current" is defined to include any current flowing through one of the chain of amplifiers, but excludes any current which is a replica, or derivative of the signal oscillation. The use of auxiliary control devices operated directly by the signal currents is also excluded.

The invention is applicable to "straight" receivers as well as to superhet. circuits. In one arrangement, a triple set of condenser plates is operated through a galvanometer, responsive to the "dip" in anode current, and serves to trim three of the tuned circuits to bring them into resonance. In another arrangement, a change in anode current is used to vary the

The British abstracts published here are prepared, with the permission of the Controller of H.M. Stationery Office, from Specifications obtainable at the Patent Office, 25, Southampton Buildings, London, W.C.2, price 1/- each. A selection of patents issued in U.S.A. is also included.

MISCELLANEOUS ADVERTISEMENTS

NOTICES

THE CHARGE FOR ADVERTISEMENTS in these columns is

12 words or less, 3/- and 3d. for every additional word.

Each paragraph is charged separately and name and address must be counted.

SERIES DISCOUNTS are allowed to Trade Advertisers as follows on orders for consecutive insertions, provided a contract is placed in advance, and in the absence of fresh instructions the entire "copy" is repeated from the previous issue: 13 consecutive insertions 5%; 26 consecutive, 10%; 52 consecutive, 15%.

ADVERTISEMENTS for these columns are accepted up to **FIRST POST** on **MONDAY MORNING** (previous to date of issue) at the Head Offices of "The Wireless World," Dorset House, Stamford Street, London, S.E.1, or on **SATURDAY MORNING** at the Branch Offices, 19, Hertford Street, Coventry; Guildhall Buildings, Navigation Street, Birmingham, 2; 260, Deansgate, Manchester, 3; 26a, Renfield Street, Glasgow, C.2.

Advertisements that arrive too late for a particular issue will automatically be inserted in the following issue unless accompanied by instructions to the contrary. All advertisements in this section must be strictly prepaid.

The proprietors retain the right to refuse or withdraw advertisements at their discretion.

Postal Orders and Cheques sent in payment for advertisements should be made payable to **ILIFFE & SONS Ltd.**, and crossed **& Co.** Notes being untraceable if lost in transit should not be sent as remittances.

All letters relating to advertisements should quote the number which is printed at the end of each advertisement and the date of the issue in which it appeared.

The proprietors are not responsible for clerical or printers' errors, although every care is taken to avoid mistakes.

IMPORTANT NOTICE.

Owing to the Coronation and Whitsun Holidays, the next issue of "THE WIRELESS WORLD" (May 21) is closing for press earlier than usual.

In accordance with the Notice that appeared last week, the latest date upon which Miscellaneous Advertisements could be accepted for the above issue was **FIRST POST FRIDAY, May 14.**

NEW RECEIVERS AND AMPLIFIERS

DEGALLIER'S, Ltd., the best firm for reliable, fully guaranteed ultra short-wave radio, have on view in London without exception the largest selection of all-wave receivers, at very low prices; for instance, a 6-valve superhet., with 3 bands going down to 16 metres, at 7 gns.; an 8-valve superhet., 4 bands going down to 12 metres, with push-pull output 8 watts undistorted, is only 13 gns.; they have a range like this right up to a 24-valve Challenger twin-chassis, valves and two auditorium speakers, 5 bands, 5-2,050 metres, 60 watts undistorted, at £50; the Midwest Royale 24-valve at the same price; they guarantee that every S.W. receiver will get stations on the low bands, including the Americas, etc.; why not call and handle these receivers at your leisure, no obligation to purchase; or send large s.a.e. (2½d. stamp) for beautifully illustrated catalogues; also in stock, Ferguson, Belmont, Crosley, etc.

DEGALLIER'S, Ltd., 18, Connaught St., Marble Arch, London, W.2. Paddington 2745. [4414]

HILL and PONDER Offer Crosley's 8-, 9-, and 10-valve jobs, with 5 bands, 13-2,000 metres; chassis or complete in cabinets; "table-console and radiogram"; all brand new and guaranteed; lists sent on request; these receivers are reduced by approximately 50% from list price.

HILL and PONDER (Dept. W.W.D.), No. 9, Lancaster Mews, London, W.2. [4415]

SPECIAL Coronation Offer: 6-valve chassis with R.F. stage, all wave, twelve months' guarantee; price £8/5; complete table model, £10/10; cash over seven days' trial; please order early.—Elect Radio, Iver, Bucks. [4405]



WE ARE DISAPPOINTED

because **WIRELESS WORLD** readers have not taken as much interest as we hoped in our new **M.A. Receiver.**

True, we have sold all the first batch and delivered them, and many of the second lot are already booked; but, curiously enough, most of the sales are traceable elsewhere,

It may be, of course, that you, our readers of this journal, are set *builders* rather than set *buyers*, but surely you have friends? **AND** if you want to keep your reputation as judges of wireless gear, you *must* learn about the set that gives distant stations **AND** *Hartley-Turner* quality.

Write for our leaflet describing it: you probably already have the 6d. "New Notes"; so just send 3d. for the supplement describing the **M.A.**

Or better still, **COME AND HEAR IT.**

Don't forget: open House on Wednesday evenings till further notice.



HARTLEY TURNER RADIO LTD.

THORNBURY ROAD,
ISLEWORTH, MIDDLESEX.
Telephone: HOUNslow 4488

"ENGINEERING OPPORTUNITIES" FREE!

This unique Handbook shows easy way to secure

**A.M.I.C.E. A.M.I.Mech.E.
A.M.I.E.E. A.M.I.A.E.
A.M.I.W.T. A.M.I.R.E.**
and similar qualifications.

**WE GUARANTEE—
"NO PASS—NO FEE."**

Details are given of over 160 *Diploma Courses* in all branches of Civil, Mech., Elec., Motor, Aero., Radio and Television, Engineering, Building, Government Employment, etc. Write for this enlightening Handbook **FREE** and post free.

BRITISH INSTITUTE OF ENGINEERING TECHNOLOGY,
387, Shakespeare House, 17, 18, 19, Stratford Place, W.1

NUMBERED ADDRESSES

For the convenience of private advertisers, letters may be addressed to numbers at "The Wireless World" Office. When this is desired, the sum of 6d. to defray the cost of registration and to cover postage on replies must be added to the advertisement charge, which must include the words Box 000, c/o "The Wireless World." All replies should be addressed to the Box number shown in the advertisement, c/o "The Wireless World," Dorset House, Stamford Street, London, S.E.1. *Readers who reply to Box No. advertisements are warned against sending remittance through the post except in registered envelopes: in all such cases the use of the Deposit System is recommended, and the envelope should be clearly marked "Deposit Department."*

DEPOSIT SYSTEM

Readers who hesitate to send money to advertisers in these columns may deal in perfect safety by availing themselves of our Deposit System. If the money be deposited with "The Wireless World," both parties are advised of its receipt.

The time allowed for decision is three days, counting from receipt of goods, after which period, if buyer decides not to retain goods, they must be returned to sender. If a sale is effected, buyer instructs us to remit amount to seller, but if not, seller instructs us to return amount to depositor. Carriage is paid by the buyer, but in the event of no sale, and subject to there being no different arrangement between buyer and seller, each pays carriage one way. The seller takes the risk of loss or damage in transit, for which we take no responsibility. For all transactions up to £10, a deposit fee of 1/- is charged; on transactions over £10 and under £50, the fee is 2/6; over £50, 5/-. All deposit matters are dealt with at Dorset House, Stamford Street, London, S.E.1, and cheques and money orders should be made payable to Iliffe & Sons Limited.

SPECIAL NOTE.—Readers who reply to advertisements and receive no answer to their enquiries are requested to regard the silence as an indication that the goods advertised have already been disposed of. Advertisers often receive so many enquiries that it is quite impossible to reply to each one by post. When sending remittances direct to an advertiser, stamp for return should also be included for use in the event of the application proving unsuccessful.

NEW RECEIVERS AND AMPLIFIERS

- AIR KING.**
- ALL** Models Feature Beam Tuning, Magic Eye indicator, gramo. pick-up connections, and special output valves.
- ALL** Sets Fully Guaranteed; H.P. terms available from 3/- per week.
- WHOLESALE** and Trade Enquiries Invited; generous terms.
- ALL** Types of American Valves Stocked; write for lists to
- AIR KING RADIO**, 115, Shaftesbury Av., Cambridge Circus, W.C.2. Phone: Temple Bar 4875 (2 lines). [3406]
- ROYAL RADIO Co.**
- ALL-WAVE** Receivers, suitable for use on ships, as supplied to officers of many shipping lines.
- OUR** 8 and 10 Metal Valve All-wave Receivers; 15-2,000 metres, acknowledged by the trade as the best for range, tone, and general performance.
- LATEST** 6-valve Car Radio, A.V.C., remote control, no suppressors required.
- A FULL** Range of the World Famous Emerson Receivers for Export.
- ALL** Sets Fully Guaranteed by Ourselves.
- ALL** Types of American Valves Stocked.
- PAY** Us a Visit Any Time, or send for full range catalogue; 1½d. stamp will be appreciated.
- ROYAL RADIO Co.**, 5, Buckingham Rd., South Woodford, London, E.18. Phone: Buckhurst 2736. [4426]
- ALERT RADIO Co.**
- "COMMUNICATION,"** "Shortwave" and "Allwave" Receivers.—21, East Rd., N.1. Clerkenwell 4871. [4381]
- "SERVICE** With a Smile."
- HENRY FORD RADIO, Ltd.**
- ELECTRONIC** House, 22, Howland St., Tottenham Court Rd., W.1. Museum 5675. [0511]
- AMERICAN** Wireless Receivers, valves and components.
- Harmar Radio**, 8, Clifford St., London, W.1. [0499]
- PILOT**, Ferguson, Sparton, American transportable, car radio, and others; traders; lists.—Perseus Co., W.W., Burton-on-Trent. [4264]
- £7/5.**—Six-valve all-wave chassis with Sin. Rola, B.V.A. valves, royalties paid, twelve months' guarantee.—Coulphone, Hutton, Preston. [4229]
- MIDGET** Radios, portable, 4 valves, any voltage, M.C. speaker, no installing, leatherette, colours, size 5¼in. x 5¼in. 7½in.; £3/5.—Luke Radio, 165, Rushey Green, London, S.E.6. Hither Green 2864. [4424]

NEW RECEIVERS AND AMPLIFIERS

A
N
GLO AMERICAN RADIO, Ltd., offer you the finest radio receivers and the finest values in the country to-day.

WORLD'S Finest Receiver, such is the new Crosley, outperforms all the multi-valve receivers of the day.

AMAZING Signal to Noise Ratio is the Keynote to the Phenomenal All World Reception; it is a revelation to all who hear it.

AMERICA Received Night After Night With Volume Set Almost at Minimum without a trace of background noise.

CUSTOMERS Everywhere are Delighted, they say they cannot buy a better radio for £60.

£12/19/6.—10-valve High Fidelity 5-band (13-31, 30-80, 75-200, 200-555, 750-2,000 meters), A.C. 97-250 volts, 10 watts undistorted output, metal valves, pre-H.F. stage all bands, A.S.C. (automatic selectivity control, push-pull output, provision grammo, doublet Super A.V.C. Meter calibration airplane dial, band-spread pointer, S.W. calibration; you cannot buy a better set—double the number of valves or three times the price; your price, £12/19/6; with 12in. American Magnavox speaker, £15; table model, £18; Console, £20; Auto Radiogram, £25; cash or c.o.d.; part exchange quotations given.

£5/19/6.—The finest car radio available under £15. Amazing volume and sensitivity, 5-valve A.V.C. superhet, fits under dash of any car; medium wave model, £5/19/6; dual wave model, £7/10.

3 UNPRECEDENTED Cash Bargains at Fraction of Usual Value; send order now cash or c.o.d. (Post 1/-.)

50/-.—Multi-band (7-2,000 meters) communications outfit, battery, valves, 8in. speaker, metal cabinet, 7in. band-spread dial, with S.W. station names and listening times, together with 8in. world rotating globe.

37/6.—Powerful 3-valve Pentode all-wave battery chassis, 12-2,000 meters, grammo., band-spread, 7in. dial, S.W. station names, complete with valves, aerial tested.

21/-.—Superheterodyne short-wave converter, 7-200 meters, 5in. dial with band-spread, operates in front of any superhet or H.F. receiver, mains or battery, complete with valves and cabinets, aerial tested.

H.P. Terms Offered With the Following Exceptional Values; deposit with order secures delivery.

11/1 With Order, 8½ gns. cash.—The amazing new Decca value, 6-valve all-wave (3-band) portable A.C./D.C. superheterodyne, 19-2,000m. 2-speed 7in. airplane dial, station names. A.V.C. (18 payments of 11/1).

20/6 With Order, 16½ gns. cash.—The magnificent new Ferguson 11-valve 4-band, 12½-2,100 meters, 8 watts output, Rola 10in. speaker in beautiful acoustically designed table cabinet (20/6 down, balance over 18 months).

DEMONSTRATIONS Arranged Within Reasonable Distance of London, or at any time at our new showrooms at 39-41, New Oxford St. Otherwise order with confidence, your satisfaction is guaranteed.

4d. Stamps Enclosed Brings Our New Coronation Year Catalogue, fully illustrated and covering every radio need and the finest radio values obtainable.

ANGLO AMERICAN RADIO (AND MOTORS), Ltd., (Dept. W.17), Albion House, New Oxford St., London, W.C.1. Telephone: Temple Bar 3231. [4436]

MCCARTHY New Series of A.C. Universal, Battery, All-wave and other receivers, many refinements, several interesting new models.

IMPORTANT!—All prices quoted for McCarthy chassis include Marconi royalty payments.

MCCARTHY All-Wave Battery Superhet with R/F Stage; £7; separate triode oscillator, L.F. stage, pentode output, ext. speaker and gram. sockets, etc., equals mains performance.

MCCARTHY 6-valve All-wave Superhet with R/F Stage; £8/5; A.C. or Universal, iron-core I.F. coils, Litz-wound tuning coils, illuminated "Airplane" dial, triode-hexode frequency changer, double band-pass coupled I.F. amplifier, L.F. stage, pentode output, D.A.V.C. tone control, ext. speaker and gram. sockets, etc.; performance equals many 8-valve receivers.

MCCARTHY Super 9-valve All-waver with Push-pull Triode Output; £12/12; a set for the connoisseur! McCarthy special 7-valve all-waver with R/F stage, four wave-bands, many interesting new features; £10/10; full particulars on application.

ALL McCarthy Receivers on Heavy Cadmium-plated Steel chassis; quality components and B.V.A. valves throughout.

SEE McCarthy Advertisement on Page 477 for Other McCarthy models; also write for complete catalogue.

MCCARTHY RADIO, Ltd., 44a, Westbourne Grove, London, W.2. [4379]

TRANS-ATLANTIC RADIO for the Finest All-wave Sets and Compacts; agents for Ferguson, Philco, etc.; radio service specialists.—Trans-Atlantic Radio Co., 15, Percy St., W.1. Museum 3096. [4353]

PILOT, Ferguson, Belmont, Pegasus, and Air King all-wavers lead the field, our deliveries are prompt in original cartons, with full guarantees; your trade card will bring our wholesale catalogue from the authorised distributors.—Leonard Heys, 36, Henry St., Blackpool. [0530]

THE Greatest Value in "Ham" Sets.—Hallcrafters Sky-buddy, £9; incorporates B.F.O., phone jack, A.V.C. on-off switch, pitch control, mechanical bandspread, Audio gain control, R.F. control, built-in speaker, 5 Raytheon tubes, all-metal cabinet, a real performer; all other models in stock.

RADIOGRAPHIC, Ltd., 66, Osborne St., Glasgow, C.1. Bell 848. [4386]

PREMIER SUPPLY STORES

All goods guaranteed perfect; carr. paid over 5/-; under 5/- postage 6d. extra.

ALL POST ORDERS TO JUBILEE WORKS, 167, LOWER CLAPTON RD., LONDON, E.5. 'Phone: Amherst 4723.

CALLERS AS USUAL, TO 165 & 165a, FLEET STREET, E.C.4 (Next door to Anderson's Hotel), Central 2833. New Branch: 50, HIGH STREET, CLAPHAM, S.W.4 (Macaulay 2381).

Have you had our GIANT ILLUSTRATED CATALOGUE AND VALVE LIST? Send 4d. IN STAMPS FOR THIS BARGAIN LIST.

SHORT-WAVE COILS, 4- and 6-pin types, 13-23, 22-47, 41-94, 78-170 metres, 1/9 each, with circuit. Special set of 3 S.W. Coils, 14-150 metres, 4/- set, with circuit. Premier 3-band S.W. Coil, 11-25, 19-43, 38-86 metres. Simplifies S.W. receiver construction, suitable any type circuit, 2/6.

COIL FORMERS, in finest plastic material, 1 1/2in. low-loss ribbed 4- or 6-pin, 1/- each.

SUPER CERAMIC CONDENSERS, 8 L.F., .00016, .0001, 2/9 each double-spaced, .00005, .00025, .000015, 3/- each. All brass with integral slow motion .00015 tuning, 3/9; .00015 standard 2/9. S.W. H.F. CHOKES, 9d.

MAINS VALVES, famous Europa 4v, A.C. types, 4/6 each, H.L. L. S.G. Var.-Mu-S.G., H.F. Pens., Var.-Mu-H.F. Pens. 1, 3 and 4-watt A.C. directly heated output Pentodes. Full-wave rectifiers, 250 v. 60 m.a. A.C./D.C. types, 20-volt 18 amp. S.H., Var.-Mu-S.G., H.L., Power and Pen. Following types all 5/6 each. Full-wave rectifiers, 350 v. 120 m.a. and 500 v. 120 m.a. 2½ watt indirectly heated Pentodes, Octode Frequency Changers.

BATTERY VALVES, 2 volts H.F., L.F., 2/3. Power, Super-Power, 2/9. S.G. Var.-Mu-S.G., 4- or 5-pin Pentodes, H.F. Pens., V.-Mu-H.F. Pens, 5/- Class B, 5/-.

AMERICAN VALVES, Genuine American HYTRON and TRIAD first-grade Valves, 3 months' guarantee. All types in stock, 5/6 each. 210 and 250, 9/6 each. New Metal-Glass Valves, all types, 6/6 each. Genuine American DUOTRON Valves, all types, 3/6 each. Valve holders for all above types, 6d. each. OCTOL bases, 9d. each.

3-WATT A.C. AMPLIFIER, 2-stage for mike or pick-up. Complete kit of parts with 3 valves, 40/-.

7-WATT A.C./D.C. AMPLIFIER, 3-stage high-gain, push-pull output. Complete kit of parts with 5 specially matched valves, £4 4s. Completely Wired and Tested, £5/5 0.

COSMOCORD PICK-UPS, with tonearm and volume control, 10/6 each. PICK-UP HEADS only, 4/6 each.

PREMIER MAINS TRANSFORMERS, wire-end type with screened primaries, tapped 200-250 v. Centre-tapped Filaments. Guaranteed one year.—H.T. 3 & 9 or H.T. 10 with 4 v. 4 a. C.T., and 4 v. 1 a. C.T., 8/6. 250-250 v. 60 m.a., 4 v. 1 a., 4 v. 2 a., and 4 v. 4 a., all C.T., 8/6. 350-350 v. 120 m.a., 4 v. 1 a., 4 v. 2 a., and 4 v. 4 a., all C.T., 10/6. Any of these transformers with engraved panel and N.P. terminals, 1/6 extra. 500-500 v. 150 m.a., 4 v., 2-3 a., 4 v., 2-3 a., 4 v., 2-3 a., 4 v. 3-4 a., all C.T., 17/6. **SPECIAL OFFER** PHILIPS MAINS TRANSFORMERS. 250-250 v. or 300-300 v. at 80 m.a., 4 v. 5 a., C.T.; 4 v. 1 a. Tapped Primary 100-250 volts, 6/11. 450-450 v. at 150 m.a. or 500-500 v. 100 m.a., 4 v. 4 a. C.T. 4 v. 4 a. and 4 v. 3 a. Screened Primary. Tapped input 100-250 v., 12/6. **AUTO TRANSFORMERS**, step up or down, 60 watts, 7/6; 100 watts, 10/-; **SMOOTHING CHOKES**, 25 m.a., 2/9; 40 m.a., 4/-; 60 m.a., 5/6; 150 m.a., 10/6. 2,500 ohms, 80 m.a. Speaker Replacement Chokes, 5/6.

Electric SOLDERING IRONS, 200-250 v., A.C./D.C., 2/3.

SPECIAL OFFER, LISSEN TWO-GANG SCREENED ALL-WAVE COILS, 13 to 2,000 metres, complete with switching and wiring diagrams, 6/11 per set.

Special Offer BTH Energised Moving Coils, 10 1/2in. diam., 1,650 ohms field. Power or Pentode transformer (state which), 14/6.

ROLA latest type P.M.s., 15/-; **GOODMANS'** Sin. mains energised 1,000 ohms field, 10/6 each; **Jensen P.M.s.**, 10/6.

W.B. 1936 STENTORIAN SPEAKERS, Standard model (list, 32/6), 22/8. Senior model (list, 42/8), 28/6. Brand new in original sealed cartons.

TRANSFORMERS, latest type Telsen E.G.4 (list, 12/6), 2/9. Lissen Hypernik Q.P.P. (list 12/6), 3/6.

OUTPUT TRANSFORMERS for Power or Pentode, 2/6; Multi-Radio, 4/6.

TUBULAR CONDENSERS, non-inductive, all values up to .5 mfd., 6d. each.

Wire-end RESISTORS, any value, J watt, 6d.; 4 watts, 1/-; 8 watts, 1/6; 15 watts, 2/-; 25 watts, 2/6 each.

Reliable **MORSE-KEYS** with Morse Code engraved on bakelite base, 2/- each.

Bakelite case **BUZZERS**, 1/6; Walnut case "Loud-tone," 2/6 each.

Super Quality lightweight **HEADPHONES**, 3/9 pair.

TELSEN DISC DRIVES, W 184, 1/- each.

GRAMOPHONE MOTORS, Collaro Gramophone Unit consisting of A.C. motor, 100-250 v., high quality pick-up and volume control, 45/-; Collaro motor only, 30/-; Collaro Universal Gramophone Motor, 100-250 v. A.C./D.C., 42/6; Edison Bell double-spring motor, including turntable and all fittings, 15/-; CosmoCORD Grammo. unit, comprising A.C. motor pick-up and volume control (list 55/-), 35/6.

NEW RECEIVERS AND AMPLIFIERS

COMMUNICATION Receivers, Hammarlund, National, Hallicrafters, R.M.E.69, Tobe-Deutschmann; transmitters, Collins 45A, Peerless DX20, or built to order; American valves, microphones, Eddystone components.—A.C.S., Ltd., 52,4, Widmore Rd., Bromley. 'Phone: Ravensbourne 0156. [0550]

RECEIVERS AND AMPLIFIERS CLEARANCE, SURPLUS, ETC.

ALL Lines Previously Advertised Still Available.

HENRY'S, 72, Wellington Ave., N.15. Stamford Hill [4435] 2907.

CLEARANCE List (Trade Only).—Write Leonard Heys, 36, Henry St., Blackpool. [0527]

ARMSTRONG Co. Have a Further Few Soiled but Genuine Brand New Radio Chassis for Disposal at Considerably Less Than Cost Price, described hereunder.

ARMSTRONG 1937 9-stage Radio-gramophone Chassis, covering 4 wavebands from 12.9 metres, circuit H.F. Pentode as radio frequency amplifier, tuned H.F. transformer coupled to hexode triode, detector oscillator, 2 band-pass coupled I.F. amplifier stages, double diode triode, detector and L.F. amplifier, push-pull output stage capable of handling 5 watts, highest grade components used throughout. "Airplane" multi radio drive, all wavebands calibrated station names, tone control works on both radio and gramophone, provision for extension speaker, etc.

SEVERAL Chassis as Above, brand new, but chassis slightly marked; price, complete with Mullard valves, 9 gns.; an exceptional opportunity.

ARMSTRONG Co. Also Offer Few Genuine 1937 Armstrong Gv. All-wave Superheterodyne Radiogram Chassis, brand new but cellulose slightly marked, complete with new full size Rola moving coil speaker and 6 new and fully guaranteed Marconi or Mullard valves; these chassis are the well known 3BPT models containing high grade British components, are ganged and aerial tested, and ready to switch on; price £6/10, complete.

ARMSTRONG Co. Have Technical Data Sheets Available.

ARMSTRONG Co. Will Willingly Send Above Chassis on 7 Days' Trial, carriage and packing free.

ARMSTRONG MANUFACTURING Co., 100, King's Rd., Camden Town, N.W.1. [4333]

CAR RADIO

PHILCO Repairs and Installations, trade distributors.—Radiorite, Ltd., Moorfields, Liverpool. Bank 8811. [4321]

PUBLIC ADDRESS EQUIPMENT

SPECIAL Offer!!!

8½ Gns. Complete.—Vortexion portable 15-20 watt 4-stage amplifier, independent mike and pick-up inputs, outputs for 7½ and 15 ohm speakers, weight 25lb., 4 independent input model, £10.

HEAVY Duty 20 watt model, as fitted to dance halls and cinemas, etc.; £15, complete with valves.

60 Watt Model for £16, with microphone and gramophone independent inputs, and outputs for 4, 7½, 15 and 30 ohm speakers, consumption 150 watts, in ventilated steel carrying case; £24 only! complete with valves less two 6L6s.

WHY Not Call and Have a Demonstration.

VORTEXION, Ltd., 182, The Broadway, Wimbledon, S.W.19. 'Phone: Lib. 2814. [4254]

ALL Types of Public Address Apparatus for Sale or Hire.

WARD, 46, Farringdon St., London, E.C.4. Tel.: Holborn 9703. [0565]

TRADERS, write for our lists; all best makes equipment supplied.—Perseus Co., W.W., Burton-on-Trent. [4266]

HARMONY HOUSE SOUND SERVICE, Southport.—Beam power amplifiers, 14 watts output; £13/10 (subject); send for lists. [0546]

Amplified Speech and Music for Fetes, sports meetings, etc., using our public address mobile equipments, also smaller equipments for dinners, dances, conferences, etc.—Harmony House Sound Service, Southport. [0548]

ARMSTRONG Latest Coronation 30-watt Public Address Amplifier, incorporating 3 input circuits and self contained Fader system; both microphone stages have a total gain of 97db. and are electron coupled; this apparatus is particularly suitable where large output is required; price complete, 16 gns.; British throughout.

ARMSTRONG 10-watt High Fidelity Amplifier, suitable for indoor public address or gramophone reproduction, two inputs, controlled by self contained Fader unit, tone control working on both inputs, Class A push-pull output; British throughout; price complete with valves, etc., 9 gns.

ARMSTRONG, 100, King's Rd., Camden Town, N.W.1. 'Phone: Gulliver 3105. [4384]

USED SETS FOR SALE AND WANTED

W.W. MONODIAL

A.C. Monodial Super, complete, bests ganging, £9; with Magnavox Duode, £12.—Box 1870, c/o The Wireless World. [4411]

EXCHANGE OR WANTED

WANTED. "W.W." push-pull quality amplifier.—Robertson, Spixworth, Norwich. [4423]

NEW MAINS EQUIPMENT

VORTEXION Quality Transformers
VORTEXION Supply the B.B.C., G.P.O., L.P.T.B., I.C.I., Borough Councils, etc. Why not you?
ALL Fitted Screened Primaries, and tapped 200-250v. with centre tapped filaments, guaranteed one year.
W.W. Q.A., 425-0-425v., 120-160 m.a., 4v. 5-10a., 4v. 2.5a., 4v. 1-2a., 4v. 1-2a., super shrouded model; 32/-.
500 0-500v. 150 m.a., 4v. 4a., 4v. 2.5a., 4v. 2a., 4v. 2a., 4v. 2a., ruper shrouded model, 2.5% regulation, 35/-; open type, 32/-; 400 or 450v., same price.
350 0-350v. 120 m.a., 4v. 2-6a., 4v. 2-4a., 4v. 1a., 4v. 1a., super shrouded, 25/-; normal shrouded, 21/-; open type, 18/6.
350 0-350v. 75 m.a., 4v. 2-4a., 4v. 1-2a., shrouded, 18/-; open type, 16/-.
250 0-250v. 60 m.a., 4v. 2-4a., 4v. 1-2a., shrouded, 15/-; open type, 12/6.
AUTO Transformers, 100-120 to 200-240v.; 80 watts 11/-; 120 watts 14/6, 200 watts 21/-, 500 watts 37/6.
CHOKES—30 h. 60 m.a., 7/6; 7-13h. 120 m.a., 12/6; 30h. 150 m.a., 15/-.
OUTPUT Transformers—4-10 watt W.W. Q.A., 21/-; 20 watt super shrouded, 30/-.
VORTEXION Ltd. 122, The Broadway, Wimbledon, London, S.W.19. (Telephone: Liberty 2814.) [3951]
PARTRIDGE Transformers for P.A., radio, relay, transmitting, recording, talkies, television, etc.—N. Partridge, B.Sc., A.M.I.E.E., King's Buildings, Dean Stanley St. London, S.W.1. [4372]
TANTALUM for A.C. Chargers, H.T. and L.T.—Blackwell's Metallurgical Works, Ltd., Garston, Liverpool. [5984]

CABINETS

RADIOGRAM Cabinets, new designs, 30/- to £5/10; inspection invited or photos for selection sent on request.
TABLE Radio Cabinets, undrilled, 6/6 upwards.
SPEAKER Cabinets, 4/6 upwards.
MANUFACTURERS' Clearance.
ULTRA Radiogram Cabinets, undrilled, 33x23x14 or 33x20x15, 30/-.
BURGOYNE "Fury" Radiogram Cabinets (undrilled), 34x22x16 1/2; 49/6.
K. B. De Luxe Walnut Cabinets, undrilled, chromium plated edges and speaker grille, 25in. wide, 14 1/2 in. high, 10 1/2 in. deep, 18/6; Console model, 42in. high, 21 1/2 in. wide, 11 1/2 in. deep, 39/6.
HALYCON Radiogram Cabinets (Reconditioned), 33x23x19, 35/-.
H. L. SMITH and Co., Ltd., 287-9, Edgware Rd., London, W.2. Tel.: Pad. 5891. [0485]

DYNAMOS, MOTORS, ETC.

ALL Types of Rotary Converters in Stock, new and second-hand.
WARD, 46, Farringdon St., London, E.C.4. Telephone: Holborn 9703. [0518]
A.C.-D.C. New Motors, all voltages; from 14/9; lists free. —Repair Specialists, Easco Electrical Service, 18w, Brixton Rd., S.W.9. [0455]

RECORDING EQUIPMENT

SIMPSON 5 gns. Recording Turntable, new; 3 gns.; offers.—Cass, Cliff Lodge, Beechen Cliff Rd., Bath. [4404]

NEW LOUD-SPEAKERS

BAKER'S Quality Surplus Speakers.
If You are Requiring Quality Reproduction at Low Cost order one of the following brand new bargain speakers now. The Auditorium models are fitted with latest triple cone comprising main curved cone and bakelite and duralumin cones combined, giving wide and even frequency response, resulting in quality reproduction of speech and music. The Coronation surplus horn models are ideal for reproduction of transients.
39/6 Only, usual price £5.—Auditorium Permanent Magnet Speaker, with Alni magnet and die cast frame, large 12in. triple cone giving wide frequency range, complete with large 25 ratio transformer suitable for all outputs, including push-pull and Class B, etc.
59/6 Only, usual price £6.—Auditorium Electro-Magnet Speaker, 1,000, 1,250, 2,000 or 2,500 ohms field exceptionally large magnet of high permeability steel giving enormous flux density, 2in. moving coil, large triple cone giving wide frequency range, complete with universal transformer, the ideal speaker for use with "Wireless World" and other quality amplifiers.
75/- Only, usual price £9.—As above, but for use on A.C. mains; complete with Westinghouse rectifier and null smoothing equipment.
49/6 Only, usual price £6.—Coronation Surplus Horn Permanent Magnet Moving Coil Speakers, suitable for domestic or public address; the horn is of moderate size and the speaker is therefore ideal for home use where good reproduction of transients is required; can be used separately or in conjunction with baffle board speakers.
15/6 Only.—Permanent Magnet Speaker, Alni magnet, 8in. cone, Universal transformer.
12/6 Only.—Permanent Magnet Speaker as above, with 7in. cone.
2/9 Only.—Brand new cabinets, 12x10x6.
8/6 Only.—Electro-Magnet Speakers, with 8in. cone, 6,500 ohms field, Universal transformer.
ALL Baker Quality Surplus Speakers are Sold for Cash or C.O.D.
BAKER'S SELHURST RADIO, Ltd., The Pioneer Manufacturers of Moving Coil Speakers, 1925-1937.—75-77, Sussex Rd., South Croydon. (Croydon 3441.) [4433]
VAUXHALL—Best quality speakers; see other column last week.—Vauxhall Utilities, 163a, Strand. [4421]

Notes

No. 38

on the Suppression of Electrical Interference with Broadcast Reception

When giving advice about the erection of an anti-interference aerial such as an "Eliminoise," we always stress the fact that the top transformer and the "capacity top," "roof" or "top span" as distinct from the shielded down lead or transmission line, must be some feet clear of any conductors (including rain gutters).

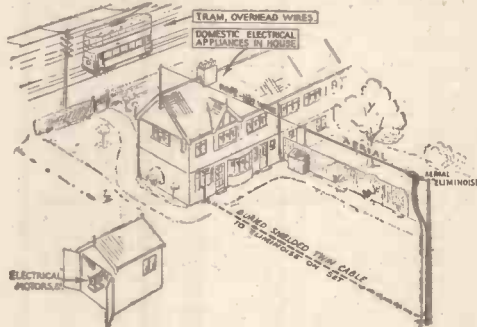

Often people consider this an insurmountable difficulty. It may be in certain cases, but, generally speaking, it can be overcome by the simple expedient of leading in from the far end of the aerial, i.e., from a pole at the bottom of the garden rather than from the house end. Few people have the pole half-way up the garden; it is almost invariably at the bottom, any unwanted length being taken up by rope. Well, let the rope be at the house end. The screened cable may either be stapled to a wall or fence, or buried. The burying of a cable is not the arduous job that it sounds, provided that the lay is across a lawn. All that is necessary is to step a spade right down and to move it backwards and forwards, making a wedge-shaped slot. This is done right across the lawn, and the cable is pushed down with a stick. The opening, barely an inch wide can be filled with earth or sand to the ultimate benefit of the lawn. When laying a cable across any part liable to be dug, it is advisable to lay in conduit or other pipes or iron tubes, or to lay a creosoted board on top of the cable to prevent accidental damage when digging.

In bad cases of interference an aerial so erected will be found of great benefit in reception.

Before going to all this trouble it is always worth while trying a mains filter such as type †300 in the mains lead to the receiver. The price is only a guinea against the material cost of 35/- plus cable at 10d. per yard, plus any labour charges. Of course, where both mains conducted interference as well as radiated interference is present, both a 300 suppressor and an "Eliminoise" will be required. The type 300 may be had on loan against remittance on the understanding that in the event of it not being the correct cure in your case, the remittance will be refunded, less C.O.D. charges. In every case please discuss this with your dealer before writing to us. He is expected to stock such a regular line, and this C.O.D. service on trial does not apply to the trade.

Go to your dealer first, it will save you time, C.O.D. charge and carriage.

* "Eliminoise" (Trade Mark) Anti-interference Aerial. For broadcast bands 10-2,000 metres 35

† "C" type Shielded Cable for Down Lead, per yard ... 16

‡ Type 300 Mains Filter, for set lead, 10 to 2,000 metres, ...

Send for the book, "Interference Suppression," post 1s. 2d., or for free copy of "The Eliminoise System" other relative literature.



Belling & Lee
 Cambridge Arterial R
 Enfield, Middx.
 Telephone: Enfield 332

LOUD-SPEAKERS

SECOND-HAND, CLEARANCE, SURPLUS, ETC.

MAGNAVOX Duode 33 Speaker, 2,500 field, universal transformer, brand new; £3.—Cobbett, 3, Birchwood Drive, Wilmington, Kcnt. [4408]
VAUXHALL—A.I. speakers previously advertised are standard lines, ready for immediate delivery.—Vauxhall Utilities, 163a, Strand. [4420]

TESTING EQUIPMENT

UNIVERSAL Avo. 36 range, nearly new, £8/8; Wcarite oscillator, £3/15, listed at £6/15; Radiolab valve tester, £5/5, listed £9/15.—451, Seven Sisters Rd., N.15. [4416]

VALVES

ANDERSON.
AMERICAN Valves, all makes, first grade only; 5/- each.
ANDERSON, 35, Lansdowne Rd., Walthamstow, E.17. Walthamstow 0827. [3351]
6L6 3/9; all other popular types American valves. 3/-; 90-day guarantee.
EIMAC, Taylor, Raytheon and R.C.A. in stock.
RADIOGRAPHIC Ltd., 66, Osborne St., Glasgow, C.1. Bell 848. [4387]
TRADERS, write for lists, cheap and best American and replacement mains and battery valves; lists.—Perseus Co., Burton-on-Trent. [4265]
AMERICAN Valves, first grade, in all types; trade supplied.—Metropolitan Radio Service Co., 1021, Finchley Rd., N.W.11. Speedwell 3000. [0436]
ALL Types of American Valves in Stock of Raytheon, Sylvania, and Arcturus makes, at competitive prices, guaranteed for six months; send for full list; 350 ohms line cords, 2/8.
WARD, 46, Farringdon St., London, E.C.4. Tel.: Holborn 9703. [0452]

NOTHING Better Available. Six months' guarantee, complete range of battery, A.C. mains, rectifiers, always in stock, 2 volt det., H.F., L.F., 2/3; Power, 2/9; screen grid pentode, H.F. pentode, 5/-; American types, six months' guarantee, 5/6 each, Nos. 18, 24A, 35, 42, 43, 45, 47, 56, 57, 58, 75, 77, 78, 80, 2A5, 2A6, 2A7, 6A7, 2B7, 6B7, 6C6, 6D6, 25Z5, 25Y5.—Write for other prices to Dulci Electrical Co., Devonshire Works, Duke's Av., Chiswick, London, W.4. [0501]

METERS, ETC.

FERRANTI Meters, 450 new and boxed; 38 discontinued types, approximately 75% off list; 200 O.P.V.; 1,000 O.P.V.—Farnell, 12, Heaton Park Rd., Bradford.

M
 SEC
 V
 V
 Ar
 V
 9d.
 V
 pr
 V

SOUND SALES

AT THE
Coronation

Our numerous friends will be interested to hear that we have secured the Public Address Contract for the Coronation Celebrations at Wembley, taking place at King Edward VII Park, Roe Green Park and Vale Farm Swimming Bath. In addition to this, S.S. equipments are being installed at Park Lane, London, W.

Naturally we pin our faith on absolutely standard amplifying equipments, and the majority of installations will consist of 30 WATT AMPLIFIERS and 14 WATT AMPLIFIERS—THE SAME AS YOU CAN BUY.

Thanks to the super-sensitivity of S.S. P.A. Speakers, we are not forced to use enormous amplifiers—our 30 watt amplifier will make itself well and truly heard.

May we send you further particulars



SOUND SALES
MARLBOROUGH RD.,
UPPER HOLLOWAY,
LONDON, N.19.

(Contractors to the
G.P.O., etc.)
Tel.: Archway 1661/2/3

COMPONENTS—SECOND-HAND, CLEARANCE, SURPLUS, ETC.

R. RADIO CLEARANCE.

ALL Lines Previously Advertised Still Available.

RADIO CLEARANCE, 63, High Holborn, W.C.1. Holborn 4631. [4398]

PREMIER SUPPLY STORES.

PLEASE See Our Displayed Advertisement on page 2. [0488]

SOUTHERN RADIO'S Wireless Bargains; all goods guaranteed and sent post paid.

RECORD Changers.—Garrard Model R.C.4, plays automatically and changes eight 10in. or 12in. records of any kind, new, in sealed cartons; 2/6.

GRAMOPHONE Motors.—Collaro electric radiogram units, for A.C. or D.C. mains, 100-250 volts, fully auto stop, complete with pick-ups, can be used on any mains, brand new, in sealed cartons. 5/7-; Collaro spring gramophone motors, with 10in. turntable, complete with all accessories. 11/7-; all Collaro motors are brand new, in sealed cartons.

SPEAKERS.—Celestion Soundex, permanent magnet, 10/7-; Telsen permanent magnet, with 10-ratio transformer, to suit any receiver, 12/6; Telsen loud speaker units, 2/6; all brand new and boxed.

COILS.—Telsen iron core W349 (Midget size), 4/7-; type W478 (twin), 9/7- pair; type W477 (triple), 16/7- per set; type W476 (triple superhet, selector and oscillator), 16/7- per set; Telsen short wave coils, matched set of three, 4-pin bases, 12-26, 22-47, 41-94 metres, 5/7- per set; Telsen dual range H.F. transformer and aerial coils, type W154, 3/7- each; all ganged coils complete on base with switch; Telsen I.F. transformer coils, 110 k.c., 5/7-; Telsen dual range coils, with aerial series condenser incorporated, type W76, 4/7-; Telsen aerial condensers, with shorting switch, 2/7-; all Telsen components brand new, in sealed cartons.

AMERICAN Valves.—A full range of valves for all American receivers; 6/7- each.

MISCELLANEOUS Bargains.—All brand new, in original sealed cartons; Telsen A.C./D.C. multi-range voltmeters, 3/7-; 3-range meters, including milliamps. 4/7-; Ace (P.O.) microphones, with transformer, ready for use with any receiver. 4/6; Bell transformers, 200-250 volts input, 3, 5, or 8 volts output, 3/6; Morse signal units, incorporating buzzer, tapper and flash, with international code, complete with batteries and bulb. 3/9 each; lightweight headphones, double-pole, 4,000 ohms each ear-piece, 3/7- pair.

REGENTONE Eliminators, A.C. 200-250 volts, type W5a, with trickle charger; 37/6.

SOUTHERN RADIO.—Branches at 271-275, High Rd., Willesden Green, N.W.10; 46, Lisle St. London, W.C.2. All mail orders to 323, Euston Rd., London, N.W.1.

SOUTHERN RADIO, 323, Euston Rd., London, N.W.1 (near Warren St. Tube). Phone: Euston 3775. [4429]

STANDARD RADIO SUPPLIES, 1, Dantzic St., Manchester. Note our very low prices.

RECEIVERS.—Vidor band pass, all-wave battery set, moving coil speaker, wavebands 17-51, 185-550, 750-2,150 metres; circuit, band pass input to VMHF pentode, triode detector, pentode output; £8/8 list, 3 gns.

GRAMOPHONE Motors.—Garrard 202 AC7, comprising AC motor and pick-up, list 4 gns., £2; Cosmocord gramophone unit, model AC7/UP, comprising AC motor, pick-up, volume control, list 59/6, 35/7-; Garrard record changer, plays automatically, changes 8 records of any kind, £5/15; Cosmocord pick-up with tone arm volume control, 9/6; pick-up heads only, 4/3.

VALVES.—Europa, AC.HL, 8G, VMSG, VMHFPen, HFPen, Pentode, FW Rectifier, all at 4/7-; FC4 type, Pen4VB type, FW350/120 m.a., 5/3 each; PM24M type, 6/3; Hivac at trade discounts.

BAND Pass Tuning Pack, comprising set of 3 ganged Wearite coil, with switching, 3 gang 0.0005 condensers with top trimmers, disc drive, 4 valve holders; 21/7- the lot.

COILS.—Telsen iron core, W349 (midget size), 3/9; W478 (twin), 8/6; W477 (triple), 15/7-; W476, 15/7-; 1F transformers, W482, 4/9; Telsen AC/DC Multimeter, 8/7-.

ALL Orders Value 5/7- Post Free; under 5/7- postage extra; no c.o.d. orders under 5/7-.

STANDARD RADIO SUPPLIES.—Every article sold is guaranteed.—1, Dantzic St., Manchester. [4418]

ALL'S RADIO, 280, High Holborn, London, W.C.1, offer new goods at knock-out prices.

AMPLIFIER, with 6-watt output, 3-stage, for A.C. 200-250v., splendid chassis, Ferranti transformer, etc with 5 valves; 50/7-.

Electrolytics, tubular can type, dry, 16x8 mfd., 50v., 1/7; 4x4 ditto, post extra on this line.

0.1 Tubular Non-inductive 1,000v. Test Condensers, 2/6 dozen, tag ends; 0.01 ditto N.S.F. 25x25 for 3/7-, tubular, wire ends.

Matched Ferranti Screened Coils, aerial and with reaction, sensitive and selective; 2/6 per set type.

Mains Transformers, as used in their own home receivers, 350-0-350v., 70 m.a., 4v. 2 1/2a., 100v. input 200-250v., brand new; 6/6 each. [4402]

700 Celebrity Polydor, H.M.V., Columbia, Decca, Brunswick, Hot Rhythm, etc.; records from 6/7- to 20/7- dozen.—Farnell, 12, Bradford. [4431]

Unused Ferranti M.1. 50/7-; nearly new Stentorian, 20/7-; unfilled brand new super capacity unit, 20% off list; various components in clean condition.—Farnell, Banham, Norwich. [4428]

RAYMART

CRAFT A CREED

We have been appointed British
Concessionaires for the
BASSETT CONCENTRIC FEEDER

This feeder marks a great technical advance on existing transmission lines and a correctly designed concentric line has long been acknowledged as being far superior to any other method of connecting an aerial to either a transmitter or receiver, with minimum attenuation of all frequencies. This Co-axial line has a surge impedance exactly equal to that of the centre of the average doublet aerial. It is absolutely impervious to weather and can be buried in the ground or even taken through water without loss.

Attenuation on the high frequency spectrum is not greater than six-tenths of one db per 100 feet and it can handle up to 2 kilowatts with ease. Accepted and used by all the principal manufacturers of transmitting and television equipment throughout the United States. Low in cost.

TYPE BCF-50, 50 ft. line with connectors ... 50/-
TYPE BCF-75, 75 ft. line with connectors ... 65/-
TYPE BCF-100, 100 ft. line with connectors ... 85/-
Deliveries in strict rotation.

Further technical information on receipt of stamped addressed envelope.

OUR SHORTWAVE MANUAL AND CATALOGUE, 48 pages in all, 32 on receivers, transmitters, aerials, circuits, etc., etc., and 16 on a splendid range of shortwave components, 6d., or post free, 7d. 16 p. Shortwave Catalogue only, 1/2d.

MICROVARIABLES.—All brass construction, latest ceramic insulation. The finest condensers made: 15 mmfd., 1/4; 40 mmfd., 1/7; 100 mmfd., 1/10; Transmuting Type—0.070in. spacing, 13 mmfd. (neutralising), 2/9; 40 mmfd. Tuning, 3/8. These are quality.

SHORTWAVE COILS.—(RD4), CA 11-25, CH 20-45 metres, 2/6. OO 44-100 metres, 2/9. Standard 6-pin types, CA6, CB6, 2/9 each; OCC, 3/7-; same range as 4-pin.

COLIFORMS.—Moulded in RD4 natural loloos material, hollow resilient pins, 1 1/2in. diameter, ribbed; identification disc in top. Four types, 4-pin, 1/3; 6-pin (standard) or to fit 7-pin valveholders, 1/9; 7-pin (for bandspread tap), 1/10; Machine threading, 2d. extra.

AMERICAN Mains Transformers, Heavy Duty 350-350v. 150 m.a. 6.5v. 4a., 5v. 3a., 12.6. GE 350-350 v. 80 m.a. 2.5v., 4.5a. 5v. 2a. 6.11. Majestic, 250-250 2.5v., 5v., 4/11; Pilot 200-200, 2.5 v. C.T., 5 v. C.T., 5/11. Ceramic American Valveholders, 1/- each.

HEAVY DUTY Bina Transformer, worth 45/-, 350-350, 150 m.a., 4 v., 2.5 A. C.T., 4 v., 6 A. C.T., 12/6; Philips 270-270, 120 m.a., same LT's, 6/6; Speaker Transformers, 2/6.

UTILITY 86 Microdots, Dials, 3/11; Radiophon, 0.00016 Shortwave Condensers, 3/6; Series gap twin, 3/9. Shortwave HF Chokes 5-100 metres, 8d.

465 KC Liz Wound IF's, 3/11; Two-speed slow-motion knobs, 1/7-; Telsen Ace Transformers, 1/11; Telsen Screened S.W. H.F.C., 1/7-; Iron Core H.F. chokes, 1/7-.

ELECTROLYTICS. Huge purchase 500 v. Aluminium Can, 4 mfd., 1/6; 8 mfd., 1/11; 8 + 8 mfd., 2/6; Block type, 500 v. peak, 4 + 4 mfd., 1/6; 8 + 8 + 4 mfd., 3/7-; 50 mfd. 50 v., 1/3; 25 mfd. 25 v., 1/7-; Tubular Condensers, 1,000 v. T., all sizes to 0.1 mfd., 6d.; 0.2 to 0.5 mfd., 8d.

FAMOUS CONTINENTAL A.C. Valves, 4/3; Battery types from 2/3; American Duotron, etc., all types, 3/6; all types of RCA Licensed first grade tubes, metal and glass, in stock from 5/6.

BRITISH RADIOPHONE .0005 straight or superhet 3-gang fully screened condensers with trimmers, 4/11; Utility Midgy 2-gang ditto, 3/11; S.L. Dial to suit above, 2/11; Utility 2-gang Unknob .0005 with Dial, 3/11.

PUSHBACK Wire, 6 yds. 6d.; heavy, 9d.; Resin-cored Solder, 6ft., 6d.; Screened Flex, single, 6d. yd.; twin 9d. yd. Assorted Solder Tags, 6d. packet.

SMOOTHING CHOKES, 20 hr., 120 m.a., 3/11; 200 m.a., swinging chokes, 3/6; Centralab Pots, all sizes, 1/6; switched, 2/7-; 20,000 ohm Pots, 1/7-; Tubular glass fuses, 2d. Milliammeters, 25 m.a. upwards, 5/9; super, 6/9.

SPECIAL OFFERS. Class B Kit, worth 30/-, comprising Driver Transformer, Valve and Holder, 5/-; Dozen wire-ended assorted resistors, 1/6. Order 5/- post free. Get our Bargain Catalogue, 11d. post free. All enquiries and requests for Catalogue must send 11d. stamp.

BIRMINGHAM RADIOMART (G5NI)
44, HOLLOWAY HEAD,
BIRMINGHAM. TELE: MID. 3254

BTH SOUND AMPLIFYING EQUIPMENT

THE FINEST TONAL QUALITY IN
THE WORLD

BTH Equipment is used for the largest
and most comprehensive Sound Amplifying
Systems in this country.

BTH RUGBY
THE BRITISH THOMSON-HOUSTON COMPANY LIMITED, RUGBY, ENGLAND.
A 2319

The Autocar EVERY
FRIDAY
FOURPENCE
v.v.16

**COMPONENTS—SECOND-HAND,
CLEARANCE, SURPLUS, ETC.**

OLIVERS Offer Erie 1-watt Colour Coded Resistances, 3/4d. each, 3/- dozen, 2/6 dozen in 3 dozen lots.

CENTRALAB Volume Controls, with switch, 2/-; speaker transformers, power and pentode, Class "B," push-pull, 3/- each.

CARDBOARD Case Electrolytics, 8 mfd., 1/9; 4 mfd., 1/6; 50 mfd. 50v., 1/6; 8 mfd. + 4 mfd., 2/5; 8 mfd. + 8mfd., 2/9; 4 mfd. + 4 mfd., 2/-; 1 mfd., 1/-; 25 mfd. 25v., 1/-; 50 mfd. 12v., 1/-; 50 mfd. 25v., 1/3.

ALUMINIUM Chassis, 18 gauge, 16in. x 10in. x 3in., undrilled, 5/3; 16 gauge ditto, 7/6.

GARRARD Record Changer Units, plays eight 10in. or eight 12in. records, complete with Garrard super pick-up, rejection switch, unit plate 14in. x 16in., motor 200-250v., 40-60 cycles A.C.; £5/10.

ROLA G.12 Speakers, stripped, but complete with transformer for push-pull, triode or pentode; £2/19.

OLIVERS, 676, Christchurch Rd., Boscombe, Hants.—Enquiries invited. Lists free. [4422]

MAINS RADIO DEVELOPMENT COMPANY Offer Guaranteed Bargains; carriage paid, call mornings.—Phone: Tudor 4046. Stamp for new list 203.

RESISTORS, absolutely finest make, one watt, colour coded, wire ends, unused, 50 ohms to 5 megohms, any size, your choice, 3/4d., 2/9 dozen; two watt, any size, 6d.

SATOR Metal Cased Condensers, 400 volt working, 1 mfd., 7/4d.; 2 mfd., 10d.; 4 mfd., 1/8.

CENTRALAB Unused Potentiometers, 500,000 ohms, 1/-; 10,000 ohms, 1/3; Cossor 50,000 ohms, 1/3; Rotorohm, 10,000 ohms with switch, 1/6; Centralab, 500,000 ohms with switch, 1/9; any other size in Centralab, with or without switch, 2/3.

B.I.O. 8 mfd., 550 volt dry, metal can electrolytics, 2/3; ten other sizes on list.

PYE 20h., 120 m/a., boxed L.F. chokes, 4/6; Arco steatite short wave condensers, 0.00016 mfd., 1/6.

TUBULAR Condensers, very best make, wire ends, 400 volt working, 0.0001, 0.002 mfd., 3d.; 0.005, 0.05 mfd., 5d.; 0.25, 0.5 mfd., 7d.; special 0.1 mfd., 450 volt working, 5d.

CLIX Latest Unused Chassis Valve Holders, 4-pin, 1/4d.; 5-pin, 2/4d.; 7-pin, 4d.; chassis, grey cellulosed metal, three valve, 12 1/2 x 6 1/2 x 3in., 1/- (9-pin, 6d.).

MAINS RADIO DEVELOPMENT COMPANY, 4-6, Muswell Hill Rd., London, N.6. [4318]

TRANSMITTING APPARATUS

G5N1—The recognised distributors for amateur equipment, National, R.M.E., Thordarson, Hammarlund, McMurda, Halligerarts, etc.; send 1/4d. stamp for catalogue.—Radiomart, 44, Holloway Head, Brompton, [0531]

MISCELLANEOUS

G.P.O. Engineering Dept. (no experience required), Commencing £3/13 per week; age 18-23; excellent prospects.—Free details of entrance exam. from B.I.E.T. (Dept. 574), 17-19, Stratford Place, London, W.1. [4371]

EXTENDED PAYMENTS

LONDON RADIO SUPPLY Co. (Established 1925), supply on convenient terms, components, accessories and sets, any make, 10% down, balance over 12 months; send for list of requirements.—11, Out Lane, London, E.C.2. [0337]

HIRE-PURCHASE—Prompt delivery of any radio apparatus on convenient terms.
WARD, 46, Farringdon St., London, E.C.4. Tel: Holborn 9703. [0539]

ELECTRIC CLOCKS

SMITHS and Ferranti Electric Clocks, Waltham and Russell watches and clocks; traders' enquiries invited.—Leonard Heys, 36, Henry St., Blackpool. [0526]

EXCHANGE

I BUŮ, sell, exchange good quality receivers, accessories, components; H.P. facilities; promptness, efficiency.—Bostock, 1, Westbourne Terrace, S.E.23. Forest Hill 2236. [0529]

PATENT AND TRADE MARK AGENTS

GEE and Co. (H. T. P. Gee, Mem. R.S.G.B., A.M.I.R.E., Estab. 1905), 51-52, Chancery Lane, London, W.C.2 (2 doors from Government Patent Office). Holborn 4547 (2 lines). Handbook free. [0001]

WANTED

TOBE or Similar Amateur Tuner Wanted.—Howes, 46, Florence St., London, N.1. [4425]

WANTED, good crystal pick-up, 10in. tracker recorder and recording motor.—Eastwood, Bawdsey Manor, Woodbridge, Suffolk. [4407]

FERRANTI and Weston Milliammeter Wanted for Cash; also clean modern components.—Newport Surplus Stores, 24a, Newport Court, Charing Cross Rd., W.C.2. [4427]

WE Buy for Cash All Types of Modern Second-hand Radio Sets and Accessories, test meters, parts, etc.; we pay more than any other dealer; part exchanges; bring, send, or will call.—University Radio, Ltd., 82, Hampstead Rd., London, N.W.1. Phone: Euston 3810. [4193]

**ELECTRADIX
CHARGERS AND RECTIFIERS**

(A.C. to D.C.) Three DAVENSET Type, G.O. Garage Charger for A.C. mains with output of 25 volts, 6 amps., D.C. 3 circuits taking 40 cells at once. Fully guaranteed. Bargain £6 5 0 each.

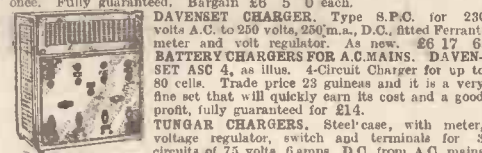

DAVENSET CHARGER, Type S.P.C. for 230 volts A.C. to 250 volts, 250 m.a., D.C., fitted Ferranti motor and volt regulator. As new, £6 17 6.

BATTERY CHARGERS FOR A.C. MAINS. DAVENSET ASC 4, as illus. 4-Circuit Charger for up to 80 cells. Trade price £33 guineas and it is a very fine set that will quickly earn its cost and a good profit, fully guaranteed for £14.

TUNGAR CHARGERS. Steel case, with meter, voltage regulator, switch and terminals for 3 circuits of 75 volts, 6 amps. D.C. from A.C. mains 200/230 volts. Robust trade job, fine order. £8 17 6.

CAR CHARGERS from A.C. Mains for 5 amps, D.C. £4 17 6. Smaller Model for 2 amps. charge, 7/6.

MAINS CONVERSION UNITS. For operating D.C. from A.C. mains, screened and filtered, 120 watts output. £2 10 0.

METAL RECTIFIERS AND CHARGERS. Westinghouse Wall type "R" Steel case, 12in. x 19in. for 200/230 volts, A.C. mains to 40 volts, 3 amps. D.C. for 40 Radio Cells. Guaranteed. £7 7 6. Similar one for Car Battery Charging, 15 volts, 6 amp., D.C. output. £6 17 6. Fine model also for A.C. mains with D.C. output of 280 volts, 250 m.a., £7 2 6. Two 50-volt circuits, each of 750 m.a. D.C. from A.C. mains is another bargain at £8 10 0. All these are in new condition.

SMALL CHARGERS. From A.C. mains to 6 volts, 11 amps., 30/- Philips A.C. Mains Charger, giving 14 volts, 3 amps., D.C., £4. Trickle Charger for A.C., giving H.T. and L.T., 35/-, Midget for 2 volt., 1 amp., 12/6. As we have a wide range of other sizes, kindly specify wants.

LARGE A.C./D.C. 200 CELL MOTOR-GEN. SET. Controls and Switch-board for 4 Radio Cell Circuits and ten 12 volt, 10 amp., Car Batter. A £50 exhibition plant complete for use, at sacrifice price of £32. Smaller A.C./D.C. M.G. Motor-coupled to 3 amps. 16 volts D.C. Gen., £9 5 0. Charging-off D.C. Mains. £14 Davenset D.C. 200/50 volt 1 amp., 200/50 volt 3 amp., £5 10 0. Others, all sizes, with meters and controls. State load.



Motor-Generators for all outputs up to 100 volts, 60 amps. to Grompton D.C./D.C. 230 volts to 17 volts, 6 amps., £4 7 6.

SWITCHES AND CONTROLS. 20-way Stud Switches on panel, two contact arms and ring for 10 amps., 5/6. 7-way Stud Switches on 2 1/2in. panel, in and out sockets, 1/3. 10-way D.P. ebonite mounted, 8 amps., 5/6. 12-way D.P. ditto, 5 amp., 4/-.

Aerial P.D.C.O. on ebonite, 3/6. Resistance Box Switch Panels and base by R.I. 8-way arm, 7/6. Larger type with two sets of mounted, 10-way studs and arm, 9/-.

Light duty Switches for Wave-change and Semi-rotary P.D.C.O., 6d. R.A.F. Switch Boxes for 3 circuits, rocker type, 1/3. 6-way Rooker-toggle, 2/-.

8-way ditto, 3/6. Yaxley D.P., 3-way, roller contact, new, 1/3. Bulgin 3-point Wave-change, 9d. Tunwell S.P. on-off, semi-rotary, 8d.

TOLE SELECTOR RELAY SWITCHES, 6 gangs of 25 volts, 8/6.

MAGNETIC TRIP SWITCHES, 1 to 1 amp. A.C. or D.C. 5v. to 500 volts. bakelite cover, ideal circuit protectors, 8/6.

HOME RECORDERS. Our prices are unbeatable, as factory cost was twice our sale price. The FEIGH RECORDER fits any Radiogram and is positive drive by worm gear and rack. 37/6 only.

If unable to visit our showrooms, be sure to send for latest Bargain List "W."

ELECTRADIX RADIOS
218, Upper Thames Street, London, E.C.1.
Phone: Central 4611



GARDNERS RADIO REWIND IS AS GOOD AS A NEW COMPONENT—there's your answer! You don't have to ask yourself if a rewind will prove inferior to a new part; all doubt is eliminated when you specify a GARDNERS RADIO REWIND, which will be guaranteed unconditionally as to quality, reliability and accuracy. The characteristics of your original component will be faithfully matched and you will have a rewind which is in every respect "As Good as New." There's no delay, either; a day or two is the most you will have to wait. Call at your usual Radio Dealer and he will gladly give you all the other details of our unique service.

GARDNERS RADIO LTD
Carbery Works W. Southbourne
BOURNEMOUTH

DEALERS: Send now for supplies of FREE Price Lists and Address Labels.

we do quite a lot of business making up transformers to customers' own specifications but we have a standard list. May we send you a copy?

W. BRYAN
WESTMORELAND RD., LONDON, N.W.9

SAVAGE LTD
PHONE: COLINDALE 7131

REPAIRS AND SERVICE

GRAHAM'S.
GRAHAM'S Radio, Repair and Rewinding Service; 24 hours' service guaranteed.—See below.

ALL Moving Iron Loud Speakers, L.F. transformers, or pick-ups, from 2/6, output transformers from 4/-; postage extra; mains transformers, moving coils, electric clocks quoted, trade discounts.—Graham's Repairs, 194-Tolworth Rise, Kingston, By-pass, Surrey. Phone: Derwent 2060. [4367]

DISTAVOX SERVICE.
GUARANTEED Service.—All makes of English and American receivers; quotation by return.

REWINDING—Mains, L.F. and output, transformers, speakers, headphones, etc.; keenest terms for contracts.

DISTAVOX RADIO SERVICE Co., 119, Bunhill Row, London, E.C.1. Phone: National 8589. [4363]

SCOTT SESSIONS and Co.

ALL British or American Sets Repaired or Modernised by Qualified Engineers; satisfied customers throughout the world are your guarantee; send to-day for free estimate; free collection 10 miles radius of London.—Scott Sessions and Co., Exchange Works, Dukes Av., Muswell Hill, London, N.10. Phone: Tudor 4101. [0552]

"SERVICE WITH A SMILE"

HENRY FORD RADIO, Ltd.—American valves, components, spares, line cords; leading trade repairers; send us your American and British receivers.—Electronic House, 22, Howland St., Tottenham Court Rd., W.1. Museum 5675. [0434]

METROPOLITAN RADIO SERVICE Co., for Guaranteed Repairs to American (Midget and Standard and British Receivers).

CLARION and Majestic Service Depot.—I.F. and mains transformers rewound, American valves and parts; trade supplied.—Metropolitan Radio Service Co., 1021, Finchley Rd., London, N.W.11. Speedwell 3000. [0435]

REPAIRS, rewinds, and construction, any size transformers, chokes, etc., to trade.—Felectric, Garden St., Sheffield, 1. [3915]

FOR Unusually Good Rewinding of Transformers, chokes, speakers, etc., trade only.—Gardners Radio, Ltd., West Southbourne, Bournemouth. [0551]

OUR Technical Department is at your Service.—Air King Radio, 115, Shaftesbury Av., Cambridge Circus, W.C.2. Phone: Temple Bar 4875 (2 lines). [3983]

NATIONAL RADIO AND TELEVISION SERVICE Co.—Leading Service Engineers and Car Radio Experts. 155-157, Great Portland St., W.1. Phone: Langham 3477. [3911]

GUARANTEED Repairs.—Any transformers, choke, motor, armature, converter, dynamo, etc.; keenest prices, immediate quotation; prompt, dependable service.—See below.

L.T.P. (LONDON TRANSFORMER PRODUCTS, Ltd.), Willesden, N.W.10. Willesden 6486 (3 lines). [3470]

POULTNEY and PURVIS: British and American Service, trade or private; "W.W." sets a speciality; free collection, estimates.—147, Pitshanger Lane, Ealing, W.5. Perivale 3765. [4362]

MAINS Transformer Service.—Repairs, rewinds, or constructions to specification of any type; competitive prices and prompt service.—Sturdy Electric Co., Dip-ton, Newcastle-on-Tyne. [0518]

F. E. GODFREY, A.M.I.R.E., qualified to build, repair and convert "Wireless World" sets, etc.; 25 years' experience, prompt service guaranteed.—30, Kemplay Rd., Hampstead. Hampstead 1104. [3509]

REPAIRS to Moving Coil Speakers a Speciality; cones and coils fitted, fields altered; prices, including eliminators, quoted, loud speakers, 4/-; L.F. and output transformers, 4/-, post free; guaranteed satisfaction; trade invited; estimates free; prompt service.—Loud-Speaker Repair Works, 5, Balham Grove, London. Battersea 1321. [0394]

TUITION

RADIO Training.—Marine, aircraft, broadcast; prospectus free.—Hull Municipal Technical College. [0523]

SITUATIONS VACANT

SKILLED Engineer for Service, construction special sets; £5 week.—Wireless Trade Service, Central Rd., Plymouth. [4430]

WANTED, qualified local wireless engineer, able to diagnose faults and repair "New Monodial" receiver.—Peachey, Pook's Hill, Hove Park Rd., Hove. Phone: Preston 2759. [4406]

RADIO Bench Repairers Required Immediately, senior and junior, permanent positions; call personally.—Works Manager, Radio Rentals, Ltd., 164-166, Kennington Rd., S.E.11. [4410]

TWO Young Men Required for Radio Technical Office Work, shorthand, typing and book-keeping essential, excellent prospects.—Dynafron Radio Ltd., Perfecta Works, Ray Lea Rd., Maidenhead. [4434]

MAN Required to Take Charge of Radio Manufacturer's Coil Department; must be fully capable of setting and maintaining machines and test gear and controlling labour.—Apply Box 1859, c/o The Wireless World. [4409]

SITUATIONS VACANT

WIRELESS Operators and Engineers Urgently Required. —Train at Britain's leading colleges; fee after appointment; boarders; prospectus free.—The Wireless College, Colwyn Bay, or The Wireless College, Calmore, Southampton. [0541]

REQUIRED Immediately, a man experienced in operation layout and planning for light accurate machine work, a knowledge of tool and jig design desirable; state experience, and salary required.—Pye Radio, Ltd., Dept. 44/WW/DO, Cambridge. [4413]

BOOKS, INSTRUCTION, ETC.

EIGHT Bound Volumes "Wireless World," 31 to 39, perfect condition; £2, or nearest.—Murray, 44, Delaware Mansions, W.9. [4412]



A wireless constructional chappie,
Was always notoriously snappy,
Until he made bubbles,
Of all of his troubles,
With FLUXITE . . . he's now
nicknamed "Happy"!

See that **FLUXITE** is always by you—in the house—garage—workshop—wherever speedy soldering is needed. Used for 30 years in Government works and by leading engineers and manufacturers. Of Ironmongers—in tins, 4d., 8d., 1/4 and 2/8. Ask to see the **FLUXITE SMALL-SPACE SOLDERING SET**—compact but substantial—Complete with full instructions, 7/6. Write for Free Book on the art of "SOFT" SOLDERING—and ask for leaflet on **CASE-HARDENING STEEL** and **TEMPERING TOOLS** with **FLUXITE**.

TO CYCLISTS! Your wheels will NOT keep round and true unless the spokes are tied with fine wire at the crossings AND SOLDERED. This makes a much stronger wheel. It's simple—with **FLUXITE**—but **IMPORTANT**

THE FLUXITE GUN

is always ready to put Fluxite on the soldering job instantly. A little pressure places the right quantity on the right spot and one charging lasts for age. Price 1/6.



ALL MECHANICS WILL HAVE

FLUXITE

IT SIMPLIFIES ALL SOLDERING

FLUXITE LTD., Dept. J. W. W., DRAGON WORKS, BERMONDSEY ST., S.E.1

THE INSTITUTE OF WIRELESS TECHNOLOGY
(Incorporated)

4, Vernon Place, Southampton Row, London, W.C.1.

THE A.M.I.W.T. EXAMINATION

Candidates for the November A.M.I.W.T. Examination must lodge their applications, on Form E, NOT LATER THAN THE 30th DAY OF JUNE, 1937.

The New Syllabus giving particulars of the valuable privileges arising from Professional Membership and Student Membership may be obtained from the Secretary.

A few copies of

The Autocar

CORONATION NUMBER

are still available

If you were unable to obtain a copy of this historic issue, which reviews motoring over the past 42 years and contains many pages in full colour and photogravure, you can now secure one through your local newsagent, price 6d., or direct from the Publisher, 9d.

post free.

LIFFE & SONS LTD., DORSET HOUSE, STAMFORD STREET, LONDON, S.E.1

INDEX TO ADVERTISEMENTS

Armstrong Mfg. Co.	PAGE
Bakers Selhurst Radio	
Belling & Lee, Ltd.	3
Birmingham Radiomart (G5N1)	4
British Institute of Engineering Technology	1
British Pix	
British Rola Co., Ltd.	Edit. 481
British Sound Recording	
British Thomson-Houston Co., Ltd.	4
Bulgin, A. F., & Co., Ltd.	4
C.A.V.	
Colvern, Ltd.	Front Cover
"Drydex"	
Ediswan, Ltd.	
Electradix Radios	5
Exide, Ltd.	
Fluxite, Ltd.	6
Gardners Radio, Ltd.	5

Goodman's Industries, Ltd.	PAGE
Gramplan Reproducers, Ltd.	Inside Back Cover
Hartley Turner Radio, Ltd.	1
Haynes Radio	Front Cover
Imhof, Alfred, Ltd.	
Institute of Wireless Technology	6
Lectro Linx	
Linguaphone, Ltd.	
Marconi's W. T. Co., Ltd.	
McCarthy Radio, Ltd.	Edit. 477
Midwest Radio, Ltd.	Inside Back Cover
Parmeko, Ltd.	
Peto Scott, Ltd.	
Postlethwaite Bros.	
Premier Supply Stores	2
Prism Manufacturing Co.	
Radio Development Co.	

Rothermel & Co., Ltd.	Inside Back Cover
Savage, W. Bryan, Ltd.	5
Sound Sales, Ltd.	4
Stern, S.	
Stratton & Co., Ltd.	Inside Back Cover
Tannoy Products	Inside Back Cover
Telegraph Condenser Co.	Edit. 479 & Front Cover
Tungsram Electric Lamp Works (Great Britain), Ltd.	Inside Front Cover
Universal Radio Distributors, Ltd.	
Voigt Patents, Ltd.	
Vortexion, Ltd.	
Ward, C. F.	Inside Back Cover
Waverley Book Co., Ltd.	
Westinghouse Brake & Signal Co., Ltd.	Inside Back Cover
Wharfedale Wireless	
Wingrove & Rogers, Ltd.	
Wright & Weir, Ltd.	Inside Back Cover

Printed in England for the Publishers, LIFFE AND SONS LTD., Dorset House, Stamford Street, London, S.E.1, by The Cornwall Press, Ltd., Paris Garden, Stamford Street, London, S.E.1. "The Wireless World" can be obtained abroad from the following: FRANCE: W. H. Smith & Son, 248, Rue Rivoli, Paris; Hachette et Cie, Réaumur, Paris, and branches. BELGIUM: W. H. Smith & Son, 74-75, Boulevard Adolphe Max, Brussels. AUSTRALIA: Gordon & Gotch, Ltd., Melbourne (Victoria), Sydney (N.S.W.), Brisbane (Queensland), Adelaide (S.A.), Perth (W.A.) and Launceston (Tasmania). NEW ZEALAND: Gordon & Gotch, Ltd., Wellington, Auckland, Christchurch and Dunedin. INDIA: A. H. Wheeler & Co., Bombay, Allahabad and Calcutta. CANADA: Imperial News Co., Toronto, Winnipeg and Vancouver; Benjamin News Co., Montreal; Gordon & Gotch, Ltd., Toronto. SOUTH AFRICA: Central News Agency, Ltd., UNITED STATES: The International News Co., New York.

Specified for the Three Valve 5-15 Metre Receiver



FREQUENTITE LOW LOSS VALVEHOLDER, No. 949, 1/5



SHORT WAVE MICA TRIMMER, No. 1023, 1/-

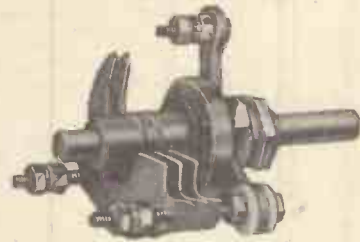

MICRODENSERS. 20 mmfd., 3/9. 40 mmfd., 4/3.

EDDYSTONE

HIGH GRADE
SEND FOR ILLUSTRATED CATALOGUE.

SHORT WAVE COMPONENTS

STRATTON & CO., LTD., BROMSGROVE STREET, BIRMINGHAM.
London Service: Webbs Radio, 14, Soho Street, W.1.

FREE ART CATALOGUE DEMONSTRATIONS

40 pages, fully illustrated, giving particulars of Midwest 11, 14, 16, and 18 valve models. at our showrooms Mondays to Saturdays from 9 a.m. to 8 p.m. (except Tuesdays, 9 a.m. to 6 p.m.).

Magnificent alike in its conception, design and performance, this the latest Midwest Model X-18 High Fidelity Receiver brings the world to your fire-side. With its 6 TUNING RANGES it gets "Everything on the Air." Its distinctive features in circuit design are not just "talking points," as a comparison will prove, but basic advantages which will assuredly appeal to "Wireless World" readers and all who appreciate Studio or Concert Hall quality of performance in the home.

1937 MIDWEST

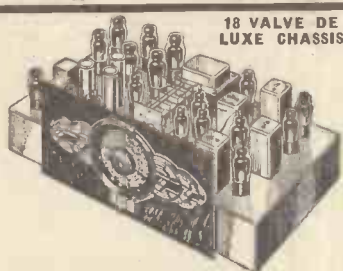

18 VALVE DE LUXE CHASSIS

MIDWEST RADIO Ltd.

Showrooms and Factory:
16, Old Town, Clapham, London, S.W.4.
Phone: MACaulay 5005.

THE ONLY ALL-WAVE RECEIVER COVERING 4½ to 2,400 METRES
Available in Chassis form complete with matched valves and 12" speaker or in Console Cabinet.

INSTALL A NOISE-MASTER "ANTI-STATIC" AERIAL FOR CLEAR ALL-WAVE RECEPTION

(Licensed under Amy, Aceves and King's World-wide Patents.)

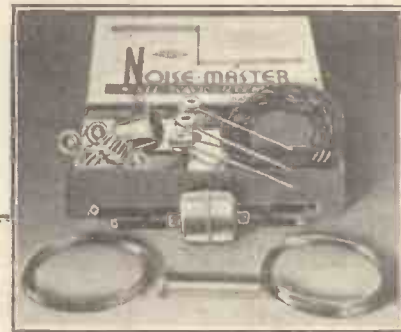

To-day Nations join hands through the medium of radio on the short wave as well as on the medium and long wave Broadcast channels. It is apparent that scientifically designed and correctly installed aerial equipment must be used in order to accumulate the extremely small energy of the foreign short waves. It further follows that the comparative strength of interference noises (commonly called "man-made static") is far greater in the case of foreign short waves, and that it is important to install aerial equipment which features the elimination of such interference if clear reception is to be obtained. Radio receiver manufacturers now recommend the use of an "anti-static" aerial system in conjunction with their all-wave models.

You can now enjoy clear noiseless reception on all wave bands by installing a Noise-Master "Anti-Static" aerial system furnished complete with—

Two 30-foot coils 7/24 standard copper aerial wire. One upper transformer coupler unit (weatherproof shell). Two glass insulators. One dual lead-in strip. One set coupling transformer unit. One 4in. porcelain lead-in tube. 50 feet special twisted lead-in cable.

R. Rothermel
Rothermel House,
Canterbury Road, High Road,
Kilburn, N.W.6.
Phone: Malda Vale 6066.

NOISE-MASTER KIT COMPLETE

PRICE - - - **35/-**

Write for technical data sheet No. N.M.1.

RADIO RECEIVER MEASUREMENTS

By Roy M. Barnard, B.Sc., A.M.I.R.E. (1934)

Complete with fifty-three illustrations and diagrams, summaries of method, four appendices and a general index.

PRICE 4/6 net
By post 4/9

From all booksellers or direct from the Publishers.

Of practical value to the radio service engineer and the amateur experimenter. Measurements of sensitivity, selectivity and fidelity are explained at length and the interpretation in estimating receiver performance is carefully set out.

Details are given of methods of receiver testing with full descriptions of commercial signal generators and their application to the adjustment of superheterodynes and "straight" receivers.

ILIFFE & SONS LTD., DORSET HOUSE, STAMFORD STREET, LONDON, S.E.1

W.W.1a.

FOR P.A. AT ITS BEST

GRAMPLAN

GRAMPLAN REPRODUCERS LTD.
Kew Gardens, Surrey.

3d Brings you "THE ALL-METAL WAY"

STANDARD HANDBOOK ON METAL RECTIFICATION

WESTINGHOUSE BRAKE & SIGNAL CO. LTD. BZ, YORK RD. KING'S CROSS N.1

TANNOY

THE SOUND PEOPLE

GUY R. FOUNTAIN LTD.
CANTERBURY GROVE, WEST NORWOOD,
LONDON, S.E.27. Phone: Str. 14122 (6 lines).

FOR ALL SOUND AMPLIFYING EQUIPMENT

HIRE PURCHASE

We can supply any Radio and Electrical Apparatus on HIRE PURCHASE having a value of over £3 at convenient terms, including Midwest, Spartan, Challenger, Armstrong, Scientific Supplies and other receivers. Spartan Refrigerators, "Easy" Washing Machines, etc., etc.

CHAS. F. WARD, 46, Farringdon Street, LONDON, E.C.4. Tel.: Holborn 9703.

WEARITE CONDENSER ANALYSER

A new instrument of the latest design for carrying out rapid complete tests of radio condensers. Electrolytic, Mica, Paper, Trimmer and Tuning condensers may now be tested for Capacity, Insulation, Power Factor, Open Short and

Intermittence. This unit is portable, entirely A.C. mains operated.

PRICE - £9.9.0

Full particulars upon request to:

WRIGHT & WEARE LTD.,

740, High Road, Tottenham, London, N.17.

SECOND EDITION

—THOROUGHLY REVISED

WIRELESS SERVICING MANUALBy **W. T. COCKING***(of "The Wireless World")*

The first complete book of reference of its kind. A reliable practical guide for amateur and professional.

The demand for this book was so great that the first edition was sold out in the short space of a very few months. A second edition containing additional material is now on sale. The "Wireless Servicing Manual" deals fully with Testing Apparatus and explains the methods of locating and curing faults in receiving equipment.

Ganging, Automatic Volume Control, Instability, Distortion, Mains Hum, Whistles and Local Interference are all separately treated.

The new edition contains much additional information on short-wave receivers, and on methods of operating extension loud speakers, the reference material including base-connections for British, Continental and American Valves and the various colour codes for components has been extended and brought up to date.

BOUND IN CLOTH BOARDS

SIZE 7½ ins. × 5 ins.

231 PAGES

PRICE 5/- net. By post 5/4

Issued in conjunction with "THE WIRELESS WORLD" and Published by the Proprietors:—

ILIFFE & SONS LTD., DORSET HOUSE, STAMFORD STREET, LONDON, S.E.1

**FOUNDATIONS
of WIRELESS**

*A Book of
First Principles
for the
Wireless
Enthusiast*

PRICE 4/6 NET

By Post 4/11

Issued in conjunction with
"THE WIRELESS WORLD"
and published by the Proprietors—

By **A. L. M. SOWERBY, M.Sc.**

An Elementary Text Book on Wireless Receivers

"Foundations of Wireless," based on a series of articles which appeared in "The Wireless World," covers the whole field of wireless from the simplest electrical phenomena to the construction of a modern set, and all the vital points in receiver design are treated in full detail. Chapters are devoted to direct and alternating currents; typical circuits; the properties of inductance and capacity; the nature of high frequency currents; the tuned circuit; and amplification by the valve.

Eleven of the eighteen chapters of the book deal with the discussion of receivers, in which the whole process of design is reviewed stage by stage to the finished article.

Special attention is paid to the important subject of tuned circuits and band-pass filters, on the correct design of which the performance of every type of set ultimately depends. Moreover, the process of detection so often imperfectly understood, is clearly explained.



4^D

The Wireless World

THE PRACTICAL RADIO & TELEVISION JOURNAL

Friday, May 21st, 1937.

Sound Sales Limited

Manufacturers of

REALLY HIGH QUALITY AMPLIFIERS,

HIGH GRADE TRANSFORMERS OF ALL TYPES

and

LOUD-SPEAKERS WITHOUT A "DIALECT."



MARLBOROUGH ROAD,
UPPER HOLLOWAY,
LONDON, N.19.

LIMITED.

(Contractors to the
G.P.O., etc.)

Tel.: Archway 1661/2/3.

EVERY Radio TEST with ONE Meter

For servicing and laboratory work an accurate multi-range meter is essential. The Model 7 Avometer provides unique facilities for all radio tests. It is an A.C./D.C. meter, having 46 ranges. Measures A.C. and D.C. amperes and volts, also resistance, capacity audio-frequency power, and decibels. No external shunts or series resistances. Extremely low current consumption ensures great accuracy. Meter protected against damage through overload by an automatic cut-out. Conforms to B.S. 1st grade requirements.



BRITISH
MADE
16 Gns.

Resistance
Range Extension
Unit (for measurements
down to 1/100th
ohm)
10/- extra.

The 36-range
Universal
Avometer,
13 Gns.

22-range
D.C. Avometer,
9 Gns.
Carrying
Cases, 2/-
Deferred
Terms if de-
sired.

★Write for descriptive pamphlet.
THE AUTOMATIC COIL WINDER &
ELECTRICAL EQUIPMENT CO. LTD.,
Winder House, Douglas Street,
London, S.W.1. Phone: V10. 3404/7

The 46-RANGE UNIVERSAL
AVOMETER 7
Regd. Trade Mark

HAYNES QUALITY RECEIVERS

Demonstration night—every Friday,
7.30—9.30 p.m.

Originators of the Quality Receiver.



Have you the Haynes Quality Booklet?
1936-37 Edition.

QUEENSWAY, ENFIELD, MIDDLESEX.
Enfield 2726

Central London area Agent, London Radio Supply Company, 11, Ost Lane, E.C.2.
Hire purchase arranged.

CAV DRY BATTERIES

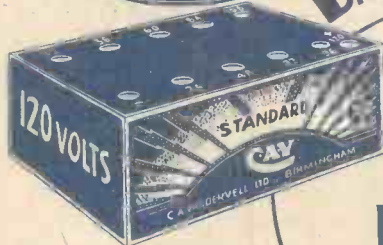

60 VOLTS 3/9

99 VOLTS 6/3

108 VOLTS 6/9

120 VOLTS 7/6

The Finest British
Battery of Standard
Capacity

C. A. VANDERVELL LTD. WELL ST., BIRMINGHAM

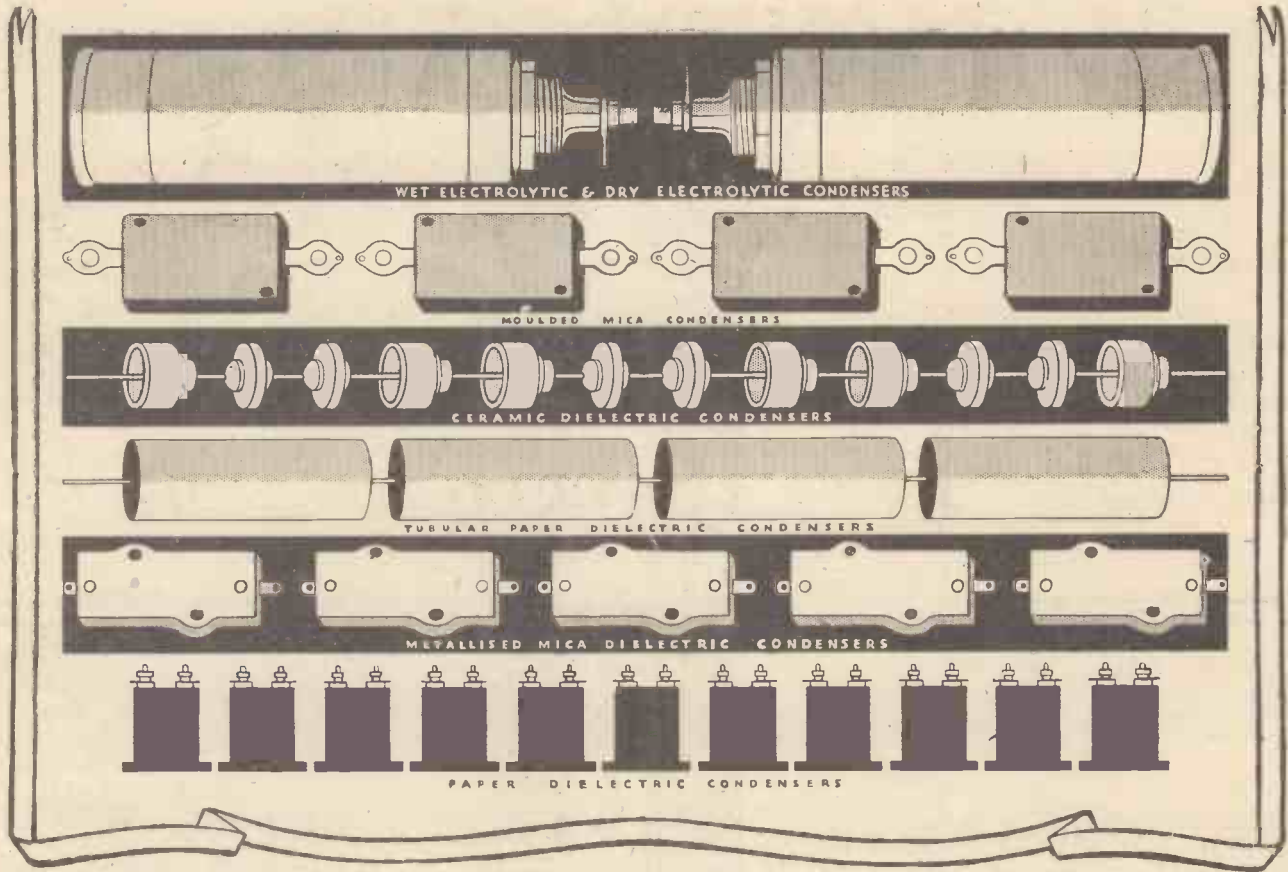

**WHEREVER
A CONDENSER IS REQUIRED
THERE IS A
DUBILIER
TO MEET THE CASE
—and meet it well**

DUBILIER CONDENSER CO. (1925) LTD., DUCON WORKS, VICTORIA ROAD, NORTH ACTON, LONDON, W.3



C. R. Casson 127

Mention of "The Wireless World," when writing to advertisers, will ensure prompt attention.

The Wireless World

THE PRACTICAL RADIO JOURNAL
27th Year of Publication

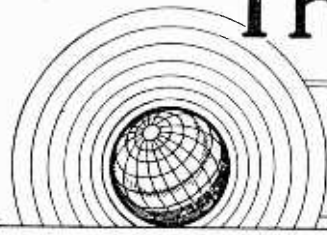

No. 925.

FRIDAY, MAY 21ST, 1937.

VOL. XL. No. 21.

Proprietors: ILIFFE & SONS LTD.

Editor:
HUGH S. POCOCK.

Editorial,

Advertising and Publishing Offices:
DORSET HOUSE, STAMFORD STREET,
LONDON, S.E.1.

Telephone: Waterloo 3333 (50 lines).
Telegrams: "Ethaworld, Sedist, London."

COVENTRY: Hertford Street.

Telegrams: "Autocar, Coventry." Telephone: 5210 Coventry.

BIRMINGHAM:

Guildhall Buildings, Navigation Street, 2.
Telegrams: "Autopress, Birmingham." Telephone: 2971 Midland (4 lines).

MANCHESTER: 260, Deansgate, 3.

Telegrams: "Iliffe, Manchester." Telephone: Blackfriars 4412 (4 lines).

GLASGOW: 26B, Renfield Street, C.2.

Telegrams: "Iliffe, Glasgow." Telephone: Central 4857.

PUBLISHED WEEKLY. ENTERED AS SECOND CLASS MATTER AT NEW YORK, N.Y.

Subscription Rates:

Home, £1 1s. 8d.; Canada, £1 1s. 8d.; other countries, £1 3s. 10d. per annum.

As many of the circuits and apparatus described in these pages are covered by patents, readers are advised, before making use of them, to satisfy themselves that they would not be infringing patents

CONTENTS

	Page
Editorial Comment	483
Screened Aerial Losses	484
The Hartley Circuit	486
More AVC for Motorists	488
Recording on Paper Tape	488
Rediffusion of Empire Broadcasts	489
Current Topics	491
Pye Baby "Q" Portable	492
Unbiased	494
New Apparatus Reviewed	495
Listeners' Guide for the Week	496
Magic from the Air	498
Broadcast Brevities	500
Practical Hints and Tips	501
Random Radiations	502
Letters to the Editor	503
Recent Inventions	504

EDITORIAL COMMENT

Television

Successful Experiment

THE arrangements made for broadcasting the ceremony and pageant of the Coronation have called forth universal admiration. It was the greatest broadcast in history and the Empire range of the transmissions was further extended through the commentaries put over the broadcast networks of other nations. By contrast, the television transmission was limited in its range to the circumscribed area covered by the Alexandra Palace ultra-short wave transmitter. We could not put the number of those who saw the Coronation procession through the medium of the television screen much higher than 50,000 and this is a very small proportion indeed of those who participated in the event, either directly or by means of sound broadcasting.

These circumstances did not, however, detract from the achievement of television. The broadcast may be described as having been in the nature of an experiment, for the reason that there was practically no time or opportunity for proper rehearsals. The television cable laid between the cameras at Hyde Park Corner and the Alexandra Palace transmitters was an innovation in itself, the possibilities of which had not been fully tested. In addition to these difficulties, the engineers were unfortunately faced with a change in weather conditions just as the procession came within range of their cameras and rain continued to the end of the transmission. In spite of these adverse circumstances, we were delighted with the detail and clarity of the picture, which compared not unfavourably with anything which has been put over

from the Alexandra Palace studio or grounds in previous transmissions.

These results are encouraging to television and should pave the way for the broadcasting of further scenes remote from the transmitter itself.

Interference

Screened Aerial Systems

WHILST we hope that the time when legislation will control interference daily draws nearer, this does not relieve broadcast receiver users from a responsibility to do whatever they can at their end to alleviate the trouble. Manufacturers of receivers, too, have their part to play and should make every reasonable effort to improve conditions at the receiving end so as to bring about the best possible reception, clear of electrical disturbances.

At present much can be done by the use of screened aerial down-leads associated with two transformers, one at the lower end of the screened lead connecting to the receiver itself. A writer in this issue puts forward the proposal that this lower transformer and the transformer on the input side of receivers, should be replaced by one transformer designed to match the impedance of the aerial "line."

A receiver so designed would not be suitable for use with an ordinary type aerial but only with a "line" of definite impedance. This seems to be the only serious objection to an arrangement which otherwise must have many advantages. It might mean that manufacturers would have to develop two models, one for use with an ordinary aerial and another for screened aerials, a line of fixed impedance being standardised.

Screened Aerial Losses

IT is shown that a screened aerial system should ideally be designed to work with a particular type of receiver and that a given equipment, though in itself beyond criticism, may introduce heavy losses when used with a receiver for which it happens to be unsuitable. The suggestion is made that the characteristics of the input tuned circuit of the receiver should be modified to serve as a line-to-valve matching transformer.

IS ONE OF THE TRANSFORMERS REDUNDANT ?

By PAUL D. TYERS

more neon signs are employed, while there is an increasing use of domestic apparatus.

The other cause is the tremendous increase in the sensitivity of the broadcast receiver. A set with a sensitivity of 20 microvolts is now quite commonplace and is sold at a low price. Previously the sensitivity of a receiver was of the order of hundreds of microvolts. It is not surprising, therefore, that the interference problem has become very real.

It has already been implied that if an aerial is located in a space where there is no interfering field, interference-free reception is obtainable. The field of the interference due to electrical apparatus is for the most part confined to a low level, and diminishes rapidly with increase in height above the ground.

If, therefore, the aerial is raised as high as possible, and its down-lead is screened, the chances of obtaining clear reception are greatly increased. An ordinary screened lead is useless as a down-lead because the capacity is far too high. The first step was to use what is commonly known as the "elephant trunk," consisting of a very large diameter tube with a small centrally-placed wire. Even this has had a rather high capacity, and by no means low losses. Accordingly, the transformer system was soon adopted.

This consists of a pair of transformers connected back to back, the low-ratio sides being connected by a screened lead, or more generally a screened pair. The basic arrangement is shown in Fig. 1. The

secondary winding of the aerial transformer and the matched primary winding of the set transformer, together with the connecting pair, form a low-impedance circuit, and accordingly the capacities between the leads, and between the leads and the screen, are not very important. Moreover, the equivalent resistance due

ELECTRICAL interference can reach a receiver in two ways. It can be mains-borne, entering the receiver through the power supply transformer, or else it can be introduced as direct radiation picked up by the aerial. Interference arising via the mains connection can be effectively cured by the fitting of a low pass filter such as the familiar centre-point-earthed condensers, but the

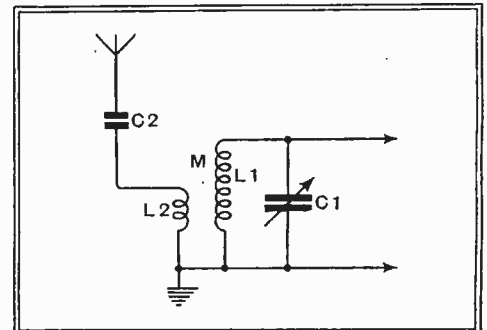

Fig. 2.—Aerial input circuit of a typical receiver ; there is no standardisation of the various constants.

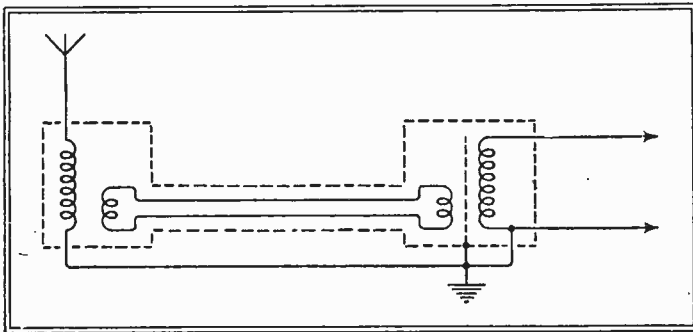

Fig. 1.—Basic anti-interference aerial circuit.

treatment of the other kind is not so simple.

The function of an aerial is to convey to the receiver minute voltages which are produced by virtue of the aerial being within an electromagnetic field due to a desired transmission. Unfortunately, electrical apparatus such as small motors, neon signs and car ignition apparatus produce fields against which normal receiving apparatus cannot discriminate, and so interference is produced.

Various systems have been proposed for balancing out the effect of radiated interference, but the present standard practice is to place the aerial in a position free from interference and connect it to the receiver through a screened down-lead. Although this system is now so well established it does seem desirable to consider its limitations and its general effect upon receiver performance.

It is well to realise at the outset that the subject of radiated interference has only become increasingly important because, in the first place, there has been, within the last ten years, a marked increase in the number of interfering sources. More and

to the dielectric losses in the connecting leads do not have very much effect upon the circuit. It might appear, therefore, that the use of such an arrangement is quite efficient. A little examination soon shows that this is not necessarily so in every case.

The input of any radio receiver comprises a tuned circuit, resonant to the frequency of reception. This must be associated with the aerial through some coupling device, and in any broadcast receiver the arrangement adopted is necessarily a compromise. In the case of a receiver working on medium and long waves, in which the aerial and down-lead are a fraction of the wavelength of transmission, there is an optimum condition for any given wavelength. Luckily, it is possible to use a coupling coil or aerial winding which forms a good compromise for each waveband employed.

If we examine the basic network in Fig. 1 we find we have a pair of transformers which are required to couple the aerial to

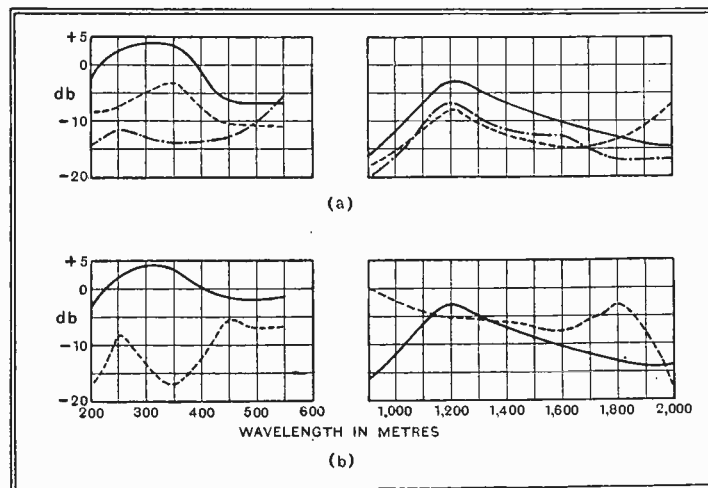

Fig. 3.—Diagram (a) shows losses introduced by the same screened aerial equipment into different broadcast receivers, while diagram (b) shows losses introduced by different screened aerials into the same receiver.

Screened Aerial Losses.

the input of a representative receiver equally efficiently over an exceedingly wide waveband. If switching is to be avoided this waveband may extend from

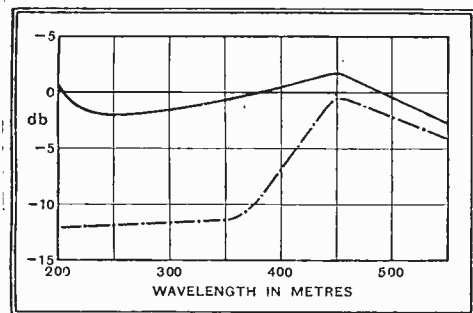

Fig. 4.—The full line shows losses introduced by a transformer system into the receiver for which it was designed; the dash-dot line represents losses with another set.

200 to 2,000 metres, with a small gap between the medium and long waves. It is obvious that if an ordinary aerial coupling coil is only a compromise, then the design of the complicated network involving two transformers and a length of screened line must be a far more difficult compromise, and it cannot, from first principles, be as efficient as a single aerial coupling coil.

Screened aerial equipment is produced for general use with representative broadcast receivers. It might be thought that this would be fairly simple, as the performance of contemporary sets is very similar. Actually, however, the constants of the input circuits of representative sets, such as those in Fig. 2, vary tremendously. Many aerial connections are made through fixed condensers, while variation in the absolute inductance of the aerial coil and the mutual inductance between the coil and the tuned circuit is far greater than is generally realised. It is a circuit of this type that is connected to the screened set transformer. These transformers are of the so-called aperiodic type and comprise tightly coupled coils with a very high L/C ratio. Accordingly, slight variations in the impedance into which the set transformer works will make a tre-

mendous difference to the frequency characteristic of the whole network.

Fig. 3 (a) shows a group of insertion loss curves of one screened aerial equipment, taken with representative modern broadcast receivers. Fig. 3 (b) is another rather interesting set of curves showing the insertion loss of two different equipments when used with the same receiver.

Fig. 4 shows the loss obtained with a transformer network designed to operate with one particular set, while it also shows what happens when it is used with a receiver having totally different constants. When it becomes obvious that a network of the type in Fig. 1 must necessarily be susceptible to very small inductance and capacity changes, one is justified in considering whether some step should not be taken to improve the arrangement.

The greater the number of circuits with a high L/C ratio the more susceptible will the network become to small changes, whilst each so-called semi-aperiodic coupling device must necessarily introduce a number of natural resonances over the entire waveband. The low insertion loss obtained with the experimental device of

a staggered amplifier in which circuits are set off-tune with a view to increasing the band width.

Losses as high as 20 to 30 decibels have been recorded with certain combinations of equipment and sets. The desirability of obtaining the highest possible voltage on the grid of the first valve with a view to eliminating background noises is well known, and it is obvious that, quite apart from the loss of signal strength, any device which introduces a large insertion loss is highly undesirable. It would seem that the less complicated we make the network the more easy would it be to obtain a lower insertion loss over a wide waveband. If, then, the sensitivity of sets is likely to increase, and if there is likely to be no diminution in the intensity of domestic electrical interference of the radiated type, the time may come when the screened down-lead equipment is an integral part of the receiver.

Under such conditions we should have, as before, the single unswitched aerial transformer, but the external set transformer immediately disappears. The mere fact of cutting out one transformer in the system should obviously help to increase the overall efficiency. The designer can then approach the problem in two ways.

In the first place, he can use some arrangement such as that shown in Fig. 5, in which the screened lead terminates in a transformer, the secondary of which is the first tuned circuit, or preselector, of the set. Actually there are further possibilities. As the external set transformer is now eliminated the introduction of switching in the input arrangement presents no difficulty whatever, because switching can be ganged with that in the remainder of the receiver. The problem might be helped even further by the use of quite involved and complicated LCR combinations which could be switched into circuit for different wavebands with a view to improving the matching or transference loss. In fact, experiments on these lines are already showing very promising results, and it does not seem to be difficult to obtain a reasonably low loss over a very wide waveband.

Should receiver design develop on the lines suggested, the only additional equipment would be the aerial transformer. It is now quite possible to produce a highly efficient aerial transformer which is very little bigger than an ordinary shell insulator. It will be more than interesting, therefore, to see whether some such change as that anticipated occurs in the immediate future.

CCIR Meeting

A MEETING of the International Technical Consulting Committee, more usually known by its French initials of CCIR, is now being held in Bucharest. At this conference the International Amateur Radio Union is represented by an American and a Canadian. The CCIR meets at intervals during the five years which elapse between the International Telecommunications Conferences.

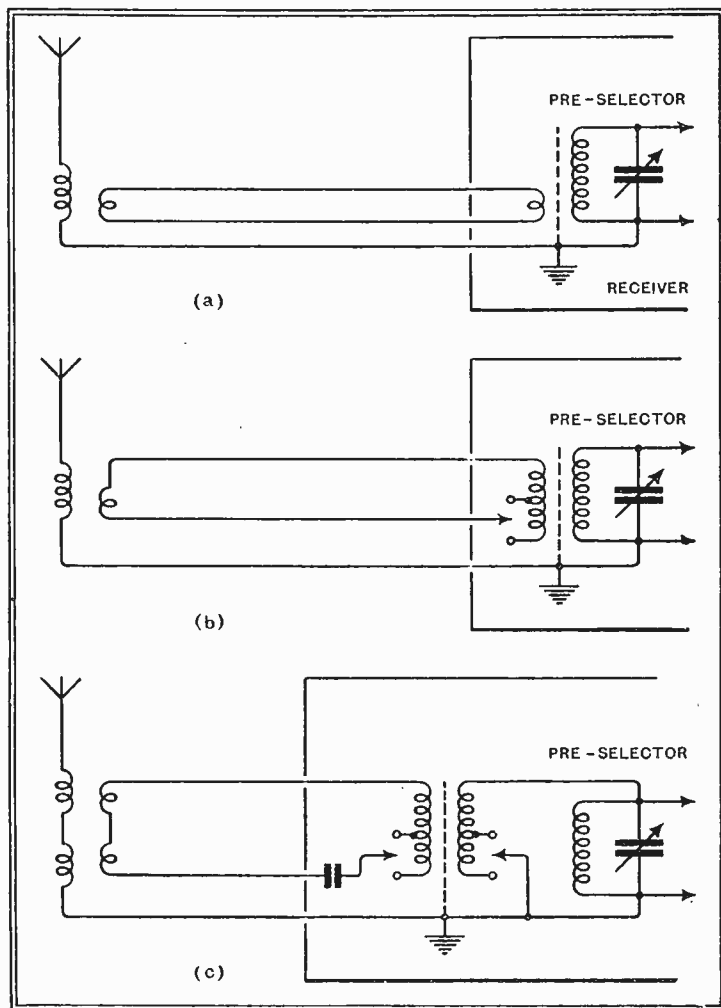

Fig. 5.—Illustrating the use of the receiver input circuit in place of the usual "set transformer" of the normal screened aerial equipment.

which a curve is given in Fig. 4, designed for one particular receiver, is due entirely to the fact that the various resonances of the whole system were intentionally controlled. The whole arrangement is then rather similar to what is known as

The Hartley Circuit

EVOLUTION OF THE "SINGLE-COIL" OSCILLATOR

By M. G. SCROGGIE, B.Sc., A.M.I.E.E.

THE Hartley circuit—sometimes called the Amateur's Fairy Godmother—has long been a favourite, as it allows a workable oscillator or receiver to be set up with the fewest and simplest of components. The basic circuit and some of its variants are described in this instalment.

DESPITE their differences in appearance, all valve oscillator circuits are really the same in principle. To side-track criticism it should be added that there are a few obvious but relatively unimportant exceptions to this rule: for example, the magnetron and the dynatron. But there is variety enough among the main body of oscillator or reaction circuits in general. As the underlying principle is identical, each of these variations has been devised because it works better or is more convenient for the particular purpose in view.

Probably the best-known of all oscillator circuits is called the Hartley; and, as very few people seem to know why, it may be of interest to mention that a Mr. R. V. L. Hartley patented it for the Western Electric Company in 1915. The Hartley circuit itself appears in several different forms; without going into legal exactitude it may be said that the features common to all are a single tapped coil, with the tuning condenser connected across the whole of it. Actually one can depart slightly from the strict letter even of this basic definition without infringing the spirit of it.

There are several reasons for the popu-

rule it out from such applications as a gang-tuned superhet. However, in some of its forms this difficulty is avoided.

Omitting all accessories, the Hartley circuit appears in its simplest theoretical form in Fig. 1. Assuming that an oscillation has somehow been started surging back and forth around the loop line formed by the coil and condenser, the oscillating voltage developed across the part of the

various circuits step by step, in order to make their applicabilities clear.

It would be possible to put in the batteries as shown in Fig. 2. Even if the grid battery is omitted, as being generally unnecessary, it is clear that whatever point on this circuit is regarded as earthed there is at least one battery "up in the air." Also the oscillating part of the valve current has to go through the anode

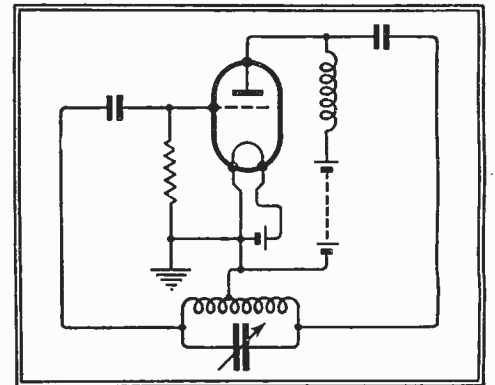

Fig. 5.—The parallel-fed arrangement.

battery. Both of these conditions are, more or less, undesirable. The latter can be got over by shunting the battery with a large-capacity by-pass condenser, but the former demands more consideration.

The most usual practice is to earth the cathode; therefore, to bring the anode battery also to earth potential it must be connected as in Fig. 3. This has the effect of putting the full anode battery voltage on the grid also, which is clearly inadmissible. There are several ways out of this difficulty. One is to stop the battery voltage off from the grid by a condenser, which, nevertheless, allows the oscillating potentials to reach the grid.

To prevent the working voltage of the grid from being indefinite, the grid is connected to cathode or to some other fixed voltage through a resistance or choke of such high impedance as not to short-circuit the oscillations (Fig. 4). This circuit is known as the series-fed Hartley. According to it, either the cathode and its

(Below) Fig. 3.— Full HT voltage on the grid—clearly an inadmissible state of affairs.

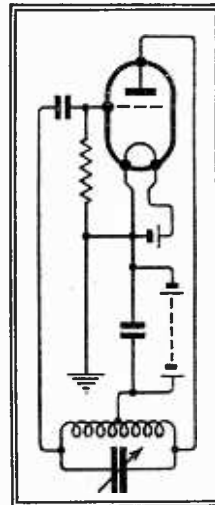
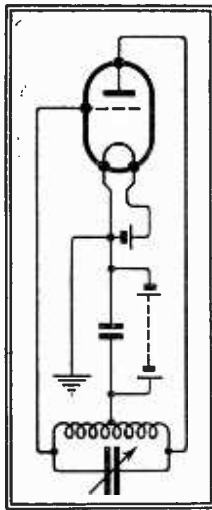

Fig. 4.—The series-fed Hartley circuit; this and succeeding diagrams show practical working arrangements.

coil between cathode or filament and grid is in the right direction to release across the other part of the coil an amplified voltage that boosts the original oscillation. And so it grows larger and larger until the valve is unable to supply it with enough power to make it grow any more.

Of course, strictly it is not the valve itself that feeds power into the oscillating circuits, but batteries under the control of the valve; and the practical varieties of Hartley circuit differ chiefly in the ways in which the batteries are accommodated. They must be arranged (1) to supply the valve with the correct operating voltages, and (2) not to mislead the oscillating currents. Perhaps the reader will forgive me if I illustrate the evolution of the

(Below) Fig. 1.— The Hartley oscillator in its simplest possible form.

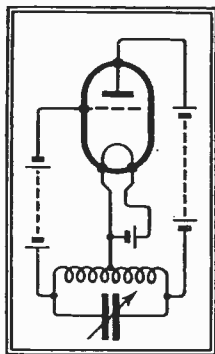
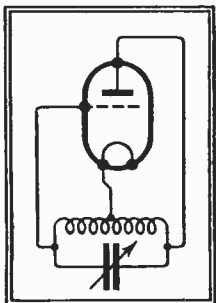

Fig. 2.—The batteries might be connected in this manner, but are "in the air."

larity of the Hartley; it oscillates very freely; it is simple; and it is easy to understand and to calculate. Against these good points there is the disadvantage that ordinarily both terminals of the tuning condenser are "live"—a feature that may

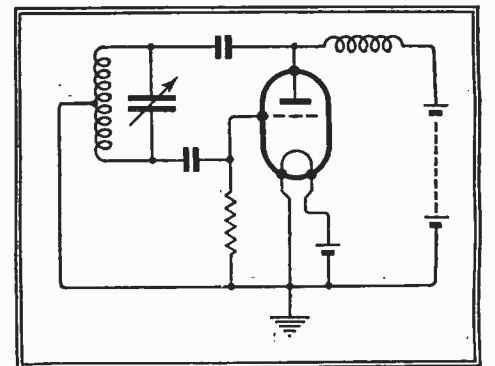

Fig. 6.—The popular parallel-fed Hartley circuit in more recognisable form.

The Hartley Circuit—

battery or the oscillating circuit must be at a high battery potential with regard to earth. Where this is undesirable, the expedient adopted for bringing the grid to the right voltage is repeated for the anode. This gives us the parallel-fed Hartley (Fig. 5), which, however, is not usually

the grid end, and, therefore, Fig. 7 is to be preferred. For example, if it is allowable to have the equivalent of 100,000 ohms reactance shunted across the whole tuning coil, and the filament is tapped one-tenth of the way up, the filament choke can be as low as $\frac{100,000}{10^2}$, or 1,000

Still another oscillator circuit which is at least very similar to the Hartley is the

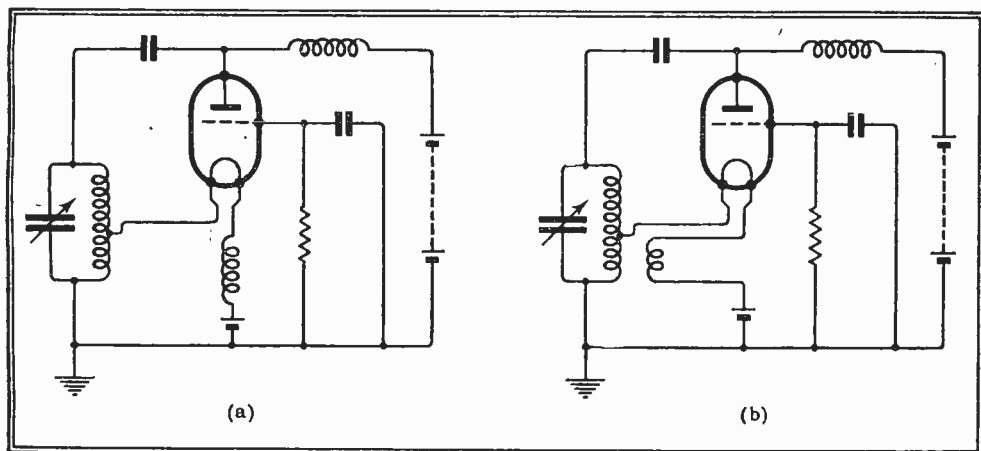

Fig. 7.—Arrangements permitting the grid end of the tuned circuit to be earthed. The filament-circuit coil in diagram (b) must be closely wound with the tuned winding.

drawn like that; Fig. 6 is the same thing in conventional diagram form.

The stopping condenser between anode and tuned circuit, if variable, makes a convenient means of controlling the feedback, both above and below the oscillating condition. The by-pass condenser is no longer necessary, because the oscillating currents have a different route provided for them. Also the grid condenser and leak are not necessary now for the original purpose, but they are often retained as an automatic source of negative grid-bias resulting from rectification of the oscillations.

Finally, the same dodge can be used once again, this time with the filament battery, making it practicable to earth one side of the tuning condenser. Either grid

ohms. At 1,000 kc/s (300 metres) this means a choke of about 160 microhenrys. At shorter wavelengths the inductance can be correspondingly less, but this influence is usually counteracted by the necessity for a higher tapping in order to obtain ready oscillation. At ultra-short wavelengths there is no difficulty in providing enough inductance in a very low resistance choke, even if the tap is half way up the coil; but this circuit is inferior to

one named after Franklin, and used quite a lot for short-wave work. The coil is split at or near the centre and the gap is bridged, so far as oscillatory currents are concerned, by a relatively large condenser (Fig. 10). At very short wavelengths, however, this circuit, for reasons not disclosed by the diagram, is more closely allied to the Colpitts circuit.

(To be concluded).

World Globe Clock

THERE are two separate features of interest to long-distance enthusiasts in this instrument—a well-mapped globe in colour and a 24-hour spring-driven clock giving the time in any part of the world at a glance.

The drum dial is divided into black and white 12-hour sections and a red pointer indicates local time. The corresponding time in 75 of the principal cities of the world can be read off from a fixed scale mounted on a bezel round the base. For some places a day must sometimes be added to or subtracted from the local date, and this can be checked by reference to the International Date Line on the globe.

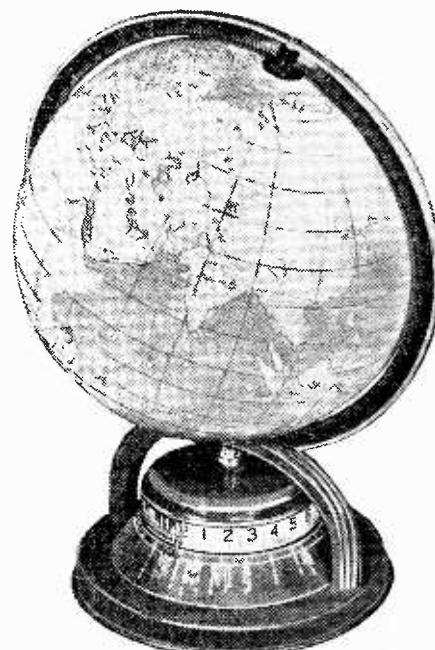

The World Globe Clock is obtainable in this country from R. A. Rothermel, Ltd., Canterbury Road, London, N.W.6, and the price is £3 12s. 6d.

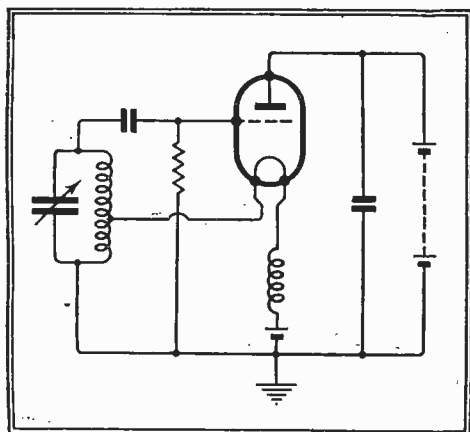

Fig. 8.—Earthing the anode end of the tuned circuit.

end (Fig. 7) or anode end (Fig. 8) can be earthed; but it is important that the filament choke should be so low in resistance as to cause negligible loss of voltage, and, unless the frequency of oscillation is high, this restriction may make it difficult to provide a high enough impedance.

Generally the filament tapping is nearer

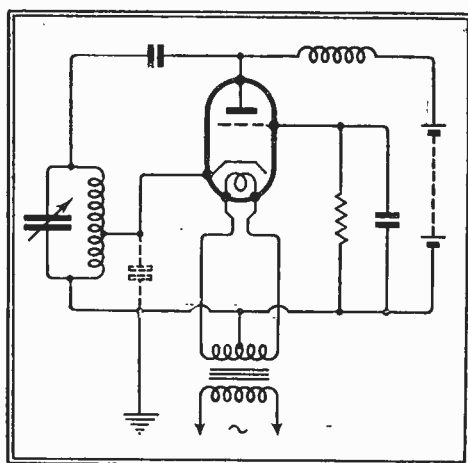

Fig. 9.—The filament choke may be avoided by using an indirectly heated valve.

earlier varieties in one respect, that the total effective stray capacity across the coil is slightly greater; and every $\mu\mu\text{F}$ counts below 10 metres.

An alternative to the filament choke is a bifilar winding (Fig. 7b), which complicates the coil but gets over the resistance difficulty.

Using a separately heated valve, the filament choke is cut out, but instead there is a stray capacity between cathode and heater that comes across part of the tuning coil, and is a nuisance at the shorter wavelengths. It is represented as a dotted condenser in Fig. 9.

More AVC for Motorists

VOLUME TO SUIT THE SPEED

THIS is not the long-sought-for scheme of automatic "velocity" control for which so many poor pedestrians yearn, but an adaptation of ordinary AVC as we know it in the household set, applied to solve a problem peculiar to those who listen-in "on the road."

In a car radio set the volume of sound required to give satisfactory hearing varies with the speed of the car. For instance, when the car is stationary a far lower level of sound is acceptable than when one is ambling gently through a thirty-mile limit; and what might pass muster then may not be loud enough when the car is going "all-out" along the Kingston by-pass.

The problem is perhaps somewhat subtle, but, according to an Ekco Patent (No. 450606), it can be solved by linking-up a variable control resistance in the input

trifugal governor, mounted or connected in any way to the transmission gear, can be used to move a contact to and fro along a potentiometer resistance.

Alternatively, the ordinary dynamo of the car can be made to serve the same purpose. As shown in the figure, the input circuit of the AF valve V includes a

potentiometer R which is tapped back to a series of contacts C. A switch arm A is pivoted at B under the control of two relay windings W, W1 shunted across the terminals of the dynamo D. In the position shown the car is running at full speed, and the control resistance is completely cut out. But if one applies the brake the current through the windings W, W1 falls off, and the arm A is gradually moved over to the left to bring in more and more resistance. This automatically makes the loud speaker volume rise or fall in sympathy with the running speed of the car.

Recording on Paper Tape

NEW-TYPE DOMESTIC GRAMOPHONE FORESHADOWED

OF the many types of recording apparatus now used for bottling broadcast programmes for future use, one of the most interesting is the Seleno-

phone reproducing apparatus. They also employ their own processing tanks, and are thus entirely independent of outside firms. The spools in the recording machine hold 900 feet of film which gives rather more than ten minutes running time, assuming that ordinary talkie speed is used. The variable-area method of recording, by means of which scratch noises are said to be reduced to a greater extent than by other methods, is used in the system.

The German broadcasting authorities are reported to be developing a very similar system of their own. The most interesting news concerning this system, however, is that it is being used as the basis of a new

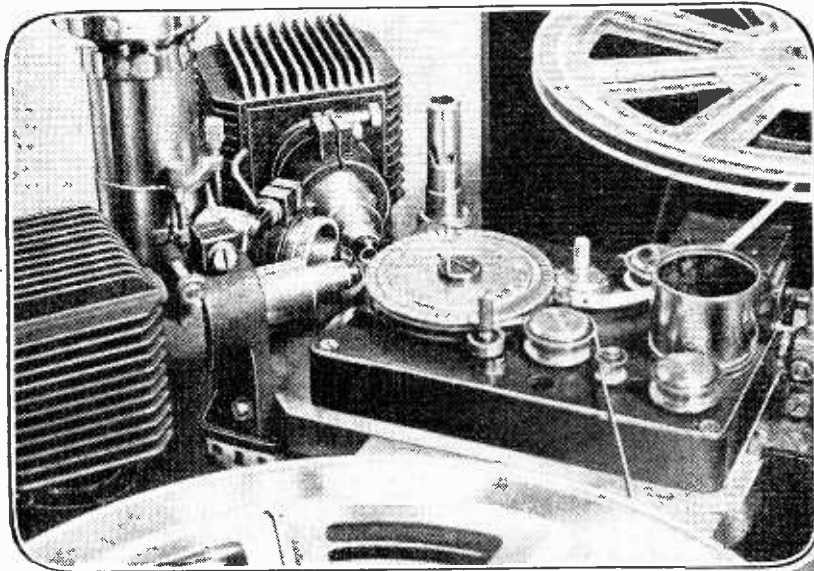

The Selenophone reproducing apparatus. Note the cooling fins on the two illuminating units between which can be seen the photo-cell tube.

circuit of the audio-frequency valve with some part of the driving mechanism that reflects the speed at which the car is moving. For instance, an ordinary cen-

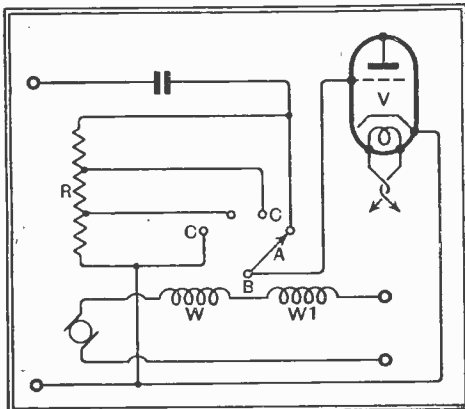

Volume according to the speed: novel application of AVC to a car radio receiver.

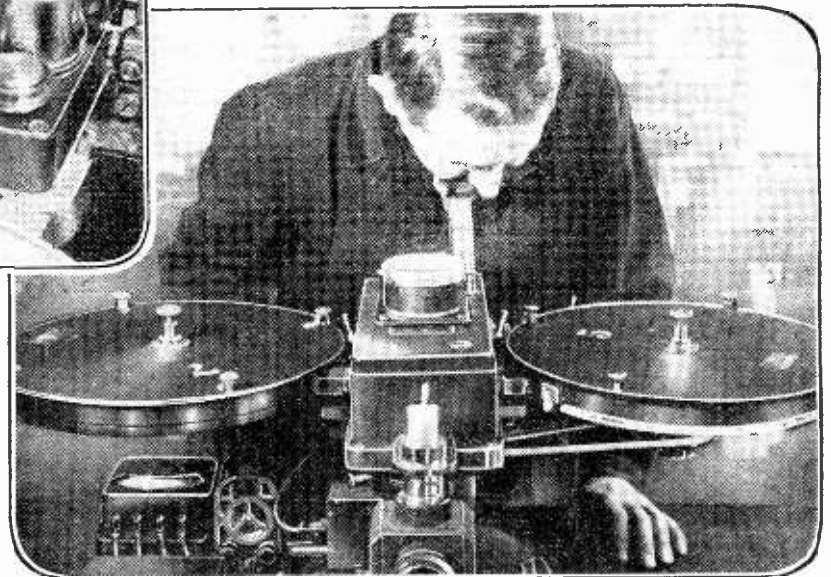

The Selenophone recording apparatus seen on the right is that used by the Austrian broadcasting authorities.

phone, used extensively by Ravag, the Austrian broadcasting organisation. This particular apparatus, which is an Austrian invention, employs either film or paper tape suitably coated with a light-sensitive emulsion. A full description of this system was given in *The Wireless World* of February 4th, 1931, and the present apparatus was illustrated in the issue dated March 29th, 1935.

The paper tape or film used is about one-sixth of the width of ordinary cinema film and, as a matter of fact, the Ravag people actually purchase unperforated cinema film

type of gramophone which its sponsors hope will eventually supplant the ordinary domestic disc machine. The home instrument will be very much smaller than its commercial prototype, and will use coated paper tape, the actual recording being done by a combination of photo-chemical and ordinary mechanical printing processes. Patent difficulties, which at first threatened to be a severe stumbling block, are now said to have been completely overcome. It is hoped that full details will be available before very long.

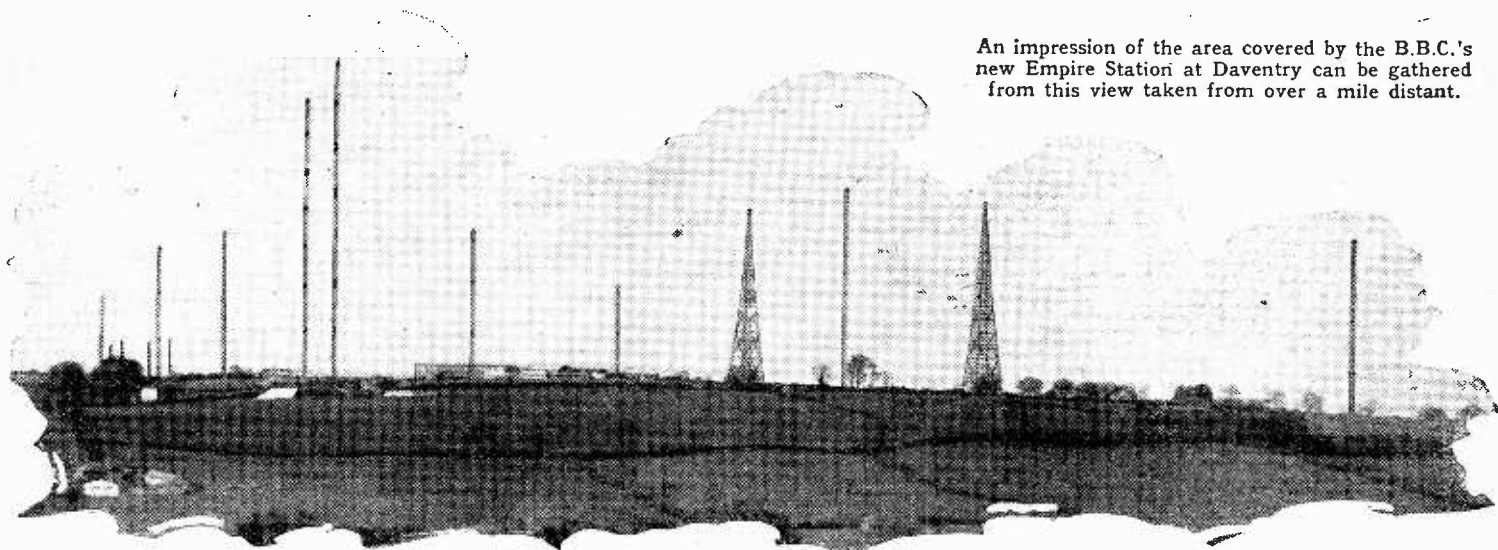

An impression of the area covered by the B.B.C.'s new Empire Station at Daventry can be gathered from this view taken from over a mile distant.

Re-diffusion of Empire Broadcasts

LOCAL SERVICES FOR ISOLATED COMMUNITIES

By EDWARD COVERLY

THE rapid development of short-wave broadcasting, together with the production of short-wave receivers as commercial articles at a popular price, has, in effect, placed world-wide reception of programmes within reach of anyone. European countries with colonies or other vital interests in various parts of the globe are thus provided with an easy means of maintaining touch with their own nationals abroad by broadcasting news of the home country and other "good will" programmes. Such is broadcasting's legitimate sphere; it has been recognised in this country and the B.B.C. has performed a valuable public service by developing its Empire station. Nevertheless, the possession of a suitable receiver is not within the means of more than a small percentage of the inhabitants of our dominions and colonies, nor are receiving conditions on the short waves by any means always ideal when the question of entertainment value as opposed to mere novelty has to be faced. Hence the establishment of local broadcasting services in all parts of the Empire is a natural development. In our larger dominions and colonies and in India such broadcasting services are now fully developed; they are self-supporting, able to provide much of their own programme material, but always working in co-operation with the B.B.C. and exchanging programmes as requisite. Similar developments in our smaller colonies, such as Gibraltar and Hong-Kong, for example, or our many small islands are, however, a different problem, if only because the financial aspect is such a limiting factor.

As a typical example of a small colony we may cite Malta. Here is a small island (or rather group of islands, but only one is of importance) only seventeen miles long and eight miles broad, yet congested with a population of about 258,000. Its

vital importance lies in its geographical position on the sea-route to India and the East and its consequent use as a base by all our fighting services. Although the majority of the natives are of Phoenician origin, a section of the upper classes are of mixed Spanish, French and Italian descent. At one time and another these people have shown an interest in Italian ideas and culture. Disputes over the use of the Italian language in the Law Courts and in schools has resulted in the withdrawal, by the British Government, of

A WELL-EQUIPPED central receiving station should always provide better reception of long-distance broadcasting than the apparatus available to the average individual listener: schemes for "community" reception and re-diffusion are especially likely to prove attractive to isolated communities.

more than one form of constitution.

Malta, unlike the majority of our Empire, is within easy range of the ordinary long- and medium-wave broadcasting stations in Europe. Reception conditions, on the other hand, are not always good, for atmospherics are often troublesome, while the high-powered transmitters belonging to the Navy and Air Force, not to mention the many ships of the Mediterranean Fleet in Valetta harbour, often cause interference which requires elaborate equipment to eliminate. Hence recep-

tion of the British long- and medium-wave stations is often out of the question. Geographical and atmospheric conditions inevitably make the local listener rely on the stations of Southern Europe and, since Italian is spoken by a considerable proportion of the native population, it is but natural that Rome and Naples should be the stations to which the Maltese listener normally turns.

The advent of short waves changed the problem, in that satisfactory reception of English programmes became possible. At about the time that the short-wave receiver became a popular commercial article, His late Majesty King George V first broadcast to the people of the Empire, on Christmas Day, 1933. The Government realised the importance of enabling the population to hear the speech.

In the absence of any local broadcasting station they turned to the Navy, and that Service hurriedly improvised a transmitter at Rinella suitable for telephony and coupled it to a short-wave receiver tuned to the Empire programme. Men from the ships begged and borrowed receivers and installed them on Christmas Day in the public squares of every village.

Such a makeshift arrangement might solve an important problem on one occasion, but it was clear that a more permanent service was necessary, and to this the Government turned their attention. The island was too small to provide more than a very occasional programme of its own. Furthermore, the revenue which could be expected from licences was so small that the utmost economy would have to be exercised. The small area of the island indicated that only a low-powered transmitter was required. And lastly, the question of interference with and from the Service and commercial stations on the island had to be considered. When all these factors were taken into account it was decided

Re-diffusion of Empire Broadcasts—

that re-diffusion was the most satisfactory solution. All parts of the Island were within easy reach of an economical land-line system. An elaborate receiving station, complete with all apparatus necessary to eliminate interference, could be erected. The B.B.C. Empire programme could be satisfactorily relayed to the people while, with the addition of a small studio at Valetta, local programmes could always be transmitted.

Here, then, surely did re-diffusing assume its legitimate role—not as a challenger to broadcasting but as a useful servant. It will only be fitting to conclude this article with a brief account of how the Government's plan has worked in practice.

The decision to adopt re-diffusion was taken early in 1935, and an English company was licensed to install the system and to run it. Unfortunately, before it had commenced operations a new factor arose. The European situation in August, due to Italy's intention to invade Abyssinia, resulted in tension between Britain and Italy, and, as is well known, intense anti-British propaganda was broadcast. The position of Malta was vital, and the need for countering such propaganda was imperative.

Since the re-diffusion service was not ready, the Government once more called on the Navy. The re-diffusion company willingly co-operated, lending the necessary receiver which was coupled to a Naval transmitter. The Empire

Four short-wave receivers at Tatsfield, where the B.B.C. pick up and relay for re-diffusion programmes from abroad.

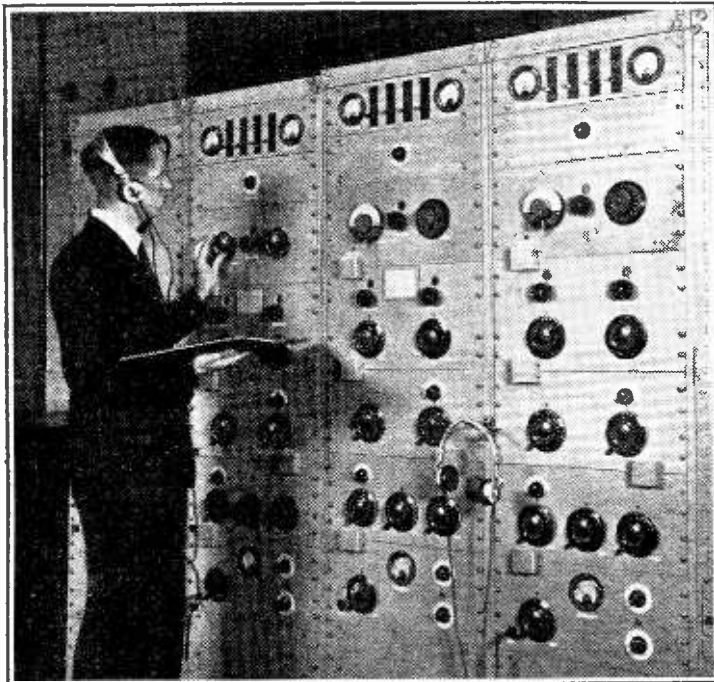

News bulletin was thus broadcast nightly in the Island and immediately afterwards a translation, in Maltese, was relayed from a room in the Governor's Palace. The re-diffusion company operated this temporary studio and provided loud-speakers in the principal public squares.

On November 11th, 1935, the company was able to open its own service, and within a year had obtained more than 2,000 subscribers. Now it is rapidly spreading its tentacles to all parts of the Island from its large receiving station erected a few miles outside Valetta. It provides its subscribers with two programmes for, in addition to the Empire transmissions, it relays selected continen-

tal stations, programmes by local artistes from its own studio, speeches by the Governor or other prominent citizens and running commentaries of any important event which may take place in Malta.

DISTANT RECEPTION NOTES

PARTLY through my own observations and enquiries and partly through information kindly supplied by a London reader I have been able to clear up once and for all the vexed question of "Radio Verdad." "Radio Verdad" does not now claim to be a broadcasting station. It is the title given to news bulletins in Catalan and Spanish, broadcast twice each night from certain Italian stations. It is sent out at 7.45 p.m. from Florence, Rome, Milan No. 1 and Genoa, and at 11 p.m. from Florence and Milan.

When I first heard the "Radio Verdad" transmissions I was pretty sure that that was what was happening, though an address (Plaza Bandos Puig, Salamanca) was several times given out for the benefit of intending correspondents. Whilst I was

Except for the fact that atmospheric have been rather a nuisance at times, the sunspot activity which has been proving so devastating on the short waves does not appear to have had any very adverse effect on medium-wave and long-wave reception. It is worth noting, though, that on the first day of this month atmospheric were so continuous and so violent, in my locality at any rate, that they interfered seriously with reception of the local stations even on a portable set using a frame aerial.

It's a pity, I think, that so many stations seem to find it necessary to change their names. Certainly it doesn't make things any easier either for long-distance folk or for those who have to make station-name tuning dials. France's present long-wave station began its career as Radiola; it is now Radio Paris, and soon it will become Radio National. The Deutschlandsender was at first Königswusterhausen (light-heartedly, if incorrectly, translated as King's sausage houses by some old hands!); the Dutch long-wave station was known at first simply as PCGG, but it soon turned into Hilversum, though not for long. Hilversum became the name of their medium-wave station and the long-wave transmitter was named Huizen. Then for a time high-powered transmissions on the long waves were labelled Kootwijk; and now the name is back again to Hilversum.

I don't so much mind this chopping and changing so long as the name of the station indicates the place where the transmitter is situated—though even so you may be rather sunk unless you are constantly buying up-to-date atlases. My own, for example, knows Angora, but not Ankara; Lemberg, but not Lwow.

The most annoying names are those like Deutschlandsender or Radio Roumania, or just Radio National, which merely show the country of origin. A pity, I think, call-signs of letters and figures have almost dropped out for broadcasting stations on this side of the Atlantic. In the United States they continue in regular use, and as they are always accompanied by both the town and the state you can find any station's location in a matter of moments and can then turn up its particulars in an alphabetical table just as quickly if you want to do so.

D. EXER.

News from the Clubs

The Dollis Hill Radio Communication Society

Headquarters: The Brainerd Schools, Warren Road, London, N.W.2.
Hon. Sec.: R. Hodgkyns, 102, Christ Road, Cricklewood, N.W.2.

At the opening meeting of the above society a lecture on 5-metre super-regenerative transmitters was given by C. J. Search followed by a demonstration. On May 25th at 8.30 p.m. a talk on valves will be given by Mr. S. C. Ash. All those interested in wireless matters will be welcomed at the meetings of the society and are invited to communicate with the hon. secretary for full particulars concerning it.

Southall Radio Society

Headquarters: The Three Tins Hotel, The Green, Southall.
Meetings: Tuesdays at 8.15 p.m.
Hon. Sec.: H. F. Reeve, 26, Green Drive, Southall.

A DF contest is being held on June 20th. A silver trophy is being provided for annual competition, and in addition to this the winning team of three will be presented with medals. The transmitter, which will be handled by Mr. Douglas Walters (G5CV), will operate on a frequency in the 40-metre band.

still making enquiries by post I rigged up a frame aerial and found that the bearing of the transmission on 368.6 metres was almost exactly south-east. This is Milan's bearing from me. Next I tried Radio Nacional, the high-powered Franco station which does broadcast from Salamanca on 274 metres and found that its bearing was a little west of south.

One or two people have asked me lately how it is that there are two EAJ's in the field at the moment, Bilbao and San Sebastian. The call-sign belongs, of course, properly to San Sebastian, but when Franco's troops were advancing on this town the radio transmitter was moved to Bilbao. Thus the original EAJ8 is the one which is now at work at Bilbao. But the Nationalists rigged up a new plant at San Sebastian and, having done so, adopted the old call-sign for it.

Current Topics

EVENTS OF THE WEEK IN BRIEF REVIEW

Super PA

A STOCKHOLM engineer named Ekman is reported to have devised a new type of loud speaker for special PA work. It is said to have a range of between six and seven miles.

Broadcasting and Art

THE first International Congress of Radio Art will be held in Paris from July 8th to 10th. The agenda is to be divided into seven sections dealing with the following subjects: The theatre, music, journalism, educational transmissions, technical arrangements for transmission and reception, television and general questions.

Australian SB

THE chairman of the Commonwealth Broadcasting Corporation announces that an all-Australian network of broadcasting stations has just been formed, modelled on the American principle. There are 15 stations in the Australian system, and it is estimated that they serve 80 per cent. of the inhabitants of the five most populous of the Australian states.

Eiffel Tower Television

THE television transmitter ordered by the French P.M.G. will have a power of 30 kW. The aerial will be mounted on the flagpole at the top of the tower and will thus be well over a thousand feet above ground level. The transmitter is being supplied by the French concessionaires of the International Telegraph and Telephone Corporation of New York.

Wavelength Changes

THE 260 kc. Oslo station has for some time past been troubled by experimental transmissions which the Finnish station at Lahti has been carrying out on 262 kc/s. Lahti has now given up the idea of putting out programmes on this frequency, and hopes to interchange wavelengths with Moscow.

The SW station at Motala may now be heard on both the 25- and 50-metre wavebands. These transmissions are at present experimental.

Another Newcomer

THE Finnish Government has set aside a quarter of a million marks for the erection of a National SW broadcasting station. It will be built by the P.O. near Lahti.

More High Power Coming

THE Icelandic Broadcasting Corporation is stated to have awarded a £20,000 contract to the Marconi Co. for the reconstruction of the Reykjavik station. Its power is to be increased to 100 kW. It is hoped to have the reconstructed transmitter in operation early next year.

Radio in the Arctic

A SPECIAL radio centre has been installed in Moscow to communicate with the stations in the Arctic regions. In spite of the great distance reception conditions are said to be very good, there being remarkable freedom from severe atmospheric conditions. The Russian Government is to erect three new stations in the Arctic Circle.

Technical Blunder

IT is revealed that considerable annoyance was caused in Paris by the wireless interference at the boat race recently held on the Seine between eight representing Paris and Oxford and Cambridge. Following the example of the annual Oxford and Cambridge boat race a relay was attempted from a launch. There



AUSTRALIAN PIONEER.
Ernest Thomas Fisk, A.M.I.E. (Aust.) Managing Director of Amalgamated Wireless (A'sia), who has played a prominent part in developing the wireless services of the Commonwealth, also received the honour of a Knighthood.

was a great deal of morse jamming from the Rugby-Karachi service, but it would seem that the French engineers were asking for trouble by attempting to use long instead of short waves.

Radio Morue

A WIRELESS transmitter has been installed on the "St. Yves," which is a special missionary vessel, known as the church boat, attached to the Newfoundland cod-fishing fleet. The station is known as Radio Morue (cod).

Car Radio Licences

REPLYING to a question in the House recently the Assistant - Postmaster - General once more found it necessary to repeat that a separate licence was necessary for a wireless set fixed in a car. A portable set, however, used in a vehicle was covered by the owner's ordinary wireless licence.

Radio Telegraphists' Union

THE headquarters of the Wireless Operators' International Union has been moved from London to Copenhagen. There are about 8,000 members in the Union, these coming from 18 different countries, and it is hoped that their numbers will shortly be reinforced by 1,500 Japanese operators. The Union is to be represented at the International Telecommunications Conference at Cairo next year.

Amateur-Night Up to date

THE system of granting auditions to amateur performers in order to discover possible hidden talent has always been a great feature of the Paris broadcasting station. It is now being adopted by the programme authorities at Radio Bordeaux and Radio Lyons, who are bent on tapping what they believe to be a great wealth of latent artistic ability in the southern half of France.

Avalanche Warnings

BY an agreement between the Swiss Ski Federation and the station authorities, the Bernmünster transmitter will broadcast bulletins concerning the state of the snow at 7 p.m. on Fridays and 12.25 p.m. on Saturdays. The report will deal specifically with all points threatened by avalanches. The service is only experimental at present, but it will be completely organised during the summer so that it will be in working order by next winter.



CORONATION HONOURS LIST included a Knighthood for Louis Saul Sterling, managing director of Electrical and Musical Industries, and a director of Marconi-E.M.I. Television.

PA in Schools

A NEW and elaborate receiving installation has been acquired by the Dala Municipal School, Goteborg. All classrooms have been equipped with loud speakers which are connected to a switchboard in the headmaster's room, so that he can supply them with the special wireless transmissions for schools picked up by the receiver or can address the whole school itself via a microphone.

Extra Television Hour

AS predicted in *The Wireless World* of April 23rd, the B.B.C. announces that an extra period of television, lasting approximately an hour, will shortly be given every weekday morning between 12.30 and 1.30 p.m. A special film, surveying the activities of television since the opening of the service about six months ago, has been produced by the B.B.C. and will be shown every day in the extra hour. The B.B.C. wishes to emphasise that this transmission is not for the entertainment of home viewers.

Television Holiday

IN order that an overhaul and certain internal adjustments may be carried out at Alexandra Palace, arrangements have been made, with the concurrence of the Television Advisory Committee and the approval of the Postmaster-General, for television transmissions to be suspended for three weeks, beginning on Monday, July 26.

N.R.E.A. Branch Meeting

A LECTURE to the Romford branch of the National Radio Engineers' Association will be given by Mr. E. W. Harris, of the Radio Development Company, at 8.30 p.m. on Wednesday, May 26th. The meeting will be held at the Victoria Hotel, Romford.

Pye Baby "Q" Portable

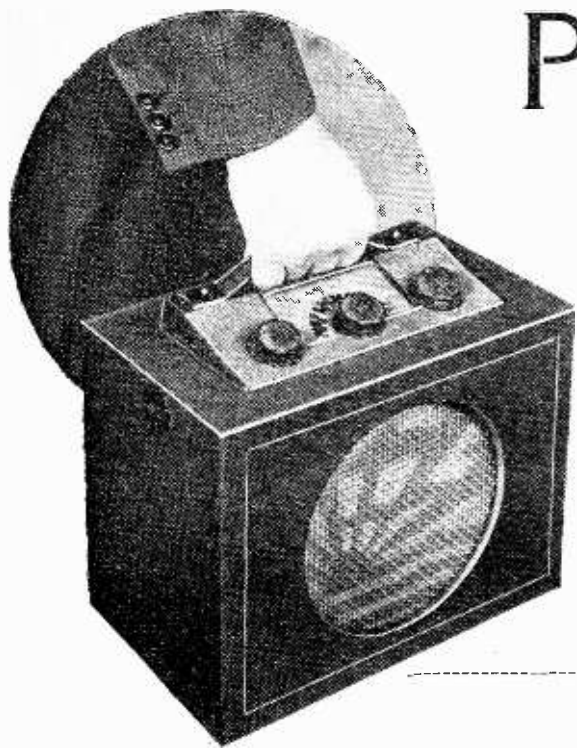

FEATURES. *Type.*—Portable battery receiver. *Circuit.*—Pentode RF amplifier—triode grid detector—triode first AF amplifier—pentode output valve. *Controls.*—(1) Tuning. (2) Combined volume and reaction. (3) Waverange and on-off switch. *Price.*—8 gns. *Makers.*—Pye Radio Ltd., Radio Works, Cambridge.

A COMPACT SELF-CONTAINED RECEIVER WITH AN EFFICIENT FOUR-VALVE CIRCUIT

ALTHOUGH of considerably smaller size than the battery portable receivers which were standard a few years ago, there is nothing else in this set which justifies a comparison with the so-called midget receivers in which minimum dimensions have been made the first consideration.

A 20-ampere-hour accumulator and a 90-volt HT battery of standard capacity are provided, and the reduction in overall dimensions is due entirely to the skill of the designers in compressing all the necessary component parts into a narrow chassis on the top of the cabinet. When it is realised that space has to be found for a permanent magnet moving-coil loud speaker and receiving valves of standard size, there can be no hesitation in awarding the designers full marks for their ingenuity.

The frame aerial winding is actually built into the thickness of the cabinet itself, and some saving in space has been effected by tilting the chassis slightly upwards to give a sloping dial and tuning panel. The latter takes the form of a moulding with which is incorporated the carrying handle. The dial is transparent and the pointer is mounted underneath. Felt washers are fitted under the tuning knobs, so that the instrument is completely dust-proof. The front of the loud speaker is covered by fabric which is in turn protected from damage by a strong wire mesh grille.

Care has been taken to ensure that both HT and LT batteries are firmly located and to this end a sponge rubber disc is fitted to the back of the loud speaker magnet which presses the battery against angle brackets. One of these can be swivelled to facilitate battery replacement. No grid bias battery is required as auto-

matic bias has been included in the circuit specification.

The first valve in the circuit is a variable-mu RF pentode with tuned anode coupling to the triode detector valve. Reaction is applied through the usual capacity controlled circuit and the condenser is ganged to a filament resistance in the negative lead to the RF amplifier. This revival of a practice which was common in the earlier days of wireless recep-

tion works remarkably well and ensures a good minimum when using the set near a powerful transmitter. There is a slight time lag due to the heat content of the filament, but the delay is not sufficient to cause serious inconvenience. Mechanically the control is so arranged that the RF valve filament is at full brilliance before reaction comes into operation. A suitable grid bias, giving the best compromise between detector efficiency and smooth reaction, is obtained by dual grid leaks forming a potentiometer which gives a voltage somewhere between + and - LT.

The detector is followed by a first stage audio frequency triode with resistance coupling. The output from this valve is then passed to the pentode output valve through a parallel-fed transformer. There can be little doubt that the generous audio frequency amplification provided is responsible for a good deal of the liveliness of the performance.

During daylight we were successful in receiving programmes of good entertainment value from ten of the fourteen stations marked on the medium-wave scale, and after dark nearly forty stations were logged, of which twenty-five were unquestionably of usable strength with a good margin for any possible fading in the case of stations near the bottom end

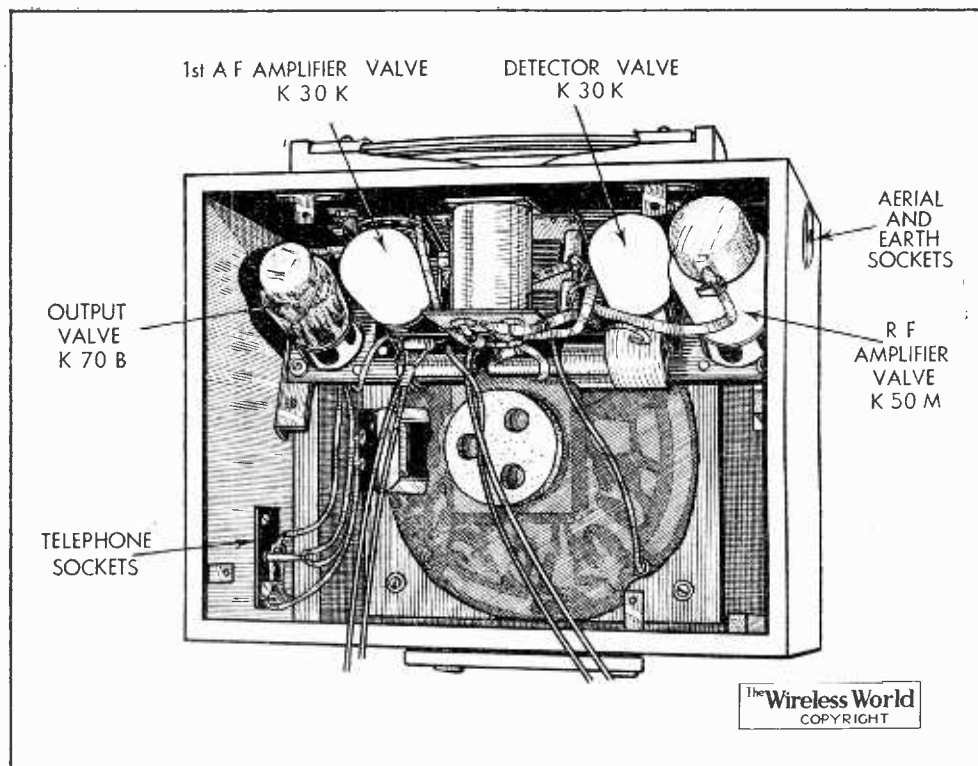

A compact receiver chassis leaves ample space for batteries of standard capacity. The frame aerial windings are incorporated in the sides of the cabinet.

Eye Baby "Q" Portable—

of the dial. The small frame aerial was perhaps not quite so efficient on long waves, but Droitwich was received without calling upon reaction and, if anything, required a slight reduction by means of the volume control. Luxembourg, Radio-Paris and Hilversum provided excellent volume with a degree of reaction which called for reasonable care but which could not be described as critical.

The efficient little moving-coil loud speaker apparently makes excellent use of the 100 milliwatts output for which the output valve is rated. Certainly the volume sounded considerably more than we are accustomed to expect for this figure. Also, the reproduction was exceptionally free from harmonic distortion at moderate levels with the volume control turned down.

tion was 0.54 amp., which at a conservative estimate should give 30 hours' service on a single charge from the jelly electrolyte LT accumulator. The weight of the set is 17½ lb., and the carrying handle is so designed that if the set is picked up in the natural way the loud speaker grille will be pointing in towards the person, and the centre of gravity will cause the set to tilt slightly outwards to avoid the discomfort of having deliberately to hold the set out sideways. In the title picture the set is being held the wrong way to show the control panel and loud speaker fret. If held normally some difficulty would be experienced in recognising it as a wireless receiver.

There is provision for an external aerial and earth, though it is extremely unlikely that the need for this will be felt. Also, for use in exceptionally noisy surroundings

**Cathode-Ray Tuning Indicator —
The Mazda ACME**

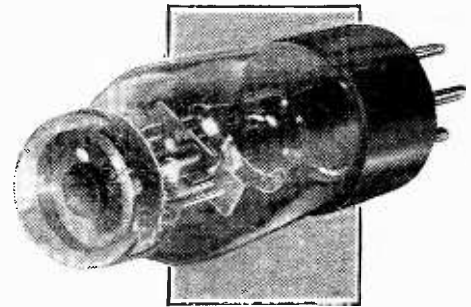

ONE of the most popular types of tuning indicator is that operating on the cathode-ray principle, and the Mazda ACME is the latest addition to this branch of electronics. Similar in appearance to an ordinary valve, it actually contains the elements of a triode amplifier and a miniature cathode-ray tube. A small fluorescent screen is mounted inside the valve and is visible through the upper end of the bulb. When the grid and cathode of the triode are at the same potential, some 270 degrees of the circular screen fluoresces green. As the triode grid is made negative, the green area expands, so that the initially unlighted segment of 90 degrees contracts. When the grid is made highly negative, almost the whole of the screen is illuminated.

The recommended connections are shown in Fig. 1 and will be seen to be extremely simple. The input terminals are connected across the diode detector load resistance, the cathode of the ACME being joined to the detector cathode. With these connections only one-half of the detector voltage is applied to the indicator, and this is about right for the average receiver. The indicator will then commence to function for

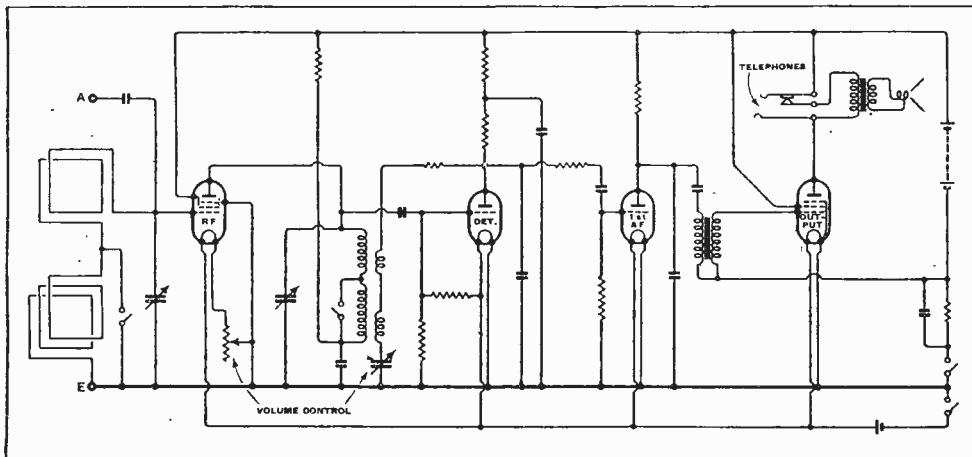

Automatic bias is provided for the output stage and the filament rheostat volume control is undoubtedly effective in practice.

Having regard to the excellent performance from the point of view of volume and quality it was surprising to find only 7.2 mA. was being drawn from the 90-volt HT battery. The LT consump-

tion was 0.54 amp., which at a conservative estimate should give 30 hours' service on a single charge from the jelly electrolyte LT accumulator. The weight of the set is 17½ lb., and the carrying handle is so designed that if the set is picked up in the natural way the loud speaker grille will be pointing in towards the person, and the centre of gravity will cause the set to tilt slightly outwards to avoid the discomfort of having deliberately to hold the set out sideways. In the title picture the set is being held the wrong way to show the control panel and loud speaker fret. If held normally some difficulty would be experienced in recognising it as a wireless receiver.

RADIO RESEARCH DURING 1936

The National Physical Laboratory Report for the Year 1936.—Pp. 144. Published by H.M. Stationery Office. Price 2s. 6d., postage extra.

MUCH interesting information on recent developments in wireless and allied subjects is to be found in this report, covering the whole of the activities of the N.P.L. The sections devoted to the work of the Radio, Electricity, and Physics Departments will no doubt be studied first, but the rest of the publication makes stimulating reading for anyone with an interest in technology.

Direction finding, with special reference to the requirements of aircraft, has occupied a good deal of the attention of the Radio Department, and the results of experiments using the short-wave Adcock direction finder over distances up to 9,000 miles with ships and 500 miles with aircraft are given. Work on the possibilities of ultra-short-wave (5- to 10-metre) direction finding, and the effects of obstacles in the path of transmission, has already begun, and the influence of cables and fences on site errors has been investigated. The properties of the ionosphere and

their effect on wave propagation have a direct connection with direction finding, and the work of the department, which has hitherto been concerned principally with vertical incidence, has now been extended to oblique incidence records on a 350-mile base line. The analysis of records taken during the Polar Year (1932-33) has been completed, and some interesting facts are given regarding the complexity of echoes obtained at Tromsø relative to simultaneous records made at Slough. Other activities of the Radio Department, of which ample details are given, include investigations into electronic oscillations in valves and oscillators of stable frequency.

In the Electricity Department apparatus has been developed with a frequency range of 10 to 10,000 kc/s for the testing of dielectrics employed in television apparatus, and in the Physics Department investigations into the measurement of noise have resulted in an objective meter giving correct indications for intermittent and impulsive sounds and suitable for the measurement of sound levels from motor car exhausts.

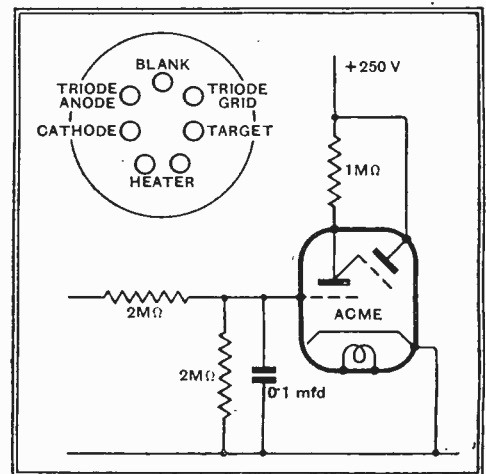

Base connections and circuit for using the ACME indicator.

detector inputs exceeding about 0.5 volt, and will continue to operate until the input exceeds 40 volts. For the clearest results, however, the detector input should not be less than 2 volts.

The indicator is indirectly heated, and it consumes 0.5 ampere at 4.0 volts for the heater. The maximum anode potential is 250 volts, and the triode anode current does not exceed 0.24 mA., the target current being nearly constant at 1.5 mA.

サイエンス UNBIASED

By FREE GRID



Badge of recognition

It is not often that I am compelled to call on you for assistance, but I always feel secure in the knowledge that if ever I should, through no fault of my own, be in desperate straits, you would be willing to do all in your power to assist me. I am now compelled to seek your help, but not so much on my own behalf as of one of your fellow readers living in far-off China who has made a desperate appeal to me for assistance.

He has sent me a letter written in quaint, but perfectly understandable English in which he requests "certain honourable information." He has, it appears, just completed the building of the famous "Everyman Four" receiver, which some of you old lags will remember was described in this journal just over ten years ago. I dare say that you are quite as familiar as I am with the old motto "Slow but Sure," but, even so, ten years may seem to you a long time to take in building a set.

The delay has, however, been due solely to the length of time the manufacturers have taken to deliver the parts, a phenomenon which appears to be even more marked out the Far East than it is over here. These few years' delay has not hitherto ruffled my correspondent's Oriental calm and patience, but even this well-known characteristic of our Eastern brethren has its limits, and the non-arrival of the valves has apparently reached it.

In anticipation of having his set completed by June 2nd he sent out some months ago an invitation to certain high police officials of his native city to come and listen-in to the world-famous Derby broadcast at his house. If he disappoints his guests he will have committed a social *faux pas* which in the Orient is looked upon as one of the seven deadly sins, namely, breach of hospitality. But quite apart from this, it appears that the chief magistrate of the city, who is among the invited guests, suffers severely from liver trouble and my correspondent informs me that if he fails to deliver the goods, "honourable body will be dismembered and components distributed to friends."

Now I am not quite sure what the latter remark means, but those of you who have lived out East will probably know. Either he means that the Chief Magistrate will execute him and afterwards send pieces

of his body round to his friends as a warning, or, alternatively, he means that he will commit *hari-kiri* and leave instructions for bits of him to be distributed to his acquaintances as souvenirs. Whichever is the true explanation, I don't relish receiving a parcel containing an odd ear or finger, and so perhaps some of you will do your best to avert the tragedy by supplying the information and help which he needs.

The information which my correspondent is in search of is whether or not the characteristics of certain locally made valves which he proposes to substitute for the British ones are suitable for the receiver. He sends me a page from the local radio journal containing advertisements which, he states, give full technical characteristics in tabular form. Unfortunately for him, my knowledge of

マツダランプの
ラヂオ用真空管
の
製造激増の爲
値下

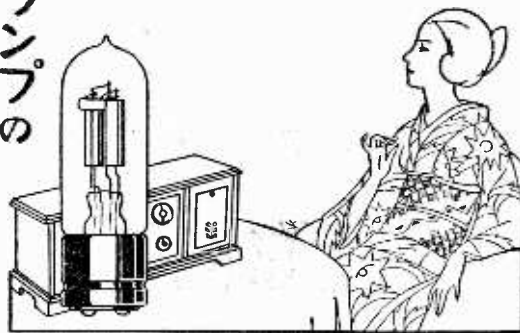

Oriental languages is limited to words describing the necessities of life, such as beer and tobacco. It is, therefore, in the desperate hope that some of you Oriental scholars may be able to read the advertisement that I reproduce it herewith.

It behoves you to act quickly, however, since if the worst comes to the worst I shall certainly pass on to you any anatomical specimens which may be sent to me.

The Ancient Order of Ether Hogs

At my age secret societies have no longer the same appeal as they had in the days of my youth, and, as a matter of fact, I have taken little or no interest in them since the early years of the century when I was thrown out of the Camorra for gross clumsiness and lack of professional *finesse* by using TNT instead of the time-honoured arsenic for removing an unwanted citizen.

I have, however, been asked to accept the presidency of a proposed society to be known as the Ancient Order of Ether Hogs, members of which will be able to recognise each other by means of a badge

which I reproduce herewith, to be worn in the buttonhole. I am not at all sure whether I ought to accept this invitation and I am seeking your advice in this matter, since the avowed objects of the association are of distinctly anti-social nature which is, I suppose, only what you would expect from a secret society.

The society's *raison d'être* is to wage war on users of too-loud loud speakers and those who take the loud speaker into the garden during the summer, by means of violet-ray machines and unsilenced electrical apparatus generally. Although noisy loud speaker owners are certainly one of the pests of society and a menace to the popularity of wireless, I do not think I ought to go so far as to encourage the generation of deliberate interference, even though the members of the proposed association have pledged themselves to make a nuisance of themselves only in those areas where a nuisance already exists.

Women and Television

The report which I noticed recently in *The Wireless World* to the effect that over 90 per cent. of the many thousands of people attending certain television demonstrations in London are men is a truly astounding commentary on the extraordinary lack of interest which women seem to have in scientific matters. Actually you would, of course, expect the figures to be reversed and the majority of the people attending these demonstrations to be women, for they have ample time and leisure to do so. It says much for the energy and intellectual superiority of men that they have managed to find time from the hard daily grind of their lives in the City and elsewhere to slip away—presumably in their lunch hour—to see the demonstrations, whereas women have not had the energy or the gumption to rouse themselves from their lotus-eating lives in the home even for one hour in order to improve their minds.

I suppose that, as usual, they are waiting for it to be brought to them served up on a plate, as it eventually will be when their husbands and other male breadwinners have saved up enough of their hard-earned cash to buy a television receiver for themselves. This revelation ought at any rate to be a valuable guide to the budding C. B. Cochran at the Alexandra Palace and enable them to give us more virile programmes and cease to put out effeminate milk-and-water items for an audience which does not exist.

New Apparatus

Recent Products of the Manufacturers Reviewed

NEW BULGIN SWITCHES

SWITCHES that operate only when the lever is pressed over by the finger are often extremely useful in the construction of certain types of test apparatus. This method of changing the internal connections is most valuable when the changes so effected render the meter ultra sensitive, as by automatically returning to the original position it can usually be arranged for the meter, or test set, to be less liable to damage in the event of an overload.

Switches of this pattern are now obtainable from A. F. Bulgin and Co., Ltd., Abbey Road, Barking, Essex. They resemble in appearance the ordinary toggle

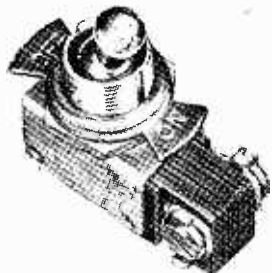

Bulgin Type S172 toggle switch.

pattern, but the internal mechanism is so arranged that the contacts are closed or opened, according to the type of switch, only while the "dolly" lever is pressed over by the finger, and on release they immediately return to the original position.

The principal features of these new models is that though in effect they are push-button switches the design is such that they will carry up to 3 amps. at 250 volts, and the make and break is of the quick, or snap-action, kind.

In the Type S171 the contacts are normally open and close with pressure on the lever, while in the Type S172 the contacts are closed in the normal position.

The price of either type is 1s. 9d.

BENJAMIN OCTAL VALVEHOLDERS

CHASSIS-MOUNTING valveholders for the new International valves now available and which are fitted with what is described as an octal base, can be obtained

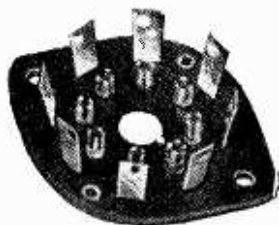

Benjamin chassis-mounting octal valveholder.

from The Benjamin Electric, Ltd., Brantwood Works, Tariff Road, Tottenham, London, N.17.

This particular type of base has eight pins and a self-locating centre plug. The Benjamin valveholder has semi-floating sockets, while the soldering tags are arranged in a concentric circle outside the sockets. Socket and soldering tag is stamped out of one piece of metal. These new-style valveholders cost 9d. each.

CROMPTON MICROPHONE

THIS is a transverse current carbon microphone of the type now largely used in PA work. It is a robust instrument and exhibits good workmanship, while it is also attractive in appearance. A turned and polished ebonite case is used with a chromium-plated front cover and four large screw eyes are provided for suspending it in a stand.

No resonances of any consequence could be traced by aural tests when the microphone is correctly matched to the input of the amplifier and provided a good transformer is used.

The reproduction of speech is very good indeed, and different individuals can easily be recognised by their particular characteristics of speech and inflexions, etc.

This microphone has a very low background noise, and it operates satisfactorily with between six and nine volts. Its resistance is approximately 500 ohms.

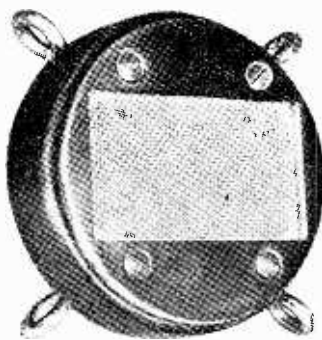

Crompton transverse current carbon microphone

The makers are G. Crompton, Woodfield House, Woodfield Terrace, Bury, Lancs, and the price is £1 19s. 6d.

WHARFEDALE OUTPUT TRANSFORMER

AN output transformer similar in size and appearance to that fitted to their loud speakers can now be obtained from Wharfedale Wireless Works, 62, Leeds Road, Bradford, at the price of 6s. It measures approximately 3in. x 2in. x 2in. overall and provides the choice of three ratios, viz., 30, 60 and 90 to 1 respectively.

The various ratios are obtained by tapping the primary winding and employing one or other of the two sections, or the whole, as the case may be.

Some measurements made with this transformer show that the whole primary wind-

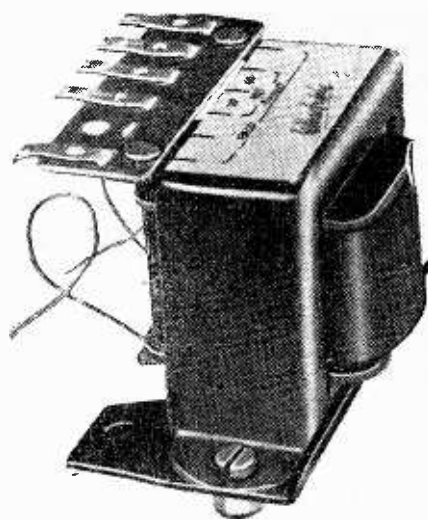

Wharfedale three-ratio replacement output transformer.

ing—90:1 ratio—without DC flowing has an inductance of 65 henrys, which is reduced to 15 henrys with 16 mA of DC, and to 9 henrys when 40 mA of DC is passing through it.

The resistance of this winding is 600 ohms. When using the 60:1 ratio the resistance of the primary is 380 ohms and its inductance with no DC is 33 henrys. This value becomes eight henrys with 20 mA of DC and five henrys with 40 mA of DC.

This transformer can also be supplied with a centre-tapped primary for push-pull use at no extra charge.

The transformer is fitted with a "Stalloy" core, and it is intended primarily as a replacement component.

BELLING-LEE FLAT-PIN PLUGS

IT should have been stated in our recent review of the new Belling-Lee flat-pin plugs and sockets that they are designed to conform to the British Standards Specification 666, which applies to plugs and sockets for use in radio speech circuits when the power does not exceed 50 watts.

The purpose of this specification is to render it impossible to confuse radio extension and mains power points and also to provide a standardised form of connector so far as its electrical properties and essential physical dimensions are concerned.

The Radio Industry

EUGEN FORBAT, agent for Ostar-Ganz universal high-voltage valves, has transferred his offices to Goschen Buildings, 12-13, Henrietta Street, London, W.C.2. The associated company, Universal High Voltage Radio, Ltd., has moved to the same address.

A new catalogue of Trix Sound Equipment has just been issued. Address, Trix Electrical Co., Ltd., 8-9, Clerkenwell Green, London, E.C.1.

New Times Sales Co., 56, Ludgate Hill, London, E.C.4, has issued a new list of short-wave sets and components.

The Cressall Manufacturing Co., Ltd., Eclipse Works, 31-32, Tower Street, Birmingham, 19, makers of resistances, etc., announce a ten per cent. increase on all existing prices.

Mr. M. Featherstone, 51, Fourth Street, Ashbury, New South Wales, Australia, would like to receive catalogues, etc., from firms exporting to Australia.

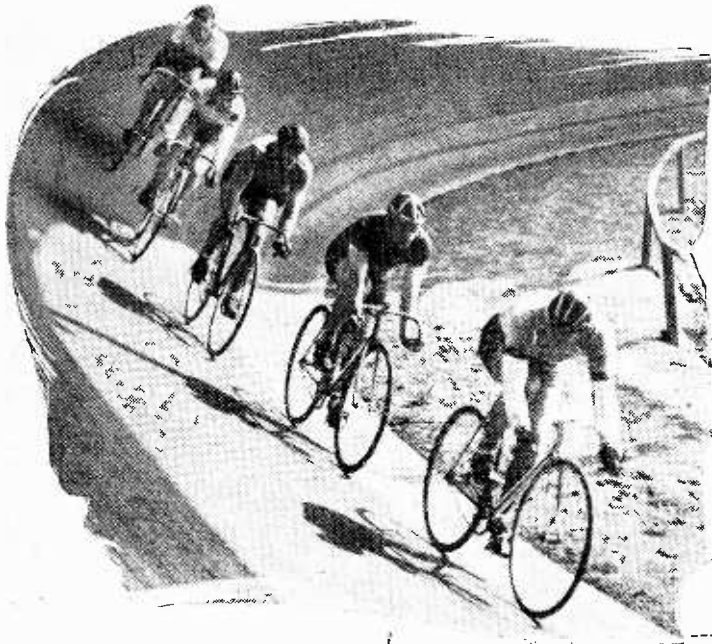

WITH so many representatives of the British Empire in the Home Country at this time added interest is given to the celebrations of Empire Day. The broadcast programmes include three special features. The first is at 11.55 a.m. when National listeners will hear the Empire Day Service from St. Paul's Cathedral. Their Majesties, King George VI and Queen Elizabeth will be present as will also representatives of the Dominions. The address will be given by the Archbishop of York and the lessons read by the Canadian Premier, Mr. Mackenzie-King.

In the evening the annual Empire Day programme will be provided by All India Radio. It will give a picture of the characteristics of the eleven Provinces, and therefore the great differences which exist among the peoples of India. Ceylon will also make a contribution. Although this will probably not be so ambitious a programme as those provided by Australia, Canada and S. Africa in the past three years, it will serve as a reminder of the importance of the Indian Empire. This programme will be radiated at 7.30 (Nat.).

Later in the evening, at 9 (Reg.), the special Empire Day Concert will be broadcast. Sir Walford Davies and Clarence Raybould will be the conductors, and Empire singers will comprise the choir. The music will include Sir Walford's own fantasy, "Big Ben Looks On," which, dedicated to the two Princesses, Elizabeth and Margaret Rose, was

MARATHON. Members of the English and Australian teams for the Six Days Cycle Race practising on the track at Wandre, near Liège, Belgium. The race, which is being held at the Empire Stadium, Wembley, will provide a short commentary for Regional listeners on Saturday at 10.50 when the last ten minutes of the race will be described.

first broadcast last month before them at the Children's Coronation concert in the Central Hall, Westminster. The Empire singers are members of, and represent, various Empire choral societies. They took part in the Coronation Service in Westminster Abbey. Margaret Godley (soprano) will be the soloist.

TOSCANINI

THIS week brings the first of the series of six Toscanini concerts from the Queen's Hall. These constitute the London Music Festival, and all six concerts will be conducted by the Maestro himself. Within a few days of the issuing of the tickets for these concerts, all the seats were sold. For Wednesday's concert which will be broadcast at 8.15 and 9.25 (Nat.), the programme includes Beethoven's overture, Coriolan, and Brahms' Symphony No. 1 in C Minor.

OXFORD EIGHTS WEEK

ADDED interest to the famous Eights Week of Oxford University is given this year by the Varsity's win over Cambridge in the annual Boat Race. For those listeners unacquainted with Eights Week, it may be explained that it is an aquatic garden party to which undergraduates' relatives flock to see the college Eights in their annual race.

Listeners' Guide

Outstanding Broadcasts at Home

The races themselves are somewhat grim affairs, the boats actually bumping each other, often much too severely. John Snagge will, from the University Boat Club, give a general description of the first division races on Monday at 6.10, which will be followed by a descriptive picture of the Isis dressed for the gala. It is hoped to bring to the microphone celebrated old Oxonians

is first-rate. The bill also includes the third broadcast of Gus Chevalier and his partner.

"DOGS OF DEVON"

AN abridged version of "Dogs of Devon," or "Foiled Again," specially prepared and adapted by Cyril Wood, will be broadcast on Saturday at 9 (Reg.). This comic opera is ideal light entertainment, and essentially English in character. It is, in fact, as attractive to-day as when it was first staged in 1913. Nearly six years ago "Dogs of Devon" was broadcast in its entirety from Cardiff. The cream of the opera, including all the favourite numbers, will be broadcast in this abridged version.

ROYAL PERFORMANCES

AN interesting programme of songs and excerpts from plays which have been acted before British royalty has been prepared for National listeners on Monday at 9.35 under the heading "Incidental to a Play."

who will be at the races, many of them whilst visiting this country for the Coronation.

VARIETY

JOHN SHARMAN is bringing back to his "Music Hall" on Saturday Alexander and Mose, the well-known black-faced pair, whose title hides Billy Bennett and James Carew. The bill also includes Forsythe, Seaman and Farrell, a comedy trio, and a new partnership billed as Major and Minor. Another act is that of the Six Viennese Singing Sisters who have broadcast once before. They are a vivacious troupe who sing songs of their native land in close harmony. Others in the cast for Saturday's Music Hall to be broadcast at 8 (Nat.) are Billy Russell and Stainless Stephen.

Listeners can rely upon a good programme of mid-week variety on Wednesday at 9 (Reg.). The cast includes Aileen Stanley, who scored a great success in the early days of the Kit Kat Club, and is visiting this country again from America. She has an excellent microphone voice and perfect technique, and her singing of American numbers



GRACIE FIELDS, who was heard by listeners on Thursday of last week, will be seen by viewers on Saturday evening.

le for the Week

nd Abroad

FREEDOM

THE programme "Louisa Wants a Bicycle," which was broadcast some time ago, will be revived for Regional listeners on Wednesday at 8.15. It deals with the fight for woman's freedom, and among the characters which will be portrayed are Florence Nightingale, Anna Jameson, Millicent Fawcett, and John Stuart Mill. It is difficult for the youth of to-day to imagine a world without women in such activities as sports, athletics and politics. And yet it is but a few years since their emancipation even in this England. The various steps in attaining this will be portrayed for listeners in the programme on Wednesday.

EMPEROR JONES

THE character of Brutus Jones, the escaped convict who became Emperor in a savage land, as portrayed in Eugene O'Neill's play "The Emperor Jones," is one which grips the hearer from the start to the finish of the story. Peter Cresswell is to produce this for National listeners on Tuesday at 6.25 and for Regional listeners on Thursday at 8.55. The part of the Emperor was played by Paul Robeson in the stage production, and will be taken by Robert Adams for the broadcast version.

OPERA

THREE broadcasts under this heading come to English listeners this week. The first is to-night (Friday) at 8.30 (Reg.), when the Second Act of Wagner's "Gotterdammerung" is relayed from the Royal Opera House. The next, also for Regional listeners, comes on Tuesday at 7.45, when the first two Acts of Debussy's "Pelléas et Mélisande" will be relayed from Covent Garden. Most of the artistes are from the Paris Opera and Opéra-Comique. The part of Mélisande, however, will be sung by Lisa

Perli (Dora Labbette), with André Gandin as Pelléas. The third comes from the Opera House at Glyndebourne, and will consist of the first act of Mozart's "The Magic Flute." This will be broadcast on Thursday at 6.45 (Nat.).

Rome gives us a treat at 9 to-night (Friday) with the relay from the Teatro Comunale, Florence, of Wagner's "Tristan and Isolde," performed by a German company which includes such well-known names as Josef von Manowarda, Hans



FROM GERMANY. Otto Dobrindt who will conduct the Deutschlandsender orchestra during a programme of light music which will be relayed from Berlin for Regional listeners on Sunday at 5.

Nissen, and Amy Konetzni. Only in recent years has it become generally known that this great love-drama of Wagner's was inspired by Mathilde Wesendonck, the woman who came into his life at the time when his genius had reached full maturity. This opera is particularly popular in the United Kingdom, dealing as it does with the romance of Isolde, an Irish princess, and Mark, King of Cornwall. It was first heard in London at Drury Lane in 1882.

Brno, one of the subsidiary Czech stations, gives us a taste of national opera, albeit a concert version only, in the 8.45 transmission of Janáček's

THE MAESTRO. Arturo Toscanini, who will conduct the B.B.C. Symphony Orchestra for each of the six concerts of the London Music Festival to be held in the Queen's Hall.



HIGHLIGHTS OF THE WEEK

FRIDAY, MAY 21st.

Nat., 8, Lauri Wylie's "Wireless Puppets" (6th edition). 9.20, Responsibilities of Empire—V. 11.30, Eye-witness account of the Wightman Cup Matches. Reg., 7.30, Tommy Matthews and his Concert Orchestra. 8.30, Covent Garden relay.

Abroad. Hilversum, 8.55, Symphony Concert by the Arnhem Orchestra.

SATURDAY, MAY 22nd.

Nat., 6.45, B.B.C. Orchestra (E) and Aubrey Brain (horn). 8, Music Hall.

Reg., 6, "Wireless Puppets." 9, Comic Opera, "Dogs of Devon." 10.50, Six Days Cycle Race.

Abroad. Prague, 7.50, Friml's Operetta, "The Vagabond King."

SUNDAY, MAY 23rd.

Nat., 6, "I Knew a Man"—Mark Twain, by Sir Ian MacAllister. 7.15, Bird Songs from a Surrey Wood. 9.5, Victorian Melodies.

Reg., 5, Relay from Berlin. 7.55, Service from St. Michael's, Cornhill. 9.5 The Miracle of Lodz.

Abroad. Berlin, 8, Love Scenes from Opera.

MONDAY MAY 24th.

Nat., 11.55 a.m., Empire Service at St. Paul's. 7.10, The Music Shop—XVI. 9.35, Incidental to a play.

Reg., 6.10, "Eights Week": commentary from the Oxford University Boat Club. 8.10, Hero and Heroine: songs and duets from famous operettas. 9.10, Empire Day Concert.

Abroad. Lille, PTT, 8.30, National Orchestra, with Poulenc as solo piano in his own Concerto.

TUESDAY, MAY 25th.

Nat., 6.25, "The Emperor Jones." 8, "Gallery Goddess": a romantic comedy of the theatre.

Reg., 7.45 and 8.40, Covent Garden relays.

Abroad. Radio Paris, 8.30, Colonne Concert Society's Symphony Concert.

WEDNESDAY, MAY 26th.

Nat., 8.15 and 9.25, London Music Festival Concert from the Queen's Hall.

Reg., 8.15, "Louisa Wants a Bicycle." 9, Variety, including the Southern Sisters, Issy Bonn and Gus Chevalier.

Abroad. Leipzig, 8.10, Dresden State Opera Woodwind Quartet and soloists in German light classical music.

THURSDAY, MAY 27th.

Nat., 6.45, Relay from Glyndebourne. 8.5, Variety—Jeanne de Casalis and Hildegard. 10.20, Pianoforte recital, Josef Wagner.

Reg., 6.30, "Gallery Goddess." 8.55, "The Emperor Jones."

Abroad. Leipzig, 7.45, "Fidelio" (Beethoven).

"Sarka," a transmission which is to be relayed by all Czech stations. This composer, a native of North Moravia, is intensely national in his compositions; indeed, so dynamic is his music that one might almost describe his work as futuristic.

Part of a famous Swedish opera is being broadcast to-night (Friday) at 8.30 from all Swedish stations, when the latter half of Peterson-Berger's "Domedagsprofeterna" (Day of Judgment Prophets) will be rendered in the Stockholm studio.

Paris PTT, at 8.15 on Saturday, gives Moussorgsky's "Boris Godunov," from the Opéra.

NORWEGIAN SONGS

THE National Students Choir of Norway will broadcast from all Norwegian stations to-night (Friday) at 9.10 an interesting programme of old Norwegian songs which should be well worth listening to.

NATION SHALL SPEAK PEACE

ANOTHER "Cabaret Across the Frontier" is to be broadcast by all Swedish and Danish stations on Saturday at 8, consisting of alternate items from Denmark and Sweden. In contrast to many other nations who apparently consider broadcasting solely as a weapon of propaganda, the Scandinavian countries are strong advocates for using broadcasting as a means to establish peace and goodwill between the peoples of Scandinavia.

THE AUDITOR.

Details of this week's Television programmes will be found on p. 499

Magic from the Air

AN OLD ENEMY IN MORE FRIENDLY GUISE

By
"CATHODE RAY"



DID you ever have the misfortune to hear certain depressing moans issuing from a loud speaker and controlled by a man jerking his hand to and from a stick, like a timid snake charmer? The injury inflicted on his hearers by this performance was usually accompanied by the insult of being asked to believe that the operator was extracting music (*sic*) from the *air*. Of course, given certain technical provisions for the continued existence of the operator, the experiment could be performed equally well in a vacuum; better, in fact, for the audience would thus be spared from hearing any of it, assuming the loud speaker to be in the vacuum too. The promoters of this enterprise were, by modern advertising standards, no doubt entitled to the use of a poetic headline phrase, not intended as a scientific definition. But even in an age tolerant of crooners, musical saws, contemporary chamber music, and "swing," this was one too many, and it has gradually faded from our scientific lecture theatres, concert halls, radio exhibitions, and fairground sideshows (in that order).

But, as an old proverb says, if you find a dead horse on your hands it is more profitable to enter the catsmeat business than to flog it. Apparently Music From The Air exponents have adopted this policy, in principle at least; for according to *Electronics* (Feb., 1937) the essence of the invention, which was due to Professor Theremin, has been developed along quite different lines. About the ingenuity of them, as well as the origin from which they sprang, there is no room for doubt, however.

"Hand-capacity Effect" Glorified

As there may be some readers who are unfamiliar with the original Theremin device I must explain that it depended on a principle unconsciously applied by many of the earlier broadcast listeners, who were publicly requested by the B.B.C. to "look to their sets," because of the annoyance caused to their neighbours by the excessive use of reaction. The essence of the

thing, then, is a valve oscillator, arranged to produce a beat note with another oscillator (in the "Theremin" the broadcast station was replaced for this purpose by a second oscillator in the instrument) and so badly screened as to have an exceptional amount of "hand capacity effect." The rod sticking up out of the instrument was, in fact, a sort of extension of one of the oscillating circuits, and the presence of a hand within the immediate neighbourhood constituted part of the tuning capacity; hence the pitch of the note issuing from the loud speaker could be varied by the owner of the hand.

As a musical instrument the technique was novel and not very easy to acquire; and the results, even with the greatest application of skill, were difficult to justify apart from novelty; although improvements were later introduced for moving from one note to another without necessarily executing a glissando, and for controlling timbre and loudness more satisfactorily.

Anyway, it has failed to obtain a permanent place among musical instruments. But it is fairly obvious that the same principle can be applied to accomplish other things than the emission of catcalls from a loud speaker. The hand capacity effect can be made to bring a tuned circuit more or less into resonance, thus controlling the current in a valve circuit, which in turn can be used to work a relay, and hence to ring a bell, explode a bomb, electrocute a gangster, launch a ship, or cause an advertisement to appear. Apparently the last of these acts offers most scope for business, and it is in this direction that it has been chiefly applied.

For example, a mirror has been set up in a prominent place, and a passer-by goes up to it to take advantage of it for some purpose or another. As she comes close to it the opaque mirror suddenly becomes translucent, revealing an invitation to share in the advantages conferred by using a certain proprietary cosmetic. The beneficent donor of the mirror, if he considers that its possibilities have not been adequately developed in this way, may go on to arrange things so that the visible

announcement referred to is supplemented by a verbal plea from a concealed loud speaker. The same may be adopted to confer on the now prominent pedestrian a wayside lecture on personal hygiene, in the frank but friendly manner familiar to the clientele of Anglo-Continental broadcasting stations. It is particularly interesting to note that the invention is so devised as to cause this talk to continue to its appointed end even if the listener finds herself unable to stay so long.

The mirror in this system is used as one plate of the tuning condenser and is coated just enough to be opaque and reflecting when illuminated only from the front, but to be semi-transparent when a light is placed behind. The presence of a person or other disturbing object alters the capacity, and trips a relay that turns on the light behind, which, of course, offers many possibilities for display. Alternatively, or additionally, the relay may be caused to switch on a talking film.

Uplift Talks

The possibilities of this are immense. Our own benevolent P.M.G. might be prevailed upon to arrange things so that when we approach the pillar box in the dark a Golden Voice remarks "You are too late to post here to-night, but if you go round the corner at the end of the road you will find the District Office box still uncollected. Post early." Or safes might be caused to deliver a good moral talk to the burglar to while away his time till the constable, summoned by the burglar-actuated alarm, comes to collect him from the burglar-actuated trap.

The burglar alarm, by the way, is another application of the capacity relay. It is not a new one, because I remember reading an exposition of this very method at least twenty years ago in the fictional works of Arthur B. Reeve. The capacity element was extended to embrace an entire room, and the variation due to the presence of an intruder was conveyed by wire or wireless to the appropriate interests. There must have been some practical difficulties which militated against its general adoption; one of these appears to be a tendency for false alarms to be caused by slow drifts from the original adjustment, due to temperature, valve ageing, or other influences. So an important part of Theremin's system is a patent for an invention whereby any changes in capacity or other operating conditions, tending to trip the relay, are compensated by a thermal device. As this device is incapable of responding

Magic from the Air—

rapidly it does not prevent legitimate action due to the relatively rapid change in capacity with the approach of a person, but it does protect the mechanism against slow drifts.

The same stabilising system is applicable to other types of relay than the capacity-sensitive sort. There is the photo-electric relay, which has become fairly familiar nowadays in connection with exceptionally valuable exhibits of jewellery, counting of newspaper bales, and the more refined Belisha crossings. The interesting feature of the photo-electric relay as contrived by Theremin's concern is that instead of being actuated by a break in the ray when an object comes between the source and the photo-electric cell it depends on the reflected light from the object. It can therefore be used where the ordinary sort is inapplicable. For instance, the beam can be shot out of a shop window (advertising again!) and the reflection of it from a person within a certain distance of the window affects the cell and causes the whole shop window to be lit up. This unexpected result not only draws the passer's attention more closely to the window than a mere constant illumination, but his absence saves current which might otherwise be wasted on a deserted street.

Lastly, as an example of this versatile technique, a problem has been solved akin to that of communicating with the

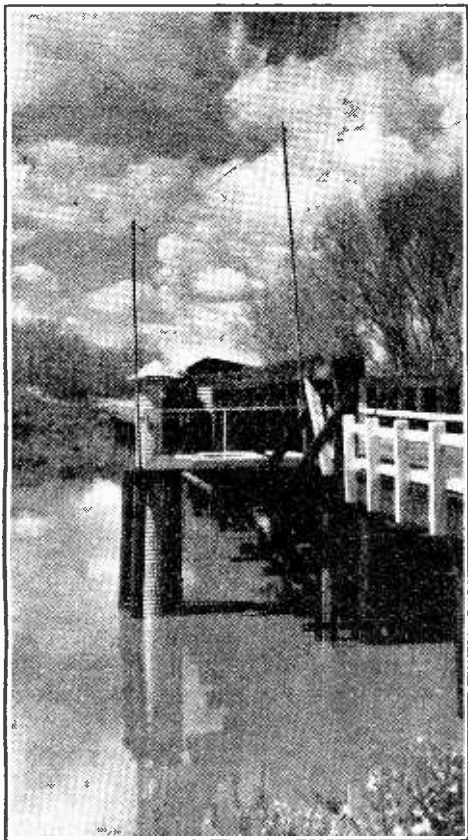

RADIO FLOOD GAUGE. As a precaution against avoidable repetition of recent disasters due to floods, the authorities in California have installed automatic wireless transmitters, actuated directly by water gauges which measure river levels, at certain of the more remote danger points. Dry batteries are used for both HT and LT, while the receivers are put into operation at pre-determined hours by time-switches.

Horse Marines or serving in the Swiss Navy. There is a synchronised AC mains clock for DC mains! The clock works off AC, as usual, and the AC is produced by a valve device due to Theremin, which operates from DC. The vital synchronising agent is the commutator ripple, which is there anyway, but which may be used to synchronise clocks if the generators are frequency-controlled as is general for AC machines.

But it is to be hoped that in this country the disappearance of DC mains will not be so long retarded as to make the establishment of this system worth while.

Television Programmes

Transmissions are from 3-4 and 9-10 daily.

Vision: 45 Mc/s. Sound: 41.5 Mc/s.

FRIDAY, MAY 21st.

3, Friends from the Zoo. 3.15, Gaumont-British News. 3.25, Scenes from the London Coliseum production "On Your Toes."

9, Music Makers; Lubka Kolessa, a Ukrainian pianist who will play in National costume. 9.10, Friends from the Zoo. 9.25, British Movietonews. 9.35, Cabaret.

SATURDAY, MAY 22nd.

3, Ernest Brisbane's Punch and Judy. 3.8, Spade work; C. H. Middleton in the grounds of Alexandra Palace demonstrating the first steps in making a garden. 3.20, British Movietonews. 3.30, Time to say Goodbye: a review of farewells.

9, Television Orchestra. 9.20, Gardening talk by C. H. Middleton. 9.35, Gaumont-British News. 9.45, Starlight; Gracie Fields.

MONDAY, MAY 24th.

3, Music Makers; Emilio Colombo (violin). 3.10, The World of Women—IV. 3.25, Cabaret Cruise. 3.50, British Movietonews.

9, Music Makers: Lisa Minghetti (violin). 9.10 and 9.25, Repetitions of 3.10 and 3.25 programmes. 9.50, Gaumont-British News.

TUESDAY, MAY 25th.

3, Royal Tournament: some of the displays that will be seen at Olympia. 3.20, Gaumont-British News. 3.30, Viennese Honeymoon: a revue for television by Hans Kafka.

9, Starlight: Billie Houston and Nina Devitt. 9.10, Look at Mars To-night; an explanation with diagrams as to why Mars is so bright this month. 9.20, British Movietonews. 9.30, "Lionel and Clarissa": the ballad opera in a shortened version for television.

WEDNESDAY, MAY 26th.

3, Canvas to cover us: display of camping equipment and practice introduced by Sir Percy Everett, Deputy Chief Commissioner of the Boy Scouts Association. 3.20, British Movietonews. 3.50, Fifty-seventh Picture Page.

9, The Four of Us. 9.20, Gaumont-British News. 9.30, Fifty-eighth Picture Page.

THURSDAY, MAY 27th.

3, Dancing lesson by Alex Moore and Pat Kilpatrick. 3.15, Gaumont-British News. 3.25, "Lionel and Clarissa."

9, Hella Kurty (Viennese songs). 9.10, Repetition of 3 programme. 9.25, British Movietonews. 9.35, Pasquinade No. 2.



6-valve all-wave Superhet with Radio Frequency Stage

8 stages.
8 tuned circuits
3 wavebands

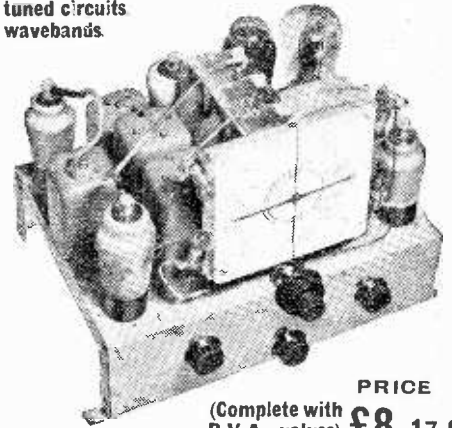

PRICE
(Complete with B.V.A. valves) **£8.17.6**

Performance (made possible by use of multi-electrode valves) equal to that of many receivers employing 8 valves or more. Brief specification includes: Large "Airplane" dial, with different coloured lights automatically switched on for each wave-range. Micro-vernier 2-speed drive. 4-point wave-change and gramophone switch. Volume control and variable tone control also operative on gramophone. Reinforced heavy-gauge steel chassis. Covers 19-2,000 metres. Circuit comprises: Preselector circuit, radio frequency amplifier (operative on all 3 wavebands), triode-hexode frequency changer, double band-pass I.F.T. coupled I.F. amplifier, double diode-triode detector and L.F. amplifier. D.A.V.C. applied to 3 preceding valves. 3-watt pentode output.

Special

6-VALVE BAND-PASS SUPERHETERODYNE

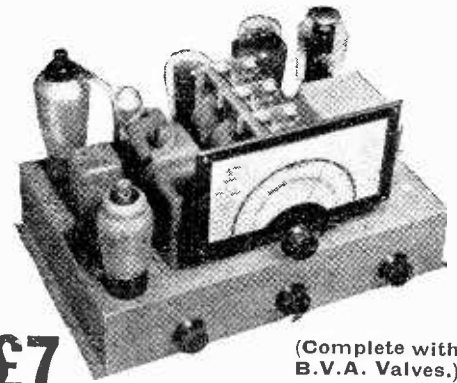

£7 (Complete with B.V.A. Valves.)

Specially designed and built for high quality radio/gram work. **SPECIAL FEATURES:** Reinforced stout steel chassis. High class components by well-known makers of acknowledged reputation used throughout. Fitted with attractive and specially large full-vision dial, glass fronted, and supplied complete with escutcheon and fittings. Separate illumination automatically switched in for radio/gramophone.

CIRCUIT DETAILS: Inductively coupled band-pass filter, triode-hexode frequency changer, band-pass I.F.T. coupled I.F. amplifier, I.F.T. coupled to diode detector. D.A.V.C. applied to preceding valves. L.F. amplifier capacity coupled to output pentode 3-3½ watts undistorted. Variable tone control and volume control operate on both radio and gramophone.

ALTERNATIVE TRIODE OUTPUT
All McCarthy receivers supplied complete with valves, knobs, pilot lamps, leads, mains cable and plug. 12 months' guarantee.

Deferred terms on application, or through London Radio Supply Co., 11, Oat Lane, E.C.2. Cash with order on 7 days' approval. Also write for illustrated catalogue of complete range of all McCarthy receivers.

MCCARTHY RADIO LTD.
44a, Westbourne Grove, London, W.2

Telephone: Bayswater 3201/2.

Broadcast Brevities

NEWS FROM PORTLAND PLACE

When Ignorance Was Not Bliss

FREDDIE GRISEWOOD, who took to television commentating like a duck takes to the water (and water was in abundance at Apsley Gate on May 12th), mystified viewers by his repeated apologies for the pooriness of the picture. The light, he explained, was dreadful, and everybody on the plinth at Apsley Gate was terribly upset.

Actually, the received picture gave the impression of a fairly bright day, so sensitive were the cameras, and it was not until Messrs. Grisewood and Cock returned to the television vans after the Procession that they learned that the whole broadcast had been an outstanding success.

Cameras Excel the Eye

And even then the Director of Television 'phoned Alexandra Palace for confirmation of the fact. "If the light had been really good," said Mr. Cock, "we should have given a picture which would have amazed even the television staff. As it was, the camera has proved how much more sensitive it is than the human eye. The light was so bad that we could hardly see the head of the Procession as it reached Stanhope Gate."

"Unforgettable Experience"

Those who saw the Procession on the television screen will recall that the first horseman could be seen plainly immediately they came into view round the bend of the East Carriage Drive.

The first telephoned congratulations reached Alexandra Palace from Brighton, and soon afterwards came a telegram from an Ipswich viewer who referred to the "unforgettable experience of seeing and hearing the Procession perfectly, at home."

No one doubts now that Coronation Day put Television "on the map."

World Reception of Coronation Broadcasts

WORLD reception of the Coronation broadcasts proved that the new Daventry transmitters were a success. In no place was complete failure experienced, though South Africa reported signals as only "poor to fair."

It should be explained that on the introduction of the new

transmitters and wavelengths the B.B.C. advised overseas listeners to try all wavelengths in turn for the time being. The engineers at Broadcasting House feel that many South African listeners failed to try the experiment.

Stream of Reports

New Zealand had excellent reception of the "Homage" programme, which was re-broadcast by all stations. Good reports also came from New Delhi, Montreal, Ottawa, Melbourne, Cairo, Shanghai, Nairobi, and the Gold Coast.

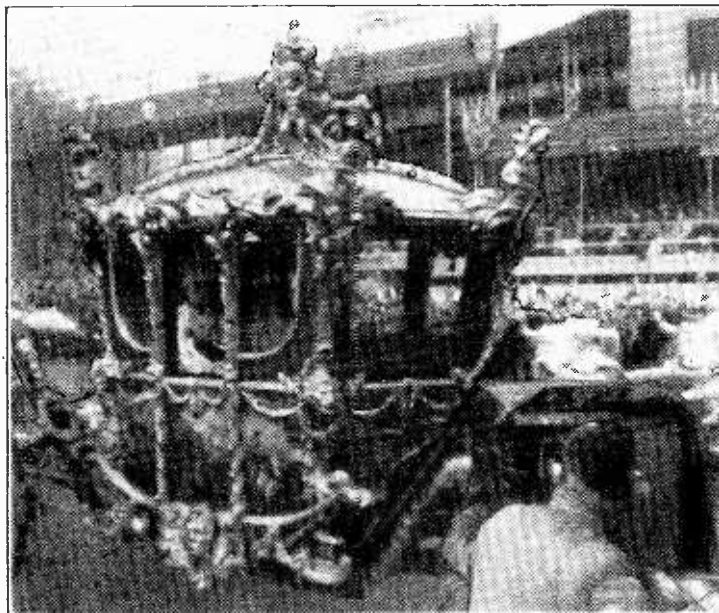

A MOMENTOUS OCCASION. One of the very few pictures taken of a B.B.C. television camera in action on Coronation Day. This event will no doubt go down in broadcasting history as one of the outstanding achievements of the pioneering days.

Hong Kong reported fair reception of the Abbey service and excellent signals in the evening. Capetown's report was in similar terms.

The first cables reached Broadcasting House at 6.30 on Coronation evening, and then continued in a steady stream until the small hours.

Hail and Farewell

WITH a very faint flourish of trumpets and an almost imperceptible wave of farewell—so much in keeping with his innate modesty and characteristic absence of "side"—Mr. J. Beresford Clark, Director of the B.B.C. Empire Service, left Victoria last week for Malta on the first stage of his seven months' tour of the Empire to discover for himself to what extent the Empire broadcasting service is fulfilling its purpose

Attitude of the Dominions

His great problem is to discover any real warmth of feeling towards B.B.C. programmes in Dominions whose own broadcasting organisations are providing effective services without any help from outside, thank you, and to whom the sole appeal of the Empire service is its patriotic and Imperial background.

Will He Get the Money?

Broadcasting House feels that if any one of its officials is likely to be taken by overseas broadcasting authorities to their hearts Beresford Clark is that man; if he is able to obtain any support for a scheme to induce the com-

Engineers in Training

The B.B.C. men are now learning how to handle the gear themselves. Six months' experience with the apparatus at Alexandra Palace has helped them considerably, but it must be remembered that the mobile gear, besides embodying improvements on its prototype at the television station, differs in many other ways as a result of the designer's efforts to incorporate as much as possible in the relatively small space.

"Televising" the Derby

SO people who had been hoping that the Derby would be televised will be disappointed. Technically the feat should not be impossible, as the ultra short wave radio link, if not quite capable of bridging the gap between Epsom and Muswell Hill, could have covered the ground as far as, say, Victoria or Hyde Park, the signals being transferred there to the permanent television cable.

Pictures from the Past

Probably, however, the B.B.C. are wise not to risk a fiasco in these early days. According to present arrangements the race will be televised in the same manner as the Grand National, the ordinary sound commentary being supplemented by plans of the course and pictures of famous races of the past.

Sidelights of Recording

"ARE you an announcer?" "I regret I have nothing to broadcast." "We never speak to strangers." "Can you tell me where I can find a taxi?" "Could you please tell me what all these people are waiting for?"

These were some of the questions and statements which were put to Lynton Fletcher and his colleagues of the B.B.C. Recorded Programmes Staff when they made records at Admiralty Arch early on Coronation morning.

For Scrapbook 1937

The wandering microphone attracted a lot of attention, and the records, which will be stored in the B.B.C. archives to commemorate the Coronation for future generations, include the singing of popular songs and cheering the King by thousands of voices.

There were also interviews with Rover Scouts putting up barriers, and with people who had come long distances to take up their stands in the Mall. There were eye-witness accounts also of the scene in Trafalgar Square as it appeared at midnight to watchers on the top of Admiralty Arch.

Six Weeks' Respite

OPEN-AIR television from Hyde Park has whetted viewers' appetites for more, but the mobile television unit will not come into regular use for at least six weeks. A good deal of "rush" work was involved in getting the vans ready for the Coronation, and it is an open secret that their operation on the great day itself was largely entrusted to the Marconi-E.M.I. engineers.

Practical Hints and Tips

IN a portable set the designer may often have allowed for a fixed degree of reaction, upon which sensitivity largely depends. It therefore sometimes happens when replacing RF and detector valves by new ones that reaction is then overdone,

Stray Reaction

resulting in a wipe-out of all stations below, say, London National. In a case recently investigated the relative position of two anode leads to valve caps were causing the trouble and the simple expedient of separating them as far apart as possible was sufficient to prevent the unwanted reaction. It might, of course, be argued that these leads should have been shielded, but here it must be remembered that the designer probably intended some reaction to take place, and it would not be wise to make alterations of this kind unless absolutely necessary. On the other hand, there would be little justification for replacing a metal-coated valve by an unmetallised specimen, even though in other respects it were suitable; the reverse generally applies as well.

ALMOST everyone knows that an audio-frequency transformer that has developed a fault may sometimes be temporarily restored to usefulness by passing a surge of current through the winding. Such surges may be produced by

Kill or Cure

momentarily interrupting one or other of the receiver power circuits or even by switching on and off the electric light in the room where the set is operating.

A correspondent claims to have had considerable success in repairing defective transformers by momentarily connecting the faulty winding across 230-volt DC mains; a lamp is connected in the manner shown in Fig. 1 to act as a current-limiting device. Voltage is applied, for a second

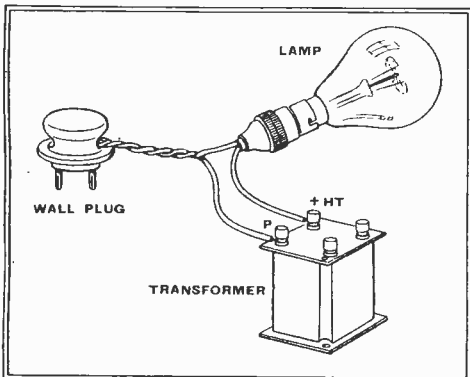

Fig. 1.—Desperate ills call for desperate remedies; illustrating a scheme that may possibly restore, if only temporarily, a defective transformer to usefulness.

or two, three or four times in rapid succession.

Without suggesting for a moment that a completely satisfactory repair can always be effected by these means, the plan suggested may be worth while trying in cases where the faulty transformer would otherwise be totally useless. A repair by the normal method of rewinding is often out of the question.

Any source of high DC voltage, and not only the mains, could, of course, be used for the experiment.

A CAUSE of crackling noises, appearing at irregular intervals, which is frequently overlooked in the expectation that the source is either within the set or a machine or sign noise, may be found in the screw connections of wiring to tumbler

“Crackling Noises”

switches and fuse boxes. Although these may have been tightened hard at one time, the screws may work loose, possibly due to the vibration of passing traffic, and although it may be in another part of the house the loose connection will make itself heard in the loud speaker.

Another cause is dependent on the crossing or touching of lead-covered cables which have not been bonded and may not cause trouble when the wiring is new, but in the course of time, when oxidation has set in, intermittent crackling noises will appear at more and more frequent intervals and the only cure for trouble due to this cause is bonding where it has been overlooked in the past or has become faulty.

IN operating a battery receiver with QPP or Class “B” output, there is often an unexpected wastage of HT current arising from the fact that heterodynes of adjacent stations are being reproduced by the output valve or valves (though not

High-Note Wastage

normally heard in the speaker, or heard only faintly). A sound of very high pitch can cause the current in such an amplifier to rise alarmingly, though the sound output from the speaker is apparently quite moderate, particularly if the conventional 0.01-mfd. shunting condenser is used across the speaker.

This trouble can be alleviated to a large extent by employing shunting condensers before the output valve—for example, between the anode and earth line of the LF valve if one is used, or across the secondary of the output transformer. Suitable values can be found by trial, and usually round about 0.001 mfd. is suitable. By inserting a milliammeter in the HT supply to the output stage it should be possible to tell whether the condensers have the desired effect, for such an increase of current is continuous, and not varying like that due to speech and music.



Can you pick the WINNER?

ONE condenser looks very much like another. On appearance alone it might be a gamble to know which will prove the winner. But it's simple to make sure of picking the right one . . . look for the initials “T.C.C.” Without them no condenser can boast a 28-year pedigree, can claim such fine materials both inside and out, or have passed through so many tests in the hands of so skilled a team of workers. Setmakers know this; they say “T.C.C. throughout” and so play for safety . . . It's a tip worth following!

PLAY FOR SAFETY—USE T.C.C. THROUGHOUT

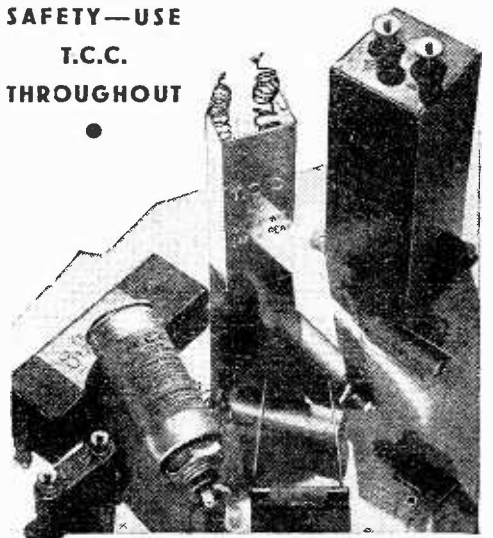

T.C.C.

ALL-BRITISH
CONDENSERS

The Telegraph Condenser Co. Ltd., Wales Farm Road, N. Acton, W.3.

RANDOM RADIATIONS

The Coronation Broadcast

THE B.B.C.'s six and a half-hour broadcast of the processions and of the service in the Abbey on Coronation Day was, without a doubt, the finest and most ambitious feat that has yet been accomplished in radio. An enormous amount of hard work was put into the preparations for it, and right well the labours of these responsible were repaid. I wasn't able to hear the whole thing from start to finish, since I had been roped in for various duties in connection with the local celebrations—including the installation of a wireless set to provide music whilst 300 schoolchildren were getting outside their Coronation tea. But I did hear the broadcast from 10.15 in the morning until nearly half-past two, and thereafter I picked up snatches of it as and when I could. During the whole time that I was listening these wasn't a single hitch. Everything ran like clockwork—and the best-quality clockwork at that.

The Abbey Service

THE relay of the service in Westminster Abbey was the most impressive thing that I have ever heard by wireless. So perfect was the placing of the microphone and the operation of the control room that everything was beautifully heard. The music—glorious music gloriously performed—came through magnificently, and every word of the Archbishop of Canterbury and of His Majesty the King was as clear as the proverbial bell. I don't know for certain who it was who read the rubrics and explained the service, though I believe it was the B.B.C.'s own chaplain, the Reverend F. A. Iremonger. The task could not have been carried out better. Everything was made plain and one could see in one's mind's eye all that was happening. It was wonderful to think of the whole Empire listening to the presentation and joining in spirit in both the acclamation and the homage.

Well Commented, Sir!

COMMENTING into the microphone on so moving a spectacle as the Coronation procession must be one of the world's most difficult tasks. Some of the commentators—or observers, to give them their official, though not, to my thinking, very happy title—were obviously so carried away by the wondrous beauty of the sight that it was difficult for them to find words wherewith to describe it. All did well, but for that part of the broadcast that I heard the honours must go to George Blake and Howard Marshall. The former excelled in the painting of word-pictures as the processions arrived and departed; the latter, never at a loss for a word, helped us to see in detail the marvellous scenes that unrolled themselves before his eyes from his vantage point in the Triforium.

World-wide Reception

SEVERAL times during the broadcast I switched over to the short waves in the hope of discovering how listeners in various parts of the Empire and in the United States were faring. I found my set, which is a pretty sensitive one, very lifeless on its short-wave range and began to fear that one of those semi-blackouts with which we have been familiar of late was taking place. It is

By "DIALLIST"

reassuring to listen, as I ply the pen, to the B.B.C.'s news bulletin, which records that reception has been excellent in the New World. In South Africa it was only "fair," but it seems to have been good in many other distant countries.

Well-named

WHO thought out the new name for Marconi House, which has now been taken over by the Air Ministry, I don't know, but it was quite an inspiration. "Ariel House," by the happiest of puns, suggests not only its present purpose but also its long connection in the past with the development of wireless in this country. Between 1912, when Marconi moved in with his Wireless Telegraph Company, and 1933, when a transfer was made to the present premises on the Embankment, the history of wireless as we know it to-day was written. One of the most interesting periods in the history of Marconi House was that when it contained the entire B.B.C., including its programme and engineering staffs, its one studio and the transmitting plant. That was in 1922. I don't think, though, that Marconi House can claim to have been the birthplace of British broadcasting. That honour must go to Writtle, whose Tuesday evening programmes old hands will remember well. Writtle possessed only a half-kilowatt plant, but it used to be heard all over the country.

Once Bitten, Twice Shy

THE other day I was asked by a friend whether or not it was advisable to have an earthing switch for an indoor aerial erected in an attic. I told him that I always used one, not with the idea of preventing the aerial from being struck by lightning, but to save myself from unpleasant surprises in the way of shocks. It is quite surprising what a charge a well-insulated and unearthed indoor aerial can collect in thundery weather. Before I made a practice of keeping mine earthed when not in use I got several muscle-twisting shocks when thoughtlessly picking up the bare end of the down-lead. I expect others have had similar experiences, though I admit that my ohmic resistance appears to be on the low side, for I'm very susceptible to electric shocks.

Sunspots and the Hindenburg

And talking of static charges, it seems more than likely that the sunspots which have been playing such pranks with short-wave reception of late were mainly responsible for the terrible fate of Germany's airship, the *Hindenburg*. In this country we don't come across the naturally produced static charge very much, but in hotter and drier climates it's a real problem. In the United States and India, for instance, it is common practice for private cars and commercial vehicles to use earthing chains to make contact between the chassis and the road. Without these the vehicle is, of course, insulated by its rubber tyres. It is quite normal for airships to collect a big-gish static charge when they are in flight, though this is normally dissipated when the ground lines are dropped to earth. It may

be that, owing to the phenomenal sunspot activity, the charge was far greater than usual and that the metal part of the ship was not properly earthed owing to the dryness of the ground lines.

The Danish Way

DENMARK manufactures no wireless valves, and for the last six years the country has therefore had to obtain the whole of its valve supplies from European sources. Recently there have been bitter complaints that the Danish listener was being exploited by European valve manufacturers. A petition has now been made to the Government to allow American valves to come into Denmark again, and it seems possible that the powers that be will lend a sympathetic ear. In any event, makers on this side of the Herring Pond have become so alarmed at the possibility that it is reported that they are about to bring their prices to Denmark down in order to stave off possible competition from the States.

What Will Happen Here?

One wonders whether we shan't see the prices of British valves forced down for a rather different reason before so very long. Our manufacturers are now making valves of American type, and I understand that some set makers are going to use American valve-holders (tube-sockets they call them over there) in their new broadcast receivers. If so, it is likely that American valve manufacturers will turn their eyes still more longingly towards our valve-replacement market, in which they are not doing so badly even now. Even after paying import duty, freight charges and so on, first-rate American valves come out a good deal cheaper than our own products, at present prices. There will undoubtedly be strong competition from across the Atlantic, and the only way of meeting it is to market first-class British valves at about the same prices as American. And it isn't only the home markets which have to be considered; there are those of the Empire as well. The Americans and the Dutch are getting too big a share of these already—and they will get more if our valve prices aren't cut drastically.



PROGRESS IN TELEVISION is not confined to this country. A television transmitting tube is shown being made in the Philco factory in America.

Letters to the Editor

The Editor does not hold himself responsible for the opinions of his correspondents

Interference Reports

I WAS rather surprised to read Mr. T. J. E. Warburton's comments in the May 7th issue.

With reference to his remarks regarding "overdue" visits, the local Post Office engineers are always ready to call on any special day, if requested to by a complainant, and if the visit was overdue I expect it was for lack of information on the form which he is expected to complete.

It would be interesting to know when he complained to the Post Office, as he states the engineers arrived on "motor bikes." This is strange in view of the fact that the motor cycles were replaced by the now familiar "Radio Service" vans some considerable time ago.

Also, the engineers consider themselves lucky if the noise happens to be on when the first visit is made; the usual procedure is to request the complainant to compile a log of the times the interference is experienced, so that further visits can be made.

Mr. Warburton should consider himself lucky that he does not suffer from continuous interference.

His remarks about local Post Offices having their own listening departments is foolish, having regard to the fact that the majority of interference is "local" to the complainant.

I wonder what aerial system he uses to experience such terrible interference, as it is obvious from his remarks under "Chain Listening" that he is using a battery set and is, therefore, not getting interference entering the receiver via the mains lead.

PHILIP W. CROUCH.

Newton Abbot, Devon.

Horn-loaded MC Speakers

MAY I be allowed to add this one further contribution to the recent correspondence on horn-loaded moving-coil speakers?

I heard the Voigt Domestic Speaker at Olympia some years ago, but have not yet heard it under proper working conditions.

Like Mr. Cotterell, I have found that the only plane baffle with any sense to it is a solid brick or stone wall. My own Hartley-Turner speaker has been so mounted for the last two years. The speaker frame is bolted to a slab of marble about two feet square and two inches thick, and the whole assembly is again bolted solidly to the wall.

Again like Mr. Cotterell, I thought this was the last word, but now begin to doubt it.

Tinkering in my workroom last evening, soldering-iron in hand and listening on a commercial set to a talk on "Timber" from the B.B.C., the speaker, referring to the many uses of timber and wood, said, "My voice is in all probability coming to you at this moment out of a cabinet made of wood."

I paused in my work, and remarked aloud to myself, "Too true" . . . and some more that I can hardly expect you to print.

My grouse about the Voigt speaker is that it is made of wood, and I cannot bring myself to see that anything about a speaker made of timber is all right.

Some day I hope Mr. Voigt's firm will provide themselves with moulds and cores so that they can go to a house and cast the Voigt design in solid concrete in the corner of the room and make it part of the house as we have done with our wall baffles. That will be my day. I will send my wife for a short holiday. . . .

With regard to the trumpet of Mr. Maggs, I think one mistake he has made is to have those curves in the folded horn. I think that, if you must bend* and fold a horn, it is better to have sharp angular bends with internal plane reflecting surfaces correctly placed in the angles to change the direction of the sound waves. I believe the old acoustic Columbia graphophone used this principle, and so does Mr. Voigt in his speaker.

Caerphilly.

W. E. LEAVER.

The Broadcast Licence

I MUST object to a view sometimes approved by *The Wireless World*, namely, that we pay for a licence to maintain a receiving station; what we get for our 10s. in the way of programmes is merely an act of grace.

That may be legally sound, but common sense dictates that it does not represent the true position. Suppose the Government closed down the B.B.C., telling us that in its place it proposed to give us the speeches from Parliament, etc., or, alternatively, that we were free to turn to France or Germany or Russia for entertainment. Do you see *me* paying for a new green slip?

No; we all know that the licence system provides a convenient mechanism whereby we can be made to pay for our programmes. Legal quibbling must not be used as an excuse for failing to give us value for our money—complete with accountant's certificate as to how it is spent.

Birmingham.

J. ALEXANDER.

Output Rating

MAY I draw your attention to a peculiar phenomenon with regard to output valves, namely, that when a certain valve is used in one receiver the output is claimed to be $3\frac{1}{2}$ watts, whereas when the same valve is used in another receiver the output is supposed to be only $2\frac{1}{2}$ watts.

I don't pretend to know much about radio, but these discrepancies are so wide and there seems so little justification for them, except, of course, from the advertisers' point of view, that it would appear desirable for some body (may one whisper the British Valve Manufacturers' Association) to fix an agreed method of test of output rating for their power valves.

Of course, one way of dealing with it is to do what one manufacturer already has done, to give his output as "undistorted $2\frac{1}{2}$ watts, maximum $3\frac{1}{2}$ watts."

The views of your readers on this suggestion would be interesting.

Manchester.

J. B.

NOTABLE FEATURES of the New ROLA F 742-PM

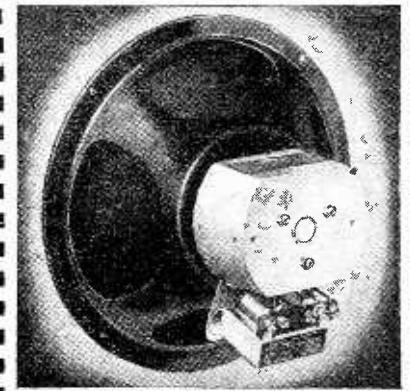

AN EXCELLENT MODEL FOR EXTENSION SPEAKER USE

Where an Extension Speaker giving unusually fine reproduction is required, the new Rola F742-P.M. is the ideal unit to use. Although not designed primarily as an Extension Speaker, its super-sensitivity renders it specially suitable for this purpose and also for battery set operation. The Rola F742-P.M. makes use of the new magnet material "Alnico." It has the same flux density in the gap as the giant G12-P.M.—11,500 lines per square centimetre—and its sensitivity is quite unequalled by any speaker in the same price class. Fitted with a new metal and compound shielded universal transformer to match most valve combinations, it is both dust-proof and moisture-proof.

Model F 742-PM 49/6

WITHOUT TRANSFORMER 42/-

OVER 8 MILLION IN USE

ROLA

The World's Finest Reproducers

THE BRITISH ROLA CO., LTD.
MINERVA ROAD, PARK ROYAL, N.W.10.
PHONE: WILLESDEN 4322-3-4-5-6.

Recent Inventions

The British abstracts published here are prepared with the permission of the Controller of H.M. Stationery Office, from Specifications obtainable at the Patent Office, 25, Southampton Buildings, London, W.C.2, price 1/- each. A selection of patents issued in U.S.A. is also included.

SCANNING SYSTEMS

WHEN amplifying the saw-toothed oscillations used for scanning there is a tendency for the straight-line parts to "degenerate" into curves, as shown in Fig. 1. This is due to "curva-

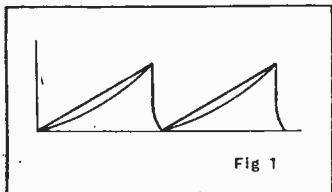

Fig. 1.—Tendency exists in scanning oscillators for straight-line parts to degenerate into curves.

ture" in the anode current of the amplifiers.

To compensate for it, a high-pass filter circuit, such as R, C, in Fig. 2, is inserted between the gas-filled oscillation-generator T and the grid of the amplifying valve V. The condenser C favours the higher frequencies, and so compensates for the inherent curvature in the output current from the tube. The same result may also be obtained by inserting a choke K, as shown in the grid circuit of the amplifier, in which case the filter R, C is omitted.

Radio-Akt. D. S. Loewe. Convention date (Germany) March 29th, 1935. No. 459422.

CATHODE-RAY TUBES

THE electron-focusing system, as well as the two pairs of deflecting-plates, in a cathode-ray tube are normally arranged and biased, so that the electron stream is brought to a focus at a given point. But this focus is maintained only so long as the point moves over the surface of a sphere.

This is not always convenient in actual practice. For instance, in some of the tubes used for receiving television, the curvature of the fluorescent screen is not spherical; often the screen is plane. The result is that a certain amount of distortion is produced. Again, in the Iconoscope type of television camera, the photo-sensitive screen is flat, and is placed at an angle to the normal path of the scanning beam.

According to the invention the electron-focusing system is arranged so as to preserve a true focus for any desired path of scanning. For this purpose auxiliary correcting voltages are added to those normally applied to the deflecting-plates as the beam travels over the fluorescent screen.

J. E. Keyston; F. H. Nicoll and O. Klemperer. Application dates March 19th and May 7th, 1935. No. 458746.

TELEVISION "CLOSE-UPS"

A TELEVISION camera of the Iconoscope type is adapted to transmit either long-range views, or enlarged "close-ups," at will and by a simple adjustment. The whole of the picture is focused on the mosaic-cell screen as usual,

Brief descriptions of the more interesting radio devices and improvements issued as patents will be included in this section.

but potentiometers are arranged to vary the scanning voltages so that, when a close-up is to be shown, the electron beam is restricted to cover only a selected part of the whole picture.

The voltages applied to the electron focusing electrodes are also adjusted to sharpen the focus proportionally to the smaller area. Simultaneously, the intensity of the stream is regulated to the new area. The net effect of the readjustments is that the picture signals developed produce an enlargement of the selected area at the receiver, since there will be no change in the total area of

question is one that does not affect the received picture, being substantially equal to a multiple plus one half of the framing frequency.

G. W. Walton. Application date August 7th, 1935. No. 460721.

SOUND AND PICTURE RECEIVERS

THE use of AVC in a combined sound and picture receiver is desirable in order to compensate for quasi-permanent differences of field-strength within a given receiving area. At the same time it is not desirable to make it depen-

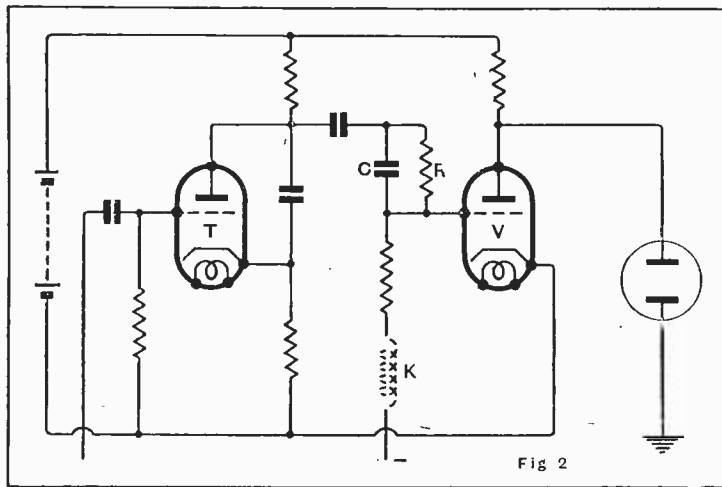

Fig. 2.—Frequency compensated amplifier for television scanning circuit.

view, nor in either of the frequencies applied to the scanning electrodes.

Marconi's Wireless Telegraph Co., Ltd. (assignees of H. Iams). Application date (U.S.A.) May 26th, 1934. No. 458750.

TELEVISION

ONE of the problems in television is to keep the background or overall brightness of the received picture—as distinct from the detailed contrasts of light and shade—in step with that of the transmitted picture. The difficulty arises because such changes of background illumination take place comparatively slowly, and, therefore, involve frequencies which are so low that they cannot be handled by the valves used to amplify the signal currents.

According to the invention, the problem is solved by energising a special photo-electric cell at the transmitter from a source of light which is controlled by the average or background illumination of the scene that is being transmitted. At the same time the source of light is cut up or interrupted at a particular frequency, so that it produces a fluctuating current capable of being handled by the amplifiers. The frequency in-

dent upon the picture-signal carrier-wave, since this is often deliberately varied in order to convey DC components corresponding to changes in the average or background brilliance of the transmitted picture.

Accordingly, the AVC voltage is derived from variations in the field strength of the sound carrier-wave, and is applied as a bias to at least one valve in the path of the received sound-signals, and to at least one valve in the path of the picture-signals, one of these valves also being part of the first frequency-changer, i.e., prior to the intermediate-frequency stage.

The General Electric Co., Ltd., and D. C. Espley. Application date November 27th, 1935. No. 460675.

SHORT-WAVE GENERATORS

RELATES to a back-coupled valve for generating ultra-short waves. The anode is connected by a single loop of wire through a blocking condenser to the grid, and the degree of back-coupling is controlled by moving a sliding contact from the high-tension supply over the wire of the loop. In such an arrangement it is found that, as the frequency is raised, the inductance of the sliding tap comes more and more into

play. In other words, it can no longer be regarded as an "earthed" lead.

According to the invention, this difficulty is overcome by housing the valve, as a whole, inside a metallic casing which can be regarded as "earth." An arc-shaped strip of metal is arranged close to the anode-grid coupling-loop, but insulated from the metal casing, and the tap in the anode-grid circuit is made very short and slides over the insulated strip, which is connected to the HT supply.

Telefunken Ges für drahtlose telegraphie m.b.h. Convention date (Germany) June 8th, 1935. No. 459348.

VOLUME CONTROL SWITCHES

THE Figure shows a circuit suitable for either wireless reception or gramophone reproduction, the volume control being common to each. For receiving wireless signals, the switch S is open, and the incoming carrier is rectified across the first diode, the AF components being tapped off as shown across the resistance R. The incoming carrier is also applied to the second diode through a condenser C, so as to provide AVC voltage across the resistance R₂, and delayed AVC across resistances R₁, R₃.

For gramophone reproduction the switch S is closed. Since the pick-up impedance is low, it will short-circuit the first diode and prevent any carrier frequency present from being rectified. Also as the pick-up PU is connected to earth there will be a negative voltage across R₁ sufficient to prevent the diode from passing any current. The gramophone voltage

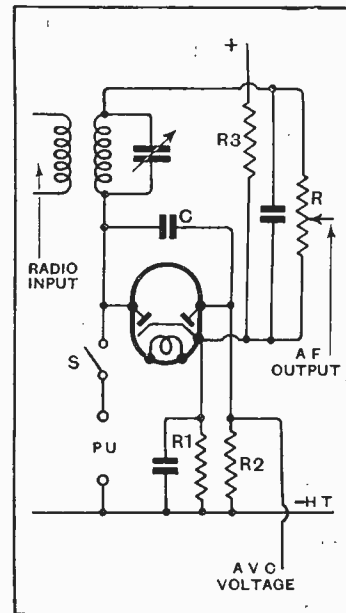

Circuit arrangement when a volume control common to radio and gramophone is used.

therefore builds up across the volume-control resistance R.

A. C. Cossor, Ltd., and F. R. W. Strafford. Application date July 22nd, 1935. No. 460214.

MISCELLANEOUS ADVERTISEMENTS

NOTICES

THE CHARGE FOR ADVERTISEMENTS in these columns is

12 words or less, 3/- and 3d. for every additional word.

Each paragraph is charged separately and name and address must be counted.

SERIES DISCOUNTS are allowed to Trade Advertisers as follows on orders for consecutive insertions, provided a contract is placed in advance, and in the absence of fresh instructions the entire "copy" is repeated from the previous issue: 13 consecutive insertions 5%; 26 consecutive, 10%; 52 consecutive, 15%.

ADVERTISEMENTS for these columns are accepted up to **FIRST POST** on **MONDAY MORNING** (previous to date of issue) at the Head Offices of "The Wireless World," Dorset House, Stamford Street, London, S.E.1, or on **SATURDAY MORNING** at the Branch Offices, 19, Hertford Street, Coventry; Guildhall Buildings, Navigation Street, Birmingham, 2; 280, Deansgate, Manchester, 3; 26a, Renfield Street, Glasgow, C.2.

Advertisements that arrive too late for a particular issue will automatically be inserted in the following issue unless accompanied by instructions to the contrary. All advertisements in this section must be strictly prepaid.

The proprietors retain the right to refuse or withdraw advertisements at their discretion.

Postal Orders and Cheques sent in payment for advertisements should be made payable to **LILFEE & SONS Ltd.**, and crossed **& Co.** Notes being untraceable if lost in transit should not be sent as remittances.

All letters relating to advertisements should quote the number which is printed at the end of each advertisement and the date of the issue in which it appeared.

The proprietors are not responsible for clerical or printers' errors, although every care is taken to avoid mistakes.

NEW RECEIVERS AND AMPLIFIERS

A A A A

DEGALLIER'S Ltd., the best firm for reliable, fully guaranteed ultra short-wave radio, have on view in London without exception the largest selection of all-wave receivers, at very low prices; for instance, a 6-valve superhet., with 3 bands going down to 16 metres, at 7 gns.; an 8-valve superhet., 4 bands going down to 12 metres, with push-pull output 8 watts undistorted, is only 13 gns.; they have a range like this right up to a 24-valve Challenger twin-chassis, valves and two auditorium speakers, 5 bands, 5-2,050 metres, 60 watts undistorted, at £50; the Midwest Royale 24-valve at the same price; they guarantee that every S.W. receiver will get stations on the low bands, including the Americas, etc.; why not call and handle these receivers at your leisure, no obligation to purchase; or send large s.a.c. (2½d. stamp) for beautifully illustrated catalogues; also in stock, Ferguson, Belmont, Crosley, etc.

DEGALLIER'S Ltd., 18, Connaught St., Marble Arch, London, W.2. Paddington 2745. [4414]

A A A A

HILL and PONDER Offer Crosley's 6-, 9-, and 10-valve jobs, with 5 bands, 13-2,000 metres; chassis or complete in cabinets; "table-console and radiogram"; all brand new and guaranteed; lists sent on request; these receivers are reduced by approximately 50% from list price.

HILL and PONDER (Dept. W.W.D.), No. 9, Lancaster Mews, London, W.2. [4415]

A A A A

AIR KING. All Models Feature Beam Tuning, Magic Eye indicator, gramo, pick-up connections, and special output valves.

All Sets Fully Guaranteed; H.P. terms available from 3/- per week.

WHOLESALE and Trade Enquiries Invited; generous terms.

All Types of American Valves Stocked; write for lists to

AIR KING RADIO, 115, Shaftesbury Av., Cambridge Circus, W.O.2. Phone: Temple Bar 4875 (2 lines). All receivers assembled in England. [3406]

ALERT RADIO Co.

"COMMUNICATION," "Shortwave" and "Allwave" Receivers.—21, East Rd., N.1. Clerkenwell 4871. [4381]

AMERICAN Wireless Receivers, valves and components.—Harmar Radio, 8, Clifford St., London, W.1. [0499]



NOW IT'S ALL OVER

you will have realised (if you are not already one of our customers) that your reception of such mixed programmes is not perfect. Speech—military bands—organ music—choral singing—vocal and instrumental solos—orchestral music: many makes of apparatus can deal with some of them.

We know of none but our own that can handle them *all*, and give lifelike results in every case.

If your set is nearly perfect, buy one of our speakers: if not, buy one of our sets as well. If your pockets are empty after a celebration week, get our leaflets and study them while you save up.

Anyway, come to our Open House demonstration one Wednesday evening soon—there will only be a few more before we give them up for the summer.



HARTLEY TURNER RADIO LTD.,
THORNBURY ROAD,
ISLEWORTH, MIDDLESEX.
Telephone: HOUnslow 4488

ENGINEERING OPPORTUNITIES



This unique Handbook shows the easy way to secure A.M.I.C.E., A.M.I.Mech.E., A.M.I.E.E., A.M.I.A.E., A.M.I.V.T., A.M.I.R.E., and similar qualifications. **WE GUARANTEE—"NO PASS—NO FEE."** Details are given of over 150 Diploma Courses in all Branches of Civil, Mech., Elec., Motor, Aero, Radio and Television Engineering, Building, Government Employment, etc. Write for this enlightening Handbook to-day **FREE** and post free.

British Institute of Engineering Technology
387, Shakespeare House, 17, 18, 19, Stratford Pl., W.1

RECORD

The quality valve in the COMPLETE range

RECORD RADIO LTD., 2/3, Eldon Street, E.C.2

NUMBERED ADDRESSES

For the convenience of private advertisers, letters may be addressed to numbers at "The Wireless World" Office. When this is desired, the sum of 6d. to defray the cost of registration and to cover postage on replies must be added to the advertisement charge, which must include the words Box 000, c/o "The Wireless World." All replies should be addressed to the Box number shown in the advertisement, c/o "The Wireless World," Dorset House, Stamford Street, London, S.E.1. Readers who reply to Box No. advertisements are warned against sending remittance through the post except in registered envelopes: in all such cases the use of the Deposit System is recommended, and the envelope should be clearly marked "Deposit Department."

DEPOSIT SYSTEM

Readers who hesitate to send money to advertisers in these columns may deal in perfect safety by availing themselves of our Deposit System. If the money be deposited with "The Wireless World," both parties are advised of its receipt.

The time allowed for decision is three days, counting from receipt of goods, after which period, if buyer decides not to retain goods, they must be returned to sender. If a sale is effected, buyer instructs us to remit amount to seller, but if not, seller instructs us to return amount to depositor. Carriage is paid by the buyer, but in the event of no sale, and subject to there being no different arrangement between buyer and seller, each pays carriage one way. The seller takes the risk of loss or damage in transit, for which we take no responsibility. For all transactions up to £10, a deposit fee of 1/- is charged: on transactions over £10 and under £50, the fee is 2/6; over £50, 5/-. All deposit matters are dealt with at Dorset House, Stamford Street, London, S.E.1, and cheques and money orders should be made payable to Lilfee & Sons Limited.

SPECIAL NOTE.—Readers who reply to advertisements and receive no answer to their enquiries are requested to regard the silence as an indication that the goods advertised have already been disposed of. Advertisers often receive so many enquiries that it is quite impossible to reply to each one by post. When sending remittances direct to an advertiser, stamp for return should also be included for use in the event of the application proving unsuccessful.

NEW RECEIVERS AND AMPLIFIERS

A N CLO AMERICAN RADIO, Ltd., offer you the finest radio receivers and the finest values in the country to-day.

WORLD'S Finest Receiver, such is the new Crosley, outperforms all the multi-valve receivers of the day. **AMAZING Signal to Noise Ratio** is the keynote to the Phenomenal All World Reception; it is a revelation to all who hear it.

AMERICA Received Night After Night With Volume Set Almost at Minimum without a trace of background noise.

CUSTOMERS Everywhere are Delighted, they say they cannot buy a better radio for £60.

£12/19/6.—10-valve High Fidelity 5-band (13-31, 30-80, 75-200, 200-555, 750-2,000 metres), A.C. 97-250 volts, 10 watts undistorted output, metal valves, pre-H.F. stage all bands, A.S.C. (automatic selectivity control), push-pull output, provision gramo, doublet, Super A.V.C. Meter calibration airplane dial, band-spread pointer, S.W. calibration; you cannot buy a better set—double the number of valves or three times the price; your price, £12/19/6; with 12in. American Magnavox speaker, £15; table model, £18; Console, £20; Auto Radiogram, £35; cash or c.o.d.; part exchange quotations given.

£5/19/6.—The finest car radio available under £15, amazing volume and sensitivity, 5-valve A.V.C. superhet, fits under dash of any car; medium wave model, £5/19/6.

3 UNPRECEDENTED Cash Bargains at Fraction of Usual Value; send order now cash or c.o.d. (Post 1/-)

50/-—Multi-band (7-2,000 metres) communications outfit, battery, valves, 8in. speaker; metal cabinet, 7in. band-spread dial, with S.W. station names and listening times, together with 8in. world rotating globe.

37/6—Powerful 3-valve Pentode all-wave battery chassis, 12-2,000 metres, gramo, band-spread, 7in. dial, S.W. station names, complete with valves, aerial tested.

21/-—Superheterodyne short-wave converter, 7-200 metres, 5in. dial with band-spread, operates in front of any superhet or H.F. receiver, mains or battery, complete with valves and cabinets, aerial tested.

H.P. Terms Offered With the Following Exceptional Values; deposit with order secures delivery.

11/1 With Order, 8½ gns. cash.—The amazing new Decca value, 6-valve all-wave (3-band) portable A.C./D.C. superheterodyne, 19-2,000m. 2-speed 7in. airplane dial, station names, A.V.C. (18 payments of 11/1).

20/6 With Order, 16½ gns. cash.—The magnificent new Ferguson 11-valve 4-band, 12½-2,100 metres, 8 watts output, Rola 10in. speaker in beautiful acoustically designed table cabinet (20/6 down, balance over 18 months).

DEMONSTRATIONS Arranged Within Reasonable Distance of London, or at any time at our new showrooms at 39-41, New Oxford St. Otherwise order with confidence, your satisfaction is guaranteed.

4d. Stamps Enclosed Brings Our New Coronation Year Catalogue, fully illustrated and covering every radio need and the finest radio values obtainable.

ANGLO AMERICAN RADIO (AND MOTORS), Ltd. (Dept. W.18), Albion House, New Oxford St., London, W.C.1. Telephone: Temple Bar 3231. [4436]

NEW RECEIVERS AND AMPLIFIERS

ROYAL RADIO Co.

ALL-WAVE Receivers, suitable for use on ships, as supplied to officers of many shipping lines.

OUR 8 and 10 Metal Valve All-wave Receivers; 15-2,000 metres, acknowledged by the trade as the best for range, tone, and general performance.

LATEST 6-valve Car Radio, A.V.C., remote control, no suppressors required.

A FULL Range of the World Famous Emerson Receivers for Export.

ALL Sets Fully Guaranteed by Ourselves.

ALL Types of American Valves Stocked.

PAY Us a Visit Any Time, or send for full range catalogue; 1/2d. stamp will be appreciated.

ROYAL RADIO Co., 5, Buckingham Rd., South Woodford, London, E.18. 'Phone: Buckhurst 2756. [4426

"SERVICE With a Smile."

HENRY FORD RADIO, Ltd.

ELECTRONIC House, 22, Howland St., Tottenham Court Rd., W.1. Museum 5675. [0511

£7/5.—Six-valve all-wave chassis with 8in. Rola, B.V.A. valves, royalties paid, twelve months' guarantee.—Coulphone, Hutton, Preston. [4229

MCCARTHY New Series of A.C. Universal, Battery, All-wave and other receivers, many refinements, several interesting new models.

IMPORTANT!—All prices quoted for McCarthy chassis include Marconi royalty payments.

MCCARTHY All-Wave Battery Superhet with R/F Stage; £7: separate triode oscillator, L.F. stage, pentode output, ext. speaker and gram. sockets, etc., equals mains performance.

MCCARTHY 6-valve All-wave Superhet with R/F Stage; £8/5; A.C. or Universal, iron-cored I.F. coils, 142-wound tuning coils, illuminated "Airplane" dial, triode-hexode frequency changer, double band-pass coupled I.F. amplifier, L.F. stage, pentode output, D.A.V.C. tone control, ext. speaker and gram. sockets, etc.; performance equals many 8-valve receivers.

MCCARTHY Super 9-valve All-waver with Push-pull Triode Output; £12/12; a set for the connoisseur! McCarthy special 7-valve all-waver with R/F stage, four wave-bands, many interesting new features; £10/10; full particulars on application.

ALL McCarthy Receivers on Heavy Cadmium-plated Steel chassis; quality components and B.V.A. valves throughout.

SEE McCarthy Advertisement on Edit. page 499 for Other McCarthy models; also write for complete catalogue.

MCCARTHY RADIO, Ltd., 44a, Westbourne Grove, London, W.2. [4379

TRANS-ATLANTIC RADIO for the Finest All-wave Sets and Compacts; agents for Ferguson, Philco, etc.; radio service specialists.—Trans-Atlantic Radio Co., 15, Percy St., W.1. Museum 3096. [4353

PILOT, Ferguson, Belmont, Pegasus, and Air King all-wavers lead the field, our deliveries are prompt in original cartons, with full guarantees; your trade card will bring our wholesale catalogue from the authorised distributors.—Leonards Heys, 36, Henry St., Blackpool. [0530

COMMUNICATION Receivers, Hammarlund, National, Hallcrafters, R.M.E.69, Tobe-Deutschmann; transmitters, Collins 45A, Peerless DX20, or built to order; American valves, microphones, Edgerton components.—A.C.S., Ltd., 52-4, Widmore Rd., Bromley. 'Phone: Ravensbourne 0156. [0550

RECEIVERS AND AMPLIFIERS

CLEARANCE, SURPLUS, ETC.

ALL Lines Previously Advertised Still Available.

HENRY'S, 72, Wellington Ave., N.15. Stamford Hill 2907. [4435

CLEARANCE List (Trade Only).—Write Leonard Heys, 36, Henry St., Blackpool. [0527

6-VALVE All-wave Superheterodyne, walnut cabinet, speaker, complete as new; £7/10.

F. M. HILLS, 32, Robin Hood Lane, S.W.15. Kingston 3856. [4444

ARMSTRONG Co. Have a Further Few Soiled but Genuine Brand New Radio Chassis for Disposal at Considerably Less Than Cost Price, described hereunder.

ARMSTRONG 1937 9-stage Radio-gramophone Chassis, covering 4 wavebands from 12.9 metres, circuit H.F. Pentode as radio frequency amplifier, tuned H.F. transformer coupled to hexode triode, detector oscillator, 2 band-pass coupled I.F. amplifier stages, double diode triode, detector and L.F. amplifier, push-pull output stage capable of handling 6 watts, highest grade components used throughout, "Airplane" multi radio drive, all wavebands calibrated station names, tone control works on both radio and gramophone, provision for extension speaker, etc.

SEVERAL Chassis as Above, brand new, but chassis slightly marked; price, complete with Mullard valves, 9 gns., an exceptional opportunity.

ARMSTRONG Co. Also Offer Few Genuine 1937 Armstrong 6v. All-wave Superheterodyne Radiogram Chassis, brand new but cellulose slightly marked, complete with new full size Rola moving coil speaker and 6 new and fully guaranteed Marconi or Mullard valves; these chassis are the well known 3BPT models containing high grade British components, are ganged and aerial tested, and ready to switch on; price £6/10, complete.

ARMSTRONG Co. Have Technical Data Sheets Available.

ARMSTRONG Co. Will Willingly Send Above Chassis on 7 Days' Trial, carriage and packing free.

ARMSTRONG MANUFACTURING Co., 100, King's Rd., Camden Town, N.W.1. [4343

The PETO-SCOTT Cathode Ray TELEVISION Receiver Kit

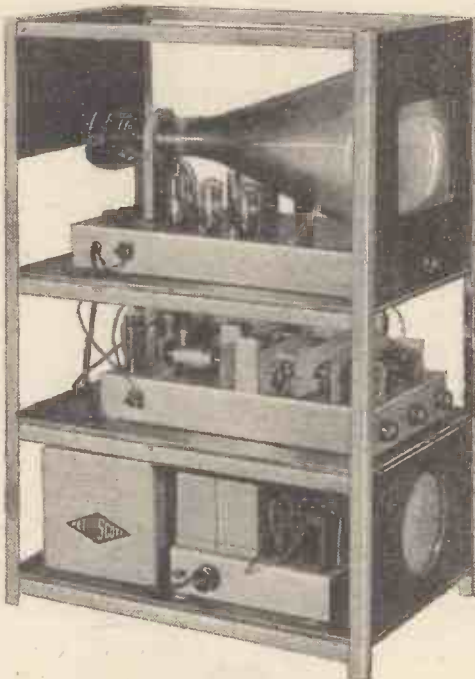

PETO-SCOTT—esteemed by every serious radio experimenter and Home Constructor throughout the World—take great pleasure and pride in announcing the triumphant result of over 10 years intense research and pioneer experimental work in Television. . . . The Peto-Scott Cathode Ray Television Receiver Kit. With the introduction of this magnificent Kit, Peto-Scott provide the Experimenter and Home Constructor with the opportunity to build their own High Definition Cathode Ray Receiver, and thus bring to them—in a form that will make an instant appeal—the latest scientific achievement, Sound and Vision Reception, for only 12/- WEEKLY.

DÉMONSTRATIONS

Free Demonstrations are given daily from 3 to 4 p.m. each day except Saturday, when we close at 1 p.m. We will be pleased to make special appointments for demonstrations on Saturday between 3 and 4 p.m. without any obligation whatsoever.

PETO-SCOTT

Established 1919

THE PETO-SCOTT CO. LTD.

77, (W.W.27) City Road, London, E.C.1

Glissold 9875-6-7

62, (W.W.27) High Holborn, London, W.C.1

Holborn 3248

Send for Free Folder

containing illustrations and full descriptions and prices of Kits for the various units in the Peto-Scott Cathode Ray Sound and Vision Television Receiver.

RECEIVERS AND AMPLIFIERS, CLEARANCE, SURPLUS, ETC.

PEERLESS Chassis De Luxe Model, 1933, 11 valves, 12" in. speaker, 5 wavebands, 18 watts output, specially made for short-wave reception, list £18/18, my price £10/10; 1937 Regentone De Luxe model, A.C. 200-250, 3 waveband superhet., 5 valves, 17.5 to 2,000 metres, handsome cabinet, list 12½ gns., my price £6/17/6; send for list.—Kay, 21, Prince of Wales Rd., Norwich. [4447

CAR RADIO

PHILCO Repairs and Installations, trade distributors.—Radiorite, Ltd., Moorfields, Liverpool. Bank 8811. [4321

PUBLIC ADDRESS EQUIPMENT

SPECIAL Offer!!!

8½ Gns. Complete.—Vortexion portable 15-20 watt 4-stage amplifier, independent mike and pick-up inputs, outputs for 7½ and 15 ohm speakers, weight 25lb., 4 independent input model, £10.

HEAVY Duty 20 watt model, as fitted to dance halls and cinemas, etc.; £15, complete with valves.

60 Watt Model for 6LGs, with microphone and gramophone independent inputs, and outputs for 4, 7½, 15 and 30 ohm speakers, consumption 150 watts, in ventilated steel carrying case; £24 only! complete with valves less two 6LGs.

WHY Not Call and Have a Demonstration.

VORTEXION, Ltd., 182, The Broadway, Wimbledon, S.W.19. 'Phone: Lib. 2814. [4254

ALL Types of Public Address Apparatus for Sale or Hire.

WARD, 48, Farringdon St., London, E.C.4. Tel.: Holborn 9703. [0555

HARMONY HOUSE SOUND SERVICE, Southport.—Beam power amplifiers, 14 watts output; £13/10 (subject); send for lists. [0546

AMPLIFIED Speech and Music for Fetes, sports meetings, etc., using our public address mobile equipments, also smaller equipments for: dinners, dances, conferences, etc.—Harmony House Sound Service, Southport. [0548

ARMSTRONG Latest Coronation 30-watt Public Address Amplifier, incorporating 3 input circuits and self contained Fader system; both microphone stages have a total gain of 97db, and are electron coupled; this apparatus is particularly suitable where large output is required; price complete, 16 gns.; British throughout.

ARMSTRONG 10-watt High Fidelity Amplifier, suitable for indoor public address or gramophone reproduction, two inputs, controlled by self contained Fader unit, tone control working on both inputs, Class A push-pull output; British throughout; price complete with valves, etc., 9 gns.

ARMSTRONG, 100, King's Rd., Camden Town, N.W.1. 'Phone: Gulliver 3105. [4384

USED SETS FOR SALE AND WANTED

EXCHANGE OR WANTED

WANTED, Standard Telephones "60" Superhet.—Write Box 1910, c/o The Wireless World. [4440

NEW MAINS EQUIPMENT

VORTEXION Quality Transformers

VORTEXION Supply the B.B.C., G.P.O., L.P.T.B., L.C.I., Borough Councils, etc. Why not you?

ALL Fitted Screened Primaries, and tapped 200-250v. with centre-tapped filaments, guaranteed one year.

W.W. Q.A., 425-0-425v., 120-160 m.a., 4v. 5-10a., 4v. 2.5a., 4v. 1-2a., 4v. 1-2a., super shrouded model; 32/-.

500-0-500v. 160 m.a., 4v. 4a., 4v. 2.5a., 4v. 2a., 4v. 2a., 4v. 2a., super shrouded model, 2.5% regulation, 35/-; open type, 32/-; 400 or 450v., same price.

350-0-350v. 120 m.a., 4v. 2-6a., 4v. 2-4a., 4v. 1a., 4v. 1a., super shrouded, 25/-; normal shrouded, 21/-; open type, 18/6.

350-0-350v. 75 m.a., 4v. 2-4a., 4v. 1-2a., shrouded, 18/-; open type, 16/-.

250-0-250v. 60 m.a., 4v. 2-4a., 4v. 1-2a., shrouded, 15/-; open type, 12/6.

AUTO Transformers, 100-120 to 200-240v.; 80 watts 11/-; 120 watts 14/6, 200 watts 21/-, 500 watts 37/6.

CHOKES.—30 h. 60 m.a. 7/6; 7-13h. 120 m.a., 12/6; 30h. 150 m.a., 15/-.

OUTPUT Transformers—4-10 watt W.W. Q.A., 21/-; 20 watt super shrouded, 30/-.

VORTEXION, Ltd., 182, The Broadway, Wimbledon, London, S.W.19. (Telephone: Liberty 2814.) [3951

TANTALUM for A.C. Chargers, H.T. and L.T.—Blackwell's Metallurgical Works, Ltd., Garston, Liverpool. [3984

PARTRIDGE Transformers for P.A., radio, relay, transmitting, recording, talks, television, etc.—N. Partridge, B.Sc., A.M.I.E.E., King's Buildings, Dean Stanley St. London, S.W.1. [4372

CABINETS

RADIOGRAM Cabinets, new designs, 30/- to £5/10; inspection invited or photos for selection sent on request.
TABLE Radio Cabinets, undrilled, 6/6 upwards.
SPEAKER Cabinets, 4/6 upwards.
MANUFACTURERS' Clearance.
ULTRA Radiogram Cabinets, undrilled, 33x23x14 or 33x20x15, 30/-.
BURGOYNE "Fury" Radiogram Cabinets (undrilled), 34x22x16½, 49/6.
K.B. De Luxe Walnut Cabinets, undrilled, chromium plated edges and speaker grille, 25in. wide, 14½in. high, 10½in. deep, 18/6; Console model, 42in. high, 21½in. wide, 11½in. deep, 39/6.
HALYCON Radiogram Cabinets (Reconditioned), 33x23x19, 35/-.
H.L. SMITH and Co., Ltd., 287-9, Edgware Rd., London, W.2. Tel.: Pad. 5891. [0485]

DYNAMOS, MOTORS, ETC.

ALL Types of Rotary Converters in Stock, new and second-hand.
WARD, 46, Farringdon St., London, E.C.4. Telephone: Holborn 9703. [0518]
A.C.D.C. New Motors, all voltages; from 14/9; lists free.—Repair Specialists, Easco Electrical Service, 18w, Brixton Rd., S.W.9. [0455]
ELECTRO Dynamic Converter, with filter and silence box, 240 D.C. 230 A.C., 250 watts; £10.—Hilsden, 122, Etchingham Park Rd., Finchley, N.3. [4442]

NEW LOUD-SPEAKERS

BAKER'S Quality Surplus Speakers.
IF You are Requiring Quality Reproduction at Low Cost order one of the following brand new bargain speakers now. The Auditorium models are fitted with latest triple cone comprising main curved cone and bakelite and duralumin cones combined, giving wide and even frequency response, resulting in quality reproduction of speech and music. The Coronation surplus horn models are ideal for reproduction of transients.
39/6 Only, usual price £5.—Auditorium Permanent Magnet Speaker, with Alni magnet and die cast frame, large 12in. triple cone giving wide frequency range, complete with large 25 ratio transformer suitable for all outputs, including push-pull and Class B, etc.
59/6 Only, usual price £6.—Auditorium Electro-ohms field exceptionally large magnet of high permeability steel giving enormous flux density, 2in. moving coil, large triple cone giving wide frequency range, complete with universal transformer, the ideal speaker for use with "Wireless World" and other quality amplifiers.
75/- Only, usual price £9.—As above, but for use on A.C. mains; complete with Westinghouse rectifier and full smoothing equipment.
49/6 Only, usual price £6.—Coronation Surplus Horn Permanent Magnet Moving Coil Speakers, suitable for domestic or public address; the horn is of moderate size and the speaker is therefore ideal for home use where good reproduction of transients is required; can be used separately or in conjunction with baffle board speakers.
15/6 Only.—Permanent Magnet Speaker, Alni magnet, 8in. cone, Universal transformer.
12/6 Only.—Permanent Magnet Speaker as above, with 7in. cone.
2/9 Only.—Brand new cabinets, 12x10x6.
8/6 Only.—Electro-Magnet Speakers, with 8in. cone, 6,500 ohms field, Universal transformer.
ALL Baker Quality Surplus Speakers are Sold for Cash or c.o.d.
BAKER'S SELHURST RADIO, Ltd., The Pioneer Manufacturers of Moving Coil Speakers, 1925-1937.—75-77, Sussex Rd., South Croydon. (Croydon 3441.) [4433]
VAUXHALL.—Best quality speakers; see other loud-speakers section.—Vauxhall Utilities, 163a, Strand, [4449]

LOUD-SPEAKERS

SECOND-HAND, CLEARANCE, SURPLUS, ETC.
VAUXHALL.—Magnavox mains energised, 2,500 or 6,500 field coil, 10in. cone, 17/6; 7in. cone, 12/6.
VAUXHALL.—Magnavox permanent magnets, universal suitable for Class "B" power or pentode, 7in. cone, 16/6; 10in. cone, 22/-.
VAUXHALL.—American Rolas, 2,500, 8in., 15/-; 9½in., 19/6; permanent magnets, 8in., 19/6; 9½in., 24/6.
VAUXHALL.—Above, fully guaranteed, complete with humbucking coils; state power or pentode transformer; unused manufacturers' stock.
VAUXHALL.—Immediate delivery, carriage paid; lists free; cash with order or c.o.d.—Vauxhall Utilities, 163a, Strand, W.C.2. Temple Bar 9338. [4450]

VALVES

ANDERSON.
AMERICAN Valves, all makes, first grade only; 5/- each.
ANDERSON, 35, Lansdowne Rd., Walthamstow, E.17. Walthamstow 0827. [3351]
6L6 3/9; all other popular types American valves, 3/-; 90-day guarantee.
EIMAC, Taylor, Raytheon and R.C.A. in stock.
RADIOGRAPHIC, Ltd., 66, Osborne St., Glasgow, C.1. Bell 848. [4387]
AMERICAN Valves, first grade, in all types; trade supplied.—Metropolitan Radio Service Co., 1021, Finchley Rd., N.W.11. Speedwell 3000. [0438]

Notes

No. 39

on the Suppression of Electrical Interference with Wireless Reception FLATS

There is an ever-increasing number of people who find themselves living in flats, and it is only when they have moved in that they find their wireless set, if it is a good one, behaves in a most disappointing manner, if it behaves at all. In a modern block, built on a steel frame, tolerable reception is practically impossible with an indoor aerial. Landlords are often reluctant to allow their tenants the freedom of the roof even if it would be of any use to them, on account of the ridiculous down-leads that would be required. This is where the community feature of the "Eliminnoise" comes in. Several receivers can be operated from each aerial, all tuned in to the same or different programmes and without interaction or radiated interference.



We will gladly send further particulars of this system to any reader of these Notes who may be interested. We also suggest that it may be mutually convenient to put us in touch with landlords or agents who take the difficult view of this question. If existing circumstances are such that programmes are sufficiently loud but are being spoilt by electrical interference, it is worth while trying a †mains filter, Type 300, in the mains lead to the receiver. Such a filter is generally necessary even with an anti-interference aerial system of any make, because no aerial device can cut out that form of interference which reaches a receiver by conduction along the mains lead.

A Typical Installation for 16 Flats.

	£	s.	d.
"Eliminnoise" Aerial Transformers.			
2—of No. 306 at 17s. 6d. each	1	15	0
16—of No. 307 at 17s. 6d. each	14	0	0
100 yards "C" type Cable at 10d. per yard	4	3	4
	£19	18	4

i.e., cost per flat of Belling-Lee apparatus is £1 4s. 11d., to which must be added the cost of material and installation for the aerial, including poles, stays, etc., which will have to be erected in accordance with the requirements of the local building regulations, which may in certain cases reach a like amount.
 * "Eliminnoise" (Trade Mark) Kit of Transformers for one aerial and receiver, 35/-.
 † Set Lead Suppressor, Type 300 (Mains filter) 21/-.
 Send for the book, "Interference Suppression," post free 1s. 2d., or for free copy of "The Eliminnoise System" and other relative literature.



Belling & Lee Ltd.
 Cambridge Arterial Road, Enfield, Middx.

VALVES

ALL Types of American Valves in Stock of Raytheon, Sylvania, and Arcturus makes, at competitive prices, guaranteed for six months; send for full list; 350 ohms line cords, 2/8.
WARD, 46, Farringdon St., London, E.C.4. Tel.: Holborn 9703. [0452]
NOTHING Better Available. Six months' guarantee, complete range of battery, A.C. mains, rectifiers, always in stock, 2 volt det., H.F., L.F., 2/3; Power, 2/9; screen grid pentode, H.F. pentode, 5/-; American types, six months' guarantee, 5/6 each, Nos. 18, 24A, 35, 42, 43, 45, 47, 56, 57, 58, 75, 77, 78, 80, 2A5, 2A6, 2A7, 6A7, 2B7, 6B7, 6C6, 6D6, 25Z5, 25Y5.—Write for other prices to Dulci Electrical Co., Devonshire Works, Duke's Av., Chiswick, London, W.4. [0501]

NEW COMPONENTS

CELLOPHANE for Home Recording and Microphone Kits from 9/6.—A. Hinderlich, 2, Bridge Rd., London, N.W.10. [4446]

COMPONENTS

SECOND-HAND, CLEARANCE, SURPLUS, ETC.

R.
RADIO CLEARANCE
ALL Lines Previously Advertised Still Available.
RADIO CLEARANCE, 63, High Holborn, W.C.1. Holborn 4631. [4398]
SOUTHERN RADIO'S Wireless Bargains; all goods guaranteed and sent post paid.
RECORD Changers.—Garrard Model R.C.4, plays automatically and changes eight 10in. or 12in. records of any kind, new, in sealed cartons; £6.
GRAMOPHONE Motors.—Collaro electric radiogram units, for A.C. or D.C. mains, 100-250 volts, fully auto stop, complete with pick-ups, can be used on any mains, brand new, in sealed cartons, 57/-; Collaro spring gramophone motors, with 10in. turntable, complete with all accessories, 11/-; all Collaro motors are brand new, in sealed cartons.
SPEAKERS.—Celestion Soundex, permanent magnet, 10/-; Telsen permanent magnet, with 10-ratio transformer, to suit any receiver, 12/6; Telsen loud speaker units, 2/6; all brand new and boxed.
COILS.—Telsen iron core W349 (Midget size), 4/-; type W478 (twin), 9/- pair; type W477 (triple), 16/- per set; type W476 (triple superhet, selector and oscillator), 16/- per set; Telsen short wave coils, matched set of three, 4-pin bases, 12-26, 22-47, 41-94 metres, 5/- per set; Telsen dual range H.F. transformer and aerial coils, type W154, 3/- each; all ganged coils complete on base with switch; Telsen I.F. transformer coils, 110 k.c., 5/-; Telsen dual range coils, with aerial series condenser incorporated, type W76, 4/-; Telsen aerial condensers, with shunting switch, 2/-; all Telsen components brand new, in sealed cartons.
AMERICAN Valves.—A full range of valves for all American receivers; 6/- each.
MISCELLANEOUS Bargains.—All brand new, in original sealed cartons; Telsen A.C./D.C. multi-meters; test anything, radio or electrical, 8/6; Telsen 2-range voltmeters, 3/-; 5-range meters, including milliamps, 4/-; Aea (P.O.) microphones, with transformer, ready for use with any receiver, 4/8; Bell transformers, 200-250 volts input, 3, 5, or 8 volts output, 3/6; Morse signal units, incorporating buzzer, tapper and flash, with international code, complete with batteries and bulb, 3/9 each; lightweight headphones, double-pole, 4,000 ohms each ear-piece, 3/- pair.
REGENTONE Eliminators, A.C. 200-250 volts, type W5a, with trickle charger; 37/6.
SOUTHERN RADIO.—Branches at 271-275, High Rd., Willesden Green, N.W.10; 46, Lisle St. London, W.C.2. All mail orders to 323, Euston Rd., London, N.W.1.
SOUTHERN RADIO, 323, Euston Rd., London, N.W.1 (near Warren St. Tube). Phone: Euston 3775. [4429]

OLIVERS Offer Erie 1-watt Resistances; 3½d. each, 3/- dozen; 2/6 dozen in 3-dozen lots.
CENTRALAB Volume Controls, with switch, 2/- each; 5-pin chassis mounting valve holders, 2½d.; 7-pin ditto, 3½d.
CARDBOARD Case Electrolytics: 4 mfd., 1/6; 8 mfd., 1/9; 50 mfd. 50v., 1/6; 8 mfd. + 4mfd., 2/5; 8 mfd. + 8 mfd., 2/8; 4 mfd. + 4 mfd., 2/4; Tubular: 1 mfd., 1/-; 25 mfd. 25v., 1/-; 50 mfd. 50v., 1/6; 50 mfd. 12v., 1/-; 50 mfd. 25v., 1/3.
ALUMINIUM Chassis, 18 gauge, 16in. x 10in. x 3in., undrilled, 5/3; 16 gauge ditto, 7/6; all sizes built to specifications; quotations upon application.
ROLA G.12 Speakers, stripped, but complete with transformer for push-pull, triode or pentode, 2,500 ohms and 1,250 ohms field; £2/19.
"MAGIC EYE" Tuning Indicator Unit, easily fitted to any A.C. receiver with A.V.C., complete with tube transformer, circuit diagram, etc., 12/6; tube only, 7/-.
OLIVERS, 676, Christchurch Rd., Boscombe, Hants. Enquiries invited, lists free. Can supply all types non-ring valves, American valves, American replacement condensers, metal electrolytics, record changers, tubular and tag condensers, etc. Orders under 6/- postage extra. [4443]
RYALL'S RADIO, 280, High Holborn, London, W.C.1, offer new goods at knock-out prices.
AMPLIFIER, with 6-watt output, 3-stage, for A.C. 200-250v., splendid chassis, Ferranti transformer, complete with 5 valves; 50/-.
T.C.C. Electrolytics, tubular can type, dry, 16x8 mfd., 450v., 1/7; 4x4 ditto, post extra on this line.
N.S.F. 0.1 Tubular Non-inductive 1,000v. Test Condensers, 2/6 dozen, tag ends; 0.01 ditto N.S.F. 25x25 mfd., six for 3/-, tubular, wire ends.
PAIRS Matched Ferranti Screened Coils, aerial and H.F., with reaction, sensitive and selective; 2/6 per pair, chassis type.
FERRANTI Mains Transformers, as used in their own commercial receivers, 350-0-350v., 70 m.a., 4v. 2½a., 4v. 4-5a., C.T. input 200-250v., brand new; 6/6 each. [4440]

PREMIER SUPPLY STORES

All goods guaranteed perfect; carr. paid over 5/-; under 5/- postage 6d. extra.

ALL POST ORDERS TO JUBILEE WORKS, 167, LOWER CLAPTON RD., LONDON, E.S. Phone: Amherst 4723.

CALLERS AS USUAL, TO 165 & 165a, FLEET STREET, E.C.4 (Next door to Anderson's Hotel), Central 2833. New Branch: 50, HIGH STREET, CLAPHAM, S.W.4 (Macaulay 2381).

Have you had our GIANT ILLUSTRATED CATALOGUE AND VALVE LIST? Send 4d. IN STAMPS FOR THIS BARGAIN LIST.

SHORT-WAVE COILS, 4- and 6-pln types, 13-25, 22-47, 41-54, 78-170 metres, 1/9 each, with circuit. Special set of 3 R.W. Coils, 14-150 metres, 4/- set, with circuit. Premier 3-band R.W. Coil, 11-25, 19-43, 38-86 metres. Simplifies B.V. receiver construction, suitable any type circuit, 2/6.

COIL FORMERS, in finest plastic material, 1 1/2 in. low-loss ribbed 4- or 6-pln, 1/- each.

SUPER CERAMIC CONDENSERS, S. L. F., .00016, .0001, 2/9 each, double-spaced, .000025, .000015, 3/- each. All brass with integral slow motion .00015 tuning, 3/9; .00015 reaction, 2/9. S.W. H.F. CHOKES, 9d.

MAINS VALVES, famous Europa 4v. A.C. types, 4/6 each, H.L.L., S.G., Var.-Mu-S.G., H.F. Pens., Var.-Mu-H.F. Pens., 1, 2 and 4-watt A.C. directly heated output Pentodes. Full-wave rectifiers, 250 v., 60 m.a. A.C./D.C. types, 20-volt, 18 amp. S.G., Var.-Mu-S.G., H.L.L., Power and Pen. Following types all 5/6 each. Full-wave rectifiers, 350 v., 120 m.a. and 500 v., 120 m.a. 21 watt indirectly-heated Pentodes, Octode Frequency Changers.

BATTERY VALVES, 2 volts, H.F., L.F., 2/3. Power, Super-Power, 2/9. S.G., Var.-Mu-S.G., 4- or 5-pin Pentodes, H.F. Pens., V.-Mu-H.F. Pens., 5/- Class B, 2/-.

AMERICAN VALVES. Genuine American HYTRON and TRIAD first-grade Valves, 3 months' guarantee. All types in stock, 5/6 each. 210 and 250, 2/6 each. New Metal-Glass Valves, all types, 6/6 each. Genuine American DUOTRON Valves, all types, 3/6 each. Valve holders for all above types, 6d. each. OCTOL bases, 8d. each.

3-WATT A.C. AMPLIFIER, 2-stages for mike or pick-up. Complete kit of parts with 5 valves, 40/-.

7-WATT A.C./D.C. AMPLIFIER, 3-stage high-zain, push-pull output. Complete kit of parts with 5 specially matched valves, £4 4s. Completely Wired and Tested, £5 5s.

COSMOCORD PICK-UPS, with tonearm and volume control, 10/6 each. PICK-UP HEADS only, 4/6 each.

PREMIER MAINS TRANSFORMERS, wire-end type with screened primaries, tapped 200-250 v. Centre-tapped Filament. Guaranteed one year. H.T. 8 & 9 or H.T. 10 with 4 v. 4 a. C.T. and 4 v. 1 a. C.T. 8/6. 250-250 v., 60 m.a., 4 v. 1 a., 4 v. 2 a., and 4 v. 4 a., all C.T., 8/6. 350-350 v., 120 m.a., 4 v. 1 a., 4 v. 2 a., and 4 v. 4 a., all C.T., 10/6. Any of these transformers with engraved panel and N.P. terminals, 1/6 extra. 500-500 v., 150 m.a., 4 v., 2-3 a., 4 v., 2-3 a., 4 v., 2-3 a., 4 v. 3-4 a., all C.T., 17/6. SPECIAL OFFER PHILIPS MAINS TRANSFORMERS, 250-250 v. or 300-300 v. at 80 m.a., 4 v. 5 a. C.T.; 4 v. 1 a. Tapped Primary 100-250 volts, 6/11. 450-450 v. at 150 m.a. or 500-500 v., 100 m.a., 4 v. 4 a. C.T. 4 v. 4 a. and 4 v. 3 a. Screened Primary. Tapped input 100-250 v., 12/6. AUTO TRANSFORMERS, step up or down, 60 watts, 7/6; 100 watts, 10/-. SMOOTHING CHOKES, 25 m.a., 2/9; 40 m.a., 4/-; 60 m.a., 5/6; 150 m.a., 10/6. 2,500 ohms, 60 m.a. Speaker Replacement Chokes, 5/8.

Electric SOLDERING IRONS, 200-250 v., A.C./D.C., 2/3.

SPECIAL OFFER. LISSEN TWO-GANG SCREENED ALL-WAVE COILS, 12 to 2,000 metres, complete with switching and wiring diagrams, 6/11 per set.

Special Offer BTH Energized Moving Coils, 10 1/2 in. diam., 1,650 ohms field. Power or Pentode transformer (state which), 14/6.

ROLA latest type P.M.s., 15/- GOODMANS' Min. mains energised 1,000 ohms field, 10/6 each; Jensen P.M.s., 10/6.

W.B. 1936 STENTORIAN SPEAKERS. Standard model (list, 32/0), 22/6. Senior model (list, 42/0), 28/6. Brand new in original sealed cartons.

TRANSFORMERS, latest type Telsen R.G.4 (list, 19/6), 2/9. Lissen Hyperak Q.P.P. (list 12/0), 3/6.

OUTPUT TRANSFORMERS for Power or Pentode, 2/6. Multi-Radio, 4/6.

TUBULAR CONDENSERS, non-inductive, all-values up to 5 mfd., 6d. each.

Wire-end RESISTORS, any value, 1 watt, 6d.; 4 watts, 1/-; 8 watts, 1/6; 15 watts, 2/-; 25 watts, 2/6 each.

Reliable MORSE-KEYS with Morse Code engraved on bakelite base, 2/- each.

Bakelite case BUZZERS, 1/6; Walnut case "Loud-tone," 2/6 each.

Super Quality lightweight HEADPHONES, 3/3 pair.

Telsen DISC DRIVES, W 184, 1/- each.

GRAMOPHONE MOTORS. Collaro Gramophone Unit consisting of A.C. motor, 100-250 v., high quality pick-up and volume control, 45/-; Collaro motor only, 30/-; Collaro Universal Gramophone Motor, 100-250 v., A.C./D.C., 49/6; Edison Bell double-spring motors, including turntable and all fittings, 15/-; CosmoCORD frame, unit, comprising A.C. motor pick-up and volume control (list 55/-), 35/8.

COMPONENTS—SECOND-HAND, CLEARANCE, SURPLUS, ETC.

PREMIER SUPPLY STORES.

PLEASE See Our Displayed Advertisement on this page. [0488]

ALL Goods Previously Advertised are Standard Lines, still available; post card for list free.

VAUXHALL UTILITIES, 163a, Strand, W.C.2. Over Denny's the Booksellers, Temple Bar 9338. [4448]

STANDARD RADIO SUPPLIES.—Bargains advertised last week still available.—Dantzic St., Manchester. [4445]

WARD.—For unparalleled bargains in set manufacturers' surplus; all goods are guaranteed unused and perfect; immediate delivery.

BRITISH Radiophone Condensers, fully screened, super-het, or straight type, 5-gang and 2-gang; 7/6.

CENTRALAB Resistances, 1-watt type, 6d.; 2-watt type, 1/2; 3-watt type, 1/9; B.I.C. 8mf. and 4mf. 550 volts peak electrolytic condensers, 3/3.

3,000 Brand New Wearite 110 kc. Pre-tune I.F. Transformers, type O.T.1, O.T.2 and O.T.2F; 1/6 each, or offer for quantity.

40 mfd. and 24 mfd. 200 Volts Peak Electrolytic Condensers; 3/.

CLIX Chassis Type Valve Holders, 4- or 5-pin, 6d.; 7- or 9-pin, 6d.; R.C.A. American valve holders, 4-5, 6- or 7-pin, 9d.

ASSORTED 1-gross Parcels of 1-watt and 1/2-watt Resistances by N.S.F.; 12/-.

MARCONI Model 25 Pick-ups; 25/-.

CONVERSION Units for Converting D.C. Receivers to A.C. Mains operation up to 110 watts, improved full-wave type; £2/10.

WESTINGHOUSE Rectifiers, I.T.4 or I.T.5, with mains transformer and variable resistance, 22/6; Varley D.P.4 output transformers, 1-1 and 25-1, 9/-.

MAINS Transformers, 350-0-350v. 60 m.a., 4v. 3 amps., 4v. 25 amps., 12/-; 425-0-425v. 120 m.a., 4v. 1 amp., 4v. 1 amp., 4v. 7 amp., 4v. 25 amp., for "W.W." Quality Amplifier, 26/-; I.T. transformers, with two 4v. 3a. C.T. windings of 2.5v. 8a., 5v. 2.5a., 8/6.

VOLUME Controls, with or without switch, by Rotor-ohm, Erie, Electradix, and other good makers, any value, 2/6; steel chassis, "Wireless World" Quality Amplifier, 8/6; Partridge 32-watt amplifier, 11/-.

WE Stock All Parts for "Wireless World" Quality Amplifier, Quality Amplifier Receiver, Imperial Short Wave Six, 1936 Mondial Q.A. Snper, All-way Super Seven, etc.

WE Can Supply Correct Equivalents for Any British Type of Valve, including side-contact Universals, J.I.F. pentodes, double diode triodes, 3-5-watt output pentodes, 500v. indirectly heated rectifiers, octodes, double diodes, single diode tetrodes, etc., at an appreciably lower price.

PHILIPS Amplifiers with 400v. triode in output stage; £2, complete.

CARRIAGE Paid, cash with order or e.o.d.; send for list.

WARD, 46, Farringdon St., London, E.C.4. Tel.: Holborn 9703. [0450]

MAINS RADIO DEVELOPMENT COMPANY Offer Guaranteed Bargains; carriage paid, call mornings. —Phone: Tudor 4046. Stamp for new list 203.

RESISTORS, absolutely finest make, one watt, colour coded, wire ends, unused, 50 ohms to 5 megohms, any size, your choice, 3/4d., 2/9 dozen; two watt, any size, 6d.

SATOR Metal Cased Condensers, 400 volt working, 1 mfd., 7/6d.; 2 mfd., 10d.; 4 mfd., 1/8.

CENTRALAB Unused Potentiometers, 500,000 ohms, 1/3; 10,000 ohms, 1/3; Cosmor 50,000 ohms, 1/3; Rotorohm, 10,000 ohms with switch, 1/6; Centralab, 500,000 ohms with switch, 1/9; any other size in Centralab, with or without switch, 2/3.

B.I.C. 8 mfd., 550 volt dry, metal can electrolytics, 2/3; ten other sizes on list.

PYE 20h., 120 m/a., boxed L.F. chokes, 4/6; Arco steatite short wave condensers, 0.00016 mfd., 1/6.

TUBULAR Condensers, very best make, wire ends, 400 volt working, 0.0001, 0.002 mfd., 3d.; 0.005, 0.05 mfd., 5d.; 0.25, 0.5 mfd., 7d.; special 0.1 mfd., 450 volt working, 5d.

CLIX Latest Unused Chassis Valve Holders, 4-pin, 1 1/4d.; 5-pin, 2 1/4d.; 7-pin, 4d.; chassis, grey cellulosed metal, three valve, 12 1/2 x 6 1/2 x 3 1/2 in., 1/- (9-pin, 6d.).

MAINS RADIO DEVELOPMENT COMPANY, 4, 6, Muswell-Hill Rd., London, N.6. [4318]

TRANSMITTING APPARATUS

G5N1.—The recognised distributors for amateur equipment, National, R.M.E., Thordarson, Hammarlund, McMurda, Hallcrafters, etc.; send 1/4d. stamp for catalogue.—Radiomart, 44, Holloway Head, Birmingham. [0531]

MISCELLANEOUS

CHEAP Printing.—1,000 billheads, 3/6; sample free.—Creteway Press, 18, Buxted, Sussex. [4312]

G.P.O. Engineering Dept. (no experience required). Commencing £3/13 per week; age 18-23; excellent prospects.—Free details of entrance exam from B.I.E.T. (Dept. 574), 17-19, Stratford Place, London, W.1. [4371]

AMBITIOUS Men.—To ensure promotion take advantage of THE T.I.G.B.'s authoritative home study courses in Radio Engineering and Servicing, Television, Sound Recording, Wireless Communications, etc.; write to-day for "The Engineer's Guide to Success"—free—which gives full particulars—contains the world's widest choice of engineering courses covering all branches—and alone gives the Regulations for qualifications such as A.M.I.E.E., A.M.I.R.E., A.M.I.T.E., A.M.I.W.T., C. & G., etc. Training until successful guaranteed—The Technological Institute of Great Britain, 5, Temple Bar House, London, E.C.4. (Founded 1917. 20,000 successes.) [4370]

ELECTRADIX AC/DC BATTERY CHARGERS & RECTIFIERS



Fine DAVENSET A.S.C. 4 as illus., 4 circuit charger for up to 80 cells. List price £22. 4 sets of Auto-charge regulators and indicators on panel with selector switch volt control. 4 independent circuits of 1, 1, 2 and 2 amps., or 3 of 1, 2 and 2 1/2 amps., etc., or one of 1/2 or 6 amps. 10 amp. valve fitted and Charger very smart. It is a very fine set that will quickly earn its cost and show a good profit. It is fully guaranteed and for quick sale a great bargain at £14/10.—Other chargers at bargain prices are below. Call and see them. All O.K. and guaranteed as new.

Four AC/DC DAVENSET Type G.C. Home, Garage wall type Charger, 3 circuits, output D.C. 25 volts 3 amps. Transf. tapped for 15 v., 20 v., 25 v. Two independent circuits, max. cell capacity 40 radio cells, £5 5/-.

Two AC/DC DAVENSET CHARGERS Type R.P.C. for 250 volts A.C. to 250 volts, 250 m.a., D.C., fitted Ferranti meter and volt regulator. As new, £6 17 6.

TUNGAR CHARGERS, Steel case, with meter, voltage regulator, switch and terminals for 2 circuits of 75 volts, 6 amps., D.C. from A.C. mains 200-230 volts. Robust trade job, fine order, £9/17 6.

CAR CHARGERS from A.C. Mains for 5 amps., D.C. £4 17 6. Smaller Model for 2 amps. charge 75/-.

D.C. CHARGING OFF D.C. MAINS. £14 Davenport DC2 Steel Cased 200-250 v. Charger, large meters, wheel controls, 2 circuits, 1 amp. and 3 amps. as new, sale price £5/10/-.

MAINS CONVERSION UNITS. For operating D.C. from A.C. mains, screened and filtered, 120 watts output, £2/10/-.

THERMATAIX. A.C./D.C., 230 v., to 2 volts 1 amp., 30/-.

HEWITTIC. 250 volts A.C. to 210 volts 6 amps D.C. £14.

METAL RECTIFIERS AND CHARGERS. Westinghouse Wall type "R" Steel case, 12in. x 19in. for 200-230 volts, A.C. mains to 40 volts, 3 amps. D.C. for 40 Radio Cells. Guaranteed. £7 7 6. Similar one for Car Battery Charging, 15 volts, 6 amps., D.C. output, £8/17 6. Fine model also for A.C. mains with D.C. output of 280 volts, 250 m.a., £7 2 6. Two 50-volt circuits, each of 750 m.a. D.C. from A.C. mains is another bargain at £8/10/-.

SMALL CHARGERS. From A.C. mains to 6 volts, 1 1/2 amps., 30/-.

PHILIPS A.C. Mains Charger, giving 14 volts, 3 amps., D.C. £4. Trickle Charger for A.C. giving H.T. and L.T., 35/-.

Motor-Generators for all outputs up to 100 volts, 60 amps. DOUBLE CURRENT DYNAMOS.—D.C. 600 volts 100 m.a. and 6 volts 3 amps., 32/6.

REBAY CONVERTERS for A.C. sets on D.C. mains. 7-watt P.M. model, 30 v. 15-watt 220 D.C. 220 A.C. ball bearings, lam. field, silent running, 45/-; 50 watt, £8; 90 watt, £7 10/-.

M.G. Sets with filter, 6 v. to 170 v. 25 m.a., for H.T., 65/-.

D.C. MAINS MOTORS.—Enclosed, self-start on load. A.C. repulsion, 1 1/2 hp. with pulley, Type 40, 1,560 revs., 18 6. Type 30, Ditto, 1,250 h.p., G.F.C., 3,500 revs., 27 6. Induction 1/10 h.p., 2,500 revs., 35/-.

D.C. MAINS MOTORS.—1 1/2 hp., Type 60, 220 v., K.B. series, 1,750 revs., 15/-.

TESTERS DIX-ONEMETERS 50 RANGE TEST SET.—Will measure 6-100 millivolts 25 microamps to 20 amps. Dix-onemeters are now only 55/-.

This is remarkably small price for a meter worth £10 in comparison with others. Latest Model. Mirror Double Scale. Mounted Base. The finest Precision Multi-Measuring Instrument is the DIX-ONEMETER. A de luxe Meter in case, only 55/-.

Multipliers, 6/6 each. "S" type Analyser, a £15 Radio Res. Set, complete in case for A.C./D.C., £5/17 6.

SPEAKER BARGAINS.—Mains energised M.C. 6in. cone, sealed but good, 4/6 only. New ditto Speakers, 6in. R. & A. 2,500 ohms, with speed transformer, 7/6. Magnavox 6in., type "144", 2,500 ohms, 12 6; R.K. 8in. cone, 1,000 ohms, 10 6.

Write for Illustrated Bargain List "W" Free.

ELECTRADIX RADIOS

218, UPPER THAMES STREET, LONDON, E.C.4

Telephone: Central 4611

THE POLYTECHNIC REGENT STREET, LONDON, W.1.

A Special Course of Four Lectures on TELEVISION

will be given by H. J. BARTON-CHAPPLE, Wh.Sch., B.Sc., A.C.G.I., A.M.I.E.E.

On MONDAY EVENINGS, 7.30-9.0, beginning 31st MAY, 1937.

The lectures will be illustrated by experiments, lantern slides, and demonstrations on modern television receiving equipment, including the reception of the B.B.C. Television Service at 9 p.m.

FEE FOR THE COURSE, 6/-.

Syllabus on application to the Director of Education.

TANNOY
THE SOUND PEOPLE
GUY R. FOUNTAIN LTD.
FOR CANTERBURY GROVE WEST NO1WOOD, ALL LONDON, S.E.27. Phone: Str. 4122 (6 lines).
SOUND AMPLIFYING EQUIPMENT

The Leading Motoring Paper
EVERY FRIDAY 4d. W.W 16

REPAIRS AND SERVICE

GRAHAM'S.

GRAHAM'S Radio, Repair and Rewinding Service; 24 hours' service guaranteed.—See below.

ALL Moving Iron Loud Speakers, L.F. transformers, or pick-ups, from 2/6, output transformers from 4/-; postage extra; mains transformers, moving coils, electric clocks quoted, trade discounts.—Graham's Repairs, 194-Tolworth Rise, Kingston By-pass, Surrey. Phone: Derwent 2060. [4367]

DISTAVOX SERVICE

GUARANTEED Service.—All makes of English and American receivers; quotation by return.

REWINDING.—Mains, L.F. and output, transformers, speakers, headphones, etc.; keenest terms for contracts.

DISTAVOX RADIO SERVICE Co., 119, Bunhill Row, London, E.C.1. Phone: National 8589. [4363]

SCOTT SESSIONS and Co.,

ALL British or American Sets Repaired or Modernised by Qualified Engineers; satisfied customers throughout the world are your guarantee; send to-day for free estimate; free collection 10 miles radius of London.—Scott-Sessions and Co., Exchange Works, Dukes Av., Muswell Hill, London, N.10. Phone: Tudor 4101. [0552]

SERVICE WITH A SMILE!

HENRY FORD RADIO, Ltd.—American valves, components, spares, line cords; leading trade repairers; send us your American and British receivers.—Electronic House, 22, Howland St., Tottenham Court Rd., W.1. Museum 5675. [0434]

METROPOLITAN RADIO SERVICE Co., for Guaranteed Repairs to American (Midget and Standard and British Receivers).

CLARION and Majestic Service Depot.—L.F. and mains transformers rewound. American valves and parts; trade supplied.—Metropolitan Radio Service Co., 1021, Finchley Rd., London, N.W.11. Speedwell 3000. [0435]

REPAIRS, rewinds, and construction, any size transformers, chokes, etc., to trade.—Electric, Garden St., Sheffield, 1. [3915]

FOR Unusually Good Rewinding of Transformers, chokes, speakers, etc., trade only.—Gardners Radio, Ltd., West Southbourne, Bournemouth. [0551]

LOUD Speaker Repairs, British, American, etc.; any make transformer coils rewound; alterations.—Sinclair Speakers, Alma Grove, Copenhagen St., N.1. [4451]

OUR Technical Department is at your Service.—Air King Radio, 115, Shaftesbury Av., Cambridge Circus, W.C.2. Phone: Temple Bar 4875 (2 lines). [3963]

NATIONAL RADIO and TELEVISION SERVICE Co., Leading Service Engineers and Car Radio Experts, 155-157, Great Portland St., W.1. Phone: Langham 3477. [3911]

GUARANTEED Repairs.—Any transformers, choke, motor, armature, converter, dynamo, etc.; keenest prices, immediate quotation; prompt, dependable service.—See below.

L.T.P. (LONDON TRANSFORMER PRODUCTS, Ltd.), Willesden, N.W.10. Willesden 6486 (3 lines). [3470]

POULTNEY and PURVIS, British and American Service, trade or private; "W.W." sets a speciality; free collection, estimates.—147, Pitsinger Lane, Ealing, W.5. Perivale 3765. [4362]

MAINS Transformer Service.—Repairs, rewinds, or constructions to specification of any type; competitive prices and prompt service.—Sturdy Electric Co., Dip-ton, Newcastle-on-Tyne. [0516]

F. E. GODFREY, AM.I.R.E., qualified to build, repair and convert "Wireless World" sets, etc.; 25 years' experience, prompt service guaranteed.—30, Kemplay Rd., Hampstead, Hampstead 1104. [3509]

REPAIRS to Moving Coil Speakers a Speciality; cones and coils fitted, fields altered; prices, including eliminators, quoted, loud speakers, 4/-; L.F. and output transformers, 4/-, post free; guaranteed satisfaction; trade invited; estimates free; prompt service.—Loud-Speaker Repair Works, 5, Balham Grove, London, Battersea 1321. [0394]

EXTENDED PAYMENTS

LONDON RADIO SUPPLY Co. (Established 1925), supply on convenient terms, components, accessories and sets, any make, 10% down, balance over 12 months; send for list of requirements.—11, Oat Lane, London, E.C.2. [0337]

HIRE-PURCHASE.—Prompt delivery of any radio apparatus on convenient terms.

WARD, 46, Farringdon St., London, E.C.4. Tel: Holborn 9703. [0539]

ELECTRIC CLOCKS

SMITHS and Ferranti Electric Clocks, Waltham and Russell watches and clocks; traders' enquiries invited.—Leonard Heys, 36, Henry St., Blackpool. [0526]

EXCHANGE

EXCHANGE H.M.V. A.C. Radiogram for D.C. Model. E.—Shimwell, 13, Bury St., E.C.3. [4457]

I BUY, sell, exchange good quality receivers, accessories, components; H.P. facilities; promptness, efficiency.—Bostock, 1, Westbourne Terrace, S.E.23. Forest Hill 2236. [0529]

★ New HIGH FIDELITY 6-7 Watt AMPLIFYING (P.A.) SYSTEM

PETO-SCOTT present the latest product of this famous House... a complete Amplifying System creating a new standard of Efficiency, Economy, Simplicity and Value-for-Money. Outcome of long and expert research, here is a general-purpose amplifying system to meet every need... Dances, Meetings, Sports Tournaments, Charabanc Commentators, for home broadcasting and radiogram reproduction.

● New PETO-SCOTT design: provides excellent response at all musical and speech frequencies. ● 6-7 Watts undistorted Push-Pull Output.

● High Fidelity Peto-Scott Energised M.C. Speakers ensure quality reproduction.

7 DAYS' APPROVAL against full cash.



MODEL A.C.67 AMPLIFIER

Circuit comprises 4 valves: Triode, Resistance Transformer-coupled 2 triple Grid Power Amplifier Valves, in Push-Pull, Full Wave Rectifier. Special precautions have been taken in the circuit design to avoid parasitic oscillation in the output stage and to provide a fixed and pleasing tone balance. Pressed Steel chassis. Large tapped Mains Transformer. Electrolytic condensers. Negligible hum-level. Volume Control. Mains consumption approx. 60 watts. Latest type mains switch. Tapped for A.C. Mains 200-250 volts. 40/100 cycles. Output 6-7 watts undistorted. Complete with Valves, or 7/6 down and 11 monthly payments 8/6. **£4.10.0**

PETO-SCOTT SPEAKER

Model G25. Especially manufactured for Peto-Scott. 10in. diam. Field Energised Resistance 1,250 ohms. Electro-magnet of special annealed steel. Power handling capacity 6-7 watts. Complete with separate push-pull input transformer, with high-grade silicon laminations. Cash or C.O.D. **25/-** or 2/6 down and 11 monthly payments 2/4.

CARBON MICROPHONE

(Transverse current type) Transportable Table Model employing carbon electrodes and fine texture granules, giving splendid response at all frequencies. Highest grade white mica diaphragm. Finished Black and Chromium. "On-off" switch. Complete with separate 30:1 Transformer and 3v. Battery in black moulded case. 25 feet extension wire. Cash or C.O.D. **£2.2.0** or 2/6 down and 11 monthly payments 4/-

COMPLETE SYSTEM comprising Model AC67 Amplifier, Microphone and Transformer, Model G25 Speaker and Transformer, 25 feet microphone flex and 50 feet 4-way speaker lead as illustrated above. Cash or C.O.D. **£8.7.6** or 15/- down and 11 monthly payments 15/6.

If Peto-Scott Super Model G70 Speaker and transformer required with above equipment instead of the G25 Speaker Cash Price of Complete Outfit is £10.12.6, or deposit £1 and 11 monthly payments of 19/6. Send for Folder containing illustrated fully descriptive leaflets of above.

PETO-SCOTT CO. 77 (W.W.26) City Road, London, E.C.1. Clissold 9875-6-7
Ltd. 62 (W.W.26) High Holborn, London, W.C.1. Holborn 3248.

1937 MIDWEST

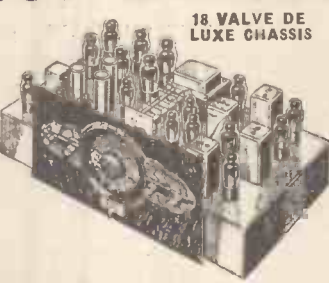

THE ONLY ALL-WAVE RECEIVER COVERING 4 1/2-2,400 METRES

Available in Chassis form complete with matched valves and 12" speaker or in Console Cabinet.

ENGLAND • THE EMPIRE • THE WORLD

in fact "Everything on the Air" is obtainable with this latest Midwest Model X-18 High Fidelity Receiver. Its 6 TUNING RANGES not only bring the broadcasts of the World into your home, but it brings them with a quality which is equalled only by the original performance. Its distinctive features in circuit design are not just talking points, as a comparison will speedily prove, but basic quality, which will assuredly appeal to "Wireless World" readers and all music lovers.

FREE ART CATALOGUE 40 pages, fully illustrated, giving particulars of Midwest 11, 14, 16 and 18 valve models. **DEMONSTRATIONS** at our showrooms Mondays to Saturdays from 9 a.m. to 8 p.m. (except Tuesdays, 9 a.m. to 6 p.m.)

MIDWEST RADIO LTD.
Showrooms and Factory:
16, OLD TOWN, CLAPHAM, LONDON, S.W.4
Phone: MACaulay 5005.

CLIX

QUALITY COUNTS

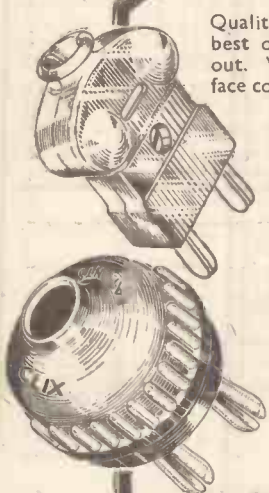

Quality receivers call for the best of components throughout. Without perfect full surface contact you will introduce annoying clicks and crackles. The certain preventative of these unwanted noises is to be found in all CLIX components.

In the CLIX Fuse and Wall Plugs the patent pins are guaranteed to give perfect, permanent contact and these pins are non-collapsible.

CLIX FUSE PLUG Fitted with two fuses of either 1, 1/8 2 or 5 amp rating. Complete **CLIX WALL PLUG** Type M. Self-centring **6d.** Self-adjusting Complete

Yours faithfully

BRITISH MECHANICAL PRODUCTIONS LTD.
CLIX
79a, Rochester Row, London, S.W.1.

RAYMART

CRAFT A CREED

STANDOFF INSULATORS

We carry large stocks and a wide variety of Stand-Off Insulators. The American types listed below are constructed of highly glazed vitreous porcelain fitted with nickel plated terminals. An exceptionally long leakage path is provided by the popular Beehive type. They are made of H.F. Ceramic; the brown model being glazed inside and out. Both types are fitted with insulated terminals. The long felt need for a substantial mounting for tank oils is met in the Heavy Duty type which are obtainable at very competitive prices. These models are 3 1/2 in. high, white glazed, and provide for 4 hole fixing.



Heavy Duty Type SX

American Type	
SM, 1 1/2 in. high	6d.
SS, 1 1/2 in. high	4d.
ST, 1 1/2 in. high	3d.
Beehive Type	
BL	6d.
SG (brown glazed)	8d.
Heavy Duty Type	
SX, 3 1/2 in. high	1/-
Kit of 2 plugs and sockets to fit above	6d.

OUR SHORTWAVE MANUAL AND CATALOGUE, 48 pages in all, 32 on receivers, transmitters, ariels, circuits, etc., etc., and 16 on a splendid range of shortwave components, 6d., or post free, 7d. 16 p Shortwave Catalogue only, 1d.

MICROVARIABLES. All brass construction, latest ceramic insulation. The finest condensers made: 15 mmfd., 1/4; 40 mmfd., 1/7; 100 mmfd., 1/10; Transmitting Type—0.70 in. spacing, 15 mmfd. (neutralized), 2/9. 40 mmfd. Tuning, 3/6. These are quality.

SHORTWAVE COILS.—(RD4). CA 11-25, CB 20-45 metres, 2/6. CC 44-100 metres, 2/9. Standard 6-pin types, CA6, CB6, 2/9 each. CC6, 3/-; same range as 4-pin.

COLIFORMS.—Moulded in RD4 natural lous material, hollow resilient pins. 1 1/2 in. diameter, ribbed; identification disc. In top. Four types, 4-pin, 1/6; 6-pin (standard or to fit 7-pin valveholders), 1/9; 7-pin (for bundspread tap), 1/10; Machine threading, 2d. extra.

AMERICAN MAINS TRANSFORMERS, Heavy Duty 350-350v., 150 m.a. 8.3v. 4n., 5v. 3n., 12/6. GE 350-350 v. 80 m.a., 2.5v., 4.5v., 5v. 2n., 6/11. Majestic, 250-250 2.5v., 5v., 4/11. PHOT 260-260, 2.5 v. C.T., 5 v. C.T., 5/11. Ceramic American Valveholders, 1/- each.

HEAVY DUTY MAINS TRANSFORMER, worth 45/-, 350-350, 150 m.a., 4 v., 2.5 A. C.T., 4 v., 8 A C.T., 12/6; Phillips 270-270, 120 m.a., same LT's, 6/6; Speaker Transformers, 2/6.

UTILITY 8/6 Microdisc Dials, 3/11; Radiophone, 0.00016 Shortwave Condensers, 3/6; Series gap twin, 3/9. Shortwave HF Chokes 5-100 metres, 9d.

465 KC Litz Wound I.F.'s, 3/11; Two-speed slow-motion knobs, 1/-; Telsen Acc Transformers, 1/11; Telsen Screened S.W. H.F.C., 1/-; Iron Core H.F. chokes, 1/-.

ELECTROLYTICS. Huge purchase 500 v. Aluminium Can, 4 mf., 1/6; 3 mf., 1/11; 8+5 mf., 2/6; Block type, 500 v. peak, 4+4 mf., 1/6; 8+8+4 mf., 3/-; 50 mf. 50 v., 1/3; 25 mf. 25 v., 1/-; Tubular Condensers, 1,500 v. T., all sizes to 0.1 mf., 6d.; 0.2 to 0.5 mf., 8d.

FAMOUS CONTINENTAL A.C. Valves, 4/6; Battery types from 2/3; American Duotron, etc., all types, 3/6; all types of RCA licensed first grade tubes, metal and glass, in stock from 5/6.

BRITISH RADIOPHONE .0005 straight or superhet 3-gang fully screened condensers with trimmers, 4/11; Utility Midget 2-gang ditto, 3/11; S.I. Dial to suit above, 2/11; Utility 2-gang Uniknob .0005 with Dial, 3/11.

PUSHBACK Wire, 6 yds., 6d.; heavy, 9d.; Resin-cored Solder, 6t., 6d.; Soldered Flex, single, 6d. yd.; twin 9d. yd. Assorted Solder Tags, 6d. packet.

SMOOTHING CHOKES, 20 hr., 120 m.a., 3/11; 200 m.a., swinging chokes, 8/6; Centralab Pots, all sizes, 1/6; switched, 2/-; 20,000 ohm Pots, 1/-; Tubular glass fuses, 2d. Milliammeters, 25 m.a. upwards, 5/9; super, 6/9.

SPECIAL OFFERS. Class B Kit, worth 30/-, comprising Driver Transformer, Valve and Holder, 5/-; Dozen wire-ended assorted resistors, 1/6 Order 5/- post free. Get our Bargain Catalogue, 1/4d. post free. All enquiries and requests for Catalogue must send 1d. stamp.

BIRMINGHAM RADIOMART (G5NI)
44, HOLLOWAY HEAD,
BIRMINGHAM TELE. : MID. 3254

★ Generosity is always a good thing; but where the design of transformers is concerned it is an absolute necessity. Leading designers of high fidelity equipment specify transformers and chokes by

W. BRYAN SAVAGE LTD.

Westmoreland Road, London, N.W.9 Telephone: Colindale 7131

FOR P.A. AT ITS BEST

GRAMPIAN

GRAMPIAN REPRODUCERS LTD.
Kew Gardens, Surrey

PATENT AND TRADE MARK AGENTS

GEE and Co. (H. T. P. Gee, Mem. R.S.G.B., A.M.I.R.E., Estab. 1905), 51-52, Chancery Lane, London, W.C.2 (2-doors from Government Patent Office). Holborn 4537 (2 lines). Handbook free. [0001]

PATENTS

"PRACTICAL Hints on Patents," free on application. —The Imperial Patent Service, First Avenue House, High Holborn, W.C.1. Preliminary consultation free. [0481]

TUITION

RADIO Training—Marine, aircraft, broadcast; prospectus free.—Hull Municipal Technical College. [0523]

SITUATIONS VACANT

RADIO Service Engineer Required.—Write, stating age and experience, to Escott Bros., Ltd., Maybank Rd., London, E.18. [4439]

WIRELESS Operators and Engineers Urgently Required.—Train at Britain's leading colleges; fee after appointment; boarders; prospectus free.—The Wireless College, Colwyn Bay, or The Wireless College, Calmore, Southampton. [0541]

VACANCIES Exist for Men Holding the Licence to Operate Radio Equipment in Aircraft, and with experience in servicing such apparatus; superannuation fund, good prospects.—Apply, for full particulars, to Box 1902, c/o The Wireless World. [4438]

SITUATION WANTED

ENGINEER, 23, 7 years fidelity design, construction, servicing, recording P.A., requires responsible position London.—35, Carysfort Pd., N.16. [4441]

INDEX TO ADVERTISEMENTS.

All-Power Transformers, Ltd.	PAGE
Automatic Coil Winder Co., Ltd.	Front Cover
Baker's Selhurst Radio	
Belling-Lee, Ltd.	3
Birmingham Radiomart G5NI	6
British Institute of Engineering Technology	1
British Insulated Cables, Ltd.	Inside Back Cover
British Mechanical Productions, Ltd.	5
British Pix	
British Rola Co., Ltd.	Edit. 503
British Sound Reproducers, Ltd.	
British Thomson-Houston Co., Ltd.	
Bulgin, A. S. & Co., Ltd.	
C.A.V.	Front Cover
Colvern, Ltd.	
Cosser, A. C. Ltd.	
"Drydex"	
Dutilleul Condenser Co. (1928), Ltd.	Inside Front Cover
Electradix Radios	4
Exide, Ltd.	
Fluxite	
Forbat, Eugene J.	
Galpin's Electrical Stores	
Gardners Radio, Ltd.	
Goodmans, Ltd.	
Gramplan Reproducers, Ltd.	6
Hartley Turner Radio, Ltd.	1
Haynes Radio	Front Cover
Henley's W.T. Cable & Wireless Works	Inside Back Cover
I.L.M.V.	
Institute of Wireless Technology	6
Lectro-Linx, Ltd.	
McCarthy Radio, Ltd.	Edit. 499
Midwest Radio, Ltd.	5
M.R. Supplies	
New Times Sales Co.	Inside Back Cover
Parmeko, Ltd.	
Peto-Scott, Ltd.	2, 5
Player's Cigarettes	Inside Back Cover
Polytechnic Institute	4
Postlethwaite Bros.	
Premier Supply Stores	4
Record Radio, Ltd.	1
Savage W. Bryan	6
Scott Sessions, Ltd.	
Shaftesbury Supplies	6
Sound Sales, Ltd.	Front Cover
Stern, S.	
Tannoy Products	4
Telegraph Condenser Co., Ltd.	Edit. 501
Universal Radio Distributors, Ltd.	
Ward, C. F.	
Westinghouse Brake & Signal Co.	
Wright & Weaire, Ltd.	6

Selection from SUMMER BARGAIN LIST —now available!

PLESSEY visual shadow tuning indicators, adaptable to any set, all new and unused, 2/6.

GARRARD, RC4 Automatic Record Changers for A.C. mains. Plays and changes eight 10in. or eight 12in. records. Complete with all fittings, new, boxed, £5 17s. 6d.

FERRANTI Pen. Speaker Trans. 2/6.

MAINS TRANSFORMERS, 350/0/350 4v. 2 1/2a. 4v. 5a, 100 m/a. 8/6. Ditto, 130 m/a. 9/6.

SHAFTESBURY set builders' trans., in polished case with input terminals, solder tags, with engraved terminal board, 1st class trans., 15/-.

STEP DOWN TRANSFORMERS, 200/250v. to 10v. 7 1/2a. Ideal mode chargers, cines, etc., 1/6 6. Also 200/250v. to 7.11.15v. at 3a. 9/6.

ROLA F.R. 6 8in. P.M. Speaker, with multi-ratio trans., 1/6 6.

ROLA F.10 40in. P.M. Speaker, with M/R trans., 1/9 6.

ROLA P.A. Speakers, energised, and P.M. types available. American type Dynamic speakers, suit battery sets, Pin. cone on chassis with leads. 5.11. 15/- Comocord Pickup with V.C. and swivel head, 7/11. Pickup heads only, 4/6.

PLESSEY, B type, 3-gang straight condensers, screened, 2/11.

SESSIONS Electric Table Clocks, assorted colours, few only, 14/6. Wal Clocks, 16/6.

ELECTROLYTIC CONDENSERS, by leading British maker. Cardboard cased, 4 M.F. 500, 1/8. 8 M.F., 500, 1/9. 8x8, 500, 3/8. Metal-cased, 8 M.F., 500v., 2/-. Many other types stocked.

Famous SHAFTESBURY Carbon type microphone now available in neat bakelite case, nothing better on the market, offered complete with trans., 42/- . Tele. table and floor stands at competitive prices.

Junior MORSE TAPPERS, with Morse code engraved on bakelite base 2/9. American Air Force tappers, brand new, silver contacts, with blinkers, few only left, 7/6.

7-Watt inkie or grammo. AMPLIFIERS, circuit incorporates 2 pentodes in push-pull, fitted with tone and V.C. complete with 4 valves and guaranteed, £5 10s. Quantity of Crooners, outfits and quality amplifiers, complete with turntable, available at clearance prices.

Actual importers Grade A. AMERICAN VALVES, prices from 2/6.

Just arrived! New model WESTON MIDGET RECEIVERS, in most attractive bakelite cabinets, available in cream, or cream and black, a set with a remarkable punch and purity of tone. Buy from the Importers, our price only £4 17s. 6d. Standard wood case midget, 1937 model. 5-valve AC/DC. 72/6.

SHAFTESBURY SCOOP!

Amazing offer of 12v. G.E.C. Car Radios. All brand new in sealed makers' boxes. 7-stage super-het. Remarkable performance on long medium. 200-2,000 metres. 3-watt output. Provision for addit. speaker. delayed A.V.C. Attractive remote control panel fitted with key, preventing unauthorised operation. Costs nothing to run! Extremely simple fitting to any car. Complete suppression equipment provided.

LIST PRICE 19 gns. —OUR OFFER £9.17.6

Quantity limited, for your benefit order now

● We have a big quantity of technical radio merchandise for disposal send enquiries to us for immediate attention. Every sale guaranteed by our "S.S." terms. Full satisfaction or money refunded 7 days. 1/6 secure latest bargain lists

SHAFTESBURY SUPPLIES

224, SHAFTESBURY AVENUE, W.C.2

Tem. Bar 4175

THE INSTITUTE OF WIRELESS TECHNOLOGY (Incorporated)
4, Vernon Place, Southampton Row, London, W.C.1

THE A.M.I.W.T. EXAMINATION

Candidates for the November A.M.I.W.T. Examination must lodge their applications, on Form E, NOT LATER THAN THE 30th DAY OF JUNE, 1937.

The New Syllabus giving particulars of the valuable privileges arising from Professional Membership and Student Membership may be obtained from the Secretary.

WEARITE CONDENSER ANALYSER

A new Instrument of the latest design for carrying out rapid complete tests of radio condensers. Electrolytic, Mica, Paper, Trimmer and Tuning condensers may now be tested for Capacity, Insulation, Power Factor, Open Short and

Intermittence. This unit is portable entirely A.C. mains operated.

PRICE - £9.9.0

● Full particulars upon request to:
WRIGHT & WEARE LTD.,
740, High Road, Tottenham, London, N.17

They're pleasing more smokers all the time



Increasing sales show that more and more smokers are saying "Player's Please"—convincing proof that the great majority realise and appreciate the truth of the Player maxim "IT'S THE TOBACCO THAT COUNTS"

PLAYER'S MILD NAVY CUT CIGARETTES are not so well known as the popular Medium Navy Cut Cigarettes, but if your taste is for a mild and very smooth smoke, ask for Player's "MILD." An old established brand, the prices are the same as for "Medium." 10-6d, 20-11d.

PLAIN OR CORK TIPPED



PLAYER'S 'MEDIUM' NAVY CUT CIGARETTES

NCC-366A

B.I. RESINKOR SOLDER AND CORALINE PASTE



B.I. Resinkor Solder, which carries its own flux, is supplied in 9-in. sticks, in coils of 1 to 20 S.W.G. weighing up to 28 lbs., and all but the largest sizes can also be supplied on reels. For use with ordinary solder, B.I. Coraline Soldering Paste is excellent. It gives off no spray or fumes, does not run or dry, and is very economical, as only a trace is required. Sold in tins from 1 oz. to 7 lbs.

BRITISH INSULATED CABLES LTD.

Cable Makers and Electrical Engineers

PRESCOT, LANCS.

Telephone No.: PRESCOT 6571

London Office: SURREY HOUSE, EMBANKMENT, W.C.2

Telephone No.: Temple Bar 7722.

RADIO RECEIVER MEASUREMENTS

By Roy M. Barnard, B.Sc., A.M.I.R.E. (1934)

Although primarily designed for the benefit of the radio service engineer, this concise handbook is also of practical value to the amateur experimenter.

It describes the methods of measuring receiver performance and provides provisional standards as a basis for judging performance. Measurements of sensitivity, selectivity and fidelity are explained at length and the interpretation in estimating receiver performance is carefully set out.

Details are given of methods of receiver testing with full descriptions of commercial signal generators and their application to the adjustment of superheterodynes and "straight" receivers.

Complete with fifty-three illustrations and diagrams, summaries of method, four appendices and a general index.

PRICE 4/6 net

By post 4/9

From all booksellers or direct from the Publishers

ILIFFE & SONS LTD.

DORSET HOUSE, STAMFORD STREET, LONDON, S.E.1

W.W.19

BARGAIN! 6 valve ALL-WAVE

ALL-MAINS SUPERHET CHASSIS
with Valves and Field-Energised Speaker

LIST PRICE £10:17:6

OUR PRICE
£6:19:6

or yours for

7/6
DOWN

and 18 monthly payments of 8/6



Overall size:
7" high: 10 1/2"
wide: 6" deep

WAVE-RANGE
18.5-50
190-560
930-2,100
Metres

TESTED AND GUARANTEED
WONDERFUL WORLD RECEPTION

America, Australia, Africa, stations galore from all parts of the Globe—with wonderful purity of tone, splendid volume, outstanding sensitivity and selectivity. This amazingly efficient All-Wave Receiver is ready for instant use. Programmes simply roll in at the touch of a knob. Note these outstanding features:

- Illuminated station named wide vision dial.
- Latest 6-valve All-wave superhet circuit, comprising, Variable Mu Frequency Changer, Variable Mu I.F. Amplifier, Double Diode Triode, Output Pentode, half-wave rectifier and Clarostat mains stabiliser valves.
- Separate tone and volume controls.
- Automatic volume control.
- Simple to tune.
- Complete with 6 valves, Field-energised moving-coil speaker, all knobs, leads and plug.
- Ready to play.
- For A.C. or D.C. Mains 100-260 volts.

Send for big list of Bargain Sets by Atlas, British Radiophone, B.T.S., K.B., Lissen, McMichael, Pilot, Peto-Scott and Zonophone.

NEW TIMES SALES Co., 56 (W.W.2) Ludgate Hill, London, E.C.4. Est. 1924

100% RELIABLE - IF IT'S ELECTRIC SOLDERING

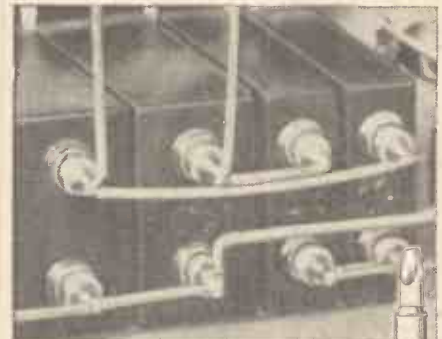

Every contact a neat, simple and lasting job—that's what Solon electric soldering gives you. Maintains constant heat where you want it—element clamped within the bit concentrates all heat at point.

8/6
DOMESTIC
MODEL
65 watts

Sold with Instruction Book, Resin-cored Solder, 6 ft. Flex and Standard Lamp Adaptor.



W. T. Henley's Telegraph Works Co. Ltd., (Dept. Y4/78/E.), Holborn Viaduct, London, E.C.1.

Mention of "The Wireless World," when writing to advertisers, will ensure prompt attention.

SECOND EDITION

—THOROUGHLY REVISED

WIRELESS SERVICING MANUALBy **W. T. COCKING**

(of "The Wireless World")

The first complete book of reference of its kind. A reliable practical guide for amateur and professional.

The demand for this book was so great that the first edition was sold out in the short space of a very few months. A second edition containing additional material is now on sale. The "Wireless Servicing Manual" deals fully with Testing Apparatus and explains the methods of locating and curing faults in receiving equipment.

Ganging, Automatic Volume Control, Instability, Distortion, Mains Hum, Whistles and Local Interference are all separately treated.

The new edition contains much additional information on short-wave receivers, and on methods of operating extension loud speakers, the reference material including base-connections for British, Continental and American Valves and the various colour codes for components has been extended and brought up to date.

BOUND IN CLOTH BOARDS

SIZE 7½ ins. × 5 ins.

231 PAGES

PRICE 5/- net. By post 5/4

Issued in conjunction with "THE WIRELESS WORLD" and Published by the Proprietors:—

ILIFFE & SONS LTD., DORSET HOUSE, STAMFORD STREET, LONDON, S.E.1

**FOUNDATIONS
of WIRELESS**

*A Book of
First Principles
for the
Wireless
Enthusiast*

PRICE 4/6 NET

By Post 4/11

Issued in conjunction with
"THE WIRELESS WORLD"
and published by the Proprietors—

By **A. L. M. SOWERBY, M.Sc.**

An Elementary Text Book on Wireless Receivers

"Foundations of Wireless," based on a series of articles which appeared in "The Wireless World," covers the whole field of wireless from the simplest electrical phenomena to the construction of a modern set, and all the vital points in receiver design are treated in full detail. Chapters are devoted to direct and alternating currents; typical circuits; the properties of inductance and capacity; the nature of high frequency currents; the tuned circuit; and amplification by the valve.

Eleven of the eighteen chapters of the book deal with the discussion of receivers, in which the whole process of design is reviewed stage by stage to the finished article.

Special attention is paid to the important subject of tuned circuits and band-pass filters, on the correct design of which the performance of every type of set ultimately depends. Moreover, the process of detection so often imperfectly understood, is clearly explained.

The Wireless World

4^D

THE PRACTICAL RADIO & TELEVISION JOURNAL

Friday, May 28th, 1937.

See the new McCarthy models first!

The new range of McCarthy all-wave receivers include many improved features, giving still better performance. Prices include Marconi Royalties.

There are also several exceptionally interesting new models of an advanced type. Write for the McCarthy Catalogue, containing illustrations, full specifications, circuit diagrams, also details of loud speakers, cabinets, etc., to:-



MCCARTHY
RADIO LTD.

44a, Westbourne Grove, London, W.2
Telephone: Bayswater 3201/2.

SEE ADVERTISEMENT INSIDE →

CERAMIC DIELECTRIC CONDENSERS

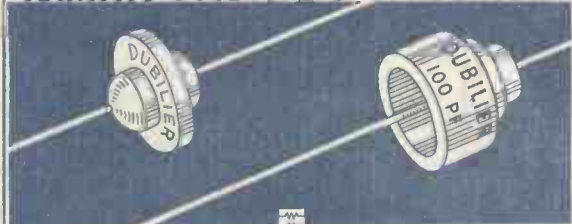

These entirely British made disc and cup type ceramic condensers cover ranges of capacity between 2 and 100 μ F. A tubular form completes the range to 1,200 μ F. All types are completely non-inductive.

DUBILIER

DUBILIER CONDENSER CO. (1925) Ltd.,
DUCON WORKS, VICTORIA ROAD, NORTH ACTON, LONDON, W.3.
C. R. Casson II

Everything for

QUALITY RECEPTION



Everything for the

TELEVISION CONSTRUCTOR

Duophase amplifier 6-watt, Duophase amplifier 6-watt for P.M. speaker, Duophase amplifier 14-watt, Duophase amplifier 14-watt (constructor's model), Duophone amplifier circuits, Duophase intervalve coupling, gramophone amplifier 6-watt, gramophone amplifier 14-watt, 1-H.F. tuner unit, 2-H.F. tuner unit, all-wave tuner unit, shortwave converter, table model receivers, radiogramophones, schools receivers, baffle boards, loud speakers, volume controls, mains transformers, smoothing and filter chokes, output transformers.

Originators of the Quality Receiver and Quality Radiogramophones.

Demonstration night
every Friday,
7.30-9.30 p.m.

Time base transformers, time base units, H.T. transformers up to 6,000 volts, heater transformers, smoothing and voltage regulating equipment, high voltage rectifiers, cathode ray tubes and holders with protecting front screen, converter units for speech reception, complete apparatus for vision receiver construction, chassis and special baseplates.

The most attractive development ever presented to the radio enthusiast.

Have you the Haynes Quality Booklet? 1936-37 Edition. Free on request. Howard 1171.

HAYNES RADIO LIMITED, QUEENSWAY, ENFIELD, MIDDLESEX.

6TH8

(CONVERSION CONDUCTANCE 1000 MICRO-MHOS)

A 6.3 v. Triode-hexode with octal base, has been evolved by Tungram for those wishing to take advantage of standardisation to one type of base, and one type of voltage. It is for use in conjunction with the "g" range of valves, which all have octal bases.

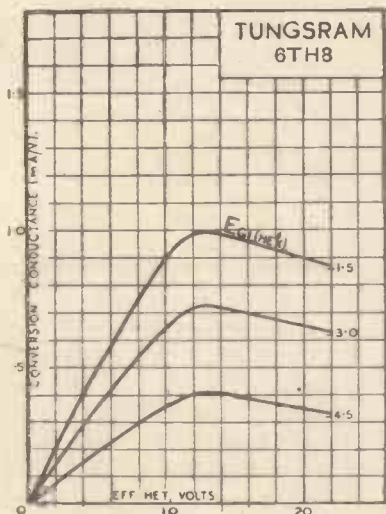

Price 15/-

TUNGSRAM

MANUFACTURED IN
TOTTENHAM, LONDON

Barium VALVES

THE VALVE WITH THE NAME BEHIND IT!

TUNGSRAM ELECTRIC LAMP WORKS (GREAT BRITAIN) LTD., 82 THEOBALDS ROAD, LONDON W.C.1. PHONE HOL. 3563

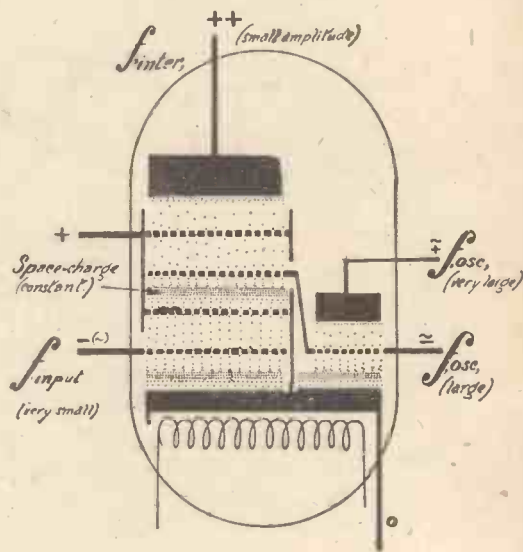

"W.W." HEARING AID

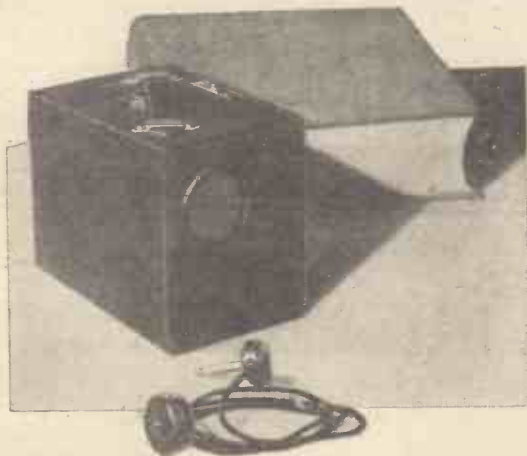

THE Peto-Scott 1937 version of the popular "Wireless World" Hearing Aid (described in issue dated April 17th, 1936). Employs two stages of valve amplification. Volume control. Sensitive high-fidelity microphone. Overall size only 6" x 5" x 4". Covered black morocco grain leather. Featherweight disc ear-piece. Guaranteed 12 months.

Model W.W.8. 6 Gns. With Tone Control 8 Gns.

A Purchaser writes: "I wish to express my appreciation of the great efficiency of the Peto-Scott Hearing Aid. It has reopened to me the avenues of intercourse and entertainment which have been closed for 20 years or more, and has immensely reduced the disability of deafness in family, social and business contacts." **Mr. J. M. (Shrewsbury)**

Send for fully descriptive Brochure of our full range of Hearing Aid instruments.

PETO-SCOTT CO. LTD.

62, High Holborn, London, W.C.1. 77, City Road, London, E.C.1.

Holborn 3248.

Clissold 9875-6-7.

Est. 1919

FREE ART CATALOGUE DEMONSTRATIONS

40 pages, fully illustrated, giving particulars of Midwest 11, 14, 16, and 18 valve models. at our showrooms Mondays to Saturdays from 9 a.m. to 8 p.m. (except Tuesdays, 9 a.m. to 6 p.m.).

1937 MIDWEST

Magnificent alike in its conception, design and performance, this the latest Midwest Model X-18 High Fidelity Receiver brings the world to your fire-side. With its 6 TUNING RANGES it gets "Everything on the Air." Its distinctive features in circuit design are not just "talking points," as a comparison will prove, but basic advantages which will assuredly appeal to "Wireless World" readers and all who appreciate Studio or Concert Hall quality of performance in the home.

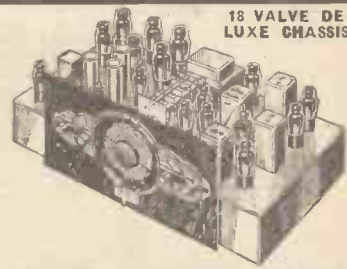

MIDWEST RADIO Ltd.

Showrooms and Factory:
16, Old Town, Clapham, London, S.W.4.
Phone: MA0aulay 5005.

THE ONLY ALL-WAVE RECEIVER COVERING 4½ to 2,400 METRES
Available in Chassis form complete with matched valves and 12" speaker or in Console Cabinet.

RADIO RECEIVER MEASUREMENTS

By Roy M. Barnard, B.Sc., A.M.I.R.E. (1934)

Complete with fifty-three illustrations and diagrams, summaries of method, four appendices and a general index.

PRICE 4/6 net
By post 4/9

From all booksellers or direct from the Publisher.

Of practical value to the radio service engineer and the amateur experimenter. Measurements of sensitivity, selectivity and fidelity are explained at length and the interpretation in estimating receiver performance is carefully set out.

Details are given of methods of receiver testing with full descriptions of commercial signal generators and their application to the adjustment of superheterodynes and "straight" receivers.

ILIFFE & SONS LTD., DORSET HOUSE, STAMFORD STREET, LONDON, S.E.1

W.W.19.

The Wireless World

THE PRACTICAL RADIO JOURNAL
27th Year of Publication

No. 926.

FRIDAY, MAY 28TH, 1937.

VOL. XL. No. 22.

Proprietors : ILIFFE & SONS LTD.

Editor :
HUGH S. POCOCK.

Editorial,
Advertising and Publishing Offices :
DORSET HOUSE, STAMFORD STREET,
LONDON, S.E.1.

Telephone: Waterloo 3333 (50 lines).
Telegrams: "Ethaworld, Sedist, London."

COVENTRY: Hertford Street.

Telegrams: "Autocar, Coventry." Telephone: 5210 Coventry.

BIRMINGHAM:

Guildhall Buildings, Navigation Street, 2.
Telegrams: Autopress, Birmingham." Telephone: 2972 Midland (4 lines).

MANCHESTER: 260, Deansgate, 3.

Telegrams: "Iliffe, Manchester." Telephone: Blackfriars 4412 (4 lines).

GLASGOW: 26b, Renfield Street, C.2.

Telegrams: "Iliffe, Glasgow." Telephone: Central 4857.

PUBLISHED WEEKLY. ENTERED AS SECOND CLASS MATTER AT NEW YORK, N.Y.

Subscription Rates :

Home, £1 1s. 8d. ; Canada, £1 1s. 8d. ; other countries, £1 3s. 10d. per annum.

As many of the circuits and apparatus described in these pages are covered by patents, readers are advised, before making use of them, to satisfy themselves that they would not be infringing patents.

CONTENTS

	Page
Editorial Comment	505
Television Aerials	506
Broadcasting in Spain	508
The Hartley Circuit	510
On the Short Waves	512
Current Topics	513
The Television Receiver	514
Random Radiations	517
Listeners' Guide for the Week	518
Ultra Short Wave Broadcasting	520
The Television Programmes	521
Broadcast Brevities	522
Larger Television Screens	523
The "Mag-Nickel" Fuse	523
Letters to the Editor	524
Recent Inventions.. ..	526

EDITORIAL COMMENT

Ultra Short Wave Broadcasting

A Growing Demand

AN article in this issue deals with some new aspects of the question of ultra short wave broadcasting. We have repeatedly urged the attractiveness of an ultra short wave broadcasting service on the grounds principally of enhanced quality and comparative immunity from interference. Everyone who listens to the sound accompaniment to television is impressed with the high quality resulting from transmissions on a wide frequency band.

The B.B.C. are not achieving popularity with the bulk of the listening public when they are obliged to develop the television by utilising funds which it is felt would otherwise be available to improve the ordinary programme service.

Our contributor points out that to start an ultra short wave experimental service would be regarded as a development associated with television. This would do much to counteract criticisms regarding television expenditure and the service would appeal to all lovers of quality reception and to a vast army of listeners who take some interest in the experimental side. In addition, we believe that it would stimulate the sale of new equipment, to the benefit of the radio industry.

Just why the B.B.C. are marking time instead of launching ultra short wave transmissions is not clear. It seems certain that it is not because of any technical difficulties, and there are unfortunate rumours circulating that the B.B.C. are being influenced by pressure from outside sources which we feel are not looking at the matter

broadly or with the interests of the mass of the listening public in mind.

Under present conditions of reception on the normal broadcasting bands, there seems to be little further scope for improvement in quality of reproduction, but ultra short wave transmissions would overcome these difficulties and open up great possibilities for the manufacturer to develop sets capable of providing reproduction of outstanding quality.

The Straight Set

Our Invitation to Readers

IT will be remembered that in our Leader in the issue of May 14th we raised the question of whether the time had come to endeavour to follow in Europe recommendations which had been put forward in the States that the superheterodyne receiver intermediate frequency should be standardised, and the authorities asked to avoid allotting this and adjacent frequencies to transmitting stations, with the object of reducing, as far as possible, the present whistles associated with superheterodyne reception.

We invited readers to express their views on the matter, which we implied could be reduced to a discussion as to whether the superheterodyne should be considered the universal standard receiver or whether the straight set had to-day special claims for reinstatement, particularly in view of recent developments in receiver design in general.

We have already had correspondence sent us on this subject and publish in this issue a letter which contains a strong claim for the reinstatement of the straight set. Further views would be welcomed.

Television

DESCRIPTION OF AND DESIGN DATA FOR SOME SUITABLE TYPES

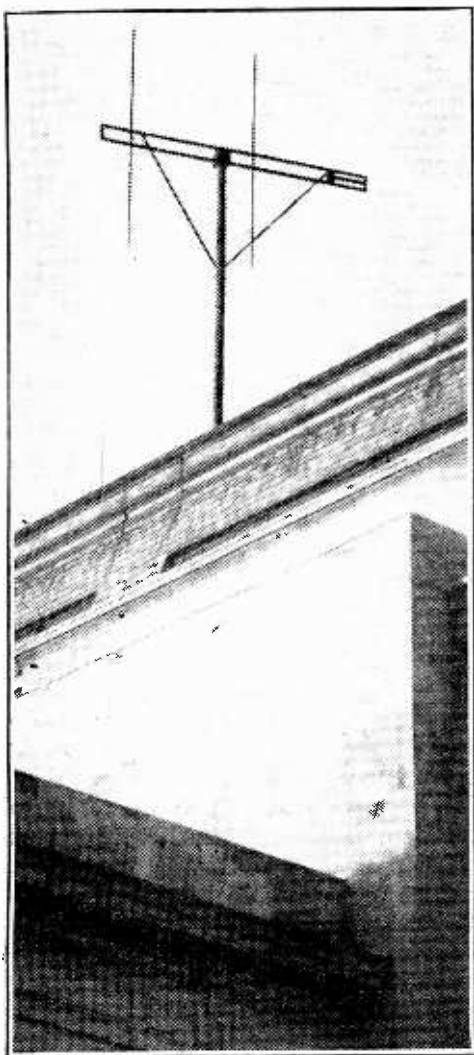

Di-pole aerial with reflector for television reception mounted on the roof of the Science Museum, South Kensington.

In Fig. 1 (a) is shown a plain di-pole aerial each half of which is a quarter-wavelength long, and to the centre is joined a low-impedance feeder. The arrangement depicted at (b) Fig. 1 is a di-pole also, but with the addition of a reflector mounted behind the aerial. The spacing of the reflector is a quarter-wavelength.

Fig. 1 (c) shows another form of half-wave aerial, differing only from the di-pole of (a) in that the feeder is joined to one end of the aerial. The hair-pin arrangement at the lower end of the aerial is part of the feeder system, and its function will be explained later.

These three aerial systems shown in semi-perspective in Fig. 1, which is a fairly close approximation to the forms they take

Owing to the manner in which the aerials at the transmitting station are arranged the receiving aerial must be mounted vertically, as shown in the drawings. Signals could be obtained with the aerials rotated through 90 degrees and lying horizontal, but reception would not be so good and this method of erection would be satisfactory only when the transmitting aerial or aerials were sited in the same plane.

The actual length of the aerial A for all the types shown is not exactly equal to half a wavelength, but is slightly less, and its length is calculated from the formula:

$$A \text{ (feet)} = \frac{492}{F(\text{Mc/s})} \times 0.94$$

which for the vision frequency of television, i.e., 45 Mc/s, gives a length of 10.27 feet.

For frequencies lower than about 30 Mc/s (ten metres) the length approaches nearer to the actual half-wave dimension. Thus for frequencies between 28 and 3 Mc/s the factor 0.94 becomes 0.95, and below 3 Mc/s 0.96.

Each wire in the matching transformer A1 in Fig. 2 (c) should be exactly half the length of the aerial A.

Where a reflector is used its length is generally made slightly greater than the aerial, and the

NEARLY all the special aerials now in use for television reception are what are known as di-poles, or some variation of this arrangement, the total length of the aerial being approximately half the length of the wave used for transmission.

A resonant aerial of this type does not require an earth connection as it resonates by virtue of its own dimensions to the required frequency when suspended in space. Thus the system has to be joined to the receiving equipment by a cable which, while conveying energy from one to the other, does not form an integral part of the aerial, and if the design of this part of the system is correct the feeder may be run round corners, fixed to a wall, and taken through several rooms without introducing any appreciable loss.

As a di-pole aerial for television reception need not exceed about ten feet in length it can be erected in a confined space, though the aerial should be mounted as high as possible, and for preference well above all surrounding buildings, as only by this means can a good signal with the minimum of local interference be obtained.

Of the many varieties of di-pole aerials used in ultra-short-wave work, the three types shown in Fig. 1 are possibly the best suited for television reception. They are all reasonably simple to design and construct; they have the advantage of taking up little space, and they can be erected on a single pole.

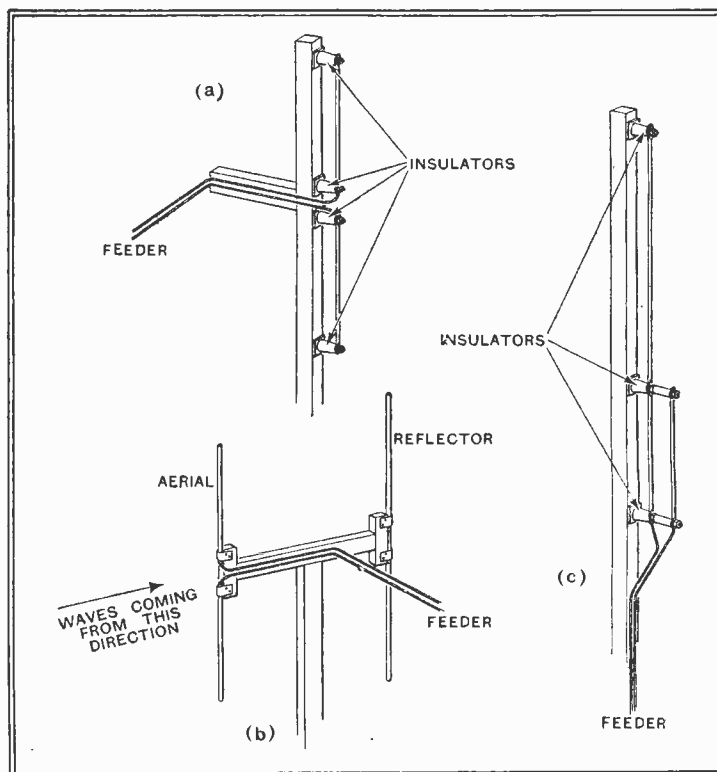

in practice, are repeated in Fig. 2, but shown as they are generally depicted in theoretical drawings.

The plain di-poles of Fig. 1 (a) and (c) are non-directional, and both respond equally well to signals arriving from all directions. When a reflector is added, however, as shown at (b) Fig. 1, the aerial takes on directional properties and the reception is enhanced when it is mounted with the reflector and the aerial in line with the transmitting station and the reflector is *behind* the aerial.

Fig. 1.—Three popular di-pole aerial systems. In (a) a low-impedance feeder is joined to the centre of the aerial. Sometimes a reflector is used when the aerial takes the form shown in (b). The feeder can be joined to one end by adding an impedance matching section as shown in (c).

formula for calculating the aerial length A should be multiplied by 0.97 instead of by 0.94. For a television aerial of 10.27 feet the reflector should be 10.6 feet long, and mounted 5.47 feet behind

Aerials

By
H. B. DENT

IT is generally agreed that a di-pole aerial is the most satisfactory for the reception of television as it is simple to erect and if correctly designed gives a good signal with comparative freedom from interference. This type of aerial is not difficult to design, for, as explained in this article, all the essential data can be obtained from a few simple formulae.

the aerial. The spacing of the reflector is found by dividing 246 by the frequency in Mc/s.

As already explained, the function of a feeder is to convey energy from the aerial to the receiver, which it should do with the minimum of loss. Space does not permit of a detailed description of every aspect of aerial design, nor of the conditions that make for best operation, so it must suffice to say that for satisfactory operation the feeder must be correctly matched to the aerial and also to the receiver circuit. Feeders have a natural or characteristic impedance depending on the diameter of the wires and also their spacing, other things being equal.

If the impedance of a di-pole aerial were the same at all parts the feeder could be joined in at any convenient place, but as it varies from about 2,500

twisted wires, cab-tyre cable, and the special low-impedance feeders, or transmission lines, as they are sometimes called, are being taken into account, so that discussion on matching problems will be restricted to this kind. Ordinary electric lighting twisted flex is not recommended, since it is not sufficiently weather-proof for use out of doors.

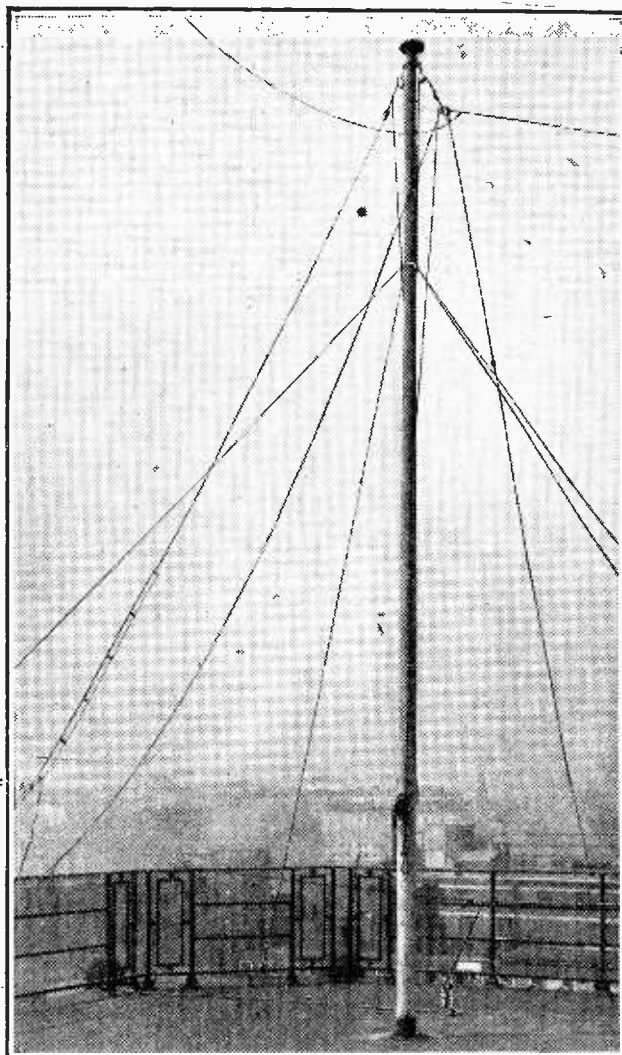

The television aerial with matching section for a low-impedance feeder can be seen to the left of other aerial systems erected on the roof of *The Wireless World* laboratory.

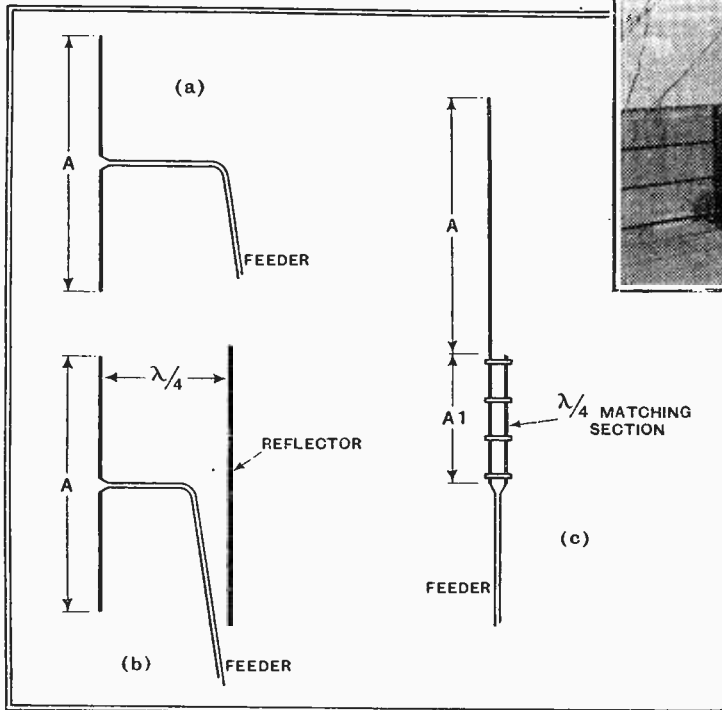

Fig. 2.—The same three aerials as shown in Fig. 1, but here depicted in theoretical form.

ohms at the ends to approximately 72 ohms at the centre the position of attachment of the feeder must be carefully chosen to achieve the correct matching conditions. In this article only feeders of low impedance, such as

Quarter-wave matching section at the foot of a half-wave di-pole aerial designed for the reception of television.

The other styles, however, are quite suitable for use on television frequencies.

For ordinary reception purposes the impedance of cabtyre cable may be regarded as being reasonably well matched to the centre of a di-pole aerial, and it can be joined to the two halves, with possibly a short "fanning" for a length of about 1ft., and by spacing the two sections of the aerial 8 or 9in. apart at the centre as shown in Fig. 3. With the 72-ohm feeder this "fanning" is not necessary.

Some importance attaches to the way in which the feeder is run from the aerial. It must not run parallel to it, but be taken away at right angles from the centre for a distance equal to about a quarter wavelength, or 5ft. in the case of a tele-

vision aerial, before the vertical turn is made.

The possible methods of arranging this in a practical case are shown in Fig. 1 (a) and (b)

In view of this it might be more convenient to join the feeder to the lower end of the aerial provided means could be found to satisfactorily match a 72-ohm line to the 2,500-ohm resistance prevailing at this point. In other branches of radio impedance matching problems often arise, one such being in the output circuit of a receiver. It is often necessary to match, say, a 2-ohm loud speaker to a valve requiring a load impedance of some thousands of ohms and a solution is found in the use of a step-down ratio transformer.

The same principle can be applied to an aerial and the quarter-wave matching section Ar shown at the lower end of the aerial in Fig. 2 (c) is in effect an impedance matching transformer, and it consists of two wires run parallel, but well insulated from each other. Provided they are each electrically a quarter-wavelength long the transformer will resonate at the required frequency even though the wire diameter and spacing be varied over quite a wide range. Yet the characteristics of no two transformers with different wire

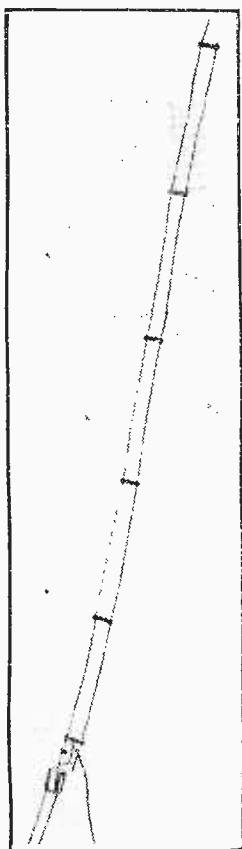

Television Aerials—

size and spacing will be the same. The characteristic impedance will vary with any change in either of these two dimensions.

If, for example, No. 14 SWG wire is used, and the spacing is 4in. the characteristic impedance will be approximately

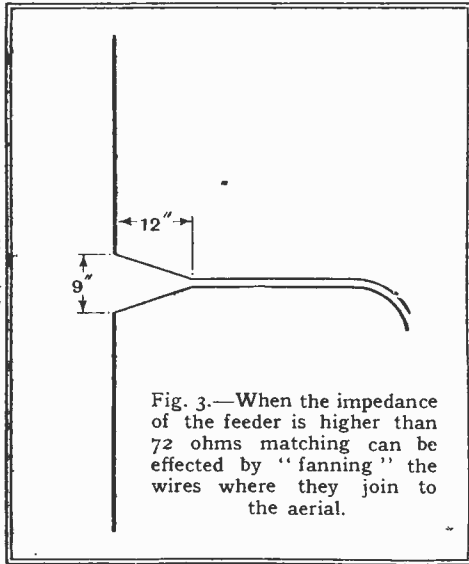

Fig. 3.—When the impedance of the feeder is higher than 72 ohms matching can be effected by "fanning" the wires where they join to the aerial.

550 ohms, but if the spacing is reduced to 2in., the wire size remaining the same, the impedance value falls to 470 ohms.

With a resonant line, or transformer, of this type the effective impedance at one end can be made to vary by changing the value of a resistance, or impedance, shunted across the other end. Take, for example, a transformer designed to have a characteristic surge impedance of 500 ohms, and RF at the optimum frequency is fed into one end. If the far end is shunted by a 500-ohm resistance the effective impedance at the input end will also be 500 ohms, or the same as the surge impedance of the transformer.

On changing the output end resistance to 1,000 ohms the impedance at the input end falls to 250 ohms. Thus a matching is effected between 1,000 ohms and 250 ohms without any appreciable loss in energy.

In all matching systems of this kind the

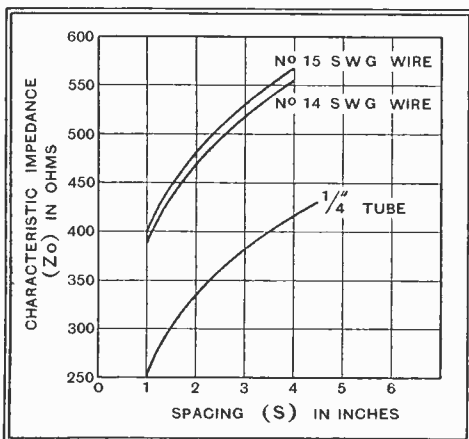

Fig. 4.—The characteristic impedance of quarter-wave matching transformers using wires or tube of the sizes given here and with different spacings between conductors can be obtained from these curves.

characteristic surge impedance of the quarter-wave matching section, A_1 , is the geometric mean of the two end impedances, and it is given by the formula:—

$$Z_t = \sqrt{Z_a \times Z_f}$$

when Z_t = surge impedance of matching transformer.

Z_a = impedance at the point of attachment to the aerial.

Z_f = surge impedance of feeder.

Taking our own particular case we can insert values for the aerial and for the feeder, thus

$$Z_t = \sqrt{2,500 \times 72} = 424 \text{ ohms.}$$

To correctly match the feeder in the case of Fig 2 (c) the matching section must, therefore, have a characteristic surge impedance of 424 ohms.

Since variation both in the wire size, and in the spacing, modify the impedance value some curves have been prepared for conductors of the most likely sizes to be used in the construction of these aerials. They are given in Fig. 4.

No. 14 SWG enamel wire is a satisfactory size for a slung or fully supported aerial while 1/4-in tube serves quite well for partially supported and self-supporting systems.

From the curves in Fig. 4 it will be found that using No. 14 SWG wire the spacing should be 1.4in., centre to centre, to give a characteristic impedance of 424 ohms. With 1/4-in. tube the spacing becomes 4 1/4 in.

In this brief treatment of the subject much relevant matter has had perforce to be omitted, but sufficient data is given to enable a perfectly satisfactory aerial for television reception, or for that matter for work on any of the ultra-short waves, to be designed.

In conclusion a few words might be said

regarding stay wires for supporting the mast or pole mounting the aerial. Since wires one half-wave long or any number of half waves in length, become resonant systems they will absorb energy, and so reduce the efficiency of the aerial. Thus, all long stay wires should be broken up by insulators so that no one piece is exactly equal to one or more half-waves.

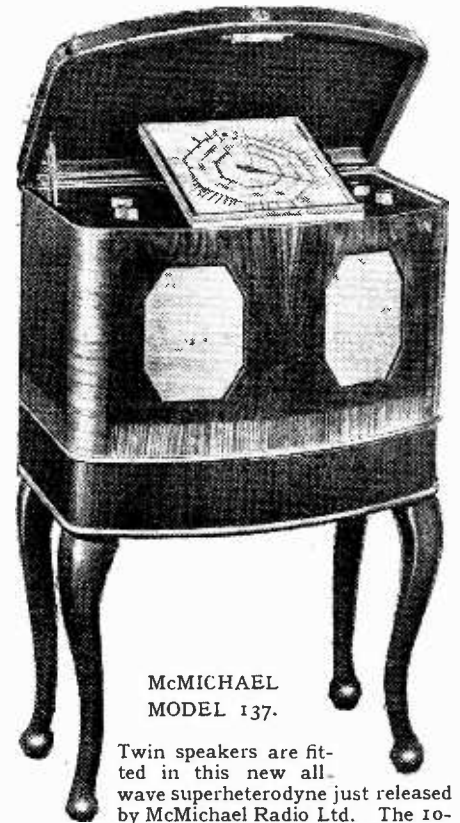

McMICHAEL MODEL 137.

Twin speakers are fitted in this new all-wave superheterodyne just released by McMichael Radio Ltd. The 10-inch square dial tilts forward as the lid is opened and has a glass cover with a specially prepared surface upon which the settings of short-wave stations can be marked.

Spanish Broadcasting

Transmissions in English from the Seat of Civil War

By IVOR MANLEY

EVER since Civil War broke out in the Peninsula many listeners have been regularly receiving the broadcasts of war news from the various Spanish Government and insurgent stations. Other listeners, however, have had little success in locating the stations, owing to the constant changes of wavelength made by some of them, and also through lack of knowledge of the times during which transmissions are made in a familiar language. The accompanying list of stations, which is as complete as circumstances will permit, should help to overcome these difficulties. Whenever news items are in English the times of transmission have been inserted, though they are liable to variations.

It will be found that many of the stations are very hard to receive, purely because they have no fixed working

hours, only transmitting when they think they have some news of topical importance. Others are hard to receive during the usual broadcast hours as their wavelengths coincide with some of the more powerful European stations; in other cases when one Spanish station starts transmitting an enemy station will start on the same wavelength, making reception impossible. This is done purposely so that the transmission will not be heard; such are the tactics of war in the ether.

The best time to listen is after 8 p.m., as by then nearly all the stations are working, though it is improbable that more than six stations will be heard on the medium-wave band before 11 p.m., as so many of them are drowned by the more powerful European transmissions. On the short-wave band several official stations have sprung up, besides a host of

amateurs who are difficult to identify, as they rarely give their proper call signs. Some of these short-wave stations, such as Barcelona ECNI, for instance, relay their transmissions simultaneously from the medium-wave band.

Distinguishing and verifying the various stations is not at times an easy matter, as they sometimes borrow the call signs from other stations, and especially from those stations belonging to the opposite party. By listening to the news bulletins one can soon find out for which side the station works, as they nearly always criticise the other party. All the Nationalist stations close down with the following announcement: "Viva Franco, Viva España" (Long live Franco, Long live Spain), this

is very often followed by patriotic German and Italian songs or marches, such as "Giovanezza." Reference to the "Frente Popular" is an indication that the station is controlled by the Government; their stations usually close down with the "Internationale."

The foregoing should be a help to the intending listener, but he should bear in mind that many of the smaller stations are

The principal broadcasting stations of the contending parties.

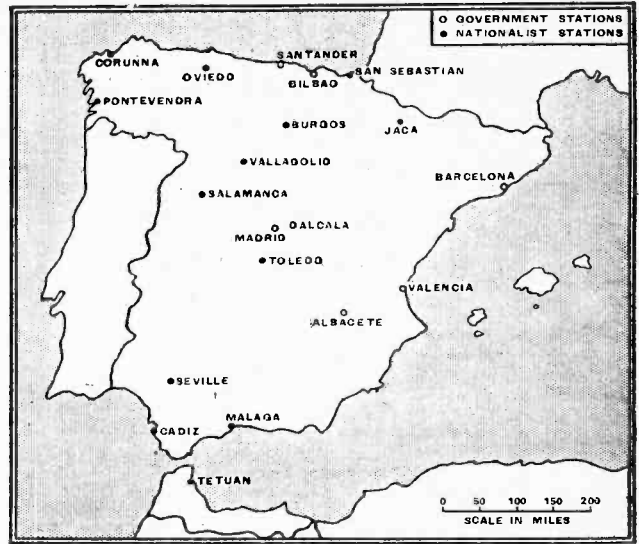

LIST OF SPANISH STATIONS IN ORDER OF FREQUENCIES

Abbreviations: P, Party; G, Government; I, Insurgent. All times B.S.T.

No.	P.	Station Name.	Call Sign.	kc/s.	Metres.	kW.	Transmission Times and Notes.
1	I	Seville ...	EAJ5	731	410.4	5.5	News in English between 1900 and 2115 (time varies). General Queipo de Llano speaks nightly at 2330.
2	G	Madrid ...	EAJ2	731	410.4	3.0	Transmits at intervals from 0900. News in French, Italian, German, English and Portuguese from 2315 to 0100.
3	G	Barcelona ...	EAJ1	795	377.4	7.5	
4	G	Valencia ...	—	850	352.9	3.0	Relays No. 3, EAJ1. Also transmits a separate programme.
5	G	Barcelona ...	EAJ15	1,022	293.5	3.0	
6	I	Oviedo ...	—	1,022	293.5	0.7	"Atención, Atención. Aquí Radio Nacional al servicio de la liberación de España." Transmits from 1500 to 1600, 1900 to 2100 and 2230 to 0130. News in French, 2150; male announcer. News in English, with a woman announcer, at 2255 and at 0100; also sometimes in English from 2200 to 2230. Frequency as measured by Tatsfield is 1096 kc/s (273.8 m.).
7	I	Salamanca ...	—	1,095	271.9	50.0	
8	G	Madrid ...	EAJ7	1,095	271.9	5.0	Very rarely heard.
9	G	Bilbao ...	EAJ6	1,258	238.5	1.0	"Habla Radio Bilbao." News in English at 2400, except Sundays. Ex San Sebastian, EAJ8. Requests reports. Address: EAJ8, Bilbao, Spain.
10	I	Burgos ...	—	1,258	238.5	—	"Habla Radio Castilla del Burgos del servicio de la liberación de España." Transmits from 1500 to 0100.
11	I	San Sebastian ...	EAJ3	1,258	238.5	1.0	"Aquí Radio Requeté de Guipuzcoa al servicio de España y por España." News in English at 1320 and 2040. Transmitter situated at Monte Igueldo.
12	G	Barcelona ...	ECN1	1,318	222.5	—	"Aquí E.C.N. uno, Radio C.N.T./F.A.I., Barcelona, España." Operated by the C.N.T. News in English at 2150 and 2330; French at 2210.
13	G	Santander ...	—	1,129	209.9	—	"Aquí Radio Basque."
14	I	Burgos ...	EAJ27	1,142	208.0	—	Alternative wavelength for No. 19.
15	G	Bilbao ...	EAJ28	1,145	207.0	—	Relays Bilbao (41 m.).
16	I	Valladolid ...	EAJ17	1,492	201.1	—	Relays Valladolid (42.83 m.).
17	G	Radio Alcala ...	—	1,500	200.0	0.2	Alternative wavelength for Madrid (30.43 m.) with which it usually works simultaneously. The wavelength is approximate.
18	G	Madrid ...	EAQ1	4,000	75.0	20.0	
19	G	Barcelona ...	ECP2	6,100	49.19	—	Works simultaneously with Burgos (208 m.).
20	I	Burgos ...	—	6,250	48.0	—	"Aquí Radio Guardia Civil Tetuan Maruecos Español." News in English at 2100; French at 2145; Arabic at 2200. Closes at 2300.
21	I	Radio Tetuan ...	—	6,507	46.1	5.0	
22	G	Barcelona ...	ECN1	6,995	42.88	—	Relays Barcelona (222.5 m.).
23	I	Valladolid ...	FE1	7,006	42.83	—	"Transmite Falange Española Radio Estacion F.E.I., Valladolid." At 1915, French; 1930, English.
24	I	Vitoria ...	—	7,040	42.5	—	"Transmite Radio Requeté Vitoria."
25	I	Malaga ...	—	7,106	42.26	—	News in English from 2330 to 2400 on Sundays and Wednesdays.
26	I	Corunna ...	EAJ41	7,113	42.0	—	
27	G	Madrid ...	EA4FIG/EGL	7,143	42.0	—	News in English at 1615.
28	I	Jaca ...	EA2BH	7,177	41.8	—	Relays San Sebastian (238.5 m.).
29	I	San Sebastian ...	EAJ8	7,200	41.65	1.0	"Atención, Atención, Aquí Radio Requeté Durango al servicio de España y por España."
30	I	Durango ...	—	7,230	41.5	—	"Aquí Radio Requeté del frente de Madrid." Transmits from 2045 to 0230. Situated on Madrid front.
31	I	Radio Requeté ...	—	7,230	41.5	—	Alternative wavelength for Burgos (48 m.).
32	G	Burgos ...	—	7,230	41.5	—	Relay station. Sometimes gives news in English at 2150.
33	G	Barcelona ...	PSU1	7,295	41.15	—	Relays Bilbao (238.5 m.).
34	G	Bilbao ...	—	7,297	41.1	—	"Habla Radio Bilbao FP2." News in English at 0100 except Sundays. News in French at 2330. Closes with "Viva la Republica."
35	G	Bilbao ...	EAJ23	7,330	41.0	—	
36	G	Madrid ...	UGT	7,400	40.6	—	News in English at 2130; in French at 2200. Closes 2300.
37	I	Toledo ...	EAJ19	7,430	40.0	—	"Aquí la Voz de la Libertad." News in English on Tuesdays and Fridays from 2045 to 2200; also sometimes after 2100. News in English on Sundays at 2100. Situated at Vallecas. Ex EDZX station.
38	G	Madrid ...	EAQ2	9,180	31.65	20.0	
39	G	Madrid ...	UGT	9,860	30.43	—	Relays Madrid (40.6 m.) and works at times when Madrid EAQ1 is not working.
40	G	Madrid ...	EAQ1	9,860	30.43	20.0	"Aquí la Voz de España." Transmits daily from 2315 to 0330; Saturdays at 1900 to 0330. News in English at 0030 and 0200, except Sundays; also sometimes at 2150 on Saturdays. News in German at 1915 on Saturdays. News in French at 0015 daily and 2015, and 0015 on Saturdays. The programmes at this station are not very regular at present. Situated at Aranjuez.
41	I	Teneriffe ...	EAJ43	10,360	28.94	4.0	"Aquí Radio Santa Cruz de Teneriffe." Transmits daily 2000 to 2120, 2315 to 0100 and 0115 to 0215. News in English at 1900, 2200 and 2400.
42	I	El Tablero ...	EDR3	10,362	28.93	—	Radio Club of Teneriffe. News in English at 2120 and 0030.
43	I	Salamanca ...	—	12,820	23.4	—	Short-wave station for Salamanca (27.1 m.). Usually transmits CW.

The Hartley Circuit

By M. G. SCROGGIE, B.Sc., A.M.I.E.E.

PROPERTIES AND SOME UNUSUAL APPLICATIONS

(Concluded from page 487
May 21st issue)

THE ready oscillation for which the Hartley is noted is due to the very close coupling that it provides. Even if the grid and anode sections of the coil are entirely separated, the tuning condenser causes enough coupling to make oscillation possible in most cases. But, in the investigation that follows, close inductive coupling is assumed. In fact, the coupling is assumed to be 100 per cent., so that the voltage ratio between anode and grid is the same thing as the turns ratio, S , which is equal to $\frac{\text{anode turns}}{\text{grid turns}}$. The other quantities involved are:

R , the dynamic resistance of the tuned circuit.

R_a , the anode AC resistance of the valve.

R_g , effective AC input resistance between grid and cathode.

μ , the amplification factor of the valve.

g , the mutual conductance of the valve,

($= \frac{\mu}{R_a}$). R is assumed to take account of all causes of loss or damping except R_a and R_g .

It has already been mentioned that the oscillating voltage across any part of the coil is in proportion to the turns—this assuming it to be a perfect transformer. The other important working principle is that any resistance connected across an n th part of the coil is equivalent to $n^2 \times$ that resistance connected across the whole coil. Thus if $S=2$, the grid turns are one-third of the whole, and the effect of R_g is the same as that of putting nine times R_g across the whole coil. And R , the whole coil, looks like $R \times \left(\frac{2}{3}\right)^2$ to the output from the anode of the valve.

Having grasped this, one can calculate the proper place for the tapping. In highbrow technical circles, after saying "one can calculate," it is etiquette to leave it at that in order to sustain the polite fiction that all members of the said circles can dash off any mere calculation on a shirtcuff or in the mind. Actually they, as well as everybody else, really like to have the results displayed clearly and concisely without the labour of working them all out. So only the general method will be indicated here before showing the results as curves.

Assume that steady oscillation has already been set up and that the oscilla-

tion voltage across the grid portion of the coil is (for simplicity) 1 volt. This is amplified by the valve in the usual way, according to which the amplification is $\frac{\mu\rho}{R_a + \rho}$, where ρ is the load in the anode circuit. As the grid voltage in our case is 1, the voltage developed across the anode portion is $\frac{\mu\rho}{R_a + \rho}$; and, as has just

been explained, ρ is equal to $R\left(\frac{S}{S+1}\right)^2$, and this is substituted for ρ to give the voltage in terms of the quantities entering into the problem. But we already know this anode voltage in another way, because

with this material it boils down to the relatively simple form $(R_a + R)S^2 + (2R_a - \mu R)S + R_a\left(1 + \frac{R}{R_g}\right) = 0$. Even this looks rather involved, but there is no need to puzzle over it unduly, for what it means can best be gathered from studying the curve sheet, Fig. 11. As there are five quantities, and a single curve on a sheet of paper can show the relationships between only two, some fixed values must be assumed for the others. The valve is assumed to have easy round numbers for its characteristics: $\mu=10$ and $R_a=10,000$; g is therefore 1 milliamp. per volt. What happens with other characteristics can easily be deduced, as will be explained presently. Sufficient values of S are given to show quite clearly the effects of varying the tapping point on the coil.

Examining the curves, look first at the top of the sheet, where R_g is about 100,000 ohms. This is the order of resistance introduced when the grid leak is about a quarter of a megohm. For tapings that are not too near the anode end (i.e., for S not much less than 1) R_g can vary considerably without affecting things

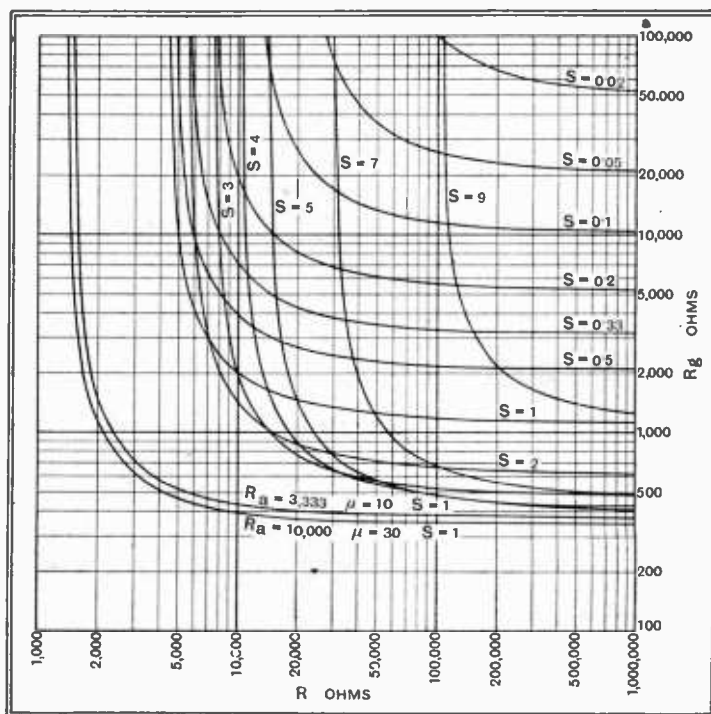

Fig. 11.—Diagram from which the best tapping point on the oscillator coil can be determined for various conditions. Other uses of the curves are explained, and still others can easily be thought of.

it is proportional to the coil turns on the anode side; in fact, it is equal to S . So the voltage, as a quantity, can be eliminated from the problem entirely, and any one from among S , R , μ and R_a can be calculated when the remainder are specified. The effect of R_g has been neglected so far; when it cannot be assumed to be infinitely large it can be allowed for by converting it to the equivalent resistance across the whole coil (i.e., in parallel with R), which is $R_g(S+1)^2$. So instead of R we must use $\frac{RR_g(S+1)^2}{R + R_g(S+1)^2}$.

When all the heavy work has been done

much. Take $S=1$; R_g can drop to 10,000 ohms before the power of oscillating low values of R is impaired appreciably. When one considers that a good radio-tuned circuit has a R of over 100,000, and that under the conditions selected a valve of even such a moderate conductance as 1 mA/V will oscillate with a R as low as 5,000 ohms, the readiness of the Hartley

The Hartley Circuit—

circuit to oscillate can be appreciated. Naturally, as the grid loss increases (R_g decreases) the power available for the oscillatory circuit is correspondingly less, and R must be greater to keep oscillation going.

But note what happens to S . When R_g is large, the most persuasive S seems to be about 1—a centre-tap (to be more exact it is $\frac{\mu}{\mu+2}$, or 0.83 in this example). But when R is very large, so that all the power goes to overcome grid losses, it is more effective in doing so if the tap is moved nearer the grid end ($S = \frac{\mu}{2}$).

It is only at ultra-short wavelengths that one is likely to want the full capabilities of the circuit merely to keep oscillation going at all. Then R cannot be very high, and R_g is lower than most people imagine—1,000 ohms, or that sort of thing. But at ordinary wavelengths the working point is much more likely to be well up in the postage-stamp corner of the sheet. Suppose R is 112,000 ohms and R_g is 100,000. Then S can have either of two values to bring the valve to the oscillation point—9 or 0.02. This means that the tap is near one end or the other. It can never quite be as large as μ , but it can be—but seldom is in practice—very close to the anode end. It is rather interesting to notice that if R_g is equal to R_a the two alternative tappings are at equal distances from the two ends of the coil, whatever R or μ may be. But what happens, you ask, if both R and R_g are large, and instead of tapping near the end you go right into the middle of the coil? The working point is then nowhere near the proper S line.

Negative Bias

What happens is that the valve pours so much more power into the circuit than is needed merely to maintain the *status quo* of oscillation that the amplitude goes on growing until something shifts. If the circuit includes a grid condenser and leak, the oscillation is rectified thereby, producing a negative bias which causes the internal resistance to rise, and the whole set of curves in Fig. 11 ceases to apply (they were based on the assumption that R_a is 10,000 ohms). Actually the whole lot are shifted bodily towards the top right-hand corner until the working spot is touched by the right S line. Any further move would bring it to the lower-left of the S line, which would have the effect of causing oscillation to die out, so reversing the movement of the set of curves. If the working point (R_g, R) had been only just inside the S line, the adjustment would settle down quietly, with a steady negative grid bias and reduced R_a . But when it is far inside the growth of oscillation is so violent as to cause the S line to shoot past the mark; the working point finds itself right outside, where no oscillation is possible; there is a violent reversal, and so on, backwards and for-

wards, giving the well-known phenomenon of "squegging."

But the valve may have no grid condenser and leak. In that case no bias is applied; the average R_a is, if anything, reduced, driving oscillation all the more fiercely; but against that a large amount of grid current flows, causing R_g to drop away down. In this case the working point falls to meet the S line; in the former the S line rushed up to meet the working

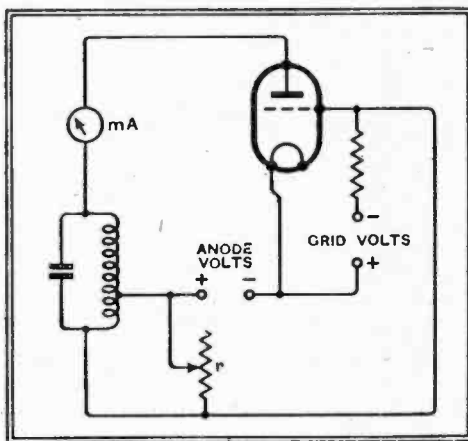

Fig. 12.—A simple form of valve tester, giving direct readings of mutual conductance, based on the information given on the curve sheet, Fig. 11.

point. Other contrasts are that the anode current rises instead of dropping, and there is no squegging. But the valve may destroy itself in the effort to stabilise operations.

To find how matters stand when the valve characteristics are different from those assumed one is greatly favoured by the fact that if the curves are plotted to logarithmic scales they are all of the same shape. A piece of paper can be cut out and moved over the sheet to show these other conditions. The rule for different R_a is easy. Move the curve along a diagonal line so that if R_a is reduced n times R and R_g are both reduced n times, and vice versa. An example is shown of R_a reduced to one-third—3,333 ohms. This is, of course, equivalent to an increase of g to 3. It is possible to increase g to 3 in another way by increasing μ to 30, leaving R_a , as before, at 10,000 ohms. The result is nearly, but not quite, the same; changing μ is a little more complicated, as an increase from 10 to μ_1 necessitates multiplying the R and R_g figures by $\frac{10-S}{\mu_1-S}$. When S is small compared with either 10 or μ_1 it can be neglected, and the process is then as simple as for R_a .

Determining the Tapping Point

Some of the many uses of these curves have been shown—to calculate the correct tapping point for known conditions; to find what happens with a given tap; or to discover whether a valve of certain characteristics will oscillate under given conditions. They can also be made the basis of a valve tester. If S is chosen so as to

be small compared with μ , then for ordinary practical accuracy the resistance across which oscillation can just be maintained is inversely proportional to the mutual conductance, g , of the valve. The thing can be worked out in this way:—

Fig 12 shows the circuit diagram; it is easy to see that it is based on Fig. 4. In fact the only difference is a variable resistance r with a maximum of about 25,000 ohms, which serves to adjust R_g . The grid leak is so high—a megohm, for instance—that it affects R_g very little. The tuned circuit has as high a dynamic resistance as possible, but this is preferably achieved by a minimum of losses rather than by using a very small tuning capacity; the latter would allow stray capacities to upset the tapping ratio. The coupling between the two sections of the coil should be as near 100 per cent. as possible, in order to justify the assumption on which the curves were based. To fulfil these conditions the coil may be an efficient iron-core transformer with a ratio of 1 : 3 or thereabouts and a total inductance (with windings connected in series as shown) of about 3 henrys, in parallel with a good condenser of 0.005 mfd. giving an oscillating frequency of rather more than 1,000 c/s.

The resistance r may be calibrated to read g direct in milliamps. per volt. The valve to be tested is plugged in, the voltages at which the test is to be made are applied, and r is slowly increased until the milliammeter reading begins to fall, indicating the start of oscillation. Phones could be used instead, except that unless they are shunted down to a very low resistance they would introduce some error; also the milliammeter reading is an extra check on the valve.

Cheap and Rapid Testing

This scheme has been tried, and works quite well. It is about as cheap and simple a tester as could be devised, and allows of rapid testing of large quantities of valves. On the other hand, the accuracy is not of a high laboratory precision standard; and—a more serious drawback—while the range of measurement in the upward direction is unlimited, it is not practicable to measure very low values of g such as are obtained with variable- μ pentodes under conditions of maximum bias. The limit is set by the dynamic resistance of the oscillating circuit, and 0.05 mA/V is about as small as one can go to.

Incidentally, it not essential for r to be across that particular section of coil; it may be across any or all of it, according to the range of resistance that may happen to be available.

Summarising the whole business :

The Hartley oscillator circuit is the most generally useful and freely oscillating, and by slight modifications can be adapted to meet almost all conditions.

The shape of the curve connecting tuned circuit dynamic resistance (R) and grid input resistance (R_g) at the point of oscillation is the same irrespective of the valve

The Hartley Circuit—

characteristics or coil tapping point; and varies only in position (assuming logarithmic scales).

The effect of changing the internal resistance of the valve (R_a) is to shift the curve diagonally so as to alter both R and R_g in the same proportion as R_a .

The effect of changing the amplification factor of the valve (μ) is to shift the curve diagonally so that R and R_g are proportional to $\frac{1}{\mu - S}$; and when S , the

ratio of anode turns to grid turns of the coil, is small compared with μ , R and R_g are inversely proportional to g , the mutual conductance of the valve.

When the grid loss is unimportant, the most powerful oscillating condition is reached when the tapping point is $S =$

$\frac{\mu}{\mu + 2}$, which is practically a centre tap unless μ is unusually small. When R is very high, the most powerful oscillating con-

dition (for overcoming grid loss R_g) is when $S = \frac{\mu}{2}$.

When R and R_g are such as to bring the working point to the lower or left side of the appropriate S line there is no oscillation. When it is on the upper or right side oscillation increases until the working point and/or S -line are automatically shifted so as to coincide. The way they shift depends on whether or not a grid leak and condenser are used.

To obtain oscillation S must always be less than μ .

If R , R_g , and S in the just-oscillating condition are known, the valve characteristics can be derived from the curves. The most convenient formula for calculating curves is:

$$R = \frac{A R_g}{R_g - B}, \text{ where } A = \frac{(S+1)^2 R_a}{S(\mu-S)}$$

$$\text{and } B = \frac{R_a}{S(\mu-S)}$$

On the Short Waves

NOTES FROM A LISTENER'S LOG

IT was most fortunate that the period of very poor conditions occurred before May 12th, otherwise the elaborate arrangements made by the B.B.C. at Daventry to give world coverage to the Coronation broadcast would not have been so successful as they seem to have been.

In all, six transmitters and a large proportion of the 25 arrays at Daventry were in practically continuous use from May 9th until the earlier hours of May 13th, when the last recording of the ceremonies and H.M. the King's speech was broadcast to the Antipodes.

Two of the six transmitters were of 10-kW power, the original transmitters installed in 1932, two of 20-kW power, one old G5SW, plus a new power-amplifier using a push-pull demountable screened-grid valve, and finally two new 50-kW transmitters, the figures, of course, refer to output to the feeder lines, and not the input power, figures given for input power are always very misleading.

One point of interest was that during the evening, owing, presumably, to the shortage of channels in the 17-Mc/s band, two transmitters were announced to be in operation simultaneously on GSG 17.79 Mc/s, one serving N. America and the other the West Indies.

This is probably the first time that synchronised, or more correctly isochronised, short-wave transmitters have been used under service conditions.

It is understood that reception of the Coronation Day broadcasts was excellent in nearly every corner of the world, the only poor reports of direct reception of Daventry coming from Australia and Capetown, when the morning broadcasts was not very well received.

It is, of course, almost impossible to give

a service directly from this country to Australia during the summer daylight hours here, but all was well because Australia picked up the broadcast relayed by Hong Kong, Schenectady and Montreal.

Although Capetown and the Union generally fared badly, the King's speech arrived safely via Rugby, however, the rest of Africa appears to have enjoyed excellent results on GSH 21.47 Mc/s during the Abbey ceremony and the commentaries on the processions, and on GSI 15.26 Mc/s in the evening.

S. America was very enthusiastic, too, about reception on GST 21.55 Mc/s until quite late in the evening, including the broadcast of His Majesty's speech.

In all, during the day, three 14-metre transmitters were used, the third being GSJ 21.53 Mc/s directional east and west, and, perhaps, it was due to this latter transmitter that Singapore reported good reception, even though a thunderstorm was in progress locally!

After the final Coronation broadcast of May 13th, two of the transmitters were taken out of service, and Daventry is now on normal schedule with the other four, some of which give almost local station signals in London during the evening.

Sunspot Activity

Conditions have continued to improve during the past few weeks, although there is again signs of very considerable sunspot activity, and the disastrous spot of April 22nd-29th is "back again," following the 27-day solar rotation cycle.

There has, so far, been no evidence of a further burst of positively charged particles from the sun, which gave rise to the violent changes during the end of April. All the

symptoms of the April storm, which was the worst for 50 years, point to neutralisation of the F region ionisation (negative electrons) by positive particles gathered up by the earth's magnetic field, this type of storm, therefore, being the complete reverse of that due to the bright hydrogen eruption.

It is significant that the latter variety of short-wave fade-out has but little effect upon the earth's field, what effect it has was first discovered by an English amateur astronomer in 1859, before the radio era, strangely enough.

The large changes, or the fall of ionisation in the F region, do seriously affect the earth's field, however, it being rather a curious case of cause and effect via the same agent.

In the first place, the steady magnetic field gathers up the charged particles, these in turn decrease the ionisation of the F (and, perhaps, lower) regions, which fall in electron flow again, as in an electromagnet, and give rise to changes in the earth's magnetic field.

To suggest, therefore, that short-wave fade-outs are due to magnetic storms is incorrect, the reverse being true.

A further point of considerable interest is that during the sunspot minimum years auroral displays are seen, when ionisation levels in the polar regions at times fall normally to very low values, due to darkness and lack of solar activity.

It might, therefore, be true to say that low levels of ionisation in the F region are productive of aurora, whether these low ionisation levels are produced naturally or by the ejection of charged particles by the sun.

It should, perhaps, be explained that were the particles not charged they would not be affected by the earth's magnetic field, and the disturbance would then not be concentrated in the polar regions.

Owing to absence from London I am afraid the report on station reception will be short this week.

On Friday, May 7th, conditions appeared to have become good again, and a station on 18 Mc/s, relaying the Kalundborg-Copenhagen programme, was heard at excellent strength around 8 p.m.

Good results were also obtained from all the stations regularly received in this country, especially W2XAD and W1XAL, but excepting W3XAL.

At 5 p.m. on Saturday, May 8th, very good signals were noted from W2XE on 21.52 Mc/s, this station with his new transmitter is certainly a valuable addition to the short-wave spectrum, and would do well to stay on 21 Mc/s until much later in the evening.

Later on Saturday evening W3XAL was fair, but W2XAD was really very good at 11 to 11.30 p.m. with a Coronation programme by the Schenectady "Kiltie Band," all the pipers being ex-service men from the Scots Guards. This broadcast was relayed from the lawn outside WGY itself.

During the remainder of the period listening was mainly confined to W3XAL, in particular to Howard Marshall on "They say in London" at 8.40 p.m. on Sundays, and to W2XAD, particularly for the Tuesday 11.30 p.m. "Mailbag."

A good Nirom programme was intercepted from PMC on 18 Mc/s at midnight on May 16th, however; a mixed bag of Javanese and Western music.

Finally, W2XE was noted as being really excellent on 21.52 Mc/s at 1 p.m. on Whit-Monday afternoon. ETHACOMBER.

Current Topics

Television in New York

THE new 441-line television station which the Columbia Broadcasting Service is to erect on top of the Chrysler Building, the city's second loftiest skyscraper, will have an estimated range of about 40 miles.

Automatic Car Radio

THE preselector principle in gear-changing which is available on certain cars is to be applied to car radio in the U.S.A. Sets are being brought out whereby the car-driver can bring in any one of half-a-dozen preselected broadcasting stations by pressing the appropriate button.

Radio Histrionics

IT is hoped to establish shortly the first radio academy in Vienna. The proposed institution will cater for the training of announcers, commentators, and others in the special requirements of the microphone. Artists will also be instructed in the technique required for broadcasting.

More Interference

THE growth of "wired wireless" for inter-office communication in the U.S.A. has led to fresh complaints of interference with broadcasting. In this system of communication, modulated radio frequencies are passed along the ordinary electric lighting mains. Complaints are being made that conversation can be picked up on ordinary wireless sets in the neighbourhood.

SW Conference

THE Vienna short-wave congress will be held from July 11th to the 17th. A certain amount of inconvenience has been caused owing to its following immediately after the International Conference of Radio Art, which is being held in Paris from July 8th to 10th. Delegates who wish to attend both these events will be compelled to make a very hasty all-night journey across Europe.

Australian SW Programmes

DURING June Sydney (VK2ME), working on 9,590 kc/s (31.28 metres), may be heard on Sundays from 0500 to 0700, 1000 to 1400, and 1630 to 1830. Melbourne (VK3ME), using a frequency of 9,510 kc/s (31.5 metres), will be working from 0900 to 1200 daily except Sundays. Perth (VK6ME) will also be heard daily, except

Sundays, the time of transmission being 1100 to 1300, and will use the same wavelength as Sydney.

Wireless Exports

DURING 1936 American radio manufacturers exported 642,368 receivers, valued at 15,000,000 dollars.

Thumbs Down for Television

IT is reported that the Italian broadcasting authorities have definitely decided not to attempt to put television on an entertainment basis at present. They are of opinion that it has not yet attained a sufficiently reliable technical standard. Transmissions are, however, being made at intervals from an experimental station.

Another Broadcasting House

THE construction of the new station building at Katowice, Poland, has now been commenced. It will be completed in 1938.

Italian Plans

IN the new Convention signed between the Italian Broadcasting Company and the Government there are extensive plans for expansion. Five short-wave stations are to be built for broadcasting to the Italian colonies. Two of these stations are to have a power of 100 kW; of the remaining three, two are to have a power of 40 kW and one of 50 kW. Two 100 kW medium-wave stations for Rome and a new broadcasting house for Turin are also to be erected. Work on the two Rome trans-

EVENTS OF THE WEEK IN BRIEF REVIEW

mitters has, as a matter of fact, already begun, and it is hoped that the stations will be in operation by the late summer. The total number of Italian listeners on March 31st was only 719,000.

New N.P.L. Director

PROFESSOR W. L. BRAGG, O.B.E., F.R.S., at present Langworthy Professor of Physics in the University of Manchester, has been appointed Director of the National Physical Laboratory. He will assume his duties during the autumn.

Another Beam Station

AT present a telephone subscriber in Scotland can speak to America or Australia, but not to many of the Outer Hebrides. There is already a cable to Lewis, but the Post Office are considering the question of improving communication with the Western Isles by means of a wireless link.

Wireless in "el Campo"

THE Argentine Government is very anxious to extend the number of broadcast listeners in remote country districts, and with this end in view the Ministry of Agriculture has appointed a committee to determine the type of receiver most suitable for use in places far removed from the amenities of towns and cities.

Gold Watches for Listeners

IN Poland the number of licence-holders shows a rapid increase since the introduction of an inexpensive "People's Set." Many, however, attribute the public's new zeal for licence-buying to the fact that a gold watch is being presented to the buyer of the licence completing each 100,000. The buyer of licence No. 600,000 has just received his watch.

An Interesting Experiment

A YEAR ago the directors of a large hat factory in Vienna decided to provide workers with broadcasting programmes, as they had heard so much of their beneficent effect on output. After a full year's trial the directors have failed to note any improvement in this respect. They admit, however, that the music does not appear to have any distracting influence, as the workers' output has not fallen.

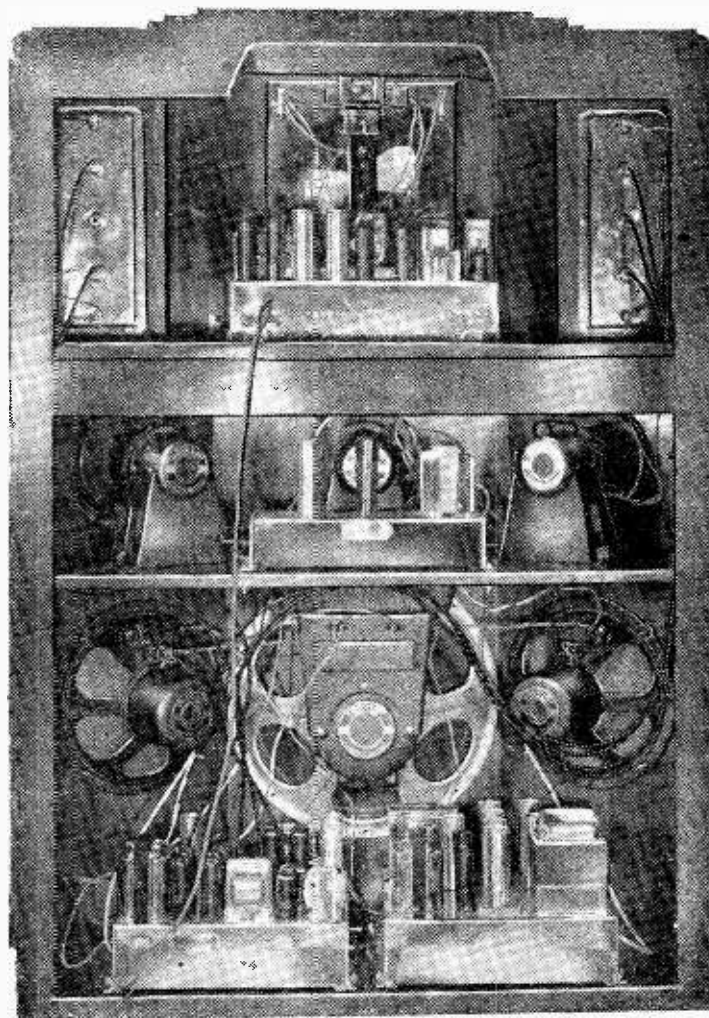

OUTSIZE IN RECEIVERS.—Almost every conceivable refinement is embodied in this 37-valve American Crosley receiver, which is fitted with no fewer than six speakers, which between them are stated to cover a frequency range of from 20 to 20,000 cycles if required, though the cut-off is generally set at 12,000 cycles. Automatic tuning and volume expansion are included, and, in addition to a general control of tone, provision is made for individual adjustment of the lower, middle and upper registers. Maximum power output is 75 watts.

The Television Receiver

X.—VISION-FREQUENCY AMPLIFICATION

By W. T. COCKING

JUST as in the case of the AF amplifier of a sound receiver, there are many possibilities of distortion in a vision-frequency stage, and careful design is necessary if a high standard of performance is to be secured. The design of a VF amplifier is discussed in detail in this article.

IT was shown in Part IX of this series that the use of vision-frequency amplification does not prevent good synchronising from being obtained, for it is possible by an artifice to replace the DC component of the signal after it has passed through an amplifier which is not responsive to very slow variations in its input potential. Since it is possible to secure greater gain per stage and a larger output from a given valve at vision frequency than at radio or intermediate frequency it will obviously pay us to adopt at least one such stage. It is consequently necessary to consider methods of VF amplification in much greater detail than we have done hitherto.

There are four types of distortion which can occur in a VF amplifier and each is important in television. Frequency and amplitude distortion are, of course, well known, for we are familiar with them in sound equipment. In such apparatus amplitude distortion is by far the more important, for the ear is very sensitive to it and remarkably tolerant of frequency distortion. In television, however, the position is reversed and quite a large

response, and this is usually taken as the frame frequency—50 c/s. The upper limit is fixed largely by imperfections in the rest of the apparatus, including the transmitter, and is taken as 1.5–2.0 Mc/s. Let us take it at 2.0 Mc/s.

The other two forms of distortion are ones which are rarely considered when dealing with sound apparatus; they are phase and transient distortion. Phase distortion occurs when signals of different frequencies take different times to pass through the amplifier. The response to an amplifier embodying pure resistance couplings is, practically speaking, instantaneous, but if the couplings are reactive, then a certain time elapses before the full response is secured. Such a time delay would not matter if all frequencies were equally affected, but they are not, with the result that the output waveform of the amplifier differs from the input.

Now, with the types of coupling employed—that is, resistance-capacity with or without correction—phase shift occurs whenever the circuit impedance becomes appreciably reactive. At low frequencies the coupling condenser and grid leak are

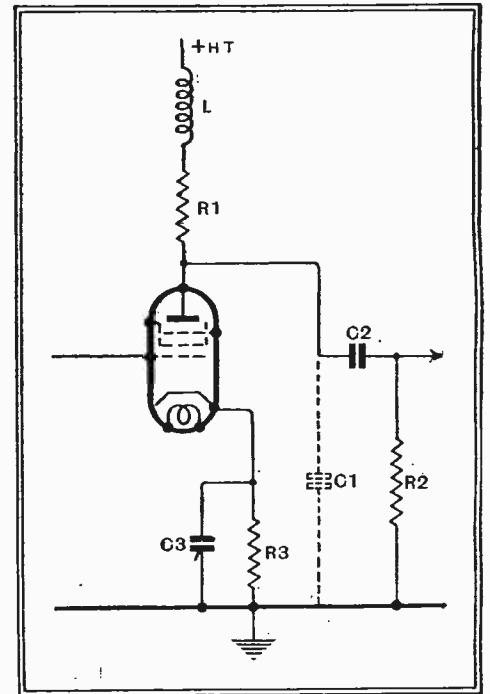

Fig. 26.—A typical VF stage is shown here. The condenser C1 represents the stray capacity.

has negligible frequency distortion over the same range, but the converse is not necessarily true.

Now let us consider transient distortion. If we change the input voltage of an amplifier suddenly we are in effect applying a signal of the waveform shown in Fig. 25 (a); the voltage rises instantaneously from one value to another, at which it is maintained. With a perfect amplifier the output waveform would be identical, but with a good practical amplifier it is more like that shown at (b). Owing to the time delay (phase distortion) caused by reactive circuits the voltage cannot rise instantaneously, and the final value is not reached until after a certain time has elapsed. This is distortion, but it is unimportant if the time is small enough.

With certain circuits, however, notably those in which a choke is used for high-frequency correction, the output waveform may be quite different. The effect obtained is shown in Fig. 25 (c), and it will be seen that the output voltage rises rapidly to a value greater than the normal level, then falls below it, rises again above it, and so on until after several oscillations about the normal level it finally settles down at this value. In other words, a damped oscillation is set up in the interval valve coupling. Under suitable conditions the effect may be very disturbing. The waveform of (a) occurs when there is a sudden change from black to white in the picture. If the corresponding output waveform is that of (c) then, with a sufficient interval between the peaks for the effect to be visible, we should expect to

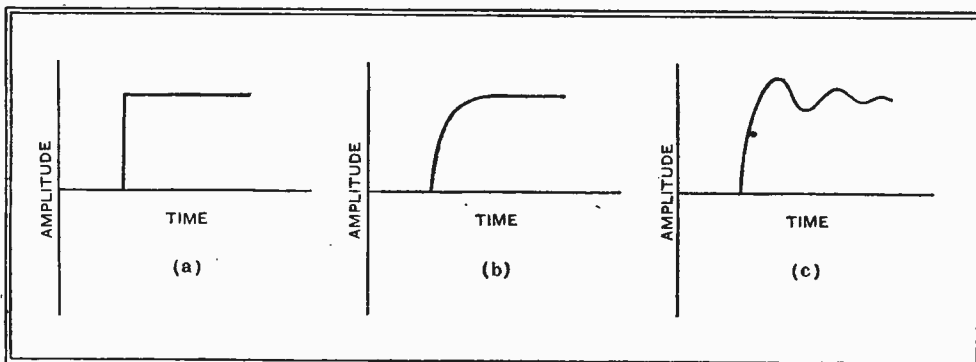

Fig. 25.—A sudden change of voltage such as that shown at (a) will be distorted in the manner depicted at (b) by an amplifier with a limited high-frequency response. With an amplifier of the type of Fig. 26, however, the output voltage may be like that of (c) if the values of components are not properly related.

amount of amplitude distortion can be tolerated; indeed, a certain amount may actually be desirable. The range of frequencies over which amplification must be maintained at a uniform level, however, is very wide and ideally would extend from zero to some 2.5 Mc/s. Since the use of a DC amplifier is impracticable an arbitrary lower limit must be placed to the re-

sponsible, while at high frequencies the coupling resistance and stray shunt capacities produce the effect. Phase shift is thus caused by precisely those elements which produce frequency distortion, and the two forms of distortion consequently occur together. It is probably true to say that an amplifier which has negligible phase shift over the working range also

The Television Receiver—

find that at the edge of the black object there is a band of unusual whiteness, corresponding to the first peak, followed by successive bands which are duller than normal and brighter than normal white, corresponding to the successive troughs and peaks.

If the effect is present to only a small degree and the natural period of oscillation is sufficiently short it is barely visible, and it is normally possible to detect no more than a slight increase in the brilliancy of white immediately adjacent to the right-hand side of a black object. In fact, when present in this degree only the effect may be useful in that it tends to make the transition from black to white appear sharper and more clean-cut. If the oscillation is absent and the time delay is appreciable, so that the waveform is like that of Fig. 25 (b), there will be some blurring at the transition.

The circuit most widely adopted for a VF stage is that shown in Fig. 26; the value of R_2 must normally be very large compared with that of R_1 . Now at high frequencies C_2 and R_2 have a negli-

Fig. 27. — These curves show the frequency response and phase shift for the amplifier of Fig. 26 for three values of L/CR^2 . The frequency scale is expressed in frequency ratios so that the curves are of universal application.

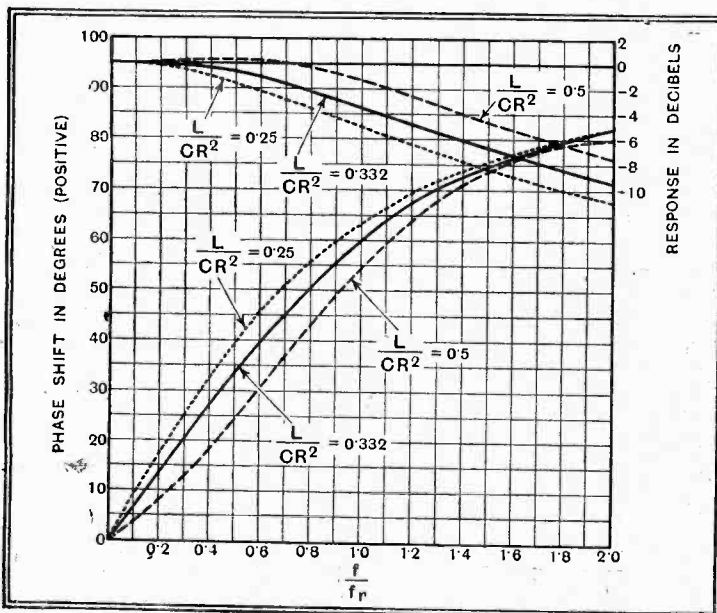

gible effect and the coupling consists essentially of L , R_1 and C_1 , this last consisting of the total of the strap capacities. This form of coupling was discussed in some detail in Part IV with particular reference to its use as an IF amplifier, and it was shown that the best compromise be-

tween an even frequency response and high amplification occurs when $L/CR^2 = 0.5$.

This circuit, however, is one in which transient distortion can occur, for L and C_1 form a timed circuit which is damped by the resistance R_2 . If the damping is not great enough, any suddenly applied voltage will cause it to oscillate at its natural frequency, and we can obtain the damped oscillation shown in Fig. 25 (c). It has been shown by McLachlan¹ that the effect just disappears

when $L/CR^2 = 0.25$, which is the critical value of damping, and that it is absent for all smaller values of L/CR^2 .

The frequency and phase distortion for this circuit are shown in Fig. 27 for three different values of L/CR^2 . These curves are plotted in frequency ratios to render

them of universal application; actually $f_r = 1/2\pi\sqrt{LC}$. The same three curves are shown in Fig. 28 replotted for the particular case when the response at 2.0

Mc/s is -3 db. for all values of L/CR^2 . It will be seen that the value of $L/CR^2 = 0.25$ gives the lowest phase shift of 51.5° at 2.0 Mc/s. This corresponds to a time

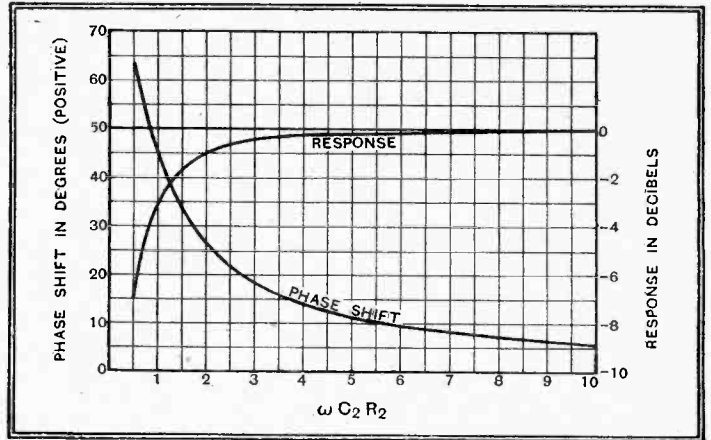

Fig. 29.—The response and phase shift at low frequencies caused by the coupling condenser C_2 and grid leak R_2 are shown here.

delay of $51.5/360 = 0.143$ cycles $= 0.143/2 = 0.0715 \mu$ sec.; with a picture 25 cm. \times 20 cm. this corresponds to a displacement of the spot position by about 0.18 mm., which is probably sufficiently small to be unimportant in a single stage.

If we adopt this arrangement with $L/CR^2 = 0.25$, so that the damping is critical and transient distortion is avoided, we see from Fig. 27 that for a response of -3.0 db at 2.0 Mc/s, $f/f_r = 0.72$, so that the resonance frequency f_r of the circuit must be 2.78 Mc/s. Consequently, if $C = 35 \mu F$ —a likely value in an output stage— $L = 95 \mu H$ and $R = 3,300$ ohms. If the valve has a mutual conductance of 6.0 mA/V, we can obtain a stage gain of 19.8 times.

Now let us consider the low-frequency response. In the coupling only C_2 and R_2 (Fig. 26) have any appreciable effect in causing unevenness of response or phase shift, unless a decoupling circuit is included. The curves of Fig. 29 show the performance in this respect; the curves are plotted against $\omega C_2 R_2$ where $\omega = 6.28 \times$ frequency (c/s) and C_2 and R_2 are in farads and ohms or microfarads and megohms.

A drop in response of 1 db. at 50 c/s is probably unimportant and is obtained when $\omega C_2 R_2 = 2$; the phase shift, however, is 26.5° . It is probably wise to keep the total phase shift of the order of 10° only, and for this value in this one coupling $\omega C_2 R_2 = 5.6$. We may have more couplings than one, however, and as will be seen later the bias circuit can also cause a phase shift. If we can manage with one coupling and the bias circuit, we ought to allow only 5° phase change in each, and for this $\omega C_2 R_2$ is about 12, and since $\omega = 314$ at 50 c/s, $C_2 R_2 = 0.0382$. Now if R_2 is to be very large compared with R it should not be less than about 0.3 megohm, since $R = 3,300$ ohms. Suppose we choose the standard value of 0.5 megohm, then C_2 should be $0.0382/0.5 = 0.0764 \mu F$. Again, it is convenient to choose a standard value, and the nearest is $0.1 \mu F$, which makes $C_2 R_2 = 0.05$ and $\omega C_2 R_2 =$

¹ "The Reproduction of Transients in Television," by N. W. McLachlan, *The Wireless Engineer*, October, 1936.

Fig. 28.—These curves are the same as those of Fig. 27, but with a frequency scale and resonance frequencies such that the response at 2.0 Mc/s is -3.0 db.

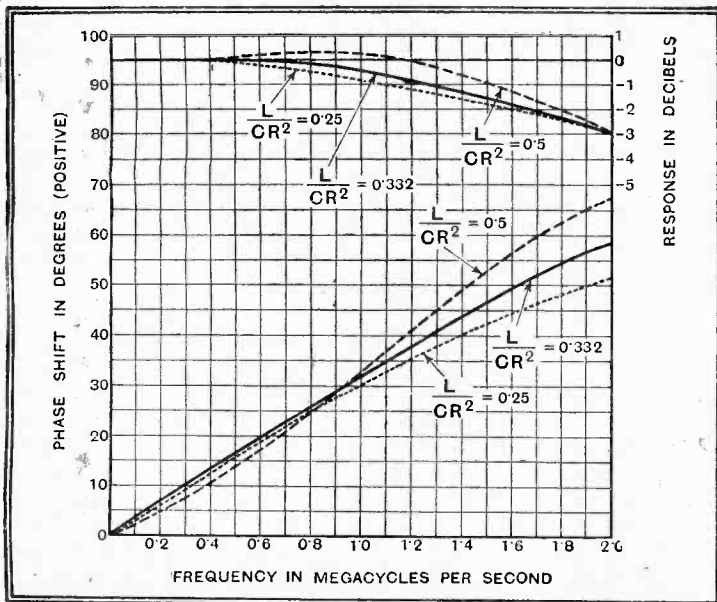

The Television Receiver—

15.7; the phase shift will be under 5° and the attenuation negligible, since it is less than 0.05 db.

We must next tackle the bias circuit C_3R_3 (Fig. 26). This is a little more complicated, since the performance depends not only upon the value of the product C_3R_3 but also upon g_1R_3 , where g_1 is the

when $R_3=100$ ohms and g_{sg} is about 1.5 mA/v, so that we can use the curve for $g_1R_3=0.75$. For a phase shift of 5° only we see that $\omega C_3R_3=8.5$, so that at 50 c/s—we find that $C_3=2.7 \times 10^{-1} F=270 \mu F$. Electrolytic condensers of 250 μF and 500 μF are readily obtainable, so that we can easily meet the required conditions in a single stage. As there is little difference

in the price of such condensers, we shall naturally choose the larger of 500 μF and obtain a response even a little better than is really necessary.

Before we go any further in this matter it is necessary to consider the question of amplitude distortion.

flows until the grid potential is more negative than -1.0 volt, however, we can only use the range between -1.0 and -3.5 volts. The anode potentials corresponding to these grid voltages are 173 volts and 222 volts, and the valve is thus capable of an output of $222-173=49$ volts peak-to-peak.

The valve input is 2.5 volts p-p, so that the stage gain is 19.6 times, and for normal operation with a resistance-capacity input coupling the steady grid bias should be -2.25 volts. With full input the valve, if operating as a sound amplifier, would then be said to introduce some 3 per cent. second-harmonic distortion. This is quite small and quite negligible in television. Under these operating conditions the anode current is 14.5 mA and the screen current 2.6 mA; the cathode current is thus 17.1 mA, and within the maximum rating of 20.0 mA.

We do not, however, require an output

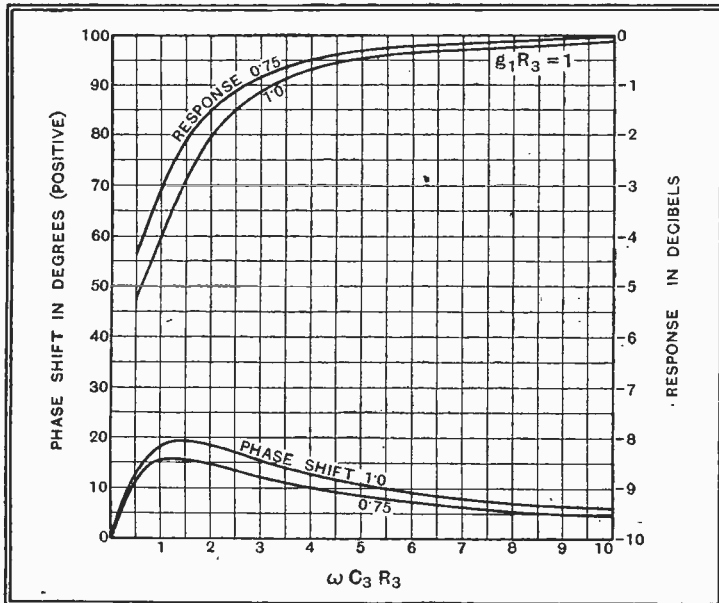

Fig. 30.—These curves show the effect of the bias resistance R_3 and its by-pass condenser C_3 .

effective mutual conductance of the valve in A/v and R_3 is in ohms. When the screen grid is effectively decoupled to the cathode, g_1 is the normal mutual conductance between control grid and anode. When no screen decoupling is used, however, or when it is returned to earth, g_1 is the sum of the mutual conductance g between control grid and anode and of that g_{sg} between control grid and screen grid. This latter figure is rarely quoted, but it is usually about 20 per cent. of the ordinary mutual conductance, so that when the precise figure is not available it is reasonable to take $g_1=1.2 g$.

The effect of the bias circuit is shown in Fig. 30 for two different values of g_1R_3 ; with a TSP4 valve, $g=6.0$ mA/v

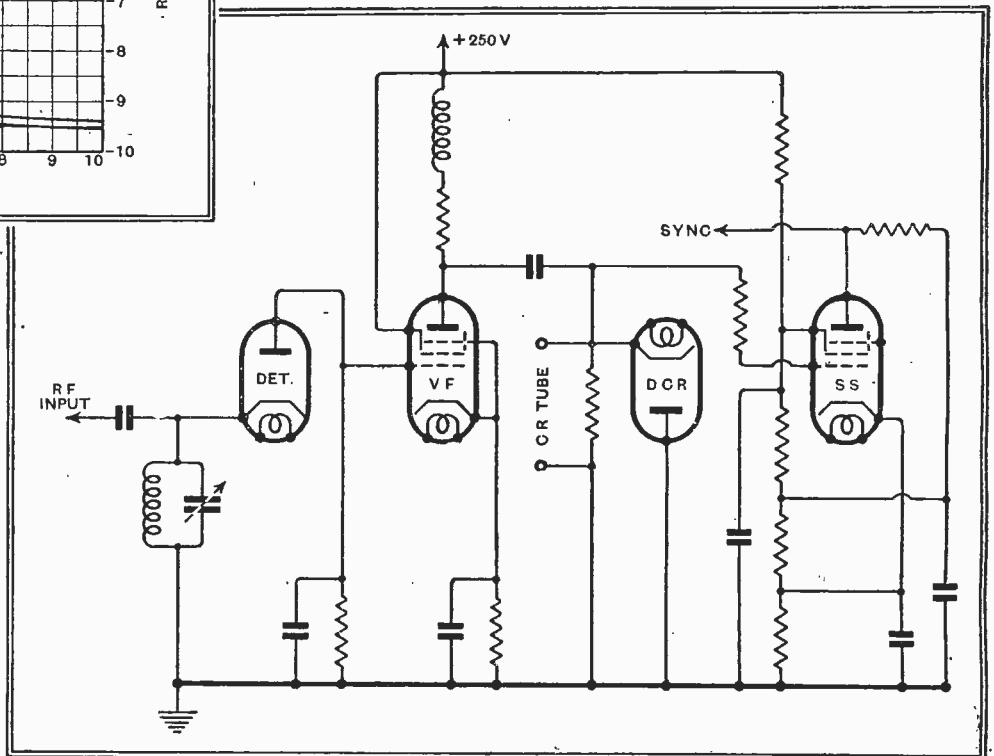

Fig. 32.—The complete circuit of the end of a television receiver showing the detector, VF amplifier, DC restorer, and sync separator.

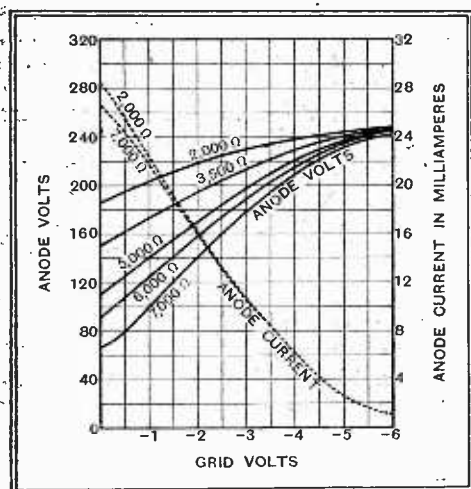

Fig. 31.—Dynamic grid volts—anode-volts curves of the TSP4 are given here.

For a normal tube the total output of the last valve must be about 30 volts p-p; this is a voltage change equivalent to that produced by a sine wave of 15 volts peak or 10.6 volts RMS. If the load resistance is 3,000 ohms, the valve must consequently be capable of an output of $10.6^2/3,000=0.0375$ watt. This is quite a small amount of power and is by no means difficult to obtain.

The dynamic characteristics of the TSP4 valve are shown in Fig. 31 for a number of different load resistances. As this valve has quite a low anode-cathode capacity we shall probably be able to use a load resistance of 3,500 ohms. Looking at the curve for this value we see that it is reasonably straight over grid potentials, ranging from zero to -3.5 volts; since grid current

of as much as 49 volts, for 30 volts p-p will fully load the tube, and we can take advantage of this to simplify the circuit somewhat by omitting the coupling condenser from the diode output. We shall then have direct coupling between the detector and the VF valve and avoid all frequency and phase distortion at low frequencies at this point.

With direct coupling the operating conditions of the VF valve are different, for the input voltage will not swing about the bias point but will always drive the grid negative with respect to its initial bias. Consequently, we may have to use a smaller value of initial bias. We want to make this as high as possible, however, because this will keep the current consumption at a minimum. We have seen that we can drive the grid so that the

The Television Receiver.

anode potential rises to 222 volts without serious distortion. For an output of 30 volts p-p, the anode voltage would then change between 222 volts and 192 volts and the corresponding grid voltages are -3.5 volts and -1.98 volts, this latter figure being the no-signal grid bias required.

At this bias the valve will take about 16.1 mA anode current and about 2.9 mA screen current, so that the total cathode current of 19.0 mA is just inside the makers' rating. A 100-ohm cathode bias resistance will thus produce 1.9 volts of bias, and as the no-signal detector anode current will also produce a small bias voltage, we shall not be far off the correct

working conditions if we adopt this standard value of resistance.

The circuit diagram of the detector, VF amplifier, DC restorer and sync separator thus takes the form shown in Fig. 32, and is extremely simple. Nevertheless, it gives good amplification and reliable synchronisation, and it is in no way critical as regards values of components. Naturally there are optimum values, as has been pointed out in this article, but they are by no means critical and the normal tolerances in components have a negligible effect on the performance. The sync separator is the most critical part, and here it is generally advisable to make provision for adjustment of its grid bias under operating conditions.

this interference could be so easily and so quickly eliminated if only the Government would take action. The cost of suppressing the radiation of interference at the source is not, as a rule, great, and, since most motorists are probably owners of "all-wave" sets which are affected by ignition interference when the short-wave range is in use, all stand to benefit whether or not they are actual or possible owners of television receivers. As it is, hundreds and hundreds of new vehicles, private and commercial, go on to the roads each week, and many of them produce the most poisonous interference. We have waited far too long already for anti-interference regulations. The more delays there are the greater will be the difficulties in the way and the heavier will be the handicap upon the developments of both television and short-wave broadcast reception.

RANDOM RADIATIONS

Microphone Gate-Crashing

ONE of the most astonishing instances of broadcast gate-crashing—the gate in question being the door of an observer's box—took place on the evening after Coronation Day. A youngster from the crowd walked into the box in the Green Park, and stated airily that he was the official observer. The engineer in charge didn't know the observer, who ought to have been there, by sight, and thought that all was well. The microphone crasher settled down to his work at once, and actually managed to broadcast to the world for a couple of minutes until the control-room operator, failing to recognise his voice, played for safety and cut out the commentary. One has often heard remarks shouted into the microphone by members of football crowds, and so on ("Can you hear me, mother?" is an old favourite), but this is, I think, the first time that a two-minute commentary has been achieved. The B.B.C. admitted the fact in its news bulletins, recounting the incident as a good story against itself.

I can tell them another story against themselves which I am certain they don't know. Not so very long ago the offspring of a friend of mine were giving a party to other young folk. Music was provided by the wireless set from whose loud speaker issued the strains of a well-known dance orchestra. "I wish," said one young thing, "that we could get them to play such-and-such a tune." "Easy," said her partner; "I'm sure I could make them do it in a minute or two." Several bets having been made, he went to the telephone, rang up the B.B.C., announced himself as Lord Clarence Marjoribanks, and demanded to speak to the dance band leader. The latter was soon at the other end of the line, and having heard what was wanted expressed himself as most willing. "Yes, my lord; certainly, my lord; we shall be delighted to oblige your lordship." And, sure enough, in a minute or two, the desired tune was announced as being given by special request!

**Why the Slow Progress?**

THOUGH considerable numbers of television receivers have been sold there's no denying that the new hobby has been slower in catching on than was anticipated at the time when the regular programmes

By "DIALLIST"

from the Alexandra Palace were started. It's a little difficult to put one's finger on the reasons why television hasn't made more rapid progress into popular favour. At first the programmes were distinctly poor and unexciting, to say the least of it, but they have improved enormously of late. It is possible that some of those who might have purchased sets last autumn were put off by the rather dreary programmes that they saw at demonstrations, and haven't realised what an improvement there has since been. I don't think that the cost of television receivers is holding back possible buyers, for in years gone by there has been a ready sale for radiograms costing quite as much. I should be inclined to narrow down the most important brakes on the wheels of television's progress to two.

Two Big Snags

Just now I mentioned there had always been a pretty good market for expensive radiograms. But the radiogram is an instrument which can, and will, provide entertainment just whenever you want it. On the other hand, the sound-and-vision receiver for the ultra-short waves can be used at present only for two hours on weekdays and not at all on Sundays. It has already been suggested in *The Wireless World* that the radiation of the whole London Regional programme every day and all day by the ultra-short-wave transmitter at the Alexandra Palace or that at Broadcasting House would have highly beneficial effects, since owners of television sets (provided, of course, that the vision part can be switched off) would be able to receive the London programme with far better quality than is now possible on the medium waves. The second snag is interference, particularly that caused by motor vehicles. It is all very well to say that the images on the screen are not very badly affected. One could put up with the visual part of the hailstorms that car ignition systems produce, provided they do not affect the sync; but when every other car gives rise to the sound portion of a hailstorm of the most intense kind beating on a tin roof, interference becomes something much beyond a joke.

And the pity of it is that the bulk of

Still Going Ahead

WE still seem to be quite a long way off that saturation point in the matter of broadcast receiving sets that has so often been talked about. At the end of March the total number of licences in force was 8,122,250, an increase of 42,381 for the month. It is curious to notice that there are comparatively small increases in places where one would expect big ones. Despite the opening of the Peimton station, Anglesey shows only three new licences, Carnarvonshire 53, Denbighshire 17, Merionethshire 18 and Montgomeryshire 17. Flintshire has actually a drop of five in its total. Just across the border Cheshire's total is up by 470 and Shropshire's by 193.

The increase for Scotland is much more satisfactory, totalling, as it does, 4,825. Glasgow shows the surprising rise of 1,639 (which is not a long way off 1 per cent.), whilst Aberdeenshire, Morayshire, Banffshire, Invernessshire and Ross and Cromarty reflect the influence of the North of Scotland transmitter by respective rises of 309, 143, 85, 174, and 63.

Though the total for Northern Ireland remains small, the increase for March was a particularly good one, being 1,217, which represents more than 1 per cent.



THE VISION MONITOR. Television Control Engineer at the N.B.C. Studio in New York. He controls the outgoing vision transmission and is in direct telephonic communication with the camera operator.

WITH the lengthening days comes an ever-growing number of Outside Broadcasts. Some, of course, are the old and well-tried perennials, whilst a few new sources are being tapped. This week the outstanding O.B.s come from the Royal Tournament at Olympia on Monday, the

Listeners' Guide for t

will be made and re-broadcast later in the day for those unable to listen to the actual broadcast which will be given at 2.45 (Nat.).

Charles Mason; a gondolier, Kaye Seely; and the Man with the Cloak, Wilfrid Rooke-Ley.

Mr. Hanson, the producer, realising one day that there was a fund of beautiful Italian music available in the B.B.C. Record Library which would provide an attractive

this thought in mind, Ernest Longstaffe has prevailed upon Harry Hemsley to bring his "four children" round a radio set for the benefit of listeners. The broadcasters which they will hear include Joan Young, Harry Champion and Neil McKay. The part of the four children and the father who will be listening-in with their mother (Gladys Young), will be taken by Harry Hemsley, the child impersonator. This novel programme, entitled "Tune in, Daddy," will be heard on Saturday at 8 (Nat.).

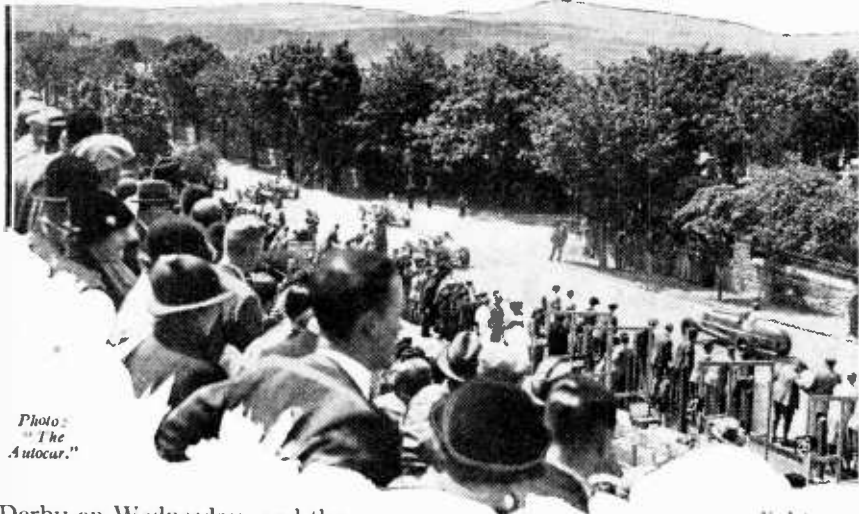

Photo: "The Autocar."

THE GRANDSTAND VIEW which Alan C. Hess will have when describing the R.A.C. International Light Car Race at Douglas, Isle of Man, for National listeners at 5 on Thursday. Victor Smythe will also be commenting at the Douglas Bay Hotel corner.

FROM THE VELDT

AN interesting and unusual broadcast comes to National listeners on Sunday afternoon at 3. It will consist of a short tour of the Kruger National Park near Johannesburg, South Africa, which will be conducted by the Warden of the Game Reserve. The commentator will give listeners an intimate picture of this sanctuary of wild life. The Park lies in the north-eastern portion of the Transvaal, bordering on Portuguese East Africa. It has a length of some 220 miles and an average width of about 40 miles, so that it is rather larger in area than Wales.

The Kruger National Park had its origin in 1898, when

Derby on Wednesday, and the R.A.C. International Light Car Race at Douglas, Isle of Man, on Thursday.

THE FIGHTING FORCES

ON Monday, at 8.30, from Olympia, Regional listeners will hear a running commentary on three events of the Royal Tournament. This gay annual military spectacle, which raises money for the Army Benevolent Funds, never ceases to draw great crowds. The events to be described will be a physical training display by the R.A.F.; the Interport Field Gun competition by the Royal Navy, and the musical drive by "K" Battery of the Royal Horse Artillery. The scenes in the arena will be doubtless fittingly described for listeners and with the background of martial music will provide a colourful sound picture.

THE SPORT OF KINGS

THE arrangements for the broadcast of the Derby follow exactly those of last year. An effects microphone will be at Tattenham Corner to pick up the hoof beats of the approaching horses, whilst an observer will, as far as possible, call out the names of the leading horses as they pass him. The Derby is always a tremendous mix-up for commentators, for it is frequently difficult to determine the colours of the jockeys.

A record of the commentary

"DERBY DAY"

No dates could be more suitable for A. P. Herbert's comic opera, "Derby Day," than the actual days of the great race and that of the Oaks (June 2nd and 4th).

The story opens the day before the Derby in the garden of the "Old Black Horse"; then comes the great day, with scenes on the road to Epsom, in the paddock, and on the rails. The last act deals with the day after the race and also takes place in the garden of the "Old Black Horse."

Gordon McConnell, who will produce this on Wednesday at 8.15 (Reg.) and Nationally on Friday, June 4th, has chosen a very strong cast, which will be supported by the B.B.C. Revue Chorus and Theatre Orchestra, conducted by the composer of the score, Alfred Reynolds.

VENICE AGAIN

A. W. HANSON, the impresario of "In Town Tonight," has devised a new form of entertainment, which he has entitled "In a Gondola." He has recruited Wilfrid Rooke-Ley, the author of "The Table Under the Tree" and "Musical Ghosts of London," to write the script telling of an English family party touring the canals of Venice. The party will consist of an elderly lady, to be played by Elaine Innescourt; her niece, Joan Carr; a young man,

light programme for the summer months, hit upon the idea of presenting this series of light entertainments. He has assembled a gifted band of players, who will provide the medium for giving listeners some of the tuneful melodies for which Italy is famous.

The first of the series will be heard by Regional listeners on Sunday at 9.5.

JUTLAND

ON May 31st, 1916, the largest naval engagement of the Great War, the battle of Jutland, took place. A dramatised story of the events of this great North Sea battle has been written by "Taffrail" (Captain Taprell Dorling, D.S.O., R.N.), which will be presented for National listeners on Sunday at 9.5.

The B.B.C. has stated that this broadcast is in no way intended to add fuel to the controversy which has raged around this battle, but to commemorate the 8,642 officers and men of the British and German Navies who lost their lives in the action.

THE CHILD LISTENER

THE remarks of children when listening to broadcast programmes are often, though amusing, very sensible. With

HARRIET COHEN, the famous pianist whose playing inspired Henry Hall to study the piano, will be heard with the Edric Cundell Chamber Orchestra at 9 (Reg.) on Saturday.



Week

an area lying between the Sabi and Crocodile rivers, about 1,500 square miles in extent, was proclaimed a Game Sanctuary. It has since been added to at various times, and now covers nearly 9,000 square miles. There is to-day probably a greater variety of wild life in this park than in any area of similar size in the world.

The commentary will be given at Skukuza, one of the twelve rest camps, it being conveyed by land line to Johannesburg and on to Cape Town, a distance of about 1,000 miles. It will then be sent via Radio Telephone Beam Service to this country.

OPERA

Home: Two relays from Covent Garden and one from Glyndebourne come into this week's programmes. On Saturday at 10.15 (Nat.) listeners will hear the third

Outstanding Broadcasts at Home and Abroad

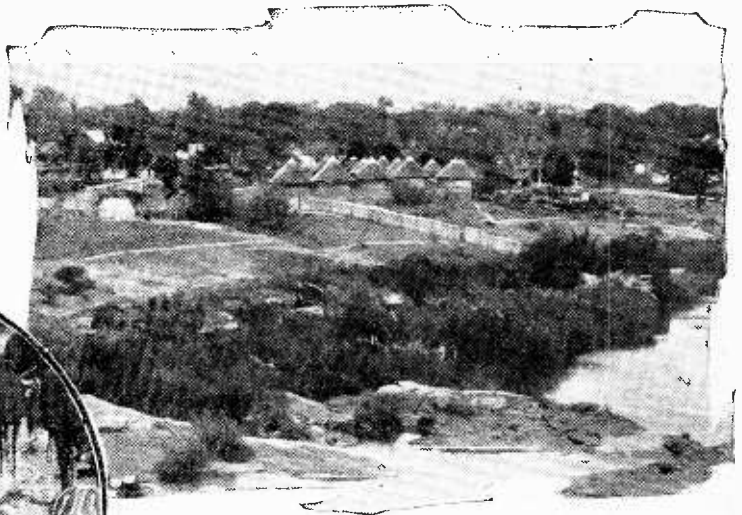
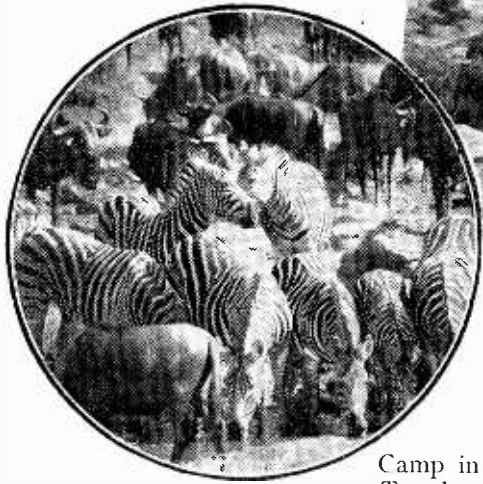

Photos: The South African Railways.

REST CAMPS are established at twelve points in the Kruger National Park, Transvaal, for the benefit of travellers. This natural home of wild life of every description will provide a twenty-minute descriptive broadcast for National listeners on Sunday. This photo is of Skukuza whence the commentary will be given. Inset are Wildebeests, which are exceedingly tame, and Zebras at a waterhole.

act of Bizet's "Carmen," with Renée Gilly in the name-part. The action takes place in Seville in the early 19th century, and the scene for this act is set in the Smugglers'

Camp in the mountains. On Tuesday at 10.5 National listeners will hear Act 3 of "Gotterdammerung." Both of these relays are from Covent Garden. From Glyndebourne on Thursday, at 8.15, the third act of Mozart's "Figaro" will be heard by Regional listeners.

Abroad: Dvorák's extraordinary and poetical opera, "Rusalka" (The Water-Sprite) is, of all the composer's works, the greatest favourite with the Czech public. It was first produced at Prague in 1900, four years before Dvorák's death. It will be heard from Prague to-night (Friday) at 7.30. This evening brings us yet another *magnum opus* of the Czech master, his magnificent Oratorio "Stabat Mater," from Hilversum 1 at 7.55.

Saturday's principal opera comes from Rome at 9, and is Verdi's "Ernani," founded on Victor Hugo's "Hernani." When produced at Venice in 1844 its success was enormous. Sunday brings us still more Czech opera in the shape of the perennial delight, Smetana's "Bartered Bride," which comes from Stuttgart at 7.45.

Twice this week, on Sunday from Milan at 9 and on Tuesday from Rome at the same hour, the veteran 74-year-old Mascagni conducts his own opera, "Iris." Since its production in 1898, it has won even more favour than any of the composer's score of operas since the delightful "Cavalleria Rusticana."

Monday brings two opera events, a new fairy opera, "La Cloche Engloutie," by the French composer, Manuel Rosenthal, from Paris at 8.30, and a complete recording of "The Barber of Bagdad," by Cornelius, from Frankfurt and Stuttgart from midnight until 2 a.m. The latter is the work in which Cornelius, a devout disciple of Wagner and Liszt, embodied the ideas of the "new" music of the Weimar School, of which he was a member.

On Thursday at 9, Milan gives us something really old, Monteverdi's "L'Incoronazione di Poppea." First produced in 1642, it is the work in which Monteverdi gave final proof of his genius for dramatic presentation and truthful characterisation. Poppea, as all know, was the second wife of Nero, her third husband and her last, for she soon died through his brutality.

DANISH MUSIC

The first of a series of municipal park concerts by a band of 70 Copenhagen musicians will be radiated on the Danish wavelengths on Sunday afternoon at 4. The programme, which consists exclusively of Danish music, will open with the King Christian X Jubilee March. The concert comes from the biggest park of Copenhagen, Faelledpark. Subsequent to this transmission, three large provincial choirs will render popular Danish songs.

THE AUDITOR.

HIGHLIGHTS OF THE WEEK

FRIDAY, MAY 28th.

Nat., 8, The Air-do-Wells. 9, Responsibilities of Empire—VI, the Rt. Hon. W. Ormsby-Gore. 9.45, Mabel Constanduros.

Reg., 8.15 and 9.30, Concert from the Queen's Hall. 9.10, "Paste and Paper." Begging letters received by a winner of the Irish Sweepstake.

Abroad.

Hilversum 1, 7.55, "Stabat Mater," oratorio (Dvorák).

SATURDAY, MAY 29th.

Nat., 3 and 5.15, Athletics, the Kinnaird Trophy. 8, "Tune in Daddy." 9.35, Quintette du Hot Club de France, from Paris. 10.15, "Carmen," Act 3.

Reg., 6 The Air-do-Wells. 7.30, The trial of James Stewart of the Glen. 1752.

Abroad.

Radio Paris, 8.30, Italian music.

SUNDAY, MAY 30th.

Nat., 3, The Kruger National Park. S. Africa—a descriptive relay. 9.5, Jutland—A history in dramatic form, by Taffrail. 10.5, Violin recital, Eda Kersey.

Reg., 5, Orchestre Raymonde and Williams Brownlow (baritone). 9.5, "In a Gondola"—a Venetian silhouette.

Abroad.

Milan, 5, Léhar's "Merry Widow."

MONDAY, MAY 31st.

Nat., 7, "Monday at Seven." 9.35, "Between Ourselves"—an intimate entertainment.

Reg., 7.30, English-American folk Songs: The B.B.C. Midland Singers. 8.30, Commentary on the Royal Tournament, Olympia.

Monday, May 31st (continued).

Abroad.

Strasbourg, 8.30, "The Ten Czardas Virtuosi"—Cigány Orchestra from Budapest.

TUESDAY, JUNE 1st.

Nat., Callender's Senior Band. 7.50, "Down Memory Lane": old melodies that still linger. 8.15, "The Purple Pileus."

Reg., 9, Music for Worship—IV. 9.30, "Intermission": Novelty numbers and solo pieces by the Variety Orchestra.

Abroad.

Strasbourg, 8.30, "Cosi fan tutte" (Mozart) from the Municipal Theatre.

WEDNESDAY, JUNE 2nd.

Nat. 2.45, Commentary on the Derby. 6.40, The London Theatre. 8.15 and 9.30, Concert from the Queen's Hall.

Reg., 7.30, "The Vagabond Lover." 8.15, Derby Day. 9.40, Men Talking (prison visiting).

Abroad.

Luxembourg, 9.50, Dances of the Nations, by the station orchestra.

THURSDAY, JUNE 3rd.

Nat., 5, Commentaries on the R.A.C. International Light Car Race. 8, Variety from the Union Cinema, Kingston-on-Thames. 9.20, Recital, Kathleen Moorhouse (cello) and Frank Merrick (piano).

Reg., 6.15, "The Purple Pileus." 8.15, Act 3 of "Figaro" from Glyndebourne.

Abroad.

Kalundborg, 8, "Les Cloches de Corneville," operetta (Planquette).

Ultra-short-wave Broadcasting

By "CATHODE RAY"

SO there is one department of broadcasting, and that not the simplest, in which this country has not merely done to-day what America did yesterday—Television. For this we are grateful to the enterprise of our B.B.C. and others concerned; even although nobody seems to know exactly what to do with it now we—or rather, the fast-disappearing wealthy members of the community—have got it. But when we consider the manner in which the proved and established demand of the seething Metropolitan millions is being supplied with sound broadcasts, the intensity of our congratulations drops off by very many db.

Presumably, it is not the intention of the B.B.C. that the Home Counties be omitted entirely from the scheme of things; and therefore the *London* station is more correctly described as the South-East station, at least. Yet even within the boundary of the County of London itself, in the south-easterly direction, the London National programme cannot be relied upon to be free from serious interference except by treating it as a distant station and accepting a correspondingly low standard of reproduction. By adopting every available device—high selectivity, tone correction, and a whistle filter as narrow and deep as an Alpine crevasse—something approaching the moderate fidelity standard of the original transmission may be possible. But why should one be obliged to do all this to get the local National programme, in the central ring of its service area? Conditions are naturally worse still in the extreme parts of the area, and have steadily deteriorated since the Regional scheme was established.

Something for Their Money

Seeing that listeners in general are contributing the money which is being used to finance television—a venture likely to be out of reach of the vast majority of them for years at least—it seems to me that they have rather a good claim to derive some benefit from the equipment now in existence, especially when the regular broadcast service leaves so much to be desired. I am referring, of course, to the proposal that when the ultra-short wave sound transmitter is not being used to supply the accompaniment to television it should radiate the National programme, or whatever programme is most likely to benefit thereby. Or if it be objected that television hours are going to be extended so much as to make serious holes in any such supplementary service, it remains

MORE ARGUMENTS IN FAVOUR OF THE PROJECTED SERVICE

that the cost of special ultra-short wave transmitters for covering local areas is small compared with that of a television service. The point is that it affects nobody who does not want it; there is no upsetting of existing services, but it would be a real boon to keen listeners.

Why and how? It is probably too well known even for "Cathode Ray" to have

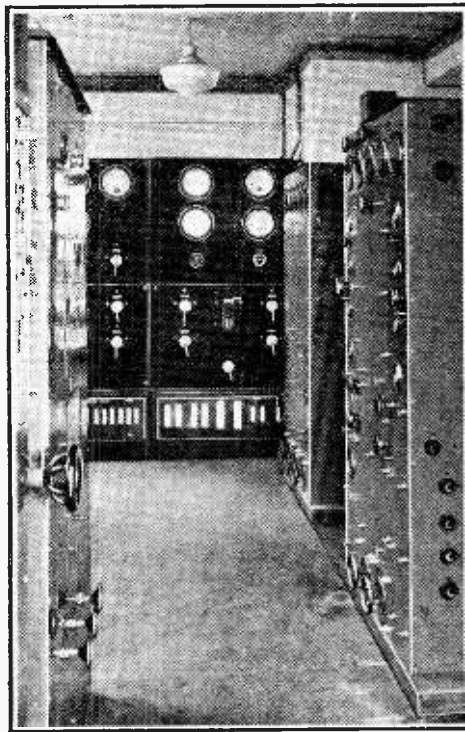

Apparatus for radiating programmes on ultra-short waves is already installed at Broadcasting House.

to explain that the broadcasting of programmes from a station occupies a band of wavelengths, not just one single wavelength as during a silent interval, and that consequently only a limited number of stations can work within fixed limits of wavelength without overlapping. Stations on all ordinary wavebands are already so crowded that, unless the desired transmission is overwhelmingly stronger than others adjacent to it in wavelength, it is necessary to reduce or cut off at the receiving end the highest audible frequencies, essential to life-like reproduction of sound. Ideally, frequencies up to

15,000 or even 20,000 cycles per second should be included; actually, broadcasting stations do not attempt to go beyond about 8,000; and except at very close range the practical limit of reception without interference is about 4,000. Some receivers are cutting off badly as low as 1,000!

The ultra-short waves are as yet wide open spaces; a television transmitter occupies several times as much frequency space as the whole medium and long wavebands combined, and still leaves plenty. I gave some idea of this in a diagram that appeared on December 4th last. So a real "high-fidelity" transmitter is entirely practicable from this standpoint. Moreover, the interference that one must expect from stations working on an adjacent or even the same wavelength is negligible compared with that on the longer waves, although the approach within the next year or so of maximum sunspot activity makes it unwise to be too dogmatic about this aspect of the matter. Anyway, there are still plenty of well-spaced wavelengths.

Perfected Contrast Expansion

Then there is an idea for improving reproduction, which is lying dormant just now because there seems to be no hope under present conditions of putting it properly into effect—contrast expansion. I explained some time ago why an attempt to restore the original *pp* and *ff* contrasts at the receiver fails; the variations in intensity of the programme are compressed by the transmission control engineer in a manner which he judges will give the most pleasing effect when reproduced in the ordinary way, with no re-expansion. But a special service, of the kind suggested, need not necessarily be bound by existing receivers everywhere, because it would be intended mainly for those who are sufficiently interested in the best reproduction to use special receivers for the purpose. The programme could be "compressed" automatically, according to a definite scale, and the receiver could be arranged to expand it again to the original. Probably the best way—and it is one for which there is room only on ultra-short waves—would be to radiate a pilot wave which would fluctuate in strength according to the degree of compression effected, and which would be used by the receiver to govern the corresponding expansion.

But perhaps that is too much to expect at first. However, apart from the things named, ultra-short waves have the advantage of being free from most forms of noise, interference, and atmospherics; with the important exceptions of motor

Ultra-short Wave Broadcasting—ignition and certain types of electro-medical apparatus. Aerials offer far more scope for high efficiency, directional properties, and reduction of interference. No person ordinarily situated is able to put up anything that is more than a mere part of an aerial on medium and long waves. The proper length for a Droitwich aerial is nearly half a mile, or quarter of a mile if erected vertically from the ground! But the ten feet for ultra-short waves is much more manageable.

Another thing is that an ultra-short wave programme can be picked up on an extra-

Television Programmes

Transmissions are from 3-4 and 9-10 daily.

Vision	Sound
45 Mc/s.	41.5 Mc/s.

FRIDAY, MAY 28th.

3, Starlight: Billie Houston and Nina Devitt. 3.5, Polo ponies and players from the Hurlingham Club. 3.20, British Movietone news. 3.30, Play Parade: repeat performance of scenes from "The School for Scandal."

9, Starlight: Hildegard. 9.15, Piatigorsky ('cello). 9.35, Gaumont-British News. 9.45, Friends from the Zoo; programme arranged for Dominion guests at the Zoological Society's Coronation Party.

SATURDAY, MAY 29th.

3, Oliver Wakefield. 3.10, Film Cartoon. 3.20, Pasquinade No. 2. Cast includes June Clyde and Richard Ainley. 3.45, National Cycling Festival. The start of the Cycle Road Race in Alexandra Park.

9, Gillie Potter. 9.15, British Movietone news. 9.25, Darts and Shove-ha'penny. Competition between rival teams of two well-known hostels. 9.35, Grill Room—Dim Drevo and Georges Gladysky (guitarists), Bela Bizony (violin) and the Hungaria Gypsy Orchestra.

MONDAY, MAY 31st.

3, Sports Review No. 2: Howard Marshall will introduce personalities who have been in the sporting news during the past month. 3.20, Gaumont-British News. 3.30, Ivy St. Hellier in "Queue for Song."

9, Repetition of 3 programme. 9.20, Viennese Honeymoon; revue for television by Hans Kafka. 9.50, British Movietone news.

TUESDAY, JUNE 1st.

3, Starlight: Charles Heslop. 3.15, British Movietone news. 3.25, "Polly": an opera by John Gay. This is a sequel to "The Beggar's Opera."

9, Personalities—IV. 9.10, Gaumont-British News. 9.20, Repetition of 3.25 programme.

WEDNESDAY, JUNE 2nd.

2.55, The Derby. Viewers will see a plan of the course and hear the commentary to be broadcast nationally. 3.10, Anne Ziegler (songs). 3.20, Gaumont-British News. 3.30, Fifty-ninth Picture Page.

9, "Queue for Song." 9.25, British Movietone news. 9.35, Sixtieth Picture Page.

THURSDAY, JUNE 3rd.

3, Display in Alexandra Park by Prunella Stack and members of the Women's League of Health and Beauty. 3.20, Maria Luth (songs). 3.25, British Movietone news. 3.35, Theatre Parade.

9, Music Makers. 9.10, Architecture—V. 9.25, Gaumont-British News. 9.35, Revue.

ordinarily simple and compact receiver, of pocket dimensions, using the super-regenerative principle. Some of the extreme fidelity is sacrificed, but then it is hardly expected from such receivers, for which 'phones are generally used; and on the other hand the super-regenerator is remarkably immune even from ignition interference. Besides which, it is the only single-valve receiver to include AVC!

Who is to Blame?

Although I may appear to have implied that it is the B.B.C. that is solely guilty of holding up ultra-short wave broadcasting, they profess to have the best reproduction of their programmes at heart, and would be unlikely to oppose such a suggestion; but it seems that the receiver manufacturers are nervous about it, though whether it is on the ground that the real high-fidelity might show up commercial "high-fidelity" for what it is, or because they think the public would instantly refuse to buy any sets not including ultra-short wave reception, is not clear. One would have thought that any pretext for offering the new season's products as an advance on the old would be welcomed by an industry in which new ideas are running short.

Of course, the fullest benefit from a "wide range" transmission of the type proposed could not be gained simply by adding the extra waveband to the standard receiving sets, although no doubt they could be made to give better reproduction than is possible now from the National medium-wave stations, especially if the B.B.C. were to co-operate by putting out the full audible spectrum. It is the design of sets primarily intended for high-quality local-station reception that would be given the greatest impetus, for at present there is no inducement to make them anywhere near as good as one knows how. It is about time for the stagnation here to be stirred up.

Radio and Aviation

MR. R. P. G. DENMAN, well known in radio and aeronautical circles, and a contributor to our pages, was formerly in charge of the electrical engineering section at the Science Museum, and later a director of the Heston Airport. Now, consequent on the Government's decision to purchase Heston, Mr. Denman has been left free to rejoin his former colleague, Mr. E. S. L. Beale, who in 1935 established a consulting practice in engineering physics at 129, Ebury Street, London, S.W.1.

Apart from radio work generally, Messrs. Beale and Denman are engaged on investigations in sound and vibration engineering, the development of photo-electric devices and cathode-ray tube applications.

"Resistance-Coupled AF Oscillator"

In this article (*The Wireless World*, May 14th) the first two diagrams were inadvertently transposed.



NEW BATTERY ALL-WAVE SUPERHET

£7

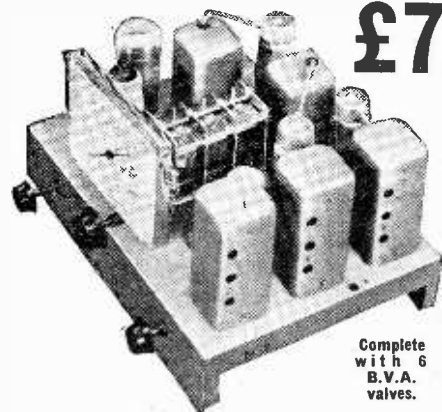

Complete with 6 B.V.A. valves.

The only receiver of its type now on the British market. Results on all 3 wavebands equal to mains receivers of equivalent type. Latest technical developments incorporated in circuit. Latest types valves, transformers, tuning coils, switches, etc.

Specification in brief: radio frequency amplifier, first detector with separate triode oscillator, I.F. amplifier, double diode detector, L.F. amplifier, low consumption pentode output. D.A.V.C. volume control and tone control both operative on gramophone. Illuminated dial with station names. Wave-ranges: 16-52, 200-530, 900-2,000 metres.

ALL-MAINS ALL-WAVE SIX

with radio frequency stage

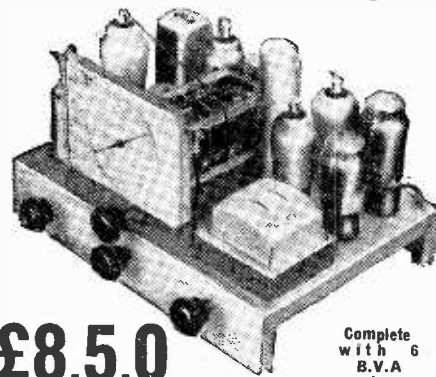

Complete with 6 B.V.A. valves.

£8.5.0

"De Luxe" 6 valve receiver, with 8 valve performance (specially recommended for tropical and foreign reception conditions). Built on special cadmium-plated 16 gauge steel chassis. Varley iron-cored I.F. coils. Litz-wound tuning coils. 3 wave-ranges—16.5-2,000 metres. Illuminated "Airplane" dial with principal station names.

Circuit comprises: Pre-selector radio frequency amplifier (operative on all wavebands), triode-hexode frequency changer, double bandpass coupled I.F. amplifier, double diode detector, D.A.V.C. applied to 3 preceding valves, L.F. amplifier and pentode output. Variable tone control and volume control operate on radio and gramophone.

Important!

The prices at which McCarthy chassis are advertised include Marconi Royalties.

Readers should, for their own protection, make sure before purchasing any receiver that the quoted price includes the Royalty payment.

All McCarthy receivers supplied complete with valves, knobs, pilot lamps, leads, mains cable and plug. 12 months' guarantee. Cash with order on 7 days' approval.

Deferred terms on application or through London Radio Supply Co., 11, Oat Lane, E.C.2.

Write for catalogue of complete range of McCarthy receivers.

MCCARTHY RADIO LTD.
44a, Westbourne Grove, London, W.2

Telephones: Bayswater 3201/2.

Broadcast Brevities

Separating Wales from the West

THE final separation of Wales from the West Region will take effect early in July, as already foreshadowed in these columns. This raises the question of the allocation of a separate wavelength to the West Region. It is definite that some reshuffling will be necessary for the comfortable accommodation of the newcomer, and the solution that probably springs first to the mind is the extinction of the three medium-wave Nationals—London, West and North.

Should the Nationals Go ?

This would release the 261.1-meter wavelength, already being used by the West Region, so that it became exclusive to that Region; but under this plan there would cease to be London and North National transmissions. If these were shifted over to the 203.5-metre wavelength which is now used by Plymouth and Bournemouth, representations would almost certainly be made that it was unprocurable on many sets.

Will Scotland Solve the Riddle ?

It would seem, therefore, that the B.B.C. will have to decide on the use of the Scottish National wavelength (285.7 metres) for the West Region, bringing Scottish National into line with the London and North Nationals on 261.1 metres. The Newcastle wavelength of 267.4 metres could then be retained for the new North-Eastern transmitter at Stagshaw, and Aberdeen could keep its 233.5 metres, as at present. An experimental period of working on this basis is the most promising solution of a by no means simple problem.

To Be or Not to Be—British

ART is universal; thus it is that broadcasting reaches out its tentacles to obtain the best that any country has to offer in the way of musical genius. The Toscaninis and Taubers, perhaps rightly, know less about international boundaries than about the dominant seventh, and the B.B.C. can therefore loosen its purse-strings with a good heart and without hurt to patriotic fervour.

Foreign Wood

But counterpoise must be secured somehow, and so Portland Place has been going into the vexed problem of "how to furnish out of income." New

NEWS FROM PORTLAND PLACE

tables and chairs for B.B.C. workers cry to high Heaven their alien origin. Whether the staff who have to write upon the one and sit upon the other are inspired to frame programmes on British or nearly all-British lines is a debatable matter. The only certain fact is that British listeners pay, both for wood and talent. And let us assume in the name of charity that when the B.B.C. can get equal quality at home, whether it be in talent or in wood, the home product takes precedence.

Toscanini and the Box Office

THE old idea that broadcasting has a detrimental effect on concert and theatre attendances dies hard, but the *coup de grâce* comes with the news that all seats for the B.B.C.'s London

introducing the "wipe" effect, familiar to all students of film technique. Another interesting effect, to be introduced in the next "Coffee Stall" programme, will be the simultaneous transmission of film and a studio scene. One-half of the picture will show a busy street and the other half the specially constructed coffee stall round which the entertainment revolves.

The Radio Link

The televising of the Coronation procession showed the capabilities of the new twin-wire balanced cable, but interest is now centring on the possibilities of the radio link. If this is a success, the scope of television O.B.s will be increased enormously. Already the likelihood of televising Wimbledon tennis is being freely discussed, and it

THE STROLLING TRANSMITTER

To permit impromptu interviews with the man in the street, the Columbia Broadcasting System of New York have designed a low-power ultra-short wave transmitter to be carried by a strolling announcer. The walking stick conceals an aerial and RF stage, a binocular case carries the modulator and AF amplifier, whilst batteries are supported by a waist belt. A wrist microphone completes the equipment, which is stated to have a range of one mile. American equipment of an even less conspicuous kind was used by Mr. Cornelius Vanderbilt for his journalistic "scoop" transmission from Westminster Abbey during the Coronation.

Music Festival, conducted by Toscanini, were sold out a fortnight ago, although the last concert will not be given until June 16th.

Seats for the first concert were sold out two hours after the opening of the box office.

Film "Wipes" for Television ?

WHILE intensive research continues on the O.B. side of television, the engineers at Alexandra Palace are still busy improving technique.

The engineer who "rocked the ship" in "Cabaret Cruise" by means of a gently tilting mirror is now at work on a device for

is also being suggested that the mobile unit be taken to Henley for the Regatta. The distance from Henley to Alexandra Palace is thirty-five miles. So the engineers are not unambitious.

More Gate-crashing

THE microphone still seems to be fair game for anyone who really has designs upon it, and the amazing thing is that so few people take advantage of its comparative defencelessness. The latest example of microphone "gate-crashing" had almost a comic-opera touch.

The stranger who gave the

"news-flash" from the B.B.C. box outside Buckingham Palace had no credentials but a plausible manner. In future, however, broadcasters will have to offer more tangible evidence of identity.

Microphone "Passports" ?

It is being suggested that everyone having access to a B.B.C. microphone should henceforth be provided with a special ticket. In the case of regular broadcasters and announcers a "season" would be required, probably designed like a passport, with the speaker's portrait inside.

"We Want the King"

NOT often is a dream translated into reality as it was in the case of Davy Burnaby in Coronation Week. The popular compère retired to bed on Coronation Night with the crowd cries of "We want the King!" ringing in his ears. He dreamt about it, so vividly, in fact, that at 3 a.m. he woke to find that he had the words of a lyric. At once he 'phoned Michael North, and the two of them evolved, on the telephone, the rousing song which formed the finale of the Coronation Music Hall broadcast on the following Saturday.

Appearances Not Deceptive

A FEW days ago the B.B.C. received a letter addressed to "Him with the two gold teeth and brass earhole, Alexandra Palace." It was at once handed to the rightful owner, Gypsy Petulengro.

No one can doubt that high-definition television has "arrived."

Captains and Kings Depart

HARD on the heels of Mr. E. R. Appleton's retirement from the position of West Regional Director comes that of Mr. E. G. D. Liveing, North Regional Director. The reason is given, in Mr. Appleton's case, as his desire to found a League of Youth with a spiritual background; in Mr. Liveing's case, as his wish to devote himself to literary and journalistic pursuits.

It is significant that both are key positions and among the plums of broadcasting, and that both these officials have chosen June 30th as the day on which to go out into the wide open spaces. The influence on the broadcasting service exercised for thirteen years past by Mr. Liveing and Mr. Appleton will be sorely missed, both inside Broadcasting House and by listeners in the North and West.

LARGER TELEVISION SCREENS

A Suggestion for Increasing Area

IN the Iconoscope type of cathode-ray tube as used in television the familiar fluorescent screen is replaced by a "mosaic" screen built up of tiny photo-sensitive cells which form an invisible "electric" image of the picture to be transmitted. This change in the function of the screen represents an outstanding development in cathode-ray technique, as applied to transmission.

Quite recently attempts have also been made to oust the fluorescent screen in

ence of the electron stream. For instance, certain phosphorous compounds are found to absorb less light, when subjected to the action of electron bombardment, than under normal conditions. Whether or not they produce phosphorescent light at the same time is immaterial, since it is the variation in transparency, or opaqueness, that is utilised in reproducing the picture.

When such an electrode is interposed between a powerful arc lamp L and a ground-glass viewing screen S, the light from the lamp is so controlled that it can only pass freely through those points in the electrode that follow the track of the electron stream from the "gun" part of the tube in its scanning motion.

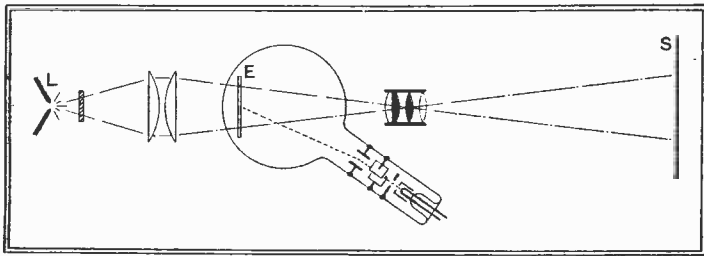

Using a cathode-ray tube for controlling a beam of light from an external source.

reception, where the arguments against its use are two-fold. First, it limits the size of the received picture, since the screen must necessarily be mounted inside the glass bulb, and, secondly, the fluorescent "glow" produced by the electron stream is, at best, only a poor substitute for direct light from a lamp.

In the arrangement shown in the Figure the usual screen is replaced by an electrode E which is capable of changing its optical characteristics under the influ-

In effect the scanning stream opens a succession of small "windows" in the electrode E, and so allows the light from the lamp L to pass through and build up the light and shade of the received picture on the screen S. The transparency of each "window" is graded by the intensity of the electron stream, and this, in turn, is varied from point to point by the amplitude of the signals applied to the control grid of the cathode-ray tube.

THE "MAG-NICKEL" FUSE

Specially Designed for Receiving Set Conditions

THE ordinary wire fuse is a thing of simple reactions, without the reasoning powers which would seem to be necessary for the post of main fuse in a receiving set. If it is heavy enough to survive the initial surges of switching on it will be insensitive to rises of primary current which, although small, may, nevertheless, be symptomatic of serious trouble somewhere inside the set. What is really required is a fuse with a reasonably narrow margin between its normal working current and fusing currents of sustained value, yet with a high enough current-carrying

capacity for overloads of short duration. The Belling Lee "Mag-Nickel" fuse satisfies these requirements and makes use of an ingenious new principle. The main conductor (not itself the fuse) consists of a thick nickel wire capable of carrying an overload of at least 400 per cent. On it are fixed two small blobs containing magnesium powder which oxidises spontaneously with the generation of intense local heat when the temperature is raised above a given point. This burns through the nickel and interrupts the supply current.

It has been found that the gauge of nickel wire required to keep the temperature below the critical point for the normal working current has a sufficiently high thermal content to absorb momentary surges; but a sustained excess current rapidly raises the temperature to the point at which the chemical reaction takes place. The fuse rated to carry ½ amp., for instance, is stated to blow 1 second after the application of a 75 per cent. overload.

Three ratings are available, namely, 250, 500 and 750 mA. The dimensions are the standard 1¼ in. long x ¼ in. diameter, and the price of all three types is 9d. each.

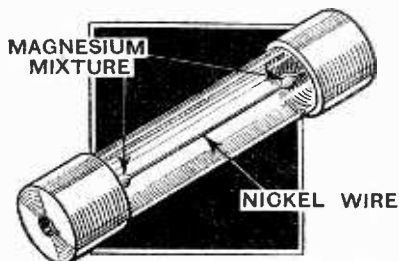

Sensitive to small sustained rises of current, the "Mag-Nickel" fuse is, nevertheless, unaffected by the surges which occur when the receiver is first switched on.

"WHEN we find

T.C.C. condensers we

look for the trouble

SOMEWHERE ELSE

A SERVICE ENGINEER



So said a service engineer to us recently. The mere fact that T.C.C. Condensers are in a Receiver, tells him straight away that at least a dozen possible breakdown points can be eliminated.

The most prolific cause of breakdown in a modern A.C. Receiver is the momentary building-up of HIGH-SURGE VOLTS at the instant of switching-on. It may result in a complete set of "blown" valves, burnt out resistances or transformer windings, and other 'mysterious' faults. Eliminate the cause itself... at source, by fitting T.C.C. 'Wets.' With these perfect safety valves in circuit high surges cannot develop, voltages are kept below peak working. Not only are the T.C.C. Condensers themselves SURGE-PROOF, but their very presence makes all associated components secure against damage. Play for safety... use T.C.C. 'Wets.'

FOUR STANDARD TYPES

- 802. 16 mfd. 440v. Continuous Peak wkg.
- 602. 8 mfd. 440v. Continuous Peak wkg.
- 805. 8 mfd. 500v. Continuous Peak wkg.
- 809. 32 mfd. 320v. Continuous Peak wkg.

— that STOP HIGH SURGE VOLT DAMAGE

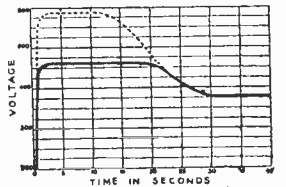

T.C.C.

ALL-BRITISH

CONDENSERS

The Telegraph Condenser Co. Ltd., Wales Farm Road, N. Acton, W.3.

Letters to the Editor

The Editor does not hold himself responsible for the opinions of his correspondents

Pirated Call-signs

FOR some ten years I have held a transmitting licence, first with the call-sign 2MQ and later, when the "G" was added, G2MQ. As most of my experimental work in radio has been confined to receivers and receiving circuits, very little transmission has taken place from this station, and, as a matter of fact, no transmitting apparatus whatever has been used here for at least six years.

For well over a year now I have been regularly receiving QSL cards from all over the world, but mostly from countries adjacent to England, proving conclusively that my call-sign has been regularly pirated. May I avail myself of the publicity of your Correspondence columns to inform experimenters generally that I am not in any way responsible for signals so sent out, that I have not transmitted from this station (or from any other) for several years, and that I should be much obliged for any information which would enable me to identify the man in question. Numerous examples of this piracy have been brought to the attention of the Postmaster-General's department concerned and the possibility of confusion with similar letters seemed ruled out by the fact that occasionally the transmitter in question has used such words as "Montreal" and "Quebec" to identify the letters, although obviously the station is somewhere in this country.

In the event of the pirate being identified the writer proposes to take legal action, not only in his own interests but in those of all amateur transmitters who conscientiously adhere to the regulations laid down.

PERCY W. HARRIS.

Wimbledon, S.W.19.

Horn-loaded M.C. Speakers

I NOTE from Mr. Barden's letter that, in mine of March 26th, I misquoted the passage which originated the discussion. I ask you and Mr. Barden to accept my apologies. I would like to point out, however, that the subtle but important difference which Mr. Barden indicates is not, in fact, there.

The original paragraph referring to air loading read: "With a baffle the loading is a maximum for wavelengths so small that the sound is thrown off as a beam, and becomes lighter and lighter with increasing wavelength." I could amplify this by stating that at high frequencies the baffle has practically no effect, but at low frequencies the air loading collapses in its absence. The baffle, by preventing this collapse at low frequencies, becomes effective at these frequencies, but it cannot preserve maximum loading on the diaphragm. This is the vital and fundamental point.

When Mr. Barden attributed to me a statement "that a baffle affects the loading at high frequencies only," I corrected him by claiming to have said "with baffle speakers, the loading is a maximum at high frequencies."

Although I admit the actual words to be different, my meaning is the same. When speaking of baffle speakers in this connec-

tion, I naturally mean the instrument as set up ready for work, i.e. on a baffle, and not separated as indicated by Mr. Barden.

I would therefore state in full that, assuming the diaphragm to be a non-resonant piston:—

(1) With a baffle speaker mounted on a baffle, the air loading is a maximum for wavelengths so small that the sound is thrown off as a beam. (At these frequencies the baffle does nothing useful.)

(2) As the wavelength increases, the loading becomes lighter and lighter (and would collapse utterly but for the presence of the baffle).

The table below gives approximate mean air loading in dynes per sq. cm. on a coin. diaphragm, velocity 1 cm. per second. Some of the figures have been quoted in my letter of March 26th, but by tabulating them the great change in loading will be more obvious.

Estimated mean air pressure in dynes/sq. cm.

Frequency.	Baffle Speaker on Baffle.		Same Speaker on 1:1 Horn.	
	Working Face.	Back.	Working Face.	Back.
5000	40	40	42	40
500	13	13	42	9
50	0.18	0.18	42	0.09

I think, after studying the above figures, that Mr. Barden will agree with me that with a baffle the air loading is greatest at the high frequencies.

His comment that most talkie equipments use a baffle speaker for the low notes, only emphasises the argument. *Firstly*, because the low-note speaker deals only with a limited frequency band, and its transformer can be matched to its average impedance over that band, regardless of how the impedance may vary outside that band.

Secondly, he will usually find that more than one speaker is used, and that they are clustered together, so that the pressure field of each one helps to load the others.

I am told that, in a recent arrangement, the bass section comprises not only four speakers, but that they are mounted in a "directional baffle" (these are really straight-sided wide-angle horns), so that it will be seen that everything possible is done to get loading at low frequencies.

With regard to the relative advantages of a horn speaker below the horn cut-off and a baffle speaker, the baffle speaker would normally have the advantage, since it is intended to be used in this manner. If, however, the frequency range of the horn speaker has been extended by the use of a bass chamber, other factors come in, not the least of which is that full use can be made of the improved constancy of the impedance curve.

Whether the overall result of the one arrangement or of the other is the better is a matter which can only be settled by a listening test.

If Mr. Barden cares to make such a test, I have no doubt of his verdict.

P. G. A. H. VOIGT.

London, S.E.26.

I MUST thank Mr. Turner for his response (May 7th) to my letter (April 16th), but

he appears to have misunderstood me. I did not imply that transient response was more or less independent of frequency response, but that their conjunction was not a *sine qua non*.

I must apologise for calling Fourier's Theorem his Analysis, but did not mention his Integral Theorem as it does not seem to be rigorously applicable to loud speakers.

It is perfectly true that "other things being equal, every increase in frequency response improves fidelity on transients," but the trouble is that other things do not remain equal if the frequency response is improved. Consider a single RC coupling; inductances in series with the resistances can improve the frequency response, but transient fidelity is usually impaired.

His desiderata for a good transient response do not seem to hold for the general case. Headphones, loud-speaking telephones and the older pick-ups (though the latter are the inverse of speakers) have restricted frequency responses and a multiplicity of resonances, but are really quite good on transients.

It is certainly unfortunate that a classical analysis has not appeared, and until it comes

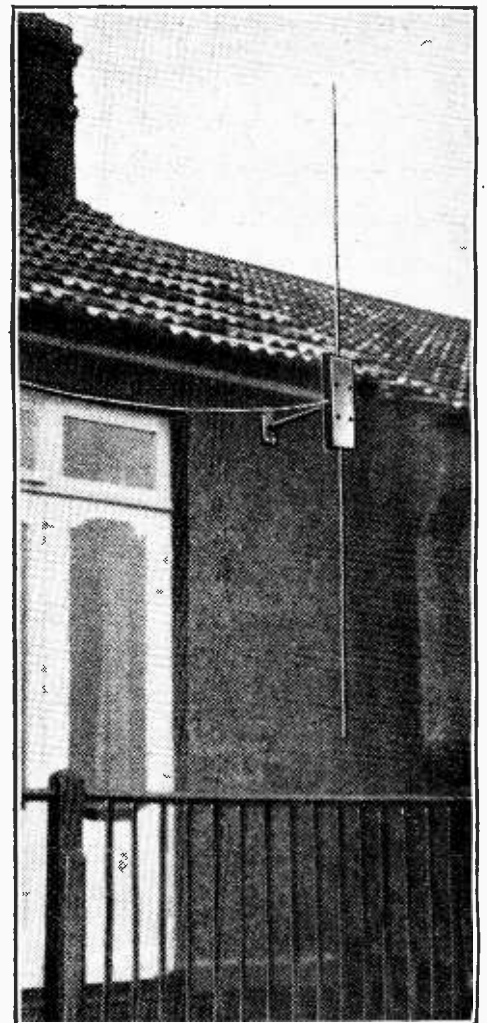

TELEVISION AERIAL. A practical interpretation of a di-pole television aerial with centre-connected feeder as shown in Fig. 1(a) on page 506 of this issue.

it seems necessary to glean what we can from a good-natured interchange of opinions. Polegate, Sussex. J. K. TODD.

I HAVE been particularly interested in the discussion on horn-loaded M.C. speakers, and it seems to me that a little confusion ought to be cleared up.

I refer to the fact that several readers have mentioned obtaining good results from a speaker designed for baffle-loading but used with horn-loading.

Now, the efficiency of a speaker depends, up to a point, on the loading, and one of the advantages of horn-loading is that (the loading is constant (roughly speaking) for all frequencies down to the cut-off frequency, whilst with baffle-loading it varies from a maximum at high frequencies to a minimum at low frequencies.

For this reason a MC unit designed for horn-loading is unsuitable for use with baffle-loading except as a "tweeter."

Conversely, then, it seems that the method of using a MC unit designed for baffle-loading with horn-loading must give equally unsatisfactory results.

Hampstead. JOHN BRIERLEY.

Superhets v. Straight Receivers

YOUR leader in the issue dated May 14th raises a multiplicity of questions which may be broadly divided into two classes, viz. :-

- (a) Local characteristics.
- (b) Universal characteristics.

I propose to deal with Section (a) initially as applicable to my own conditions as a resident on the south coast in the vicinity of the Solent and as a user of both TRF and superhet receivers.

As is common to almost every sea coast near a naval or merchant seaport, the most common source of interference is morse transmission. This may be CW or ICW and even spark transmission.

Now let me analyse the possible sources in which such transmissions may be received by a superhet receiver:—

- (1) IF channel.
- (2) Signal frequency.
- (3) Self-oscillating frequency.

In the case of (1) the suggestion of reserving a specific channel for this frequency is not likely to be successful as it would restrict naval ships from using it. It is generally known that restrictions of this nature are not feasible to essential Services, who must have free access to any part of the RF spectrum.

Item (2) is a variable quantity extending over the broadcast band, which now includes SW. Thus it is quite impossible to prevent morse signals from being received in this circuit.

Likewise (3) is a variable quantity, but greater precautions in receiver design can effectively prevent the reception of morse transmissions at this frequency. I regret to note many commercial receivers do not provide adequate isolation of this circuit from the aerial circuit in this respect. Furthermore, the radiation of the self-oscillator frequency into the aerial circuit is far too common. To (3) must also be added the question of either the reception of interfering signals on harmonic frequencies or production of audible beats on fundamental or harmonic frequencies from CW.

It does not require advanced mathe-

matical ability to realise the "ingress" channels of a superhet are manifold.

Contrasting with this, the TRF receiver has but one channel, and so confers many benefits under these circumstances.

Dealing now with the superhet under Section (b), we must enumerate the benefits conferred by the superhet circuit over the TRF set. I consider these to be as follows:—

- (1) Greater intrinsic selectivity.
- (2) More uniform amplification over the whole tuning range.
- (3) Easier facilities for the provision of variable selectivity.
- (4) Possibly greater overall efficiency for a given number of valves.

On the debit side I enumerate the following:—

- (1) The average 5-valve is still too noisy in the matter of hiss if the conditions approaching "high fidelity" are attempted.
- (2) Self-generated whistles, even though there may be only two, are two too many.
- (3) The increased sensitivity of superhets has resulted in "cheese-paring," with the result that over-complex valves have been developed to "pay the piper."
- (4) The quality of reproduction from some of these receivers with their double diode output pentodes leaves much to be desired.

Summarised, then, instead of the benefits of superhets being utilised on sound progressive lines, they have been appropriated to the base purposes of cheapening everything with little regard to either quality reproduction or replacement costs.

Therefore I contend finality in choice of circuit has by no means been reached. Moreover, I contend further logical development of TRF receivers of 5-8 valves is very desirable.

I seriously consider that a really exhaustive analysis of present-day bands should be made, starting with the idea that reproduction as faithful as can be achieved, should be the starting point in design.

This step alone will prune the unwieldy valve list no end.

Now to satisfy listeners' requirements, They are really simple and fall under two headings:—

- (a) Real programme value (that is, genuine high fidelity).
- (b) Receivable programmes.

The first section is self-explanatory. The second I interpret as meaning intelligible speech or music, but of such quality as to make long-period listening a strain. It does not need a psychologist to tell us that no "top" and perpetual "boom" is distracting to even those professing to be quite unmusical.

Who says, then, that the TRF set is a nonentity, either on the grounds of selectivity, range or quality reproduction? Who cares to claim unquestionable superiority in all these respects for the superhet?

Finally, which manufacturer claims the superhet is cheaper to make *good* than the TRF, and which type gives the most trouble?

My deep regret is that the public permitted themselves to be swept off their feet with the term "superhet." What of superinductance, so well developed by Philips? Portsmouth. "NAUTICUS."

NOTABLE FEATURES of the *New* ROLA F 742-PM

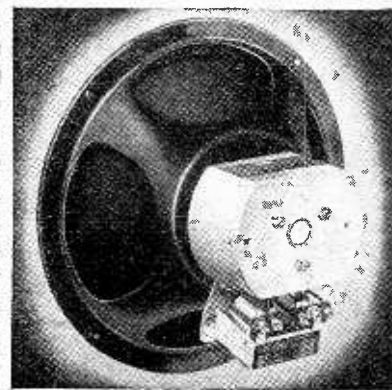

NEW METAL SHIELDED
TRANSFORMER GIVES
LONGER LIFE AND
UTMOST RELIABILITY

Not even moisture, let alone dust, can penetrate the newly designed metal and compound shield of the universal transformer on the Rola F742-P.M. And important though this special feature is, the popularity of this new 9 $\frac{1}{2}$ " unit will probably rest even more upon its wonderful performance. With 11,500 lines per sq. cm. in the gap the flux density is equal to the famous G.12-P.M. It employs the new magnet metal "Alnico" and is so sensitive that it sets a new standard for battery set reproduction, whilst as an extension speaker it gives truly remarkable results. Let us send you full particulars.

Model
F 742-
PM 49/6

WITHOUT TRANSFORMER 42/-
OVER 8 MILLION IN USE

ROLA

The World's Finest Reproducers

THE BRITISH ROLA CO., LTD.
MINERVA ROAD, PARK ROYAL, N.W. 10.
PHONE: WILLES DEN 4322-3-4-5-6.

Recent Inventions

Brief descriptions of the more interesting radio devices and improvements issued as patents will be included in this section

SHORT-WAVE SIGNALLING

TWO short-wave stations A and B, outside the normal range of intercommunication, are kept in touch with each other by an intermediate relay station C, which may be unmanned. Short-wave signals from A are picked up by station C, and, after being rectified, are used to modulate an outgoing carrier, which may be of any desired wavelength, so long as it reaches station B. Signals from station B are similarly received by station C and retransmitted to station A.

The relay station C uses the same wavelength in both directions. The same aerial can also be used at the relay station, both for transmission and reception, provided it is connected at appropriate nodal points.

O. Pöschl; A. Dietrich; and P. Habig. No. 461204.

VARIABLE SELECTIVITY

THE coupling between two of the intermediate-frequency amplifiers in a superhet receiver is

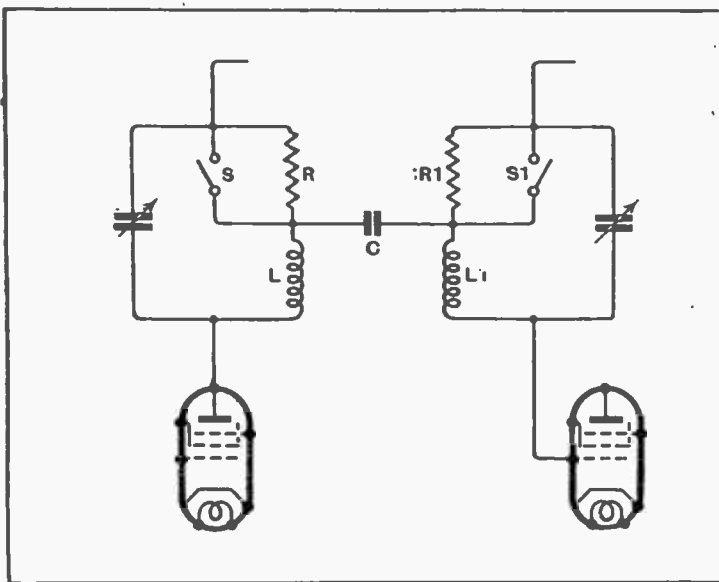

Variable selectivity circuit for superhet IF amplifiers.

altered, to vary the overall selectivity of the set, by switches S, S1, which cut resistances R, R1 in and out of the tuned circuits. The total coupling is partly that between the coils L, L1, and partly that due to the condenser C when the switches are open. In the

latter case, the resistances are in circuit and serve to broaden the response curve.

When the switches are closed, the resistances are cut out, and selectivity is increased. The coupling between the valves is then almost completely an inductive one, since both plates of the condenser C are effectively earthed so far as high-frequency potentials are concerned. The resistances are made variable, so that the degree of selectivity may be controlled over a given range.

E. K. Cole, Ltd., and A. E. Falkus. Application date September 14th, 1935. No. 460787.

RADIO-NAVIGATION SYSTEMS

ONE well-known method of guiding an aeroplane in flight is to transmit two directed beams of energy, so that they overlap slightly. The desired course is the centre-line of the overlapping part, which is indicated by the merging of two separate morse signals into a continuous note. In practice, however, the radiation from the transmitting beacon is not entirely confined to the path of the main beam. There may be secondary lobes of radiation which are liable to give a false indication to the pilot.

The invention consists in modulating such secondary lobes with a warning note, which clearly distinguishes them from the naviga-

tional signals sent out along the main beams, thereby relieving the pilot of any doubt as to which is the correct course.

Telefunken Ges. Für Drahtlose Telegraphie m.b.h. Convention date (Germany) September 24th, 1935. No. 460883.

The British abstracts published here are prepared, with the permission of the Controller of H.M. Stationery Office, from Specifications obtainable at the Patent Office, 25, Southampton Buildings, London, W.C.2. price 1/- each. A selection of patents issued in U.S.A. is also included.

CATHODE-RAY TUBES

OCCASIONALLY the external pressure on the walls of a cathode-ray tube is too great for the strength of the glass, and the tube collapses. In an "implosion," as it is called, the frag-

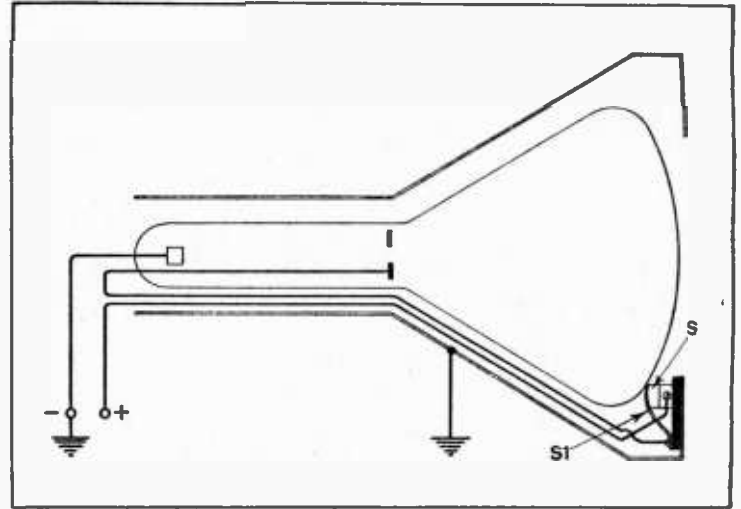

Automatic voltage cut-out for cathode-ray tubes.

ments of glass usually blow inwards so that there is little danger of mechanical injury. But the electrical risk is more serious, because some of the internal electrodes may be at a pressure of several thousand volts.

As a safeguard the circuit to the high-pressure electrodes is maintained by a make-and-break switch S, which is held in the closed position by the pressure of the end wall of the bulb. Should this break, the switch is automatically thrown open by a spring S1, and the internal electrodes at once become "dead."

The General Electric Co., Ltd., and L. C. Jesty. Application date December 5th, 1935. No. 461374.

TELEVISION "CAMERAS"

THE picture to be televised is first focused on to a photoelectric cathode mounted at the large end of a cathode-ray tube. The electrons emitted from the cathode are controlled by the field from an external winding, so that they traverse a "line" anode. This consists of a number of small conductors, mutually insulated from each other, but forming in conjunction with a common earthed element an equal number of small condensers.

Each condenser thus acquires an electric charge which simulates the light-and-shade value of a line-element of the original picture. The condensers are discharged in sequence by a scanning beam from the "gun" part of the cathode-ray tube. The arrangement is designed to increase the time during which each picture element can build up its equivalent electrical charge.

V. A. Jones and Baird Television, Ltd. Application dates August 14th, 1935 and March 10th, 1936. No. 461197.

SHORT-WAVE AERIALS

IN order to ensure the efficient reception of a wide band of short waves, the aerial comprises two conductors arranged, as shown, to form four diverging arms A, B, A1, B1. The transmission-line feeding the set is connected to the arms at a non-central point, such that the arms A, A1 are both equal in length, and form a half-wave resonator at the lower end of the desired frequency

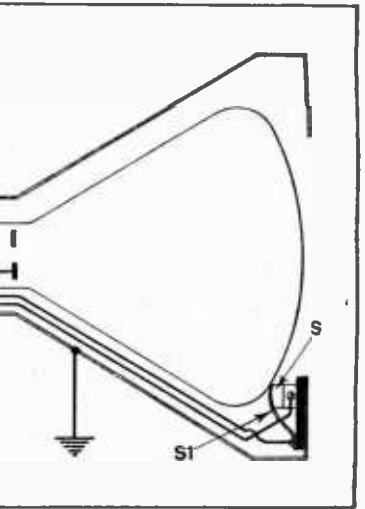

band. Similarly, the shorter arms B, B1 are equal to each other and resonate at a frequency towards the upper end of the wave-band range. The impedance of the down-lead is chosen to give a substantially flat response to frequencies lying between the two extremes represented by the dipoles. The two dipoles may be arranged in the same plane or otherwise, and may be set at right

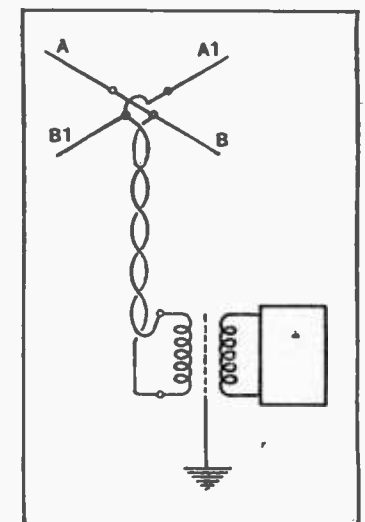

Aerial designed for efficient reception over a wide band of short-waves.

angles to each other as shown in the drawing or at any desired angle.

Marconi's Wireless Telegraph Co., Ltd. (Assignees of V. D. Landon and J. D. Reid). Convention date (U.S.A.) April 28th, 1931. No. 460570.

MISCELLANEOUS ADVERTISEMENTS

NOTICES

THE CHARGE FOR ADVERTISEMENTS in these columns is

12 words or less, 3/- and 3d. for every additional word.

Each paragraph is charged separately and name and address must be counted.

The proprietors retain the right to refuse or withdraw advertisements at their discretion.

Postal Orders and Cheques sent in payment for advertisements should be made payable to **ILIFFE & SONS, Ltd.**, and crossed **& Co.** Notes being untraceable if lost in transit should not be sent as remittances.

NEW RECEIVERS AND AMPLIFIERS

A.
A.
A.
NOTICE

DEGALLIER'S, Ltd., would point out that they hold the copyright of their Radio Gram Cabinet "Challenger 800," the number at the British Patent office being R.D.818496; any company or person copying this design in any detail is liable to damages for infringement of copyright.

COPYRIGHT No. R.D.818496 States: "The novelty consists in the shape, configuration and ornamentation of the cabinet as shown in the representations."

THIS Notice is Made as we Understand That Several Firms Have Copied this Actual Cabinet.

A.
DEGALLIER'S, Ltd., the firm for reliable short wave radio, have on show in London the largest selection of fully guaranteed brand new all-wave receivers; callers invited to handle all these at their leisure without obligation to purchase; all S.W. receivers will get stations on the low bands, including the Americas, etc. Closed all day Mondays. All goods cash with order or c.o.d. Handsomely illustrated catalogues forwarded on receipt of large stamped addressed envelope or stamp 2/6d. Our models receive American transmissions at full programme strength; demonstrations daily after 4.30.

6/6 Each—Valves for American receivers, all guaranteed, each a first, no seconds or throw-outs; for every known set from 1927-37; metal, metal glass, glass counterparts, and glass; in ordering just state type and number, we have it, all post paid; line cords for all midsets, 4/6 each.

£3/10—T.R.F. Midget receiver, "The smallest of its type in the world," medium and long wavebands, moving coil speaker, 2 watts output, no earth required, compact and transportable, leather cloth covered, obtainable in various colours; carriage 1/-.

£7/7—Table model six-valve all-wave superhet, tuning 16½-50, 200-250, 800-2,000 metres, high efficiency resistance-capacity circuit with A.V.C., station calibrated dial, 8in. moving coil speaker, cabinet of handsome appearance and super acoustic, 17x13x9½, operates on A.C. and D.C. mains 200-250 volts; never before such tone from a D.C. receiver, carriage 4/6.

13 Gns.—The new Challenger 8 (type 800) table model De Luxe, 22x18x12, high fidelity 8-valve superhet, A.C. 200-250 volts, waveband coverage 11-32, 27-65, 190-550, 900-2,000 metres, simplified centralised tuning, super slow motion vernier slow-fast tuning dial calibrated in metres, with station names, self contained control panel, perfect tone quality at low volume, new type, M.C. 10in. speaker, from a whisper to 8 watts pure undistorted tone, no overloading at full volume, oscillator fundamental without use of harmonics, persistent oscillator of highest output, isolating filters eliminate oscillation and motor boating, fully delayed A.V.C., P.U. terminals (switching and volume control incorporated in the front panel), absolute minimum of noise, sensitivity control for noise suppression. Reinforced capacitors prevent drift, pre-aged intermediate frequency transformers, I.F. barrier discs, anchor coil leads, plug-in loudspeaker, moisture sealed out by tropical zone impregnation, self heating electrolytic condensers. One complete chassis of dreadnought construction, moderate voltages assure full valve life, economical to operate, 75 watts consumption, correct valve selection, no compromise, no hum, full weight transformers, true push-pull, stabilised H.T. supply, stabilised biases, ceramic coil insulation, fully loaded plate coils give maximum gain, pre-balanced coil assembly, sealed insulation, thin laminations of special silico steel.

7 k.c. selectivity, fractional microvolt sensitivity, shielded switching permits high gain, positive silver plated contacts eliminates switch noises, audio frequency range 30-8,000 cycles, diode detection, Prizmatec high fidelity, R.F. selector stages on all bands; carriage 5/6.

£12/18—"800" chassis valves and 10in. speaker with all escutcheons, etc.; carriage 4/-.

£14/18—"800" chassis valves and G.12 12in. Rola high fidelity speaker; carriage 6/-.

£17/17—Challenger "800C" Console, height 3ft. 6in., width 24in., depth 12½in.; this is the 800 chassis with G.12 Rola; carriage and crate 10/-.

NOTE—The Challenger 800 is available in 11-valve, N.A.C./D.C. 200-250 volts, at an additional cost of 20/- on each model.

29 Gns.—Challenger "800RG" radiogram, with automatic changer "Garrard"; this job also incorporates the G.12 high fidelity Rola, carriage and crate 15/- A.C./D.C. model £2 extra.

14 Gns.—Challenger 351 8-valve 14-2,060 metres, Polychromatic dial scale, improved vision master, beam power output, band spread Magna dial and second-hand magic eye tuning, automatic band indicator, high image frequency suppression, hair line selectivity, 5 kc. separation; carriage 5/6; less cabinet, £13/18; carriage 4/-.

FOR Wonderful Value, come and see the following "samples" available to callers only. Every receiver brand new and fully guaranteed.

£9/10—8-valve Console A.C. 100-250 volts, 3 bands, 16-52, 190-550, 900-2,000 metres, 6 watts undistorted output.

(This advertisement continued in third column.)



REDIFFUSION

One S.A. Receiver, six G.A. 12.S. Amplifiers, thirteen P.M. Speakers, and about half-a-mile of wire. This was the equipment for distributing the Coronation Broadcast to forty rooms.

We do not often ourselves undertake "rediffusion"; but that was a special job: the owners of the building were at the head of the Electrical Industry, and the guests were a specially distinguished gathering—so they came to us.

And we were able to satisfy them completely by the supremely lifelike reproduction given by our standard apparatus—just the same goods that we offer you. So whatever you want in faithful apparatus, ask for it—with two exceptions:

We don't touch battery-driven gear, nor short waves.



HARTLEY TURNER RADIO LTD.,

THORNBURY ROAD,
ISLEWORTH, MIDDLESEX.

Telephone: HOUnslow 4488

ENGINEERING OPPORTUNITIES

This unique Handbook shows the easy way to secure A.M.I.C.E., A.M.I.Mech.E., A.M.I.E.E., A.M.I.A.E., A.M.I.W.T., A.M.I.R.E., and similar qualifications.

WE GUARANTEE—NO PASS—NO FEE.

Details are given of over 150 Diploma Courses in all branches of Civil, Mech., Elec., Motor, Aero, Radio and Television Engineering, Building, Government Employment, etc. Write for this enlightening Handbook to-day FREE and post free.

British Institute of Engineering Technology, 387, Shakespeare House, 17, 18, 19, Stratford Pl., W.1.

FREE 268 PAGES

WESTINGHOUSE

METAL RECTIFIERS

for Reliability

WESTINGHOUSE BRAKE & SIGNAL CO. LTD. 82 YORK RD. KING'S CROSS, N.1

ADVERTISEMENTS for these columns are accepted up to **FIRST POST** on **MONDAY MORNING** (previous to date of issue) at the Head Offices of "The Wireless World," Dorset House, Stamford Street, London, S.E.1, or on **SATURDAY MORNING** at the Branch Offices, 19, Hertford Street, Coventry; Guildhall Buildings, Navigation Street, Birmingham, 2; 260, Deansgate, Manchester, 3; 26a, Renfield Street, Glasgow, C.2.

The proprietors are not responsible for clerical or printers' errors, although every care is taken to avoid mistakes.

For particulars of Box Number Advertisements and Deposit System see previous issues.

NEW RECEIVERS AND AMPLIFIERS

(This advertisement continued from first column.)

£12/12—10-valve chassis and 12in. Magnarox 66 speaker, A.C. 95-267 volts, 20-60 cycles 5 bands, 12-2,050 metres, push-pull output 10 watts, Neon tuning device; or in table model cabinet, 14 gns.; Console 43½x24x13, 16 gns.; radiogram with automatic changer, £28.

£35—24-valve Lafayette twin chassis and 2 speakers, 5 bands, 8-2,000 metres, 30 watts undistorted, or in radio gram cabinet with automatic changer, £50.

£37/10—24-valve Garod twin chassis and 2 public address speakers, 5-2,000 metres, 60 watts undistorted, or in massive console cabinet, high 4ft. 2in., wide 2ft. 4in., deep 1ft. 3in., £7 extra; cabinet alone worth £20.

27 Gns.—Midwest D.D.18 Console, 6 bands, 4½-2,050 metres (1 only).

£60—Midwest 24-valve Royale Console twin chassis and 3 speakers, 6 bands, 4½-2,050 metres (1 only).

DEGALLIER'S, Ltd., 18, Connaught St., Marble Arch, London, W.2. Telephones: Paddington 2745 and Bayswater 5732. [4469]

A
AIR KING.

ALL Models Feature Beam Tuning, Magic Eye indicator, grammo. pick-up connections, and special output valves.

ALL Sets Fully Guaranteed; H.P. terms available from 3/- per week.

WHOLESALE and Trade Enquiries Invited; generous terms.

ALL Types of American Valves Stocked; write for lists to

AIR KING RADIO, 115, Shaftesbury Av., Cambridge Circus, W.C.2. Phone: Temple Bar 4875 (2 lines); All receivers assembled in England. [3406]

A.

HILL and PONDER Offer Crosley 8-, 9-, and 10-valve Jobs, with 5 bands, 13-2,000 metres, chassis or complete in table, Console or radiogram cabinets, at approximately 50% off original prices; also a limited number of British Decca receivers.

TYPE 400 A.C./D.C., 2 bands; £6.

TYPE 550 A.C. 6-valve, 2 bands; £7.

TYPE 510, 2 bands, A.C. radiogram; £13.

TYPE 520, 3 bands, 6-valve A.C.; £8.

ALL of the Above Receivers are Brand New and Covered by the Usual Guarantee.

HILL and PONDER (Dept. W.W.D.), No. 9, Lancaster Mews, London, W.2. [4470]

ALERT RADIO Co.

"COMMUNICATION," "Shortwave" and "Allwave" Receivers.—21, East Rd., N.1. Clerkenwell 4371. [4381]

ROYAL RADIO Co.

ALL-WAVE Receivers, suitable for use on ships, as supplied to officers of many shipping lines.

OUR 8 and 10 Metal Valve All-wave Receivers; 15-2,000 metres, acknowledged by the trade as the best for range, tone, and general performance.

LATEST 6-valve Car Radio, A.V.C., remote control, no suppressors required.

AFULL Range of the World Famous Emerson Receivers for Export.

ALL Sets Fully Guaranteed by Ourselves.

ALL Types of American Valves Stocked.

PAY Us a Visit Any Time, or send for full range catalogue; 1/6d. stamp will be appreciated.

ROYAL RADIO Co., 5, Buckingham Rd., South Woodford, London, E.18. Phone: Buckhurst 2736. [4487]

"SERVICE With a Smile."

HENRY FORD RADIO, Ltd.

ELECTRONIC House, 22, Howland St., Tottenham Court Rd., W.1. Museum 5675. [0511]

FOR the Finest Value in All-wave Receivers see McCarthy Advertisement on Edit. page 521.

MCCARTHY RADIO, Ltd., 44a, Westbourne Grove, London, W.2. Telephone: Bayswater 3201. [4468]

AMERICAN Wireless Receivers, valves and components.—Harmar Radio, 8, Clifford St., London, W.1. [0499]

TRANS-ATLANTIC RADIO Offer the Finest Value in All-wave Radio; prices on application; Midgets, from 55/-.—Trans-Atlantic Radio Co., 15, Percy St., W.1. Museum 3096. [4484]

AT LAST!

A Speaker with Something Missing.

It is usual to claim all kinds of good qualities for all kinds of Loud-speakers, Good, Bad and Indifferent. Every speaker according to its claims appears to have something that the other hasn't, so just to be as contrary as we possibly can, we propose to claim that our speaker has something missing and we are very proud of it.

The missing item is purely RESONANCE. Thanks to a special form of Dual Suspension (Patents Pending) we maintain that the Sound Speaker will handle a greater input than any other speaker, before showing signs of resonance.

If you want to try this out, listen to speech on every other speaker, listen to Organ Music at about 12 watts on any other speaker, then come and buy the SOUND SPEAKER, they are different. By no means a perfect speaker, but not quite so many faults as you have been accustomed to in the past.



SOUND SALES

MARLBOROUGH RD., UPPER HOLLOWAY, LONDON, N.19. (Contractors to the G.P.O., etc.) LIMITED. Tel.: Archway 1661/2/3

A Six Valve All-Wave Record-Changing Radiogramophone for 22 Gns.!

This Radiogramophone provides dependable World-Wide Radio Reception together with high quality gramophone reproduction. The latest type of Garrard Record Changer is incorporated, capable of taking eight 10 inch or 12 inch records.

Brief Specification of Receiver.

Six valve all-wave superheterodyne, with B.V.A. valves, octode frequency changer, I.P. stage, double diode triode, 3.5 watt output pentode and rectifier. Intermediate frequency 465 kc. Airplane dial, having principal short-wave stations marked—thereon, in addition to the usual medium and long wave stations. Tone control and volume control—ranges 16-80, 200-550, 800-2,000 metres. For operation on A.C. or D.C. 200-250 volts.

The cabinet is of artistic design, and well-finished in Walnut veneer. Size—32 inches long, 18 inches wide, 33 inches high.

A. Rola P7 Speaker is fitted.



This Radiogramophone can be supplied without record changer at £18.10.0. If required for A.C./D.C. Universal, the price will be 30/- extra in each case. Table Model 29.15.0. A.C. or A.C./D.C. Hire-purchase terms are available on these units, and we have prepared a scheme for Radio Dealers. We will be pleased to give details on application.

CHAS. F. WARD, 46, Farringdon Street, E.C.4. Tel.: Holborn 9703.



TANNOY

THE SOUND PEOPLE

GUY R. FOUNTAIN LTD.
CANTERBURY GROVE, WEST NORWOOD,
LONDON, S.E.27. Phone: Sir. (122 G lines).

SOUND AMPLIFYING EQUIPMENT

NEW RECEIVERS AND AMPLIFIERS

AN GLO AMERICAN RADIO, Ltd., offer you the radio receiver of the century at 50% saving, but you must order or get in touch with us now.

50%—We are only able to offer this extraordinary saving for a very limited period now; stocks of present consignment are running low and it is now definite that we shall be unable to repeat at less than list prices.

HERE is the World's Finest Receiver at an Amazing Price; the new Crosley outperforms all the multi-valve receivers of the day.

AMAZING Signal to Noise Ratio is the Keynote to the Phenomenal All World Reception; it is a revelation to all who hear it.

AMERICA Received Night After Night With Volume Set Almost at Minimum without trace of background noise.

CUSTOMERS Everywhere Delighted, say they cannot buy a better radio for £60.

£12/19/6—10-valve High Fidelity 5-band (13.31, 30-80, 75-200, 200-555 750-2,000 metres), A.C. 97-250 volts, 10 watts undistorted output, metal valves, pre-H.F. stage all bands, A.S.C. (automatic selectivity control), push-pull output, provision gramo., doublet, Super A.V.C. Meter calibration airplane dial, band-spread pointer, S.W. calibration; you cannot buy a better set, double the number of valves or three times the price; your price, £12/19/6; with 12in. American Magnavox speaker, £15; table model, £18; Console, £20; Auto Radiogram, £35; cash or c.o.d.; part exchange quotations given.

9- and 8-valve 5-band Chassis Also Available; 8-valve with speaker, £12; 9-valve ditto, £14.

£6/19/6—Limited number Crosley 6-valve 3-band A.C. chassis; a magnificent job at approximately 50% saving; complete in table cabinet, few only £7/10; and consoles, £7/19/6; 100-250v. 4 watts output.

£6/19/6—Our new 6-valve superhet. communications receiver, 10 bands covered 7.2-100 metres, Model Dxl6, complete outfit, all parts, drilled chassis, 8in. dial, coils, metal shroud finish cabinet, 6 matched universal valves, 8in. speaker and full instruction booklet; wired and aerial tested, £1/5 extra; unequalled in appearance, performance and value, employs highly efficient circuit, with electron coupled oscillator variable Mu. L.F.s, powerful 3-stage audio amplifier, continuous coverage, 8in. band-spread dial, control for C.W., operates from A.C./D.C. 100-250v., an unequalled bargain; order now, cash or c.o.d. (carriage 2/-); terms available.

UNPRECEDENTED Cash Bargains at Fraction of Usual Value; send order now cash or c.o.d. (Post 1/-)

50/-—Multi-band (7-2,000 metres) communications outfit, battery, valves, 8in. speaker, metal cabinet, 7in. band-spread dial, with S.W. station names and listening times, together with 8in. world rotating globe.

37/6—Powerful 3-valve Pentode all-wave battery chassis, 12-2,000 metres, gramo., band-spread, 7in. dial, S.W. station names, complete with valves, aerial tested.

21/-—Superheterodyne short-wave converter, 7-200 metres, 5in. dial with band-spread, operate in front of any superhet. or H.F. receiver, mains or battery, complete with valves and cabinets, aerial tested.

H.P. Terms Offered With the Following Exceptional Values; deposit with order secures delivery.

11/1 With Order, 16½ gns. cash.—The amazing new Decca, 6-valve all-wave (3-band) portable A.C./D.C. superheterodyne, 19-2,000m. 2-speed 7in. airplane dial, station names, A.V.C. (18 payments of 11/1).

20/6 With Order, 16½ gns. cash.—The magnificent Ferguson 11-valve 4-band, 12½-2,100 metres, 8 watts output, Rola 10in. speaker in beautiful acoustically designed table cabinet (20/6 down, balance over 18 months.)

DEMONSTRATIONS Arranged Within Reasonable Distance of London, or at any time at our new showrooms at 39-41, New Oxford St. Otherwise order with confidence, your satisfaction is guaranteed.

4d. Stamps Enclosed Brings Our New Coronation Year Catalogue, fully illustrated and covering every radio need and the finest radio values obtainable. You must get your copy now. Thousands distributed.

ANGLO AMERICAN RADIO (AND MOTORS), Ltd., (Dept. W.19), Albion House, New Oxford St., London, W.C.1. Telephone: Temple Bar 3231. [4494]

PILOT, Ferguson, Belmont, Pegasus, and Air King all-waves lead the field, our deliveries are prompt in original cartons, with full guarantees; your trade card will bring our wholesale catalogue from the authorised distributors.—Leonards Heys, 76, Henry St., Blackpool. [0530]

COMMUNICATION Receivers, Hammarlund, National, Hallcrafters, R.M.E.69, Tobe-Deutschmann; transmitters, Collins 45A, Peerless DX20, or built to order; American valves, microphones, Eddystone components.—A.C.S., Ltd., 52-4, Widmore Rd., Bromley. Phone: Ravensbourne 0156. [0550]

RECEIVERS AND AMPLIFIERS CLEARANCE, SURPLUS, ETC.

ALL Lines Previously Advertised Still Available.

HENRY'S, 72, Wellington Ave., N.15. Stamford Hill 2907. [4435]

6-VALVE All-wave Superheterodyne, walnut cabinet, speaker, complete as new; £7/10.

F. M. HILLS, 32, Robin Hood Lane, S.W.15. Kingston 3856. [4444]

CLEARANCE List (Trade Only).—Write Leonard Heys, 36, Henry St., Blackpool. [0527]

PEERLESS Chassis De Luxe Model 1938, 11 valves, 12½ gns.; speaker, 5 wavebands, 18 watts output, specially made for short wave reception, list £18/18, my price £10/10; send for list.—Kay, 21, Prince of Wales Rd., Norwich. [4485]

RAYMART

CRAFT A CREED

SHORT WAVE AND SERIES GAP CONDENSERS

Short-wave Type V.C.1. The use of extension brackets is obviated in the construction of these highly efficient all brass condensers, the whole assembly is fitted on a steatite base, no other insulation being used. Noiseless operation is secured through pig tail connection being taken to point of lowest potential.

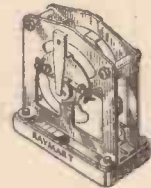

Series Gap Type V.C.2. These condensers may be used at 1,000 volts or as split stator at 500 volts; they may also be employed as two gang '00015 (Bridged Matched).

TYPE V.C.1.
-00015 mfd., 4/6.
TYPE V.C.2.
-00015 mfd., 5/-.

RAYMART SHORT-WAVE MANUAL AND CATALOGUE.

48 pages in all, 32 on receivers, transmitters, aerials, circuits, etc., etc., and 16 on a splendid range of short-wave components, 6d., or post free, 7d. 16 Page Short-wave Catalogue only, 1d.

MICROVARIABLES.—All brass construction, latest ceramic insulation. The finest condensers made: 15 mmfd., 1/4; 40 mmfd., 1/7; 100 mmfd., 1/10; Transmitting Type.—070in. spacing, 15 mmfd. (neutralising), 2/9. 40 mmfd. Tuning, 3/6. These are quality.

SHORT-WAVE COILS.—(RD4), CA 11-25, CB 20-45 metres, 2/6. CO 34-100 metres, 2/9. Standard 6-pin types, CA6, CB6, 2/9 each; CC6, 3/-; same range as 4-pin.

COILFORMS.—Moulded in RD4 natural lola material, hollow resilient pins, 1 1/2in. diameter, ribbed; identification disc in top. Four types, 4-pin, 1/6; 6-pin (standard or to fit 7-pin valveholders), 1/9; 7-pin (for bandspread tap), 1/10; Machine threading, 2d. extra.

AMERICAN Mains Transformers, Heavy Duty 350-300v., 150 m.a. 5/3; 4in. 4in., 5v. 3a., 12/3. CB 350-350 v. 80 m.a., 2.5v., 4.5a., 5v. 2a. 6/11. Malesic, 250-250 2.5v., 5v., 4/11; Pilot 360-260, 2.5 v. C.T., 5 v. C.T., 5/11. Ceramic American Valveholders, 1/- each.

HEAVY DUTY Mains Transformer, worth 45/-, 350-330, 150 m.a., 4 v. 2.5 A. C.T., 4 v., 6 A C.T., 12/6; Phillips 270-270, 120 m.a., same LT's 6/6; Speaker Transformers, 2/6.

UTILITY 8/8 Microscopic Dials, 3/11; Radiophone, 0.00016 Shortwave Condensers, 3/6; Series gap twin, 3/9. Shortwave HF Chokes 5-100 metres, 9d.

465 KC Litz Wound IP's, 3/11; Two-speed slow-motion knobs, 1/-; Telson Ace Transformers, 1/11; Telson Screened S.W. H.F.C., 1/-; Iron Core H.F. chokes, 1/-.

ELECTROLYTICS. Huge purchase 500 v. Aluminium Can, 4 mf., 1/6; 8 mf., 1/11; 8 x 8 mf., 2/6; Block type, 500 v. peak, 4 x 4 mf., 1/8; 8 x 8 x 4 mf., 3/-; 50 mf. 50 v., 1/3; 25 mf. 25 v., 1/-; Tubular Condensers, 1,500 v. T., all sizes to 0.1 mf., 6d.; 0.2 to 0.5 mf., 8d.

FAMOUS CONTINENTAL A.C. Valves, 4/6; Battery types from 2/3; American Duotron, etc., all types, 3/6; all types of RCA Licensed first grade tubes, metal and glass, in stock from 5/3.

BRITISH RADIOPHONE, 0.0005 straight or superhet 3-gang hollow screened condensers with trimmers, 4/11; Utility Midget 2-gang ditto, 3/11; S.I. Dial to suit above, 2/11; Utility 2-gang Unlknob 0005 with Dial, 3/11.

PUSHBACK Wire, 6 yds., 6d.; heavy, 9d.; Resin-cored Solder, 6ft., 6d.; Serrated Flex, single, 6d. yd.; twin 9d. yd. Assorted Rolder Taps, 6d. packet.

SMOOTHING CHOKES, 20 hy., 120 m.a., 3/11; 200 m.a., swinging chokes, 8/6; Centralab Pots, all sizes, 1/6; switched, 2/-; 20,000 ohm Pots, 1/-; Tubular glass fuses, 2d. Milliammeters, 25 m.a. upwards, 5/9; super, 6/9.

SPECIAL OFFERS. Class B Kit, worth 30/-, comprising Driver Transformer, Valve and Holder, 5/-; Dozen wire-wound assorted resistors, 1/8. Order 5/- post free. Get our Bargain Catalogue, 11d. post free. All enquiries and requests for Catalogue must send 11d. stamp.

BIRMINGHAM RADIOMAT (G5NI)
44, HOLLOWAY HEAD,
BIRMINGHAM TELE: MID. 3254



SOUND AMPLIFYING EQUIPMENT

Including the:—
Latest Development in Moving Coil and Metal Diaphragm Horn Type Speakers.

THE FINEST TONAL QUALITY IN THE WORLD

BTH RUGBY

THE BRITISH THOMSON-HOUSTON COMPANY LIMITED, RUGBY, ENGLAND.

RECEIVERS AND AMPLIFIERS,
CLEARANCE, SURPLUS, ETC.

ARMSTRONG Co. Have a Further Few Soiled but Genuine Brand New Radio Chassis for Disposal at Considerably Less Than Cost Price, described hereunder.

ARMSTRONG 1937 9-stage Radio-gramophone Chassis, covering 4 wavebands from 12.9 metres, circuit H.F. Pentode as radio frequency amplifier, tuned H.F. transformer coupled to hexode triode, detector oscillator, 2 band-pass coupled I.F. amplifier stages, double diode triode, detector and L.F. amplifier, push-pull output stage capable of handling 6 watts, highest grade components used throughout, "Airplane" multi radio drive, all wavebands calibrated station names, tone control works on both radio and gramophone, provision for extension speaker, etc.

SEVERAL Chassis as Above, brand new, but chassis slightly marked; price, complete with Mullard valves, 9 gns.; an exceptional opportunity.

ARMSTRONG Co. Also Offer Few Genuine 1937 Armstrong 6v. All-wave Superheterodyne Radiogram Chassis, brand new but cellulose slightly marked, complete with new full size Rola moving coil speaker and 6 new and fully guaranteed Marconi or Mullard valves; these chassis are the well known 3BPT models containing high grade British components, are ganged and aerial tested, and ready to switch on; price £6/10, complete.

ARMSTRONG Co. Have Technical Data Sheets Available.

ARMSTRONG Co. Will Willingly Send Above Chassis on 7 Days' Trial, carriage and packing free.

ARMSTRONG MANUFACTURING Co., 100, King's Rd., Camden Town, N.W.1. [4343]

CAR RADIO

PHILCO Repairs and Installations, trade distributors.—Radiorite, Ltd., Moorfields, Liverpool. Bank 8811. [4456]

PUBLIC ADDRESS EQUIPMENT

ANGLO AMERICAN RADIO, Ltd., offer the finest range of amplifiers, microphones, and portable public address equipment.

LOWEST Prices in the Country for Highest Quality Equipment; every amplifier fully guaranteed 2 years.

HIRE Purchase Terms; 20% down, with balance over 12 months.

£5/19/6—4.5-watt A.C. amplifier, tone volume controls, mike, speaker sockets, etc., 200-250v., absolutely complete with valves, guaranteed 2 years.

£14/14—Portable microphone and gramophone unit, 4.5-watt A.C. amplifier, Garrard motor, auto stop, Rola speaker, super quality double button microphone, leatherette case 18in.x15in.x11in., weight 25lb.

£19/19—6-watt A.C./D.C. unit, otherwise as above but with moving coil microphone, wonderful value.

4D. Stamp Brings Complete Catalogue Amplifiers, equipment and accessories, radio receivers and equipment; see also advertisement under New Receivers section.

ORDER Now; terms, cash or c.o.d., carriage on above 3/-; your satisfaction guaranteed.

ANGLO AMERICAN RADIO (AND MOTORS), Ltd. (Dept. W.P.1), Albon House, New Oxford St., London, W.C.1. Demonstration rooms at Banham House, 39, New Oxford St. Telephones: Temple Bar 3231, 9821. [4493]

SPECIAL Offer!!!
81 Gns. Complete—Vortexion portable 15-20 watt 4-stage amplifier, independent mike and pick-up inputs, outputs for 7½ and 15 ohm speakers, weight 25lb., 4 independent input model, £10.

HEAVY Duty 20 watt model, as fitted to dance halls and cinemas, etc.; £15, complete with valves.

60 Watt Model for 6L6s, with microphone and gramophone independent inputs, and outputs for 4, 7½, 15 and 50 ohm speakers, consumption 150 watts, in ventilated steel carrying case; £24 only complete with valves less two 6L6s.

WHY Not Call and Have a Demonstration.

VORTEXION, Ltd., 182, The Broadway, Wimbledon, S.W.19. Phone: Lib. 2814. [4254]

ALL Types of Public Address Apparatus for Sale or Hire.
WARD, 46, Farringdon St., London, E.C.4. Tel.: Holborn 9703. [0555]

USED for Coronation Only—Rothermel-Brush crystal mike, list £5/19/6, bargain, £4.—Wiles, 120, High St., Huntingdon. [4467]

ARMSTRONG Latest Coronation 30-watt Public Address Amplifier, incorporating 3 input circuits and self contained Fader system; both microphone stages have a total gain of 97db. and are electron coupled; this apparatus is particularly suitable where large output is required; price complete, 16 gns.; British throughout.

ARMSTRONG 10-watt High Fidelity Amplifier, suitable for indoor public address or gramophone reproduction, two inputs, controlled by self contained Fader unit, tone control working on both inputs, Class A push-pull output; British throughout; price complete with valves, etc., 9 gns.

ARMSTRONG, 100, King's Rd., Camden Town, N.W.1. Phone: Gulliver 3105. [4384]

USED SETS FOR SALE
AND WANTED

MURPHY

1936 Murphy A.C. Console, little used, genuine; £7/15.—48, The Warren, Heston, Middlesex. [4471]

Notes

No. 40.

on the Suppression
of Electrical Interference
with Broadcast Reception

It is surprising how many letters come to us which indicate that more than one receiver is being used in one house. Many readers of these Notes have a receiver in their own den for DX or other amateur or experimental work, and a second receiver for the entertainment of the household. Then sometimes a separate receiver is required for the kitchen or nursery.

Normally two receivers cannot be worked off one aerial, because if someone alters the tuning of one of the receivers, the other is affected. This interaction is even noticeable when two aerials are in close proximity.

With an "Eliminoise" anti-interference aerial up to ten receivers may be used, each being tuned to the same or different programmes and without interaction. Provided the span of the aerial has been erected outside the field of interference, the absence of radiated "plops" and "crackles" will be an agreeable improvement.

(From the foregoing it will be obvious that neighbours in flats, detached or terrace houses may share an "Eliminoise." Those interested in this possibility are advised to refer to Notes Nos. 12 and 23, or to write to us for the book on the "Eliminoise.")

If there is any residue of interference this is almost certain to be reaching the receiver by conduction along the mains lead and calls for a mains filter in each set lead. You can try one without fear of spending money on something that may not work. Talk about it to your dealer or write asking for details of our C.O.D. offer.

The "Eliminoise" and the set lead suppressor are both efficient on all broadcast bands between 10 and 2,000 metres.

The "Eliminoise" is as easy to erect as an ordinary "L" type aerial and is similar in appearance. The type 300 set lead suppressor† has a patented filter in the earth lead which makes it much more efficient on all wavelengths and is merely plugged in, the work of a moment.

* "Eliminoise" (Trade Mark) Anti-interference Aerial. For all broadcast bands 10 to 2,000 metres, 35s.

† "C" type Shielded Cable, extra per yard, 10d. Extra set end transformers, each, 17s. 6d.

‡ Type 300 Mains Filter (with earth choke), for set lead, 21s.

Send for the book, "Interference Suppression," post free 1s. 2d., or for free copy of the "The Eliminoise System" and other relative literature.

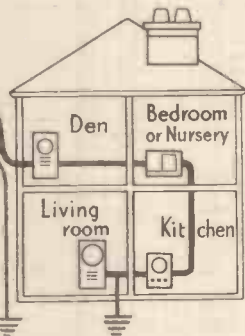

**BELLING-LEE
SUPPRESSION SERVICE**

Belling & Lee Ltd.
Cambridge Arterial Road,
Enfield, Middx.

Telephone: Enfield 3322.

USED SETS FOR SALE AND WANTED

WIRELESS WORLD AMPLIFIER

10-12 Watt Modified W.W. Amplifier, complete valves and Goodmans special high-fidelity speaker, cost over £22, as new; sacrifice, £10/10; demonstrated by appointment only.—48, Wakegreen Rd., Birmingham. [4480]

EXCHANGE OR WANTED

WANTED, recent Haynes 2HF, unit only, cash.—Maden, 17, Donnington Gardens, Scunthorpe. [4465]

NEW MAINS EQUIPMENT

VORTEXION Quality Transformers

VORTEXION Supply the B.B.C., G.P.O., L.P.T.B., I.C.I., Borough Councils, etc. Why not you? **ALL Fitted Screened Primaries**, and tapped 200-250v. with centre tapped filaments, guaranteed one year.

W.W. Q.A., 425-0.425v., 120-160 m.a., 4v. 5-10a., 4v. 2.5a., 4v. 1-2a., 4v. 1-2a., super shrouded model; 32/-.

500—0-500v. 150 m.a., 4v. 4a., 4v. 2.5a., 4v. 2a., 4v. 2a., 4v. 2a., super shrouded model, 2.5% regulation, 35/-; open type, 32/-; 400 or 450v., same price.

350—0-350v. 120 m.a., 4v. 2-6a., 4v. 2-4a., 4v. 1a., 4v. 1a., super shrouded, 25/-; normal shrouded, 21/-; open type, 18/6.

350—0-350v. 75 m.a., 4v. 2-4a., 4v. 1-2a., shrouded, 18/-; open type, 16/6.

250—0-250v. 60 m.a., 4v. 2-4a., 4v. 1-2a., shrouded, 15/-; open type, 12/6.

AUTO Transformers, 100-120 to 200-240v.; 80 watts 11/-; 120 watts 14/6, 200 watts 21/-, 500 watts 37/6.

CHOKES—30h. 60 m.a., 7/6; 713h. 120 m.a., 12/6; 30h. 150 m.a., 15/-.

OUTPUT Transformers—4-10 watt W.W. Q.A., 21/-; 20 watt super shrouded, 30/-.

VORTEXION, Ltd., 182, The Broadway, Wimbledon, London, S.W.19. (Telephone: Liberty 2814.) [3951]

TANTALUM for A.C. Chargers, H.T. and L.T.—Blackwell's Metallurgical Works, Ltd., Garston, Liverpool. [3984]

PARTRIDGE Transformers for P.A., radio, relay, transmitting, recording, talking, television, etc.—N. Partridge, B.Sc., A.M.I.E.E., King's Buildings, Dean Stanley St. London, S.W.1. [4372]

CABINETS

RADIOGRAM Cabinets, new designs, 30/- to £5/10; inspection invited or photos for selection sent on request.

TABLE Radio Cabinets, undrilled, 6/6 upwards.

SPEAKER Cabinets, 4/6 upwards.

MANUFACTURERS' Clearance.

ULTRA Radiogram Cabinets, undrilled, 33x23x14 or 33x20x15, 30/-.

BURGON'S "Fury" Radiogram Cabinets (undrilled), 34x22x16½, 29/6.

K.B. De Luxe Walnut Cabinets, undrilled, chromium plated edges and speaker grille, 25in. wide, 14½in. high, 10½in. deep, 18/6; Console model, 42in. high, 21½in. wide, 11½in. deep, 39/6.

HALYCON Radiogram Cabinets (Reconditioned), 33x23x19, 35/-.

H. L. SMITH and Co., Ltd., 287-9, Edgware Rd., London, W.2. Tel.: Pad. 5891. [0485]

DYNAMOS, MOTORS, ETC.

ALL Types of Rotary Converters in Stock, new and second-hand.

WARD, 46, Farringdon St., London, E.C.4. Telephone: Holborn 9703. [0518]

E.D.C. 230, D.C. 230, A.C. 90 watts, filter and cabinet complete, in perfect order; £7.—Graht, 61, Victoria Rd., W.8. [4476]

A.C.-D.C. 1- and 3-phase Motors, all voltages; from 14/9; list free. Repair specialists.—Easco, 18w, Brixton Rd., S.W.9. [0455]

G.E.C. Rotary Converter, 200-250 D.C. to 200-250 A.C., 200 watts, complete with smoothing equipment in silence cabinet; cost £28/10, accept £5/5.—Johnson Engineering, 86, Great Portland St., W.1. [4461]

NEW LOUD-SPEAKERS

BAKER'S Quality Surplus Speakers.

IF You are Requiring Quality Reproduction at Low Cost order one of the following brand new bargain speakers now. The Auditorium models are fitted with latest triple cone comprising main curved cone and bakelite and duralumin cones combined, giving wide and even frequency response, resulting in quality reproduction of speech and music. The Coronation surplus horn models are ideal for reproduction of transients.

39/6 Only, usual price £5.—Auditorium Permanent Magnet Speaker, with Alni magnet and die cast frame, large 12in. triple cone giving wide frequency range, complete with large 25 ratio transformer suitable for all outputs, including push-pull and Class B, etc.

59/6 Only, usual price £6.—Auditorium Electro-59/6 Magnet Speaker, 1,000, 1,250, 2,000 or 2,500 ohms field exceptionally large magnet of high permeability steel giving enormous flux density, 2in. moving coil, large triple cone giving wide frequency range, complete with universal transformer, the ideal speaker for use with "Wireless World" and other quality amplifiers.

75/- Only, usual price £9.—As above, but for use on A.C. mains; complete with Westinghouse rectifier and full smoothing equipment.

49/6 Only, usual price £6.—Coronation Surplus Horn Permanent Magnet Moving Coil Speakers, suitable for domestic or public address; the horn is of moderate size and the speaker is therefore ideal for home use where good reproduction of transients is required; can be used separately or in conjunction with baffle board speakers.

(This advertisement continued on next page.)

NEW LOUD-SPEAKERS

(This advertisement continued from previous page.)

- 15/6 Only.—Permanent Magnet Speaker, Alni magnet, 8in. cone. Universal transformer.
- 12/6 Only.—Permanent Magnet Speaker as above, with 7in. cone.
- 2/9 Only.—Brand new cabinets, 12x10x6.

8/6 Only.—Electro-Magnet Speakers, with 8in. cone, 6,500 ohms field. Universal transformer.

ALL Baker Quality Surplus Speakers are Sold for Cash or C.O.D.

BAKER'S SELHURST RADIO, Ltd., The Pioneer Manufacturers of Moving Coil Speakers, 1925-1937.—75-77, Sussex Rd., South Croydon. (Croydon 3441.) [4433

VAUXHALL.—Best quality speakers; see other column last week.—Vauxhall Utilities, 163a, Strand. [4490

LOUD-SPEAKERS

SECOND-HAND, CLEARANCE, SURPLUS, ETC.

BAKER'S 8in. Cone, 2,500 ohms, universal transformer; 12/-.—Woodyatt, R.A. Mess, Woolwich. [4473

VAUXHALL.—All speakers previously advertised are standard lines, ready for immediate delivery.—Vauxhall Utilities, 163a, Strand. [4489

TESTING EQUIPMENT

AVO Oscillator; £3/15; listed £6/15.

RADIOLAB Valve Tester; £5/5; listed £8/8.—451, Seven Sisters Rd., N.15. [4491

LYONS Hickok Oscillator, all-wave and 2-range output meter, cost £17/10; also Standard Telephones oscillator (batteries); offers.—Puga, Elm Grove, Hayling Island. [4477

VALVES

ANDERSON.

AMERICAN Valves, all makes, first grade only; 5/- each.

ANDERSON, 35, Lansdowne Rd., Walthamstow, E.17, Walthamstow 0827. [3351

6L6 3/9; all other popular types American valves. 3/-; 90-day guarantee.

EIMAC, Taylor, Raytheon and R.C.A. in stock.

RADIOGRAPHIC, Ltd., 66, Osborne St., Glasgow, O.1, Bell 848. [4387

AMERICAN Valves, first grade, in all types; trade supplied.—Metropolitan Radio Service Co., 1021, Finchley Rd., N.W.11. Speedwell 3000. [0436

ALL Types of American Valves in Stock of Raytheon, Sylvania, and Arcturus makes, at competitive prices, guaranteed for six months; send for full list; 350 ohms line cords, 2/8.

WARD, 46, Farringdon St., London, E.C.4. Tel.: Holborn 9703. [0452

NOTHING Better Available. Six months' guarantee; complete range of battery, A.C. mains, rectifiers, always in stock; 2 volt det., H.F., L.F., 2/3; Power, 2/9; screen grid pentode, H.F. pentode, 5/-; American types, six months' guarantee, 5/6 each, Nos. 18, 24A, 35, 42, 43, 45, 47, 56, 57, 58, 75, 77, 78, 80, 2A5, 2A6, 2A7, 6A7, 2B7, 6B7, 6C6, 6D6, 25Z5, 25Y5.—Write for other prices to Dulci Electrical Co., Devonshire Works, Duke's Av., Chiswick, London, W.4. [0501

METERS, ETC.

FERRANTI Meters, 500 moving coil single and triple range, 200 o/p/v and 1,000 o/p/v, new boxed discontinued types; approximately 75% off list.—Farnell, 12, Heaton Park Rd., Bradford. [4466

NEW COMPONENTS.

CELOPHANE for Home Recording and Microphone Kits from 9/6.—A. Hinderlich, 2, Bridge Rd., London, N.W.10. [4446

COMPONENTS

SECOND-HAND, CLEARANCE, SURPLUS, ETC.

R. RADIO CLEARANCE

ALL Lines Previously Advertised Still Available.

RADIO CLEARANCE, 63, High Holborn, W.C.1, Holborn 4631. [4398

PREMIER SUPPLY STORES.

PLEASE See Our Displayed Advertisement on this page. [0488

OSTAR-GANZ Amplifier, Pentodes, push-pull, cost 10 gns.; price £2/15.

MAGNAVOX 66 Loud Speaker, 1,250 ohms, new; £2/15; rectifier for same, £1/5.—Geudes, 44, Sandgate, Ayr. [4454

RYALL'S RADIO, 280, High Holborn, London, W.C.1, offer new goods at knock out prices.

AMPLIFIERS, with 6w. push-pull output, 3-stage, for AC200/250v., good chassis, complete, with 5v., 50/-.

BI Electrolytics, 12x8 ml., 350v., 1/8; NSF 25x26v., 6 3/4; NSF tubular tag ends, 0.15, non-inductive, 750v., 2/6 dozen.

PAIRS Ferranti Screened Coils, 2/6; Ferranti aerial coils, 6 3/6; Ferranti 3-range coils, 1/3; with circuits, chassis types.

FERRANTI Mains Transformers; as used in their commercial sets, 350-0.350v., 70 m.a., 4v. 4.5 a. C.T., 4v. 2.3 a. input, 200/250v., brand new; 6/6. [4464

GARRARD 202a Motor, complete, £1/6/6; B.T.H. pick-up, 9/6; Rothermel super-piezo ditto, new, £1/19/6; Ferranti A.F.5c, 12/6; list of others for stamp.

—43, Wakegreen Rd., Birmingham. [4481

PREMIER SUPPLY STORES

Offer the following Set Manufacturers' Brand New Surplus Goods at a Fraction of the Original Cost; all goods guaranteed perfect; carr. paid over 5/-; under 5/- postage 6d. extra. Orders under 5/- cannot be sent C.O.D. **ALL POST ORDERS TO**

JUBILEE WORKS, 167 LOWER CLAPTON RD., LONDON, E.5

CALLERS, AS USUAL, TO 165 & 165a, FLEET ST., E.C.4 (Next door to Anderton's Hotel). Central 2833. New Branch:—50, HIGH STREET, CLAPHAM, S.W.4 (Macaulay 2381).

Have you had our **GIANT ILLUSTRATED CATALOGUE AND VALVE LIST**? Send 4d. in **STAMPS** FOR THIS BARGAIN LIST.

FOR AMATEUR TRANSMITTERS!

Self-powered A.C.-D.C. 7 watt. C.W. 3 Tube Transmitter, using Triode as Crystal Oscillator. Wired and Tested on Metal Chassis, with Meter Tubes, Crystal (please state frequency required) and enclosed holder. With Key. Ready for immediate use - - - - **£4.4.0**

The New "Premier" Short Wave with Trolitul Insulation. Certified superior to Ceramic. All-brass Construction. 15 mmfd. 1/4; 40 mmfd. 1/7; 100 mmfd. 1/10; 160 mmfd., 250 mmfd. 2/6.

1937 1-VALVE SHORT-WAVE RECEIVER OR ADAPTOR KIT, 13- to 86 metres without coil changing. Complete Kit and Circuit, 12/6. VALVE GIVEN FREE!

DE LUXE MODEL 14 to 150 metres, complete Kit with Chassis, 4 Coils and all parts, 17/6.

1937 SUPERHET CONVERTER KIT, 13/6. DE LUXE MODEL, 18/6.

S.W. SUPERHET CONVERTER KIT for A.C. Mains Receivers, 20/-. A.C. Valve given FREE!

1937 2-VALVE S.W. KIT, 13 to 86 metres without coil changing. Complete Kit and Circuit, 19/6. VALVES GIVEN FREE. DE LUXE MODEL, 14 to 150 metres, complete Kit and Chassis, 4 Coils and all parts, 25/-. VALVES GIVEN FREE. 3-VALVE S.W. KIT, S.G. Det. and Pen., 42/-. VALVES GIVEN FREE!

MAINS VALVES, famous Europa 4 v. A.C. types, 4/6 each. H.L., L., S.G., Var.-Mu-S.G., H.F.-Pens., Var.-Mu-H.F. Pens. 1- and 4-watt A.C. directly heated output Pentodes. A.C./D.C. types. 20-volt 18 amp. S.G., Var.-Mu-S.G., H., H.L., Power, Pen, H.F. Pen and V.-Mu-H.F. Pen.

Following types all 5/6 each. Full-wave rectifiers, 350 v. 120 m.a. and 500 v. 120 m.a. 2 1/2-watt indirectly-heated Octode Pens., PX4 type, 6/6. D.D.T., 6/6.

BATTERY VALVES. 2 volts, H.F., L.F., 2/3. Power Super-Power, 2/9. S.G., Var.-Mu-S.G., 4- or 5-pin Pentodes, H.F. Pens., V.-Mu-H.F. Pens., 5/- Class B, 5/-.

American Valves. Genuine American HYTRON and TRIAD first-grade Valves. 3 months' guarantee. All types in stock, 5/6 each. 210 and 250, 8/6 each. New Metal-Glass Valves, all types, 6/6 each. Genuine American DUOTRON Valves, all types, 3/6 each. Valve holders for all above types, 6d. each. Octal bases, 9d. each.

PREMIER MAINS TRANSFORMERS, wire-end type with screened primaries, tapped 200-250 v. Centre-tapped Filaments. Guaranteed one year. H.T. 8 & 9 or H.T. 10 with 4 v. 4 a. C.T. and 4 v. 1 a. C.T., 8/6. 250-250 v. 60 m.a., or 300-300 v. 60 m.a., 4 v. 1 a., 3 v. 2 a., and 4 v. 4 a., all C.T., 8/6. 250-350 v. 120 m.a., 4 v. 1 a., 4 v. 2 a. and 4 v. 4 a., all C.T., 10/6. Any of these transformers with engraved panel and N.P. terminals, 1/6 extra. 500-500 v. 150 m.a., 4 v. 2.3 a., 4 v. 2.3 a., 4 v. 2.3 a., 4 v. 3.4 a., all C.T., 17/6. Super Model, 19/6. **AUTO TRANSFORMERS, step up or down, 60 watts, 7/6; 100 watts, 10/-.**

SPECIAL OFFER OF PHILIPS MAINS TRANSFORMERS. WITH TAPPED PRIMARY, 100-250 v., 500-500 v. 100 m.a., 4 v. 4 a. C.T., 4 v. 4 a. and 4 v. 3 a., 12/6. LIMITED NUMBER ONLY.

A NEW PREMIER TRANSFORMER, 350-350 v. 120 m.a., 5 v. 2.3 a. C.T., 6.3 v. 1.5 a. C.T., and 2.5 v. 3-4 a. C.T., with Panel and Terminals, 15/-.

MILLIAMMETERS, moving-iron, flush 2 1/2in.; all ranges from 0-10 m.a., 5/9. Visual tuning, 6 or 12 m.a., 5/9. Moving-coil meters, 2 1/2in. 0-1 m.a., 18/6; 3 1/2in. 0-1 m.a., 22/6. Multipliers, 1/- each. Ampmeters, 0-1, 3, 5, 10 or 20 a., 5/9.

ELECTROLYTICS. U.S.A., 4 or 8 mfd. 530 v. peak, 1/9 each. Duffier, 4 or 8 mfd. 500 v., 3/-; 50 mfd. 50 v., 1/9; 6 or 10 mfd. 50 v., 6d.; 25 mfd. 25 v., 1/-. T.C.C. 8 mfd. 650 v., 4/-; 15 mfd. 50 or 100 v., 1/-; 50 mfd. 12 v., 1/-. Carboard Electrolytics, 4 or 8 mfd. 500 v. peak, 1/6 each. Paper Condensers, W.L., 250 v. working 4 mf., 2/-; 2 mf. 1 - 1 mf. 8d.; 350 v. working 4 mf., 2/8; 2 mf. 1/6. Duffier 500 v. working 4 mf., 4/-; 800 v. 4 mf., 6/-.

P.O. PATTERN "MIKES," 3/9. "Suprovox," 6/6. Transverse current Mike, 30/-.

SHORT-WAVE COILS, 4- and 6-pin types. 13-20, 22-47, 41-94, 78-170 metres, 1/9 each, with circuit. Special set of 3-4-Pin S.W. Coils, 14-150 metres, 4/- set, with circuit. Premier 3-band S.W. Coil, 11-25, 10-43, 38-86 metres. Suitable any type circuit, 2/6. **COIL FORMERS, in finest plastic material, 1 1/2in. low-loss ribbed, 4- or 6-pin, 1/- each.**

CERAMIC S.W. VALVE HOLDERS, 4-, 5- or 7-pin. Chassis types, 6d.; B.B. type, 8d. **GLASS AERIAL INSULATORS, 4d. each. BEEHIVE STAND-OFF, 6d. each. SCREENED FLEX, single, 3d. yd.; twin, 4d. yd.**

H.F. CHOKES, S.W., 10-200 metres, 9d.

ALL-BRASS SLOW-MOTION S.W. CONDENSERS, .00015 tuning, 3/9; .00015 reaction, 2/9. British Radiophone 2-gang 2X .00016 all-brass S.W. Condensers, 5/6.

SPECIAL OFFER. LISSEN TWO-GANG SCREENED ALL-WAVE COILS, 12 to 2,000 metres, complete with switching and wiring diagram, 6/11 per set.

"LUCERNE" SCREENED IRON-CORED COILS, 200-2,000 metres. With circuit, 2/- each. TELSEN Screened Iron-cored Coils, W.349, 4/- each.

Reliable **MORSE KEYS** with Morse Code engraved on bakelite base, 2/- each.

Bakelite case **BUZZERS, 1/6; Walnut case, "Loud-tone," 2/6 each.**

Special Offer of MAGNAVOX MAINS ENERGISED SPEAKERS. D.C.136, 6 1/2in. diam., 6,500 meg. or 10,000 meg., 7/6. D.C.167, 8in. diam., 2,500 meg. or 6,500 meg. 9/6. Power or Pentode Transformer.

MAGNAVOX. Mains energised M.C. Speakers. "154," 7in. cone, 2,500 ohms, 12/6; "152," 9in. cone, 2,500 ohms, 17/6; "152 Magna," 9in. cone, 2,500 ohms, 37/6. Magnavox P.M.s.—"254," 7in. cone, 16/6; "252," 9in. cone, 22/6. TELSEN P.M.s with 10 ratio Transformers, 12/6. ROLA latest type P.M.s, 15/-; Jensen P.M.s, 10/6. **B.T.H. ENERGISED MOVING COIL, 10 1/2in. diam. 1,650 ohms field. Power or Pentode Transformer. (State which). SPECIAL LINE at 14/6.**

W.B. 1936 STENTORIAN SPEAKERS. Standard model (list, 32/6), 22 6. Senior model (list, 42/-), 28/6. Brand new in original sealed cartons.

3-WATT A.C. AMPLIFIER, 2-stage for mike or pick-up. Complete kit of parts with 3 valves, 40/-. Wired and tested, £2/15/-.

7-WATT A.C./D.C. AMPLIFIER, 3-stage high-gain, push-pull output. Complete kit of parts with 5 specially matched valves, £4/4/-. Completely Wired and Tested, £5/5/-.

10-WATT A.C. KIT, £5/5/-. Wired and tested, £7/7/-.

FERRANTI AF3 LF TRANSFORMERS. Used. Guaranteed perfect, 6/-.

COSSOR PARAFEEED TRANSFORMERS, 1/- each.

ORMOND .0005 SLOW-MOTION LOG CONDENSERS, air spaced, 2 1/11.

COSMOCORD PICK-UP HEADS, 4/6 each.

LINE CORD RESISTORS, 350 ohms, 2/6.

BELL TRANSFORMERS, for A.C. mains, 2/-.

LIGHTWEIGHT HEADPHONES, 3/- pair. Super Quality, 3/9.

PREMIER FULL-VISION DIAL, 10:1 and 150:1, 5/6. Utility 4in. Cursor Micro Dial, 100:1, 6/3.

ELECTRADIX

Bargains! Bargains! Bargains! Bargains!

This BATTERY SUPERSIDER provides H.T. from your L.T. 2-volt battery, rectified and smoothed. 3 tappings. A boon to those who are not on the mains. Reduced from £3 15s. New and Guaranteed, 37/6.

TELEPHONES for House, Office, Garage and Field Sports. Table, wall and waterproof portable. 5, 10, 30 and 100 watt Plug Boards. State your wants. We will gladly quote. Headphones, 2/9 pair.

HOME RECORDING. Electradix Home Recording with the all-bearing PEIGH Electric Recorder. Ball-bearing centre gear box and traverse rod; is the lowest-priced electric home recorder that will fit any gram. The set with tracking gear, pick-up, and tone-arm with diamond, 37/6. Gear only, 21/6.



CRYSTAL SETS for crystal-pure reception. Table type "A", 5/6. Double circuit type "B", 7/6. **HEADPHONES**, with cords, 2,000 and 4,000 ohms, 2/6. Single high res. car-pieces, 2/6. Sullivan 120 ohms, 2/9. **BELL PUSHES** in porcelain and brass. Big stock, all types, from 6d. English Bells, 2/-.

CHARGERS AND RECTIFIERS

WESTINGHOUSE Metal Rectifiers D.C. Type R. 200/220 v. A.C. to 110 volts 2 amp. D.C. Two circuits, 35 volts ea., 27 10s. WESTINGHOUSE "R" 200/250 v. A.C. to 200 volts 250 m.a. D.C., 27 10s. WESTINGHOUSE "B" 200/250 v. A.C. to 40 volts 1 amp. D.C., 25 10s. WESTINGHOUSE "R" 200/250 v. A.C. to 40 volts 3 amps. D.C., 27 10s. WESTINGHOUSE 200/250 v. A.C. to 15 volts 60 amps., 28 10s. E.C. 110 v. 50 cy. to 6 volts 5 amps., single circuit, 23. E.C. 110 v. 50 cy. to 12 volts 2 amps., single circuit, 22 15s.

E.C. 110 v. 25 cy. to 12 volts 3 amps., single circuit, 24. E.C. 110 v. 25 cy. to 6 volts 2 amps., single circuit, 23. **A.C. DAVENSET** 4 circuit ASC4 Charger for 80 cells, fully automatic, as new. 23 guinea set for £14. **DAVENSET GARAGE CHARGERS**, Type G.C. to 25 v., 6 amps., three circuits for 40 cells, 26 5s. Type S.P.C.L. DAVENSET, 230 v. A.C. to 230 v. 250 m.a. D.C., meter and regulator 26 17s. 6d.

55 X-RAY VACUUM DISCHARGE TUBES for 15- New Government Hospital Surplus. Tin. dia. lub. Big solid Tungsten electrodes. Emission guaranteed. COST 25/- SALE, 10/- Packing, 2/0 extra.

LIGHT AND RAY CELLS. Selenium Raycraft, 21/-; Kingston, 15/-; Raycraft outfit with relay and amplifier, 45/-; Photo-Cells, for sound on Film, Television and Ray work, R.C.A., 25/-; Beck, Angle Prisms, mounted in carrier, 5/6; Micrometer adjusters for lens, 1/-; Eyepieces with prism and lenses for photocell, 12/6.

ALUMINIUM PANELS for Transmitters and Receivers, substage or front. Heavy gauge flat and true, enamelled one side, black or brown, 18 gauge, 12in. x 12in., 3/-; 16 gauge, 3/10; 18 gauge, 12in. x 18in., 4/6; 10 gauge, 5/8; 18 gauge, 18in. x 18in., 5/6; 10 gauge, 6/4. Black Faxonite and Ebonite Panels, all sizes from 24 x 24in. Tubing and formers. **MEGERS AND OHM-METERS**, from 45 10/- Large Stock of Bridge Megers and Recording Ammeters, cheap.

Send for New Illustrated Electrical Bargain List "W"

ELECTRADIX RADIOS

218, UPPER THAMES STREET, LONDON, E.C.4. Telephone: Central 4611

OSTAR-GANZ

The only Universal Valves working direct from the mains, 100-250 volts. They have longer life, greater sensitivity, cheaper construction. No barretters and no biasing-down resistances required, no mains transformers needed. Guaranteed for six months. Why not build up a SET, RADIOGRAM, AMPLIFIER, TRANSMITTER or S.W. ADAPTOR with these Valves? We feel certain that with our free technical advice these facts will be proved. We offer generous part-exchange and H.P. Terms.

The High-Voltage Valve is ideal for use with all kinds of electrical appliances.

Ask for catalogue and free blue print.

EUGEN J. FORBAT Goschen Buildings, 12/13, Henrietta St., London, W.C.2. Telephone: Temple Bar 4965 & 6908.

Before you decide, see

HYVOLTSTAR

UNIVERSAL All Waves All Mains A.C./D.C. Receivers. Acknowledged the most Advanced Radio on the market. The many new and exclusive features incorporated will greatly interest the technician. Working on 100 to 250 volts A.C. or D.C. without alteration. Covers all wave bands from 13-2,000 m. Push-pull output stage, providing undistorted output of 6.7 w. Adjustable selectivity. Automatic silent tuning. Extreme sensitivity. Automatic Volume Control and Fading Compensation on all wave bands, even on ultra-short waves. Two-speed tuning as easy on short waves as on medium or long. Chassis Prices complete with Valves from 10/- gns. to 29 gns. Full details from Dept. P.M.

ALL MODELS CAN BE HAD ON APPROVAL

UNIVERSAL HIGH VOLTAGE RADIO LTD. Goschen Buildings, 12/13, Henrietta Street, London, W.C.2. Telephone: Temple Bar 4965 & 6908.

COMPONENTS—SECOND-HAND, CLEARANCE, SURPLUS, ETC.

V. VAUXHALL.
V. VAUXHALL.—Polar Midget 3-gang condenser, straight or superhet, 8/9; Polar full vision, horizontal or Arcuate dial and drives, 5/-.
V. VAUXHALL.—J.B. drives with station-named scale, latest type, complete, 5/6; T.C.C. tubular, 0.25 mfd., 9d.
V. VAUXHALL.—Flat, sheet aluminium, hard rolled, 18 gauge, 12in. x 12in., 3/-; 18x18, 5/6; other sizes pro rata.
V. VAUXHALL.—Hivac, Tungstam valves, full range; full discounts allowed from new prices.
V. VAUXHALL.—Polar station-named scales, for horizontal dials, latest settings; 1/9 each.
V. VAUXHALL.—Polar 2-gang condenser, 6/8; Colvern twin-gang iron core coils, on base with switch, 20/-.
V. VAUXHALL.—Colvern coils, G1, G2, G3 or G1, G2, and G8, superhet type, 30/-; Colpaks, £2/4; Polar drives, 5/-.
V. VAUXHALL.—Iron core coils, 3-gang, on base, with circuits, 17/-; B.T.H. Minor pick-ups, 13/3.
V. VAUXHALL.—All-wave tuning pack, 16.5 to 52 metres, medium and long waves; 87/6.
V. VAUXHALL.—Heayberd low frequency smoothing choke, 10 henrys, 120 m.a., fully shrouded; 11/6.
V. VAUXHALL.—Set manufacturers' surplus skeleton type Westinghouse rectifiers, H.T.B. 8/6; H.T.R. 9/-; H.T.10, 10/-; fixing brackets free.
V. VAUXHALL.—T.C.C. electrolytic condensers, 8 mfd. and 4 mfd., 550 volt, 3/-; 500 volt, 2/6; 450 volt, 2/5.
V. VAUXHALL.—T.C.C. condensers, tubular, non-inductive, 0.3, 6d.; 50 mfd., 50v. working, 1/6; 50 mfd., 12v., 1/3; 0.5, 6d.; 0.002, 0.002, 0.001, 0.001, 4d. each.
V. VAUXHALL.—T.C.C. mica, 0.002, 2,000 volt test, 1/-; 0.001, 4d.; 0.001, 1/-; 1 mfd. Mansbridge, 1/3.
V. VAUXHALL.—Resistances by well-known manufacturers, 1-watt type, 6d. each; all values.
V. VAUXHALL.—Centre tapped iron core I.F. transformers, bases, terminals, 110 k/c.; 6/6, guaranteed.
V. VAUXHALL.—Volume controls, Erie, Colvern, Centralab, 2/-; with switch, 3/-; all values, from 2,000 to 2 meg. 6d.; 6BA, screws or nuts, 4d. dozen.
V. VAUXHALL.—T.C.C. 200 mfd. 10v. dry, 2/6; 8 mfd., wet, 450v. working, 3/3; Westectors, WX6, 4/-.
V. VAUXHALL.—Colore A.C. electric motors, boxed, 28/-; similar model complete pick-up and volume control, 45/6.
V. VAUXHALL.—Universal motors, 52/6.
V. VAUXHALL.—Clix valve holders, terminals, 7-pin, 9d.; 5-pin, 7d.; 9-pin, ordinary, 9d.; baseboard, 4-5-pin, 6d.
V. VAUXHALL.—Post paid 2/6 or over, or cash on delivery 5/- minimum.
V. VAUXHALL UTILITIES, 163a, Strand, W.C.2, over Denny's, the Booksellers, Temple Bar 9338. Send postcard for lists free. [4488]

STANDARD RADIO SUPPLIES.—Bargains advertised May 14 still available.—Dantzic St., Manchester. [4463]

M. MAINS RADIO DEVELOPMENT COMPANY'S Amazing Reductions; carriage paid; call mornings.—Phone 4046. Stamp for list 204.
T. TUBULAR Condensers.—Very finest make, wire ends, 400 volt working, 0.0001-0.002 mfd., 2d.; 0.005, 0.01, 0.02, 0.05, 0.1 mfd., 4d.; 0.2 mfd., 6d.
S. SATOR Metal Cased Condensers, 400 volt working, 1 mfd., 7d.; 3 mfd., 1/-; 4 mfd., 1/8; Formo tag condensers, 0.0001, 0.002 mfd., 1/4d.
C. CLIX Latest Chassis Valve Holders, 4-pin, 1 1/2d.; 5-pin, 2 1/2d.; 7-pin, 4d.; 9-pin, 6d.; three-valve grey cellulosed metal chassis, 12 1/2 x 6 1/2 x 3 1/2 in., 1/-.
B. B.I.C. Metal Can, 8 mfd., 550 volt dry electrolytics, 2/3; Pye 20b. 120 m.a. boxed L.F. chokes, 4/6; Steatite short wave condensers, 0.00016 mfd., 1/6 only; Ormond efficient H.F. chokes, 6d.
C. CENTRALAB Unused Potentiometers, 500,000 ohms, 1/-, with switch, 1/9; 10,000 ohms, 1/3; Rotorohm, 10,000 ohms, with switch, 1/6; Cossor, 50,000 ohms, 1/3; any other size in Centralab, with or without switch, 2/3.
M. MAGNUM Unused 465 k/c I.F. Transformers, grey cellulose cased, trimmers, pigtail, 4/3 each.
R. RESISTORS.—Absolutely finest make, one watt, colour coded, wire ends, any size, 50 ohms to 5 megohms, your choice, 3/4d. each, 2/9 dozen; two watt, any size, 6d.
M. MAINS RADIO DEVELOPMENT COMPANY, 4-6, Muswell Hill Rd., London, N.6. [4462]

E. EPOCH Super Auditorium Speaker, 15in. diaphragm, 6 volt field, octagonal walnut baffle 1 1/2 in. thick, beautifully finished job, as new; 24/10, or offer.
A. ALSO Garrard Auto-changer in walnut enclosed case, hardly used; 4/4.
A. ALSO B.T.H. Senior Speaker, self-contained mains unit and rectifier valve, 220 volt mains; 30/-.—Mansell, Woodfield, Malvern, Worcs. [4472]
S. SOUTHERN RADIO'S Wireless Bargains.—All lines advertised in previous issues of "Wireless World" still available; complete new range of wireless bargains now in course of preparation and will be advertised shortly.
S. SOUTHERN RADIO, 323, Euston Rd., London, N.W.1 (near Warren St. Tube), and Branches. Telephone: Euston 3775. [4482]

C. COMPLETE Set New, unused components (best manufacturers) for 4,000 volt cathode ray television time base, described in "Television To-day," less valves, including drilled, engraved panel, baseboards, valve holders (mounted), 49 condensers, 75 resistors, 12 potentiometers, chokes, meter, high tension sleeving, transformers for 200-250v. A.C.; £10 or offer.—Woodyatt, R.A. Mess, Woolwich. [4474]

TRANSMITTING APPARATUS

G. G5N1.—The recognised distributors for amateur equipment, National, R.M.E., Thordarson, Hammarlund, McMurda, Hallicrafters, etc.; send 1/4d. stamp for catalogue.—Radiomart, 44, Holloway Head, Birmingham. [0531]

MISCELLANEOUS

C. CHEAP Printing.—1,000 billheads, 3/6; sample free.—Creteway Press, 18, Buxted, Sussex. [4312]
G. G.P.O. Engineering Dept. (no experience required). Commencing £3/13 per week; age 18-23; excellent prospects.—Free details of entrance exam. from B.I.E.T. (Dept. 574), 17-19, Stratford Place, London, W.1. [4371]

PETO-SCOTT
Transverse Current
MICROPHONE

For Public Address & Transmitting



A Carbon Microphone for home entertainment and all Public Address purposes. Transverse current type, giving excellent response at all frequencies. Carbon electrodes and finely graded carbon granules. Diaphragm of finest grade white mica, protected by metal grill. Microphone housed in attractive bakelite moulding.

The whole microphone assembly is supported on 4 sensitive springs attached to a chromium-plated ring, mounted on a black moulded base. Microphone connections are made to two terminals on back. On-off switch. 30-I microphone Transformer housed with a bias battery in separate bakelite moulding, giving greater efficiency and freedom from parasitic noises. Including 25ft. of heavy braided and twisted flex.

Cash or C.O.D.

£2:2:0

Height of Microphone Assembly 10 1/2". Size of Transformer 3 1/2" high; 5 1/2" wide; 3 1/2" deep.

Or 2/6 down and 11 monthly payments of 4/-.

6-7 Watt 4 Valve AMPLIFIER

Model AC 67 for use with above. Designed to eliminate parasitic oscillation in output stage. Fixed tone balance. For A.C. Mains 200-250 volts. Ready to connect to microphone. £4:10:0 Cash or C.O.D.

Or 7/6 down and 11 monthly payments of 8/6.

COMPLETE PUBLIC ADDRESS SYSTEM comprising Microphone, Transformer, Flex and Amplifier as above, with Energised 1250 Ohms Push-pull Speaker, Transformer, and 50ft. 4-way Speaker Lead. Cash or C.O.D. £8:7:6

Or 15/- down and 11 monthly payments of 15/6.

PETO-SCOTT Co. Ltd. 77 (W.W.28.) City Rd., London, E.C.1. 62 (W.W.28.) High Holborn, London, W.C.1. Est. 1919.

AMERICAN SET OWNERS INSIST ON

THE WORLD'S STANDARD VALVE



The Standard Valve for Standard Sets
FOR RELIABLE CONSISTENT PERFORMANCE

UNIVERSAL RADIO DISTRIBUTORS LTD. 24, FITZROY SQUARE, LONDON, W.1.

REPAIRS AND SERVICE

GRAHAM'S
GRAHAM'S Radio, Repair and Rewinding Service; 24 hours' service guaranteed.—See below.
ALL Moving Iron Loud Speakers, L.F. transformers, or pick-ups, from 2/6, output transformers from 4/-; postage extra; mains transformers, moving coils, electric clocks quoted, trade discounts.—Graham's Repairs, 194, Tolworth Rise, Kingston By-pass, Surrey. Phone: Derwent 2060. [4367]
DISTAVOX SERVICE
GUARANTEED Service.—All makes of English and American receivers; quotation by return.
REWINDING.—Mains, L.F. and output, transformers, speakers, headphones, etc.; keenest terms for contracts.
DISTAVOX RADIO SERVICE Co. 119, Bunhill Row, London, E.C.1 Phone: National 8589. [4363]
SERVICE WITH A SMILE.

HENRY FORD RADIO, Ltd.—American valves, components, spares, line cords; leading trade repairers; send us your American and British receivers.—Electronio House, 22, Howland St., Tottenham Court Rd., W.1. Museum 5675 [0434]
METROPOLITAN RADIO SERVICE Co. for Guaranteed Repairs to American (Midget and Standard and British Receivers).
CLARION and Majestic Service Depot.—I.F. and mains transformers rewound. American valves and parts; trade supplied.—Metropolitan Radio Service Co., 1021, Finchley Rd., London, N.W.11. Speedwell 3000. [0435]

REPAIRS, rewinds and construction, any size transformers, chokes, etc., to trade.—Felectric, Garden St., Sheffield, 1. [3915]
FOR Unusually Good Rewinding of Transformers, chokes, speakers, etc., trade only.—Gardners Radio, Ltd., West Southbourne, Bournemouth. [0551]
LOUND Speaker Repairs, British, American, etc.; any make transformer coils rewound; alterations.—Sinclair Speakers, Alma Grove, Copenhagen St., N.1. [4451]

OUR Technical Department is at your Service.—Air King Radio, 115, Shaftesbury Av., Cambridge Circus, W.C.2. Phone: Temple Bar 4875 (2 lines). [3963]
GUARANTEED Repairs.—Any transformers, choke, motor, armature, converter, dynamo, etc.; keenest prices, immediate quotation; prompt, dependable service.—See below.
L.T.P. (LONDON TRANSFORMER PRODUCTS, Ltd.), Willesden, N.W.10. Willesden 6486 (3 lines). [3470]

POULTNEY and PURVIS, British and American Service, trade or private; "W.W." sets a speciality; free collection, estimates.—147, Pitshanger Lane, Ealing, W.5. Perivale 3765. [4362]
MAINS Transformer Service.—Repairs, rewinds, or constructions to specification of any type; competitive prices and prompt service.—Sturdy Electric Co., Dip-ton, Newcastle-on-Tyne. [0516]
TRANS-ATLANTIC RADIO for Repairs to Any Type of Radio, British or American; trade work a speciality; estimates free.—Trans-Atlantic Radio Co., 15, Percy St., W.1. Museum 3096. [4483]

F. E. GODFREY, A.M.I.R.E., qualified to build, repair and convert "Wireless World" sets, etc.; 25 years' experience, prompt service guaranteed.—30, Kemplay Rd., Hampstead, Hampstead 1104. [3509]
REPAIRS to Moving Coil Speakers a Speciality; cones and coils fitted, fields altered; prices, including eliminators, quoted, loud speakers, 4/-; L.F. and output transformers, 4/- post free; guaranteed satisfaction; trade invited; estimates free; prompt service.—Loud-Speaker Repair Works, 5, Balham Grove, London. Battersea 1321. [0394]

EXTENDED PAYMENTS

LONDON RADIO SUPPLY Co. (Established 1925). I supply on convenient terms, components, accessories and sets, any make, 10% down, balance over 12 months; send for list of requirements.—11, Oat Lane, London, E.C.2. [0337]
HIRE-PURCHASE.—Prompt delivery of any radio apparatus on convenient terms.
WARD, 46, Farringdon St., London, E.C.4. Tel.: Holborn 9703. [0539]

ELECTRIC CLOCKS

SMITHS and Ferranti Electric Clocks, Waltham and Russell watches and clocks; traders' enquiries invited.—Leonard Heys, 36, Henry St., Blackpool. [0526]

EXCHANGE

IBUY, sell, exchange good quality receivers, accessories, components; H.P. facilities; promptness, efficiency.—Bostock, 1, Westbourne Terrace, S.E.23. Forest Hill 2236. [0529]

PATENT AND TRADE MARK AGENTS

GEE and Co. (H. T. P. Gee, Mem. R.S.G.B., A.M.I.R.E., Estab. 1905), 51-52, Chancery Lane, London, W.C.2 (2 doors from Government Patent Office). Holborn 4547 (2 lines). Handbook free. [0001]

BULGIN

AC/DC WATTMETER
 The consumption of any apparatus may be easily and quickly measured by plugging this meter in circuit. Direct reading on all mains, 200-250 v.
 No. U.M. 12 0-250 Watts
 No. U.M. 14 0-125 Watts
17/6 each.



METERS

VISUAL TUNING METERS
 These strongly made meters give full scale deflection at 6 mA. Bobbin 5,000Ω approx. With walnut bakelite escutcheon. Vertical or horizontal mounting.
 List No. 8/9 each.
 V.T. 50 8/9 each.

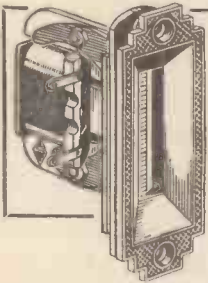

Send for Catalogue!

To A. F. Bulgin & Co., Ltd., Abbey Rd., Barking
 Please send me Catalogue No. 156, for which I enclose 3d. stamps.
 Name.....
 Address.....
 W

Experimenters will find their needs fully met by the wide range of our components. Fill in the coupon below.

P.A. at its Best
GRAMPIAN
 PUBLIC ADDRESS EQUIPMENT
 GRAMPIAN REPRODUCERS LTD.
 Kew Gardens Surrey

THE INSTITUTE OF WIRELESS TECHNOLOGY (Incorporated)
 4, Vernon Place, Southampton Row, London, W.C.1.
THE A.M.I.W.T. EXAMINATION
 Candidates for the November A.M.I.W.T. Examination must lodge their applications, on Form E., NOT LATER THAN THE 30th DAY OF JUNE, 1937.
 The New Syllabus; giving particulars of the valuable privileges arising from Professional Membership and Student Membership may be obtained from the Secretary.

CROMPTON MICROPHONES
For PUBLIC ADDRESS HOME RECORDING AMATEUR PHONE
 Transverse Current Model as reviewed in "The Wireless World," May 21st, 1937 **£1.19.6**
 G. CROMPTON, Woodfield House, Woodfield Terrace, Bury, Lancs.

TUITION

RADIO Training.—Marine, aircraft, broadcast; prospectus free.—H.M. Municipal Technical College. [0523]

WANTED

UNIVERSAL Avometer, very little used; £8.—Box 1982, c/o The Wireless World. [4478]
"WIRELESS World," 1930 to 1935, bound or unbound.—Stechert and Co., 2, Star Yard, Carey St., W.C.2. [4459]
WANTED, second-hand 30-watt amplifier and speakers, for use with microphone.—Write to: Cox, 1, Clare St., Cambridge. [4453]
WANTED, rotary converter, 12 to 24 volts input, 400 volts, 200 to 250 m.a. output D.C.—Clitherow, King St., Saffron Walden. [4460]
WANTED, Partridge 30w. amplifier, also 200w. converter, 12-24 volts input.—Sound Amplifiers, Vernon Place, Cheltenham. [4475]
ROTARY Converter, 240 volts D.C. input, 230 volts, 180 watts, 50-100 output, in silenced cabinet.—Box 1950, c/o The Wireless World. [4457]
WANTED, four projection horns only, condition immaterial; state make; quotation for singles invited.—Box 1916, c/o The Wireless World. [4452]
WE Buy for Cash All Types of Modern Second-hand Radio Sets and Accessories, test meters, parts, etc.; we pay more than any other dealer; part exchanges; bring, send, or will call.—University Radio, Ltd., 82, Hampstead Rd., London, N.W.1. Phone: Euston 3810. [4479]

SITUATIONS VACANT

WIRELESS Operators and Engineers Urgently Required.—Train at Britain's leading colleges; fee after appointment; boarders; prospectus free.—The Wireless College, Colwyn Bay, or The Wireless College, Calmore, Southampton. [0541]
YOUNG Man, age 16-19, required to train for radio maintenance work in North London; some previous knowledge of service work essential; sales experience an advantage; good commencing salary; excellent prospects for ambitious young man of good appearance.—Box 1944, c/o The Wireless World. [4455]
RESearch and Development Engineer Wanted to Assist in Design of Interference Suppressors, aerial systems, fuses and radio components, laboratory experience and sound knowledge of mathematics and physics essential, B.Sc. degree or equivalent an advantage.—Apply by letter only, stating age, experience and salary required, to Belling and Lee, Ltd., Cambridge Arterial Rd., Enfield, Middlesex. [4486]

SITUATION WANTED

RADIO Engineer, 25, Public School education, extensive and unique experience service, sales and organisation with leading manufacturer, desires position with progressive retail concern; own car and gear; North preferred.—Box 1960, c/o The Wireless World. [4458]

BOOKS, INSTRUCTION, ETC.

"WIRELESS World,"—What offers? 1929 to 1933 inclusive with index.—8, Nunnery Lane, Luton. [4492]

M.R. SUPPLIES have it!
CAR RADIO
 The finest opportunity ever presented.

150 only brand new G.E.C. 12-volt Car Radios, complete in every detail, under half-price. Compact and sensitive 7-stage super-het with results equal to up-to-the-minute domestic receivers. Tuning 200 2,000 metres with smart, remote control panel and Yale lock. Tone and sensitivity control, built-in H.T. Generator (not inverter) and Moving Coil Speaker. Complete suppression equipment and adjustable mounting brackets for extremely simple fitting.
 A first-hand, first-rate bargain—in makers' sealed cases with illustrated instruction and service books.
 List price £19.19.0. Limited quantity as stated, **SELLING RAPIDLY AT ONLY**

£9.10.0 complete
 (Part carriage 2/6 extra.)

Order immediately from
M.R. SUPPLIES 11, New Oxford Street, London, W.C.1.
 (Telephone: HOLborn 7058.)

WEARITE CONDENSER ANALYSER

A new instrument of the latest design for carrying out rapid complete tests of radio condensers. Electrolytic, Mica, Paper, Trimmer and Tuning condensers may now be tested for Capacity, Insulation, Power Factor, Open Short and

Intermittence. This unit is portable entirely A.C. mains operated.

PRICE - £9.9.0

• Full particulars upon request to:
WRIGHT & WEARE LTD.,
 740, High Road, Tottenham, London, N.17.

We don't claim to make the cheapest transformers, but we do claim to make good ones. Most of the professional P.A. men seem to think so, too.



W. BRYAN SAVAGE LTD
 Westmoreland Rd., London, N.W.9. Phone: Colindale 7131

**A Book of First Principles for the
Wireless Enthusiast**

**FOUNDATIONS
of WIRELESS**

By A. L. M. SOWERBY, M.Sc.
An Elementary Text Book on
Wireless Receivers

Covers the whole field from the simplest electrical phenomena to the construction of a modern set, and all the vital points in receiver-design are treated in full detail. Eleven of the eighteen chapters of the book deal with the discussion of receivers in which the whole process of design is reviewed stage by stage to the finished article. Special attention is paid to the important subject of tuned circuits and band-pass filters, on the correct design of which the performance of every type of set ultimately depends. Moreover, the process of detection, so often imperfectly understood, is clearly explained.

Bound in Cloth Boards
Size 7½ ins. x 5 ins. 272 Pages

PRICE 4/6 NET. By Post 4/11

Issued in conjunction with "THE WIRELESS WORLD" and published by the Proprietors—
LILFE & SONS LTD., DORSET HOUSE, STAMFORD STREET, LONDON, S.E.1

W.W.45



WITH FLYWHEEL TUNING

British Patent 447-559 Flywheel Tuning Device.

PERFECT CONTROL "simplifies short-wave reception."

**HALCYON 1937/8 ALL-WAVE MODELS
ARE READY NOW, incorporating**

- FLYWHEEL TUNING MECHANISM.
- 14-in. SUPER SCALE—STATION NAMES FOUR TIMES LARGER THAN NEWSPRINT.
- POWER LAMP FOR ILLUMINATION. LONG LIFE—NO FLICKER.
- ELEGANT CABINET DESIGN.

Create the desire to possess—by showing the **NEW HALCYON ALL-WAVE FLYWHEEL MODELS.**

Prices: TABLE MODEL (A.C.) 581 15 Guineas
NEW 6801 (Universal) 16 Guineas
R.G. 581 Radiogram £25



ISMA DISTRIBUTORS LTD., Sterling Works, DAGENHAM, Essex.



PRICE 2/6 net
By post 2/10

From all Leading Booksellers, or direct
from the Publishers

**NOW READY—A new book which will help
you to get the best results with your camera!**

**Brighter
Photography**

by DAVID CHARLES, F.R.P.S.

This handy book reveals in a clear, attractive way the secrets of successful photography. Though primarily intended for the novice, it is invaluable to every keen camera user.

The carefully arranged chapters cover the whole field from the choosing of a camera to developing and printing the finished picture. Details of the various photographic materials on the market are given, and there are important sections dealing with Focusing, Aiming the Camera, Photographic Groups, Lighting and Exposing.

In addition there are over one hundred and sixty illustrations, each numbered and each conveying a really useful hint. By simple cross references these illustrations provide a series of clear, concise lessons in the art of making better pictures.

LILFE & SONS LTD., DORSET HOUSE, STAMFORD STREET, LONDON, S.E.1

Mention of "The Wireless World," when writing to advertisers, will ensure prompt attention.

SCOTT-SESSIONS & CO.



The Coronation has made such demands on our Radio Service that our display advertising had to be temporarily discontinued—'Nuff Said!—Coronation over, let it be known that we have recently undertaken and SATISFACTORILY COMPLETED, jobs for many well-known members of the Church, Army, Navy and Air Force, and very many other readers of "The Wireless World." If you are not one of our regular clients, write or 'phone to us to-day. Special Quality Sets and Amplifiers for home use, Schools, Colleges, Municipal Undertakings, Government Departments, Industrial use, etc.



New Sets—Repairs—Modern sing—Overhauls—Transmitting and Receiver Apparatus—Sets and Radio Gramophones to tropical specification for Overseas use.



SCOTT-SESSIONS & Co.

Radio Engineers & Consultants
EXCHANGE WORKS,
MUSWELL HILL, LONDON, N.10

Telephone: TUDOR 4101
Overseas Cables: "TROISET, LONDON"

Contractors to H.M. Govt. Depts.

Second Edition—

Completely Revised

RADIO DATA CHARTS

A SERIES OF ABACS

providing most of the essential Data required in Receiver Design

By

R. T. BEATTY, M.A., B.E., D.Sc.

Published from the Offices of "THE WIRELESS WORLD"

RADIO DATA CHARTS—now issued in a completely revised edition—provides designers of wireless apparatus with a ready, convenient means of solving all the more familiar problems connected with the design of modern radio apparatus without having recourse to complicated formulæ and mathematics.

In order to keep abreast of the great advances in wireless communication since the first edition of "Radio Data Charts" appeared, obsolete abacs have been omitted from this second edition and important fresh material added. The book is now completely up to date.

By the use of the new "Radio Data Charts," such abstruse problems as the design of tuning coils are solved almost as easily as the simple applications of Ohm's Law.

(37 CHARTS and 46 Diagrams)

Price 4/6 net

By Post 4/10

From all leading Booksellers or direct from the Publishers

ILIFFE & SONS LTD.

Dorset House,
Stamford St., London S.E.1

AMPERITE presents..

The NEW RBm VELOCITIES

Distinguished in Quality, Design, and Construction

Featuring..

1. Output increased 6 DB.
2. Triple shielded—against all RF or magnetic fields, entirely eliminating hum pickup.
3. Eliminates feedback troubles.
4. Excellent for close talking and distant pickup.
5. Acoustically designed to eliminate any possibility of cavity resonance.

Models RBHa (High Impedance); RBMa (200 ohms)

NEW! Models RBSa, RSHa—Excellent All-around Microphones for Speech and Music. Slightly lower output and frequency range than above. Appearance same as above.

NOW! A specially designed microphone built to Amperite standards, can be used for both speech and music. No peaks. Flat response. Triple shielded. Shock absorber. Swivel bracket.

Models RAL (200 ohms); RAH (2000 ohms)

FREE TO DEALERS AND SERVICE MEN: A striking window decal, advertising your SOUND SERVICE, and displaying the new Amperite Velocity. Write for it now!

AMPERITE Co. 561 BROADWAY, N. Y. Cable Address: Alkem, New York

AMPERITE Velocity MICROPHONE

A wireless constructional chappie, Was always notoriously snappy, Until he made bubbles, Of all of his troubles, With FLUXITE... he's now nicknamed "Happy"!

See that FLUXITE is always by you—in the house—garage—workshop—wherever speedy soldering is needed. Used for 30 years in Government works and by leading engineers and manufacturers. Of Ironmongers—in tins, 4d., 8d., 1/4 and 2/8. Ask to see the FLUXITE SMALL-SPACE SOLDERING SET—compact but substantial—Complete with full instructions, 7/6. Write for Free Book on the art of "SOFT" SOLDERING—and ask for leaflet on CASE-HARDENING STEEL and TEMPERING TOOLS with FLUXITE.

TO CYCLISTS! Your wheels will NOT keep round and true unless the spokes are tied with fine wire at the crossings AND SOLDERED. This makes a much stronger wheel. It's simple—with FLUXITE—but IMPORTANT

THE FLUXITE GUN

is always ready to put Fluxite on the soldering job instantly. A little pressure places the right quantity on the right spot, and one charging lasts for age. Price 1/6.

ALL MECHANICS WILL HAVE

FLUXITE

IT SIMPLIFIES ALL SOLDERING

FLUXITE LTD., Dept. J, W.W., DRAGON WORKS, BERMONDSEY ST., S.E.1