

The Wireless World

AND
RADIO REVIEW
(18th Year of Publication)

No. 601.

WEDNESDAY, MARCH 4TH, 1931

VOL. XXVIII. No. 9.

Editor: HUGH S. POCOCK.

Assistant Editor: F. H. HAYNES.

Editorial Offices: 116-117, FLEET STREET, LONDON, E.C.4.

Editorial Telephone: City 9472 (5 lines).

Advertising and Publishing Offices: DORSET HOUSE, TUDOR STREET, LONDON, E.C.4.

Telephone: City 2847 (13 lines).

Telegrams: "Ethaworld, Fleet, London."

COVENTRY: Hertford St. BIRMINGHAM: Guildhall Bldgs., Navigation St. MANCHESTER: 260, Deansgate. GLASGOW: 401, St. Vincent St., C.2.

Telegrams: "Cyclist, Coventry."

Telegrams: "Autopress, Birmingham."

Telegrams: "Hiffe, Manchester."

Telegrams: "Hiffe, Glasgow."

Telephone: 5210 Coventry.

Telephone: 2979 Midland (3 lines).

Telephone: 8970 City (4 lines).

Telephone: Central 4957.

PUBLISHED WEEKLY.

ENTERED AS SECOND CLASS MATTER AT NEW YORK, N.Y.

Subscription Rates: Home, £1 1s. 8d.; Canada, £1 1s. 8d.; other countries abroad, £1 3s. 10d. per annum.

As many of the circuits and apparatus described in these pages are covered by patents, readers are advised, before making use of them, to satisfy themselves that they would not be infringing patents.

Competitive Programmes.

HOWEVER much the B.B.C. may desire to persuade themselves and their listeners to the contrary, there is abundant evidence to show that dissatisfaction with the programmes is still rife, and if there are to-day less frequent public outbursts on the topic it is probably because kicking against a brick wall is a pastime which is apt to become wearisome.

We have frequently contended that what is principally wrong with the B.B.C. programmes is that, because there is a monopoly and absence of competition, there is nothing to act as an effective stimulus to the programme compilers, particularly as the general attitude adopted by the B.B.C. tends to make them as self-complacent individually as the organisation has become as a whole.

Now that the regional programmes have been started, we believe that the way is open to provide a solution of the unsatisfactory effects of monopoly in the compilation of the programmes. There could, we believe, be two separate programme organisations set up within the B.B.C. itself, with independent programme directors who would be in active competition in the endeavour to put out the most attractive programmes. These two directors would have independently staffed departments, and the funds available for programme preparation would be equally divided between the two departments. What slight increase in personnel would be necessary would be amply justified by results and the improvement in the entertainment value.

Such a division of programme activity was not possible until the alternative-programme regional scheme was introduced, but now there would seem to be every possibility of such a competitive arrangement being conducted satisfactorily. The B.B.C. would, as at present, of course, exercise a general censorship over all broadcast matter, and a proportion of broadcasting time of both programme boards would be available for special broadcasts and educational matter which the general policy of the B.B.C. requires should be put out. Such transmissions would, of course, be common to both the alternative programmes.

There is, as far as we can see, nothing in the present constitution of the B.B.C. which would make it difficult to introduce such a scheme as this, and it might even be tried out, as an entirely temporary arrangement, by a division of duties at the B.B.C. without any permanent reappointments being made at present. It

would, however, be important that the public should know which was which of the transmissions, in order that their comments and criticisms on any particular programme would go to those responsible for its compilation.

It would not take long, we think, before the preferences of the public would show up and provide a valuable guide to the B.B.C. Competition is invariably an excellent stimulus to sustained effort, and here we have an opportunity for the B.B.C. to profit by it without any encroachment upon their monopoly.

In This Issue

BUILDING THE
PRE-SELECTION A.C. THREE.
FROM AERIAL TO LOUD SPEAKER.
CURRENT TOPICS.
TESTS ON NEW APPARATUS.
MODERN TERMS DEFINED.
B.B.C. TIME SIGNAL AND THE MOON.
THE LAST COMPONENT.
UNBIASED OPINIONS.
BROADCAST BREVITIES.
COLUMBIA REGIONAL RECEIVER.
CORRESPONDENCE.
READERS' PROBLEMS.

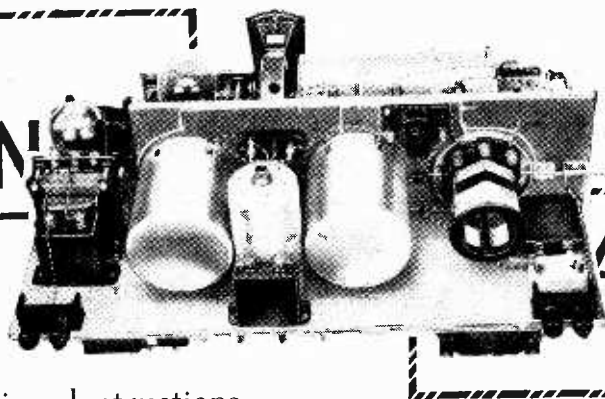
PRE-
SELECTION

A.C. THREE

By H. F. SMITH.

*(Concluded from page 200
of last week's issue.)*Constructional
Details and Operating Instructions.

IN order to reduce overall dimensions and to avoid long leads between high-potential points in the H.F. circuits, a somewhat unconventional layout has been adopted. The main high-frequency components, including the triple-ganged condenser unit and the three "potted" coil assemblies, are mounted on either side of a vertical sub-panel, which is secured by angle brackets to the baseboard. On the underside of this board is mounted all "eliminator" equipment, a sheet of tin being screwed to the wood to act as a screen. It is intended that the receiver should be built as a self-contained chassis, which can be housed in any type of cabinet.

As already indicated, the need for constructing special components has been almost entirely avoided, although three simple brackets must either be made or purchased from one of the firms who undertake work of this sort. The largest bracket is for supporting the tuning-condenser drive, and the trimming and reaction condensers; it is made of $3/32$ in. aluminium sheet, bent and drilled as shown in the accompanying sketch. A smaller bracket, of the same material, is needed for mounting the differential volume-control condenser, as is a support for the variable coupling condenser. Insulating material must be used for the latter bracket, as it is important that stray capacities should be kept down; a small piece of paxolin sheet, screwed to a wooden block, was actually used by the writer.

With regard to the variable coupling condenser itself, we need a component with a low minimum capacity, vanes of "straight-line frequency" shape (more or less), a maximum capacity of some 10 micro-microfarads, and—from the essentially practical point of view—a

$1/2$ in. spindle, so that a commercial form of flexible joint can be used to link the condenser to the main spindle. Further, it is essential that direction of rotation be right, so that both tuning and coupling capacities are increased or decreased in unison.

All these features do not seem to be combined in any one component on the market, but fortunately it is an easy matter to modify a "Utility" bakelite-dielectric condenser of 0.0002 mfd. so that it will meet the case. With the tuning condenser assembled as supplied, direction of spindle rotation will be wrong, so it must be completely dismantled, both the spindle bush and insulating thimbles being transferred to the reverse side of the heavy back plate. Sufficient capacity is provided by one fixed and one moving vane, which are mounted as shown in Fig. 5; distance washers are interposed as necessary to give correct spacing, both between the fixed vane and the end plate and between fixed and moving vanes. If the exact layout as shown is to be followed, it will be necessary to shorten the spindle by $1/2$ in.

Standard "Tangent" tuning coils, with windings slightly modified to suit this particular receiver, are used. Each of the three inductance assemblies includes the necessary switch gear which is fitted in the base, and so the whole can be regarded when wiring as a self-contained unit. It is

understood that these coils, with suitable windings, are now available. For the benefit of those who prefer to make their own coils, details are given in Fig. 4. Six-ribbed ebonite formers of $2\frac{3}{4}$ in. overall diameter may be used, and there is no real reason why external switches for wave-range changing should not be mounted on the sub-panel, in close proximity to their associated coils.

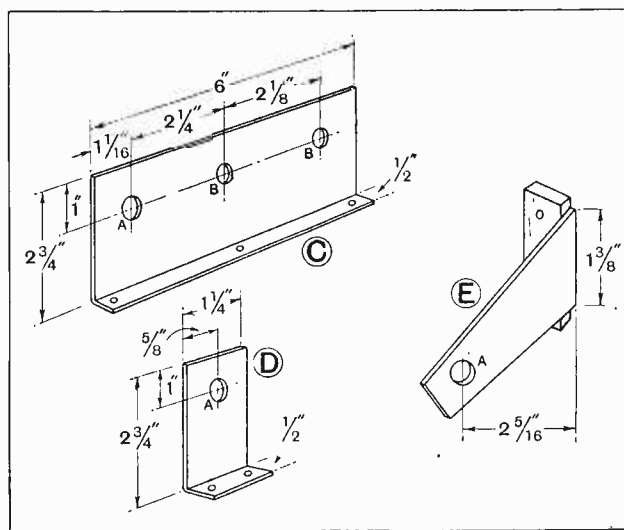
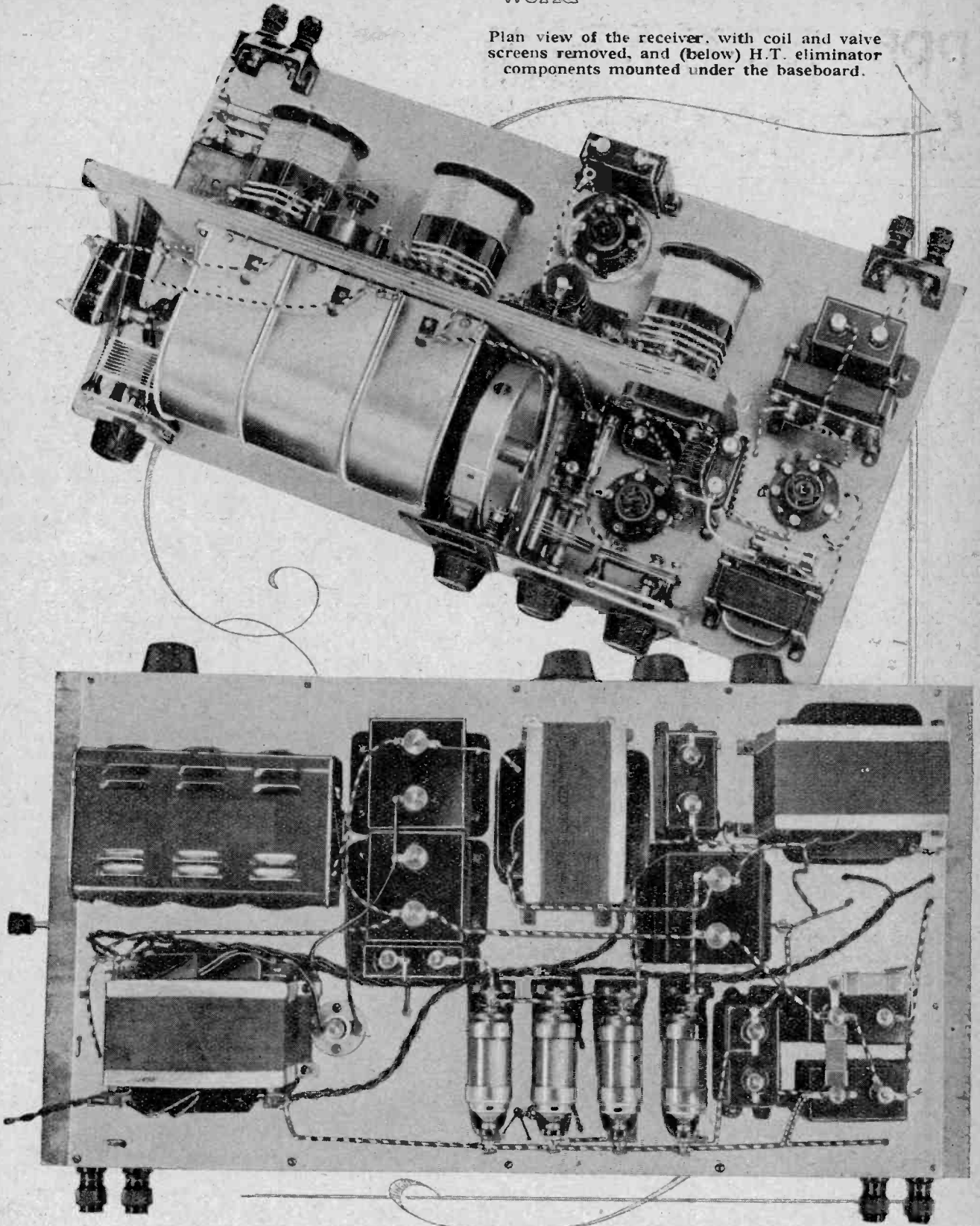

Fig. 3.—Details of condenser supports. Brackets C and D are made of sheet aluminium, $3/32$ in. thick. Drilling dimensions: A, $7/16$ in.; B, $3/8$ in.

Plan view of the receiver, with coil and valve screens removed, and (below) H.T. eliminator components mounted under the baseboard.



(This receiver is available for inspection at the Editorial Offices, 116-117, Fleet Street, London, E.C.4.)

Pre-selection A.C. Three.—

Winding data is given in the following table, and it should be observed that all sections are wound in the same direction. If satisfactory "ganged" control is to be achieved, particularly over both wavebands, it is essential that all tuned windings should be accurately matched, and meticulous care in this matter will be amply repaid. Finished coils should be handled carefully, as it is quite possible to introduce appreciable changes of inductance by "spreading" the windings.

coupling coil assembly) are passed through the metal coil base and this panel.

As stated last week, a Marconi or Osram 4-volt pentode, type P.T.425, is intended to be used as an output valve. A Mullard S4VA. screen-grid valve and a Mazda AC/HL. are suggested as H.F. amplifier and detector. The substitution of others with different characteristics would, at best, involve the redesign of the feed and bias circuits.

When making initial tests, it is best to set the coupling

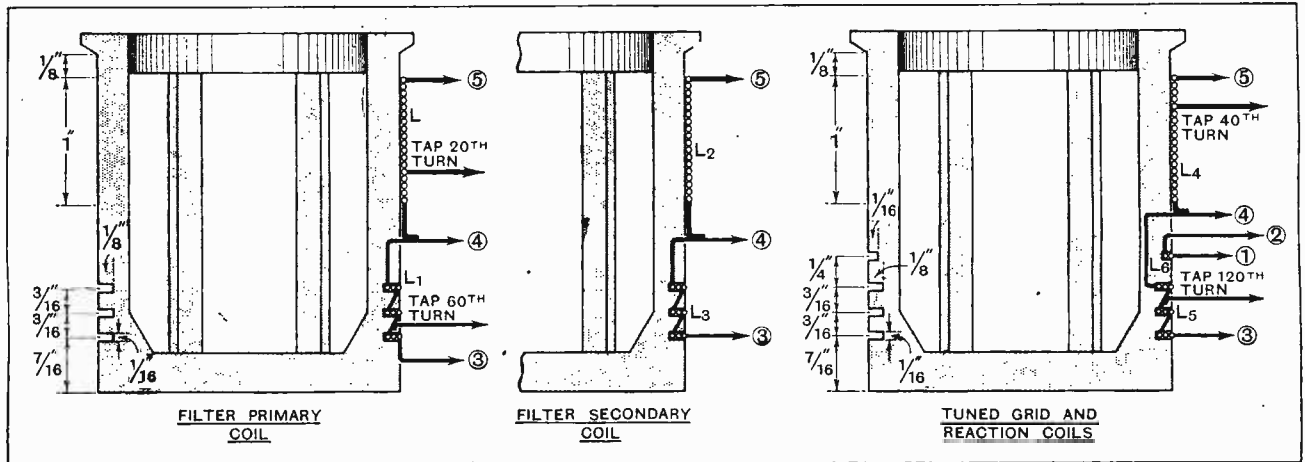

Fig. 4.—Construction of the tuning coils, wound on ribbed formers of 2 3/8in. overall diameter. Spacing between medium- and long-wave windings is 11/16in. Numbers indicate connections to terminals.

Assembly of the components is as straightforward as needs be, but in one or two places we are working to fairly close limits with regard to clearances, and positions should be determined with reasonable accuracy before the parts are finally screwed down.

It will probably be found best to start the operation of wiring with the eliminator section (below the base) and then to drill the necessary holes through the board—their positions are indicated in Fig. 6—before turning attention to the receiver circuits proper. By doing so, one avoids the trouble of constantly reversing the set on the work table.

It will be noted that holders are not provided for the grid bias resistances R₆ and R₇, as these components are mounted directly on the terminals of their associated by-pass condensers.

All connecting wires follow the shortest path, and some of them must accordingly be passed through holes drilled in the vertical wooden sub-panel. Leads from the reaction coil (terminals 1 and 2 on the intervalve

condenser CC to minimum by loosening one of the nipping screws which secure the flexible link. The screws controlling the built-in trimming condensers of C₂ and C₃ should be rotated in a clockwise direction until it can be felt that they are just engaging, but the corresponding screw on C₄ should be slacked off fully, as there is an external trimmer, which should be set at about one-sixth of its total capacity.

If everything is more or less in order, signals should be heard—though probably not at full strength—as the main tuning knob is rotated. The first and most important operation is to set the trimming condensers, and too much care cannot be devoted to this task. A millimeter in the detector anode circuit is a great help, but is not essential, provided that adjustments are made while listening to a station (preferably between 300 and 400 metres) which is so

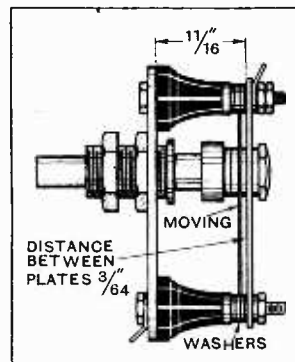

Fig. 5.—Assembly of the variable air-dielectric coupling condenser.

WINDING DATA.

Coil Reference.	Wire.	Turns.	Tapping.
L ₁	No. 28 D.S.C.	60	20th turn
L ₂	No. 28 D.S.C.	60	none
L ₄	No. 28 D.S.C.	60	40th turn
L ₁	No. 36 D.S.C.	180	60th turn
L ₃	No. 36 D.S.C.	180	none
L ₅	No. 36 D.S.C.	180	120th turn
L ₆	No. 36 D.S.C.	35	none

distant that it provides comparatively weak signals. If possible, this adjustment should be made during the daytime, as night signals are notoriously inconstant; even if a millimeter be used, one may easily be misled by deflections due to a transmission on the adjacent frequency channel.

B.B.C. TIME SIGNAL

and the MOON

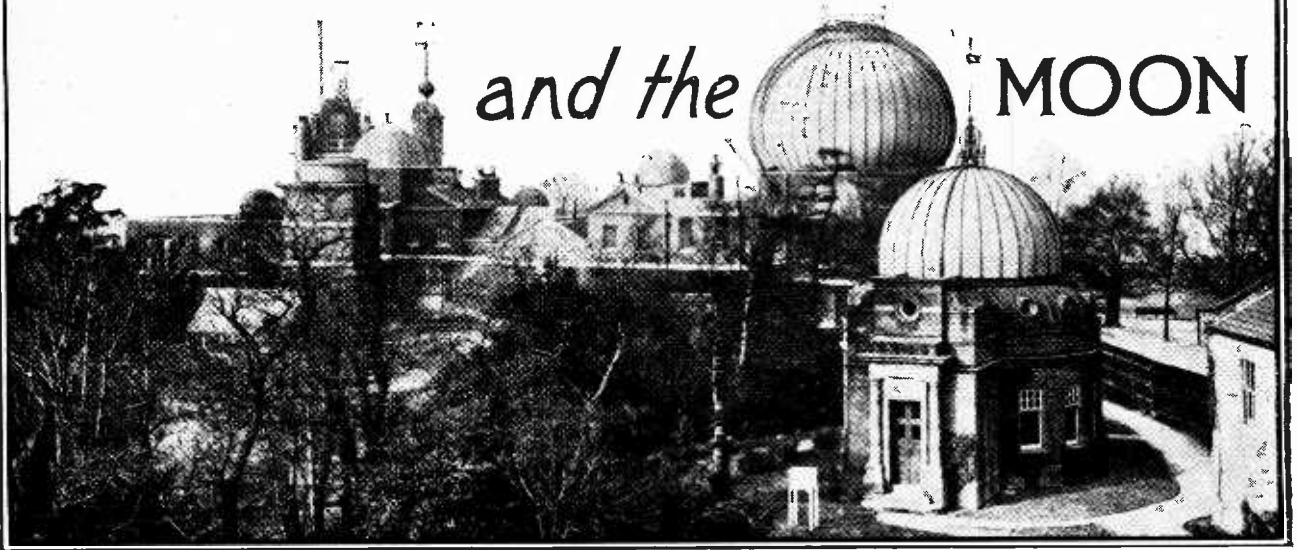

A view of Greenwich Observatory.

The Revolution of the Earth as our Master Clock.

By F. ADDEY, B.Sc., F.R.A.S., M.I.E.E.

WE have all, I suppose, from time to time heard musical enthusiasts voicing their disapproval at the superposition of the Greenwich time signals on B.B.C. programme items, when these items have happened to overrun their time. A short explanation of the important use to which these signals are now being put will therefore probably be of interest, and may help the critics to bear with the small amount of interference which they cause.

The standard clock, by which all other clocks on the earth are ultimately regulated, is the earth itself, turning once a day on its axis. The sky is the dial, and the stars the figures on the dial. The hands of this gigantic clock are the special telescopes, known as transit telescopes, at the large observatories — in this country the Royal Observatory at Greenwich.

The transit telescope is so mounted that it can only move up and down in a north and south direction, so that when a star is seen in the centre of its field that star is due south. The exact time shown by the standard clock at the observatory when this occurs is noted. This time may not, however, be correct, for the observatory clock may

be, and usually is, either fast or slow. By calculation, however, the true time when the star was due south can be ascertained, and thus the error of the observatory clock can be found. By continued observations of this nature the rate at which the observatory clock is gaining or losing can also be discovered. With this information we can then at any instant calculate the correction which has to be applied to the time shown by the observatory clock to get the true time.

The standard clock is never altered, but a second clock at the observatory is adjusted from it in the way just described to show true time, and from electrical contacts connected with the pendulum of this second clock the six-dot time signals are sent to the British Broadcasting Corporation.

Now wireless time signals are very useful to sailors, enabling them at frequent intervals to check the chronometers which give them Greenwich time and so enable them to find their longitude. For this

purpose, however, the missing of a signal occasionally would not be very important. Before wireless time signals were available sailors often had to go for long intervals without being able to check their chronometers, and for

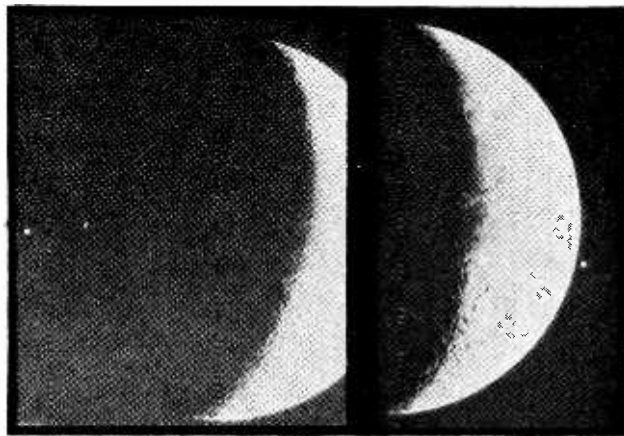

Occultation of a star by the moon moving across the sky from right to left. In the left-hand picture the invisible dark edge of the moon is about to come in front of the star and so cause it suddenly to vanish. In the right-hand picture the moon has moved right across the star, which is now visible beyond the bright edge.

B.B.C. Time Signal and the Moon.—

the accuracy needed for navigational purposes the time-keeping of the modern chronometer is amply good enough for it to be depended on over these intervals. It is more in connection with a special scientific investigation now in progress that the frequent time signals sent out by the British Broadcasting Corporation are proving so useful.

The Earth as a Master Clock.

As explained above, the rotating earth is our fundamental clock, by which all other clocks, and therefore also the wireless time signals, are regulated, and until recently no one had any doubt that its accuracy could be absolutely trusted. Recently, however, misgivings have arisen on this point.

It was long ago discovered that the rotation of the earth is being gradually slowed down by the friction of the tides, so that the day is becoming longer.

This effect can be allowed for, and does not prevent the use of the earth as a reliable standard clock. It is a clock which is slowly losing, but its rate of loss is known.

During the last fifty years, however, it has been found that, in addition to the steady loss just mentioned, the earth clock is running irregularly, sometimes losing more than usual, and sometimes gaining. These irregulari-

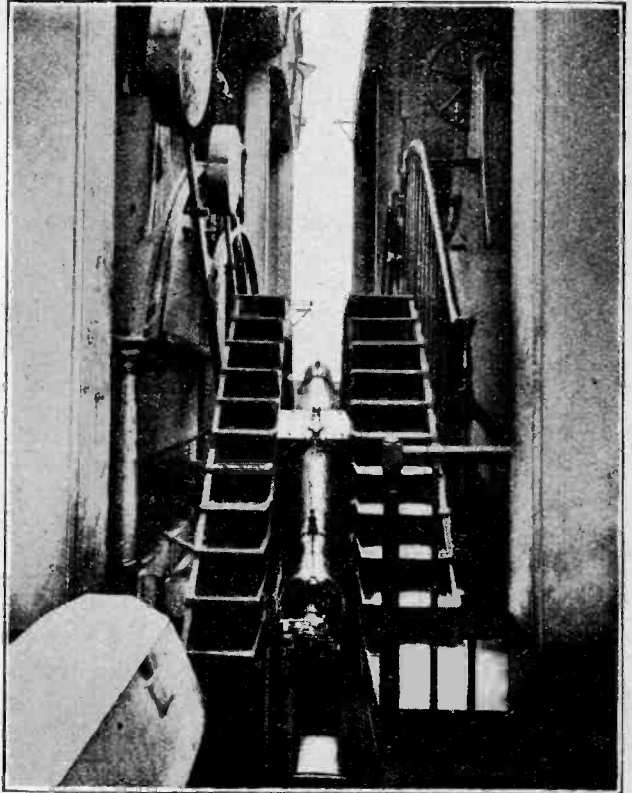

The transit telescope at Greenwich observatory; it is used for telling the time from the stars. It is mounted so as always to point in a north or south direction, and its centre line is Greenwich meridian (Zero longitude).

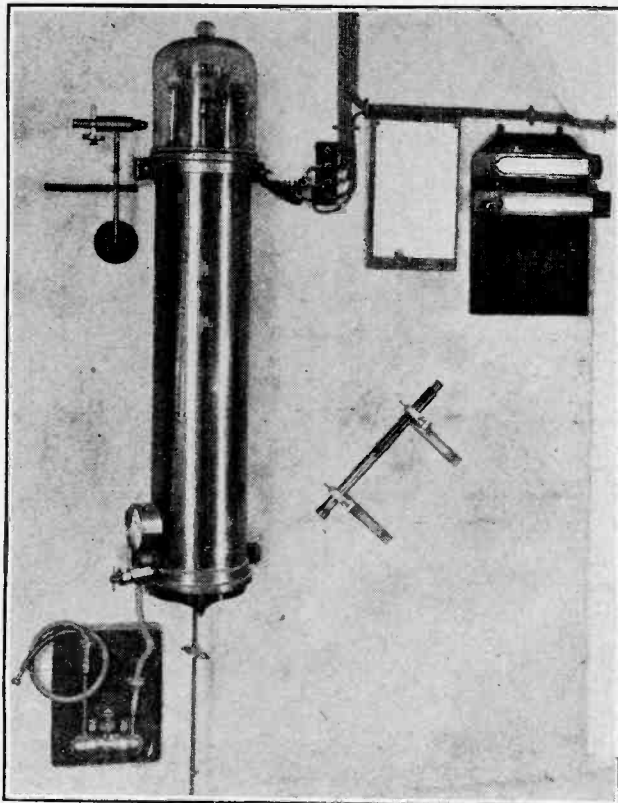

The standard clock at Greenwich observatory. It has no dial, being simply an electrically driven pendulum which swings in a cylinder from which most of the air has been pumped. It is kept in an underground cellar to avoid changes of temperature. Another pendulum kept by electrical control in step with this one drives the indicating dials.

ties show up when the position of the moon in her orbit round the earth is studied. Sometimes the moon seems suddenly to be going too slowly, and then suddenly she seems to move too fast. Actually the moon is moving steadily, and these apparent sudden changes in her speed are really caused by sudden changes in the speed of rotation of the earth; that is, by irregularities in the clock by which we time the moon's movements.

Why the Earth Changes Speed of Rotation.

The cause of these sudden changes in the speed of rotation is not known. It may be due to the whole earth expanding or contracting a few inches, or it may be due to changes taking place in the deeply seated strata forming the core of the earth. To discover what is really happening careful and continuous observations are necessary, and it is here that the time signals of the British Broadcasting Corporation come in. In her monthly passages round the sky the moon occasionally passes in front of a star and so hides it from observers on the earth. Such phenomena are called occultations. The exact position of the moon in her orbit where she will just cover or just uncover any particular star can be determined. The time when this happens is noted. This, of course, is done with a watch or clock which, by wireless time signals or other means, is adjusted to keep time with the fundamental clock, the rotating earth, and, as mentioned above, this fundamental clock may not be correct. But from gravitational theory the posi-

B.B.C. Time Signal and the Moon.

tion which the moon ought to occupy, if the observed time were correct, can be calculated. From the difference between these two positions of the moon any irregularity in the running of the earth clock can be found.

These observations are at present being carried out by many astronomers, both professional and amateur, in this country and the United States. The professional astronomer has reliable clocks to refer to, but the amateur has usually only an ordinary watch. It is for these latter observers that a frequent service of time signals is essential. For the accuracy which is required in this investigation an ordinary watch cannot be relied on for more than a few hours at the most, but it can be used if it can be checked with a time signal shortly before and shortly after each observation. It is, therefore, important that every night all these signals should be available, as without them an observer might be unable to give the correct time of an observation which otherwise was perfectly satisfactory. Without the time signal service many amateurs who are at present doing useful

work towards the solution of the problem of the cause of the earth's changes in rotation would not be able to take part in this investigation. Every possible occultation observation which can be taken is required, because at any one place many are always spoiled by clouds, but what is lost by one observer may be seen by another, so that the more observers who can co-operate in this work the better.

In view of the scientific interest attached to this investigation, everyone, including the musical critics, will, I am sure, agree that it is worth while putting up with the slight inconvenience of the superimposed time signals. May I go farther and invite any readers who possess small astronomical telescopes, and who would like to assist in this investigation, to join the British Astronomical Association, which has organised the work in this country? They would receive every assistance, and would find the observations quite fascinating, while at the same time they would have the satisfaction of knowing that they were helping to solve a very interesting and important scientific problem.

NEWS FROM THE CLUBS.**A.C. Valves.**

A valuable lecture on A.C. valves, illustrated with lantern slides and a film, was given by Mr. Parr, of Ediswan's, at the last meeting of the Ilford and District Radio Society. The members displayed a keen interest in the subject, and it was found that many were using A.C. valves in D.C. receivers on account of their greater efficiency and robustness. On the following evening thirty-two members and friends paid an official visit to the Southend and District Radio Society and were entertained by Mr. Knipe with a short lecture on television. After refreshments, Mr. Britton demonstrated his radio gramophone, with which he won the presentation cup at the recent Southend Exhibition.

Hon. Secretary, Mr. C. E. Lazen, 16, Clements Road, Ilford.

○○○○

Metal Rectifiers.

The popular lecture, "Metal Rectifiers," was repeated by the Westinghouse Co. at the meeting of the Bee Radio Society on February 10th, when the speaker was Mr. Stevens, B.Sc. Members were shown a series of new slides from photographs of oscillograms obtained during experiments which showed clearly the voltage and current changes arising when valve and metal rectifier were operated under various conditions. A detailed description was given of the voltage-doubler circuit and its advantages.

The film, "Metal Rectifiers," was also exhibited, and, to conclude, Mr. Stevens showed a new film of the Westinghouse works at Chippenham.

Hon. Secretary, Mr. A. L. Odell, 9, Westway, Grand Drive, Raynes Park, S.W.20.

○○○○

Back to Fundamentals.

Using the title "Simple Facts about Radio" for his recent lantern lecture before the South Croydon and District Radio Society, Mr. Furner touched upon nearly every phase of wireless. A series of instructive slides showed how an electro-magnetic wave is modulated at the broadcasting station. Dealing with the receiver, the lecturer explained the fundamental principles of the valve and disclosed some of the interesting processes of valve manufacture. Various types of valve were dealt with, and Mr. Furner later discussed modern mains sets and the various methods of obtaining H.T. current. The chairman, Mr. Nightingale, in his concluding speech, emphasised the value of elementary talks of the kind given by Mr. Furner. The Society had reached an advanced technical stage, but it was useful to make sure that there was a firm foundation of elementary knowledge.

Hon. Secretary, Mr. E. L. Cumbers, 14, Campden Road, South Croydon.

Triode v. Pentode.

An animated debate on the respective merits of the triode and the pentode took place at the last meeting of Slade Radio (Birmingham). Mr. G. T. Peck championed the pentode, while Mr. N. B. Simmonds supported the claims of the three-electrode. Points raised during the discussion included the effect of varying voltages, the responsibility of the pentode for poor loud-speaker results, and the question of triode output in the treble. A vote was taken after the debate and revealed an overwhelming majority in favour of the pentode.

Hon. Secretary, 110, Hillaries Road, Gravelly Hill, Birmingham.

○○○○

Television.

The difficulties associated with the development of television were entertainingly described by Mr. Denton, of the Television Society, at the Tottenham Wireless Society's meeting on February 18th. Mr. Denton's lecture covered a wide field, from the early Baird scanning experiments to the recent adoption of the Photo-electric cell.

Hon. Secretary, Mr. W. B. Bodemeald, 29, Pendennis Road, Tottenham, N.17.

Photo-electric Cells at Work.

At the Central Library, Ipswich, on February 20th, a lecture on Photo-electric Cells was given to the Ipswich Engineering Society by Mr. R. C. Walker, B.Sc., of the General Electric Co., Ltd.

The lecture, which was illustrated by lantern slides, dealt particularly with the progress made by the research staff of the G.E.C. in the development of the Osram photo cell for television and other purposes.

After touching upon the fundamental photo-electric principles, the lecturer described with illustrations the characteristics of vacuum and gas-filled cells, especially the Osram C.M.G.S. cell, with its high emission and sensitivity to infra-red rays. Methods of using cells were described and a demonstration shown illustrating the operation of the cell in a simple valve circuit controlled by invisible rays.

A novel demonstration was shown in which broadcast music was received on an Osram "Music Magnet" wireless set and transmitted by light waves across the room to a photo cell amplifier and loud speaker.

○○○○

Old and New.

"Sets, Ancient and Modern," was the title of an unusual talk given at a recent meeting of the Wembley Wireless Society by Mr. Chapman, whose radio experiences dated back to 1911. Mr. Chapman gave a fascinating account of the days when transmissions were confined to Morse messages sent out by the various coast stations to ships at sea. Several very ancient pieces of apparatus created some amusement when they were picturesquely described by Mr. Perry. The evening came to a fitting conclusion with a demonstration of one of the very latest American receivers operated from the mains. Twenty different stations were received at excellent quality on a very short aerial.

Hon. Secretary, Mr. H. E. Conben, 21, Park Lane, Wembley.

○○○○

A.C. Receivers on D.C. Mains.

The M-L Magneto Syndicate, Ltd., gave a lecture and demonstration to members of the Bristol and District Radio and Television Society at the University. Mr. Woodall, of the M-L Co., outlined the principle of rotary transformers and their undoubted service to D.C. consumers, who were thus enabled to take full advantage of A.C. receivers. The lecture was illustrated by a series of lantern slides. After the lecture, Mr. Woodall successfully demonstrated a McMichael 3-valve A.C. receiver, deriving its power from a 12-volt car starter battery transformed up to 230 volts A.C.

Hon. Secretary, Mr. S. T. Jordan, 1, Myrtle Road, Cotham, Bristol.

FORTHCOMING EVENTS.**WEDNESDAY, MARCH 4th.**

Institution of Electrical Engineers, Wireless Section.—At 6 p.m. At Savoy Place, London, W.C.2. The following paper will be read and discussed: "The Practical Correction of a Wireless Direction-finder for Deviations due to the Metal-work of a Ship." By Mr. C. E. Horton, M.A.

Muswell Hill and District Radio Society.—At 8 p.m. At Tullington School, Tetherdown, N.10. Lecture: "The Modern Trend in Valve and Set Design." By Mr. F. E. Henderson, A.M.I.E.E.

THURSDAY, MARCH 5th.

Slade Radio (Birmingham).—At 8 p.m. At the Parochial Hall, Broomfield Road, Erdington. "Short-wave Transmission and Reception," by Mr. G. Hefferman, of Messrs. Philips Lamps, Ltd.

FRIDAY, MARCH 6th.

Leamington Radio Society.—At 6.15 p.m. At the Lecture Theatre, 16, Finsbury Circus, E.C.2. Joint Meeting with Radio Society of Great Britain.

MONDAY, MARCH 9th.

Hackney Radio and Physical Society.—At the Electricity Showrooms, 18.24, Lower Clapton Road, E.5. "Modern Loud-speaker Design."

The Last

Component

How the Ear Constructs
Music from Fragments.

By

R. T. BEATTY, M.A., B.E., D.Sc.



LET us imagine that, by some strange accident, total deafness falls upon all human beings, and that, in compensation, our eyes acquire the power of seeing the ultimate particles of which the air is composed. In such a world speech and music can only be perceived by watching the air particles as they dance to and fro under the urge of the waves of sound. Conversation appears as a visible record resembling the curve produced by an oscillograph, and in time we could probably learn to interpret this record by the shape followed as easily as we can read a book.

In this world of visible sound, broadcasting, as it exists to-day, would immediately crash. For the waves which leave the loud speaker bear little resemblance to those which enter the microphone, and the change, though all but unappreciated by the ear, would be hopelessly confusing to the eye. Thus, in Fig. 1 we see the change in wave-form of a vowel sound after it has passed through a high-class receiving set. The transformation is as profound as if Carnera should enter a Tube station and, as the result of some subterranean rearrangement of his cellular structure, should presently emerge in the guise of the Bishop of Birmingham. This would cause some justifiable surprise, and might lead to dissatisfaction with our transport system.

But no general dissatisfaction exists among listeners to wireless, for, though the wave-form may be mutilated in an apparently hopeless manner, the ear has an extraordinary power of piecing together the fragments and reconstructing the missing parts.

The Suppression of Low Frequencies.

An example of this synthetic action is the illusion

of hearing bass notes from a loud speaker which is opaque to the lower register. The lower useful limit of the musical scale lies at about 50 cycles per second, while many loud speakers do not reproduce below 200 cycles. If the sounds of music were pure tones such as are emitted by tuning-forks—tones which an oscillograph would record as sine waves—the low notes would fail to come through, with serious disturbance of the balance of musical performance. With the bass viol mute, bassoon and trombone limited to half their range, the whole bass clef dissolved in silence, wireless reception would be a mockery.

The situation is saved by the fact that nearly all musical sounds are complex. The basic constituent is a pure tone of the nominal frequency of the sound, this fundamental tone being accompanied by harmonic overtones whose frequencies are 2, 3, 4, etc., times that of the fundamental. The note an octave below middle C on the piano has a frequency of 128 cycles, accompanied by satellites at 2×128 cycles, 3×128 cycles, up to about 8×128 cycles. We strike a note and create a chord. Even though the fundamental may be suppressed by the loud speaker, the upper tones of this chord reach our ears.

At this stage the ear performs an extraordinary act of aural legerdemain in adding the missing components to the fragments supplied to it. Owing to the unsymmetrical arrangements of the ear bones, the ear drum behaves like a spring door in yielding to pressure more easily in one direction than in the other; it is a mechanical rectifier and, consequently, has the property common to all rectifiers, of heterodyning two frequencies f_1, f_2 , to produce a third frequency $f - f_1$. Thus the overtones

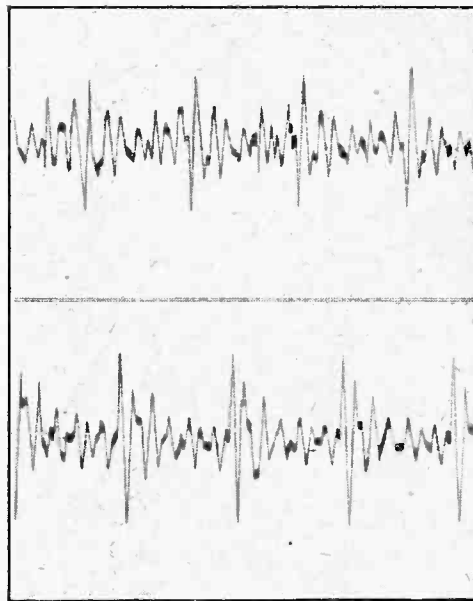

Fig. 1.—Oscillograph records of the sung vowel "a." (Above) Original wave form as transmitted. (Below) Wave form after passing through a high-grade amplifier.

The Last Component.—

2*f*, 3*f*, 4*f*, etc., are heterodyned in successive pairs to supply the missing fundamental *f*, not at its full strength indeed, but still with sufficient intensity to give a tolerable imitation of the original.

Speech.

Still more curious is the relation between speech and hearing. Most of the energy of speech is concentrated in the lower frequencies (Fig. 2), and one would naturally think that this is the region which must be reproduced faithfully to give intelligible results. But it has been found that if the frequencies *below* 300 cycles are removed by an electric filter circuit 98 per cent. of the words remain intelligible, while if the cut is made at the same frequency by a filter circuit removing frequencies above 300 cycles, then the intelligibility is only 2 per cent. Sound and sense occupy different regions, and the loud speaker which is dumb for low notes is a more intelligible talking machine than the human vocal organ.

High Frequencies.

The upper limit of instrumental scores is reached at a frequency of about 3,400 cycles (the top note

of the piano, Fig. 3), but still higher frequencies are carried by overtones, and musicians demand that reproduction should be carried up to 10,000 cycles. Actually many loud speakers fail beyond 3,000 cycles, so that instrumental high notes lose their distinctive quality and sound like pure tones. The ear has no mechanism for supplying missing overtones, and the difference between a cut-off at 3,000 cycles and one at 6,000 cycles is immediately evident to anyone who makes the comparison. Yet we get on reasonably well with a cut-off at 3,000 cycles, partly because the tones above this form a small part of the total mass of music, but chiefly because we rapidly become accustomed to the imperfect rendition.

When an alternating voltage drives current through a pure resistance, the current keeps in phase with the voltage, that is, the current curve, when drawn to a suitable vertical scale, fits the curve of E.M.F. exactly.

But when an inductance coil is substituted for the resistance the current lags behind the voltage by an amount which becomes greater the higher the frequency. With a condenser the effect is reversed, the current being *advanced* more and more as frequency rises. Thus the currents due to a single musical note are altered by

the changes of phase of the overtones relative to each other and to the fundamental, and the wave-form is greatly changed, as shown in Fig. 1.

What is the audible effect of this transformation which is so patent to the eye? The surprising answer is that the ear takes no notice whatever of phase changes,

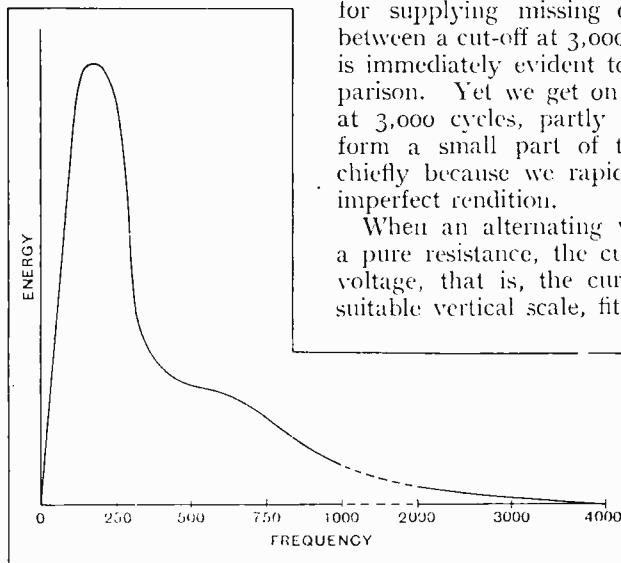

Fig. 2.—Average energy distribution of speech sounds. The greater part of the energy occurs at low frequencies, but the high-frequency components are necessary for intelligibility.

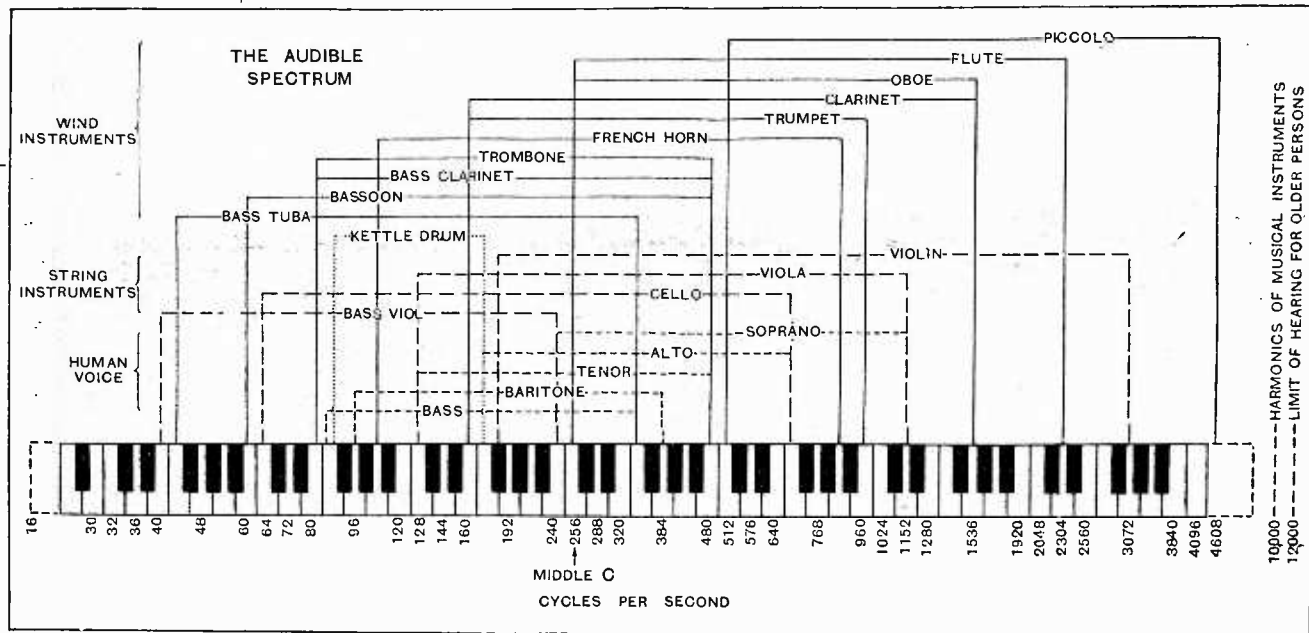

Fig. 3.—The frequency of audible sounds, showing the cycles per second of the notes of a pianoforte and the usual range of various musical instruments and voices.

The Last Component.—

provided that the relative amplitudes of the fundamental and overtones remain unaltered. This is the result which an analyser would give if it worked by tuning-in to each frequency in turn, thus measuring each amplitude without reference to the rest, and the phenomenon is indeed one of the chief arguments in favour of a resonance theory of hearing.

In such ways the ear makes good the defects of the receiving set. Are we to infer that the main purpose of auditory evolution has been to improve the amenities of wireless communication? Hardly so, but it is plain that the art of the telephone and radio engineer must include a knowledge of the physiology of that wonderful listening device which forms the last and least understood link in the broadcast chain.

CURRENT TOPICS

Events of the Week in Brief Review.

LOCAL COLOUR.

A colour attachment for radio receiving sets, consisting of coloured electric lamps responsive to the different tone variations of the loud speaker, has been invented and patented by Richard M. Craig, of San Antonio, Texas.

o o o o

FRENCH RADIO BILL AT LAST?

French wireless amateurs are considerably cheered by indications that the new Postmaster-General, M. Guernier, intends to "push" the projected Wireless Act, which aims at the creation of some sort of order in the French ether, writes our Paris correspondent. M. Guernier has exhibited his good intentions by asking for the views of the two rival factions, viz., those who demand a system of "controlled liberty" (giving technical and commercial freedom, limited only by the needs of technical defence) and those who advocate a State monopoly.

It is believed that there is a majority in the French Parliament for the first principle. In any event, there is a reasonable prospect that France will have her Wireless Act before the end of the year if the Laval Government remains in office.

o o o o

RADIO AND U.S. UNEMPLOYMENT.

Station WLS, Chicago, has fed 75,000 unemployed men and distributed 80,000 articles of clothing at a soup kitchen

established in Chicago, writes our Washington correspondent. Radio appeals brought contributions of food and clothing from thirty-four States.

o o o o

THE RADIO MILLENNIUM?

Another halcyon period for wireless transmission and reception is at hand, according to American radio prophets

NEW READERS' NUMBER.

The reception accorded our New Readers' Number issued last week (February 25th) has been far greater than our publishers anticipated, and although a very much larger number of copies of this issue were printed, we have by no means been able to meet the demand.

It has not been possible to arrange for reprinting the whole issue, but believing that the Station Identification Chart issued with that number is especially in demand, our publishers inform us that they are reprinting this sheet separately and that it will be ready on sale at bookstalls and newsagents to-day, Wednesday, March 4th, at the price of 2d. per copy.

quoted by our Washington correspondent. January and February so far this year appear to have been periods of exceptional radio reception, confirming predictions made last year that with the coming "minimum" of the eleven-year

sun-spot cycle, radio conditions would return to the halcyon days of 1920 and 1921, when a little 50-watt broadcaster could be heard 3,000 miles away.

Only the congested condition of the wavelengths stands in the way of the ideal DX conditions of the old days. Nevertheless, reports come from all parts of North America that distance reception this month is the best ever in the history of modern receiving sets.

o o o o

"MISSING FROM HIS KENNEL . . ."

The Dutch police report that out of 2,372 appeals broadcast by them during 1930, 187 were successful.

Nine stolen bicycles out of a total of 197 were recovered through the agency of broadcasting, while eight out of eighty lost dogs were returned to their owners. Broadcast descriptions brought back seven stolen cars.

o o o o

"PHONE V. MORSE.

Amateur radio-telephony proved the most rapid medium for the transmission of messages under perfect conditions, as the outcome of the transcontinental message relay contest which has been sponsored during the past month by the American Radio Relay League, while radio-telegraph demonstrated that it continues to excel in all-round reliability. The competition, which was an outgrowth of the ancient rivalry between the telephone



TRAFFIC CONTROL OF THE ETHER. Prominent personalities in European broadcasting photographed at Semmering (Austria), where the Union Internationale de Radiodiffusion held its recent meeting. In the front row (left to right) are MM. Chanton (France), Steinbach (Czecho-Slovakia), Divoire (Belgium), Braillard (Belgium), Van der Pol (Holland) and Harbich and Schäfer (Germany). On the extreme right (standing) is Mr. Noel Ashbridge, chief engineer of the B.B.C., while third from the left is Mr. Arthur Burrows, formerly of the B.B.C. and now secretary of the Union.

and telegraph men, was held during three Sundays in January, states a message from the League headquarters, Hartford, Conn.

A victory for the radiotelephone operators on the basis of greater speed in handling messages resulted from the first of the tests, while in the second the code men won by successfully relaying a larger number of messages to the opposite coast and back to the originating station. The result of the final contest is not definitely known as yet, but another victory for the code men is indicated.

The three points considered in judging the outcome of the relay were speed, the number of relays, and the percentage of messages returned to their starting point. Over the period of the contest telegraph stations returned more messages and averaged the highest speed.

SÖTTENS: THE SCOTSMAN'S TELEGRAM.

Striking evidence of the keen public interest in broadcasting was forthcoming a few days ago when the first tests were carried out on the new 25-kilowatt station recently manufactured and installed by Standard Telephones and Cables, Ltd., at Söttens (Switzerland). The testing engineer broadcast a request that listeners who picked up the station should send in to the manufacturers reports regarding the quality of the reception. As a

Reina del Pacifico. The ship will be able to rely on constant direct wireless communication with this country, whether her voyages take her through the Panama Canal, down the west coast of South America, or by the Atlantic route *via* Rio de Janeiro and Buenos Aires.

LOCAL STATION HEARD.

Radio-Rennes (Brittany) has changed its aerial and, according to the *T.S.F. Revue*, the local listeners can now hear its signals and are in a state of consternation over their consequent inability to pick up more distant transmitters.

It is to be hoped, writes our Paris correspondent, that this unpleasant tendency towards the reception of local signals will not mar the future of French broadcasting.

U.S. AMATEURS PROVIDE BROADCAST RELAY.

An automatic volume control used by members of the American Amateur Radio Relay League successfully overcame fading during their relay of the Pope's speech from the Vatican City station. The transmission, which was picked up on a specially designed two-valve short-wave converter employed as a short-wave "superhet," was amplified in turn by a standard superheterodyne broadcast receiver, which fed through a coupling

SOUND RECORDING AND REPRODUCTION.

Three Cantor lectures are to be given on Monday evenings, March 9th, 16th and 23rd, on "The Recording and Reproducing of Sound," by Mr. A. G. D. West, M.A., B.Sc. (of the Gramophone Co., Ltd.), at the Royal Society of Arts, John Street, Adelphi, London, W.C.2. The lectures begin at 8 p.m.

MORE POWER FROM CZECHOSLOVAKIA.

Czecho-Slovakia's well-known broadcasting station at Brunn will shortly increase its power from 3 to 36 kilowatts. The wavelength will remain at 341.7 metres.

THE RULING PASSION.

That his establishment is "full of clandestine wireless amateurs" is the complaint of the headmaster of a famous Paris school, writes a correspondent. He states that pupils are constantly "making radio sets on the sly," installing them in their dormitories, and sometimes concealing them under their beds.

Certain pupils, he declares, have hidden receivers in their classroom desks, and when they have appeared to be listening to their professors, have actually been holding phones to their ears.

D.F. AND SHIPS' METAL WORK.

"The Practical Correction of a Wireless Direction-Finder for Deviations due to the Metal Work of a Ship" is the title of a paper to be read this evening (Wednesday) by Mr. C. E. Horton, M.A., at a meeting of the Wireless Section of the Institution of Electrical Engineers at Savoy Place, W.C.2, at 6 o'clock.

"COMMUNITY RADIO, INC."

Mr. Clarence Cummins, owner of station WBAK, Williamsport, Pa., has submitted a scheme to the U.S. Federal Radio Commission for the construction of 400 low-power broadcasting stations which would require only 125 separate wavelengths to provide the American people with local programmes to suit every taste. "Community Radio, Inc.," as the projected concern would be called, would eventually embrace 1,000 stations. It is understood, however, that the Federal Commission is not exhibiting a "community" spirit!

MULTI-DIRECTIONAL SUCCESS.

The directors of the new German high-power broadcasting station at Heilsberg (276.5 metres) state that excellent reports have been received from Canada, Egypt, and Siberia.

RADIO AT BUENOS AIRES EXHIBITION.

Many readers of *The Wireless World* will probably find their way to the British Empire Trade Exhibition at Buenos Aires, where not the least interesting displays will be those relating to wireless. We hear that the General Electric Company's stand will make a feature of Gecco-phon radio apparatus and valves.



LIGHT-CONTROLLED TRAIN. Mr. F. W. Straw, who recently organised a radio exhibition at Colchester, demonstrating a model train which could be started or stopped by throwing a light beam on a photo-electric cell.

result of this request more than one hundred letters were received next day, as well as a telegram from Dundee. On the second day a further two hundred reports were received.

15-20,000 METRE SET.

A valve receiver covering all wavelengths from 15 to 20,000 metres has been installed as part of the Marconi gear on the Pacific Steam Navigation Co.'s liner,

device into the telephone lines linking all the stations of the Columbia chain.

That a great organisation like the Columbia system relied on the services of the A.R.R.L. is considered as a feather in the cap of amateur radio.

FEELING THE PINCH.

Trade depression and unemployment are held responsible for the non-renewal of 40,000 German receiving licences.

INTERFERENCE *in* GERMANY

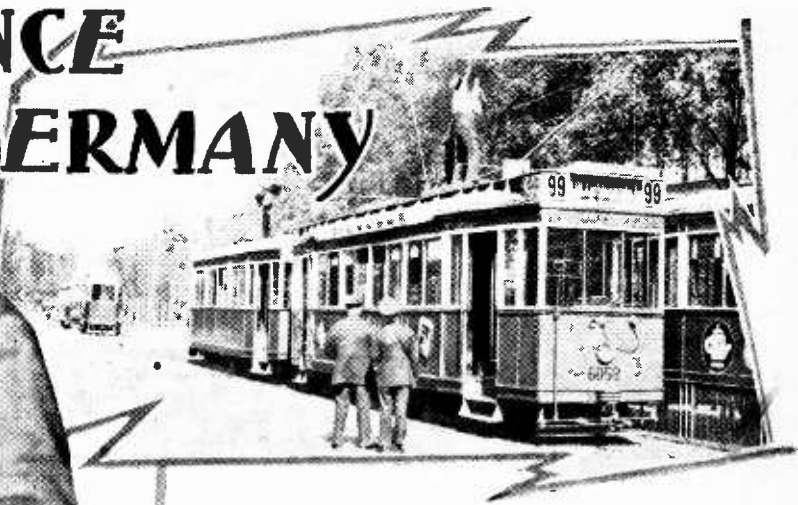

Committees of Unpaid Enthusiasts
Track Down Offenders.

By R. RAVENHART.

THE law in Germany as regards interference is peculiar. One would have expected, knowing the elaborateness of police and legal restrictions, that man-made interference would be "verboten," and that that (since, with all their faults, our cousins are at any rate law-abiding) would be that.

As a matter of fact, the position is quite different, the right to hear broadcasting being regarded as a "possession." Therefore, if anyone interferes with my reception, I can prosecute him; but only if it can be proved that the interference is deliberate is it a criminal offence. In all other cases it is a civil matter, and I, as the person whose rights are affected, must take out the summons against the interferer.

Hunting Down Interference.

Unfortunately, I have to find him first, and this is practically impossible for the average listener. Realising this, the German postal and broadcast authorities provide help.

Here, again, their methods are not what one would expect: at any rate not with the usual conception of Germany as the paradise of officialdom. Instead of squads of postal or broadcast officials with elaborate interference-hunting vans and commensurate salaries, the system preferred has been to form "Broadcast Help Committees" of unpaid enthusiasts.

The actual organisation varies from district to district—that of the Silesian (Breslau-Gleiwitz) group may be taken as an example: incidentally, I believe this was the first to adopt the system.

In this case, then, there are about eighty such committees in the area, each, as a rule, headed by a postal official (for convenience in relations with other official quarters) and with at least one wireless engineer or technician, the remaining members being wireless dealers, amateurs with technical knowledge, "or other interested

persons," as an official account puts it. And, one may add, it is by no means hard to be "interested": interference hunting can be as enthralling a sport as one could wish for, not altogether devoid of danger from irate quarry, and amply rewarded by the thanks of the rescued listeners. Incidentally, expenses are paid, which one hopes does not impair the amateur status of the hunters!

Each committee—or shall we say "hunt"—is equipped with one or more special interference-chasing receivers, and also with a stock of interference-eliminating devices, so that owners of offending apparatus can be shown what steps to take and how the interference is thereby reduced. The quarry is, as a rule, confined to violet-ray apparatus, small motors, electric lifts, and the like: big game such as trams, electric railways, radio-telegraphic stations, and electric supply companies are left to the central postal and broadcast authorities.

Needless to say, informative literature on methods of chasing and clearing interference is provided, and also a considerable amount of literature for distribution, especially to persons suspected of owning interference-producers. An example of such a leaflet is shown: the general tone is: "If you are causing interference, better eliminate it yourself than be forced legally to do so," and: "Anyhow, don't use your violet-ray machine during the principal broadcasting hours," ending with an appeal to "genuine community spirit and real respect for the rights of your neighbours."

Records as an Aid to Identifying Interference.

Mention should also be made of the gramophone record recently produced by the Telefunken Company to help in the identification of interferences: the sounds typical of fourteen different sources are recorded, both alone and also as the accompaniment to music. The list will give an idea of the variety of the game hunted: violet-ray machines, high-frequency apparatus, faulty con-

Interference in Germany.—

tacts in electric wiring, electric bells, thermo-operated switches for advertising signs, heating-pads (which lend variety by croaking like a frog at times), sewing-machine motors, motors of hair-drying, vibratory massage, and vacuum cleaner apparatus, lift motors (with their awful crash on starting), small and large electric motors, tramways, reaction squeals, and "reaction-fading" (when a neighbour's set in oscillation causes a large reduction in volume). Similar specimen interferences, with their removal by suitable filters, have also been demonstrated by wireless.

The chase starts as a rule with some listener who reports the interference to his post office, which passes the complaint on to the committee. One or more members then set to work, beginning with an interview with the complainant (more especially to make sure that he is not in reality complaining of a faulty contact in his own set—or of electrical storms!).

Simple Portable Equipment.

The receiver used in the hunt is of a very simple nature, having one high-frequency (screen-grid) valve, a detector with reaction, and one transformer-coupled low-frequency stage, all fed from dry batteries for filament and plate. A frame antenna is provided, though experience has shown that this is rarely of any great service; as a rule, capacity-coupling from the electric-light wires is used. At the complainant's house the

receiver is tuned to the wavelength on which maximum interference is experienced, and thereafter left alone during the whole hunt, the reaction being also left fixed at a convenient value.

The actual search is carried out by comparing aurally the loudness of the interference at various points in the neighbourhood, working, of course, in the direction of increasing loudness. Despite the apparently vague nature of such tests, the mind being forced to carry the memory of the last-heard degree of loudness during a considerable period, results have shown that in most cases the quarry can be run to earth by such simple means.

The real fun starts, of course, when difficulties arise;

when, for example, the trail is crossed by another hare—when the ear gets led off on a new trail and an entirely different source of interference is cleared, with the result that a return to the complainant's house shows that the chase has to be restarted; or when a false location is made, due to the fact that two sets of electric-light wires combine to give a maximum at a point where they happen to run together in close proximity, owing to the fact that each is bringing interference with it. Without such and similar difficulties, however, the sport would not exist.

But the real point to emphasise is the excellence of the results obtained, with very simple methods and at practically no cost to the public—not to mention the new sport offered to the wireless enthusiast! The German method might well be followed.

Merkblatt der Oberpostdirektion

Seit einiger Zeit treten hier heftige Rundfunkstörungen auf. Sie rühren von hochfrequenten Schwingungen her, die von elektrischen Haushaltsmaschinen — Staubsaugern, Heißluftgezeugern, Ventilatoren, Heizkissen — oder auch gewerblichen Betriebseinrichtungen elektrischer Art — Bohrmaschinen bei Zahnärzten, Haarschneidemaschinen, Röntgenapparaten bei Ärzten, Motoren — sowie schließlich von dem gefährlichsten aller Rundfunkstörer, dem

Hochfrequenz-Bestrahlungs-Apparat

ausgehen. Oft kennen die Besitzer die unangenehme Nebenwirkung gar nicht, die von ihrem elektrischen Gerät in die Ferne geht, weil sie selbst niemals etwas davon merken. Unbewußt verursachen sie dadurch fortgesetzt gegen die Besonderen Interessen der Allgemeinheit verstoßen. Nach dem Gesetz vom 28. 8. 1928 (S. 858—862 u. 906 des

Pamphlets are distributed drawing attention to the common causes of interference.

Epoch Radio Manufacturing Co., Ltd., Farringdon Avenue, London, E.C.4.—Booklet S4, illustrating and describing their latest range of permanent magnet and electro-magnetic types of moving-coil loud speakers. A special extra powerful model for cinema use has now been introduced.

Marconiphone Co., Ltd., 210-212, Tottenham Court Road, London, W.1.—Illustrated leaflets describing the new season's range of mains and battery fed sets, the Marconiphone gramophone pick-ups and the new moving-coil loud speakers, also descriptive list of Marconi valves.

Dulcetto-Polyphon, Ltd., 2 and 3, Newman Street, London, W.1.—188-page illustrated catalogue of proprietary components and accessories stocked by this firm. Also a 40-page catalogue of receivers and a 48-page list dealing exclusively with gramophone accessories.

Catalogues Received.

A. C. Cossor, Ltd., Cossor Works, Highbury Grove, London, N.5.—16-page catalogue illustrating the extensive range of Cossor receivers now available, also 44-page catalogue dealing with valves.

Igranic Electric Co., Ltd., 149, Queen Victoria Street, London, E.C.4.—Publication No. 6681, a 48-page catalogue of Igranic radio devices.

Ormond Engineering Co., Ltd., Ormond House, Rosebery Avenue, London, E.C.1.—Illustrated catalogue dealing with receivers, loud speakers, variable condensers and components.

J. J. Eastick and Sons, Felex House, 118, Bunhill Row, London, E.C.1.—Illustrated folder in colour of the "Felex" terminals and connectors.

Scientific Supply Stores, 126, Newington Causeway, London, S.E.1.—Descriptive folder of "Scientific" receivers and radio-gramophones.

Houghtons (Ensign, Ltd.), High Holborn, London, W.C.1.—General catalogue of proprietary receivers and accessories stocked by this firm for the 1931 season.

A. J. Dew and Co., 32-34, Rathbone Place, Oxford Street, London, W.1.—320-page illustrated catalogue of receivers, accessories and components listed by this firm.

Mullard Wireless Service Co., Ltd., Mullard House, Charing Cross Road, London, W.C.2.—Booklets dealing with the Mullard range of A.C. valves and the 2-volt battery type. Also descriptive folder illustrating the "Pure Music" range of loud speakers, mains unit and components.

Broadcast Brevities

By Our Special Correspondent.

Masts in Portland Place.—Britain's Best Station.—Anonimity at the Microphone.

Those Masts.

It is no betrayal of secrets to say that the shapely little masts, 25 feet high, which now surmount "Broadcasting House" are really intended for ornament rather than utility. Their object, I take it, is to give the place an "air" which shall distinguish it from a hostelry or treading factory.

There will, of course, be no transmission from Portland Place, and it seems certain that any distant reception would be carried out by selective frame aerial methods.

○○○○

When the B.B.C. Pays Rent.

"Broadcasting House" is expected to be out of the builders' hands by July next; the B.B.C. will then begin supervising the internal construction work and decorations, and will begin to pay rent to the owning syndicate. The Corporation will be running two establishments for about three months, at the end of which time the exodus from Savoy Hill will begin.

○○○○

Lack of Space.

Whether the present headquarters will be completely evacuated is still being questioned. Quite startling remarks are already being made concerning the "crampy" appearance of some of the rooms at Portland Place. When, a few weeks ago, I was privileged to tour the building I was struck by the lack of elbow room in the staff offices.

○○○○

Britain's Best Station.

That Northern Regional has not yet caused any real excitement among the listening public is probably entirely due to the fact that the transmissions are made after broadcasting hours with a comparatively small power output.

A friend who has toured much of the Continent and has seen many broadcasting stations, tells me that Northern Regional occupies one of the finest, if not the finest, broadcasting sites in Europe.

○○○○

The Carrier Wave.

Probably by the time these lines are read the first modulated signals will have gone out after midnight from the new transmitter, and the power should startle many listeners unless the engineers are very cautious in the matter of initial output.

Encouraged by official hints of an early start, I have been tuning in after midnight on the 479-metre wavelength for several days past, but have heard only an irritating carrier wave.

B 27

Artificial Stone for Scottish Regional.

All the outer main walls of the new Scottish Regional station are to be constructed of artificial stone produced by the Craighall Cast Stone Company of Edinburgh. This pre-cast stonework, I am told, gives a sturdy and weather-resisting finish to a building. An example of its use is to be found at the new town hall and library at Leith.

The preliminary constructional work has already begun at Wester Glen, where the new station is to be located.

○○○○

Anonymous Broadcasters.

Although there was no truth in the rumour that Mr. Charles Chaplin was induced to broadcast during the Epilogue on Sunday, February 22nd, the story was not so far-fetched as might appear. Quite a number of distinguished folk have made their microphonic debut anonymously during those quiet few minutes on Sunday evening.

○○○○

The Prime Minister and the Epilogue.

Mr. Ramsay MacDonald has several times read the scripture passage; sometimes the speaker is Sir John Reith or Mr. J. L. Stobart, and Mr. Alan Howland occasionally fills the position.

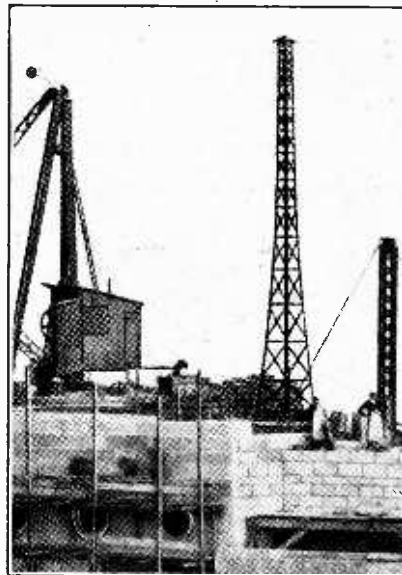

ON THE ROOF OF "B.H." A photograph taken from the west side of Portland Place last week showing the first of three small lattice masts to be erected above the new B.B.C. headquarters.

The "Epilogue Voice."

The prior necessity is a sympathetic and well-modulated voice, but it is surprising that the only announcer to be entrusted with the task with any regularity is Mr. Hibberd, whose dignified and almost grave manner of speaking certainly accords more satisfactorily with Epilogues than Vaudeville turns.

○○○○

Woodman, Spare That Tree!

By the way, I hear that a Savoy Hill announcer who has recently been feeling the strain of working every day (Sundays included) for three weeks has resorted to the late Mr. Gladstone's invigorating but expensive hobby of tree-felling. I am all in favour of our announcers retaining the physical fitness which is reflected in a manly voice, but it would be painful to think that every news bulletin or weather forecast involved the downfall of a monarch of the forest.

○○○○

"Talkie" Excerpts for Broadcasting.

A varied programme composed of excerpts from some of the recent talkies is to be heard by National listeners on March 7th. This relay from a central source in the West End will occupy twenty minutes. The only relay of the kind previously carried out consisted of excerpts from "The Love Parade."

○○○○

A Welshman.

My paragraph last week exhorting Savoy Hill to find a Welshman has brought a speedy reply from Cardiff. It appears that the Welsh have an energetic countryman—a University graduate—on the West Regional staff whose function for several years has been to maintain a healthy Cambrian standard in the transmissions.

I am glad to have these facts, but I still think that there should be a Welshman at Savoy Hill.

○○○○

Esperanto.

If enthusiasm, like faith, could remove mountains, the Esperantists would by now have made the world rather like a newly rolled bowling green. They are still pressing the B.B.C. for a weekly half-hour at the microphone, and, although I hold no brief for this or any other international language, I think the Corporation might at least lend them an indulgent ear. From what I can gather, the Esperantists are met with a stony silence which may mean anything from mild indifference to brazen hostility.

Two-Station

Regional Set



Inexpensive All-Electric Receiver with Pre-set Tuning.

IF the reception of two programmes is all that is required, and there is no objection to putting up an outside aerial, then the Columbia receiver, Model 309, will exactly meet the need. This simple requirement avoids the need for tuning, while it is much easier to throw a switch as a means of changing the programme as compared with turning a dial to a critical setting and probably readjusting other controls. The demand among listeners for this class of receiver is greater than for any other type, for with its simplicity comes compactness, freedom from trouble, and a considerable saving in cost. Built for operation from the supply mains, the set requires little attention, has practically no maintenance cost, and can be operated by anyone.

Like other Columbia radio productions, the set is built mainly from pressed parts, which gives greater reliability than the wiring of a number of components not expressly made to suit the purpose for which they are intended. A cadmium-plated iron frame supports the apparatus. On the top side is a mains transformer, smoothing choke, bridging condensers and metal rectifier. Part of the frame is cut away and bent up to form a screen around the rectifier, and in the recess thus created a bakelite panel is fitted, which carries the valves, tuning coils, and switch parts. Two-range tuning is obtained by entirely switching over the tuning coils and the tuning and reaction condensers, so that there is, in fact, a duplication of the whole tuning equipment. Such a change-over requires many switch contacts, and unless the switch is well designed there is every chance of trouble from bad connections. In this instance, however, a reliable action is obtained by the use of long spring contacts and rubbing blades. The arrangement is such that the contact surfaces are kept clean and bright, and, while a hard pressure is obtained at the points of contact, a lever action makes the switch light to operate. Four tuning condensers assembled as a single unit tune the coils and provide capacity reaction.

Maximum signal strength results by the use of low-capacity tuning condensers, these having a maximum

value of only 0.0002 mfd., and, while in a tuned circuit reduction of the tuning capacity calls for a compensating increase in the size of the coil tending towards flatness of tuning, ample separation is provided between the two London stations. For use in London, the pair of tuning coils fitted have wave-ranges of 250-275 metres and 340-375 metres. Fitted with pin-connectors like those of a valve base, these coils are wound on small bakelite mouldings, and consist of both tuning and reaction windings. In switching over between the two circuits, the grid of the detector valve remains connected to the aerial,

and one side of each tuned circuit remains earth-connected. Switching, therefore, consists of transferring the aerial-grid lead alternatively between the two tuned circuits, and at the same time transferring the connection from the valve anode to one or other of the reaction coils. Additional contacts are provided, so that as well as making this change-over the tuned circuit not in use is short-circuited.

Detection is by grid condenser and leak, and a 1 to 6 ratio transformer provides a coupling to the output valve.

Decoupling is introduced in the H.T. feed of the primary of the transformer, while a load of 0.5 megohm shunts the transformer secondary. The detector valve is a Cossor 41 M.L.F., and the output valve a pentode, the Mullard P.M.24. Tone compensation is introduced in the anode of the pentode, consisting of a shunt circuit comprising resistance and capacity, having the effect of bringing out the bass frequencies. Bias of the output valve is provided by a grid bias battery, which experience shows is very apt to be neglected. Inclusion of "free grid bias" would avoid this possibility. A balanced armature movement is used in the loud speaker, a surround of cotton-wool holding the diaphragm in place.

Access to the two sets of tuning controls is obtained by the removal of the cover plate, which forms an escutcheon to the control levers. Setting of the tuning and reaction controls is quite simple, and signal strength up to forty or fifty miles is adequate. Incidentally, foreign

SPECIFICATION.

Complete A.C. all-mains operated receiver.
Alternative programme reception by
change-over switch.

Pre-set tuning by duplicate coils and
condensers.

Indirectly heated detector (Cossor 41
M.L.F.) and pentode output (Mullard
P.M.24).

Differential aerial condenser volume
control.

Chassis built and housed in oak-finished
cabinet complete with valves and loud
speaker.

Height 15½ in. × 14 in. × 8½ in.

Price, £12 12s. 0d.

Alternative model available for use with
D.C. supply.

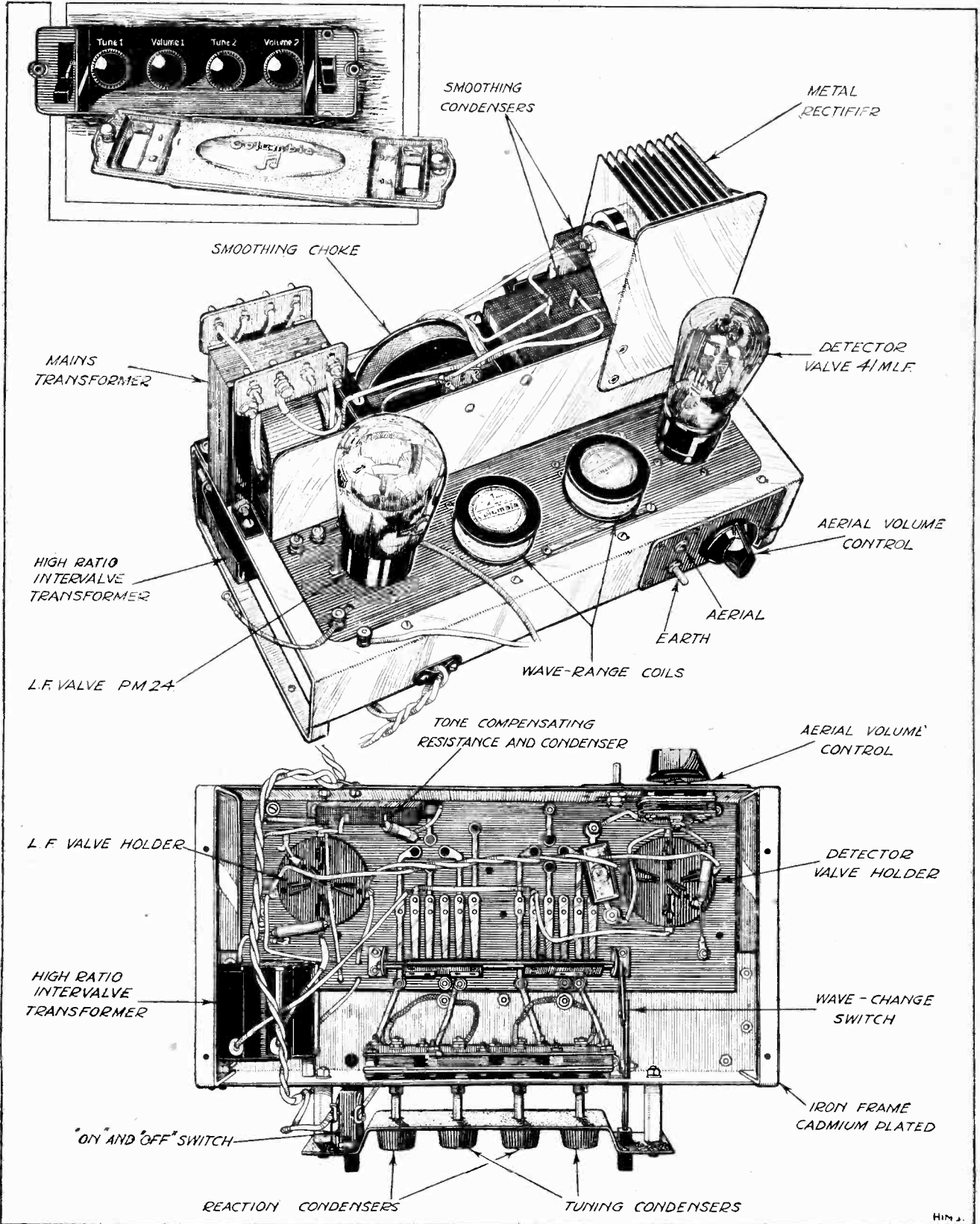

COLUMBIA A.C. RECEIVER, MODEL 309. Top and underside views of the chassis. The tuning controls are concealed behind the switch cover plate.

Two-Station Regional Set, Columbia 309.—

stations could be faintly heard while setting the dials. An ~~control~~ volume control is fitted, but is not intended as a normal adjustment, being at the back of the set. It con-

being but small chance of distortion with a single-stage amplifier. By the use of key switches for "on" and "off" and programme change-over, no outfit could be more simple. With slightly tapering sides and circular

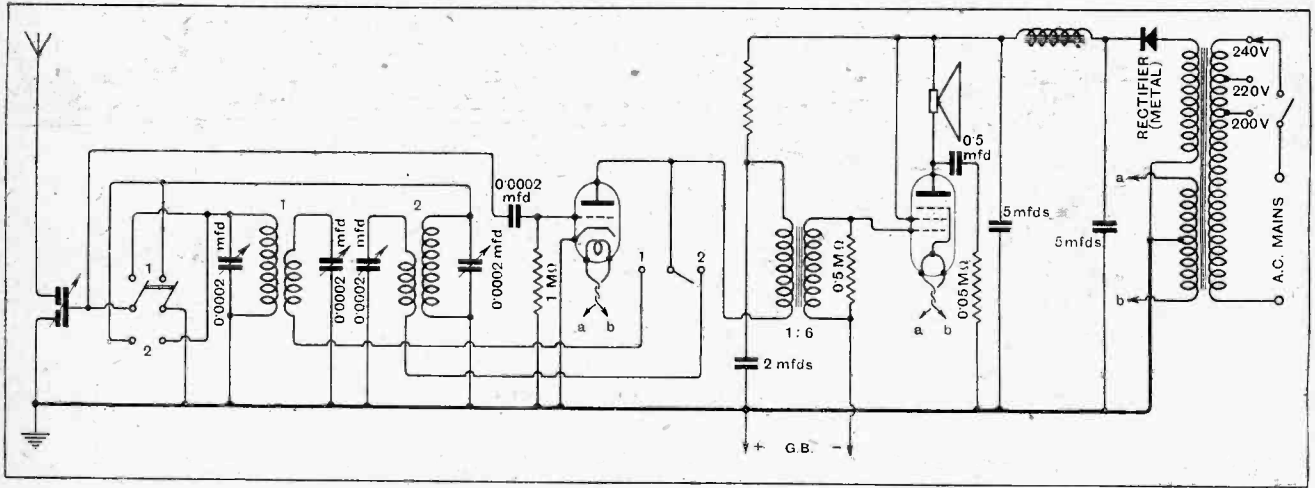

Two-range tuning by change-over switch is obtained by a complete duplication of the tuning equipment.

sists of a differential aerial condenser used to limit the signal strength from a near-by dual programme station in order to gain adequate selectivity.

loud speaker grille, the oak finished cabinet is of good appearance, and at 12 guineas this receiver meets the needs of possibly ninety per cent. of the listening public.

The reproduction is good, and speech natural, there

A similar model is available for direct current mains.

Another Amateur in India.

Mr. J. W. J. Tyrell (2BLX) is now in "L" Company, Royal Corps of Signals, at Jubbulpore, India, and hopes soon to be working on 42 and 20 metres. He will be pleased to hear from any amateur transmitter in England or elsewhere who wishes to carry out tests with India and to report on signal strength, weather conditions, etc.

○○○○

Short Waves and Earthquakes.

The theory that earthquakes affect short-wave working was put forward about a year ago by Mr. C. J. Mumford, who at that time was operating the station CT1BL, at Lisbon, and aroused some discussion among members of the R.S.G.B. A correspondent attributes the unsatisfactory conditions experienced in short-wave working, especially on the 7 mC. band, on Monday, February 2nd, to the effect of the New Zealand shocks. The regular schedule between G6YL, G2ZC and G6PP failed entirely, and Mr. E. R. Radford (G2IM) felt sure, when he switched off his receiver in the early morning, that the news of a severe earthquake was to be expected.

○○○○

Hints to Intending Transmitters.

A publication by the American Radio Relay League, entitled "How to Become a Radio Amateur," gives, in a popular form, useful advice to intending transmitters on learning the Morse code, sending, building a simple receiver and transmitter, and the elementary points to be observed and avoided in operating a station. This 29-page

Transmitters' Notes.

pamphlet, though written for the guidance of budding enthusiasts in the United States, is, in general, equally applicable to those in Great Britain, though it certainly seems to be an easier matter to obtain a licence on the other side of the Atlantic.

○○○○

Portuguese Amateurs.

Wireless amateurs in Portugal have now joined the International Amateur Radio Union, following the example of Australia, Belgium, Canada, Denmark, France, Holland, Germany, Great Britain, Irish Free State, Italy, New Zealand, Norway, Poland, South Africa, Sweden, Switzerland and the United States. The Union, which was organised in Paris in 1925, has now a membership of nearly 30,000 transmitting amateurs, represented by the various affiliated radio societies.

○○○○

Two Changes.

Mr. Robert Holmes tells us that the correct address of his station G6RH is 26, Crane Avenue, Worpole Estate, Isleworth, and not 446, London Road, as given in error on page 137 of our issue of February 11th.

Mr. E. F. Baker, 5, Currie Road, St. John's, Tunbridge Wells, advises us that his call-sign has been changed from 2ANJ

(as stated in our issue of January 7th) to 2ANU, as it was found that the former call-sign had already been allotted to another amateur.

○○○○

New Call-signs and Changes of Address.

- G2XG Corpl. A. G. Carr, Electrical and Wireless School, R.A.F., Cranwell, Lincs.
- G2YI (ex 2ABK), R. C. Horsnell, "Heban," Guernsey Gardens, Wickford, Essex.
- G5LA (ex 2BMB), A. W. Alliston, "Corners," Cross Rd., Tadworth, Surrey.
- G6PM F. Pemberton, 115, Cambridge Rd., S.W.20.
- G6WF B. Whitehouse, Bourne House, Moss Grove, Kingswinford, Staffs. (Change of address).
- G6XN L. A. Moxon, 37, Vallis Way, W.5. (Change of address).
- 2AGD G. Melhuish, 75, Springfield Rd., Cotham, Bristol.
- 2AMC R. E. Griffin, 7, Davis Buildings, West St., Bedminster, Bristol.
- 2AUQ E. C. Taylor, 35, Grant Rd., Addiscombe, Croydon.
- 2BIW A. Hine, 51, Claworth Rd., West Bridgford, Notts.

○○○○

BOOKS RECEIVED.

Wie helfe ich mir wenn mein Rundfunk-Empfänger versagt? By Hans Coler and Karl Roessger. A short treatise on testing for and repairing faults in wireless receivers. Pp. 31, with 22 illustrations and diagrams. Published by Rothgier and Diesing, A.G., Berlin. Price RM.1.

○○○○

Kennelly-Heaviside Layer, Height Observations for 4,045 and 8,650 Ic. By T. R. Gilliland (Research Paper No. 246), being the report of observations made between January 16th and June 19th, 1930. Pp. 7, with 8 illustrations and diagrams. Issued by the Bureau of Standards, U.S. Department of Commerce, Washington, D.C., price 10 cents.

From Aerial to Loud Speaker



The Purpose of Every Component.

By A. L. M. SOWERBY, M.Sc.

WITH the exception of the grid-bias battery we dealt, last week, with the functions of all the components that precede the valve-holder into which V_1 (shown in the diagram) is to be inserted. Since the coils that have been suggested have a moderately high dynamic resistance (i.e., are reasonably "low-loss") it is desirable that this valve-holder, which has to be connected in parallel with the second tuned circuit C_2L_2 , should not introduce dielectric losses of any great magnitude. Some of the best-known and highest-priced valve-holders are very bad offenders in this direction, their reputation having been gained by quite other virtues. The best valve-holder, from our present point of view, will be one in which there is the absolute minimum of insulating material; what little there is should, if possible, be ebonite.

The Screen-grid Valve Circuit.

In any modern set the first valve will of necessity be of the screen-grid type, for the screen-grid valve offers far greater amplification than the neutralised triode can provide, and gives at the same time considerably better stability. Everyone knows that the purpose of the screening-grid is primarily to prevent amplified signals from passing back from the anode of the valve to the grid, and so setting up unintentional and uncontrolled oscillation. It is not quite so obvious that the screening-grid only operates as a perfect screen when it is kept rigidly at earth potential. Owing to the fact that the screening-grid is connected to a tapping on the H.T. battery (or its equivalent if an eliminator is being used), the valve is all the time tending to behave as an ordinary triode, the screening-grid acting like the plate of a three-electrode valve. The amplified voltages that appear on the screen must, therefore, be short-circuited very carefully to earth if the valve is to work in the manner intended. The path

to earth is provided by the condenser C_s , which is connected back directly to the negative filament terminal (cathode terminal in the case of mains valves) of the valve-holder itself. To avoid the formation of an inductive loop, which could feed currents back into the coil L_2 , C_s should be placed right up against the valve-holder, and the wires by which it is connected up should be crossed.

Supplying the Screen Voltage.

If it is to fulfil its purpose adequately C_s must offer the lowest possible impedance to high-frequency currents; any failure in this respect may lead, especially in a two-stage set, to hopeless instability. Practical experiments have shown that a suitably constructed condenser of capacity 1 mfd. offers a lower impedance than any other at the wavelengths upon which instability is most likely to arise; a non-inductive condenser of the capacity mentioned should therefore be chosen.

If C_s should become disconnected it is quite certain that the receiver will oscillate until the connection has been repaired, while a short-circuit would result in no signals, because there would be no voltage on the screening-grid. In addition, one or more of the feed-resistances R_1 , R_2 , and R_3 , would probably suffer.

As well as providing an easy path to earth for the high-frequency currents from the screening-grid of the valve, it is necessary to ensure that they do not find their way, through the various battery supply leads, to other parts of the set. The resistance R_3 is inserted to act as a barrier; it is usual to choose a value of 600 or 1,000 ohms, though the actual value is not in any way critical. If R_3 is short-circuited the set is very liable to break into oscillation, while if it becomes disconnected the opposite failing, complete lack of signals will result owing to cutting off the high-tension supply to the screening-grid

THIS article, the second of a series explaining the function of every component in a typical modern four-valve receiver, gives a fund of information concerning the best circuit for a screen-grid valve. Stress is laid on the importance of screening and decoupling and it is shown that dielectric losses must be reduced to the minimum.

From Aerial to Loud Speaker.—

of the valve. A very low value of resistance hardly provides a sufficiently effective barrier to high-frequency currents, while the choice of too high a value will do no more than lower the screen-voltage by an insignificant amount. The self-capacity of the resistance should be kept low, or the high-frequency currents will sneak across the resistance through the small condenser formed. If the number of turns in the resistance is anywhere near the number required to tune to any of the wavelengths that the set has to cover, the adoption of a non-inductive winding is a very sound precaution to take against unexpected oscillation. Some designers prefer to replace the resistance with a high-frequency choke; the writer is inclined to prefer a resistance not only because it is cheaper and smaller, but even more

comes exactly against the hole in the box, we can ensure that the external screens carry on, to the best possible advantage, the screening within the valve. In this way the first box can be made to contain every component and every lead carrying high-frequency currents that have undergone one stage of amplification, while not containing so much as an inch of wire carrying un-amplified, or twice amplified, currents. Provided that the screening-boxes make really good electrical contact along every edge, and do not merely "fit where they touch," the screening may be said to be practically perfect. For a two-stage set using coils of the type described, which have moderately high inductance and reasonably low resistance, the precautions against instability that have been outlined are not in any way excessive.

Indeed, in many cases it may be necessary to take

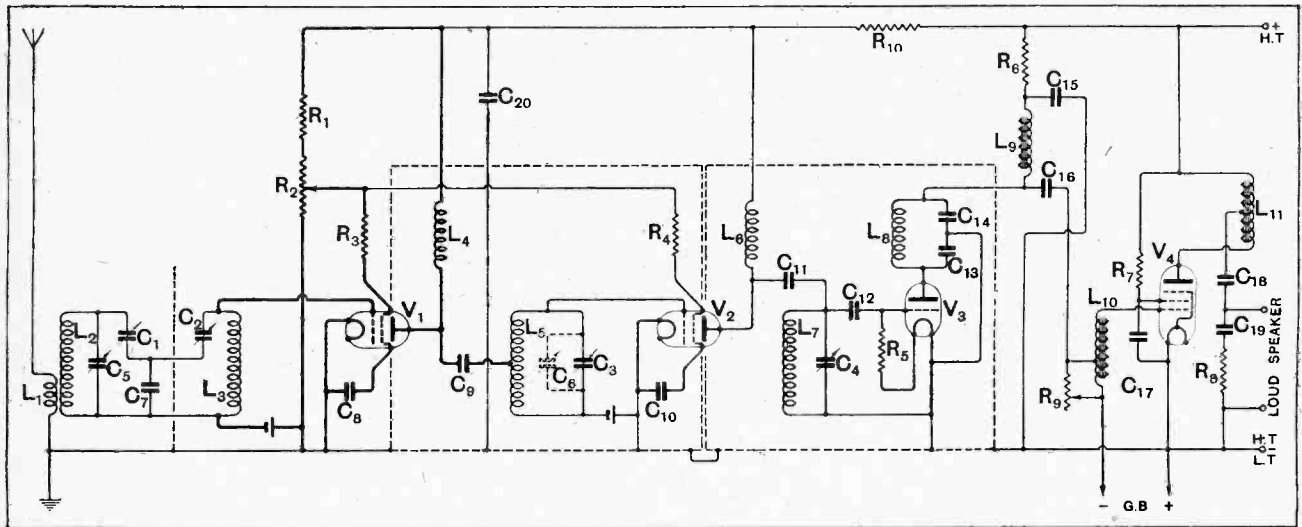

How the circuit of the screen-grid valve is built up is explained, reasons are given for the values of the parts, while the effects of the use of faulty components are indicated.

because it has a smaller inductive field than a choke, and so is less likely to cause trouble through stray couplings.

The Valve Screening.

R_3 and C_8 , between them, ensure that the internal screening of the valve shall be used to the best possible advantage; it is important to ensure that the care taken in this respect shall not be nullified by the arrangement of the screening external to the valve. The valve-screening leaves a capacity of the order of one-hundredth to one-thousandth of a micromicrofarad (seven o's one to eight o's one of a mfd.) still remaining between grid and anode; a very small imperfection in screening or wiring outside the valve might well increase this minute capacity to ten times its value.

In the diagram V_1 is shown mounted on its side in such a way that while the grid, filament, and screen-grid connections are in the open, the plate of the valve, where the amplified high-frequency voltages make their first appearance, is enclosed within the box indicated by the dotted lines. If the valve-holder is so placed that the "skirt" of the screen-grid, visible as a horizontal plate within the valve,

the further precaution of protecting the screen-grid valve from the coils, for interaction between these has been known to produce instability. For this purpose it is usually enough to cover each screen-grid valve with metallic foil or gauze, allowing this to make contact with the screening box. Alternatively, the valve may be accommodated, in a vertical position, in a little "sentry-box" built on to the outside of the main screening box, or built into one corner within it.

The Importance of Complete Screening.

It must be pointed out that the system of screening to be adopted in the finished set is an integral part of the design; if, for example, screening of a much less thorough-going order than that described were to be adopted, the whole design of the high-frequency amplifier would have to be revised. It would be necessary to design for much lower stage-gain and much lower selectivity in order to keep the set stable.

A further vital factor in the efficiency of the screening system lies in the choice of the screen-grid valve. It is entirely fallacious to believe that the capacity between grid and anode of such a valve has been reduced to zero by the interposition of the screening-grid; truly,

From Aerial to Loud Speaker.—

the capacity that remains is minutely small, but it is still there. Moreover, some valves have a higher residual capacity than others. Were it not for certain other precautions, which will be mentioned in due course, three out of four of the screen-grid valves on the market would be too incompletely screened to be usable in the set we are discussing. For information on the internal screening of valves, reference should be made to *The Wireless World Valve Data Sheet* (Nov. 26th, 1930), where the residual anode-grid capacities* of the various screen-grid valves are given, and choice should be restricted to those valves in which this capacity has the lowest values. Further suggestions as to choice of valve and of operating voltages will have to be postponed until the circuits following the valve have been discussed.

The High-frequency Choke.

The first component within the screening-box is the high-frequency choke L_1 . This is connected between the anode of the screen-grid valve and H.T. plus, and has two duties to fulfil. First, it must offer as high an impedance as possible to high-frequency currents, so that these may flow through, and energise, the tuned circuit L_2C_2 that feeds the signals to the next valve.¹ Secondly, it has to carry the steady anode current of V_1 , from which it follows at once that if it is disconnected V_1 will cease to amplify. If, on the other hand, L_1 is short-circuited, it will cease to offer a high impedance to the high-frequency currents, which will flow, by way of the high-tension supply, to earth instead of passing on through the set. In either case signals will cease entirely.

The choke L_1 possesses three properties: inductance, resistance, and capacity, and is primarily designed to have a high value of the first of these. The resistance is of no great import, for it only has to carry the small anode current of the screen-grid valve. Only a few volts will be lost across it, even if it has a resistance much higher than the average commercial choke. The self-capacity of the choke is of even less moment, for it is effectively in parallel with the tuning condenser C_2 in the sense that both run from a point at high high-frequency potential to earth, either directly or through the high-tension battery. As a consequence, a choke of high self-capacity will merely mean that the tuning condenser has to be advanced a degree or so less towards maximum than if the choke

has no stray capacity at all. The high-frequency losses in the self-capacity are of more importance; they depend more on the material of the former and the disposition of the terminals upon it than upon the gauge of wire or the method of winding. If the terminals are at opposite ends of the former, and more especially if, in addition, the latter is of ebonite, the choke may be assumed to be above criticism in this respect.

The inductance of L_1 is not critical; all that is essential is that it should exceed some 40,000 microhenrys in order that it should be high compared with the inductance of the coil L_2 , with part of which it is in parallel. A more important requirement is that L_1

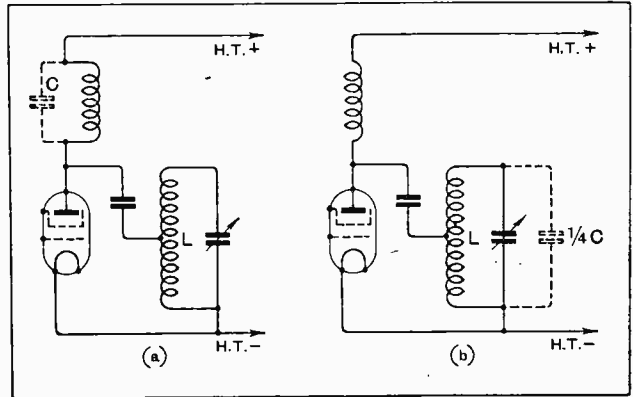

The effect of self-capacity of a high-frequency choke. In (a) is shown the circuit as it exists in the set: C is the self-capacity. In (b) is shown an equivalent circuit: C is now replaced by $\frac{1}{2} C$ (if L is centre-tapped) across the tuning condenser. Its effect is negligible. The losses in C may be represented by 2 to 6 megohms in parallel with $\frac{1}{2} C$ —also negligible.

should contain no subsidiary circuits that will resonate to any wavelength to which the set may be tuned. Some of the chokes on the market have been designed with this point in view, and if one of these is chosen, one is sure not to find that the set is inexplicably "dead" over one or more narrow bands of wavelengths.

Feed Condenser Values.

The high-frequency voltages developed across L_1 have to be passed on to the succeeding tuned circuit; from the point of view of signals only this could quite well be done by connecting the anode of V_1 to a point on L_2 by a piece of wire. To avoid short-circuiting the high-tension supply, however, it is necessary to insert the condenser C_3 . A usual value for a feed-condenser of this type is 0.001 mfd., but almost any other value will serve the purpose. The dynamic resistance of the part of the tuned circuit lying between C_3 and earth will probably be about 40,000 ohms or so; if the capacity of C_3 is such that it offers an impedance considerably smaller than this to high-frequency currents of the lowest frequency (highest wavelength) to be received, no noticeable voltage will be dropped across it, and the whole signal voltage will be available for energising the succeeding tuned circuit.

At 2,000 metres a condenser of capacity 0.0002 mfd. has a reactance of about 5,000 ohms, so that if C_3 is given this value barely more than 1 per cent. of the voltage across the choke will be lost through the intro-

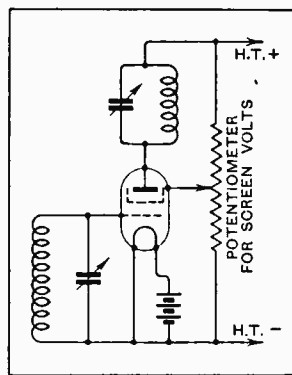

A simplified H.F. stage, in which the screening-grid entirely fails to screen. Unless a suitable condenser were connected between screen-grid and earth, so as to keep the screen at earth potential, the stage would oscillate. For further details see *The Wireless World*, Sept. 25th, p. 299.

¹ This is the "tuned grid" coupling discussed in *The Wireless World*, January 21st, 1931, p. 57.

From Aerial to Loud Speaker.—

duction of C_0 , leaving 99 per cent. for the coil.² However great the capacity of C_0 may be made, the voltage on the coil can only regain that lost 1 per cent., which would be too small an improvement to be appreciable. If C_0 is made very large, however, it can pass low-frequency impulses, which would increase the likelihood of the set oscillating at low frequencies, and might perhaps give rise to "motor-boating." It is not worth while to risk this for an inappreciable gain in signal strength, so that the value chosen for C_0 should be anything from 0.0003 down to 0.0001 mfd.

² This statement appears absurd, but is actually correct. The dynamic resistance of the coil and the reactance of the condenser have to be added "vectorially," which always leads to apparent contradictions.

CORRESPONDENCE.

The Editor does not hold himself responsible for the opinions of his correspondents.

Correspondence should be addressed to the Editor, "The Wireless World," Dorset House, Tudor Street, E.C.4, and must be accompanied by the writer's name and address.

RADIO DEALERS AND RADIO SOCIETIES.

Sir,—I read with much interest the article on radio dealers and radio societies written by your correspondent Mr. J. Baggs, of Manchester.

Whilst agreeing with Mr. Baggs in his statement that quite a number of radio societies must have suffered a decrease in membership during the last few years, the society of which I am hon. secretary has actually increased its membership, and I must say that this has only been made possible by the number of excellent lectures and demonstrations, technical and otherwise, which have been given to us by various manufacturers.

The professions and trades of our members are varied, and include university professors and lecturers, radio dealers, a director of a motor works, master builders, and, last but not least, the hard-boiled enthusiast.

We are also in possession of our own transmitter, namely, G6YN, and I think that our society can be taken as a good representative example; I know that it has been in existence for eighteen years.

S. T. JORDAN.

Hon. Sec.,
Bristol and District Radio and Television Society.

Sir,—I am heartily in agreement with all that Mr. Baggs says in his letter published in your issue of February 11th. There is no question that for some time the membership of many radio societies has been declining in view of the fact that the majority of people who, up to a year or two ago, constituted the bulk of the membership have acquired sufficient knowledge to enable them to differentiate between the tuning condenser and the reaction condenser of their set, which, in many cases, seems to be sufficient knowledge for their needs.

We certainly have got back to the pre-broadcast condition—radio societies composed of the real enthusiast, or, as Mr. Baggs has it, "the really 'hard-boiled' enthusiast."

There has been a tendency apparent latterly for something in the nature of a small revival, which, in the case of my own society, may to some extent possibly be due to the fact that we set ourselves a definite task, i.e. of converting "junk apparatus" received in response to a public appeal into usable wireless sets for blind people.

I do think that Mr. Baggs has made a very sound suggestion when he proposes that radio societies should obtain their membership mainly from the radio retailer and others associated directly with the radio industry, and possibly with the music trade. With all respect to many excellent men with whom I am acquainted in these trades, there is unquestionably much scope for an improvement in the technical knowledge of many of them or of their salesmen, and recent activities by one of the large manufacturers were no doubt consequent upon this fact. The

If C_0 should become disconnected, there will be no path for signals from the anode of V_1 to the coil L_5 . In view of the very small capacity needed to hand on an audible signal, it is probable that reception would not be cut off entirely. The local stations would be heard much as usual, though the set would need to be "turned up" a bit more to get them, but distant stations would certainly be very weak. A short-circuited condenser would connect the H.T. supply to earth, *via* L_5 and the grid-bias battery. The result of this is difficult to predict with any certainty, but there is not much doubt that at least one component would have to be replaced after the fireworks were over.

In next week's issue we shall examine the functions of the inter-valve tuned circuits and the grid condenser and leak.

lack of really sound theoretical and practical knowledge on the part of many people engaged in the radio industry, especially on the retail side, is, to say the least, appalling; to quote only one case which is so typical of many within my knowledge. I was once offered a 30-ohm rheostat in substitution for 400-ohm potentiometer, and the salesman assured me that the rheostat would serve my purpose quite well. This type of thing simply serves to emphasise the argument which Mr. Baggs advances. I am sure that other radio society officials, like myself, will adopt this suggestion so far as possible, but I am afraid, from my experience of the small retailer, that many of them are so engrossed in selling bicycles, gramophones, perambulators, and the other things to which wireless is quite often a sideline that we may find the matter presents some little difficulty.

Many thanks, however, to Mr. Baggs for the suggestion, which possibly you yourself, through your excellent journal, may be able to support.

J. HARTLEY.

President,
Stretford and District Radio Society.

CIRCUIT DIAGRAMS.

Sir,—I was very interested to read some of "Free Grid's" remarks on page 147 of your issue of February 11th, with reference to the set which he brought up to date, and the remarks he has to make about the difficulty, and often impossibility, of obtaining a circuit diagram from an English maker. I have constantly asked for such circuit diagrams from the various radio manufacturers, and in season and out of season have almost invariably been met with a refusal, generally on the ground that the circuit is a desperate trade secret and is something very wonderful. These contentions are, of course, sheer nonsense, for, as pointed out by "Free Grid," anyone can buy a set and reconstruct the circuit with a few hours' work.

Our manufacturers' methods contrast very markedly with the methods of the American manufacturers, who issue circuit diagrams and hints as to how to effect ordinary repairs and all sorts of constructional details in the form of a loose-leaf sheet. Such sheets, issued by all makers, are standard, and are bound together in a loose-leaf book known as "The Official Radio Service Manual," and this book is, I understand, in the hands of all wireless retailers, thus enabling them to give immediate service to their customers. From what I have been able to learn, the English manufacturer has not yet grasped the meaning of the word "service," let alone attempting to put into operation any efficient scheme.

Chorley Wood, Herts.

SANFIL.

THE STENODE.

Sir,—The recent abstract of a paper by Dr. Robinson on the Stenode does not alter the position that whether the sideband theory is used or the decrement of the circuit is considered the

result is the same, viz., that as the circuit decrement is decreased so the higher modulation frequencies suffer greater attenuation.

The question whether sidebands are physical realities or a mere mathematical fiction seems a matter for discussion by philosophers rather than to be answered by engineers. The results of experiments carried out under the guidance of Prof. C. L. Portescue at the City and Guilds (Eng.) College may be of interest and help to clarify the position. The apparatus used gave the response of a normal oscillatory circuit to an injected oscillation as the tuning capacity was varied about the

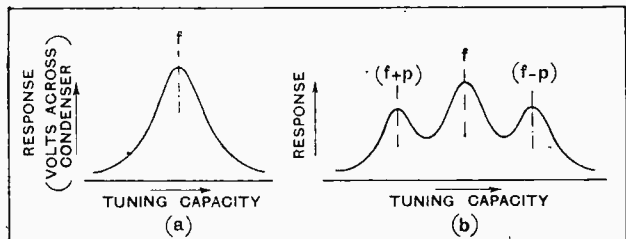

position for resonance. For an unmodulated frequency f the result was the familiar resonance curve (a). When this oscillation was (amplitude) modulated in the normal manner by an audio frequency p three resonant humps were obtained as in (b). The positions of the humps corresponded to resonant positions for frequencies $(f+p)$, f , and $(f-p)$, and as the modulation frequency was increased so the side resonant humps moved away from the carrier resonance to take up their proper positions according to the sideband theory. This response curve is precisely that for three separate oscillations, of suitable amplitudes, at frequencies $((f+p)$, f , and $(f-p)$. So we can say that a modulated wave, as far as its effect on a receiver is concerned (and at present this is all that matters), is equivalent to three distinct frequencies.

C. H. CROCKER, A.C.G.I., D.I.C.

Wireless Laboratory,
G.E.C. Telephone Works,
Coventry.

Sir.—I should, indeed, have been bold if, as Mr. Hallows implies, I had criticised a paper which I had not read. I thought I had made it quite clear, however, that I was dealing with the article as it appeared in *The Wireless World*. That article has doubtless been read by many people to whom the original paper was no more accessible than it was to Mr. Hallows and myself, and I do not see why it should be allowed to remain uncontradicted merely because Dr. Robinson prefers to expound his views before an American audience.

The reception of Stuttgart and Graz free from interference at fifteen miles from Brookmans Park is certainly a very good performance, but I have yet to be convinced that a band-pass filter with a very sharp cut-off at about 4,000 cycles could not accomplish this while still reproducing the highest notes of the violin. It is true that such a filter would not be easy to construct, and that is precisely why I said that the Steinode might be a useful alternative. If, however, Mr. Hallows' receiver definitely cuts out interference due to heterodyne tones whose frequencies are within its range of response to modulation, I will agree with him that it is a step far beyond the band-pass filter, and will be the first to congratulate him on achieving something that Dr. Robinson himself has apparently on his own admission been unable to do.

Such claims, however, cannot be regarded as established until proper quantitative experiments have been carried out, preferably in such cases as this, by some independent body as *The Wireless World* has recommended.

Oxford. N. L. YATES-FISH.

IS THE B.B.C. A PUBLIC SERVICE?

Sir.—Your leading article in your issue of the 4th inst. arouses me, and I am in entire sympathy with its remarks. I think everyone will admit that it is time a general stir was made by the listening public to make themselves heard, and perhaps,

felt, seeing there are nearly three and a half million licence-holders.

With the licence figures soaring, it is really amazing how listeners as a whole seem to rest content with such appallingly bad programmes and such unchecked and wanton expenditure of their funds.

While admitting the licence to be purely a tax, of which the B.B.C. receives a percentage, why should it be used so wantonly on reorganisation, so expensive, without a single suggestion from the donors as to how it should be disposed of or invested?

I am not blaming the B.B.C. for entering the publication world, as you complain of, but I do agree that the entertainment world must be casting anxious, if not jealous, eyes upon the Giant Studio and its entertainment licence, if procured. Surely this will take all the B.B.C.'s efforts to keep down the old controversy with the theatre and concert interests again.

But to get down to facts, we ordinary listeners, as we are designated, are powerless to express an opinion at all as to our satisfaction with the programme or an alternative or the expenditure in general.

For this state of affairs I blame the licence holder; he let the "Wireless League" simply peter out, and to-day he finds himself bound to pay the tax and has no voice in the expenditure of the fund he helps to create.

The radio trade and manufacturers are organised, but so long as they can dispose of their manufactures they will do nothing other than protect themselves; they will not blame the B.B.C. for their lack of customers until perhaps too late.

It seems to me appalling that in a democratic country three and a half million people pay licences and are content to listen or switch off when the programmes do not blend with their temperament.

The appalling outlay on the betterment of the service seems to me to be pure squandering of public money. We have seen it with the scrapping of 2LO and the stand-by to give place to the London Twin; building Broadcast House to scrap Savoy Hill, and, no doubt, a similar suite of buildings will arise at every regional headquarters.

With all this investment in properties and the so-called improvement of the service, I, for one, fail to see where I benefit.

London always had 2LO and 5GB to choose from for valve sets and, with crystal sets well in decline, where is the justification of the expenditure?

The service, I argue, is, if anything, worse, as the alternative is often on the other station within a day or so, if a studio effort.

The interference from the Continent is alarming, and the home transmitters require a volume control to prevent being overpowered by their programmes.

Surely these three and a half million people can, and should, have a say in what is taking place, and how their money should be spent. Therefore, I hope that the day is not far distant when the listener will take an interest and overpower the B.B.C. spendthrifts and their Programme Committee; until such is the case and listeners organise they will have to be content with switching off for many hours of leisure when they could enjoy the entertainment they pay for in taxation.

New Barnet, Herts. C. W. OLIVER.

L.S. MOVING COILS.

Sir.—Dr. McLachlan's remarks from time to time are always of value to those interested in M.C. speakers, but I have not seen any reference made by him as to the gauge of wire which should be used for low resistance M.C. speakers.

Take as an example a permanent magnet with a gap of .050 x 3/16 in. Several different coils could be wound to fit this gap. If we use 36 S.W.G. wire a two-layer coil would do; if, on the other hand, 40 S.W.G. were used, a four-layer coil could be made to fit.

Dr. McLachlan must have reached some conclusion as to the optimum size of wire with regard to a balance between quality and volume. Of course, weight and flexibility must be considered in order to get good high-frequency response, and on these points it would be interesting to have some further information.

Sheffield. R. HOIT.

MODERN TERMS DEFINED

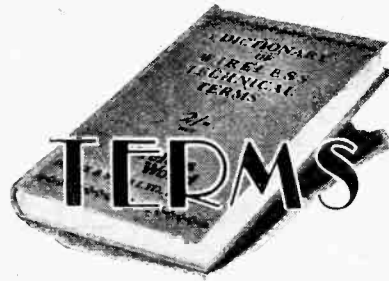

A Concise Summary of Recent Developments in Receiver Design.

Band-Pass Filter: Although the use of band-pass filters in broadcast receivers is a comparatively recent development, the term is by no means new. Band-pass and band-stop filters are commonplace in telephone engineering, where they are used extensively to correct the characteristics of cables and land lines.

Briefly, a band-pass filter is a network of inductances and condensers so arranged that the system responds to and passes on a well-defined band of frequencies to the exclusion of all others. In the ideal band-pass filter the response to every frequency within the selected band should be uniform; further, the cut-off at each end of the selected band should be abrupt.

In broadcast-receiver design the band-pass principle has been applied to tuned H.F. circuits with distinctly successful results, both from the point of view of selectivity and quality. In some American sets band-pass filters are used to couple the intermediate H.F. stages, but the principle finds its most useful application in the aerial tuning circuits preceding the first H.F. valve as it reduces cross modulation.

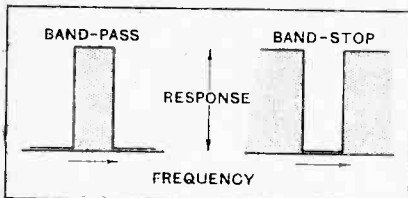

Ideal band-pass and band-stop filters.

Essentially, the band-pass filter consists of two (sometimes three) tuned circuits coupled through the medium of a common capacity or

* See *The Wireless World*, February 18th, 1931, page 164.

inductance, or a combination of capacity and inductance.¹ In practice, the ideal square-topped re-

IMPROVEMENTS in broadcast receiver technique during the past two or three years and the discovery of hitherto obscure interference troubles and defects in quality of reproduction have resulted in a wide extension of the technical vocabulary of the wireless experimenter.

For the benefit of the new reader and of those who, for any reason, have been out of touch with recent developments, we propose, in the present series, to give a brief explanation of the more important modern terms, in order that the reader may be in a position to take up the thread of modern progress.

The scope of this series will be restricted to modern terms, and will not include general terms which may have been in current use since the inception of broadcasting. For definitions of established terms the beginner is referred to the "Dictionary of Wireless Technical Terms," by S. O. Pearson, B.Sc.¹

¹ Obtainable from the publishers, Messrs. Hife & Sons Ltd., Dorset House, Tudor Street, London, E.C.4, price 2/2, post free.

sponse curve is unattainable; the "flat top" generally exhibits two slight humps or peaks, and the sides, instead of dropping perpendicularly to the datum line, diverge outwards to form a skirt. Nevertheless, the skirt is by no means as wide as that of the response curve for even the most-sharply-tuned simple circuits, and the practical improvement in selectivity resulting from the adoption of band-pass tuning is now universally acknowledged.

Of equal, if not of greater importance, are the advantages conferred by the approximately square top of the response curve. It is well known that during the transmission of speech or music the carrier wave of a broadcast station

is expanded into a band of frequencies lying symmetrically on either side of the carrier wave. The lower audio frequencies are associated with the side bands nearest the central carrier wave, and the frequencies increase progressively outwards on either side. The simple tuning circuit, with its sharply peaked response curve, selects the middle side bands carrying the low audio frequencies to the exclusion

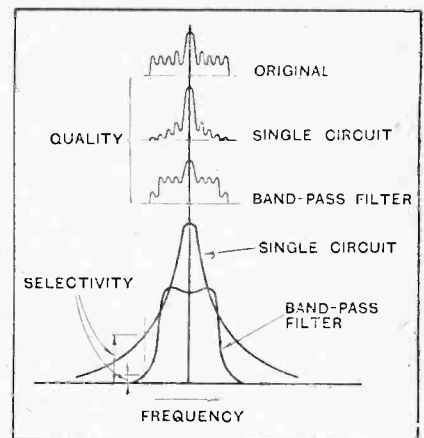

Illustrating the advantages of band-pass tuning from the point of view of selectivity and quality of reproduction.

of the outer high-frequency side band. The band-pass filter, on the other hand, gives a sensibly uniform response to the whole band without appreciably curtailing the upper frequency side bands.

To summarise, the band-pass tuner is capable of giving a high degree of selectivity without detriment to the quality of reproduction.

Pre-selection: The employment of highly selective circuits, generally of the band-pass type, in the aerial circuit of a receiver, as distinct from the early method of building up the desired degree of

Modern Terms Defined.—

selectivity progressively throughout the H.F. interval couplings. The principle of pre-selection ensures that the requisite degree of selectivity is attained before the signal is passed to the grid of the first H.F. valve. In this way interference troubles such as cross modulation, which are essentially by-products of the process of amplification by the valve, are materially reduced.

Peak Separation:

The "flat" top of the resonance curve of a band-pass filter exhibits two more or less well defined peaks or humps which serve as a useful indication of the band width over which the tuned circuits give a sensibly uniform response.

Peak separation therefore serves as a criterion of the performance of a band-pass filter. A good filter should give constant peak separation over the whole of its tuning range. In general, a peak separation of 10 kilocycles (10,000 cycles) is the aim of the designer. This gives adequate reproduction up to 5,000 cycles (side-bands appear on both sides of the carrier frequency), and so affords the best compromise between selectivity and quality permitted by the present allocation of wavelengths under international agreement (9 kilocycle separation).

Ganging :

Mechanical coupling between variable condensers as a means of unifying the control of a series of tuned circuits. Introduced

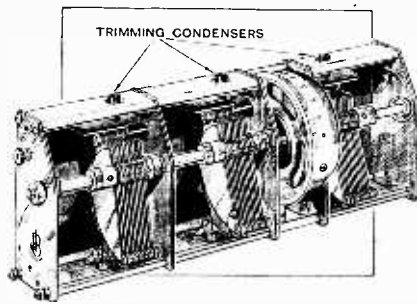

Typical ganged condenser assembly, showing trimming adjustments.

originally in multi-stage H.F. circuits on account of its convenience, ganging has now come to be regarded as a necessity in any circuit employing band-pass filters.

Accurate ganging throughout the

entire tuning range of the condensers depends primarily on the careful matching of the inductances

most useful application as a pre-H.F. volume control in the aerial circuit. It is well known that the

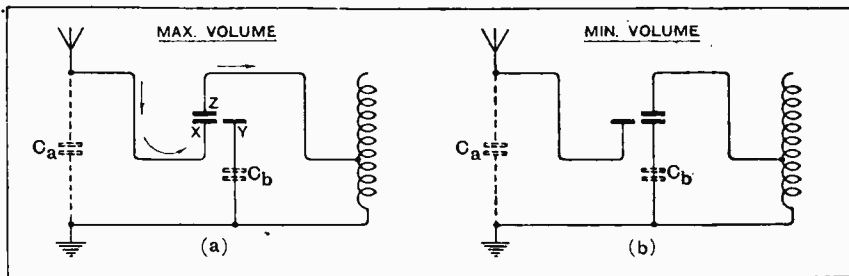

The differential condenser connected as a pre-H.F. volume control.

associated with each section of the condenser. The next essential in order of importance is that the fixed minimum capacity in each circuit (including wiring and valve capacities) should be brought up to some suitable arbitrary level. For this purpose semi-variable condensers, known as trimmers, are connected in parallel with each section of the condenser assembly. With the inductances and minimum capacities carefully matched, the accuracy of ganging is limited only by the mechanical accuracy of the condenser vanes and their spacing.

Differential Condenser :

A special type of variable condenser in which there are three sets of vanes, two fixed (X and Y) and one moving (Z). The construction is such that as capacity is reduced in one set of fixed vanes an equal amount of capacity is added to the other set. In other words, it is possible to alter the *distribution* of capacity in the circuit in which the condenser is connected without appreciably altering the *total* capacity associated with the circuit.

The differential condenser finds its

capacity of the aerial throws a load on the first circuit of the aerial tuner. With the older method of volume control consisting of a simple series variable condenser, this load varied with the setting of the condenser, thus upsetting the alignment of the tuning circuits where ganged condensers were employed.

The function of the differential

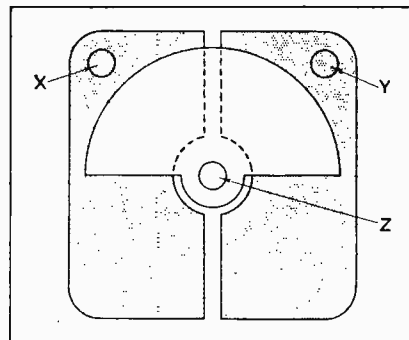

Arrangements of plates in a differential condenser. X and Y are fixed and Z is variable.

condenser is to control the amount of energy transferred from the aerial to the tuning circuits without appreciably changing the load due to the aerial capacity. The accompanying

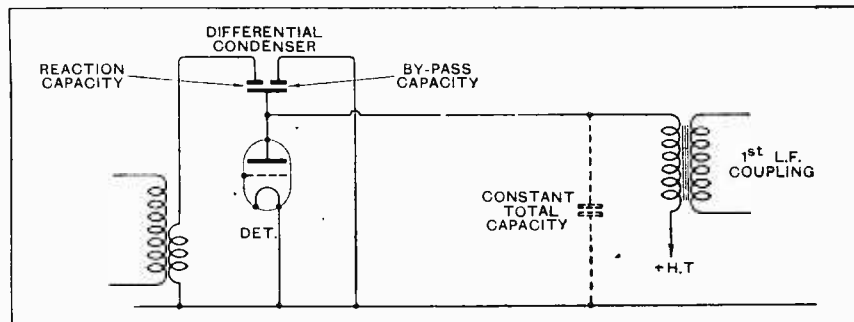

Reaction control by means of the differential condenser.

Modern Terms Defined.—

diagrams in which the condenser is shown in its maximum and minimum positions indicate the manner in which this result is achieved. Best results are obtained when a semi-variable condenser C_b , equal in value to the aerial capacity C_a , is connected at the point indicated. In practice C_b is generally omitted, but, even so, the results obtained with the differential condenser are

superior to those given by the simple series aerial condenser.

Another application of the differential condenser is in connection with the capacity control of reaction. Here the capacity load in the anode circuit of the detector is involved, and this capacity is virtually in parallel with the L.F. coupling device preceding the H.F. valve. If the anode circuit capacity can be assumed to be constant, there

is a reasonable possibility of designing the L.F. coupling—whether resistance-capacity or transformer—to give a good frequency characteristic without high-note loss. The differential condenser keeps the total anode capacity constant, and reaction is varied by altering the distribution of this capacity between the reaction and direct by-pass paths from the detector anode.

(To be continued.)

UNBIASED

* * *

Miracles Wanted.

I SUPPOSE that medical men more than any other class of the community have repeatedly brought home to them the simplicity and child-like faith of humanity at large; indeed, a medical friend of my acquaintance, has often told me that when he first began practising the thing which astounded him most was the faith which his unfortunate patients had in his ability to give immediately an accurate diagnosis. Fortunately, his partner saved him from professional ruin by telling him never to hesitate, but always to assume a boiled-owl look and prescribe a harmless potion until such time as the symptoms developed sufficiently for him to recognise the malady.

I have had something of the same sort happen to me when importunate neighbours have dragged me round to their house so that I may look at some ghastly wireless contraption which had suddenly petered out. On such occasions the look of eager expectancy and dumb admiration on the faces of the family as they gather round eager to see me instantly diagnose the fault always causes me to feel "all motor-boaty" inside as I feebly prod the beastly thing, hoping vainly that a miracle may happen. If I don't happen to spot the fault immediately I generally fall back on some technical jargon, and advise them to send a strong letter to the makers about it, and this, I find, nearly always adds to my prestige. Of course, they don't expect the great man himself to soil his hands with the thing, any more than they would expect an eminent surgeon to deign to re-

By FREE GRID.

move a fly from their eye should they happen to be sitting next to him on the top of a bus when such a misfortune happened.

The foregoing preamble is all leading up to an incident that occurred to me the other day which left me almost speechless with amazement. A business acquaintance of mine—actually he is the financial Editor of one of our leading dailies—happened to drop across me as I was quaffing my lemonade at the "Cheshire Cheese." "Ah," said he, as soon as he looked up and

and, of course, nothing expensive." "Certainly," I replied, "and now perhaps you can give me a bit of advice about some money I want to invest, nothing risky, you know, just a steady fifteen or twenty per cent. will satisfy me." My shaft failed to penetrate his hide, however, and he waxed quite eloquent on the subject of laymen who expected miracles to be performed for them. Such is human nature.

A Hasty Conclusion.

It is astonishing how often the lay press slips up when attempting to pass on technical tips to its readers. The other day I was glancing through the columns of one of our most influential national dailies, and came across a perfect gem. Readers were advised that greatly improved signal strength could be had from certain European stations if they wound their earth lead two or three times round their aerial coil. Apparently the writer of this advice had tried it in his own case and had found that it did do as he said. He thereupon rushed into print under the impression that it would work in every case. All that the phenomenon indicated was that probably his aerial system could do with a little tighter coupling to the grid coil of the first valve, in order to obtain optimum signal strength with that particular station. It rather reminds me of the man who wrote to the papers some time ago pointing out that his range was vastly increased when he touched the anode of his detector valve. Presumably he wrote in all good faith, thinking that he had solved the unemployment problem, whereas, all that he had shown was that probably he had insufficient capacity between the plate and filament of his detector valve.

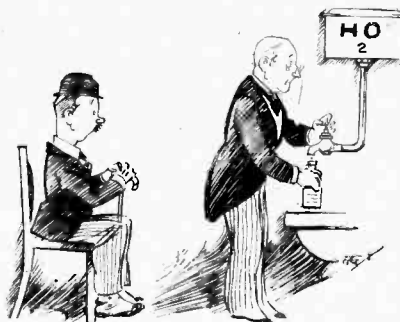

Child-like faith of humanity.

spotted me, "the very man I was looking for. I want you to work out a simple little circuit for me. I want it for an aunt of mine who lives about a couple of miles from Brookmans Park, and is rather keen on hearing Continentals, especially Mühlacker, and, therefore, wants something very selective. None of this band-pass or other new-fangled arrangements, you know, old man, but just a little two-valve affair—

Wireless World
Laboratory Tests

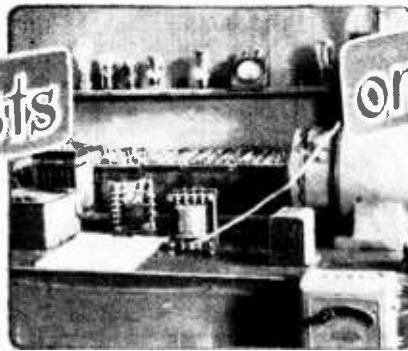

on New Apparatus

WATMEL RESISTANCES.

A new style of wire-wound resistance enclosed in a compact bakelite-moulded case measuring 1½ in. x 1 in. x ¾ in. high has just been introduced by the Watmel Wireless Co., Ltd., Imperial Works, High Street, Edgware, Middlesex. These are

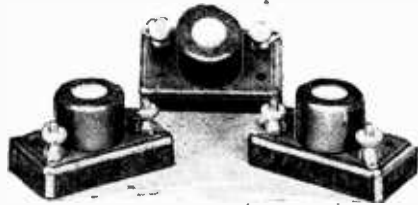

Watmel wire-wound resistances enclosed in compact bakelite cases.

made in values ranging from 100 ohms to 100,000 ohms, and will dissipate between 2.5 and 3 watts.

A few samples sent in for test were measured, their resistances, together with other useful information, being tabulated below.

A Review of the Latest Products of the Manufacturers.

viation from the marked values were well within the 10 per cent. limit, which is generally regarded as the tolerable order of accuracy in resistances of this type.

Prices of some of the higher values are: 25,000 to 50,000 ohms, 4s.; 50,000 to 75,000 ohms, 5s. 6d.; and 100,000 ohms, 7s. 6d.

o o o o

R. I. G.P. TRANSFORMER AND CHOKE.

These two new components have been introduced recently by Radio Instruments,

the superior class of article made by the same firm.

Some measurements were made of the primary inductance of the transformer at



General purpose L.F. choke to carry 60 mA. of D.C. The rated inductance is 25 henrys. An R.I. product.

50 cycles when passing various values of steady D.C. These are tabulated below:—

D.C. in mA's.	A.C. in mA's.	Inductance in henrys.
0	0.55	60.8
1	0.67	48.4
2	0.83	40.0
3	0.98	34.2
4	1.12	30.0
5	1.25	26.8
6	1.36	24.4

Having regard to the price, which is 10s. 6d., these values are exceedingly good, and providing the steady D.C. through the primary is restricted to about 2 mA's. there is no reason why the transformer should not give excellent results

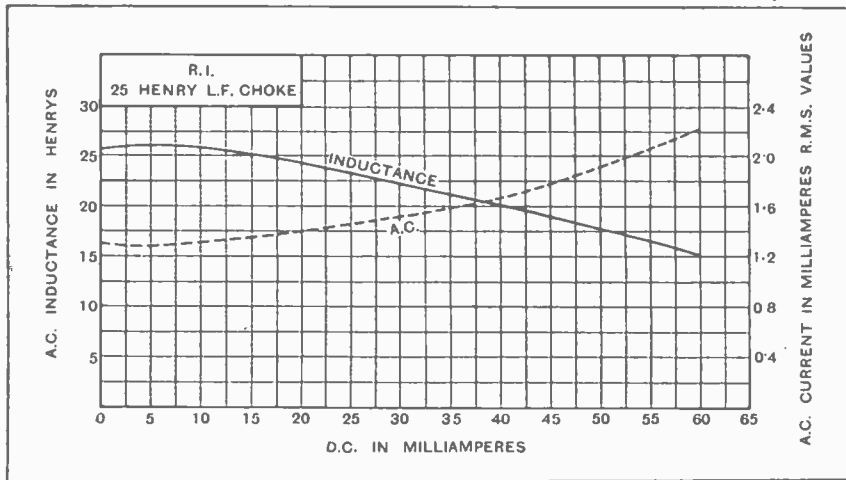

Curves connecting A.C. inductance and polarizing D.C. for the R.I. G.P. L.F. choke. The broken line curve shows the R.M.S. current component of the A.C. which was maintained at 10.5 volts R.M.S. throughout the test.

It will be seen that the lower values are singularly accurate, and the same can be said of some of the higher values. Those that did show any considerable de-

Nominal Value.	Measured Value.	Percentage Deviation.	Maximum Permissible Current.	Price.
600 ohms	603	+ 0.5	50 mA.	1/6
1,000 ..	1,005	+ 0.5	30 ..	2/-
5,000 ..	4,870	- 2.6	20 ..	2/6
15,000 ..	16,260	+ 8.4	11 ..	3/6
20,000 ..	19,640	- 1.8	11 ..	3 6

ltd., Purley Way, Croydon, to meet the demand for a general purpose L.F. transformer and a choke of good quality selling at a reasonable price. This has been found possible by using an improved type of iron core, which, although not possessing those excellent qualities associated with the various alloys of nickel and iron, enables the article to be kept within reasonable dimensions. Needless to say, the two components are larger than those embodying the nickel iron cores.

Both the transformer and the choke are enclosed in bakelite moulded cases coloured green to distinguish them from



R.I. improved general purpose 1:3.5 L.F. transformer.

when preceded by a valve of some 15,000 ohms, A.C. resistance.

The measured D.C. resistance of the primary is 1,100 ohms, and the step-up ratio 1 to 3.5. The maximum current that the primary will carry without saturation of the core is about 5 mA.

The general purpose L.F. choke is rated to carry 60 mA. of D.C., its nominal inductance being 25 henrys. Measured at 50 cycles, we found that an inductance slightly in excess of this figure was possible of attainment with D.C. polarising currents not exceeding 15 mA.'s, but beyond this value a steady decline was recorded. That the inductance is well maintained even up to the maximum rated value is shown by the curve connecting inductance with D.C. and here reproduced. This speaks for itself and needs no further comment on our part. The D.C. resistance of the choke is 400 ohms, and the price 12s. 6d. We can confidently recommend these two components as affording excellent value for money.

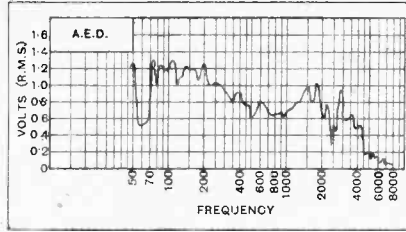

Frequency characteristic of the A.E.D. pick-up with loud tone H.M.V. needle recommended by the makers.

Normally, terminals are used in place of the flex leads shown in the illustration. The price is £3 17s. 6d., and supplies are obtainable from Messrs. Sound Sales, Tremlett Grove, Junction Road, London, N.19.

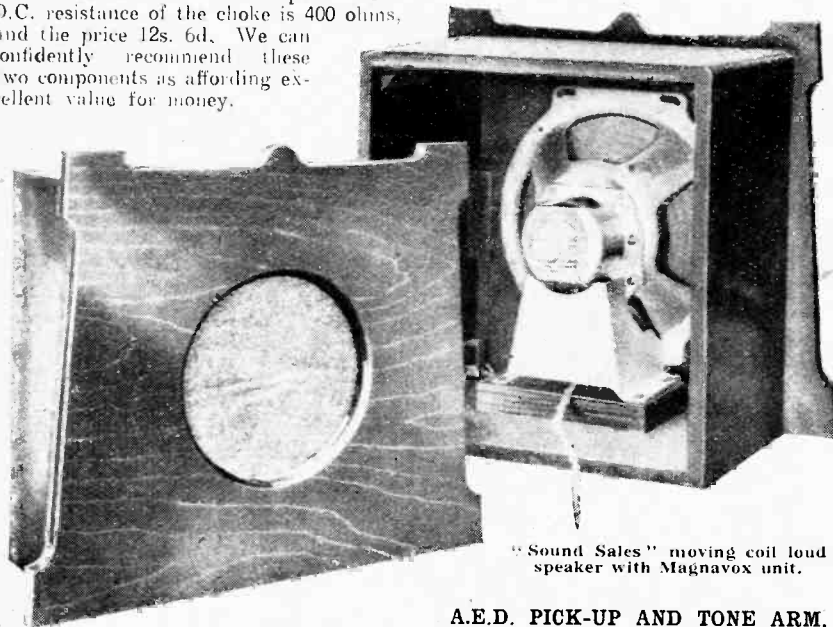

"Sound Sales" moving coil loud speaker with Magnavox unit.

SOUND SALES M.C. LOUD SPEAKER.

This loud speaker consists of a Magnavox Model 130 moving coil unit in a robust cabinet of simple design. The moving coil winding is of the low impedance type, but a transformer is incorporated in the chassis so that the loud speaker can be connected directly in the anode circuit of a low or medium impedance output valve. The field winding is designed for excitation from a 6-volt accumulator, the measured current consumption in the specimen submitted for test being 0.68 amp.

The unit is sensitive and the power handling capacity much greater than the size of the diaphragm would seem to indicate. Quality of reproduction of both speech and music is excellent. The output is highest between 2,500 and 6,000 cycles, and the response from 1,000 downwards is at a somewhat lower level. Balance is restored, however, by a resonance between 100 and 150 cycles, which has the effect of filling out the tone in the lower register.

A.E.D. PICK-UP AND TONE ARM.

The design of this pick-up shows originality in the arrangement of the magnetic circuit to give a differential variation of flux. It will be seen in the accompanying diagram that the flux is carried by the armature itself, and that the tip of the armature moves across the pole faces near the air gap without actually entering



A.E.D. pick-up and tone arm.

the gap. The movement is thus similar to some types of inductor loud speaker.

The damping of the armature is exceptionally light, and from the point of view of freedom from record wear the A.E.D. pick-up is definitely in the highest class.

The frequency response curve is of good general form, though two "valleys" were recorded in the specimen tested at

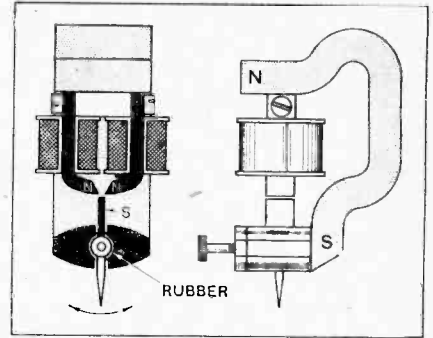

Layout of magnet system in the A.E.D. pick-up.

60 and 2,500 cycles respectively. Nevertheless, the response is excellent up to 4,500 cycles, and a measurable output was obtained up to 8,000 cycles.

The pick-up movement is housed in a neat moulded case, and is readily detachable from the tone arm. In addition, a swivel joint is provided to facilitate the changing of needles, and also a terminal for earthing the tone arm. The price of the complete pick-up and tone arm as illustrated is 2 guineas, and the makers are Messrs. Auto Electric Devices, Ltd., Diamond Works, Brighton.

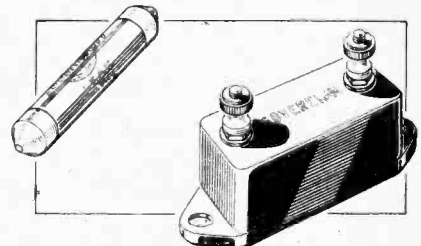

Two new Sovereign components—a 0.002 mfd. fixed condenser and a 1 megohm grid leak.

NEW SOVEREIGN COMPONENTS.

New components introduced recently by the Sovereign Products, Ltd., 52-54, Rosebery Avenue, London, E.C.1, include a range of fixed condensers and grid leaks. The condensers are mounted in brown bakelite cases and are supplied with or without grid leak clips. They are available in values ranging from 0.0001 mfd. to 0.004 mfd. The prices are 10d. each up to and including 0.0003 mfd., and 1s. 3d. each for the higher values.

A sample 0.002 mfd. size was tested, and its capacity measured, the actual value being 0.00179 mfd.

The grid leaks are of the cartridge type with nickel-plated metal end caps, and are made in 0.25, 0.5, 1 and 2 megohm sizes. The price of these is 10d. in each case.

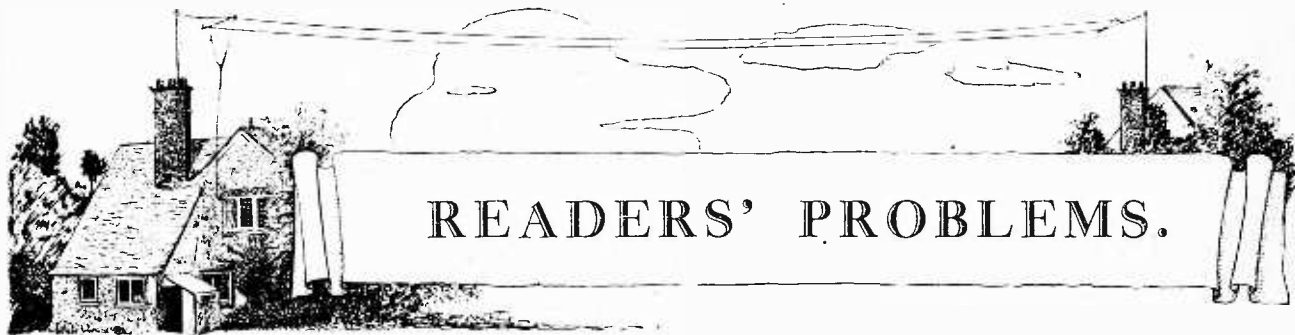

READERS' PROBLEMS.

Replies to Readers' Questions of General Interest.

Technical enquiries addressed to our Information Department are used as the basis of the replies which we publish in these pages, a selection being made from amongst those questions which are of general interest.

Power-handling Capacity.

With regard to the Celestion D.20 loud speaker unit, reviewed in your issue dated February 4th, will you please say if it is capable of handling the output of a valve delivering, according to "The Wireless World" Data Sheet, a maximum of 750 milliwatts?

This loud speaker unit is of the single-acting type, and, consequently, its power-handling capacity—and sensitivity—may be changed by operation of the control knob. With an average all-round adjustment there can be no question that it will deal with a considerably bigger output than that mentioned.

○○○○

Ganged Wave-range Switches.

Is it likely that instability will be produced by fitting independent wave-changing switches for each of the three tuned circuits of my receiver? I notice that most modern sets are fitted with linked switches operated by a single knob.

On the contrary, the mechanism used for coupling these switches is a potential source of trouble, although in modern designs this has been entirely overcome by such measures as the fitting of insulated links and by earthing metal parts where necessary. There is no objection to fitting separate switches, except that the operation of the receiver will be rather less convenient than it might be.

○○○○

Loading a Transformer.

I have just found out that the L.T. secondary winding of my power transformer delivers a voltage, when under normal load, about 20 per cent. in excess of its rating. It is inconvenient to remove turns, and it occurs to me that the best way out of the difficulty is to connect in parallel a high-consumption lamp which will act as a condenser dial light as well as bringing down voltage to the right value. Can you tell me where a lamp taking about one ampere at six volts can be bought?

Lamps of this rating are obtainable from dealers in motor car accessories. You may find that illumination is uncomfortably brilliant unless a screen of frosted glass or similar material is interposed.

Gramophone-Radio Fader.

I am building a two-valve A.C. mains-operated radio-gramophone with which it is not desired to receive any other transmission than that from the local station (about two miles away). If possible, I should like to use a centre-tapped potentiometer (as in the "Independent Gramophone Amplifier"), so arranged that either form of reproduction can be "faded" in or out at will.

Will you please give me a circuit diagram? Grid detection is to be used.

A suitable form of connection is given in Fig. 1. It will be necessary to make arrangements for changing the valve-operating conditions with regard to grid

City Reception Conditions.

Since moving to London I have noticed an appreciable falling-off in the range of my H.F.-det.-2 L.F. receiver, which was highly satisfactory when I lived in the country. I am told that this must be due to local screening, but there are no obvious obstructions, and my new aerial is, if anything, rather better than the original one. Do you consider that a decline in sensitivity is to be expected?

Reception conditions in large cities are almost invariably much worse than in the country, and you may rest assured that the reduction in range which you have noticed is quite normal.

○○○○

Long-wave Filter.

It has been stated that the tuning peaks of a filter circuit should be separated by, roughly, one degree on a 0-100-deg. condenser dial. This applies to the medium band. Does the same rule hold good on the long waveband?

No; we may assume that the tuning system of the average broadcast receiver covers a frequency range of about 1,000 kilocycles on the medium band, but for long-range reception it covers little more than 200 kc. Thus, assuming a condenser of more or less "straight-line frequency" type, and, with a 0-100 deg. dial, it will be seen that each degree will correspond to slightly more than 2 kc. Allowing the usual 10 kc. separation, the peaks would be spaced nearly 5 deg. apart.

○○○○

Surplus Voltage Needed.

I have a spare power transformer, originally intended for heating A.C. valves, which gives an output of four amps. at four volts. Would it be possible to use this as part of a trickle charger for recharging a four-volt L.T. battery?

Practically speaking, no. Every popular form of rectifier used in conjunction with a trickle charger requires an A.C. voltage input considerably in excess of that of the battery to be charged, and it would be quite impossible to use your transformer with an ordinary half- or full-wave rectifier. It might, possibly, be used in a voltage-doubling circuit, however.

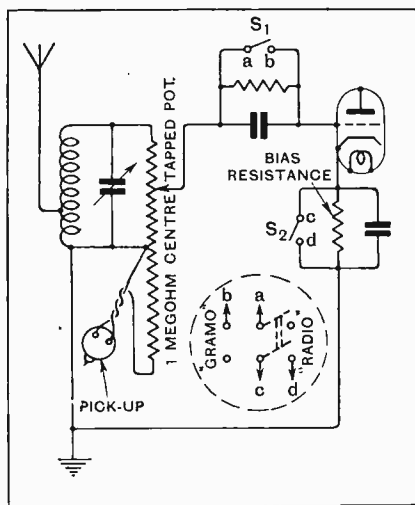

Fig. 1.—A centre-tapped potentiometer as volume control for both radio and gramophone inputs. A double-pole change-over switch, connected as shown in the inset, may conveniently be used instead of separate switches.

bias by means of switches: these are shown separately for the sake of simplicity, and are marked S_1 and S_2 . In practice, it will be more convenient to use a single double-pole change-over switch, for which connections are shown in the inset. The switch bears lettering corresponding with that of the main diagram.

All-wave Mixed Filter.

Will you please give me a circuit diagram showing how the new "mixed" band-pass filter described in your issue of February 18th may be arranged for wave-range switching? With regard to the long-wave coupling coils and condenser, I intend to adopt suggestions made in the descriptive article.

The receiver to which the filter will be fitted is mains-operated, and has a single H.F. stage.

A convenient method of connecting wave-range switches is shown in Fig. 2. Although the connections of the "negative inductance" coupling coils may appear to be involved, they are really quite simple if one realises that the two assemblies are merely connected in series, ar-

change, there is a serious risk of impairing the general performance of the set. Further, when gauged control of several condensers is to be adopted, it is wise to adhere strictly to the recommended capacities.

o o o o

Reducing Mains Voltage.

I wish to use a power transformer, designed for 220 volts, on a 240-volt mains supply. Do you consider that it would be safe to use a 400-ohm Igranic potentiometer as a variable resistance in series with the primary?

Assuming that your transformer is of the usual type, consuming some 30 or 40 watts, this component would be quite suitable for absorbing the surplus voltage. Its resistance winding is rated by the manufacturers to pass 0.25 amp.

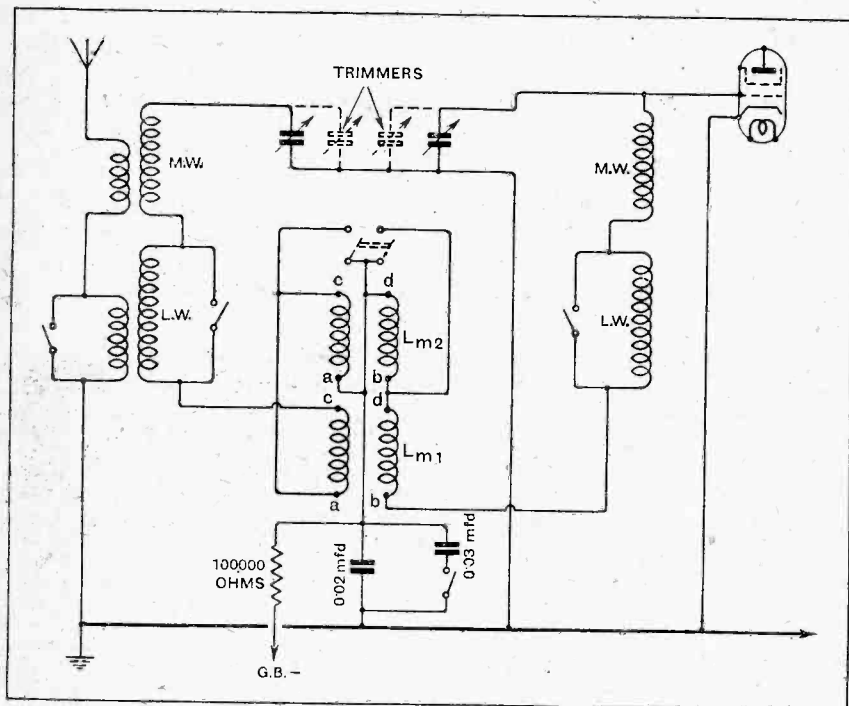

Fig. 2.—"Mixed" filter arranged for medium- and long-wave reception. M.W., medium-wave tuning coils; L.W., long-wave coils; L_{m1}, medium-wave coupling coils; L_{m2}, long-wave coupling coils.

rangements being made to short-circuit the long-wave sections when it is desired to receive on the medium waveband. To simplify this matter, the ends of these coils have been given reference lettering to correspond with that in the article to which you refer.

o o o o

An Open Condenser Scale.

When a tuning condenser of 0.00035 mfd. is specified in a receiver, is any great harm done by substituting a component with a capacity of 0.0005 mfd.?

The larger condenser can always be used, but there is the drawback that the scale will be very much more "crowded" than is necessary. Of course, this may be overcome by using tuning coils of lower inductance, but, by making this

One Set: Two Eliminators.

My receiver is being rebuilt, and I find that when a new set of valves is fitted the existing D.C. mains eliminator, according to the data provided by its manufacturers, will fail to provide an adequate output. Is there any reason why another eliminator should not be obtained for feeding the last valve only, which, naturally, consumes the heaviest current?

From the technical point of view, no objection can be raised to your proposal of using two separate eliminators, but it seems rather uneconomical to do so. Would it not be better to modify your present eliminator. If you care to send us a circuit diagram we may be able to suggest an easy way of doing so.

How Not to Use a Pentode.

In an attempt to obtain more magnification I have recently fitted a pentode output valve to my receiver, and now find that a high-pitched whistle is produced. How can this trouble be overcome? The set comprises a grid detector followed by two transformer-coupled I.F. stages.

It may be taken as a general rule that a pentode provides too much magnification for use in a two-stage I.F. amplifier, and we are not at all surprised to hear that you have had this trouble, particularly as transformer coupling is used in both stages.

We fear that there is no simple, and at the same time entirely unobjectionable, way (from the point of view of quality) of reducing magnification to a suitable extent in your case. If it is specially desired to retain the pentode, you might replace the first transformer by a resistance-capacity coupling, with a resistance of low value.

o o o o

Stray Couplings.

My newly constructed three-valve receiver is working well, but I am perturbed to find that quite loud signals—even from distant stations—are received when the coupling condenser of the input filter is short-circuited. This means, I suppose, that the filter is not working as it should, and I should be obliged if you could suggest what may be wrong.

Although it is almost impossible to avoid all traces of coupling between the elements of a filter, it is clear that in your case these couplings are altogether excessive, and that screening is inadequate. Possibly you have screened your coils carefully, but have overlooked the fact that electrostatic coupling will take place between the associated tuning condensers, unless suitable precautions are observed.

FOREIGN BROADCAST GUIDE.

GRENOBLE PTT

(France).

Geographical position: 45° 13' N.; 5° 42' E.
Approximate air line from London: 525 miles.

Wavelength: 328.2 m. Frequency: 914 kc.
Power: 1.2 kW.

Time: *Greenwich Mean Time.
*France adopts B.S.T.

Standard Daily Transmissions.

12.40, G.M.T. concert; 16.30 or 17.00, relay of École Supérieure, Paris, or local concert; 20.15, news and main evening programme.

Man announcer. Call: Allo! Allo! Ici le poste de radio-diffusion de la région des Alpes à Grenoble; abbreviated sometimes to: Ici Grenoble PTT.

Opens transmission with a gramophone record: Les Allobroges.

Closes down with usual French formula (see PTT Paris) and La Marseillaise.

The Wireless World

AND
RADIO REVIEW
(18th Year of Publication)

No. 602.

WEDNESDAY, MARCH 11TH, 1931.

VOL. XXVIII. No. 10.

Editor: HUGH S. POCOCK. Assistant Editor: F. H. HAYNES.
 Editorial Offices: 116-117, FLEET STREET, LONDON, E.C.4. Editorial Telephone: City 9472 (5 lines).
 Advertising and Publishing Offices: DORSET HOUSE, TUDOR STREET, LONDON, E.C.4.
 Telephone: City 2847 (13 lines). Telegrams: "Ethaworld, Fleet, London."
 COVENTRY: Hertford St. BIRMINGHAM: Guildhall Bldgs., Navigation St. MANCHESTER: 260, Deansgate. GLASGOW: 101, St. Vincent St., C.2.
 Telegrams: "Cyclist, Coventry." Telephone: 5210 Coventry. Telegrams: "Autopress, Birmingham." Telephone: 2970 Midland (3 lines). Telegrams: "Jiffe, Manchester." Telephone: 8970 City (4 lines). Telegrams: "Jiffe, Glasgow." Telephone: Central 4857.
 PUBLISHED WEEKLY. ENTERED AS SECOND CLASS MATTER AT NEW YORK, N.Y.
 Subscription Rates: Home, £1 1s. 8d.; Canada, £1 1s. 8d.; other countries abroad, £1 3s. 10d. per annum.
As many of the circuits and apparatus described in these pages are covered by patents, readers are advised, before making use of them, to satisfy themselves that they would not be infringing patents.

Interference Hunting.

INTERFERENCE is daily becoming a more and more serious menace to the progress of broadcasting and it is high time that steps should be taken to effect a remedy. Interference which is due to the close proximity of stations or to excessive power is the subject of investigation by the broadcasting authorities throughout Europe, so that in this direction, although the results are not very promising up to the present, we feel that some efforts, at least, are being made and that the matter is not being simply left to drift. One position with regard to interference produced by electrical machinery, electric signs, oscillating receivers and various other causes presents an outlook which is by no means promising. In this country, especially, do we seem to be backward in this respect, and practically no steps have been taken beyond spasmodic and only partially successful efforts to educate the listening public in the matter of avoiding oscillation.

In a recent article we described the methods which have been adopted in certain large towns in Germany for combating the nuisance, where, with the official support of the Post Office, voluntary bands of amateurs have been formed with equipment for detecting, and then hunting down, the sources of interference, and finally educating those responsible in ways and means of preventing radiation, and, where necessary, supplying apparatus to effect a cure.

Statistics showing the interesting results of the activities of "hunting parties" in Berlin during 1930

have just been made public. In this city alone 143 hunting parties were formed during 1930, with a total membership of 938. Despite the fact that none of these parties were formed prior to March, and, in many of the outlying districts, not until June or later, the complaints of interference received reached the interesting total of 22,389. Of this total about one-quarter was traced to oscillating receivers and about the same proportion to high-frequency apparatus, such as electric signs and violet-ray apparatus. All other electrical machinery provided only 16 per cent., this figure including tramcars and electric railways. About 12 per cent. of the complaints were due to faults originating in the complainants' own sets. It is of special interest that only about 1 per cent. of the cases of interference dealt with escaped detection.

Serious as interference in this country has become, we believe that these results obtained in Berlin should give us encouragement. We believe that if the necessary backing from the Post Office were forthcoming, with technical assistance and advice from commercial companies who have investigated the problems involved, then we should not have to ask twice for volunteers to form the "hunting parties." It is a work which the wireless societies in every part of the country might well undertake, and the interest derived from these investigations would well repay the effort, quite apart from the invaluable results which would obviously benefit the whole of the listening public.

In This Issue

- RADIO READING LAMP.
- ELIMINATING STATIC.
- HAMMARLUND SHORT-WAVE KIT.
- RADIO TERMS DEFINED.
- CURRENT TOPICS.
- FROM AERIAL TO LOUD SPEAKER.
- FERRANTI SCREENED GRID THREE.
- BROADCAST BREVITIES.
- LABORATORY TESTS ON APPARATUS.
- LETTERS TO THE EDITOR.
- READERS' BROBLEMS.

FOR SHORT DISTANCE
HEADPHONE RECEPTION

Radio Reading Lamp



NO BATTERIES: NO AERIAL
OPERATES FROM D.C. MAINS

By H.F. SMITH.

A Set for Use Where a Loud Speaker is Impracticable.

THESE must be many thousands of people who, for various reasons, are unable to use a loud speaker, but are willing enough to listen to the programmes with headphones. Of this number a fair proportion must have a D.C. mains supply, and probably most of them live "in rooms"; indeed, one is tempted to point the moral by saying that the proverbially unhappy lot of the lodger—or of his more polite equivalent, the paying guest—might often be alleviated by a suitable headphone receiver, which cannot disturb his fellow guests or incur the wrath of his landlady. But any reference to that unfortunate butt of the British humorist is certain to convey the impression that this article is not to be taken seriously; although the writer would not suggest that any serious contribution to radio science is embodied in the receiver to be described, he considers it likely that it will be news to many readers that an "all-D.C." single-valve mains set can be constructed so easily and at such small expense.

Naturally enough, no very extended range can be expected when the mains are used as an aerial-earth system as well as for power supply. The set is primarily intended for reception at a few miles' distance from a transmitting station, although its sensitivity may be increased by adding a short indoor aerial if found necessary. To give an idea of its possibilities, it may be stated that, when testing in various localities in the London district, signals have been obtained in every case without any external connection, but their strength varied considerably. The uncertain behaviour of "mains aeri-

als is notorious, and in some cases an appreciable change in intensity was observed on transferring the receiver adaptor from one lamp-socket to another in the same building—or even in the same room.

Power for Nothing.

In any D.C. set a certain amount of power must inevitably be dissipated, and, as most of us do the greater part of our listening at night-time, it is economical to dissipate any surplus in the form of light. It is for this reason that a lamp is used in the present case instead of a wire-wound resistance, which would serve the purpose equally well, and which, incidentally, may be preferred by those who need an even more compact receiver.

The purpose of whatever type of resistance may be chosen is to limit the filament current of the single

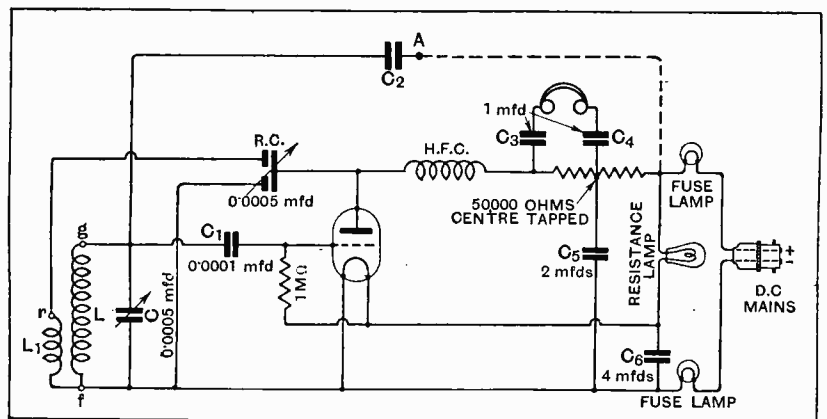

Fig. 1.—Complete circuit diagram, with values of components. Aerial connection to the mains is shown in dotted lines.

Radio Reading Lamp.—

valve, which functions as a reacting grid detector, to a suitable value. Other details of the circuit will be evident from a consideration of Fig. 1, which shows that a differential reaction control condenser is employed.

Sufficient filament circuit smoothing for any mains supply that is not excessively "rough" is provided by a large by-pass condenser (C_6) in conjunction with the lamp resistance already mentioned. Irregularities in anode supply current are smoothed out by the combined action of the condenser C_5 and one-half of the centre-tapped 50,000-ohm resistor.

The other half of this resistor, with condensers C_3 and C_4 , acts as a resistance-capacity feed for the headphones. It is generally and rightly considered that adequate insulation should be provided between 'phones and mains, and, of the various methods of coupling, the resistance-capacity system has been adopted in this case as the least expensive and most compact. Loss of anode voltage in the resistance is not, in this case, a disadvantage, as we have an excess pressure, and the arrangement is absolutely safe, provided that the insulation of C_3 and C_4 is adequate. The cautious amateur may check this point by connecting the condensers in question across the mains before they are fitted in the receiver. A tapped resistance, instead of two separate resistances, is used for the sake of economy.

Fuse lamps are inserted in each mains lead as an extra safety precaution. It will generally be best to obtain for this purpose the ordinary flashlamp bulbs consuming about 0.25 amp.; high-efficiency bulbs rated at 0.1 amp. may afford protection for the valve filament, but will need fairly frequent replacement, as their filaments will glow at full brilliancy while the receiver is in operation.

It is as well to use a grid condenser and leak as specified, as these afford greater freedom from "hum" than the more conventional values, and do not introduce any appreciable distortion or loss of sensitivity.

Layout of components is relatively unimportant in a set of this kind, and there is no reason why the apparatus should not be mounted in any convenient container. Far be it from the writer to suggest that the actual arrangement as illustrated is the best that can be devised; it was adopted because a fairly well-made oak cabinet of suitable size (which had originally contained cigarettes) was to hand. By using components with physical dimensions chosen with due regard to the space available to them, it should be possible to make an even more compact set. As the lamp will generally be used for reading purposes, the height of its supporting holder should be determined with an eye to the position in which the set will be normally placed.

As no commercial tuning unit that was entirely suitable for the purpose could be found, a special coil was wound on a 2½ in. ribbed former. Dimensions are given in Fig. 2, where terminal points are lettered to correspond with the other diagrams. The tuned winding L consists of 40 turns of No. 28 D.S.C. wire, and the reaction coil L_1 , of 25 turns of No. 36 D.S.C. Due to the fact that the aerial series condenser C_2 is, in effect, in parallel with the variable tuning capacity when the mains are used as an aerial, it will be found that stray capacity existing across the tuned circuit is high, and, in consequence,

the wave-range covered is rather more restricted than usual. Accordingly, it may be necessary to make an adjustment of the number of turns in coil L, but only if the wavelength to be received is at either end of the normal medium broadcast band.

It will be obvious that, when tuning and reaction condensers are mounted on the lid of the containing

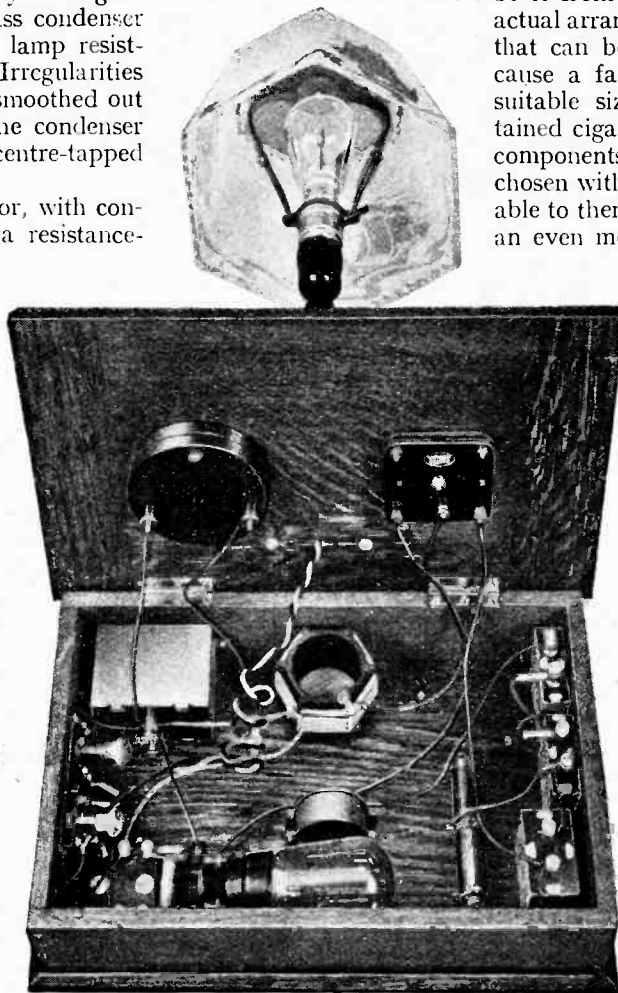

The complete receiver, with lid partly opened.

LIST OF PARTS.

- | | |
|---|--|
| 1 Variable condenser, 0.0005 mfd. (Graham Farish "Microficient"). | 1 Wire-wound resistance, 50,000 ohms, centre tapped (Colvern). |
| 2 Fixed condensers, 0.0001 mfd. (Walmel). | 1 Valve holder, horizontal type (W.B. "Universal"). |
| 2 Fixed condensers, 1 mfd. | 1 H.F. choke (Telsen). |
| 1 Fixed condenser, 2 mfd. | 1 Table lamp holder. |
| 1 Fixed condenser, 4 mfd. | 1 Lamp, 20 to 25 watts, to suit mains voltage. |
| 1 Differential condenser, 0.0005 mfd. (Burton). | 2 Flash lamp holders, with lamps. |
| 1 Grid leak, 1 megohm (Ediswan). | Box, wire, screws, etc. |

Radio Reading Lamp.—

box, as in the case of the receiver illustrated, it will be necessary to wire these components with flexible leads.

Regarding the choice of a valve, a good "general purpose" type, with an impedance of, very roughly, 20,000 ohms, is recommended. Most of these valves have a filament taking 0.1 amp.; a 2-volt specimen is best, as grid voltage will then be right for effective detection combined with reasonably smooth reaction.

For mains voltages of from 200 to 220, a 20-watt lamp will pass, as nearly as need be, the correct value of current for a valve of the type suggested in the preceding paragraph. Higher voltages, of from 230 to 250 volts, will necessitate the use of a 25-watt lamp. No alteration need be made to the anode resistance for voltages within the limits mentioned.

How to Increase Range.

When, by reason of distance or through any other cause, a mains aerial does not provide sufficient signal strength, there is no alternative but to connect an external aerial of some sort; at reasonable ranges some 15 or 20 feet of wire, led round a picture rail if convenient, will be sufficient. At the same time, the receiver must be modified by removing the connection shown in dotted lines in Figs. 1 and 3, and connecting the aerial to the fixed condenser terminal marked A in those diagrams. As the receiver is already fairly well earthed through the mains, no other external connection will be necessary.

Although a lamp makes a most convenient resistance for absorbing surplus voltage, it is possible that some readers who are interested in a receiver of this kind will prefer to use a wire-wound resistor, which is, as already suggested, a possible alternative. It is none

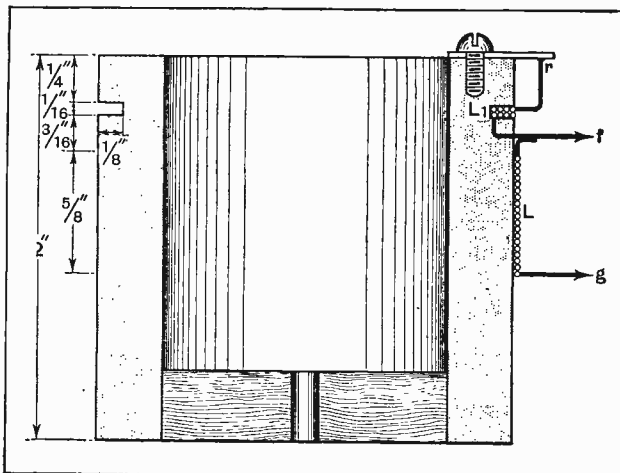

Fig. 2.—Details of the tuning coil and reaction winding. The ribbed former measures 2 1/2 in. in diameter.

too easy to find components of the right value, with sufficient current-carrying capacity, but the writer has used Rothermel "Electrad" fixed resistors, which are rated at 25 watts, with satisfactory results. A resistance unit of this type will become hot, particularly if fitted in a confined space, and it is a good plan to mount it on the outside of the cabinet, with a protective cover of perforated metal to ensure good ventilation.

It will hardly be necessary to say that the resistance in question should be wired in place of the lamp. Its value may be calculated by dividing "volts to be absorbed" by "current to be passed," the latter quantity being expressed as a fraction of an ampere. "Volts to be absorbed" is the difference between mains voltage and valve filament voltage rating.

If it is considered that a 20-watt lamp gives insufficient illumination, the remedy is to use a 0.25-amp. valve with a lamp (or parallel lamps) rated at a total of 50 or 60 watts, depending on mains voltage. These would be suitable, respectively, for 200 and 240-volt supplies.

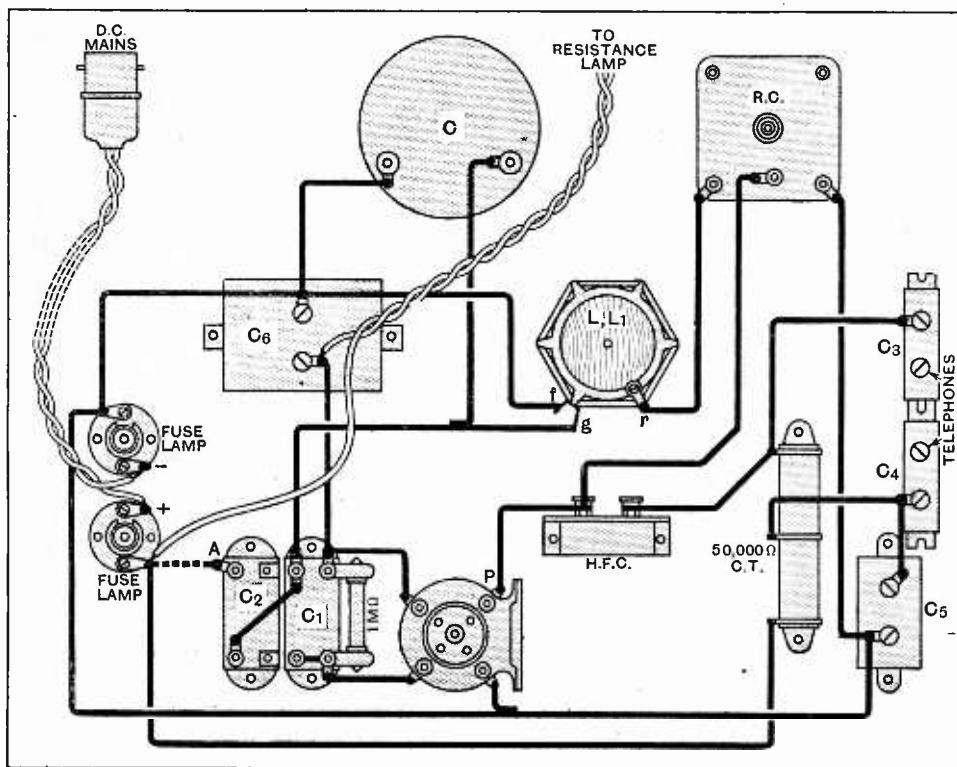

Fig. 3.—Practical wiring plan. The telephones are connected directly to the output condenser terminals.

Modern Terms Defined

A Concise Summary of Recent Developments in Receiver Design.

(Continued from page 248 of previous issue.)

Cross Modulation: The term used to describe the aggravation of interference from stations off tune due to the presence of a strong signal from the station to which the receiver is tuned.

It is necessary to make a clear distinction between the cross-modulation effect and the normal qualities of selectivity associated with the aerial tuning circuits. Thus it is a common experience to find that with the receiver tuned to the wavelength of the local station at a time when the carrier wave of that station is switched off, no trace of the interfering station can be heard, the inherent selectivity of

pronounced in modern screen grid valves than in the older three-electrode valves. The mathematical analysis which is necessary in order to show the exact origin of the effect is beyond the scope of this series. It is sufficient to state that cross-modulation is experienced as the result of curvature of the valve characteristic, i.e., under conditions which also produce H.F. amplitude distortion. Thus the trouble is most marked when an excessive negative bias and/or a reduction of screen grid voltage are used as a means of producing volume control.

The degree of interference is known to be proportional to the square of the residual voltage at the grid of the H.F. valve, due to the interfering station. Any improvement in the selectivity of the aerial tuning circuits tends to reduce cross-modulation irrespective of any measures which may have been taken to improve the working conditions of the valve.

With the S.G. valves at present available, the following rules will mitigate, if they do not entirely remove, interference due to cross-modulation: (1) Adjust the grid bias so that the operating point is as far removed as possible from the foot of the valve characteristic without running into grid current; (2) do not reduce the screen grid volts below the figure specified for the particular H.T. voltage applied to the S.G. valve into the coil of the intervalve tuned circuit; (3) tap the anode of the S.G. valve into the coil of the intervalve tuned circuit; (4) use a highly selective input circuit, preferably of the band-pass type, with an abrupt cut-off as distinct from the wide "skirt" generally associated with simple tuning circuits; (5) employ a pre-H.F. volume control.

Beat Interference:¹ A special case of cross-modulation arising from the production of combination

frequencies in the H.F. valve as the result of stray pick-up from two stations, *neither of which is in tune with the receiver.* If the combination frequencies fall within the tuning range of the receiver and rectification takes place in the H.F. stage as a result of curvature of the valve characteristic, both stations will be heard simultaneously, though without the high-pitched whistle accompanying ordinary heterodyne interference.

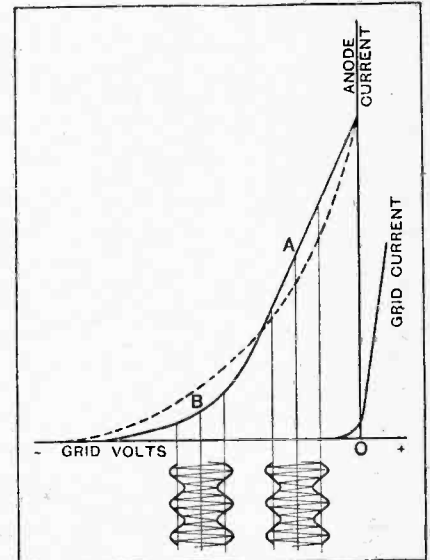

In the ideal S.G. valve characteristic cross-modulation will occur with an excessive bias at B, but not when working on the straight portion at A. Unfortunately the majority of S.G. valve characteristics are curved throughout their useful length as shown by the dotted line.

Modulation Distortion: The change in percentage modulation of a signal (generally an increase) as a result of amplification by a screen grid valve. This effect is yet another consequence of partial rectification due to curvature of the valve characteristic, and the distortion is greatest when the bias is excessive and the operating point is near the foot of the characteristic. Under these conditions the right-hand modulated fringe of the signal falls on a part of the curve having a steeper slope than the left-hand fringe; the right-hand half of the signal, therefore, receives a greater degree of amplification. The net result is that the signal induced in the tuned-anode circuit of the valve is found to be more deeply modulated than the original.

(To be continued.)

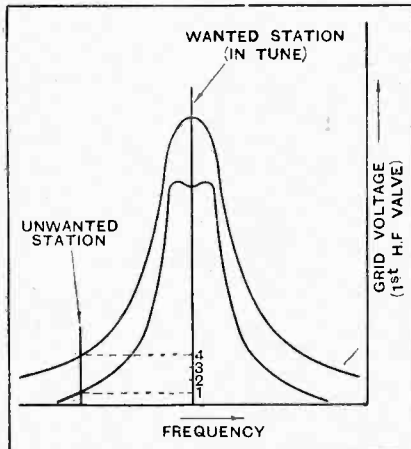

Assuming that the use of a band-pass tuner reduces the unwanted signal volts at the grid of the H.F. valve to a quarter of its value with a single-tuned circuit, then the cross-modulation is reduced to one-sixteenth of its original value.

the aerial circuits being more than sufficient to cope with the interference. Immediately the local transmitter starts up, however, serious interference is experienced. Further, this interference persists when the difference in wavelength between the two stations is wide enough to preclude all possibility of the more common form of heterodyne interference.

The seat of the trouble is in the H.F. valve, and the effect is more

¹ See *The Wireless World*, November 5th, 1930, page 524.



Eliminating Static

WHILE comment on the interference problem comes from all quarters, rarely do we hear of helpful suggestions as to the elimination of the noises which ruin long-range reception. In this article the problem is tackled from the practical standpoint, and the remedies put forward are based on considerable experience arising out of the difficulties met with in the installation of highly sensitive receiving sets.

By A. B. CALKIN, M.A. (Tech. Dept., Philips Lamps Ltd.)

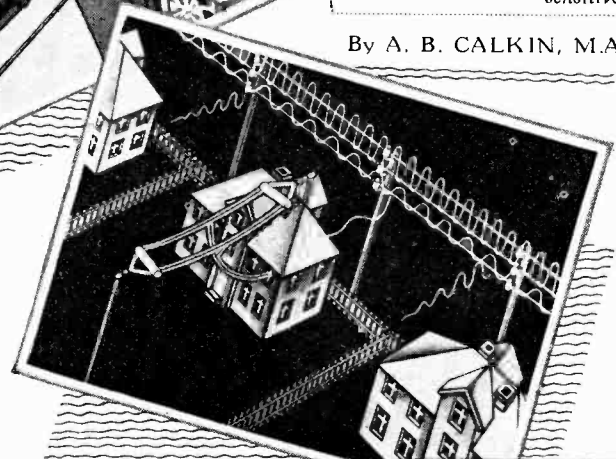

IN a recent Editorial in *The Wireless World*¹ the subject of "Avoidable Interference" was discussed from a general standpoint. The fact that the question of interference to radio reception is being given serious consideration in this country is welcomed, and it is gratifying to note that the listener is beginning to realise that he is entitled to expect broadcast reception free from troublesome interference. While the old proverb, "Prevention is better than cure," is particularly applicable to radio interference of all kinds, one might, nevertheless, not overlook the steps which may be usefully taken to mitigate the trouble at the receiver. As it is usually beyond the power of the individual listener to set about tracking down the source of interference he may, by taking various precautions, gain some measure of relief.

Interference to Signal Ratio.

The one object we must keep constantly in view when combating the problem of radio interference is simply this: We must aim at keeping the ratio of signal strength to interference level as high as possible in all cases. Any means, therefore, which tend to produce an increase in signal strength or a decrease in interference strength at the receiving aerial, or both, will evidently achieve something in the right direction. If, too, it can be established that mush and background noises are composed of certain frequencies, then an obvious cure for this type of interference is the suppression of those frequencies, and this procedure would be justifiable if the resulting reproduction were not unduly affected.

There are a number of ways of increasing the ratio of signal strength to interference level at the

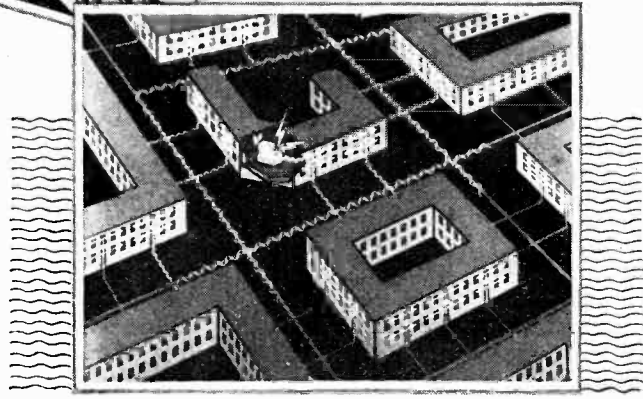

receiving aerial. Best of all, of course, is to wipe out the interference at its source. It is not intended, however, to deal with this interesting branch of the subject in the present article, as the problem more directly concerns electric supply corporations and manufacturers of electrical machinery than the radio-receiving public. Another solution,

but, of course, beyond the control of the listener, is to increase the power of the broadcast transmitters. The same effect, however, can be produced by increasing the effective height of the receiving aerial, and, as this is a matter over which every listener usually has complete control, it will be dealt with in greater detail. The object of this article is to explain how a carefully designed outdoor aerial-earth system can be employed to lessen the interference often picked up in industrial centres when receiving distant stations.

There are three principal factors in a receiving installation which determine the extent to which interference is experienced. These are sensitivity, high-note reproduction, and the aerial-earth system. By sensitivity is meant the total high- and low-frequency amplification prior to the grid of the output valve. It should be

¹ 11th February, 1931.

Eliminating Static.—

pointed out that the ratio of interference experienced on a given transmission to the signal strength of the transmission is independent of the sensitivity of the receiving set, other things, such as low-frequency response, being equal. As, however, a sensitive set is intended to receive extremely weak signals, these signals may produce less effect in the loud speaker than the local interference, and for this reason special care must be taken, when installing a sensitive receiver, to keep the ratio of signal strength to interference level as high as possible.

High Note Filter.

It can be shown experimentally that a large proportion of the mush and background noise usually associated with long-distance reception is composed of frequencies in excess of 4.5 kilocycles. For this and other reasons, it would seem advisable, when receiving distant stations, to limit the high-note response of the receiver to this value. The reproduction under these conditions lacks brilliance, but, at the same time, a satisfactory compromise is achieved between first-class quality and freedom from mush. For local-station listening, when the sensitivity of the receiver can be reduced to a point where interference becomes inaudible, it is, of course, desirable, in the interests of quality, to include the full range of frequencies which the receiver can reproduce. For this reason, in some of the most up-to-date receivers on the market, we find a tone filter (sometimes known as an interference filter) incorporated, which can be made to limit the high-note response to 4.5 kilocycles when desired.

Use a Good Aerial.

The most important point, however, which governs the interference problem from the listener's point of view is that of the aerial-earth installation. It has been established experimentally that by far the greater portion of interference experienced in towns, including the clicks and bangs caused by the make-and-brake of electrical circuits, the crackling and whirring noises from motors, etc., reaches the receiver by way of the lighting and power mains, gas and water pipes, gutters, etc., these noises being propagated from the ground upwards.

This being the case, it is obviously unreasonable to

operate a sensitive receiver in conjunction with an *inside* aerial and expect to get satisfaction from any but a few high-powered stations. It must be evident that a receiver fed from an aerial situated in the very midst of the interference will reproduce that interference to a marked extent.

Unfortunately, it has recently become far too common practice in many industrial towns to operate a sensitive receiver with only a few yards of wire carefully concealed round the picture rail as an aerial, and a radiator or gas pipe as an earth. Although a few stations can be received in this manner, free from interference, a point is very soon reached, as the volume control is advanced, when the interference level exceeds the strength of the desired transmission, and reception, consequently, becomes impossible.

Bearing in mind the problem before us, namely, to

obtain the biggest proportion of signal strength to interference level, the solution surely lies in using a *good outside aerial*, and a really sound earth connection. By a good outside aerial is meant, not necessarily a long one, but one which is raised well above the level of the house-top, and erected as far as possible from all conductors liable to propagate interference. The free end, in particular, should be kept clear of buildings, lead roofs, gutters, water pipes, power and telephone lines, etc. By adopting such an aerial we do two things. First, we increase the signal strength of the station to be received. Secondly, we decrease the coupling between the aerial and the ground interference, with the result that a great improvement is at once noticed in the ratio of signal strength to interference level.

Lead-in Precautions.

Although the high-potential end of the aerial may be thus separated from ground interference, the advantage so gained may be largely offset by the presence of a badly arranged down-lead or a long lead-in wire. Here the greatest care should be exercised. The down-lead, if running parallel with the house, should be kept at least 3ft. away, and clear of gutters, telephone wires, etc. In this connection it might be helpful to quote an analogy which has recently been brought to the attention of the writer by a friend.

If it was intended to supply a building with perfectly pure water from a clear mountain spring some distance

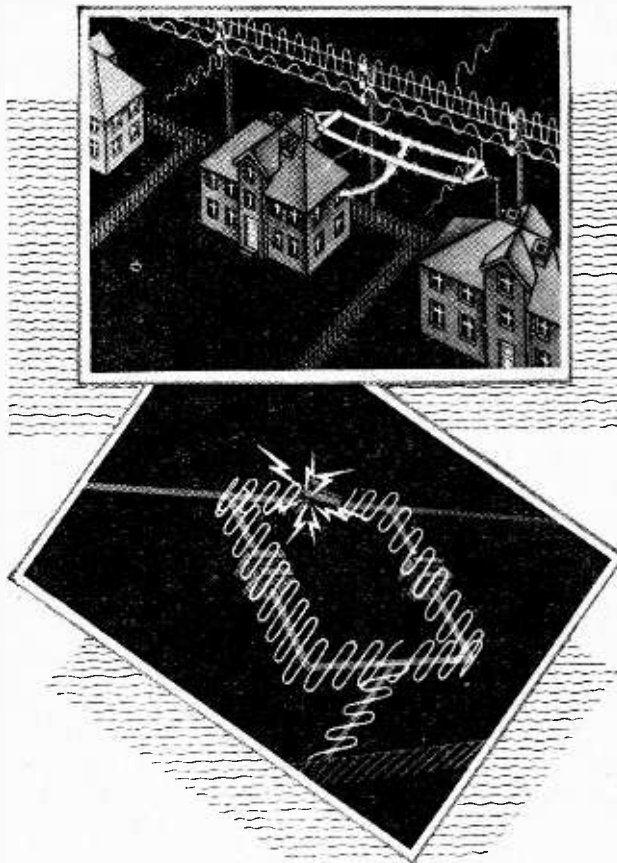

Eliminating Static.—

away, it would be necessary to conduct the water through carefully constructed ducts or pipes in order to keep the supply free from impurities in the intervening surroundings. Moreover, the shorter the length of duct the less opportunity would there be of picking up contaminating particles. The radio receiver, too, requires a perfectly pure input, and this condition can only be realised if the down-lead be kept short and isolated from conductors liable to propagate interference. The set itself should be placed close to the lead-in insulator, so as to ensure the shortest possible length of lead-in wire and earth connection. This is important. It should be borne in mind that with a well-erected aerial, the lead-in wire may be the most sensitive part of the aerial system from the point of view of pick-up, and for this reason it should be kept as short as possible. In many instances improved results can be obtained by running the lead-in wire to the set through earthed flexible metal tubing.

If this procedure is adopted it should be borne in mind that the additional capacity to earth imposed by the tubing is in parallel with the series-coupling condenser in the aerial, if any, and that, consequently, this additional capacity should be kept as small as possible to prevent undue loss of signal strength. If the selectivity of the receiver is impaired, due to the loading of the longer aerial, this can be restored by the use of a suitable series capacity. The earth connection, too, requires far more respect than is usually given it. Earthing a sensitive receiver to central-heating or gas pipes, or to the conduit encasing electric light or power mains, is thoroughly bad practice. As experiment shows that this is liable to increase, rather than decrease, interference, a so-called earth connection of this type must always be viewed with suspicion. Direct connection by

a stout copper wire to a copper earth tube buried in damp soil immediately beneath the receiver offers the best solution, and this practice may alone be sufficient to reduce interference. Where such an earth connection is not available, connection to a main water pipe is probably the best alternative.

If interference is known to originate from an outside source, such as overhead tramway systems, the horizontal portion of the outside aerial should be run perpendicular to the overhead wires. In such cases, too, where the interfer-

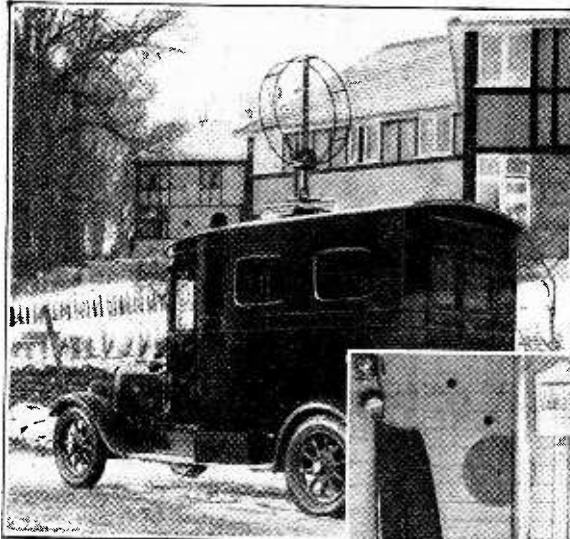

TRACING INTERFERENCE.
—Much useful information on the localising of interference should have been gleaned by the Post Office in the course of operating this patrol van, which took to the road four years ago.

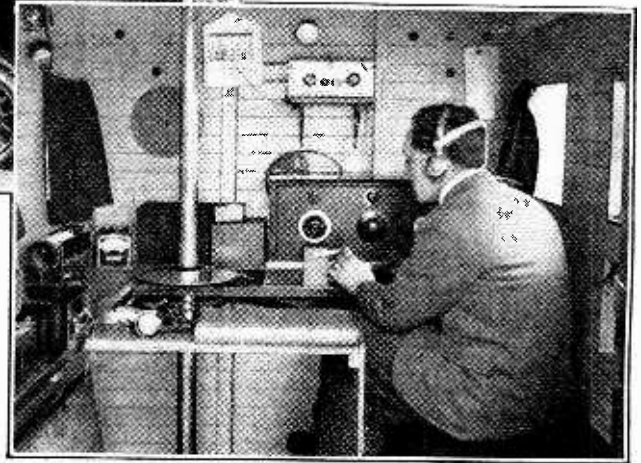

ence can be localised, the directional properties of a frame aerial may be put to useful account. If, however, as is generally the case, the interference is picked up in the immediate vicinity of the receiver, as outlined above, the adoption of a frame aerial in place of an outside aerial will generally aggravate, rather than lessen, the interference.

In conclusion, the listener who is in possession of a sensitive receiver is advised, if he has not already done so, to consider the attendant advantages of a good outside aerial, and a properly installed earth, particularly if the district is known to be "noisy" and long-distance reception of low-powered stations is required.

Philips Lamps, Ltd., 145, Charing Cross Road, London, W.C.2.—Leaflet describing the new Philips 3-valve receiver, Type 2534.

o o o o

Ripaults, Ltd., 1, King's Road, London, N.W.1.—Publication, "Light on the H.T. Battery," giving much useful data concerning dry-cell H.T. batteries.

o o o o

Star Engineering, Albert Street, Didsbury Manchester, manufacturers of the well-known "Webson" products, have issued a booklet, at 1s. 6d., dealing with the operation of moving-coil loud speakers. A limited number of copies are available for free distribution.

Catalogues Received.

Dubilier Condenser Co. (1925), Ltd., Ducon Works, Victoria Road, North Acton, London, W.3.—Illustrated List No. 930, describing the full range of Dubilier components, accessories and receivers.

o o o o

Ferranti, Ltd., Hollinwood, Lancashire.—Revised edition of their complete radio catalogue, together with constructor's broadsheets of A.C. and D.C. supply units, and two-, three- and four-valve receivers.

Harlie Bros. (Edmonton), Ltd., Balham Road, Lower Edmonton, London, N.9.—Sixteen-page booklet dealing with electric gramophone reproducing equipment.

o o o o

Ipsenthal and Co., Ltd., Ducon Works, Victoria Road, North Acton, London, W.3.—Illustrated List No. M.1030, dealing with mercury switches and relays.

o o o o

The Loewe Radio Co., Ltd., 4, Fountain Road, Tottenham, London, N.15.—Fourteen-page catalogue of radio components and accessories, also illustrated leaflets dealing with receivers, loud speakers, and gramophone pick-ups.

Unbiased — "FREE ^{by} GRID" —

Dials that Irritate.

I HAVE had an opportunity of testing a considerable number of commercial sets, both British and foreign, during past weeks, and there is one seemingly small, but nevertheless highly important, item that very few manufacturers seem to have considered yet. I have observed that in cases where the tuning scale is a vertical one, i.e., a drum dial rotating in a vertical plane, the eye very rapidly becomes tired when tuning in different stations, and a feeling of irritability is created, whereas if the dial is moving horizontally before the eye one can go on for quite a long time without fatigue. In order that I might not be misled by the fact that some scales were marked with the ordinary close-set dial divisions—always very trying to the eye—and others in widely set wavelength divisions, I took care to make tests on instruments with similar scale divisions. I was so impressed that I rang up a well-known radio manufacturer whose set was the worst offender in the matter of tiring the eye. At first he pooh-poohed my ideas, but four hours' testing so completely convinced him that he is arranging for a horizontal scale to replace the vertical scale in his next season's models. We went more deeply into the problem, and decided that tuning in different stations rapidly seemed far easier when the whole scale was exposed to the eye all the time than when only a small portion of it was visible at one time through a "window." The old-fashioned open dial was distinctly in advance of some of the latest American vertical drum dials, but horizontal scales easily hold the field. I wonder if an oculist would explain the above facts?

Eternal Rectification.

A friend sought my advice the other day about a rectifier for an A.C. eliminator he was building. He was undecided as to whether to use a valve or a metal rectifier. He was inclined to use the latter, as he

knew that I had had one in continuous use for three years, for test purposes, and he asked me if I could, from my own experience, testify as to the accuracy of a statement that he had seen to the effect that they were everlasting. Upon my replying that I was unfortunately not in a position to confirm the statement, he rather peevishly asked me how much longer I proposed to carry on my tests before I *would* confirm the statement that they were everlasting. I replied emphatically that I should *never* be in a position to confirm



Is it everlasting?

the statement. I am afraid that his mentality must be of a very low order, as even now the reason for my emphatic statement has not dawned on him.

Broadcast Calibration Notes.

I often wish the B.B.C. could spare a small portion of the day to transmit test signals of various sorts and on various wavelengths so that we could calibrate our sets, gang up our band-pass tuners accurately, and check up our domestic receivers in the matter of response at different musical frequencies, etc. Apart from this, I think there is a great need for the radiation of a constant signal for the set-builder of limited means who does not possess a wavemeter of any kind and wants to make rough adjustments to his set. The news bulletin provides quite a steady signal for rough adjustments, but its duration is brief and there are annoying gaps in it. Those who require a really steady

signal of half-hour duration, however, could not do better than tune into the London National transmitter from midnight to 12.30 a.m. each night. They will, I feel sure, find it very useful.

A Ray of Light.

A friend who has recently returned from Germany brought to him an inexpensive all-mains set, and invited me round to his house to test it. During our experiments the small light behind the dial suddenly burnt out, and, on removing it, I was surprised to find that an ordinary 3.5 volt flash-lamp bulb was used. My friend suggested that it was probably due to the fact that it was being lit from the 4-volt winding on the transformer without any resistance to absorb the odd half volt. I told my friend that I doubted his theory, and betted him that an ordinary flash-lamp bulb would not last long on A.C., even if run at the correct voltage. In order to test my theory we set up a circuit consisting of a step-down transformer, with a regulating resistance and an A.C. ammeter in series, a similar bulb being connected up to a 4-volt accumulator. The bulb which was on A.C. lasted for a few hours only, and it was then replaced. My friend continued his experiments, and finally proved to his satisfaction that my words were true. It is, of course, a well-known fact that ordinary household lamps have a much shorter life on A.C. mains than on D.C. mains, all other things being equal. In most British sets where a dial light is employed, I believe that a thick filamented lamp, not of the flash-lamp variety, is employed. Incidentally, while on the subject of dial lights, I am surprised at the number of mains sets on the market which still lack these small, but highly desirable, refinements. There is one set in particular which I have in mind where the scale is set right back in a deep recess that simply cries aloud for such a light. Apart from lighting the scale, the instrument serves the purpose of indicating whether or no the set is switched on, although I am sorry to say that this is unnecessary in quite a large number of highly priced sets owing to most unpardonable mains hum.

Hammarlund

Short
Wave
KitAn Easily Built Two Set
with Interchangeable Coils.

RECEPTION on wavelengths below 100 metres presents a totally different problem from that obtaining on the normal broadcast wavebands. High selectivity is not demanded, since there are comparatively few stations operating a regular broadcast programme, and these are so widely separated that interference is rarely encountered. When it does occur it is generally of short duration, being occasioned either by experimental transmissions or by commercial stations. The latter generally use interrupted C.W., which, if responsible for interference, could not be eliminated by any of the recognised selective arrangements.

Thus the simplest of circuits offers adequate selectivity, and although H.F. amplification has been employed quite successfully, the regenerative detector followed by one or more L.F. amplifiers has proved a highly efficient arrangement on these very short wavelengths.

Simple Construction.

The Hammarlund short-wave kit set is a case in point. It is of American origin, and is marketed in this country by the Rothermel Corporation, Ltd., 24, 26, Maddox Street, London, W.1, the price being £8 complete. A paxolin panel, measuring 12in. x 7in. x $\frac{1}{8}$ in. thick, is supplied, drilled and with all holes cut, so that for assembly the only tools required are a screwdriver, a pair of pliers, and a soldering iron. Even a stick of resin-core solder and a quantity of insulated wire are included.

The set can be built comfortably in two evenings: the first will be taken up mainly by the assembly, and probably a few connections can be made. During the latter part of the second evening it should be possible to make the first test and become acquainted with the controls. Needless to say, these are of the simplest, as there are only two main controls, for the reaction condenser must be regarded as one, since the sensitivity depends largely upon its use.

In the circuit diagram the grid condenser C_2 is shown to be semi-variable, and by correctly adjusting it reaction can be made delightfully smooth. Once set, it should not require further attention.

The wave range covered extends from 12.4 metres to 105 metres, four coil units being used to cover this band. Each unit consists of two coils (L_2 and L_3 in the diagram), and these are fixed in relation to each other. The aerial coil, L_1 , is permanently attached to the base fitting, but its coupling with L_2 is variable.

The four coil units are, for convenience, referred to as the 20-, 30-, 40-, and 80-metre coils, the actual range covered by each being 12.4 to 24.5 metres, 21.2 to 43.1 metres, 35.5 to 73 metres, and 56.2 to 105 metres respectively. Thus there is a comfortable overlap between each range.

In the illustrations and the circuit diagram the output valve shown is a pentode, the use of which was found to be very advantageous, and is recommended. Hand-capacity effects were slightly in evidence when using this valve, but it can be remedied by fitting an H.F. stopping resistance of about 0.1 megohm in the position R_3 . Alternatively, an H.F. choke can be inserted between the telephones and the anode of the output valve.

The most suitable valve for the detector stage is one having an A.C. resistance of about 20,000 ohms, and this should be given between 50 and 60 volts H.T. Ample volume will be available with 100 volts H.T. on the pentode when headphones are used, but at least 120 volts will be required should a loud speaker be employed.

During the first evening of test strong telephony signals were received from six American stations on the 30-metre coil. Of these only two were identified by announcement, namely, W2XAF and W8XK. On the 40-metre band 3XAL was definitely identified, and in addition there were some half-dozen others not so strong at the best and fading far too badly for

identification either by the programme or by the announcer.

The 80-metre range was alive with morse signals and a few modulated carrier waves too weak to resolve. On the lowest range only morse was heard, but no doubt these two ranges would add their quota also, in the course of time.

SPECIFICATION.*Leaky grid detector with reaction.**One L.F. stage.**Range: 12.4 to 105 metres.**Interchangeable coil units.*

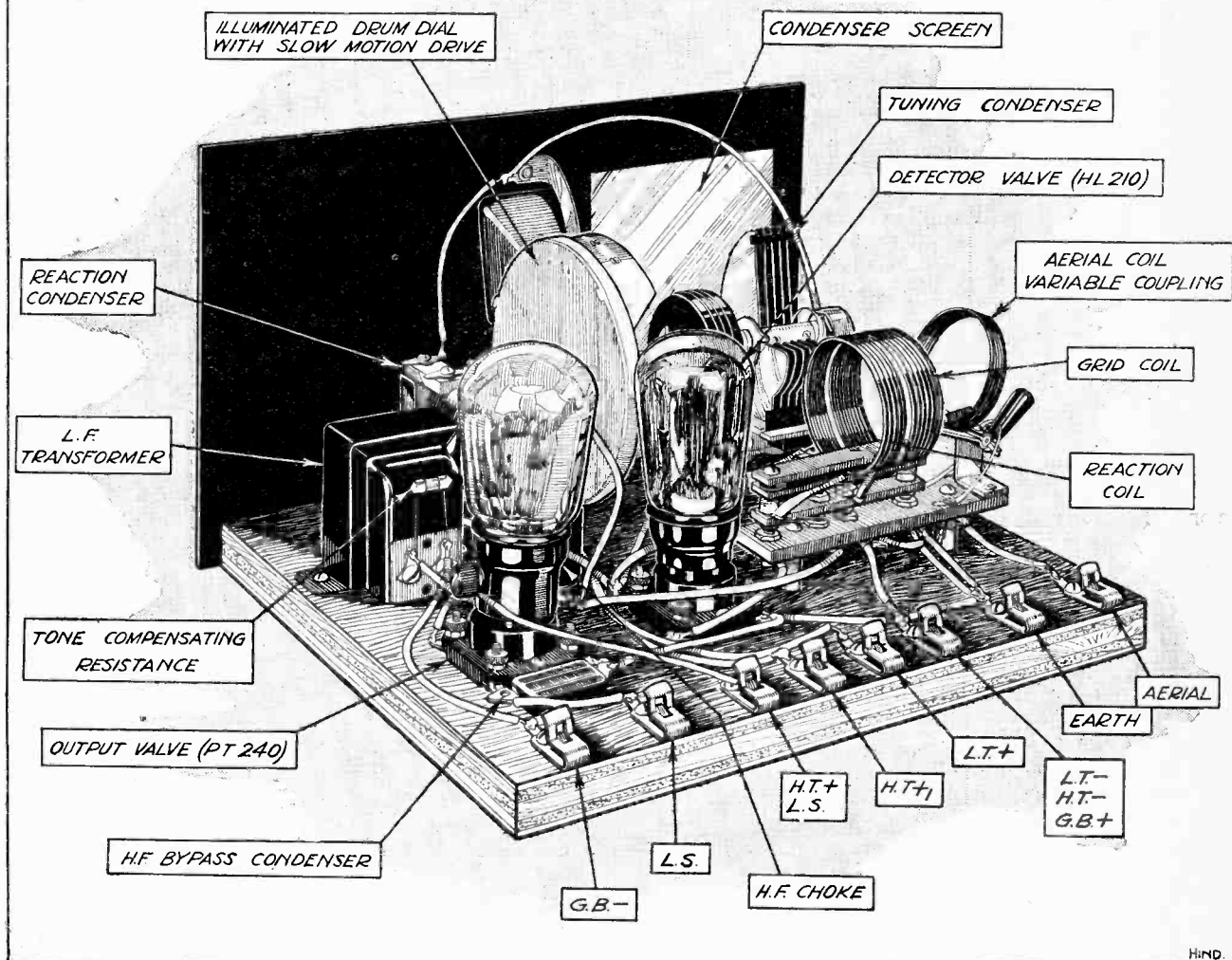
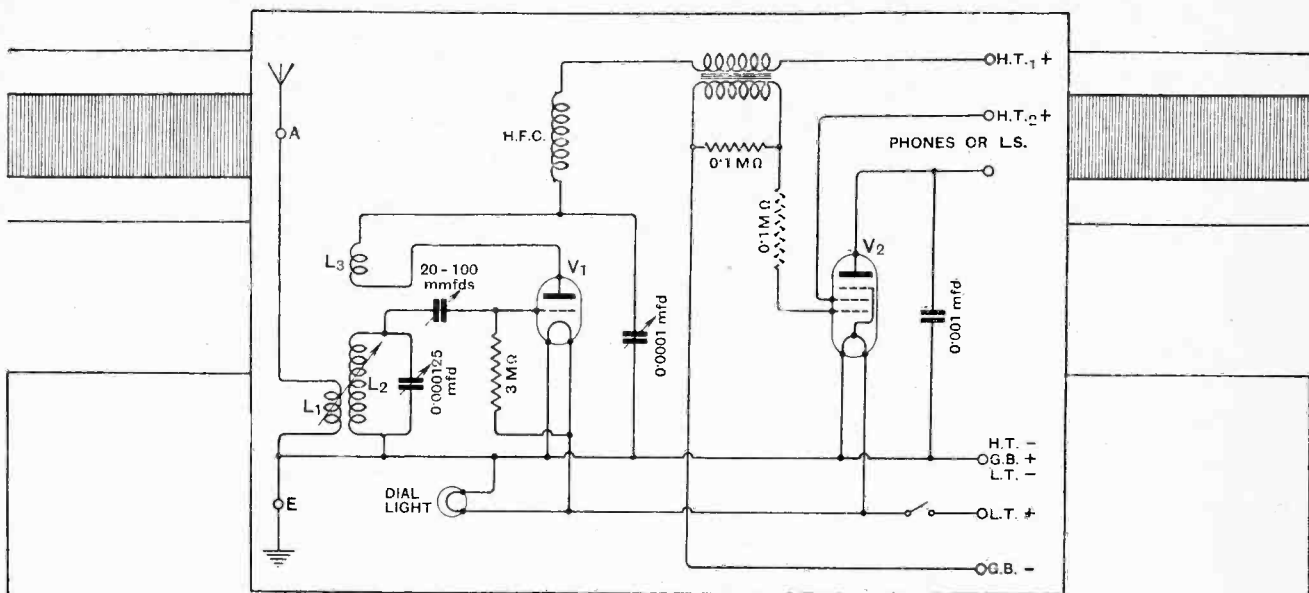

Theoretical diagram and layout of the Hammarlund short-wave receiver.

Current Topics

News of the Week in Brief Review.

SHIP AHOY!

The Dutch station at Scheveningen, which broadcasts news bulletins on 1,847 metres during the daytime, announces itself with a ship's siren.

o o o o

VANISHING PIRATES.

Topping the list of visitors to Bradford this week is the famous Post Office direction finding van, which has been carrying out an extensive tour in the North of England. It is significant that in every town visited the licence figures have gone up with a rush.

o o o o

OLYMPIA DATES.

This year's National Radio Exhibition will be held at Olympia from Friday, September 18th, to Saturday, September 26th. As announced in *The Wireless World* of February 4th last, the Exhibition will this year occupy the Empire Hall for the first time as well as the New Hall as previously.

Still more ambitious are the arrangements for 1932, which include the booking of the Olympia Main Hall.

o o o o

END OF THE "INDO-ROUTE."

Wireless, which is usually given a halo of romance, was actually responsible for the termination of a romantic episode in Empire history when, on February 28th, the Indo-European cable route was closed. This 6,000-mile line, running from London to India, has been rendered unnecessary by the efficiency and cheapness of the beam wireless system. It was opened for service in 1870, and since then many lives have been lost in the perpetual "war" against brigands, rioters, and other influences tending to break the chain.

o o o o

A FRENCH "LISTENING SERVICE."

If France lags behind other nations in the matter of broadcasting, the same can hardly be said of her police radio organisation. Our Paris correspondent reports that the Ministère de l'Intérieur is now extending the operations of the radio police arm by incorporating a direction finding plant at the official "listening centre" in the Rue de Saussaies, Paris. The function of the new branch will be to track secret transmitters and other radio law breakers.

Vacancies are announced for radio inspectors, between the ages of 22 and 30, who must have a good technical knowledge in addition to "elementary notions of criminal law."

Our cynical office boy asks whether the two qualifications are compatible.

HAVE YOU GOT YOURS?

Although there has been a large demand for the reprinted Station Identification Chart originally issued with *The Wireless World* of February 25th, we understand that a number of copies are still available from booksellers and newsagents, price 2d. per copy.

o o o o

RELAYS: YES OR NO?

Apparently the odds are even on whether or not a wireless relay company can obtain permission from any particular local authority to establish a broadcast relay service. Doncaster Council has just rejected an application. To-morrow Wigan may jump at the idea.

o o o o

WHEN BUZZES MEAN BUSINESS.

A warning note on his pocket buzzer informs the user of one of the new police pocket radio sets that a message is coming through from headquarters. Miniature receivers were tested at Patcham Police Station last week, excellent signals being received from a transmitter at Brighton, three miles distant. The designer of the new receiver, which can be produced in quantities at about £4 each, is Mr. C. L. P. Dean, of



RULING THE WAVES.—Major C. R. Atlee, M.P., who, last week, succeeded Mr. Lees-Smith as Postmaster-General.

Slough. It is stated that the set weighs less than 2 lb., and has an effective range up to 100 miles.

o o o o

NEW R.M.A. PRESIDENT.

Lt.-Col J. T. C. Moore-Brabazon has been elected president of the Radio Manufacturers' Association in succession to the late Sir William Bull.

Col. Moore-Brabazon has been interested in wireless for many years and held a transmitting licence before the War.

EARL RUSSELL.

Earl Russell, who died suddenly last week at the age of 65, added to his other numerous interests an amateur's enthusiasm for wireless. At one period he frequently contributed to the radio Press on experimental matters, and was often to be seen at meetings of the Radio Society of Great Britain, of which he was at one time a council member.

o o o o

SMALL ADS. AT EASTER.

With the approach of the Easter holidays slight alterations are necessary in our printing arrangements. The latest date on which small advertisements can be accepted for our issue of April 1st is Wednesday, March 25th.

o o o o

FILIGREED FADDOLES.

In the mind of Mr. Martin Ullman, artist, of New York City, there is not the slightest doubt that modern radio furniture is stodgy. Advertising his studio in the *New York Times*, he says:—

Radio, the miracle voice out of the ether, wears dull, nondescript, nitwit clothes. Its "cabinets" are doddering left-overs from phonograph days, with the addition of a few filigreed faddoles. Radio designers seem to be merely sublimated carpenters in white collars instead of overalls.

How blind we have been, dear Watson!

o o o o

BELGIAN AMATEURS UNITE.

From a Continental correspondent comes the news that Belgian listeners are banding together for mutual defence under the banner of "The Association of Belgian Radio Amateurs."

The Association claims the objects common to most organisations of its type, but there is an unusual clause in the regulations whereby all profits are handed over to the broadcasting stations in return for weekly facilities for microphone announcements.

o o o o

EUROPE'S BIGGEST BROADCASTER.

The Marconi long-wave 160-kilowatt wireless broadcasting station which has now been put into operation near Warsaw is at present the most powerful broadcasting installation in Europe.

Reports already received show that it gives good crystal reception all over Poland, and listeners in England and Scotland describe it as perfect, in volume, quality and freedom from fading.

The aerial at Rasin is of the half-wave type, terminating in a feeder house beneath the aerial. Feeder lines from

the transmitting hall to the feeder house convey the energy to the aerial, which is carried on two masts 600 feet high and 750 feet apart. With the exception of the Eiffel Tower these are the highest masts in use at any of the European broadcasting stations.

The station operates on 1,411 metres, which is the wavelength of the existing Warsaw broadcasting station.

The various parts of the transmitter are contained in aluminium and glass panels completely screened from one another to prevent inter-action. In the main or last stage magnifier eight 100 kW. valves deliver the modulated energy to the aerial which, at 80 per cent. modulation, will amount to 160 kW. Normally, six of these powerful valves will be used. The total primary energy required to operate the whole of the equipment amounts to 700 kW.

○○○○

NEW APPOINTMENT.

Group Captain R. H. Verney, O.B.E., has been appointed to the command of the Electrical and Wireless School of the R.A.F. at Cranwell.

○○○○

FOR HAMMERSMITH AMATEURS.

West London amateurs have for a long time wanted a wireless society of their own, and we therefore extend a warm welcome to the Amateur Radio and Television Society, which has just been formed with temporary headquarters at the London Lagonda Service Depot, 195, Hammersmith Road, London, W.6.

Mr. E. G. Nurse, the hon. secretary, writes to say the Society already possesses radio and television transmitting and receiving apparatus, thus providing members with first-hand opportunities of witnessing actual demonstrations of television and radio transmission. All enquiries should be sent to Mr. Nurse at the above address.

○○○○

TYPING BY WIRELESS.

The time when the business man and his typist may never meet seems to be brought a step nearer by the invention of a wireless typewriter in New York. According to a *Times* correspondent, the "Watsonograph" enables an operator sitting at a typewriter to type out a message which is automatically and simultaneously conveyed by short-wave wireless to another typewriter at any distance. The receiving typewriter automatically types out the message as sent.

A transmitter for ordinary commercial use can be made to weigh only about 20 lb. Speed of transmission is limited only by the skill of the operator, since the typewriter can record 1,200 letters a minute. Any receiving typewriter, synchronised with the transmitter, could be tuned in wherever the receiver might be, and the message could be typed simultaneously on several receivers.

The business man of the future will remain in the bosom of his family while dictating by wireless telephone to his typist a hundred miles away, and the words will be wirelessly typed a moment after they are uttered.

A 23

SHEIKHS AS SET CONSTRUCTORS ?

The amateurs of Southern Morocco have been invited to participate in a competition for home-built radio sets. The entries will be exhibited at the forthcoming Marrakech Fair, writes a correspondent.

○○○○

A TUNING CHART.

A useful station identification chart has just been published by Messrs. Philips Lamps, Ltd., for use with instruments incorporating a Philips' 4-valve all-electric receiver. The chart, which is printed on strong cardboard, gives a vertical dial reading strip down the centre, while on the right and left are open columns for inserting long- and medium-wave stations respectively opposite the appropriate dial reading. On the back of the chart are valuable hints on receiver operation.

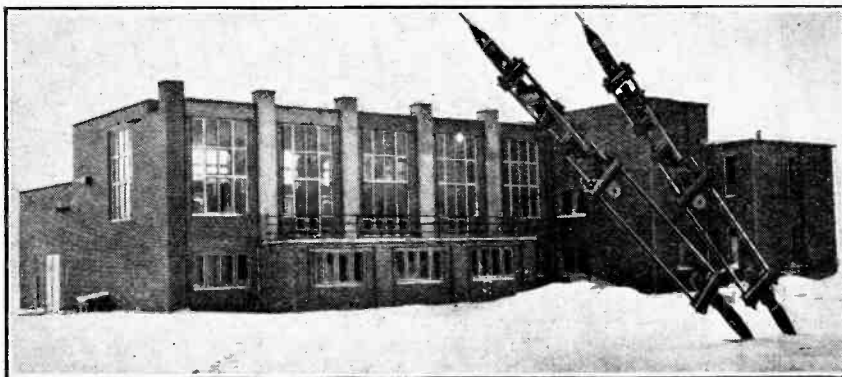

MODERN RADIO ARCHITECTURE.—The clean and simple outline of the new Rasin (Poland) station is accentuated by its wintry setting. The station has just been completed for the Polish Broadcasting Company by the English Marconi Company.

M. GAVART OBJECTS.

"To tax a wireless listener because he may unwittingly pick up a broadcasting station is like granting a street singer the right to demand compulsory "alms" from anyone who is unfortunate enough to hear him," declares M. Gavart, a Frenchman who is conducting an anti-radio-tax campaign.

An opponent of M. Gavart's, writing to the same journal, sadly remarks that you cannot continue broadcasting for years without giving the public the impression that radio is "free," like water and air.

○○○○

AN EXAMPLE FROM FRANCE.

Deputies Raval Aubaud and Jammy-Schmidt have introduced a Bill into the French Parliament which is more popular with radio amateurs than with manufacturers of electrical apparatus, writes our Paris correspondent. The first clause prescribes that every electric machine or installation must be provided with adequate devices for the suppression of all radiation likely to interfere with wireless reception.

To assist manufacturers to comply, the National Laboratory of Electricity will draw up a list of suitable devices, such as screens, condensers, etc.

Should the Bill become law, users of

electrical apparatus will be granted a year in which to take the necessary measures.

If the Bill is passed, France will be definitely ahead of this country in at least one department of radio enterprise.

○○○○

A RADIO "ROLL OF HONOUR."

An "honour roll" of American broadcasting stations, necessarily incomplete because only about half the country's stations were measured, has been compiled by William D. Terrell, chief of the Department of Commerce radio division, whose staff of experts scattered throughout the country monitor stations to determine whether they are guilty of "wave wobbling" or wandering off their assigned frequencies.

Among the 339 stations measured by the district inspectors during one month recently, writes our Washington correspondent, 101 deviated less than 200 cycles

in spite of the fact that Federal Radio Commission regulations allow up to 500 cycles. This 500-cycle tolerance, incidentally, will probably be narrowed very considerably soon, because of advances in radio technique, especially improvements in the quartz crystals.

○○○○

WIRELESS AT WESTMINSTER.

(From Our Parliamentary Correspondent.)

Half-yearly Licences ?

Asked in the House of Commons last week by Mr. Freeman whether, in view of the number of people of limited means who applied for wireless licences, he would consider the desirability of issuing a half-yearly licence where desired or allowing applicants to pay in two instalments, Mr. Viant, the Assistant Postmaster-General, said that there were at present more than three and a half million wireless licences in force, and the cost of collecting and accounting for the fees and securing the renewal of the licences was already considerable. The introduction of a system of half-yearly licences would practically double this work, and the additional expense would be out of proportion to the benefit derived by the public.



No. 3.—The Purpose of Every Component.

By A. L. M. SOWERBY, M.Sc.

THE second tuned circuit in the receiver is made up of the coil L_5 and the tuning condenser C_3 , and is connected in the grid circuit of V_2 , the second valve of the set. Of the main design of this tuned circuit little need be said, for it has to possess the same virtues, and avoid the same faults, as the two circuits in the band-pass filter, which have already been discussed. L_5 is therefore identical with L_2 and L_3 , while C_3 , like C_1 and C_2 , has a maximum capacity of 0.00035 mfd.

It is a well-known fact that a tuned circuit of this type offers quite an easy path (i.e., a small impedance) to the passage of high-frequency currents so long as the circuit is not tuned to the wavelength of the currents in question, but that when C_3 is so set that the circuit resonates to the wavelength of the signals being received the circuit as a whole offers, to these particular signals, a very high impedance indeed. Provided that the tuning condenser is accurately tuned, the whole circuit becomes equivalent, for that particular wavelength, to an ordinary resistance, and in carrying out calculations in connection with high-frequency amplifiers it is usual to regard the tuned circuit as a simple resistance.

Explaining Dynamic Resistance.

To mark the fact that the value of this resistance may be different at different wavelengths, and to emphasise that the circuit must be tuned to the correct wavelength for the resistance to make its appearance at all, the term "dynamic resistance" is usually employed. With the coil and condenser specified, the dynamic resistance of the tuned circuit we are considering will be somewhere about 160,000 ohms at a middle wavelength, such as 300 metres.

In a normal "tuned-grid" circuit, such as is shown in Fig. 1, this dynamic resistance is connected directly in the anode circuit of the valve, since the tuned circuit offers the only path from the plate of the valve to earth. The choke may be regarded as blocking off the

direct route through the H.T. supply. As the voltage which is applied to the grid of V_2 is that developed by the passage of the high-frequency anode current of V_1 through the tuned circuit, it is clear that the higher the dynamic resistance of this is made the greater will be the voltage passed on to the valve which follows it. Further, since the dynamic resistance only makes its appearance when the circuit is tuned to the wavelength which it is desired to amplify, it follows that if L_5 or C_3 is either short-circuited or disconnected (whereupon the circuit will cease to tune) the anode of V_1 will be practically short-circuited to earth so far as the high-frequency currents are concerned. Signals will, therefore, fail to reach the grid of the next valve, and the set will become silent, or practically so.

In the circuit diagram of the complete set (Fig. 2) L_5 is shown tapped at the centre point, and this tap is connected to the feed condenser C_9 . Only a part, therefore, of the available dynamic resistance of the complete tuned circuit is included in the anode circuit of the valve. The results of this small departure from the more usual arrangement, in which C_9 would be joined to the top of the coil, as in Fig. 1, are rather more far-reaching than one would expect at first sight. But before these results can be discussed there must be a small digression to review the behaviour of a tapped tuned circuit.

Since there is only half a coil, and no tuning condenser at all, connected between C_9 and earth, it might appear that the tuned circuit has been removed entirely from the anode circuit of V_1 . From this point of view it would seem that there would now be no dynamic resistance connected between the anode of V_1 and earth, and that there would, in consequence, be no amplification, and no signals, to be had. If the tuning condenser and the rest of the coil L_5 were removed altogether from the set, this would be approximately

true, but in real fact the half of the coil through which the anode current of the screen-grid valve flows is closely coupled to the upper half of the coil, and the

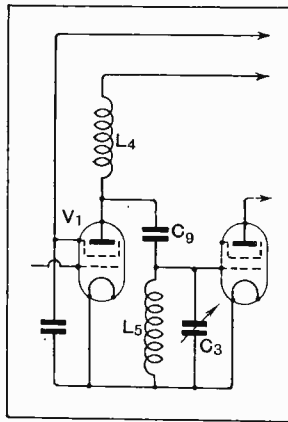

Fig. 1.—The tuned-grid intervalve coupling. The dynamic resistance of the complete tuned circuit is shown included in the anode circuit of the valve V_1 . Stability, with a reduction of cross-modulation, results when the connection from condenser C_3 is made to a point midway on the coil L_5 .

From Aerial to Loud Speaker.—

coil as a whole, in conjunction with the tuning condenser, forms a tuned circuit. As a result of this the lower half of the coil does possess a dynamic resistance, though it is less than that of the whole tuned circuit. One may regard the dynamic resistance of the lower half of the coil as a kind of pale ghost of the dynamic resistance of the whole circuit, following the changes brought about by tuning the latter, but always having a magnitude only one-quarter of the dynamic resistance of the complete circuit, shown as C_3L_5 in the circuit diagram (Fig. 2).

This low value of dynamic resistance has the unfortunate effect of decreasing considerably the amplification obtained from the screen-grid valve, though the loss is, to a great extent, offset by the fact that there is now a 2:1 step-up of the voltage developed in the anode circuit of the valve. Further, this loss can be minimised still farther if the screen-grid valve chosen to precede the tapped coil has a low A.C. resistance (impedance), so that it is more nearly matched to the impedance of the half of the tuned circuit that it has to feed.

There are advantages, however, in this centre-tap which more than make up for the losses it introduces.

of a much more low-loss character than would otherwise be safe from the point of view of stability, so that the loss in amplification that has not been made up in other directions can be finally made good in this way. By so doing, we have a set in which the selectivity is that associated with low-resistance coils, while the tendency towards instability is no greater than if we had chosen much more heavily damped coils. The net result is a gain in selectivity, with nothing to set against it on the debit side.

But the centre-tap has still other effects. There is a rather obscure trouble that has arisen only since the introduction of the screen-grid valve, and which is known as "cross-modulation." It arises, primarily, from the fact that the screen-grid valve has a very high amplification factor, and so can only accept a very minute H.F. voltage before overloading begins.

Selectivity and the Screen-grid Valve.

If the first valve of a receiver, tuned to a station, not far removed in wavelength from the local station, receives at the same time, from the local station, a high-frequency voltage great enough to overload it, the local programme is partly converted into a modulation of the carrier-wave of the station to which the set is nomin-

THIS third article of the series deals with the tuned-grid H.F. intervalve coupling and the practical requirements necessary for maximum stable amplification. Cross-modulation, a condition that destroys selectivity, is explained, while the best arrangement of the tuned circuit preceding the detector is clearly described, together with the requirements for power-grid detection.

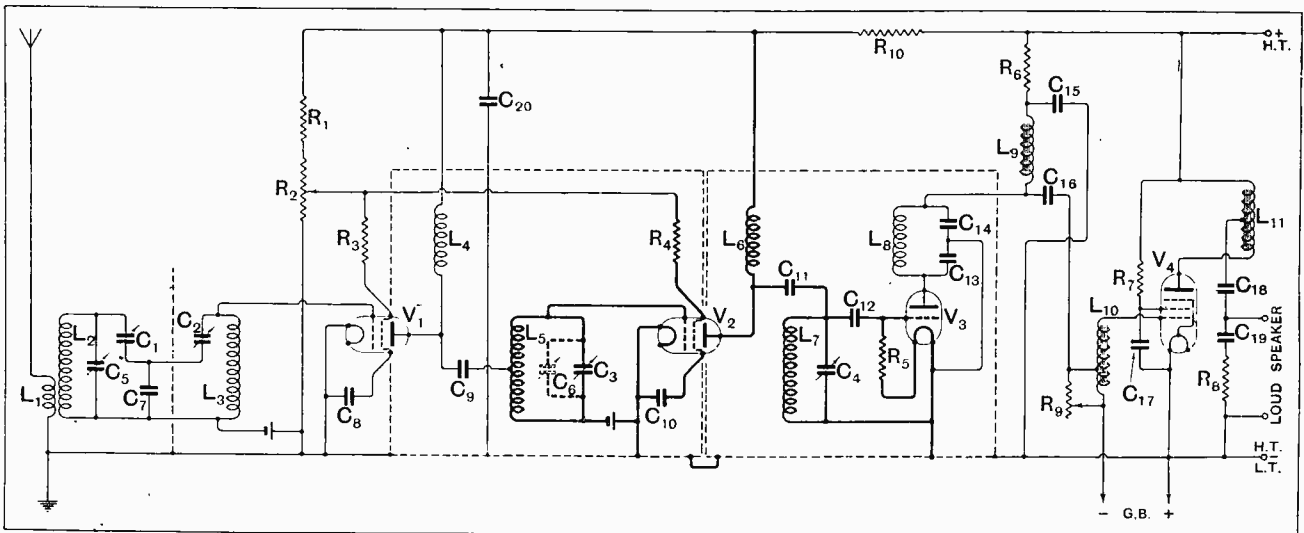

Fig. 2.—Complete receiver circuit, showing the arrangement of the tuned-grid input couplings to the H.F. and detector valves. The components discussed in this article are shown in heavy type.

In the first place, the high-frequency voltage appearing at the anode of the screen-grid valve is cut down to about one-quarter of the value it would have had if the standard tuned-grid circuit had been adopted. As it is this high-frequency voltage which, when fed back to the grid circuit of V_1 through the imperfect internal screening of the valves, causes the set to become unstable, the adoption of a centre-tap on L_5 is a simple and satisfactory safety measure against unwanted oscillation. Further, its introduction allows us to use coils

ally tuned. As a result, the local station's signals will pass through the rest of the set and be heard, even though the tuned circuits following the first valve are highly selective. A whole article on this point will be found in a recent issue of *The Wireless World*.¹

This extremely annoying source of unselectivity can be combated in several ways, of which the two most important are embodied in the set under discussion. The

¹ W. I. G. Page. "Pre-selection," *The Wireless World*, November 5th, 1930, p. 518.

From Aerial to Loud Speaker.—

first precaution is the inclusion of a band-pass filter before the first valve, which helps to keep the signals from the local station off the grid of the first valve. The second is the centre-tap on L_5 , which, by decreasing the impedance in the anode circuit of this valve, enables the valve to accept a greater signal before overloading begins. This second precaution is further assisted by the fact already pointed out, that the use of this tap makes it necessary to choose a screen-grid valve of impedance rather lower than the average.

Another result of the use of the centre-tapped coil is that the capacity between anode and screen of the screen-grid valve is now connected across only half the tuned circuit, in which position it has only one-quarter the effect it would have in the standard tuned-grid circuit. With L_5 tapped and L_7 not tapped, in conjunction with the fact that V_2 , being a screen-grid valve, reflects only a small capacity into its grid circuit compared with V_3 , one may with perfect confidence put a trimmer, shown as C_6 , in parallel with C_3 for matching up C_3 and C_4 for ganging or twin thumb-control dials.

This trimmer, like the trimmer C_5 used in the band-pass filter, need have a maximum capacity no greater than 0.0003 mfd. or so; for preference, it should have an air dielectric to minimise losses. If two trimmers of different capacity are to hand, the larger should be chosen for the position C_6 .

Avoiding Identical Chokes.

The valve-holder used for V_2 , which is the second screen-grid valve, and the decoupling resistance and condenser for its screening grid (R_1 and C_{10}), may be identical with the corresponding components of the previous stage, since they have the same work to do. The same may be said of the high-frequency choke L_6 and the feed condenser C_{11} , though it is sometimes a sound precaution to refrain from using two identical chokes in the same set, in case oscillation should be set up at their fundamental frequency. If any of these components should fail the results produced will be those discussed in connection with their earlier counterparts.

The coil L_7 and its associated tuning condenser C_4 form the last tuned circuit in the receiver. This tuned circuit is distinguished from all the others by the fact that it is followed by a valve acting as a grid-circuit detector of the modern "power-detector" type. Partly through grid current, and partly owing to negative reaction, this valve will damp its tuned circuit very heavily indeed. It will, therefore, be of no assistance, either to selectivity or to amplification, to make this coil of low-resistance type, for the losses in the circuit will

be almost entirely due to V_3 in any case. From the point of view of matching the tuning dials, it may be of some help to make L_7 identical with L_2 , L_3 , and L_5 ; but if space in the second screening box is at all cramped a much smaller coil may be wound to the same inductance. For example, 84 turns of No. 28 d.s.c. might be wound on a former of diameter $1\frac{3}{4}$ in., which will give the 230-microhenry inductance required to match the preceding coils. The tuning condenser C_4 must, of course, have the same capacity, 0.00035 mfd., as the others in the set if the dials are to run nicely together. A failure in either this or the coil will have results similar to faults arising in earlier tuned circuits.

It will be noticed that the centre-tapped coil which was so important a feature of the preceding inter-valve coupling does not appear again here. This is due to the fact that it is necessary, if the maximum stage-gain is to be extracted from a valve, that the part of the tuned circuit included between its anode and earth should have an effective dynamic resistance not very widely removed from the A.C. resistance of the valve. Owing to the heavy damping of the detector, the dynamic resistance of the

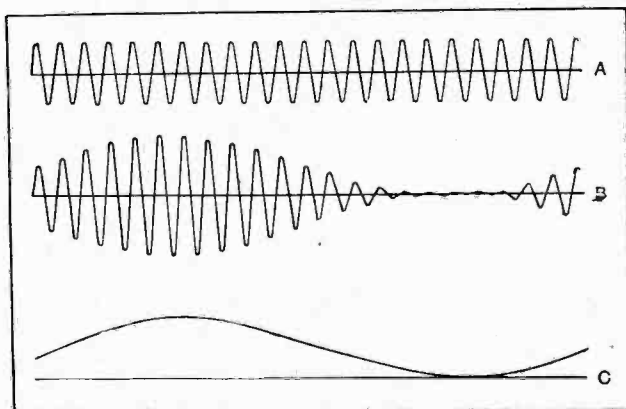

Fig. 3.—The action of the detector. (A) Unmodulated high-frequency voltage. (B) Modulated high-frequency voltage. (C) Current in anode circuit of valve.

tuned circuit L_7 , C_4 will be so low that it will be difficult in any case to find a screen-grid valve of A.C. resistance low enough to match it; it would be quite hopeless to try to find one to match a quarter of that resistance. There is, therefore, no centre-tap.

The grid condenser C_{12} and the grid-leak R_3 are inserted to enable the valve V_3 to rectify the incoming signals. In effect, the grid and filament of the valve only, without the plate, are in action during the rectifying process, which is that of the diode rectifier. With no signal coming in, or with an unmodulated carrier, the grid of the valve sets itself at a voltage very close to that at which grid current ceases, the steady grid current flowing through the leak being of such a magnitude as to cause a voltage drop equal to the difference between the steady grid voltage and that of the positive end of the filament (or, in the case of a mains valve, the cathode) to which the lower end of the grid-leak is connected. Then, when the modulation varies the signal voltage on the grid of the valve, extra grid current flows through the leak, so dropping further volts across it and making the grid more negative. As the modulated high-frequency current rises and falls in amplitude (Fig. 3) at the frequency of the audible notes impressed upon it, it is necessary for the grid-leak to be of low enough resistance for the charge on the condenser C_{12} to follow the rise and fall of amplitude at the rate of vibration of even the highest note to be received; if the charge can only leak away to a small extent between one amplitude peak and the next, the high notes will

From Aerial to Loud Speaker.—

be partially suppressed. In conjunction with this requirement it is necessary that the condenser should offer a reasonably low impedance to the high-frequency currents that have to flow through it to actuate the valve. A combination of leak and condenser that is found to be a satisfactory compromise from these two points of view is 0.0001 mfd. and 0.25 megohm, though the substitution of other values will make no audible difference provided that the change is not very great. In particular, a larger condenser requires a leak of lower resistance to give the same results; from the point of view of the high notes 0.00005 mfd. and 0.5 megohm would be quite indistinguishable from the combination suggested.

It will have been noticed that the grid of the valve is made, by the rectifying action described, to follow the variations in amplitude of high-frequency voltage; these voltage variations will, therefore, make their appearance in the anode circuit of the valve as changes in anode current, the valve acting as an amplifier as well as a detector. It follows that both the valve and the

working voltages applied to it must be chosen with this dual function in view.

If the condenser C_{12} should become disconnected, the signals will not arrive at the grid of V_3 , so that the set will become silent. The same thing will happen if C_{12} is short-circuited, because the grid-leak will have the tuning coil L_7 directly in parallel with it, thereby offering a very low resistance path to earth for the rectified currents. These will, therefore, build up no voltage on the grid of the valve. Shorting R_5 will have the same effect as shorting C_{12} , because the two are virtually in parallel, though they do not look so at first sight. If R_5 is disconnected, almost anything may happen. The set will hum, if there are mains connected to it, or even near it; it may motor-boat; it will certainly distort in a manner which gives the impression that a speaker has a hot potato in his mouth, though more violent phenomena may mask the distortion completely. Oscillation at some audible frequency is another possibility that is often realised. But if the valve base, valve holder, or grid condenser is leaky, the set will carry on as though nothing had happened.

CORRESPONDENCE.

The Editor does not hold himself responsible for the opinions of his correspondents.

Correspondence should be addressed to the Editor, "The Wireless World," Dorset House, Tudor Street, E.C.4, and must be accompanied by the writer's name and address.

THE STENODE.

Sir,—Recent correspondence in *The Wireless World* shows that there is still much doubt about what the Stenode will actually do. The following curves, therefore, which were published in the U.S.A. by Dr. Robinson, may throw some light upon the matter. For easy comparison, I have converted both curves to the same ordinates, and they show the overall frequency response excluding the loud speaker.

For the benefit of those unacquainted with the R.C.A. Radiola superheterodyne, I may say that it consists of a medium wave H.F. stage with a band-pass filter and a two-stage I.F. amplifier peaked at 175 kc. and coupled entirely by band-pass filters. In all, there are nine tuned circuits, and the loss of the higher modulation frequencies brought out by the curve can be attributed to the fact that the filter couplings are somewhat deficient.

The two curves are made equal at 400 cycles, and this frequency is taken as the criterion; it will be obvious, therefore, that the curve for a perfect set would be a horizontal straight line between 50 and 5,000 cycles, and this can be approached by a combination of filters and single circuits, such as that used in the Band-Pass Four.

The frequencies below 400 cycles are unimportant in a comparison between the Stenode and the band-pass filter methods of reception, since they depend chiefly upon the design of the L.F. amplifier. The important part is the region above 400 cycles, and it will be seen that the R.C.A. curve drops steadily for frequencies above 800 cycles, until at 5,000 cycles the response is only 12 per cent. This is quite a large loss, but it could be overcome by a different design of the I.F. amplifier; it is, however, little, if any, greater than the loss caused by low loss cascade circuits, such as those used in the Everyman Four receiver.

The Stenode curve rises for frequencies higher than 400 cycles until, at 1,600 cycles, it reaches the enormous value of 250 per cent. Beyond this it drops very rapidly, and the 5,000 cycles response is only 2.6 per cent.!

It is at once evident how the Stenode can cut out a heterodyne whistle of this frequency or over; unfortunately, however, it also cuts off these modulation frequencies! Mr. Hallows' claim, therefore, that the Stenode gives perfect quality and also eliminates heterodyne whistles is hardly substantiated. The R.C.A. superheterodyne, which, in my opinion, has far too great a high-note loss, gives nearly five times as good high-note reproduction.

It is quite probable that on a comparative listening test the Stenode would appear higher pitched than the R.C.A., due to the enormous peak at 1,600 cycles. This is an entirely false treble, however, and it is well known that by reproducing the frequencies in this neighbourhood out of all proportion to the low frequencies an illusion of plenty of high notes can be obtained. The various instruments are not brought out in their true timbre.

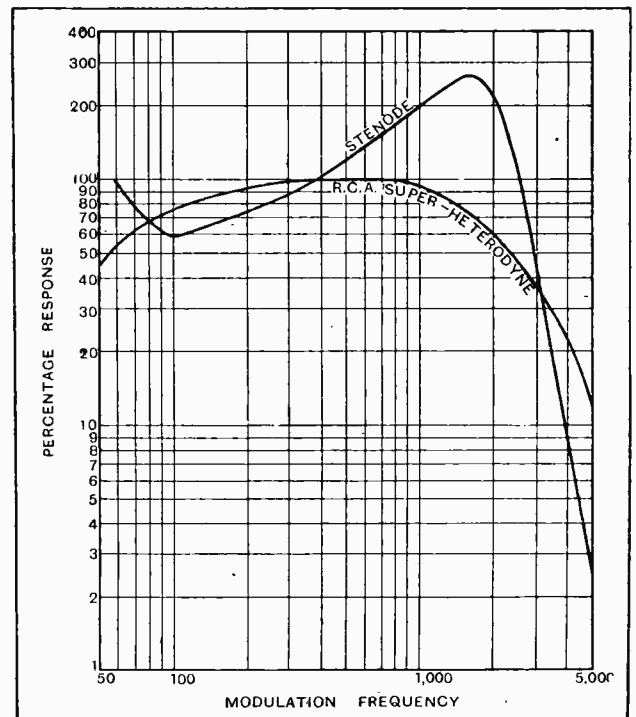

Response curves of the Stenode and the Radiola superheterodyne.

however, for it is upon the frequencies higher than 2,000 cycles that we rely for faithful reproduction.

The curious shape of the Stenode curve is probably connected with difficulties of compensation. Dr. Robinson has pointed out that the compensation ratio must be directly proportional to frequency in the case of a single resonant circuit of low decrement. This means that if an L.F. amplification at 50 cycles of only 50 times be required the amplification at 5,000 cycles must be 5,000 times; this is quite difficult to obtain, and leads to an inefficient and expensive L.F. amplifier.

I may remark that in certain of my own experiments on the Stenode I have found it impossible to eliminate all interference from the London Regional when receiving Mullhacker. The interference takes the well-known form of breaking through during deep modulation at London, and is no less prominent than with a good band-pass superheterodyne. In these experiments, which were conducted at only nine miles from Brookmans Park, an outdoor aerial was used, so that I should not be misled by the directional properties of a frame aerial.

The use of a quartz crystal involves many practical difficulties; absolute constancy of the oscillator is essential, and one which is perfectly satisfactory in a band-pass set is useless in the Stenode, for it becomes impossible to hold a station for more than ten seconds or so! The tuning is so sharp that it is reminiscent of the earliest short-wave sets; indeed, I have found it easier to tune in and hold 3LO, Melbourne, on a single-valve set than to tune in any of the medium waveband stations on a seven-valve Stenode.

This criticism, of course, only applies to the crystal-controlled receiver, and the difficulties are not met with to the same degree when a series of cascade resonance circuits are used. The compensating difficulties with such circuits, however, are enormously increased, and instead of a compensation ratio of 100-1 being required, it may be as high as 1,000-1.

Southgate, N.14.

W. T. COCKING.

"FREE" WIRELESS SETS—A WARNING.

Sir,—In view of certain statements that have recently appeared in the Press, may I ask for the courtesy of your space to define the attitude of the Federation which I represent in regard to the "giving" of so-called "free" wireless sets in exchange for a number of coupons?

The wireless set has been selected by those who are responsible for exploiting "gift" schemes as being the most attractive of all "gifts"; for the wireless set apparently exercises, more than anything else, a lure over the potential collector of coupons.

As a result, large numbers of wireless sets have been "given away" to members of the public if they have managed to buy or secure enough coupons.

If it could be proved that the public obtains these "free" sets absolutely for nothing, and really free, then the situation of every radio dealer in this country would indeed be deplorable; but my Federation feels that the time has come when the public should be truthfully informed as to what this system really means.

The public does *not* obtain its wireless sets free under the coupon system, but, on the contrary, must inevitably pay for them, and in doing so it restricts itself unnecessarily as to the choice of set. It does not, therefore, benefit the public, and, in addition, this system (which, besides hoodwinking an innocent public and exacting from it by clever trick selling, a full payment for a "free" wireless set) is slowly depriving the radio dealer of his legitimate livelihood and the public of certain essential needs and privileges.

The proper "servicing" of wireless sets, once installed, is a vital consideration. The coupon concerns ignore this, and rely on our trade to do this for them. After very careful consideration, therefore, my Federation has advised its members to refrain from giving any kind of service whatever to the "free" wireless sets hereafter obtained by these means.

We feel that in the public's own interest these facts should be known, and we trust that the ultimate effect of this decision will be to remove a blemish from a young and otherwise flourishing British industry.

A. DE VILLIERS,

Organising Secretary,

London, S.E.1.

National Federation of Radio Retailers.

RADIO SOCIETIES.

Sir,—I wish to express my extreme interest in your recent Editorial relating to the revival in the formation of local and provincial Radio Societies. One of the saddest features in British amateur radio history is the demise of so many of the early societies into which so much work was put.

An important object of the Incorporated Radio Society of Great Britain is to foster and assist in the formation of local associations interested in radio work, and it will at all times lend its assistance in any way possible. By the creation of local societies, affiliated to itself, the advantages of unity in all amateur work is gained, thus enabling the amateurs of the British Isles and Empire to consolidate their work and guard their interests in a united manner. The Society issues a set of rules which may be adopted in whole or in part by any new association and thus relieves a newly formed body of much of the initial spade work. Advice will also always be gladly given to any in the methods of constitution formation and how to get together.

A word of warning is, however, necessary to any who intend to form a local association. If we analyse the cause of failures of many of the early societies valuable lessons can be learned which cannot remain unheeded. The main troubles in the past have been apathy, falling off of interest and attendance at meetings, bad organisation, bad choice of executive officers, financial and bad meeting room accommodation. In the first case it is useless to set about forming a local society unless a sufficient number of really enthusiastic members can be assured. These must not be men to whom interest in radio is but a mere passing fancy. Such a member is a distinct danger. He is generally found in the tyro who, having succeeded in building himself a radio set, probably from a set of kit parts, which actually works, is intensely pleased with himself and promptly poses as an authority upon all radio matters. His fickle nature is easily diverted by some new interest, leaving his comrades in the lurch. Then we have the man who joins for purely selfish motives with the sole object of seeing what he can get out of it. He generally expects a full course of instruction in electrical matters and radio generally in return for his small subscription. Obviously he is disappointed and promptly deserts.

The founder members must be those who are genuinely interested in radio work both in its present and future developments, and who appreciate the real value in society work, where by association together, interchange of ideas can take place with mutual benefit to all. They should then see that subsequent joining members are only those who will be staple in their intentions and are of similar mind. It is far better to have a small society of enthusiastic members who have the real association spirit rather than a large body with indifferent intentions.

The choice of an efficient executive is everything to a society and is one of the main features where so many go wrong. The most important is the secretary. He must be a man with good organising ability and a considerable amount of spare time to devote to the work. He must be able to realise that upon himself depends the whole success or otherwise of the society. He must be able to carry on his voluntary duties cheerfully and be able to make prompt decisions upon vital matters. He must command the just respect of every member of the society who should at all times remember that they appointed him themselves to the position and therefore have no ground to contest any of his actions.

The secretary must be backed by a chairman versed in the constitutional procedure of meetings and possessing infinite tact. Having selected and appointed the officers, the members must loyally support their every action. Many a society has failed because dissensions arose between the executive and the membership. The latter always appear to fail to realise that they made a mistaken choice themselves in such cases.

It is extremely easy to form a society, but to carry it on successfully year after year is not so easy a matter as some appear to think. Anyone who has had practical experience as secretary will corroborate my statements in this respect. While, therefore, I am only too anxious to offer the assistance of my Society in the formation of any new associations, I would emphatically express the above warnings to prevent a repetition of the earlier disasters.

H. BEVAN SWIFT,

President, The Radio Society of Great Britain.

ULTRA-MODERN IDEAS IN BROADCASTING.

Acoustic Experiments
in Hamburg's
Radio House.



IDEAL studio acoustics were aimed at by the architects of Hamburg's new broadcasting house which has just been opened at Rothenlaunchaussee, in the "best part" of the city, by the Nordischer Rundfunk A.G., whose service covers most of Northern Germany. The upper photograph gives a good impression of the futuristic style of the "Norag" building with its imposing clock tower over the main entrance.

The most interesting feature of the building is the principal studio, which embodies the very latest developments in broadcast studio design. No attempt has been made to damp echo effects by the ordinary absorption methods; instead the sound characteristics are controlled by several novel devices, including a movable wall and a number of small cubicles which can be opened or closed at will. The entire wall at the back of the stage, seen in the bottom picture, can be moved backwards or forwards. The cubicles are to be seen in the side galleries. Besides acting as "dampers" when necessary, these cubicles can also house additional microphones with effects which are described as remarkable.

From the small platform near the roof the control engineer is able to direct the placing of the microphones.

The studio also contains a specially constructed organ, in which an effort has been made to secure the transmission of the pure diapason tone, usually one of the most difficult effects to reproduce.

The centre photograph shows a special talks studio dedicated to the memory of Heinrich Hertz.

Adjacent to the main studio is a metal-lined research room in which the engineers can carry out tests without fear of high-frequency interference.

The Hamburg headquarters afford another indication of the spirit of enterprise and progress which permeates German broadcasting.

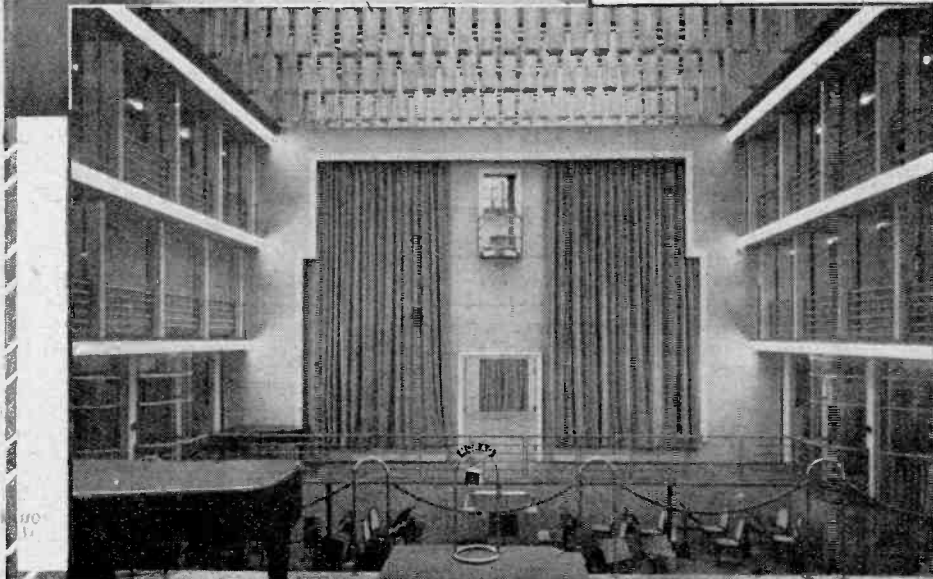
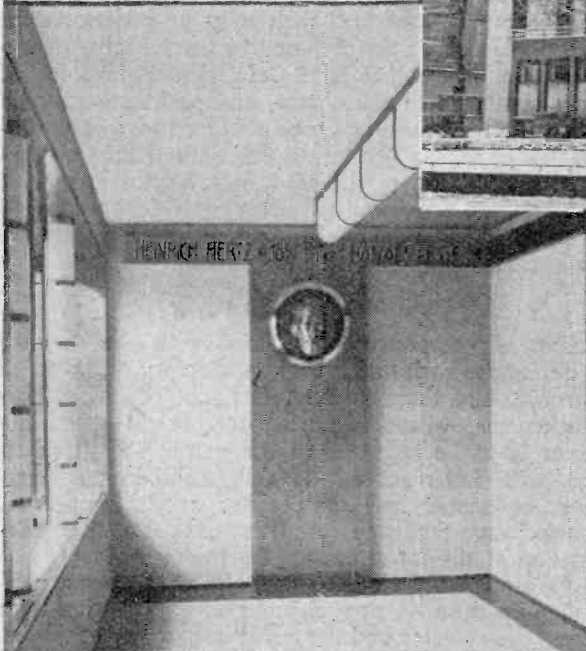

FERRANTI

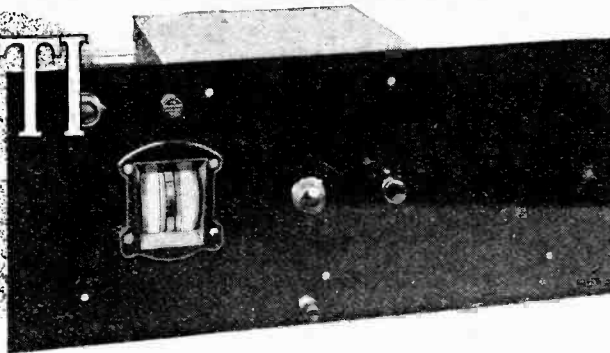
SCREENED
GRID
THREE

A Three-valve General-purpose Receiver for Home Construction.

TO the amateur who really appreciates refinements in design, and who is willing to face the fact that better performance and an exceptionally large factor of safety must be paid for, the Ferranti three-valve kit set makes a special appeal. In essentials it closely resembles the A.C. set, produced by the same firm, which was reviewed in *The Wireless World* for January 14th; indeed, it may be regarded as a battery version of that set, rearranged as to layout and dimensions in order to make it more suitable for home construction.

As a nucleus around which the set is assembled, a special "H.F. kit" is supplied. This comprises a pair of dual-wave H.F. transformer assemblies, complete with wave-range switches and reaction coil, a special screen-grid valve-holder, and a large aluminium screening box packed in sections. Other components are obtained separately, and it is all to the good that certain variations may be introduced when desired, as, for instance, a suitable output transformer for supplying a moving-coil loud speaker.

A Popular Circuit.

It will be seen from the specification that the basic circuit arrangement is that of a single H.F. stage, followed by a detector feeding directly into an output valve. The aerial-grid circuit is of the single-tuned variety, and is conventional, except that a double-wound transformer is used, and that a series condenser is fitted to act both as an input volume control and for the regulation of selectivity. An alternative aerial terminal provides a direct connection to the transformer primary, and is intended to be used where maximum range is desired under conditions where interference from other stations is not present.

Coupling between the H.F. and detector valves is effected by another double-wound transformer, which carries a rotatable reaction coil, controlled from the panel by a flexible Bowden wire mechanism, and so mounted that it is in suitably close inductive relationship with both medium- and long-wave windings. An

important point in connection with this system of reaction control is that feed-back may be introduced in the reverse sense, as the coil may be turned through 180 degrees; in effect, this is the electrical equivalent of adding resistance to the circuit, and so tuning may be broadened in order to embrace a wider range of modulation frequencies. Naturally, one cannot take advantage of this feature of the set if interference is severe, or if there is no reserve of signal strength, but, used with discrimination, it often allows "brighter" reproduction to be obtained than is normally possible.

High L.F. Magnification.

Values of components associated with the detector grid circuit are such that a very satisfactory compromise is effected, and there is the refinement of a grid bias potentiometer, which is particularly useful when the receiver is to be operated at the extreme limit of its range, with full reaction. A very small by-pass condenser, connected between detector anode and earth, prevents any tendency towards uncontrollable self-oscillation at the lower end of the tuning scale.

A Ferranti A.F.6 transformer, which provides a voltage step-up ratio of 1:7, is used as an electrical link between the detector and the triode output valve. Overall amplification of L.F. impulses is comparable with that normally obtainable from a pentode, and, if a detector valve of reasonably low impedance be used, reproduction of the lower frequencies does not suffer.

In order that the loud speaker and output valves may be matched, a transformer with a tapped secondary is fitted. In cases where sufficient anode current can be supplied it is pointed out in the manufacturers' published instructions that a super-power valve may be used to feed a moving-coil

instrument through the appropriate type of transformer. A list of suitable valves for each position is given; practically any of the better-known screen-grid types are suitable, while, for the detector, an impedance not greatly in excess of 12,000 ohms is advocated.

A gramophone pick-up may be interposed in the

SPECIFICATION.

GENERAL: For operation with batteries or H.T. eliminator, with an open aerial.

CIRCUIT: Screen-grid H.F. valve, transformer coupled to grid detector. Magnetic reaction, positive or negative. High-ratio L.F. transformer coupling to triode output valve. Variable-ratio output transformer. Provision for gramophone pick-up.

CONTROLS: Two separate tuning condensers, input volume control, reaction, wave-range switch, on-off switch, radio-gramophone switch.

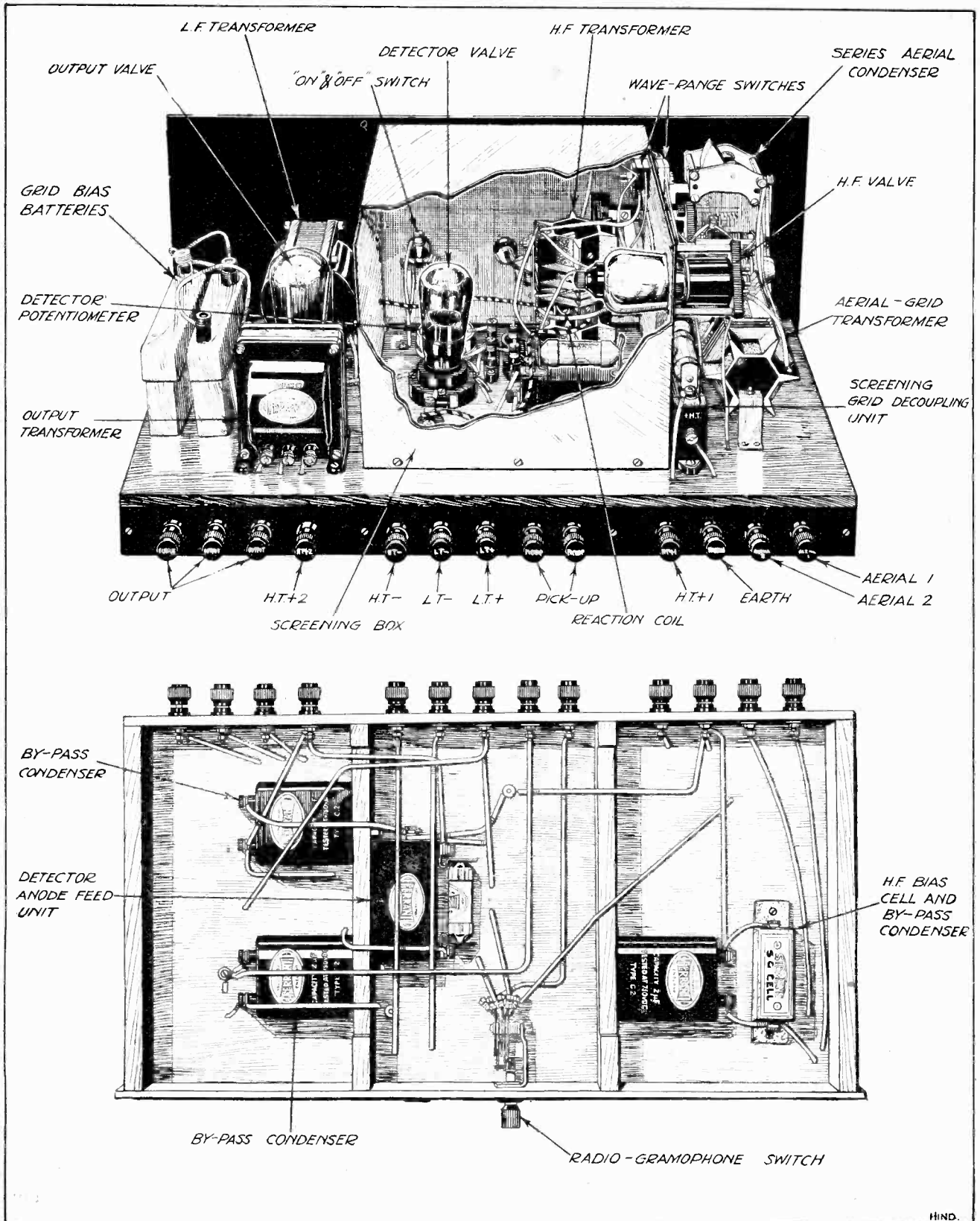

The Ferranti three-valve kit set, with screening box broken away to show positions of components. Below: Underside of baseboard.



A striking architectural design characterises Lwow (Lemberg) broadcasting station, built by Marconi's for the Polish Broadcasting Company.

Secular Broadcasting on Sundays.—Dr. Adrian Boulton.—New Wavelength Plan?—Northern Regional Testing.—Ireland Calling.—Savoy Hill and the Census.

Sunday Broadcasting Changes.

The idea of brightening the British Sunday dinner, always a solemn feast, has suddenly caught the imagination of officials at Savoy Hill. We are not to have dance music or anything similar, of course, but I believe that the notion of a little light "dinner music" at one o'clock on the Sabbath, of the sort given by the Gershom Parkington Quintet, has actually not been frowned upon.

○○○○

Trouble on the Board?

The entire arrangements regarding Sunday broadcasting are said to be in a state of "fluidity," but I am assured that there is not the remotest chance of any alteration in the general tenor of the programmes despite rumours that have reached me of an approaching "split" on the board of governors on this very question.

○○○○

Is a "Secular" Station Wanted?

It would be interesting to know whether there is a really popular demand for an "all-secular" alternative transmission on Sundays. I think the majority of people would consider that Jack Payne deserved his seventh day rest and that even the comedians should be allowed to forget their indiscretions for one day in the week. But this is not to say that listeners would give the cold shoulder to a station that guaranteed "no uplift" throughout its Sunday transmission period.

○○○○

This Freedom.

By the way, the B.B.C. has been re-reading its original transmission licence in which the P.M.G. states that "the Corporation shall provide programmes on every day of the week, including Sundays," and is congratulating itself

upon being the only organisation which has been officially commissioned by a Minister of the Crown to break the Sabbath Day Observance Act.

○○○○

Illness of the B.B.C.'s Music Director.

Dr. Adrian Boulton's indisposition, which prevented him from conducting the D'Erlanger Requiem, was much more serious than the public were led to believe. Despite a warning not to conduct the symphony concert at the Queen's

Hall on the previous Wednesday, he had insisted on mounting the rostrum, while his physician remained close at hand in case of emergency. Only a herculean effort of will enabled Dr. Boulton to pilot the orchestra through the last movement of the "Eroica" symphony.

The director of music is already very popular at Savoy Hill, and there is general satisfaction at the news that he is on the road to recovery.

○○○○

Overhauling the Prague Plan.

A new wavelength scheme to supplant the Prague plan is being freely discussed in connection with the long series of experiments about to be undertaken by the principal European transmitters. It is believed that the new field strength measurements will reveal a number of striking absurdities in the present scheme. A little "swopping" of wavelengths, it is hoped, may make a tremendous difference.

○○○○

Too Simple a Cure?

This cure for our troubles seems so simple that one inevitably suspects it. However, it indicates the biggest concerted effort on the part of the European broadcasting authorities to make the ether fit for listeners, and as such it deserves every encouragement.

○○○○

Meet Mr. Söttens!

Söttens, the new Swiss broadcasting station on 403 metres, seems to need more elbow room than is necessary for a 25-kilowatt transmitter, and I am not surprised that the B.B.C. engineers are showing some concern, particularly as the station threatens to be an unpleasant neighbour to Midland Regional when the latter changes down to 398.9 metres on the opening of Northern Regional!

Glasgow, which uses this wavelength

FUTURE FEATURES.

National (261 and 1,554 metres).

MARCH 16TH.—"The Ridgeway Parade," a song and dance show.

MARCH 18TH.—B.B.C. symphony concert —IS, relayed from the Queen's Hall.

MARCH 19TH.—Hallé Pension Fund concert, Part I, relayed from the Free Trade Hall, Manchester.

MARCH 20TH.—"The Italia," a play adapted from the German by Cecil Lewis.

MARCH 21ST.—Running commentary on the Oxford and Cambridge Boat Race.

London Regional.

MARCH 17TH.—"Aida" (Verdi), relayed from the Prince of Wales Theatre, Birmingham.

MARCH 18TH.—"The Ridgeway Parade."

MARCH 19TH.—"The Italia."

MARCH 20TH.—Students' songs.

Midland Regional.

MARCH 17TH.—Worcestershire Association of Musical Societies Festival Concert relayed from the Winter Gardens, Malvern.

West Regional (Cardiff).

MARCH 21ST.—The "Roosters" Concert Party relayed from the Central Hall, Bristol.

MARCH 19TH.—Hallé Pension Fund concert relayed from the Free Trade Hall.

Glasgow.

MARCH 21ST.—Running commentary on the International Rugby Match, Scotland v. England, relayed from Murrayfield, from Edinburgh.

at present, is seriously upset by the barging tactics of Sötten's.

○○○○

Testing at Last.

Two pamphlets have been prepared by the B.B.C. to assist listeners in the North Regional area during their coming hour of trial. The tests have already begun, and the engineers are following the precedent set by Brookmans Park a year ago.

Probably by the time these lines are read the Regional transmitter will have started a schedule of daily transmissions on 479.2 metres from 11.5 to 11.50 a.m., with extra transmissions on Mondays, Wednesdays, and Fridays from 11.15 p.m. to midnight.

○○○○

Northern National.

The North National will open transmissions on 501 metres, but not until the public are thoroughly accustomed to the Regional station.

modulated voice to broadcast the most unutterable bunk about someone's cough drops, tooth paste, or other rubbish.

○○○○

More.

Ay, there's the rubbish. I sometimes think how poignant it would be if our own announcers were suddenly called upon to spend their lated breath on the boosting of proprietary articles less wholesome than the B.B.C. publications.

I am sure that rather than descend from S O S's to sausages, the majority of the present B.B.C. announcers would say, "Good-night, everybody," and go.

○○○○

A Programme from Ireland.

St. Patrick's Day, March 17th, will be marked by a programme for National listeners relayed from Belfast. Charles J. Brennan, the Belfast City and cathedral organist, will play Irish airs on the organ of the Ulster Hall. Jeanne Erskine and Anna Warnock will play the

donderry will come the Derry Orpheus Choir, conducted by A. J. Cunningham

○○○○

Greetings from Irish Free State.

Seamus Clandillon, director of the Dublin broadcasting station, will broadcast a greeting to listeners during the evening. The programme ends with a relay of the carillon (carillonneur, Thomas W. Holden) from St. Patrick's Cathedral, Armagh.

○○○○

Pavlova: "In Memoriam."

"In Memory of Anna Pavlova," a concert of the music to which she danced, will be broadcast on the National wavelengths on March 30th. The B.B.C. Orchestra will be conducted by Walford Hyden.

○○○○

A Mishap.

One would imagine that the B.B.C. after eight years of broadcasting had experienced nearly every possible kind of breakdown at one time or another, but an entirely new source of trouble displayed itself last week when the sustaining pedal of the Savoy Hill harpsichord suddenly stuck half-way through Mrs. Gordon Woodhouse's recital.

○○○○

A Considerate Announcement.

I was glad that the announcer took us into his confidence by explaining what was wrong, and stating that a few minutes might be necessary to remedy the trouble. "I'm afraid it has beaten us," he said at last, but Mrs. Woodhouse completed her recital so brilliantly that few listeners would have detected anything wrong.

○○○○

A Big Problem.

"What *are* we?"—the question now on the lips of nearly everybody at Savoy Hill—is prompted, not by a spirit of philosophical speculation, but by the imminence of the national census.

The problem is serious, because no one quite knows what he, or she, really is, and this will be awkward when filling in the space marked "occupation."

○○○○

An All-embracing Term.

What is needed is an all-embracing term which shall describe anybody in the B.B.C. from a governor to a terminal tightener. "Broadcaster" sounds impressive, but suggests actual association with the microphone, an honour which not everybody at Savoy Hill can claim, although certain of the cleaning staff handle the microphone daily.

It is no use referring to what was done at the previous census, for ten years ago there was no broadcasting!

○○○○

Not Short and Pithy.

The portmanteau term which will probably find favour (and perhaps cover a multitude of sins) is "broadcasting official." This may be clumsy, but it compares favourably with that gem of the last census, namely, "scissors-putter-together."

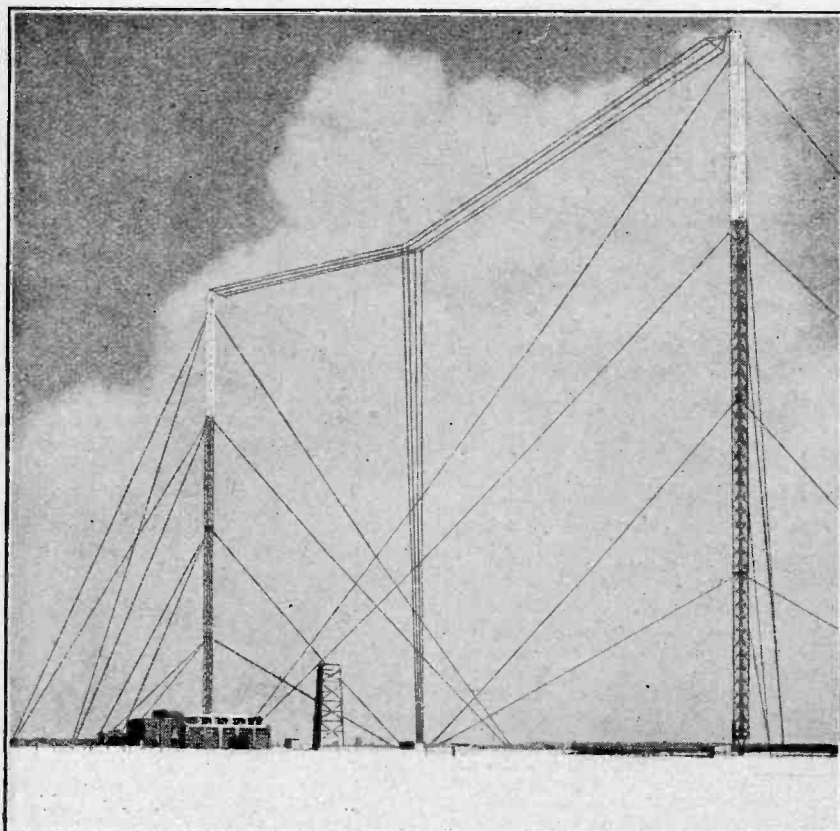

EUROPE'S BIGGEST.—Rasin, the new Polish station near Warsaw, with its output of 160 kilowatts, is undoubtedly the most powerful in Europe, although this doubtful distinction of creating the largest wipe-out area may soon be won by Russia. The Rasin transmitter was built at the Marconi Company's Chelmsford works.

Sob Stuff.

"Pity the poor announcer!" is the cry of a New York correspondent, who lets off some steam in my direction on the subject of broadcast advertising.

"As often as not," he writes, "the American announcer is now a cultured gentleman of good sense and good taste; but he has to use his sonorous well-

parts of the Kilshano woman and the Belfast woman in an Ulster sketch, entitled "The Things that Happen."

○○○○

Singing in Londonderry.

Irish Pipes of the Royal Inniskilling Fusiliers and Ernest A. A. Stoneley (violin) will provide traditional airs and jigs of the countryside, and from Lon-

WIRELESS WORLD



LABORATORY TESTS

A Review of Manufacturers' Recent Products.

KABILOK CABINET FOR EVERYMAN TWO RECEIVER.

The cabinet illustrated below has been constructed by W. and T. Lock, Ltd., 11, Red Lion Square, London, W.C., especially to house the "Everyman Two" receiver, described in our issue of February 25th. Although severely plain and unrelieved by fancy furbishings, it has quite a pleasing appearance, the sides being given a slight slope. The cabinet measures some 22½ in., less at the top than at the base.

The interior fittings include a shelf fixed 4½ in. down from the top, on which will be assembled the receiving apparatus. The back is held in position by a tongue fitting into a groove cut in the base, and a lock is provided. The

values are accurate within even closer limits than is necessary. Further, there



Set of Watmel wire-wound resistors for "Pre-selection A.C. Three" receiver.

is an ample margin of safety in the matter of current-carrying capacity.

The complete set of six resistances, of the values specified, which range from 100 to 50,000 ohms, costs 17s. 6d.

AN INEXPENSIVE LOUD SPEAKER ASSEMBLY.

Made by Reproducers and Amplifiers, Ltd., Frederick Street, Wolverhampton, this unit consists of a 12-inch shallow-angle cone mounted in a cast aluminium chassis and driven by an adjustable four-pole differential movement. The pole pieces are cast as inserts in the die-cast base plate, a method of construction which ensures rigidity and enables a high degree of accuracy to be attained in the subsequent machining processes. Twin permanent magnets are pressed against the machined sides of the pole pieces by set screws supported in four lugs projecting from the base plate. The design is ingenious and the workmanship thorough.

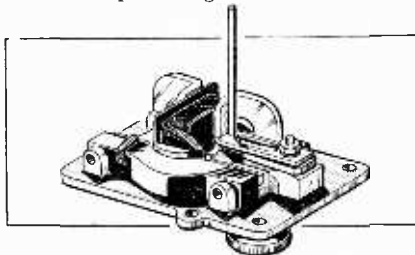

"R.A." loud speaker unit in which the pole pieces are incorporated as inserts in a die-cast base plate.

Impedance measurements gave the following results:—

Frequency (cycles).	Impedance (ohms).
50	1,190
100	1,540
200	2,360
400	3,210
800	4,840
1,600	7,950
3,200	13,400
6,400	16,100

The unit is of more than average sensitivity and has a useful frequency output from 100 to 3,800 cycles. There is, however, some response up to 6,000 cycles and also down to 50 cycles, though

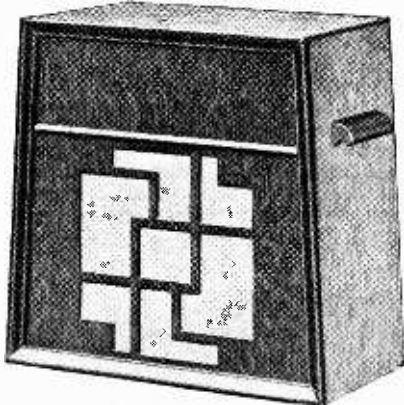

Kabilok cabinet to house The Wireless World Everyman Two receiver.

principal inside dimensions are: width at top, 14 in.; width at bottom, 16½ in.; height, 16 in., and depth, 7½ in. The price is 28s. 6d. in oak.

WATMEL RESISTANCES FOR THE PRE-SELECTION A.C. THREE.

A complete set of Watmel fixed wire-wound resistors for the "Pre-Selection A.C. Three," as described in the last two issues of this journal, has been submitted by the manufacturers, the Watmel Wireless Co., Ltd., of Imperial Works, High Street, Edgware.

As regards physical dimensions, these components are quite suitable for inclusion in the receiver, and their resistance

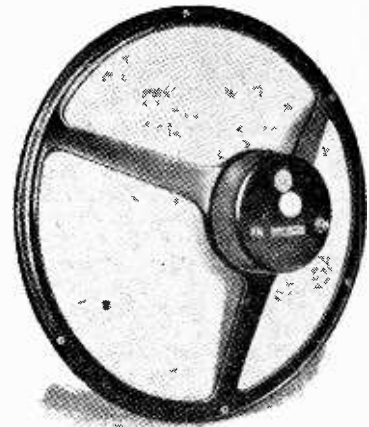

"R.A." type 40 loud speaker assembly.

there is evidence of frequency doubling below 100 cycles. Resonances occur at 160 cycles and 3,000 cycles, but otherwise the ear is unable to detect any departure from a straight line characteristic between 100 and 3,800 cycles. It is difficult to trace any effect of the resonances in the reproduction of music, and the 160-cycle resonance is too low to affect speech, which is exceptionally good, even by comparison with moving-coil instruments.

A power input of 218 milliwatts just caused the reed to chatter at 160 cycles, but at other frequencies an input of 1,000 milliwatts was handled with ease. In practice it is possible to feed an

average input of 500 milliwatts into the unit without provoking chatter at the reed resonance. This provides more than sufficient volume for normal requirements.

The performance and workmanship of this unit bear all the marks of a thoroughbred, and at the very reasonable price of 16s. 6d. it stands in a class by itself.

o o o o

CLARKE'S ATLAS RHEOGRAD.

This is a variable high resistance of the compression type, affording a range of values of from a few ohms to 2 megohms. Its principal uses are: I.T. voltage control in all-mains sets and battery eliminators, and volume control by shunting it across the primary of L.F. transformers. Many other applications will, of course, suggest themselves to the reader.

The body of the resistance is die cast, and to this is riveted a cover plate carrying the single-hole fixing bush. Two soldering tags are located at the back, being readily accessible when the component is mounted on the panel.

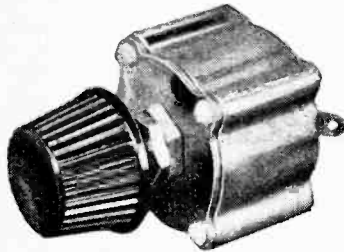

Clarke's Atlas Rheograd will dissipate 6 watts and is variable from a few ohms to 2 megohms.

The resistance is rated to dissipate 6 watts, and the price is 8s. 6d. The makers are H. Clarke and Co. (Manchester), Ltd., Atlas Works, Eastnor Street, Old Trafford, Manchester.

o o o o

COLVERN COILS FOR THE "PRE-SELECTION A.C. THREE."

A set of three screened coils for the "Pre-Selection A.C. Three" is now manufactured by Colvern, Ltd., Mawneys Road, Romford, Essex. In order to simplify the home constructor's task, these coils are already mounted in their correct positions on a plywood sub-panel of the specified size.

Special attention has been paid to the switch gear, which has been completely redesigned. Heavy springy contact blades, fixed to a moulded cross-bar in the base of the coil in such a way that imperfect register is impossible, are fitted with substantial contact rivets of non-corrodible metal, and are operated through a rotary bakelite cam by a brass rod which passes through all the coil bases. In this case, as it is necessary to change over connections on two coils, as well as to "short out" the long-wave windings, the cams have two working contours. Repeated tests fail to bring to light any weakness in this system, which should function faultlessly for an indefinite time.

Inductance values are suitable for the receiver, and all coils are matched within close limits. Fitting is simplified by pro-

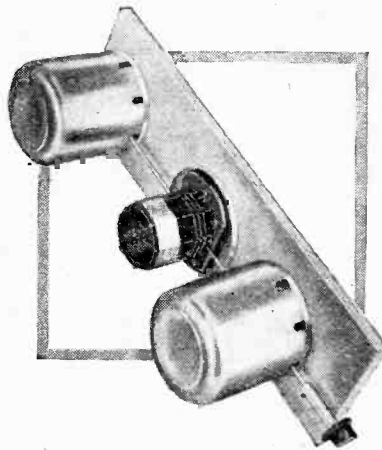

Colvern screened coil unit, ready for mounting, with ganged wave-range switches.

viding a removable switch knob on a brass sleeve, which fits over the control rod. The complete unit, mounted as described, and including screens, costs 37s. 6d. Springy earthing contacts for the switch control rod are fitted, in order that stray inter-circuit couplings may be avoided. Apart from their uses in connection with the "Pre-Selection" receiver, these coils would be suitable for a number of modern circuits.

o o o o

SOUND SALES CHOKES AND BOBBINS.

A range of bobbins suitable for winding small mains transformers and L.F. chokes has been introduced recently by the Sound Sales, Tremlett Grove, Junction Road, London, N.19. They are made of paxoline, and designed to take the familiar "T" and "U" shaped

four sections, the width of each being adjustable to individual requirements. The prices of these bobbins are: plain type, No. 4 size, 1s.; four section, No. 4 size, 1s. 6d.; and the smaller sizes, 8d. each.

One of the L.F. chokes illustrated is built to the specification given in *The Wireless World* of October 29th, 1930, and is a constant inductance type rated to carry 100 mA. of D.C. The measured D.C. resistance of the winding is 205 ohms. Its inductance was measured at 50 cycles and a curve, reproduced here, shows change of inductance with D.C. flowing, an inductance of 23.5 henrys

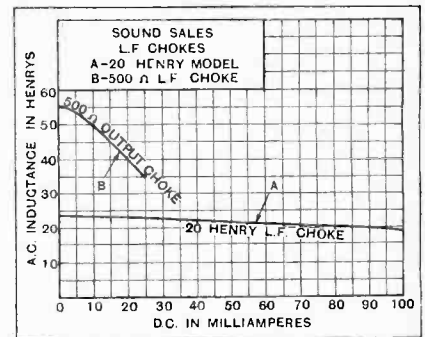

Inductance curves relating to A, 20-henry constant inductance L.F. choke and B, a 300-ohm output choke to carry 15 mA. of D.C.

was obtained, this falls to 21.5 henrys with 50 mA., and to 18.7 henrys with 100 mA. of D.C. flowing. This compares very favourably indeed with the original model. The price has been fixed at the reasonable figure of 15s.

The other sample is designated a 500 ohm output choke and rated to carry some 15 mA. of D.C., and sells at 10s. 6d. The inductance is considerably influenced by the steady D.C. flowing, as can be seen from the inductance curve relating to this model and shown on the graph. In spite

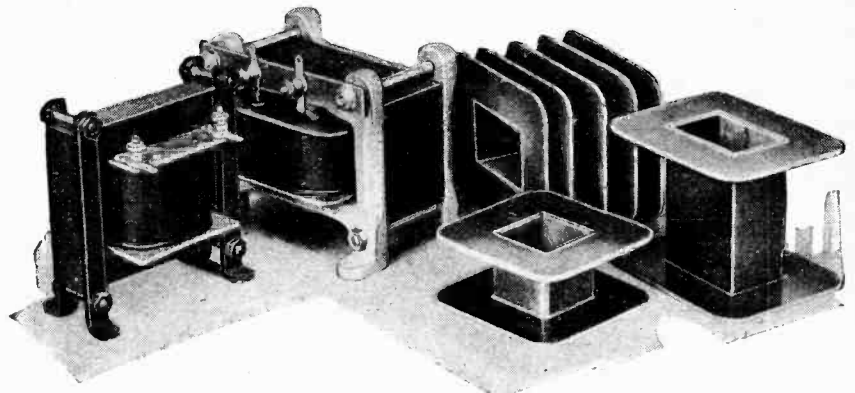

Sound Sales L.F. chokes and some samples of paxoline bobbins for home construction.

stampings used in chokes and transformers described from time to time in this journal. In addition to the usual plain type formers with two end cheeks only, there is one fitted with three loose partitions which divide the former into

of this the inductance attains quite a high value with D.C. of the order of 20 mA. flowing and at 15 mA., its normal working state, the satisfactory value of 40 henrys was recorded when measured at 50 cycles.

READERS

PROBLEMS



Replies to Readers' Questions
of
General Interest.

Range Switch.

As the differential volume control condenser fitted to my H.F.-det.-L.F. receiver (with input filter) is hardly adequate for reducing volume of signals from the local station to a sufficient extent, I was naturally interested to read, in your issue for February 25th, of an arrangement for diminishing the sensitivity of the H.F. stage. All three tuned circuits of my set are controlled by a triple-ganged condenser, and I am wondering whether the method advocated will introduce any change of tuning; if it does, can this change be avoided in any simple manner?

By fitting a double-pole switch arranged as in Fig. 2, in conjunction with a balancing condenser, C, it is possible to avoid any change of tuning brought about by "desensitising" the receiver in this manner.

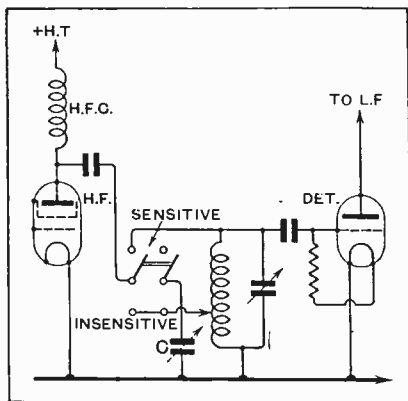

Fig. 2.—Restricting H.F. amplification for short-range reception: switching system for use in conjunction with an input volume control.

The ganged tuning system should be accurately adjusted with the switch in the "sensitive" position; and then, after changing over to "insensitive," condenser C should be adjusted until signals are again at maximum strength. No further adjustment will be necessary.

Conditions in India.

I am shortly returning to India, and should like to know whether it would be worth while to take out a receiving set. Have you any information regarding the conditions there? Is it possible to receive British stations?

The Bombay and Calcutta stations, operating within the normal medium waveband, are well received at great dis-

tances, but atmospheric disturbances are generally severe, except during the cool season. Although we have received many reports of reception of British stations, this is not in any way consistent, and can only be regarded as a "freak." The short-wave station 5SW is, on the other hand, well received in most parts of the country.

Avoiding Inductance Interference.

It has been stated that provision of a separate aerial winding is beneficial in avoiding induction interference, which may become evident when a simple tapped connection for the aerial is used. In spite of this, I notice that many published receiver designs still include the auto-transformer system. Is this done purely to avoid constructional complications, and can it be assumed that a separate winding will always be beneficial?

Induction interference may certainly increase when auto-transformer coupling is used, but only when the input circuit is so arranged that there is a relatively high impedance in the tuned grid circuit. This condition will arise when a capacity-coupled input filter is set up with earthed tuning condenser rotors, and in such cases a separate aerial winding is always recommended. In general, the benefits conferred by this winding are insufficient to warrant the extra complication.

British and American Valves.

I have lately been comparing the published characteristics of a number of American valves with those manufactured in this country, and find that our own productions seem in almost every case to be very much better. Do you think that there would be any risk of causing instability by using British valves in an American set (which would, of course, be fitted with suitable valve holders)?

Although our own valves are not excelled by those made in any other country, it is only fair to point out that in America it is usual to give mutual conductance under working conditions; this makes the valves appear to be rather less good than if this characteristic were determined at zero grid volts, as is customary in this country. Unless

Technical enquiries addressed to our Information Department are used as the basis of the replies which we publish in these pages, a selection being made from amongst those questions which are of general interest.

the American receiver to which you refer is of highly specialised design, it is probable that you could find valves on the market here with suitable characteristics.

"Pre-Selection A.C. Three."

Will you please give me a diagram showing how the eliminator portion of the "Pre-Selection A.C. Three" may be modified for use with a full-wave valve rectifier?

The necessary alterations are shown in Fig. 1, in which the outputs of the eliminator are marked A and B. Point A is connected to L.F.C.₃, and the output choke, while point B is joined to the junction between R₆ and R₇, and also to one end of the decoupling resistance R.

It will hardly be necessary to add that some alteration to feed and bias resistance values will be necessary if your

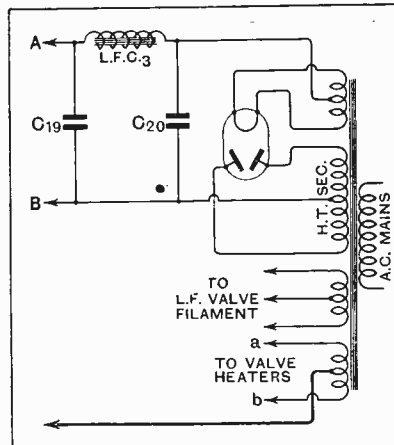

Fig. 1.—Valve rectification for the "Pre-selection A.C. Three"; modifications of the power supply circuits.

rectifier provides an output differing sensibly from that included in the original design.

An Obsolete System.

Will you please refer me to the published description of an H.F.-det.-2 L.F. receiver in which provision is made to switch out one of the L.F. stages for local-station reception?

The expedient of switching out a complete amplifying stage is generally condemned nowadays, as it is usual to arrange matters so that, when the detector is properly loaded, a signal voltage of suitable value will be applied to the grid of the output valve. No set embodying L.F. switching has been described in *The Wireless World* for many years.

Mixed Band-pass Filter.

Although the mixed filter unit described in your issue of February 18th is intended for use with a det.-L.F. set, I take it that it would work quite satisfactorily in conjunction with a receiver having one H.F. stage? Will you please confirm this, and also say if any alterations will be necessary?

Yes; this type of filter is quite satisfactory for a set with H.F. amplification. In this case, you will naturally omit the reaction winding and the reaction control condenser.

○○○○

Parallel Transformer Primaries.

I have a power transformer intended for use with 220-volt mains and wish to use it temporarily on a 110-volt supply system. An examination shows that the primary winding consists of two hobbins with an accessible junction. Will you please show me how the actual connections should be made for the new conditions.

Your transformer should work quite satisfactorily with the primary sections in parallel; the necessary alterations are shown in Fig. 3.

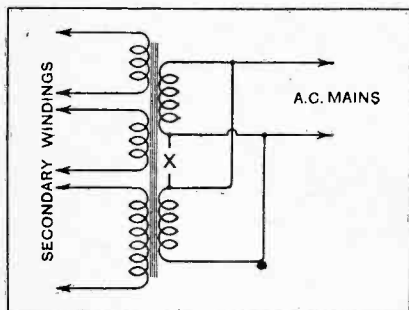

Fig. 3.—Sections of a power transformer primary connected in parallel. The original interconnection is broken at the point X.

○○○○

Fading: True and False.

I have lately noticed serious fading of medium-wave signals; intensity changes considerably, and as far as distant stations are concerned, never seems to remain at a constant level for more than a minute or so at a time. Will you tell me what I can do to prevent it?

If this effect is indeed due to true fading, we cannot help thinking that you must have been extremely unfortunate in

choosing your times for listening, or that your locality is an extremely unfavourable one for wireless reception. It seems much more likely that variations in signal strength is due to some fault in the receiver, or in the aerial-earth system.

In any case, this can be determined by making a test during the daytime; if fading does not then occur, you will know that your trouble is due to natural causes, and cannot be overcome, but if it still persists, there must be a fault, as true fading only occurs during the hours of darkness.

○○○○

Paper for Pentodes.

In an article in "The Wireless World" for November 26th, 1930, it is stated that a moving-coil loud speaker cone of softer paper than that usually employed may with advantage be used in conjunction with a pentode output valve. I should like to do some experiments on these lines: will you please suggest a suitable type of paper?

Very pleasing results can be obtained from a cone made with Ford's thin blotting paper.

○○○○

On the Safe Side.

I intend to construct a simple two-valve mains-operated receiver for reception of the local station, which is about fifteen miles distant. Do you consider that it would be wise to fit a reaction control?

With a good aerial-earth system, you should obtain a large H.F. input, but, to be on the safe side, provision for reaction should be made, especially if the receiver is to employ grid detection, and is to be fitted with an L.F. valve needing a considerable voltage input to its grid.

○○○○

Asymmetrical Tuning Peaks.

I have modified my 1-v-1 receiver by fitting an input band-pass filter. Although I am more than pleased with results, I notice that a milliammeter connected in the detector-anode circuit does not behave quite as one would expect. Admittedly, there are two distinct deflections, as the circuits are "tuned through" a carrier wave, but one of these is not nearly so clearly defined as the other. Do you consider that my filter is working satisfactorily?

If the tuning condensers are accurately ganged you should obtain peaks of sensibly equal height when detector-anode current is plotted against frequency (or condenser dial readings) in the usual

FOREIGN BROADCAST GUIDE.**POSTE PARISIEN,
PARIS (France).**

Geographical position: 48° 51' 30" N.; 2° 17' 43" E.

Approximate air line from London: 214 miles.

Wavelength: 327.5 m. Frequency: 916 kc. Power: 1.2 kW. (temporarily).

Time: *Greenwich Mean Time.
*France adopts B.S.T.

Standard Daily Transmissions.

09.00 G.M.T., transmission of photographs (exc. Sun. and Tues.); 20.25, gramophone records, talks, news bulletin, concert (Tues. excepted).

Man announcer. Call: Ici Poste Parisien.

Opening signal: gramophone record.

Closes down with usual French formula, followed by La Marseillaise.

way. The fact that you do not do so would indicate that there is unequal loading on the two component circuits of your filter; perhaps your aerial is of unusual dimensions, and is either too loosely or too tightly coupled. It is often found that a filter will behave in this way when current is flowing in the H.F. valve grid circuit, due to the lack of sufficient negative bias.

○○○○

Reaction Control.

I have recently tried a receiver in which reaction is controlled by adjusting grid voltage of the screen grid H.F. valves. This device seems to work so well that I should like to include it in my own set. My difficulty is, however, that initial experiments show that actual self-oscillation cannot be produced, whatever setting of grid voltage is adopted, and no bias value seems to give louder signals than those normally obtained. Can you make a suggestion?

The success of this system of control depends on matters being so arranged that the H.F. amplifier tends to go into self-oscillation when the grids are operating at zero, or with a slightly negative voltage; sensitivity is reduced, of course, to a value below the normal by increasing the negative grid bias. We do not consider that this is a suitable method of control to apply to a set unless it is primarily designed for it.

THE WIRELESS WORLD FOUR.

THE interest which the publication of the design of THE WIRELESS WORLD FOUR has created amongst our readers has resulted in an overwhelming volume of correspondence on this receiver. In the course of replying to questions an analysis was made of readers' requirements and the article "Hints on Building THE WIRELESS WORLD FOUR" which appeared in the issue of December 10th, 1930, was prepared to meet readers' needs and difficulties, practically all of which are covered by this article, with the exception of requests for modifications to the original design.

We take this opportunity of pointing out that we are not prepared to give suggestions for the modification of all-mains receivers, since often quite small departures from the original plan necessitate a complete revision of the design.

Readers who are now building the Battery Model WIRELESS WORLD FOUR are reminded that additional information on construction is contained in the article which appeared in the issue of December 10th, and they should also refer to the original articles on the all-mains operated set which appeared in the issues of October 15th and 22nd, 1930.

Homer willing we may be to assist our readers by replying individually to their enquiries, we now find that the enormous volume of correspondence makes it no longer possible even to contemplate sending replies through the post. We wish to point out, also, to those readers who are contemplating the construction of the set, that our experience is that difficulties met with have invariably been traced to modifications in the design or the substitution of different valves or components. We have overwhelming evidence from our correspondence to show that those who have followed precisely the instructions given have had the utmost satisfaction from the receiver.

Whilst being obliged to decline to reply individually through the post to enquiries we may receive, we shall do our utmost to give general assistance to constructors through the pages of this Journal.

The Wireless World

AND
RADIO REVIEW
(18th Year of Publication)

No. 603.

WEDNESDAY, MARCH 18TH, 1931. VOL. XXVIII. No. 11.

Editor: HUGH S. POCOCK.

Assistant Editor: F. H. HAYNES.

Editorial Offices: 116-117, FLEET STREET, LONDON, E.C.4.

Editorial Telephone: City 9472 (5 lines).

Advertising and Publishing Offices: DORSET HOUSE, TUDOR STREET, LONDON, E.C.4.

Telephone: City 2847 (13 lines).

Telegrams: "Ethaworld, Fleet, London."

COVENTRY: Hertford St. BIRMINGHAM: Guildhall Bldgs, Navigation St.

MANCHESTER: 260, Deansgate. GLASGOW: 101, St. Vincent St., C.2.

Telegrams: "Cyclist, Coventry."
Telephone: 5210 Coventry.

Telegrams: "Autopress, Birmingham."
Telephone: 2970 Midland (3 lines).

Telegrams: "Hiffe, Manchester."
Telephone: 8970 City (4 lines).

Telegrams: "Hiffe, Glasgow."
Telephone: Central 4857.

PUBLISHED WEEKLY.

ENTERED AS SECOND CLASS MATTER AT NEW YORK, N.Y.

Subscription Rates: Home, £1 1s. 8d.; Canada, £1 1s. 8d.; other countries abroad, £1 3s. 10d. per annum.

As many of the circuits and apparatus described in these pages are covered by patents, readers are advised, before making use of them, to satisfy themselves that they would not be infringing patents.

A Warning to the Post Office.

THE Post Office may be regarded normally as an extremely cautious authority, which would not be expected to make hasty or ill-considered decisions but rather to err on the side of seeking for a precedent to provide a guide to every authorisation. It is not surprising, therefore, that we have watched with some amazement the attitude of the Post Office towards Broadcast Relay Services. By Broadcast Relay Services we mean those local organisations for receiving broadcasting on a central set and distributing from thence by wire to loud speakers in the homes of subscribers to the system. The system is one which is dependent upon a licence from the Postmaster-General, and, therefore, every installation of the kind has been set up with the permission of the Post Office.

To grant to a local organisation permission to connect up subscribers' houses may not at first appear to be leading to any serious trouble, but if we picture the arrangement pushed to its logical conclusion, when, assuming that the system gains in popularity with subscribers, almost every other house in many streets is so wired, we can at once picture a network of new wire communications spreading out from a centre and producing an even worse state of affairs than existed some years back before Post Office telephone lines were run underground. We can imagine all sorts of induction and interference troubles arising, quite apart from the insecurity and general untidiness of overhead wiring. To suggest the possibility

of buried wires is even more impossible. Surely there are to-day sufficient underground channels of communication, the maintenance of which is a constant source of traffic interruption in roadways, and any extension of these privileges could not be contemplated in the absence of extremely important reasons.

Can the Post Office Control It?

Again, the permits granted are for distributing broadcasting, but what assurance have we that these means of communication amongst private subscribers may not be used for the distribution of other forms of entertainment or intelligence, such as we ordinarily regard as the monopoly of the Post Office? Already it appears that the channels of communication are being used for the purposes of giving instructions to subscribers who are using loud speakers, and if this is permitted why should it stop at that, and what possible control can the Post Office have over the nature of the matter transmitted.

We have no desire to provoke a scare, but in granting these licences so many points seem to us to have been overlooked by the Post Office that we feel we should be failing in our duty if we did not urge that no further permits for Broadcast Relay Services should be granted until the Post Office devise a means of satisfying themselves that they are not being led into future difficulties from which it will be extremely difficult to extricate themselves when the broadcast relay idea may have got a strong footing.

In This Issue

INEXPENSIVE QUALITY.
TELEVISION BY CATHODE RAY.
UNBIASED OPINIONS.
CURRENT TOPICS.
MAJESTIC SUPERHETERODYNE.
MODERN TERMS DEFINED.
FROM AERIAL TO LOUD SPEAKER.
BROADCAST BREVITIES.
REVIEW OF NEW APPARATUS.
LETTERS TO THE EDITOR.
READERS' PROBLEMS.



Making the Most of Moving Iron Cone Units and Small Output Valves.

THE moving coil principle of loud speaker construction is universally acknowledged to be capable of giving the most faithful reproduction of speech and music at present known to the art, and the possession of such an instrument is an aspiration of every true enthusiast. Unfortunately, the question of cost is in many cases an insurmountable barrier to the attainment of this ideal.

It is not merely the cost of the loud speaker itself, but of the incidental equipment necessary to do full justice to the qualities of the loud speaker. For it is of little use to buy a first-class moving coil loud speaker and then find that funds provide for only a skimmed amplifier equipment to go with it. The quality reproduced by any loud speaker is intimately connected with the volume level at which it is worked, and if for reasons of economy the input must be reduced below the optimum level for which the instrument was designed, distortion (generally a lack of the middle and lower registers) will be experienced. There is little point in making the additional outlay on a moving coil, unless one has the means of revealing its superior qualities.

The majority of moving coils give of their best when

THE article discusses some of the outstanding characteristics of present-day moving-iron type cone loud speakers, and the points to look for in choosing a suitable unit. Suggestions for the choice for a suitable output valve and the adjustment of the receiver to improve quality are also given.

supplied with an input level of about 1,000 milliwatts of undistorted audio-frequency power, whereas the average moving iron unit is happiest with inputs in the region of 250 to 500 milliwatts. The writer's experience is that this range of power gives just the right volume for the living-room of the modern small house. In support of this estimate it may be pointed out that the average portable operates with 150 to 250 watts in the loud speaker circuit.

Deceiving the Ear.

Thus at the very outset we find that the conditions under which the average broadcast receiver is worked are favourable to the moving iron cone loud speaker. It has another powerful ally in the human ear, which possesses remarkable powers of accommodation, and is capable of reconstructing sounds from which important frequencies have been suppressed in the loud speaker.¹ Judged by comparison with the best moving coils, every moving iron type of coil will exhibit one or more of a variety of defects typical of its class. In choosing a unit, therefore, since defects are inevitable, those should be chosen to

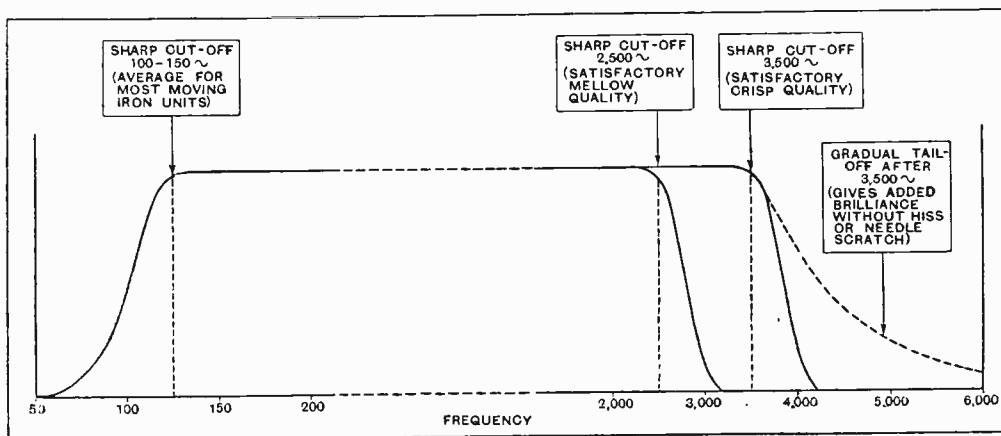

Fig. 1.—Typical cut-off frequencies and their effect on quality.

¹ See *The Wireless World*, March 4th, 1931, page 231.

Inexpensive Quality.—

which the ear tends to show the greatest leniency.

There are two principal causes of distortion: (1) Resonances; (2) falling off in response at the upper and lower extremities of the frequency range. Speaking generally, bad quality can be more often traced to resonances than to high-note loss or cut-off in the bass.

Let us examine first the question of cut-off. In the bass there seems to be a surprising unanimity among the units at present on the market. With few exceptions the reproduction is satisfactory down to 100 cycles, but below this frequency the cut-off is precipitous. Theoretically, this should wipe out the bottom two octaves of the piano, yet we know from experience that these lower notes somehow manage to make their presence felt. When the cone unit enthusiast says with pride "Just listen to that bass!" he is drawing attention to frequencies which are seldom lower than 100-150 cycles; the ear has conveniently reconstructed the 50-cycle fundamental for him from harmonics. Exceptions to the above generalisation are provided by the inductor moving iron movements which give a response comparable to the moving coil from 100 cycles downwards.

High-frequency Response.

At the upper end of the frequency scale we find a much wider variety of performance, not only as regards cut-off frequency but also in the rate at which the response falls as the frequency is increased above the cut-off point.

compensates for deficiencies in the response of the loud speaker. It is well known that the various tone qualities of musical instruments are determined by the frequency and strength of the harmonics which they produce. In

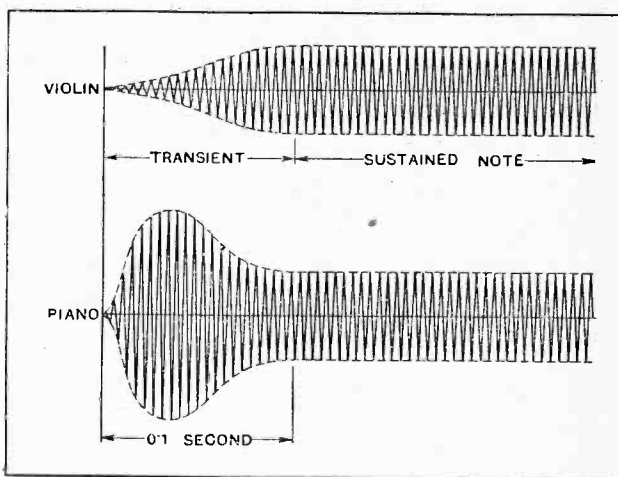
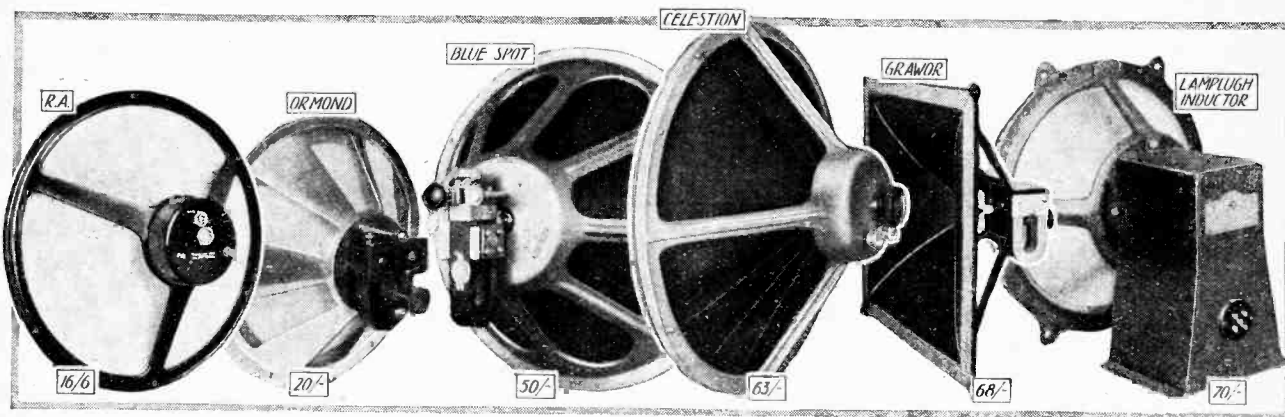

Fig. 2.—In the upper register where harmonics are feeble, the various musical instruments are recognised by their initial transients.

the upper register, say at 3,000 cycles, the wave-forms of sustained notes are generally the same, for the loud speaker is seldom able to reproduce the harmonics (6,000, 9,000, 12,000, 15,000, etc.). Yet it is still possible to distinguish between, say, the violin, piano



Typical examples of low-priced moving iron type cone units.

Those who prefer mellowness to brilliance will choose a unit with a cut-off at about 2,500 cycles. The writer's preference is, however, for a good response up to 3,000 or 3,500 cycles with a gradual falling off to about 6,000 cycles. It is useful to have some sort of response between 3,500 and 6,000 cycles, for this can be accentuated if desired by the use of a pentode output valve. In a few instances the unit has a natural response up to 6,000 cycles, and in these circumstances a pentode should be avoided, otherwise background noise and needle scratch may become a trifle too prominent.

While dealing with the upper frequencies it may be worth while to mention another instance in which the ear

and piccolo at this frequency. Actually, the ear ignores the wave-form of the steady note and uses the transient at the commencement of each note as a means of identification. Thus the piano note starts with a clang, the piccolo with a minute "pop," whereas the violin tone builds up gradually as the bow passes over the strings. The same sort of thing occurs in the extreme bass where the sousaphone in a dance band is recognised by a rythmical series of "pops," caused by the sudden opening of the valves, without any trace of pitch.

Thus in the matter of frequency response the ear permits us to choose a unit with a cut-off below 100 cycles and above 3,500 cycles, without seriously penalising the quality of the general result.

Inexpensive Quality.—

In the matter of resonances, however, the ear is more exacting. While it is tolerant to resonances at the extremities of the useful frequency range, no amount of use will accustom it to resonances in the middle register. For instance, a resonance in the neighbourhood of 1,500 cycles invariably produces a tinny, nasal quality reminiscent of early horn-type loud speakers. Fortunately, there are but few examples of this type of resonance remaining in cone units at present on the market. Of much more frequent occurrence is a resonance in the vicinity of 300-500 cycles. This resonance is responsible for the hollow, woolly quality of speech, which is perhaps the most common failing of moving iron cone loud speakers. The more successful designers of loud speaker movements are finding means of lowering this resonance into the region of 100-200 cycles, where it is

Bearing these points in mind, the reader is left to make his own personal choice from the reviews of loud speaker units appearing from time to time in the pages of this journal.

The Output Valve.

Having acquired a suitable unit, the next step is to ensure that the operating conditions in the output stage are adjusted to give the best results both as regards efficiency and good quality. The highest efficiency is attained when the A.C. resistance of the valve is approximately one-half of the impedance of the loud speaker. Impedance values (not to be confused with the D.C. resistance generally quoted by the makers) are given in all *Wireless World* test reports, and serve as a guide to the choice of a suitable valve. It will be observed that the impedance rises rapidly with increasing frequency,

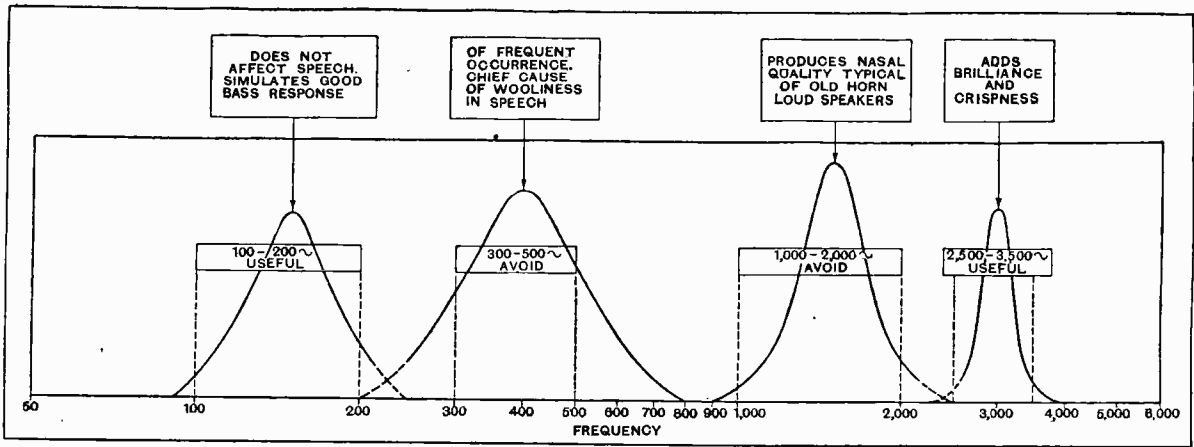

Fig. 3.—Typical useful and harmful resonances occurring in moving iron cone units.

comparatively innocuous as far as speech is concerned and is useful in strengthening the simulated bass already referred to. In A.C. mains sets this resonance should not be too low, otherwise any remaining 100-cycle hum may be enhanced.

Thus we find that although defects are to be found in the characteristic of every moving iron cone loud speaker, it is possible so to choose the defects that they are overlooked by the ear and do not actively militate against our enjoyment either of speech or music. Briefly, the considerations governing the choice of a suitable unit may be summarised as follows:—

- (1) The bass response should be maintained down to at least 150 cycles.
- (2) A high-frequency cut-off as low as 2,500 cycles can be tolerated, but satisfactory results as regards crispness will not be obtained unless the output is maintained up to 3,500 cycles. A gradual tailing-off up to 6,000 cycles is preferable to a sharp cut off at 3,500 cycles.
- (3) Avoid resonances in the vicinity of 300-500 cycles and 1,000-2,000 cycles.
- (4) Resonances between 100 and 200 cycles and between 2,500 and 3,500 cycles can be tolerated and often definitely improve the general effect.

so that in theory it is possible to match the valve and loud speaker only at one particular frequency. In

TYPICAL 2-VOLT OUTPUT VALVES.

(UNDISTORTED POWER OUTPUT 250 TO 500 MILLIWATTS.)

TYPE.	Power Output (Milliwatts).	A.C. Resistance (Ohms).	Optimum L.S. Impedance (Ohms).
TRIODES.			
Cossor 230 X.P.	450	1,500	3,500
Mazda P220 A	330	1,850	5,000
Mazda P240	350	1,900	5,600
Marconi P2	300	2,300	5,000
and			
Osram P240	400	2,500	5,500
Mullard PM 252	320	2,600	6,000
Mullard PM 2A.....	270	3,600	8,000
PENTODES.			
Mazda 230 PEN	350	—	10,000
Mullard PM 22	400	—	11,000
Cossor 230 PT	400	—	11,000
Marconi and Osram PT 240	500	—	10,000

Inexpensive Quality.—

practice, however, a good deal of latitude is permissible as the matching holds over a very wide band of frequencies on either side of the optimum frequency. In general it is best to arrange for the optimum matching to occur at about 200 cycles where the loud speaker impedance is fairly low. In other words, of two valves having the same power output choose the one with the lower A.C. resistance. There are, of course, exceptions, and the reader will find plenty of scope for experiment in modifying the quality by using output valves of varying A.C. resistance. As an example of what may be accomplished by careful matching of impedances, the "Dual Unit" loud speaker, described in the June 18th, 1930, issue of this journal, may be cited. In cases of serious deficiency in the upper register a pentode output valve may be used with advantage, as it is capable of maintaining a good circulation of current in the loud speaker windings at the higher frequencies where the impedance is also high.

It should be emphasised that the quality of reproduction is determined primarily by the intrinsic characteristics of the loud speaker end only to a secondary degree by the matching of impedances. It is wisest, therefore, to choose the unit in the merits of its frequency response, and to make the best of whatever impedance values it may present.

Final Adjustments of Quality.

Having made the most of the opportunities provided by the output stage, there is still scope for improvement in quality in the adjustment of the receiver itself. Naturally every effort will have been made to maintain good quality in the L.F. stages. Special care should be taken to guard against high-note loss, but there is little point in using expensive intervalve transformers with a view to maintaining amplification below 100 cycles, since these frequencies are seldom reproduced in moving iron instruments. For the same reason economies may be effected in the smoothing equipment of an A.C. set,

provided the bass resonance of the loud speaker (if any) is not too near 100 cycles, and a half-wave rectifier can be used instead of the more expensive full-wave type.

The distortion of side bands by sharply-tuned circuits in conjunction with reaction can be turned to useful purpose in modifying quality. For instance, a general raising of pitch results from pushing reaction to the limit and slightly detuning. Of course, a good ear is essential, and the precise setting of the controls is intuitive, but there is not the slightest doubt that it is quite possible to

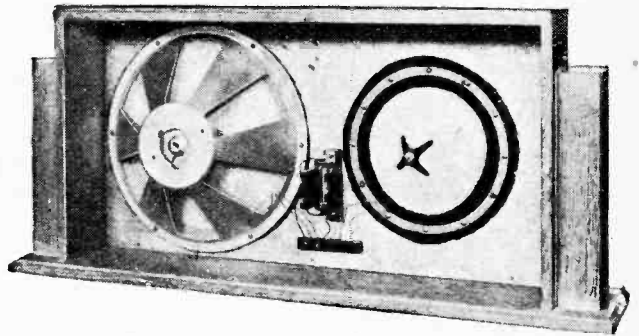

The "Dual Unit" loud speaker; an example of the application of impedance matching methods.

tune for quality. Adjustment of the general level of the output is another useful method of obtaining a final adjustment of quality. If the L.F. and output stage adjustments have in themselves achieved the desired standard, a band-pass tuner is indicated to preserve the side bands in their true relationship.

In the writer's opinion the moving iron cone loud speaker unit is capable of producing quality which is entirely satisfying to the musical ear, and the experimenter will find in this study full scope for the exercise of ingenuity. His reward will be the knowledge that he has achieved at least 75 per cent. of the quality provided by the moving coil at not more than one-quarter of the cost.

Battle of the Giants.

Loud speaker history was made at South Croydon on March 3rd when instruments of every conceivable type were compared without fear or favour. Mr. Remington, technical adviser to the Society, had in operation a unique switching device whereby he could make an instant change from one speaker to another. For the purposes of comparison the loud speakers were divided into two classes, one for moving-coil instruments and one for cone units. The battle of the evening was between the "big guns," i.e., the moving-coil speakers, and some surprising results were achieved when these formidable opponents were pitted against each other. The chairman, in summing up, confessed that he had no idea there were loud speakers capable of reproducing sound in so many different ways!

Hon. Secretary, Mr. E. L. Cumbers, 14, Campden Road, S. Croydon.

Dissecting A.C. Valves.

Equipped with lantern slides and a cinematograph projector, Mr. Parr, of the Ediswan Co., recently gave members of the North Middlesex Radio Society an illuminating lecture on "A.C. Valves," and demonstrated one of the latest radiogram models. Mr. Parr deftly sketched the main features of A.C. valves, dealing with their construction and operation, and also touched upon the question of automatic grid bias. Before the conclusion of the evening, the lecturer kindly promised to make arrangements for a conducted tour by members round the Mazda valve factory.

CLUB NEWS.

Meetings of the Society are held on alternate Wednesdays at St. Paul's Institute, Winchmore Hill. Visitors are welcomed.
Hon. Secretary, Mr. E. H. Laister, "Windflowers," Church Hill, N.21.

FORTHCOMING EVENTS.

WEDNESDAY, MARCH 18th.

Muswell Hill and District Radio Society. At 8 p.m. At Tollington School, Tetherdown, N.10. Lecture by Mr. Leonard Hartley, B.Sc., A.I.C.

THURSDAY, MARCH 19th.

Slade Radio (Birmingham). At 8 p.m. At the Parochial Hall, Broomfield Road, Erdington. Lecture: "Fault Tracing," by Mr. R. Heaton.

MONDAY, MARCH 23rd.

Hackney Radio and Physical Society. At the Electricity Showrooms, 18-24, Lower Clapton Road, E.5. Sale of members' spare apparatus.

WEDNESDAY, MARCH 25th.

Radio Society of Great Britain. At 6.15 p.m. At the Institution of Electrical Engineers, Savoy Place, W.C.2. Lecture by Mr. E. Megaw.

Building an All-Mains Set.

The construction of a simple two-valve all-mains set was the subject of a talk and demonstration by Mr. Bodemeid at a recent meeting of the Tottenham Wireless Society. The speaker first dealt with the construction of the A.C. battery eliminator, giving H.T. and L.T. output. He favoured a separate unit for power supply as the set could then be run from batteries in the event of no mains supply being available. Mr. Bodemeid made frequent reference to *The Wireless World* in connection with various points that arose, one being the method of tapping down on the grid tuning circuit coil to relieve the circuit of grid leak detector damping.

All communications regarding the Society should be addressed to the Hon. Secretary, Mr. W. B. Bodemeid, 29, Pendennis Road, Tottenham, N.17.

New Society in Gloucester.

Short-wave receivers constructed by members will be on view at the meeting this evening (Wednesday) of the newly formed Gloucester and District Radio Society, which was inaugurated on Wednesday, March 4th. Mr. J. W. Hamilton, the hon. secretary, will give a talk on 10-metre work. Later in the evening Mr. Gowing will demonstrate various pick-ups. Any interested amateurs in the Gloucester district are asked to communicate with the hon. secretary, Mr. J. W. Hamilton, Upper Parting, Sandhurst, Gloucester. To-night's meeting will be held at the Wessex Hotel, Gloucester, at 7.30 o'clock.

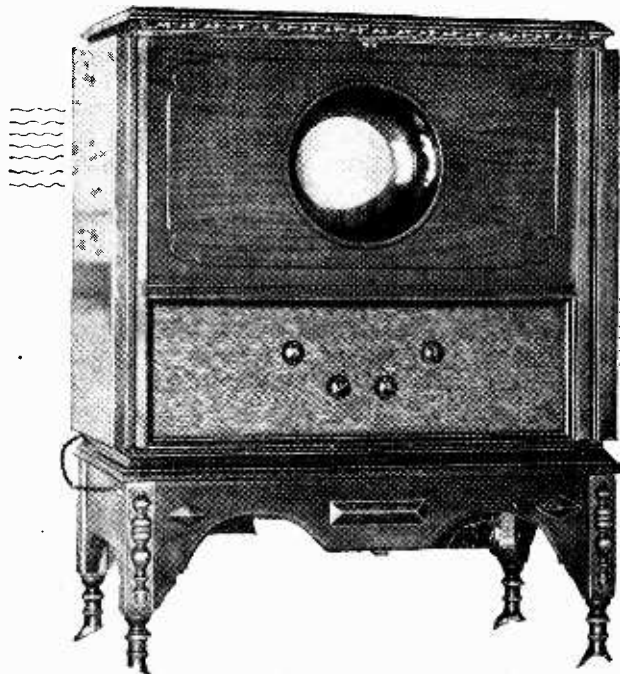

Television

by

Cathode Ray

The New Farnsworth System.

By A. DINSDALE.

It is now fairly generally realised that television, in the fullest sense of the meaning which has come to be attached to the word, is most unlikely ever to reach maturity by existing mechanical methods, and it is difficult to visualise any other form of mechanism which will enable the fullest expectations to be realised. The only alternative method so far developed which seems to hold promise of complete success involves the use of cathode rays which, being composed of weightless electrons moving at speeds rapidly being brought close to that of light, possess sufficient speed and inertia to conform to the enormously high scanning speeds necessary to the full realisation of television.

The latest investigator to employ cathode rays in his television researches is Philo T. Farnsworth, of San Francisco. From a study of the structure of the human eye and what it is able to see, Farnsworth set about his television investigations on the premise that 200,000 picture elements are adequate to give sufficiently pleasing detail to a picture measuring 4in. by 2 $\frac{3}{4}$ in., giving a three-quarter length view of three people. Scanning is achieved by a transverse process, there being two scanning frequencies, one a saw-tooth wave having a frequency of 12 cycles per second, and the other a similar wave having a frequency of 4,800 cycles per second. The highest fundamental picture frequency is 1,200 kc.

Farnsworth uses cathode ray tubes for both transmission and reception. The transmitting tube (called

the "image dissector tube") is of the cold cathode, high vacuum type, and has at one end a flat window which is polished before it is sealed in. At the same end, also, is the "target electrode," which is nothing more nor less than a small tubular photoelectric cell which has all but a very small portion of its active area shielded from the electron discharge. At the opposite end of the tube there is a stem upon which the electrodes of the tube are mounted and through which the high-tension leads pass. The inner end of the stem has mounted on it a short pillar which terminates in a square button, C. On this button is mounted a silvered mirror which is coated with a photo-sensitive film. A band clamp supported by the stem carries the anode structure, which is made by winding a very thin tungsten wire round a thin, flat frame of tungsten-nickel. The anode is so mounted that it is closely parallel to the cathode. The electrostatic shield S is formed by depositing a thin film of platinum on the inner walls of the tube.

Considered broadly, this tube is a form of photoelectric cell wherein provision is made for the formation of an "electron image" of an optical image focused on the cathode surface through the flat window opposite it. By "electron image" Farnsworth means that if a fluorescent screen were placed in the plane of the photoelectric cell (target electrode) the original optical image would be reproduced. For this to happen, it is essential that every electron emitted from any single point on the cathode surface

shall impinge on a corresponding point in the plane of the electron image. The difficulties in the way of securing a sharply focussed electron image have prevented earlier investigators from obtaining successful results from the cathode ray, because of the normal tendency of the rays to spread.

Magnetic focusing is accomplished by applying a

AS long ago as 1908 the late Mr. Campbell Swinton, F.R.S. suggested the use of controlled cathode ray beams as providing a solution to the problem of television. Cathode rays, he explained, consist of immaterial streams of negative electrons possessing extreme tenuity as compared with the limitations imposed by the adoption of a mechanical picture analyser.

In America the Farnsworth system represents a considerable advance in the use of cathode rays for television. Mr. Dinsdale, the author of this article, has given much attention to television development and here briefly describes the Farnsworth apparatus.

Television by Cathode Ray.—

magnetic field of the proper density in such a manner that the lines of force are parallel to the axis of the tube.

In operation an image of the object to be transmitted is focused through the window at the target end of the tube on to the cathode at the other end of the tube. Electrons are emitted from the cathode mirror (the surface of which is photosensitive) in proportion to the amount of light falling on it, and these electrons are accelerated by a potential of the order of 500 volts, which is applied between the cathode and the anode screen. Most of the electrons are projected into the equipotential region between the anode screen and the target, wherein they follow a helical path and recombine to form an electron image in the plane of the target. This electron image is then shifted by the two transverse magnetic fields, so that the entire image is caused to move over the aperture in the target shield, thus achieving scanning of the image in a zig-zag fashion.

Scanning Frequency.

The transverse scanning field is produced by two sets of coils which are mounted at right angles to one another on the outside of the tube, and outside the focusing coil winding, as shown in the accompanying illustration.

A saw-tooth wave alternating current of about 3,000 cycles flows through one set of coils and produces a horizontal deflection of the image. A 15-cycle current of similar wave form flows through the other set of coils and produces a vertical deflection of the image. Thus each individual square picture is scanned in 200 lines (3,000 divided by 15), 15 pictures are transmitted per second, and the amplifier which handles the output of the target or photoelectric cell must therefore be capable of dealing with a frequency band width of approximately 300 kc. ($\frac{200 \times 200 \times 15}{2} = 300,000$). The design and construction of an amplifier to handle such an enormous frequency band width is a difficult problem in itself, but Farnsworth claims to have solved it by making use of what he terms a system of "admittance neutralisation," which permits input impedances (as well as interstage impedances) of as high as several megohms to be obtained up to frequencies as high as one million cycles without distortion.

At the receiving end the incoming picture impulses are transformed into a visible image by means of a cathode ray tube which Farnsworth calls an "oscillite" and is of the hot cathode type. The oscillite is similar in some respects to the kinescope constructed some time ago by Dr. Zworykin, of the R.C.A.-Victor Company, but makes use of the magnetic coupling

principle, and scanning carried out by means of two sets of coils mounted at right angles to one another, just as in the dissector tube. The electron gun element has been designed with the object of driving the greatest possible number of electrons through an aperture of given size and limiting the angle of this beam so that it can be easily focused. This element consists of a helical filament, oxide-coated only on the inside. A shield is placed over this filament, having in it a hole

of the same diameter as the filament helix. The anode, which is tubular in form, is positioned in front of the cathode, and midway between the filament shield and the anode there is mounted a ring grid, R. The advantage of this type of element is that the anode tube is mounted approximately at the focal point of the electrons leaving the emitter or filament. The anode potential required to provide this focal point may be any voltage between 1,500 and 2,500 volts for tubes in use at the time of writing. The current consumed is negligible.

An interesting point which has been observed when using these tubes is that they function only when secondary electrons are emitted from the fluorescent screen. Sometimes a black spot will appear on the end of the tube, caused by that point

charging up negatively. This effect is due to the fact that unstable conditions exist at this point, which may assume a large positive or negative charge with respect to the anode. According to Farnsworth, the effect is not bothersome at all, for it is necessary to have a very high current density in order to observe it.

Synchronising.

In order to achieve synchronism, two alternating currents of saw-tooth wave form are generated at the receiver, identical with those at the transmitter. In order to do this, advantage is taken of the fact that these currents can be made to induce a strong voltage pulse into the picture frequency circuit during the steep part of their slope. These pulses are used at the receiving end to hold the local generators in step. The pulses, which are transmitted only during the interval between individual pictures, serve also to turn off the oscillite spot during the return part of its path. This system of achieving synchronism is claimed to be both

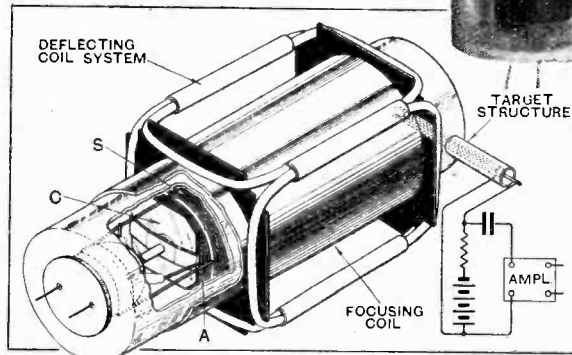
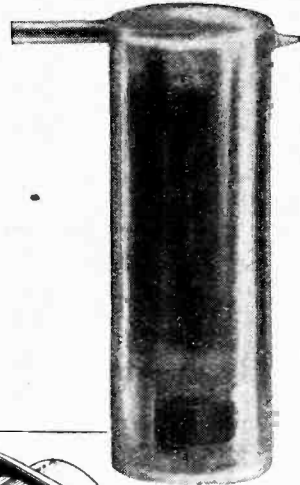

The Farnsworth transmitter tube combining the properties of a cathode ray tube and photoelectric cell. A system of coils is used for focusing the cathode ray beam and for producing the necessary traverse of the image.

Television by Cathode Ray.—

simple and effective. No additional communication channel is necessary to convey the synchronising impulses, nor is any additional equipment, such as filters, etc., required to separate the synchronising impulses from the picture frequency. The reason for using a saw-tooth wave form in preference to a pure sine wave for energising the deflector coils is that if a sine wave current were used a double picture would be produced at the receiver whenever the two currents were not in phase. At the receiver, each scanning frequency is generated by means of a helium glow discharge tube in combination with a small power valve used as an oscillator, and one stage of amplification. The glow tube has an electrode sealed into it which is coupled through a 10 mmfd. condenser to the picture frequency circuit. It is found in practice that the pulses present in this circuit lock the receiver oscillators tightly in step with those at the transmitter.

Considerable work has been done on the development of a 4-metre wireless link, and it is stated that the progress to date indicates that a quite satisfactory television service could be conducted on this wavelength over distances up to about 50 miles, providing proper care is taken in choosing the location of the transmitter. This involves so placing the transmitter that it will be almost visible from any part of the area which it is designed to serve, for only the ground or direct component of the wave can be relied upon to affect the receiver. More successful results are claimed by the use of "wired radio" as the channel of communication. It has been found perfectly feasible to modulate a 1,000 kc. carrier wave with a 300 kc. picture frequency and transmit it over a telephone line. The pictures so transmitted are said to be practically as good as those seen on a receiver placed close to the transmitter. A frequency band 300 kc. in width cannot, of course, be transmitted by an ordinary broadcasting station. Quite apart from the technical difficulties involved, broadcasting stations are confined to a channel only 9 kc. wide.

However, having thus very ingeniously developed a special amplifier for very high frequencies, and means for transmitting those frequencies both by wireless and by wire, Farnsworth has recently announced the invention of what he calls an "image compressor." Details of this have not yet been released, but the writer, in the course of a recent conversation with the inventor, understands that, by means of this new

development, part of the wide picture frequency band is suppressed before transmission, so that the width of the frequency band which must actually be handled by the amplifiers and transmitted is only about 7 kc. The operation is similar in character to the "compression" effected by single-sideband-carrier-eliminated transmission, though accomplished in a totally different manner. By applying the new transmission principle to speech current as well, Farnsworth hopes to be able to transmit television signals on one side band of existing broadcasting stations, and speech on the other, thus providing a complete sound and vision service through a single ordinary broadcasting station.

Performance and Cost.

As regards results, the writer has not yet had an opportunity of witnessing a demonstration, but independent and reliable witnesses report that the images are better than the seventy-two-line images produced by the Bell Telephone Laboratories' two-way television system, which are unquestionably the best images produced to date by mechanical means. Furthermore, Farnsworth states that his images, when transmitted and received by the "image compressor" method, are even better than when transmitted in the ordinary way by wire or by wireless. The present images are about four inches square, unmagnified.

It is hoped to market the Farnsworth apparatus before the end of this year, and it is estimated that a complete unit, comprising television and wireless receiver, will cost about £50. An adaptor, comprising oscillite, synchronising unit, and a two-valve L.F. amplifier, suitable for attachment to existing wireless sets, should sell for about £20. The average life of the oscillite is 1,000 hours, the cost of renewal £2 to £3, and the operating voltage, obtainable from a mains unit, 2,000 volts. In time, no doubt, the life of the oscillite will be extended and the cost of renewal reduced.

The inventor has not, of course, provided the complete solution of the television problem; that is still a long way off. But, in the humble opinion of the writer, he has probably gone farther, and on more solid ground, than any other investigator whose work has been made public to date, and his future activities merit the serious consideration of all who take more than a passing interest in the progress made towards the achievement of practical television.

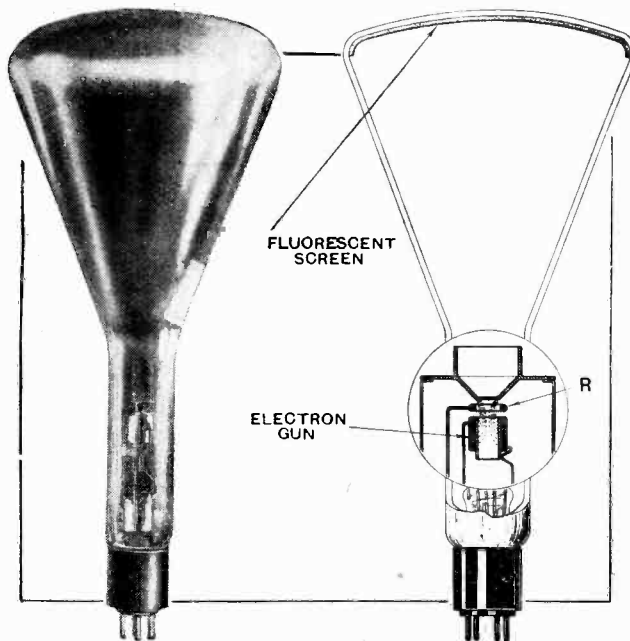

The Oscillite used at the receiver. The image is formed by the cathode ray traversing the fluorescent screen.

UNBIASED BY FREE GRID

Books that Baffle.

I WONDER when all reputable manufacturers will issue lucid instruction books readily understood by the lay mind. I happened to be in the radio section of a large departmental store the other day when a man came in with a rather wild and haunted look in his eye, and feebly fluttered a book before the assistant who hastened towards him, and commenced babbling somewhat incoherently. I knew his trouble immediately I saw the cover of it;



Readily understood by the lay mind.

the man who wrote it is evidently a skilled mathematician as in the book he goes very deeply into various mathematical considerations underlying the design of the receiver with which the book happened to deal. Sandwiched somewhere amid the various cabalistic signs which the book contains are the necessary instructions for twiddling the knobs, and our friend had evidently driven himself to the verge of a nervous breakdown trying to discover them. Other firms err on the other side and issue instruction books that appear to have been compiled by the office boy.

"Powerful" and "Sensitive."

I wonder how many people have noticed how the radio scribes of the lay Press persistently refer to a

"powerful" receiver when in reality they mean a sensitive one. They are constantly referring to the necessity of a powerful receiver to bring in this or that station. Usually, of course, a long-distance set, or, in other words, a sensitive set, is designed for loud speaker work, and has, therefore, a fairly powerful A.C. output. The terms "powerful" and "sensitive" are, however, by no means synonymous, since a receiver having a power output of several watts may be capable of receiving only the local station, as in the case of many of the hospital receivers; whereas, on the other hand, if the L.F. side of, say, a superheterodyne receiver is removed, its power output is reduced to a few miserable milliwatts, but its range-getting properties are not in the least altered.

A thing which is often mistaken for power is an unearthly din. The reverberations of a hard-pressed o-v-i receiver used in conjunction with an old horn loud speaker will, because of its very cacophony, produce the illusion of considerable power output.

Another Valve Coming?

The other day a friend who lives in one of the northern suburbs of London came to me with an appeal to settle an argument between himself and his local dealer. My friend stated that he had built a receiver with two modern S.G. stages, using tuned anode coupling. In order to improve selectivity he had determined to buy two new valves of high A.C. resistance, since he remembered reading in this journal long years ago that this procedure meant more selectivity. His dealer had, in the course of conversation, asked him why he wanted valves of such extremely high A.C. resistance. Upon my friend informing him of the facts, the dealer had stated that in view of his locality these valves would lessen, rather than increase, his selectivity, and it

was possible that he might be a little better off with valves of somewhat lower A.C. resistance. "Who," asked my friend, "is right, my dealer, or *The Wireless World*?" "Both," I replied, "but I should advise you to follow the dealer's advice, as he probably has a thorough knowledge of your local receiving conditions." It is true, of course, that the higher A.C. resistance makes for better selectivity, but if the signals coming in from the local station are sufficiently strong to cause overloading and cross-modulation, selectivity will actually be lessened. Probably the puzzle may eventually be solved by the development of a special type of valve, as already foreshadowed in this journal.

Cutting Out "Slowit."

A faithful hobby-horse which the scribes in the lay Press are fond of riding is the fearful selectivity which they imagine is necessary to cut out the local station and receive several foreigners without interference. I have noticed this tendency of late in the Northern Press, owing to the fact that the "Slowit" station is starting tests. Although, of course, this station is expected to have a much larger field strength

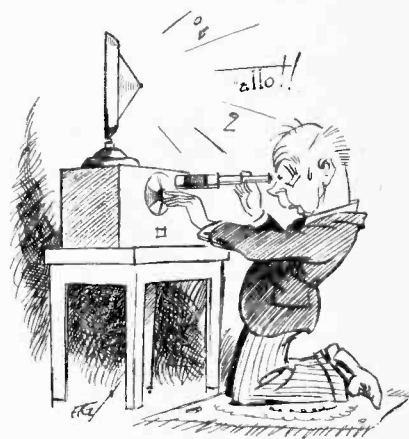

Fearful selectivity.

than Brookmans Park, owing to the fact that its aerial masts are two and a half times higher, nobody who is prepared to go to the trouble of using a separately tuned aerial circuit—band-pass for choice—need have the slightest qualms.

LES MISERABLES.

Radio Paris has been ordered to pay 25 francs damages (about 4s.) to the heirs of Victor Hugo for infringement of copy-right. The author died in 1885.

o o o o

NOW HE KNOWS.

"If it is desired to avoid liability as regards a licence, the high-frequency amplifying and the detecting devices should be removed from the set," runs a letter from the General Post Office to a Nottingham enquirer who had asked whether a wireless licence was necessary with a set used solely for gramophone reproduction.

o o o o

DOUBLE DUTCH.

The great Hilversum-Huizen mystery again crops up with the announcement that Hilversum will shortly increase its power. Does the news actually refer to Huizen? The problem revolves round the old Dutch custom of "swopping" the wavelengths of the two stations every three months. Hilversum is at present operating on 1,875 metres, and is announced as "Huizen," while Huizen, to avoid any confusion, is announced as "Hilversum," and operates on 298 metres. The next change-over occurs, appropriately enough, on April 1st.

o o o o

PRIZE FOR BEACON INVENTORS.

The famous Talking Beacon installed at the Cumbrae Lighthouse (Clyde) has won for its inventors, Messrs. Charles A. Stevenson and David Alan Stevenson, a prize of £100 offered by the Royal Society of Arts for "a valuable improvement in the science or practice of navigation proposed or invented during 1929 and 1930."

o o o o

WELL-DESERVED PUBLICITY.

Apparently the man who buys a wireless licence in India is assured of lasting fame. The Indian Radio Times "acknowledges with pleasure the receipt of Rs. 10 as a donation from W. G. A. Bourne, Esquire, of Jamnagar, Nawanganar State, towards his Licence Fee," and expresses the hope that other listeners will follow his example!

o o o o

LICENCES—BUT NO STATION.

Fiji Islands, in the Pacific, have no broadcasting station, yet listeners are mulcted in a sum of 10s. as an annual licence fee. They tune in New Zealand and Australian stations.

o o o o

BOMBS IN BROADCASTING STATION.

The Brussels police have released the secretary and the treasurer of a local political organisation which is accused of placing bombs in the transmission room of the Brussels broadcasting station as a protest against the expression of certain views at the microphone, writes a correspondent. The Belgian National Institute of Broadcasting, in a published declaration, refuses to be intimidated by threats of further "bomb treatment," and announces its determination to continue its political programmes on the same lines.

We are listening nightly to Brussels for sounds of "bomb treatment."



News of the Week in Brief Review.

TO SOLVE RADIO LAW PROBLEMS.

Wireless and flying have added so much to the work of lawyers that New York University has decided to found an American Academy of Air Law, "designed to promote academic interest in the new jurisprudence of aviation and radio."

o o o o

OVER THE BORDER.

Dr. John Brinkley, the Kansas "goat gland specialist," whose broadcasting licence was not renewed by the Federal Radio Commission when it expired in

February, has obtained a permit from the Mexican Government to erect a 50-kilowatt station at Monterey, just over the border, says our Washington correspondent. The U.S. authorities are apparently unable to prevent the goat gland specialist from spreading his doctrines over their territory.

o o o o

EASTER ALTERS "SMALL AD." DATES.

The demands of the Easter holidays make necessary some slight alterations in our printing arrangements. The latest dates on which small advertisements can be accepted for our issues of April 1st and 8th are respectively Wednesday, March 25th, and Tuesday, March 31st.

o o o o

CONFERENCE ON POLICE WIRELESS.

Mr. Clynes, the Home Secretary, stated in Parliament last week that no decision had been reached on the question of equipping the police with pocket wireless sets, but he added that the whole question of the development of wireless as an aid to police work was under review by a Conference on which the Home Office was represented.



O.B.s IN U.S. The "outside broadcasts" department of the American National Broadcasting Company uses many devices in its search for the unusual. The upper picture shows the knapsack short-wave transmitter used in tight corners such as aeroplanes and coal mines. The equipment includes a microphone which can be strapped to the head, giving the commentator the free use of both hands. The van in the lower photograph resembles the "O.B." van of the B.B.C. Note the balloon-supported aerial.

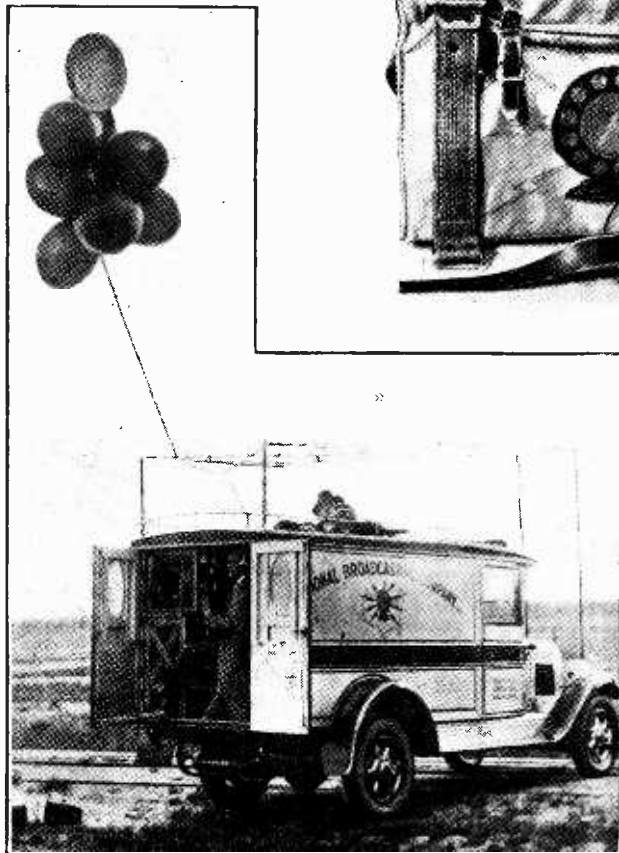

LUCKY HUNGARIANS.

The 200,000 listeners in Hungary pay only 2½ pengos for the annual wireless licence, writes a correspondent. A pengo is less than a shilling.

o o o o

OCEAN HAIR-CUTS TO WIRELESS.

The ship's barber on the new Wellington-San Francisco liner, *Monowai*, which replaced the ill-fated *Tahiti*, has a first-class American screen-grid A.C. broadcast receiver in his hair-dressing saloon on the vessel, writes a New Zealand reader. The barber obtains good loud speaker reception of American stations

when far out in the Pacific, and receives New Zealand stations for several hundreds of miles.

o o o o

NEW LINES FOR BROADCAST RELAYS IN U.S.

A new cable system for linking broadcasting stations to permit them to render musical notes more faithfully over a wider range of frequencies is being laid down by the American Telephone and Telegraph Co., writes our Washington correspondent. With a test circuit 2,200 miles in length already operating successfully between New York and Pittsburg, the

new system will be extended as rapidly as possible to embrace all of the 35,000 miles of telephone lines utilised to link radio stations into networks for programmes of common origin. Where the frequency range in present radio telephone lines is around 150-5,000 cycles, the new cable will widen this to 50-8,000 cycles.

Broadcast cable developments may also be expected in Great Britain in the near future. We understand that the Post Office is collaborating with the B.B.C. in the substitution of underground cables to replace all the overhead lines still used for broadcasting purposes.

SPECIAL RADIO-GRAMPHONE NUMBER.

NEXT WEEK'S ISSUE.

DO you want details for making a needle scratch filter, particulars of various circuit systems for pick-up volume control, data on the design of gramophone motors and pick-ups? Such information will be found among the special articles to be included in next week's issue. In addition, typical radio-gramophone equipments are to be described.

Complete constructional details of a gramophone amplifier of easy assembly are also included. This

any risk of the constructor encountering difficulties not readily traceable. High-grade components and valves have been chosen in the construction of this amplifier, bearing in mind the need to keep the price as reasonable as possible and that the acquisition of the parts will form the essential basis of any subsequent quality equipment.

LIST OF PARTS required for constructing "THE WIRELESS WORLD" ALL A.C. QUALITY AMPLIFIER.

- 4 Valve holders, 5-pin (Clitz).
- 3 Condensers, 2 mfd., 1,500-volt D.C. test (Hydra).
- 2 Condensers, 1 mfd., 1,500-volt D.C. test (Hydra).
- 3 Condensers, 4 mfd., 1,500-volt D.C. test (Hydra).
- 2 Condensers, 0.1 mfd. mica (T.C.C., Type 25A).
- 1 Smoothing choke (Rich and Bundy, Type E 101).
- 1 Output choke (Rich and Bundy, Type E 102).
- 1 Mains transformer, 500+500 volts, 100 mA., 4 volt 3 amps., 6 volt 2 amps., 7.5 volt 2.5 amp. (Rich and Bundy).
- 2 Grid leaks, 0.5 megohm (Loewe).
- 2 Porcelain grid leak holders (Bulgin).
- 1 Anode resistance, 20,000 ohms, and holder (Ferranti).
- 1 Anode resistance, 50,000 ohms, and holder (Ferranti).
- 2 Anode resistances, 10,000 ohms, and holders (Ferranti).
- 1 Resistance, 600 ohms, tapped at 200 ohms (Colvern).
- 1 Resistance, 1,500 ohms (Colvern).
- 1 Variable resistance, 50,000 ohms (Colvern).
- 2 Terminal mounts (Belling-Lee).
- 4 Board shrouded terminals (Belling-Lee, Type B).
- Wood, Wire, Sleeving, Screws, etc.

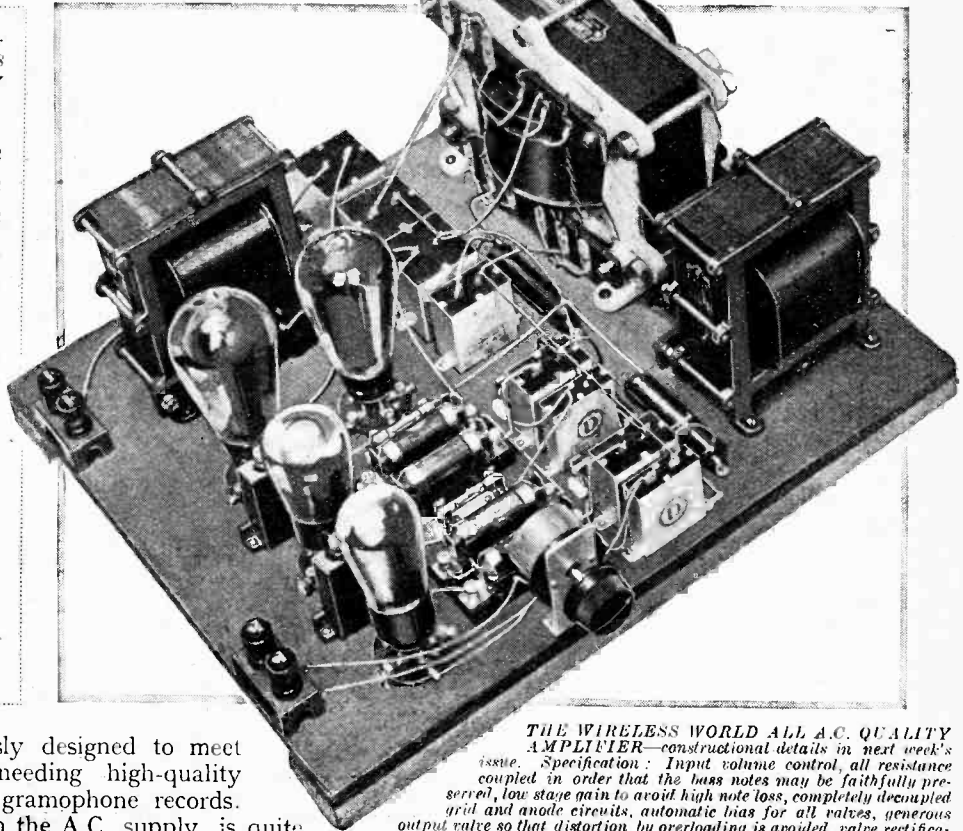

THE WIRELESS WORLD ALL A.C. QUALITY AMPLIFIER—constructional details in next week's issue. Specification: Input volume control, all resistance coupled in order that the bass notes may be faithfully preserved, low stage gain to avoid high note loss, completely decoupled grid and anode circuits, automatic bias for all valves, generous output valve so that distortion by overloading is avoided, valve rectification. This amplifier is entirely free from mains hum, in operation giving a power output up to 3½ watts and ideally suited for operating a moving coil loud speaker. By simple modification this amplifier may be used with a tuned circuit as a radio set for quality reception.

amplifier has been generously designed to meet the requirements of those needing high-quality reproduction when playing gramophone records. It is all-mains operated from the A.C. supply, is quite straightforward to construct, and can be relied upon to give the quality reproduction intended without

Screen Grid Superheterodyne

IF the merits of radio receivers are to be judged under the headings of quality, range, selectivity, ease of control and price, it will be readily agreed that the Majestic Superheterodyne would gain full marks on most points. From the viewpoint of the enthusiast who has a good standard of comparison and who knows what a modern long-range set should do, the performance of this forerunner of the single-dial superheterodyne class is something of a revelation. This observation is based upon the reception of more than forty stations with a single rotation of the dial, taking care not to count twice certain of the stations, which, owing to their considerable strength, came in at two positions when the volume control was at maximum. The forty stations are clear of one another and free of heterodyning, and they are tabulated in an adjoining table so that the dial readings may be entered on *The Wireless World* Station Identification Chart. Five American stations were heard at intelligible strength on a single occasion after midnight.

While the bass notes predominate, one cannot criticise the general quality of reproduction. It is admirably suited for speech reproduction in consequence of the good bass, but there is no booming, and, in fact, there is weakening as the bass frequency of 150 cycles is approached. At the top end of the scale the high-note cut-off is not approached until a frequency of 3,000 is passed, an observation of fundamental importance when considering the possibilities of good-quality reproduction and the failings of superheterodynes of old.

From the viewpoint of originality in design, the single-dial control is the outstanding feature. Some of the circuits are tuned to the incoming signal, while an oscillator, tuned by a condenser running on the common tuning shaft, follows a wavelength scale, representing, all the time, a uniform frequency displacement from the other circuits. This requirement of the single-dial superheterodyne might be achieved by the obvious method of ganging together straight-line frequency condensers, bringing their minimum up to a given value and

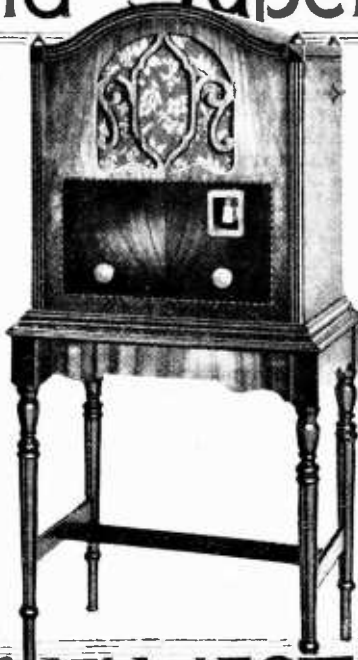

The MAJESTIC
MODEL 50

displacing the rotor controlling the oscillator. An unsatisfactory scale of station separation would result, however, and in the Majestic receiver we find that the tuning condensers are all similarly ganged and roughly follow the logarithmic law. A condenser is, however, connected in series with the ganged oscillator condenser so that the frequency of the circuit is displaced and the law of the tuning condenser modified. In addition, both the variable and fixed or "tracking" condensers are bridged by trimmers, which, in turn, cause the frequency scale of the oscillator to follow that of the other tuned circuits, but with a uniform frequency displacement.

Other unique details are to be noted in the circuit. We find a pre-H.F. volume control which is, incidentally, ganged with a control of bias applied to the first H.F. and detector valves. There is an aerial compensating condenser, and,

passing on, we find the important refinement of a pre-H.F. inductively coupled band-pass filter. Between the H.F. and first detector valve is an H.F. coupling embodying yet another new feature, having been designed to correct the sensitivity level so that the set gives uniform performance across the tuning range and as the inductance to capacity ratio of the tuned circuits is altered. Being a high-frequency amplifier, the first detector is a screen-grid valve. It is followed by a single intermediate-frequency stage working at constant frequency and in which selectivity and quality are maintained by the use of two inductively coupled band-pass units. While the amplification of correctly

designed band-pass couplings gives rise to loss of signal, the second detector, biased back for anode bend, is fully loaded. Some degree of automatic volume control results from the use of a detector anode resistance of 25,000 ohms, while the bias resistance, being connected in the cathode lead, causes the biasing voltage to run back more and more

negative as the current representing the signal increases.

As the fully loaded anode-bend detector delivers considerable signal we find its output split across a pair of generous power valves connected in push-pull. An

SPECIFICATION.

*Majestic Super heterodyne model 50. A.C. mains operated.
Inductively coupled aerial band pass filter.*

Uniform sensitivity compensation.

Single stage H.F. amplifier at signal frequency.

Inductively coupled band pass filters as I.F. coupling.

Intermediate frequency 175kc. (1,700 metres approx).

S.G. valves in radio frequency circuits, triode oscillator and second detector. Push-pull output. Valve rectification.

Illuminated single dial control calibrated in kilocycles.

Tuning covers single-wave range only. Price, £29 8s. complete.

Majestic Electric Co. Ltd., Majestic Works, Tottenham, London, N.17.

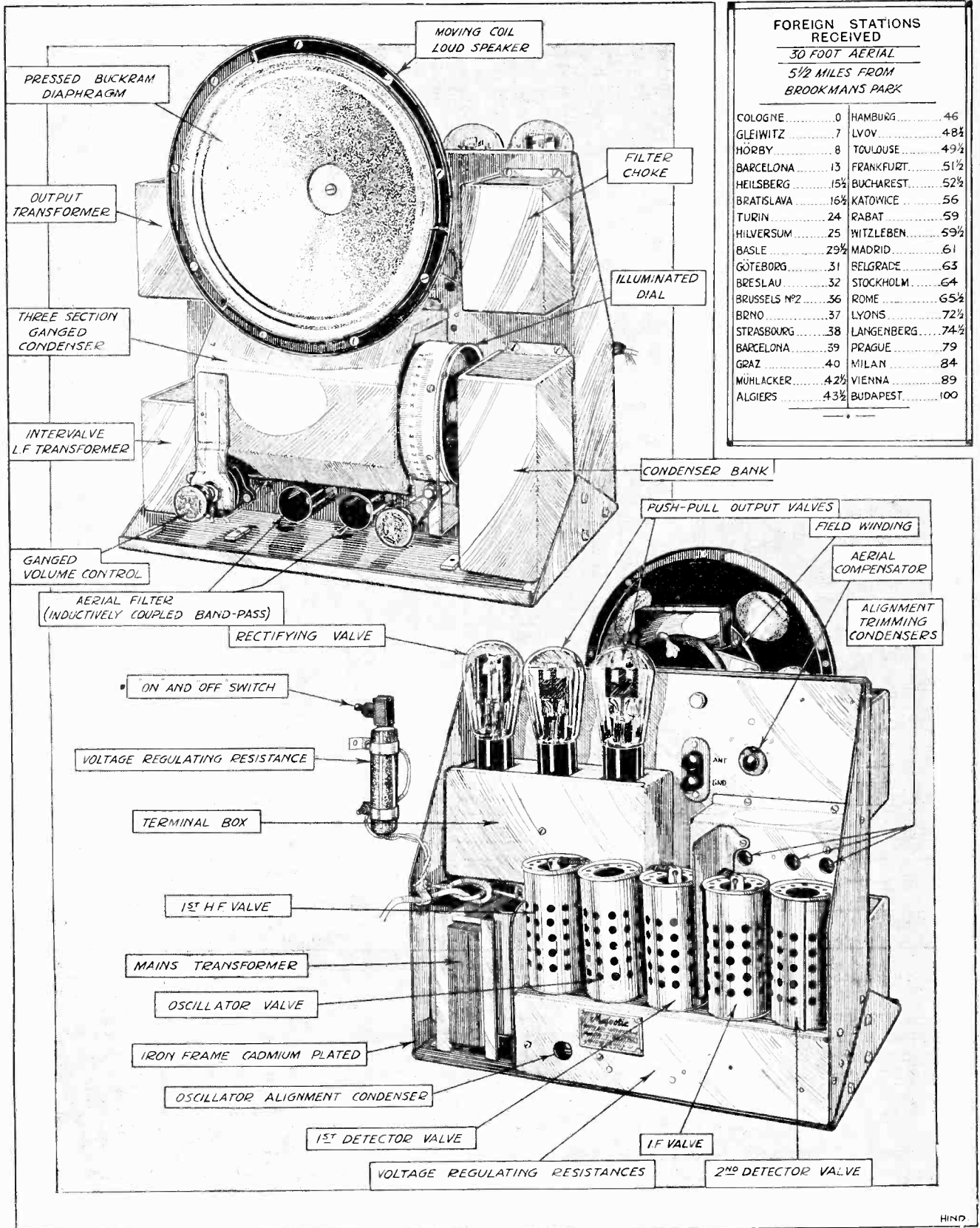

FOREIGN STATIONS RECEIVED
 30 FOOT AERIAL
 5 1/2 MILES FROM BROOKMANS PARK

COLOGNE	0	HAMBURG	46
GLEIWITZ	7	LVOV	48 1/2
HÖRBY	8	TOULOUSE	49 1/2
BARCELONA	13	FRANKFURT	51 1/2
HEILSBURG	15 1/2	BUCHAREST	52 1/2
BRATISLAVA	16 1/2	KATOWICE	56
TURIN	24	RABAT	59
HILVERSUM	25	WITZLEBEN	59 1/2
BASLE	29 1/2	MADRID	61
GÖTEBORG	31	BELGRADE	63
BRESLAU	32	STOCKHOLM	64
BRUSSELS Nº2	36	ROME	65 1/2
BRNO	37	LYONS	72 1/2
STRASBOURG	38	LANGENBERG	74 1/2
BARCELONA	39	PRAGUE	79
GRAZ	40	MILAN	84
MÜHLACKER	42 1/2	VIENNA	89
ALGIERS	43 1/2	BUDAPEST	100

MAJESTIC SUPERHETERODYNE. Tuning positions on the single dial control are given for the reception of the principal foreign stations.

BROADCAST BREVITIES

By Our Special Correspondent

Joy in the North.—Jack Payne's Cough.—Another Welsh Deputation.—Visitors from Abroad.—No Snow Drops.—Announcers in Trouble.

Cries in the Night.

Northern listeners who have waited so long and anxiously for the natal cries from Moorside Edge will be comforted by the doctors' report that all is well. I understand that the first midnight outburst convinced hearers in all directions that the infant lungs are functioning extremely well on a comparatively low-power output. "Magnificent" is the term that appears in many of the reports already received at Savoy Hill.

o o o o

Extravagant Praise.

There are two reasons, to my mind, why the preliminary praise is likely to be extravagant. In the first place, northern listeners are relieved to find, after all these weary months of waiting, that there actually is a transmitter on that bleak hillside and not (as seemed possible) merely the apparatus for a grand practical joke by the B.B.C. on April 1st.

o o o o

Pardonable Joy.

Secondly, northern listeners have been badly served in the past, many of them having to be satisfied with Daventry 5XX. With a real regional station at their elbow for the first time, it would be passing strange if there were not some who showed signs of hysteria, dour northerners though they be.

o o o o

The Fading-in Process.

Some impatience has been expressed by the more knowledgeable of listeners in the north on the question of "fading-in" the station by the gradual process. On this point I think the B.B.C. are right in following the Brookmans Park precedent. Listeners in the South were glad to have six weeks in which to adapt their sets to the new conditions, despite the fact that only one wavelength change was involved. In the North listeners must familiarise themselves with two entirely new wavelengths.

A 27

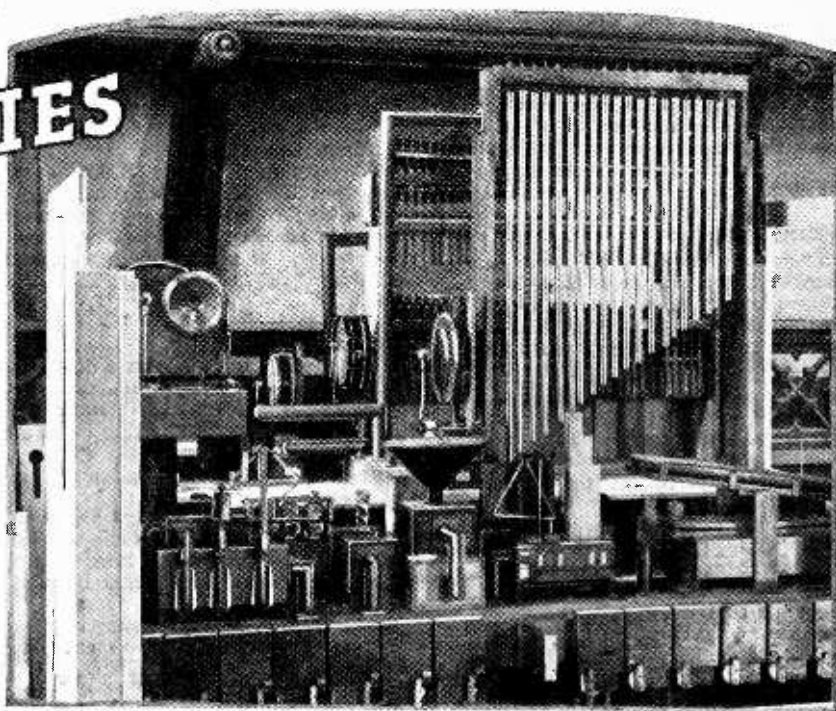

A portion of the specially constructed organ in the New Berlin "Funkhaus," showing the many devices for the provision of "noises off."

More Selective Sets.

One point in favour of the northern listener is that since the opening of Brookmans Park the average standard of selectivity of receivers has risen considerably.

Judging from the preliminary noises from Moorside Edge, I imagine the standard will have to rise still further.

o o o o

A Tale of a Cough.

A new horror attaches to broadcasting. Jack Payne coughed in the studio the other day and the report at once flew

from mouth to mouth: "Jack's got consumption!"

Although baseless, the rumour was so persistent that Mr. Payne's family doctor actually phoned to ascertain the truth and to advise his illustrious patient to undergo an examination.

o o o o

The Real Truth.

Many musicians, of course, have been deceived into thinking that male singers in modern dance bands suffer from a form of lingering consumption. This is quite understandable. Only a musician who is also a wireless expert would guess that dance band vocalists adopt the falsetto tone out of consideration for the frailties of our loud speakers.

o o o o

Diagnosis by Broadcast.

Frankly, however, there is something to be scared about in the way the microphone can communicate physical symptoms. Perhaps we have not always made enough allowance for these unpleasant manifestations. Who knows but what some of the "man-made static" of the past has had a literally human origin, viz., the chattering jaw of a nervous broadcaster?

Listening to voices at the microphone, the skilled physician could probably diagnose over a wide range of complaints, from chronic catarrh to simple indigestion.

o o o o

More Wails from Wales.

Yet another Welsh deputation is raising its banner in the forlorn hope of persuad-

FUTURE FEATURES.

National (261 and 1,554 metres).

MARCH 25TH.—B.B.C. Symphony Concert, relayed from the Queen's Hall.

MARCH 26TH.—Railway Clearing House Choir Concert, relayed from the Kingsway Hall.

MARCH 27TH.—"Precession," a Caricature by K. B. Indoe.

MARCH 28TH.—"World for Sale," a revue

London Regional.

MARCH 22ND.—Sunday Orchestral concert—20.

MARCH 26TH.—Royal Philharmonic Concert, relayed from the Queen's Hall.

MARCH 27TH.—"World for Sale."

MARCH 28TH.—"Precession."

Midland Regional.

MARCH 26TH.—"Come, Pipe a Song," choral programme.

MARCH 27TH.—"The Test," a play in one scene, by H. Simons and K. J. Thomas.

MARCH 28TH.—"Running commentary on Rugby League Cup Semi-Final."

MARCH 29TH.—"Running commentary on Rugby League Cup Semi-Final."

MARCH 30TH.—"Running commentary on Rugby League Cup Semi-Final."

MARCH 31ST.—"Running commentary on Rugby League Cup Semi-Final."

MARCH 31ST.—"Running commentary on Rugby League Cup Semi-Final."

MARCH 31ST.—"Running commentary on Rugby League Cup Semi-Final."

MARCH 31ST.—"Running commentary on Rugby League Cup Semi-Final."

MARCH 31ST.—"Running commentary on Rugby League Cup Semi-Final."

MARCH 31ST.—"Running commentary on Rugby League Cup Semi-Final."

MARCH 31ST.—"Running commentary on Rugby League Cup Semi-Final."

MARCH 31ST.—"Running commentary on Rugby League Cup Semi-Final."

MARCH 31ST.—"Running commentary on Rugby League Cup Semi-Final."

MARCH 31ST.—"Running commentary on Rugby League Cup Semi-Final."

MARCH 31ST.—"Running commentary on Rugby League Cup Semi-Final."

MARCH 31ST.—"Running commentary on Rugby League Cup Semi-Final."

MARCH 31ST.—"Running commentary on Rugby League Cup Semi-Final."

ing the B.B.C. to provide an all-Welsh broadcasting station. Because I warmly sympathise with the Welsh, I advise the deputation to save their train fare to London. As the B.B.C. explained in their recent pamphlet, the number of broadcasting licences held in Wales is far below that required to justify the allocation of a transmitter exclusively to the Welsh people. ○○○○

Fewer Deputations.

There have recently been fewer deputations at Savoy Hill than in earlier days of broadcasting when nobody knew quite how far they could trust the new Corporation to consider everyone's likes and dislikes. ○○○○

Sure of a Hearing.

Only on the rarest occasions does Sir John Reith himself interview these earnest little parties. Usually matters are settled very amicably by Mr. Gladstone Murray or some other high official. At any rate, all who have a "grouse" are depend upon a fair hearing. ○○○○

Foreign Visitors.

There is still a fairly constant stream of visitors from other countries who are glad to have an opportunity of comparing

Quick Lessons.

From what I can gather, it is considered that the B.B.C. officials learn all they need to about foreign broadcasting at the meetings of the Union Internationale de Radiodiffusion. ○○○○

No Snow Drops.

Congratulations to the B.B.C. on the fact that last week's snowstorms caused not a single mishap at any station—not even at Daventry, where one or other of the aerials usually crumpled up in the old days if the snow was more than $\frac{1}{8}$ inch thick. ○○○○

Announcers in Trouble.

Last week I quoted from a New York correspondent's letter in which he sympathised with the unfortunate American announcer—"often a cultured gentleman"—who has to waste his talents in advertising cough drops and toothpaste.

Now another correspondent writes in a different strain enclosing a clipping from *The New Yorker*, which pitches into the poor blamed announcer rather heavily. ○○○○

When They Were Very Young.

"We have met radio announcers before," remarks the writer. "The sound of their voices touches a familiar

THE CHILDREN'S HOUR.

Uncle Walter: Good-evening, children.

Helen is first on the programme to-night. She is going to begin by reading some poems; if you like them, and I'm quite sure you will, you should write to the B.B.C. for the book from which they come, entitled "Angela Arkwright's Awful Adventure," price 2s. 6d. Now, Helen, are you ready?

Helen: Hullo, children. Do you know that Uncle Walter is quite right? You'll just love these little poems. I wish I had time to read them all, but I'm afraid you'll be able to hear only a few to-night, but you can read them all for yourselves if you write to the B.B.C. for "Angela Arkwright's Awful Adventure," price 2s. 6d. Now let me see. Which shall I read first, "Three in the Forest" or "Apples on the Apple-tree"? Oh, I know, "Angela's Surprise."

"Angela stared at the—"

Uncle Walter: Time's up, Helen—I'm sorry Helen didn't have time to read all the poems to-night, but Maria is going to speak to you now; her talk is called "The News of the Day Told in Little Words for Little Children."

Maria: Good-evening, children. I expect all you little listeners-in have seen your daddies and mummies read the newspapers, and have asked what they are reading about; the answer generally given is: "Nothing that would interest you," and they are quite right. Mummy and daddy always are right, aren't they? Because there is so much in the newspapers nowadays that I'm sure you would not like to know even if you could understand it, and so I am going to tell you each day the most interesting news in a way that will help you to understand what is going on in this big, beautiful world. Have you ever heard Mummy and Daddy speak in a displeased sort of way about "Raising the School-age"? I expect you have; anyway, what it means is—

Uncle Walter: Thank you very much, Maria. Now, Helen, will you read the birthdays?

Helen: Happy birthdays to all birthday children, especially Dorothy Boxen, of Birmingham; Michael Stoner, of Ringwood; Irene Corling, of Southampton and John Corling, of Southampton. Hullo, twins! Katherine Wolff, of Winchester; Gavin Howard, of Liverpool; Gordon Christopher, of Hampstead.

Uncle Walter: That's all the birthdays for to-night; and, as it's one minute to six, before we say Good-night I have just one correction to make. "Angela Arkwright's Awful Adventure" is priced 2s. 6d., or 2s. 8d. post free. Well, good-night, children. M. W.

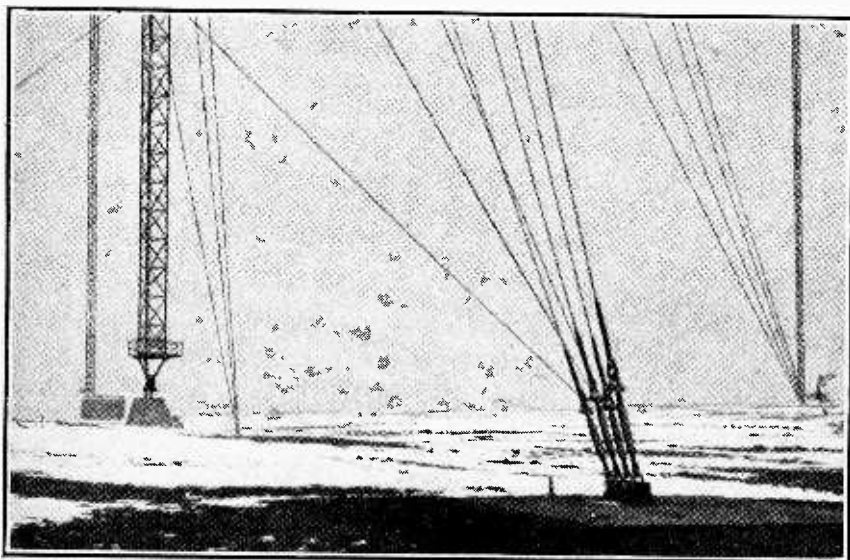

A PROBLEM PICTURE. This is not a view on the Russian Steppes. It gives us a glimpse of Moorside Edge as it appeared last week. Northern Regional is now testing daily outside programme hours on 479.2 metres.

British broadcasting methods with their own. Recent parties have included Germans, Japanese, Hungarians, Frenchmen and Swedes, while even the Near East has been represented in the persons of visitors from Mesopotamia. ○○○○

The B.B.C. Stays at Home.

Americans, too, have shown a laudable curiosity, and the interesting fact emerges that the only people who do not systematically examine the broadcasting machinery of other nations are the B.B.C.!

chord in memory. We knew what chord it is, too; radio announcers are the little boys of 20 years ago who used to delight their grammar-school teachers by reading "with expression." ○○○○

Cruel to be Kind?

"They are still doing it, still raising their voices on the last word of the sentence in the ecstasy of putting their personalities over with teacher. We could have knocked their little blocks off in those days. We still can, damn it. Give us that rock!"

Modern Terms Defined

Some Properties of Screen-grid and Indirectly Heated Valves.

(Continued from page 257 of previous issue.)

Secondary Emission: When a rapidly moving stream of electrons impinges on a metal surface in a vacuum fresh electrons are dislodged from the surface of the metal, in some cases as many as twenty fresh electrons being released by each bombarding electron.

The effect of secondary emission is most marked in screen-grid H.F. valves when the operating conditions are such that the anode voltage is

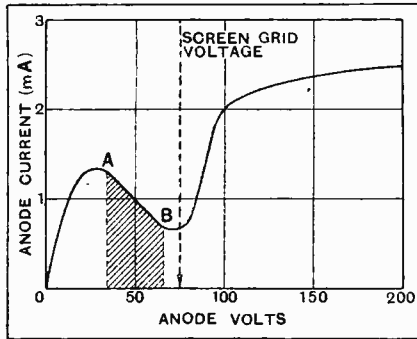

Typical screen-grid valve characteristic showing region of negative resistance caused by secondary emission.

of the same order as the screen-grid voltage. Under these conditions the electrons released from the anode under bombardment from the electron stream from the filament are drawn to the screen-grid, and as they exceed in number those absorbed by the anode from filament the total anode current is reduced. Thus in the region AB of the anode-volts/anode-current characteristic, where the anode voltage is equal to or a little less than the screen-grid voltage, the anode current decreases as the anode voltage is increased. Between A and B the valve is said to have "negative resistance" and would maintain oscillations in any associated tuned circuit without deliberate coupling between the grid and anode circuits. Under working conditions this region of the characteristic is avoided by keeping the anode always at a higher potential than the screen-grid.

Grid Emission:¹ An effect which takes place in some types of indirectly heated A.C. valves due to an excessive filament voltage. The abnormal heat radiated from the filament raises the temperature of the grid to a point at which it commences to emit electrons.

Contact Potential: It was discovered by Volta that when two dissimilar metals are placed in contact and then separated a potential difference is established between them. Since the advent of the thermionic valve it has been discovered that the same effect takes place *in vacuo* even though the metals may not be in actual contact. The original term "contact potential," or "contact E.M.F.," is, however, still used to describe the phenomenon, which is closely related to the evaporation constant of the metal, i.e., the work done by an electron in escaping from the surface of the metal.

In practice, it is the contact potential which influences the point at which grid current starts in a valve. The use of different metals and alloys for grid and filament by valve manufacturers accounts for the fact that grid current starts in some cases with a negative bias and in others with a zero or positive bias.

Residual Capacity: The term usually applied to the minute inter-

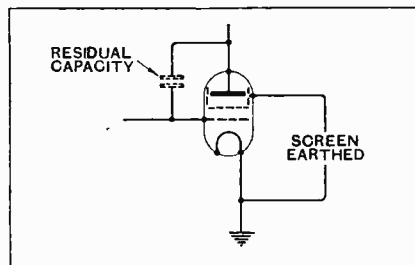

Residual capacity between the working-grid anode of a screen-grid valve.

¹ See *The Wireless World*, February 25th, 1931, page 209.

electrode capacity remaining between the anode and working grid of a screen-grid four-electrode valve. In three-electrode valves the anode-grid capacity was of the order of 5 micro-microfarads, and was a serious cause of instability in H.F. amplifiers. The function of the screen-grid is to prevent the establishment of direct capacity coupling between grid and anode. To make the screening complete would be to detract materially from the efficiency of the valve as an amplifier, and the designer is forced to legislate for a small residual capacity of the order of 0.005 micro-microfarad. The balance between the efficiency of the valve as an amplifier and the residual capacity is adjusted to give the highest possible amplification per stage *with stability*. For a full discussion of this aspect of screen-grid valve design the reader is referred to the December 4th, 1929, issue of this journal.

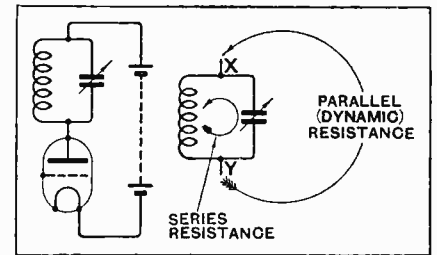

The dynamic resistance of a circuit is its parallel resistance between X and Y at resonance.

Dynamic Resistance: The effective resistance which a tuned circuit offers to radio-frequency currents when connected, say, in the anode circuit of a valve is called its dynamic resistance. At resonance the circuit acts as a pure resistance and, in spite of the fact that the direct-current resistance of the coil may be only 1 or 2 ohms, may offer a resistance of as much as 150,000 ohms to H.F. currents of the frequency to which it is tuned. Dynamic resistance is another term for parallel resistance, i.e., the resistance of the circuit at resonance when measured between the points X and Y in the diagram, and should not be confused with the series resistance of the circuit. At resonance the series resistance is at minimum, while the parallel or dynamic resistance is at maximum.

(To be continued.)



No. 4.—The Purpose of Every Component.

By A. L. M. SOWERBY, M.Sc.

WE have now given careful consideration to the most satisfactory method of coupling two screen-grid valves in an H.F. amplifier and to the mechanism of grid rectification. So far as the circuit diagram is concerned, V_3 might be either an "ordinary" grid rectifier or a modern "power" grid rectifier. The difference between the two lies chiefly in the strength of the signal applied to the valve. If the signal voltage is small then the valve operates entirely in the neighbourhood of the curved part of its rectification characteristic (Fig. 1). Rectification is therefore accompanied by a certain amount of distortion, though it is not always noticeable unless the loud speaker is at least better than the average. If the signal supplied to the detector is large, so great a part of the characteristic is used that the curved portion becomes negligible, and rectification is completely distortionless for all save very deeply modulated signals. If the loud speaker is a really faithful reproducer (as such instruments go) the improvement due to the bigger input is very evident. It is therefore intended that V_3 shall represent a power detector.

A detector is no exception to the general rule that when a big input is supplied a big output may be expected; care has therefore to be taken that the valve is of a type that will handle a fairly large output, and it must be given an anode voltage adequate to prevent overloading. This means that V_3 must be a valve of fairly low impedance (not much over 10,000 ohms), which in turn implies that with about 120 volts actually on its plate the anode current will be some 6 to 10 milliamps. This current is too large to put through

the primary of most transformers; if a transformer is used it must therefore be shunt-fed, as in the circuit of our set. There must either be a resistance or a choke to carry the anode current, and as a 30,000-ohm resistance will drop from 180 to 300 volts at the anode current we require, a choke will have to be used unless at least 300 volts is available from the eliminator. As we are assuming that this delivers only 200 volts a choke L_9 is used in our particular case.

After this "bird's-eye view" of the anode circuit of the detector as a whole we can go into details without losing sight of the main plan.

The condenser C_{13} , connected between anode and filament of the detector, acts as a low-impedance path for the high-frequency component of the anode current. If this condenser is omitted, or disconnected, the set will show the most remarkable versatility in misbehaviour. In the absence of reaction into the grid circuit of the detector, the omission of C_{13} will lead to a very heavy loss in signal strength, for the high-frequency choke offers a very high impedance to high-frequency currents. As a result V_3 will become a very effective aperiodic high-frequency amplifier, damping down its grid circuit by reverse reaction through the anode grid

capacity of the valve. This effect is enormously large, the tuned circuit L_1C_1 behaving as though it had been shunted by a resistance of perhaps 5,000 ohms—which, from the point of view of a tuned circuit, is only one stage removed from being directly shorted.

A further result of disconnecting C_{13} would be that the high-frequency currents, having no easy path to

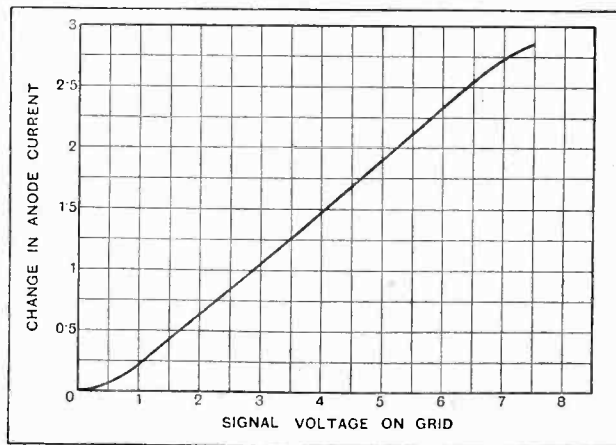

Fig. 1.—Typical rectification curve of power grid detector. With a small input the curved foot of the characteristic is an appreciable part of the whole. With too low an anode voltage the curve bends over sooner than shown here so that overloading readily occurs.

From Aerial to Loud Speaker.—

earth, would leak through into the choke L_9 , the transformer L_{10} , the output valve, and the loud speaker leads. Some or all of these would radiate back to the aerial lead-in, so that the set would tend to oscillate. In addition, large high-frequency voltages on the anode of V_3 would cause that valve to "choke" when called upon to rectify any but a very quiet signal—an expressive term, since the distortion introduced suggests that the announcer is being slowly throttled.

The dire results following upon the omission of C_{13} suggest that, for safety's sake, we had better put in the biggest condenser we can find. In a valve voltmeter, where no low-frequency output is required, this is the proper course to pursue; in a receiver it would have the unfortunate effect of by-passing at least the higher audio-frequencies as well as the unwanted H.F. currents. A compromise has to be made; with a valve of about 10,000 ohms A.C. resistance 0.001 to 0.002 mfd. is found to have a negligible effect on the high notes while satisfactorily by-passing the high-frequency currents for which, when once rectified signals have been produced, we have no further use. The exact value to be chosen depends to some extent on the loud speaker and other factors, and is often best settled by ear.

The development of a short-circuit in C_{13} is an unpleasant topic, best not dwelt upon; the H.T. supply, R_6 , L_9 , and L_8 , will all suffer, while, apart

two are deliberately intended to amplify at high frequency, and do so with high efficiency, while the detector, even if unintentionally, also contributes something in this direction. It is therefore necessary to take considerable care that none of the highly amplified signals escape from the

second screening-box; for if they do they are no longer shut off from the aerial lead-in, and can cause serious instability by feeding back into it. We therefore insert this choke and extra condenser to filter out high-frequency currents from the anode circuit of

the detector before bringing it out of the screening-box to L_9 .

Anode Circuit of the Detector.

It is necessary to ensure that L_8 has an inductance high enough to choke back the longest wavelengths with which the set will have to deal, and as low a self-capacity as possible; 150,000 microhenrys, and not more than 5 micro-microfarads, will be adequate here. A short-circuited choke, by permitting the high-frequency currents to escape from the box, will often cause instability, and a choke of too low an inductance may have the same effect. If it is open-circuited, the anode circuit of the detector will be interrupted, and no signals will be heard.

The condenser C_{14} may be unnecessary in many cases; whether it is needed depends rather upon the wiring of the actual set, and so can hardly be predicted

THE preceding three instalments of this series have brought us as far as the detector valve in the course of a detailed survey of a typical modern four-valve set. In this article the anode circuit of the detector is treated at some length and the conflicting requirements of rectification efficiency, high-note loss and feed-back are explained in simple terms.

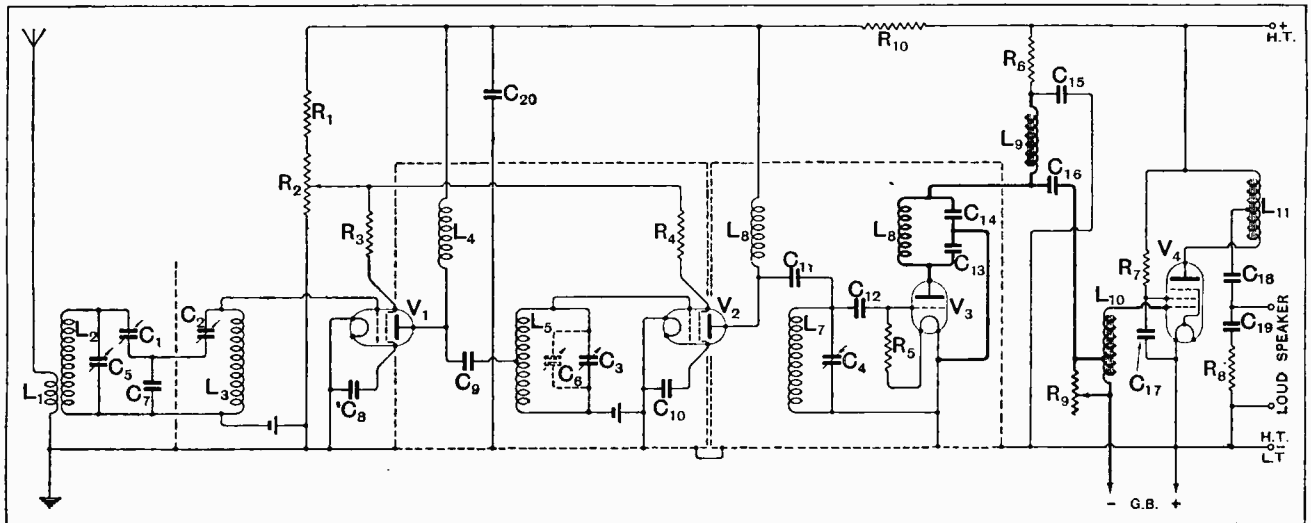

The typical four-valve circuit which is taken as the basis of discussion. The components examined in this instalment are shown in thick lines.

from the death-agonies of these components, the set will become dumb.

Leaving C_{13} , the next components in order are the high-frequency choke L_8 and the condenser C_{14} . These, in the circuit shown, are really part of the screening. Between the choke and the aerial there are three valves;

from a theoretical circuit-diagram. If the wire from L_8 runs straight from the terminal through a hole in the screen, C_{14} may usually be left out without detriment; if the wire has to go several inches before finding a convenient exit there may be instability, or some tendency towards it, if C_{14} is not included. In such

From Aerial to Loud Speaker.—

a case C_{14} should be joined to the wire where it leaves the box rather than to the terminal of the choke. A capacity of 0.0005 mfd. will almost always suffice; if it does not, L_8 should be suspected, or the other terminal of C_{14} should be connected to the screen close to the hole through which the wire L_8 — L_9 passes instead of to the filament of V_3 , especially if the latter connection would mean a long lead. Values of C_{14} higher than that quoted are to be avoided as being likely to lead to a loss of high notes; lower values, if found to be adequate for their purpose in any individual set, should be adopted in preference.

From what has been said it will be clear that a disconnection of C_{14} may make no difference at all; a short-circuit in this component will be almost as disastrous as the same fault in C_{13} , except that L_8 will no longer be in the path of the resulting flow of current.

Emerging now into the open, we encounter L_9 . This is an iron-core choke, the function of which is to block the passage of the low-frequency signals and to divert them through the feed-condenser C_{16} and the primary of the transformer L_{10} . Its duties are exactly analogous to those of L_4 and L_6 in the high-frequency couplings, and to that of L_{11} in the output stage. L_9 has to offer as high an impedance as possible to currents of all audible frequencies, and at the same time has to carry the steady anode current of V_3 , which, as we have seen, is moderately high. Taken together, these two requirements mean that the choke will need a big iron core with plenty of wire wound round it. In a "quality" set, driving a moving-coil loud speaker, an inductance of some 200 henrys, effective when the anode current is flowing, will be desirable, though something a little smaller may be used in a less exacting case.

Parallel-fed L.F. Amplifier.

The impedance offered by any choke is less for low notes than for high, so that the governing factor in the choice of a choke is the standard of low-note reproduction required. If the inductance is too low, the bass notes of music will not be fully reproduced; if, on the other hand, it is made very much higher than necessary, it is probable that the additional stray capacity across the windings will tend towards a loss of high notes.

If L_9 is short-circuited, the impedance it offers to currents of audible frequencies will no longer be present, and signals will vanish entirely. If, on the other hand, it should become disconnected, the same result

will follow owing to breaking the anode circuit of the detector.

The discussion of R_6 and C_{15} will be postponed; like R_1 , R_2 , and R_{10} , these are part of the anode-current supply system, and concern the signals only indirectly.

The feed-condenser C_{16} is the next component in the direct route of the signals; like C_9 and C_{11} , it is inserted to block off the high-tension voltage from the grid circuit of the succeeding valve, while allowing the signal to pass. We are now no longer dealing with high-frequency currents, so that capacities as small as those used in the pre-detector stages will not be adequate. If the primary of the step-up transformer or auto-transformer L_{10} has an inductance of 120 henrys, it will offer an impedance of 38,000 ohms at 50 cycles. The impedance of the condenser should be small compared with this, in order that nearly all the signal voltage should be dropped across the transformer primary and as little as possible across C_{16} .

If this is to have an impedance of 3,800 ohms at 50 cycles (one-tenth of that of the primary), a

capacity of 0.83 mfd. will be needed; we therefore choose 1 mfd. as the nearest standard size.

In that the transformer primary and the condenser, taken together, form a low-frequency tuned circuit, there is more in the choice of value for the latter than has been discussed. With the values given, the frequency of resonance is below audibility, but it is sometimes useful to shift the peak into the useful range by juggling with the capacity of C_{16} ¹.

Except for the movement of this peak, the choice of a much smaller capacity for C_{16} will have no effect other than that of restricting the reproduction of low notes. The choice of a larger value, up to 10 mfd. or even more, will have no audible effect at all, unless, by increasing the amplification at absurdly low frequencies, it allows an otherwise well-behaved set to start "motor-boating."

If the feed-condenser should become disconnected there will be no path for the signals from detector to output valve; while if it should become shorted it will unleash the fury of the H.T. supply, which will vent itself on L_9 and the primary of the transformer.

The choice of a transformer to fulfil the duties of L_{10} is not a very difficult matter nowadays—unless it be because there are so many good ones on the market. The ratio, by which alone transformers were once chosen, is of small importance; attention should rather

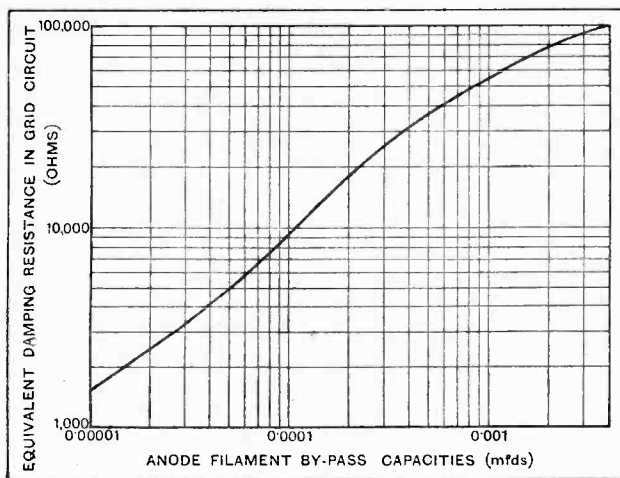

Fig. 2.—Approximate curve showing the order of damping-resistance introduced into the grid circuit of a power detector with different values of anode-filament by-pass condenser. The disconnection of this condenser is shown to result in practically short-circuiting the grid circuit of the valve.

¹ Aughtie and Cope. "The Parallel-fed L.F. Amplifier," *The Wireless World*, December 11th, 1929, p. 644

From Aerial to Loud Speaker.—

be fixed on the inductance of the primary. If this is too low, the deeper notes will not be fully amplified; apart from questions of self-capacity, there is no such thing as too high an inductance. With a valve of about 10,000 ohms A.C. resistance in the detector position the transformer primary should have an inductance not less than 100 henrys. Allowing for the shunting effect of L_9 , which is virtually in parallel with it, the impedance in the anode circuit of V_3 will then be about 21,000 ohms at 50 cycles, which is just about enough for first-class reproduction with a good moving-coil speaker. At 50 cycles the amplification will be two-thirds of that at the middle frequencies; this drop is only just audible, even when rapid comparison is made with another amplifier of true "straight-line" characteristics.

L.F. Transformer Ratio.

The higher the ratio of the transformer the greater the amplification it will provide; though not needed when the detector is fully loaded up on a powerful station, the extra gain of a high-ratio transformer may be useful when listening to a station at some distance. Many comparatively cheap transformers of low ratio have a 100-henry primary;² a high-ratio transformer with this primary inductance is a more expensive component, costing some twenty shillings at least.

A disconnection in the transformer will usually result in the cessation of signals, though there may be a quiet, high-pitched residuum due to currents through stray capacity paths. A more serious result of a breakdown of the winding will be the disconnection of the grid-bias

² This is only true when, as in the present circuit, the primary does not have to carry any steady current.

battery from the grid of the output valve, enabling that valve to draw an anode current great enough to overrun it considerably. In such a case the premature demise of that valve is not at all unlikely.

Volume Control.

If the transformer primary is short-circuited completely, the signals delivered by V_3 will run straight to earth without setting up any voltage in the grid-circuit of V_1 , so that the set will be silent. Advantage is taken of this fact to provide a volume control in the form of the variable resistance R_9 , by which the transformer primary can be progressively short-circuited at will. The maximum value of R_9 should be about 20,000 ohms, and it should, for preference, have an "off" position so that it can be open-circuited completely when full volume is required. The choice of too high a resistance here will make it necessary to turn the knob very far round before any noticeable decrease in volume occurs, so that the whole of the useful control will be compressed into a very few degrees of rotation. Too low a resistance, on the other hand, will give a very considerable drop in volume the moment the rotating arm makes contact with the resistance element; alternatively, if no "off" position is provided, it will cause a marked loss in strength even when turned to maximum.

For the sake of obtaining even control of volume, the resistance chosen should be, if possible, of the "tapered" or "logarithmic" type.

If R_9 is short-circuited by any accident there will, naturally, be no signals, since this is equivalent to setting the control at zero; if it is disconnected, maximum volume will always be had, irrespective of the position of the knob. The next instalment of this series will deal with the output stage.

The South London and District Radio Transmitters' Society.

At an enthusiastic and well-attended meeting of amateur transmitters recently convened in South London it was unanimously decided that a society should be formed to further the aims and interests of radio amateurs generally, and those resident in or near London especially.

It is hoped to enlist the support of every interested amateur, whether he be a member of the R.S.G.B. or otherwise, and thus consolidate the initial success of the movement.

All preliminaries have been arranged, and a confirmatory meeting will be held at 7.45 p.m. on Thursday, April 9th, at the Greyhound Hotel, Kirkdale, Sydenham, S.E.

Full particulars as to times and place of future meetings may be obtained from the Hon. Secretary at 25, The Gardens, East Dulwich, S.E.22, or from the Assistant Secretary (*pro tem.*), Mr. Arthur H. Bird (G6AQ), at 35, Bellwood Road, Waverley Park, Nunhead, S.E.15.

French Amateurs.

The Réseau des Emetteurs Français has recently been somewhat divided over the question of their official organ, but

Transmitters' Notes.

at the general meeting, held early in February, the differences of opinion were amicably settled, and our esteemed contemporary, the *Journal des 8*, gracefully relinquished its claim and left the field clear for *Radio R.E.F.* as the official chronicler of the doings of French transmitters, though we trust that our old and valued contemporary will still carry on its good work as a means of communication between European amateurs. The forwarding agency for QSL cards and other correspondence has been moved to the offices of *R.E.F.*, 19, rue Claude-Vellefaux, Paris X, in place of Boulogne, Billancourt, as hitherto.

International Amateur Radio Union.

In our issue of March 4th we stated that amateurs in Portugal had joined the International Amateur Radio Union, and it is probable that by the time these notes appear the Amateur Radio Club of

Finland will also be affiliated. The I.A.R.U. now comprises nineteen wireless societies, viz., the American Radio Relay League; the Canadian Section, A.R.R.L.; the Radio Society of Great Britain; Asociacion E.A.R., Spain; Associazione Radiotecnica Italiana; Deutsche Amateur-sende und Empfangsdienst, Germany; Experimenterende Danske Radioamatörer, Denmark; Lwowski Klub Krotkofalowcow, Poland; Nederlandsche Vereening voor Internationaal Radio-amateurisme, Holland; New Zealand Association of Radio Transmitters; Norwegian Radio Relay League; Rede dos Emissores Portugueses; Réseau Belge; Réseau des Emetteurs Français; South African Radio Relay League; Sveriges Sandareamatörer, Sweden; Union Schweiz Kurzwellen Amateure, Switzerland; Wireless Institute of Australia; and the Wireless Society of Ireland.

A.R.R.L. New Offices.

The headquarters of the American Radio Relay League, and of the International Amateur Radio Union, have been moved to 38, La Salle Road, West Hartford, Conn., U.S.A., together with the editorial offices of their official organ, *Q.S.T.*

Wireless World
Laboratory Tests

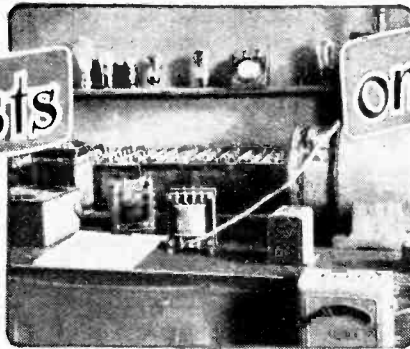

on New Apparatus

original model. Previous examination had shown that the air gaps in the core had opened during transit; consequently, before test, these were closed up. Possibly an extra tap with a hammer would

LIMIT PICK-UP AND TONE ARM.
The outstanding feature of this pick-up is the provision of an external adjustment for centring the armature. The adjustment is quite light in operation, and the correct setting can be obtained under playing conditions without forcing the needle out of the record groove. Rubber damping pads are fitted on both sides of the upper extremity of the armature, and

Components Reviewed.

The workmanship and finish are of a high order, the pole pieces being accurately machined from the solid. The tone arm is spring-loaded and set at an angle for correct needle track alignment. It is necessary, however, to cut a $\frac{5}{16}$ in. hole in the baseboard to accommodate the tone-arm bearing.

The price of the complete pick-up and tone arm is 32s. 6d., and of the pick-up alone 21s. The makers are Limit Radio, Ltd., Albion Street, London, N.1.

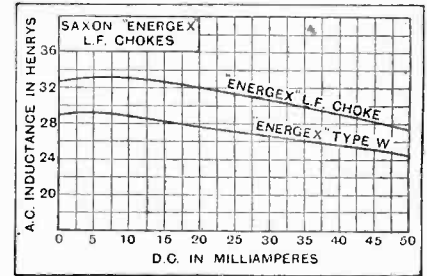

Curves connecting inductance with D.C. for Saxon L.F. chokes, types "W" and "Energex."

have raised the inductance to the correct level. The production samples will not exhibit this defect.

The "Energex" L.F. model shows a higher level of inductance throughout, due, we believe, to an increase in the number of turns. Finer gauge wire is used, as the space occupied is considerably less and the measured D.C. resistance is 497 ohms, while that of the type "W" is 210 ohms only. Thus, if 50 mA. flows in each, the "Energex" L.F. choke will absorb about 30 volts, while that dropped across the type "W" will amount to 10.5 volts.

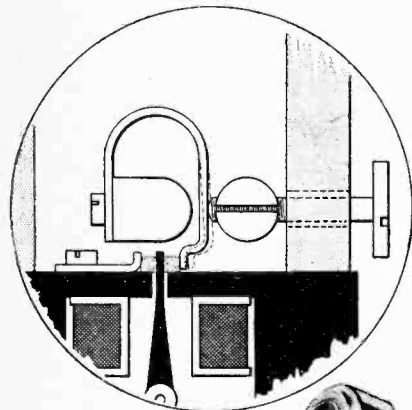

The Limit pick-up and tone arm and, above, the armature adjustment.

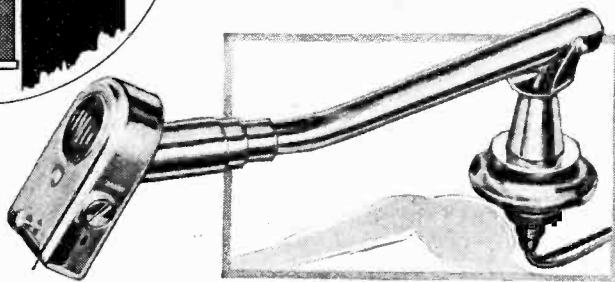

SAXON L.F. CHOKES.

By the time this report is published the Saxon Radio Co., Henry Street, Blackpool, will have in production two L.F. chokes, the one officially known as the "Energex Type W" and the other the "Energex" L.F. choke. The type "W" is constructed to the design for a 30-henry choke published in *The Wireless World* of January 28th last, and is priced at 22s. 6d., while the other is a modified version of this design, and the price is 19s. 6d.

The samples sent in for test are early models, and we understand that sundry modifications are to be incorporated in the production samples. These apply only to the external finish.

Inductance measurements were made at 50 cycles with various selected values of D.C. up to 50 mA. flowing and with an A.C. voltage of 10.5 applied to the two ends of the choke. The A.C. current passing through the winding was of the order of 1 mA. Curves were then prepared connecting inductance with D.C., as these show at a glance the behaviour of the component under the influence of polarising currents.

The overall inductance of the type "W" is slightly lower than that of the

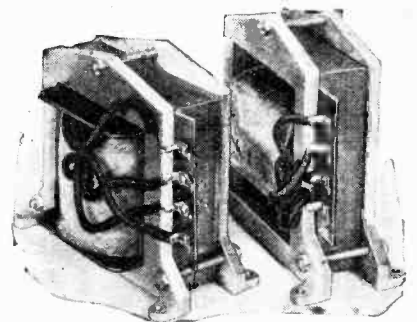

Saxon "Energex" and type "W" L.F. chokes, the latter constructed to *Wireless World* design.

SIEMENS SUPER RADIO H.T. BATTERY.

This is the largest capacity battery listed in the Full O' Power range of dry-cell H.T. batteries made by Siemens Bros. It is officially known as the Size V.6, has a nominal voltage of 50, and weighs 15 lb. Intermediate tapings are provided, giving 16½ and 33 volts and stout spring-clip terminals, after the style of the American pattern, are fitted in

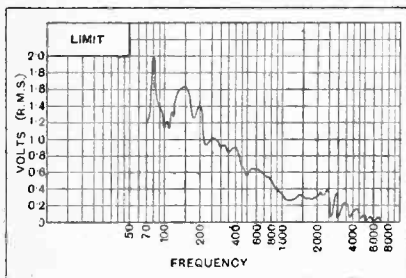

Frequency characteristic of the Limit pick-up with optimum armature setting and H.M.V. half-tone needle.

place of the conventional plug sockets. Although this particular battery is primarily intended for heavy discharge work, it will provide a very economical source of H.T. for receivers whose demands would appear to be met by batteries of much lower capacity. But as the most useful information is that concerning the life of the battery when subjected to heavy discharge, we decided to commence our test at 25 mA.

Discharge was, of course, intermittent, periods of four hours being allowed between each four-hour spells of work. In the graph showing the behaviour of the battery only the actual working hours are included.

Starting with a current of 25 mA., the terminal voltage was 56. In common with all dry-cell batteries, this fell rapidly in the very early stages, but after some forty hours began to settle down

when the voltage has fallen to 0.9 volt. The useful life of the battery, assuming an initial discharge of 25 mA.s is 360 hours, which in the case under dis-

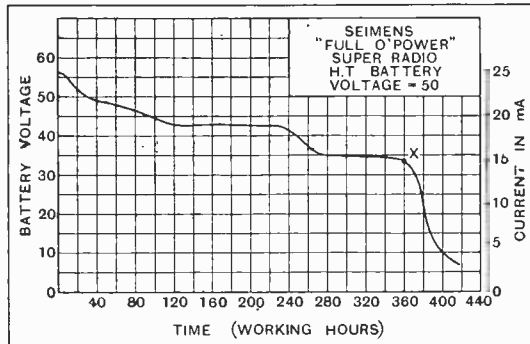

Discharge curve of Siemens Super Radio H.T. battery. Note the well-defined cut-off point marked with an X.

cussion affords some 6,700 milliampere-hours' capacity. Even to the very end of its life the battery voltage is maintained at the exceedingly satisfactory value of 34 volts.

The makers are Siemens Bros. and Co., Ltd., Woolwich, London, S.E.18, and the price is 25s.

BELLING-LEE S.G. ANODE CONNECTOR.

The purpose of this small insulated connector is to protect the H.T. lead to the anode of a screen-grid valve where it passes through the hole cut in the top of the tubular container now generally used to enclose these valves.

It consists of two main parts—a socket portion provided with a tapped hole so that it can be screwed on to the anode terminal in place of the insulated head, and an insulated plug part to which is attached the flex lead.

The price of these connectors is 6d. each, and the makers are Belling and Lee, Ltd., Queensway Works, Ponders End, Middlesex.



Siemens Super Radio H.T. battery for heavy discharge duty.

to a more gentle decline, which continued up to the 120th hour. Then followed a period of 110 hours during which the voltage was maintained at a constant value of 42.5, the current flowing being 18.5 mA.s. Here a rather sharp decline set in, and during the following forty hours the voltage fell to 35, at which value it was maintained for a further eighty hours. During the next ten hours there was a slight fall, and then followed an exceedingly rapid decline, which continued until the battery was practically exhausted.

The well-defined cut-off, shown at the point marked by an X on the curve, actually coincides with a fall in the voltage of each cell to 0.9 volt. This is a calculated value, since it was obviously not practicable to measure each cell individually. It is interesting to recall that most authorities on dry batteries assume the life of a cell of this type to terminate

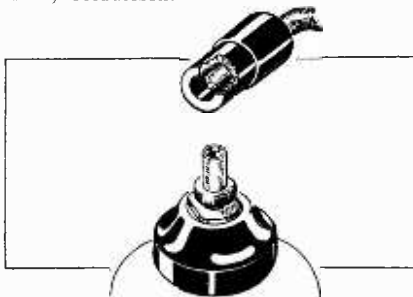

Belling-Lee insulated anode connector for screen-grid valves.

SCIENTIFIC EXPONENTIAL HORN.

To obtain a satisfactory response over the essential part of the audible range, using an exponential horn type loud speaker, the length of the air column in the horn should measure between 5ft. and 8ft.; furthermore, the area of the mouth must necessarily be considerable. These two features, and, in particular, the latter, go to make a rather bulky structure,

which cannot always be camouflaged adequately.

With a view to remedying this, the Scientific Supply Stores, 126, Newington Causeway, London, S.E.1, have produced two new horns styled the "Organ" model, and each has an effective length of 8ft. The calculated "cut-off" frequency is approximately 78 cycles, but frequencies as low as 50 cycles are claimed to be reproduced sufficiently well to give really good reproduction.

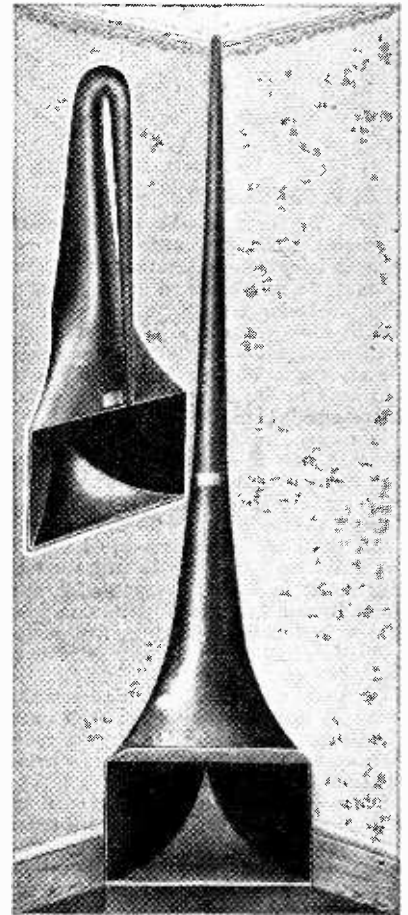

New "Organ" model exponential horns by the Scientific Supply Stores, intended for corner mounting.

These horns have been designed to fit into a corner of the room, with the flare or mouth, close to the floor. Mounted in this manner the two side walls and the floor actually form an extension of the horn, having the effect of increasing the area of the mouth, which in the horn itself is not of the correct size for one having a cut-off frequency of the order mentioned above. Only by mounting the horns in this manner will the acoustic qualities claimed by the designers be attained.

The "Organ" model is made in two styles, one a straight pattern standing 8ft. high, and the other a folded model measuring 54in. high. The prices are 37s. 6d. and 39s. 6d. respectively.

CORRESPONDENCE



The Editor does not hold himself responsible for the opinions of his correspondents.

Correspondence should be addressed to the Editor, "The Wireless World," Dorset House, Tudor Street, E.C.4, and must be accompanied by the writer's name and address.

ETHER CONGESTION.

Sir,—Any listener who tunes his receiver night after night through the medium waveband (200 to 550 metres) will probably allow it to be no exaggeration to say that European broadcasting has now definitely broken down. It is exceptional, if not impossible, to find a transmission free from heterodyne interference, and in many cases interference is of so violent and complicated a character as to be described only as appalling. It is clear, therefore, that any new allocation and separation of wavelengths will have to introduce changes of a very drastic kind if a real improvement is to be effected.

It may be reasonably suggested that when negotiations preliminary to a new distribution are entered into the B.B.C. will find themselves in a position of weakness. Great Britain is the only country to undertake an alternative-programme service through the medium of dual-wavelength high-power transmitters. Continental representatives are likely, therefore, to insist that the scarcity of wavelengths will allow the provision of only one programme in any one transmission area, and, further, that as Great Britain finds five distribution points adequate for the purpose of a double programme, five exclusive wavelengths should suffice to enable her to give a satisfactory service on a common single-programme basis.

Countries, moreover, who desire multiple transmission on low power as the better suited to their peculiar geographical conditions, may be expected to urge a reduction in the number of wavelengths assigned to countries where high-power transmission has been found practicable.

There is the further point that it may be found necessary, with a view to securing adequate separation, to allot to high-power stations a wider space in the waveband than the present standard of nine kilocycles. Allocation may have to be made, therefore, on a basis, not of wavelengths, but of waveband space occupied.

In the circumstances it may be doubted whether the B.B.C. can justify the erection of the Scottish and Western Regional stations, except as single-wave transmitters, until a satisfactory and final agreement as to wavelength distribution has been reached. If Great Britain is to establish a claim to the exclusive wavelengths at present allowed her, the two remaining dual-wave transmitters now planned may have to be abandoned in favour of four single-wave stations using only moderate power.

Newcastle-on-Tyne.

K. M. C.

MUSIC CONTROL.

Sir,—As a regular reader of your very interesting paper, I also find good reading in your section, "Broadcast Brevities," and the paragraphs entitled "Are Northerners Patient," in your issue of February 25th, specially appealed to me.

The B.B.C. may continually try to do their best, but I should like to know why they must always soften a good transmission when the music gets too loud for their delicate ears.

I listen pretty regularly to Queen's Hall concerts, and was especially interested to hear "Music of Machines" on February 25th, 1931, at about 9.10 p.m. This piece is naturally very loud and should be received that way, so I wonder why the B.B.C.

control room should spoil this interesting work entirely. Here in The Hague the music was absolutely rotten, and sounded as if it was being squeezed through a mouldy saxophone.

Why must the B.B.C. "put the brake" on anything lively? Don't they know that radio sets are drowned in volume controls, reaction condensers, and high-tension regulators?

Why must they also put the brake on the applause? If the public applaud heartily, then the piece must have been good and must have sounded just as good to a listener, who is then surely not hurt by hearing applause he would give if listening to that particular concert.

Like your Manchester man, I generally listen to some other foreign station which does not hide its light under a bushel.

The Hague, Holland.

JACK FRITZ.

LOUD SPEAKER MAGNETS.

Sir,—In your issue, November 26th, 1930, Dr. McLachlan gave a well-considered article on loud speaker magnets. He showed that the flux density in the air gap is of no value as a guide to the output. The criterion he developed was the product of gap area and square of mean flux density ($A \times B_g^2$). It would be of great help to those of us who use loud speakers if manufacturers would specify Dr. McLachlan's criterion, $A \times B_g^2$, together with the particulars of A and B_g .

London.

DISCRIMINATOR.

NORTH REGIONAL DELAYS.

Sir,—The very apt comments of your broadcasting correspondent on the "This year—next year—sometime—never" atmosphere which surrounds the Moorside Edge transmitter, and his suggestion that we Northerners are strangely placid and patient in face of the prolonged delays, prompts me to assure you that many listeners, in this part of the world at all events, have chafed under the postponements and the stupid silence of the B.B.C.

Does not the B.B.C. carry its ideas of caution and margins of safety to extremes? Judging by the way high-power stations spring up on the Continent, one cannot help feeling that lethargy is being allowed to dog the process of providing listeners with alternative programmes.

According to B.B.C. standards of service areas, this part of Yorkshire is tied down to the National programme from 5XX, and I may say that, so far as quality reception goes, this is so in practice, since all other English stations fade out.

A fact which is, apparently, overlooked is that we have had to maintain multi-valve sets since the most expensive days of wireless. Four valves were probably standard when most listeners used crystal sets, of which there were, and are, none here. Small wonder, then, that we are irritated to the point where we entertain no polite thoughts regarding the B.B.C., and, always having had to make efforts in connection with our wireless, cannot understand a prolonged "sliding-in" process to enable listeners to accommodate their receivers to the new conditions.

Scarborough.

G. F. HYDE.

Sir,—In your Broadcast Brevities on page 183 of the February 18th issue of *The Wireless World*, you say that we Northerners are showing very little signs of impatience at the delay in the opening of the Northern Regional Station.

What can be done? How can we be vocal? I have been writing to the B.B.C. till I am sick and tired of the whole job, and we can only sit and wait until the B.B.C. condescend to let us have some squawks from their mighty aerial.

The B.B.C. treat us like a lot of little children who should

pay and not be heard, and who have to be told only what is good for them.

I have been on the site scores of times, but have not yet seen any trace of an aerial, though I believe they had a wire up once, and took it down again until the weather gets a bit warmer (or so the watchman told me).

Everybody up here talks Pole Moor, thinks Pole Moor, and, I daresay, dreams Pole Moor, and the retailers say the uncertainty is killing trade. Of course, there is always something killing trade. It used to be an expression in conversation, "When Pole Moor starts . . ."; now it becomes, "If Pole Moor ever starts . . ."

Seriously, though, the B.B.C. are not playing the game with the Northern listener. Not that this is anything fresh. They are the rottenest sports who ever existed, and we feel nothing but contempt for them up in this part of the country. Everything is done for the South, and what is left is for the North, if there is anything left.

LOUIS J. WOOD, Hon. Sec.,
The Halifax Wireless Club.

RADIO SOCIETIES.

Sir,—Mr. Baggs' letter on this subject in your issue of February 11th was most interesting.

I rather think that the societies would not be especially eager to welcome the dealers as such. However, Mr. Baggs' point is that the dealer shall be the bait for the manufacturer. Here, then, is the dealer's worth proved, for it is obvious enough that the manufacturer can give the amateur an immense amount of knowledge. At present most manufacturers do so; but how much more would they to their best customers, the dealers?

On the other hand, I may be narrow-minded enough to fear that the amateur will lose his individuality under the scheme. He will miss his "heart-to-heart" talks with the manufacturer at society meetings, affected as they are by the commercial aspect, due to the presence of the dealer.

The amateur, however, must inevitably realise that something has got to be done to create bigger membership of radio societies, so why not, after all, invite the radio dealer to join him, secure in the thought that his presence must induce the manufacturer to air his views on a scale never possible before?

E. L. CUMBERS (Hon. Sec.),
South Croydon and District Radio Society.

Sir,—I fully agree with Mr. Baggs' letter in your February 11th issue, and fail to understand why, when we have written many well-known manufacturers asking them for demonstrations and lectures at our club rooms, they cannot see their way clear to do so. Out of two dozen invited only two were willing to give lectures. Surely, if the trade thinks anything of its sales, wireless societies and clubs should interest them greatly.

The above club has a membership of 450 (one of the largest, I think, in this country), and we can always depend on 70 to 100 members attending any lecture.

J. R. BOOTE,
Vice-Chairman, Bristol Listeners' Club.

Sir,—The question of Society members who are also radio traders has been discussed from time to time amongst members of this Society during the past eight or ten years. The general feeling—and it is also my own view—appears to be that, while members of the trade are always welcome, a considerable membership from such a source would be undesirable for the following reasons:—

First, when new apparatus is described or demonstrated, it is desired to hear absolutely unbiased comments and criticisms (as far as such a thing is possible), these more particularly from the point of view of the user and the amateur enthusiast. The presence of dealers tends to deter the expression of these views.

The second and perhaps the most important reason is that the radio trader has an axe to grind. He has his living to get, and, naturally, views the apparatus rather from the sales point of view than from the technical interest side. He wants to know what are its attractions for his customers and how much he can make out of it. The niceties of design and soundness of theory are of no interest to him from any other point of view, even if he is able to appreciate them.

Thirdly, I gather that the radio trader frequently considers it

rather beneath his dignity to belong to an amateur radio society. One sometimes suspects that there are other and quite different reasons! In any case, attendance of a dealer at a radio society meeting in any other capacity than that of a man looking for business is something of a busman's holiday.

From these remarks it is apparent that the objects of an amateur society and a trader are quite different, and if the latter wants a society for trade demonstrations, there is nothing to prevent him from forming one among his fellow dealers. But if you try to form one from the present type of society you will kill it for the amateur, and, more than likely, it will fall between two stools.

I should like to add that the technical staffs of the manufacturing firms are of a different class altogether, and some of them form the valued backbone of many a society. They are nearly all keen men, willing to help anybody, and, above all, modest.

E. H. LAISTER,
Hon. Sec., North Middlesex Radio Society.
Winchmore Hill, N.21.

IS THE B.B.C. A PUBLIC SERVICE?

Sir,—I am in complete agreement with Mr. C. W. Oliver's exemplary article of the 4th inst.

It is surely a deplorable thing that such a large body of people (as the listening public must be to-day) should be content to listen to some of the efforts broadcast from the Studio as entertainment, specially with regard to Sunday programmes, which can hardly be called representative of the listening public's tastes.

It would be interesting to consider the financial position of the B.B.C. if its revenue depended on the number of Sunday listeners to B.B.C. programmes.

Surely through the medium of a popular and authoritative wireless journal, such as *The Wireless World*, a scheme could be devised to cater for the needs of the listening public.

Bulford, Wilts.
P. FORD.

Sir,—I feel Mr. Oliver's letter in your issue of March 4th needs some comment, as surely his attitude towards the B.B.C. is a little unreasonable.

He complains that too much money is devoted to engineering progress and too little to the betterment of programmes, and asserts that he personally has not benefited by the introduction of the Regional Scheme, and that, in fact, he is worse off, as sometimes the same programme is sent out twice in one week.

Now, I think Mr. Oliver's attitude towards listening is all wrong. Surely technical excellence of transmission itself adds tremendously to programme values, and no one can say that a Queen's Hall broadcast concert of to-day is not 100 per cent. better than it was three years ago, although the actual concert room performance be identical. For myself, I should be only too glad to hear that the B.B.C. was going to spend more money modernising 5XX. As to Mr. Oliver's vision of a number of provincial replicas of Broadcasting House, I think it is unlikely to be substantiated, as I fear everything points to centralisation.

With regard to Mr. Oliver's last point, the fact that some outstanding broadcasts, such as radio plays or revues, are sometimes repeated in the same week should be welcomed by listeners. How often have we been glad to hear a play on its second broadcast because we have unavoidably missed the first? And how the programmes director would have to rack his brain to provide fourteen separate and varied programmes each week!

Warwicks.
N.C. BAKER.

CARS HAVE SILENCERS—WHY NOT ELECTRICAL APPARATUS?

Sir,—With reference to your Editorial entitled "Avoidable Interference" which appeared in *The Wireless World* dated February 11th, it would be interesting to learn what obstacle is there preventing electric motor manufacturers from incorporating in their machines a condenser or condensers in order to lessen the interference radiated from them.

The automobile manufacturer is compelled to equip all his cars with a silencer, why should this not apply to the electric motor manufacturer? The seriousness of electrical interference is very profound to-day in this era of sensitive multi-valve receivers.

Cardigan.
GRIFF THOMAS.

READERS' PROBLEMS.

Replies to Readers' Questions of General Interest.

Technical enquiries addressed to our Information Department are used as the basis of the replies which we publish in these pages, a selection being made from amongst those questions which are of general interest.

Mains Interference.

My reception has of late been marred by crackling noises, which I believe must be due to a defect in my house wiring system. At any rate, my immediate neighbours, whose power is supplied through the same electric mains, have not been troubled in this way. Can you suggest a way of settling this point? As the set is entirely mains-operated it is obviously impossible to disconnect the supply altogether by taking out the mains switch.

We assume that you have already tried the expedient of switching off or disconnecting every piece of electrical apparatus in the house, and we can only suggest that you should open the main switch and run a temporary flexible lead directly from the mains to the receiver. Then, if the interfering noises persist, you will know definitely that your house wiring is not at fault.

Total Anode Current.

With the help of an ammeter, I have been endeavouring to check the total anode current consumption of my receiver, but am puzzled by the fact that the sum of the currents taken by individual valves do not agree with the figure obtained when the meter is connected in the common negative H.T. lead. Can you explain this discrepancy, and also say how an accurate reading may be obtained?

We expect that the insertion of the meter (which has appreciable resistance) at a point common to all anode circuits has brought about self-oscillation, and this accounts for a change in mean anode current. It is suggested that, before making a measurement in this way, you should short-circuit the impedances in each grid circuit.

Indication of "Softness."

The volume control of my H.F.-det.-L.F. receiver consists of a high-resistance potentiometer in the grid circuit of the output valve. The set has worked well for some time, but I have lately noticed that quality is bad, and a milliammeter in the output valve anode circuit shows current readings from 18 to 25 milliams, as the volume control potentiometer slider is moved from one end to the other of the resistance. Originally, anode current was quite unaffected by operation of this control. Can you tell me what is likely to be wrong?

It seems fairly certain that your output valve has become "soft," and that current is flowing in the grid circuit, giving

rise to a change of grid voltage in sympathy with the potentiometer slider movements. A similar effect would be produced if positive grid bias were applied.

Fitting a Pick-up.

If it can be done without much difficulty, I should like to add a gramophone pick-up to the "Pre-Selection A.C. Three" as described in your issues for February 25th and March 4th. Will you please give me a circuit diagram?

If you are willing to forgo the advantages of automatic grid bias as far as the pick-up circuit is concerned, the necessary alterations can be done in an extremely simple manner, as indicated in Fig. 1 (a). As the existing condenser in the grid circuit of the detector valve (which will, of course, be converted into an amplifier for gramophone reproduction) is of very low capacity its presence may be ignored.

If automatic bias is required, you might adopt the slightly more complicated

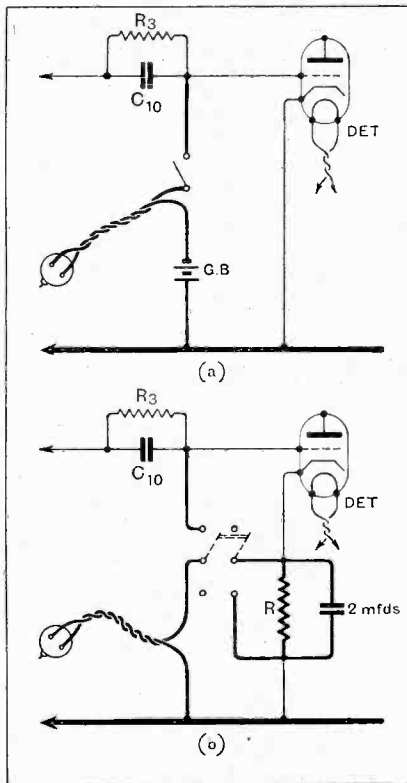

Fig. 1.—With battery or "free" grid bias: alternative connections for a pick-up. Extra wiring is shown in heavy lines.

method of connection shown in Fig. 1 (b). The bias resistance R should have a value of 600 ohms.

L.F. for Short Waves.

Do you think that a single-valve detector set with reaction would be suitable for short-wave reception with headphones?

It is generally preferred to use a stage of L.F. magnification after the detector. This is not only because the extra amplification is valuable, but because the interposition to another valve and its associated apparatus helps to isolate the headphones from the H.F. circuits, thus avoiding to some extent at least the effects of body capacity.

No Prejudice.

My mains supply is A.C., and I have, up to the present, hesitated to buy a moving-coil loud speaker because of the difficulty and complication of rectifying and smoothing the feed current supply. Although a permanent-magnet loud speaker would overcome this difficulty, there seems to be a prejudice against this type of instrument. Will you please give me your views on the matter?

We think you are mistaken in imagining that there is any prejudice in well-informed circles against permanent-magnet, moving-coil loud speakers. By using modern steel alloys for the magnet system it is possible to produce a highly satisfactory loud speaker.

Economy Valves.

I find that the life of my H.T. batteries is a good deal shorter than I could wish, and I am wondering if you could make any suggestions as to how economies could be effected without any serious sacrifice of volume or quality.

Without details of your receiver, we cannot enumerate all the points at which consumption might be reduced, but in any case it is probably the output valve that accounts for the majority of the drain on the battery. We expect that you would find it worth while to replace your present output valve by one of the modern high-efficiency type, such as the LP2 or the PM2A. For a given anode current, these valves give a considerably increased undistorted output as compared with those of less advanced design.

Ganged Condensers.

I should like to bring my 1-v-1 set up to date, and am about to rebuild it entirely. As an input filter is to be used, there will be a total of three tuning condensers; do you consider that these should be ganged? Expense is an important consideration, and my present condensers are of such a design that they cannot be linked mechanically.

Your filter circuit tuning condensers should certainly be "ganged," but it is quite permissible to tune the inter-valve coupling circuit by means of an entirely separate condenser.

The Wireless World

AND
RADIO REVIEW
(18th Year of Publication)

No. 604.

WEDNESDAY, MARCH 25TH, 1931. VOL. XXVIII No. 12.

Editor : HUGH S. POCOCK.

Assistant Editor : F. H. HAYNES.

Editorial Offices : 116-117, FLEET STREET, LONDON, E.C.4.

Editorial Telephone : City 9472 (5 lines).

Advertising and Publishing Offices : DORSET HOUSE, TUDOR STREET, LONDON, E.C.4.

Telephone : City 2847 (13 lines).

Telegrams : "Ethaworld, Fleet, London."

COVENTRY : Hertford St.

BIRMINGHAM : Guildhall Bldgs., Navigation St.

MANCHESTER : 260, Deansgate.

GLASGOW : 101, St. Vincent St., C.2.

Telegrams : "Cyclist, Coventry."
Telephone : 8210 Coventry.

Telegrams : "Autopress, Birmingham."
Telephone : 2970 Midland (3 lines).

Telegrams : "Diffe, Manchester."
Telephone : 8970 City (4 lines).

Telegrams : "Hilfe, Glasgow."
Telephone : Central 4857.

PUBLISHED WEEKLY.

ENTERED AS SECOND CLASS MATTER AT NEW YORK, N.Y.

Subscription Rates : Home, £1 1s. 8d. ; Canada, £1 1s. 8d. ; other countries abroad, £1 3s. 10d. per annum.

As many of the circuits and apparatus described in these pages are covered by patents, readers are advised, before making use of them, to satisfy themselves that they would not be infringing patents.

The Radio-Gramophone.

FOR several years now *The Wireless World* has produced annually a special number devoted to Wireless and the Gramophone, and this subject is dealt with again in the present issue.

A special Radio-Gramophone number provides the opportunity for reviewing the development of types of apparatus for the dual purpose of record reproduction and broadcast reception, and from year to year we see how closely the two interests are being brought together to form a combined instrument of entertainment and interest.

Two or three years ago, when the electrical reproduction of gramophone records first became popular, elaborate electrical gramophones were produced in which provision for broadcast reception, if included at all, was treated rather as an afterthought than as an essential part of the equipment. To-day, radio-gramophones have reached a high standard, and manufacturers put into them the best of their designs both for radio reception and high-quality amplification for gramophone reproduction.

In this issue we describe and illustrate representative types of the modern "radiogram," and, in addition to articles dealing with various aspects of gramophone reproduction by electrical means, we give a modern design for a high-quality amplifier operating from A.C. mains.

It is interesting to remember that at the time when broadcasting was first introduced there existed a very general opinion that the popularity

of the gramophone would at once commence to wane and that eventually broadcasting would practically kill the gramophone. Time has shown that such a supposition was entirely erroneous, for, if anything, the gramophone has been helped to greater popularity and wider appreciation through broadcasting.

Far from being independent of the gramophone or replacing it, we have seen during the past few years a steadily increasing use being made of recorded music for broadcasting purposes, either to fill gaps in the regular programmes or to provide items of special interest which could only be obtained by the aid of the record.

Some objection has from time to time been raised against the use of records as a source of broadcasting items, but, provided that they are not merely used as a cheap source of programme matter, but are chosen as being of definite entertainment value, then their use can but enhance the interest of the programmes to the listener.

The enormous sale of records to-day is in itself evidence of public interest, and to prospective purchasers it is helpful to hear new records played over via broadcasting, whilst at the same time it provided general entertainment.

Progress in recording and in record making has brought the gramophone record up to a standard to-day when the broadcast transmitter and the design of the receiver have to be of a very high order if full justice is to be done to the excellence of the record.

In This Issue

ALL-A.C. QUALITY AMPLIFIER.

VOLUME AND TONE CONTROL
OF GRAMPHONE PICK-UPS.

CURRENT TOPICS.

NEEDLE SCRATCH FILTER.

POINTS IN THE DESIGN OF
THE GRAMPHONE MOTOR.

RADIO-GRAMOPHONES REVIEWED.

BROADCAST BREVITIES.

READERS' PROBLEMS.

A Two-stage Resistance Amplifier for the Electrically Reproducing Gramophone.

By F. H. HAYNES.

ALL A.C.



Overall frequency response of amplifier.

WIRELESS WORLD Quality Amplifier

SPECIFICATION.

Three-valve gramophone amplifier, resistance-coupled. Small gain per stage avoiding high-note loss. Input volume control for pick-up. All A.C. operation. Automatic grid bias. Valve rectification. Undistorted power output up to 5 watts.

AMONG radio apparatus which may be home-constructed nothing is more readily put together and possesses such lasting utility as the heavy-duty L.F. amplifier. Once constructed it will not go out of date, and is the nucleus around which we may build high-frequency stages for local or distant reception, and, in addition, the loud-speaker equipment. Although more modest valves have continued to advance in their performance during the past few years, experience has taught us that a heavy-duty output valve is best suited to the requirements of the moving-coil loud speaker.

the components for the gramophone amplifier are an inevitable acquisition when quality moving-coil loud speaker reproduction is contemplated.

From 40 to 10,000 Cycles.

It was as a result of testing the possible alternatives in their behaviour over a frequency range of 50 to 5,000 cycles that an all-resistance amplifier was decided upon. By using two resistance-coupled valves of low stage gain bass frequencies are preserved, and the criticism of high-note loss levelled against the resistance amplifier of high gain cannot be maintained. As proof of this point it will be noted from the accompanying curve that the test frequency had to be pursued up to 16,000 cycles before a tailing-off was encountered, and this bearing in mind that an amplifier is rarely called upon to deal with frequencies above 5,000. At the

This does not mean that overpowering volume is the aim, but that the vastly differing relative amplitudes of voltage can be accommodated by its grid, bearing in mind also that the permissible maximum grid potentials are seriously cut down when the reactance of the loud speaker rises to a value several times the A.C. resistance of the output valve. The Marconi or Osram L.S.6A has been chosen as a generous output valve of moderate price which, for ordinary room conditions, may be under-run so that the effect of the curvature of its characteristic becomes insignificant, while considerable power output is available when occasion demands. Unlike complete radio receivers demanding specialised apparatus in some cases of only temporary interest.

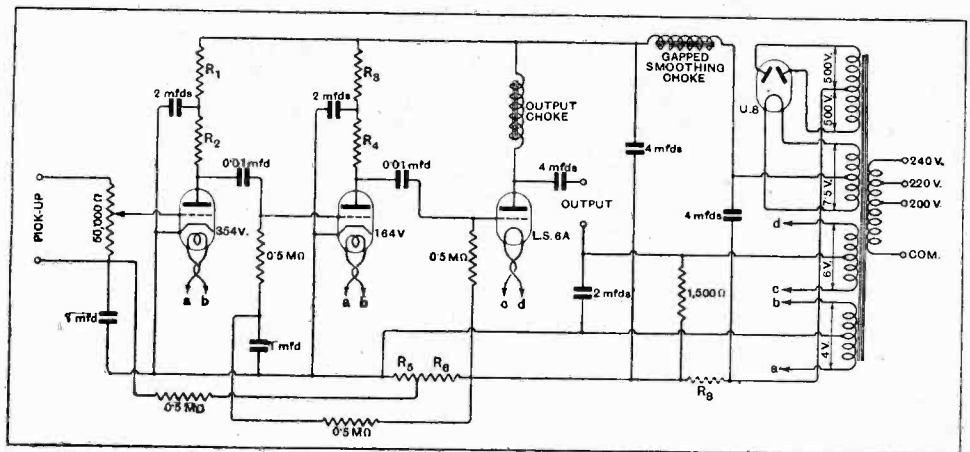

The circuit diagram. The values of the resistances are as follows: R₁ 10,000 ohms; R₂ 80,000 ohms; R₃ 10,000 ohms; R₄ 30,000 ohms (for 104V valve R₄ 10,000 ohms); R₅ 300 ohms; R₆ 500 ohms (for 104V valve R₅ 200 ohms; R₆ 400 ohms).

Quality Amplifier.—

lower end of the scale, test showed that even down at 20 cycles the output had not seriously fallen; in fact, there was a slight rise at about 40 cycles, although this was probably due to the values chosen in the decoupling circuits. The overall test consisted of applying a given voltage at the various frequencies to the grid of the first valve and measuring the output in watts developed in a 3,500-ohm load, thus taking into account not only the intervalve couplings, but also the output choke.

requirements of this valve are dissipated across a 90,000-ohm resistance passing a current of just over 3 mA. Of this resistance 10,000 ohms are used for decoupling.

With 80,000 ohms left, therefore, for interstage coupling, a theoretical stage gain of 85 per cent. of the amplification factor of the valve, which is 35, should result. Due to the fact that the valve data with regard to impedance and amplification factor are given at zero grid volts, and that the performance is not so good at the normal value of negative bias, we find, on measurement, that the actual voltage gain taken at 50 cycles from the grid of the first valve to the grid of the second is not quite 20 times.

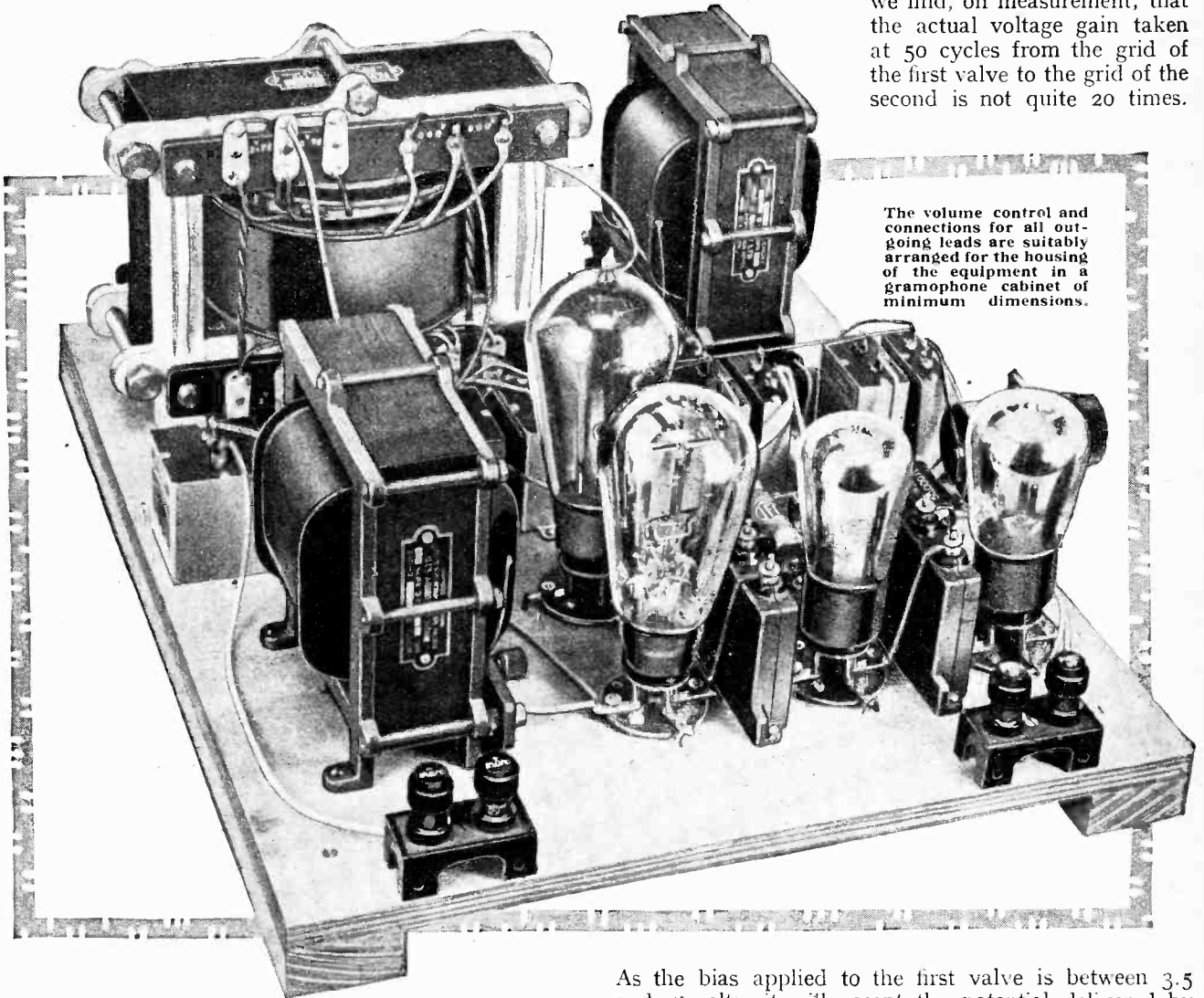

The volume control and connections for all outgoing leads are suitably arranged for the housing of the equipment in a gramophone cabinet of minimum dimensions.

Turning to the circuit, which is quite straightforward and contains no complications, mention might be made of the voltages existing at the various points and the values adopted for the resistances to suit the valves chosen. After applying the output from the pick-up to the potentiometer, which serves as a noiseless input volume control, the signal voltage is stepped off and taken to the grid of the first valve, a Mullard 354V. As the H.T. potential, after smoothing, is approximately 495 volts, the excess 200 volts over the anode

As the bias applied to the first valve is between 3.5 and 4 volts, it will accept the potential delivered by almost any pick-up representing a value up to 2.5 volts r.m.s. Pick-ups give maximum output voltages of between about $\frac{1}{4}$ and $1\frac{1}{2}$ volts, according to their type.

Avoiding for the moment an alternative, the Mullard 164V is used in the second stage. Requiring a current of 8 mA., the total resistance in the anode circuit cannot exceed 40,000 ohms while maintaining approximately 200 volts at the anode. This value is split up into 10,000 ohms for decoupling and 30,000 ohms for coupling. This should result in a stage magnification

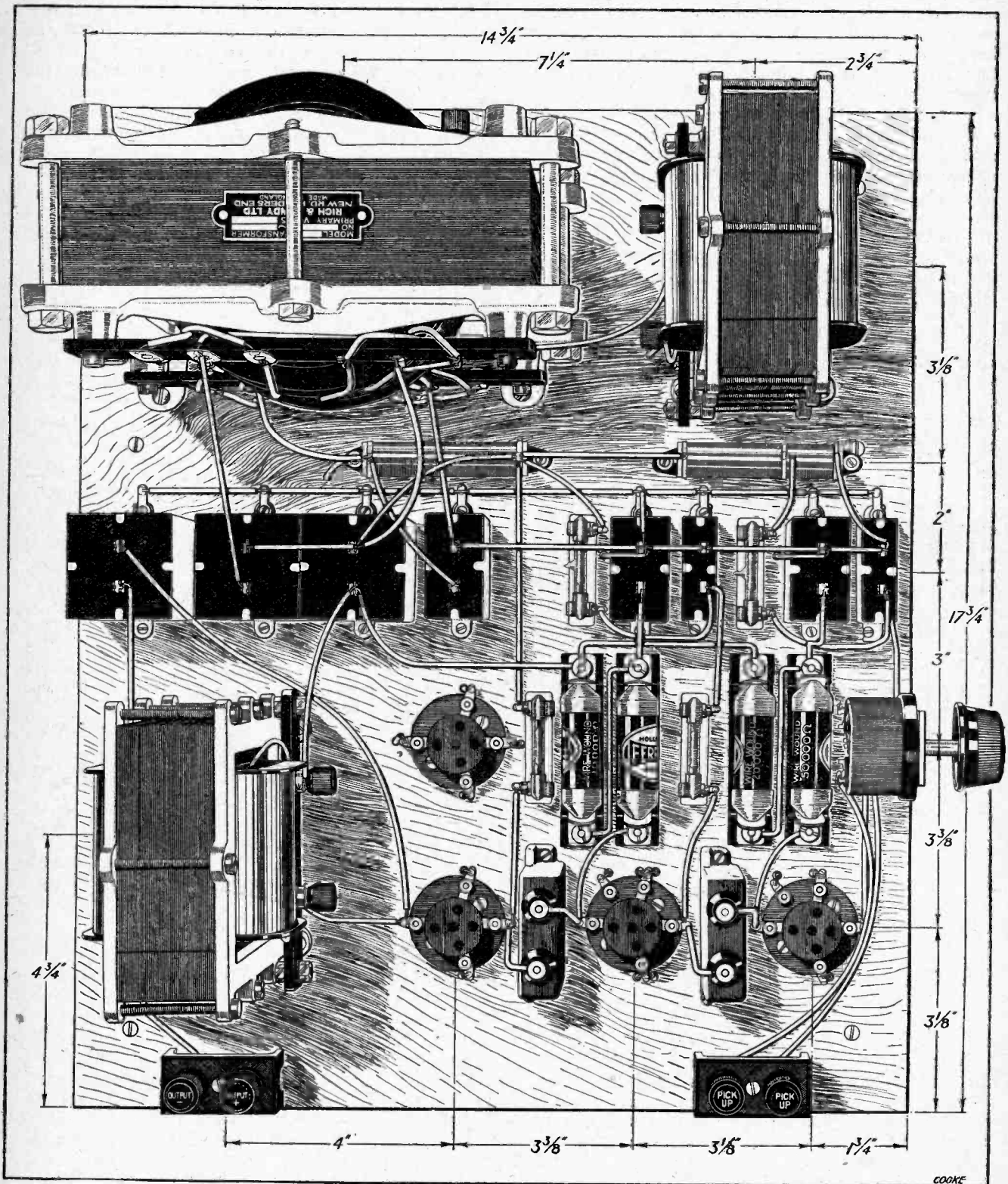

Layout of the components together with dimensional details. Precise positioning of the components is not important, but in following the leading dimensions given here a tidy layout of the apparatus and wiring results.

Quality Amplifier.—

of 75 per cent. of the amplification factor of the valve, which is 16. Actually the voltage gain between the grid of the second valve and the grid of the output valve is 11 times, thus nearly approaching the theoretical figure.

Matched Stages.

The output valve working on its full anode voltage of 400, and passing just over 60 mA. when biased at 90 volts, will accept an A.C. signal potential on its grid of about 65 volts before giving rise to distortion by grid current. When thus fully loaded, with a constant signal on the grid, an output of 4.7 watts was

of handling a greater signal. Such a valve is the 104V, taking a current of 17 mA., so that the coupling and decoupling resistances are each of 10,000 ohms when the voltage on the anode is nearly 200. In accepting a greater input signal this intermediate valve gives a stage gain of about seven times, so that, while the overall magnification of the amplifier has been slightly reduced, the output valve may still be fully loaded.

Values of 0.01 mfd. and 0.5 megohm are used in both intervalve couplings in order that at the low frequency of 50 cycles over 80 per cent. of the signal voltage developed across an anode resistance may be passed on to the grid of the following valve. These

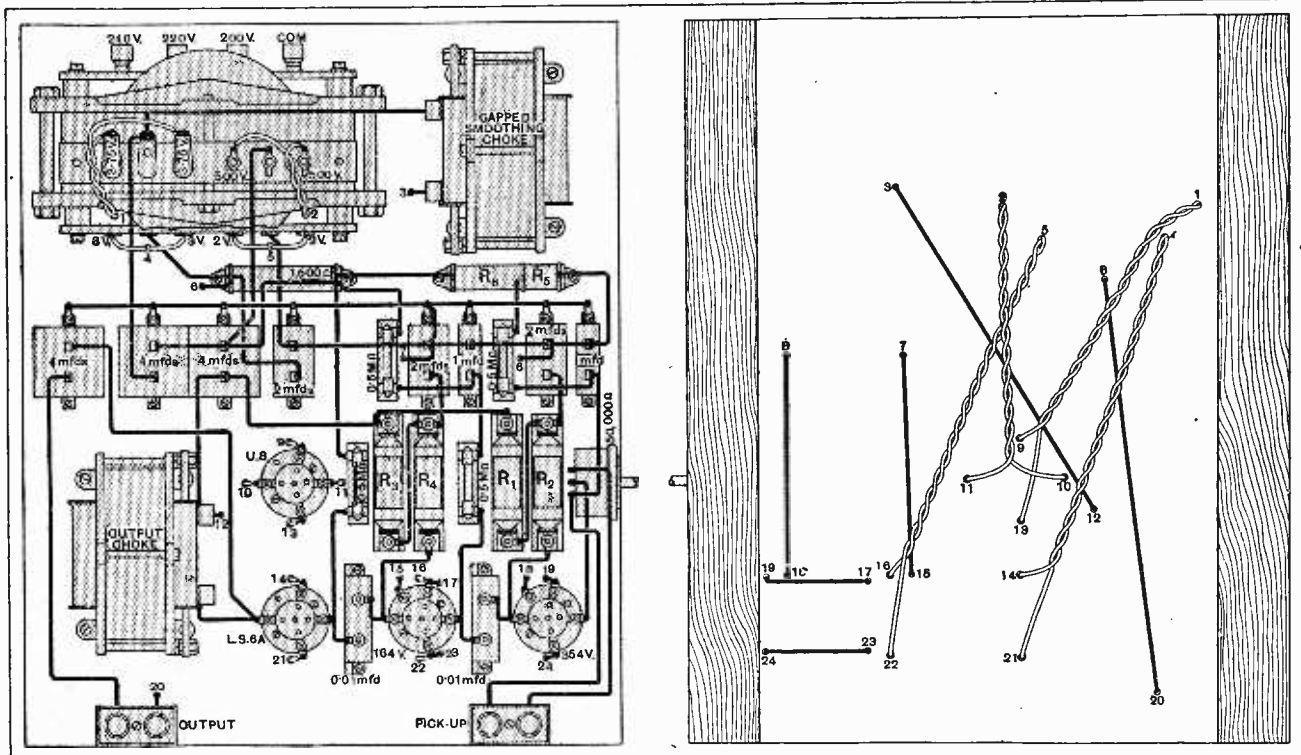

Wiring diagram of the baseboard and under-baseboard. No. 22 wire in fine silk sleeving is used for the connections with the exception of those for the filaments, where No. 18 is required.

obtained into the stated optimum load of 3,700 ohms. This represents a volume suitable for adequately filling a small hall. Working back from the potential which the output valve will accept, we must divide by 11—the amplification of the second stage—to determine the voltage on the grid of the 164V valve, which will fully load the output. This valve is biased at 8.5 volts, and will, therefore, accept the necessary potential of 6 volts r.m.s. Going back again through the 354V, and dividing by 20, the 6-volt signal now becomes 0.3 volt, a convenient value which can be obtained from the volume-control potentiometer.

The arrangement as described is therefore suited for use with a pick-up, such as the Blue Spot, where the average potential delivered is fairly low. On the other hand, a B.T.H. pick-up calls for either more drastic use of the potentiometer or, alternatively, the substitution of another valve in the intermediate stage capable

values are considered to be entirely safe as regards the maximum interval of time required for a charge on the condenser to leak away in the event of valve overloading.

Brief reference might be made to the details of biasing. The anode current of the first two valves is passed through a tapped resistance, from across which the two biasing potentials are taken. It is not advisable to take the total H.T. current through a resistance for this purpose, as it then forms part of the anode circuit of the output valve and the powerful signal potentials which may be developed across it will increase the chances of L.F. oscillation. When using the 164V valve the values for the resistances R_5 and R_6 are 300 and 500 ohms respectively. Should a 104V valve be substituted, these values are reduced to 200 and 400, owing to the change of biasing potential required and the increased anode current passed.

LIST OF PARTS.

- 4 Valve holders, 5-pin (Clix).
- 3 Condensers, 4 mfd. 1,500 volt D.C. test (Hydra).
- 3 Condensers, 2 mfd. 1,500 volt D.C. test (Hydra).
- 2 Condensers, 1 mfd. 1,500 volt D.C. test (Hydra).
- 2 Condensers, 0.01 mfd. mica (T.C.C. Type 33).
- 1 Smoothing choke (Rich & Bundy, Type E.101).
- 1 Output choke (Rich & Bundy, Type E.102).
- 1 Mains transformer, 500 + 500 volts 100 mA.; 4v. 3 amps.; 6v. 2 amps.; 7.5v. 2.5 amps. (Rich & Bundy).
- 4 Grid leaks, 0.5 megohm (Loewe).

- 4 Porcelain grid leak holders (Bulgin).
 - 1 Anode resistance, 80,000 ohms and holder (Ferranti).
 - 1 Anode resistance, 30,000 ohms and holder (Ferranti).
 - 2 Anode resistances, 10,000 ohms and holders (Ferranti).
 - 1 Resistance, 800 ohms tapped at 300 ohms (Colvern).
 - 1 Resistance, 1,500 ohms (Colvern).
 - 1 Variable resistance, 50,000 ohms (Colvern).
 - 2 Terminal mounts (Belling-Lee).
 - 4 Ebonite shrouded terminals (Belling-Lee, Type B).
- Wood, wire, sleeving, screws, etc.

In the list of parts given in last week's issue, the two 0.01 mfd. mica condensers were erroneously shown as 0.1 mfd.

In consequence of the U.8 rectifying valve running on a comparatively light load, an A.C. potential of 465+465 on the high-voltage winding will give the requisite 495 volts after rectification and smoothing. As some readers may contemplate using the eliminator ultimately on heavier load they may think it advisable to adopt a transformer having an output of 500+500 volts, thus using the rectifying valve up to its full capacity. In this instance the resistance R_s must be introduced having a value of 800 ohms, or when substituting a 104V valve 700 ohms.

Constructional Hints.

To avoid excessive temperature rises in the various resistances it should be noted that the 80,000-ohm resistance is dissipating about $\frac{3}{4}$ watt and the 30,000-ohm resistance of 104V valve nearly 2 watts. The alternative valve—the 104V—gives rise to a dissipation of nearly 3 watts in each of its 10,000-ohm anode resistances, necessitating the substitution of resistances possessing an adequate watts rating. Only a fraction of a watt is dissipated in the tapped biasing resistance, but the high value of about 6 watts is reached in the biasing resistance of the output valve. By a simple modification this resistance may be substituted by the field winding of a suitable moving-coil loud speaker.

Assembly and wiring details are straightforward and call for little comment. The whole job, assembled on a piece of 9-ply $\frac{1}{2}$ in. board, strengthened by battens, may be neatly wired in a few hours, taking most leads by the shortest routes. Run all A.C.-carrying leads first as twisted pairs under the baseboard. Wire not

finer than No. 18 is used for all filament circuits, and No. 22 for the remaining leads. Note that the two chokes differ, that in the smoothing circuit having a more generous air gap. In operation the amplifier is absolutely hum-free. If hum is encountered look first to the brushes on the motor, should such be fitted. Next earth the frame of the motor and then look to the pick-up. Not the slightest difficulty has been encountered in this direction, but if earthing of the pick-up is required this is, in effect, carried out by earth-connecting the cathode wire of the first two valves. In dimensions the amplifier will suit the space available in most gramophone cabinets, while it may occur to the reader to build a simple H.F. stage with its tuning equipment on a platform above the amplifier and deriving its current from the common eliminator. The first valve of the amplifier then becomes the detector by the customary switching arrangement in the grid lead, adding the necessary H.F. choke and anode condensers. The optimum anode load of the output is given as 3,700 ohms, and in specifying the loud-speaker winding this value represents the mean impedance and must, of course, not be confused with the D.C. resistance of the speech coil. A winding of 800 turns of No. 47 wire on a 2in. former suits the L.S.6A valve, but loud speaker makers now usually supply windings for any of the output valves. If a low-resistance loud speaker is used the manufacturer will specify details of the transformer required to match his coil winding to the L.S.6A.

This amplifier is available for inspection at the Editorial Offices, 116-117, Fleet Street, London, E.C.4.

For Woodford and Wanstead Amateurs.

The Woodford, Wanstead and District Radio Society is still energetically pursuing the needs of local wireless enthusiasts. The lectures and demonstrations are specially designed to be of the utmost value to all. On April 2nd, special attention will be given to common faults, their detection and correction.

Full particulars will be gladly furnished by the Hon. Secretary, Mr. H. O. Crisp, 2, Ramsay Road, Forest Gate, E.7.

o o o o

Radio-gramophone Demonstrated.

Radio-gramophones have occupied the attention of the Slade Radio (Birmingham) Society at two recent meetings. An excellent demonstration was given by Mr. A. F. Poynton, who described the circuit of his radio-gramophone and supplied interesting details of the separate rectifier for the loud speaker feed and a safety switching device. At the following meeting Mr. W. R. Parkinson, of the Radio Gramophone Development Co., demonstrated a new model, incorporating a band-pass filter and four H.F. ganged tuned circuits giving a remarkable range and selectivity.

CLUB NEWS.

A special welcome is given to all interested in wireless, and full particulars of the Society can be obtained from the Hon. Secretary, 110, Hillaries Road, Gravelly Hill, Birmingham.

Membership Doubled.

Founded only last November, the Northwood Radio and Gramophone Society has already doubled its original membership. A number of interesting lectures have been given, the subjects dealt with including "The Recording of Talking Films," "All-Mains Receivers" (by Messrs. McMichael, Ltd.), "Mazda Valves" (by Edison Swan Electric Co.), and "The History and Development of the Gramophone" (by Mr. V. S. Homewood, of the Gramophone Company).

The Society has been honoured by the consent of Mr. L. McMichael to become the first president.

Full particulars of the Society may be obtained from the Hon. Secretary, Mr. D. B. Close, Cranleigh, Watford Road, Northwood.

A Radio Prophet.

In one of the most interesting lectures of the session of the Radio Experimental Society of Manchester, Mr. W. Symes, in prophetic mood, dealt with the subject of broadcast design. He did not favour the Stenode or the "Superbet," but showed how the straight circuit would develop to meet all requirements. The designs of the future would include a laboratory calibrated, sealed selectivity unit which would precede any amplifiers; this unit to include a variable selectivity control and four stages of tuning controlled by one knob, resistance coupling for all stages, including H.F. valves of greater efficiency, and also pentodes with further screening and greatly increased heater wattage of mains valves.

o o o o

A Valve on Holiday.

The meeting this evening (Wednesday) at the Society's rooms (8, Water Street, off Bridge Street) will be the occasion of a lecture entitled "A Wireless Valve on Holiday." Visitors are invited, and should get in touch with the Hon. Secretary, Mr. R. M. Kay, 58, Daisy Bank Road, Victoria Park, Manchester.

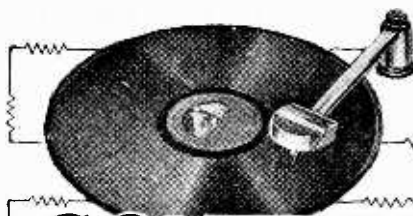

TONE AND VOLUME

CONTROL of Gramophone Pick-ups

The Design of Correcting Devices.

By JOHN HARMON.

ONE evening in 1877 a young man stood in a room in London holding to his ear a hastily improvised apparatus comprising an iron diaphragm and a horse-shoe magnet wound with two coils of wire. As he waited, with no great expectation of anything unusual about to happen, a ghost-like voice whispered in his ear a sentence of intelligible speech; the voice was that of Graham Bell speaking in a distant room over the first telephone of his own manufacture. That crude telephone was the precursor not only of the loud speaker of to-day but also of the miniature collecting instrument which skims the music from the grooves of the gramophone record and which is known, somewhat inelegantly, as the pick-up.

For the pick-up is akin to the loud speaker; indeed, it is merely the loud speaker worked backwards. A pick-up may be provided with a diaphragm and used as a telephone, while the moving-iron type of loud speaker when divested of its cone serves as a clumsy pick-up.

Both these instruments had to bide their time till the advent of the amplifying valve made it possible to use them. The loud speaker was first in the field and had well-nigh assumed its present standardised form before electrical technique began to permeate the gramophone industry. So skilfully had the designers of the mechanical sound-box worked to obtain an even level of reproduction over the scale of audible frequencies, that it is barely a year since the special advantages of electrical reproduction became generally admitted. These advantages are, in brief, due to the greater simplicity and rigidity of the moving part of the pick-up as compared with the mechanical device, whereby the numerous resonances of the latter can be reduced to two only, and these, as will be shown later, can be made use of to maintain the level of reproduction where it begins to fail at the extreme limits of the musical scale. In addition, the use of valve amplification allows the motion of the armature to be made small enough to avoid amplitude distortion, and a volume control, and if necessary, a tone corrector, can be easily fitted ahead of the first valve.

A permanent magnet such as is shown in Fig. 1 (a) is a source of magneto-motive force which drives magnetic flux round the compound circuit consisting partly of iron and partly of air, and the smaller the magnetic resistance of the circuit the greater is the flux. Since the magnetic resistance of air is some hundreds of times greater than that of iron the flux is increased when the air gap is bridged by a piece of iron (Fig. 1 (b)).

The Effect of a Moving Armature.

An electrical analogue to Fig. 1 is afforded by an apparatus consisting of a battery connected to two copper wires whose free ends dip into a basin of dilute acid. The analogous magnetic and electrical operations can be inferred from the table of equivalent quantities.

Then we say that the electro-motive force of the battery drives a current round the circuit whose resistance is partly due to copper and partly to acid. Since the resistance of acid is much greater than that of copper, the current can be increased by placing a fragment of copper in the gap between the free ends of the wires.

The magnet shown in Fig. 1 is usually made of cobalt steel, which can retain more permanent magnetism than any other known substance, and the pole pieces are made of soft iron so as to bring down the magnetic resistance and thus increase the flux. There is a limit, however, to the amount by which the cobalt steel can be advantageously replaced by iron, for though the magnetic resistance decreases the disappearance of steel lowers the magneto-motive force more and more rapidly, and careful design is required to apportion the relative amounts of steel and iron to make the flux a maximum.

In Fig. 1 the lines of flux are only shown where

WITH the experience gained in the design of loud speakers it might have been expected that the pick-up would have emerged from the shell in a final and perfect shape. But actually evolution seems to have taken an independent course, and the early instruments showed undesirable resonances and faults of design which delayed their adoption considerably. All possible types appeared, together with some which were impossible. The well-known principles which had been used for loud speakers were tried again, resulting in the attracted reed, the balanced armature, the moving coil and electrostatic and piezoelectric movements. Of these types only the first two have won general acceptance, and these alone are considered in this article. In the instalments which will appear in subsequent issues, various types of correcting device will be described.

Magnetic Quantity.	Electrical Quantity.
Magneto-motive force	Electro-motive force
Magnetic flux	Electric current
Magnetic resistance	Electric resistance

Tone and Volume Control of Gramophone Pick-ups.—

they leave the metal and traverse the air gap, but we must imagine them as continuing their course in closed loops right round the metallic part of the circuit. Accordingly, if coils of wire are slipped over the pole pieces and joined in series they will be threaded by the flux, and if the free piece of iron in Fig. 1 (b) is made to move in and out of the gap the resultant flux variation through the pole pieces will induce in the coils an e.m.f., proportional at any moment to the rate at which the flux is changing.

Magnetic Pick-ups.

The attracted reed type of pick-up, Fig. 2 (a), depends on the principles just described. The reed must be sufficiently stiff to avoid being drawn against the pole pieces, which it overlaps, and this stiffness causes the needle to transmit an undue amount of its motion to the magnet box, the record being rapidly worn in consequence. Another disadvantage, which also occurs in converse fashion in loud speakers containing an attracted reed, is that the reed is unsymmetrically placed with regard to the flux so that a sinusoidal motion of the needle is not accompanied by a truly sinusoidal flux change, and hence the output is distorted.

These difficulties do not occur in the balanced armature type, Fig. 2 (b). Here the armature is placed symmetrically with regard to four magnetic poles, and, as

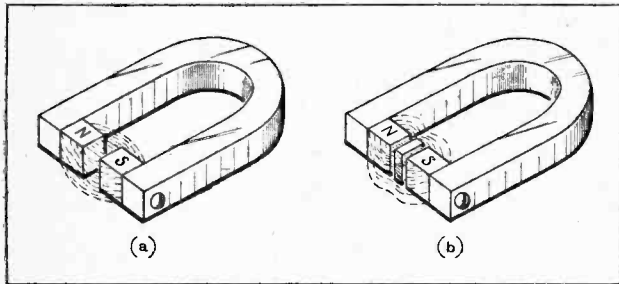

Fig. 1.—A cobalt steel magnet drives magnetic flux lines round the metallic circuit and across the air gap. When iron is placed in the air gap the flux increases, due to the fall in magnetic resistance.

Fig. 3 shows, no force of magnetic attraction is exerted upon it in the zero position. Consequently, the stiffness can be reduced to a degree where the needle follows the groove without imparting any considerable motion to the magnet box. As the armature oscillates the flux swings up and down, and if the amplitude of motion is not too great the output is undistorted. In this type the coil usually surrounds the armature, thus enclosing the region where the flux changes are greatest.

If, in Fig. 3, the flux along the armature is proportional to the angular displacement of the armature from its central position, then the angular velocity of the armature is proportional to the rate at which the flux changes, and hence, by Faraday's law, to the e.m.f. induced in the coil. Accordingly, a test record designed to produce a constant peak e.m.f. in an ideal pick-up at all frequencies should have the undulations of its grooves so arranged that the peak velocity of the needle is the same in whichever groove it is placed. Fig. 4 shows two such grooves, the upper corresponding to

a frequency of 1,000 cycles per second, the lower to 2,000. If the needle is to have the same peak velocity in either groove, then since it must execute a complete swing to and fro in the lower groove in half the time allowed in the upper groove, the amplitude of the un-

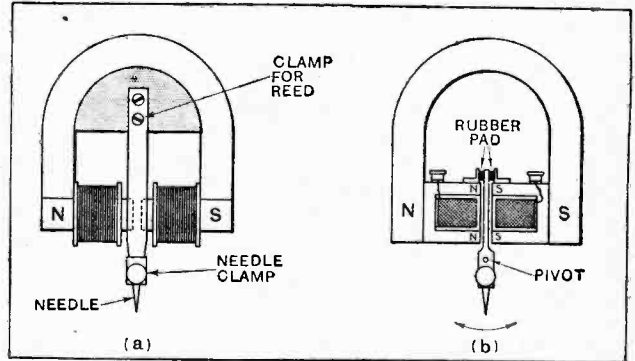

Fig. 2.—Types of magnetic pick-up (a) attracted reed, (b) balanced armature.

dulation must also be halved, and we have the well-known rule that the amplitude must be inversely proportional to the frequency.

In a commercial record the grooves are so close together that the maximum safe amplitude is 0.002in. Taking this value at 250 cycles per sec. the amplitude at 5,000 c.p.s. would be 1/20th of 0.002in., i.e., 0.0001in. It is truly remarkable that such minute displacements should give rise to good reproduction of music at loud-speaker strength. Let us now imagine a needle and balanced armature forming a lever so rigid that no resonance can occur in the audible region. Let us also suppose that the damping due to the rubber pad is so small that the motion is not appreciably transmitted to the magnet box. Such an instrument would give even reproduction from a test record with a minimum of record wear, and reference to tests¹ made in *The Wireless World* laboratory shows that some pick-ups do fulfil substantially this exacting condition. Unhappily, this perfection is marred when ordinary records are used in conjunction with typical forms of amplifier and loud speaker, as is shown in Fig. 5. For the distance between consecutive grooves is insufficient to allow of the neces-

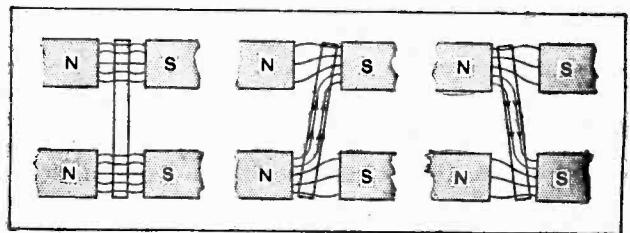

Fig. 3.—Movements of the lines of magnetic flux as a balanced armature oscillates.

sarily large amplitude of undulation required to reproduce frequencies below 250 c.p.s. without attenuation, and the high frequencies are attenuated by the average amplifier and loud speaker. There are two ways in

¹ *The Wireless World*, March 26th, 1930, p. 321, and April 2nd, 1930, p. 356.

Tone and Volume Control of Gramophone Pick-ups.—

which this deficiency in bass and treble can be corrected ; the first is the introduction of suitable mechanical resonances in the design of the pick-up, the second is the use of some kind of electrical tone control at a point ahead of the first valve.

Resonance at Low Frequencies.

At low frequencies, where the armature and needle may be taken as forming a single rigid lever, the pick-up may be represented as in Fig. 6 (b), in which the inertia of the tone-arm has been neglected in comparison with that of the pick-up and a spiral spring represents the control exerted by the rubber pad. The frequency of resonance only depends on the mass of the box, the stiffness of the spring, and the distance *h* from pivot to end of needle. The system is equally well expressed by Fig. 6 (c), and it is evident that the natural frequency is lowered by increasing *M* or *h*, or by decreasing the stiffness of the spring. Instead of stiffness it is better to speak of the *compliance* of the spring, which is the reciprocal of the stiffness. Compliance is the angle through which the spring turns when unit torque is applied to it, and Fig. 6 (d) shows how it may be measured. An important point is that if *M* and *h* are altered the natural frequency will be unchanged if the product *Mh*² remains the same, and this product is called

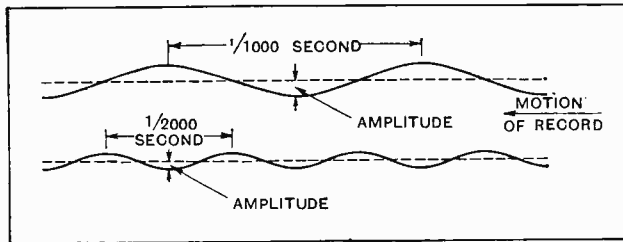

Fig. 4.—Two grooves from a test record. The upper corresponds to a note of 1,000 cycles frequency, the lower to 2,000 cycles. As the record travels from right to left the needle travels along a vertical line in the paper. If the peak velocity of the needle is to remain constant the amplitude must vary inversely as the frequency.

the *moment of inertia* of the pick-up round the needle point. Let us then put

$L = \text{moment of inertia of pick-up} = Mh^2.$

$C = \text{compliance of spring.}$

The resonance frequency is then given by the formula :

$L C = 1 / (2\pi f)^2 \dots \dots \dots (1).$

This is the same formula as holds for a tuned electric circuit, so that if we replace the pick-up by a coil of inductance *L* henrys and the spring by a capacity of *C* farads we shall have an electrical analogue to the pick-up at low frequencies, Fig. 7 (a). Tapping the pick-up with the finger corresponds to shock excitation of the analogous system by a single discharge through a loosely coupled coil, while the effect of supplying A.C. current to the terminals of the pick-up flex corresponds to the insertion of an A.C. generator in the analogous circuit.

To make the analogy perfect we must take into account the damping (which is equivalent to resistance) and include the moment of inertia of the armature needle

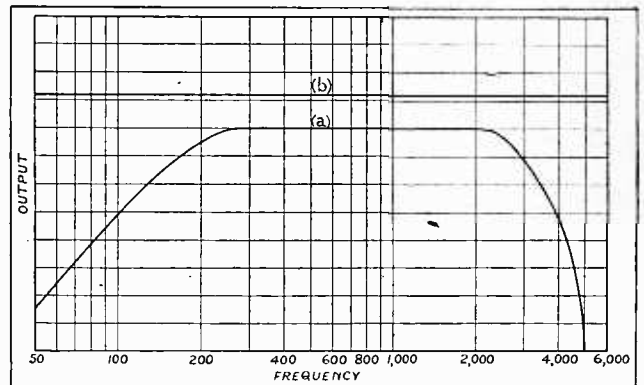

Fig. 5.—The output from a loud speaker may be attenuated at low and high frequencies as in (a), even though the pick-up gives even voltage reproduction on a test record as in (b).

lever round its pivot, thus obtaining Fig. 7 (b). The natural frequency is then given by $(L + L_a)C = 1 / (2\pi f)^2$, but L_a is always so small compared with *L* that it may be neglected. An additional refinement is to take into account the effective mass of the tone-arm which for a uniform tone-arm is one-third its actual mass, and this value should be added to *M*.

An Example.

A certain pick-up gave the curve (a) Fig. 9 on a test record, with a peak at about 105 cycles, at which frequency the vibration of the box was appreciable to the touch. The mass of the pick-up was found to be 140 gms., the effective length of the needle 1.2 cms., and the compliance of the armature 1.5×10^{-8} radians per dyne-cm. The formula $L C = 1 / (2\pi f)^2$, which has been quoted with reference to resonance with the needle point at rest, also holds when the point is driven by the record, and hence

$L C = 140 \times 1.2^2 \times 1.5 \times 10^{-8} = 2.03 \times 10^{-6} = 1 / (2\pi f)^2,$

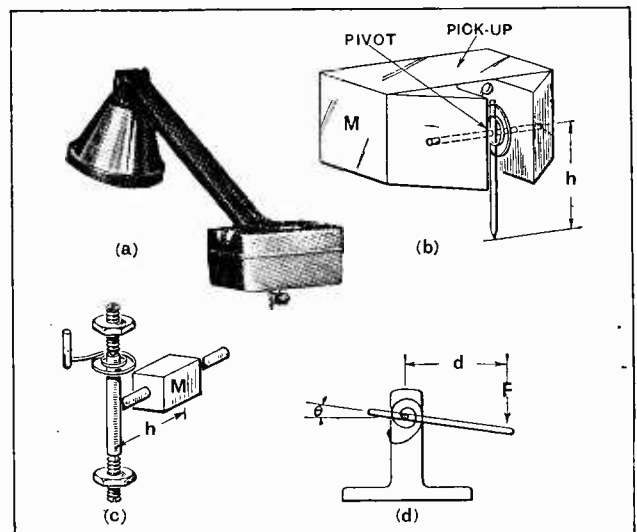

Fig. 6.—(a) A typical pick-up. (b) The equivalent system of the pick-up, consisting of a mass *M* pivoted to a rod with spring coupling. (c) An alternative way of representing the system of the pick-up. (d) Method of measuring the compliance of a spring. A force *F* acting on a lever of length *d* causes an angular deflection θ . The compliance is θ/Fd .

Tone and Volume Control of Gramophone Pick-ups.—

from which $f=98$ cycles. This is somewhat smaller than the observed value, but the agreement is fairly close.

An attempt was then made to displace the resonance peak to a lower frequency by increasing the inertia of the pick-up and tone-arm. It was considered inadvisable to load the pick-up, since the bearing pressure of the needle on the record was already rather high, and instead a new tone-arm was fitted on which balanced

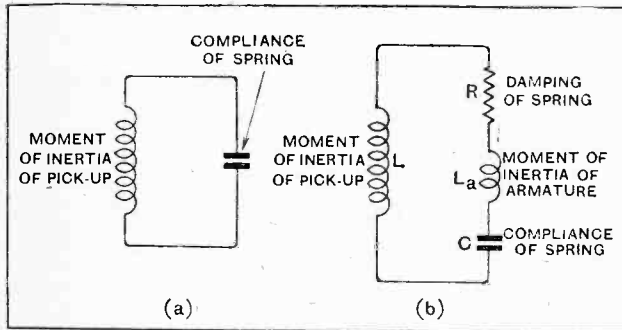

Fig. 7.—(a) An approximate electrical analogue to the pick-up system. (b) A complete electrical analogue at low frequencies.

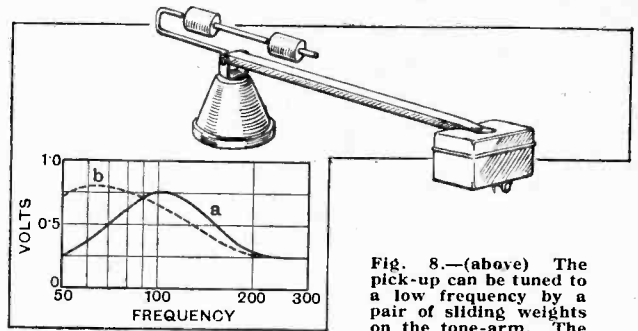

Fig. 9.—(Left) By increasing the inertia of a pick-up a resonance at 105 cycles (curve a) was displaced to 63 cycles (curve b).

weights could be clamped (Fig. 8). In this way the resonance was brought down to $f=63$ cycles, as in curve (b) Fig 9. This rising characteristic at low frequencies counteracts the insufficient amplitude of record grooves below 250 cycles, and is brought about by tuning the pick-up by varying its inertia without allowing the bearing pressure of the needle to exceed about 150 grammes.

(To be continued.)

POWER AMPLIFIER FOR GRAMOPHONE RECORDS.

The "Trix" Type G.A.25A.

THIS is a three-stage power amplifier designed to give a large power output such as would be required for the reproduction of gramophone records in dance halls, restaurants and large public halls. It operates entirely from the A.C. supply mains, 200-250 volts at from 40 to 60 cycles, and consumes approximately 100 watts.

The valves recommended by the makers are Mazda AC/HL first stage, Mazda AC/P second stage, and Marconi or Osram L.S.6A or Mullard DO/25 for the output position. The output valve is rated to give some 5,000 milliwatts of undistorted A.C. power, which is about five times that required to operate, at full bore, the average type of moving-coil loud speaker used in the home.

Provision is made for the use of either high- or low-resistance type loud speakers, the former deriving their input from a

choke-condenser filter unit, while the latter are fed from a 16:1 step-down ratio transformer. Three or four speakers can be used, but they should be all of the same resistance; mixing high- and low-resistance types is not recommended.

We found that the amplifier responded very well indeed to all audible frequencies of from 43 to 6,000 cycles, and only the limitations of the apparatus available at the time of test prevented us exploring the frequency ranges higher and lower than this.

No provision is made for control of volume, but, since it is usual to include a volume control on the gramophone motor and pick-up unit, its omission is justified.

In a recess on one side of the amplifier case are the A.C. connection, two fuses, on-and-off switch, three sockets for selection of the correct transformer tapping for the supply voltage, and a jack marked "loud speaker field." This will supply 100 volts D.C.

at approximately 60 mA. The resistance of the field winding on the loud speaker used must not be less than 1,500 ohms.

The principal dimensions of the amplifier are 18in. x 15in. x 8in., and the weight is 44lb.

It is entirely metal cased, well ventilated, thus complying with the I.E.E. regulations, and finished in crystalline black enamel. A terminal is provided for earthing the case if necessary.

The makers are Eric J. Lever (Trix), Ltd., 8-9, Clerkenwell Green, London, E.C.1, and the price is £25, including valves.

o o o o

Catalogues Received.

Philips Lamps, Ltd., 145, Charing Cross Road, London, W.C.2.—Descriptive literature dealing with Philips receivers, H.T. supply units, trickle chargers and other accessories.

o o o o

Manufacturers' Accessories Co. (1928), Ltd., 85, Great Eastern Street, London, E.C.2.—New season's radio catalogue of proprietary sets, components and accessories handled by this firm.

o o o o

Varley, 103, Kingsway, London, W.C.2.—Illustrated folder describing the Varley Senior All-Electric Receiver, Pedestal-type Moving-coil Loud Speaker, and Electric Radio-gramophone.

o o o o

Belling and Lee, Ltd., Queensway Works, Ponders End, Middlesex.—Publication, "Radio Connections," dealing with the range of insulated terminals and connections made by this firm.

o o o o

Fel-Ectric Radio Co., 56, Garden Street, Sheffield.—Illustrated folders dealing with Portass screw-cutting lathes and accessories.

o o o o

Partridge and Mee, Ltd., 74, New Oxford Street, London, W.C.1.—Illustrated catalogue, List A, describing "Parmeko" mains transformers, L.F. chokes, and L.F. and output transformers.

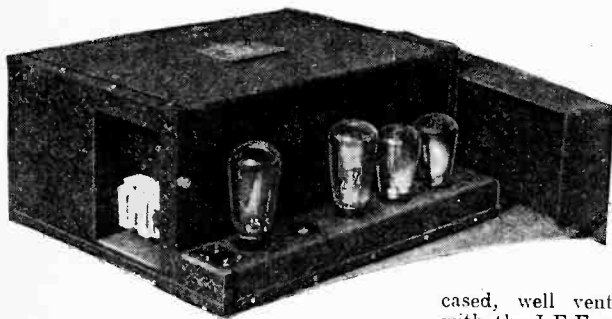

"Trix" 3-stage power amplifier, type G.A.25A, for A.C. supplies, giving a maximum undistorted A.C. output of 5,000 milliwatts.

CURRENT

News of the Week

RECORDS FROM SLOT MACHINES.

The first of several thousand automatic machines to be installed all over the country for the supply of flexible gramophone records is already in position outside a West London picture house.

We are sorry to note the absence of an electric gramophone attachment, which would enable us to try the record before purchase.

○○○○

BRITISH PROGRAMMES FREE?

The best story of the week comes from Stratford, where Mr. Thomas Wooley, fined £1 for omitting to obtain a wireless licence, pleaded that his set would not pick up foreign stations.

○○○○

WHEN CHARITY BEGINS ABROAD.

While it is interesting to know that the amateurs of Lyons are forming an anti-interference league, we wish that steps could first be taken to ensure that their local station, Radio Lyons, will not in future heterodyne the British relay stations.

○○○○

A SOUND-PROOF HOUSE.

If the "Hush, Hush!" room in the House that Jack Built at the forthcoming Olympia Ideal Home Exhibition fulfils all that is claimed for it, we shall certainly take our neighbour to view it. The "Hush, Hush!" room, like the rest of the house, is said to be absolutely soundproof, and in it a gramophone or loud speaker can be played without a sound even reaching the landing, not to mention the house next door.

○○○○

"5SW" FOR FRANCE.

France's short-wave Colonial broadcasting station will be ready to function at Vincennes when the International Colonial Exhibition opens there in May, says the French Postmaster-General.

○○○○

BIG LICENCE JUMP.

More than sixty thousand new licence holders emerged from the post offices during February, bringing the total up to 3,570,293. The increase is double that of February, 1930.

○○○○

"ADS." ACROSS THE SEA.

Those of us who wince at the possibility of American "sponsored" programmes being transmitted across the Atlantic for redistribution in Europe have a worthy defender on the other side in the person of Mr. Ellis A. Yost, who, in an appeal before the Federal Radio Commission, is hotly opposing the misuse of the short waves.

The trouble started, according to our Washington correspondent, with a demand by the Westinghouse Company for four short-wave channels for sponsored programme transmission through W8XK, auxiliary of KDKA, Pittsburg.

A 29

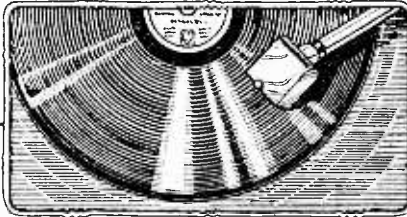

A WORD FOR THE LOUD SPEAKER.

Municipal authorities have usually met with very little opposition when making bylaws prohibiting noisy loud speakers in public places, but the Bradford City Council is being vigorously taken to task by the local Chamber of Trade because it has proposed the institution of anti-loud speaker regulations. The matter will be fought out at the next meeting.

○○○○

NORTHERN REGIONAL TIME-TABLE.

The new B.B.C. station at Slaithwaite is making test transmissions daily on 479.2 metres at the following times:—

Mornings (Sundays excepted): 11.5 a.m. to 11.45 a.m.

Nights (Sundays excepted): Mondays, Wednesdays, and Fridays, 11.15 p.m. to 12 midnight; Tuesdays, Thursdays and Saturdays, 12.15 to 1 a.m.



ANNOUNCING IN ITALY.—How much longer we shall hear the charming accents of Signorina Luisa Rizzi, of the Turin station, is doubtful in view of the news that the Italian broadcasting authorities are considering the employment of male announcers.

THE GRAMOPHONE MERGER.

The outstanding event of the past week in the gramophone world is the amalgamation of the Gramophone Company and the Columbia Graphophone Company. The fusion will be effected through the formation of a new company, which will acquire the entire issued capital of both companies by an exchange of shares.

○○○○

MORE SHOCKS FOR U.S. LISTENERS.

Although a tax on radio receiving sets has been declared unconstitutional by the North Carolina Supreme Court, the California legislature is going ahead with a Bill to create a Department of Radio

TOPICS

in Brief Review.

Supervision which would levy an annual tax on all radio users. A popular outcry is expected.

○○○○

THE PRINCE'S SPEECH.

The remarkable relay of the Prince of Wales's speech at Buenos Aires on March 14th is said to have started a mild wireless boom in this country. Apparently, nearly everybody felt themselves under a patriotic obligation to tune in, and the demand for portables went up accordingly. And nobody who heard the speech was disappointed.

○○○○

EASTER PRINTING ARRANGEMENTS.

The latest date on which small advertisements can be accepted for our issue of April 8th is Tuesday, March 31st.

○○○○

A WORLD-BEATER STARTS.

After a period of stagnation, the world's largest receiving station is about to get busy. This is the constant frequency monitoring station of the U.S. Department of Commerce at Nebraska, which cost £50,000, and is intended to "police" the American ether waves. The station has been standing idle owing to a lack of qualified staff, but eight district radio inspectors have now been detailed to eavesdrop on American transmissions. The station is said to be able to pick up anything worth hearing in any part of the world.

○○○○

ACHES AND PAINS.

"Invalids' Night" is now a regular feature for listeners to the Turin station, who, according to a correspondent, are now favoured with weekly medical talks at the microphone. Listeners are permitted to send in particulars of their ailments, and the worthy medico gives hygienic hints every Wednesday.

○○○○

FIRST TELEVISION PLAY IN U.S.

America's first television play, "The Maker of Dreams," has just been given from the Chicago broadcasting stations W9XAP and WMAQ. Before the transmission was carried out, experiments were conducted to determine the most suitable form of artistes' make-up.

A correspondent states that the Americans are turning their attention seriously to television problems, but it would appear that they are lagging behind Britain. A television play was broadcast in this country over a year ago.

○○○○

EDISWAN IN BELGIUM.

Our many readers in Belgium will be interested to know that the Ediswan agents in that country are the Société d'Electricité et de Mécanique, 54, Chaussée de Charleroi, Brussels.

Needle Scratch

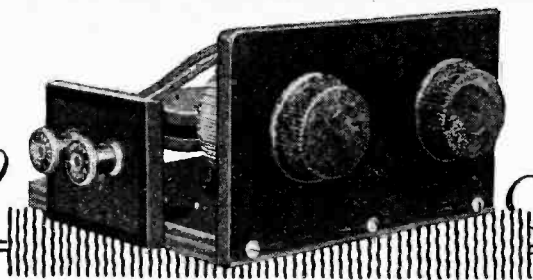

Constructing a Simple Filter to Minimise Background Noise.

By N. P. SLADE.

EVERY user of a gramophone is aware of that unwanted background of noise, which generally accompanies even the best reproduction, and which is familiarly known as "needle scratch." The provision of as clear a background as possible is a matter of so great importance in effective sound reproduction, whether by broadcast, disc, or film, that the writer feels that the following observations, embodying his own experience, in the case of gramophone records may be of interest to the reader who has neither the time nor opportunity to arrive at them for himself.

Normal needle scratch (excluding that produced by badly worn or damaged records) may best be regarded as a complex sound of high audio-frequency and constant intensity, which necessarily accompanies the friction between the groove and the needle-point. It is practically independent of the modifications produced in the groove by impressed audio-frequency variations, and its intensity level only varies relatively to the intensity level of the recorded matter, depending upon whether this level is high or low. Thus, on the loudest passages, the scratch is practically the same as on silent or unmodulated parts of the record, although it does not *sound* so pronounced, since louder passages may nearly, or entirely, cover it.

Pick-up Alignment.

As the scratch-level remains practically constant, it is obvious that it should be most prominent on the softest passages, particularly if these are of high frequency, and it is in the reproduction of such passages that scratch reduction presents its greatest difficulties. It is important, at the outset, to regard scratch as a

band of frequencies, and not, vaguely, as just indeterminate noise, which frequencies will, other things being as they should, be amplified and reproduced in the same way as the recorded matter. Regarded from this point of view, the problem of scratch reduction is capable of scientific approach, and becomes rather less of a boggy than when a more empirical view is taken of it.

Scratch production is, under the present scheme of things, a normal and necessary function of the mechanical means taken to convert the variations in the record groove into corresponding variations of electrical energy, and may, therefore, be conveniently considered

the case of ordinary steel needles, and least on the record.

The next consideration is pick-up alignment. This should always be so arranged that the needle point can follow the groove accurately, from the outermost to the innermost groove, without changing its position relative to the groove. If this is not the case, or very nearly the case, the needle will tend to cut across the groove, and to impose more resistance on one side than the other. In all good pick-up arms tracking errors have been reduced to a minimum, and the experimenter is relieved of the task of correction.

Comparing Needles.

Scratch can also be considerably influenced by alterations in the angle made by the needle with the record, and experience shows that the best angle for most purposes is 50°. Another point to consider is the type of needle. Most pick-ups work best with a steel needle, and of the many varieties of these the writer has obtained the most satisfactory results from "medium" or "soft-tone" needles. Those made by H.M.V. and Columbia give excellent results. It is, also, the writer's experience that fibre needles are not so satisfactory with pick-ups as the steel variety.

The actual weight imposed by the needle on the record influences scratch, and needs consideration. In the majority of cases, the lightest pressure, which will at all times hold the needle in the groove, is the best at which to aim. This point, again, is well considered in the design of the best pick-ups.

If, as suggested above, scratch is regarded as a composite sound of high audio-frequencies, the frequency-amplitude characteristic of

THE presence of needle scratch in the reproduction of gramophone records, while not necessarily interfering with the quality of music or speech, must always serve to remind the listener of the mechanical nature of the performance. Like the perpetual flicker of the old-time cinematograph, it tends to destroy the illusion of reality. The causes of background noise are carefully examined in this article and practical details are given for the construction of a scratch filter.

under definite headings. The first of these is the condition of the record. A brand-new record will often give rise to slightly more scratch than a used one. When properly applied to it, the effect of the rubbing of the needle should be to burnish the groove, and when this process has attained its maximum, scratch becomes noticeably less. The wear, for one playing, should always be greatest on the needle point, in

Needle Scratch.—

the pick-up must play an important part in passing these on to the amplifier. An important point now arises. Part, or all, of the frequency band occupied by scratch may be—and usually is—also occupied by recorded notes of the upper register. It is also occupied by harmonics of notes of lower frequency, which harmonics are a necessary part of the tonal quality of the sound concerned. From this, then, the dilemma is at once apparent. If we attempt to remove scratch, what is going to happen to the other sounds in the same frequency band? The answer can only be that they will be altered in intensity, and the whole tone of the recorded frequencies having harmonics in this band will also be altered.

Scratch Frequency.

It would appear, therefore, that, in attempting to remove scratch, we are taking the risk of spoiling the whole reproduction; and this is the point which must be kept foremost in mind when experiments are contemplated. At this point the writer would suggest to anyone who is thinking of purchasing a pick-up the importance of choosing one that *will* reproduce scratch, and therefore has an effective response in the higher register, and not to be tempted into purchasing one with a low cut-off. In doing so he will miss far more than the scratch. Some time ago *The Wireless World*¹ published a series of curves for different pick-ups, which forms an admirable guide, and the purchaser is advised to choose the instrument which gives the best and most even response from 250 to about 5,000 cycles. Below this a much higher gain is desirable, and in no case in the writer's knowledge is this gain too high. Having chosen a pick-up with a good high-frequency response, steps may be taken to reduce the scratch from it; but to *increase* the frequency range of a low cut-off pick-up is obviously impossible without actually altering the instrument.

Given that the pick-up, with its associated reproducing system, is capable of reproducing scratch, the

¹ See "Gramophone Pick-Ups Tested," March 26th, 1930.

question of getting rid of it resolves itself into the effecting of a compromise, which will depend very largely upon the individual listener's auditory susceptibilities. The level of recorded sound is generally kept as high as possible above the scratch level by the record manufacturers, and the only course open to us, therefore, is to reduce the amplification of the scratch frequency band to such a level that it is at a minimum when the recorded sounds are not very noticeably reduced in intensity. At this lower level the ear loses sensitivity rapidly, and scratch is rendered very much less audible than the relative proportion of it and the recorded sounds might lead one

amplitude of the upper frequency range.

Methods to Avoid.

In applying these methods, the reproducing system must be regarded as a whole; it is quite fallacious to consider the pick-up curve, the reproducer curve, or the possibilities of the amplifier alone. These all act as a unit, and as such must be balanced to meet their individual characteristics. The experimenter must know not only his pick-up, but the rest of the chain, and can then apply the methods to be mentioned to meet his own particular needs. For purposes of generalisation it is assumed that the amplifier and re-

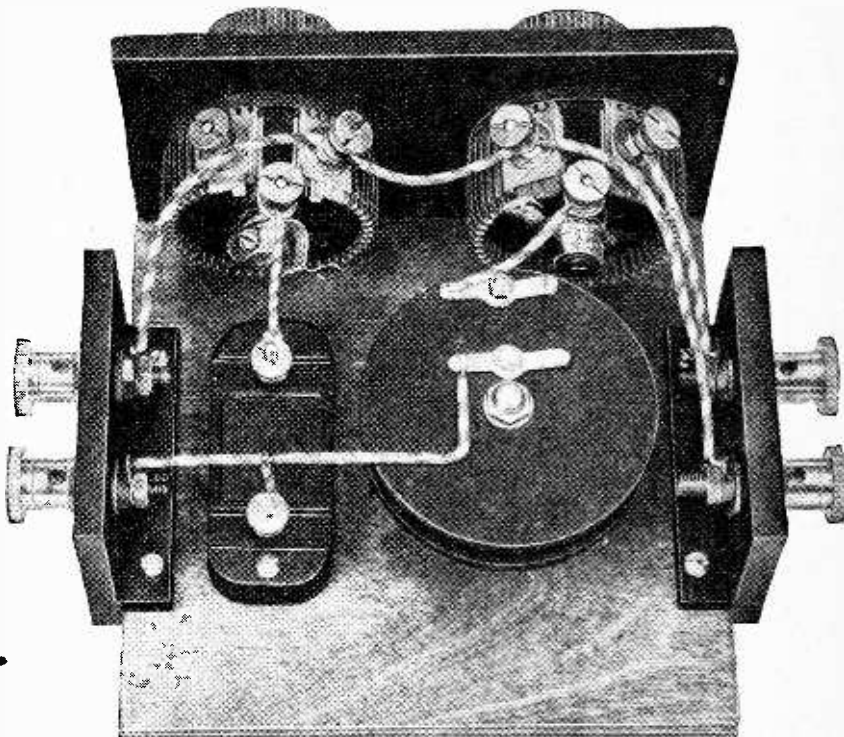

A scratch filter made up according to the circuit of Fig. 3. The two variable resistances are mounted on the panel and the inductance is wound on a small former clamped between two circular paxolin discs of 2½ ins. diameter.

to suppose. The apparent *relative* increase in the bass register forms a pleasing addition to those pick-ups which do not compensate for the lowered level of bass-recording quite sufficiently. Thus to reduce scratch effectively requires not only a nice decision on the part of the experimenter as to the degree of "musical balance" attained, but also a proper use of those methods which may be used to reduce the

producer have a good, even response at all frequencies which the pick-up will reproduce.

Higher audio-frequency response may be reduced by various devices, some good and some bad. Among the bad methods is the adding of a resistance in parallel with the pick-up. This will reduce the upper register according to the load it imposes; similarly, a condenser will shunt the upper frequencies, accord-

Needle Scratch.—

ing to its capacity. Both these methods are bad, because they give us, even if arranged to be variable, the wrong kind of control. What we require to do is to reduce the upper frequencies very gradually at

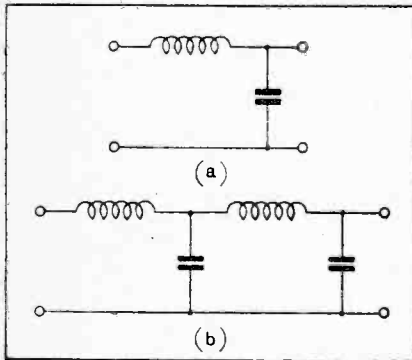

Fig. 1.—The circuit shown as (b) gives a sharper cut-off than (a), but the more gradual characteristic of (a) is considered preferable for scratch reduction.

first, and then more sharply, as we approach the cut-off level of the pick-up where the scratch frequencies are most effective.

Position of Filter.

The only proper way in which this type of attenuation may be brought about is by the use of a filter network; and, as has been seen, we require one so designed that the scratch level is shifted down to a point of very low gain, while the recorded frequencies, at their normal higher level, remain at a sufficiently high level to be still effective. An excellent example of such a filter is the simple single-element type (Fig. 1 (a)), which consists of a single inductance and a capacity. The actual construction of the filter is a very simple matter, but before going into details the importance of its position in the chain should be considered. "Filtering" may be employed either directly following the pick-up or at any point in the amplifying chain. If, however, the best use is to be made of the compensating effect obtainable, the filter should be placed after the first amplifying valve, as in Fig. 2.

In the case of those who use an amplifier which they do not wish to interfere with, the above method may still be employed if the valve and the filter are made up as a unit, and the output taken to the existing

pick-up connections of the amplifier. Precautions must, of course, be taken against overloading the input valve, and the use of a one-to-one ratio coupling transformer with an extra potentiometer volume control across its secondary is strongly advised. If it is decided to place the filter directly after the pick-up the circuit of Fig. 3 should be used, the modifications in values being noted. A practical unit to this specification is shown both in the title illustration and in the text. Suitable variable resistances are made by Regentone, Ltd.

Variable Resistance Control.

It is of great convenience to arrange that the filtering effect should be variable within limits, as one setting seldom suits all recordings. This may be done very simply and effectively by the addition of a

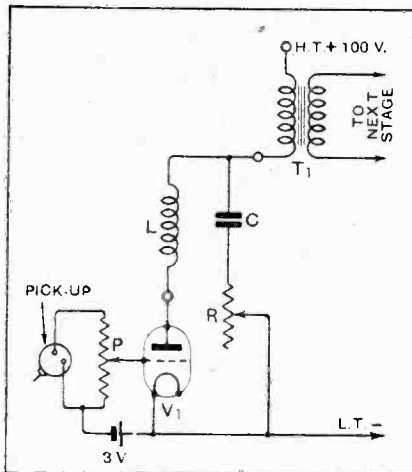

Fig. 2.—Scratch filter for use after the first valve in the amplifier. P is a potentiometer of 120,000 ohms; V₁ amplification factor 12.5 and A.C. resistance 3,600 ohms; L, 4,000 turns No. 40 enamelled wire on 1½ in. former; C, 0.1 mfd., and R, 2,000 ohms. The ratio of the coupling transformer T₁ depends upon the grid swing of the next valve, and where this is about 9 volts a one-to-one ratio is satisfactory.

variable resistance as indicated in the diagrams. With regard to the actual values of the various components, these are, of course, not hard and fast. Thus the same attenuation characteristic may be obtained with other values of L and C than those indicated, provided both are altered. The behaviour of the filter will also be affected by the input and output impedances. The experimenter should choose his own

values, to suit his own conditions, but the values given may be taken as a serviceable basis from which to work.

In conclusion, the reader is again reminded that the design of the filter is dependent on the behaviour of the whole "sound-amplification system," including the acoustical

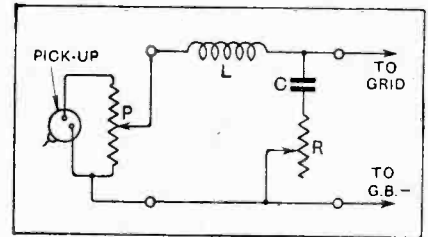

Fig. 3.—A filter to be interposed between the pick-up and the first valve. It will be found that the action of P and R are to some extent interdependent. P can be 120,000 ohms, and R, 50,000 ohms, whilst L has the same value as in Fig. 2. The condenser C is 0.006 mfd.

properties of the auditorium, and the orientation of the listener relative to the reproducer, and due allowance must be made for the effect of all these factors.

o o o o

"KABILOK" GRAMOPHONE CABINET.

A new cabinet, styled the Model G.P/1 Table Type Gramophone and Pick-up Cabinet, has just been placed on the market by W. and T. Lock, Ltd., 11, Red Lion Square, High Holborn, W.C.1. This is intended to house a gramophone motor and pick-up only, thus affording those possessing a receiver with provision for gramophone reproduction all the benefits concomitant with a complete radio-gramophone.

The inside dimensions are 15in. x 15in., and the depth below the motor board is 6in. This allows ample space for the

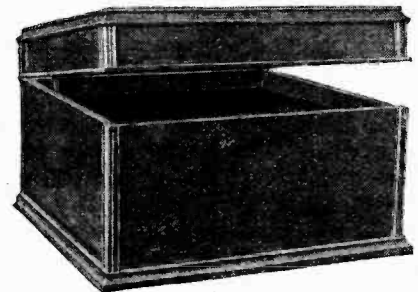

New "Kablok" cabinet designed especially to accommodate a gramophone motor and pick-up.

accommodation of a clockwork, or electric, motor. The overall clearance above the motor board is 3½ in., which should be more than sufficient for practically every type of pick-up at present available.

The price of this cabinet in oak is 45s.

POINTS in the DESIGN

of the

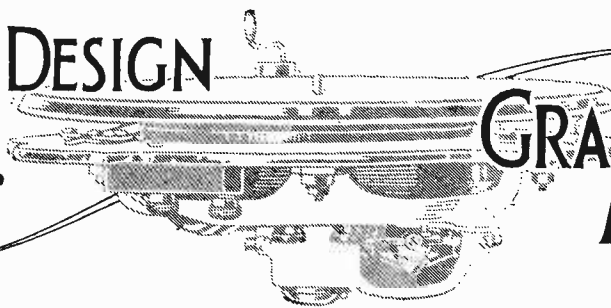

GRAMOPHONE MOTOR

THERE are to-day a large number of gramophone motors to select from and splendid efforts have been made by well-known manufacturers to provide low-priced reliable turntable driving units.

The home constructor usually has no means of judging accurately the performance of the various types, and the increasing variety makes the selection of the most suitable machine a matter of increasing difficulty. This article has been written to give an idea of the capabilities of the various types of gramophone motor—spring and electric—at present on the market, and to suggest and describe simple tests whereby the performance can be estimated fairly accurately.

What to Look for when Making your Choice.

ON account of low price, reliability and satisfactory performance, the spring motor is likely to remain a popular driving unit. Assuming a good motor, the only drawback generally apparent is the necessity for winding; but, to compensate for this, the unit is independent of all electrical supplies with attendant possibilities of electrical interference and breakdown. In addition, it usually gives very silent running, and will stand a fair amount of misuse.

While these qualities are possessed of spring motors in general, there are often marked differences in performance between one make and another which show up readily when relatively simple tests are carefully applied.

Ignoring the point of view of those who can enjoy music and wind a motor at the same time, it will be obvious that the playing capacity of a motor is of first importance. Motors are generally rated as being capable of playing one, two or more records; but, owing to the variation in the length of records, and to the different ideas of the makers of the motors, it is sometimes found that the motor is incapable of playing its quota of records without the reproduction falling off very badly towards the end, necessitating a hurried rewind. In a certain number of two-record motors tested, for example, the playing time during which reproduction was satis-

factory varied from eight minutes to eleven minutes. Obviously, in the lowest instance, the time had been cut too fine, and the motor would rarely do its appointed task without a rewind being necessary during the playing of the second side of a 12in. record.

The length of running time during which reproduction is satisfactory is determined by the main spring, the gearing and the governor; and, fortunately, it is not necessary to consider the action of these independently. Owing to the unwinding of the spring, the torque available gradually decreases. One of the functions of the governor is to keep the speed as constant as possible in spite of the falling-off in driving power; but as no governors perform this function perfectly, there is generally a falling in turntable speed, as the motor runs down

independent of any variation in the retarding load applied by the needle on the record.

Speed Variation Tests.

With a good motor this fall in speed should take place so gradually, and be so small, that its effect upon the reproduction should not be noticeable to the ear unless some standard of comparison is available—as, for instance, when the record is accompanied on a piano.

A quantitative determination of the reduction in speed can, however, be

easily made with a stop-watch, and a stroboscope disc and lamp (Fig. 1). A standard lighting lamp on A.C. supply will do in place of a properly controlled neon lamp, which, though giving more accurate results, is not likely to be available in the ordinary way.

The speed is measured when the motor is fully wound,

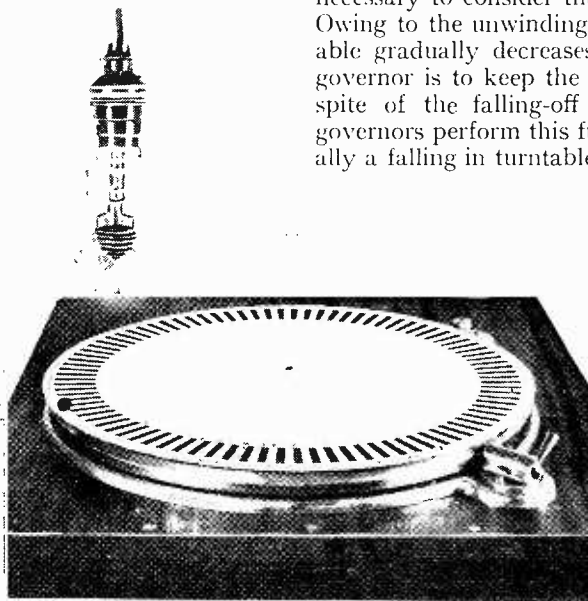

Fig. 1.—A large stroboscope disc fitted to a gramophone turntable and illuminated by a neon lamp for the purpose of checking the speed regulator.

Points in the Design of the Gramophone Motor.—

and then at succeeding intervals of time, by observing the rates at which the stroboscope dots move past a fixed point. The instrument should not be playing while these observations are being made. The results of such tests are often very surprising. A number of two-record motors gave the curves shown in Fig. 2. The curve marked A was obtained from a high-class experimental motor, and shows what excellent results can be obtained by good design. Curve B was obtained

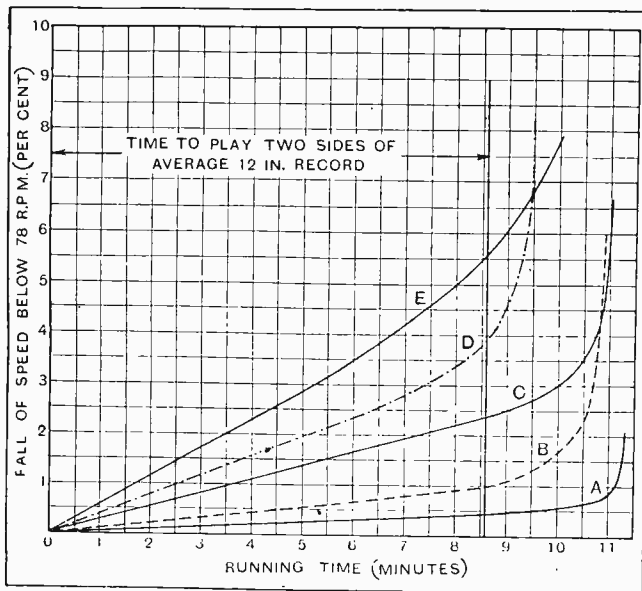

Fig. 2.—Speed-time curves for various makes of two-record spring motors. No record being played.

from a high-grade motor made and used by a well-known firm, while curves C, D and E were obtained from proprietary motors which are giving quite good service in the hands of the public.

Typical double-spring motors are the Collaro and the Garrard Super-Enclosed designs; the latter is self-lubricating by means of an oil pump, and is illustrated in Fig. 3.

The Value of the Stroboscope.

In addition to variations in driving force, variations in load are also encountered, due, among other things, to the varying radius on the record at which the needle is working, to loud and soft passages on the record, and to variation in coefficient of friction at the needle point due to uneven record wear. This comment applies, of course, equally in the case of all electric gramophone motors. The ability to withstand these load variations without noticeable speed variation is again dependent on the combination of main spring torque, gearing and governor. The change in pitch which occurs when a poor motor is used and a loud passage on a record is encountered can often be heard without difficulty; but in the absence of a suitable record this means of comparing two motors is useless.

If a stroboscope and stop-watch are available, however, a comparison is easily made, no matter what record

is used. The simplest plan is to set the motor speed so that the stroboscope disc marks are stationary before the needle is lowered on to the record, and to observe the time taken for a given number of marks to slip by when the selected test passage is played. As the slip observed depends, to some extent, on how far the spring motor is wound, care must be taken to ensure that the test conditions are really comparable for the different motors. This test will show that there is a considerable variation between one make of motor and another, though both may be designed for the same purpose, and may, to all intents and purposes, appear to be very similar.

A number of well-known spring motors tested in this manner, with loud-tone needles, gave measured values of slip varying from 0.1 per cent. to over 1.0 per cent. A quick-speed change of about 0.6 per cent. can just be detected by ear, and thus some motors would fail to pass a test where this value was taken to be the highest permissible limit. With a new motor, regular variation in speed during each revolution is not likely to occur; but, if such unsteadiness is present, it is usually noticeable aurally, particularly if a record having long, sustained notes is used for test purposes. Before drawing conclusions, however, it is necessary to make sure that the record is flat, and that it is revolving concentrically.

Silent Running.

Certain other details should also be examined before deciding on a motor. Although there is little to choose between different makes of motor from the point of view of silent running when new, the incorporation of certain features may add somewhat to the silent running life of the motor. In this connection it is interesting to examine such items as the finish of the gears, the design of the bearings, the materials used, the fits of the spindles in them, and the provision made for bearing lubrication.

The winding gear is also an item of importance. The mean features of interest are possibly the number of turns to wind and the means taken to provide good lubrication of the gear if of the worm type, as the ease and smoothness with which the motor can be wound depends to a considerable extent upon these factors.

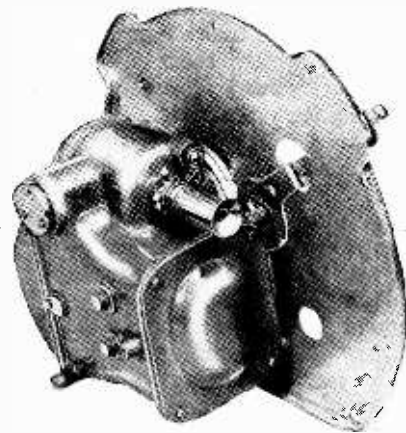

Fig. 3.—Self-lubrication by means of an oil pump is a feature of this Garrard super double-spring motor.

Although one of the disadvantages of the spring motor—the necessity for winding—is overcome in the

Electric Motors.

Although one of the disadvantages of the spring motor—the necessity for winding—is overcome in the

Points in the Design of the Gramophone Motor.—

electric motor, a number of other undesirable features are introduced which will be discussed in some detail. In addition, there are a number of features common to both types of motor.

We may, for instance, at first sight expect the torque of an electric motor to be constant, and assume that the governor has merely to compensate for changes in load. While the torque of an electric motor does not fall away in the same way as does that of a spring motor, nevertheless, it fluctuates as the supply voltage rises or falls, and also falls slightly as the motor heats up. Generally, however, the changes take place too slowly to produce an audible effect, though if it is possible to make a comparison with another instrument which does not vary over longer periods of time, the

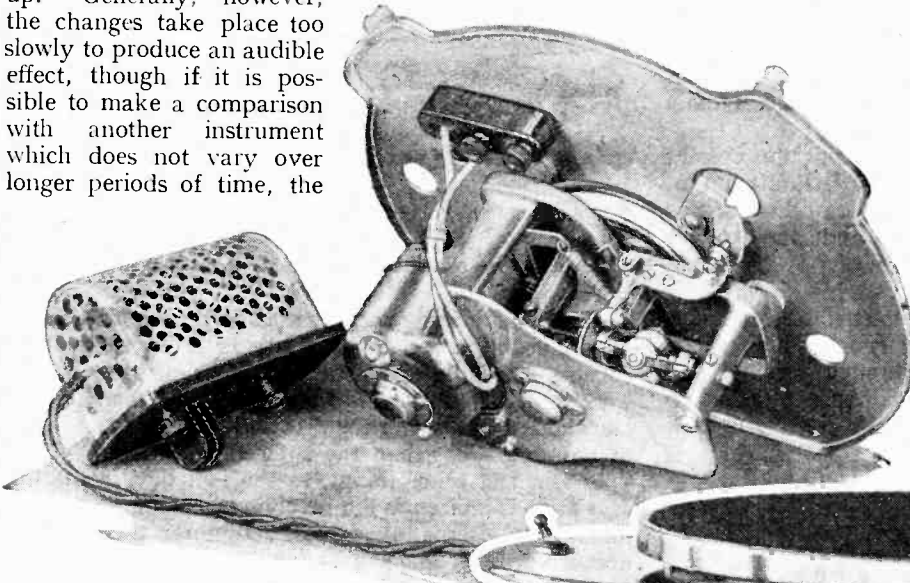

Fig. 4.—A universal type of motor where-by the turntable spindle is driven by means of an endless belt and is equally suitable for operation by A.C. or D.C. mains is shown in the above illustration of the Garrard Universal model.

change in pitch due to changes in voltage and temperature may just be noticeable. The change in speed due to a change in applied voltage as ordinarily encountered, should, for a good motor, be quite small.

On a 220-volt induction disc motor, for instance, a change of 10 volts produced a change in speed of just under 0.1 per cent. of normal speed, but this figure, however, is often exceeded. Likewise, the reduction in driving torque caused by the heating of the motor may cause the turntable speed to be lowered by over 0.5 per cent. after three or four hours continuous running. The question of change of speed with change in load has already been touched upon when discussing spring motors, and there is little to add. The problem encountered with the electric motor is, however, rather simpler, as the driving torque is practically constant.

At the present time, there is a diversity of types of electric motor upon the market, this being due partly to the variation in electric supplies—voltage, frequency, etc.—and partly to the differing ideas of the motor manufacturers. Each type of motor, of course, has its own advantages and limitations.

A very popular layout is a medium-speed universal motor driving the turntable spindle by means of an endless woven or rubber belt, typical examples being the Garrard Universal, shown in Fig. 4, and the higher priced of the two B.T.H. Units. This type has appealed in the past no doubt on account of its universality—being equally suitable for direct-current supplies of any voltage and alternating-current supplies of various voltages and frequency.

As the belt is kept tight by a tensioning device and the governor is positively driven by the turntable spindle through gearing, there is little possibility of speed variation, but if new belts are fitted they should be of the variety with no pronounced joint. The only attention which this type of motor requires is occasional oiling, and cleaning of the brushes and commutator. Excessive sparking gives rise to noise and possibly electrical interference with other units.

An alternative scheme is that adopted in the new B.T.H. lower-priced model—Fig. 5—in which the motor drives the turntable through gearing. This arrangement eliminates the belt and gives a more compact

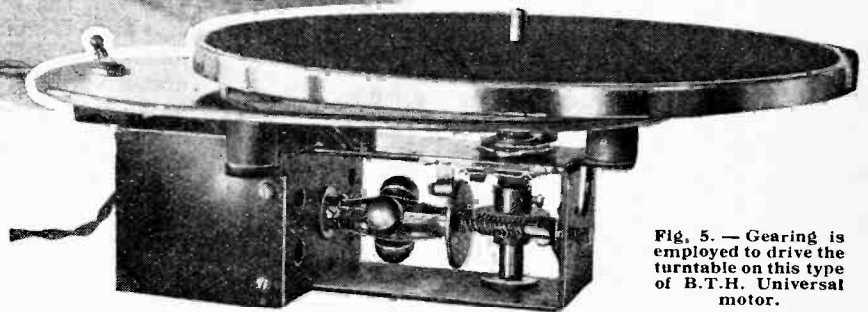

Fig. 5.—Gearing is employed to drive the turntable on this type of B.T.H. Universal motor.

arrangement. The motor, however, generally runs at a higher speed than that in the belt-drive type, and is generally more noisy in consequence.

An unusual arrangement is adopted in the Dual Universal Motor. Here there is no iron in the armature, the coils being placed on a non-magnetic cup-shaped former which rotates in the air gap between electro-magnets inside the cup and the steel case of the motor. There is, however, nothing to choose between this and the more conventional design.

Universal Motors are, in themselves, only suitable for fairly low voltages and, to accommodate a range of voltages and frequencies, have to be used with suitable resistances. The Garrard Universal motor operates on 50 volts, the voltage drop being effected through a box resistance. On the more expensive motors this resistance is a separate unit, but on the lower-priced types the field coils are often wound with resistance wire, and a number of tappings are provided to accommodate different standard voltages and fre-

Points in the Design of the Gramophone Motor.— frequencies. This construction is adopted on the new B.T.H. Motor and on the Dual Motors. Usually, much more power is wasted in the resistance than is turned to useful account in the motor. For this reason those motors in which the field winding is made to serve as the motor resistance usually become hotter on running, this causing greater torque variation between cold and warmed-up conditions—and hence greater speed variation—than is usual with the type having an external resistance.

The item likely to cause most trouble on a universal motor, however, is the commutator. Mainly for this reason, as voltages and frequencies are becoming standardised, and D.C. supplies are being converted to A.C., universal motors of the types already described will probably be superseded by special purpose A.C. motors which do not require a commutator.

Progress in this direction is indicated at the present time by the introduction of the Garrard, Paillard 150, and Collaro induction motors, which, like others of this type, are suitable for 100-130-volt and 200-250-volt 40-60 cycle supplies. The Garrard motor is illustrated in Fig. 6.

Induction motors fall into two distinct classes, namely, those in which the motor element runs at high speed and drives the turntable spindle through gearing, and those in which the motor element is directly attached to the turntable spindle. Both types, of course, need a

represented by the Garrard, and the Paillard 120, is very satisfactory for A.C. supplies, and is widely used.

It is possible to design a motor to work satisfactorily over a voltage range of 100-125 and 200-250, and over a frequency range of 40-60 cycles, and this is generally all that is required. The rotating field necessary for the starting and the running of this type of motor is obtained by splitting the phase either by using inductive and non-inductive windings on the field-magnet units or by using the shaded pole construction.

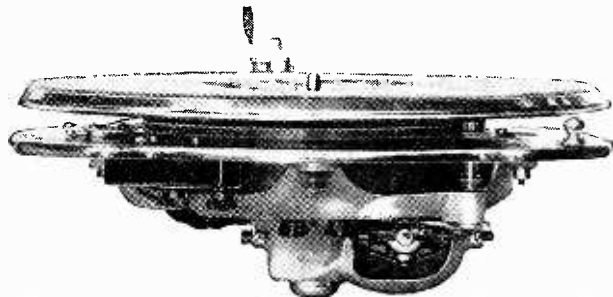

Fig. 6.—The induction type of motor drive is shown in the above Garrard model.

The former arrangement is used on the Apollo Paillard 120 induction motor. The squirrel cage and shaded pole construction is, however, adopted in the Garrard motor. The results obtained with both types are generally similar, though of the two the disc and cup types are likely to be more silent than the squirrel-cage type. This is due, amongst other things, to the fact that in the first case there is no iron in the revolving element, which simplifies the alternating forces acting on this portion, because the air gaps are definitely fixed, not being formed between a stationary member and one rotating in bearings, and because irregularities in the revolving element are less likely to occur.

Compared with other types, however, the motors are very silent running, and remain so after prolonged use, mainly owing to the fairly uniform driving torque and to the absence of the commutator and brushes which need regular attention if the best results are desired.

There is also no possibility of electrical interference through brush sparking, and A.C. hum should be scarcely audible. Another important feature is that no external resistance is required, the motors usually being arranged so that certain coils can be connected in series or in parallel to accommodate two voltage ranges.

Synchronous Motors.

Synchronous motors, in which the speed is determined solely by the A.C. supply frequency, have made little headway up to the present; but this type will undoubtedly receive more attention as a supply frequency of fifty cycles becomes

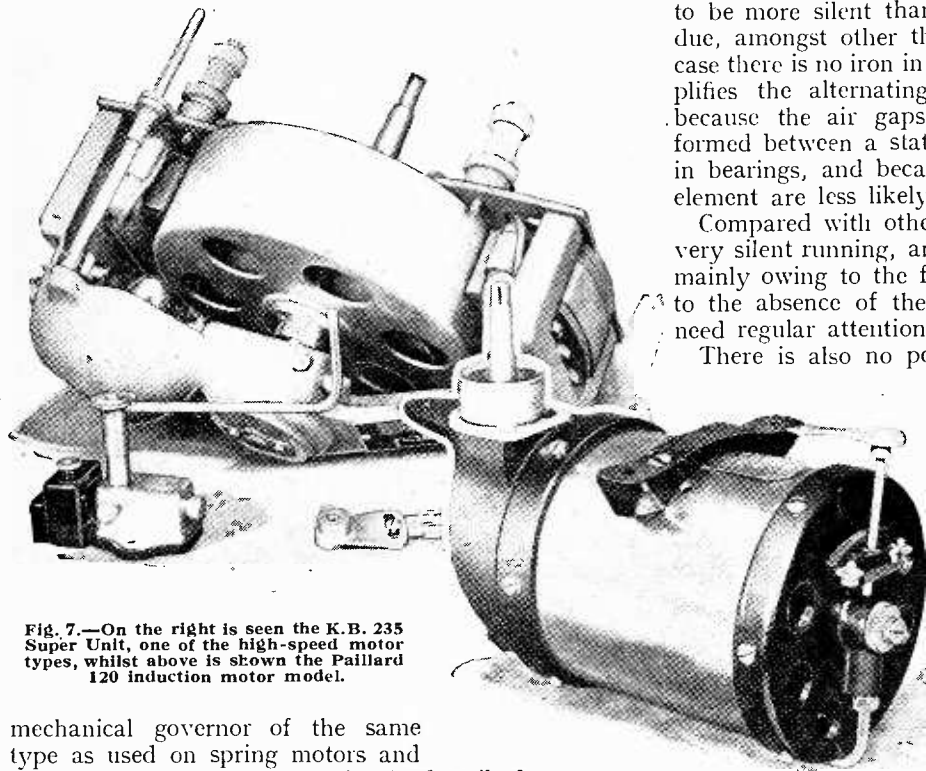

Fig. 7.—On the right is seen the K.B. 235 Super Unit, one of the high-speed motor types, whilst above is shown the Paillard 120 induction motor model.

mechanical governor of the same type as used on spring motors and universal electric motors previously described.

The latest high-speed motor is the Paillard 150, which is a very neat design giving a good performance. Another example, which has been in use for some time, is the K.B. 235 Super, shown in Fig. 7. The slow-speed type,

Points in the Design of the Gramophone Motor.—

standardised and is more accurately maintained. These motors require no governor, and are thus of simpler construction than the other types, as a motor can be designed to run at turntable speed without any gearing being necessary. This is done on certain motors of Continental and American origin, but none are sold in this country.

An alternative scheme is to run the synchronous motor at a higher speed and to drive the turntable spindle by gearing, but the scheme then loses some of its simplicity. Single-phase synchronous motors are not self-starting, but the high-speed ones can be made so by combining the induction and synchronous principles—the motor starting and running up to synchronous speed as an induction motor. When the synchronous speed is reached, the motor continues running as a synchronous motor owing to the special design of the armature and field system. The only motor of this type available in this country is the Harlie, which is self-starting, runs at 1,500 r.p.m., and drives the turntable by means of a belt. The power consumption of this motor is 35 watts, which is greater than that of the simple non-starting variety.

The majority of slow-speed synchronous motors manufactured abroad are rather noisy mechanically, have considerable A.C. hum, and give unsteady reproduction. This latter fault can, however, be overcome by suitable design. The power consumption of this class is very low, in some cases being about five watts.

The only other class of motor of which mention should be made is the combined spring-electric unit, which sets out to incorporate the good features of both component types.

The Dual Motor, shown in Fig. 8, is an interesting example. In this case the unit is composed of two standard motors—one spring and the other electric—and the turntable may be driven by each independent of the other. In the A.E.D. Unit, however, the electric motor is used solely to wind the spring motor, being automatically stopped when this operation is completed. The turntable is thus always rotated by the spring motor, but this may be wound either electrically or by hand. Unless a motor is required definitely capable of being operated either electrically or by hand, these double motors seem to have little to recommend them, and this view is supported by the lack of examples adopted by makers of radio-gramophones.

It will be gathered from the above that the power consumption of different classes of motors varies somewhat. Those with which a series resistance must be used have to be credited with the power which is wasted in the resistance, and then compare unfavourably with

the types employing the induction and synchronous systems.

As the figures for the different types overlap considerably it is impossible to say one type is more economical than another. But as in nearly all motors available the consumption is less than 25 watts (excluding losses in resistance when these are used with Universal Motors), it is so small that it should have little or no influence on the choice of a motor.

Conclusion.

The foregoing discussion is far too brief to cover every point likely to arise in the selection of a gramophone motor, but enough has probably been said to enable a general idea of the capabilities of each type being obtained.

Within the limitations imposed by their principles of operation, spring motors have been highly developed and progress in design is mainly in detail. With electric motors, however, the field open to development is greater, and, in consequence, greater progress is being made in design.

If the choice of a motor lies between spring and

electric types it should be remembered that practically the only disadvantage of the former is the necessity for winding. On the other hand, its first cost is about half that of an electric motor of equivalent quality; its running costs are nil; it is more silent than the best electric motor; it needs less frequent attention; and the reproduction obtainable leaves little to be desired. If an electric motor is decided upon, for D.C. supplies there is no alternative to the commutator motor, but where conditions of voltage and frequency are favourable the turntable speed induction motor is to be preferred. Its advantages over the commutator motor from the point of view of silence and smooth, trouble-free running are incontestable.

The incorporation of the electric motor in electrical-reproducing instruments is, of course, the natural line of development, and, in the higher-priced instruments on the market, the supersession of the spring motor is already complete.

o o o o

"TURNTABLE."

FOR PHOTOGRAPHERS.

FOR many years Wall's "Dictionary of Photography" has been the standard reference book for amateur and professional photographers. The twelfth edition has just appeared, edited and largely rewritten by F. J. Mortimer, F.R.P.S., Editor of *The Amateur Photographer and Photographs of the Year*.

The contents are arranged in dictionary form, and the edition is up to date in amateur cinematography, colour photography, and the latest processes, although the price is lower at 7s. 6d. The publishers are Iliffe and Sons Ltd., Dorset House, Tudor Street, E.C.4.

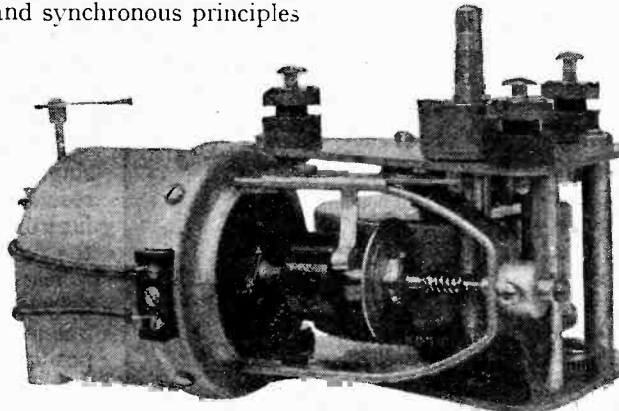

Fig. 8.—A combined spring and electric unit is incorporated in this Dual Motor unit.

RADIO-GRAMOPHONES.

Representative Types Reviewed.

In the following pages brief descriptive reviews are given of six representative radio-gramophones, together with circuit diagrams and drawings showing the arrangement of apparatus within the cabinets. In limited space it is impossible to deal with the finer points of design, but an attempt has been made to draw attention to all the more important features of each instrument.

Models designed for operation on A.C. mains have been selected for description, although for the benefit of those with a D.C. supply, it should be pointed out that in several cases alternatives are available for this type of current, or a special rotary converter can be supplied.

Each instrument is intended for operation on an outside aerial, but almost every set is sensitive enough to provide a sufficiently wide choice of programmes to meet the average requirements of a radio-gramophone user—who naturally insists on quality rather than quantity—with the help of quite a short indoor aerial.

COLUMBIA

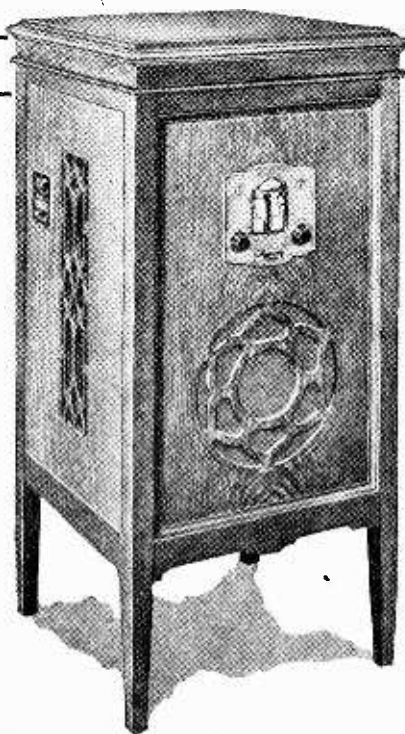

Pedestal Model 310

UNTIL recently the so-called standard receiver circuit, having a single H.F. stage followed by a detector feeding direct into the output valve, was rather neglected as far as radio-gramophones were concerned. It is hard to see why, as all the well-known advantages of this circuit arrangement, of which not the least is comparative immunity from L.F. interaction troubles, apply with equal or even greater force to an instrument which is to be used for gramophone reproduction. For a long time it has been possible to obtain from two valves sufficient L.F. amplification for almost any requirements, except, perhaps, when the least sensitive type of pick-up is used.

The Model 310 Columbia instrument, described officially as a "Radio Graphophone," is illustrative of what may be done by making the most of the circuit in question. A number of refinements are included, and, although more controls are fitted than is usual, this may be considered as an advantage rather than otherwise, provided that the user will trouble to learn the purpose of the various adjustments—not a matter of any real difficulty, as a comprehensive instruction book is supplied.

Signal input to the H.F. valve, which is coupled by a tuned anode circuit, is regulated by a differential aerial condenser, so arranged that changes of tuning are largely avoided when regulation is made. There is also an H.F. potentiometer for controlling input. This apparent duplication of control is by no means without its uses, particularly when operating the set near a powerful transmitter, especially of the "twin" type. It will be observed that the tuned anode circuit is arranged on the so-called "Hartley" principle, in which a

single coil serves both for tuning and reaction; symmetry is maintained by inserting the long-wave loading coil at the centre point.

The next valve functions as a grid detector, or as a first-stage gramophone amplifier, depending on the position of the change-over switch. A transformer is fitted for the pick-up, and, by connecting a tapped potentiometer across the primary, matters are so arranged that reproduction of normal or extra volume may be obtained. Final regulation of intensity is effected by a continuously variable potentiometer joined across the transformer secondary winding.

The L.F. coupling is rather unconventional, in that a choke is used as a parallel feed device for the transformer, in place of the more usual resistance. A step-down transformer transfers the output of the directly heated L.F. valve to a low-resistance moving-coil loud speaker; it should be noted that the field winding of this instrument, in series with a fixed limiting resistance, is shunted directly across the rectifier output.

Grid bias for all valves is obtained from a potentiometer in the H.T. negative lead, and the possibility of introducing mains hum at these points is avoided by shunting the resistances with an electrolytic condenser of high capacity.

Construction is on modern lines throughout, and the receiver unit has clearly been designed as a complete entity rather than as a mere assembly of components.

The instrument is made by the Columbia Graphophone Co., Ltd., 102-108, Clerkenwell Road, London, E.C.1, and, in an oak cabinet, costs 40 guineas complete. In figured Honduras mahogany, the price is increased to 43 guineas

SPECIFICATION.

CIRCUIT: Single H.F. stage, coupled by tuned anode circuit to grid detector. Choke-fed L.F. transformer coupling to triode output valve.

CONTROLS: Two side-by-side tuning drums; H.F. input volume control and H.F. potentiometer; gramophone volume control, combined wave-range and radio-gramophone switch; on-off switch; normal and full-volume gramophone switch.

GENERAL: For operation on A.C. supplies with outside or mains aerial.

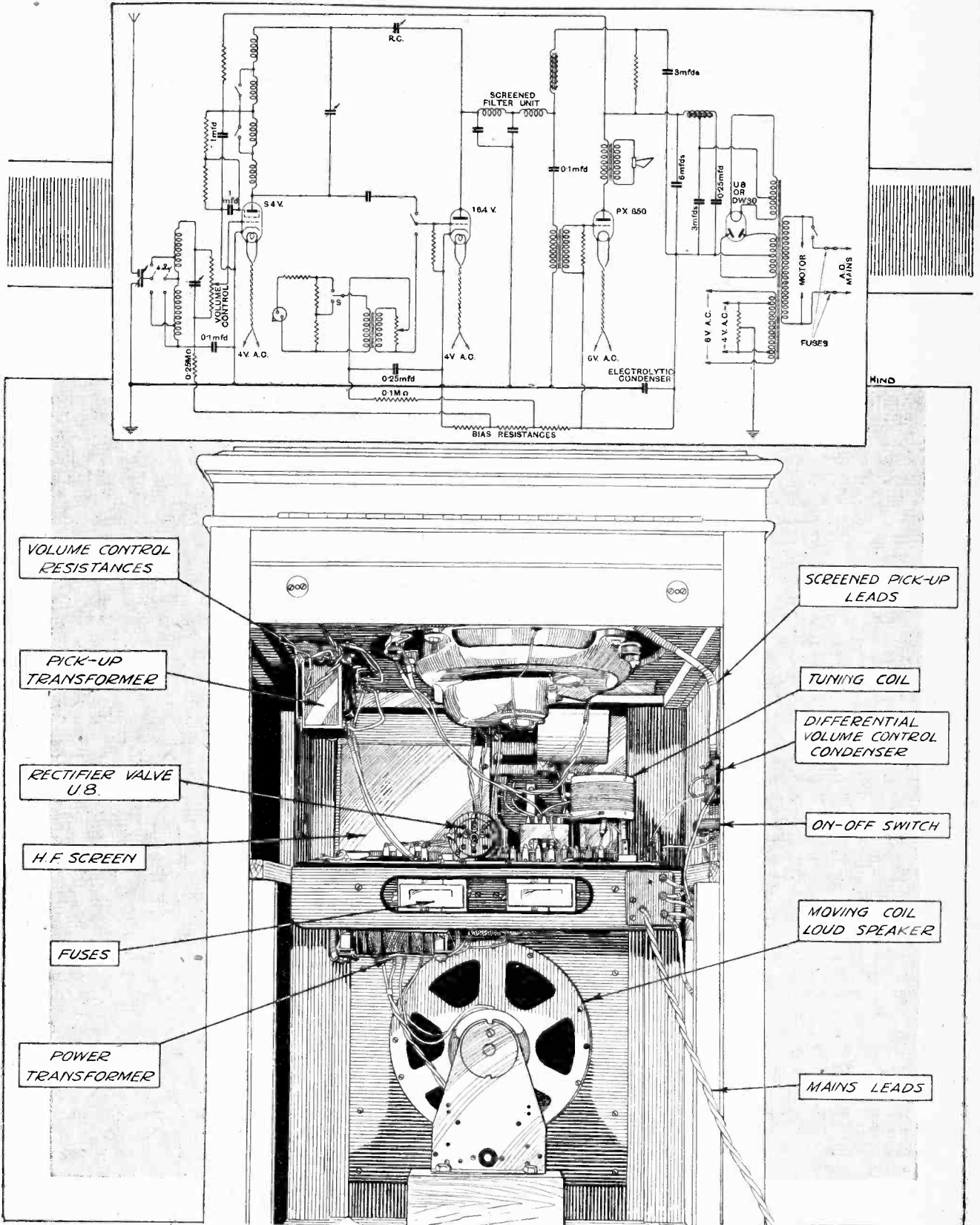

Circuit diagram and interior layout of the Columbia Model 310 radio-gramophone.

HIS MASTER'S

IT was sometimes urged against radio-gramophones—in their early days—that insufficient care was devoted to the design of the H.F. circuits. Such reproaches cannot be applied to the "H.M.V." instrument, which embodies a sensitive radio receiver of the most advanced design, with two H.F. stages, ganged control, and many other refinements, both with regard to its circuit arrangement and its constructional details. Although the set is much more sensitive than that usually fitted in a radio-gramophone, the L.F. amplifier has not been allowed to suffer, and we find an obviously carefully planned circuit, with a special—and, it is believed, unique—feature, in the form of a "bass regenerator," which compensates for any shortcoming that the pentode output valve may have as an amplifier of very low frequencies in normal circuits.

Aerial coupling is direct, but through a fixed condenser of such small size that the disturbing effect (on the ganged tuning system) of aerial capacity is practically negligible. Tuned grid couplings of conventional design are used in the H.F. amplifier, and there is no reaction in the ordinary sense, although a certain amount of regenerative amplification may be introduced by suitably adjusting the volume control, which is in the form of a grid voltage regulating resistance.

The detector operates on the grid principle, and the circuit constants are chosen to give sensibly linear rectification combined with a large power output, which is necessary in view of the fact that there is but a single L.F. stage. A transformer, fed by a parallel resistance-capacity circuit, is used as a coupling between the detector and a pentode output valve. By making a part of the bias resistance in the grid circuit of this valve common to the L.F. return path of the detector anode circuit, regeneration is introduced. Due to the presence of by-pass condensers, this regenerative or "boosting" effect will be most effective so far as signal impulses of low frequency are concerned, and, in consequence, only these frequencies will receive additional amplification.

A moving-coil loud speaker with a permanent field magnet is fed from the pentode through a step-down

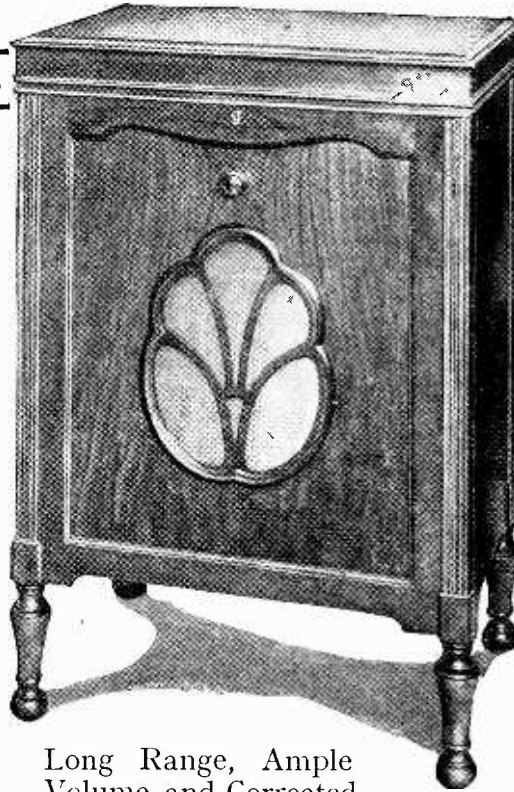

Long Range, Ample
Volume and Corrected
L.F. Amplification.

VOICE Model 521

transformer—the speech coil is of the low-resistance type—with a shunting resistance across its secondary winding. Grid-bias potentials for the H.F. and output valves, and also for the detector when this valve is converted to act as part of the gramophone amplifier, are developed across resistances connected in appropriate positions in each of the cathode leads.

The entire receiver chassis is cleverly planned, and is a real engineering job. Not only has it been developed to perform its appointed functions in the best possible way, but the question of service has been taken into account; both by virtue of layout and the "colour code" wiring scheme, repair work and internal adjustments can be effected much more quickly than usual. As time is money in these matters, the point is clearly of importance to prospective purchasers.

Among other interesting features of design, mention should be made of the die-cast tuning condenser assembly, which is operated through a cord passing round a worm wheel. Radio and gramophone controls are mounted on a common spindle, and the wave-range and change-over switches, which are actuated by a four-position control knob, look as if they should never give trouble through intermittent contacts.

There is automatic control for the turntable motor, which is stopped or started by movements of the pick-up arm. Calibration of the tuning scale drum indicator is directly in wavelengths.

Provision is made for an aerial connection to the mains; this will usually provide sufficient sensitivity to give a fair choice of programmes, but greater range may be had with the help of an outdoor aerial.

Designed to harmonise with modern furnishing schemes, the cabinet is of dull polished walnut, and is commendably free from efforts at ornamentation. Bulk is by no means excessive; indeed, the instrument is rather smaller than usual. No set could be easier to operate, as the number of controls has been reduced to the minimum.

The complete instrument as described costs 48 guineas, and is manufactured by The Gramophone Company, Ltd., 363-367, Oxford Street, London, W.1.

SPECIFICATION.

CIRCUIT: Two H.F. stages with tuned grid couplings; grid detector, coupled by resistance-fed transformer to pentode output valve.

CONTROLS: Single-knob tuning; combined wave-range, on-off, and radio-gramophone switch; combined volume control.

GENERAL: For operation with mains aerial or external aerial on A.C. supplies.

M. R. G.

THE principle of "switch tuning," by means of which a selection of programmes varying from the efforts of a local twin transmitter to perhaps a round dozen or even more stations, is by no means new, and is slowly gaining ground as applied to ordinary receivers. In spite of the fact that the system would seem particularly suitable to a radio-gramophone, the instrument with which we are here concerned seems to be the only one in which it is adopted.

It will hardly be necessary to point out that the great advantage of the system lies in its simplicity; anyone can turn a switch, but there are still those who profess inability to master the supposed intricacies of tuning, or else assert that the artistic merit of a programme is partly lost if it has to be "fished out of space" by delicate adjustments.

In the case of the "Regionogram" we have three separate tuned circuits, controlled by variable condensers of which the knobs are mounted on a sunk panel. Two of these circuits can be adjusted to resonate within the normal broadcast waveband, while the third may be tuned to a long-wave transmission. Appropriate circuit changes are effected through a switch, by means of which either of the first-mentioned condensers may be connected across the medium-wave inductance coil; in the third position a long-wave loading coil is open-circuited, and the fourth setting provides for gramophone reproduction.

As an example of the way it is intended that the receiver should be operated, the medium-wave circuits will normally be tuned to the local twin Regional stations, while the long-wave circuit will be set to receive the "National" transmission from Daventry. Reception of distant stations is not entirely precluded, particularly as the set employs highly efficient modern valves, as any one of the circuits may be set to any wavelength within their range of tuning.

Apart from this special feature, the circuit is fairly conventional, consisting as it does of a regenerative detector, transformer-coupled to an indirectly heated pentode output valve. Decoupling and smoothing is rather more complete than usual, as there is a double resistance-capacity filter in series with the detector anode circuit.

The receiver is entirely mains operated, and it will

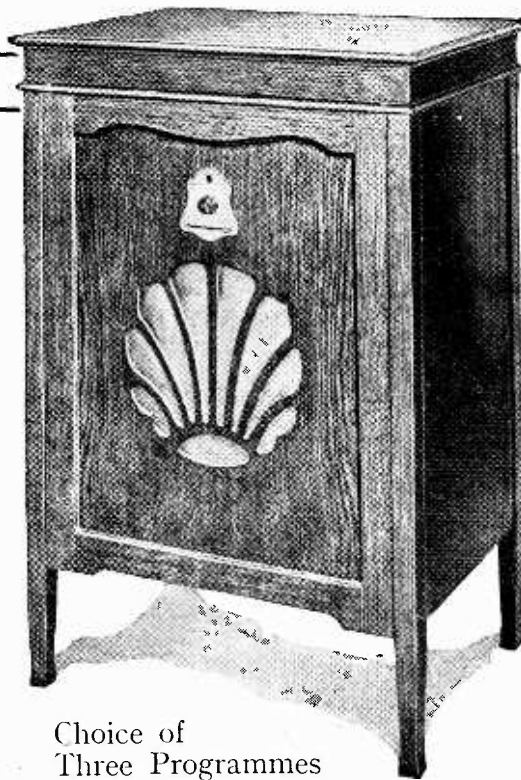

Choice of
Three Programmes
with Station Selector Switch.

Regionogram

be observed that the loud speaker field winding is made to serve as a smoothing choke.

Grid-bias potentials are derived from the anode current supply in the conventional way, and these circuits are fully decoupled. Simplicity of operation is increased by combining the station selector switch with the radio-gramophone change-over and with the on-off switch. Further, the gramophone volume-control potentiometer is mounted on a common shaft with the reaction condenser; thus regulation of intensity of both methods of reproduction is made by operation of the same knob. This ingenious and highly practical detail is certainly worthy of praise, particularly in view of the special purpose of the receiver.

A two-pole induction motor with an automatic break switch is fitted, and the B.T.H. pick-up

is of the reversible type, which facilitates the changing of needles.

As the AC/PEN output valve is operated under optimum conditions, power output is more than adequate for ordinary domestic purposes. It will be seen from the circuit diagram that a tone-control condenser is shunted across the primary winding of the output transformer, which, incidentally, is designed for its special purpose.

The receiver is solidly constructed, and an examination of the components which usually account for troubles failed to reveal any weakness whatsoever. In spite of its simplicity and comparatively unambitious character, a set of this sort should be well capable of satisfying the needs of those who are satisfied with good reproduction of signals at short to medium range—and, of course, of gramophone records. Thanks to the fact that aerial connection may be made through a semi-variable condenser, conditions should hardly ever arise where selectivity will not be adequate, always provided that consistent long-distance reception

is not expected. For those who must have more choice of programmes, the manufacturers, Mains Radio Gramophones, Ltd., 6 and 9, Vaughan Street, Bradford, produce a more ambitious model with an H.F. stage and input band-pass filter.

In an exceptionally well-made and finished oak cabinet, the complete set as described costs 26 guineas.

SPECIFICATION.

CIRCUIT: Detector with reaction and transformer-coupled pentode output valve.

CONTROLS: Combined station selector, on-off, and radio-gramophone switch. Combined radio and gramophone volume control.

GENERAL: For operation with inside or outside aerial and A.C. supply mains.

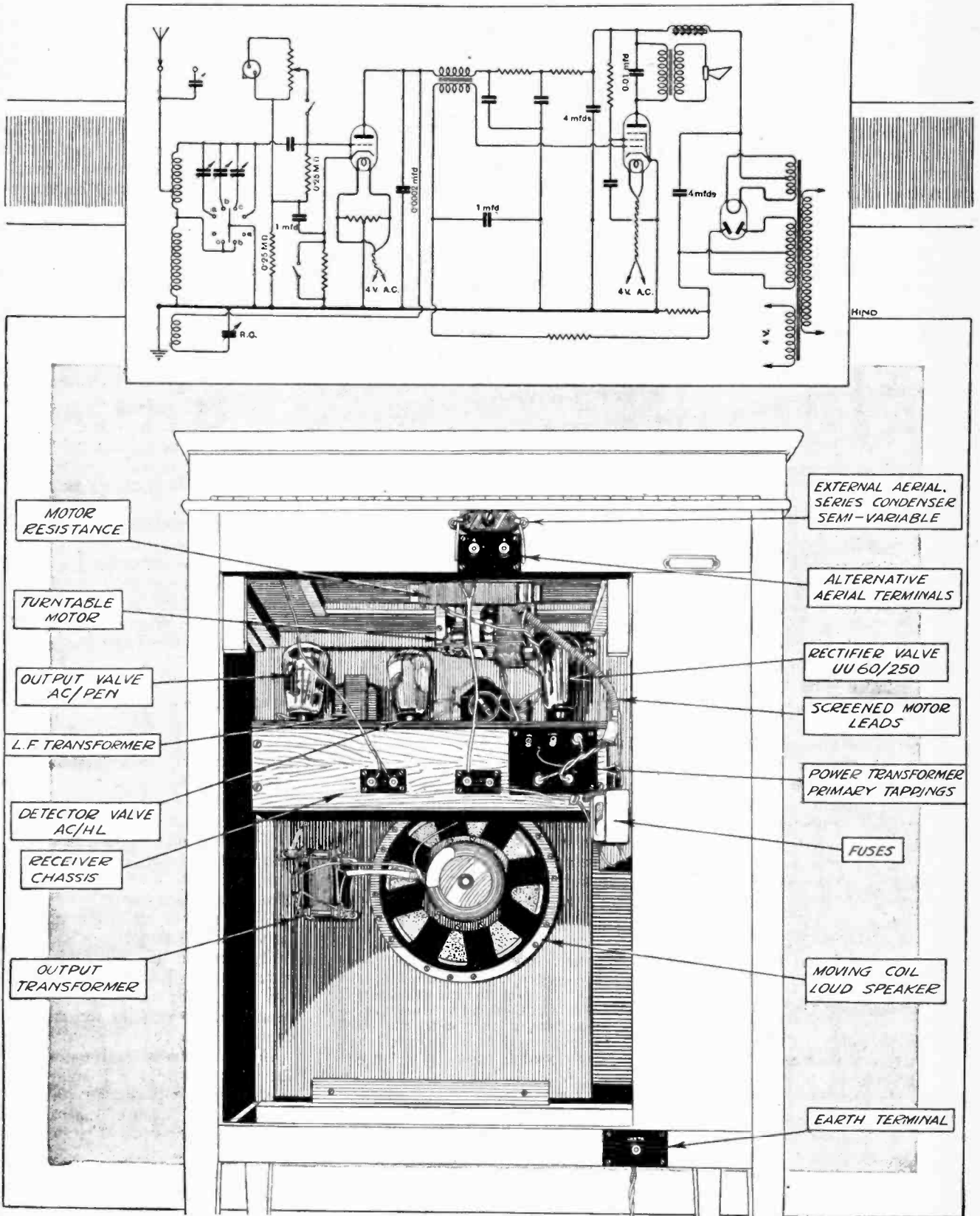

A detector-L.F. two-valve receiver with station selector switch: the M.R.G. "Regionogram."

A 11

PHILIPS

Type 2811.

ONE always rather envies the designers of radio-gramophones, who are generally less hampered by considerations of cost than those who deal with the ordinary type of receiver. A combined set is almost certain to be fairly expensive in any case, and in consequence non-essential but nevertheless desirable refinements are more likely to escape the axe of economy.

Although the Philips Model 2811 radio-gramophone is not particularly costly, especially when one takes into account the fact that nothing has been skimped in its circuit arrangement or construction, it embodies details which are not usually to be found in similar instruments.

With regard to the circuit, the receiver unit fitted is practically the well-known Philips set, type 2511, but with a greater power output. Two H.F. amplifying stages are used, and the valves are coupled by the tuned anode method, matters being so arranged that the frames and rotors of the three-member ganged tuning condenser assembly are earthed. Wave-changing is effected by the usual expedient of inserting series-loading coils, which are shunted by short-circuiting switches.

Grid detection is employed, and a transformer is used to couple the rectifier to a special type of directly-heated super-power pentode (PM24C), which gives an exceptionally large undistorted power output, actually in the neighbourhood of $3\frac{1}{2}$ watts. In conjunction with the moving-coil loud speaker which is included, volume is not only sufficient for domestic purposes, but is even enough to fill a small hall, should it be necessary to do so.

Bias is obtained by picking up suitable negative voltages from a potentiometer in the H.T. negative lead, and, on the "radio" side, volume is controlled by changing the negative grid voltage of the first H.F. valve. Another potentiometer (not shown in the accompanying circuit diagram) is provided for regulating the intensity of gramophone reproduction.

It will be observed that decoupling is unusually complete, as a double filter arrangement is included in the first grid circuit and in series with the detector anode. Valve rectification is provided for the H.T. supply, and there is a separate rectifier for the loud-speaker field.



A High-grade Radio-Gramophone with Large Output and Many Refinements.

A Philips type 506K valve is used for this purpose.

Another feature which will be widely appreciated is a variable tone control, by means of which high frequencies may be attenuated or suppressed. The primary purpose of this filter is to reduce needle scratch, but it will mitigate interference due to heterodyning carrier waves, and, on occasion, to neighbouring power circuits.

A two-unit system of construction for the receiver has been adopted, and the H.F.-detector and L.F. chassis are both mounted on the floor of the cabinet. As all control knobs are concentrated around the turntable, it becomes necessary to operate the variable condensers from a distance; the difficulty has been overcome in an ingenious manner by fitting a spring-tensioned metal belt drive, which acts without back-

lash and in a positive manner. Similarly, a metal link is connected between the control panel and the master switch of the receiver.

In order that internal adjustments may be carried out without risk of shock, a safety switch is fitted in the back lid in such a way that the mains supply lead is automatically broken when this lid is removed.

The turntable is driven by an electric motor, for which, by the way, a special oiler is provided. There is an automatic stop, so that the armature comes to rest as soon as a record has been played.

It will be observed that the output transformer is tapped, in order that external loud speakers of different impedances may be matched to the output valve. Sockets are provided for these connections.

What strikes one as a particularly useful fitting is a pneumatic buffer for the lid, which, in consequence, need not be closed with any particular care after it has been opened to obtain access to the controls or to change a record.

Both internally and externally, the instrument is extremely well made, and, in particular, the construction and finish of the polished

walnut cabinet are beyond criticism. There is an internal space for records, and albums are supplied. The makers are Philips Lamps, Ltd., Philips House, 145, Charing Cross Road, London, W.C.2, and the price is 80 guineas complete.

SPECIFICATION.

CIRCUIT: Two H.F. stages with tuned anode couplings; grid detector, coupled by transformer to super-power output pentode.

CONTROLS: Combined wave-range, radio-gramophone, and on-off switch, single-knob tuning, gramophone volume control, radio volume control, scratch filter (or tone control).

GENERAL: For operation on A.C. mains with inside, outside, or frame aerial.

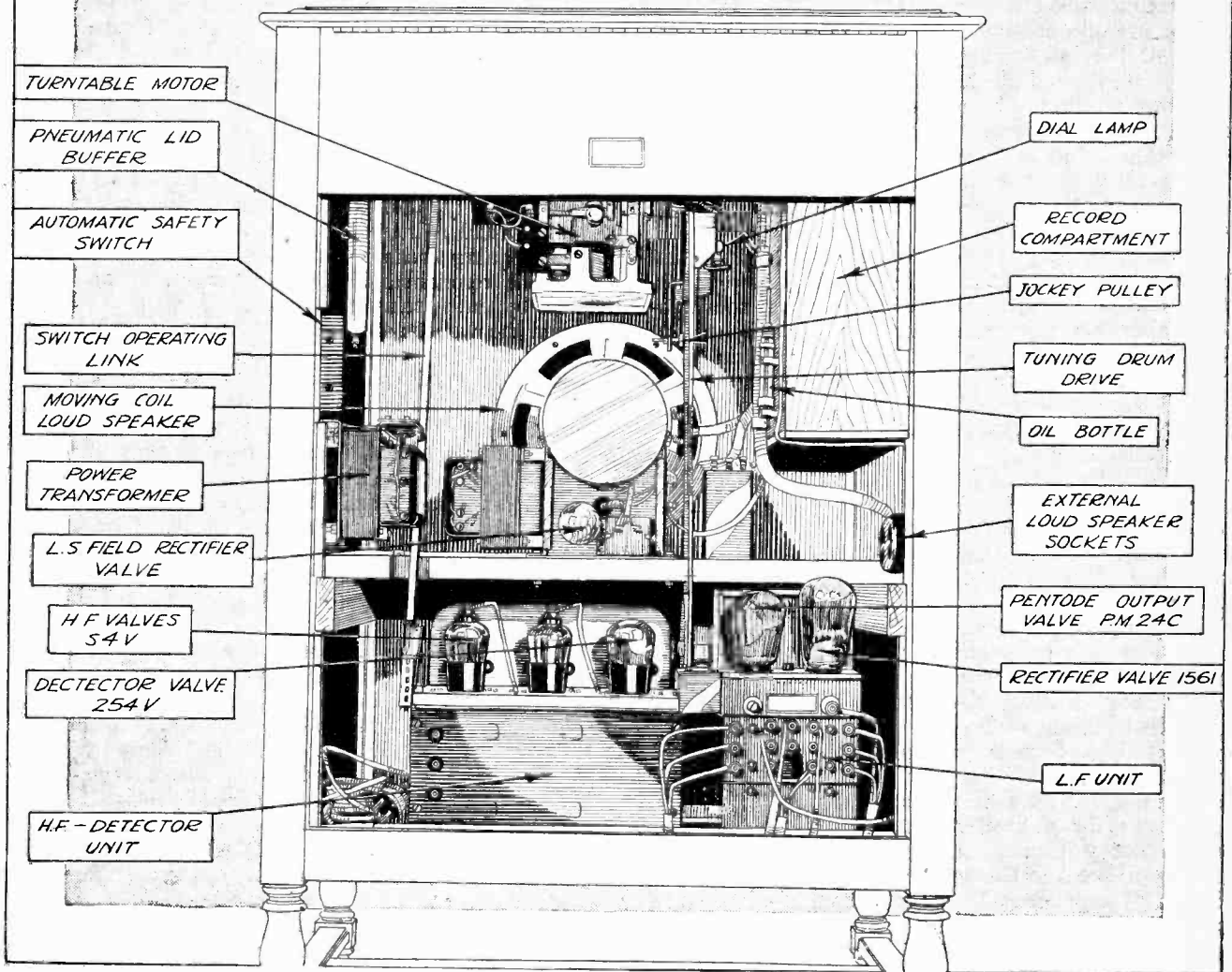
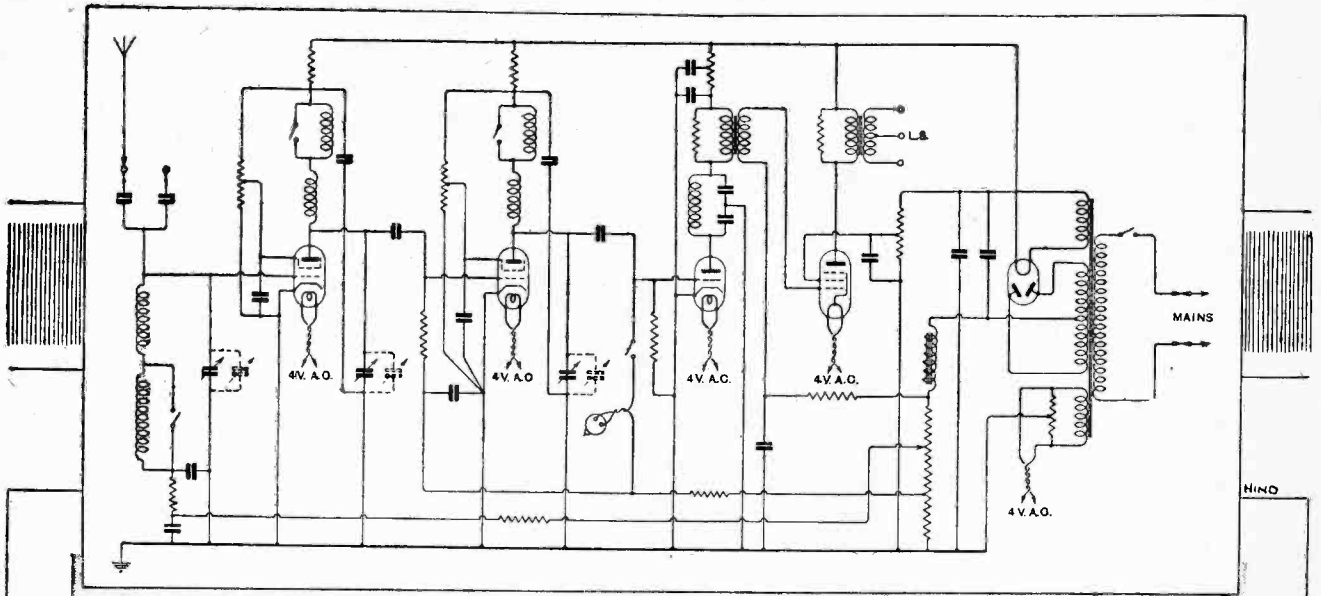

TURNTABLE MOTOR

PNEUMATIC LID BUFFER

AUTOMATIC SAFETY SWITCH

SWITCH OPERATING LINK

MOVING COIL LOUD SPEAKER

POWER TRANSFORMER

L.S. FIELD RECTIFIER VALVE

H.F. VALVES 54V

DETECTOR VALVE 254V

H.F. - DETECTOR UNIT

DIAL LAMP

RECORD COMPARTMENT

JOCKEY PULLEY

TUNING DRUM DRIVE

OIL BOTTLE

EXTERNAL LOUD SPEAKER SOCKETS

PENTODE OUTPUT VALVE PM 24C

RECTIFIER VALVE 1561

L.F. UNIT

Circuit details and interior arrangement of the Philips radio-gramophone.

TANNOY

Senior Model



A Carefully
Designed Instrument with
Several Unusual Features.

ALTHOUGH the present fashion of passing the detector output direct to a single L.F. valve has much in its favour, the advantages of the older plan of using two low-frequency amplifying stages—generally one of which is arranged to have a low gain—still has much in its favour. In the case of a radio-gramophone, choice of a pick-up is not restricted, and there is a greater margin of safety with regard to detector design, as it is not necessary to legislate for such a large rectified output when an intermediate stage of amplification is available. Further, there will be less complete dependence on valve characteristics, and the use of a specimen rather less good than the average will not be accompanied by the usual disastrous results. The volume regulation problem also becomes rather easier, and in the case of the Tannoy radio-gramophone, with which we are here dealing, a single L.F. potentiometer controls both forms of reproduction.

Double-wound aerial-grid and intervalve H.F. transformers are used, and, contrary to the usual practice, arrangements are made completely to isolate the high-potential ends of the transformers that are switched out of circuit. An H.F. stopping filter is inserted in series with the grid detector anode circuit, and this valve is coupled to the first L.F. valve by the resistance-capacity system, the grid leak of which acts as a volume control potentiometer.

The intermediate L.F. valve is coupled to the last stage by a resistance-fed transformer, another transformer, this time of the step-down type, being used to feed a low-resistance moving-coil loud speaker.

Valve rectification is adopted for the anode power supply, and energy is provided for the loud speaker magnet system by inserting its field winding in the negative feed lead. A resistance shunt connected across this winding acts as a source of bias voltage for the output valve; the indirectly heated valves that are used in earlier stages are biased in the usual way by the interposition of suitable resistances in their cathode leads. It is hardly necessary to say that decoupling resistances and by-pass condensers are inserted where necessary in all grid and anode circuits.

Provision is made for the connection of an external loud speaker of the high-resistance type by the simple expedient of making the normal output transformer primary act as the L.F. choke of an output filter.

It will be observed that, in addition to the L.F. potentiometer volume control already mentioned, there is also another potentiometer across the pick-up itself. This component is actually mounted inside the cabinet, and it is intended that it should not be continually adjusted, but set to give a good average volume to suit the user's tastes, final adjustment being made by means of the external control. Similarly, a variable series aerial condenser is mounted on the receiver chassis, and serves as a selectivity control.

A stroboscopic speed indicator is fitted as a permanent fixture to the turntable, which is driven by a Paillard motor of the induction type, with an automatic stop switch. A rather unusual refinement is noticed in the shape of a record cleaning brush mounted on the pick-up arm.

Acoustic resonances in the receiver chassis are prevented by interposing strip insets of sponge rubber between the various sheet metal sections of which it is built.

Thanks to good workmanship and obvious care in assembly, the possibilities of breakdown are certainly no greater in this instrument than in any other, but the question of service has been taken into account, and it is possible to remove the complete chassis after taking out three or four screws. Subsequent replacement of leads will not present the usual difficulties, as all connections are made by means of plugs and sockets, both of which are clearly marked.

It is stated by the manufacturers that the low-frequency characteristics of each instrument, with its own valves, are recorded before despatch, and that this information is passed to the purchaser without extra cost if specially requested. A PX4 valve, as normally fitted, gives an undistorted output of well

over 1,000 milliwatts, which may be considered as ample. The manufacturers of the radio-gramophone are Tannoy Products, of 1-7, Dalton Street, West Norwood, London, S.E.27, and the price, with oak cabinet, is 55 guineas. For mahogany, 10 guineas extra is charged.

SPECIFICATION.

CIRCUIT: One H.F. stage, transformer-coupled to grid detector. Two-stage L.F. amplifier, with resistance-capacity and resistance-fed transformer couplings (in that order). Triode output valve, with transformer feed to low-resistance moving-coil loud speaker.

CONTROLS: Two separate tuning condensers; reaction; combined wave-range and radio-gramophone switch; L.F. volume control, effective on both radio and gramophone reproduction; on-off switch.

GENERAL: For operation on A.C. mains with indoor or outdoor aerial.

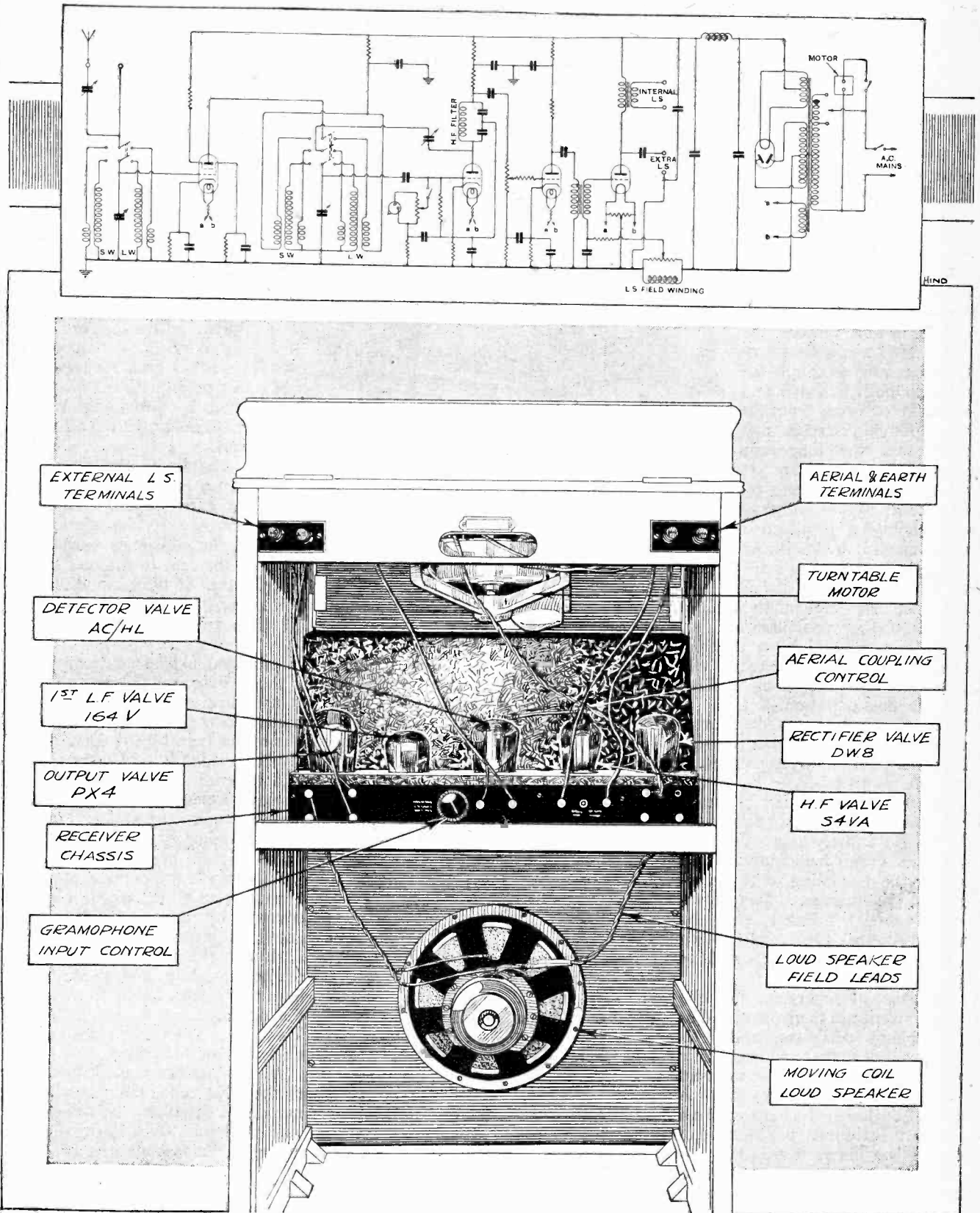

The Tannoy Senior Model radio-gramophone: circuit diagram and mounting of receiver chassis.

VARLEY

CONSOLE

THE Varley All-Electric Console Radio-Gramophone is another example of the popular H.F.-det.-L.F. three-valve circuit. Actually, there is a total of four valves, as the outputs are paralleled, and the apparatus is enclosed in an exceptionally fine and solid cabinet of burr walnut.

A double-wound transformer is used to couple the aerial to the H.F. valve, and it will be observed from the accompanying circuit diagram that the long-wave secondary winding is shunted by a damping resistance of 25,000 ohms.

A choke-fed transformer serves as an H.F. intervalve coupling, and in this way the ill-effects of a possible short-circuit between primary and secondary windings are made less serious than would otherwise be the case.

Reaction between plate and grid circuits of the detector is controlled by a differential condenser. The component values associated with this valve, which rectifies on the grid principle, should provide practically distortionless detection.

Coupling between the detector and the parallel output valves is carried out by a transformer, and bias for all valves is provided by separate resistances joined in the cathode return leads.

Anode circuits are fed in the usual way through decoupling resistances by a full-wave rectifier valve. There is also an entirely separate metal rectifier (not shown in the diagram) for supplying energising current to the magnet field winding of the moving-coil loud speaker. This instrument, actually a Baker, is of the high-resistance type, its speech coil being fed through a choke filter output circuit.

Acoustic resonances in the cabinet work are the bane of radio-gramophone designers, and it is obvious that more than usual care has been taken in this case to avoid the bad effects of vibration. A specially designed expansion chamber surrounds the rear of the loud speaker, and there is no flimsy woodwork; exceptionally thick and heavy material is used everywhere. Similar precautions are observed with regard to the chassis and its mounting. This matter is of greater importance than is commonly realised, and the loud speaker or amplifier



Good Quality and Exceptionally
Handsome Cabinet-work.

circuits are often blamed for distressing bass resonances for which they are actually in no way to blame. Unpleasant reproduction of speech is often attributable to this cause.

Like most other radio-gramophones, the Varley instrument comprises several inter-connected units, and the task of rewiring after one or more of them has been removed for test or adjustment is facilitated by providing a distribution board for all loose leads.

Thanks to the provision of an effective H.F. stage, an external aerial is quite unnecessary for short- or medium-distance reception;

a length of wire is led round the case to the rear metal grille, which acts as a collector, or built-in aerial. It should be emphasised, however, that a greatly increased range will be obtained when an outside aerial is employed.

Variable coupling is provided between primary and secondary windings of the H.F. coupling transformers. This adjustment gives an extra selectivity adjustment for use in special circumstances, though it is intended to be made at the works rather than by the user. Normally, interference may be avoided by choosing a suitable setting for the variable series aerial condenser.

Although the two tuning condensers are "ganged," there is an external trimming condenser, which is useful when extreme accuracy of tuning is required, as, for example, when very weak signals are being received.

All controls are concentrated on a small front panel, which may be covered by doors, which, it is noted, are arranged to fold back flush with the cabinet, where they are not unsightly, and, much more important, are out of the way of the operator, as they should be. There is an automatic stop for the electric turntable motor.

As the parallel L.F. valves are of the PX4 type, there is a good margin of safety in the matter of

power output; even one of these valves is capable of supplying as much volume as the average user is likely to require.

The instrument is made by Varley, Kingsway House, 103, Kingsway, London, W.C.2, and is priced at 85 guineas complete.

SPECIFICATION.

CIRCUIT: Single H.F. stage, coupled by tuned transformer to grid detector, with reaction. Detector is transformer-coupled to two parallel triode output valves; choke-filter feed to loud speaker.

CONTROLS: Single-dial tuning; reaction; radio-gramophone switch; wave-range switch; radio volume control; gramophone volume control; on-off switch.

GENERAL: For operation with A.C. mains and an external or built-in aerial.

Broadcast Brevities

By Our Special Correspondent.

B.B.C.'s Clockwork Gramophones.—The Record "Library."—More Delays at Slaithwaite?—Fighting Tram Interference.—A Sunday Innovation.—Organ Pipes in Portland Place.

been made of it in this respect for quite a long time. A special Providence seems to watch over the Programme Department, for when things do go wrong, there is generally some odd talent "knocking about the building."

o o o o

Programme Plans "Gang Agley."

The biggest programme upheaval in the Corporation's history has been threatened in the last few days, several long-standing plans having been upset. First, Senor Casals intimated that family bereavement would prevent him from fulfilling his engagement to play in to-night's symphony concert at the Queen's Hall, and I understand that his place is being taken by Madame Suggia.

o o o o

Postponed Play.

At the same time came the news that Mr. Vernon Bartlett was suffering from appendicitis, and this was followed by a conspiracy of circumstances which made it necessary to postpone the radio play "Krassin saves 'Italia,'" which was in the programme for Thursday and Friday last.

o o o o

More Delays at Slaithwaite?

Although Northern Regional has now started public tests there is still considerable misgiving at Savoy Hill as to whether the station can take over the complete twin-wave service before June next. Much will depend on the nature of the reports received during the coming fortnight.

o o o o

The Enthusiasts.

The engineers are grateful to the many listeners who have already written in praise of the transmissions, but unfortunately they feel that these enthusiasts are the people who are least likely to be inconvenienced by the wavelength changes.

o o o o

The Big Problem.

It is the very ordinary listener, disrespectfully called the "yob," who presents the biggest problem and who is likely to make the loudest noise in the next few weeks.



"AN HOUR OF GRAMOPHONE MUSIC."—A new portrait of Mr. Christopher Stone, whose broadcast gramophone recitals owe much of their popularity to the apt and helpful commentaries which accompany them.

Gramophones at Savoy Hill.

That the standard of reproduction attained by the B.B.C. in their broadcasts of gramophone records is higher in one particular than anything the ordinary radio-gramophile can hope for was made clear to me last week by the courteous official at Savoy Hill who is "O.C. Music Library." Not a single record, it seems, is ever broadcast more than four or five times. If further repetition of the same piece is necessary a new record is obtained. How many private radio-gramophiles can afford to follow the same plan?

o o o o

The Record "Library."

About a thousand records are to be found in the gramophone "library" at any particular moment, and the majority of these are soon despatched to the hospitals in a practically brand new condition.

o o o o

Home-made Gramophone Cabinets.

The B.B.C. is showing its independence once more by constructing its own studio gramophone cabinets, which are specially designed to make the operator's task as easy as possible. The cabinet in use in No. 6 studio at Savoy Hill strongly resembles an office desk in weathered oak with a turntable to the right and left and a sloping reading-board in the middle just under the microphone. A three-way switch enables the operator to bring in left-hand pick-up, microphone and right-hand pick-up in turn.

o o o o

Good Old Clockwork!

I noticed that Savoy Hill still sticks to the clockwork motor, despite the advent of the reduction motor in modern gramophones, with its absence of electrical noise.

Winding Up.

So, while we are revelling in the broadcasting of some specially lovely record it would be kind, I think, to spare a thought for the operator who at the same moment may be laboriously winding up the other motor. I say "may be" because, occasionally, he does forget.

o o o o

The Gramophone as a Standby.

On an average the B.B.C. transmits about 64 record sides a month.

The gramophone is always regarded as a splendid "standby" in case of emergency, but actually very little use has

FUTURE FEATURES.

National (261 and 1,554 metres).
MARCH 29TH.—Concert in celebration of the jubilee of the Albert Hall, relayed from the Albert Hall.
MARCH 30TH.—Orchestral concert in Memory of Anna Pavlova.
APRIL 1ST.—The Ridgeway Parade.
APRIL 2ND.—"The Little Flower of the Wood," a play by Leonard Merrick.
APRIL 3RD.—"Parsifal" (Wagner), relayed from the Queen's Hall.

London Regional.

MARCH 29TH.—Sunday Orchestral Concert—21.
MARCH 31ST.—The Ridgeway Parade.
APRIL 4TH.—"The Little Flower of the Wood."

Midland Regional.

MARCH 30TH.—"Canteen Cantata," a Mess-cellaneous Mixture.
APRIL 4TH.—"From the Musical Comedies"—orchestral programme.

West Regional (Cardiff).

APRIL 1ST.—"A Woman of Compassion," a play in four acts, by Florence Howell.

North Regional (Manchester and Leeds).
APRIL 1ST.—"The Aerial," a comedy in one act, by John H. Bone.

Belfast.

MARCH 31ST.—"Insurance Money," a comedy in three scenes, by George Shiels.

Two Types of "Yob."

From the B.B.C.'s point of view it is a mercy that "yobs" are not all of one type. The unpleasant sort are those who, knowing nothing of the technical difficulties, expect perfection all the time, and are virtuously indignant if a relay from America fails to resemble the London Regional Children's Hour as heard in one of the new villas at Brookmans Park.

o o o o

Easily Pleased.

The other kind is well described in a letter received by the engineers last week. "This same lady," says the correspondent, "writes to all the papers thanking them for the lovely programmes—but if you could hear your programmes from her end you'd chew cinders as a counter-irritant."

o o o o

The Football Final.

April 25th is the date of the running commentary on the Final of the F.A. Cup.

o o o o

Shakespeare's Birthday.

From the Shakespeare Birthday Celebrations at the Town Hall, Stratford-on-Avon, on April 23rd, speeches by John Drinkwater, Sir Nigel Playfair, Miss Lillian Braithwaite, and the Mayor of Stratford-on-Avon will be relayed to National listeners. On the same evening the play, "Will Shakespeare," by Clemence Dane, will be broadcast from the National transmitters, and it will be repeated for Regional listeners on April 24th.

o o o o

Flutes at Oxford Circus.

A work by Arthur Bliss in the National programme of April 7th should appeal to listeners for its novelty. It is described as "Conversations for flute, bass flute, oboe, cor anglais, violin, viola, and violoncello." The movements are entitled The Committee Meeting, In the Wood, In the Ballroom, Soliloquy, and In the Tube at Oxford Circus.

o o o o

Europe Listens to the B.B.C. Orchestra.

The international reputation of the B.B.C. Symphony Orchestra is being strengthened by the frequency with which its performances are being relayed to Continental listeners. To-night's concert at the Queen's Hall will also be broadcast by Brussels, Vienna and Prague—all three cities famous for their musical associations.

This is a real tribute to the B.B.C. orchestra and to Dr. Adrian Boult as well as to British music, which will occupy the second half of the programme in the shape of Arthur Bliss's "Morning Heroes" for orchestra, chorus and orator.

o o o o

Less Interference from Mühlacker.

Mühlacker has not seemed to me quite so assertive in the last week or two, and the same opinion is apparently shared by a large number of listeners in the London area. The number of letters to the B.B.C. on the subject has dropped very considerably, though this is not

invariably an indication that a wrong has been righted.

What Letters Show.

Generally speaking, the tide of popular indignation as shown by the Savoy Hill letter bag recedes as rapidly as it originally advanced; in fact, this relationship between onslaught and retreat is often very marked—a thought which helps to fortify the B.B.C. staff at critical moments.

o o o o

Field-strength Measurement.

Work has already begun on the new field-strength measurements of European broadcasting stations, but I am assured that it will be many weeks before the results can be collated and used for the formulation of a new wavelength scheme.

o o o o

B.B.C. in Static Fight.

A word of encouragement is due to the B.B.C. for the efforts which they are still putting up to save listeners from man-made static. Just now, I understand, the engineers are concentrating on the very real bugbear of tramway interference, and many letters have recently been exchanged between Savoy Hill and certain municipal authorities.

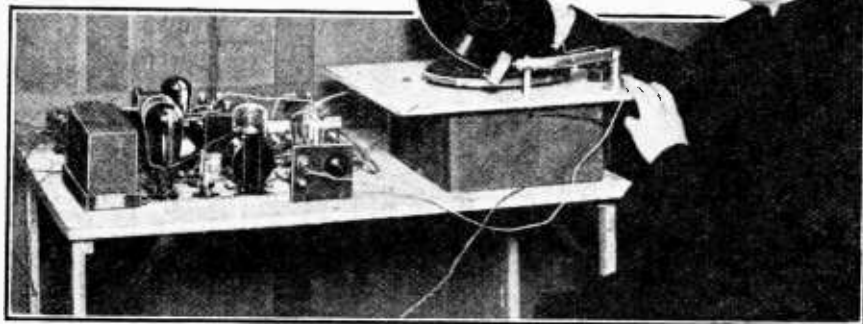

THE RADIO-GRAMOPHONE IN CHURCH.—A loud speaker has been installed in the belfry of Totteridge Church, Hertfordshire, famous peals being reproduced from gramophone records played in the vestry. The photograph shows the Rev. C. McLaughlin with a temporary installation, which will shortly be replaced by a more powerful equipment.

Bournemouth's Juggernauts.

There was a fleeting hope that in Bournemouth, where complaints are fairly common, the tramways system would be replaced by motor services, but the authorities have definitely decided to keep their juggernauts on the road for another five years.

o o o o

For Motorists.

Lord Cottenham, chairman of the Order of the Road, will broadcast on "How to use Speed Properly," on March 30th.

o o o o

Alternative to Bach Cantatas.

The B.B.C. announces that an alternative to the Bach Cantata will be introduced into the Sunday afternoon programmes as from Easter Day. This alternative will be given from the London and Midland Regional transmitters which have hitherto been silent until 3.30 p.m. The effect will be that as from April 5th

the regional transmitters will start at 3 p.m., that is, half an hour earlier than at present, providing an appropriate contrast to the programme broadcast from the National transmitters.

o o o o

Organ for "Broadcasting House"?

Mr. Tudsbury, the B.B.C.'s civil engineer, is still enamoured of the idea of putting a large organ in the big studio at "Broadcasting House," and is not alarmed by talk about the booming and zooming that a real organ would communicate to other parts of the building. Some people, apparently, have forgotten the seaweed which was incorporated in the walls to make them soundtight.

o o o o

Pipe Tests.

The tests about to be undertaken with a few selected organ pipes should be conclusive. If I may venture a prophecy, I predict that an organ of respectable dimensions (not a cinema organ) would

make itself heard throughout any building also of respectable dimensions whether the walls are of seaweed or sandstone.

o o o o

Mr. Tudsbury's Adventure.

When the idea of a "Broadcasting House" in the West End was first mooted, Mr. Tudsbury did some prowling on his own account to discover a suitable building.

One of his calls was at a certain flourishing hotel. The manager was naturally rather astonished when asked to name a price for the hotel as it stood, and he said so.

o o o o

Holding a Board Meeting.

As his caller seemed perfectly serious, however, a special board meeting was held to discuss the question, and only after some earnest debating did the board decide not to "shut up shop" there and then in the interests of broadcasting.

READERS' PROBLEMS.

Replies to Readers' Questions of General Interest.

A Double Filter.

In order to attain high selectivity without using more than one H.F. stage, I am thinking of making up a set with filters in both input and intervalve circuits. The method of filter coupling recently described in your journal, in which a small condenser ganged to the main spindle is used, will be adopted for both circuits.

Will you please give me a diagram showing details of the part of the receiver concerned, bearing in mind that I wish to use ganged tuning condensers with earthed rotors, battery valves, and grid detection with reaction.

Capacity coupling between the high potential ends of the circuit would be suitable for a set such as you describe, and we give in Fig. 1 a skeleton circuit diagram including the points specified. It would probably be as well to use a

Technical enquiries addressed to our Information Department are used as the basis of the replies which we publish in these pages, a selection being made from amongst those questions which are of general interest.

very simple manner. All you have to do is to join one lead from the pick-up directly to the detector valve-holder grid terminal, and the other, through one or two dry cells, to some convenient point which is in direct metallic connection with the low-tension negative terminal. Regarding the polarity of the bias battery its negative terminal must be joined to the pick-up.

It should be pointed out that the pick-up must be disconnected when it is desired to receive wireless signals. Although this simple method of connection is not entirely beyond criticism, it will almost always yield quite satisfactory results.

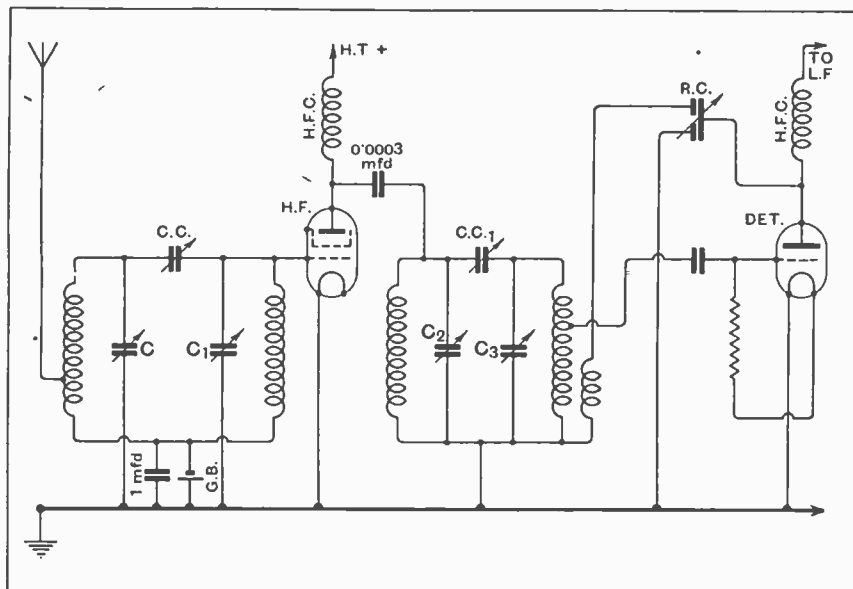

Fig. 1.—An "all-filter" receiver, with coupled input and intervalve circuits.

coupling condenser for the intervalve circuit (C.C.₁) with capacity considerably smaller than that of the input circuit coupling (C.C.), but a good deal depends on the design of your coils, etc.

○○○○

Wiring without Tears.

I am a new reader of your journal, and regret that I have not yet mastered the art of reading circuit diagrams. I should like temporarily to connect a gramophone pick-up to my three-valve receiver; would it be possible for you to explain very simply how this can be done?

Assuming your set to include grid detection—which is almost universal nowadays—this addition can be made in a

High-voltage D.C. Mains.

The two "outer" leads of my D.C. supply mains (normally 240 volts, three-wire system) are brought into my house, and consequently a voltage of 480 is available. Unless you advise me not to do so, I am thinking of using this source for supplying anode current to a radio-gramophone. Should any special safety precautions be observed?

The D.C. mains may be used in the way you suggest, and no precautions need be taken other than those that are normally observed when dealing with a dangerously high voltage. Of course, you will see that insulation everywhere is of a high order, and it should be remembered that a potential of 240 volts exists between either positive or negative leads and earth.

○○○○

Medium-wave Interference on the Long-wave Band.

My H.F.-det.-L.F. set, of which I am sending you a circuit diagram, works fairly satisfactorily, except that its selectivity is not of a high order. In particular, I have noticed that when tuned to stations at the lower end of the long broadcast waveband (in the neighbourhood of 1,000 metres) there is serious interference from the local medium-wave station. Can you suggest how this can be avoided?

This troublesome form of interference is well known, and is particularly likely to arise in the case of a receiver with an aperiodic single-tuned input circuit—an arrangement which we notice is included in your own set. The use of a two-circuit aerial tuner or filter should entirely obviate the trouble, but if you do not wish to go to the length of making the necessary additions, we recommend you to try the effect of connecting a loading coil with some 60 turns in series with the aerial.

Matters should be so arranged that this loading coil is in circuit only for long-wave reception.

○○○○

L.T. Eliminator.

Have you ever published an article dealing with the construction of an L.T. battery eliminator for use on D.C. mains?

We have not described an instrument of this sort, and are almost tempted to say that there is no such thing. Perhaps this would not be strictly true, but the running costs of an L.T. battery eliminator intended to be used indiscriminately with almost any receiver would be high. When filaments are to be supplied from D.C. mains, it is usual to wire the L.T. circuits of the receiver in a special manner; if you will give us the particulars of your set perhaps we can refer you to a constructional article that will be helpful.

Two Loud Speakers.

I have a low-resistance moving-coil loud speaker and a high-resistance reed-driven cone instrument, and should often like to use these simultaneously. Unfortunately, it seems impossible to devise a method of connection that gives satisfactory results, although either instrument works well alone. Will you please advise me?

The ideal method of feeding two loud speakers of different type is to provide separate output valves (with grids in parallel), but we quite realise that this may be impracticable. It is suggested that you should obtain a double-ratio output transformer, and join the two instruments across the appropriate secondary terminals.