

UNIVERSITY OF SOUTHERN CALIFORNIA

FEB 14 1930

LIBRARY

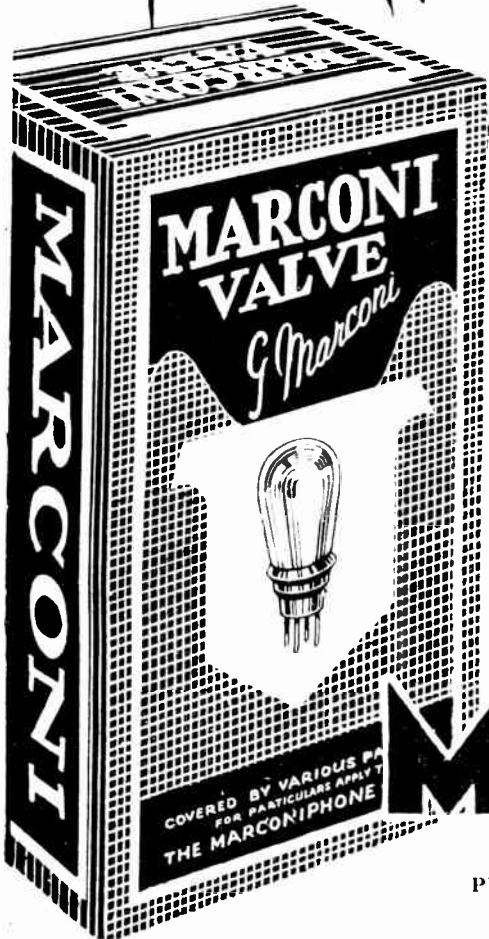

The name first and foremost in radio for 30 years, guarantees the supremacy of Marconiphone products—Receiving Sets, H.F. and L.F. Amplifiers, Ideal Transformers and Components, also the famous Sterling Loud Speakers, Sets and Components.

For POWER Purity of TONE and ECONOMY in CURRENT CONSUMPTION

The
MARCONI D.E.5.

DULL EMITTER VALVE for 6 Volt Accumulators

Recommended as last valve of a Receiver or Amplifier. For this purpose the valve requires a negative grid bias of 6 to 8 volts with an anode voltage of 120. Can also be used as a detector or high frequency amplifier, in which case the anode voltage should be about 40.

Filament Volts.....	5-6
Filament Current.....	0.25
Anode Volts.....	20-120
Impedance (Ohms).....	8,000
Amplification Factor.....	7

Write for valve publication No. 443 giving characteristic curve of the D.E.5, together with particulars of other Marconi Power Valves for 2 and 4 volt accumulators.

MARCONI VALVES

IN THE PURPLE BOX.

THE MARCONIPHONE COMPANY LIMITED

Registered Offices: Marconi House, Strand, London, W.C.2

Head Office: 210-212 Tottenham Court Road, London, W.1

Branches: Aberdeen, Bristol, Birmingham, Belfast, Cardiff, Cheltenham, Dublin, Glasgow, Leeds, Liverpool, Manchester, Newcastle, Nottingham Southampton, Swansea.

Figures to Remember



The Town Crier

Old Times are changed—old manners gone, leaving just the remembrance of perfect service and faithfulness. With quickened feelings of real pleasure you can recollect the service Six Sixty Valves have rendered you—nay more, you will always remember the figures 660 as the mark of

PERFECTION OF QUALITY.

This is true for every valve in our new range. You say you want a valve suitable for a small or medium-sized Loudspeaker, and which will cost very little to run. You can't do better than get the S.S.3 L.F. (green disc). **The filament consumption of this valve is only .06 amps.—a remarkable saving not only on Bright Valves but even on the average Dull Emitter on the market to-day.** Bear this in mind and effect the maximum economy whilst at the same time ensuring perfect quality of tone. Two good dry cells will operate these valves with entire satisfaction. but a 4-volt accumulator—in conjunction with a 30-ohm filament rheostat—may be used with equal success and economy.

If you want a Power Valve—you have the S.S.7. to fall back on. This wonderful D.E. is absolutely non-microphonic, has a current consumption of only 1 amp, and is capable of handling output sufficient to work the largest Loudspeaker without distortion.

For long Life, good Service, perfect Tone, insist on—SIX SIXTY VALVES.



S.S.3 L.F.
(Green Disc).
Voltage 3 volts.
Consumption .06 amps.
PRICE 16/6.

Ask your Dealer for Leaflet S.S.1.7 for full particulars of complete range.



BETTER BY SIX TIMES SIXTY.

The Electron Co., Ltd., Triumph House, 189, Regent St., London, W.1. 4.



The Secret

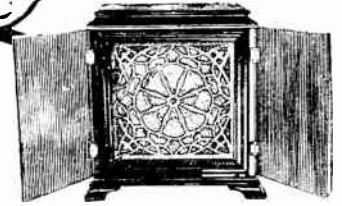

"BECO-DE-LUXE."

of "Beco" popularity lies in the exceptional purity of tone of these wonderful hornless loud speakers. No blatant, distorted "noise," but a beautiful pure tonal rendering of music, song and speech, with surprising volume and clarity.



HORNLESS LOUD SPEAKERS

The "Beco-de-Luxe" (British Made) is an artistic piece of furniture for any home and the volume from it will fill a large hall. Obtainable fitted in either oak or mahogany cabinet. Height 13".

Oak £5 - 0 - 0 Mahogany £5 - 5 - 0

The small 1926 "Beco," a very efficient model with a very pleasing and attractive appearance, gives unusual volume, with crystal clarity 6" high and obtainable at the following prices:

Finished in Nickel Plate
52/6

Oxydised Silver or Copper
55/-



"The 1926 BECO."

Ask your dealer to demonstrate these Models.

Dept. W, British Electrical Sales Organisation, 623, Australia House, Strand, W.C.2.

Telegrams - - - - - "Becospeker. Estrand, London."



Telephone : CITY 7665



Silvertown

WIRELESS ACCESSORIES

Quality guaranteed by over 50 years' electrical manufacturing experience.

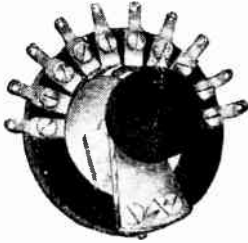

B.570. 10-WAY INDUCTANCE OR CAPACITY SWITCH
(Patent 226245)

This is a simply and compactly constructed component, suitable for numerous and varied circumstances where it is desired to vary the impedance of a circuit, or for opening and closing a plurality of circuits by the manipulation of a single member. It enables the experimenter to build up large capacities and is an invaluable addition to any set.
Price 5/6 each.

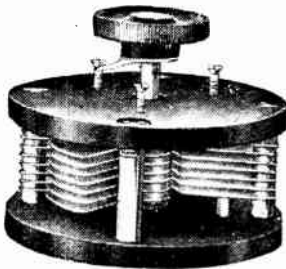

VARIABLE CONDENSERS
(for panel mounting)

Strongly constructed. Moving vanes are shaped to give low minimum capacity. Fitted with a stop to allow of a movement of 180 degs. only. Price 5/6 each.

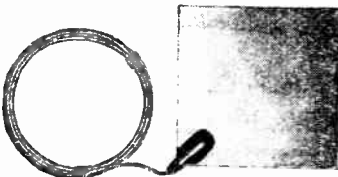

1572. EARTH PLATES

Size, one foot square, complete with 10 ft. of insulated lead-in wire well soldered on. Price 4/- each.

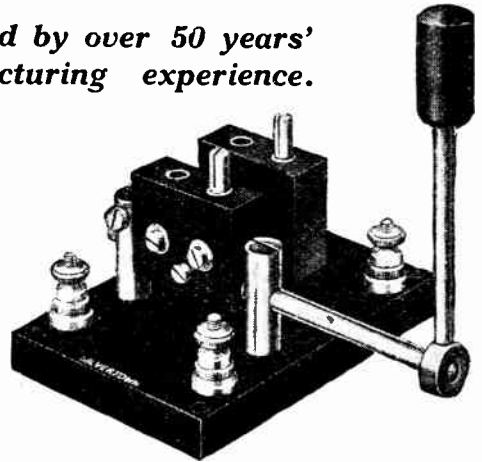

B.565. DOUBLE COIL HOLDERS.

Comprising one fixed and one moving coil holder, mounted on ebonite panel $3\frac{1}{2}$ in. \times $2\frac{1}{10}$ in. \times $\frac{3}{8}$ in. thick, together with four finished and lacquered double terminals. Weight $8\frac{1}{2}$ oz.
Price 6/6 each.

No. B.601. SILVERTOWN VERNIOMETER. (Patent applied for.)

The Silvertown Verniometer is a most ingenious device for applying slow motion to variable condensers, coil holders, variometers, etc., consisting of an ebonite dial and knob (0.180 degs.) fitted with wormwheel bracket and worm-spindle, micrometer barrel and pointer, complete with fixing screws. Gear ratio 240-1. Fitted with instantaneous release. Backlash entirely eliminated. Hand capacity reduced to a minimum. Suitable for the following makes of condensers: Silvertown, Burdopt, Igranic, Polar, Sterling, Ormond, Jackson, Devon, Utility, Ashdown, Lamplush, Ediswan, Edison-Bell, Bowyer, Lowe, Atlas, W. & M., A. J. S., etc., etc.
Price 6/- each



AN AID TO ENTHUSIASTS.

We have prepared a logging chart for recording wavelengths, condenser settings, etc., of those stations which require careful calibration to tune in. A copy of this chart, printed on stiff card, with hanger, can be obtained free of charge at any of our Branches or from any high-class dealer.

Makers:

THE SILVERTOWN COMPANY

106 Cannon Street, London, E.C.4

Works: Silvertown, E.16

BELFAST: 75, Ann Street.
BIRMINGHAM: 15, Martineau Street.
BRISTOL: 4, Victoria Street.
CARDIFF: Pier Head Chambers, Bute Docks.

DUBLIN: 70, Middle Abbey Street.
GLASGOW: 15, Royal Exchange Square.
LEEDS: 1, New York Road.
LIVERPOOL: 54, Castle Street.

LONDON: 100 and 102, Cannon Street.
MANCHESTER: 16, John Dalton Street.
NEWCASTLE-ON-TYNE: 59, Westgate Road.
PORTSMOUTH: 49, High Street.
SHEFFIELD: 88-90, Queen Street.



**"Just listen to the difference
this LEWCOS Coil makes!"**



CLEAR as a bell the typical French Orchestra came through as the listener tuned in with his LEWCOS Coil. Coil after coil had been tried and discarded in an endeavour to realise that rare selectivity and fine tuning so essential to complete radio enjoyment.

Test this new coil yourself. Each LEWCOS Coil is tested in our laboratory. It is then boxed and sealed up, and reaches you in perfect condition. Be sure the LEW seal is unbroken. Ask your radio dealer for a demonstration.

LEWCOS

Inductance Coil

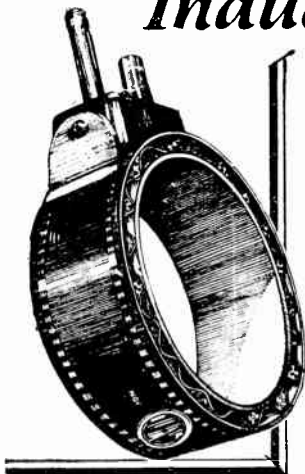

3 LEWCOS advantages:

- 1 High electrical efficiency with great mechanical strength.
- 2 Great selectivity resulting in extremely fine tuning.
- 3 Exceptionally low high frequency resistance with increased signal strength.

**THE
LONDON ELECTRIC WIRE
CO. and SMITHS LTD.,**

Manufacturers of Glazite

**Playhouse Yard, Golden
Lane, London, E.C.1.**

JUD.

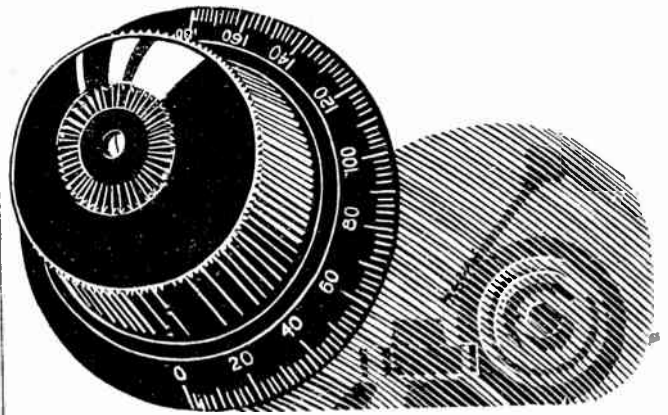

Among experimenters there are various shades of opinion on the best method of obtaining micro-selective tuning.

In advertising to readers of this publication the Pelican Univernier control we are confident that they will fully appreciate the value and efficiency of apparatus that is designed and constructed only after exhaustive experimental work and practical tests, and for these reasons we ask you to replace your present control dials with

THE PELICAN UNIVERNIER.

The Pelican Univernier does provide that super-fine adjustment essential to truly selective tuning.

The price is 6/- and they can be obtained from all dealers, or if more convenient from

CAHILL & CO. LTD., 64, NEWMAN ST., LONDON—W.1.



H.F. 15

CAXTON 4-VALVE CABINET

**Made for Editor of Wireless Magazine
for Set "As good as money can buy"
described in issue February, 1925.**

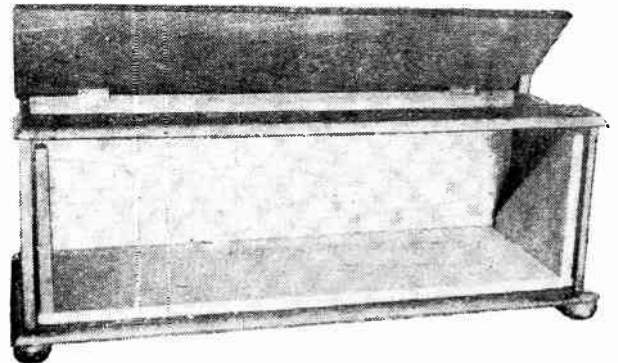

Cash with Order. Fumed Oak ... £1 5 0
or Real Mahogany polished ... £1 14 0

With detachable recess fitted Base Board to mount 21 in. by 7 in. panel to slide out of Cabinet front. Extra 10/- with two beaded front doors totally enclosing fitted panel. Cabinet overall length 22½ ins. Width 8½ ins. Height 9 ins. Polished with the new enamel that gives a glass hard surface that cannot be soiled or scratched. SENT FREE.—Catalogue of standard Wireless Cabinets in various sizes and woods. Special Cabinets made to customer's orders.

PACKED AND DELIVERED FREE IN U.K.

CAXTON WOOD TURNERY CO., Market Harborough

FROM FATHER TO SON

"My great grandfather bought this Ormond Condenser in the year 1926!"—this remark was suggested by a curious test that we recently carried out. Although purely imaginary to-day, of course, it is a remark that our great grandsons may very well make in the year A.D. 2000.

We were demonstrating our latest **BALL BEARING FRICTION CONTROL CONDENSER** to a visitor when he suddenly asked "How long will it last?"

In order to satisfy his curiosity, and our own, we put the Condenser on a rotary machine and gave it 2,000,000 turns. On examination afterwards we found it to be as good as new, and fit to be sold as new.

Now 2,000,000, revolutions of a Condenser—if you figure it out—equals over 100 years' continuous use, so that in A.D. 2000 an Ormond Condenser bought to-day will be every bit as good as new.

Prices: '0005 15/-; '0003 14/6; '00025 13/6
(Complete with Knob and Dial)
Brass End-Plates, highly nickelled finish.
IDEAL RATIO 55-1



199-205 PENTONVILLE ROAD,
KING'S CROSS, LONDON, N.1
Telephone Clerkenwell 9344-5-6.
Telegrams "Ormondengi, Kingcross."
Factory: Whiskin Street, Clerkenwell, E.C.1.



-FOR FOUR GENERATIONS

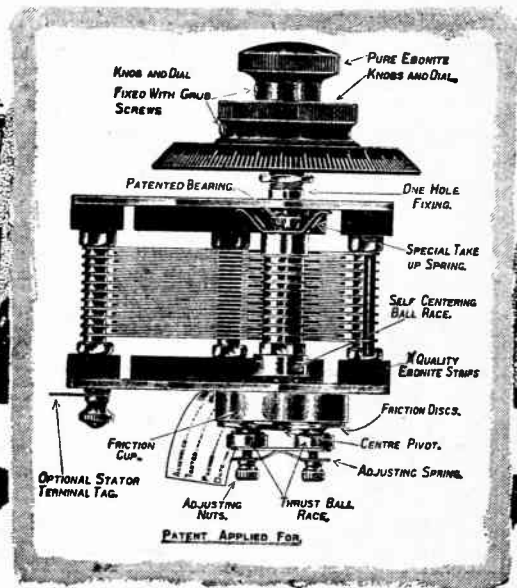

The Valves for your set are in the BURNDEPT RANGE

NO matter what kind of set you own, there is a Super Valve in the Burndept range, which will suit your requirements exactly.

Burndept Super Valves are guaranteed. The extraordinary care and skill in manufacture and the rigorous tests each Valve undergoes before leaving the factory enable us to do this.

Ask your Dealer to show you the range of Burndept Super Valves and test their efficiency for yourself.



**BRANCHES AND AGENTS
THROUGHOUT THE WORLD**

Type L. 505.
Price **22/6**

Type H. 310.
Price **16/6**

Type HL. 310.
Price **16/6**

Type II. 512.
Price **22/6**

Type III. 512.
Price **22/6**

Type L. 240.
Price **18/6**

Write for Technical Catalogue.
BURNDEPT WIRELESS LTD.,
Aldine House, Bedford St., Strand, London, W.C.2.
Telephone: Gerard 9972 (4 lines).
Telegrams: "Burndept, Westminster, London."

THE CHOICE OF RADIO EXPERTS

AMERICA'S BEST SUPERHETERODYNE KIT.

331

271

For the Intermediate Frequency Amplifier of ANY Superheterodyne Receiver, the GR Kit is superior to any other. As employed in American Navy Type "Superhets," C-8, C-10, "L"; also Golden-Leutz, "Super Phidyn 9," "Ilicdyne 6," and by thousands of American Home Constructors.

Complete Kit of four transformers, one Tuned Type 331 and three Type 271 (30 K.C. = 11,000 metres, the best intermediate frequency), in original GR sealed carton, guaranteed Laboratory "Matched" **£4 10 0**

Sent post free if your dealer cannot supply; guaranteed and on approval against cash. Enormous amplification per stage. Guaranteed Matched. Positively noiseless. Shielded electromagnetically and electrostatically. Work on any "superhet" circuit. Sold separately at **22/6** each, post free. Send for free GR Radio Catalogue and interesting booklets, etc. from:

Sole Concessionaires for Great Britain:—
Radio Specialist. **CLAUDE LYONS** Est. 1918.
76, Old Hall St., LIVERPOOL
Phone: Central 4641. Grams: "Minnetkem, Liverpool"

GENERAL RADIO CO. AMERICA

The COLVERN LOW LOSS SELECTOR

SELECTORS actually convert your receiver to an accurate wavemeter, ideal for short wave and all exacting requirements. Perfectly insulated, and may be mounted on metal panel.

Pamphlets on request.

Capacity:—	.001	£1 3 0
	.00075	1 2 0
	.0005	1 1 0
	.0003	1 0 0
	.0002	19 0
	.00015	18 0

CALIBRATION with certainty to the 1,000th part of the variable capacity. This is the tuning efficiency obtained with the Colvern Selector. The complete circle of the dial is divided to provide a value of 100 intervals for every rotation of the index. Presupposing your condenser and inductance to cover 300 metres, each interval represents 3 metres—obviously every station can be calibrated definitely.

The Colvern is logically the only condenser worthy of the attention of serious experimenters. An insulated spindle reduces the effect of hand capacity to a minimum, a point of paramount importance in the reception of distant signals.

See the Colvern at your dealers!
THE COLVERN LOW LOSS SELECTOR
(Geared 20-1.)

COLLINSON PR CISION SCREW CO., Ltd.,
Provost Works, Macdonald Road, Walthamstow, London, E. 17.
Telephone: Walthamstow 532

For every valve — for every circuit

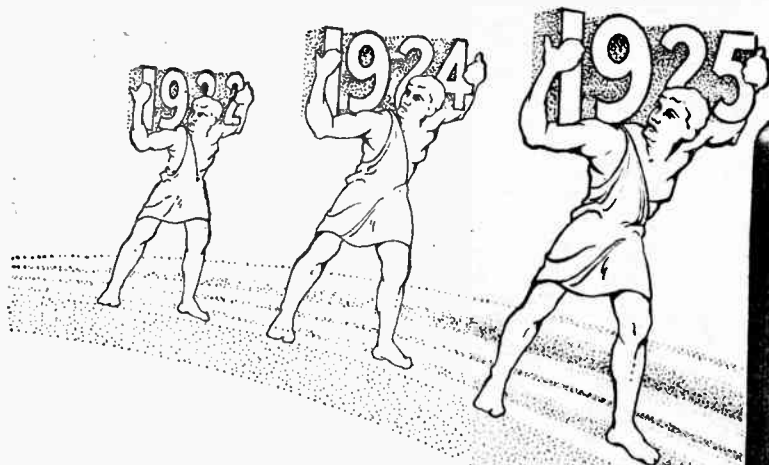

A Multi-Ratio Transformer

7 RATIOS

1926

PRICE 27/6

R.I. are now able to market, after many years intensive experimental work, a multi-ratio transformer which, while still retaining all the features of their original model, has a larger number of turns on the primary and secondary, and by tapping certain points and bringing them to a terminal block seven different ratios can be selected as desired. The impedance value covers approximately the wide range of from 6,000 to 60,000 ohms. Thus, whatever the circuit or valve in use, a winding of an impedance suitable for that particular circuit or valve can be chosen at will.

RATIO TABLE.

Ratio.	Approx. Primary Impedance in ohms.
1 — 1	60,000
1½ — 1	28,000
2 — 1	60,000
3 — 1	7,000
	28,000
	60,000
4½ — 1	28,000
6 — 1	7,000
9 — 1	7,000

In addition to the seven ratios available it is possible to obtain the main one by three alternative methods, allowing a different value of impedance to be selected for the same ratio.

The self capacity of the transformer is greatly reduced by the patented system of winding the coil, giving a greater degree of amplification on the higher frequencies, up to the useful point of audibility.

This new model is totally encased with a **steel shroud**. The coil is treated in such a way as to render it suitable for any climate in the world, and the celluloid enamel is practically rust-proof. The terminal block is a bakelite moulding.

A year's guarantee is given with each instrument, and in addition a book of circuits showing the best method of using a transformer as a standard intervalve coupling.

Write now for special booklet W.W.

THE MARK OF BETTER RADIO



Adv. R.I. Ltd., 12, Hyde St., New Oxford St., London, W.C.1

Advertisements for "The Wireless World" are only accepted from firms we believe to be thoroughly reliable.

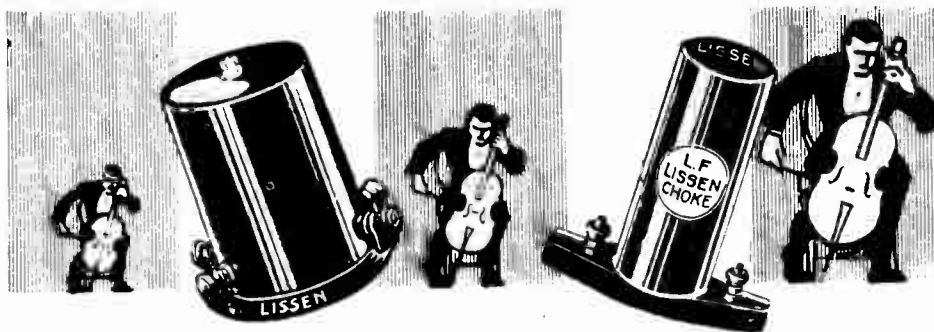

Building up volume without a trace of distortion

Lissen Amplifying Devices build up whispers into voluminous sound, yet never do they sacrifice tone purity for the sake of volume. Add a 2-valve Amplifier built from Lissen parts to your receiver and it's just as though the player had changed his instrument for one that was much larger—much more powerful. But volume is the only thing you add—harshness and distortion have no place in a Lissen Amplifier.

For the first L.F. stage use the Lissen T.1 Transformer, Price 21/-. Then follow this with a Lissen L.F. Choke, Price 10/-, or if you prefer it, use Lissen Chokes throughout.

When building a Choke Coupled Amplifier it is always advisable to use a variable grid leak having a wide range of variation. Use the Lissen Variable Grid Leak—you can obtain any resistance between



$\frac{1}{4}$ and 12 megohms, smoothly, gradually and *noiselessly*. One hole fixing, of course. Price 2/6.

The capacity of the Lissen Fixed Condenser recommended for choke coupled stages is .01 mfd., Price 2/4. It is also worth while to fit Lissen Fixed Condensers in every stage of your receiver. Accurate to within 5% of their marked capacities they will not vary and will not leak.

NOTE THE NEW PRICES:
 .0001—.001 1/3 .002—.006 2/-
 (mica dielectric).

With each .0002 and .0003 there is included free a pair of clips to take a grid leak.

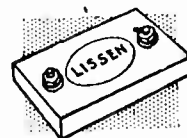

LISSEN

THERE IS NO 'WEAKEST LINK' IN THE LISSEN CHAIN

Lissen Limited, 21-25, Friars Lane, Richmond, Surrey

Phone: Richmond 2285 (4 lines).

Grams: "Lissenium, Phone, London."

L. 18

The Wireless World

AND
RADIO REVIEW
(13th Year of Publication)

No. 342.

WEDNESDAY, MARCH 3RD, 1926.

VOL. XVIII. No. 9.

Assistant Editor:
F. H. HAYNES.

Editor:
HUGH S. POCOCK.

Assistant Editor:
W. JAMES.

Editorial Offices: 139-40, FLEET STREET, LONDON, E.C.4

Telephone: City 4011 (3 lines).

Advertising and Publishing Offices: DORSET HOUSE, TUDOR STREET, LONDON, E.C.4

Telephone: City 2847 (13 lines).

Telegrams: "Ethaworld, Fleet, London."

COVENTRY: Hertford Street.

BIRMINGHAM: Guildhall Buildings, Navigation Street.

MANCHESTER: 199, Deansgate.

Telegrams: "Cyclist, Coventry."
Telephone: 10 Coventry.

Telegrams: "Autopress, Birmingham."
Telephone: 8970 and 2971 Midland.

Telegrams: "Diffe, Manchester."
Telephone: 8970 and 8071 City.

Subscription Rates: Home, £1 1s. 8d.; Canada, £1 1s. 8d.; other countries abroad, £1 3s. 10d. per annum.

As many of the circuits and apparatus described in these pages are covered by patents, readers are advised, before making use of them, to satisfy themselves that they would not be infringing patents.

FUTURE OF THE B.B.C.—A FORECAST.

ALTHOUGH it is not expected that the findings of the Broadcast Committee will be made public for several weeks to come, yet certain indications of the views of the Committee may be gathered from a careful study of the public proceedings of the Committee when the various witnesses were examined.

There is no doubt but that the Committee views broadcasting as a public service, and that it will take steps to prevent the B.B.C. from being dominated in its policy by any one body of interests. It is on this account that we anticipate that the representation of wireless traders on the board of direction of the B.B.C. will be considerably curtailed, and such members as cease to retain their seats will be replaced by persons representing the public user with, probably, a representative of the Post Office.

The service which the wireless traders have done in helping to bring the Broadcasting Company into existence is not to be lightly esteemed, and their subsequent service as directors of the Company has also been valuable, but the time has now come, and we believe that the wireless traders will be the first to admit it, when the broadcasting service in this country should be directed by a body more representative of national interests and uninfluenced by commercial considerations.

Another recommendation which we expect to see embodied in the Committee's report is one which will limit the competitive activities of the B.B.C. so as to avoid,

as far as possible, bringing the organisation into conflict with the various interests which would be adversely affected if the B.B.C. were permitted to extend its activities outside the scope of broadcasting, as would result, for instance, from the manufacture and sale of wireless apparatus by the B.B.C., or the assumption of the business of music publishers.

It is of the utmost importance that the B.B.C. should live in harmony with those with whom the Company must always be associated, and we therefore think that such a recommendation will go far to remove that suspicion which so many interests at present have of the B.B.C., not knowing where the activities of the B.B.C. will cease.

As regards the constitution of the Company, we do not anticipate that any changes will be recommended here beyond those of the Board which we have already indicated, and possibly the constitution of Advisory Committees on such sections of the programmes as music, education, science, etc. It seems probable also that the present monopoly of broadcasting will be vested in the Company for a further term of years, and that the existence of the Company will be guaranteed for a longer period than was provided for under the previous agreement.

No change is likely in the annual licence fee, nor do we think that the public would desire it. The B.B.C. is receiving only about half the amount subscribed by the public, and we hope that it will be recommended that a much bigger share should go to the improvement of the programmes. We feel sure that the public would regard this as preferable to any reduction in the fee.

CONTENTS.

	PAGE
EDITORIAL VIEWS	325
WORLD-WIDE WIRELESS	324
LOW LOSS COIL TESTS	328
DISTANT CONTROL UNIT	329
By A. P. Castellain.	
FURTHER NOTES ON THE LOADING	
EFFECTS OF CRYSTALS	334
By W. H. F. Griffiths.	
CURRENT TOPICS	337
A STABLE H.F. RECEIVER	339
By E. J. Martin.	
NEW APPARATUS	541
NEWS FROM THE CLUBS	342
PIONEERS OF WIRELESS—9.	343
By Ellison Hawks.	
WIRELESS CIRCUITS IN THEORY AND	
PRACTICE—6	345
By S. O. Pearson.	
HINTS AND TIPS FOR NEW READERS	349
BROADCAST BREVITIES	351
ELECTRIC TELEVISION	353
By Dr. H. Kroncke.	
LETTERS TO THE EDITOR	354
DICTIONARY OF TECHNICAL TERMS	355
READERS' PROBLEMS	357

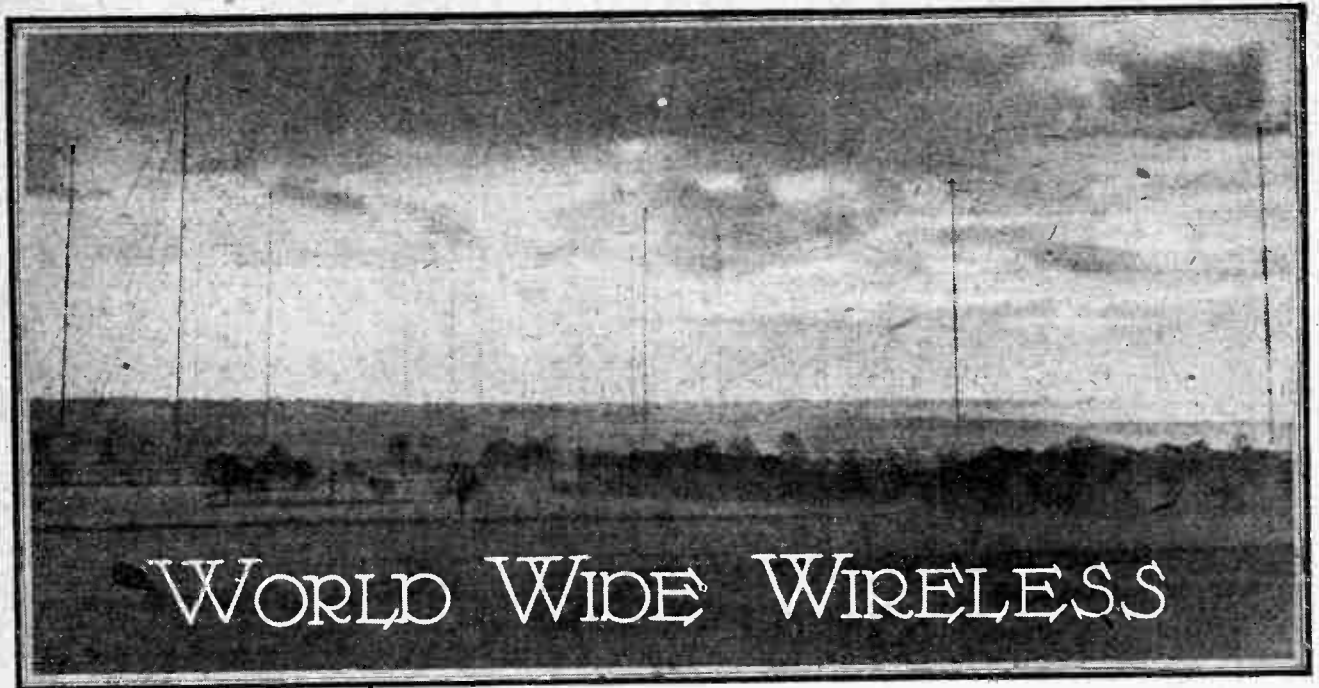

Technical Description of the Rugby Station.

THE question of providing wireless communication with all parts of our Empire has long been the subject of discussion. The British Government has been slow in the setting up of a wireless system which will link up England with the Colonies, yet tardiness in this case has probably been beneficial, inasmuch as the last few years have seen rapid progress in long-distance communication. At one time a chain of stations encircling the globe was considered desirable, but with the development of the valve as a generator of continuous waves almost unlimited in the power that can be handled the adoption of a single high-power station with a world-wide range has become possible. The construction of the Rugby station was decided upon to provide a means of communication with Australia and other parts of the Empire both by day and night without the necessity of interposing intermediate stations.

Selecting the Site.

The station is situated in the parish of Hillmorton, near Rugby, the site being selected mainly on account of the flatness of the land, with absence of screening. Other considerations naturally included a sufficiency of water for cooling purposes, suitability of the sub-strata to withstand the heavy concentrated loads of the masts, presence of good roads, a railway line and proximity to a main telegraph route, strategical considerations in the event of war, and nearness to a town of medium size to provide social amenities for the staff. The station stands approximately 340 feet above sea level, and covers an area of 900 acres.

The main buildings are situated almost at the centre of the site, with eight of the twelve masts to the south,

spaced 140 yards apart and forming the corners of an irregular octagon. The remaining masts are to the north of the building and are for use with the Transatlantic telephony equipment, sufficient space being available for the erection of four additional masts in symmetrical arrangement should they be considered necessary.

Each of the masts are identical in form, rising to a height of 820 feet. They are triangular in section, and the sides are 10 feet across. The mast equipment includes a ladderway as well as a lift capable of carrying three persons, the winding mechanism of the lift being arranged also to coil in the halyard for raising the aerial. A 440-volt 3-phase motor of 20 horse-power drives each winch. An interesting friction device forms part of the drum on which the halyard is wound, and when the pull exceeds 10 tons the drum slips, thus letting out the halyard and relieving the tension. The pulley gear at the masthead is free to revolve, and moves with the hand rail and circular platform, which is about 9 feet across.

Insulated Masts.

The base of each mast terminates in an inverted tripod, the apex forming a socket seating on the spherical surface of a cast steel plate, thus providing a free movement. Beneath the pivot are a series of insulators, consisting of porcelain cylinders to give adequate voltage insulation, followed by a Swedish granite block 5ft. 6in. square to limit the capacity to earth. The insulation from earth of such stupendous masts is an ambitious undertaking, aiming in its purpose at increasing the effective height. Each mast is supported by fifteen guy ropes arranged in five groups of three.

Two independent aeriels are in use, both being of

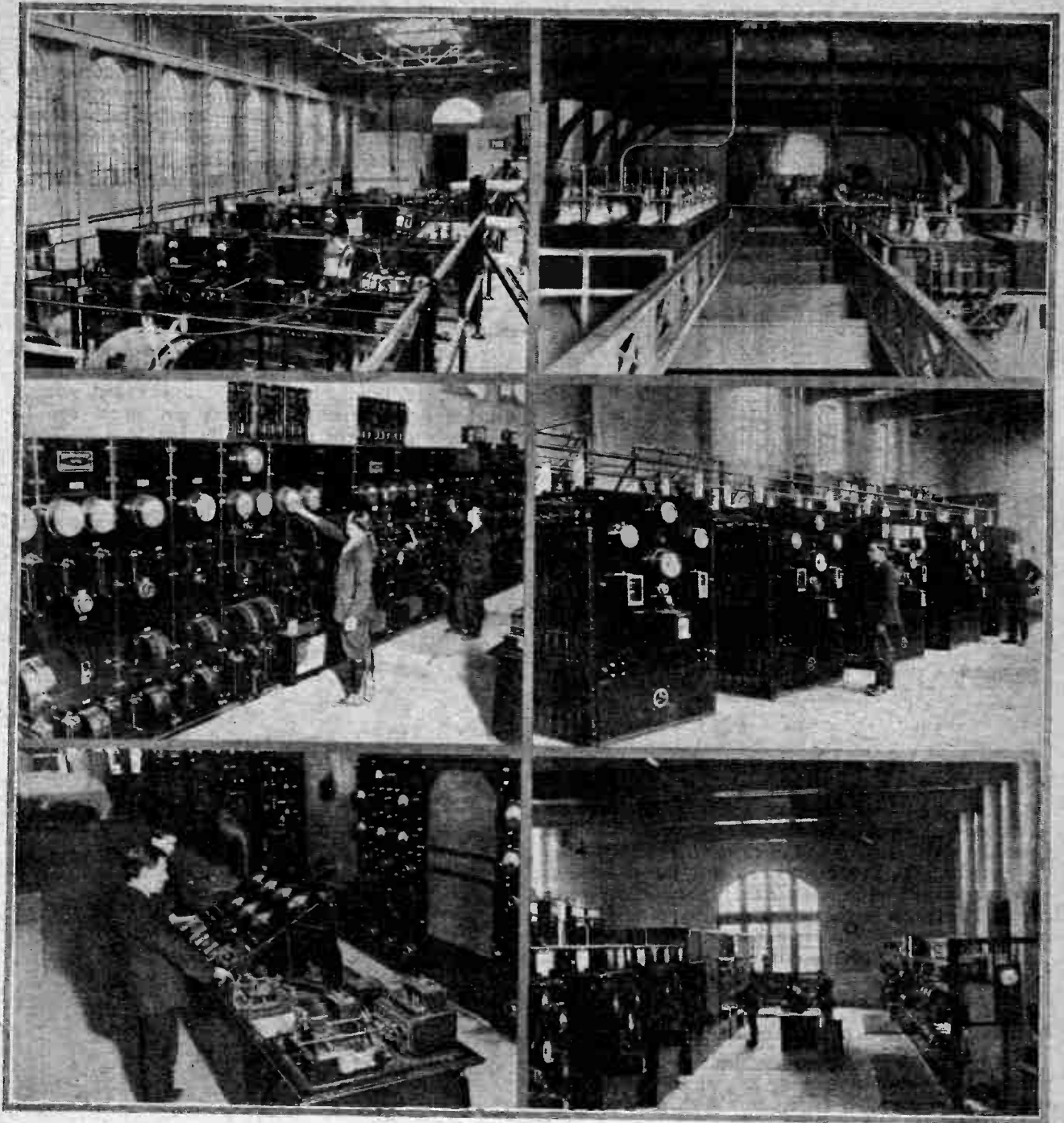

(Top) **POWER ROOM.** The high voltage motor generator sets are in the foreground. There are three units, each capable of producing 6,000 volts. Each set comprises two dynamos running in series driven by a 3-phase motor.

(Top) **THE CLOSED CIRCUIT CONDENSERS** arranged on a gallery immediately beneath the tuning inductances

(Centre) **THE MAIN SWITCHBOARD** is immediately behind the observation desk. The engineer on duty controls the entire plant.

(Centre) **VALVE SECTIONS.** Each cubicle contains the equipment associated with the running of eighteen 10-kw. valves.

(Bottom) **OBSERVATION DESK.** The serial ammeter and other important instruments showing the performance of the station are carried on the instrument panel, whilst the keying and telegraph circuits which are connected with the Central Telegraph Office in London, are to be seen on the right.

(Bottom) **THE CONTROL ROOM** contains the main switchboard, observation desk and valve sections.



ONE OF THE TUNING VARIOMETERS. It is built entirely on a wooden frame work and the cable consists of 6,561 strands of No. 36 S.W.G. enamelled wire.

"sausage" type. The eight-mast aerial consists of eight $7/14$ S.W.G. silicon-bronze wires mounted on 12ft. diameter steel spiders assembled around a central 2in. steel rope. The four-mast aerial differs inasmuch as copper-clad wire is used instead of bronze. The lead up to the aerial is composed of eight $7/14$ S.W.G. wires on spreaders 6in. in diameter, so that the capacity is here reduced without increase of the high-frequency resistance. The larger aerial has a capacity of about 0.03 mfd., and the smaller 0.023 mfd.

The aerial insulators are of hollow porcelain tube 6in. in external diameter and tested to withstand a pull of 20 tons, and a potential of 200,000 volts at 50 kilocycles.

Constancy of Wavelength Maintained by a Tuning Fork.

The transmitting equipment, which has been designed throughout by the Engineering Department of the Post Office, makes use of a tuning fork both for setting up and maintaining the oscillatory currents which, when magnified by high-power water-cooled valves, excite the aerial system. The tuning fork is electrically driven and has a fundamental frequency many times lower than the oscillation frequency of the aerial circuit. The oscillations set up by the fork are amplified by means of a valve the grid potential of which is adjusted so that it operates near the lower bend of its characteristic. By this means a wave form rich in harmonics is set up in the plate circuit, and a suitable harmonic is selected by means of a filter circuit and amplified by a series of oscil-

lation amplifiers. Each amplifying stage is built as a separate unit, and tuning is carried out by means of a Moullin voltmeter with input terminals connected to a plug. Break-jacks are fitted to each high-frequency unit so that the plug from the Moullin voltmeter can be inserted stage by stage in the amplifiers and each brought to resonance. Some five intermediate high frequency stages are employed advancing in the type of valve used from the ordinary receiving valve to a large valve dissipating approximately 600 watts.

The Water-cooled Valve Equipment.

Water-cooled valves are used for aerial excitation, and are manufactured by Mullard, Phillips and the Western Electric Co. The valves are rated at 10 kW. with an anode potential of 10,000 volts. The filament current is 41.5 amperes, and an emission of 7 to 8 amperes is obtained. The valves are arranged in sections of eighteen, and five complete panels are installed, suitable switches being arranged so that any panel can be separately connected to the main bus bars. Three panels comprising fifty-four valves are required to generate 500 kilowatts of high frequency power on the aerial circuit.

The filaments are heated from a three-phase alternating current supply at a frequency of 100 cycles, the current

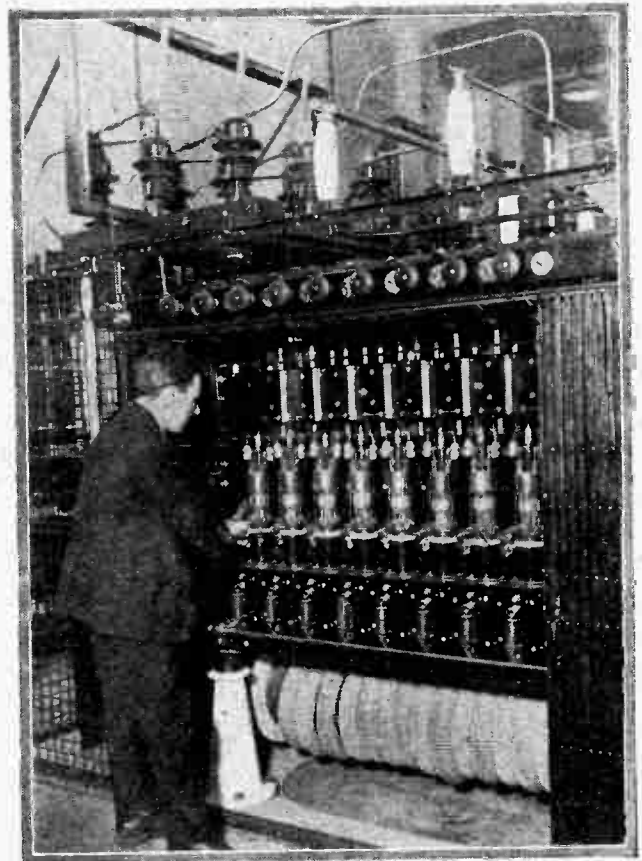

ONE SIDE OF ONE OF THE VALVE SECTIONS. Nine 10-kW. valves are mounted on each side of the section and the auxiliary apparatus includes the overload anode relays to be seen beneath the valves and the chokes and resistances, which are just above the valves. The coiled piping carries the cooling water.

World Wide Wireless.—

being obtained from motor generators. The three phases are distributed amongst the various valves to maintain constant emission. To provide for small differences in the filament characteristics each valve is provided with separate filament control, and by means of a series of key switches a voltmeter can be connected across the filament terminals of any valve to indicate the filament potential. Each valve is provided with a cut-out relay in the anode circuit, in addition to choke coils and resistances to prevent the setting up of circulating currents. Negative grid biasing is maintained by means of direct current motor generators.

The closed circuit inductance is composed of three hexagonal spiders of approximately 14ft. diagonals, the cable used for winding the inductances consisting of 6,561 strands of No. 36 S.W.G. enamelled wire in bunches of 81 strands provided with silk coverings. The tuning circuit is designed to give a wavelength of 1,800 metres. The aerial tuning coil consists of five spiders of 15ft. 6in. diagonals, each being wound with eight turns of similar cable.

Power is supplied by the Leicestershire and Warwickshire Power Co. at 12,000 volts 50 cycles, and the three-phase mains are duplicated to ensure continuity.

The High Voltage Generators.

High tension supply to the valves is derived from three 500 kW. motor generator sets. Each set consists of a synchronous motor driving two 3,000-volt single commutator generators joined in series. The generating sets are insulated from earth so that the voltage difference

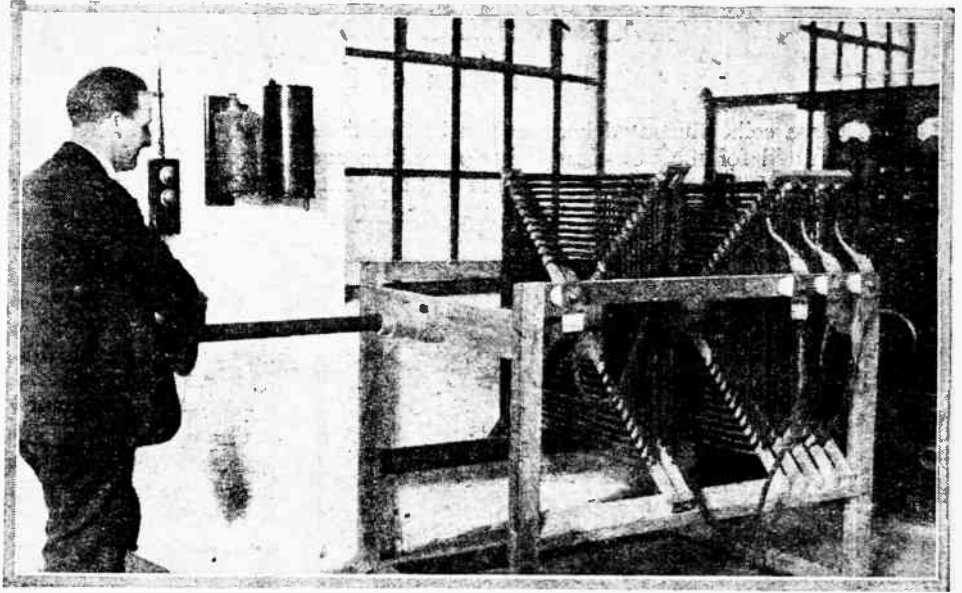

Another form of variometer used in the aerial tuning circuit.

between the frames and windings does not exceed 3,000 volts. The motors which are self synchronising are rated at 640 kW., and are run at a speed of 570 r.p.m. As the frames of the motors are above earth potential the input is obtained through a transformer specially insulated to stand 50,000 volts between primary and secondary windings. The neutral point of the motor is connected to the frame.

Current for Controls.

The generating sets are arranged to be run in series so that 6,000, 12,000 or 18,000 volts continuous current is obtainable as required. High speed circuit breakers throw a limiting resistance into circuit on a short circuit occurring. Normally an overload operates a relay and trips the field circuit of the H.T. generators. Other machines which supply the filament heating current have already been referred to in addition to which a continuous current of 240 volts is provided for controls, excitation for motors of frequency converters, etc., while a 200 ampere hour battery is installed for stand-by lighting and control purposes.

World Wide Range.

No details are given here of the Transatlantic telephony equipment with which experiments are at present being conducted. The equipment makes use of the side band system in which the carrier wave is suppressed by means of filter circuits, and reception is carried out with the aid of a local oscillator.

That the success of the station is already assured is indicated by the fact that direct communication with Australia has already been established, whilst it is stated that signals from the Rugby station are received in the United States at greater strength than the signals from Bordeaux. Hitherto the Bordeaux signals were stronger in the United States than signals from any other European station.

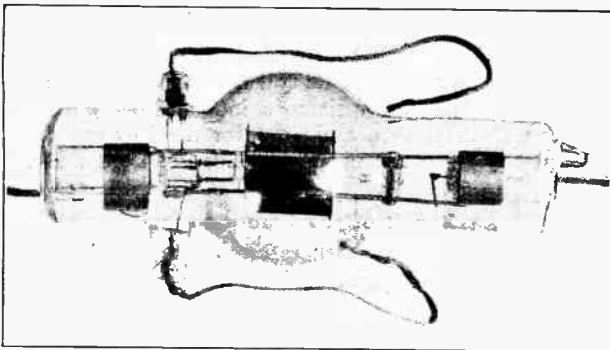

NEW SHORT-WAVE TRANSMITTING VALVE. Of American manufacture, the electrodes of this new valve have been designed so that the total capacity of the circuit will not necessarily lie mainly within the valve itself. Under normal conditions the plate can be operated at a dull red and plate voltages between 1,000 and 3,000 used with a current from 40 to 50 milliamperes.

LOW-LOSS COIL TESTS.

Description of the Most Efficient Coils.

THE two coils illustrated here are the best of those submitted for the Low-Loss Coil Competition and very careful tests have been made to find the better coil of the two.

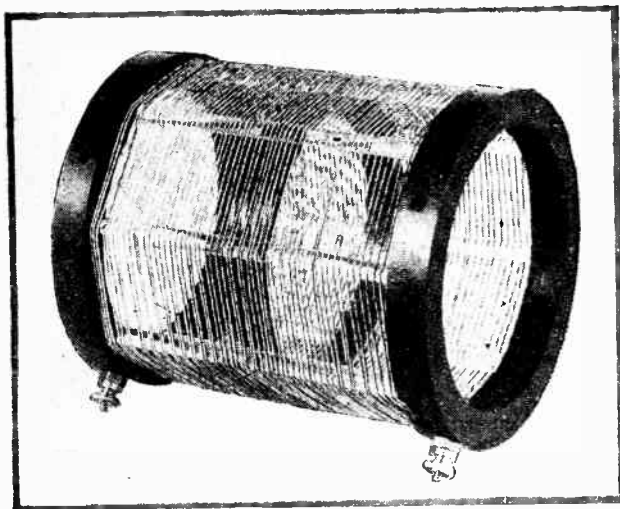

The most efficient coil. It is wound with Litz wire, and the former consists of a number of glass rods held by ebonite rings.

One of them has 56 turns of 20-38 Litz wire, a mean diameter of $2\frac{15}{16}$ in., and a length of $3\frac{1}{8}$ in. The former consists of two ebonite rings, $3\frac{1}{4}$ in. external diameter by $\frac{3}{8}$ in. thick, and has 8 glass rods $\frac{1}{16}$ in. diameter, a thin stiff ring being used to support the rods at their centre.

Resistance Measurements.

The resistance of this coil was taken at four wavelengths, and was found to be:—

1.8	ohms	at	500	metres.
2.05	„	„	400	„
2.4	„	„	350	„
2.6	„	„	320	„

and its inductance was 134 microhenries at 400 metres.

The second coil is wound with 38 turns of bare No. 19 S.W.G. copper wire, the spacing at the corners being $\frac{1}{16}$ in., and having intermediate spacers of $\frac{1}{8}$ in. diameter

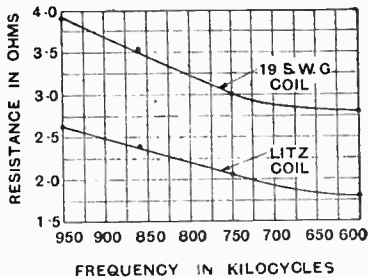
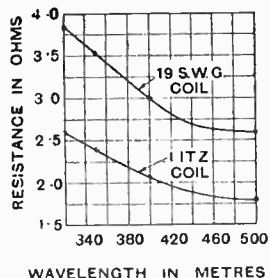

Variation of the H.F. resistance with wavelength and frequency.

ebonite rods. The coil is practically air-spaced, has a length of $2\frac{3}{8}$ in., and a mean diameter of practically $5\frac{1}{8}$ in.

Tested at the same wavelengths as the first coil, the following results were obtained:—

2.58	ohms	at	500	metres.
3.00	„	„	400	„
3.52	„	„	350	„
3.85	„	„	320	„

The inductance of this coil is 170 microhenries at 400 metres.

H.F. Resistance in Ohms per Millihenry.

Curves are given to show the variation of the H.F. resistance with wavelength and frequency; it is interesting to note that the resistance increases as the wavelength is reduced, as one would expect.

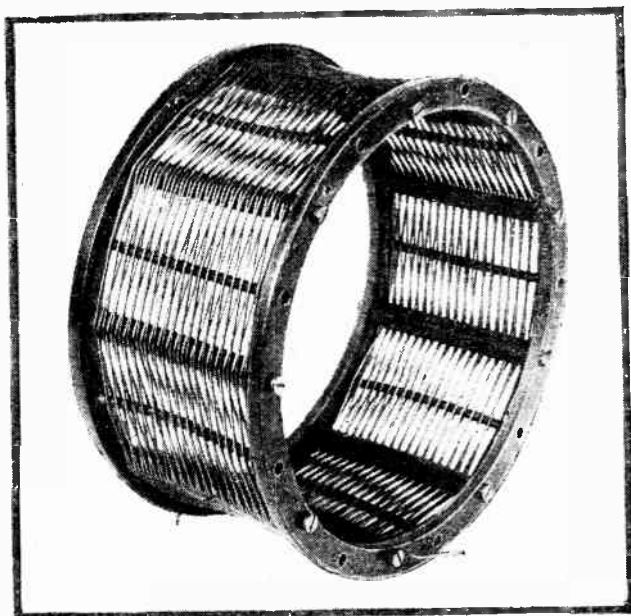

A very good coil, only slightly less efficient than the winning coil. Bare wire is used, and the turns are carefully spaced.

If the ratio of resistance to inductance is worked out, it will be found that the Litz coil is superior to the coil of bare copper wire, the resistance in ohms per millihenry being 13.4, 15.3, 17.9 and 19.4 for the Litz coil at the wavelengths given above, and 15.2, 17.7, 20.8 and 22.8 for the coil of bare copper wire.

Result of the Competition.

The prize of £5 has, therefore, been awarded to the designer of the Litz coil (Mr. Hamilton Emmons, of Southampton).

No doubt many readers will be rather surprised that a coil wound with Litz wire proved the best. We are, therefore, making further tests on a number of coils adjusted to 200 microhenries, with the object of comparing their efficiencies over the broadcast band of wavelengths.

W. J.

Distant Control Unit.

Filament Switching and Volume Control Through Extension Leads.

By A. P. CASTELLAIN, B.Sc., D.I.C.,
A.C.G.I.



THERE are many people who regard wireless merely as a means of enabling them to enjoy music and entertainment in their own homes, and such people regard the upkeep of their wireless sets as a necessary evil and do not wish continually to be "playing with the knobs" on their set to get distant stations.

For such people the local broadcast station is sufficient, and a simple two-valve set, with its attendant simplicity of control, is usually all that is necessary to operate a loud-speaker successfully. The only controls on such a set will be a tuning condenser, which will be adjusted once and for all on the local station, with either a filament resistance or a master switch to turn on the valves.

When the loud-speaker is in the same room as the set it is a simple matter to switch the latter on and off as required, though it is sometimes rather a nuisance to get up out of a comfortable armchair and switch the set off when one particular item is not required. However, when it is not convenient to have the set in the same room as the loud-speaker, or when the loud-speaker is required in several rooms of the house, it certainly is rather a bother to go and switch the set, and it is probably this fact which has prevented many people from wiring their house so as to be able to use the loud-speaker in more than one room.

Advantage of Distant Control.

It is quite possible, however, to arrange matters so that the set is switched on and off as required from the room in which the loud-speaker happens to be. For example, if an item which was particularly required to be heard

happened to be broadcast some time during dinner, all that it would be necessary to do would be to take the loud-speaker, fitted with a special little switch, into the dining-room and plug it into its socket, and to switch it on when required.

The control unit to be described will enable the user to control the set from the loud-speaker as stated above, and to control the volume of sound produced.

The principle of operation of the unit is as follows: The switch on the loud-speaker closes a circuit comprising a battery and the magnet coils of a relay, situated near the set, which closes the filament circuit of the valves and so switches on the set.

The action of the relay may be studied in reference to Fig. 1. The relay consists essentially of an iron core A, generally shaped more or less as shown, carrying a coil of wire B on one limb. Screwed on to the other limb is a flat springy strip, which may be of steel, carrying a piece of iron D so placed as to be immediately over the part of the core carry-

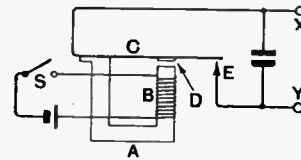
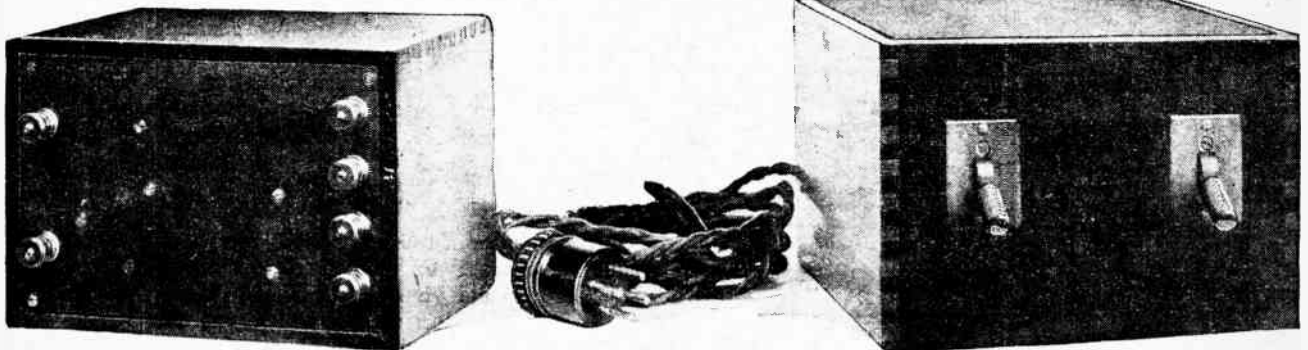

Fig. 1.—Connections of the filament switching relay.



The relay unit (left) which is installed near the receiver, and (right) the control unit and adaptor for connection to the loud-speaker extension leads.

Distant Control Unit.—

ing the coil, but separated from it by a small air-gap.

On closing the switch S a current flows round the coil B and magnetises the iron core. The piece of iron D is thus attracted to the core immediately below it, and it therefore moves towards and may touch it, but in so doing it bends the spring C. A contact E is arranged as shown to touch an extension C when the latter is bent sufficiently.

When the switch S is opened the core ceases to be magnetised, so that the pull on D, which is bending the spring, also ceases, and the spring returns to its former position, in which it does not touch the contact E.

Thus the switch S opens and closes the path between C and E, which may be connected through terminals X and Y respectively to the L.T. circuit.

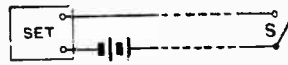

Fig. 2.

Suppose we take the case of two bright-emitter valves taking 0.75 ampere each, making a total of 1.5 amperes. This means that every ohm introduced by the leads gives a reduction of battery voltage available to the valves of 1.5 volts. If 4½ to 5 volts are required on the valve filaments and a six-volt L.T. accumulator is used the total resistance of the leads must be less than one ohm, which necessitates either thick leads of, say, 7/22 light cable or thinner leads and an increase of accumulator voltage—and both these expedients are expensive.

A relay, on the other hand, is not expensive to make and can be made to operate on a few milliamps supplied by the existing filament battery, so that thick and expensive leads to the switch will not be necessary. The case of a set using dull-emitter valves is not quite so bad as the bright-emitter example given above, except in the set where two-volt valves taking 0.4 amp. each and running off a two-volt accumulator are used. The margin between battery voltage and the voltage required on the valves (1.8-1.9 volts) is extremely small, and the current

So far the advantage of the relay is not apparent, as it would be easier to put the switch S between X and Y without using any relay at all. The great advantage of the relay, however, lies in its property of being able to control very much larger currents than those by which it is operated—that is, a small current flowing round the coil B can control a large current between X and Y.

It may be argued that the set can easily be controlled from each room by extending the leads from the L.T.

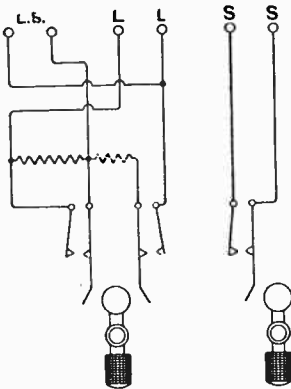

Fig. 3.—Connections of the switch box.

battery after the fashion of Fig. 2, without using any relays. Well, so it can, provided certain things are done. It will be obvious that the leads to the switch will introduce extra resistance in the filament circuit, which will mean that there is a drop of voltage across the leads. This voltage drop will depend on the resistance of the leads and on the total filament current taken by the set.

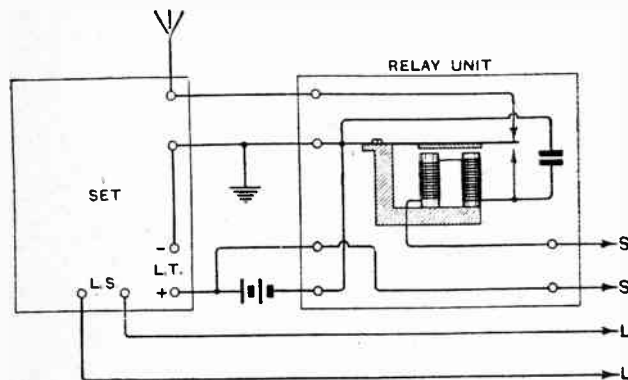
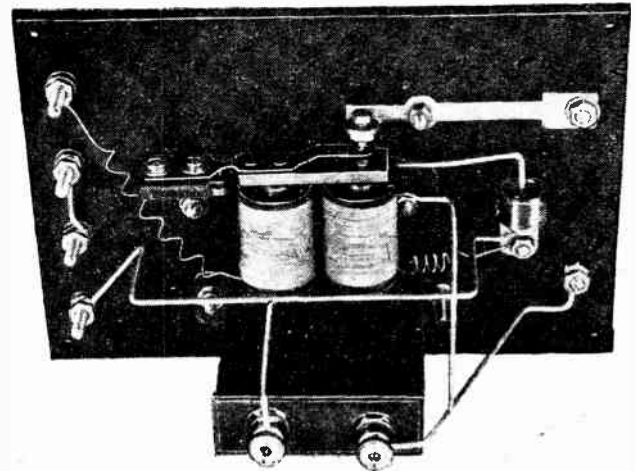

Fig. 4.—Internal connections of the relay and method of connection to the receiving set and extension leads.



Back-of-panel view of the relay unit.

is 0.8 amp. for two valves, necessitating very thick wires to the control switch if the arrangement of Fig. 2 is to be used.

Enough has been said by now to show that the relay method of control is much cheaper and neater to instal and use.

It is very often desirable to diminish the volume of sound from the loud-speaker—for example, when it is desired to hear the commencement of a certain broadcast item which follows uninteresting matter. In such a case the provision of a switch to control the loudness of reproduction is desirable. The circuits used for this are shown in Fig. 3 and for the relay in Fig. 4.

The Relay Unit.

This consists of the relay itself, mounted in a box with suitable terminals for connection to the set, and is shown in back-of-panel view of the unit. The relay itself is made from an electric bell which was purchased from the Economic Electric Co., Ltd., price 2s. 6d., and, as will be seen, most of the parts except the bell and baseboard have been utilised.

Distant Control Unit.—

On obtaining the bell the first thing to do is to remove the spring and striker by undoing the two holding screws. The wires leading from the bobbins to frame and terminals should be cut and the bobbins gently eased off the cores. It will be found that the bobbins will come off if pulled by hand, but they must on no account be

liquid paste is formed. If the amalgam is too liquid when cold, add more lead; if too thick, add more mercury. The advantage of using amalgam is that it will stay where it is put much more readily than mercury, and is rather easier to adjust in height in the cup.

The cup should be about half full of amalgam or

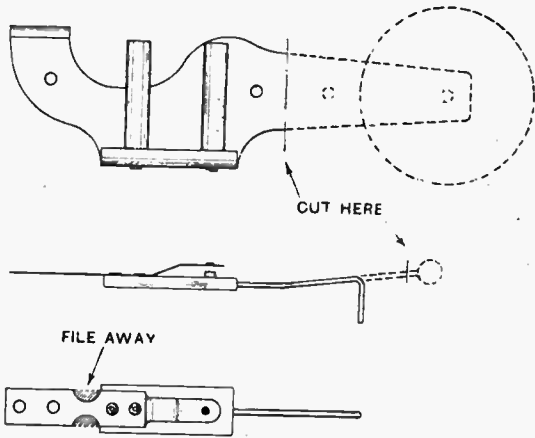
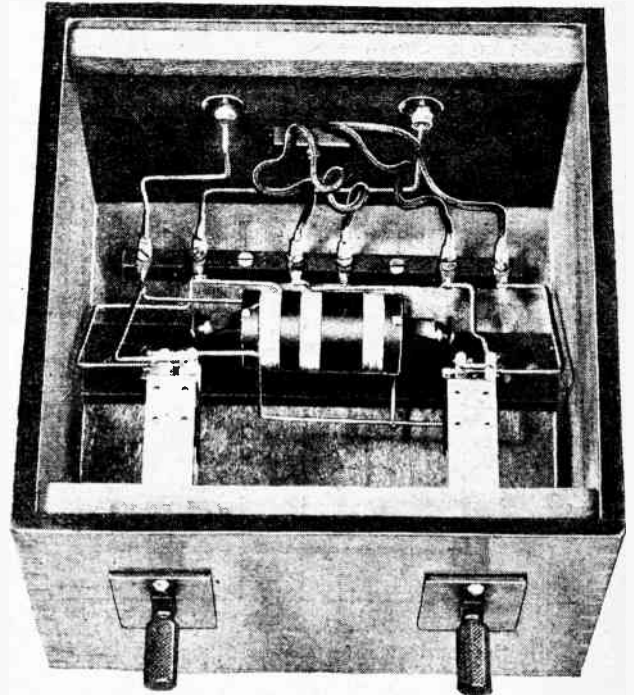

Fig. 5.—Modifications of the bell parts necessary in constructing the relay.



Interior of the control unit.

levered off by means of a screwdriver, since this will break them and fresh ones will then have to be made.

Construction of the Relay.

The striker ball should be cut off and the rod bent as shown in Fig. 5, which also shows core and frame alterations. To increase the sensitivity of the relay the spring should be weakened by filing as shown.

The layout and wiring diagram of the relay is given in Fig. 6, so that no difficulty should be experienced in making up the unit. The crystal cup is used to hold mercury or, better, an amalgam made by gently heating a mixture of clean lead and mercury until a semi-

mercury, and should have a few drops of machine oil added to keep the surface clean after the relay is completely assembled and ready for use.

The existing wire on the bobbins is removed and the bobbins filled with No. 38 S.W.G. D.C.C. copper wire.

For sets with 2-volt valves the windings should be connected in parallel, while for a 4- or 6-volt L.T. accumulator they should be in series. If it is desired, the bobbins may be wound with No. 40 S.W.G. wire for a 6-volt battery, as this will reduce the current consumption.

On reference to Figs. 1 and 6 it will be seen that there is a 1 mfd. condenser connected across the mercury cup contact; this is to prevent sparking and consequent deterioration of the contact surfaces. It will also be noticed that when no current is flowing through the relay windings, i.e., when in the "off" position, that the aerial is connected to earth, which is a thing that many people forget to do when they switch off the set.

The Control Unit.

The unit is mounted in a box suitable for carrying the loud-speaker or for putting in any convenient position near at

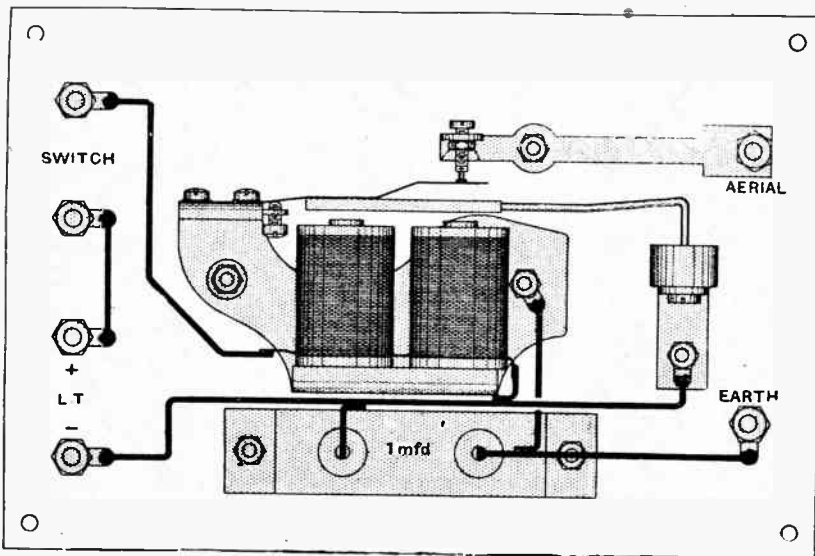

Fig. 6.—Practical wiring diagram of the relay.

COMPONENTS REQUIRED.

Relay Unit.

- 1 Electric bell (Economic Electric Co., Ltd.).
- 6 Terminals.
- 1 Crystal cup.
- 1 Box, 6in. x 4in. x 4½in., with ebonite panel.
- 1 T.C.C. condenser, 1 mfd.

Control Unit.

- 1 Box, 6in. x 6in. x 4½in.
- 1 Panel, 6in. x 6in., to fit (ebonite or wood).
- 1 Single-pole single-way Dewar switch.
- 1 Two-pole two-way Dewar switch.
- 2 Terminals.
- Ebonite rod and phosphor bronze strip.

Approximate cost, 25s. to 30s.

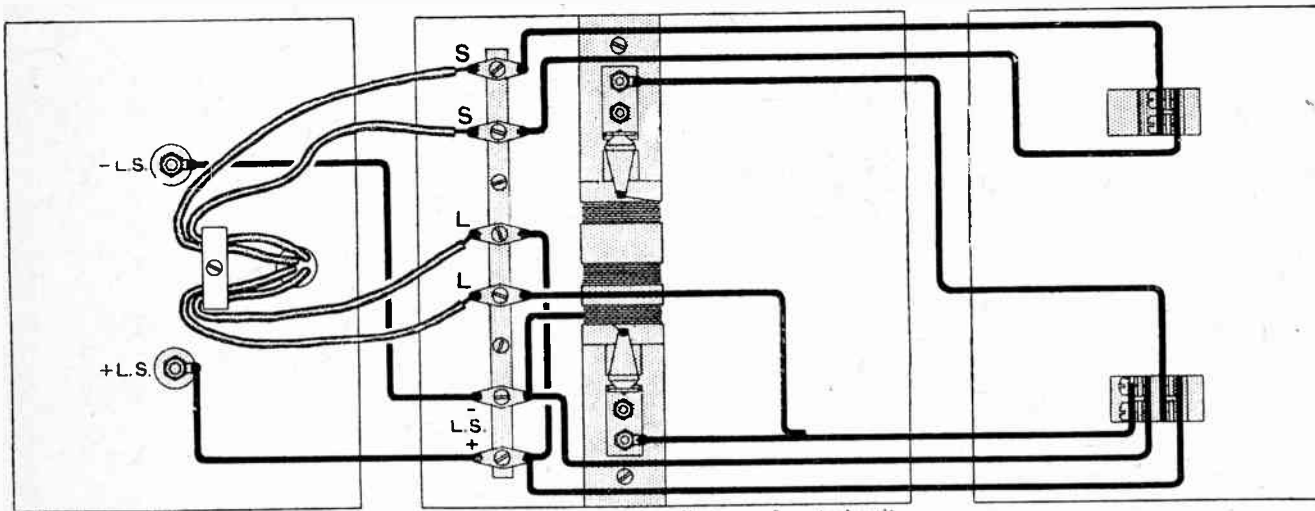

Fig. 7.—Practical wiring diagram of control unit.

hand, while the loud-speaker may be placed further away. The writer has found that different people like widely different degrees of "softness," so that, although definite values of windings will be given for the resistance, the reader who prefers to try other values may

"soft" position a shunt resistance is placed across the loud-speaker and also a resistance is put in series with the loud-speaker, so that the total D.C. resistance in the last valve circuit, and thus the H.T. on the plate of this valve, shall remain unchanged. This is quite necessary when using a power valve of low resistance for the last valve.

WINDING TABLE FOR RESISTANCE BOBBIN.

Loud-speaker Resistance ..	2,000 ohms.		4,000 ohms.	
	Gauge of wire, S.W.G.	40	44	44
Shunt winding	22 yds.	10 yds.	20 yds.	8 yds.
Series winding	40 yds.	18 yds.	36 yds.	15 yds.

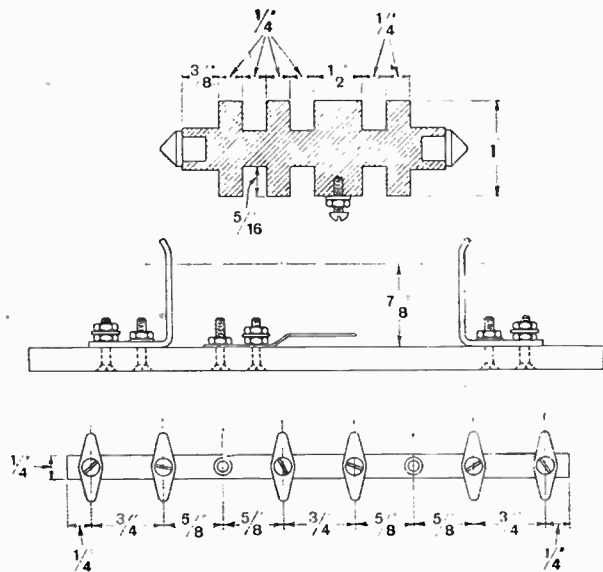

Fig. 8.—Details of the resistance coil former, mounting and terminal strip.

The wiring from the set to the various rooms may conveniently be made of bell wire, terminating in ordinary valve sockets in the rooms. If the loud-speaker is connected directly in the plate circuit of the last valve, then the wire coming from the loud-speaker terminal on the set connected to the plate of this valve must be kept away from the other wires to the control unit, and is preferably kept one or two inches away from the wall by small ebonite or wood distance-pieces which may conveniently be

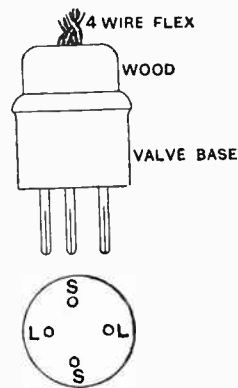

Fig. 9.—Connections of the valve base adaptor.

easily do so by pulling out the bobbin and winding on or unwinding the turns until he is quite satisfied. The clip method of holding the bobbin is also by far the most satisfactory in practice. When the switch is in the

Oct.	Nov.	Dec.	Jan.	Feb.	Mar.	Apr.	May
MAXIMUM VALUE							
GOOD VALUE							

Announcing A Substantial Reduction in A.J.S. Prices.

A.J.S. Receivers and the two Cabinet Loud Speakers have been reduced in price from March 1st. At the new prices the apparatus concerned represents the maximum radio value, and will therefore appeal to the enthusiast who is satisfied only with the best obtainable.

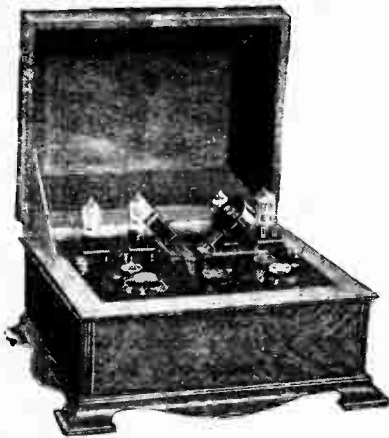

This illustration shows the T.M.2 model, being a 4-Valve Receiver. Price £26 15s.
This receiver may be ordered in a sloping cabinet similar to that illustrated on the right.
4-Valve Standard Receiver, in sloping cabinet, £13 15 0
2-Valve Standard Receiver (1 H.F. and Det.) as illustrated £8 10 0

Instrument.	Old Price.	New Price.
Two-Valve Standard, complete	£16 17 6	£13 17 6
Two-Valve Standard, receiver only	£11 10 0	£8 10 0
Three-Valve Standard, complete	£21 13 6	£15 17 6
Three-Valve Standard, receiver only	£14 17 6	£9 16 6
Four-Valve Standard, complete	£26 15 0	£22 0 0
Four-Valve Standard, receiver only	£18 10 0	£13 15 0
T.M.1, complete	£35 0 0	£29 17 6
T.M.1, receiver only	£25 15 0	£21 12 6
T.M.2, complete	£30 10 0	£26 15 0
T.M.2, receiver only	£21 5 0	£18 10 0
P.1, complete	£65 0 0	£52 10 0
P.1, receiver only	£55 15 0	£44 5 0
P.2, complete	£52 0 0	£45 0 0
P.2, receiver only	£42 15 0	£36 15 0
S.1, Console Receiver, complete	£75 0 0	£62 10 0
S.1, Console Receiver, receiver only	£65 15 0	£54 5 0
Concert Amplifier	£15 19 0	£11 15 0
One-Valve Amplifier	£5 2 6	£4 2 6
Two-Valve Amplifier	£8 2 6	£6 10 0

ALL INCLUDING ROYALTIES.

Cabinet Loud Speaker	£4 15 0	£3 15 0
Pedestal Loud Speaker	£22 10 0	£19 19 0

Sent for Publication No. 120, which illustrates and fully describes the complete range.

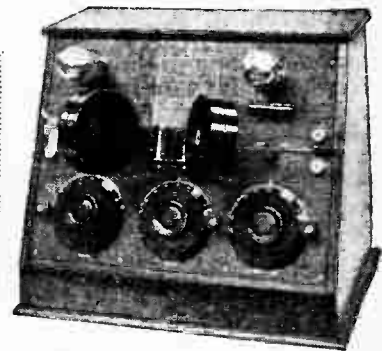

Hire Purchase.

Messrs. H. Taylor & Co., Ltd., 49/53, Sussex Place, South Kensington, S.W.7 (near South Kensington Station), are prepared to arrange for the sale of A.J.S. Receivers and Loud Speakers on easy payments.

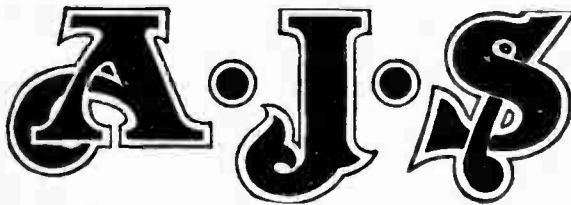

A. J. STEVENS & CO. (1914) LTD.,
RADIO BRANCH, WOLVERHAMPTON

Telephone: 1748 (7 lines). Telegrams: "Reception, Wolverhampton."

London Showrooms: 122/124, Charing Cross Road, W.C.2.

Telephone: Regent 7161-2. Telegrams: "Ajayesso, Westcent, London."

Glasgow Showrooms: 223, St. George's Road, Glasgow.

Telephone: Douglas 3449. Telegrams: "Reception, Glasgow."

A. J. STEVENS & O. (1914) LTD.,
RADIO BRANCH, WOLVERHAMPTON.

Please send Publication No. 120.

Name

Address

W.W. 3/3/26.

ISSUED BY THE PUBLICITY DEPT., A.J.S.



Shall I Scrap my
 H.F. Transformer

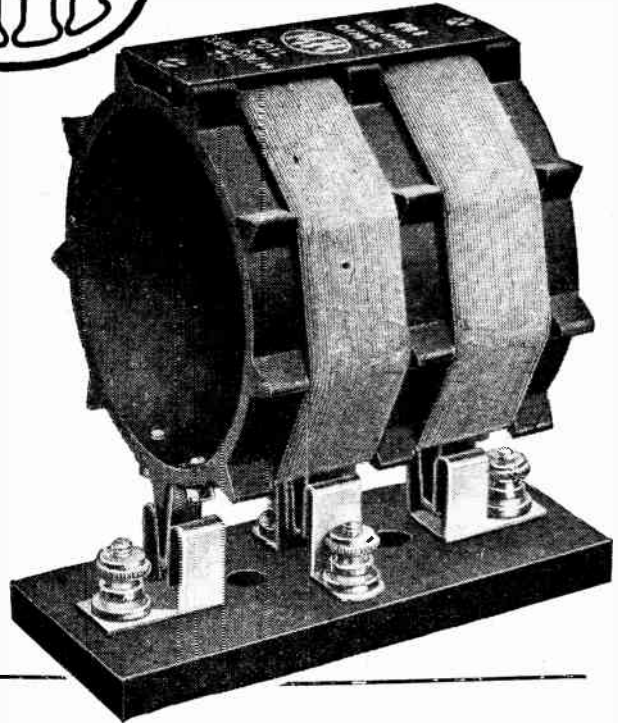
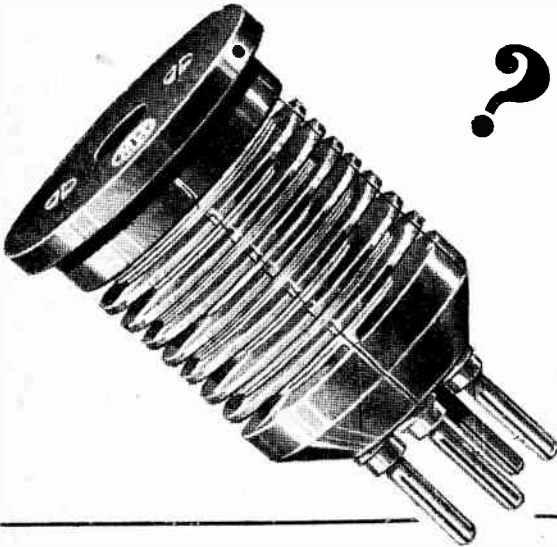

FOLLOWING on the introduction of the "DIMIC" Coil, we have frequently been asked the above question. Our answer is given diagrammatically, from which it will be seen that the H.F. Transformer need not, and we think never will, be scrapped. It is a highly efficient device supplementary to, and not supplanted by, the "DIMIC" COIL.

If you desire a higher performance from your Set, spend a little more money on a further stage of H.F. amplification rather than replace your  H.F. Transformers with "DIMICS." A full diagram for this is shown. It gives extraordinarily good results with very high selectivity. At approximately 18 miles from

2LO we have frequently had Cardiff at Loud Speaker strength without any interference from 2LO when the latter was working—although adjustment for this is naturally very critical. Manchester at the same distance is comparatively easy to obtain and separate from London completely, even with the headphones on

On two stations at a distance, and heterodyning each other, either station has been brought in at full Loud Speaker strength, clear from, but naturally distorted by, the other.

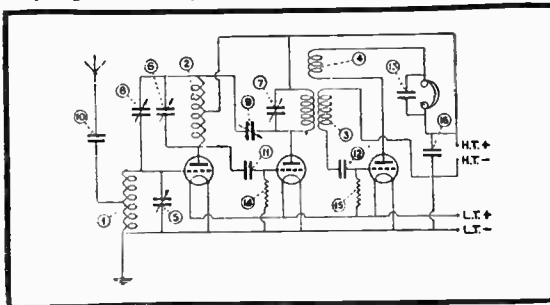

 "DIMIC" COILS

are available in the following sizes:—

- No 1 300/ 600 M.
- .. 1a 450/ 950 M.
- .. 2 600/1300 M.
- .. 2a 900/2000 M.
- .. 3 1100/3000 M.
- .. 3a 2000/4500 M.

PRICE 10/- EACH.
 BASE EXTRA 2/6

INDEX TO CIRCUIT DIAGRAM.		
Item		Each/ Base
1 and 2	MH "Dimics" ..	10/- 2/6
3	MH H.F. Barrel Type Transformer ..	10/-
4	MH Reactor ..	15/-
5 and 6	'0005 Variable Condenser ..	10/6
7	'0003 Variable Condenser ..	8/6
8 and 9	Neutralising Condenser ..	2/10
10, 11, and 12	'0003 MH Mica Condenser ..	2/6 1/-
13	'001 Mica Condenser ..	3/- 1/-
14 and 15	MH Grid Leak, 1 megohm. ..	2/6 1/-
16	'01 MH Mica Condenser ..	4/- 1/-

OUR ADVICE AND OUR PRODUCTS ARE EQUALLY GOOD.
 TAKE BOTH AND BE SATISFIED.

Telephone:
 Slough 441-442.

L.M. MICHAEL LTD

Manufacturers of Wireless and Scientific Apparatus
 WEXHAM ROAD :: SLOUGH :: BUCKS.

Telegrams:
 Radiether, Slough

Distant Control Unit.—

made to fix on the picture-rail. This is done in order to keep down the capacity between the loud-speaker leads, which gives rise to muffling with long leads if a high-resistance loud-speaker is used. (See N.P. Vincent-Minter in the Feb. 10th issue of *The Wireless World*.)

The other wires may be bunched together if necessary and fixed along the skirting board.

The four wire leads from the control unit to the valve socket in each room are made with bell flex about two yards long, twisted together, and preferably of two different colours, terminating in a plug made from a "dud" valve, as shown in Fig. 9. Incidentally, it will be found that a standard G.E.C. wall plug top will

just exactly fit a Mullard valve base, and a plug made on these lines is shown in the photograph. The writer uses the filament sockets of the valve-holder for the switch connections SS (Fig. 4), and the grid and plate sockets for the remaining connections LL.

It is possible to use a four-pole Dewar switch to do all that is required, but this entails bringing the LL and SS connections (which are connected to plus and minus of the high-tension battery respectively) rather near together, so that for safety reasons the writer advises the use of two switches.

The whole arrangement of the units forms one step towards increasing the pleasure obtained from a broadcast set.

INTERFERENCE DUE TO SHORT-WAVE TRANSMITTERS.

By A. J. GILL, M.I.E.E.*

DURING the last two years there has been considerable development in the use of wavelengths below 100 metres owing to the phenomenal ranges that can be obtained with such wavelengths with the expenditure of very little power. As a result there is a continual increase in the number and power of short-wave transmitters.

In some cases the installation of a powerful short-wave transmitter has led to complaints from broadcast listeners of interference on the broadcast band of 300 to 500 metres. In particular a number of complaints were being received from residents in the neighbourhood of the Post Office experimental station at Dollis Hill, which works on wavelengths of 50 metres and below. On receipt of these complaints it was assumed that the whole trouble was due to "key clicks," and the keying system of the transmitter was thereupon altered from suppressed wave to marking and spacing wave working. While this change relieved much of the interference complaints were still received from listeners.

A number of cases were investigated by the Post Office engineers. It was obvious that the trouble was not caused by harmonics from the transmitting station concerned, and the interesting fact emerged that the majority of complaints came from users of crystal sets. In some cases it was ascertained that the substitution of a valve set for a crystal set cured the trouble. This gave a clue to the solution, as it is known that the majority of crystal sets are direct coupled to the aerial and tuned by a vario-

meter, variable inductance, or inductance with series condenser (Fig. 1, a, b, c), while valve sets on the other hand are more frequently tuned by means of fixed plug-in inductance and variable condenser in parallel (Fig. 1, d).

Experiments were then carried out at Dollis Hill using a crystal receiver adjacent to the transmitter. The circuit used was a variometer with variable condenser of 0.001 microfarad capacity in parallel as shown in Fig. 2. Such a circuit has an infinite number of adjustments for any particular wavelength.

It was found that when 2LO was tuned in with the condenser at minimum capacity signals were inaudible owing to interference from the short-wave transmitter, but that as the capacity was increased and the inductance decreased (the tuning of 2LO being maintained) the interference gradually diminished until when the full capacity of 0.001 microfarad was in use no trace of interference was perceptible, while 2LO came in with good strength on three pairs of phones in parallel.

The transmitter during these tests was working with a radiated power probably exceeding that of 2LO on an aerial supported from the same mast as the receiving aerial, the upleads of the two aerials being about 20 feet apart.

The tests demonstrate the desirability of crystal receivers being designed for parallel tuning, as the increasing use of short waves will render all receivers of types a, b, and c liable to interference in many localities.

* Engineer in-Chief's Office, General Post Office.

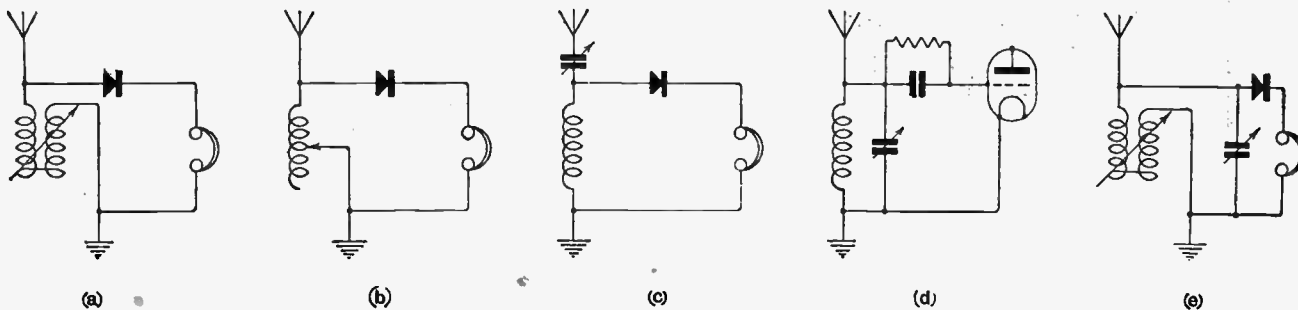

Typical broadcast crystal receiving circuits shown in (a), (b) and (c), in which resonance is produced by the use of a comparatively large value of inductance, are particularly susceptible to short-wave interference. Local interference from a short-wave transmitting set is eliminated by the use of the parallel tuned circuits (d) and (e).

FURTHER NOTES ON THE LOADING EFFECTS OF CRYSTALS.

Experiments with Frame Aerial Crystal Receivers.

By W. H. F. GRIFFITHS.

IN an article in the February 17th and February 24th issues of this journal the present author illustrated, by means of curves, the difference in behaviour between the two chief crystals of present-day practice. Galena was shown to be of much lower resistance than Perikon, and, because of this, it was shown that the former crystal very seriously loaded any oscillatory circuit across which it was connected. Since the loading of an oscillatory circuit by a crystal (or any other form of load) is proportional to the square of the reactance of that circuit, it is obvious that the circuit associated with a large aerial is much less affected than most others. Even with a moderately large receiving aerial, however, the loading of galena was very marked, although that of Perikon was not so marked. The author has more recently, in the course of some experiments with frame aeri-

als and reproduced here for reference. In Fig. 2 is shown the variation of rectified telephone current obtained when galena and Perikon crystals are shunted across varying portions of the aerial tuning inductance L . The circuit employed is given in Fig. 1, in which L_1 is the portion of the inductance tapped for the detector circuit. The variable condenser C is required to adjust the tuning of the circuit to resonance when preparing the curves of Fig. 2 and to vary the tuning about resonance in preparing the curves of Figs. 3 and 4.

From Fig. 2 it will be seen that when using galena the maximum rectified telephone current is not obtained

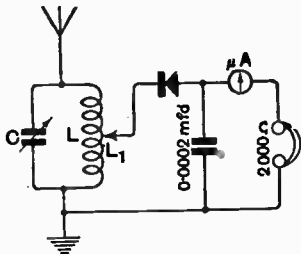

Fig. 1.—Circuit used in obtaining the curves of Figs. 2, 3 and 4.

with a large aerial is much less affected than most others. Even with a moderately large receiving aerial, however, the loading of galena was very marked, although that of Perikon was not so marked. The author has more recently, in the course of some experiments with frame aeri-

als and reproduced here for reference. In Fig. 2 is shown the variation of rectified telephone current obtained when galena and Perikon crystals are shunted across varying portions of the aerial tuning inductance L . The circuit employed is given in Fig. 1, in which L_1 is the portion of the inductance tapped for the detector circuit. The variable condenser C is required to adjust the tuning of the circuit to resonance when preparing the curves of Fig. 2 and to vary the tuning about resonance in preparing the curves of Figs. 3 and 4.

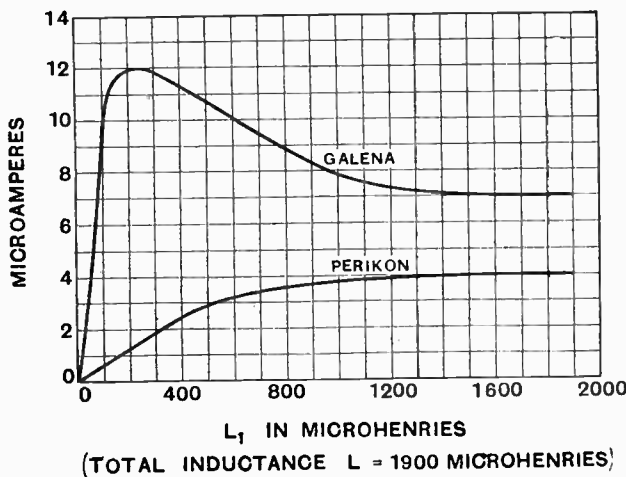

Fig. 2.—Curves showing the optimum values of detector circuit tapping point with galena and Perikon crystals. (Reactance of total inductance = 2,240 ohms.)

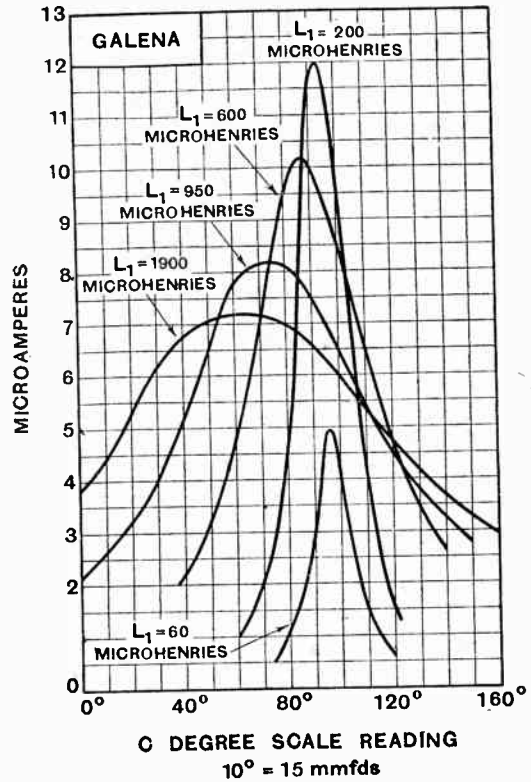

Fig. 3.—Tuning curves obtained with galena with various values of L_1

when the crystal is shunted across the whole of the inductance, due to the fact that the effective resistance of the crystal is sufficiently low to overload the tuned aerial circuit, thereby causing a reduction of oscillatory potential difference across L . When L_1 is adjusted to about 230 μH , or 12 per cent. of the total value of L , it will be seen that a maximum value of rectified telephone current is obtained because, although L_1 is then a sufficiently low percentage of L to prevent an appreciable aerial current and potential reduction at resonance, it is

Further Notes on the Loading Effects of Crystals.—

just sufficiently great to produce an appreciable potential difference for application to the detector circuit.

When Perikon is used for detection, since it is of much higher resistance, the rectified telephone current increases as the value of L_1 is increased, even when L_1 closely approaches L in value.

Resonance Curves and Selectivity.

The resonance or tuning curves of rectified telephone current plotted against tuning variations about resonance are shown in Figs. 3 and 4. Those for galena crystal (Fig. 3) indicate beautifully the tendency to increasing signal strengths and "sharper" tuning as L_1 is reduced to the optimum value of $200 \mu\text{H}$, whilst below this value (curve $60 \mu\text{H}$) the signal strength rapidly falls off, due to the fact that, even with a maximum aerial current flowing through L , L_1 becomes too small to produce a sufficient potential difference, ωLI , for application to the

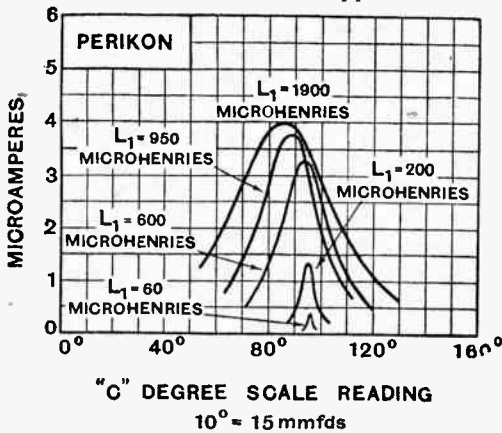

Fig. 4.—Tuning curves obtained with Perikon with various values of L_1 .

detector circuit. A corresponding set of resonance curves for the same tapping points and the same circuit but taken with a Perikon crystal combination are given in Fig. 4; these show no great change of tuning sharpness until the signal strength at resonance is considerably reduced. The curves of Figs. 3 and 4 should, of course, be compared in order to observe the great difference between the two crystals.

All the curves referred to above were plotted from

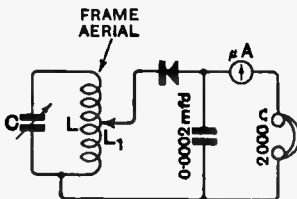

Fig. 5.—Frame aerial circuit with which the curves of Figs. 6, 7 and 8 were obtained.

would have been the case with an inductance of, say, $100 \mu\text{H}$, the latter being the inductance required to tune the average aerial to a wavelength of 365 metres (that of the local broadcasting station, 2LO).

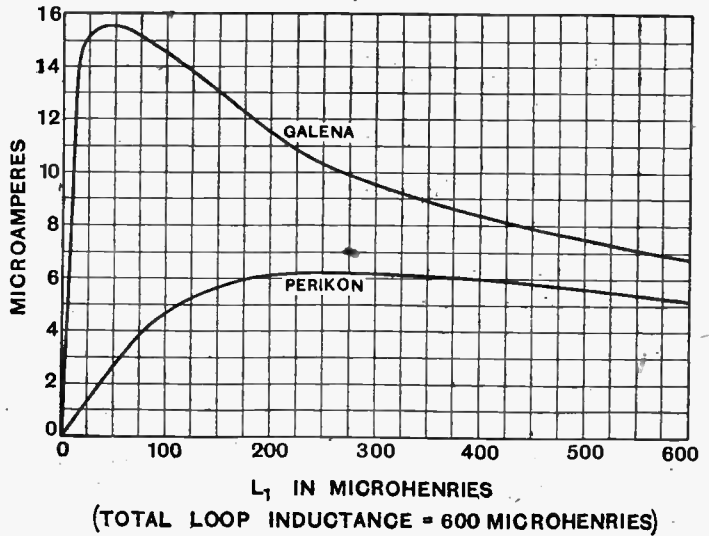

Fig. 6.—Curves showing the optimum values of detector circuit tapping point with galena and Perikon crystals. (Reactance of total loop inductance = $3,130 \text{ ohms}$.)

The curves which follow, however, were plotted from results obtained in the reception of 2LO at a distance of ten miles on a simple frame aerial circuit when making use of the energy re-radiated from a local large aerial resonant to the same wavelength. By this means it was possible to employ a loop aerial of $600 \mu\text{H}$ total inductance tuned by a very small variable air condenser C having a uniform capacity change of about 8 mmfd. for a 10 degrees angular displacement, and a capacity at

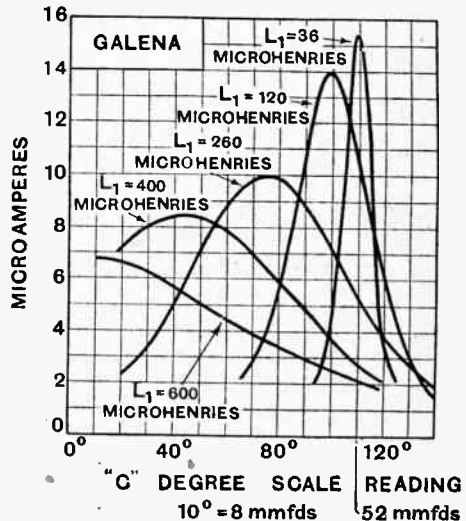

Fig. 7.—Tuning curves obtained with galena with various values of L_1 (frame circuit).

110 degrees of the order of 50 mmfd only. The circuit is given in Fig. 5.

In Fig. 6 the rectified telephone current obtained with galena and Perikon crystal detector circuits tapped across varying portions, L_1 , of the loop aerial is shown. The maximum signal strength with galena is seen to be when $L_1 = 35 \mu\text{H}$, or only 5.8 per cent. of the total loop inductance, an extraordinarily low value of optimum

Further Notes on the Loading Effects of Crystals.

detector tapping. Even when the comparatively high resistance Perikon crystal was being used, its loading effect was sufficient, with the high values of reactance of this loop circuit, to exhibit a maximum value of signal strength at an ill-defined optimum value for L_1 of about $250 \mu\text{H}$.

The resonance or tuning curves obtained when using galena (Fig. 7) and Perikon (Fig. 8) illustrate admirably the difference in the behaviour of low- and high-resistance crystals. The five curves of each figure were taken when using similar tapping points on the loop aerial corresponding to inductance values of 36, 120, 260, 400, and $600 \mu\text{H}$. In the case of galena the increase of rectified telephone current at resonance and the decided sharpening of tuning obtained by decreasing the value of L_1 towards its optimum value illustrates well the benefit resulting from the relief of the oscillatory circuit from the heavy loading of the low-resistance crystal. As one would expect, the Perikon curves, on the other hand, show no such very marked and beautifully graduated changes, and that obtained for the condition of $L_1 = 36 \mu\text{H}$ forms an excellent contrast to the corresponding curve of the galena group of Fig. 7.

The curves of Figs. 2, 3, and 4 should, of course, be compared with those of Figs. 6, 7, and 8, the difference in reactance in the two cases being remembered. The resistance, ωL , of the aerial coil of the first case

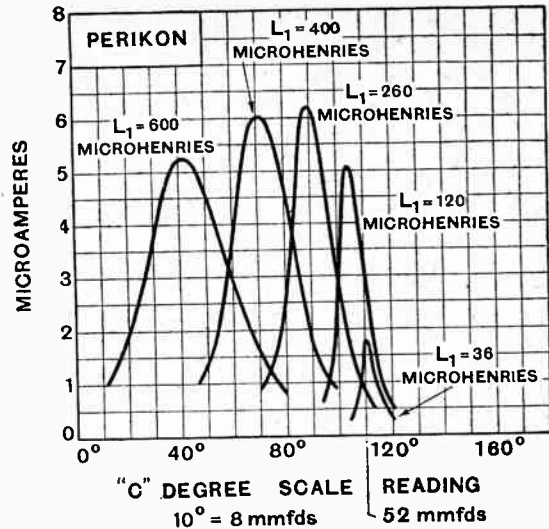

Fig. 8.—Tuning curves obtained with Perikon with various values of L_1 (frame circuit).

was 2,240 ohms, while that of the loop aerial of the second case was 3,130 ohms. It must also be noted, however, that the effective resistance of the unloaded loop aerial circuit was appreciably less than that of the aerial circuit.

General Notes.

Mr. Martin E. Solotar (U 2CYX), 1,104, Clay Avenue, New York, the Bronx City Manager of the A.R.R.L., will welcome reports from British amateurs of signals from U 2CYX.

○○○○

Mr. C. A. Jamblin (G 6BT), 82, York Road, Bury St. Edmunds, tells us that he is in touch with U NOT, the U.S.S. "Pittsburgh" now in the Mediterranean, which left Livorno on the 4th inst., and, as he has a list of the ports of call for several weeks ahead, will be pleased to forward QSL cards. U NOT is transmitting on 40-45 metres and will welcome reports.

○○○○

We understand that the short-wave transmissions from U 2XAF of programmes from GGY Schenectady are now on a 35-metre wavelength in place of 41.9 metres.

○○○○

A successful relay is recorded from French Indo-China to Brazil. A message from F18LBT, Saigon, was relayed to PI1HR operated by Lient. Roberts, Rizal, Philippine Islands, thence to Mr. S. A. Mayer (G 2LZ), "Stilemans" Wickford, Essex, who, not being at the time in touch with South America, sent it via Mr. J. S. Streeter (O A4Z), Irwell Street, Observatory, Cape Town, who in turn passed it on to Mr. R. Oxenham (O A4L), 136, Long Street, Cape Town. Mr. Oxenham was able to transmit the message to BZ1AF in Rio de Janeiro, who sent it on to its final destination, BZ5AB, Mr. J. C. Ayres, at Recife, Pernambuco.

B 20

**TRANSMITTERS' NOTES
AND QUERIES.**

The Belgian station B U2 is now transmitting on 45 metres and will welcome reports, which should be sent *via* Réseau Belge, 11, Rue du Congrès, Brussels.

○○○○

A correspondent comments, with some justification, on the growing neglect of the regulation requiring transmitters to give their call-signs three times at the beginning and end of each transmission, especially when working on telephony. This may possibly account for some of the ever-increasing complaints about the misuse of call-signs, and it certainly prevents transmitters getting many valuable reports from listeners on the strength and quality of their signals, which is, or should be, one of the main objects of their experimental tests.

○○○○

Transmitters in Madeira.

Mr. A. C. de Oliveira has kindly corrected and supplemented the limited information we have hitherto been able to give regarding amateur transmitters in Madeira. The prefix "P" has been adopted on account of the geographical position of the island in relation to Portugal, but the call-signs begin with the figure "3" to distinguish them from

those in Lisbon, which have the figure "1" as their first component. Portugal and Madeira will adopt the excellent American system of using these figures to indicate the district in which the station is located. The experimental stations at present in operation are:—

P 3CO.—A. C. de Oliveira, c/o The Western Telegraph Co., Box 56, Funchal.

P 3FZ.—J. Ferraz, Rue Ste. Maria 263, Funchal.

P 3GB.—G. de Bianchi, Quinta da Paz, Funchal.

The station R31 ascribed in our issue of January 27th to Mr. H. T. G. de Freitas does not exist, and was inserted under a misapprehension.

○○○○

New Call-sign Allotted.

G 2VS.—J. D. R. Hammett, 38, Fairlop Road, Leytonstone, E.11, transmits on 44 and 175 metres.

○○○○

QRA's Wanted.

G. 2BY, 2SE, 5UC, 5VO, 6BG, 6CR, 6EE, 6MB, 6NC, 6ZZ, D 7BX, SMSG, U 1XAE, ANDIR.

○○○○

A Correction.

We regret that on page 264 of our issue of February 17th the name of the owner of G 5XO was incorrectly spelt. It should read "Capt. L. A. Bratt, 24, Marriott Road, Barnet."

○○○○

Misuse of Call-signs.

Mr. R. H. Brown (510), 10, Coverdale Road, W.12, wishes to trace an offender who is using his call-sign on 440 metres and is believed to be located near Keighley, Yorks.

CURRENT TOPICS

News of the Week — in Brief Review

BROADCASTING FRENCH SENATE DEBATES.

The French Government has been asked to consider the possibility of broadcasting debates in the Chamber and Senate.

BERLIN'S HALF-MILLION.

Statistics just issued show that Germany's broadcast listeners holding licences now number 1,108,845. Of these, half a million are in the Berlin area.

TOKIO TEACHES ENGLISH.

Lessons in English are an educational feature at the Tokio broadcasting station. Subscribers to the course receive printed copies of the talks so that they can follow the English spoken words of the instructor.

BROADCAST SOS MESSAGES.

The far-reaching appeal of broadcasting is shown by the returns just published by the B.B.C. concerning the transmission of "SOS" messages. The average number per month is 30, and of these 25 are generally successful, two are failures, and three show no known result.

WIRELESS EXHIBITION, 1926.

The wireless trade as a whole is to be invited to participate in the wireless exhibition to be held in the early autumn under the auspices of the National Association of Radio Manufacturers and Traders.

The exhibition will be held in the New Hall, Olympia, from September 4th to 18th next, and it is hoped that sufficient support will be forthcoming to make it thoroughly representative of the British radio industry.

PARIS "WIRELESS CHAMPIONSHIP."

A new sport has blossomed out in Paris, and a few days ago its exponents participated in a contest for the first "Wireless Championship."

The tests applied were: (1) The picking up in five minutes of the greatest number of stations, and (2) the obtaining of two foreign stations in the shortest possible time on a "word of command" from the judges.

One of the winners (says *The Wireless Trader*) obtained six stations in less than five minutes, including two English ones. In addition to catching one "on the wing" that he was not seeking.

WIRELESS "PUSH" IN CZECHOSLOVAKIA.

A Radio Recruiting Week has been organised in Prague for the purpose of stimulating popular interest in broadcasting.

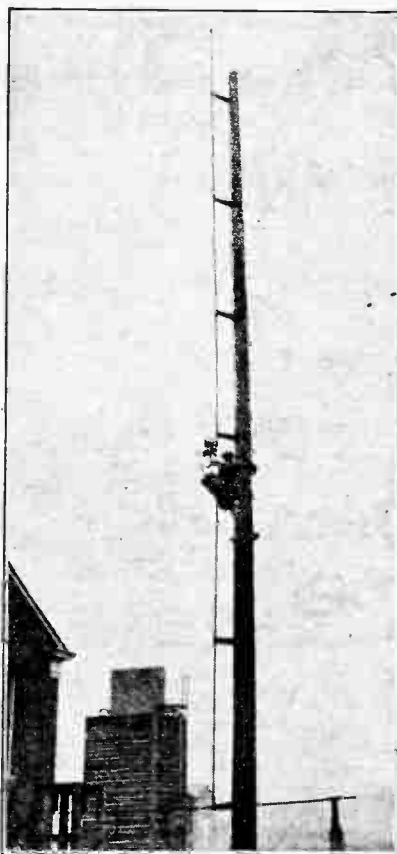

A 70-METRE AERIAL. The short-wave aerial, composed of copper tube, in use at the Bound Brook broadcasting station at New Jersey. Note the antenna coil half way up the aerial.

AUSTRALIAN BROADCAST LICENCES.

A recent computation of the number of broadcast licences held in the Commonwealth of Australia gives the figure as 77,485. This represents 1.31 per cent. of the population.

WIRELESS TO THE EAST.

Europe has a new link with the Orient in a recently inaugurated wireless service, controlled by the Società Italo-Radio, between Italy and Egypt, Palestine and Iraq.

R.A.F. WIRELESS IN INDIA.

Wireless experiments conducted by the Royal Air Force in the Delhi district have resulted in the establishment of communication with Perth (Western Australia) and Johannesburg.

AMERICAN WIRELESS REVENUE.

The Radio Corporation of America has had to report a large drop in revenue for 1925 as compared with that of the previous year. The net earnings for 1925 amounted to \$5,737,206, whereas in 1924 the corresponding figure was \$9,503,442.

TELEVISION AND WAR.

A few days ago the *Vossische Zeitung* credited Senatore Marconi with the arresting statement that in two years time war would be impossible owing to television. The famous inventor has issued an emphatic denial that he ever made such an assertion.

MISSIONARY BROADCASTING.

A broadcasting station which will be installed at Akureiri, Iceland, for missionary purposes is being constructed by the well-known Highgate amateur, Mr. F. L. Hogg (G2SH).

Operating on 200 metres, the transmitter will be used by Mr. Arthur Gook, a British missionary in Iceland, to establish touch with the remotest parts of the country. Attempts will also be made to relay British and American broadcast programmes.

TENNIS PHOTOGRAPHS BY BELINOGRAPH.

M. Edouard Belin, the well-known French wireless experimenter, scored a triumph at the conclusion of the Lenglen-Wills tennis contest at Nice. With the use of M. Belin's apparatus photographs of the event were successfully telegraphed to Paris and were subsequently published in London.

Although a land line was used on this occasion, M. Belin has also been successful in the transmission of pictures by wireless.

WIRELESS WAGES IN CANADA.

Canadian wireless operators are becoming restive, with a view to obtaining increased wages and improved conditions. The employers express a desire for a downward wage revision.

○○○○

RADIO WORLD'S FAIR.

The next Radio World's Fair, which has become an annual event in America, will be held in the New Madison Square Garden, New York, from September 13th to 18th inclusive. To use the words of the promoters, it will be "not only the largest but by far the most interesting exposition, tracing the tremendous development of radio that has ever been staged."

○○○○

LOUD-SPEAKER ON EXPRESS TRAIN.

Loud-speakers were installed in the dining car of the Cornish Riviera express which left Paddington yesterday morning. In addition, headphones were available in a first-class coach.

The Great Western Railway announces that this innovation has been introduced in order to make the longest non-stop run in the world an entertaining one for passengers. The apparatus used was similar to that employed in the recent test between Bristol and Cardiff and was constructed by Burndept Wireless, Ltd.

○○○○

THE MONTE GRANDE HIGH-POWER STATION

In connection with the illustrated description of the high-power station at Monte Grande, Argentina, published in *The Wireless World* of January 27th, the Société Française Radio Electrique, of Paris, ask us to point out that they also contributed in the construction of the station.

This company furnished the four great masts, each nearly 700ft. high.

○○○○

OFFICIAL WAVELENGTH FOR CANADIAN AMATEURS.

Canadian amateur transmitters are jubilant over the Government's decision to grant them the wavelength of 52.51 metres for experimental work. The wavelength originally assigned, 120 metres, was sufficiently satisfying during the winter of 1924-25, but the advent of short-wave working last summer gave birth to discontent.

In order to ensure that the new wavelength is adhered to, the Canadian Government stations at Ottawa have transmitted a series of calibration signals.

All transmitting amateurs were required to tune in these signals in order to facilitate the accurate calibration of their wavemeters.

B 22

WANTED: A WIRELESS SET.

An appeal for a wireless receiver and loud-speaker for installation in a hall in a poor district of East London is made by the Rev. J. Ough, vicar of St. Jude's, Bethnal Green, E.2. Contributions or portions of apparatus would be very acceptable.

○○○○

TACKLING INTERFERENCE IN AMERICA.

The interference lugbear in the Middle West of America is leading to the formation of listeners' organisations with the idea of suppressing the nuisance.

One such body, the Broadcast Listeners' Association of Indianapolis, has prepared an ambitious programme for the elimination of all forms of interference. In particular, a campaign is being waged



SIR HARRY LAUDER LISTENS. A characteristic picture of the famous comedian enjoying broadcast reception in the Marconiphone Showrooms last week.

against single valve reaction sets. Street car noises are also being tackled, and in this connection the Indianapolis Street Railway Company has co-operated with a thorough examination and improvement of the system.

○○○○

WIRELESS OPERATORS' "SIX POINTS."

As arranged at the conclusion of the wireless strike, negotiations were opened last Monday between the Association of Wireless and Cable Telegraphists and the London and District Association of Engineering and Allied Employers.

Six outstanding points regarding service conditions remain to be discussed. First, the operators ask for the concurrence of the Shipping Federation with any agreement made; secondly, they ask for an increase in the foreign service allowance, and, thirdly, that operators

on passenger ships shall not be required to carry out duties other than those connected with wireless. Point four urges that the operators should be paid their maintenance allowance direct instead of the money being paid into a common mess fund. The last two points are concerned respectively with annual leave and stability of employment.

The wages question is also raised, and if agreement has not been reached by March 31st, the two sides have arranged that the whole matter shall be referred to the Industrial Court for settlement.

○○○○

BROADCAST WARNINGS TO SHIPS.

The suggestion made by Mr. C. C. Ammon, M.P., that, in view of the submarine M1 disaster, broadcast warnings should be issued to merchant ships when submarine exercises are taking place, has evoked a reply from the Admiralty. The Board considers that in the majority of cases such warnings would be unnecessary, but it has been decided that in special circumstances steps will be taken to broadcast warnings through the Post Office station nearest the area affected.

○○○○

BARCELONA'S NEW BROADCASTING STATION.

The official inauguration of the new Barcelona broadcasting station, one of the most powerful in Europe, took place on Thursday last. EAJI is situated on the top of Tibidabo, 1,745 ft. high, a position which should be of material assistance in extending the range of the station. The wavelength of the new station is 325 metres.

○○○○

OSCILLATORS BEWARE

The Post Office Engineering Department, we understand, has ordered a specially constructed and equipped motor car which will be used in an endeavour to combat the oscillation nuisance.

Fitted with a direction-finder and frame aerial, the car will patrol the London areas in which oscillation is most noticeable.

○○○○

BROADCASTING AND THE IDEAL HOME.

Several exhibits of special interest to the broadcast listener are on view at the Ideal Home Exhibition, which opened yesterday (Tuesday) at Olympia.

Between 4 p.m. and 7 p.m. every Tuesday and Saturday the London programme will be actually broadcast from Olympia. The exhibition closes on Saturday, March 27th.

A CORRECTION.

In the advertisement of Messrs. The British Glowlamp and Valve Co. appearing in this issue the working anode potential of the valves which they repair is given as 70-100 volts. This should actually be 20-100 volts.

A STABLE H.F. RECEIVER.

Practical Tests with a Balanced H.F. Circuit.

By E. J. MARTIN.

EVEN with the best of aerials one or more stages of H.F. amplification is desirable for long-distance and loud-speaker reception on the B.B.C. wavelengths. The most commonly used system is the tuned anode method of H.F. coupling, but this suffers from many disadvantages. To maintain such a set at its most sensitive condition, when searching for weak stations, that is, just short of oscillating, three controls must all be moved simultaneously, as they are all dependent upon one another; this type of set is also liable to re-radiate if mismanaged.

The solution of these faults is some form of balanced H.F. circuit. The most commonly used circuit of this type is the Hazeltine "Neutrodyne," but the circuit to be described, though not commonly used in this country, has some advantages over the "Neutrodyne."

Briefly, the set to be described in this article was built to conform to the

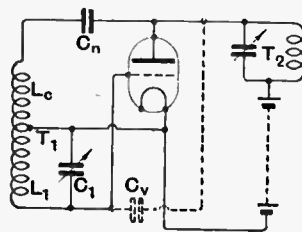

Fig. 1.—Method of neutralising adopted in the receiver.

following conditions:—

- (1) To be sensitive and selective.
- (2) To be non-radiating.
- (3) To be easy to adjust; *i.e.*, the three controls which the set possesses are to be entirely independent of one another.

The method of neutralising is shown diagrammatically in Fig. 1, while the complete circuit is shown in Fig. 2.

Here, in Fig. 1, T_1 is the tuned input circuit (consisting of the inductance L_1 and condenser C_1), T_2 the tuned output, and C_v the effective capacity between grid and plate of the valve. Neutralisation of C_v is accomplished by the coil L_c very closely coupled to L_1 , and the neutralising condenser C_n .

The grid-plate capacity C_v is neutralised when

$$\frac{C_n}{C_v} = \frac{L_1}{M} = \sqrt{\frac{L_1}{L_c}} = \frac{N_1}{N_c}$$

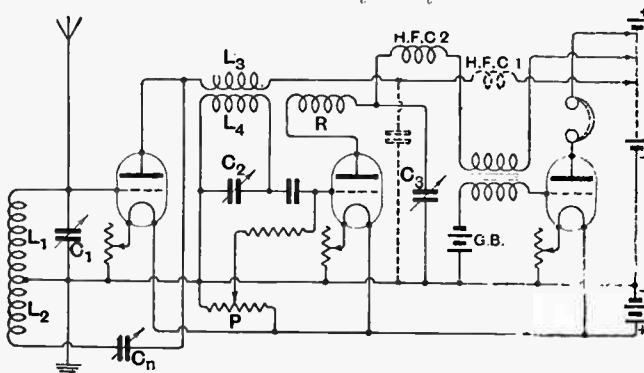

Fig. 2.—Complete circuit diagram.

where M is the mutual inductance between L_1 and L_c , and N_1 and N_c are the number of turns respectively in L_1 and L_c . This neutralisation is quite independent of the wavelength.

One advantage of this method of neutralisation is that the neutralising device has nothing to do with the tuned output of the H.F. valve: this means, that any sort of coupling may be used between the H.F. valve and the detector. In Fig. 2 an H.F. transformer having an untuned primary and a tuned secondary is shown: this was used mainly to obtain greater selectivity. Tuned anode coupling is simpler and gives very good results. When the neutralising condenser is correctly adjusted,

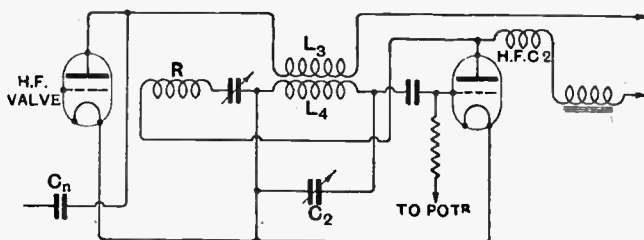
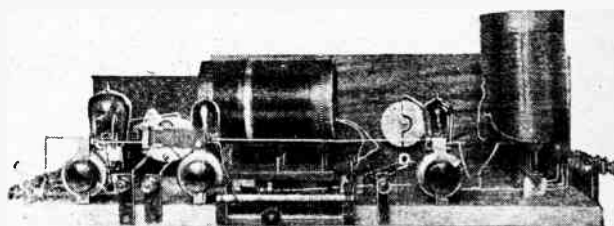

Fig. 3.—Reinartz method of applying reaction to the H.F. transformer.

variations in the tuning of the aerial circuit will not affect the tuning of the H.F. transformer.

Reaction is applied from the detector on to the H.F. transformer. A fixed reaction coil is used, and control is obtained by means of the "throttling condenser" C_3 and the H.F. choke H.F.C₂. This method of control



Rear view of the experimental layout. Note the relative positions of the aerial coil (vertical) and H.F. transformer (horizontal).

does not upset the tuning of the H.F. transformer at all, and does not seem to alter very much with the wavelength. When C_3 is at its minimum, the set is a long way off the point of oscillation due to the H.F.C₂.

The Reinartz method of control, shown in Fig. 3, may be used instead, and this again gives a reaction control that does not interfere with the tuning of the set: if this is used, the number of turns in the reaction coil must be increased.

If the same H.T. battery is used for all three valves, there may be a certain amount of interaction between the H.F. valve and detector; this may be nullified by putting

A Stable H.F. Receiver.—

in an H.F. choke, H.F.C.₁, and fixed condenser (0.001 mfd.) in the plate circuit of the H.F. valve, as shown in dotted lines in Fig. 2.

A few constructional details may now be given. L₁ and L₂ are wound on as one winding, with a tapping for the earth connection. L₁ consists of 50 turns, and L₂ of 35 turns, of No. 22 S.W.G. enamelled wire on a 4in. diameter former. L₁ is tuned by a 0.00025 mfd. square law variable condenser. The secondary, L₃, of the H.F. transformer consists of 60 turns of No. 22 S.W.G. enamelled wire on a 4in. diameter former, and the reaction coil R is wound on the same former, spaced

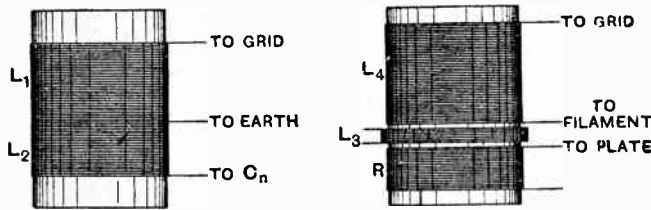

Fig. 4.—Tapping points on the aerial coil and H.F. transformer windings.

3/4 in. from the end of the secondary, and consisting of 25 turns.

The untuned primary L₃ consists of 25 turns of No. 26 S.W.G. D.C.C. wire, wound on in a bunch between the secondary coil and reaction coil. The secondary coil is tuned by a 0.00025 mfd. square law condenser, and the "throttling" or reaction condenser has the same value.

The H.F. chokes may very well be those manufactured by Lissen, Ltd., or, for the B.B.C. wavelengths, may consist of 150 turns of No. 26 S.W.G. wire on a 3in. diameter former. A really good low-frequency intervalve transformer should be used.

A special H.F. valve with a high amplification factor should be used. It will be noted that the grid of the H.F. valve is connected to L.T. — : the filament end of the grid leak on the detector valve is connected to the sliding contact of a potentiometer P connected across the

L.T., to eliminate possible overlap of reaction. The L.F. valve, which should be a power valve, has a suitable grid bias battery. All valves have separate H.T. taps.

The neutralising condenser consists of one fixed and

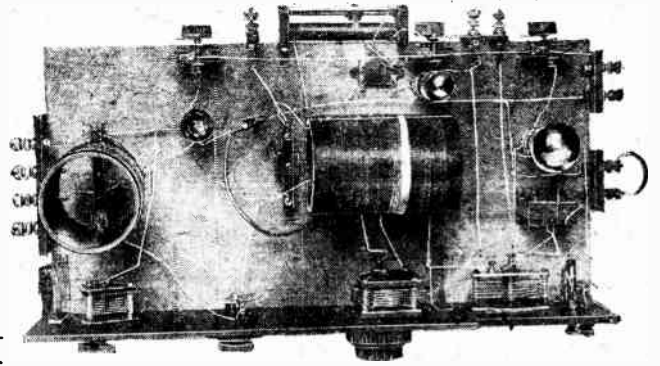

Layout of components in the experimental receiver. The various components will be readily identified with the symbols of the circuit in Fig. 2.

one moving plate. This may be adjusted as follows: The reaction condenser is increased until the set oscillates. With the neutralising condenser at minimum a *weak* station is tuned-in. It will be found that alteration of C₁ (see Fig. 2) will alter the tuning of C₂; leaving C₂ fixed, the neutralising condenser C_n should very slowly be increased until alteration of C₁ no longer alters the tuning of C₂. The H.F. valve is then properly neutralised. The effect should be tried of reversing the connections to L₃, as one way usually works better than the other.

The general experimental layout of the set may be seen from the photographs. The H.F. transformer must be spaced at least 8in. from the aerial coil, and must be at right angles to it, to eliminate magnetic coupling. The wiring must be well spaced, and everything done to avoid stray capacities.

Such a set, when properly adjusted, will be found to be exceedingly satisfactory: sensitive, selective, easy to adjust, and free from distortion.

TIME IN ALL PARTS OF THE WORLD.

The following table will be of use to those who wish to compare the time in the principal cities of the world with Greenwich Mean Time.

The times given below correspond with noon G.M.T. :—

Longitude.		Longitude.		Longitude.	
Adelaide 138.35 E.	9.30 p.m.	Constantinople 28.55 E.	2.0 p.m. (E. European).	Pekin 116.24 E.	8.0 p.m.
Athens 23.45 E.	2.0 p.m. (E. European).	Copenhagen 12.35 E.	1.0 p.m. (C. European).	Perth (W.A.) 115.52 E.	8.0 p.m.
Auckland (N.Z.) 174.48 E.	11.30 p.m. (N. Z. Mean Time).	Dunedin 170.30 E.	11.30 p.m.	Philadelphia 75.39 W.	7.0 a.m. (E. American).
Amsterdam 4.55 E.	12.20 p.m.	Havana 88.22 W.	6.0 a.m.	Quebec 71.12 W.	7.0 a.m.
Bangkok 100.30 E.	7.0 p.m. (7th Zone E.).	Hobart 147.21 E.	10.0 p.m.	Rio de Janeiro 43.12 W.	9.0 a.m. (3rd Zone W.).
Batavia 106.50 E.	7.0 p.m. (7th Zone E.).	Hong-Kong 114.12 E.	8.0 p.m.	Rome 12.28 E.	1.0 p.m. (C. European).
Berlin 13.25 E.	1.0 p.m. (C. European).	Honolulu 157.51 W.	1.30 a.m.	San Francisco 122.25 W.	4.0 a.m. (Pacific).
Bombay 72.54 E.	5.30 p.m.	Leningrad 30.15 E.	2.0 p.m. (E. European).	Singapore 103.51 E.	7.0 p.m.
Brisbane 150.30 E.	10.0 p.m.	Lima 77.02 W.	7.0 a.m.	Stockholm 18.05 E.	1.0 p.m. (C. European).
Brussels 4.22 E.	12.0 noon (W. European)	Lisbon 9.07 W.	12.0 noon (W. European)	Sydney 151.12 E.	10.0 p.m.
Buenos Aires 58.20 W.	8.0 a.m. (E. American).	Madrid 3.43 W.	12.0 noon (W. European)	Tokio 138.45 E.	9.0 p.m.
Callao 77.04 W.	7.0 a.m. (E. American).	Mauritius 57.35 E.	4.0 p.m.	Toronto 79.20 W.	7.0 a.m. (E. American).
Cairo 31.15 E.	2.0 p.m. (E. European).	Melbourne 145.02 E.	10.0 p.m.	Valparaiso 71.40 W.	7.0 a.m.
Calcutta 88.30 E.	6.0 p.m.	Montreal 73.34 W.	7.0 a.m.	Vancouver 123.05 W.	4.0 a.m. (Pacific).
Capetown 18.25 E.	2.0 p.m.	Moscow 37.37 E.	2.0 p.m. (E. European).	Vienna 16.22 E.	1.0 p.m. (C. European).
Chicago 87.40 W.	6.0 a.m. (C. American).	New York 74.01 W.	7.0 a.m. (E. American).	Washington 77.04 W.	7.0 a.m. (E. American).
Colombo 79.56 E.	5.30 p.m.	Oslo 10.40 E.	1.0 p.m. (C. European).		
		Paris 2.20 E.	12.0 noon (W. European)		

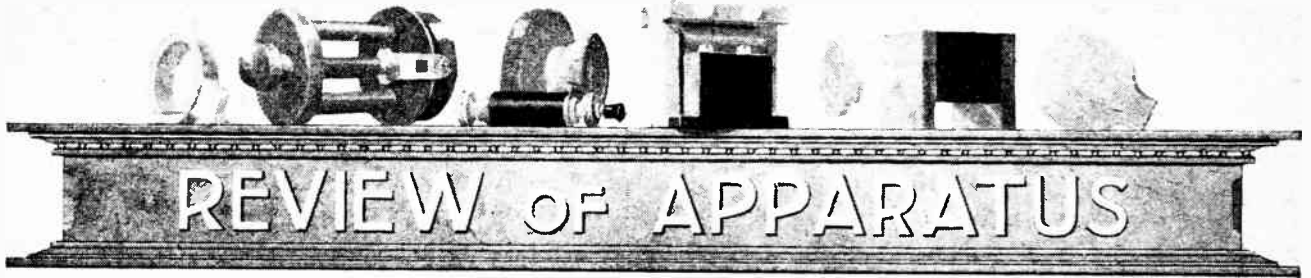

Latest Products of the Manufacturers.

THE "LOWFORMA" INDUCTANCE FRAME.

To facilitate the construction of air-supported tuning inductances, A. H. Clackson, Ltd., 119, Fleet Street, London, E.C.4, are producing an ebonite former consisting of a number of rods supported by end discs. The rods on which the wire is to be wound are suitably threaded so that a turn-to-turn spacing is obtained equal to the pitch of the thread. The supporting rods measure 6in. in length and will accommodate 120 turns with a mean diameter 3½in. A wider turn-to-turn spacing is produced by winding in alternate slots, so that, if necessary, heavy gauge wires may be used.

For constructing a receiving inductance No. 24 enamelled covered wire will probably be found most suitable, and the turns can, of course, be arranged to form a loose-coupled winding. To prevent the supports sagging, an ebonite ring is placed centrally in the winding. Although it is intended that the former should be used in the form supplied, the reader is reminded that if it is cut down to nearly half the present length so as to accommodate about 70 turns, the ratio of length to diameter will be improved, and it will serve as a useful former for constructing the inter-valve high-frequency trans-

MELLOWTONE AERIAL REACTION UNIT.

A simple method for interchanging tuning coils is obtained by the use of a "Mellowtone" aerial reaction unit, a product of Midland Radiotelephone Manufacturers, Ltd., Brettell Lane Works, Stourbridge.

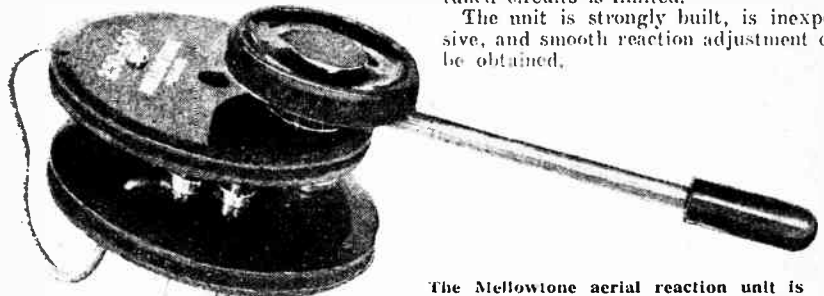

The Mellowtone aerial reaction unit is intended to replace the usual two coil holder for aerial tuning

The unit consists of both aerial inductance and reaction coil carried on a four-pin mount so that it may be connected in the receiving circuit by insertion in a standard valve holder. The usual two-coil holder is thus dispensed with. The windings are carried in grooves, and although this form of construction does

is to be connected in an aerial circuit possessing a resistance value far in excess of the coil. Thus little would be gained as regards signal strength when the unit is replaced by coils of low-loss design. The compact winding, moreover, produces a comparatively small external field and thus interaction with other tuned circuits is limited.

The unit is strongly built, is inexpensive, and smooth reaction adjustment can be obtained.

BOOKS RECEIVED.

Les Grandes Etapes de la Radio, by Joseph Guinchant. Part 1. The early discoveries. Pp. 90, with 60 illustrations and diagrams. Published by Dunod, Paris.

o o o o

"Radio-Frequency Resistance and Inductance of Coils used in Broadcast Reception," by August Hund and H. B. De Groot. Pp. 18 with 19 illustrations and diagrams. Published by the Department of Commerce, Bureau of Standards, Washington, D.C., price 10 cents.

o o o o

"The International Amateur Radio Call Book" (Nov. 1st, 1925), edited by C. A. Service and A. L. Budlong, of the A.R.R.L. Pp. 62. Published by International Call Book Co., Hartford, Conn., U.S.A., price 50 cents.

o o o o

"Svenska Radioklubbarnes Förbund, Årsbok, 1925," containing a list of Swedish wireless societies. Call signs and particulars of Swedish amateur transmitters and other useful information. Pp. 142, published in Stockholm, price Kr.2.

o o o o

"B.N.B. Wireless Circuits." A series of envelopes containing diagrams and instructions for making various receivers, published by the Radio News Bureau, Ltd., London, W.C.1, price 1s. 6d. to 2s. 6d. each.

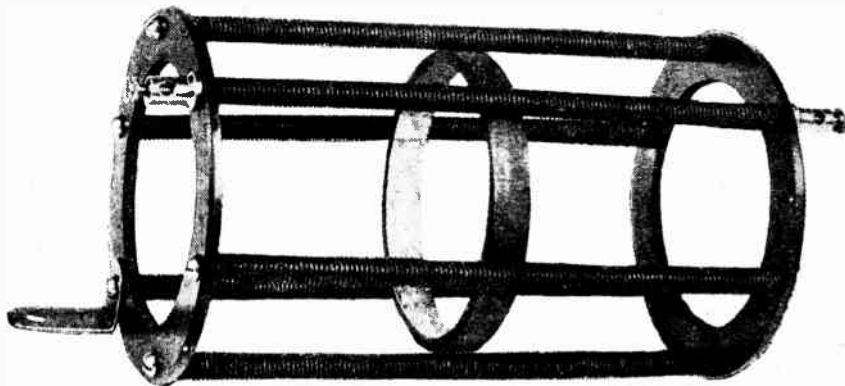

The "Lowforma" for the construction of inductances with air spaced turns.

formers of a neutrodyne receiver, whilst it is also suitable for the construction of the small inductances required when building a low power transmitter.

not produce a coil with minimum losses it must not be overlooked that little purpose is served in building a cumbersome coil of minimum resistance when it



NEWS FROM THE CLUBS:



Secretaries of Local Clubs are invited to send in for publication club news of general interest. All photographs published will be paid for.

That Ubiquitous Echo.

Freaks played by echo in the broadcasting studio were among the points raised by Mr. J. H. A. Whitehouse, a B.B.C. engineer, in his lecture before the Muswell Hill and District Radio Society on February 10th. In one studio an oscillograph record showed that an echo travelled round the walls 15 times.

Echo effects had always provided a problem for research, said the lecturer, and the present draping arrangements in the B.B.C. studios were the result of three years' careful investigation.

The malcontents who are among the first to telephone to Savoy Hill when a breakdown occurs would have been interested to hear the lecturer's description of how the down lead on the Selfridge building had recently to be replaced during a gale. The short period of delay was covered by the announcement: "There has been a slight mechanical breakdown"!

Hon Secretary: Mr. Gerald S. Sessions, 20, Grasmere Road, Muswell Hill, N.10.

o o o o

Teignmouth Society's Rapid Growth.

The new wireless society formed at Teignmouth, Devon, on February 11th, with a starting membership of 80, is rapidly extending its appeal.

Within a week of the inaugural meeting the membership had increased to 114!

The hon. secretary is Mr. A. L. Rose, Leicester House, Teignmouth.

o o o o

Reed Type Ear Pieces.

Despite the inclemency of the weather a large number of members of the Tottenham Wireless Society gathered on February 17th to hear a lecture given by Mr. Lucy, of Messrs. S. G. Brown, Ltd.

The development of the reed type ear piece was first dealt with, two interesting exhibits being the earliest and latest examples of this type.

Several mechanical methods of obtaining amplification were explained, and a long and interesting discussion ensued on the operation of the "Crystovox."

Hon. Secretary: Mr. A. G. Tucker, 42, Drayton Road, Tottenham, N.17.

o o o o

A Trigger Circuit.

A three-valve receiver, embodying a "Trigger" circuit, was described by Mr. R. Kirlew, A.M.I.M.E., in his recent lecture before the North Middlesex Wireless Club.

Designed to give purity in the reception of broadcasting, the set is arranged

so that the first valve exercises an extremely fine control of the potentials applied to the detector. Only about 9 volts are put on the anode of this valve, a higher potential necessitating the use of grid bias without improving results. The principal drawback to the design seemed to be the rather heavy plate current required, but the purity of results was amply demonstrated at the club's recent loud-speaker competition.

This evening (Wednesday) Mr. A. L. Kirke, of the B.B.C., will lecture on "Selectivity in Simple Circuits." All interested are cordially invited to this meeting, and members are asked to bring friends.

Hon. Secretary: Mr. H. A. Green, 100, Pellatt Grove, Wood Green, N.22.

o o o o

Modulation and its Control.

"Difficulties of Broadcasting from my Point of View" was the title chosen by Mr. Bird, Chief Engineer of the Manchester Broadcasting Station, for his address to members of the Manchester Radio Scientific Society on February 10th.

FORTHCOMING EVENTS.

WEDNESDAY, MARCH 3rd.

Institution of Electrical Engineers, Wireless Section. At 6 p.m. (Light Refreshments at 5.30). At the Institution, Savoy Place, W.C.2. Lecture: "The Directional Recording of Atmospherics," by Mr. R. A. Watson Watt, B.Sc. (Eng.).

Tottenham Wireless Society. At 8 p.m. At 10, Bruce Grove. Lecture: "Photographing Radio Sets," by Mr. Taylor. *Muswell Hill and District Radio Society.* At 8 p.m. At St. James's Schools, Fortis Green. Sale and Exchange Evening.

Edinburgh and District Radio Society. At 117, George Street. Business Meeting and Questions Evening.

Barasley and District Wireless Association. At 8 p.m. At 22, Market Street. Discussion: "Cause and Remedy of Distortion."

North Middlesex Wireless Club. At 8.30 p.m. At Shaltesbury Hall, Boxes Park. Lecture: "Selectivity in Simple Circuits," by Mr. A. L. Kirke, of the B.B.C.

THURSDAY, MARCH 4th.

Golders Green and Hendon Radio Society. —At 8 p.m. At the Club House, Willifield Way. Lecture: "Rectified H.T. Supply," by Mr. H. N. Ryan (5BV).

FRIDAY, MARCH 5th.

Sheffield and District Wireless Society. At 7.30 p.m. At the Department of Applied Science, St. George's Square. Elementary Lecture (5): "Simple Valve Circuits."

Inland Revenue Radio Society. At Somerset House. Talk and Demonstration: "The Neutrodyne," by Mr. H. Vigurs, L.L.B.

MONDAY, MARCH 8th.

Swansea Radio Society. Lectures: "Care and Maintenance of Accumulators," by Mr. Morgan, of Messrs. Morgan Bros.

Mr. Bird spoke of the effect of modulation and of how, with certain forms of music, it was necessary to reduce the modulation of particular portions to avoid overloading the transmitter and causing distortion.

Arrangements are being made for a party of members to visit 2ZY.

o o o o

Theory and Practice.

A talk on "General Radio Theory and Practice" was given before the South Manchester Radio Society on February 5th, the speaker being Mr. J. Baggs, of the Manchester Radio Scientific Society.

Mr. Baggs dealt at some length with the capabilities of crystal receivers, and later, on the question of valve reception, discussed the relative advantages of grid and anode rectification. Much interest was shown in a series of graphs which demonstrated the performances of different loud-speakers.

o o o o

Short Waves and the Amateur.

The story of the amateur's fight for recognition and his subsequent triumphs formed the main theme of Mr. W. Williamson's lecture on "Short Wave Work" before the Grimsby and District Radio Society on February 9th.

The speaker affirmed his belief that the present efficiency in short-wave work was due to the amateur, who was first given the supposedly "hopeless" ultra-short waveband, and had shown that marvellous results could be obtained using a microscopic fraction of the power employed by the great commercial stations.

Practical information was given on the construction of low loss coils, and in the ensuing discussion the lecturer answered many questions upon which the members had been in doubt.

Hon. Secretary: Mr. W. Markham, 104, Torrington Street, Grimsby.

o o o o

How Valves are Made.

An insight into the mysteries of valve manufacture was gained by members of the Inland Revenue Radio Society on February 19th, when Mr. Davies, of the General Electric Company, delivered an illustrated lecture on the subject.

All the stages of manufacture and testing were carefully dealt with, the processes being made clear by means of a large number of slides and exhibits. The valves so described ranged from the small dull-emitter receiving types to the big water-cooled 10-kW. type.

Hon. Secretary: Mr. W. J. Tarring (5TG), Room C2, York House, Kingsway, W.C.2.

PIONEERS OF WIRELESS.

By ELLISON HAWKS, F.R.A.S.

9.—Early Suggestions for Communication by Wireless.

"A LARGE number now interested in the most modern developments of wireless," Sir Oliver Lodge has said, "will have but little idea—perhaps none at all—of the early work, in apparently diverse directions, which preceded and made such developments possible. And even those who are high authorities in wireless telegraphy and know nearly all that can be known about it can hardly know the early stages quite as well as those who have lived through the nascent and incubating period. Only those who have survived the puzzled and preliminary stages of a discovery can fully appreciate the contrast with subsequent enlightenment."

To-day we too easily lose sight of this early work of the pioneers, and pay no tribute to those who, by their researches, have made possible the achievements of the present. In this connection one wonders how many of the hundreds of thousands of those who listen to broadcast each night have heard of Sömmering, an investigator who in the early part of the nineteenth century studied electricity and made what was probably the first serious suggestion of wireless telegraphy.

A Sixteenth Century Suggestion.

We say "serious" because an earlier suggestion for communication without wires was made by one Famiano Strada, an Italian Jesuit and historian who lived 1572-1649. Strada announced a fantastic plan to use "two Needles of an equal length and bigness, being both of them touched with the same Lodestone. Then let the Letters of the Alphabet be placed in the circles in which they [the needles] are moved at the Points of the Compass under the Needle of the Mariner's Chart. Let the Friend that is to travel take one of these with him, first agreeing upon the Days and the Hours wherein they should confer together: at which time, if one of them move the Needle, the other Needle will move by sympathy on to the same Letter in the other instantly, though they are ever so far distant. And thus by several Motions of the Needle to the Letters, they may easily make up Words or Sense which they have a mind to express."



S. Th. Von Sömmering.

Needless to say, this wonderful suggestion for a very convenient and universally useful piece of apparatus was nothing more than the figment of a fantastic imagination!

As early as 1729 experimenters gave some attention to endeavouring to use frictional electricity—the only form then known—for the purpose of communicating at a distance. In that year Stephen Grey found that pack-thread or twine could be made to conduct electricity. He even succeeded in producing motion in light bodies at a distance of 666ft., the object of the experiment being to ascertain the greatest distance to which the electric force could be transmitted.

Earth Return Circuits.

Grey also discovered that metallic wire would conduct electricity, and he deserves our tribute for his pioneer work, which must have been carried out under serious difficulties, for at the time of his experiments there were no means of storing up electricity, the Leyden jar not being introduced until about 1745.

In studying the history of electricity, we find that in their experiments several of the early workers appear to have used only one wire, employing the water of a river or the earth itself as a return to complete the circuit. Winkler of Leipsic seems to have been one of the first to do this (July 28th, 1746) when he included the River Pleisse in his circuit.¹ Later in the same year he successfully transmitted over a distance of two miles, with the earth as a return circuit. It is interesting to note in passing that for these experiments he insulated his wires with baked wood.

Whilst these and other similar experiments are very interesting—and must be mentioned, as they are the first records we have of the transmission of the electric current without wires—it is to be pointed out that they were not conducted in connection with any research in wireless telegraphy, but with a view to determining the speed at which the electric current travels. Incidentally, it may be remarked that the experimenters came to the conclusion that "the velocity is instantaneous."²

¹ *Encyclopaedia Britannica* (1810), p. 59.

² *Ibid.*, p. 736.

Pioneers of Wireless.—

It was not until ninety years later that the "earth-return" was used in connection with telegraphy. In the meantime, electricity had made great progress. Current electricity had been discovered (in 1800) by Volta—as we have already seen—and attempts were being made to use the new force for communication between distant places.

Even at the outset efforts were directed to discovering a system that could be employed without wires. In 1811 an eminent German scientist named Sömmering, who was experimenting with a form of telegraph, was the first to suggest using water in place of wires to conduct the current for telegraphic purposes. He found that if each wire were interrupted by a tub of water, the current com-

pleted the circuit without interruption exactly as before. Sömmering soon found, however, that the signals ceased when both wires were dipped into the same tub. As a matter of fact, had he been able to use a more delicate instrument for recording the signals, he would have noticed that a minute current did actually cross the water, even when both wires were introduced into the same tub.

As two separate bodies of water are not often to be found together in natural conditions, Sömmering believed his suggested method to be impractical, and discontinued his experiments in this direction.

Although Sömmering's system had only a brief life, it was the earliest practical method proposed for wireless communication, and as such deserves special notice.

Saltley, Birmingham.

(December 5th-January 27th.)

Brazil: 1AB, 1AC, 1AG, 1AF, 1IC, 1IG, 1IN, 5AA, 5AB, 2AF, SQ1, RGT, AABZ. Argentina: AF1, BG8, DG2. Canada: 1AR, 1AK, 2AX, 2BE, 2FO, 3FC. Cuba: 2MK, NVE. New Zealand: 2XA, 3BR (?), 4AG, 2AQ. Philippine Islands: 1CW, 1HR, 1HV, NAJD. South Africa: A3B, A3E, A4S, A6N. Australia: 2CM, 3EF, 3XO, 2YI, 5BG, 6AG. Porto Rico: 4JE, 4SA. U.S.A.: 4DM, 4FC, 4FM, 4IT, 4RM, 4TV, 5YW, 9AWK, 9AJJ, 9WMJ, 9BPB, 9FF, 9GX, 9KWV. China: FI 8LBT, GECQ (Hong Kong). Various: XGB1, X2BG, GHA, SGT, SGC, SKA, AVLS, ANF, P 3FZ, PE 6ZK.

B. and F. Smith.

(0-v-1 Grebe and Reinartz.)

Amersham, Bucks.

(January 23rd, 24th, 31st.)

Great Britain: 2KF, 2RW, 2SZ, 2XV, 5DA, 5HS, 5WV, 6DW, 6ME. U.S.A.: 1AOF, 1APL, 1ARN, 1AYL, 1BDX, 1BGC, 1CPQ, 1CRE, 1GA, 1HJ, 1KC, 2AES, 2AG, 2AHK, 2AHM, 2AIM, 2AMJ, 2BM, 2CFT, 2CLG, 2CNS, 2KG, 2NZ, 2PP, 3AHA, 3BIT, 3BWT, 3CAH, 3DH, 3MW, 3PS, 3XI, 3ZO, 4AAH, 4SI, 5ACL, 5ADL, 5FC, 5YD, 8ATV, 8BUY, 8CAC, 8VX, 9BJK, 9EJI, 9WO, 9ZT. Holland: OKH, OMS, OTH, 2PZ. Belgium: S5, U3, Z1. France: 8NN, 8NS. New Zealand: 2XA. Brazil: 1AC. Canada: 1DD. Italy: 1GW. Various: EG EN, WVC.

K. E. B. Jay

(On 35-45 metres.) (G 2BMM).

Burnley, Lancs.

(December 21st-January 21st.)

U.S.A.: 40M, 4JR, 4RM, 4RR, 5ACL, 5AHP, 5JF, 5UX, 5ZAI, 6AT, 6OI, 9BHT, 9BMD, 9CJW, 9ONG, 9DXJ, 9EJI, 9ZA, 99X. Australia: 2CK, 2CS, 2TM, 2YI, 3BD, 3BQ, 3EF, 3GN, 3KB, 3XO, 4AN, 5BG, 5BR, 5DA, 6AG. New Zealand: 2AC, 2AQ, 2XA, 4AA, 4AC, 4AV, KFUH. South Africa: A4Z, AGN. Philippine Islands: 1AR, 1DNA, 1HR. Brazil: 1AB, 1AC, 1AE, 1AN, 1AP, 1IA, 1BO, 2AF, 5AB, 6QA, 3Q1. Argentina: AF1, BA1, FH4. Porto Rico: 4JE, 4KT, 4SA. Miscel-

Calls Heard.

Extracts from Readers' Logs.

aneous: Y HBK, M1AA, BEBER, FI 8QQ, LA 1A, CS OK1, C1AR, C 1DJ, C 3KP, CH 2LO, NRL, CRL.

W. H. Dyson.

(20-60 metres.) (0-v-0 Reinartz.)

Harborne.

Australia: 2RJ, 2YI, 3KB, 3QH, 3BQ, 5BG, 3CH, 3XO. New Zealand: 1AX, 3AF, 4AH, 2AQ, KFCH. Guam: NPN. Alaska (?): WVC. Argentina: AA8, FA4, FH4. Uruguay: JCP. Brazil: 6GF, 1BC, 1AQ, 1AY, 1AH, 1AR, 2AB, 2AJ. America: 5ACL, 5AGN, 5AHP, 5ASP, 5ATX, 5EW, 5GF, 5JF, 5MI, 5UK, 5UX, 6AED, 6AMM, 6BLS, 6CGW, 6OB, 6OI, 7DF. Honolulu: HU WYI. French Indo-China: FI 8LBT, HVA. Philippine Is.: NEQQ, NEGG, NIPM. Japan: J 1PP. Various: Q 2BY, P 1AR, P 3FZ, P 3CO, P 3GB, EG EH, C 8AR, ANF, WYV, OCA, 5RF.

T. S. Calder.

(0-v-1) receiver.

Bedford.

(December, 1925.)

U.S.A.: 1FU, 1YB, 1AAO, 1ZA, 1ZAO, 1CH, 1UK, 1XA, 1AIU, 1BL, 1AHL, 1ZL, 1BC, 1ACO, 1NN, 1CAB, 1AV, 1ALL, 1CAL, 1AI, 1BIT, 1KAI, 1BSD, 1CNP, 1CMP, 1BA, 1HN, 1RD, 1AD, 1HJR, 1HJ, 1SJ, 1GA, 1CH, 1NO, 1CN, 1AIU, 1AOF, 1SA, 1AH, 1ZT, 2NTI, 2UK, 2BR, 2QB, 2ANM, 2BRB, 2UK, 2API, 2AR, 2XZ, 2AG, 2IP, 2NN, 2BWC, 2AES, 2AKB, 2GP, 2NTI, 2AR, 2RD, 2ATR, 2AI, 2LZ, 2BTU, 2AWF, 1CYX, 2AGO, 3AMJ, 2CXI, 2AOF, 2AIS, 2RM, 2CO, 2BVA, 2CC, 2RS, 3ATI, 3TN, 3HW, 3CJ, 3JA, 3LU, 3BMZ, 3PS, 3HG, 3XP, 3IM, 4AC, 4RM, 4RR, 5BK, 5WB, 5YD, 5DA, 5PH, 5ER, 5JF, 5ACL, 5JF, 6NA, 6LS, 7NPB, 7ZI, 7AK, 7UG, 7NE, 7OK, 7VX, 7ST, 8ALY, 8RF, 8DGJ, 8DGO, 8DAA, 8AZ,

8MC, 8JQ, 8JM, 8BQ, 8KSC, 8BSO, 8DW, 8BDH, 8DI, 8DAA, 8RR, 8DRS, 8SE, 8RV, 8AWU, 8JM, 8CC, 8BWW, 8JY, 8CQ, 8AXO, 8BR, 9CF, 9BH, 9DNG, 9BF, 9EJI, 9ZA, 9DYY, 9AL, 9ST, 9CIP, NRDM, WIR, WIZ. Canada: 2OD, 4AR. Australia: 2LG, 2LO, 3KB. New Zealand: 2AC, 4AC. Porto Rico: 4SA. South Africa: A4Z, O9J. Palestine: PE 6ZK. Ireland: GI 6MU. Japan: 2PP, 2PR. Brazil: 1AB. Argentina: AA2, AB8. Russia: RRP, RAK. Germany: 4LV, POF. Scandinavia: SMYU, STTS, SMZS, 2LP, SMTN, LA 4X. Belgium: S4, V2, P7, 4R, J9, S3, 8K, 4RS. Italy: 1BH, 1BI, 1RM, 1NO, 1NT, 1AU, 1GN, 1GT, 1BS, 1FC, 1MA, 1BB, 4ED. Holland: 2PZ, PCLL, NAB, 10KS, 10WB, 10MS, 10BL, 10II, 12BB, PB2. Great Britain: 2LZ, 2IT, 2KW, 2EC, 2GO, 2ZF, 2XZ, 2FM, 2RB, 5FS, 5NF, 5SK, 5IK, 5XY, 5SI, 5UQ, 5HS, 5XO, 5MA, 5AX, 6YQ, 6BD, 6VP, 6HB, 6YU, 6QB. France: 8TUP, 8DK, 8RR, 8JN, 8JK, 8KIR, 8XH, 8VX, 8EU, 8RBP, 8CQ, 8BU, 8HU, 8PEP, 8ZM, 8RDP, 8JK, 8VO, 8IX, 8RZ, 8PK, 8KGZ, 8NJD, 8VO, 8WOZ, 8PKX, 8LDR, 8DGS, 8AWI, 8DI, 8HM. Unknown: GB 4K, KPL, 4L, 1KU, 1CW, 4SEEA, R 8GN, 5P, W 8HC, F 8TII.

S. Williamson (G 2ACI).

(0-v-1) on 25-50 metres.

Leigh, Lancs.

(January 3rd to 31st.)

U.S.A.: 1BLB, 1BZ, 1CRE, 1AY, 1KL, 1ZS, 2GK, 2MM, 3BD, 3QT, 8XX (?). Great Britain: 2AO, 2CC, 2DN, 2FM, 2LZ, 2NM, 2WJ, 2XV, 2XY, 2YG, 5II, 5LF, 5MA, 5MB, 5IZ, 5JW, 6FT, 6FQ, 6MX, 6OG, 6OH, 6TD, 6TM, 6YU. France: 8DGS, 8DTG, 8GGA, 8DDS, 8HSF, 8IR, 8NS, 8PEP, 8RPI, 8SU. Italy: 1CN, 1CO, 1GW, 1NO, 1RM. Brazil: 1AB, 1AC, 2AB, 2AF. Holland: N PBY, OBX, 2PZ. Russia: 1ND, 1PU. Portugal: 1AF. Denmark: 7BX. Palestine: G 6ZK. Norway: 4X, 1A. Belgium: Q2, S4, K3. New Zealand: 2AC, Czecho Slovakia: 1AR. India: CRP. Various: WIZ, WQO, WQL, FG2, O PCLL, FW, A B8, B PCF2, ANF. Sweden: SMTX, SSMN.

W. P. Stainton.

(0-v-1)

WIRELESS CIRCUITS

in Theory and Practice.

6.—Resonance and Oscillating Circuits.

By S. O. PEARSON, B.Sc., A.M.I.E.E.

At the conclusion of the last instalment the properties of a series circuit were considered in which the inductance was 5,065 microhenries, and the capacity 0.0005 mfd., and a curve was developed showing the variation of impedance with frequency, the resistance being 500 ohms. In order to show the effects of resistance on the impedance at various frequencies, including the resonant frequency $\frac{1}{2\pi\sqrt{LC}}$, a number of impedance curves are given in Fig. 1 for various values of the resistance, namely, 4,000, 2,000, 500, and 0 ohms, the values of inductance and capacity being as above.

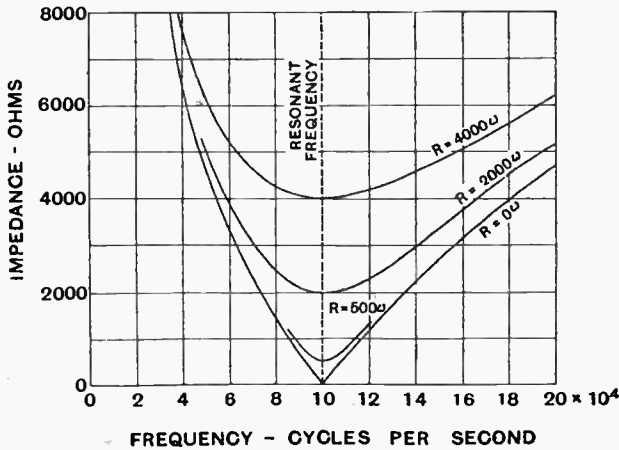

Fig. 1.—Impedance curves for a series circuit showing the effects of resistance.

It will be seen that for zero resistance the impedance curve comes to a sharp point and the impedance has a value equal to zero when the frequency is $\frac{1}{2\pi\sqrt{LC}}$, in this case 100,000 cycles per second. When resistance is present in the circuit this point is rounded off as shown by the three upper curves, and the minimum value of the impedance is in each case equal to the resistance.

Effect of Resistance.

The curves show further that the higher the value of the resistance the more pronounced is the rounding off at the resonant frequency. This means that when the frequency is changed by a given small percentage from the resonant frequency, the resulting percentage increase of impedance is very much less when the resistance is high than when it is low. For instance, if the resistance of the circuit is 10 ohms and the frequency is increased by 10 per cent. above the resonant value, the impedance increases from 10 ohms to 600 ohms, or an increase of

5,900 per cent. If the resistance of the circuit is 500 ohms, the impedance increases from 500 to about 770 ohms for the same increase of frequency, equal to an increase of only 54 per cent. Thus, for a frequency increase of 10 per cent. above the resonant value, in the former case the impedance is increased 60 times, and in the latter case only just above one and a half times. The importance of this fact will be realised when we come to consider the selectivity of tuned circuits.

The Closed Circuit.

Consider a closed circuit containing inductance, capacity, and resistance, such as that shown in Fig. 2(a), and suppose that a constant electromotive force of E volts (R.M.S. value) is induced into the coil LR by mutual induction due to an alternating current flowing in the coupling coil L_1 . The resulting current round the circuit L, R, C will be equal to E/Z where Z is the impedance of the circuit due to L, R and C in series as previously considered. Obviously, then, this circuit is equivalent to the circuit of Fig. 2(b), where the alternator A represents the source of driving E.M.F., the only difference being that in the former case the P.D. across the condenser C is exactly equal to that across the inductive coil RL , this voltage including the driving E.M.F., whereas in the latter case the generated voltage is external to the coil, and therefore the voltage E_z across the coil will not be the same as that across the condenser; but when the circuit is tuned to complete resonance, the applied voltage E is small compared with

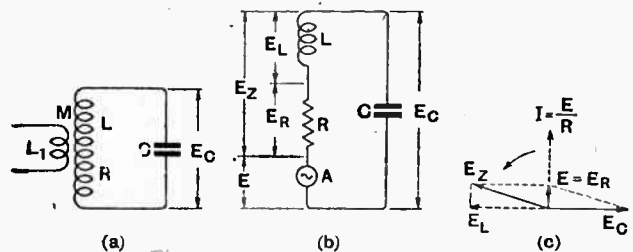

Fig. 2.—(a) Circuit in which the applied E.M.F. is induced into the inductive coil. (b) Series circuit which is electrically equivalent to (a). (c) Vector diagram for complete resonance where $E_L = E_C$

the voltages across the coil and the condenser respectively if the resistance is low, as will be seen from the numerical example below. The values of, and phase relations between, the three voltages at the frequency of resonance are shown by the vector diagram, Fig 2(c), where E is the E.M.F. induced into the circuit. Since the circuit is tuned to resonance the current is in phase with the applied E.M.F. and is equal to E/R amps. Thus when the E.M.F. is induced into the coil, as in Fig 2(a),

Wireless Circuits in Theory and Practice.—

the voltage across the circuit will be $IX_c = \frac{E}{R} \times \frac{I}{2\pi fC}$ volts, and this is out of phase with the applied E.M.F. by 90° . Suppose that the applied E.M.F. had an effective value of 0.1 volt, and that the condenser in the circuit had a capacity of 0.0005 mfd. as before. Then for a circuit resistance of 10 ohms the current at the frequency of complete resonance would be $\frac{0.1}{10} = 0.01$ ampere, and the voltage across the circuit would therefore be $0.01 \times \frac{10^6}{0.0005} \times \frac{1}{2\pi f}$ volts. It must be remembered that for purposes of calculation the capacity must

is a minimum at the resonant frequency, the current, and hence also the voltage across the circuit, will be greatest at this frequency. Suppose the E.M.F. induced into the coil is 0.1 volt R.M.S. value, and that the inductance and capacity values are 5,065 microhenries and 0.0005 mfd. respectively as before. The current at any particular frequency is given by dividing the voltage by the impedance of the circuit at that frequency as found from one of the curves of Fig. 1, according to the value of the resistance. A number of the current values have been worked out for frequencies between zero and 200,000 cycles per second, and the curves showing the relationship between frequency and current, known as *resonance curves*, are given in Fig. 3. Each curve corresponds to a definite value of resistance as marked on the curve.

Currents Induced near Resonance.

These resonance curves show us that a circuit of this nature has the property of "selecting" currents whose frequencies are within a small band near the resonant value $\frac{1}{2\pi \sqrt{LC}}$, and of choking back all currents whose frequencies are not near the resonant value. For instance, if two equal E.M.F.s of 0.1 volt are induced into the circuit simultaneously, one being at the resonant frequency of 100,000 cycles per second, and the other having a frequency of 80,000 cycles per second, the current due to the former will be 10 milliamps if the circuit resistance is 10 ohms, whereas that due to the latter will be only 0.075 milliamp. or 75 microamps. It is this property of the circuit that makes possible the tuning-in of a particular wireless signal to the exclusion

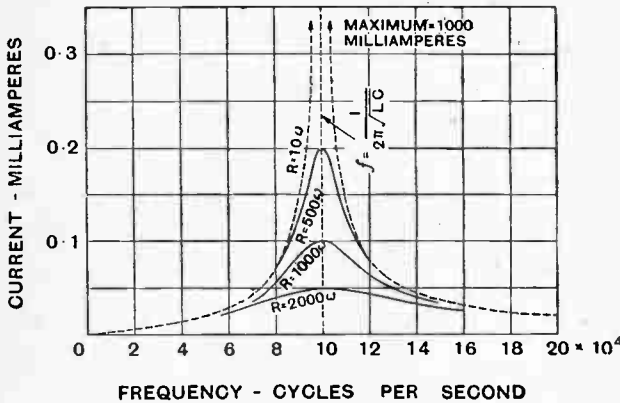

Fig. 3.—Resonance curves for a series circuit showing the effect of resistance. Inductance, $L = 5,065$ microhenries, and the capacity, $C = 0.0005$ mfd.

be in farads, so that if its value is given in microfarads we must divide it by 10^6 . For a circuit in which the inductance is 5,065 microhenries the resonant frequency f will be, as shown above, equal to 100,000, or 10^5 cycles per second. Thus the voltage across the circuit will be $\frac{0.01 \times 10^6 \times 1}{0.0005 \times 2\pi \times 10^5} = 31.8$ volts, or 318 times as great as the voltage applied to the circuit.

We see then that for a given applied voltage the resultant potential difference across the circuit when tuned to complete resonance is inversely proportional to the re-

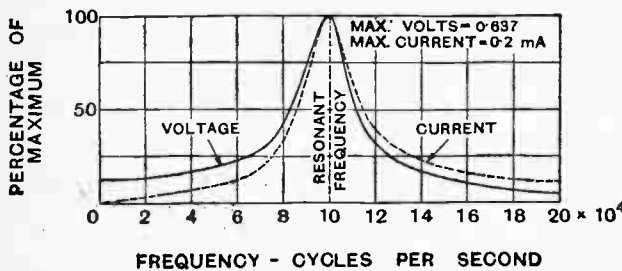

Fig. 4.—Comparison of voltage and current resonance curves for a series circuit whose constants are as follow: Inductance, $L = 5,065$ microhenries; capacity, $C = 0.0005$ mfd.; resistance, $R = 500$ ohms.

sistance, and thus in order to get a high voltage across the circuit at the resonant frequency the resistance must be as low as possible. Since the impedance of the circuit

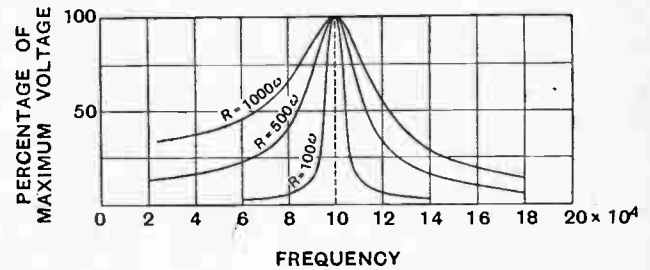

Fig. 5.—Effect of resistance on selectivity of a series resonant circuit.

of other signals whose frequencies or wavelengths differ by a small percentage from that of the desired signal.

Selectivity of Tuned Series Circuits.

We see, then, that, in order to receive a certain signal free from interference by other undesired signals of approximately the same wavelength or frequency, it is necessary to design our tuned circuit to have a high degree of selectivity. Now, in the great majority of wireless receivers in use at the present time it is not the current in the circuit that is made use of but the potential difference set up across the circuit as a result of this current; that is to say, potentially operated devices are employed for detecting wireless signals, such, for instance, as the crystal detector or valve detector. In order to see clearly the best conditions for high selectivity it is necessary to examine the curves showing the variation of circuit volt-

Wireless Circuits in Theory and Practice.—

age with frequency. We have already seen that the voltage set up across the circuit of Fig. 2(a) is equal to $I \times \frac{1}{2\pi fC}$ where I is the current round the circuit, so that the voltage is directly proportional to the current and inversely proportional to the frequency. Now, since the current and the condensive reactance are both changing with frequency, the voltage resonance curves will not be the same shape as the current curves of Fig. 3, as will be seen by reference to Fig. 4, where the voltage curve and current curve have been plotted for a circuit resistance of 500 ohms. The various values for both are given as percentages of the respective maximum values in order that the peaks of the two curves shall coincide and so facilitate comparison.

Effects of Resistance and Capacity on the Selectivity.

In Fig. 5 a number of voltage resonance curves are given for various values of circuit resistance, these also being plotted as percentages of the maximum values for purposes of comparison. It is not the actual maximum value of voltage produced across the circuit that determines the selectivity or sharpness of tuning, but the percentage change of voltage obtainable for a given *small* change of frequency from the resonant value; for if two signals of equal strength but slightly different frequency (or wavelength) are acting on the circuit it is necessary for the voltage set up across the circuit by the undesired signal to be small compared with that set up by the desired signal, and therefore the resonance curve should

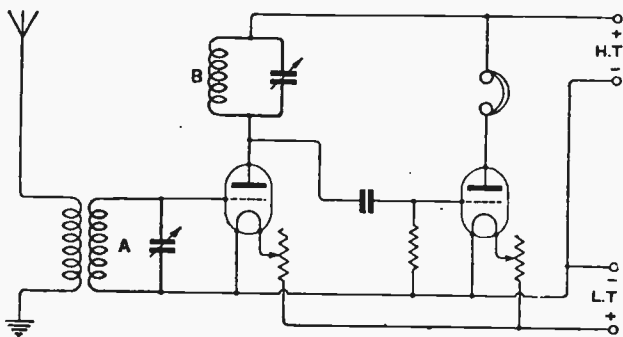

Fig. 6.—Typical receiving circuit which includes a series circuit A and a parallel circuit B.

be as sharp as possible and narrow near the base. The curves of Fig. 5 show that the lower the value of the resistance the sharper is the resonance curve, and, therefore, the better the selectivity. It will be shown later that the effective resistance of an inductive coil is usually several times greater at the high frequencies used in wireless work than that offered to a steady direct current, and one of the greatest problems in the design of tuning inductances has been the production of a coil with low resistance at high frequencies.

There is yet another factor which determines the degree of selectivity, namely, the value of the capacity in the circuit. The maximum voltage at the resonant frequency was found to be $\frac{E}{R} \times \frac{1}{2\pi fC}$ volts, where E is the signal

voltage induced into the coil. By transferring factors in the two expressions this may be rewritten:—

$$E_{max} = \frac{I}{RC} \times \frac{E}{2\pi f}$$

$$= \frac{1}{RC} \times \text{constant.}$$

Thus we see that, although the maximum value of the current was independent of the capacity, this is not the case with the voltage; in fact, the maximum voltage obtainable is inversely proportional to the product of resistance and capacity, so that it is equally important to keep the capacity down to a low value. But to tune

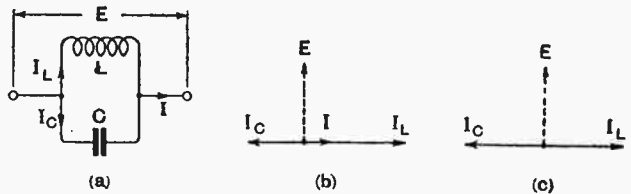

Fig. 7.—(a) Parallel resonance circuit without resistance. (b) Vector diagram for non-resonant frequency; I_L and I_C unequal. (c) Vector diagram for complete resonance; $I_L = I_C$.

to a given frequency, f , we have seen that the product of inductance and capacity must have a definite value,

because $f = \frac{1}{2\pi\sqrt{LC}}$, and thus

$$LC = \frac{1}{4\pi^2 f^2} = \text{a constant.}$$

Therefore, if C is made smaller the inductance must be increased in the same proportion, and from this it follows that the greater the ratio $\frac{L}{C}$ the better will be the selectivity and also the signal strength, which depends alone on the maximum value of the circuit voltage. In practice it is advisable never to use a variable condenser for tuning purposes of greater maximum capacity than 0.0005 mfd. in a circuit of this kind for moderate wavelengths, and not greater than, say, 0.00025 mfd. for wavelengths below 200 metres.

Resonance in Parallel Circuits.

We come now to the consideration of a closed circuit possessing inductance and capacity as before, but where the impressed E.M.F. is applied across the circuit instead of being induced into the inductive coil—in other words, a circuit in which L and C are truly in parallel. In practical wireless circuits we depend on the resonating properties of parallel circuits as well as of the series circuit which we have been discussing. For instance, in the tuned anode method of coupling two valves in a high-frequency amplifier, a parallel circuit is employed, and in Fig. 6 part of a typical receiving circuit is shown where both the parallel circuit and the equivalent of the series circuit are employed. The grid circuit at A is a series circuit because the signal E.M.F. is induced into the inductive coil, and the anode circuit at B is a parallel circuit because the E.M.F. is applied across it.

Consider the circuit of Fig. 7(a), the coil inductance being L henries, and the condenser capacity being C farads, and assume for the present that the resistance of

Wireless Circuits in Theory and Practice.—

the coil is zero. Let E be the steady R.M.S. value of an alternating voltage applied across the circuit, the frequency being f cycles per second. Then the current through the coil will be $I_L = \frac{E}{X_L}$ amperes, and, as explained previously, this will lag behind the voltage E by an angle of 90° . Similarly, the current through the condenser will be $I_c = \frac{E}{X_c}$ amps., and this will lead the voltage by 90° . Thus the two currents are exactly opposite in phase, and when we draw a vector diagram, the two current vectors will point in opposite directions, as indicated in Fig. 7(b). The total current taken from the source of supply will therefore be equal to the difference between I_L and I_c ,

$$i.e., \quad I = I_L - I_c \\ = E \left(\frac{1}{X_L} - \frac{1}{X_c} \right) \text{ amperes.}$$

Obviously, then, the current I taken by the circuit will always be less than either of the currents in the branch circuits.

Suppose, now, the frequency could be varied; we see that I_L is inversely proportional to the frequency, and I_c is directly proportional to the frequency, so that a particular value of frequency could be found for which the currents in the branch circuits would be equal, and therefore the resultant current in the external circuit would be zero, because its value is given by the difference between the currents in the branch circuits. We see from

the equation above that this occurs when $\left(\frac{1}{X_L} - \frac{1}{X_c} \right) = 0$.

Under these conditions the circuit is tuned to complete resonance, and, since no current is taken by the circuit, its impedance is infinitely great at the resonant frequency. Hence, at the frequency of complete resonance,

current is flowing backwards and forwards (or oscillating) round the closed loop, the current in the condenser circuit being at every instant equal to the current in the inductive coil, and no current whatever flows in the external circuit from the source of supply. It may seem, at first sight, that, because we are getting an appreciably large current round the closed circuit without taking any current from the supply, energy is being created in the closed circuit from apparently nowhere! But, of course, this is not the case, and the explanation is really quite simple: the current taken by the coil lags by 90° , and that taken by the condenser leads by 90° , and therefore the average power taken by each branch of the circuit is zero, because in any circuit where the current and voltage are out of phase by 90° the average power is zero. Apparently, then, since nothing is coming from the source of supply, if we disconnected our closed circuit from the supply the alternating current would keep on flowing in it at the resonant frequency, and this would actually be the case in practice if we could eliminate all sources of loss. Thus, once the *oscillations* in the closed circuit L.C. have been started they will continue indefinitely with constant amplitude if there is no resistance or other source of energy loss. These oscillations take place at the resonant frequency in this case, and it is therefore called the *natural frequency* of the circuit. Of course, if there were resistance in the circuit, as is always the case in practice, energy would be lost, as heat and the oscillations would commence to die down as soon as the supply were disconnected. However, in the case where no resistance is present, we see that complete resonance occurs when $\frac{I}{X_L} = \frac{I}{X_c}$, that is, when $1/2\pi fL = 2\pi fC$, from which we get the resonant frequency

$$f = \frac{1}{2\pi\sqrt{LC}} \text{ cycles per second,}$$

which is exactly the same as for the series circuit.

A CLUB'S RECEIVING EQUIPMENT.

Interesting Apparatus for Demonstration Purposes.

The Tottenham Wireless Society is collecting together a complete broadcast receiving equipment for demonstration purposes. The design adopted has been carefully considered and the instruments will serve as a guide to members in the construction of receiving sets embodying

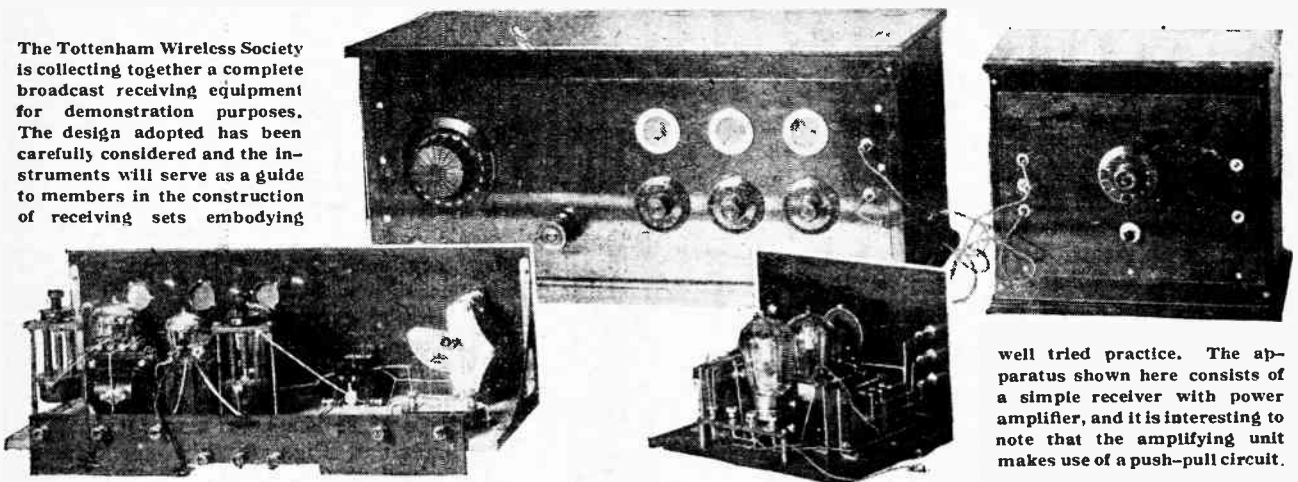

well tried practice. The apparatus shown here consists of a simple receiver with power amplifier, and it is interesting to note that the amplifying unit makes use of a push-pull circuit.

ACCURACY
GUARANTEED
 Value absolutely constant



You know where you are
 with
Dubilier Condensers

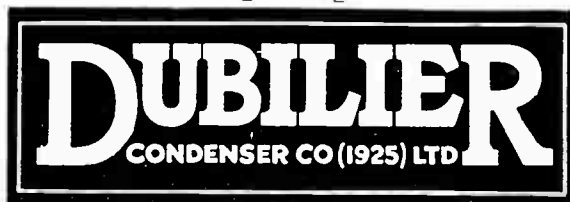

ADVERTISEMENT OF THE DUBILIER CONDENSER CO. (1925) LTD., DUCUN
 WORKS, VICTORIA ROAD, N. ACTON, W.3. TELEPHONE: CHISWICK 2241-2251.

E.P.S. 180

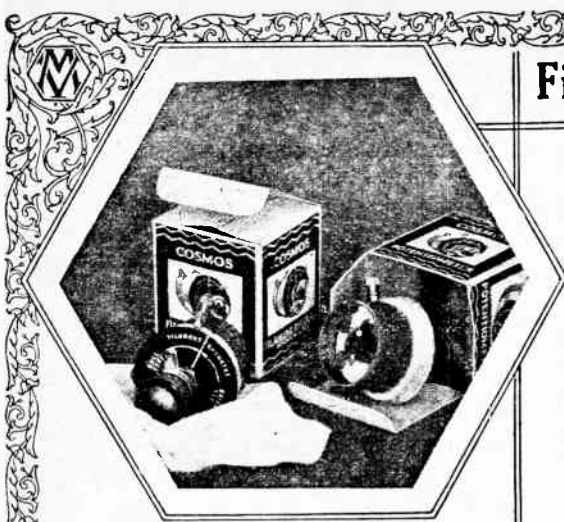

Filament Rheostats and Potentiometers

WITH the windings carried on a porcelain bobbin and having the contact arm moving on its inner side, the "Cosmos" Filament Rheostat takes up remarkably little space, is strong in construction, and has a very smooth and reliable movement. It is fixed by ONE HOLE and is provided with a handsome knob and dial. Made in four types, two of which are double wound for Dull OR Bright Valves, and one a Potentiometer.

Prices and particulars are given in the adjacent panel.

METRO-VICK SUPPLIES, LTD.,

(Proprietors—Metropolitan Vickers Elec. Co., Ltd.)

4, Central Buildings, Westminster, London, S.W.1.

Description.	Ohms.	Current Carrying	Price.
Single Wound	6'0	1'0 amp.	4/6
Double "	18+2	4-1'5 "	5/0
" "	30+4	2-1'0 "	5/0
Potentiometer	300	—	6/0

Cosmos

RADIO COMPONENTS

The Famous GAMBRELL COILS at REDUCED PRICES.

AT THESE PRICES

Maximum efficiency is within reach of everybody.

DO YOU KNOW

that Gambrell Coils can be used for many purposes, such as H.F. Transformers, Neutrodyne Units, etc., etc., with much better results, thus doing away with the necessity of purchasing special gadgets which may have to be discarded when altering your circuit.

Write for particulars of other price reductions to :

GAMBRELL BROS., LTD., 76, Victoria Street, London, S.W.1.

GAMBRELL COILS.

Size	Nearest size in ordinary coils	Old Price	NEW PRICE
a/2	18	5/9	4/10
a	25	5/9	4/10
A	30	5/9	5/-
B1	40	6/-	5/3
B	50	6/-	5/6
C	75	6/9	5/9
D	100	8/-	6/3
E1	150	8/9	6/9
E	200	9/6	7/9
F	300	10/3	8/6
G	500	12/-	10/-
H	750	14/-	12/6
I	1000	16/-	14/-
J	1500	19/-	17/6

Any Gambrell Coil can be supplied tapped at its electrical centre for 6d. extra.



A Section Devoted to the Practical Assistance of the Beginner.

CONSTRUCTING INTERMEDIATE-FREQUENCY TRANSFORMERS.

The following constructional details of easily made transformers, suitable for use in the intermediate-frequency amplifier of a superheterodyne receiver, may be of interest to readers who desire, as far as possible, to make their own components. The design given is suitable for following general-purpose valves of moderate impedance.

A cylindrical former, of which a sectional sketch is given in Fig. 1, should be turned from ebonite or hard wood. If the latter material is used, it should be thoroughly impregnated by boiling in paraffin wax until bubbles cease to rise. If a lathe is not available, the work of preparing the formers might be entrusted to the

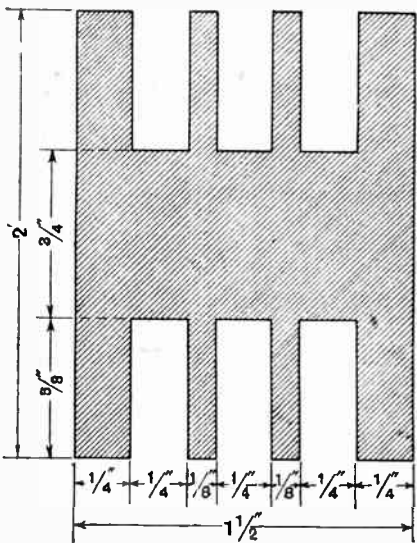

Fig. 1.—Former for I.F. transformers.

local wood-turner, or, alternatively, it can be built up with seven wooden discs (which may be cut out with a fretsaw), clamped together by means of a threaded brass rod passing through a centre hole.

The primary is wound in the centre slot, and consists of 1,100 turns of No. 35 S.W.G. D.S.C. wire. The secondary is divided into two sections, which are wound in the outer slots, and are joined in series. Each section has 1,200 turns of No. 38 S.W.G. D.S.C. wire, the end of one section being joined to the beginning of the next. All windings are in the same direction. A V-shaped groove should be cut in the inner surface of each cheek, to take the commencing end of the wire, and to prevent damage to it. This wire may be secured in the groove with a little molten wax.

In connecting up the external circuit, the plate of the preceding valve should be joined to the end of the primary winding, while the end of the secondary is connected to the grid of the succeeding valve.

o o o o
REACTION IN A NEUTRODYNE RECEIVER.

In the case of the standard neutrodyne receiver having two H.F. amplifying valves, it is doubtful if provision for reaction is necessary or desirable, and the majority of sets of this description have no such adjustment. In a set containing only one stage of amplification, however, reaction will make a very distinct improvement both to sensitivity and selectivity, particularly if grid rectification is used, as the damping effect caused by grid currents in the detector valve may be largely compensated for by its use. Where a crystal detector or anode rectifying valve follows the high-frequency amplifier, a sufficient control of regeneration may generally be obtained by partial denneutralisation, which does not call for the addition of any complications in the way of a reaction coil.

Reaction may be introduced in the normal manner by variably coupling

a coil inserted in the plate circuit of the detector valve with the grid end of the H.F. transformer secondary. This arrangement, however, calls for a certain amount of fairly accurate mechanical work, and may be inconvenient if ready-made neutralised transformers are used. The capacity-controlled system of reaction shown in Fig. 2 will, as a rule, be found more convenient. In this case the reaction coil, which may be wound on an extension of the secondary former, is in close inductive relation with the grid end of the transformer secondary, but no provision is made for relative movement, as the proportion of oscillatory anode current fed back to the grid circuit is determined by the setting of the condenser.

The capacity of this condenser will depend on the number of turns in the

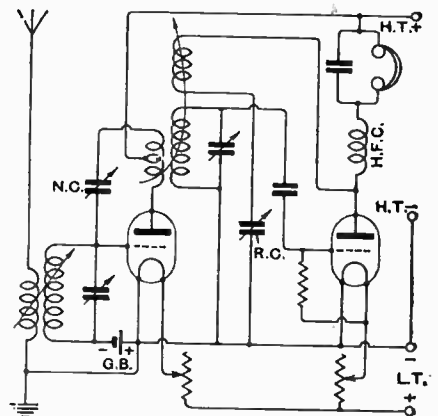

Fig. 2.—A "neutrodyne" receiver with capacity reaction.

reaction winding. For the 300-500 metre waveband, 0.0003 mfd., with about 15 turns on a former of the usual size, are suitable values. There seems little difference in effectiveness if a smaller condenser, with a maximum capacity of as little as 0.00005 mfd. and a reaction coil of 30 or 40 turns are used, and this

arrangement has the advantage that less panel space is occupied, as a small condenser of the Igranic "Micro" or similar pattern will be suitable.

The size of the reaction coil itself should be reduced as much as possible by winding it with fine wire; about No. 36 D.S.C. is recommended. Where interchangeable neutralised H.F. transformers are used, plug-in coils may very conveniently be made to serve for this purpose; a good example of this

form of construction was shown in the issues of *The Wireless World* dated February 3rd and February 10th, under the heading "Oscillation Without Radiation."

ADDING A SECOND H.F. STAGE.

The addition of a high-frequency amplifier to an existing receiver is, in the majority of cases, not to be embarked on lightly and without careful consideration. More especially is this the case when the set already has one H.F. stage, coupled,

perhaps, by the tuned anode method to the detector valve. When used as intended by the designer, with a direct-coupled aerial, sufficient damping is imposed to prevent uncontrollable self-oscillation, but when this damping is removed by the interposition of another valve, with its associated coupling circuits, the set will probably be hopelessly unstable, unless, perhaps, a potentiometer is fitted. Even in this case an excessive amount of positive grid damping may be necessary.

DISSECTED DIAGRAMS.

No. 20.—A Valve-crystal Reflex with Choke-coupled L.F. Amplification.

For the benefit of readers who find difficulty in reading circuit diagrams, we are giving weekly a series of sketches, showing how the complete circuits of typical wireless receivers are built up step by step. The diagrams given below will make clear the method of adding a choke or resistance-coupled L.F. amplifier to a reflex receiver.

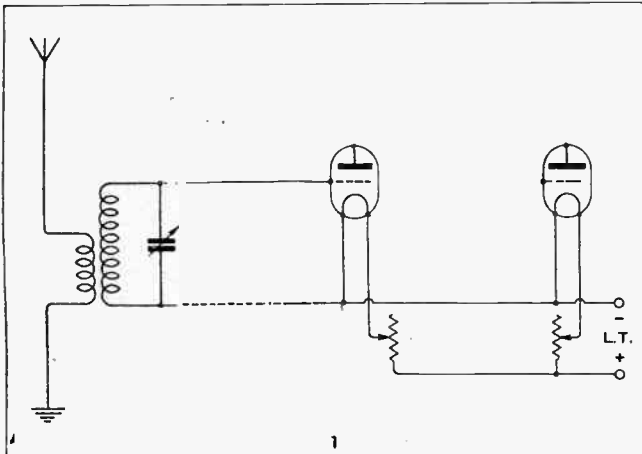

The conventional arrangement of two valves, with normal filament connections. The secondary of an "untuned aerial" coupler is connected across the grid and filament of the first valve, which has in its anode circuit—

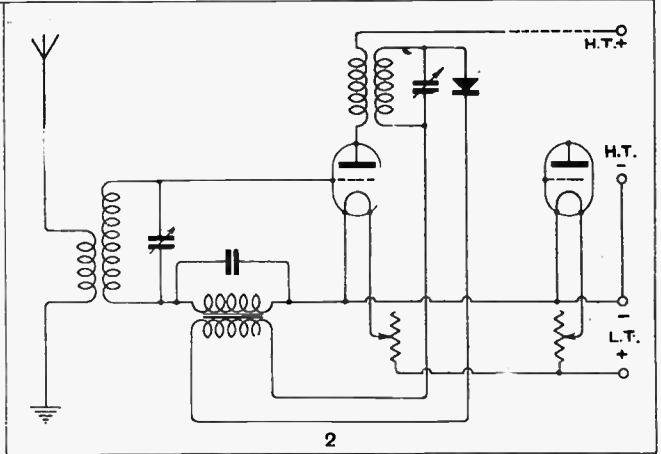

—an H.F. transformer, across the secondary of which is connected a crystal detector. Rectified pulses are passed back through the primary of an L.F. transformer; the secondary is shunted by a by-pass condenser and inserted in the grid circuit.

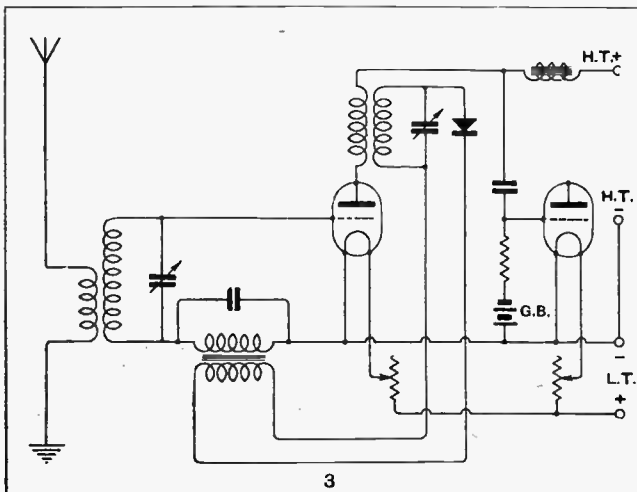

A choke is inserted in the anode circuit of the first valve, L.F. voltages set up across it being applied to the second grid through a condenser, which insulates the grid from the H.T. battery. A leak and bias battery are connected as shown.

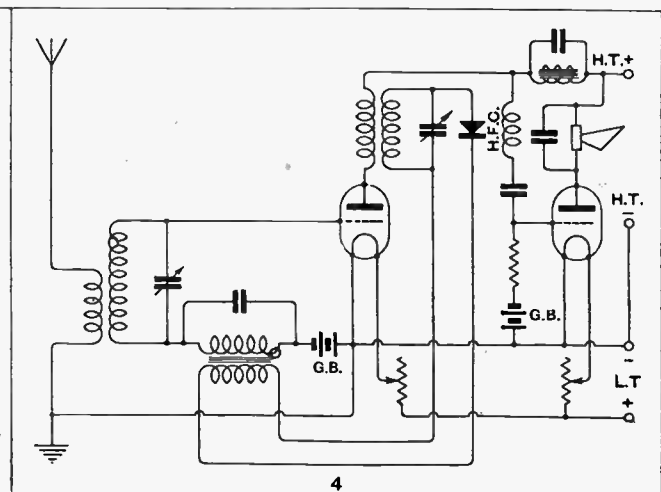

A very small by-pass condenser is shunted across the choke, H.F. impulses being deflected through it by the insertion of a suitable choke in the grid lead. The anode circuit of the second valve is completed through the loud-speaker and H.T. battery.

BROADCAST BREVITIES

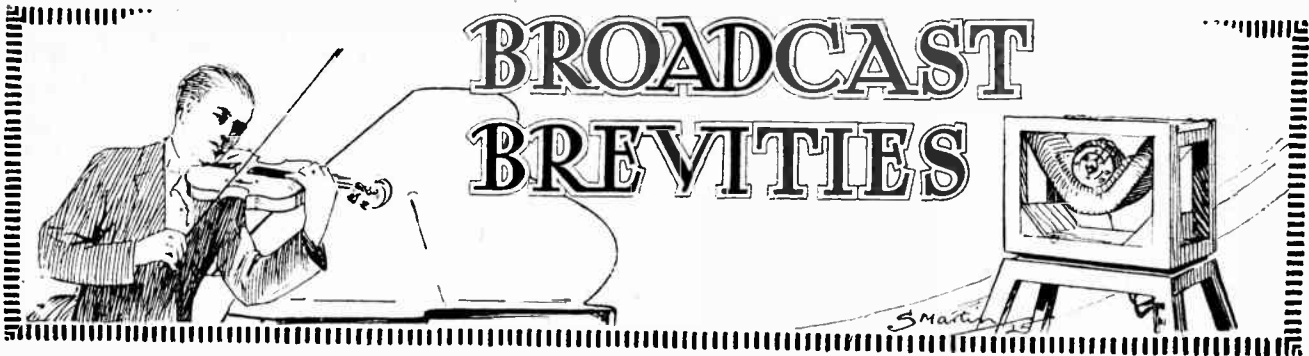

SAVOY HILL TOPICALITIES.

By OUR SPECIAL CORRESPONDENT.

The Broadcasting Conference.

When the Broadcasting Conference meets at Geneva on the 25th of this month, discussion will, I understand, take place respecting the practical extension of the waveband by 100 metres. I can say definitely that while there is a possibility of some British stations coming down to 250 metres—subject to the consent of the Postmaster-General—the likelihood of any reduction below 250 metres is extremely improbable.

○○○○

When Stations Break Down.

The B.B.C. is being pressed by listeners to devise some method of sending out a notification whenever a station suffers a breakdown, however slight the trouble may be. Fortunately, these irritating intervals of silence are few and far between; but the matter, listeners will be glad to know, is already under consideration. All the stations stock spares; but in present conditions a certain amount of time is necessarily taken up in replacing faulty apparatus and in that period many listeners go to the trouble of overhauling their receiving sets to see if the fault is at their end.

○○○○

Warning Listeners.

The ideal would be to have two complete systems of transmission from every station, so that programmes could be broadcast on either by the mere turning of a switch in the control room. Failing such an elaborate method of maintaining the service, the use of a warning note which could be easily identified might be sent out from the nearest main station, or from 5XX, on higher power than that normally employed for programme transmissions. At any rate, the convenience of listeners is to be studied, so that, as far as possible, they may not be left in doubt whether their own apparatus or that of the transmitting station is at fault.

○○○○

S.O.S. Calls.

In what circumstances are S.O.S. appeals accepted by the B.B.C.? I put this question to the officials at Savoy Hill and pointed out that a suggestion had reached me from a correspondent that the machinery of broadcasting was being used

for the purpose of conveying secret code messages, and some at least of the appeals were not *bonâ fide*.

○○○○

All Precautions Taken.

The practice, I am assured, is to broadcast only those appeals on behalf of sick persons which are accompanied by a certificate either from the doctor in attendance on the invalid, or from a hospital. In cases of extreme urgency, where no certificate accompanies the appeal, which, as a matter of fact, seldom happens, the applicant is informed by letter that the appeal has been broadcast, but it is neces-

Are Radio Plays Too Long?

My correspondence bag shows that there is a strong desire for the limitation of time taken up in the broadcasting of story plays. Many listeners appear to prefer two half-hour plays in one programme to a single play which runs the full hour. Radio plays, however, cannot be uniformly cast to run for thirty minutes, and no hard and fast rule can be laid down for a time limit of this nature; but seeing how difficult it is to hold the attention of listeners with dialogue for any great length of time, particularly of listeners who have loud-speakers and can and do allow their attention to be diverted, the suggestion which is being considered is that rather than perform the longer plays in full, extracts might be made and a *compere* give outlines and introductions to the chosen episodes.

○○○○

Good News for Plymouth.

As the result of the collaboration now agreed upon between Government and B.B.C. officials at Plymouth, the long-protracted interference by foreign trawlers with broadcast reception in the south-western counties is likely to be stopped. Ever since broadcasting began these trawlers have made a practice of using their wireless transmitting apparatus when they were in port, and the news that the fishery authorities will assist in tracing the offenders will be welcomed by listeners in the South and West.

○○○○

A Diving Broadcast.

The diving programme, which was to be prefaced by a talk by the diver, describing his experiences under water, has been postponed from next week to a date in June.

○○○○

A Ladies' Programme.

All the artists taking part in the evening programme from Manchester on March 18th will be ladies. Even the duties of announcer will be performed by a lady, namely, Miss Violet Fraser, who has charge of the women's and children's transmissions from that station.



A TWIN MICROPHONE. A novel form of double microphone which has made its appearance in America. It is designed to give extreme sensitivity over a wide range of frequencies.

sary that a medical certificate should be forwarded at once, to be filed with the S.O.S. records, and in no case has there been any failure to comply with this request. Enquiries for missing persons, or for persons who witnessed a street accident, are only broadcast at the request of Scotland Yard.

Talk About "Taxes."

"To make the listener pay a licence fee is one thing, but to *tax* him is another," says a newspaper critic. It sound like a pious conclusion to a homily on the rights and wrongs of the listener; but one of the latter writes to me to say that when he read it he had just returned from booking three seats at a London theatre, and on each ticket he had to pay 1s. 6d. tax. The three tickets cost 25s. 6d. in all. This, for just under three hours' entertainment. "These criticisms of the receiving licence fee," he winds up, "leave me cold." ○○○○

A Spanish Musician.

A musical programme will be given on March 10th by the quartet organised by Enrique Casals, the Spanish violinist and composer, who is a brother of the still more famous 'cellist, Pablo Casals. He is leader of the Pau Casals Orchestra in Barcelona, and the opportunity given to listeners of hearing him and his colleagues arises from their present visit to this country to undertake special concerts for the Musical Society. ○○○○

Nearly Two Million Licences.

The vast body of listeners must feel gratified at the latest returns of wireless licences issued. A feeling has always existed that whereas most listeners have not failed in their obligation to take out a licence, others have evaded their duty. The sudden jump in figures no doubt has some bearing on the activity of the Post Office in prosecuting the "pirates." At the end of December last 1,644,325 licences had been issued. The total announced in the House of Commons recently was 1,841,000. Happily, the impression that some people have been getting for nothing that which others have paid for as a legal obligation and a duty is being effaced. ○○○○

Sumner is Icumen In.

A hint of the coming of the summer season will be given by the Manchester station on March 26th. when Mr. B. Kennedy will broadcast the first of a series of tennis talks. Mr. Kennedy is a keen athlete and a prominent figure in the Manchester tennis world. His talks, entitled "Tennis for the Beginner," will contain some valuable hints for all whose thoughts turn to this sport with the advent of the longer and brighter days. ○○○○

Shakespearian Cameos.

The heroines of Shakespeare will form the theme of a new series of Sunday afternoon transmissions in the near future. These broadcasts will consist of cameos, each lasting not more than ten minutes. ○○○○

Sir Harry Lauder Again.

The second edition of "Listening Time," the broadcast revue which succeeded "Radio Radiance," will be given on March 6th. On this evening also Sir Harry Lauder will broadcast at 9 p.m.

FUTURE FEATURES.**Sunday, March 7th.**

LONDON.—3.30 p.m., Light Classics. 9.15 p.m., Band of H.M. Royal Air Force.
 ABERDEEN.—9.15 p.m., Bach, Beethoven, and Schubert.
 BOURNEMOUTH.—3 p.m., Concert and Organ Recital.
 BELFAST.—8.30 p.m., Belfast Radio Trio.

Monday, March 8th.

LONDON.—7.40 p.m., Lady Tree on the National Memorial to Queen Alexandra.
 BIRMINGHAM.—8 p.m., A Light Musical Evening.
 GLASGOW.—8 p.m., Empire Phonoflight, Lord Strathcona: An Epic of Canada.
 MANCHESTER.—8 p.m. and 8.45 p.m., The String Band of H.M. Grenadier Guards.

Tuesday, March 9th.

LONDON.—8 p.m., An Unannounced Orchestral Concert.
 BELFAST.—8 p.m., What's Wrong With This?" A Musical Competition.

CARDIFF.—8 p.m., A Russian Recital. 9 p.m., A Merry-Go-Round. Banjo Duets.

GLASGOW.—9 p.m., Songs and Pianoforte Recitals.

LIVERPOOL.—7 p.m., The Liverpool Philharmonic Society's Tenth Concert, "The Passion" (Bach).

Wednesday, March 10th.

LONDON.—8 p.m., Variety. 8.45 p.m., Chamber Music.

ABERDEEN.—8 p.m., Concert by the Aberdeen Railway Male Voice Choir.

EDINBURGH.—8 p.m., Recital of Old French Music.

LEEDS.—8 p.m., A Yorkshire Evening Party in 1860.

Thursday, March 11th.

LONDON.—7.30 p.m., Part I. "The Apostles," by Sir Edward Elgar.

CARDIFF.—8 p.m., In Cap and Bells. John Henry and Blossom.

NEWCASTLE.—7.30 p.m., An "All-Brows" Concert.

Friday, March 12th.

LONDON.—7.25 p.m., Debussy interpreted by Kathleen Long. 9.50 p.m., "No No Nanette," relayed from the Palace Theatre.

BIRMINGHAM.—8 p.m. and 9.15 p.m., John Henry and Blossom. 8.15 p.m., The Casals Quart.

MANCHESTER.—8 p.m., Lancashire Talent Series; Contribution by Liverpool.

Saturday, March 13th.

LONDON.—4.15-7 p.m., Programme relayed from the Ideal Home Exhibition, Olympia. 8 p.m., "The Roosters" Gatherround.

BOURNEMOUTH.—9 p.m., "Listening Time." The New Radio Revue (2nd Edition).

Day v. Night Transmissions.

One of the possible causes of distortion is described by a B.B.C. engineer as night effect due to the confusion of those rays which travel tangentially to the earth's surface and those which are reflected downwards from a supposed electrified layer. To support this theory the B.B.C. has reports from listeners in various parts of the country affirming that the day transmissions are better than those at night. Since the new Birmingham studio was opened the transmissions from that station are much improved, and 5TT now appears to head the list of stations which are noteworthy for the purity of their transmissions, with 5XX, 6BM and 5WA following in the order named. ○○○○

The "Roosters" Gather Round.

The programme from 2LO on Saturday evening, March 13, will be provided by "The Roosters," who are to give listeners their idea of a "Gather Round." Listeners now expect from "The Roosters" that type of intimate performance which is eminently suited to a programme of this kind, and this should be their opportunity to illustrate their versatility. ○○○○

Are Earlier Broadcasts Wanted?

One or two requests have reached the B.B.C. for earlier Saturday afternoon transmissions. The demand does not seem to be very widespread. As a general rule the Saturday afternoon programmes begin at 4 o'clock, and sometimes extra items are given before that hour. With the coming of the warmer days an increasing number of listeners will be spending the earlier part of Saturday afternoon out of doors, and there does not seem to be any urgent need to revise the existing arrangements. ○○○○

"Broadcasting" a Film.

Miss Fay Compton and Mr. John Stuart will take part in a broadcast of the production of a film play to be relayed from the Gaumont Studios on March 5th. A special script is being prepared for this transmission, and the production which is to figure in it will be "The Whirlpool," by Mr. Manning Haynes. ○○○○

Transmission from York Minster.

The B.B.C. is arranging to relay part of the "St. Matthew Passion" from York Minster to 5XX on March 28th. This is additional to the Military Sunday transmission which listeners may also hear again this year. The Military Sunday broadcast from the Minster in 1925 was one of the best, heard more clearly by listeners at a distance of 200 miles than they were in the Minster itself. ○○○○

Sundays at Southampton.

Arrangements have been made by the Bournemouth station to broadcast the Sunday concerts from the New Central Hall, Southampton, which possesses not only fine acoustic qualities but also a magnificent organ. The first of these will be on March 7th.

ELECTRIC TELEVISION.

Recent Developments in Germany.

By Dr. H. KRÖNCKE.

HOWEVER valuable broadcasting may be, even at its present stage of development, its importance would be enhanced very considerably if it were possible to transmit not only speech and music, but also the scenes before the transmitter. It would then be possible to reproduce wherever desired what was going on in front of the transmitter and in a manner exactly similar to the manner in which it was enacted at the place of transmission. The problem of *electrical television*, which is the one here at issue, represents a further stage in the development of telephotography. As is known, for about twenty years past pictures have been successfully transmitted by electrical means, at first over wire conductors, and subsequently by wireless. The method adopted is that the picture is "keyed" with a small cell sensitive to light so that the fluctuations of light which are produced by the greater or lesser darkening of the picture are converted into electric current. Selenium cells were formerly used, as cells sensitive to light, but, on account of their considerable inertia, they were not very suitable for the purpose, for which reason photoelectric cells have now been used for several years past. The latter, it is true, only permit of the passage of a very weak current through them, but with present-day amplification methods there is no difficulty in transmitting these weak currents faithfully over long distances and, if need be, by wireless. As regards wireless transmission, it is especially the interference produced by atmospheric discharges which stands in the way. Notwithstanding this obstacle, however, much has been accomplished in recent times towards the solution of the problem of electric television.

Speeding Up the Transmission of Photographs.

The great advances which have been made recently are due to Dr. Karolus, of Leipzig, who has succeeded notably in increasing to an extraordinary degree the speed of the keying and, consequently, of transmission. The distant transmission of a picture now takes but a few seconds, making possible, even if merely to a modest degree, the electrical television of moving objects. To accomplish this, it is necessary for the whole picture to be keyed photoelectrically at least twelve or fifteen times in each second, and to be reproduced at the place of reception. It is already possible to transmit small moving pictures in this way, and the picture is produced at the receiving end in exactly the same way as is customary with the reproduction of photographs. A ray of light, the intensity of which is modulated by the intensity of the current of transmission, moves about with great speed over a screen, and therefore appears bright at some points and dark at others, corresponding exactly to the original picture. The speed of transmission is so great that the eye cannot follow the ray, but as, moreover, each speck of light strikes the eye for a short time, one gains a comprehensive impression of the picture.

The considerable increase of speed in the electrical transmission of pictures by Dr. Karolus is not to be attributed solely to the use of the photoelectric cell in the transmitter, but is due primarily to the utilisation in the receiver of a phenomenon in physics known for years past as the *Kerr effect*. Whilst in the case of the old picture telegraphy the intensity of light in the receiver was modulated electromagnetically, Karolus uses the rotation of the polarisation plane of light in carbon disulphide, in consequence of electrical tension. In the receiver, therefore, light polarised by a Nicol prism is used to produce the picture. This light passes through a layer of carbon disulphide, which is placed between two plates to which potentials are applied corresponding to the fluctuations of current of the transmitter. The plane of polarisation is, therefore, rotated more or less strongly, and thus varies the intensity of light passing through a second Nicol prism. The power required for the purpose in the receiver is generated by means of resistance amplification. The turning of the polarisation plane is effected practically without inertia, so that in principle an extraordinarily high increase in the speed of transmission can be counted upon.

The Prospect of Success.

The task of effecting television, or the transmission of moving pictures, has, of course, not yet been solved completely. Nevertheless, a considerable advance has been made towards its final solution owing to the extraordinary increase of speed now secured. Even now there are quite serious technicians who are reckoning upon the possibility of being able to transmit by wireless in a few years moving pictures in a manner entirely similar to that by which broadcasting is now effected. The *Telefunken* Company, especially, in collaboration with Dr. Karolus, has been devoting its attention to the problem for some time past, and we shall not fail to report upon further progress as soon as any considerable advance becomes known.

HIDDEN ADVERTISEMENTS COMPETITION.

The following are the correct solutions for "The Wireless World" Hidden Advertisements Competition for Feb. 17th, 1926.

Clue No.	Name of Advertiser	Page
1	Igranic Electric Co., Ltd.	iv
2	The Electron Co., Ltd.	7
3	British Electrical Sales Organisation	10
4	The Marconiophone Co., Ltd.	1
5	Telegraph Condenser Co., Ltd.	7
6	A. J. Stevens & Co. (1914) Ltd.	11

The prizewinners are as follow:

A. Price, Leeds	£5
Richard W. Nundy, Peterborough	£2
E. Wilkinson, Bolton	£1

Ten shillings each to the following:

C. A. Wuy, Milan.	A. Howard, Hereford.
I. Kramer, Dunstable.	G. E. H. Rawlins, Bembridge, I.O.W.

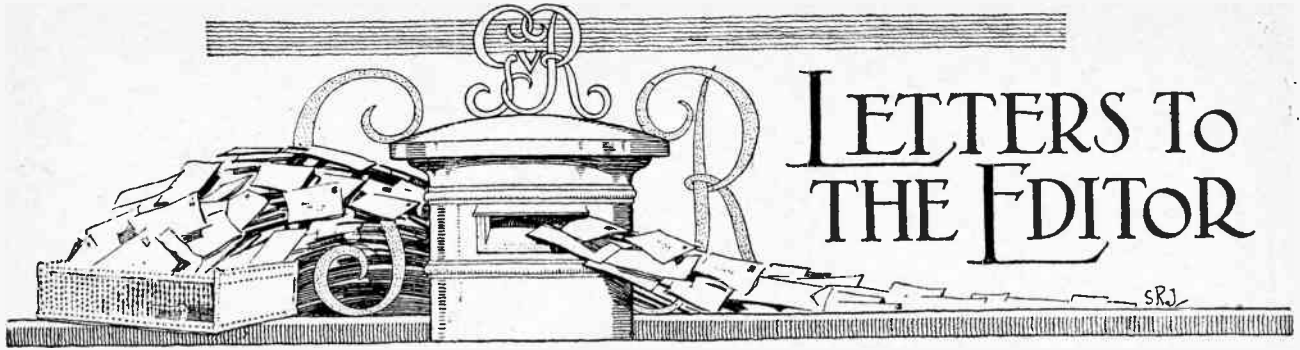

The Editor does not hold himself responsible for the opinions of his correspondents.

Correspondence should be addressed to the Editor, "The Wireless World," Dorset House, Tador Street, E.C.4, and must be accompanied by the writer's name and address.

MORSE PRACTICE MESSAGES DURING BROADCASTING.

Sir,—With reference to the letter headed "Morse Practice Messages during Broadcasting," by Mr. A. Howton, in *The Wireless World* of February 17th, the station Mr. Howton complains of, as interfering with Birmingham, is the military wireless station at Aldershot, GGB. It works on a wavelength of exactly 1900 metres, the schedule being as below:—

20.04 G.M.T.—Monday, Wednesday and Friday, Morse at six words per minute; Tuesday and Thursday, Morse at eight words per minute.

20.23 G.M.T.—Monday, Wednesday and Friday, Morse at 10 words per minute; Tuesday and Thursday, Morse at 12 words per minute.

20.42 G.M.T.—Monday, Wednesday and Friday, Morse at 14 words per minute; Tuesday and Thursday, Morse at 16 words per minute.

The station calls CQ de GGB, and then proceeds with text, which often deals with the military sports and games.

These transmissions have been going on since 1921, if not earlier, and are a great asset to Morse beginners, especially where clubs give Morse lessons.

The harmonic which would possibly interfere with Birmingham is on a wavelength of 475 metres, and Birmingham's wavelength is 479. GGB is very loud, but sharply tuned, and if put on to a non-radiating aerial would no longer serve its purpose. It is quite within the reach of a one-valve set anywhere in the British Isles, and may become a help to those beginners who did not previously know of its existence.

Southport. O. B. KELLETT (G2AZS).

Sir,—In his letter published in your issue of February 17th Mr. A. Howton complains of interference on the Birmingham wavelength by the Aldershot Army station, working on 1,600 metres c.w., and he suggests that for this practice a buzzer would be sufficient.

This would not be possible, as the Aldershot station practice is transmitted for the benefit of Army wireless instruction schools, universities and public school O.T.C. wireless sections, all over the country, to whom the War Office supplies apparatus, consisting generally of a 30-watt c.w. transmitter and a two-valve receiver.

I would suggest that if Mr. Howton used a less complicated set—say crystal-valve reflex, followed by a two-valve note magnifier—he would receive Birmingham in South London without interference, and at the loud-speaker strength he apparently desires.

R. E. SHERWIN-WHITE.

Chiswick, W.4.

RUGBY TELEPHONY TESTS.

Sir,—Respecting your paragraph in the issue of February 17th on "Transatlantic Telephony from Rugby," I note several amateurs picked up *one-way* conversations.

This is rather peculiar, as I myself picked up the tests,

but heard both ends on the same wavelength—about 5,000 or 6,000 metres. Both operators could be heard on the loud-speaker in the next room with detector and two L.F., and although the Long Island speaker was not very clear he could be understood. Another queer point was that, unless the receiver was oscillating and very slightly detuned, speech from Rugby was blurred and indistinguishable, although in the oscillating condition was perfectly clear.

Perhaps someone could explain why both ends were heard on the same wavelength. Was I listening on the wavelength resulting from heterodyning of both transmitters?

Kent.

W.E.P.

Sir,—I read with interest your paragraph "Transatlantic Telephony from Rugby" in "Current Topics" for February 17th. On the two Sundays following that referred to Rugby was again testing, and I listened in several times to the transmissions. If, as I presume, the method of ensuring privacy lies in so distorting the telephony as to render it unintelligible to listeners it would appear that the engineers have been very successful.

Only a few words, such as "Hallo," "London," "Yes" and "No," could sometimes be made out; the remainder of the speech was quite unintelligible. I tried two sets, a two-valve H.F. and detector without reaction and an ordinary crystal set, with the same distorted results. Curiously enough, in spite of the tremendous power used at Rugby, the reception on each set was barely as strong as that from Daventry.

Atmospherics were also very bad, in fact I have never heard them so strong before on the wavelength Rugby was using, which was approximately 5,500 metres. I am unable to understand, however, how it can be possible to hear the two-way conversations, as, when listening on the two-valve set, there was always an answering voice, considerably weaker, of course, than the Rugby speaker, and also badly distorted.

Jersey.

J.C.V.

Sir,—While listening for long-wave C.W. stations the other night I was very surprised to hear telephony between two stations which was of rather bad quality in the case of one station, though quite intelligible.

It consisted of single words spoken slowly by the near station (Rugby?) and then repeated by the operator at the distant station, who seemed to be an American by his speech. Later the distant station took charge, and the near station repeated when he heard correctly. In several cases I was able to distinguish the word the first time it was spoken, while the near station asked for it to be repeated. The quality of the speech from the distant station was quite good, though the set had to be oscillating to receive it at all.

I wonder how many of your readers have heard this long-wave telephony?

Surrey.

T.F.B.

DICTIONARY OF TECHNICAL TERMS

Definitions of Terms and Expressions commonly used in Wireless Telegraphy and Telephony.

This section is being continued week by week and will form an authoritative work of reference.

Transmitter (wireless). An apparatus for the sending out through the medium of ether waves telegraphic or telephonic signals. The actual sending apparatus at a wireless sending or transmitting station.

Triode. A three-electrode valve.

Trigger Action. See VALVE RELAY.

True Power or True Watts. The actual average power in an alternating current circuit, given by the product of amperes, volts, and the *power factor*, as opposed to the *apparent power* which is given by the product of amperes and voltage. See POWER IN A.C. CIRCUITS.

Tubes of Force. See LINES OF FORCE.

Tuned Anode. A common type of *inter-valve coupling* used for connecting the successive three-electrode valves of a

of *resistance-capacity coupling*. Cf. RESISTANCE-CAPACITY COUPLING.

Tuned Circuit. An oscillatory circuit adjusted to give *resonance* at a desired wavelength. See RESONANCE.

Tuned Plate Circuit. The anode circuit or *plate circuit* of a three-electrode valve in which a tuned oscillatory circuit is included either as a *tuned anode coupling* for high-frequency amplification or to produce local oscillations for *heat reception*. On account of the capacity between the electrodes of a valve, *self-oscillation* will usually occur when the *plate circuit* is brought into tune or *resonance* with the *grid circuit* unless special precautions are taken to prevent it.

Tuned Reed Rectifier. A mechanical rectifier of low-frequency currents in which contacts are made by a reed vibrating at the same frequency as that of the alternating current to be rectified. This reed is in the nature of a flat spring and is so weighted as to have a natural period of vibration equal to that of the period of the alternating current. It is kept vibrating by the action of electro-magnets operating from the source of alternating current.

Tuner. An apparatus consisting of one or more oscillatory circuits the *natural frequency* of which can be varied over a considerable range by variation of the inductance or capacity or both simultaneously so that *resonance* can be obtained with any desired frequency or wavelength, *i.e.*, the circuit can be "tuned" to the desired frequency. In a tuner which has an inductance and a condenser in *parallel* the *impedance* offered to oscillations whose frequency is equal to the *natural frequency* of the tuned circuit is very high, whereas the impedance offered to all other frequencies is low. Thus such a circuit is capable of selecting a signal of any given wavelength to the total or partial exclusion of all others. See MULTIPLE TUNER and OSCILLATION CONSTANT.

Tungar Rectifier. A thermionic rectifier of special construction for dealing with fairly large currents. It is a *thermionic valve* with two electrodes. Used extensively for rectifying alternating currents for obtaining the *high tension* supply for valve transmitters.

Tuning. The careful adjustment of the capacity or inductance (or both simul-

taneously) of an oscillatory circuit so that *resonance* is produced with some desired frequency so as to give the greatest response to that frequency or the wavelength corresponding to it, and a minimum of response to all other frequencies or wavelengths. See RESONANCE.

Tuning Coil. See TUNING INDUCTANCE.

Tuning Condenser. The *variable condenser* used for *tuning* an oscillatory circuit.

Tuning Inductance. A variable inductance used for *tuning* an oscillatory circuit. The name is also applied to the inductance of a *tuned circuit* or *tuner* even if it has a fixed value.

Two Circuit Tuner. A receiving circuit in which there are two distinct tuned oscillatory circuits, such as that of a loose coupler in which both primary and secondary circuits are tuned to the same wavelength.

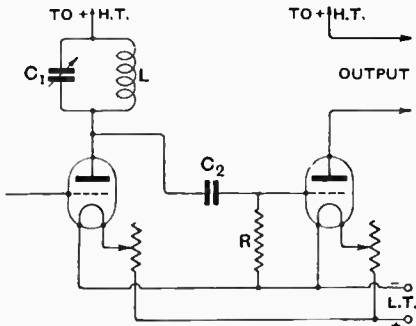

Tuned anode high-frequency valve coupling.

high-frequency amplifier in cascade. An inductance coil *L* is connected in the plate circuit of the valve whose output is to be applied to the grid circuit of the next valve in the series, and this inductance is tuned to the wavelength of the oscillations being amplified by means of a condenser *C*₁ connected in parallel with it. This tuned circuit then offers a very high *impedance* (see RESONANCE) to the desired signal oscillations and low impedance to oscillations of other frequencies just as in an ordinary tuner. Thus a comparatively large oscillating voltage is set up across the inductance or anode coil and the capacity. This oscillating voltage is transferred to the *grid* of the next valve through the medium of a *grid condenser* *C*₂ in exactly the same manner as in the case

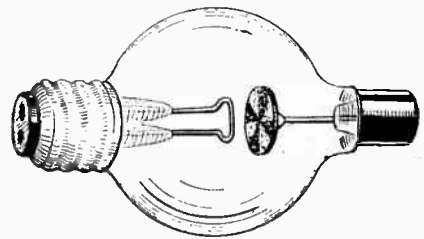

Two-electrode tungar rectifier valve.

Two-Electrode Valve. A thermionic tube having two electrodes, *i.e.*, a filament (or cathode) and a plate (or anode) such as the *Fleming valve*, *Tungar rectifier*, *etc.* Sometimes called a "diode." See THERMIONIC VALVE.

Two-Phase. An alternating current system in which there are two distinct sets of alternating currents and E.M.F.s differing in *phase* by 90°. Sometimes called "four-phase."

Two-Pole Switch. A switch which opens or closes two circuits simultaneously by the operation of a single handle, also called a "double-pole switch." It may be either one-way (single throw) or two-way (double throw), according to whether one or two pairs of alternate circuits can be brought into operation.

Two-Way Switch. One by means of which either of two circuits can be operated singly or alternately. Cf. TWO-POLE SWITCH.

Dictionary of Technical Terms.—

U.

Ultra-Magnifier. A name sometimes applied to *regenerative circuit*.

Ultra-Audion Circuit. A special type of *regenerative circuit for beat reception*.

Umbrella Aerial. An aerial with a number of wires which radiate from a central mast and slope downwards to the ground, the angular spacing between the wires being equal.

Undamped Oscillations or Undamped Waves. Oscillations or waves which continue with constant or undiminished amplitude, *i.e.*, *continuous waves*. Waves or oscillations in which the *logarithmic decrement* is zero. Compare DAMPED OSCILLATIONS.

Unidirectional Current. A current which flows in one direction only round a circuit, but is not necessarily of constant strength, *e.g.*, a *pulsating current* or an *intermittent current*. A *direct current* is a unidirectional current of constant strength.

Unilateral Conductivity. That property of some electric circuits whereby a current can only pass in one direction through it and not in the reverse direction. Such a circuit is capable of acting as a *rectifier* of alternating currents. As an example, a *thermionic valve* possesses unilateral conductivity between the plate and the filament.

Units. See ABSOLUTE UNITS.

Unit Charge. See QUANTITY OF ELECTRICITY.

Unit Pole. A magnetic *pole* of such a strength that it will exert a force of one dyne on an equal pole when the distance between them is one centimetre.

Unloaded Aerial. An aerial circuit in which no extra inductance has been added to increase the wavelength.

Untuned Aerial. Refers to a receiving circuit in which the aerial circuit is inductively coupled to the tuned oscillatory circuit, and where no special provision has been made for tuning the aerial circuit itself. Such an arrangement is very effective on short waves where it would be otherwise difficult to obtain efficient *reaction*. Sometimes called *aperiodic aerial*.

Untuned Circuit. A circuit which has no particular *natural frequency* or wavelength of its own, *i.e.*, an *aperiodic circuit*.

Upper Side Bands. See SIDE BANDS.

V.

Vacuum Tube. In general a closed glass tube or bulb containing two or more *electrodes* and from which the gas has been pumped to a low pressure so that a discharge can be passed between the electrodes in the form of a current conducted by the *ionised gas*. The term is also commonly applied to a *thermionic tube*, especially in America.

Vacuum Valve. A vacuum tube possessing *unilateral conductivity*, *i.e.*, having the properties of a *rectifier*. The name is also applied to a *thermionic valve*.

Valve. A device which only allows current to flow in one direction through it, *i.e.*, something which possesses *unilateral*

conductivity. The term is now universally applied to all *thermionic tubes*, whether used for rectification, amplification, or the production of electrical oscillations. See THERMIONIC TUBE and THREE-ELECTRODE VALVE.

Valve Adaptor. An accessory by means of which a valve of one type can be adapted to a holder meant for another type. For instance, the caps of receiving valves used in America are of a different pattern from those used in this country, and a suitable valve adaptor enables an American valve to be used on a set with standard British valve holders.

Valve Amplifier. See THERMIONIC AMPLIFIER.

Valve Detector. See THERMIONIC DETECTOR.

Valve Oscillator. See THERMIONIC OSCILLATOR.

Valve Receiver. A wireless receiver employing one or more *thermionic valves*.

Valve Relay. A *three-electrode valve* arranged in a circuit in such a manner that a signal of sufficient strength applied to the grid will cause the valve to break into continued *self-oscillation*, the resulting increase in plate current being made to operate an ordinary *electromagnetic relay*. The self-oscillation continues even after the signal ceases and has to be stopped artificially; this is conveniently done by the back-stop of the electromagnetic relay short-circuiting the *reaction coil*. A valve is put into this condition by applying a suitable steady negative potential to the grid so that the valve operates on the lower curved portion of its *static characteristic curve*.

Variable Condenser. A condenser the *capacity* of which is continuously adjustable between certain limits. This is done by having the two sets of plates movable relatively to one another. In the type where one set of semi-circular plates are rotatable between another set of semi-circular plates the change in capacity is proportional to the angle of rotation of the moving plates. Cf. SQUARE LAW CONDENSER.

Variable Inductance. See VARIOMETER.

Variocoupler. An instrument embodying two coils, one rotatable inside the other, enabling the *inductive coupling* between them to be varied between wide limits. The construction is similar to that of a *variometer*, only the connections of the windings being different.

Variometer. A variable inductance consisting of two coils or windings, one coil being mounted within the other and rotatable with respect to it. The two windings are connected in series, and when the movable coil (or rotor coil) is turned so that its axis coincides with that of the outer coil (or stator coil) the inductance will have a maximum value if the magnetic fields set up by the current in the coils are in the same direction, *i.e.*, if the two windings assist one another in producing the magnetic field. If the rotor is turned through 180°, so that the coils

oppose each other, the inductance will have a minimum value. With a good quality variometer an inductance ratio of about 10 to 1 can be obtained between maximum and minimum settings.

Vector. A vector is a straight line whose length represents the magnitude of some quantity to some convenient scale, and whose direction is parallel to the direction of that quantity, *e.g.*, a force, velocity, etc. Cf. ROTATING VECTORS.

Vector Sum and Vector Difference. The addition and subtraction of *vectors*. To add two vectors OA and OB, complete the parallelogram OACB. Then the diagonal OC is the vector sum of OA and OB. The other diagonal,

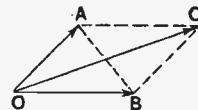

Resultant OC of two vectors OA and OB.

AB, is the vector difference of OA and OB. In adding or subtracting alternating currents or voltages the operation must be done by vectors in this manner, the angle of *phase difference* being taken into account. The diagonal gives the resultant not only in magnitude, but in the correct phase relation.

Velocity of Propagation (of ether waves). Electric waves are propagated through the ether with the same velocity as light, *i.e.*, about 186,000 miles per second, or 3×10^{10} cms. per second.

Vernier Condenser. The name given to a variable condenser of small capacity when used in parallel with a condenser of larger capacity in order to get fine

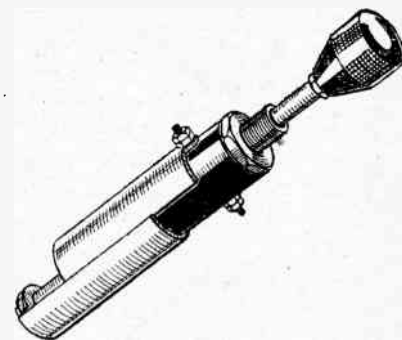

Vernier condenser.

adjustments. Some variable condensers of normal capacity value have a "vernier" arrangement embodied in them; one of the movable vanes or plates is capable of being rotated independently of the rest by means of a small knob on the top of the main control knob.

Virtual Value. Another name for the *effective value* or *root-mean-square value* of an alternating current, voltage, etc.

is fitted certain relay apparatus is caused to operate which switches on the valve filaments, it being necessary, of course, that the receiver be left tuned to the local or high-powered station as the case may be. Upon conclusion of the programme and cessation of the carrier wave the receiver is once more switched off by the relay apparatus. It should not be forgotten that the device will operate at all times, as, for instance, if the local station comes "on the air" at an unusual time for testing purposes, or to make an urgent announcement in any unforeseen emergency.

o o o o

Push-Pull Amplifier.

Being interested in the push-pull method of amplification, I wish to incorporate the system in a new receiver which I am constructing, but as I have a number of spare interval transformers and L.F. chokes, I should like to use them if possible without incurring the expense of purchasing the special input and output transformers customarily used. If therefore this is at all possible, I should be pleased if you could give me a wiring diagram. G.P.K.

It is by no means necessary to go to the expense of obtaining special transformers. Providing that you have two ordinary interval transformers and two L.F. chokes, or alternatively, four

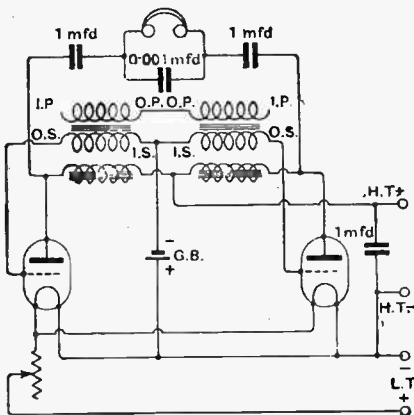

Fig. 2.—Push-pull amplifier, with ordinary L.F. transformers and chokes

interval transformers, you can construct a very efficient push-pull amplifier by following the diagram of connections given in Fig. 2, which is, as you will see, quite straightforward. The transformers and L.F. chokes are of the ordinary type. If you have four transformers you should use two for the input in accordance with the diagram, whilst the second two should have their primaries and secondaries joined in series, so that they form L.F. chokes, and then the circuit will be exactly as given. This arrangement may be used immediately after a detector valve, or may be preceded by an ordinary stage of L.F. amplification, which may be transformer, choke, or resistance coupled.

BOOKS ON THE WIRELESS VALVE

Issued in conjunction with "The Wireless World."

"WIRELESS TELEPHONY," by R. D. BANGAY. Price 2/6 net. By Post, 2/9.

"THE OSCILLATION VALVE—THE ELEMENTARY PRINCIPLES OF ITS APPLICATION TO WIRELESS TELEGRAPHY," by R. D. BANGAY. Price 6/- net. By Post, 6/3.

"WIRELESS VALVE RECEIVERS AND CIRCUITS IN PRINCIPLE AND PRACTICE," by R. D. BANGAY and N. ASHBRIDGE, B.Sc. Price 2/6 net. By Post, 2/10.

"THE THERMIONIC VALVE AND ITS DEVELOPMENT IN RADIO TELEGRAPHY AND TELEPHONY," by Dr. J. A. FLEMING. Price 15/- net. By Post, 15/9.

"CONTINUOUS WAVE WIRELESS TELEGRAPHY," Part 1, by W. H. ECCLES, C.Sc. Price 25/- net. By Post, 25/9.

Obtainable by post (remittance with order) from **ILIFFE & SONS LIMITED** Dorset House, Tudor St., London, E.C.4 or of Booksellers and Bookstalls

What is the Most Sensitive Receiver?

In perusing foreign radio journals, especially American publications, one gains a great impression of the extraordinary sensitivity of the 2-v-2 neutrodyne receiver, apparently almost universally used in that great country. Now I have frequently read in The Wireless World and other periodicals that two well-constructed H.F. stages are approximately equal to regeneration, from the point of view of sensitivity. The neutrodyne system merely serves to stabilise a receiver and does not itself add sensitivity to a receiver. Logic would therefore tell us that our customary 0-v-2 regenerative receivers are equal in sensitivity to the American five-valve neutrolynes which abjure reaction, and that our 1-v-2 receivers, which are nearly always regenerative, should surpass them. A criticism of my argument would be greatly appreciated. P.T.R.

Your argument, which is very interesting, is also fundamentally correct, but at the same time this does not alter the fact that, both from a theoretical point of view and on practical test, a well-constructed 2-v-2 neutrodyne receiver without reaction is a far better receiver than either the 0-v-2 or 1-v-2, both employing reaction which are favoured by the average amateur in this country. In the first place, let it be said that if H.F. transformers are correctly designed and constructed with a view to the valves with which they are to be associated, then a 2-v-2 receiver will probably be at least equal to, and probably superior to, the average 0-v-2 regenerative receiver from the point of view of sensitivity, whilst from the point of view of selectivity, stability, and ease of control the conventional regenerative receiver is an "also ran." With regard to the popular tuned anode receiver, as it usually is, in conjunction with a valve chosen with a view to minimum filament consumption rather than of suitability of character-

istics, it is a debatable matter whether any useful purpose is served at all by the H.F. stage. In connection with this you are advised to read the conclusions drawn on page 155 of the February 3rd issue of this journal. There is, however, no harm whatever in attempting to increase selectivity and sensitivity by using reaction as well as H.F. amplification in a neutrodyne receiver. Unfortunately, however, the customary swinging coil method of reaction has a great effect on the tuning of the circuit to which it is applied, and this negatives any attempt at calibration, and it is well, therefore, to attempt to find some method of applying reaction which avoids this evil. This can be done quite successfully, the result being a highly sensitive and selective receiver employing neutralised H.F. amplification and smooth non-interfering reaction control such as is described on page 154 of the issue of *The Wireless World* to which we have previously referred.

o o o o

The Flewelling Super-regenerative Receiver.

I wish to experiment with the Flewelling single valve circuit, as I understand that enormous ranges are possible with this arrangement. P.R.D.

We illustrate this circuit in Fig. 3. Whilst, of course, long distance results are possible with this receiver under certain conditions, it must not be thought that this receiver is one which is constant and reliable, as in the case of any

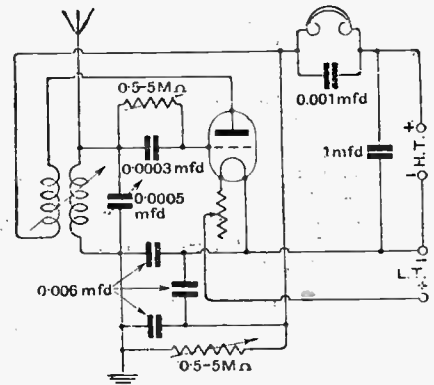

Fig. 3.—The Flewelling super-regenerative circuit.

ordinary circuit such as the Reinartz circuit, or the conventional regenerative receiver. In common with all super-regenerative circuits, this arrangement will be found unstable and "fickle," and it is almost impossible to give any definite data for operation. It is certainly a very interesting circuit for the experimenter, and as such it possesses great potentialities, but it is not to be recommended to the man who is desirous of listening to distant broadcasting stations with a minimum of trouble and expenditure. If desired the aerial tuning system may be substituted by a frame aerial and, indeed, this is advisable in the interest of one's neighbours, as the circuit is a very virile radiator.

Constructors!



WHEN you are making that new set or adding that extra valve, be sure to use **T.M.C. LOW CAPACITY KEYS** for your switching arrangements.

With these well designed, efficient keys you can put into practice innumerable switching combinations.

They can be mounted on a panel of any material because all the live parts are effectively insulated from the frame.

They are positive in action. There are no rubbing parts to wear out. The contacts of "gold-silver" alloy are lifted apart by a small but rapid movement of an ebonite roller. The switch cannot spring back, once it is set. The ends of the contact springs are tinned to facilitate soldering.

Because of their very low self-capacity, they can be used for High Frequency as well as Low Frequency switching.

They are neat in appearance. Visible parts are of polished and lacquered brass, or, if desired, bright nickel plate.

TMC Low Capacity Keys

Made in three models.

No. 1.	12 point, 3 position	7/-
No. 2.	6 point, 2 position	6/-
No. 3.	24 point, 3 position	15/6

Other T.M.C. Lines.

Concert Loud Speaker	£5 10 0	Crystal Set No. 2a (From)	£1 17 6
Standard Speaker	5 0 0	Crystal Set No. 8	2 7 6
Junior Loud Speaker	2 10 0	Four-Valve Set No. 4b	21 0 0
Lightweight Headphones	1 2 6	(Plus Marconi Tax)	2 10 0
Major Headphones	1 5 0	Two-Valve Set No. 7b	12 0 0
Minor Loud Speaker	1 1 0	(Plus Marconi Tax)	1 5 0
Crystal Set No. 9	12 6		

WRITE FOR FREE CATALOGUE.

TELEPHONE MANUFACTURING CO., LTD., Hollingsworth Works, West Dulwich, S.E.21.

Phone: Sydenham 21601r.



1ST AND 2ND STAGE

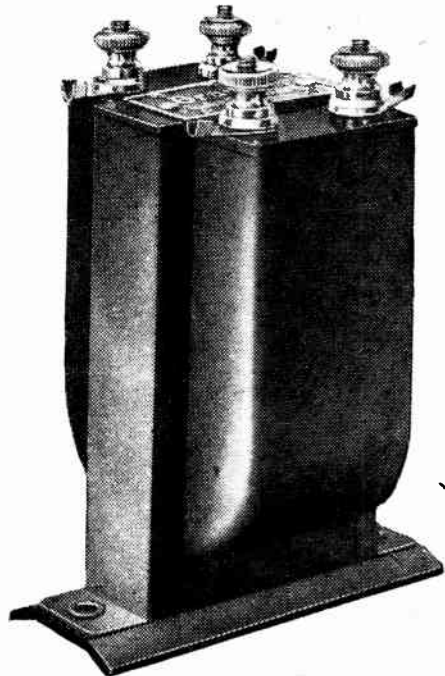

THE AUDIO TRANSFORMER

Are you building? Do you want more power without choking the purity of those smooth, level tones? The Brandes 1st stage Transformer has a high voltage amplification ratio of 1-5. This, together with a straight line amplification curve, means that the amplification is constant over a wide band of frequencies, thus eliminating resonance. The 1-3 Transformer amplifies over speech, pianoforte and harmonic ranges equally well. Mechanically protected and shielded against interaction. Terminals and outside soldering tags.

17/6

Ratio 1-5 (black finish).

Ratio 1-3 (brown finish).

Table-Talker 30/- Brandola 90/- Matched Tone Headphones, 20/-

Brandes

BRANDES LIMITED, 296, REGENT ST., LONDON, W.1

from any good Dealer.

£10 Weekly in Cash Prizes



A New and Simple Competition
for all Readers of "The Wireless World"

To be continued weekly until further notice.

HIDDEN ADVERTISEMENTS

Below will be found six reproductions of fragments cut from the Advertisement pages of this issue of "The Wireless World." Each fragment is a clue. Can you from these clues identify the Advertisements? Seven cash prizes will be awarded to the first seven readers who send us correct solutions. No technical skill is required, merely observation. There are no restrictions or entry fees and the conditions are simple.

£5
for the first
correct solution
opened.

h	
1	2
KXII	to a minute
3	4
W	
5	6

£1
for the third
correct solution
opened.

and
4
consolation
prizes of
10/-
Each
for the next four
correct solutions
opened.

£2
for the second
correct solution
opened.

CONDITIONS

1. All solutions must be written on the special coupon appearing on an advertisement page in this issue and addressed to *The Wireless World*, Dorset House, Tudor Street, London, E.C.4, and marked "Hidden Adverts." in bottom left corner.
2. Clues will not, of necessity, appear in the same way as in the advertisement page, but may be inverted or placed in some other position.
3. In order that town and country readers may compete on equal terms, solutions will not be dealt with until 10 a.m. on Monday next. All solutions received before that date will be retained until Monday morning. Competitors may submit any

- number of entries. Erasures or alterations on a coupon will disqualify the entry.
4. The first prize of £5 will be awarded for the first correct solution opened; the second prize of £2 to the next correct solution; the third prize of £1 for the third, and four consolation prizes of 10/- each for the next four correct answers. In the event of no readers sending correct solutions the prizes will be awarded to the competitors whose solutions are most nearly correct.
5. The decision of the Advertisement Manager of *The Wireless World* is final, and no correspondence can be entered into. Competitors enter on this distinct understanding. No member of the staff of the paper is permitted to compete.

Cabinets FOR HOME CONSTRUCTORS

All Cabinets are made of Seasoned Oak in antique or light finish as required - Cabinets for "The Wireless World" sets a speciality.

Panel Size:

18" x 7" 21" x 7" 24" x 7"
17/- 17/6 19/6

Cash with order. Carr. Paid.

Write for Price Lists.

W. SANDERS, 35, Lyndon Road, Olton, Warwickshire.



8 1/2" x 8 1/2" inside measurement.
SOLID OAK. GRAIN FILLED.

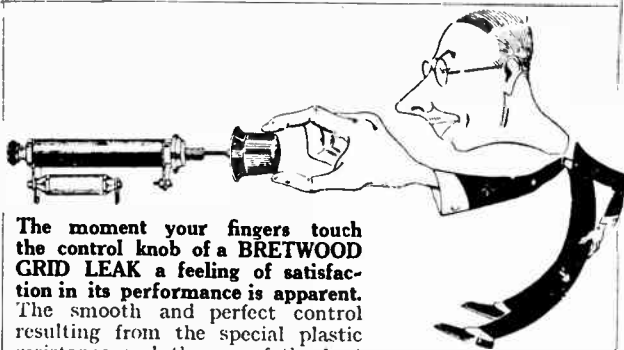

The moment your fingers touch the control knob of a BRETWOOD GRID LEAK a feeling of satisfaction in its performance is apparent. The smooth and perfect control resulting from the special plastic resistance and the use of the best quality materials only in their construction enable us to guarantee them for three years.

The Bretwood Grid Leak gives accurate readings consistently from 50,000 ohms to over 10 megohms.

Bretwood Grid Leaks have been used in several sets described in "Radio Press" publications. See page 469 of March issue of "The Wireless Constructor."

The Bretwood Variable Grid Leak and Anode Resistance

(Patent No. 224295)

GRID LEAK OR ANODE RESISTANCE With Condenser (as illustrated) 4/-. Postage 3d. **3/-**

BRETWOOD LTD. 12-18, London Mews, Maple St., London, W.1.

"BRETWOOD" COMPONENTS are guaranteed for three years.

They include:

THE "BRETWOOD" FILAMENT RESISTA.CE. Price 3/6. Postage 3d.

THE "BRETWOOD" ANTI-CAPACITY VAL. E HOLDER. Price 1/8. Postage 3d.

THE "BRETWOOD" ANTI-CAPACITY SWITCH. Price 5/-. Postage 3d.

WIRELESS VALVE TRANSMITTERS

The Design and Operation of Small Power Apparatus.

Obtainable from Booksellers or direct from the Publishers,

Price 9/- net. By post, 9/9.

ILIFFE & SONS LTD., Dorset House, Tudor Street, LONDON, E.C.4.

No More Short Circuits if you use a "CAN'TCROSS" CONNECTOR

(Patent Applied for.) Consists of a Plug element for fitting to the panel, to replace the usual H.T. and L.T. terminals. The Socket element corresponds to the Plug element, and is arranged to receive the necessary leads from the respective batteries.

BURNT-OUT VALVES IMPOSSIBLE. ACTS AS A DISCONNECTING SWITCH. EASILY FITTED TO ANY SET.

3 Terminal, 5/- each, 5 Terminal, 8/- each, 7 Terminal, 7/- each. (Leads not included).

Adaptable to all Circuits. Example Wired as follows: 1. H.T. 1. 2. H.T. 2. 3. H.T. 3. 4. H.T. 4. 5. P. + 6. L.T. Post Free on receipt of Postal Order and Dealer's Name from **J. & W. BARTON, 22a, Virginia Street, SOUTHPORT.**



All Post Free At Callers Prices

Orders 5/6 value, carriage paid.

Under 5/6, 2d. per 1/- for packing, etc.

Ebonite Panels.

Matt.	1"	3/10"
9" x 6"	2/2	1/10
12" x 9"	4/6	3/9
12" x 12"	5/9	5/-
15" x 9"	5/6	4/9
15" x 12"	7/6	5/8
4" x 4"	8d.	6d.
7" x 6"	1/8	1/2
9" x 6" x 1"		10d.

Any size cut. Sq. in 1". 1d., 1". 1d. NO ADVANCE.



Square Law Var. Condensers. with knob and Dial. 001 panel type... 6/6. 005 .. 5/- 0083 .. 4/6 Vernier Bladeextra 1/4 "J.B." "Ormond" & "Utility" usual prices. Vernier, no dial 2/6 6 vane, 5/3; 7 3/6 Polar type 10/6 NO EQUAL.

SEND FOR NEW FREE Comprehensive Price List. TRADE ENQUIRIES INVITED! Generous Terms Prompt Service.

Aerial Wire 7/23 Enamelled. Bright 100' 3/3
.. Electron 1/8
.. Mara 9/6
Lead-in 4d. yd.

Insulators.
Shell, 2 1/2" x 2 1/2" 3d.
Crystal Bowl .. 1/-
.. Lead-in .. 4/-
4" & 6" .. 9d.
9" 1/- 12" & 16" 1/3

Valve Holders.
Type A 7d., Polar 1/8
Screwed 8 nuts .. 2/3
Ebonite .. 10d.
Antiphonic .. 1/6
Security type 1/-
Baseboard type.. 6d.

Condensers.
Dublier, McMichael's, Mulard (Usual Edison-Bell prices)
New Mansbridge, 2 mtd., 3/6, 1 mtd. 2/6

Coil Holders.
Igranite 3 Set .. 8/6
Ebonite 3 Coil .. 3/-
.. 2 Coil 2/6
Vernier 2 Coil 3/9
Anode Holder 8d.



VERNIER COIL HOLDER.

Polished ebonite. 2-coil type with plated fittings. Panel mounting type with back connections. Extended handle with rubber contact roller gives exceptionally fine tuning, a splendid example of Reliability value.

ONLY 3/6

All 'Igranite', 'Lissen', 'Burndep', 'Edison-Bell', 'Atlas' & 'Sterling' goods supplied.

New Edition RELIABILITY WIRELESS GUIDE, No. 2 Ready. Have you got one? IT'S FREE.

Transformers L.F. Radio Inst. (new) 25/- Silvertown .. 21/- Igranite 21/- & 20/- Burndep (new) 24/- Eureka No. 2 .. 21/- Concert Grand 25/- Baby Grand 15/- Ferranti A.F.4 17/6 Tangent 22/6 & 14/6 Royal 4E-1, 3-1 20/- H.F. Tangent .. 5/6 McMichael's .. 10/- Ooiah 900 metres 5/6

File Resistances. Good quality .. 1/8 Igranite .. 3/6 Vernier type .. 5/6 Ormond 2/-, Alax 4/- .. Vernier No 4 2/6 Burndep 5/-, 6/- & 7/6 Microstat .. 2/6 Peerless Jr. .. 2/6

Headphones. 4,000 ohms. Brown's "E.T.H.", Siemens, Brander, G. & Co. Radio, Clarifone 20/- Erlsson and Sterling .. 22/6 Handphone .. 5/- Air weight .. 9/- .. Adjustable 10/6

J.H. TAYLOR & Co. 2 RADIO HOUSE, MACAULAY ST., HUDDERSFIELD. Tel 591 Grams: THOROUGH HUDDERSFIELD

EBONITE OF THE FINEST QUALITY

SHEETS RODS & TUBES.

PANELS CUT ANY SIZE AND ANY THICKNESS.

Awarded Silver Medal for Ebonite, Crystal Palace Electrical Exhibition, 1892.

Egg Shell Matt or Polished Surface.

LARGE STOCKS. IMMEDIATE DELIVERY.

BRITKAM-EBONITE (Britannia Rubber & Kamptulicon Co. Ltd.) 7, NEWGATE STREET, LONDON, E.C.1.

Telephone: Central 2165 (2 lines).

Telegrams: Britannia, London.



This
BOWYER-LOWE
LOW-LOSS
CONDENSER
for 10/-

If the Bowyer-Lowe Popular Condenser does not give you thoroughly good service for twelve months after purchase, it will be exchanged free.

•0003 M.F.
10/-
 •0005 M.F.
10/6

Such a guarantee could only be given with an instrument whose efficiency is beyond question. Try this condenser in your sets. No better instrument has ever been produced at the price.

Ball bearing control, compensated square law tuning and low loss design are the three characteristics through which it gives you rich, pure, undistorted signals and a surprisingly great wavelength range.

Ample supplies are ready. Order direct if your dealer cannot deliver from stock.

The Bowyer-Lowe
"POPULAR" CONDENSER

BALL BEARING-LOW LOSS-SQUARE LAW

Bowyer-Lowe Co. Ltd., Letchworth

Your Loudspeaker

WILL SING

THE PRAISES OF

NELSON MULTI
3-FILAMENT VALVES



Here is a Valve giving you Finest Quality and Volume with Economy. It is of equally high grade as H.F., Detector, L.F., or Power Amplifier.

The little switch places at your command each of 3 Filaments separately, or any 2 in parallel for Power Amplification. Each Filament gives the Valve a New Life.

ALL VALVES are Guaranteed.

FOUR IMPROVED TYPES.

- Obtainable at All London & Large Stores.
- A. 4 to 5 VOLTS, 0.45 AMPS. per Filament - 9/6
- D.E.A. 2.6 VOLTS, 0.18 AMPS. per Filament - 15/-
- D.E.2. 1.8 to 2 VOLTS, 0.35 AMPS. per Filament - 15/-
- D.E.03. 3 VOLTS, 0.06 AMPS. per Filament - 16/6

If unable to obtain from your dealer, write direct to:-

NELSON ELECTRIC COMPANY LIMITED,
Merton Park, London, S.W.19.

Telephone: Valence, Wembley, London. Telephone: Wembley 172.

REFLEX
FOR BETTER RECEPTION

Best for
 your Set.



REFLEX
Coil Plug.

Why it is better: Made of real "bakelite." Skeleton design reduces losses to almost nil. Connections made underneath coil. Tapered holes for taking twice, also special lip to facilitate mounting. Demand REFLEX. Pack of 1/- in separate coil.

1/-

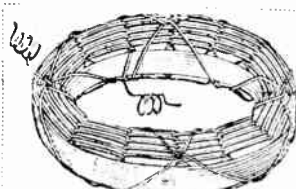

REFLEX Unmounted COILS.

REFLEX is the ideal low-loss coil—entirely free from capacity-causing gadgets. Quite self-supporting through special winding that also gives scientific air spaces. These and other features explain why listeners do get better results with REFLEX. Buy a REFLEX to-day. From No. 25 at **8d.**, to No. 1500 at **12/-**. Also 5 XX Loading Coil **1/6d.**

Ask your dealer to show the
NEW REFLEX COIL MOUNTED!

A highly efficient product at very low prices.

REFLEX RADIO CO., LTD.,

198, Lower Clapton Rd., London, E.5. Phone: Clissold 4852.

The Wireless World **COUPON**
 and Radio Review for

"HIDDEN ADVT." COMPETITION

This coupon is available until Monday, 10 a.m., March 8th, 1926

Clue No.	Name of Advertiser.	Page
1		
2		
3		
4		
5		
6		

I enter the above solution subject to the published rules.

Name _____
 (Please write clearly)

Address _____
 3 3/26

MISCELLANEOUS ADVERTISEMENTS.

NOTICES.

THE CHARGE FOR ADVERTISEMENTS in these columns is:

12 words or less, 1/- and 1d. for every additional word, e.g., 18 words 1/6; 24 words, 2/- Name and address must be counted.

SERIES DISCOUNTS are allowed to Trade Advertisers as follows on orders for consecutive insertions, provided a contract is placed in advance, and in the absence of fresh instructions the entire "copy" is repeated from the previous issue: 13 consecutive insertions, 5%; 28 consecutive, 10%; 52 consecutive, 15%.

ADVERTISEMENTS for these columns are accepted up to **FIRST POST** on **THURSDAY MORNING** (previous to date of issue) at the Head Offices of "The Wireless World," Dorset House, Tudor Street, London, E.C.4, or on **WEDNESDAY MORNING** at the Branch Offices, 19, Hertford Street, Coventry; Guildhall Buildings, Navigation Street, Birmingham; 199, Deansgate, Manchester.

Advertisements that arrive too late for a particular issue will automatically be inserted in the following issue unless accompanied by instructions to the contrary. All advertisements in this section must be strictly prepaid.

Postal Orders and Cheques sent in payment for advertisements should be made **& Co.** payable to **ILIFFE & SONS Ltd.**, and crossed **Treasury Notes**, being untraceable if lost in transit, should not be sent as remittances.

All letters relating to advertisements should quote the number which is printed at the end of each advertisement, and the date of the issue in which it appeared.

The proprietors are not responsible for clerical or printers' errors, although every care is taken to avoid mistakes.

NUMBERED ADDRESSES.

For the convenience of advertisers, letters may be addressed to numbers at "The Wireless World" Office. When this is desired, the sum of 6d. to defray the cost of registration and to cover postage on replies must be added to the advertisement charge, which must include the words Box 000, c/o "The Wireless World." Only the number will appear in the advertisement. All replies should be addressed No. 000, c/o "The Wireless World," Dorset House, Tudor Street, London, E.C.4. *Readers who reply to Box No. advertisements are warned against sending remittance through the post except in registered envelopes; in all such cases the use of the Deposit System is recommended, and the envelope should be clearly marked "Deposit Department."*

DEPOSIT SYSTEM.

Readers who hesitate to send money to unknown persons may deal in perfect safety by availing themselves of our Deposit System. If the money be deposited with "The Wireless World," both parties are advised of its receipt.

The time allowed for decision is three days, during which time, if the buyer decides not to retain the goods, they must be returned to the sender. If a sale is effected we remit the amount to the seller, but, if not, we return the amount to the depositor. Carriage is paid by the buyer, but in the event of no sale, and subject to there being no different arrangement between buyer and seller, each pays carriage one way. The seller takes the risk of loss or damage in transit, for which we take no responsibility. For all transactions up to £10, a deposit fee of 1/- is charged; on transactions over £10 and under £50, the fee is 2/6; over £50, 5/-. All deposit matters are dealt with at Dorset House, Tudor Street, London, E.C.4, and cheques and money orders should be made payable to Iliffe & Sons Limited.

THE SALE OF HOME-CONSTRUCTED UNLICENSED APPARATUS.

A New Service to our Readers.

We have made an arrangement with the Patentees whereby readers who wish to dispose of a home-constructed receiver not licensed under the patents made use of, can do so by means of the Deposit System referred to above.

The person desiring to sell, in sending us particulars for his advertisement, will in every case make use of a Box No., and should add to the price which he requires the amount of royalty customarily paid by manufacturers, viz. in the case of Marconi Patents the amount should be calculated at 12/6 per valve holder.

If the purchaser is satisfied with his purchase, the sum realised will be forwarded to the seller, less the amount due in respect of royalties, which amount will be paid by "The Wireless World" to the owners of the patents concerned, and a certificate will be handed on to the purchaser of the set.

FOR SALE.

TELEPHONES.—Pair Brown's A type, 2,000 ohms; pair 120 ohms, ditto; offers. 2 Lissen-T1 L.F. transformers, 15s. each. All perfect.—14, Brook Avenue, Wembley. (1831)

3-VALVE Portable Set, 1 Det., 2 L.F., with 3 D.E.R. valves, good order, 300-3,000 λ ; £9.—Box 6952, WIRELESS WORLD Office. (1828)

For Sale.—Contd.

CRYSTAL Amplifiers increase range five times. Price, complete, 25s. Oscillating zincite 1s. 6d. Original circuit 1s. All parts stocked.—Particulars: Ledsham's, 297, King Street, Hammersmith. (1817)

GENERATOR, 600 volts, Marconi, new, hand or power driven, motor $\frac{1}{2}$ A.C., 220 to 250 volts, or D.C. 220 to 250 volts, £8; var. condenser £1; Microphone 7s. 6d.; Microphone transformer 7s. 6d.; transmitting valves, 25 watts, 15s. each; accumulator, Exide, new, 180 amps., 6 volts., £2 15s.; offers accepted.—2XO, 13, Elgin Avenue, London, W.9. (1827)

500 to 2,500 Electrostatic Voltmeter, exchange for Milliampmeter or high-resistance moving coil voltmeter.—Lottimer, The Croft, Newton Mearns, Renfrewshire, N.B. (1820)

4-VALVE "Wireless Equipment" Receiver; "Sparta" loud-speaker, 300-3,000 metres; particulars, offers.—Robertson, 1, New Square, Cambridge. (1825)

FOR SALE.—4-valve Set, bargain, complete with Brown loud-speaker, batteries, phones, 250 coil.—Box 6898, WIRELESS WORLD Office. (1824)

H.T. Motor Generator, belt drive, 200v., A.C. Crypto, 600v., 100 ma., £12; Mark III. tuner, polished case, complete, £4; both as new, seen by appointment.—Box 6966, WIRELESS WORLD Office. (1833)

5-VALVE "R.A.F.10" Receiving Set, 5 D.E. Osram "C" valves, telephones, remote control tuner and rheostat, brand new, perfect, £6; also 2 Gambrell neodyne condensers, 0s. 1., 0003 Ormonde condenser and 2,000s, the lot 15s.—Loch, 14, Freeland Road, Ealing W.5. (1840)

FOR SALE.—Anglo-American 6 Set, with 3 sets McMichael H.F. transformers, good as new, two-thirds cost.—Box 7038, WIRELESS WORLD Office. (1830)

PETRO-SCOTT 5-valve Unit Set (2 H.F., 1 Det., L.F., and Power L.F.), £5.—14, Manor Place, Hackney, E.8. (1838)

SUPER Het Transformers, 3 I.F., Input, Oscillation Coupler, perfect order. Range 150 to 650 metres. £4 the set. Cost over £5.—Box 7000, WIRELESS WORLD Office. (1835)

2-VALVE Det. and L.F. with coils, 37s. 6d., plus Royalties.—Box 7043, WIRELESS WORLD Office. (1842)

McMICHAEL Transformers, 0, 1, 2, 3, 4, two each, matched, perfect, 5s. 6d., or separate.—Taylor, Builder, Rochdale. (1845)

FELLOPHONE Super Three and Amplifier Instruments only.—Apply: Bolton, Rossett Hall, Wrexham. (1847)

WHAT Offers?—1 Magnavox speaker, 1 Magnavox 3-valve set, cost £25; 1 4-valve Polar, sloping cabinet, cost £31 5s.; 1 3-valve Polar, American cabinet, cost £20; 1 Brown microphone amplifier cabinet, cost £5 13s. 6d.—Lawson, Peel Square, Barnsley. (1837)

THREE R.I. Super-Het transformers, new, two months ago, £2 10s.—Crabtree, 77, Reed Street, Burnley, Lancs. (1846)

PATENT AGENTS.

W. BRYSON, B.Sc., Chartered Patent Agent, 29, Southampton Buildings, W.C.2. Phone: Holborn 672. (1297)

MISCELLANEOUS.

FREE.—Home Constructors' Catalogue. —Stamp: Garner, Everything Wireless, 31, Little Britain, E.C.1. (1830)

SECOND-HAND Apparatus taken in part-purchase of new ones. Leading lines supplied.—Wharton, 9, Victoria Street, Westminster. (1412)

CHARGE Your Own Accumulator.—Send 3d. stamp to-day for lists of our small gas and petrol engines and dynamos, and complete charging sets, from 20 to 160 watts.—Tom Senior, Cleckheaton, Yorks. (0013)

REPAIRS.

TRANSFORMER Repairs.—Rewound to original efficiency and guaranteed 12 months. 4s., post free. Phones 3s. 6d. Trade supplied.—Transform, 70a, Longley Road, Tooting. (0011)

WANTED.

WANTED.—Someone to help a poor district in East London by giving a Wireless Receiver and Loud-speaker for a hall; portions of apparatus very acceptable; and contributions for the same.—Rev. J. Ough, Vicar of St. Jude's, Bethnal Green, E.2. (1848)

SITUATION WANTED.

WIRELESS Expert.—3 years' experience and study; competent in designs, circuits, theory, practice.—Box 6957, WIRELESS WORLD Office. (1832)

GENTLEMAN (41), 4 years A.M.I.R.E., desires responsible position with wireless firm; good organiser and salesman.—Box 6997, WIRELESS WORLD Office. (1834)

QUALIFIED Ship Operator; experienced designing, manufacturing radio apparatus, works and sales managing; keen, energetic; 25; any capacity except traveller; home or abroad.—Box 7008, WIRELESS WORLD Office. (1836)

WIRELESS Operator (24), trained motor driver, wants position Driver-salesman; London.—Box 7049, WIRELESS WORLD Office. (1843)

ADVERTISER (30), 12 years' radio experience, all branches, knowledge languages, accustomed writing technical articles, requires responsible position.—Box 7044, WIRELESS WORLD Office. (1841)

RADIO Engineer seeks post; good knowledge of modern theory and practice; experience of demonstrations, testing, and repair work; correspondence.—Box 7050, WIRELESS WORLD Office. (1844)

BOOKS.

BACK Numbers of all Wireless Publications. —Fangs, Ltd., 11, Tavistock Square, W.C.1. (1829)

WIRELESS becomes much more interesting when you are able to read Morse. Now is your opportunity to acquire a knowledge of the Morse Code.

PERRY'S AUTO-TIME MORSE SYSTEM, Price 6d. net, By post 7d., provides a ready means of becoming proficient in Morse reception.

Published by the Offices of "The Wireless World," Dorset House, Tudor Street, London, E.C.4

TUNING COILS

and

METHODS of TUNING

By W. JAMES.



A VERY useful manual giving the maximum of information on the subject. Following a simple explanation of the principles of wireless, the author discusses the many methods of tuning circuits, with explanations of spade, condenser and variometer tuning. Other chapters treat in detail of the choice, construction and design of coils, and give particulars as to size of coil required, the best shape, size of wire, type of insulation, and special uses of the various coils.

PRICE 2/6 NET
By Post 2/10

Obtainable from all booksellers or direct from the Publishers:

ILIFFE & SONS LTD.,
Dorset House, Tudor Street,
LONDON, E.C.4. W.W.32



Here's an opportunity for you to try out the PUREMAX Loud Speaker—the marvel of present-day manufacture

SPECIAL TRIAL OFFER

If your dealer is out of stock, post us 70/- with his name and we will send you a PUREMAX by return post free. If in one week you're not perfectly delighted, return it and we will refund your money in full, plus postage.

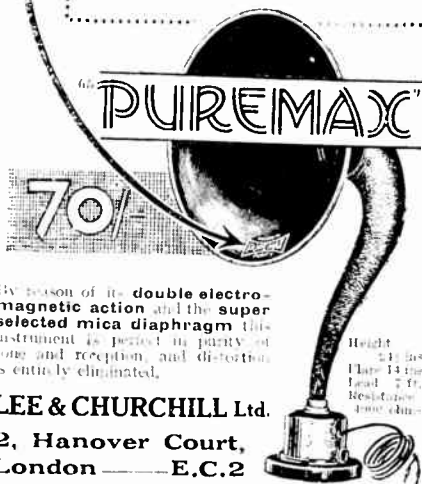

By reason of its double electro-magnetic action and the super selected mica diaphragm this instrument is perfect in purity of tone and reception, and distortion is entirely eliminated.

Height 24 ins.
Plate 14 ins.
Lead 7 ft.
Resistance 400 ohms.

LEE & CHURCHILL Ltd.
2, Hanover Court,
London — E.C.2

PATENTS, DESIGNS AND TRADE MARKS.

J. S. Withers & Spooner.

CHARTERED PATENT AGENTS.

STABLE HOUSE,
11 & 62, CHANCERY LANE,
LONDON, W.C.2.

CRAMPTON — TEMPORARILY,
HOLBORN, LONDON, W.C.1.
TELEPHONE — 480 HOLLERON

06 DE'S 10/6

Our Valves are admitted to be the best British valve valves on the market. 3 Volt 00 L.F. or H.F. only 10/6. 2 Volt 34 only 10/6. Power Valves from 12/6. Write at once for our FREE BOOK and get full particulars. If your dealer is "tied" we supply direct. RADION LTD. Radiion Works, BOLLINGTON, Macclesfield, England.

RADION
Reliable Valves

Absorbs shock—Protects your valves

You know it's good — because of the name LOTUS.

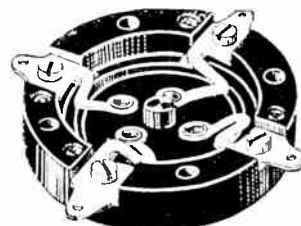

UNDERSIDE SHOWING SPRINGS.

Don't have your valves spoiled by shock. The Lotus Valve Holder has been specially designed to counteract the microphonic elements that are so injurious to the delicate valve filaments.

The unique and original springs of the Lotus Valve Holder absorb any shock and eliminate all microphonic noises.

Protect YOUR Valves by fitting the Lotus Holder.

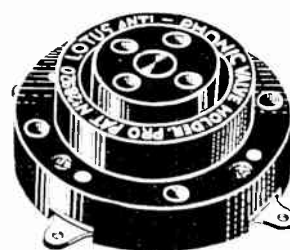

TOP VIEW.

Valve sockets and springs are locked together by a mechanical process making a definite and permanent connection. Bakelite mouldings, nickel silver springs and phosphor bronze valve sockets. Nickel-plated.

LOTUS

VALVE HOLDER

GARNETT, WHITELEY & CO., LTD.,
Lotus Works,
Broadgreen Road, Liverpool.

Makers of the famous Lotus Buoyancy Valve Holder.

2/3

With Terminals 2/6

INDEX TO ADVERTISEMENTS.

	PAGE		PAGE		PAGE
Accumulators Elite	20	Finston Manf. Co., Ltd.	16	Nelson Electric Co., Ltd.	17
Barton, J. & W.	15	Fitzpatrick, H. D. & Co.	20	Ormond Engineering Co.	5
Bowyer-Lowe Co., Ltd.	17	Fuller's United Electric Works, Ltd.		Partridge & Wilson	16
Brandes, Ltd.	13	Gambrell Bros., Ltd.	12	Pugh Bros.	20
Bretwood, Ltd.	15	Garnett, Whiteley & Co., Ltd.	20	Radio Communication Co., Ltd.	
Britannia Rubber & Kamptulion Co., Ltd.		General Electric Co., Ltd., The		Radio Instruments, Ltd.	7
British Electrical Sales Organisation	2	General Radio Co., Ltd.	16	Radios, Ltd.	19 & 20
British Glowlamp & Valve Co.	16	Graham, Alfred, & Co.	Cover ii.	Relax Radio	17
British L.M. Ericsson Manf. Co., Ltd.	16	Igranie Electric Co., Ltd.	Cover iv.	Robinson, K. A.	20
Burdopt Wireless, Ltd.	6	Jones & Stewart		Sanders, W.	15
Cahill & Co., Ltd.	4	Lamplugh, S. A., Ltd.		Silvertown Co., The	3
Caxton Wood Turnery Co.	4	Lee & Churchill, Ltd.	19	Stevens, A. J., & Co. (1914), Ltd.	9
Chloride Electrical Storage Co., Ltd., The		Lissen, Ltd.	8	Stratton & Co., Ltd.	
Christie, James, & Sons, Ltd.		London Elec. Wire Co. & Smiths, Ltd.	4	Taylor, J. H., & Co.	15
Collinson Precision Screw Co., Ltd.	6	Lyons, Claude	6	Telegraph Condenser Co., Ltd.	
Darex Radio, Ltd.	16	Marephonophone Co., Ltd., The	1	Telephone Manf. Co., Ltd.	13
Dixon, Leslie & Co.		M-Michael, L., Ltd.	10	Tunometer Works	20
Dubilier Condenser Co. (1925), Ltd.	11	Metro-Vick Supplies, Ltd.	12	Varley Magnet Co., Ltd.	16
Edison Swan Electric Co., Ltd.		Milley, J.	20	Wilkins & Wright, Ltd.	
Electron Co., Ltd.	2	Mullard Wireless Service Co., Ltd., The		Withers, J. S. & Spooner	19
Ferranti, Ltd.					

THINK WHAT THIS MEANS!



NO CONDENSERS, VARIOMETERS, OR VERNIERS

The only infinitely variable all-wire tuner available, adaptable to Electro-Magnetic Coupling, that will allow the B.B.C. main wave-band to be tuned. Really surprising.

NICK-O-TIME TUNOMETER
INDUCTANCE 25/-

NICK-O-TIME TUNOMETER
REACTION 25/-

TUNOMETER WORKS,
GOSFORD ROAD,
BECCLES, SUFFOLK, ENGLAND.

Telegrams: Tunometers.

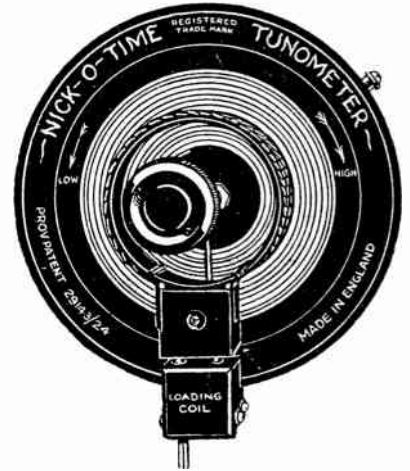

H.T. Accumulators 37/6
60 Volts 3 Actual Amp.-hour



The finest H.T. Accumulator in the world.

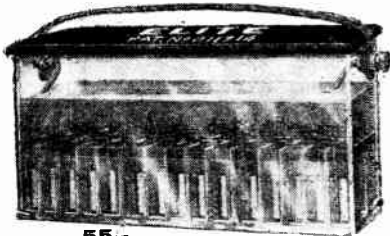

55/-

60-volt, 3-amp. hour oil submerged. Will last a lifetime. Write for descriptive Folder.
MONEY RETURNED IF NOT SATISFIED. Obtainable only from ACCUMULATORS ELITE, 31, Waterhouse St., Halifax. Trade Supplied. Telephone: 1304.

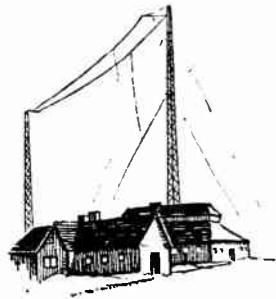

A Guide to
WIRELESS
LITERATURE

This is the title of a booklet which describes all the volumes published in conjunction with "The Wireless World." There are books for every phase of wireless and for all wireless workers, from the beginner to the advanced experimenter and research worker. Write for your copy to-day.

FREE on REQUEST.

HLIFFE & SONS LIMITED
Publishers of "The Wireless World"
Dorset House, Tudor Street, London, E.C.4.
W.W. 38.

VALVES Repaired Quick

Let our valve making plant repair your broken or burnt-out valves efficiently & promptly (most makes). Guaranteed equal to new. Bright emitters 5/-; D.E.'s 2 and 3v types, 7/6. Power valves slightly more. See list. No repairable: S.P.'s WECO v.24, Co. or D.E.'s.



RADIONS Ltd., Bollington, Nr. MACCLESFIELD, Ches. Largest valve-repairing firm in the world. List Free.

TROLITE PANELS

Mahogany Grain . . 3/6 lb.
Black Engraved wavy 3/9 lb.
Black plain polished 3/- lb.

Machine cut to your own measurements. Tested to 50,000 Volts.

PUGH'S WIRELESS, 95-101, Holloway Road, London, N.7

DE VALVES for DX WORK

.06. 3/- 4 volts. 8/6 Post Free.

These valves are strongly recommended for long distance reception owing to their excellent performance as detectors.

Immediate delivery.

K. A. ROBINSON, F.R.G.S., 325, Hamlet Court Road, Westcliff-on-Sea.

REPAIRS SETS PHONES TFORMERS

— Officially approved by Radio Association —

ALL WORK GUARANTEED. LOWEST RATES. 24 HOUR SERVICE.

JOHN W. MILLER, 68, Farringdon Street, E.C.4
PHONE: CENTRAL 1950

PATENTS, DESIGNS & TRADE MARKS.

H. D. FITZPATRICK & CO.
Chartered Patent Agents,
49, Chancery Lane, London, W.C.2
Phone: Holborn 458.

reminder that even in the bitter month of March it is advisable to "earth" the receiver when not in use to avoid the unpleasant possibility of a thunderstorm.



THE WIRELESS SPRITE. An original costume seen at the Three Arts Ball last Wednesday. The set represented is an Ethodyne III.

TROUBLE IN CHICAGO.

A protest is being made by the Zenith Radio Corporation of Chicago, who own the broadcasting station WJAZ, on account of the Government stipulation that transmissions must be limited to two hours a week.

To provide a test case WJAZ broadcast a programme "out of hours," with the result that a legal contest is being fought which may have interesting results.

o o o o

MICROPHONES AT AN EXECUTION.

A gruesome use of the microphone is to be made by medical doctors at the State prison in Carson City, Nevada. According to the Central News, microphones are to be fastened to the bodies of three murderers undergoing the capital penalty in the lethal chamber of the prison. Outside the chamber the doctors will listen to the heartbeats of the three men as the gas is being turned on.

o o o o

SOUTH AFRICAN "PIRATES" UNHAPPY.

Heavy penalties for wireless "pirates" are provided for in the Wireless Telegraphy Bill which is now being considered in the South African Union House of Assembly at Cape Town.

The Bill also provides for a £5 penalty in the case of illegal broadcasting, confiscation of the apparatus, and the cancellation of the station owner's licence. Competent postal officials are authorised to enter any premises to inspect wireless apparatus.

o o o o

NIGHT FLYING BY WIRELESS.

Important experiments in the use of wireless for guiding aeroplane pilots at night are being conducted by Imperial Airways, Limited, on the cross-Channel route. In the experimental machine frame aeriels are built into the planes. Croydon, acting as a beacon station, will transmit a series of Morse signals which will be received by the pilot, who will thus know, from the strength of reception, whether his machine is flying in the direction of the transmitting station.

o o o o

RELAY BROADCASTING IN SOUTH AFRICA.

Pretoria listeners to the Johannesburg broadcasting station may shortly enjoy the advantages of a local relay station. A successful relaying experiment has been carried out at Pretoria with a 50-watt Western Electric transmitter connected by landline to "J.B."

At present the 40 miles separating Pretoria from Johannesburg make reliable reception on crystal sets rather difficult, and the prevalence of atmospherics does not improve conditions.

A feature of special interest, particularly to members of The Wireless League, will appear in the issue of "The Wireless World" for March 24th.

WIRELESS ON DANISH FERRYBOATS.

The Danish Government has been asked to consider the possibility of equipping the State ferryboats with wireless telephony installations.

o o o o

STATE ENCOURAGES HOME CONSTRUCTORS.

University extension lectures in the theory and practice of wireless are now being given in the Massachusetts Institute of Technology. An additional class has been opened for instruction in building and repairing receivers.

o o o o

HOUSE FULL!

An idea of the congestion obtaining in the American ether can be gained from the fact that the U.S. Department of Commerce has received between 250 and 300 applications for broadcasting facilities, but is unable to grant licences as no wavelengths are available.

o o o o

THE B.B.C. SILENT TESTS.

With reference to our paragraph entitled, "The Silent Test," on page 314 of our issue of February 24th, we wish to say there is no reflection on the genuineness or accuracy of the independent wavelength tests carried out by Radio Press Limited.

TRADE NOTES.

B.S.A. Radio Catalogue.

In embarking on the wireless market, B.S.A. Radio, Ltd., have issued an attractive catalogue setting forth illustrated particulars of the range of B.S.A. receivers, loud-speakers, telephones and valves. The B.S.A. Company has entered into an agreement with Standard Telephones and Cables, Ltd. (formerly the Western Electric Co., Ltd.) whereby it will profit by the long experience of the latter in broadcast research and development.

o o o o

Supersonic Components.

Messrs. L. McMichael, Ltd., are issuing an interesting pamphlet giving instructions and notes on the use of "M.H." supersonic transformers. A seven-valve superheterodyne is taken as a model and methods are shown for the compact assembly of such a receiver with M.H. components.

o o o o

A "Claritone" Ordeal.

A Claritone loud-speaker recently survived an extraordinary ordeal. Through the inadvertence of a Manchester listener his Claritone was subjected for a period of five minutes to a supply pressure of 220 volts D.C. Although the windings were temporarily overheated, the instrument emerged unscathed and is still functioning normally!

Throughout the five minutes the many hundreds of turns of extremely fine copper wire composing the windings were carrying a steady current of approximately 110 milliamperes, to say nothing of the strains imposed upon the insulation!

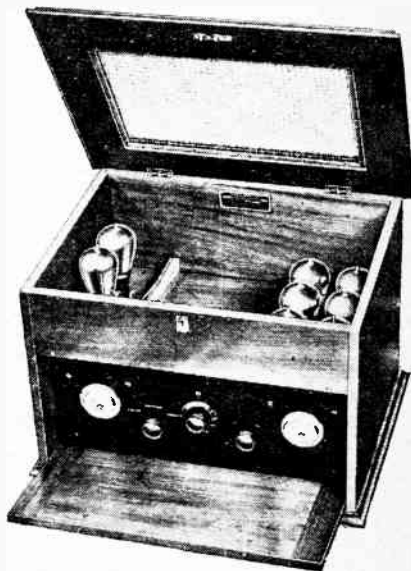

The new Marconiphone demonstration equipment, incorporating an amplifier capable of working three "Super" loud-speakers.

New Premises.

New works have been acquired by the Athol Engineering Company. Their new address is Seymour Road, Crumpsall, Manchester.

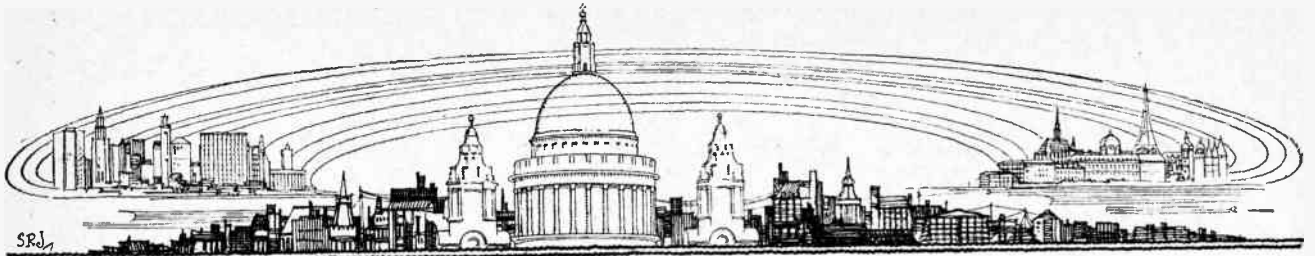

S.R.J.

CURRENT TOPICS

Events of the Week in Brief Review.

ONE IN THREE.

That one of every three families in New York City owns a wireless receiver is shown by the latest survey of the U.S. radio trade. In other parts of the United States the proportion is one in five.

o o o o

CZECHO-SLOVAKIAN WIRELESS BOOM.

In Czecho-Slovakia there are now more than 32,000 licensed broadcast listeners. The inauguration of the Strasnice station has been responsible for a big increase in the number of licences.

o o o o

POOR RECEPTION ON S.E. COAST.

Listeners on the Kent and Essex coasts are complaining that the transmissions from 2LO are inferior to those received from Hamburg! Is this the opening of a campaign for the installation of a new relay station?

o o o o

WIRELESS IN SHEFFIELD SCHOOLS.

Pupils at the Duchess Road Evening School, Sheffield, are to give a public performance of the opera "Maritana," the proceeds from which will be handed over to the fund for providing wireless sets in Sheffield schools.

o o o o

POLAR FLIGHT WITH WIRELESS.

Highly efficient wireless transmitters and receivers, together with direction-finding apparatus, are to be carried on the semi-rigid airship "Norge," on which the Amundsen-Ellsworth Expedition party are to attempt to cross the Polar Ocean from Spitsbergen to Alaska. Transmissions during the flight, which will take place in the spring, will probably be on wavelengths of 450, 600, 900 and 1,200 metres.

o o o o

PORTABLE RECEIVERS.

Enthusiasts who believe they can already detect signs of approaching spring are turning their thoughts in the direction of portable receivers.

A discussion on "Portable Receiving Apparatus" will take place this evening (Wednesday) at an informal meeting of the Radio Society of Great Britain to be held at the Institution of Electrical Engineers, Savoy Place, W.C.2, beginning at 6 p.m. The discussion will be opened by Mr. F. H. Haynes, Assistant Editor of *The Wireless World*.

HOTEL WIRELESS.

Broadcast receivers are being installed in all the private sitting-rooms in the main south block of the Hotel Cecil, Strand. Very shortly, we understand, all the rooms in the hotel will be similarly equipped.

o o o o

PERU HEARD ON CANADIAN TRAIN

What is probably a record in mobile wireless telephony reception is reported by the Canadian National Railways, whose trains have recently been equipped with broadcast receivers.

On a recent occasion when an express was travelling at a good speed about 1,000 miles west of Montreal, concerts were picked up from Lima (Peru) and Oakland (California).

HIGHER POWER AT ROME.

Test transmissions have begun from the new 12-kilowatt broadcasting station in Rome. The installation closely resembles that at 2LO, so that no great difficulty should be experienced in picking up the transmissions in this country.

The original 6-kilowatt apparatus at Rome will probably be transferred to Naples.

o o o o

DAVENTRY AERIAL STRUCK.

Listeners to 5XX on Wednesday last were surprised soon after 10 p.m. by the sudden interruption of the programme, followed by a dead silence.

The fact that the Daventry aerial had been struck by lightning came as a useful

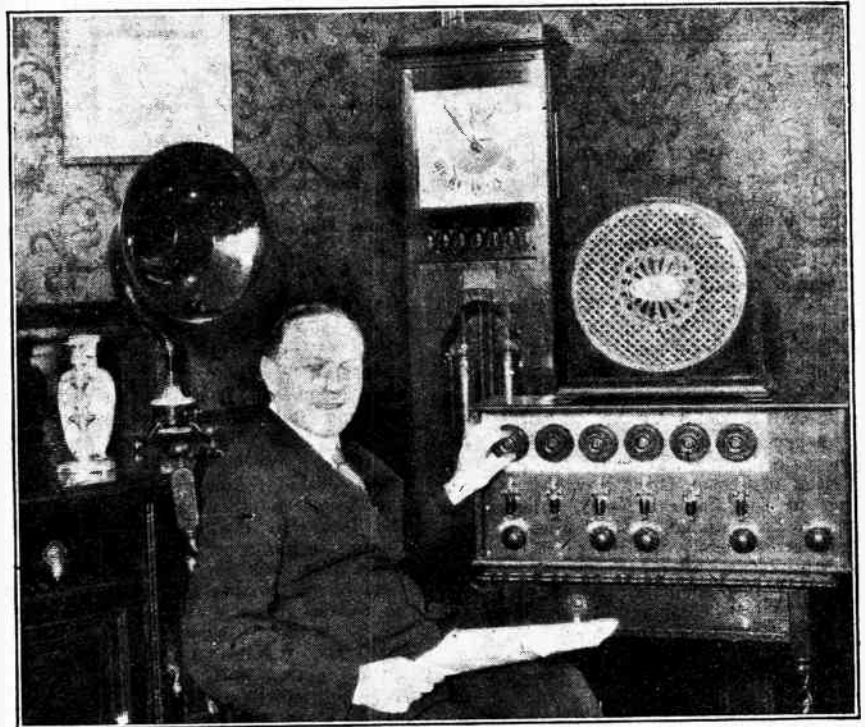

CONTROLLING THE EUROPEAN ETHER. Mr. Arthur R. Burrows, the well-known B.B.C. pioneer, who is now Director of the International Radiotelephony Bureau at Geneva. Mr. Burrows is seen with his eight-valve receiver, by means of which he is able to keep an ear on the activities of Europe's many broadcasting stations.

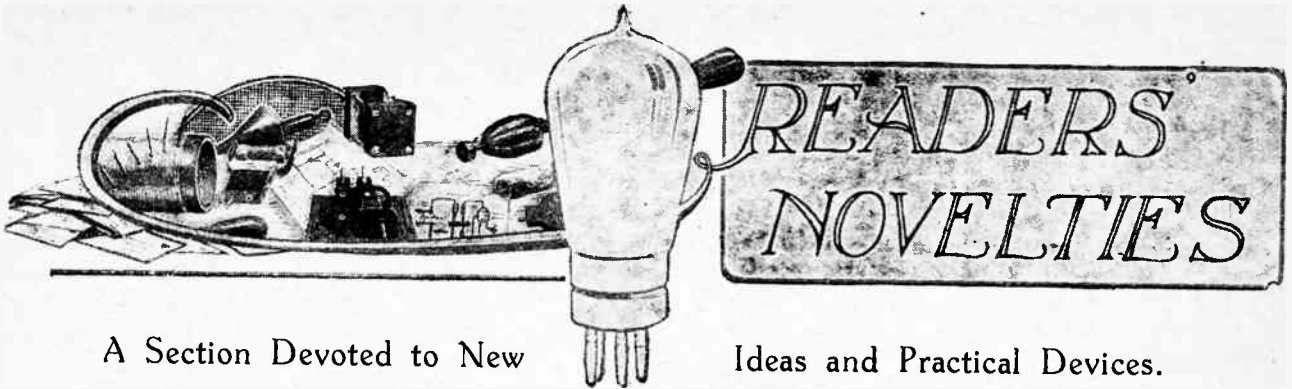

A Section Devoted to New

Ideas and Practical Devices.

An Experimental Valve Adaptor.

The valve adaptor shown in the diagram has been constructed with the object of facilitating connection to the various sockets of a valve holder in order that experimental variations of circuit may be made in the case of completed receivers. For instance, it may be desired to add a further stage of L.F. amplification to an existing receiver. In this case a two-valve unit is constructed with an

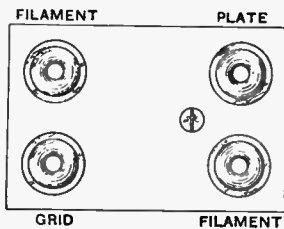
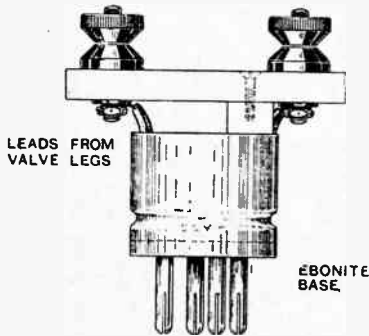

Experimental valve adaptors.

interval transformer connected in the usual way between the two valves. The four leads from the valve adaptor are then connected to the unit in the following way. The grid lead is taken to the grid of the first valve and the plate lead to the plate of the second valve, the filament current for the two-valve unit being drawn from the two filament terminals. It will then be seen that the telephone

A 22

currents returned to the original set through the plate terminal of the valve adaptor have received a further stage of L.F. amplification.—H. B. C.

Aerial Safety Cord.

The safety cord is attached to the insulator at the mast end of the aerial and is taken over the halyard pulley to a spool mounted loosely on a bracket secured to the base of the mast. In the event of the halyard breaking, the safety cord is free to pay out from the spool when the aerial drops. A means is thus provided for attaching a new halyard and drawing it through the pulley without having to take down the mast. A large size cotton reel may be used for the spool, and the cost of fitting is only a few pence.—H. D.

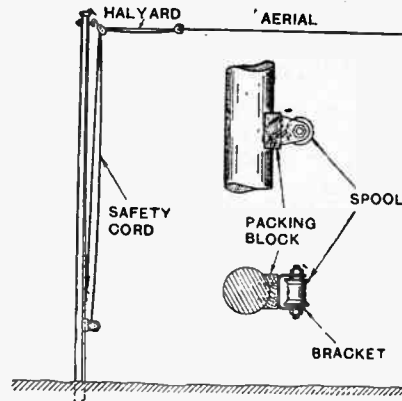

Safety cord for fitting new halyard in the event of breakage.

Preventing Filament Sag.

In receivers with vertical or sloping front panels it is important that the valves should be so mounted that there is no tendency for the filament to sag under its own weight, as this

may eventually cause a short-circuit with the grid. Often the original arrangement of the valve sockets is unsuitable for other types of valve.

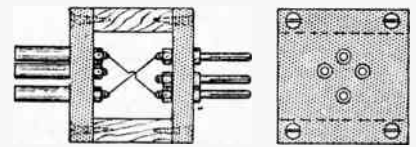

Valve adaptor to prevent filament sag.

By means of adaptors constructed according to the diagram this difficulty may be overcome, since the centre lines passing through the valve sockets and pins may be set at any relative angle to correct the tendency of the filament to sag.—R. H.

Fine Tuning.

The circuit diagram shows a convenient method of obtaining fine adjustment of wavelength in a crystal receiver tuned by means of a slider coil.

Two sliding contacts are fitted to the same bar, or if two bars with separate sliders are available, the same circuit may be obtained by joining together the ends of the bars. Preliminary adjustments should be made with the contacts as near together as possible, then to obtain fine adjustment the lower contact in the diagram is moved to vary the number of short-circuited turns in the coil.

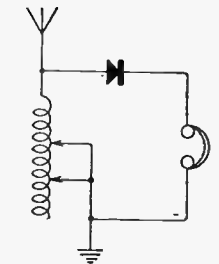

Fine tuning by means of short-circuited turns.

The diagram is moved to vary the number of short-circuited turns in the coil. An increase in the number of short-circuited turns will produce a decrease in wavelength.—H. W. W.

An Instantaneous Direct-Reading Goniometer.—

transformer, the two coils of one loop being co-axial and having their common axis at right angles to the axis of the coils belonging to the other loops. A primary coil is mounted at their centre, and is capable of being rotated with respect to the two pairs of coils. The primary is fed from the oscillator, and can thus be used to induce into either of the aerials. (The arrangement is very similar to the crossed transformer used in the Bellini-Tosi direction finder, except that here the rotatable coil is the exciter instead of it being the receiving search-coil, as in the Bellini-Tosi D.F. reception.) The exciting primary coil may thus be coupled to one loop alone, and this loop tuned up, then the other loop tuned independently. Finally, both may be tuned to absolute identity, as judged by the complete closing of the ellipse. If the operation is complicated by the presence of signals, the loops may be replaced by dummy circuits of the same inductance and resistance.

This arrangement also permits the testing of the voltage amplification and output of each side.

These should normally be the same, but one may be made slightly greater than the other to correct for the slight difference in position of the two pairs of deflecting plates, already referred to. This is simply done by slightly increasing the amplification on the weaker side until the deflections corresponding to identical inputs to the two systems are the same. Since the result on the screen is the only convenient measure of the relative amplifications, it will be seen that by adjusting these to equality the error referred to is automatically compensated.

Simultaneous Direction Finding.

In dealing with the properties of the new system the authors describe its behaviour in the case of two or more signals. Its virtue in this respect is due to the fact that the electronic beam gives instantaneous response to every impulse. In the simplest case with two stations, if a marking impulse arrives from one while the other is spacing, the oscillograph will trace a line giving the bearing of the former, and *vice versa*. If the stations are working quite independently at hand speed, the marking periods in each case will be interrupted by comparatively long spacing gaps, during which marking impulses from the other station may be received. Two bright

lines, each indicating the correct direction and amplitude of the corresponding signals, will thus be made to stand out clearly on a background of faint fluorescence. If the stations are working independently at high speeds, the pattern becomes a parallelogram full of fluorescence whose edges, clearly defined, are respectively parallel to the two required bearings; even three stations on high speed merely increases the complexity of the image, but it is still possible to determine the bearings simultaneously.

Application to Navigation.

This behaviour on signals makes the arrangement very suitable for use on the reception of beacon stations for navigational purposes, and the writers make some interesting suggestions in this respect. The suggestion outlined is for C.W. transmission modulated to an extent of *m* per cent. at a frequency of *n*. It is pointed out that *n* need only be a fraction of one cycle per second, *i.e.*, the whole cycle of modulation occupying two or three seconds. The modulation *m* can be made large, and both *m* and *n* can be given individual values for a series of beacons. The beacons could work simultaneously on the same wavelength. On a cathode ray direction finder two such beacon transmitters might cause a typical screen image of two lines intersecting, say, at an angle of 55°, one varying once in three seconds from full to half length, and the other varying once in five seconds from full to quarter length. The navigator would then simply have to find in a list the two stations stated to have these characteristics.

Interesting examples of the use of the system on atmosphericics from thunderstorms are also given in the paper. On one occasion quoted, observation of distant flashes on a dark sky gave very good agreement with the directions observed on the cathode ray oscillograph. For another occasion, a polar co-ordinate diagram shows the lines from which strong atmosphericics were seen to be arriving. Meteorological records subsequently provided information as to places reporting thunder at the times of the observations. These are similarly plotted, and show excellent agreement with the observed atmosphericics.

It is pointed out that the arrangement as described suffers the usual direction-finding ambiguity of 180°, but that this can be resolved by methods already used in direction-finding systems, as also by methods peculiar to the oscillographic arrangement.

Sheffield.

(January.)
Finland: 2NN, 2CO. Italy: 1AY, 1CO, 1RM, 1AS. Sweden: SMVG, SMZU, SMZS, SMTX, SMUK, SMRI. Belgium: J3, 4YZ, 4G, D4, P7. Holland: 0NAA, PCLL, OWC, PCZ. U.S.A.: WIR, WQO, KDKA, WIZ. France: 8PEP, 8WW, 8CAN. Spain: EAR23. Germany: 2HK. Unknown: AIN, FW, 1RA, AG 5MA, MIBB.
(0-v-1) on 25-110 metres.

A. S. Williamson.

London.

(January-February.)
Great Britain: 2AKG, 2BAZ, 2DA, 2DX, 2FM, 2GO, 2MX, 2QB, 2QM, 2QV, 2SV, 2VQ, 2VR, 2XV, 2XY, 5AX, 5HS, 5KZ, 5SI, 5SO, 5TZ, 5UL, 5US, 5XO, 5YD, 5ZU, 6CI, 6DO, 6ER, 6KK, 6NF,

Calls Heard.
Extracts from Readers' Logs.

6OS, 6OU 6QB, 6RY, 6TD, 6FM, 6XG, 6YC, 6YQ, 6ZC, 6ZL, 6FT, 6HA, 6HAP. Palestine: 6YX, 6ZK. Australia: 3BQ, 3EF, 3XO. New Zealand: 2AC, 2XA, 4AC. South Africa: A6X. India: IIBK. Canada: 1AR, 4AR. U.S.A.: 1BI, 1CKP, 1CMP, 1GA, 1YK, 2ACT, 2AMJ, 2AMQ, 8RPD. Porto Rico: 4UR. Brazil: 1AB, 2SP, 6QH. Scandinavia: 1NN, 2NN, SMQZ, SMSR,

SMTG, SMUX, SMXU, SMZS. American Navy: NBA, NOSN, NOT. All on about 45 metres.
R. Bboxham (G 5LS).

Whitman, Mass.

(January 1st to February 11th.)
Great Britain: 6LJ, 6TD, 6RM, 6RY, 6TM, 2SH, 2CC, 2NM, 2BZ, 2VQ, 5NM, 2IT. France: 8YOR, 8JN, 8AIX, 8BF, 8XP, 8CS, 8DK, 8NN, 8IP, 8PEP. Spain: AR9, AR25, AR24. Belgium: B2, B4, D4, B72. Italy: 1NO, 1RM, 1AS, 1GW, 1NA. Holland: PB7, PC2. Portugal: 3GB. Czechoslovakia: OK1. Luxembourg: LJW. Brazil: 1IA, 1AB, 1AP, 2AB, 2AF. Sweden: SGC. Australia: 5AY, 2DS, 3BD, 5BG. Chile: 3IJ. Morocco: MAROC. South Africa: A4Z, A3B, A3M. Cuba: 2JT. Porto Rico: 4SA. S. C. Littlefield.

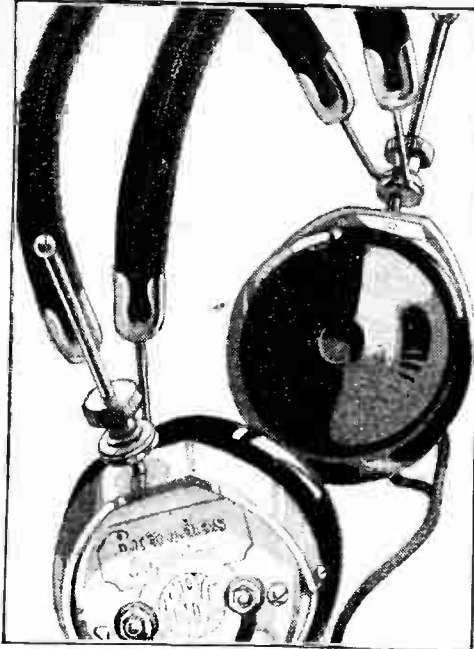

MATCHED TONE HEADPHONES

IF you're fond of sitting up in the wee sma' hours to stretch a hand across the world, Matched Tone are extremely able confederates. With radio you span continents and with Matched Tone it becomes easier, "comfier" and much more efficacious. Distant signals stand out clearly; Matched Tone grope in the ether with unflinching accuracy. The specially matched receivers make them super-sensitive and tone perfect. You are logging a new call-sign every day with Matched Tone.

20/-

Table-Talker	Brandola	Audio Transformer
30/-	90/-	17/6

Brandes

Brandes Limited, 296, Regent Street, W.1.

From any good Dealer

3/563.B.

SERVICE ADVERTISING

CLEARTRON

IRON-CLAD GUARANTEE

ALL CLEARTRON VALVES ARE GUARANTEED TO GIVE POSITIVELY PERFECT SERVICE & WE AUTHORIZE OUR DISTRIBUTORS WITHOUT COST OR QUESTION TO MAKE REPLACEMENT OF ANY CLEARTRON VALVE WHICH PROVES UNSATISFACTORY TO THE USER. THE ONLY REQUIREMENT IS THAT THE FILAMENT MUST NOT HAVE BEEN BURNED OUT.

CLEARTRON RADIO LIMITED
OF THURLOW ROAD, LONDON



Alfred Easton

BRITISH MADE

RADIO VALVES

CLEARTRON RADIO LTD. Works, Birmingham

America's foremost Valves made in Britain's newest factory.

Valves for every need
**PERFORMANCE
GUARANTEED**

12/6 ALL DULL 15/-
EMITTERS

The CLEARTRON Ironclad Guarantee means positively perfect performance or instant replacement. Your Dealer will replace a faulty valve without cost or question.

Catalogue from your Dealer or:

CLEARTRON RADIO LIMITED

1, CHARING CROSS, London (Works: Birmingham)

Telephone:
Re/ent 2231/2.

Grams:
Cleartron, Westrand, London.

British Made



41/573. C.

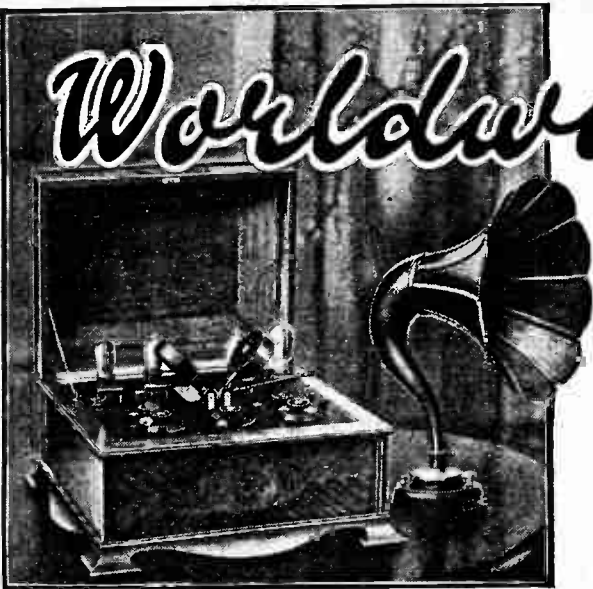

Worldwide Satisfaction

IT matters not whether a Radio Receiver is used for the artistic pleasure it gives, or for bringing in distant stations under the expert hand of a keen experimenter, it must, above all other things, be reliable.

A.J.S. Receivers are highly efficient and give WORLD-WIDE SATISFACTION. The method of intervalve coupling used cannot easily be surpassed when musical reproduction is being considered.

Moreover, the standard receivers are more selective than usual, owing to the method of aerial coupling, and the fact that the coils for use on the lower Broadcast range are single layer wound, and that the variable condensers are of the A.J.S. low loss type. The wavelength range is from 150 metres upwards. When used above 550 metres, plug-in coils are employed. The standard type receivers are so constructed that the aerial cannot be energised by self-oscillation.

4-Valve Table Type Receivers.

These may be obtained in Cabinets of Oak or Mahogany.

Table model de Luxe, complete	£29 17 6
Receiver only	£21 12 6
Type T.M.2 (as illustrated), complete	£26 15 0
Receiver only	£18 10 0
Type T.M.3, similar to T.M.2, but without feet	£24 10 0
Receiver only	£16 5 0

All Prices include Royalties.

Loud Speaker extra in all cases. The model illustrated, with Mahogany or Oak flare, £4 15 0

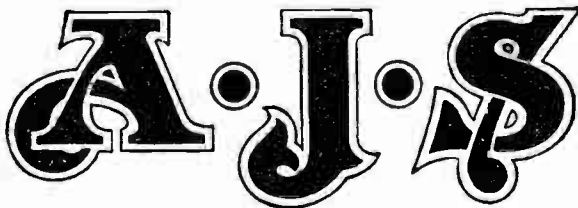

2-Valve Loud Speaker Receiver, complete with all accessories as illustrated and inclusive of Junior Loud Speaker. Price £13 18 6. Receiver only, £8 2 6. Junior Loud Speaker from 35/-.

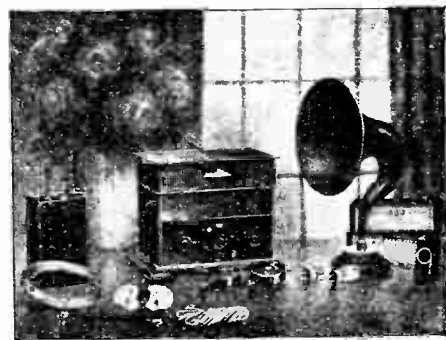

A. J. STEVENS & CO. (1914) Ltd., Radio Branch, WOLVERHAMPTON.

Telephone: 1748 (7 lines). Telegrams: "Reception, Wolverhampton."

LONDON SHOWROOMS: 122/124, Charing Cross Road, London, W.C.2

Telephone: Regent 7161-2. Telegrams: "Ajayesseo, Westcent, London."

GLASGOW SHOWROOMS: 223, St. George's Road, Glasgow.
Telephone: Douglas 3449. Telegrams: "Reception, Glasgow."

A. J. STEVENS & CO. (1914) Ltd., Radio Branch, Wolverhampton.

Please send publications Nos. 120 and 118.

Name

Address

W.W. 10 3'26

ISSUED BY THE PUBLICITY DEPT. A.I.S.

An Instantaneous Direct-Reading Goniometer.—

same angle with the vertical axis of reference on the tube screen as the signal makes with the NS loop.

Electrical Symmetry Necessary.

Two minor theoretical sources of error are pointed out, these being not inherent defects of the principles of the system, but simply the fact that in the Western Electric oscillograph actually used one pair of deflecting plates is nearer to the source of the electron beam than the other. One of these errors, a very slight difference of phase between the two components actually applied to deflect the beam, is shown to be negligible even at such short wavelengths as 300 metres. The other is a slight inequality of amplitude, due to the pair nearer the source bending the beam with a greater "leverage" than the other. This error is also very small, and can actually be corrected by a method mentioned later in the paper, while both could be completely eliminated by a re-arrangement of the deflecting plates, so that both pairs should act on the beam at exactly the same place.

The assembly, as actually described by the authors, is, of course, arranged primarily for their work on atmospherics. Here it is obvious that there is no possibility of even a rough check on the accuracy of the indications, so that it is necessary to eliminate all possibilities of error. Consequently the loops employed at Ditton Park are very large, so that a minimum of amplification may be used, since it is a general experience that quantitative uncertainties increase rapidly with amplification.

The circuits are also arranged to give the most complete symmetry and freedom from error. To eliminate "antenna effect" the mid-points of the horizontal stretches of the loops are connected to earth, and the tuning arrangements of the loops broken up into two half loops completely symmetrical on either side of the earth lead. The tuning of each half loop is practically independent of the tuning of the other half. In the standard Western Electric oscillograph one plate of each pair is joined together and commoned to the anode (the other plate of each pair being joined through an external resistance path to this common point). To ensure complete symmetry, special oscillographs have been obtained for this purpose, in which each plate is separately terminalled. The anode of the tube is joined to the earthed mid-point of the whole system.

Use of Amplifiers.

For strong signals or powerful atmospherics no amplification at all need be used, the oscillograph plates being joined directly to the condensers, as in Fig. 1. For weaker E.M.F.s suitable amplification may be introduced between the tuning condensers and the oscillograph plates. The authors show the circuits of a two-stage amplifier, from which Fig. 2 has been redrawn to show the simple arrangement for one stage. Resistance-capacity

coupling is used on the "push-pull" system. This maintains the symmetry of the arrangement, while the resistance-capacity system is very suitable for use on atmospherics. The anode resistances are wire wound to 100,000 ohms, and the stage shown is tapped in thirds, so that voltage amplifications of 5, 10, and 15 are obtainable on this stage (in conjunction, if necessary, with a further multiplication by 15 provided by the subsequent similar stage shown in the original). The loop aerials each consist of five turns of 1,200ft. horizontal length, by about 150ft. deep. The total area-turns thus amount to about 20 acres. It is pointed out, however, that such large loops are not essential; nor is the push-pull system of amplification. These have been used by the writers chiefly in accordance with the general policy of minimising amplification and ensuring symmetry for their work on atmospherics. Much smaller loops—down to an area of even 30 square metres per turn—with one pair of vertical limbs coincident, in combination with normal amplifiers and the standard form of Western Electric oscillograph, have already been shown to be practicable.

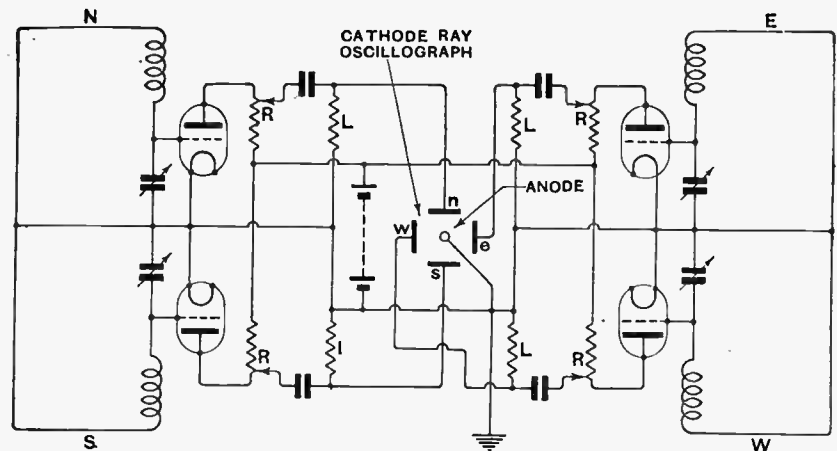

Fig. 2.—Amplifying valves inserted between the loops and oscillograph electrodes.

The accurate tuning of the loops is a matter of some importance, and details are given of the tuning and testing arrangements as used by the writers at Ditton Park. When, of course, the whole system is correctly tuned and adjusted the arrival of a signal causes the spot of the oscillograph to trace a straight line, which directly indicates from, say, the vertical axis, the angle which the signal makes with the north-south loop. In order to have a sharp line it is essential that the two components applied to the oscillograph should be in phase. Any slight mistune produces immediately a difference of phase in these two components which manifests itself by opening the single straight line into an ellipse.

This at once forms an effective safeguard against errors of bearing due to bad tuning, since the ellipse becomes quite wide before its major axis begins to depart by a measurable amount from the correct angle. This tuning can thus be performed directly on the signal, while it can also be conveniently performed in advance on locally generated oscillations of the desired frequency. The authors' arrangement uses a local screened oscillator in conjunction with the tuning inductances shown in Figs. 1 and 2. The four coils are arranged to form a crossed

AN INSTANTANEOUS DIRECT-READING GONIOMETER.

Account of a new and interesting direction-finding system described by Messrs. R. A. Watson Watt and J. F. Herd, at the Wireless Section, I.E.E., on March 3rd, 1926.

LAST Wednesday's meeting of the I.E.E. Wireless Section was devoted chiefly to atmospherics. Two papers were read, the first—by Mr. R. A. Watson Watt, superintendent of the Radio Research (Atmospherics) Station at Ditton Park, near Slough—dealing with a continuous directional recorder for atmospherics. This is in the form of a single rotating frame aerial, clock driven, working in conjunction with a resistance capacity-coupled amplifier and writing a record of atmospheric "kicks" on a drum revolving with the frame aerial.¹

Limitations of Ordinary D.F. Methods.

The second paper, by Mr. Watson Watt and Mr. J. F. Herd, dealt with a new and interesting system of direction finding, which has many features promising important applications. Although the system has been developed chiefly for the authors' work on the investigation of atmospherics, it is equally applicable to the reception of signals, and has many points of distinct novelty as compared with the usual D.F. methods. Chief among these is the fact that the indication of direction is read directly on the screen of a cathode ray oscillograph, which is the essential element of the indicating device. This results in it being possible to get the directions of two or even more stations simultaneously, a condition which is quite impossible with ordinary aural D.F., where even a weak interfering signal may easily give rise to error. The absence of inertia from the indicating system also renders it possible to read directly the *instantaneous direction of individual atmospherics*. This is in marked distinction to the usual D.F. methods, which tend naturally to treat atmospherics from all sources as a "lumped" signal, indicating a mean direction of minimum arrival. While this mean may be statistically true, it may be physically fictitious, since the atmospherics so averaged may be due to two (or more) streams.

Direction of Individual Atmospherics.

Interesting details are quoted in the paper when the arrangement was used to determine the direction of arrival of individual atmospherics, due to several different thunderstorms, subsequently verified from meteorological records. This suggests important applications of the device for X location for meteorological purposes, as well as for the wider radiotelegraphic interest. The new system also appears to be particularly applicable for use with beacon transmitters for navigational purposes, as well as to many other D.F. applications which will readily suggest themselves to the practical mind.

The cathode ray device used as an indicator is the Western Electric Company's tube. This is now so well

known as to call for little description. A beam of electrons is produced by means of a heated cathode and a tubular anode, producing a spot of bright fluorescence when it impinges on a screen at the end of the tube. The beam is acted upon (for electrostatic deflection) by two pairs of deflecting plates mutually at right angles. These can best be shown diagrammatically, as in Fig. 1, which illustrates the use of the arrangement for direction finding.

Two large loops are arranged at right angles to each other and crossing at their centres. A signal arriving in the plane of the north-south loop NS will give an E.M.F. in that loop with nothing in the east-west loop, EW. The voltages developed across the tuning condensers in the NS loop circuit are applied to the plates *ns* of the oscillograph, producing vertical deflection of the cathode ray spot. As a result, the spot on the screen is opened out into a vertical line, the length of which will depend on the amplitude of the signal. Similarly, a signal arriving in the plane of the east-west loop will give an E.M.F. in that loop and nothing on the NS loop, causing the spot to be opened out into a horizontal line. In the

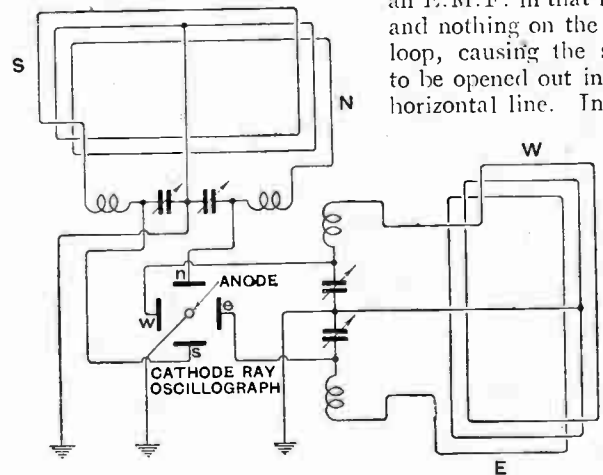

Fig. 1.—Directional frame aerials connected directly to the oscillograph for recording strong atmospherics.

same way a signal arriving in a plane, say, half-way between the angle of the loops, will give an E.M.F. in each loop, the amplitude of which is proportional to the sine or cosine of 45°. Each of the pairs of plates will act simultaneously on the beam, moving it in a resultant direction. The spot will therefore be opened out into a line making an angle of 45° with either of the axes of reference. The length of this line will be the same as that in either of the two previous and simpler cases (that is, of course, for the same strength of signal with only the arrival angle altered).

Similar reasoning will readily show that, for a signal making any other angle with, say, the plane of the NS loop, the spot will be opened out into a line making the

¹ A short description, with photographs, of this recorder appeared in *The Wireless World* of August 1st, 1923.

"Listening-In" at 70 Miles an Hour.—

dynamo out of commission, attached to the 4.10 p.m. *ex* Plymouth.

Reception was begun before leaving Plymouth, and while the train was still standing in the station Daventry was tuned-in at concert strength, much to the amazement of a large crowd of onlookers.

Soon after the journey was commenced a peculiar fading effect was observed. The train was now skirting Dartmoor, which, lying to the north-east, appeared to be screening Daventry's signals. The suggestion was put forward that this interesting phenomenon may have been due to an absorption effect exerted by metallic deposits.

Signal strength was beginning to improve near Totnes when the train plunged into the Brent tunnel. Signals at first seemed to die out completely, but when close to the loud-speaker one could still hear faint music, even in the heart of the tunnel.

Continuous fading was also produced in the Devonshire section owing to the tortuous curves in the line, which necessitated constant manipulation of the frame aerial.

An entertaining incident during the tests was the tuning-in of Radio Paris (1,750 metres) while the train was standing at Newton Abbot. A group of enthusiastic townsfolk listened with rapt attention to a pianoforte recital followed by a talk in French!

Between Dawlish and Exeter good reception was obtained from Cardiff, while, a minute or two later, through a background of atmospherics and Morse, Aberdeen was



Music provided a happy distraction in the restaurant car.

A 16

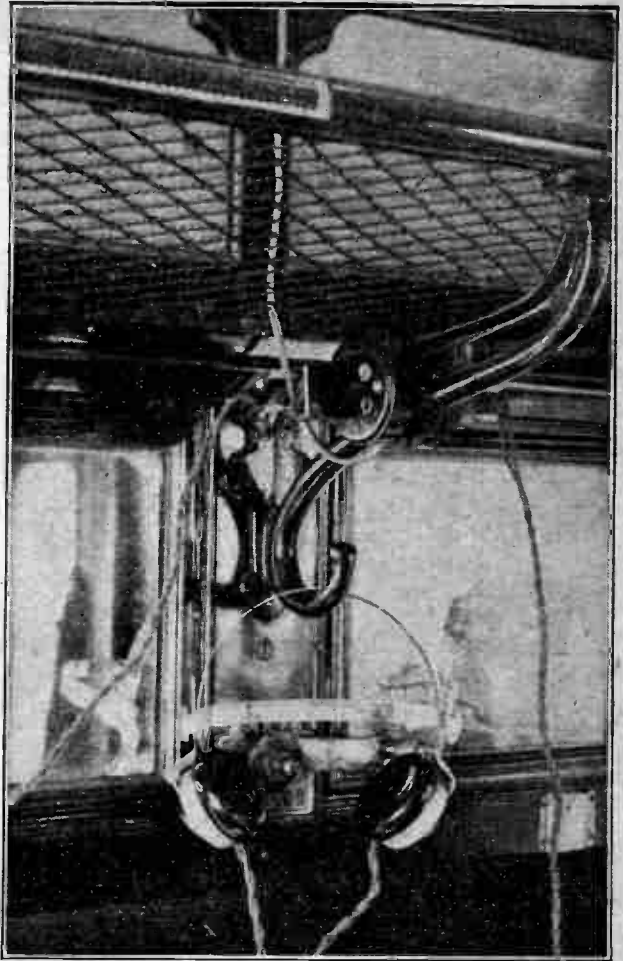

Four pairs of telephones were allotted to each compartment. The photograph shows the neat method of plugging-in without damage to the carriage fittings.

distinctly recognisable. Shortly before Tiverton was passed Daventry's carrier wave was again tuned-in and held until, on passing the junction, the six o'clock chimes of Big Ben burst through with astonishing clarity.

But the best was still to come. On the final stages of the run, between Newbury and Paddington, when the train was maintaining speeds varying between 70 and 80 m.p.h., the London programme *via* Daventry came through on loud-speakers in the restaurant car in a manner that would have been creditable in a private drawing-room. If the reproduction was slightly harsh, it had to be remembered that the loud-speakers were operating at full strength.

One more "search" for Continental stations brought in San Sebastian (Spain), when the train was running through Reading.

This interesting experiment proved that the few remaining obstacles to broadcast reception on a swiftly moving train are by no means insuperable. Whether a frame aerial is a suitable form of antenna for this purpose is open to doubt, but what is certain is that consistent reception can be carried out, except in tunnels, throughout a long railway journey.

E. C. T.



Broadcast Reception on the Cornish Riviera Express.

IF the experiment in broadcast reception carried out on express trains between Paddington and Plymouth on Tuesday, March 2nd, was unsuccessful in its early stages, the results subsequently obtained fully rewarded the enterprise of the Great Western Railway officials and Messrs. Burndept Wireless, Ltd.

The object of the experiment was to determine whether the installation of wireless would usefully contribute towards relieving the tedium of a long railway journey.

Five compartments of a first-class coach in the Cornish Riviera Express were fitted with twenty pairs of headphones for the use of Press representatives, while the restaurant car was equipped with loud-speakers. The receiving equipment consisted of a standard seven-valve superheterodyne—an Ethodyne—with frame aerial.

Extraneous noises due to bridges and crossings frustrated attempts to pick up the 10.30 time signal from Daventry as the train steamed out of Paddington, but at Southall a serious effort was made to receive Daventry's morning concert. It soon became apparent that great difficulty would be experienced in cutting out the incessant roar in the telephones, which was first attributed to the fact that the train was travelling at over a mile a minute.

Dynamo Induction Trouble.

At 11.20, when high speed was being maintained between Reading and Savernake, it was possible to make out the first distinguishable sounds of music, consisting of military band selections from 5XX. Considerable volume was obtained between Savernake and Thatcham, but the annoying background of "mush" still persisted to such an extent that any real enjoyment of the programme was impossible. Although the frame aerial was rotated in all directions, no relief was obtained, and it became evident that the interference was being caused by the lighting dynamo beneath the coach. Plymouth being scheduled as the first stop, nothing could be done to overcome the trouble, and experiments were abandoned.

The really successful tests were carried out on the up journey from Plymouth to Paddington. The apparatus was installed in a first-class coach, with the lighting

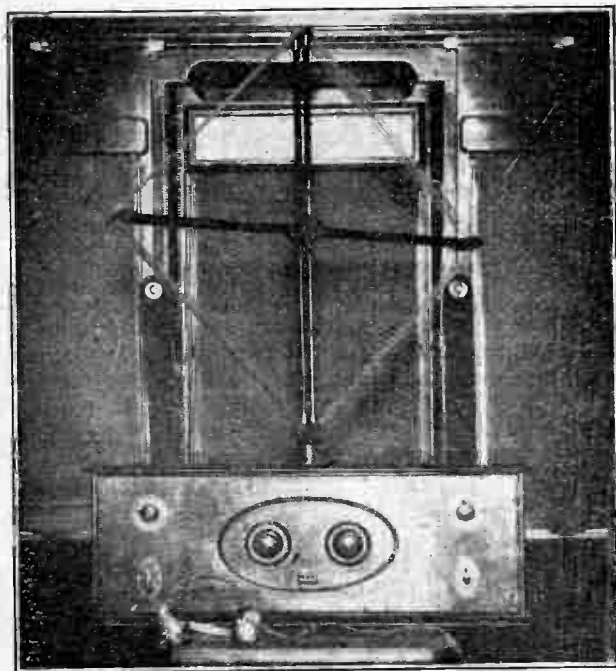

The standard seven-valve "Ethodyne" which successfully operated five loud-speakers and twenty pairs of telephones while the Cornish Riviera express was travelling at 70 m.p.h.

PARTS REQUIRED.

Variable condenser, 0.0005 mfd. (Igranic).
Cabinet, 12in. x 9in. x 6in., type No. 209 (Compton Electrical and Radio Trades Supplies).
4 Condensers, 0.01 mfd., type No. 577 (Dubilier).
Grid condenser, 0.005 mfd.
Anode resistance, for use as grid leak (Oliver Pell Control Ltd., Granville House, Arundel Street, W.C.2).
4 Ebonite shrouded terminals (Belling & Lee).
"On and off" switch (Argonaut Manufacturing Co., 16, Norman Buildings, Old Street, E.C.1).

Milliammeter, 0-25 mA. (Elliott Bros.). This instrument is not essential, but is recommended.
Ebonite panel, 12in. x 8in. x $\frac{1}{2}$ in.
Ebonite tube, 2in. dia., 3in. required.
1st. $\frac{3}{8}$ in. ebonite rod.
Valve holder (Aermonic), model D.
Pieces of $\frac{1}{4}$ in. and $\frac{3}{8}$ in. ebonite for coil formers.
Various 6BA screws and nuts.
Small quantities of No. 10 and No. 14 S.W.G., bare copper wire.
2 oz. No. 24, D.S.C.

Approximate cost, without meter - - £4 ros. od.

Before the wiring up is proceeded with a small choke coil must be made for connecting in the negative lead to the milliammeter. This consists of about twenty turns of No. 38 D.S.C. wire wound on a cardboard former $1\frac{1}{2}$ in. in diameter and having nine slots $\frac{1}{4}$ in. in depth. This choke coil is for the purpose of relieving the meter

soldered permanently in position until tests have been made for uniform oscillation over the range of the tuning condenser. Preliminary tests may be made with a D.E.5, D.E.5a, B.4, or D.F.A.1 valve, using about 40 to 60 volts on the plate. It is not necessary to incorporate the anode or filament batteries as part of the wave-

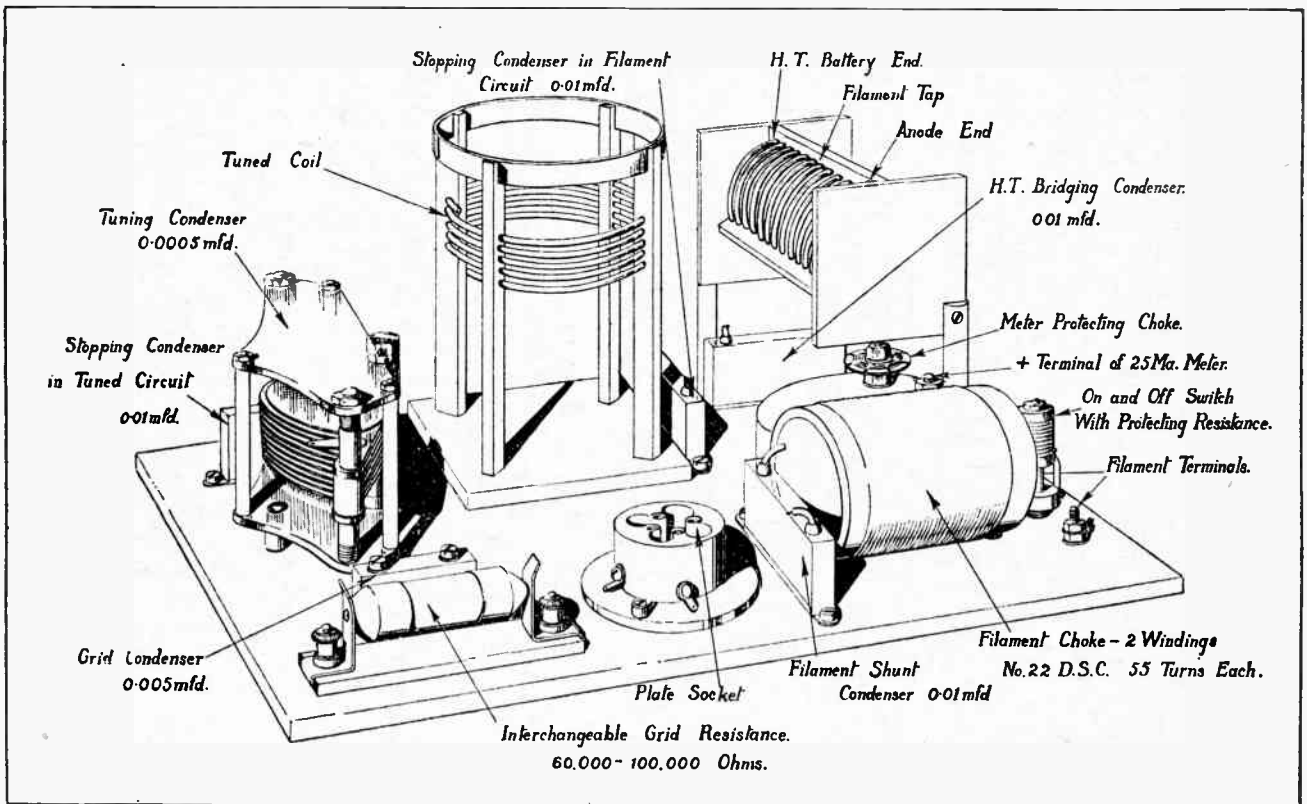

The components assembled in position ready for wiring. The various fixed condensers can here be identified

winding from the strain and likely damage due to high-frequency currents taking a path through the meter. The "on and off" switch is of a type which, working through a resistance, brings the filament current slowly to a maximum.

The layout of the parts has been considered with a view to simplifying the wiring. The leads which form part of the oscillatory circuit are composed of strip made up by laying three straight lengths of No. 16 wire side by side on the bench and passing the soldering-iron along them.

The tapping contact on the exciter coil should not be

meter, providing short leads are used for connecting and that the batteries are entirely disconnected from other circuits. The correct adjustment for the tapping contact on the exciter coil is found by moving the connection along turn by turn until the point of minimum feed is reached, the tuning condenser being set roughly in the middle of the scale. The condenser is then rotated through its full scale, and if oscillation is found to cease at any point, as indicated by a rapid increase in plate current, a slight readjustment of the tapping point is necessary.

(To be concluded.)

New Short-wave Oscillator.

of $\frac{1}{4}$ in. ebonite, and is filed to accurately fit, the fillets on the inside of the box being raised, if necessary, so that the edge of the panel projects $\frac{1}{16}$ in. all round. Assuming that a suitable cutter is not available for drilling out the hole in which the meter is fitted, a circle should be scribed showing the position of the meter, and within this another circle, so that, by drilling a number of $\frac{1}{16}$ in. holes almost touching, the barrier can be sawn away with a fine blade or fretsaw and the hole finished with a half-round file.

The construction of the inductances should next be proceeded with. In each case the strips are made about $\frac{1}{4}$ in. longer than required, and, after drilling and threading on the wire, the ends are adjusted to come level. In this form of coil construction the wire is first shaped by winding on a cylinder with turns touching, the wire having been previously straightened. In the case of the exciter coil three supporting bars are employed, secured at the ends to square pieces of $\frac{1}{8}$ in. ebonite. Three legs are used to support this coil made from $\frac{3}{8}$ in. ebonite rod. The larger coil, which is connected in the tuned circuit, is held rigid at one end by mounting on a $\frac{1}{4}$ in. ebonite base piece and at the other

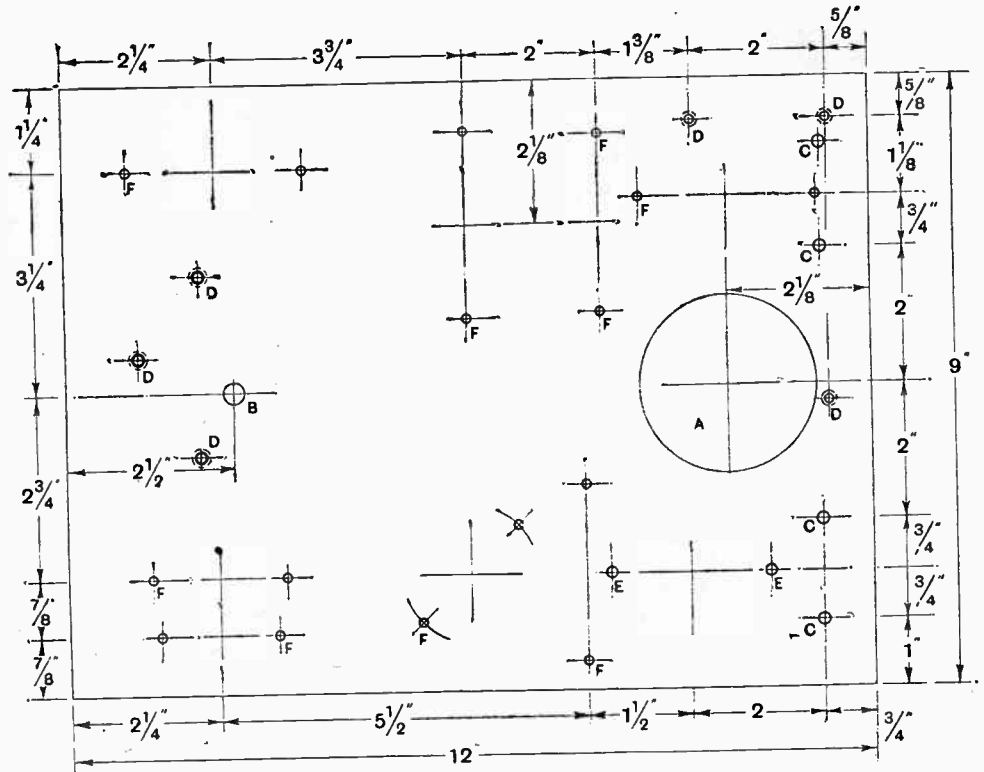

Drilling details of the top ebonite panel as viewed from the underside. A, 2-5/8 in. dia.; B, 5/16 in.; C, 3/16 in.; D, 5/32 in. and countersunk on top; F, 5/32 in.

with an ebonite ring sawn from a piece of $\frac{3}{4}$ in. tube. It might be mentioned that, owing to the springy nature of the heavy gauge wire, a cylinder is required smaller in diameter than the finished coil, and tests should therefore be made with several formers. The holes in the ebonite, which, of course, give clearance to the wire, should not be so large as to allow the turns to be loose, though the wire must slide through freely.

The filament choke coil is wound on an ebonite tube lifted from the base by means of two $\frac{1}{8}$ in. ebonite spacers. Four 8 B.A. screws with nuts serve as terminals. A wrapping of thin insulating paper separates the two layers, both of which are wound in the same direction, that is, starting from one end of the coil, both windings can represent, as it were, a right-hand screw. It will thus be seen that, as regards acting as a choke, both windings are in parallel.

Assembly.

All of the components are held down to the panel by means of 6 B.A. screws and blind holes. Although the writer does not make a practice of adopting tapped holes in the construction of broadcast apparatus, their adoption is perhaps permissible in this instance, where the constructor is certain to have had some experience in the making up of receiving sets. All tapped holes are, however, uniform in size—6 B.A.

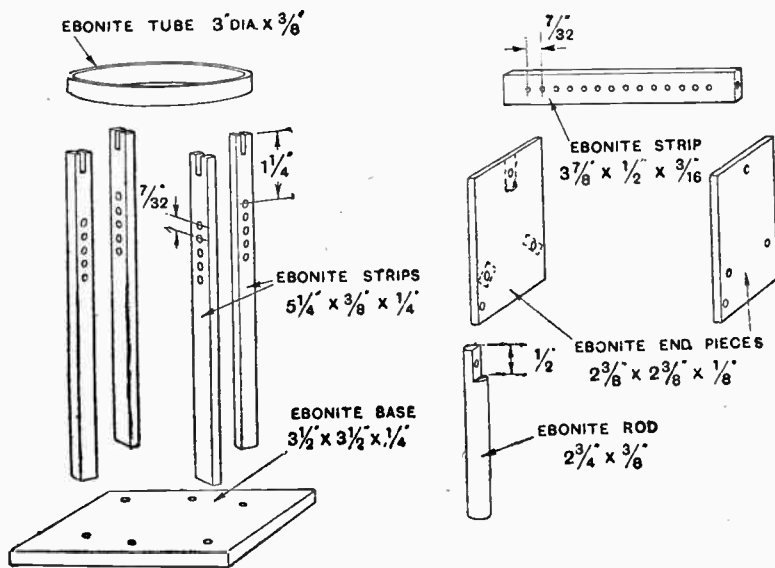

Constructional details of the tuning and exciter coils.

New Short-wave Oscillator.—

leads, but, in any case, so long as the filament leads possess inductance, a potential will be built up between filament and the battery terminals which, in turn, will permit of a potential difference existing across the few turns forming the grid coil. The filament is bridged with a condenser, so that oscillating current will have equal access to both ends.

Other Circuit Considerations.

The tuned circuit is connected between grid and filament, achieving the object of making the grid-plate capacity of the valve insignificant compared with the relatively large value of the tuning condenser. By this means valves, similar in type, may be interchanged without appreciably affecting the calibration of the instrument, assuming that this is not relied upon on the 0 to 5 setting of the condenser scale. It is, of course, always inadvisable to make use of the scale of a variable condenser within a few degrees of the zero end. For this circuit arrangement can be claimed, therefore, fairly uniform oscillation over a wide range of adjustment, calibration is uninfluenced, within practical limits, by interchanging valves, and an important practical consideration is that coupled coils, often placed one within the other, are dispensed with, for the

difficulty of rigidly setting up coils which are in close proximity must not be overlooked.

The grid potential is regulated by means of a shunted grid condenser, suitable values being 0.005 mfd. and 10,000 ohms. By substituting a leak resistance having a value of 50,000 or 100,000 ohms, the circuit can be made to whistle by cutting up the continuous oscillations into a series of oscil-

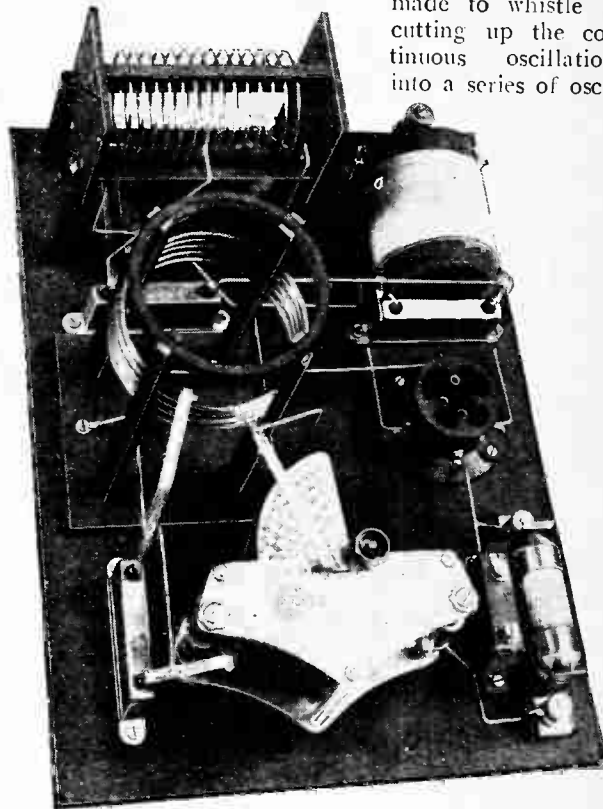

The components are arranged so that connecting up is carried out by means of short direct leads, an important feature in wavemeter design.

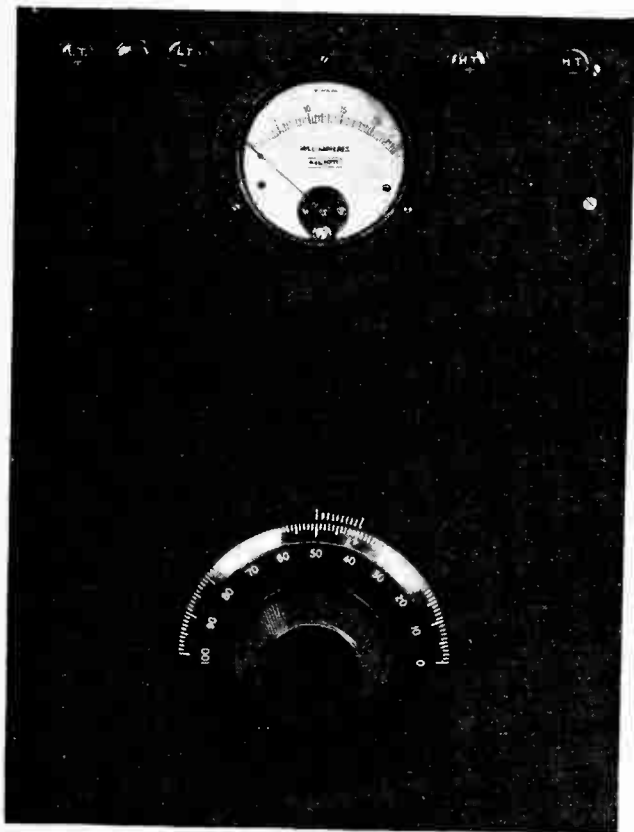

The front panel has a clean appearance owing to the absence of screw heads. The components, which are attached to the underside, are light in weight and are secured in position by means of screws and blind holes. The two screws in the top right-hand corner may be blued or treated with camera black to render them less conspicuous.

A 12

lation trains, the pitch of the note depending upon the value of the resistance combined with a given condenser. The advantages gained by modulating the oscillations in this way are that the signals from the wavemeter can be picked up on a receiver which is not oscillating, that the note, which is exceedingly constant, can be caused to beat with the heterodyne note permitting of exceedingly critical tuning adjustment, and, moreover, as the oscillation trains are cut off as a result of the grid potential becoming excessively negative, harmonics will be set up which likewise will be modulated. By making use of the harmonics, the wavemeter can be used to measure wavelengths as low as 5 metres. A hot wire ammeter connected in the oscillatory circuit reveals that the tendency to oscillate over the entire scale of the tuning condenser is less uniform than when the leaky condenser is merely used for grid biasing, yet, nevertheless, self-oscillation is maintained.

Constructional Data.

In constructing the set, cabinet-making is avoided by adopting a standard containing box. The top panel is

NEW SHORT WAVE OSCILLATOR

Wavemeter with
an Optimum
Wavelength of
40 Metres.



Suitable for Use
as a Low-power
Transmitter or
Drive Oscillator.

By F. H. HAYNES.

It is to be wondered how many transmitting amateurs there are who have in their possession an accurately calibrated wavemeter. This remark is based, not only upon conversation with those who are privileged to transmit, but also on the observations one hears when listening in on the short-wave band. "What do you make my wavelength?" is quite a common remark, though the operator making this request should have a precise knowledge of the wavelength he is using before opening up communication with another station. The reply from the other station usually bears equal evidence of the absence of a wavemeter if only by the evasiveness of the reply, but when statements are made it has rarely been the experience of the writer to find that they were anything like accurate. When listening with a short-wave set, it is an undisputed fact that the various stations in Great Britain are to be picked up at settings widely distributed across the tuning dial, whilst, in fact, the wavelengths allocated by the Post Office for experimental working are normally fixed at 8, 23, 45, and 90 metres. For a station to use a wavelength of 47 metres, or 22 instead of 23, might be regarded as a contravention of the transmitting permit.

In reception the wavemeter is a luxury, yet to the methodical experimenter it must be regarded as a necessity. To rely on dial setting as an indication of wavelength is not permissible in any receiver where variable coupling is employed, and it is even less desirable in the case of a short-wave set where the inductance of the coil in the tuned circuit varies appreciably according to the positions of the aerial and reaction windings.

The design of an oscillator for metering short waves presents many problems which are not met with on the longer wave bands. The principal difficulty is to arrange and proportion the circuit so that oscillation amplitude is reasonably constant with all settings of a relatively large variable tuning condenser. In this wavemeter a separate inductance in the plate-circuit is used for excitation having the property of maintaining oscillation for all settings of the tuning condenser which has a maximum value of 0.005 mfd.

Separate Coil for Excitation.

It will be seen from the circuit diagram that a portion of the anode coil is common to the grid circuit, for the grid filament path is *via* the grid condenser and leak, the negative battery terminals, the H.T. bridging condenser, a few turns of the exciter coil, and thence through the stopping condenser to the filament. The condenser in the exciter coil tapping lead, referred to as a stopping condenser, is charged to the potential of the H.T. battery, and in tracing the action of the circuit one should imagine the H.T. battery as being connected in this lead. Thus with a tapping point somewhere near the middle of this coil at filament potential as regards oscillatory currents and with the valve plate connected to one end and the grid to the other (*via* the H.T. bridging condenser), an oscillating circuit is formed. The operation of this arrangement depends upon the effectiveness of the choke coils in the filament

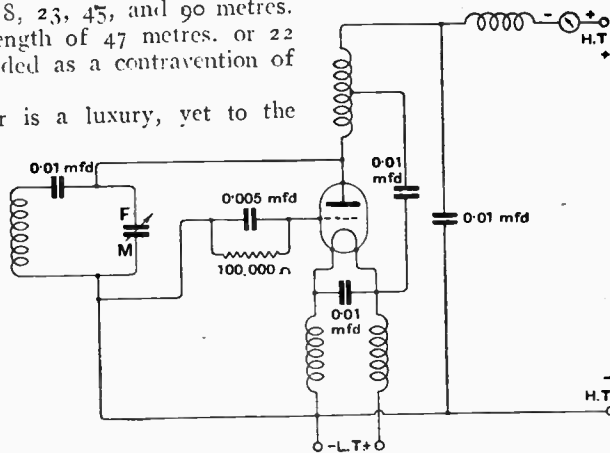

Self-oscillation is maintained by means of the inductance inserted in the valve plate circuit. The mid-point is connected to the filament, the lower end to the plate and the upper end indirectly to the grid.

this reason that we have avoided doing so. There seems little doubt that ultimately the use of the frequency designation will find favour, but certainly when dealing with short wavelengths it is, at present, less cumbersome to refer to metres, whilst those who desire to do so can always convert into kilocycles for their own benefit, and for precise work on short waves the frequency designation would, of course, be essential, unless we preferred to refer, for example, to 5.2625 metres, or divide the metre fractionally.

o o o o

COPYRIGHT OF THE B.B.C. PROGRAMME.

AT the time of writing, a legal case of unusual interest has just been concluded before Mr. Justice Astbury, in the Chancery division. The plaintiffs were the British Broadcasting Co., Ltd., and the defen-

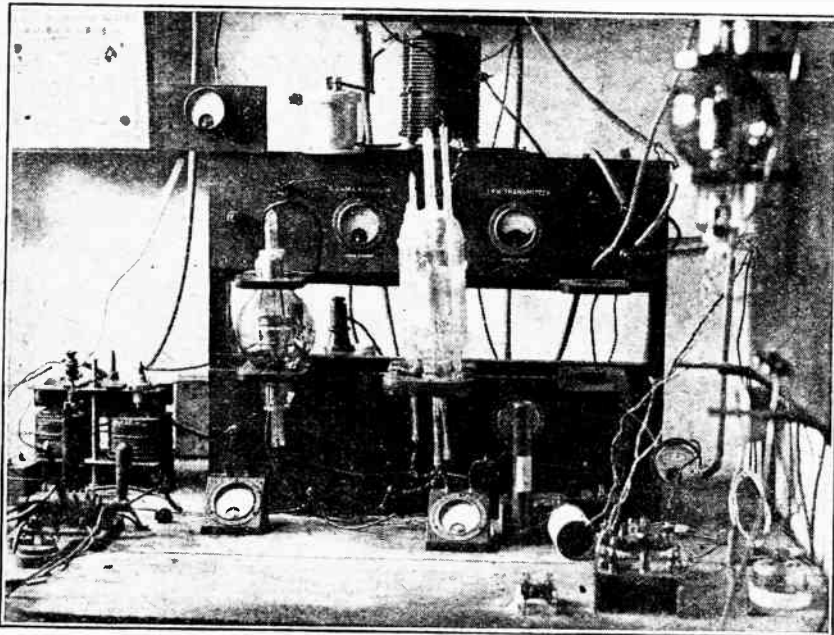

PROGRESS AT 2NM.—Mr. Gerald Marcuse avails himself of his well-earned facilities in regard to the use of high power for world wide telephony tests. This recent photograph shows the installation of a Mullard 1-kW. valve.

dants the Wireless League Gazette Publishing Co., Ltd. The defendant company, which is unconnected with the Wireless League, produced a journal which contained a summary of the broadcasting programme for the following week. The British Broadcasting Co. sought an injunction to restrain the defendants in the present action from continuing the publication of advance programmes, but in the case just concluded the defendants denied infringement and the existence of any copyright in the programmes, and pleaded, alternatively, that the copyright, if any, was not owned by the B.B.C.

The history of the publication of the programmes of broadcasting events is an interesting one. In the early days of broadcasting, before publication of the "Radio Times" was commenced, details of the principal items of the programmes were published in the daily Press. After a time, however, the daily Press instituted what practically amounted to a boycott of the B.B.C., and excluded the programmes from newspapers, and for a

time the public were without any means of obtaining advance information regarding the forthcoming broadcast items. It was after this that the "Radio Times" commenced publication, and the daily papers also resumed the printing of the programmes of the day because they were forced to recognise the news value of this advance information.

The result of the case is that an injunction has been granted to the B.B.C., restraining the defendants from copying the broadcasting programmes published in the "Radio Times." It was also held by the judge that the B.B.C. owned the copyright of the programmes.

It would be difficult to conjecture what would have been the outcome of the present action if it had not been decided in favour of the B.B.C. and the copyright upheld. From the point of view of the broadcast listener the result is of some importance, because if it had been established that there was no copyright in the broadcast programmes, then it is doubtful whether, if every paper were thus placed in the position of being able to publish the programmes, it would have been satisfactory for an official programme paper to continue, because it would undoubtedly lose circulation through competition. On the other hand, the absence of any official programme might mean that no paper would publish programmes in full, but only extracts of the principal items, because it must be remembered that considerable space would be occupied by the publication of the entire programmes from all the British stations, and, without a monopoly in the publication, it seems uncertain whether a remunerative publication could be produced, since it is, of course, due to the programme monopoly that the "Radio Times" has obtained its present large circulation.

o o o o

GOVERNMENT-CONTROLLED BROADCASTING.

ALTHOUGH at the time of writing no official statement is available, rumours are current that the Broadcasting Committee of Enquiry includes in its recommendations the proposal that broadcasting should cease to be run by the B.B.C., but should be taken over by a Government-appointed Board of British Broadcasting, under the direction of which the present personnel of the B.B.C. would act.

We sincerely hope that the official recommendations are not so drastic as the rumours imply, because such a procedure would be converting the present organisation virtually into a Government Department, and we very much fear that, under such circumstances, there would no longer be the enthusiasm and incentive to persistent effort which has characterised the work of the B.B.C. organisation in the past.

The Wireless World

AND
RADIO REVIEW
(13th Year of Publication)

No. 343.

WEDNESDAY, MARCH 10TH, 1926.

VOL. XVIII. No. 10.

Assistant Editor:
F. H. HAYNES.

Editor:
HUGH S. POCOCK.

Assistant Editor:
W. JAMES.

Editorial Offices: 139-40, FLEET STREET, LONDON, E.C.4

Telephone: City 4011 (3 lines).

Advertising and Publishing Offices: DORSET HOUSE, TUDOR STREET, LONDON, E.C.4

Telephone: City 2847 (13 lines).

Telegrams: "Ethaworld, Fleet, London."

COVENTRY: Hertford Street.

BIRMINGHAM: Guildhall Buildings, Navigation Street.

MANCHESTER: 199, Deansgate.

Telegrams: "Cyclist Coventry."
Telephones: 10 Coventry.

Telegrams: "Autopress, Birmingham."
Telephone: 2970 and 2971 Midland.

Telegrams: "Hiffe, Manchester."
Telephone: 8970 and 8971 City.

Subscription Rates: Home, £1 1s. 8d.; Canada, £1 1s. 8d.; other countries abroad, £1 3s. 10d. per annum.

As many of the circuits and apparatus described in these pages are covered by patents, readers are advised, before making use of them, to satisfy themselves that they would not be infringing patents.

THE IMPORTANCE OF THE LISTENER.

IT is difficult to over-estimate the importance of the listening section of the wireless public, by which we mean those whose principal interest, at the moment at any rate, is in listening to the programmes without concerning themselves with how wireless works or why the movement of certain controls on their receivers will produce different effects. We who are concerned mostly with the experimental and amateur side of wireless are inclined, perhaps, to overlook the fact that by far the majority of those who participate in broadcasting are simply listeners. To them, broadcasting, quite apart from the scientific aspect of the subject, is a wonderful new service with infinite possibilities before it. Wireless to-day has probably only entered a small proportion of the homes of the country, and certainly it has not yet achieved anything like the ultimate possibilities which must still lie ahead.

To a vast and ever-increasing number of persons, therefore, broadcasting is appreciated for the service which it gives, and we should not forget its potentialities purely as a public service as distinct from the technical aspect.

We believe that the listening public should be given a larger voice in the conduct of broadcasting, and especially in any new changes which may come about as a result of the recommendations of the Committee of Enquiry. It does not, to us, seem right that any drastic change in the organisation and control of broadcasting should take effect without an opportunity being given first to the

listening public to state whether they are satisfied or not with the present control. We understand that a promise has been given that Parliament shall have full opportunity for consideration of any proposed changes before these are put into force, and, therefore, it is through Parliament that the public must give expression to its views. A recent statement shows that the total number of wireless licences issued has reached 1,841,000, and the actual number of listeners is, of course, considerably greater, because the majority of receivers are used by two or more individuals. There would appear to be the opportunity for an organisation representing the interests of the listener to become extremely influential and valuable, not only to the listeners themselves, but to the whole machinery of broadcasting, because by means of such a body, if well supported, the views of the listening public on all matters appertaining to broadcasting could be easily ascertained.

o o o o

METRES v. KILOCYCLES.

UNDER the above heading a reader contributes to the Correspondence columns of this issue a letter expressing

his views on the subject, oft discussed, of whether the use of kilocycles should be adopted in preference to metres. There is, of course, a good deal to be said on either side, but we are strongly in support of our reader's view that the sudden adoption of kilocycles generally in place of metres would lead to great confusion.

Our own readers, we feel sure, would not appreciate it if we introduced the change in our Journal, and it is for

CONTENTS.

	PAGE
EDITORIAL VIEWS	359
NEW SHORT WAVE OSCILLATOR	361
By F. H. Haynes.	
"LISTENING IN" AT 70 MILES AN HOUR	365
AN INSTANTANEOUS DIRECT-READING GONIOMETER	367
READERS' NOVELTIES	370
CURRENT TOPICS	371
PRACTICAL HINTS AND TIPS	373
SHORT WAVE NOTES	375
By J. A. Partridge.	
BROADCAST BREVITIES	377
SHORT WAVE RECEIVER	379
By F. A. Boyce.	
RECENT INVENTIONS	384
DICTIONARY OF TECHNICAL TERMS	385
NEWS FROM THE CLUBS	387
LETTERS TO THE EDITOR	388
READERS' PROBLEMS	389

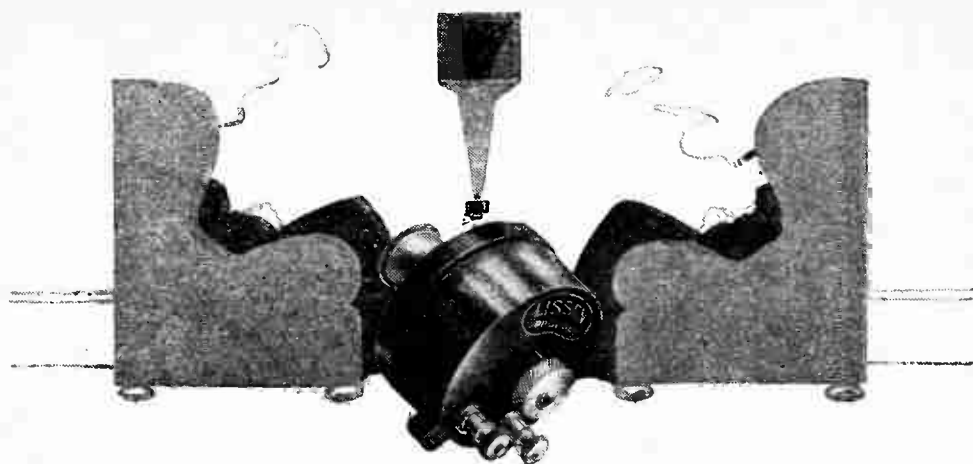

Build your own Loud Speaker and discard your headphones

Gone are the days of troublesome 'phones. The Lissenola brings loud speaker convenience to every home at a record in low price. For 13s. 6d.—less than the cost of headphones—you can buy the Lissenola, which only needs the addition of a horn to make it a powerful, full-sized instrument yielding results equal to an expensive loud speaker.*

Compare the price last. Make this test *before* buying: Go to your dealer—ask him to put on the best loud speaker he has in stock—then use the same horn on the Lissenola, and see if you can notice any difference.

You can build a horn yourself—with each Lissenola we give you full-size exact patterns and clear instructions how for a few pence you can build a big horn of proved efficiency. The illustration above shows the effective horn you will build. It can be covered with fancy paper or painted so as to resemble a factory-made article.



In addition, the Lissenola will fit the

tone-arm of any gramophone, instantly converting it into a radio loud speaker.

By using the Lissen Reed (sold separately for 1s.) the Lissenola will carry a cone or any other diaphragm working on the reed principle. You can quickly make a paper diaphragm yourself.

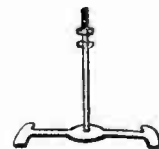

**The secret of the Lissenola's remarkable efficiency rests in the effective manner in which the electro-magnetic sound-reproducing system is concentrated.*

Your dealer will gladly demonstrate and supply—or post free by return from the makers—price 13/6, or with Lissen Reed 14/6.

BUY THE LISSENOLA and build your own Loud Speaker

Lissen Limited, 21-25, Friars Lane, Richmond, Surrey

'Phone: Richmond 2285 (4 lines).

'Grams: "Lissenium." 'Phone, London."

L.11

Constructors!



WHEN you are making that new set or adding that extra valve, be sure to use **T.M.C. LOW CAPACITY KEYS** for your switching arrangements.

With these well designed, efficient keys you can put into practice innumerable switching combinations.

They can be mounted on a panel of any material because all the live parts are effectively insulated from the frame.

They are positive in action. There are no rubbing parts to wear out. The contacts of "gold-silver" alloy are lifted apart by a small but rapid movement of an ebonite roller. The switch cannot spring back, once it is set. The ends of the contact springs are tinned to facilitate soldering.

Because of their very low self-capacity, they can be used for High Frequency as well as Low Frequency switching.

They are neat in appearance. Visible parts are of polished and lacquered brass, or, if desired, bright nickel plate.

TMC Low Capacity Keys

Made in three models.

No. 1.	12 point, 3 position	7/-
No. 2.	6 point, 2 position	6/-
No. 3.	24 point, 3 position	15/6

Other T.M.C. Lines.

Concert Grand Loud Speaker	£6 10 0	Crystal Set No. 2a (From)	£1 17 6
Standard Loud Speaker	5 0 0	Crystal Set No. 3	2 7 6
Junior Loud Speaker	2 10 0	Four-Valve Set No. 4b	21 0 0
Lightweight Headphones	1 2 6	(Plus Marconi Tax)	2 10 0
2a Headphones	15 0	Two-Valve Set No. 7b	12 0 0
Minor Loud Speaker	1 1 0	(Plus Marconi Tax)	1 5 0
Crystal Set No. 9	12 6		

WRITE FOR FREE CATALOGUE.

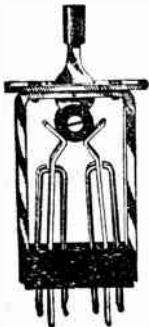

No. 1 L.C. Key, Price 7/-

TELEPHONE MANUFACTURING CO., LTD., Hollingsworth Works, West Dulwich, S.E.21.

Phone: Sydenham 2460/1.



"Going to make a set? Don't forget to use

GLAZITE
BRITISH MADE REGD.
COLOURED CONNECTING WIRE"

Red, Yellow, Blue and Black

10 foot COILS
Be sure to see the LEW seal
Per 1/- Coil

2 foot LENGTHS
Four assorted colours in an envelope
Per 1/2 Pkt.

Obtainable from all dealers

Write for interesting descriptive leaflet

THE LONDON ELECTRIC WIRE CO. AND SMITHS LTD.
(Makers of Electric Wire for over 40 years.)
Playhouse Yard, Golden Lane, London, E.C.1

This mark



guarantees quality.

JUDD

FOR TRUTH IN MUSIC USE



INTERVALVE TRANSFORMERS

TYPE AF 3
25/-



TYPE AF 4
17/6

FERRANTI LIMITED HOLLINWOOD LANCASHIRE

NEW LAMPLUGH STRAIGHT LINE CONDENSER LOW LOSS

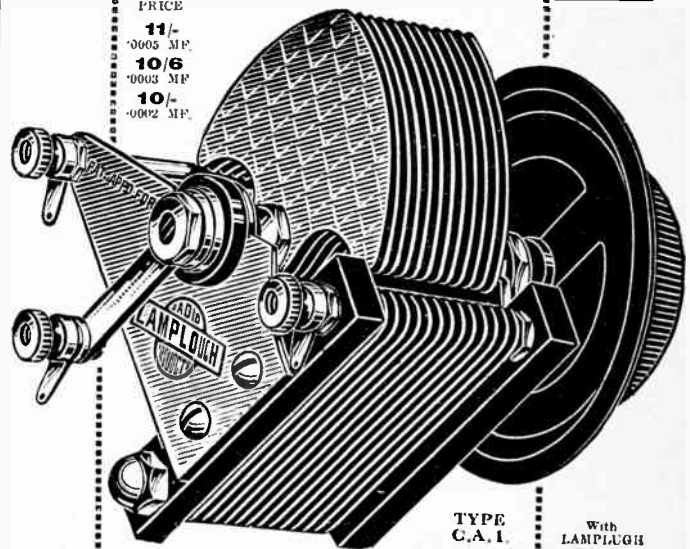

PRICE
11/- '0005 MF
10/6 '0012 MF
10/- '0022 MF

TYPE C.A.I.

Produced in response to numerous requests for a cheaper condenser having the same electrical qualities as the De Luxe model.

If your dealer cannot supply we can. Send for list.

With LAMPLUGH Grip-dial. Minimum capacity - 84 - Micro-Micro Farads.

S. A. LAMPLUGH, Ltd., King's Road, Tyseley, BIRMINGHAM

The Wireless World and Radio Review

COUPON for

"HIDDEN ADVT." COMPETITION

This coupon is available until Monday, 10 a.m., March 15, 1926

Clue No.	Name of Advertiser.	Page
1		
2		
3		
4		
5		
6		

I enter the above solution subject to the published rules.

Name (Please write clearly)

Address 10/3/26

Your Loudspeaker

WILL SING

THE PRAISES OF

NELSON MULTI-FILAMENT VALVES



Here is a Valve giving you Finest Quality and Volume with Economy. It is of equally high grade as H.F., Detector, L.F., or Power Amplifier.

The little switch places at your command each of 3 Filaments separately, or any 2 in parallel for Power Amplification. Each Filament gives the Valve a New Life.

ALL VALVES are Guaranteed.

FOUR IMPROVED TYPES.

Obtainable at All London's Largest Stores.	A. 4 to 5 VOLTS, 0.45 AMPS. per Filament 9/6
	D.E.A. 2.6 VOLTS, 0.18 AMPS. per Filament 15/-
	D.E.S. 1.3 to 2 VOLTS, 0.35 AMPS. per Filament 15/-
	D.E.O.S. 3 VOLTS, 0.06 AMPS. per Filament 18/6

If unable to obtain from your dealer, write direct :- NELSON ELECTRIC COMPANY LIMITED, Merton Park, London, S.W.19.

Telegrams: Valvenelco, Wimbale, London.

Phone: Wimbledon 172.



SP 18
RED SPOT
GREEN SPOT
SHORTPATH

Take the SHORTPATH to Better Reception

COMPARE the characteristics of SP 18 valves with the published figures of other makers. Take the Voltage Amplification Factor, multiply it by the Mutual Conductance in micromhos. The square root of the product is the figure to use when comparing the relative merits of valves. The characteristics of SP 18 valves are:

	RED SPOT	GREEN SPOT
Voltage Amplification Factor	7	15
Impedance	7,000	17,000
Mutual Conductance micromhos	1,000	850
Figure of Merit	84	113

Then buy a S.P. 18 Valve and make the practical comparison
Obtainable from most wireless dealers.

METRO-VICK SUPPLIES LTD.,
(Proprietors, Metropolitan-Vickers Electrical Co. Ltd.)
4, Central Buildings, Westminster, London, S.W. 1

Compare also the filament details. SP 18 Valves require only a single cell 2-volt accumulator consuming 0.3 Amp. at 1.6 to 1.8 Volts.

Compare finally the price. "Cosmos" SHORTPATH Valves cost:

Green Spot or Red Spot	} 12/6
------------------------------	--------

Cosmos

RADIO VALVES



FIT A "MELLOWTONE" COUPLER

and save 50%

The "MELLOWTONE" COUPLER is the most efficient and economical method for Tuned Anode and Reaction, Variable H.F. Transformers, Super Heterodyne, Oscillators and Super Heterodyne Couplers.

Designed to avoid distortion, gives excellent selectivity and perfectly smooth reaction control. Neat, compact and finished in first-grade precision manner. Plugs into standard valve holder, takes up small panel space, has small external field and high coupling ratio.

**Replaces Coils and Holders
at less than half the cost.**

Obtainable from all reputable dealers. Write for Illustrated List of this and other Mellowtone Specialities—and if interested in QUALITY Receivers, ask for Catalogue of Mellowtone Two and Four Valve Sets.

AERIAL & REACTION	
25	5/6
35 (B.B.C.)	5/6
50	5/6
75	5/6
Daventry	7/6

MELLOWTONE

MIDLAND RADIOTELEPHONE MFRS LTD.

BRETTELL LANE WORKS
STOURBRIDGE

TUNED ANODE and REACTION	
250-650	5/6
650-1650	7/6
1500-3000	10/6
(Daventry)	

Telephone: Stourbridge 318. Experimental Station: 2WQ. Radio-Ads.

A Famous AMPLION Model Reduced in Price

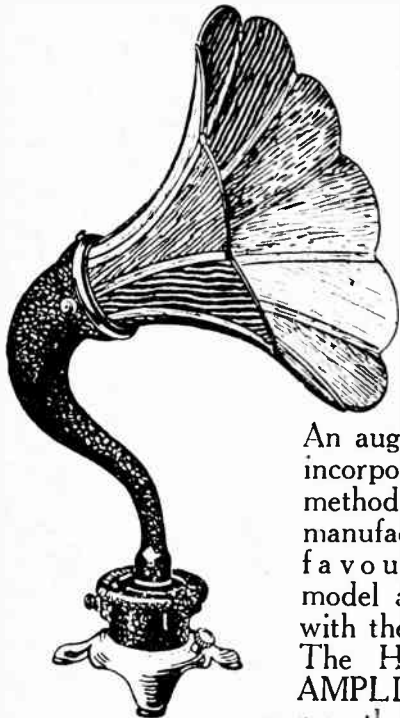

An augmented production incorporating new scientific methods has reduced the manufacturing costs of a favourite AMPLION model and, in accordance with the regular policy of The House of Graham, AMPLION purchasers reap the benefit.

De Luxe SWAN-NECK with wood flare in oak or mahogany,

£4. 15. 0

With metal flare £4. 4. 0
Other Swan-Neck models at 38/- & 53/-



Obtainable from AMPLION STOCKISTS, Radio Dealers or Stores.
Demonstrations gladly given during business hours at the AMPLION Showrooms:

25-26 Savile Row, London, W.1.
79-82 High Street, Clapham, S.W.4.

101, St. Vincent Street, Glasgow.
10, Whitworth St., West, Manchester.

There is no substitute for a genuine AMPLION

Announcement of Alfred Graham & Co. (A. A. Graham), Crofton Park, London, S.E.4.

Satisfaction is guaranteed because if you have any cause for complaint, you have only to send the component back to us, and we will replace it entirely free of charge. Every "Utility" product is unconditionally guaranteed.

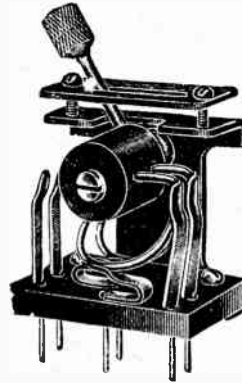

"UTILITY" NO CAPACITY CHANGE OVER SWITCHES.

Made to change over any number of contacts. The design ensures that self-capacity is negligible and contacts are rubbing and therefore self-cleaning.

Made in two styles—Knob and Lever Patterns.

Price (each) Knob.		Lever.	
No. W.130/1*	3/6	No. W.147/1*	4/6
No. W.130/2	4/-	No. W.147/2	5/-
No. W.130/3	5/-	No. W.147/3	6/-
No. W.130/4	6/-	No. W.147/4	7/6
No. W.130/5	7/-	No. W.147/5	10/-
No. W.130/6	8/-	No. W.147/6	10/-

*This figure shows the number of poles changed over, e.g., W.130/4 indicates Knob type 4 pole change over.

Nickel plate finish—Knob type 3d. Lever 6d. each extra.

Utility

GUARANTEED

COMPONENTS

Wilkins & Wright, Ltd.,
Utility Works, Kenyon Street, Birmingham.

F.P.S.7.

CLIX

REGD TRADE MARK

WANDER-PLUGS

(NON-MICROPHONIC)

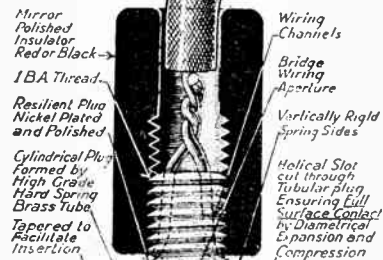

A perfect fitment for every type of H.T. Battery.

PRICE:
2D.
EACH

The diametrical expansion and compression of the CLIX WANDER-PLUG ensures rigid full-length, full-surface contact, with 90% of the efficiency of a soldered joint.

For all other connections use CLIX plugsockets and adapters.

From all traders or direct from:

AUTOVEYORS LTD., 84 VICTORIA ST., LONDON, S.W.1

Too economical even to glow

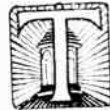

THE wonderful "N" filament valves are so economical that no sign of glow can be discerned. They require only ONE-TENTH AMPERE from a 4-volt accumulator (or 3 dry cells). This means SEVEN TIMES THE LIFE of each accumulator charge; a distinct saving of your time and money.

ASK FOR THE P.M.3 - - 16/6

The general purpose Valve, suitable for every circuit. Gives clear strong signals free from microphonic disturbance.

ASK FOR THE P.M.4 - - 22/6

A power valve for majestic Loud Speaker volume. The finest Loud Speaker Valve ever produced.

GET THEM FROM YOUR RADIO DEALER



These Valves only require the same H.T. current as for equivalent types.

Mullard
THE MASTER VALVE

ADVT. THE MULLARD WIRELESS SERVICE CO., LTD., BALHAM, LONDON, S.W.14

Advertisements for "The Wireless World" are only accepted from firms we believe to be thoroughly reliable.

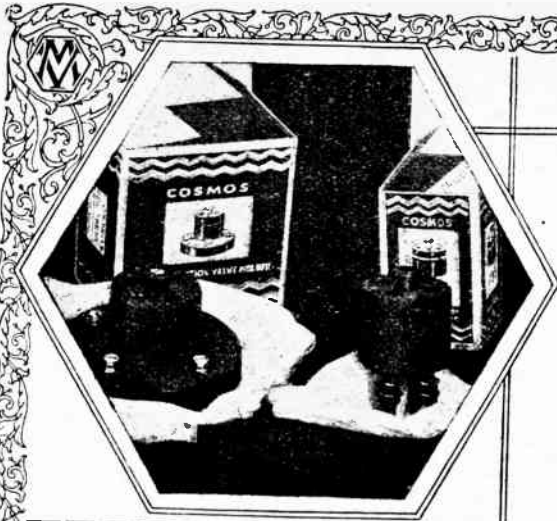

Anti-vibration Valve Holders

No sponge rubber, which absorbs moisture, is used in the construction of "Cosmos" Anti-vibration Valve Holders. They are made in two types as shown in the illustration. The panel mounting type can be readily fitted in place of an ordinary holder, as the fixing screws have standard spacing while the baseboard type can be fitted to a wooden base with wood screws. "Cosmos" Anti-vibration Valve Holders abolish the objectionable noises due to vibration and "sound coupling" and obviate trouble from the microphonic tendency of some valves.

METRO - VICK SUPPLIES LTD.
(Proprietors. Metropolitan-Vickers Electrical Co., Ltd.)

4, Central Buildings, Westminster, London, S.W.1.

Price { Panel Mounting } 2/9
 { Base Mounting }

Cosmos

RADIO COMPONENTS

The choice of 40 leading Manufacturers



IGRANIC-PACENT PORCELAIN RHEOSTATS and POTENTIOMETERS

(Patent No. 238462.)

Low price, pleasing appearance and a smooth reliable contact—these are some of the features of the Igranic-Pacent Porcelain Rheostats and Potentiometers.

The special method of construction greatly facilitates mounting and preserves the original accuracy of judgment.

Rheostats.

Supplied in Resistances of 6, 10, 20, 30 or 50 ohms, with current carrying capacity of from 1.5 to 3 amps. Price 2/6 each.

Potentiometers.

Supplied in Resistance of 400 ohms, with current carrying capacity of 25 amps. Price 2/6 each.

This is the unique position held by Pacent Radio Essentials in America—surely an eloquent proof of their very high quality and efficiency. Why not make IGRANIC-PACENT RADIO ESSENTIALS your choice also? Igranic enterprise has made it possible for you to obtain these distinctive components from your usual wireless dealer—at prices within the reach of every radio constructor.

Here are illustrated and described two components of the range. If you would know about them all, write for our Booklet P59.

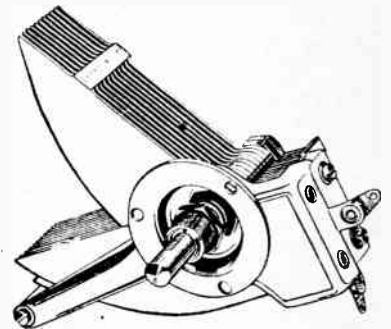

THE IGRANIC-PACENT TRUE STRAIGHT LINE FREQUENCY VARIABLE CONDENSER.

A high-grade variable condenser with low-loss characteristics, a true straight line frequency curve and negligible minimum capacity. Fixed and moving plates are of brass, riveted together and soldered, ensuring permanent alignment and sound electrical connection. Only two small pieces of highest quality insulating material are used, so arranged that the absorption losses are negligible.

Dust-proof bearing results in smooth, silky movement. Positive stops at minimum and maximum are contained within the bearing.

Single or three-hole fixing is provided for. Two condensers can be mounted to form a dual instrument with single dial control.

Prices: '00035 mfd., 14/6; '0005 mfd., 18/6.

IGRANIC ELECTRIC CO. LTD., 149, Queen Victoria St., London. Works: Elstow Rd., Bedford
Exclusive Manufacturing Licensees of PACENT Radio Essentials.

MARCONI VALVES

Type D.E.3

Use THE MARCONI D.E.3 Dull Emitter for economical working. Equally suitable as a Detector or L.F. or H.F. Amplifier. Current consumption 0.06 amps. For use with a 4-volt accumulator or 3 dry cells.



The name MARCONI on a Valve is a guarantee of outstanding performance, sound design and extreme durability. The best known experimenters and the principal Broadcasting stations of the world are equipped with MARCONI Valves.

Write for Valve Publication No. 443-A.

Write for Publication No. 364F.

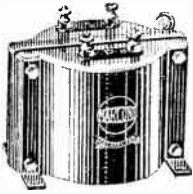

Marconiphone IDEAL Transformers.

Each Transformer guaranteed to comply with the curve supplied with it.

Type "A" ratio 27 to 1	} Price	30/-
" " " " 4 to 1		
" " " " 6 to 1		
" " " " 8 to 1		

Junior Model. New Reduced Price 21/-



STERLING "Miniloss" Square Law Variable Air Condenser.

Made in	00025 mfd.	Price	21/-
3	0005 mfd.	"	24/-
capacities:	100 mfd	"	30/-



Marconiphone High-Frequency Choke.

For coupling H.F. circuits. Suitable for all wavelengths up to 4,000 metres.

Price **10/6**



Marconiphone Wavemeter.
Enables any station to be identified without waiting for its call sign.

Range 300-500 metres.
Not recommended for crystal sets.
Price complete with Dry Cell
£3 : 7 : 6



MARCONIPHONE "Velvact" Potentiometer.
Perfectly silent and smooth in operation

Price **9/-**



Marconiphone Auto Series-Parallel VARIOMETER.

Entirely new pattern. Without any condenser and connected to 100 ft. aerial, it covers wavelengths 230-1630 metres. With a 1001 Condenser in parallel wavelengths up to 3380 metres may be received.

Price **16/-**

Marconiphone and STERLING COMPONENTS

The Marconiphone Company, Ltd., Registered Office: Marconi House, Strand, London, W.C.2 and 210-212, Tottenham Court Road, London, W.1.



STERLING "Non Pong" Shock Absorbing Valve Holder.
Does away entirely with all microphonic noises.

Price **3/6**

SPARTA - a 4 valve "all-stations receiver" for

Fuller
ALL BRITISH
LONG RANGE CONCERT RECEIVER

This set provides a reliable "all stations" circuit at a really reasonable price. It is highly selective; distant stations can be tuned in without "local interference." The set is supplied in handsome polished oak case complete with grid bias battery. FULLER'S UNITED ELECTRIC WORKS, LTD., CHADWELL HEATH, ESSEX.
Telegrams: "Fuller, Chadwell Heath." Telephone: Ilford 1200.

£16.16.0
ROYALTY
5/- EXTRA

Opal inspection windows for valves.

HF Amplifier Control.

Aerial Tuning Condenser Control.

Selector Tuning Switch.

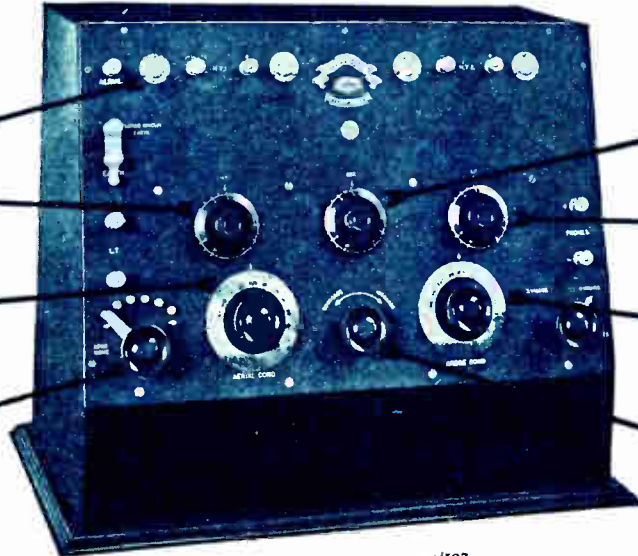

Detector Control.

L.F. Control.

Anode Tuning Control.

Anode Reaction Control.

7-4/107.

EDISON BELL RADIO

THERE IS NOTHING BETTER THAN THE BEST—WE SUPPLY YOU WITH THE BEST.

USE THESE JACKS AND BE SATISFIED



S.O. No. 1. Single Open. Price 1/8.



S.C. No. 2. Single Closed. Price 2/2.



D.C. No. 3. Double Closed. Price 2/9.



S.F. No. 4. Single Filament. Price 2/6.

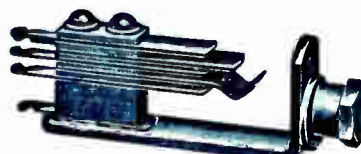

D.F. No. 5. Double Filament. Price 3/4.



1 Pair Plug. Price 2/9.

TESTED 500 VOLTS
FLAT TYPE



BRITISH THROUGHOUT

Ask your dealer for catalogues or write direct to:—
J. E. HOUGH, Ltd., Edison Bell Works, LONDON, S.E.15, & HUNTINGDON.

TESTED 500 VOLTS
UPRIGHT TYPE



INSIST ON EDISON BELL CONDENSERS

THEY ARE BRITISH MADE AND GUARANTEED BY A NAME WITH 30 YEARS REPUTATION BEHIND IT

Mention of "The Wireless World," when writing to advertisers, will ensure prompt attention.

4^p

The Wireless World

The Paper for Every Wireless Amateur

Wednesday, March 10th, 1926



New Short Wave
Oscillator.



PRACTICAL HINTS AND TIPS

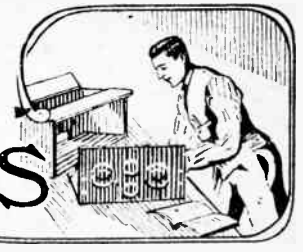

A Section Mainly for the New Reader.

A "NEUTRODYNE" PROBLEM.

Probably the greatest difficulty confronting the designer of a "2 H.F. neutrodyne" receiver is to arrange for reception of the long waves. Suitable plug-in transformers do not seem to be generally available, and in any case they are apt to be bulky, and difficulties may arise in mounting them in such a way that magnetic interaction is prevented. One is, indeed, apt to envy the American designer, who is called upon to cover only a restricted waveband, and, in consequence, finds it comparatively easy to produce a neat set without undue complications and with a "clean" layout and simple wiring.

An excellent method of overcoming these difficulties was suggested in *The Wireless World* for October 21st, 1925, where there was described a neutralised H.F. unit containing two amplifying stages. The output of the second transformer was connected to a standard pin-and-socket plug, so that it could be connected across the grid and filament of the first valve of a conventional detector and L.F. receiver by merely removing the aerial coil from the latter and substituting the amplifier plug. The transformer secondary was tuned by what was originally the parallel A.T.C. of the receiver, the aerial connection being, of course, transferred to a coupling transformer connected in the grid circuit of the first H.F. valve.

It will hardly be necessary to stress the advantages of such an arrangement. For local work the H.F. amplifier is disconnected (which operation should only require a few moments, if a suitable system of interconnecting leads is arranged), and the simple receiver is used with plug-in coils for reception both of the near-by short-wave station and for

Daventry and other long-wave transmitters. For distance work on the 250-550-metre waveband, where, of course, there is the greatest need for a high degree of sensitivity and selectivity, the amplifier should be connected up.

If an existing detector-and-L.F. receiver has a coupled aerial circuit, this system is still applicable, as the plug connected across the transformer secondary may in this case be inserted in the secondary instead of the aerial coil socket.

o o o o

SWITCHING A RESISTANCE-COUPLED AMPLIFIER.

Due to the fact that resistance-capacity coupling does not afford such a high degree of magnification per valve as is obtainable from the L.F. transformer method, it is usual to provide three stages of amplification when the former system is adopted. If, however, suitable valves are used, with sufficient high-tension voltage, it will be found that two low-frequency stages are ample for local work under most conditions, even if the detector is not preceded by H.F. amplifica-

tion. The operator may use the appropriate number of valves for the strength of signals being received.

As has frequently been pointed out in this journal, it is correct practice to arrange switching in such a way that the loud-speaker is always in the anode circuit of the last valve, if this is (as is generally the case) the only one in the receiver capable of handling sufficient power for its satisfactory operation. It will, accordingly, be best to arrange to switch off the second L.F. valve, and this may conveniently be effected by following the scheme of connections suggested in Fig. 1. When the switch is "up," all valves are in operation.

At the expense of a very slight complication in wiring, and by the use of a three-pole switch in place of that shown, automatic filament control may be introduced by wiring the filament circuit of the valve to the spare pole in such a way that its continuity is broken when the valve is switched off.

o o o o

CARE OF DULL EMITTERS.

The manufacturers of dull-emitter valves almost invariably specify the maximum anode voltage which may safely be applied to their products without unduly shortening their lives. Users should remember, however, that it is not so much the voltage applied as the *current* passed in the anode circuit which will decide how long a satisfactory degree of emission may be obtained.

If the characteristic curve of a typical small power valve is examined, it will be seen that a heavier current is flowing with only 80 volts applied to the plate and a zero grid than is the case with 120 volts high-tension and a correct value of negative voltage impressed on the grid. This is a further argument in favour of observing the rule that grid bias

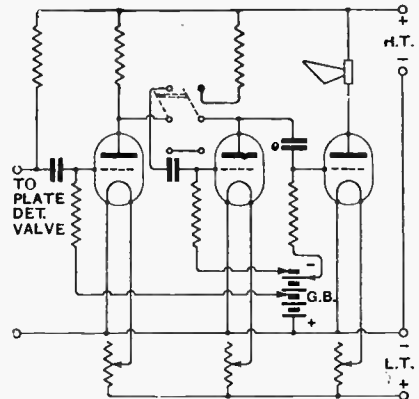

Fig. 1.—Switching a three-valve resistance-capacity coupled amplifier.

and, therefore, to avoid overloading, some form of switching should be introduced in order that

should always be applied to an amplifying valve.

It is usual to connect either the grid return lead or the leak of a detecting valve in such a way that a positive voltage is applied; here our only means of reducing anode current, with a consequent saving both in valves and high-tension battery, is to use the lowest possible voltage value of the latter, consistent with good results. Luckily, most valves operate well as detectors on quite low anode voltages—lower, indeed, than those usually applied.

o o o o

TESTING THE H.T. BATTERY.

When a suitable meter for reading the voltage of the high-tension battery is not available, a rough-and-ready test, giving a good idea as to whether this component is at fault, may be made by varying the negative biasing voltage applied to the grid of one of the L.F. amplifying valves. If it is found that a grid voltage of a lower value than would be expected (both from previous experience and a knowledge of the characteristics of the valve) results in a diminution of

signal strength and distortion, due to encroachment on the lower bend of the curve, it may safely be assumed that the voltage of the high-tension battery has dropped.

In making this test, it has been assumed that the grid battery itself is in order, and is supplying roughly the voltage indicated at its various tapping points. This is perhaps rather a bold assumption, but is likely to be justified unless the battery is an old one, as the current taken from it is negligible.

In the case of a receiver employing reaction, it is generally possible to make a good guess as to whether the H.T. voltage has dropped appreciably by noticing if the reaction coupling can be made tighter than usual without producing actual oscillation.

Still another fairly helpful indication is provided by the adjusting screw of certain loud-speakers; if it is possible to move the magnet pole pieces closer to the diaphragm than the normal setting without producing the usual rattling sound, it may be assumed that the anode voltage has fallen off.

While none of these tests afford absolutely conclusive evidence of the condition of the H.T. battery, they are helpful when no definite method of testing is available.

o o o o

H.T. FROM THE MAINS.

When using the supply mains as a source of anode voltage for a direct-coupled receiver, it is often necessary to insert a large condenser in series with the earth lead. In spite of the fact that the negative main may be earthed, it is not unusual to find that there is a difference of potential between this earth and the earth connection of the set, with the result that differences of voltage due to fluctuations in the supply, etc., may affect the grid of the first valve.

Generally speaking, better results are obtained if a coupled aerial circuit is used. In this case there is no metallic connection between the aerial and the mains, so there will be no need to insert a series condenser. It is not likely that instability will be introduced, as the low-tension battery will be more or less "earthed" through the mains.

DISSECTED DIAGRAMS.

No. 21.—A "Parallel Feed-back" Reflex Receiver.

For the benefit of readers who find difficulty in reading circuit diagrams, we are giving weekly a series of sketches showing how the complete circuits of typical wireless receivers are built up step by step. Below is shown one of the alternative arrangements for obtaining both high- and low-frequency amplification from a single valve.

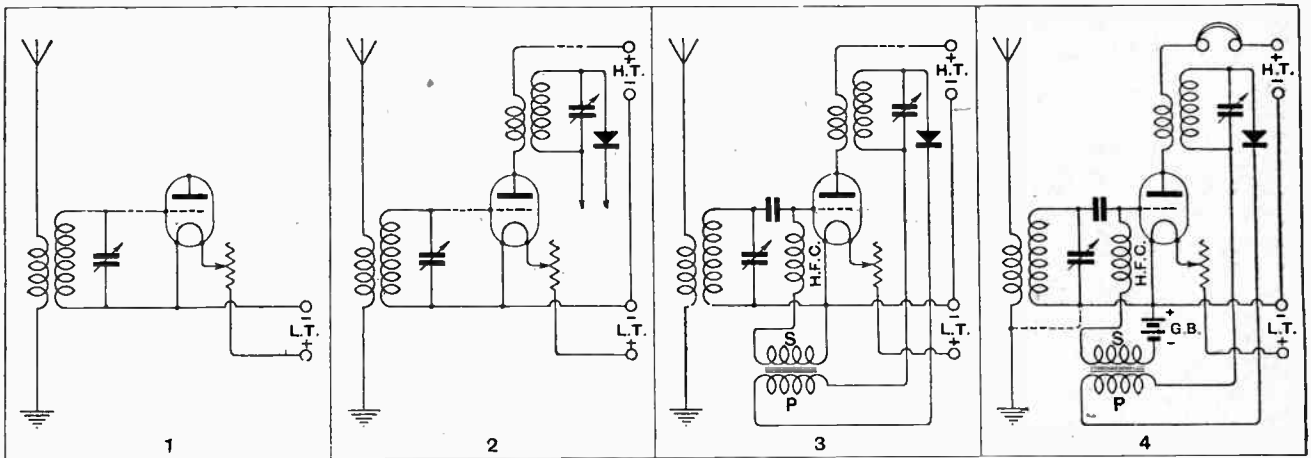

The conventional arrangement of a valve with completed filament circuit, and the tuned secondary of an aerial coupling transformer connected between the grid and negative filament lead.

The anode circuit is completed through the primary of an H.F. transformer and the H.T. battery. Across the tuned secondary is connected a crystal detector, the output of which is passed through—

—the primary of an L.F. transformer, the secondary of which is connected between filament and grid of the valve: a condenser and choke are inserted, the former preventing a short-circuit as far as L.F. pulses are concerned—

—while the latter performs a similar function with regard to H.F. currents. Phones are inserted in the anode circuit, while the grid is biased negatively. The batteries may be earthed.

SHORT-WAVE NOTES.

A Review of the Past Month.

THE month of January has, on the whole, proved rather disappointing to short-wave enthusiasts, and conditions for long-distance working have been far from favourable on the popular 45-metre band. A number of experimenters returned to the higher wavelengths, and a considerable amount of two-way working was carried on with stations in the U.S.A. on and around 90 metres, the Americans using 70-80 metres, the arrangement which was so extensively used during the early part of 1925.

Contact has, however, been maintained with stations in U.S.A., Canada, and the Antipodes on 45 metres by many of the better-known stations on this side, and although perhaps the strength of the received signal has not been so good as those heard on 70-80 metres, the shorter wavelengths have been practically free from the rapid fading effects which render good communication exceedingly difficult.

Active South Americans.

Brazilian stations have been heard at good strength using 35-40 metres as early as 11 p.m. G.M.T., but for our stations to effect communication has been a different matter, for in almost every case the South Americans have reported strong atmospheric disturbances at their receiving stations which have rendered two-way working impossible.

American stations in and around New York and occasionally amateurs in Porto Rico have exchanged signals with England, but our men have had to continue working

well into the early morning before good reports and contact have been obtained.

Australian amateurs have been few and far between, and are usually only on the air during the week-end, although A 3BD and A 6AG have been copied on Wednesday evenings at 7 p.m. G.M.T. New Zealand stations are, however, to be heard almost every morning between 6 and 8.30. Z 2AC has been particularly active, and is now endeavouring to establish contact between his own country and South Africa. Quite recently this station, when in communication with G 2KF, arranged to be on the air during the evening of the same day with the express purpose of working, or at least attempting to work, O A6N, and was received by the London station on his first call on 37 metres at 5.30 p.m. G.M.T.

The attempt to connect the two countries failed, however, for, although the English station informed A6N and also Russian NRI that the Z station would call them, the call was not heard in Cape Town.

A Station Frequently Heard.

The station at Saigon, Indo-China, operated by French 8QQ is particularly active and may be heard calling and working stations in almost every part of the world, especially those in France and Palestine. The intermediate sign used by F 8QQ is FI, and that used by 6YX (Palestine) is P. The Philippine Islands stations, who, for the main part, work traffic schedules with U.S.A., employ the letters PI to denote their location, and of these stations PI 1HR still has the best signal. On Sundays, between 2 and 5 p.m., this station may be heard working at regular commercial rate with U.S.A. 6th District, and it is only on very rare occasions that a G station is able to hook him.

Several stations operated by the U.S. Navy and Air Force have been erected in the Panama Canal zone; one of the latter, located at Coco-Solo and using the call sign U99X, has been in touch with this country.

Experimental stations in Sweden are increasing in number and may be heard almost any time of the day or night working with France, Italy, and Finland, and are conspicuous for the pure D.C. notes, which, although weak, are very easily copied. It would seem that the majority of the Swedish amateurs are relying on dry

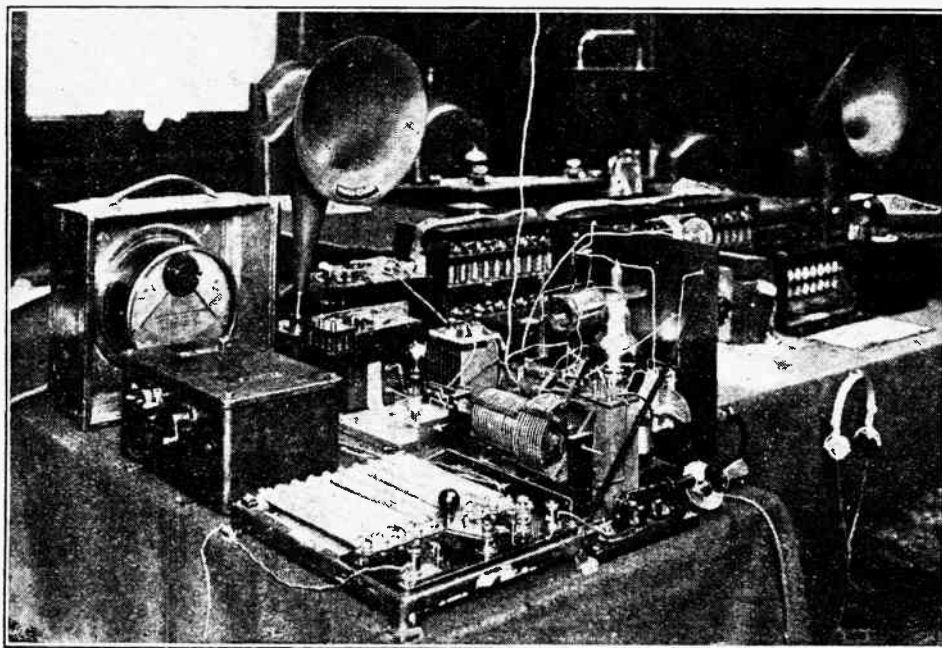

BELOW 100 METRES. The apparatus used by Mr. P. H. Dorte in his lecture on "Short-Wave Communication," which he recently gave to the London Students Section of the Institution of Electrical Engineers.

Short Wave Notes.—

cells or accumulators for their plate supplies, and that their power is limited owing to this reason.

Iceland BG 1, who a few months ago was prominent on 90 metres and who was successful in working several British stations, has ceased operations temporarily, the owner and operator being at present in this country.

Recently a station signing GFD, whose location is given as Leuchars, Scotland, was heard on 45 metres exchanging signals with GHA in Malta. GCS, who was logged some time ago on the same wavelength, has seemingly returned to his more natural surroundings on the higher waves.

Untiring British Transmitters.

The activities of the G stations continues apace. G 2LZ may be heard at all times of the day and night, and from the recent successful efforts of this station the best performance is the regularity with which contact is held with PI 1HR and O A6N. Many experimenters are wondering how the operator at 2LZ manages to continue working throughout the day and night irrespective of BCL's and loss of sleep. G 2NM does not appear to be quite so busy in the ether of late, but manages to work a few long-distance stations at week-ends. G 2OD has been heard working on 45 metres with telephony, and has also been in touch with his old friend A 2CM. Canadian 1DD has been in contact with many G stations, and his signals have been logged on 40 metres as early as 7 p.m.

The 20-metre band still fails to attract the main body of our experimenters, although U 2AHM has repeatedly endeavoured to stimulate the interest on this side by arranging tests on 18-20 metres on Sunday afternoons, when most of our stations are listening. Steady signals from this American station are to be received at 5 p.m., and it is possible, under favourable weather conditions, to carry out some very interesting tests with him.

HIDDEN ADVERTISEMENTS COMPETITION.

The following are the correct solutions for "The Wireless World" Hidden Advertisements Competition for February 24th issue, 1926.

Clue No.	Name of Advertiser.	Page
1	Midland Radiotelephone Mfrs., Ltd.	6
2	The London Electric Wire Co. and Smiths, Ltd.	17
3	Wilkins and Wright, Ltd.	2
4	The Paragon Rubber Manufacturing Co., Ltd.	19
5	The Dubilier Condenser Co. (1925) Ltd.	1
6	The Marconiphone Company, Ltd.	iv

The prizewinners are as follow:

H. J. Pearce, Croydon	£5
R. J. Winholt, Hampstead	£2
L. F. Wilkinson, Southampton	£1

Ten shillings each to the following:

A. I. Rimer, Warkworth.
C. de Beaufort, Leusden, Holland.
T. Davies, Barry Dock, Glamorgan.
W. Blundell, Fleet.

To give a general idea of the conditions governing short-wave working during the month of January, the following extracts are taken from the log book of a G station engaged in experiments on 20 and 45 metres.

January 3rd.

Signals exchanged with U 99X, U.S.A. Air Station, Coco-Solo, at 1 a.m. G.M.T.
 2.30 a.m.—Station NBA heard calling U 6BHZ.
 3 a.m.—NOSN (U.S. Submarine Base, Coco-Solo) working with U 8BWV.
 4.7 a.m.—Exchanged signals with U 1RD.
 4.55 a.m.—Two-way working with U 4BU (U signals gaining strength).
 5 a.m.—NKF heard calling BZ 5AB.
 5.30 a.m.—BZ 1AB calling CQ, Rio.
 11 a.m.—CQ de BK8.
 6.20 p.m.—Two-way working with O A6N.
 12 midnight.—No signs of signals from U.S.A. on either 20 or 45 metres.

January 8th.

G.M.T.
 11.15 p.m.—U 5AB working with BZ 1AB.
 11.20 p.m.—CQ from BZ 5Q1.
 11.25 p.m.—ABC de WIR. Strength only R3.
 11.30 p.m.—BZ 5Q1 working with U 1CMP.

January 9th.

G.M.T.
 8.20 a.m.—Two-way communication with Z 3AF.
 8.57 a.m.—CQ de A 2TM.
 9.5 a.m.—BYZ v Q48.
 9.15 a.m.—Called by U 2AFS.
 6.5 p.m.—CRP (India) working with O A6N (Cape Town).
 6.25 p.m.—Called by O A6N, two-way contact till 7.10 p.m.
 11.25 p.m.—U 2CXI, working with BZ 1AB.
 12.30 p.m.—BZ 1AB in touch with U 5HI.

January 17th.

G.M.T.
 5.30 p.m.—Two-way communication with A 5BG (South Australia).
 6.15 p.m.—Tests with O A6N.
 7.45 p.m.—Canadian 1AR received strength R5 steady signal.
 7.52 p.m.—CQ de A 3EF.
 8 p.m.—CQ de O A4Z.

January 22nd.

G.M.T.
 10.20 p.m.—Heard BZ 1AB in touch with PI 5AA.
 10.28 p.m.—BZ 1CH calling CQ.
 10.40 p.m.—Heard BZ 1CH calling SGC.

January 24th.

G.M.T.
 6.30 a.m.—In touch with U 2AHM arranging 20-metre tests.
 5.30 p.m.—Tests with U 2AHM on 20-metre band.

Improving Conditions.

The first few days of February have proved more favourable, and a considerable improvement in receiving conditions has been noticed.

Observations on KDKA working on the shorter wavelength show that this station varies in strength and quality to a great extent from night to night, often becoming entirely indistinguishable.

WGY has recently reduced his wavelength from around 40 metres to 33 metres, and has been heard at fair strength within the last few days, but the quality of the telephony received leaves much to be desired.

American stations using the ordinary broadcast band (300 to 500 metres) have failed almost entirely this season, and in very few cases indeed have their signals or programmes been heard in this country.

Broadcast Brevities



TOPICALITIES FROM

The New B.B.C.

The extent to which the Postmaster-General decides to recommend the alteration of the present broadcasting constitution, on the strength of the Broadcasting Committee's report, will provide a forecast of the development which the industry is likely to experience in the next few years.

Changes that are Desirable.

I learn that the officials of the B.B.C. are agreed that some changes are necessary in the constitution and are anxious to see the public service character of broadcasting widened; but while so much remains to be done in the way of research and experiment, and while we are still only on the threshold of fresh revelations respecting the scientific possibilities of radio telephony, it would be a bad move to alter drastically the present system on the administrative side by the introduction of bureaucratic control. The opponents of nationalisation will feel some misgivings at any attempt to form a closer union between broadcasting and Government, and it is not unlikely that the critics of the service who have been most vociferous in the past three years will be the first to clamour, when it is too late, for a return to the old conditions.

By Our Special Correspondent.

Warnings of Breakdowns.

I referred recently to the consideration which is being given by the B.B.C. engineers to a scheme for advising listeners when trouble has occurred in the transmitting apparatus of a broadcasting station, so that no listener shall be put to the unnecessary trouble of overhauling his receiving apparatus on the assumption that the fault is at his end. A suggestion which will go some way towards dealing with this question may soon be put in operation. It is that a series of dots should be transmitted when telephone lines or outside broadcast apparatus is

SAVOY HILL.

responsible for the breakdown. Listeners would thus know that the station is working all right and would have preliminary warning of the nature of the trouble, which could later be announced more fully.

o o o o

A Mystery Solved.

The mystery of wireless interference in the St. John's Wood district, to which allusion was made in these columns a fortnight ago, has been solved through the publicity given to the matter. It was stated that for over two years past a listener in that district had been the victim of a system of high-frequency interruption and had spent a good deal of time in trying to trace the source of the trouble. Violet rays from a nearby hospital were first of all suspected; but at length the interference was found to be due to a postal franking machine at the local sorting office.

o o o o

A New Radioview.

The new programme on March 20th will begin with a broadcast founded upon Ouida's famous novel, "Under Two Flags," which will consist of six radioviews similar in production to those given of "Westward Ho!" The essential story of the book will be told; but no attempt has been made to adhere absolutely to the original version. Certain incidents have been transposed to make it possible to tell the story within convenient time limits, while others are suggested by inference only. The aim of the producer has been to make a radio story founded on the novel, rather than to give a mere radio version of the novel as written.

o o o o

Wee Georgie Wood.

That well-known comedian, Wee Georgie Wood, will appear before the microphone at 2LO on March 20, when he will broadcast songs and stories.

o o o o

Cardinal Bourne to Broadcast.

Cardinal Bourne, Cardinal Archbishop of Westminster, is to broadcast for the first time on March 17th, when he will speak in support of the toast of "Ireland," proposed by the Prime Minister at the St. Patrick's Day banquet of the Union of the Four Provinces of Ireland Club at the Hotel Cecil. The Chairman of the Club, Mr. Jeremiah MacVeagh, will broadcast an introductory speech in addition to proposing the Royal Toast. The string band of the Irish Guards will also be heard from the Hotel Cecil on this occasion.

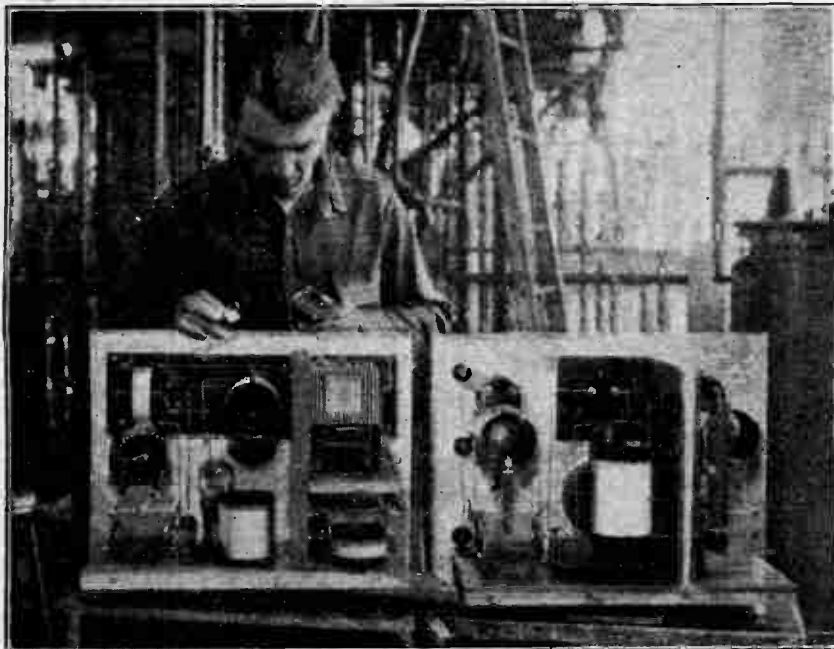

CRYSTAL TRANSMITTING CONTROL. An engineer at WGY, Schenectady, holding the piece of quartz crystal, less than an inch square and barely 1/8 in. thick, which controls the 50 kilowatt output of the famous station. The crystal maintains the frequency at exactly 790 kilocycles.

St. Patrick's Day.

The St. Patrick's Day programme from 2LO studio will be entirely Irish in character. It will begin at 8.0 p.m. with a relay of the bells from Armagh Cathedral. The programme will consist of Irish orchestral items played by the Wireless Orchestra, favourite Irish ballads by Molly O'Callaghan (contralto), recitation of Irish verse by Florence Marks, stories from Jerome Murphy, an Irish entertainer who has been heard many times on the wireless, and songs by Denis O'Neil (baritone), who will give a number of those exhilarating Irish songs which are written by Percy French, including the old favourite, "Phil the Fluter's Ball."

○○○○

Scenery to Aid Broadcasting.

The critics seem to have developed divided opinions respecting the play "The Quest of Elizabeth," by Reginald Berkeley, which provoked some protest when it was broadcast from 2LO about a month ago. The paper which then declared that the play was "gruesome" took the opposite view when the play was staged.

○○○○

A Different Atmosphere?

The opinion expressed by one critic that the stage setting conveyed a different atmosphere from that of the broadcast performance, and the reception of the play was consequently more favourable, may have some truth in it. The B.B.C. will shortly be testing this psychological factor in radio plays by providing the actors with appropriate costumes and introducing scenery. The question of the reception will, however, still remain with the listener, and in order to carry the idea to its logical conclusion it will be necessary for him to reproduce, as far as possible, the conditions of the theatre, even as the B.B.C. proposes to do. For example, it would help the listener considerably if he were to turn the lights down during a radio play transmission.

○○○○

Imagination.

Imagination would thus be helped in visualising any scene that is described. In the majority of human beings the functions of the ear have been developed to a less extent than those of most other organs of the body. The eye is undoubtedly much better developed. In wireless reception, therefore, the imagination must assist the ear, say those concerned in dramatic production at Savoy Hill, to a much greater degree than is the case under any other conditions, in view of the fact that the eye is useless.

○○○○

A Galsworthy Broadcast.

On March 28th Mr. Conal O'Riordan will read a sketch entitled "Philanthropy," from Mr. John Galsworthy's book "Caravan." Mr. O'Riordan has at present the exclusive rights for broadcasting Mr. Galsworthy's works, and the selected sketch is at once ludicrous and tragic. The little revue "Out of the Hat" will be broadcast on March 31st. It is written by Mr. George Western, the popular member of "The Roosters," and his brother Kenneth.

A 30

FUTURE FEATURES.**Sunday, March 14th.**

LONDON.—3.30 p.m., H.M. Grenadier Guards Band, violin recital, songs and recitations. 9.15 p.m., De Groot and the Piccadilly Orchestra.

MANCHESTER.—3.30 p.m., The Incidental Music of Grieg by the Augmented Station Orchestra.

Monday, March 15th.

LONDON.—8.45 p.m., Act III of "Rigoletto" (Verdi), performed by the B.N.O.C., relayed from Bradford. 9.15 p.m., Albert Sandler and the Grand Hotel, Eastbourne, Orchestra.

DAVENTRY.—8.30 p.m., "The Waterman," by Charles Diddin, produced and conducted by L. Stanton Jefferies.

CARDIFF.—8 p.m., March Winds, Orchestra and Songs.

GLASGOW.—8.20 p.m., A Popular Programme.

Tuesday, March 16th.

LONDON.—8 p.m., Chamber Music. The Kutcher String Quartet.

BIRMINGHAM.—8 p.m., Musical Comedy.

BOURNEMOUTH.—9 p.m., Variety. Leo Dryden in his own Compositions.

Wednesday, March 17.

LONDON.—8 p.m., St. Patrick's Day.

DAVENTRY.—8.30 p.m., The String Band of the Irish Guards. 8.45 p.m., The Prime Minister.

ABERDEEN.—9.15 p.m., Scottish Programme.

BELFAST.—9 p.m., Carillon from Armagh Cathedral. Dance Music.

NEWCASTLE.—8 p.m., St. Patrick's Day Programme.

Thursday, March 18th.

LONDON.—8 p.m., Symphony Concert conducted by Weingartner.

BIRMINGHAM.—8 p.m., "The Dream of Gerontius" (Elgar).

GLASGOW.—10.30 p.m., The Scottish Regiments Series.

Friday, March 19th.

LONDON.—8.30 p.m., Potted Musical Version of "La Fille du Tambour Majon" (Offenbach).

BOURNEMOUTH.—8 p.m., The New Forest Concert Party.

CARDIFF.—8.30 p.m., "A Cameo of the Court of St. James."

MANCHESTER.—8 p.m., Lancashire Talent Series.

NEWCASTLE.—8 p.m., Syncopated Music and Humour.

Saturday, March 20th.

ABERDEEN.—8 p.m., Musical Comedy and Drama.

BIRMINGHAM.—8 p.m., "Down South," The Station Repertory Choir in Plantation Songs and Spirituals.

MANCHESTER.—8 p.m., Popular Concert.

"The Disorderly Room."

"The Disorderly Room" is to be given on April 1st. Mr. Tommy Handley, who is earning a name as a radio comedian, and is also a familiar figure on the variety stage, is again appearing in this amusing musical sketch by Eric Blore.

○○○○

Music While Travelling.

The reception of 5XX and other broadcast programmes on the Cornish Riviera Express during a non-stop run of 237 miles on March 2nd showed conclusively that the use of wireless on passenger trains is a possibility of the near future. For this experiment a seven-valve superheterodyne with frame aerial was used. In Plymouth Station 5PY was received on the train in good volume and without interference. After Plymouth, until the train reached the borders of Somerset, hills and railway cuttings between the train and 5XX affected reception. It was found that when, as the train progressed on its journey, certain hills were in direct line with Daventry, as revealed by the compass, fading to a very marked degree took place. As, however, this phenomenon was not of regular occurrence, it was suggested that the hills under the lee of which fading took place must be those in which mineral deposits were most marked.

○○○○

Fading.

No fading was noticed when the train passed beneath bridges, but as a rule the transmission faded out in the middle of tunnels and returned with a rush some ten or fifteen yards from the opposite end. A singular effect observed was that, whereas the fading out had been gradual, the transmission came in at full strength. In Brent tunnel a successful attempt was made to continue the transmission right through the tunnel by altering the tuning. It does not appear obvious how this could affect the reception, but it is stated that it did.

○○○○

Distortion.

At times the volume was cut down in order to improve the purity, and experiments were tried with directional changes of the aerial. One expert opinion declared that there is undoubted daylight fading on 5XX and that it was experienced on this occasion. Distortion seemed to be present when the frame was turned on to 5XX at an angle of about 45 degrees from the line of direction of the train, whereas it was not present when the frame was turned away from that angle, thus indicating that the distortion was probably caused from the station and not from the train. Other scientific deductions were that in train transmissions the aerial must be across the carriage rather than pointing direct at the station. If the frame is in line with the train interference from generators in distant carriages will be brought in at once. As the line curves and as the train proceeds the direction of the transmitting station relative to the train is changed. This suggests the use of a "gyro" for giving the direction desired.



A Two-valve Circuit with
Capacity Control of
Reaction.

By F. A. BOYCE.

TO obtain satisfactory reception on wavelengths down to fifteen metres by no means implies that the components forming the high-frequency circuits are to be assembled or mounted in a weird manner. Neither does it mean that the amateur must build a set that is useless on other wavelengths.

Rather one must admit that if a set be designed with short-wave reception as its primary function, then the advantages so gained in reducing the losses will obtrude when the set is used on the present British broadcasting band. That is essentially the case with apparatus described here.

Fig. 1 is a schematic diagram of the circuits, an examination of which is interesting.

A two-valve set is indicated; one detector and one note magnifier of an elementary character, but differing from the usual two-valve set with reaction in the manner in which the latter is applied.

Reaction Control.

The reaction coil is fixed in position, while the by-pass condenser C_3 across the H.T. and phones or the primary of a low-frequency transformer is made variable. The reactance of this condenser to high-frequency currents being variable, the method therefore provides a convenient control of reaction.

High-frequency chokes are shown at X, Y, and Z. The first two mentioned are in the filament supply leads, while Z was designed to keep back the H.F. currents from the second stage, where they are not wanted. X also acts as an H.F. choke in the negative lead of the high-tension battery, it will be noted.

Reading notes of the experiences of other experimenters in the reception of the higher frequencies influenced the writer to make provision for these chokes; actual working tests have proved their utility to be decidedly questionable. In fact, it was found that unless the correct winding was used results were vitiated more than otherwise; oscillation was not so easy to control, and, in short, if the correct choke were used results were apparently little better and oscillation no more easily obtained

than when the chokes were removed altogether and the sockets short-circuited.

The effect differs with the valves, however, and as one may encounter conditions under which chokes are necessary, it would be advisable to make provision even if the units are not wound up at the outset. We would add here that when the circuit was set up roughly on the bench for test purposes, chokes were really needed to obtain oscillation; it would seem then that the design of the final apparatus alone is responsible for their being sometimes superfluous.

Coupling to the Aerial.

Other deviations from the conventional are the fixed condensers in the aerial, earth, and grid tuning condenser leads. For the reception of British broadcasting, these condensers can be short-circuited, and the connections made in the usual way; this straightforward method can be used downwards until the wavelength approaches the natural wavelength of the aerial.

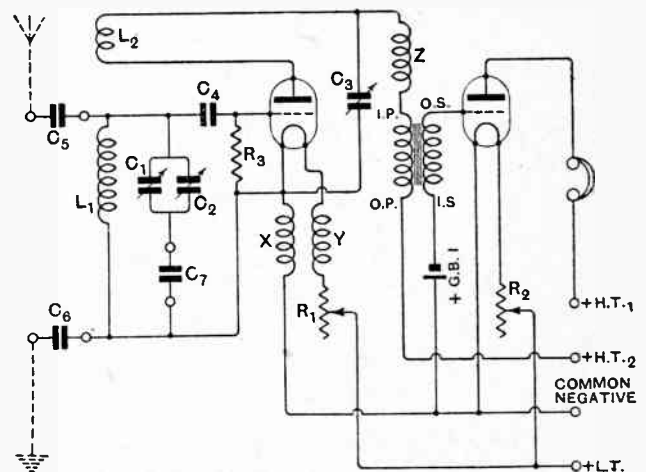

Fig. 1.—Circuit diagram. Chokes X, Y and Z are inserted in the filament leads and anode circuit of the first valve to confine H.F. currents to the detector circuit.

Short-wave Receiver.—

In the experimental stage of the design extraordinarily misleading results were obtained, due to the manner in which the aerial was coupled to the set. The use of a loosely coupled aerial with interchangeable coils was tried and discarded, since to obtain any degree of signal strength the coupling, though relatively loose, was tight enough to stop oscillation altogether when the grid circuit was tuned to a harmonic of the aerial circuit. This made the set unmanageable. Eventually coupling by metallic connection to the aerial was indicated and louder signals were obtained the higher the tapping to the grid coil. Again, in proportion to the height of the tapping the set would oscillate the aerial to a harmonic. Finally, it was found that by inserting a suitable fixed condenser between the aerial and the negative of the system, as shown, control over the whole tuning range of the condenser was possible, though at the aerial harmonics again a few degrees more of reaction condenser are required.

With such a coupling and a standard outside aerial, short-wave signals can be brought up to good strength. Fig. 2 shows the layout of the baseboard. The baseboard itself scales 12in. x 9in., and consists of ebonite sheet $\frac{1}{8}$ in. thick. This is subsequently screwed to a wooden baseboard rin. thick and rin. shorter in the width—as will be seen in the photograph—allowing the important terminals to stand clear of the wood at the back. The use of thin ebonite facilitates working, as the components can be fastened down by No. 4 B.A. screws from

the under-side through clearance holes. With the exception of the variable condensers the high-frequency units stand supported on small posts of ebonite rod $\frac{3}{16}$ in. diameter. This method lengthens all leakage paths, while it is an attempt to keep masses of insulating material from the high-frequency field.

Mounting the Components.

We have endeavoured to make Fig. 2 as clear as possible by leaving out details such as soldering tabs and other obvious points. The 12in. x 9in. x $\frac{1}{8}$ in. sheet should first be drilled out with No. 4 B.A. clearance holes at every point shown, excluding terminals but including the fixing centres for the L.F. transformer. Remember also that the Bretwood valve-holders stand on posts.

For the tuning coils 2 $\frac{1}{4}$ in. posts are required, five in number. For the choke sockets X, Y and Z three rin. pieces should be cut, while the choke formers, shown with the socket in Fig. 4, may be tackled to advantage, three in number, each 2in. long. The grid condenser and leak posts as well as the supports for the valve-holders are each 1 $\frac{1}{2}$ in. long, five in number.

Care should be taken in cutting up; if possible give the job to a man with a lathe; he will be able to part off to size and drill and tap each end very quickly. If a hack saw is used it will require some skill to cut the rod square.

The valve-holders are tapped No. 6 B.A. and screws provided; it may be convenient to leave it at that and tap the top of the posts No. 6 B.A. to suit. The posts are now to be fitted to the baseboard by No. 4 B.A. countersunk screws from below.

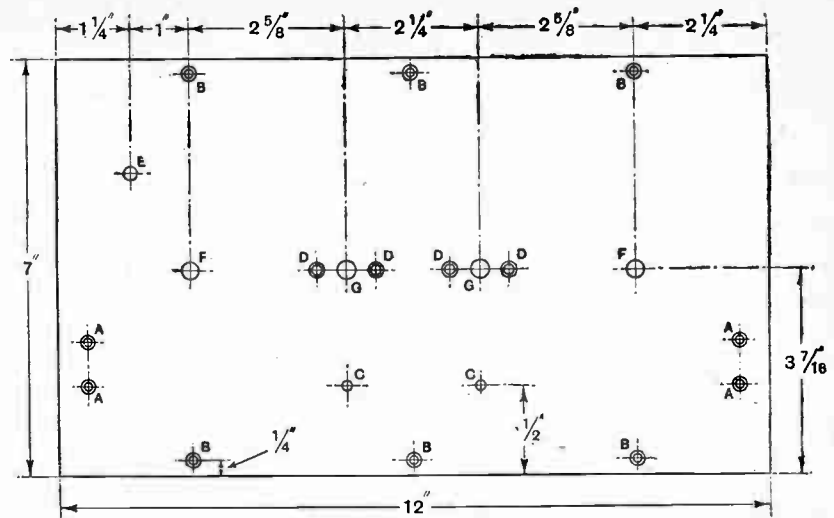

Fig. 3.—Drilling details of the front panel. Sizes of holes are as follow: A, 1/8in. dia., countersunk for No. 6 B.A. screws; B, 1/8in. dia., countersunk for No. 4 wood screws; C, 5/32in. dia.; D, 5/32in. dia., countersunk for No. 4 B.A. screws; E, 7/32in. dia.; F, 9/32in. dia.; G, 5/16in. dia.

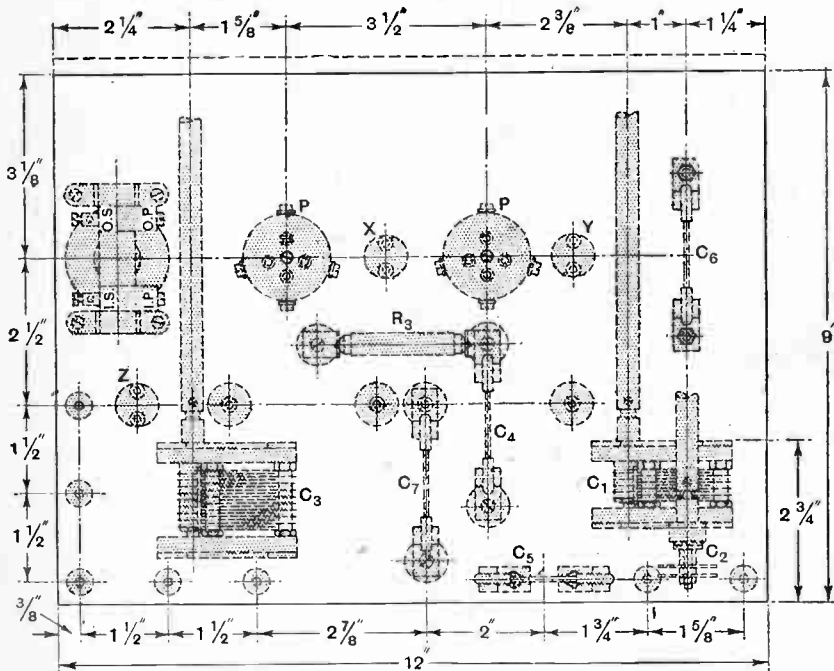

Fig. 2.—Layout of components on the baseboard, which is cut from 1/8in. ebonite sheet. The ebonite base is screwed to a wooden baseboard 12in. x 9in., leaving 1in. overhanging at the back for the terminals.

Short-wave Receiver.—

The McMichael condenser clips are mounted in the manner shown in Fig. 2; in one case—exactly opposite the grid tab of the first valve-holder—both condenser and leak clip are mounted together to dispense with one lead. The low-frequency transformer can be fitted last of all

when the wooden baseboard is attached, since wood screws can be used, incidentally keeping down the ebonite to the wood on that edge.

The screw-down neutrodyne condenser can be fixed permanently to the back top edge of the 0.0003 mfd. Ormond variable. The neutrodyne condenser carries two terminals; one assists in keeping the fixed plate in position. Under the fixed plate is an ebonite distance piece and a brass washer, both threaded upon a short length of No. 4 B.A. screwed rod, which at the

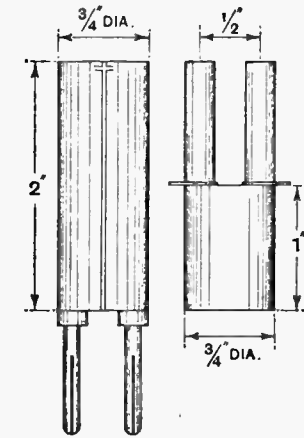

Fig. 4.—Former and socket mounting for H.F. choke coils.

other end simply screws into a keyhole-shaped base of insulating material.

The whole of the fixed plate arrangement should be taken apart and reassembled. Before doing the latter, however, drill and tap a No. 4 B.A. hole in the back of the top strip of the Ormond to take the No. 4 B.A. screwed

rod of the neutrodyne condenser. The rod should be screwed right through its hole in the neutrodyne condenser's base and made to enter the new hole. The brass washer, the ebonite distance piece, and the fixed plate can be assembled in turn, but now fit a soldering tab and

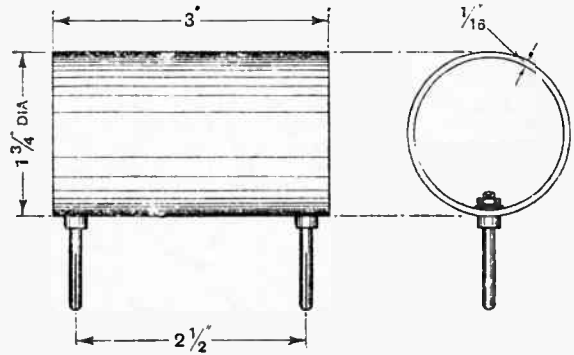

Fig. 5.—Cylindrical former for H.F. transformer windings.

a thin nut in place of the terminal to hold the fixed vane in position; in any case, the screwed rod is now not long enough for a terminal.

The fitting of the variable condensers is a sure test of one's skill in the use of the dividers and drill; if the spindle is not directly in line with the holes made in the front panel later the dials will wobble, and, on the other hand, if the holes in that case are not oversize the spindles will bind.

The ebonite extension spindles are of 3/4 in. rod. At the condenser end the latter should be drilled and tapped to take the vernier spindle, since a locking nut is supplied to make fast. On the other hand, the condenser ends of the short pieces should be drilled out with a 1/4 in. hole and fitted with a small cheesehead set-screw, say No. 6 or No. 8 B.A. In tightening up these set-screws later, be considerate lest the thread be stripped in the ebonite.

Extension Rods.

At the operating end of the vernier extension the rod should be tapped and drilled No. 2 B.A. to take a short length of No. 2 B.A. screwed rod, upon which the standard ebonite knob will screw.

The ends of the larger variable condenser spindles can be treated in one of two ways: either by reducing the tip to a 1/4 in. diameter or by drilling out and inserting carefully a short length of 1/4 in. brass rod. Both methods allow of the dials

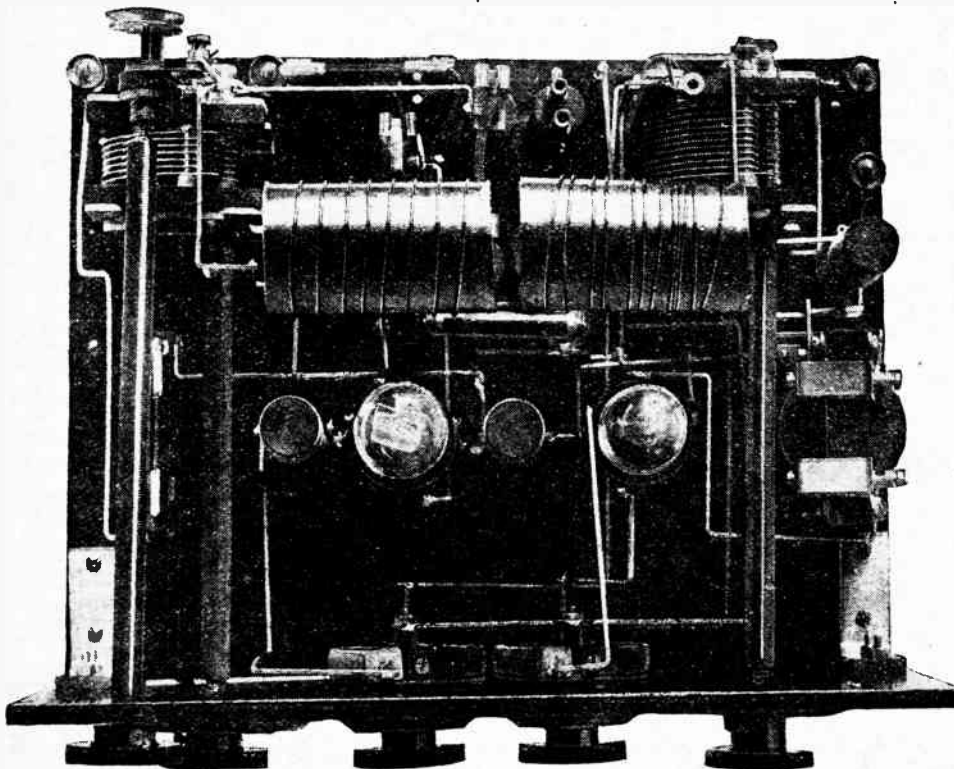

Plan view of the receiver with short-wave coils in position.

Short-wave Receiver.—

being fastened by the set-screw supplied with the Ormond dials. In point of fact, the cutting and threading or drilling and tapping of the $\frac{3}{16}$ in. rod is another job for a friend with a lathe to obtain satisfactory fittings and to save time.

We now pass to the front panel of $\frac{1}{4}$ in. ebonite. The dimensions given in Fig. 3 need no amplification, but it must be remembered that the upright centres for the condenser dials depend absolutely on the thickness of the wooden baseboard. That used by the writer is 1 in. thick. If another thickness is found convenient or desirable then the difference must be added or taken from the $3\frac{1}{16}$ in. given—by adding the two lower figures together—otherwise the binding of the condenser spindles or the wobbling of the dial mentioned previously will occur.

The condenser spindle holes are drilled $\frac{3}{32}$ in. diameter and opened out slightly with a reamer. The dual rheostat holes for the spindles are drilled $\frac{5}{16}$ in. and opened out in a similar way, while the fixing holes have 1 in. centres for the screws supplied with the units. The latter fixing points are unnecessary if you are fortunate enough to obtain centre fixing models.

The three screw holes at the lower edge should be adjusted to come nicely along a middle line on the edge of the wooden baseboard. Brackets, so far as we know, are not standard fittings; the holes should be drilled, therefore, to suit those purchased or made.

As we have said, in the reception of British broadcasting all condenser clips with the exception of the raised grid rectifying condenser are short-circuited by means of a brass strip in each case.

Wiring.

The set should be wired with No. 16 S.W.G. square or round section tinned copper wire, and can be carried out easily by following the wiring diagram (Fig. 6). The leads in the high-frequency circuits should be kept as short as possible, but this is easy since the layout is designed to help. The grid tab of the first valve-holder is but an inch from the grid condenser and leak clip. The grid end of the aerial coil will eventually be plugged into the socket post just to the right and above the last-mentioned post. In short, the grid and anode ends of the aerial and reaction coil respectively are next to one another. This point should be noted particularly, otherwise reaction will be incorrect. The McMichael neutrodyne condenser is connected directly across the Ormond upon which it stands.

If choke coils are found to be necessary, refer to No. 4, noting that a shallow saw cut is made the entire length of the former, and at the top a shorter one at right angles to it. In preparing to wind, the wire should first be

bared and gripped under one valve pin collar; pressed into the long slot and out again at right angles by means of the transverse slot; the wire is then wound down to the valve pin end again, where it is advantageous to make a nick on the edge of the former to keep the wire in position before it is gripped under the other valve pin collar. If some amyl acetate celluloid solution is available it will not be wasted on the coils to fix the wires

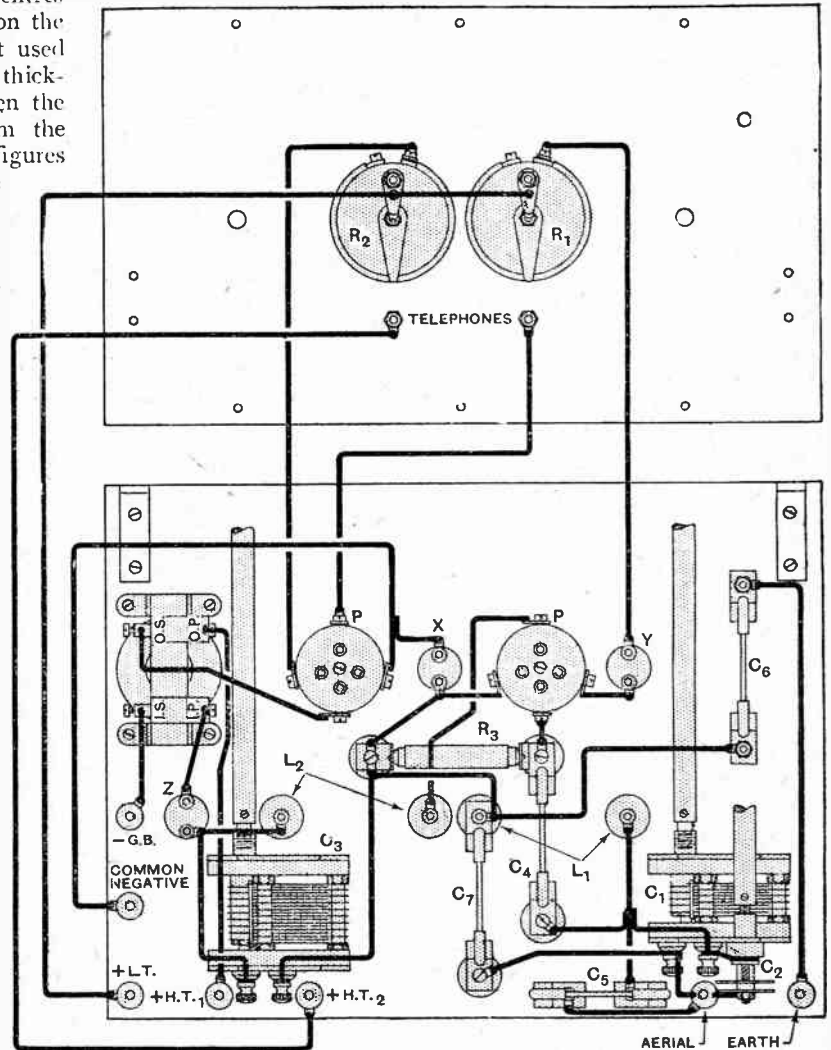

Fig. 6.—Complete wiring diagram.

permanently in position; but great care must be exercised to ensure that all traces of the solvent are dried out.

The design of the coils has, perhaps, taken up more time than the design of the set and its subsequent construction. In the first place, for the lowest values (or the highest frequencies) brass rod $\frac{1}{16}$ in. diameter was used. Ends of the coils fit exactly, of course, into the coil sockets raised upon the posts. To show the style of coil one was plugged in when taking one of the photographs.

Excellent results were obtained, including the reception of NKF (Anacostia, D.C.), on 17 metres, and an amateur in Buenos Aires, Argentina, South America, on 18 metres. Subsequent experiment, however, proved that by using

Short-wave Receiver.—

the Paxolin or Ebonite tubing and valve pins together with No. 18 S.W.G. enamelled wire distant signals could be found and brought up to apparently the same strength. Theoretically, there should be greater loss with such a supporting former in contact with the wire throughout its length, and writers usually plump for the air-spaced and self-supporting coils, in face of which we cannot, once more, be dogmatic, but would say that up to the present we find no advantage in departing from the standard coil formers of this set.

Coil Formers.

Fig. 5 shows the method of constructing the formers, and coils are as below; the direction of winding must always be the same:—

Turns 8, 12, 20, 30 and 40 of No. 18 S.W.G. enamelled copper wire, and from that point using any convenient wire, wind coils similar to the values of the well-known duolateral coils, *i.e.*, 50, 75, 100, 150, 200, etc. Reference to the photograph shows that no attempt has been made to locate the wire on the former in the case of the short coils. Eight turns are spread out conveniently along the $2\frac{1}{2}$ in. between the centres of the valve pins, and the same with the others until, on the 40 turn coil, the turns lie side by side.

The series tuning condenser is taken out at the 40 coil and cover is obtained if the 75 coil is next plugged in, but it will be found convenient to wind up the 50 coil since at this point the aerial and earth connections can be changed over to the normal arrangement; that is to say, the aerial is connected to the extra terminal carrying the series condenser, and the earth to the other with the condenser clips short-circuited. The 50 coil will be found useful here. Difficulty may at first be experienced when tuning is somewhere in the vicinity of the natural wavelength of the aerial, but it can be dodged by trying another coil for reaction and perhaps short-circuiting the series condenser clips (aerial terminal) until the best combination is found for broadcasting.

It is very nice to be able to select suitable wire to give the correct number of turns exactly between the $2\frac{1}{2}$ in. centres of the valve pins, so forming a solenoid; this entails the use of so many different gauges of wire. If the 300-600 broadcast band is well cared for, the other longer coils need not be strictly solenoid. The writer is using 75 turns of No. 26 gauge Mars stranded wire for the grid coil in the reception of 2LO and 100 turns for reaction. The first nicely fits the coil former; in the second case, however, 60 turns are wound on, then the wire is taken back for ten turns, and forward again

for the remaining 30. The wire is bunched, therefore, somewhere near the neutral point of the coil. This method can be adopted throughout according to the wire available. For the reception of Daventry, the $2\frac{1}{2}$ in. is completely filled with No. 40 S.W.G., S.S.C. wire, while the reaction coil is filled with 38 double, both single layers, and because the wire was to hand.

With regard to the valves, the best results in volume

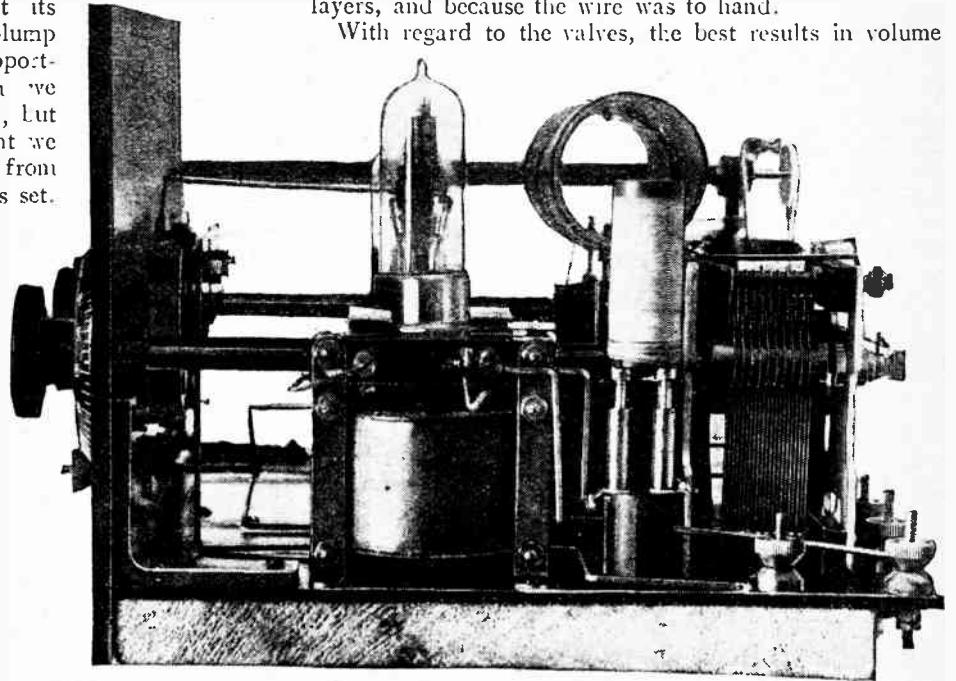

End view, showing one of the H.F. chokes.

and distance and ease of operation have been obtained on D.E.3 valves (the 0.06 class).

On the short waves care must be taken to eliminate all noises; though normal H.T. voltages are used the battery must be up to scratch, while the leak should be connected to negative of the filament. Regarding condensers it would be as well to add that other good quality units should work as well, and no doubt a considerable improvement could be effected by using a slow motion or vernier condenser of the cam movement type so long as there is no back lash, rather than the separate control as shown.

Results.

Results are good all round; with the D.E.3 valves mentioned, normal H.T. and an outside aerial 2LO at 20 miles on an Amplion is loud enough for a room 15ft. x 12ft. One has to be careful in speaking of loud-speaker results; by the above we mean that one has to raise one's voice to speak to a companion in the room. Dancing to the Orpheans is pleasant from the volume obtained. All other B.B.C. stations are tunable. This shows that low-loss design effects decided economies on normal wavelengths.

On the higher frequencies, amongst many we have to report the reception of WNP, the "Bowdoin" of the MacMillan Arctic Expedition; NKF, the well-known American precision station, and amateurs in North and South America, and as far away as Australia.



Brain Waves of the Wireless Engineer.

Screened Aerial-Earth Circuit from Receiving or Transmitting Set.
(No. 242,759.)

Application date: October 20th, 1924.
Mr. W. Rawsthorne describes in the above patent specification a receiving or transmitting circuit in which the usual aerial-earth circuit A, E is screened or shielded from the rest of the set by a

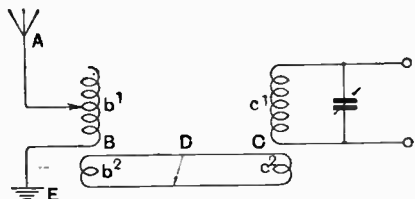

Aerial circuit coupling. (No. 242,759.)

step-down transformer B, the primary b^1 of which is arranged in the aerial-earth circuit, the secondary b^2 being connected through live wires D, or one wire and earth, to the primary c^1 of a high frequency step-up transformer C adjacent to the succeeding instrument in the set, the secondary winding c^2 being in circuit with such instrument.

o o o o

Single Battery for H.T., L.T. and Grid Bias.
(No. 233,718.)

Convention date (Germany): May 7th, 1924.

The Edison Swan Electric Co. describe in the above British patent specification a circuit arrangement whereby a single battery B supplies the filament K through the medium of two resistances W_1 and W_2 connected respec-

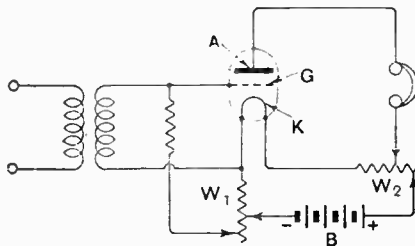

Anode current and grid bias from the L.T. battery (No. 233,718.)

tively between the two terminals of the filament and the two terminals of the battery B, the same battery also supplies the voltage for the plate A and the grid G.

Improved Leading-in Device.
(No. 243,517.)

Application date: Nov. 19th, 1924.

Mr. A. H. Guinness describes in the above patent specification an aerial leading-in device comprising a pair of metal plates adapted to be placed on opposite sides of the glass of a window in combination with a yoke for holding the plates in position and terminals for connecting the aerial to one plate and the

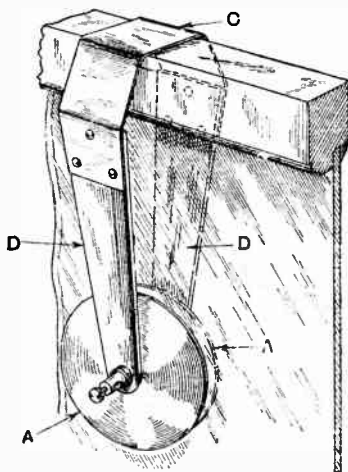

Capacity lead-in. (No. 243,517.)

wireless apparatus to the other. The two metal plates A and the glass of the window form a fixed condenser in series with the aerial lead-in.

The yoke member is U-shaped and is made in two portions, one consisting of a piece of springy material such as spring steel C and the other of insulating material D.

o o o o

Improved Variometer.
(No. 244,879.)

Application date: Nov. 5th, 1924.

Mr. E. W. Hovenden's invention consists in the arrangement of the supporting structure for two relatively movable inductances whereby the capacity hysteresis and other losses are kept as low as possible and the efficiency of the instrument is maintained as high as possible.

The stator A and rotor B are shaped to form hollow zones of a sphere and retained in shape by means of adhesive tapes.

The complementary halves of the stator and rotor are secured one half to each outside surface of two flat rings of insulating material C spaced apart by distance pieces D.

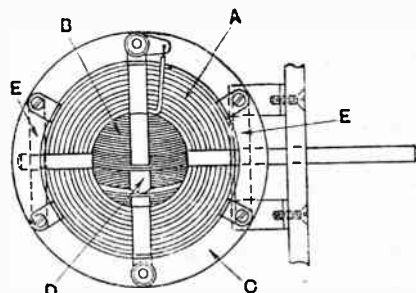

Variometer construction. (No. 244,879.)

Bearings E consisting of complementary metal strips are fitted between the flat rings C and serve to make the necessary connections between the stator and rotor.

o o o o

Four-electrode Detector Circuit.
(No. 223,580.)

Application date (France): October, 1923.

The invention of Compagnie Générale De Télégraphie Sans Fils relates to a detector circuit for a four-electrode valve 1, having two grids 3, 4, and an anode 5. According to the invention the input circuit is between the outer grid 4 and a suitable point in the filament heating circuit, and the output circuit between

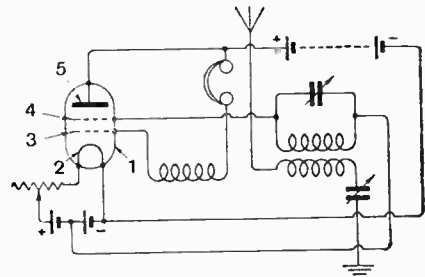

Four-electrode valve detector circuit. (No. 223,580.)

the inner grid 3 and the anode 5, the outer grid 4 being maintained at a positive potential with respect to the negative end of the filament. Reaction may be provided between the input circuit and the circuit of the inner grid.

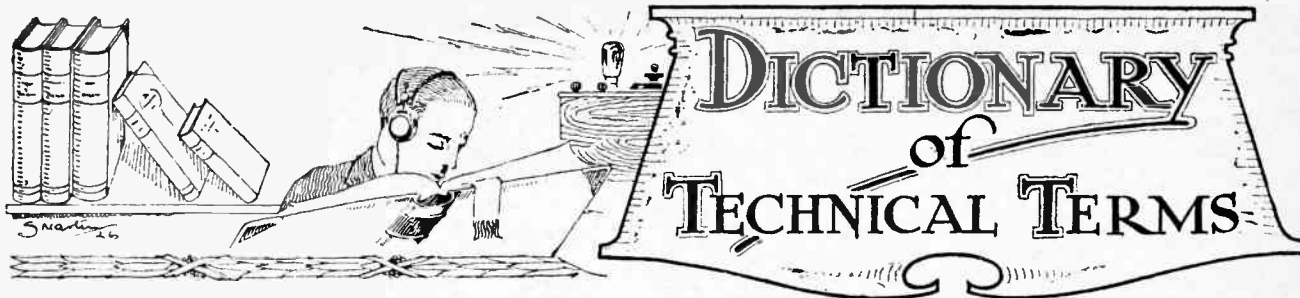

Definitions of Terms and Expressions commonly used in Wireless Telegraphy and Telephony.

The concluding instalment of a section that has been continued week by week with the object of forming an authoritative work of reference.

W.

Volt. The practical unit of electrical pressure or *potential* or electromotive force. It is defined as that electrical pressure which is required to drive a steady current of one *ampère* through a fixed resistance of one *ohm*. It is equal to 10^9 absolute electromagnetic units of potential and to $1/300$ electrostatic units.

Volt-Amperes. The product of current and voltage in an alternating current circuit taken independently of the *power factor*; the *apparent power* in an A.C. circuit.

Voltage. A term commonly used to mean *electromotive force* or *potential difference* measured in *volts*.

Voltage Amplification. The ratio of the output voltage to the input voltage of an *amplifier*. The voltage amplification of a three-electrode valve when used as a *thermionic amplifier* depends on the *amplification constant* of the valve, the *internal impedance* of the valve, and the external impedance of the *plate circuit*. The higher the ratio of the external impedance of the plate circuit to the total impedance the higher is the voltage amplification. Theoretically the voltage amplification cannot be greater than the amplification constant under any conditions, and in practice it never reaches this value.

Voltage Amplification Factor. See AMPLIFICATION CONSTANT.

Voltage Drop. See POTENTIAL DROP.

Voltage Multiplier. An extra series resistance for use with a *voltmeter* to enable it to read higher voltages than possible with the instrument alone.

Voltmeter. An instrument for the direct measurement of voltage, the readings being given by a pointer on a scale. The construction of the instrument does not as a rule differ from that of an *ammeter*, only the nature of the winding and connection to the circuit being different. See MOVING COIL and MOVING IRON INSTRUMENTS.

For high frequency voltage measurements the ordinary type of instruments is not suitable. See THERMIONIC VOLT-METER, MOVING COIL INSTRUMENTS, and MOVING IRON INSTRUMENTS.

Volume Resistivity. See SPECIFIC RESISTANCE.

Wander Plug. A plug at the end of a flexible wire for making connection with any one of a number of sockets such as those on a dry battery as used for the *high tension* supply for three-electrode valves.

Watch Receiver. A telephone receiver made in a compact form resembling the shape of a watch, the term usually being applied to a telephone receiver which has only one earpiece.

Watt. The practical unit of electrical *power*, being the rate at which work is done by a current of one *ampère* under an electrical pressure of one volt, the power in a D.C. circuit being given by the product of amps. and volts. See POWER and POWER IN A.C. CIRCUITS.

Wattful Current. Another term for the *power component* of an alternating current.

Wattless Current or Wattless Component. An alternating current or the component of an alternating current, which is out of phase with voltage by 90° and thus does not represent any power. See POWER IN A.C. CIRCUITS.

Waves (electrical). The disturbances of a regular nature which are set up in the ether by electrical oscillations in a conductor, these disturbances radiating outwards from the conductor in all directions with the velocity of light, namely, 186,000 miles per second. These waves or disturbances have two distinct components, one being set up by the oscillations of potential in the conductor and known as the "electrostatic component," and the other being set up by the oscillations of current in the conductor and known as the "magnetic component." See RADIATION.

Wave Aerial. A special form of aerial whose length is equal to a simple multiple of the wavelength to be received, the open end being connected to earth through a resistance, the end being a voltage *node*. This type of aerial has considerable directional properties. It is also known as the "Beverage aerial."

Wave Distortion. See DISTORTION.

Wave Filter. A combination of inductances, capacities, and resistances ar-

ranged so that a desired frequency is "filtered out," other frequencies being suppressed.

Wave Form. The actual shape of the curve showing the values of an alternating quantity for successive instants throughout one complete cycle.

Wavelength. The distance at any given instant between the maximum positive points of two successive waves. The relation between the wavelength, the velocity of propagation, and the frequency is quite a simple one, viz., velocity = wavelength \times frequency, so that for wireless waves we have $\lambda = 3 \times 10^8 / f$, where λ is the wavelength in metres, and f is the frequency in cycles per second, the velocity of propagation of ether waves being 3×10^8 metres per second. Thus for a frequency of a million cycles per second the wavelength will be $3 \times 10^8 \div 10^6 = 300$ metres, the wavelength being inversely proportional to the frequency. The wavelength of a *tuned circuit* is given by $\lambda = 1885 \sqrt{LC}$, where L is the inductance of the circuit in *microhenries*, and C is the capacity in *microfarads*.

Wavemeter. An instrument for the measurement of *wavelength*. The instrument takes various forms; in the first place the wavemeter may either send out waves of known length or may simply be equivalent to a calibrated receiver; then, again, each of these two classes can be either (a) a *buzzer wavemeter* for sending and a crystal for receiving and (b) a *heterodyne wavemeter*. See BUZZER WAVEMETER and HETERODYNE WAVEMETER.

Wave Shape. See WAVE FORM.

Wave Trap. A special sharply tuned *rejector circuit* included in a receiving circuit in order to eliminate some undesired strong signal whose wavelength is near to that of the desired signal.

Weak Coupling. See LOOSE COUPLING.

Wheatstone Bridge. A device for the measurement of resistances by a *null method*. A battery supplies two parallel circuits which are each divided into two portions. One of the parallel circuits consists of two fixed resistances P and Q , called the "ratio arms," the

Dictionary of Technical Terms.—

other circuit consisting of a variable known resistance S and the unknown resistance to be measured R . A galvanometer is connected between the junction of P and Q and the junction of S and

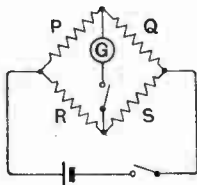

Wheatstone bridge method of measuring resistance.

R . When S is adjusted so that the galvanometer shows no deflection, then $Q \times R = P \times S$, or $R = PS/Q$. See **POST OFFICE BOX** and **METRE BRIDGE**.

Wipe Out. The state of affairs which occurs in a valve circuit where a grid condenser and high resistance leak is used, on the occurrence of a violent signal such as that of a strong atmospheric disturbance; the grid is given such a high negative charge that the valve is rendered inoperative and no signals can get through until the excessive negative charge on the grid has had time to leak away.

Wire Gauge. See **STANDARD WIRE GAUGE**.

General Notes.

Mr. D. Woods (5WV), Station House, Braintree, Essex, was in two-way communication, at 1940, on January 16th, with EG BH at Cairo, working on 5 watts with a LS 5-valve. Signals from each station were about R4. Mr. Woods asks if any other British amateur has yet worked with EG BH.

Mr. E. J. Simmonds (G 20D), Gerards Cross, has been carrying out tests on a 23-metre wavelength with Egypt. On February 15th and 16th at 1800 G.M.T. telephony transmission was effected with an input of only 4 to 5 watts. He sent, by speech, a difficult combination of figures, input powers, etc., all of which were perfectly received by the operator in Egypt and repeated back on telegraphy. Mr. Simmonds was using an Osram T 250 transmitting valve, and the total absence of distortion was remarked on by the Egyptian receiver. The strength of his signals was given as R9. Mr. Simmonds believes that this is the first time a 23-metre wavelength has been used successfully for long-distance telephony on such inputs, and the results are the more surprising because, during the same period, his 45-metre set, with an input of over 100 watts, failed to convey intelligible speech to the same station.

○○○○

The attention of amateur transmitters, who for various reasons do not wish their full addresses published, is directed to the suggestion printed on page 298 of our issue of February 24th, that extensive use of the Monomark system would

Wired Wireless. A system whereby messages are sent through wires by means of high-frequency currents, the sending and receiving apparatus being very similar to that used for ordinary wireless transmission through space. A number of different messages can be sent simultaneously on the same line, each on a different frequency. By means of *filter circuits* at the receiving end the messages are separated out and taken down by a number of operators or automatic recorders.

Wireless Beam. Wireless waves sent more or less in one direction from a special aerial system part of which acts as a reflector.

Wireless Compass or Wireless Direction Finder. See **DIRECTION FINDER**.

Wood's Metal. An easily fusible alloy of lead, tin, bismuth and cadmium, used for mounting receiving crystals in their cups. The alloy melts at a temperature below 70° C., and therefore the rectifying properties of the crystal are not impaired by excessive heating when being mounted.

Work. Work is said to be done when an applied force overcomes a resisting force through a certain distance. The C.G.S. unit of work is the *erg*, being the work done when a force of one *dync* acts through a distance of one centimetre. The practical electrical unit of

work is the *joule*, which is the work done when a current of one *ampere* flows for one second under a pressure of one *volt*, i.e., the work done when a power of one *watt* is expended for one second. One *joule* = 10^7 ergs.

X.

X. The usual symbol for *reactance*.

"X's." A name commonly applied to atmospheric disturbances or *atmospherics*.

"X" Stopper. A special device used in connection with a wireless receiver to limit the interference caused by *atmospherics*. In one form a conducting path is provided between a *node* in the aerial circuit and the earth, so that any currents whose frequency is different from that of the desired signals is conducted away to earth.

Z.

Z. The usual symbol for *impedance*.

Zero Method. See **NULL METHOD**.

Zero Potential. For practical purposes the *potential* of the earth is taken to be zero, and any conductor at earth potential is said to be at zero potential. See **EARTH POTENTIAL**.

Zincite. A crystalline oxide of zinc used in conjunction with *bornite* or copper pyrites as a *crystal detector*, the combination being known as a "Perikon detector."

TRANSMITTING NOTES AND QUERIES.

enable them to receive reports from listeners without the necessity of disclosing their private addresses.

○○○○

The Secretary of the Association des Radio-Amateurs Français informs us that all QSL cards for French transmitters will be forwarded if addressed *via* "Radio-Amateurs," 45, rue St. Sebastian, Paris XI.

○○○○

Col. E. C. Jennings (G 50C), Gelli-Deg, Kidwelly, S. Wales, will be glad to hear from any transmitters on 180-200 metres with a view to arranging tests on C.W. and 'phone.

○○○○

Mr. A. E. Livesey, of Ludlow, Salop, informs us that on February 22nd at 10.10 p.m. he heard Uruguay Y CD1 calling BZ 2AF, and asks if this station has previously been heard by any listeners in England. He has also, since December 1st, 1925, received forty different Brazilian stations.

○○○○

Mr. C. H. Targett (G 6PG), 21, High Street, Dartford, who has been experimenting with an underground aerial, was

in communication on February 22nd with P 3GB, G. de Bianchi, at Funchal, Madeira. He was transmitting on a wavelength of 44.8 metres with an input of 8 watts, using 230 volts H.T. from D.C. mains, M.O. DE5 valve, and a Hartley circuit. The aerial is 70ft. long, 50ft. of which is buried to a depth of 18in. to 24in. Signals were reported R5 on 0-v-1 receiver.

○○○○

We give below the addresses to which cards for unknown foreign transmitters may be sent for forwarding. Most of these have appeared before in these columns, but, for ready reference, we have collected them together.

Belgium.—Roseau Belge, 11, Rue du Congrès, Brussels.

Chile.—Comm. L. M. Desnaras, Casilla 50D, Santiago.

Germany.—Herr Rolf Formis, Alexanderstrasse 31, Stuttgart.

Holland.—M. R. Tappenbeck, Hon. Sec., I.A.R.U. (Dutch section), Hoogduin, Noordwijk-aan-Zee.

Italy.—Signor Franco Pugliese, Sec., A.D.R.I., Via Borgonuovo 21, Milan.

Spain.—Senr. Miguel Moya, Megia Lequerica 4, Madrid.

Sweden.—M. Bruno Rolf, Hamngatan 1A, Stockholm.

U.S.A.—The Traffic Manager, A.R.R.L., 1045, Main Street, Hartford, Conn.

○○○○

QRA's Wanted.

G 2ZA, D 7XP, PI 3NO, SMKG, PT 1, PT 2, etc. (on 28 to 31 metres).

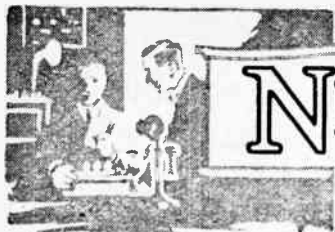

NEWS from the CLUBS

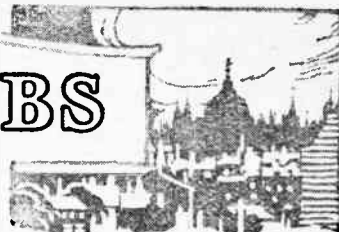

Secretaries of Local Clubs are invited to send in for publication club news of general interest. All photographs published will be paid for.

The Modern Loud-speaker.

A fortune awaits the experimenter who invents a loud-speaker giving faithful reproduction of all sounds, said Mr. Welcher, a founder member, in his lecture before the Ilford and District Radio Society on Tuesday, February 23rd. Mr. Welcher, who dealt with loud-speaker developments, provided a mass of useful information gathered during his extensive experience in the manufacture of loud-speakers. He considered that the present-day loud-speaker was anything but the most efficient component in a wireless receiving installation.

o o o o

Superheterodyne v. Neutrodyne.

A discussion on Superheterodyne v. Neutrodyne attracted a large audience at the meeting of the Golders Green and Hendon Radio Society on February 18th. Mr. A. S. Bremner, B.Sc., opening the discussion in favour of the "superhet," stated that he preferred this instrument owing to its selectivity and ease of manipulation. The neutrodyne found a champion in Mr. C. L. Thompson, who argued that the superheterodyne was extravagant in the number of valves it employed. He considered the absence of an aerial a disadvantage, and that the detector valve, owing to the poor input, did not work at its maximum efficiency. He contended that the frame must be counted as a third control, and while, in a properly designed neutrodyne, the three condensers could be made to give practically the same reading, those of the superheterodyne were always different.

Hon. Secretary: Lt.-Col. H. A. Scarlett, 357A, Finchley Road, N.W.3.

o o o o

Home-builders' Night.

A "Home-constructed Set Night" was held with great success by the Norwich and District Radio Society on February 12th, when an enthusiastic band of members brought their home-built receivers for testing on the club aerial. Variety in design characterised the sets submitted, which could be roughly classified as "experimenters" and "listeners" instruments. Considerable interest was taken in a three-valve (1-v-1) portable receiver in which dried wood was used in place of ebonite. Other instruments claiming special attention were a hand-some 0-v-2 set, a short-wave receiver, and, last but not least, a three-valve neutrodyne.

The society's transmitting section spent a profitable evening on February 17th, when a number of British and Continental

amateurs were picked up on wavelengths in the neighbourhood of 45 metres.

Hon. Secretary: Mr. J. Hayward, 42, Surrey Street, Norwich.

o o o o

A.C. Mains for Plate and Filament.

The advantages of A.C. over D.C. electrical mains from the wireless amateur's point of view were referred to by Mr. A. W. Knight in his interesting lecture before the Croydon Wireless Society on February 15th.

The lecturer exhibited a particularly neat and compact rectifier which he used for obtaining H.T. from the A.C. mains. A convincing demonstration was given in which a receiving set was first tuned in to 2LO, an ordinary dry cell battery being used for H.T. supply. The A.C. mains were then brought into use by means of the rectifier, a quick change over being obtained with an ordinary D.P.D.T. switch. The success of the rectifier was amply proved by bringing it close to the receiving set, not the slightest sign of hum being noticeable. Useful instructions were also given for utilising the rectifier for L.T. supply.

Hon. Secretary: Mr. H. T. P. Gee, 51-52, Chancery Lane, W.C.1.

o o o o

Significance of Valve Curves.

On February 17th Mr. L. Hirschfield, B.Sc., gave the second of his interesting series of lectures on "Valve Characteristics" before the Muswell Hill and District Radio Society.

The lecturer explained how an intelligent examination of a valve curve can show us what duty that particular valve is best suited to perform. Taking as an example the curious curve exhibited by a soft Dutch valve, Mr. Hirschfield demonstrated why this valve is so efficient as a detector.

An interesting circuit was drawn on the blackboard showing the type of set used by the lecturer for obtaining clear reception from 2LO. The set consisted of a crystal and two transformer-coupled L.F. valves.

The society is growing rapidly, but vacancies still exist for new members. Full particulars may be obtained from the Hon. Secretary, Mr. Gerald S. Sessions, 20, Grasmere Road, N.10.

o o o o

Tracing Faults.

Before a keen audience of members of the Lewisham and Bellingham Radio Society on February 23rd, Mr. W. A. Kell lectured on the important subject of "Tracing Faults." Much of the value of Mr. Kell's lecture lay in the manner in which he described the effects produced by particular faults. A knowledge of these effects could not fail to be extremely useful.

As was to be expected, the lecturer was called upon to answer innumerable questions, a task to which he proved quite equal. Mr. Kell will shortly lecture on "Faults in Multi-Valve Sets."

Joint Hon. Secretary: Mr. E. J. Chapman, 56, Crofton Park Road, S.E.4.

o o o o

Ideal Headquarters.

Through the courtesy of the local Electricity Committee and the Borough Electrical Engineer, the Hackney and District Radio Society have been fortunate in securing the new "Demonstration Halls," Lower Clapton Road, for their weekly meetings. The new headquarters are particularly suited to this purpose, being fitted with a cinema, and a most efficient aerial and earth system. Seating accommodation is provided for 100 persons.

A good programme has been arranged for the coming months, and prospective members are asked to communicate with the Hon. Secretary, Mr. Geo. E. Sandy, 114, Parnell Road, E.3.

FORTHCOMING EVENTS.

WEDNESDAY, MARCH 10th.

Radio Society of Great Britain. Informal meeting. At 8 p.m. At the Institution of Electrical Engineers, Savoy Place, W.C.2. Talk on "Portable Receiving Apparatus," by Mr. F. H. Haynes, Assistant Editor of The Wireless World.

Tottenham Wireless Society. At the Institute, 10, Bruce Grove. Lecture, with demonstration. "The Superheterodyne," by Mr. F. A. Hall.

Muswell Hill and District Radio Society. At 8 p.m. At St. James's Schools, Fortis Green, N.10. Lecture: "Wireless Reception," by Mr. H. F. Klotz, Edinburgh and District Radio Society. In R.S.S.A. Hall. Technical Lecture by a representative of the B.B.C.

Barnley and District Wireless Association. At 8 p.m. At 22, Market Street. Lecture: (U.) "Valves," by Mr. D. W. Milner, B.Sc.

FRIDAY, MARCH 12th.

Sheffield and District Wireless Society. At 7.30 p.m. At the Dept. of Applied Science, St. George's Square. Lecture: "The Trend of Modern Radio Design," by Mr. M. G. F. Jones.

Radio Experimental Society of Manchester. At 7.30 p.m. At the Athenaeum, Princess Street. Lecture: "The Detector," by Mr. E. Butterworth.

MONDAY, MARCH 15th.

Hackney and District Radio Society. "1" Night.

Southport and District Radio Society. At 7.30 p.m. in St. Andrew's, Part Street. Lecture by Mr. C. F. Spencer (President).

Swansea Radio Society. Members' Visiting Night.

TUESDAY, MARCH 16th.

Hatfield Wireless Club. Discussion Evening, to be opened by Mr. A. Jowett (610).

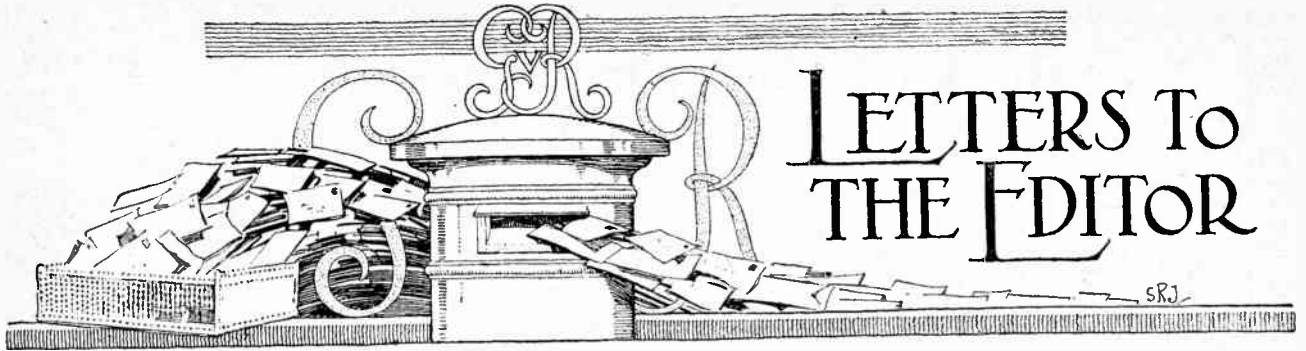

The Editor does not hold himself responsible for the opinions of his correspondents.

Correspondence should be addressed to the Editor, "The Wireless World," Dorset House, Tudor Street, E.C.4, and must be accompanied by the writer's name and address.

G6XG's FAREWELL.

Sir,—Being one of the oldest readers of *The Wireless World* from pre-war days, the first journal in Great Britain to interest itself in the cause of the amateur transmitter, I wish to express my appreciation for the pleasure and knowledge I have gained through the years, mainly through the medium of your pages.

In a few days' time I am leaving England to make my home in Australia, consequently my previously well-known call-sign G6XG will no more be heard on the air from my hands.

I wish to say to my many DX friends in Europe that I hope eventually to be operating from "down under" with an "A" prefix.

The advent of world-wide amateur communication will help me to keep those bonds of radio friendship with the Home Country, and my hope will be for as many QSO's as possible with my brother DX men here.

I am looking forward to my meeting the same spirit of friendship which exists among the transmitting fraternity here.

Although I naturally leave England with one or two regrets, I look forward with interest to hearing our "G" signals over the 12,000 miles between. DONALD B. KNOCK.
Birkdale, Lancs. Ex-G6XG.

METRES v. KILOCYCLES.

Sir,—May I put in a plea for the retention of the metre wavelength scale instead of reverting to kilocycles?

I purchased, when in Marseilles, *The Wireless World*, along with another wireless periodical, and was delighted to find that my old friend had kept to the old unit, while the other talked mysteriously about 15,000 kilocycles instead of 20 metres, when giving an article on short-wave reception.

I am all for progress (indeed, who, connected with wireless, isn't?), but is there any advantage in using "kilocycles" instead of the widely known term "metres"?

I am a ship's wireless operator and a keen amateur as well, and what would happen if the Berne International Bureau of the Telegraphic Union suddenly decided to change the "Berne List" from a metre denomination to kilocycles?

Anyway, let the old paper stick to metres, and if anybody else wishes to use kilocycles—let them.

What are readers' opinions?
EDWARD F. AMOS, Wireless Operator,
C/o Union-Castle Mail S.S. Co., Ltd.

THE AMATEUR AND MORSE.

Sir,—The suggestion of A. Davenport that *The Wireless World* should print weekly a few Morse signs to help the beginner has one fundamental objection, and that is that it would only train the eye. The brain centres are so isolated that this would be of little assistance to the ear. Nothing but assiduous listening will effect the desired result. Do not despair—the art comes in time, and progress gets increasingly rapid as one learns, and, like skating, say, is not readily forgotten. After some practice the ear controls the hand

directly without any conscious intervention of the brain. I tested this one day by writing down half a dozen words and looking them up in a dictionary with my left hand while taking down press with my right. No doubt experts can do many other things.

In order to obtain slow Morse signals gramophone records might be of great assistance. What the learner requires, however, is not slow letters but letters sent at the standard rate of, say, 12 or 20 words per minute, and with long intervals between each letter to enable him to think what it is. The first record might have two or three seconds even, and succeeding records would gradually close up the spaces until standard transmissions of that speed was attained. A slowly sent letter, on the contrary, keeps one waiting to see what it is, and there is still no time to think. If an endeavour be made to write down the actual dots and dashes, it is more rapid to make the dashes vertical instead of horizontal as shown. In order rapidly to find out what letter corresponds to a heard sign it is necessary to arrange the letters in some systematic way, so as to know where to look. The following arrangement which I made may be useful to others:—

E	••	é	•••••	G	•••••
I	•••	Z	•••••	Z	•••••
S	••••	§	•••••	Q	•••••
H	•••••	ä	•••••	K	•••••
A	••	é	•••••	Y	•••••
W	••••	?	•••••	C	•••••
J	•••••	Under-	•••••	X	•••••
U	••••	line	•••••		
ü	••••	T	••	ç	•••••
P	•••••	M	••••	l	•••••
		O	••••	ï	•••••
		ch	•••••	ñ	•••••
R	••••	N	••••		
L	•••••	D	••••		
ä	•••••	B	•••••		
P	•••••				

Ships in their conversation use a lot of contractions, and this is very puzzling, and one wonders if one has made mistakes in the Morse. Some I have guessed at from time to time are the following:—

<i>English.</i>	<i>French.</i>	<i>German.</i>
mge = message	nr = monsieur	gt = guten tag
pse = please	bjr = bon jour	ga = guten Abend
see = service	bsr = bon soir	ds = danke schön
tfc = traffic	bcp = beaucoup	mhr = mein Herr
uw = now Wheatstone	vc = voicit	mfrd = mein lieber Freund
om = old man	prvs = pour vous	wth = wiederhören
cul = see you later		wds = wiederschön
73's = kind regards		bln = Berlin

With practice one can learn to read Morse without writing it down, but I am of the opinion that that means the development of another brain centre, and that it does not come from facility in writing.

Braintree. H. E. ADSHEAD.

[We agree entirely with our correspondent's view that learning the Morse code is far more a question of aural than of visual training. Visual memorising of the Morse code is but a question of the application of an hour or two.—Ed.]



"The Wireless World" Information Department Conducts a Free Service of Replies to Readers' Queries.

Questions should be concisely worded, and headed "Information Department." Each separate question must be accompanied by a stamped addressed envelope for postal reply.

Care of Accumulators.

My accumulator, which was new about fifteen months ago, has latterly given a considerably less period of service on each charge than its normal rating, and I am told that I should renew the acid. I am in some doubt, however, whether to change the acid when the accumulator is in a charged state or otherwise. Some advice on this matter would be appreciated.

I.F.B.

You should certainly renew the acid in your accumulator, and always make a practice of renewing it annually. The acid should never be changed when the accumulator is in a discharged state. You should proceed as follows:—Put the accumulator on charge, giving it a somewhat longer charge than normal, and then empty away the electrolyte and wash out with two or three changes of distilled water, after which fresh acid of the correct specific gravity should be put into the accumulator. It is most important that acid of the correct density be used. The actual S.G. required varies in different makes of accumulator between the values of 1.215 and 1.250, and the correct gravity of any particular accumulator will be found on the manufacturers' label of instructions attached to the instrument. It will be found that it is possible to put the accumulator into immediate use without further charging, but in practice it is advisable to place the accumulator on a slow charge before it is again brought into use.

o o o o

A Selective Two-valve Circuit.

I have lately seen a reference to a capacity-coupled circuit for which a very high order of selectivity is claimed. Can you give me any information concerning this? D.B.

As is well known, in the ordinary loose-coupled circuit the nature of the coupling is magnetic, this being brought about by the magnetic coupling between two coils mounted, for instance, in an ordinary two-way coil holder. Good selectivity is obtained by this method, but, unfortunately, any alteration in the coupling between the two coils has a very great effect on the tuning, and retuning is necessary after each coupling variation. This prevents any rapid loosening of coupling in the event of any sudden and unexpected interference arising, thus rendering it unsuitable for commercial work. To obviate this difficulty, a capacity

coupling between aerial and secondary is used instead of the usual magnetic coupling, and by this means it is possible to vary the coupling within certain limits without varying the tuning. In the circuit which we reproduce in Fig. 1, the 0.0003 mfd. variable condenser must not be considered as a tuning instrument, but purely as a coupling device between primary and secondary. The circuit is equally suitable for the normal B.B.C.

difficult for the novice to distinguish between the two. There are, of course, as many variations possible in correctly neutralised circuits as there are in reversed reaction circuits, but the difference in results obtainable with correct and incorrect methods is very marked. It should be mentioned that the expression Neutrodyne, strictly applies to only one system of neutralising valve capacities, namely, that system which is the

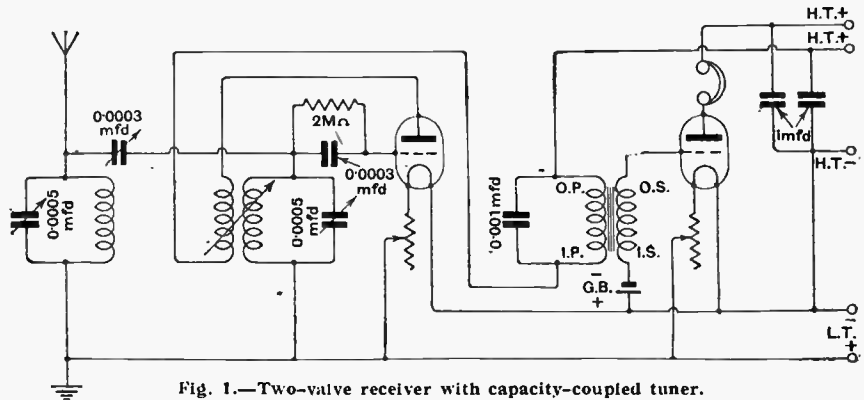

Fig. 1.—Two-valve receiver with capacity-coupled tuner.

wavelengths as for Daventry wavelength, the coils being of the normal value. High selectivity is possible with a well-constructed receiver of this type.

o o o o

The Neutrodyne System.

It has been suggested to me by a friend that in reality the neutrodyne method of stabilisation of H.F. amplifier is virtually our old friend reversed reaction in disguise. I should be glad, therefore, if you will either confirm or dispel this aspersion on the character of the neutrodyne.

J.H.H.

Whilst it must be admitted that many so-called methods of neutralising the inter-electrode and associated capacities of a valve are nothing more or less than variations of reversed reaction, it should be distinctly understood that a properly designed neutrodyne receiver has nothing in common with reversed reaction. The neutrodyne system is essentially an A.C. bridge which actually effects stability by balancing the stray capacity associated with the valve, whilst many spurious systems affect stabilisation by introducing negative reaction into the circuit in one form or another. It is sometimes very

subject of patent rights by Professor Hazeltine, the original Neutrodyne inventor.

o o o o

Using Air-spaced Winding for Internal Connections of Sets.

In modern receivers it appears to be the practice to wire up with well spaced wire, presumably in order to lessen the capacity between the various wires in the spaced circuit. Is it absolutely necessary to use wiring for the filament leads, since these are at all times at earth potential with respect to both H.F. and L.F. currents?

L.S.B.

Whilst it is important that all wires which are above earth potential with respect to H.F. and L.F. should be well spaced it is not only unnecessary to use spaced wiring for filament leads, but is absolutely detrimental, since if the filament wires are to be spaced out it will mean that there is less room for the remaining wiring which does need to be well spaced. It is advisable that not only the wiring of the filament leads, but also all the wiring at earth potential be carried out in rubber-covered wire which can be carried along the surface or even underneath the baseboard.

Anode Rectification in Tuned Anode Receiver.

In the "Readers' Problems" section of your journal, you give in the issues of December 2nd, 1925, and January 20th, 1926, two circuits for obtaining alternative grid and anode rectification, neither of which adequately meets my needs. I have a conventional 1-v-1 receiver employing the tuned anode system of H.F. amplification, and wish, if possible, to adapt it for these two alternative forms of rectification provided that it does not call for unduly complicated switching arrangements.

J. F. I.

So far from being complicated, the adaption of a receiver such as you describe to alternative anode and grid rectification is exceptionally simple, the only requirement being a two-way switch. We give in Fig. 2 the necessary connections, for which it will be seen that scarcely any alteration is required in the wiring of your receiver. A separate biasing battery is quite unnecessary, and you can make use of the existing battery used for supplying grid bias to your L.F. valve. The most suitable tapping for adjusting the valve to give anode rectification is best found by experiment. Once found, this adjustment need not,

BOOKS FOR THE WIRELESS EXPERIMENTER

Issued in conjunction with "The Wireless World."

"THE AMATEUR'S BOOK OF WIRELESS CIRCUITS," by F. H. HAYNES. Price 3/6 net. By Post, 4/-.
 "TUNING COILS AND METHODS OF TUNING," by W. JAMES. Price 2/6 net. By Post, 2/10.
 "WIRELESS VALVE RECEIVERS AND CIRCUITS IN PRINCIPLE AND PRACTICE," by R. D. BANGAY and N. ASHBRIDGE, B.Sc. Price 2/6 net. By Post, 2/10.
 "WIRELESS VALVE TRANSMITTERS—THE DESIGN AND OPERATION OF SMALL POWER APPARATUS," by W. JAMES. Price 9/- net. By Post, 9/6.
 "DIRECTION AND POSITION FINDING IN WIRELESS," by R. KEEN, B.Eng. Price 9/- net. By Post, 9/6.
 "THE RADIO EXPERIMENTER'S HANDBOOK," Parts 1 & 2, by P. R. COURSEY, B.Sc. Price 3/6 net. By Post, 3/10.

Obtainable by post (remittance with order) from **ILIFFE & SONS LIMITED,** Dorset House, Tudor St., London, E.C.4, or of Booksellers and Bookstalls.

The name of this coil bears no reference to its distance-getting properties, but it is so called because of its shape, which somewhat resembles a pair of binoculars, it actually consisting of two small cylin-

drical coils mounted side by side and connected in series. There are various coils upon the American market masquerading under various names such as "toroidal coils," "balloon coils," etc., all of which, in common with the "binocular coils," are designed for the purpose of reducing the external field of an H.F. inductance or transformer. As you know, there are three main difficulties associated with the design of a multi-stage H.F. amplifier. The first is instability due to stray capacity coupling, both between the actual valve electrodes and also in their associated external winding. This is counteracted by means of the neutrodyne system. Now there is a further difficulty due to the fact that in the ordinary type of inductance, the magnetic field radiates widely in various directions, and tends, therefore, to set up a voltage and cause a current to flow in any wire or coil through which it cuts as it rises and falls, thus causing magnetic coupling and consequently perpetual oscillation. This can be remedied by widely spacing the coils and so disposing them that their external fields do not interact with each other. A third difficulty is that these coils are apt to pick up strong signals direct from a powerful local broadcasting station and so abort all efforts in designing selective tuning circuits. This latter difficulty can be got over by placing each coil in a separate metallic screening box. The neutrodyne system, by which the first-mentioned difficulty can be overcome, is a perfectly successful method. The two methods of widely spacing coils or using screening boxes possess the disadvantage of making the receiver bulky and difficult to build, and if care is not taken trouble may be caused by the eddy currents set up in the walls of the screening boxes. Certain designers have set out to overcome these difficulties by producing H.F. inductance coils or transformers having a closed magnetic circuit, thus eliminating the external magnetic field altogether, and enabling coils to be placed close together without mutual interference, and also preventing any external influence such as strong nearby signals, having any influence in setting up a current flow in the coils, any voltage set up across one part of the coil being counteracted by an equal voltage set up on the other side, thus dispensing with the need for complicated screening boxes. These results are brought about by various methods such as winding an inductance in toroidal form, which can best be described by supposing that an inductance were wound on a cylindrical former of some flexible material such as a length of the inner tube of a motor tyre, the ends of the coil then bent round so as to form a complete circle. In the balloon coil the same effect is produced by winding the coil on a spherical former, the wires being disposed in the same position as are occupied by the seams in a football. In the low loss variety the spherical former is actually a specially prepared small inflated bladder, which is afterwards deflated and removed, the coils being self-supporting. The "binocular" coils consist usually of two long and two short cylindrical coils arranged in the form of a rectangle in order to form a closed circuit.

Although these closed circuit coils have met with a large measure of success in achieving the purpose for which they were designed, and are actually incorporated in many high-class receivers, they are not necessarily more efficient, considered from the point of view of inductances, and since they are by no means easy to construct without special workshop facilities, it frequently happens that the amateur produces a coil having a very low efficiency, and such instruments are therefore best left to the professional mechanic or purchased ready wound for inclusion in receivers.

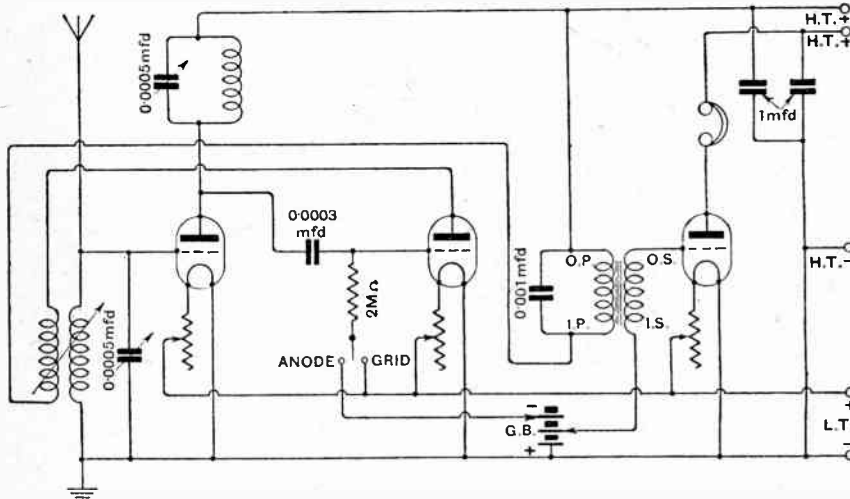

Fig. 2.—Alternative grid and anode rectification in a tuned anode circuit.

of course, be touched again, a simple movement of the switch being all that is required to change from anode rectification back to the more customary grid rectification.

o o o

Difficulties of H.F. Amplifier Design.

Recently perusing a foreign radio journal, I came across a reference to a "binocular coil" for which great claims were made in respect of its performance in a long distance receiver. I shall be glad if you can give me any details concerning the method in which this type of coil functions

P. W. H.

2-VOLT VALVES
with a 6-Volt Result

Osram
D.E.2
H.F. & L.F.

Osram Valves

for Broadcasting

Only .12 amp. filament
current consumption
at 1.8 Volts - The most
economical 2-Volt
Valve obtainable.

PRICE 15/6 EACH

The G.E.C. - your guarantee

£10 Weekly in Cash Prizes



A New and Simple Competition for all Readers of "The Wireless World"

To be continued weekly until further notice.

HIDDEN ADVERTISEMENTS

Below will be found six reproductions of fragments cut from the Advertisement pages of this issue of "The Wireless World." Each fragment is a clue. Can you from these clues identify the Advertisements? Seven cash prizes will be awarded to the first seven readers who send us correct solutions. No technical skill is required, merely observation. There are no restrictions or entry fees and the conditions are simple.

£5
for the first
correct solution
opened.

691	or in
1	2
50	
3	4
L	
5	6

£1
for the third
correct solution
opened.

and
4
consolation
prizes of
10/-
Each
for the next four
correct solutions
opened.

£2
for the second
correct solution
opened.

CONDITIONS

1. All solutions must be written on the special coupon appearing on an advertisement page in this issue and addressed to *The Wireless World*, Dorset House, Tudor Street, London, E.C.4, and marked "Hidden Adverts." in bottom left corner.

2. Clues will not, of necessity, appear in the same way as in the advertisement page, but may be inverted or placed in some other position.

3. In order that town and country readers may compete on equal terms, solutions will not be dealt with until 10 a.m. on Monday next. All solutions received before that date will be retained until Monday morning. Competitors may submit any

number of entries. Erasure; or alterations on a coupon will disqualify the entry.

4. The first prize of £5 will be awarded for the first correct solution opened; the second prize of £2 to the next correct solution; the third prize of £1 for the third, and four consolation prizes of 10/- each for the next four correct answers. In the event of no readers sending correct solutions the prizes will be awarded to the competitors whose solutions are most nearly correct.

5. The decision of the Advertisement Manager of *The Wireless World* is final, and no correspondence can be entered into. Competitors enter on this distinct understanding. No member of the staff of the paper is permitted to compete.

CAXTON 4-VALVE CABINET

Made for Editor of Wireless Magazine for Set "As good as money can buy" described in issue February, 1925.

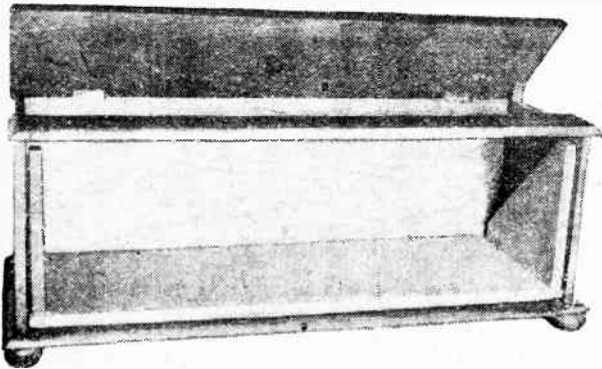

Cash with Order. Fumed Oak ... £1 5 0
or Real Mahogany polished ... £1 14 0

With detachable recess fitted Base Board to mount 21 in. by 7 in. panel to slide out of Cabinet front. Extra 10/- with two beaded front doors totally enclosing fitted panel. Cabinet overall length 22½ ins. Width 8½ ins. Height 9 ins. Polished with the new enamel that gives a glass hard surface that cannot be soiled or scratched. SENT FREE.—Catalogue of standard Wireless Cabinets in various sizes and woods. Special Cabinets made to customer's orders. *PACKED AND DELIVERED FREE IN U.K.*

CAXTON WOOD TURNERY CO., Market Harborough

FORMO
TRADE MARK

RADIO COMPONENTS OF ADVANCED DESIGN. NEW CATALOGUE NOW READY. Straight Line Frequency. Ultra Low Loss Condenser. Micro-Vernier Dial. High Efficiency. Low Loss Variocoupler, etc.

The FORMO Company, Crown Works, Cricklewood, N.W. 2
Manchester: Mr. J. B. Levee, 23 Hartley St., Levenshulme.
10/6

No More Burnt-Out Valves!
if you use a
"CAN'TCROSS" CONNECTOR
(Patent applied for.)

Consists of a plug element for fitting to panel to replace the usual H.T. & L.T. Terminals. The socket element corresponds to the plug element, and is arranged to receive the necessary leads from the respective batteries.

SHORT CIRCUITS IMPOSSIBLE. ACTS AS A DISCONNECTING SWITCH. EASILY FITTED TO ANY SET.

1 Terminal 5/- each 5 Terminal 6/- each
7 Terminal 7/- each

Adapt. table to all Circuits.
Example wired as follows: 1. H.T.1. 2. H.T.2. 3. H.T.3. 4. H.T. 5. L.T. 6. L.T. 7. L.T.

Post Free on receipt of Postal Order and Dealer's name from—
J. & W. BARTON, 22a, Virginia St., SOUTHPORT

Athol
TRADE MARK

For any circuit, any set, anywhere

Bracket for back-of-panel mounting. 2d. each extra.

VALVE HOLDER

Gives perfect insulation, brass sockets almost entirely air-spaced, minimum capacity effects. One-hole fixing to base board, or above panel; easily mounted below the panel. Complete with soldering tags and fixing bolt.

ATHOL ENGINEERING CO.,
Feymour Road, Crumppall, MANCHESTER.

PARAGON

PANELS AND CONDENSERS

1st ASK THE TECHNICAL EXPERTS.
2nd ASK YOUR DEALER,
but if you experience difficulty in securing supplies write direct to us giving dealer's name.

PARAGON RUBBER MANUFACTURING Co. Ltd.,
SCULCOATES, HULL.

NOW!

When you can buy a Loud Speaker which will give you full volume, crystal-clear reproduction at a cost of 35/- don't procrastinate! Tell your dealer you want to hear the new "Hearthside" now—to-day!

Send Post Card for new catalogue.
General Radio Co. Ltd., 235, Regent St., W.1

35/-

ALL DEALERS DEMONSTRATE—SEE IT TO-DAY

General Radio ★

The **"GRIPPLESHELL"**
Registered design No. 716927.

A device for simplifying Aerial Erection
These brackets are made from 1" best quality Wrought Iron painted with weather-proof enamel.

PRICES

Combined corner bracket, insulator & pulley	3/6
4" Hold-off bracket	1/11
9"	0/6 3/4
12"	0/6 3/4

Manufactured by **PARTRIDGE & WILSON, ELECTRICAL ENGINEERS.**
217a, Loughborough Road, LEICESTER.
Telephone 5812.

MISCELLANEOUS ADVERTISEMENTS.

NOTICES.

THE CHARGE FOR ADVERTISEMENTS in these columns is:

12 words or less, 1/- and 1d. for every additional word, e.g., 18 words 1/8; 24 words, 2/- Name and address must be counted.

SERIES DISCOUNTS are allowed to Trade Advertisers as follows on orders for consecutive insertions, provided a contract is placed in advance, and in the absence of fresh instructions the entire "copy" is repeated from the previous issue: 13 consecutive insertions, 5%; 28 consecutive, 10%; 52 consecutive, 15%.

ADVERTISEMENTS for these columns are accepted up to **FIRST POST on THURSDAY MORNING** (previous to date of issue) at the Head Offices of "The Wireless World," Dorset House, Tudor Street, London, E.C.4, or on **WEDNESDAY MORNING** at the Branch Offices, 19, Hertford Street, Coventry; Guildhall Buildings, Navigation Street, Birmingham; 189, Deansgate, Manchester.

Advertisements that arrive too late for a particular issue will automatically be inserted in the following issue unless accompanied by instructions to the contrary. All advertisements in this section must be strictly prepaid.

Postal Orders and Cheques sent in payment for advertisements should be made payable to **ILIFFE & SONS Ltd.**, and crossed **Treasury Notes**, being untraceable if lost in transit, should not be sent as remittances.

All letters relating to advertisements should quote the number which is printed at the end of each advertisement, and the date of the issue in which it appeared.

The proprietors are not responsible for clerical or printers' errors, although every care is taken to avoid mistakes.

NUMBERED ADDRESSES.

For the convenience of advertisers, letters may be addressed to numbers at "The Wireless World" Office. When this is desired, the sum of 6d. to defray the cost of registration and to cover postage on replies must be added to the advertisement charge, which must include the words Box 000, c/o "The Wireless World." Only the number will appear in the advertisement. All replies should be addressed No. 000, c/o "The Wireless World," Dorset House, Tudor Street, London, E.C.4. Readers who reply to Box No. advertisements are warned against sending remittance through the post except in registered envelopes; in all such cases the use of the Deposit System is recommended, and the envelope should be clearly marked "Deposit Department."

DEPOSIT SYSTEM.

Readers who hesitate to send money to unknown persons may deal in perfect safety by availing themselves of our Deposit System. If the money be deposited with "The Wireless World," both parties are advised of its receipt.

The time allowed for decision is three days, during which time, if the buyer decides not to retain the goods, they must be returned to the sender. If a sale is effected we remit the amount to the seller, but, if not, we return the amount to the depositor. Carriage is paid by the buyer, but in the event of no sale, and subject to there being no different arrangement between buyer and seller, each pays carriage one way. The seller takes the risk of loss or damage in transit, for which we take no responsibility. For all transactions up to £10, a deposit fee of 1/- is charged; on transactions over £10 and under £50, the fee is 2/6; over £50, 5/-. All deposit matters are dealt with at Dorset House, Tudor Street, London, E.C.4, and cheques and money orders should be made payable to Iliffe & Sons Limited.

THE SALE OF HOME-CONSTRUCTED UNLICENSED APPARATUS.

A New Service to our Readers.

We have made an arrangement with the Patentees whereby readers who wish to dispose of a home-constructed receiver not licensed under the patents made use of, can do so by means of the Deposit System referred to above.

The person desiring to sell, in sending us particulars for his advertisement, will in every case make use of a Box No., and should add to the price which he requires the amount of royalty customarily paid by manufacturers, viz. in the case of Marconi Patents the amount should be calculated at 12/6 per valve holder.

If the purchaser is satisfied with his purchase, the sum realised will be forwarded to the seller, less the amount due in respect of royalties, which amount will be paid by "The Wireless World" to the owners of the patents concerned and a certificate will be handed on to the purchaser of the set.

FOR SALE.

FOR SALE.—Anglo-American 6 Set, with 3 sets McMichael H.F. transformers, good as new, two-thirds cost.—Box 7038, WIRELESS WORLD Office. (1839)

PETO-SCOTT 5-valve Unit Set (2 H.F., 1 Det., L.F., and Power L.F.), £5.—14, Manor Place, Hackney, E.8. (1838)

For Sale.—Contd.

CRYSTAL Amplifiers increase range five times. Price, complete, 25s. Oscillating zincite 1s. 6d. Original circuit 1s. All parts stocked.—Particulars: Ledsham's, 207, King Street, Hammersmith. (1817)

GENERATOR, 600 volts, Marconi, new, hand or power driven, motor ¼ A.C., 220 to 250 volts, or D.C., 220 to 250 volts, £8; var. condenser £1; Microphone 7s. 6d.; Microphone transformer 7s. 6d.; transmitting valves, 25 watts, 15s. each; accumulator, Exide, new, 180 amps., 6 volts., £2 15s.; offers accepted.—2NO, 13, Elgin Avenue, London, W.6. (1827)

500 to 2,500 Electrostatic Voltmeter, exchange for Milliammeter or high-resistance moving coil voltmeter.—Lottimer, The Croft, Newton Mearns, Renfrewshire, N.B. (1826)

H.T. Motor Generator, belt drive, 200v., 1 A.C. Crypto, 600v., 100 ma., £12; Mark III, tuner, polished case, complete, £4; both as new, seen by appointment.—Box 6060, WIRELESS WORLD Office. (1833)

5-VALVE "R.A.F.10" Receiving Set, 5 D.E. Osram "C" valves, tele-phones, remote control tuner and rheostat, brand new, perfect, £20; also 2 Gambrell neodyne condensers, 1s.; 2003 Ormonde condenser and 2,000s. the lot 15s.—Loch, 14, Froeland Road, Ealing W.5. (1840)

SUPER Hot Transformers, 3 L.F., Input, S Oscillation Coupler, perfect order. Range 150 to 650 metres. £4 the set. Cost over £5.—Box 7000, WIRELESS WORLD Office. (1835)

2-VALVE Det. and L.F. with coils, 37s. 6d., 2 plus Royalties.—Box 7643, WIRELESS WORLD Office. (1842)

McMICHAEL Transformers, 0, 1, 2, 3, 4, two each, matched, perfect, 52s. 6d., or separate.—Taylor, Builder, Rochdale. (1845)

FELLOPHONE Super Three and Amplifier Instruments only.—Apply: Bolton, Rossett Hall, Wrexham. (1847)

WHAT Offers?—1 Magnavox speaker, 1 Magnavox 3-valve set, cost £25; 1 4-valve Polar, sloping cabinet, cost £31 5s.; 1 3-valve Polar, American cabinet, cost £20; 1 Brown microphone amplifier cabinet, cost £5 15s. 6d.—Lawson, Peel Square, Barnsley. (1837)

THREE R.I. Super-Hot transformers, new, two months ago, £2 10s.—Crabtree, 77, Reed Street, Burnley, Lancs. (1846)

GENLINE "DeLambé" High-tension Batteries, noiseless, no charging required and will last for years, 6d. and 10d. per volt.—Particulars: Shaw, Skipton Road, Trawden, Lancs. (1859)

MACKIE Generator, 800 volts and ½ h.p. Century A.C. motor, 220-240 volts, 50 cycles, all mounted on base-board with terminal blocks: 14—5 S.Z., "White Croft," Bare Lane, Morecambe. (1857)

BURNDIPT Rotary Transformer and Smoothing Unit, new, input 12 volts 10 amps., output 1,000 volts, list price £31, accept £15.—5 S.Z., Bare Lane, Morecambe. (1858)

For Sale.—Contd.

CRUX Transformers, 5:1 and 3:1. Guaranteed genuine, 4s. each, postage 4d.—Continental Supplies, 497, Old Ford Road, London, E.3. (1855)

TROPADYAE Kit, as new, what offers?—Dixon, Ryeground Lane, Formby, Liverpool. (1851)

SCRAP your H.T. Battery and buy H.T. Supply Unit, complete with flex and adapter to plug in ordinary lamp-holder. Running cost 1d. per week. Money-back guarantee. Complete, with full instructions, 30s., postage 1s.—Continental Supplies, 497, Old Ford Road, London, E. Note.—To work off D.C. current only. (1856)

SET "Amateur Mechanic," 4 volumes, as new, cost £3, exchange loud-speaker; offers.—45, Goodiers Lane, Salford, Manchester. (1854)

FIVE-VALVE "Transatlantic" Receiver. Built from good components. 1 to 5 valves can be used. Perfect condition. Including two pairs matched H.F. transformers, £10, or with valves (Mullard & Cossor dull emitters) £13 (plus royalties). Also selection suitable coils.—Box 7095, WIRELESS WORLD Office. (1852)

7-VALVE "Wireless Equipment" Receiver, 7 valves (one power), 300-3,000 metres, enclosed cabinet, partition for batteries; £12 10s. or offers.—Robertson, 1, New Square, Cambridge. (1825)

3-VALVE Set, all accessories, loud-speaker; £12 or nearest offer.—Box 7125, WIRELESS WORLD Office. (1860)

AMATEUR has for disposal 4 "Tropafomer" super-hot transformers, £4; 2 "King Quality" low loss variable condensers, 10s. each; 2 "Accuratone" dials, 7s. 6d. each; 1 "Royal" inter-valve transformer, 10s.—Faulk, 31, Fenwick Road, S.E.15. (1865)

MISCELLANEOUS.

FREE.—Home Constructors' Catalogue.—Stamp: Garner, Everything Wireless, 31, Little Britain, E.C.1. (1830)

SECOND-HAND Apparatus taken in part-purchase of new ones. Leading lines supplied.—Wharton, 9, Victoria Street, Westminster. (1412)

INSTRUCTION in Morse, day or evening. Easy terms.—Telegraph School, 29, Talford Road, Peckham, S.E. (1853)

A WIRELESS Doctor.—If your set is giving trouble or you want advice a competent expert will call (anywhere in Greater London) and put you right. No result, no charge.—Alexander Black, 2a, Woodville Grove, N.16. Clissold 3687. (1811)

AMATEUR Carpenters!—For 1s. we will post two sheets Leatherette, 20in. X 30in., in a useful cardboard cylinder. Just the thing for finishing off wireless cabinets, etc., ensuring handsome appearance. When ordering specify Crocodile Seal or Fancy Designs. P.O. or stamps.—The Imperial C. & S. Co., Ltd., 89, Blackfriars Road, London, S.E.1. (1866)

PATENT for Sale.—Small Wireless Accessory which should prove a good seller.—Letters only to W., King's Park, Boscombe, Hants. (1863)

PATENT AGENTS.

W. BRYSON, B.Sc., Chartered Patent Agent, 29, Southampton Buildings, W.C.2. 'Phone: Holborn 672. (1297)

PATENTS and Trade Marks Obtained.—H. T. P. Gee, Patent Agent, Member R.S.G.B., A.M.I.R.E., 51-52, Chancery Lane, London, W.C.2. 'Phone: Holborn 1525. (0001)

KING'S PATENT AGENCY, LTD (B. T. King, Registered Patent Agent, G.B., U.S., and Can.). Free "Advice Handbook" and Consultations. 40 years' references.—140A, Queen Victoria Street, London, E.C.4. (0002)

REPAIRS.

TRANSFORMER Repairs. — Rewound to original efficiency and guaranteed 12 months. 4s., post free. Phones 3s. 6d. Trade supplied.—Transform, 70A, Longley Road, Tooting. (0011)

WANTED.

COPIES of No. 307, Vol. XVII., No. 1, "Wireless World."—G. Brame, Diss, Norfolk. (1867)

GENERAL Radio (America) Quality Components (See advertisements last four issues this journal).—Required, Large, Sound Wholesale Electrical Concern as Exclusive Distributing Agents for London and Home Counties, preferably with good London show-rooms and travellers used to selling components of the very highest quality procurable; satisfactory discounts; generous credits; goods well advertised; also agents in Scotland, Midlands, and Ireland to cover generous territories; every possible assistance from the sole concessionaires for the British Isles, Claude Lyons, 76, Oldhall Street, Liverpool. (1862)

SITUATIONS WANTED.

WIRELESS Expert.—3 years' experience and study; competent in designs, circuits, theory, practice.—Box 6957, WIRELESS WORLD Office. (1832)

GENTLEMAN (41), 4 years A.M.I.R.E., desires responsible position with wireless firm; good organiser and salesman.—Box 6997, WIRELESS WORLD Office. (1834)

QUALIFIED Ship Operator; experienced designing, manufacturing radio apparatus, works and sales managing; keen, energetic; 25; any capacity except traveller; home or abroad.—Box 7008, WIRELESS WORLD Office. (1836)

ADVERTISER (30), 12 years' radio experience, all branches, knowledge languages, accustomed writing technical articles, requires responsible position.—Box 7044, WIRELESS WORLD Office. (1841)

WIRELESS Mechanic, 10 years' experience, desires position with reputable firm.—Box 7067, WIRELESS WORLD Office. (1849)

RADIO and Mechanical Engineer, A.M.I.R.E., experienced as lecturer, and has held posts in production works, requires similar post, or as Lecturer and Demonstrator; would accept post as Traveller on salary and commission; well connected in South Wales.—Box 7068, WIRELESS WORLD Office. (1850)

YOUNG Gentleman desires appointment; 10 years' practical experience; American, Continental, and English wireless apparatus.—Box 7126, WIRELESS WORLD Office. (1861)

BOOKS.

BACK Numbers of all Wireless Publications. —Fangs, Ltd., 11, Tavistock Square, W.C.1. (1829)

125 "Amateur Wireless," 80 "Popular," 20 "Modern Wireless," 30 other Wireless Publications. Offers.—Bell, 10, Cross Street, Kirkcaldy, Fifeshire. (1864)

COMPLETE Training Course in Electrical Engineering issued by The Electrical Engineer Institute of Correspondence Instruction. Seven volumes. Bound half-leather. Price £2 10s. Approval deposit system.—Box 7124, WIRELESS WORLD Office. (1859)

"WIRELESS WORLD," Vol. 12, bound, Vols. 13-17 unbound. Offers.—Russell, 93, Albert Road, S.E.25. (1868)

AUCTION SALES.

13, HIGH HOLBORN, LONDON, W.C.1. SALE BY AUCTION, WITHOUT RESERVE.

HENRY J. SHAW

is instructed to sell by auction on THURSDAY, MARCH 18TH, and following day, at 11.30 each day.

THE STOCK OF A WIRELESS AND ELECTRICAL GOODS MERCHANT, including: 200 Sterling Magnavox Loud-speakers, 1,000 Polar Universal Coil-holders, 30 New Marconi Amplifiers, 100 Polar Variable Condensers, 750 Magnavox Loud-speakers, 950 Crystal and One-valve Receiving Sets, 8,000 New T.C.C. 5 Condensers, 100 New Twin Crystal Sets in Leather-covered Cabinets, 100 Junior Crystal Sets, Marconi One and Two-valve Sets, 100 Marconi Hand-driven Generators, 700 New Fallon Square Law Variable Condensers, 300 Various Laboratory Voltmeters, Wheatstone Bridges, Megger patt Testing Sets, 8 NEW PETROL-ELECTRIC GENERATING SETS WITH STORAGE BATTERIES, 200 pairs 4,000 ohms Headphones, 200 Linesman's Galvos, 200 EDISWAN AND FULLER NEW SIX-VOLT ACCUMULATORS, 1,000 Telephone Plugs, 3,000 Cords, 100 Aerial Panels, 30 NEW THREE-VALVE SETS, Western Electric Power Amplifiers, Armoured Car Flex, High-tension Cable, G.P.O. Relays, Marconi Transformers, Electric Fans, Motor Generators, Marconi Heterodyne Wavemeters, Marconi S.W. Tuners, Cabinets, Cell-testing Voltmeters, Motors, Microphones, etc., etc.

On View Days Previous and Mornings of Sale. Catalogues from the Auctioneers. 85, NEWINGTON CAUSEWAY, S.E.1. 'PHONE: Hop 3862.

The
Amateur's Book
of
Wireless Circuits

By F. H. Haynes.

The most up-to-date book of circuits published. It contains 117 practical circuits for reception and transmission, with notes and descriptive matter.

Price 3/6 net. By post, 4/-

Obtainable from Booksellers and Wireless Stores; or direct from the Publishers: ILIFFE & SONS LTD., Dorset House, Tudor St., London, E.C.4. w.w.19

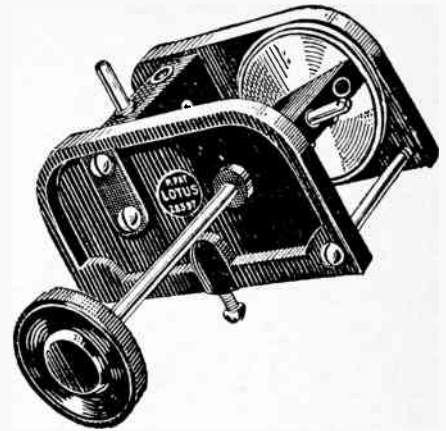

Tuning remains accurate because the Moving Block cannot fall back.

Do away with that irritating, time wasting, fading away of volume caused by the falling of your Moving Block.

Fit a Lotus Geared Vernier Coil Holder and get really accurate tuning. The Lotus Moving Block cannot possibly fall back. Has an easy Vernier movement which reduces the speed by eight times, and stays where it's put—exactly!

Fit in any position, with any weight of coil—you'll be satisfied with the results.

Bakelite mouldings for the side plates, coil blocks and knobs; heavy Nickel Plating for the metal parts.

LOTUS
VERNIER
COIL HOLDERS

From all reliable Radio Dealers.

GARNETT, WHITELEY & CO., LTD.,
Lotus Works,
Broadgreen Road, Liverpool.

Makers of the famous Lotus Buoyancy Valve Holder.

2/3

With Terminals 2/6

INDEX TO ADVERTISEMENTS.

	PAGE
Accumulators Elite	16
A.J.S. & Co. (1914), Ltd.	9
Athol Eng. Co.	13
Autoveyors, Ltd.	4
Barton, J. & W.	13
Bowyer-Lowe Co., Ltd.	10
Brandes, Ltd.	10
Britannia Rubber & Kamptulicon Co., Ltd.	10
British Electrical Sales Organisation	10
British Glowlamp & Valve Co.	10
British L.M. Ericsson Manf. Co., Ltd.	16
Burndept Wireless, Ltd.	10
Caxton Wood Turnery Co.	13
Chloride Electrical Storage Co., Ltd., The	10
Christie, James, & Sons, Ltd.	10
Cleartron Radio, Ltd.	10
Darex Radio, Ltd.	10
Darimont Electric Batteries, Ltd.	10
Dixon, Leslie & Co.	10
Dubliher Condenser Co. (1925), Ltd.	Cover iv.
Edison Swan Electric Co., Ltd.	10

	PAGE
Electron Co., Ltd.	10
Encore Manf. Co.	10
Ferranti, Ltd.	6
Finston Manf. Co., Ltd.	10
Fitzpatrick, H. D., & Co.	16
Formo Co.	13
Fuller's United Electric Works, Ltd.	Cover ii.
Gambrell Bros., Ltd.	10
Garnett, Whiteley & Co., Ltd.	15
General Electric Co., Ltd., The	11
General Radio Co., Ltd.	13
Graham, Alfred, & Co.	4
Hayberd, F. C., & Co.	10
Hough, J. E., Ltd.	Cover ii.
Igranio Electric Co., Ltd.	2
Lampugh, S. A., Ltd.	6
Lissen, Ltd.	8
London, Elec. Wire Co. & Smiths, Ltd.	7
Marconiphone Co., Ltd., The	1
Metro-Vick Supplies, Ltd.	2 and 5

	PAGE
Midland Radiotelephone Mfrs, Ltd.	5
Miller, J.	16
Mullard Wireless Service Co., Ltd., The	9
Nelson Electric Co., Ltd.	6
Ormond Engineering Co.	13
Paragon Rubber Co., Ltd.	13
Partridge & Wilson	13
Pickett Bros.	16
Pugh Bros.	16
Radians, Ltd.	16
Radio Communication Co., Ltd.	16
Reflex Radio	16
Sanders, W.	16
Shaw, H. J.	15
Sifan Elec. Inst. Co.	16
Stratton & Co., Ltd.	16
Telephone Manf. Co., Ltd.	7
Watmel Wireless Co., Ltd., The	16
Wilkins & Wright, Ltd.	4
Withers, J. S., & Spooner	16

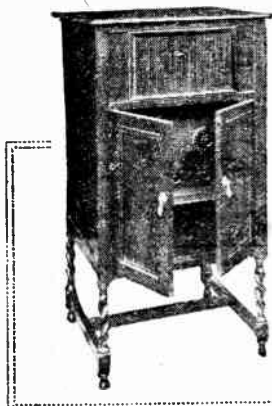

COMBINATION CABINETS FOR THE HOME CONSTRUCTOR

Oak Cabinet 3' 6" high by 1' 9" wide by 1' 6" deep, with double doors. Correctly designed built-in wooden loud-speaker horn with attachment to take AMPLION or other loud-speaker unit. Pleated silk cover to loud-speaker aperture; accommodation for batteries, etc.

PRICE 5 gns.

Carriage paid, as illustrated, cash with order.

W. SANDERS, 35, Lyndon Road, Olton, Warwickshire.

Write for illustrated list.

WIRELESS VALVE TRANSMITTERS

The Design and Operation of Small Power Apparatus.

Obtainable from Book-sellers or direct from the Publishers,

Price 9/- net. By post, 9/9.

ILIFFE & SONS LTD., Dorset House, Tudor Street, LONDON, E.C.4.

W.W.5

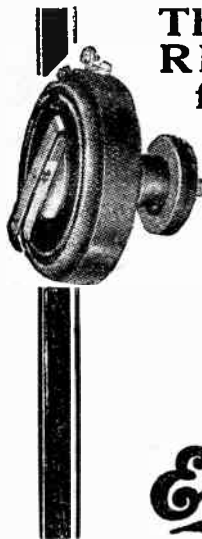

The ideal Rheostat for any valve.

Only the special spring arm, the perfected bearing and winding of the Ericsson Dual Rheostat permits such velvety smoothness.

By means of small auxiliary knob the resistance of 6 ohms can be altered to one of 60 ohms. Price complete with pointer, knob, scale and screws, **8/6.**

Write for lists to-day. **THE BRITISH L.M. ERICSSON MFG. CO., LTD., 67, 73, Kingsway, London, W.C.2.**

Ericsson
DUAL RHEOSTATS.

PATENTS, DESIGNS AND TRADE MARKS.

J. S. Withers & Spooner.

CHARTERED PATENT AGENTS

ESTATE HOUSE, 61 & 62, CHANCERY LANE, LONDON, W.1. Grams: IMPROVABLY HOLB., LONDON. Tel: 480 HOLBORN

Amateurs! Let us make your Cabinets

In Beautiful Polished Mahogany or Oak - SENT ON APPROVAL, De Luxe Models - Parlour Model, etc., from 25/- to 55/- Crystal Cabinets from 1/6. Any size MADE TO ORDER. Designs and Lists Free. Estimates per Return Post. Panels and Accessories Post Free.

Send to actual Makers: Pickett Brothers, Members B.B.C. (W.W.) Cabinet Works, Boxley-heath. *It will pay!*

TROLITE PANELS

Mahogany Grain . . . 3/6 lb.
Black Engraved wavy . . . 3/9 lb.
Black plain polished . . . 3/- lb.

Machine cut Tested to your own measurements. 50,000 Volts.

PUGH'S WIRELESS, 95-101, Holloway Road, London, N.7

PATENTS, DESIGNS & TRADE MARKS.

H. D. FITZPATRICK & CO.
Chartered Patent Agents,
49, Chancery Lane, London, W.C.2
Phone: Holborn 459.

H.T. Accumulators 37/6
60 Volts 3 Actual Amp.-hour

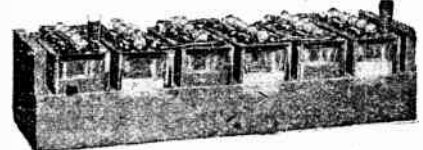

The finest H.T. Accumulator in the world.

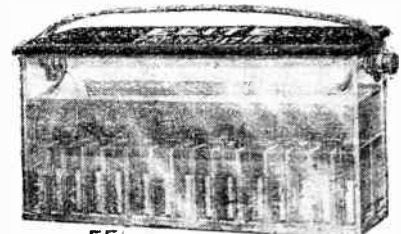

55-
60-volt, 3-amp.-hour oil submerged. Will last a lifetime. Write for descriptive folder. MONEY RETURNED IF NOT SATISFIED. Obtainable only from **ACCUMULATORS ELITE, 31 Waterhouse St., Halifax.** Trade Supplie. Telephone: 1304.

VALVES Repaired Quick

Let our valve making plant repair your broken or burnt-out valves efficiently & promptly (most makes). Guaranteed equal to new. Bright emitters 5-: "DE's" 2 and 3 v (typ-a). 7/6. Power valves slightly more, see list. Not repairable: S.P.'s WECO v.24, Co-sor D.E.'s.

RADION Reliable Repairs
RADIONS Ltd., Bollington, Nr. MACCLESFIELD, Ches.
Largest valve-repairing firm in the world. List Free.

REPAIRS SETS PHONES TFORMERS
— Officially approved by Radio Association —
ALL WORK GUARANTEED. LOWEST RATES. 24 HOUR SERVICE.
JOHN W. MILLER, 68, Farringdon Street, E.C.4
PHONE: CENTRAL 1950

30 MILLION DUBILIER Condensers *Are now in use*

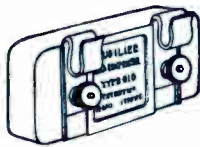

Type 610 Mica Condenser
for general use in receive-
ing circuits. Capacities
0.0001-0.015µF.
From 3/-

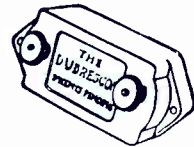

The Dubrescon
Permanent Valve
Protector - 6/-

These stupendous figures seem at first sight almost incredible. Yet they are correct, for Dubilier products are known and used all over the world.

The World's leading set manufacturers have standardised on Dubilier condenser equipment; the World's most important transmitting stations are equipped with banks of Dubilier Condensers, and every important Government department in the principal countries of the World makes use of Dubilier products for radio purposes.

The Dubilier Condenser Co. (1925) Ltd. manufacture Fixed Mica Condensers, Variable Air Condensers, Anode Resistances, Grid Leaks, the Dubrescon Valve Protector, the Ducon Aerial Adaptor, the Minicap Switch and the Mansbridge Variometer.

The Company are also sole concessionaires for the products of the Mansbridge Condenser Co. Ltd.

Specify Dubilier

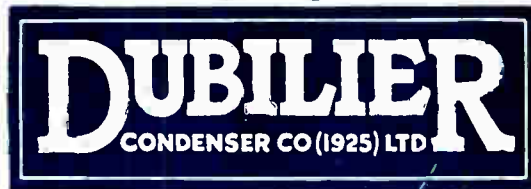

ADVERT. OF THE DUBILIER CONDENSER CO. (1925) LTD., DUCON WORKS, VICTORIA ROAD, NORTH ACTON, W.3.

TELEPHONE: CHISWICK 2341-2'S.
E.P.S. 172

Printed for the Publishers, LITTLE & SONS LTD., Dorset House, Tudor Street, London, E.C.4, by The Cornwall Press Ltd., Paris Garden, Stamford Street, London, S.E.1.

Colonial and Foreign Agents:
 UNITED STATES—The International News Co., 83-85, Duane Street, New York. FRANCE—W. H. Smith & Son, 248, Rue Rivoli, Paris; Hachette et Cie, Rue Réaumur, Paris.
 BELGIUM—W. H. Smith & Son, 79, Marche aux Herbes, Brussels. INDIA—A. H. Wheeler & Co., Bombay, Allahabad and Calcutta. SOUTH AFRICA—Central News Agency, Ltd.
 AUSTRALIA—Gordon & Gotch, Ltd., Melbourne (Victoria), Sydney (N.S.W.), Brisbane (Queensland), Adelaide (S.A.), Perth (W.A.) and Launceston (Tasmania).
 CANADA—The American News Co., Ltd., Toronto, Winnipeg, Vancouver, Montreal, Ottawa, St. John, Halifax, Hamilton; Gordon & Gotch, Ltd., Toronto; Imperial News Co., Toronto, Montreal, Winnipeg, Vancouver, Victoria. NEW ZEALAND—Gordon & Gotch Ltd., Wellington, Auckland, Christchurch and Dunedin.

4^D

The Wireless World

UNIVERSITY OF TORONTO

The Library of the

Department of

AMERICAN

The Paper for Every Wireless Amateur

Wednesday, March 17th, 1926



Two Stage

Radio Frequency
AMPLIFIER



Like Caesar's Wife
ALWAYS ABOVE SUSPICION
DUBILIER CONDENSERS



THE MANSBRIDGE CONDENSER.

This condenser is just what you want across your H.T. terminals to stop crackling due to the H.T. battery. Made only by the Mansbridge Condenser Co., Ltd., and sold and guaranteed by Dubilier.

Capacities from 0.01 mfd. to 2.0 mfd.

Prices from 2/6 to 5/-

THE VANICON CONDENSER.

This is the standard quality condenser for general purposes. Positive connection to moving plates is secured by a phosphor-bronze strip—a very special and important feature.

Sold complete with vernier.

0.00 25 mfd. . 17/6

0.0005 mfd. . 22/6

0.001 mfd. . 27/6



Specify Dubilier.





for POWER and PURITY

The name MARCONI on a valve is a guarantee of sound design, faithful performance and extreme durability. Marconi valves are used by the best known experimenters and by the principal broadcasting stations throughout the world.

There are various types of Marconi valves, each designed for a special purpose, and when used in correct combination, radio reception has a charm and perfection unattainable any other way.

MARCONI POWER VALVES

D.E.6. 2-volt accumulator. Anode volts 60-120	18/6
D.E.4. 4-volt accumulator. Anode volts 120	22/6
D.E.5. 6-volt accumulator. Anode volts 120	22/6
L.S.5. 6-volt accumulator. Anode volts 60-100	40/-



The name first and foremost in radio for 30 years, guarantees the supremacy of Marconiphone products—Receiving Sets, H.F. and L.F. Amplifiers, "Ideal" Transformers and Components, also the famous Sterling Loud Speakers, Sets and Components.

THE MARCONIPHONE COMPANY, LTD.

Regd. Office: Marconi House, Strand, London, W.C.2.
Head Office: 210-212, Tottenham Court Road, London, W.1.

MARCONI VALVES

IN THE PURPLE BOX

Write for Valve
Publication No. 443

COVERED BY VARIOUS PATENTS
FOR PARTICULARS APPLY TO
THE MARCONIPHONE

USE BURNDEPT COMPONENTS and ensure perfect results

EVERY requirement for radio reception is covered by the Burndept range of components. Their use ensures complete satisfaction, as the quality of Burndept products never varies—this is a fixed policy.

All stages of manufacture are carefully supervised and the finished products rigorously tested before leaving the factory.

Fit Burndept Super-Vernier Dials to your set and find out how easy "tuning" becomes.

There is a Burndept Super Valve to suit your set, and every valve is guaranteed. Any Burndept dealer will be pleased to show you the complete range. Demonstrations can be arranged



Aldine House, Bedford St., Strand, London, W.C.2.

Telephone :
Gerrard 9072
(4 lines).

Branches and Agents
Everywhere.

Telegrams :
Burndept. Westrand,
London.

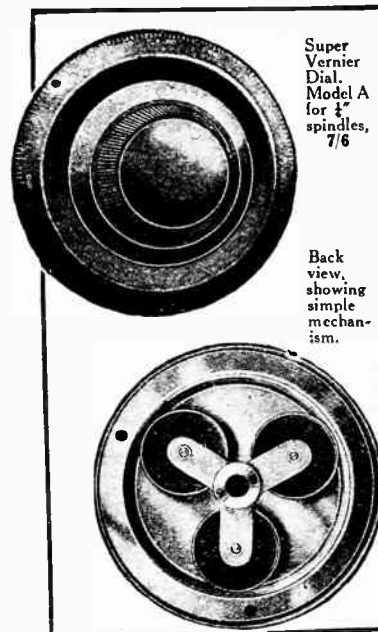

Super Vernier Dial, Model A for 4" spindles, 7/6

Back view, showing simple mechanism.

The Wireless World COUPON for "HIDDEN ADVT." COMPETITION

This coupon is available until Monday, 10 a.m., March 22, 1926

Clue No.	Name of Advertiser.	Page
1		
2		
3		
4		
5		
6		

I enter the above solution subject to the published rules.

Name _____
(Please write clearly)

Address _____
17B/26



The Journal of Radio Research and Progress

"EXPERIMENTAL WIRELESS" is a monthly publication devoted to the interests of all keen radio enthusiasts, advanced amateur workers and experimenters, and professional wireless engineers. It contains authoritative technical and scientific information relating to every aspect of wireless experiment and research.

The following articles in the MARCH ISSUE will appeal to readers of "The Wireless World":

- "Rejectors and Absorbers," by Prof. G. W. O. Howe, D.Sc.
- "H.F. Resistances," by P. K. Turner, A.M.I.E.E.
- "Loud-Speakers." A Lecture to the R.S.G.B., by N. W. McLachlan, D.Sc., M.I.E.E.
- "The Propagation of Radio Waves," by J. Killingworth, M.A., B.Sc.
- "Rectifiers for High Tension Supply," by R. Mines, D.Sc.

Monthly 1s. : Post Free 1s. 3d. : Subscription, 15s. per ann.

Publishers: ILIFFE & SONS LTD., Dorset House, Tudor Street, London, E.C. 4
W.W.2

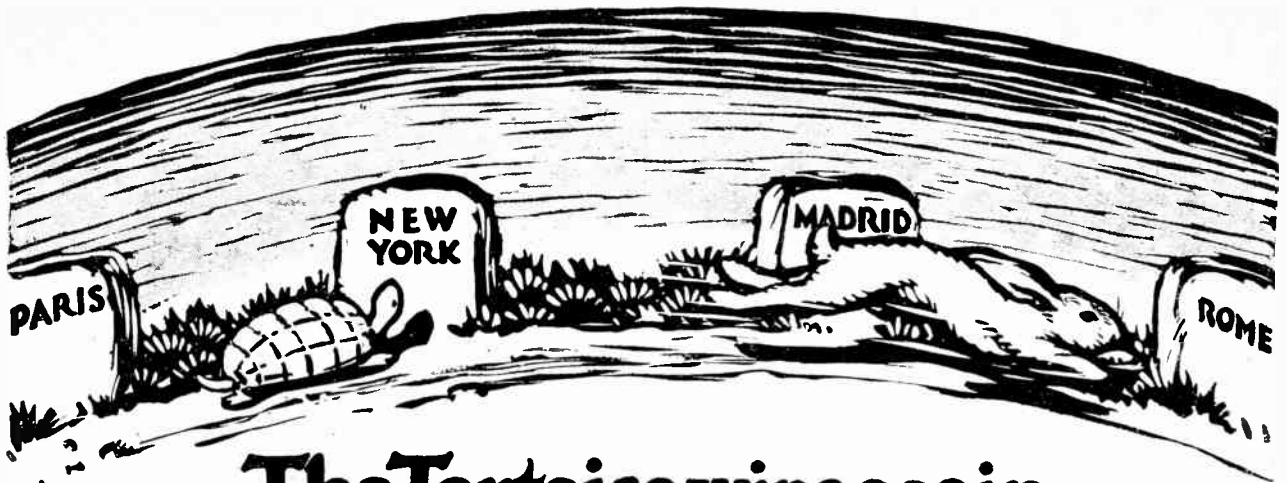

The Tortoise wins again

THE VICTORY of the new "Ormond" Slow Motion Condenser is the victory of the tortoise over the hare. Its smooth, steady progress is unfailing. Every station is approached slowly and gently and you can stop dead just wherever you want to. Inferior condensers are like the hare—slower in the long run. They whirl you past station after station, and before you can pull up at one you are half way to the next.

Ask your dealer for the new **ORMOND** BALL-BEARING FRICTION CONTROL CONDENSER.

IDEAL RATIO:
55-1

PRICES:

'0005 15/-
'0003 14/6
'00025 13/6

Complete with Knob and Dial.

Brass End Plates. Highly Nickelled Finish.



199-205, Pentonville Road,
King's Cross, London, N.1.

Telephone - - - Clerkenwell 9341, 5, and 6.
Telegrams - - - "Ormondengi, Kingcross."

FACTORY: WHISKIN STREET, CLERKENWELL, E.C.1.

THE KING OF SLOW MOTION CONDENSERS

BRITISH MADE, Using Only BRITISH MATERIALS.

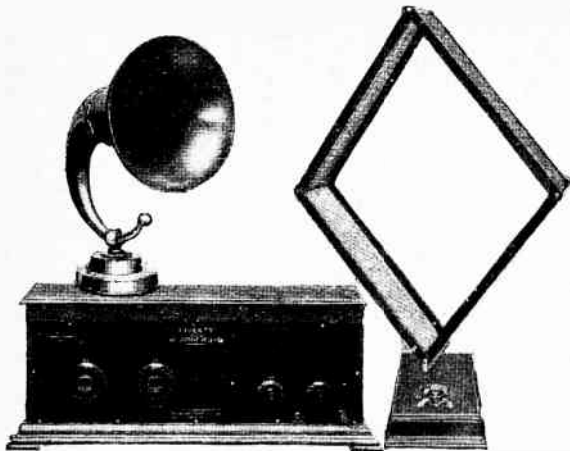

LIBERTY SUPERSONIC HETERODYNE RECEIVER

(British Patent No. 143583.)

PRICES : 6 Valve Set £28. 8 Valve Set £32 plus Royalties.
DEMONSTRATIONS WILLINGLY GIVEN AT ANY TIME.

NOTE.—TWO CONTROLS ONLY.

RECEIVES any BRITISH, CONTINENTAL, and Principal AMERICAN STATIONS at will, not by accident.

With each set is supplied a chart showing the settings of both controls for all chief broadcasting stations, and all receivers are calibrated to receive such stations on a frame aerial using British Standard Dull Emitter Valves, at loud-speaker strength, and guaranteed to cut out any unwanted station entirely.

LIBERTY SUPERSONIC UNITS

(Provisionally patented.)

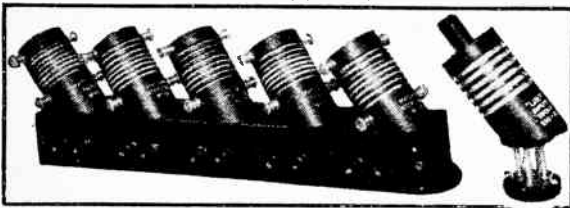

Comprising four intermediate matched transformers, filter, long and short wave oscillator and balancing device, enabling all stations from 250/3,000 metres to be received. Each transformer matched to half a turn, also secondary windings of the filter. Ensures ultra selectivity. Delivers maximum signal strength to detector valve. Air cored transformers and filter, no iron being used, thus the sharpest uniform peak at super-sonic frequency is obtained.

Full description and illustrated leaflet on request.

* NOTE.—Knobs controlling mechanical balancing device which enables the constructor to select his super-sonic frequency peak and to match each individual stage to a frequency not merely a number of inductive turns. Any variations of valve capacities can be accurately rectified.

PRICE: £5 complete including theoretical and practical wiring diagrams and list of other components required.

March 1st, 1920.

I am pleased to say I managed to log 72 Stations in 3 hours, at terrific loud speaker strength, four of these being "Lanks." Please repeat order and send me set of units as soon as possible. Signed G.E.O.

Sole Manufacturers—**The Radi-arc Electrical Co. Ltd.**

Bennett Street, Chiswick, LONDON, W.4.
Telegrams—"Radiarc, London."
Telephones—Chiswick 1834 & Gerrard 1706.

BECOL—the dependable **EBONITE**

(REGISTERED TRADE MARK) "BECOL" is more than a trade mark—it is your protection. It stands for all that is best in ebonite manufacture—it is a positive guarantee of panels free from surface leakage. That's why the expert, wherever he may be, says "BECOL." He knows from experience there is no better ebonite in the world.

RODS, TUBES, SHEETS, MOULDINGS.

Always ask for "BECOL"

THE BRITISH EBONITE Co. Ltd., Hanwell, LONDON, W. 7.

No More Short Circuits

"CAN'TCROSS" CONNECTOR

(Patent Applied for.)

Consists of a Plug element for fitting to the panel, to replace the usual H.T. and L.T. terminals. The Socket element corresponds to the Plug element, and is arranged to receive the necessary leads from the respective batteries.

BURNT-OUT VALVES IMPOSSIBLE. ACTS AS A DISCONNECTING SWITCH. EASILY FITTED TO ANY SET.

2 Terminal, 5/- each. 5 Terminal, 8/- each. 7 Terminal, 7/- each. (Leads not included.)



Adaptable to all Circuits.

Example Wired as follows: 1. H.T.1. 2. H.T.2. 3. H.T.3. 4. H.T.— 5. L.T.+ 6. L.T.—

Post Free on receipt of Postal Order and Dealer's Name from

J. & W. BARTON, 22a, Virginia Street, SOUTHPORT.

GUARANTEED VALVE RENOVATIONS

ONE PRICE FOR ALL TYPES

(Power Valves excepted)

Per **3/6** Valve

— Power Valves 6/6 —

FOR 3/6 your burnt out valve can be renovated, under guarantee by our new process, to any one of the following specifications.

Type	Fil. Volts	Fil. Amps.	Anode Volts	Bright or Dull
I	3.5	.5	20 to 100	Bright
II	1.8	.33		Dull
III	2.5	.12		Dull

VALVES should be sent, with P.O. 3/9 (or 6/9 if Power Valve), securely packed, stating which type is selected, to:—

THE BRITISH GLOWLAMP & VALVE CO.,
27 Kirby Street, Hatton Garden, London, E.C.1.

Telephone Holborn 4553.

Performance of Every Returned Valve Guaranteed.

Open on Saturdays until 4 p.m.



Two in One!

Here's a splendid little component, the Watmel combined Grid Condenser and Fixed Grid Leak. Saves space, time and money. Built to allow the Grid Leak to be connected either across the condenser or direct to the filament of the detector valve.

Price 2/6 each.

Send a postcard for full details of the various Watmel products.

The Watmel Wireless Co. Ltd.,
332a, Goswell Rd., London, E.C.1.

Representative for Lancashire & Cheshire:
Mr. J. B. Levee, 23, Hartley Street, Levenshulme, Manchester.

For trouble-free condenser efficiency always specify the famous round Watmel fixed condenser.

Sizes up to '002 - - - - 2/-
Sizes '0025 to '006 - - - - 2/6



The Secret

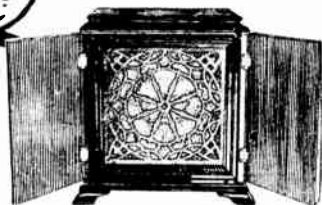

"BECO-DE-LUXE."

of "Beco" popularity lies in the exceptional purity of tone of these wonderful hornless loud speakers. No blatant, distorted "noise," but a beautiful, pure tonal rendering of music, song, and speech, with surprising volume and clarity.

BECO

HORNLESS LOUD SPEAKERS

The "Beco-de-Luxe" (British Made) is an artistic piece of furniture for any home and the volume from it will fill a large hall. Obtainable fitted in either oak or mahogany cabinet. Height 13"

Oak £5 - 0 - 0 Mahogany £5 - 5 - 0

The small 1926 "Beco," a very efficient model with a very pleasing and attractive appearance, gives unusual volume, with crystal clarity 6" high and obtainable at the following prices:

Finished in Nickel Plate
52/6

Oxydised Silver or Copper
55/-



"The 1926 BECO."

Ask your dealer to demonstrate these Models.

Dept. W, British Electrical Sales Organisation, 623, Australia House, Strand, W.C.2.

Telegrams - - - - - "Becospek. Estrand, London."

Telephone : CITY 7665



Try the coil that "makes all the difference"!

Every listener who has tried the new LEWCOS Coil is talking about the difference it makes. Some say that this coil in the blue box is as different from ordinary coils as "Glazite" is from the old connecting wire.

The Lewcos Coil embodies high electrical efficiency with great mechanical strength. It gives extremely fine tuning and, having an exceptionally low high frequency resistance, increases signal strength.

Try the LEWCOS COIL for yourself—it makes *all* the difference! Your radio dealer stocks or can obtain this new coil.

LEWCOS Inductance Coil

The LONDON ELECTRIC WIRE COMPANY & SMITHS, LTD.

Manufacturers of Glazite Connecting Wire

Playhouse Yard, Golden Lane, London, E.C.1



This mark



guarantees quality.

THE HOME CONSTRUCTOR'S WIRELESS GUIDE By W. James. A useful little encyclopedia of wireless technology which will solve difficulties met with in practical work.

PRICE
3/6
By post 3/10.

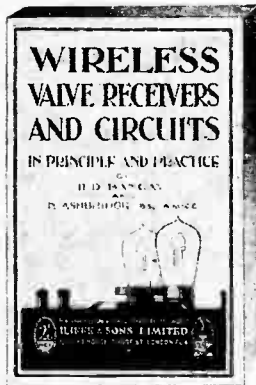
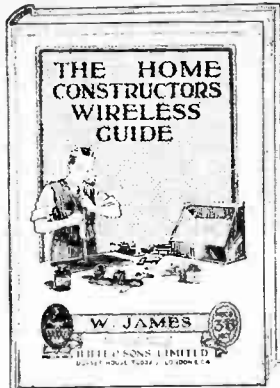

WIRELESS VALVE RECEIVERS AND CIRCUITS. In Principle and Practice. By R. D. Bangay and N. Ashbridge, B.Sc. Written to enable the amateur to understand the working of any circuit he constructs.

PRICE
2/6
By post 2/10



THE HOME CONSTRUCTOR'S EASY TO BUILD WIRELESS SETS. By F. H. Haynes. Well illustrated with working drawings and diagrams.

PRICE
1/6
By post 1/9



TUNING COILS AND METHODS OF TUNING. By W. James. A manual discussing the principles and practice of tuning coils, with explanations of spade, condenser and variometer tuning.

PRICE
2/6
By post 2/10

Get to the Root of the Subject!

THOSE wireless workers who get to the root of the subject derive the greatest pleasure and profit from their hobby. Many are content to dabble in wireless without ever really understanding the whys and the wherefores of things. They do not know what they miss! By reading practical books, by recognised authorities on wireless matters, a wide field of new interests is opened up for the amateur.

This FREE Booklet helps you to select the best books.

A postcard will bring you our FREE Booklet: "A Guide to Wireless Literature." This list gives particulars of a very extensive range of wireless books issued in conjunction with "The Wireless World" and "Experimental Wireless."

There is a book for every phase of wireless and for every wireless worker. A few of the volumes are illustrated on this page. General headings—under which the library is classified—are "Explanatory Books": "Home Constructional Books": "Books for the Amateur": "Books for Experimenters": "Miscellaneous Books." These indicate the extensive ground which is covered.

Write for your copy to-day!

ILIFFE & SONS LIMITED
Dorset House, Tudor Street,
LONDON, E.C.4

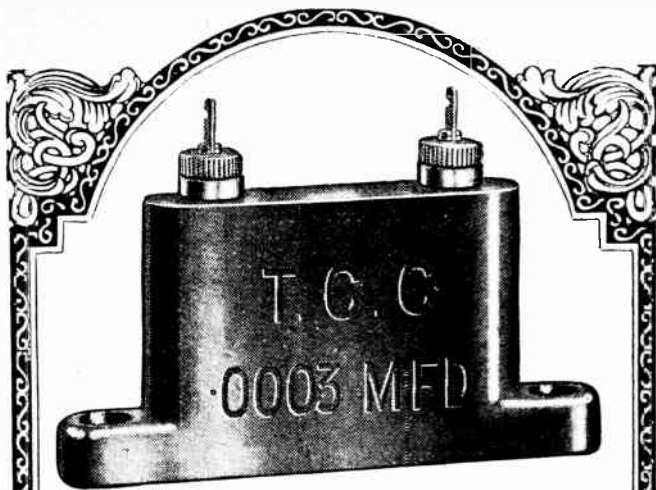

The new T.C.C. Mica Condenser

Here is the latest T.C.C. production—an accurate mica Condenser in a green moulded case with duplex terminals. Owing to its convenient shape it takes up very little room on the panel, and because it is sealed from below instead of from above it is proof against the heat of the soldering iron. For those who do not wish to solder their connections, a convenient milled head is provided to ensure a perfect electrical contact.

No need to ask if it is accurate—the name T.C.C. guarantees it.

Every T.C.C. Condenser—whether Mica or Mansbridge—has to pass so many tests before it is released for issue that its accuracy within a very small percentage of error is a foregone conclusion. Your fixed Condenser—on which so much depends—is one of the least expensive of all the components you buy. The difference in cost between one of doubtful reputation and a genuine T.C.C. may only be a copper

or two, yet the difference in results may be phenomenal. Experts say that the majority of faults in home-built receivers are traceable to the use of inferior and badly insulated condensers. If your own Set is not giving the results you should expect, suspect the condensers—substitute T.C.C. Mica (for small values) and T.C.C. Mansbridge (for large values) and you obtain a permanent insurance against Condenser breakdown.

Prices:

- No. 33, all capacities between '004 and '001 mfd. 2/4
- No. 34, all capacities between '0009 and '0001 mfd. 2/4

From all Wireless Shops.

T.C.C. Mica Condenser

Advertisement of Telegraph Condenser Co., Ltd., Kent, Surrey.

Gilbert Ad. 1951.

Simplify your switching arrangements! with TMC Low Capacity Keys

THE Amateur Constructor will find many of his switching problems easy of solution if T.M.C. Low Capacity Keys are employed.

These Keys are of simple design, strong and accurately made. Being compact they are most useful where space behind the panel is limited. They are particularly easy to connect up because the ends of the springs are tinned to facilitate soldering.

T.M.C. Low Capacity Keys have many uses. Here are but a few:—

- Distant Control.*
- To give choice between:—*
- Crystal Detector only and Crystal Detector with low frequency amplification.*
- Valve Detector only and Valve Detector with low frequency amplification.*
- One or more stages of low frequency amplification.*
- Change over from headset to loud speaker.*



No. 1 L.C. Key, Price 7/-

T.M.C. Low Capacity Keys are made in 3 models.

- No. 1. 12 point, 3 position . . . 7/-
- No. 2. 6 point, 2 position . . . 6/-
- No. 3. 24 point, 3 position . . . 15/6

Write for descriptive leaflet.

If you cannot obtain T.M.C. Low Capacity Keys from your local dealer apply to the sole manufacturers:—

TELEPHONE MANUFACTURING CO., LTD., Hollingsworth Works, West Dulwich, S.E.21.

Phone: Sydenham 2160/1.

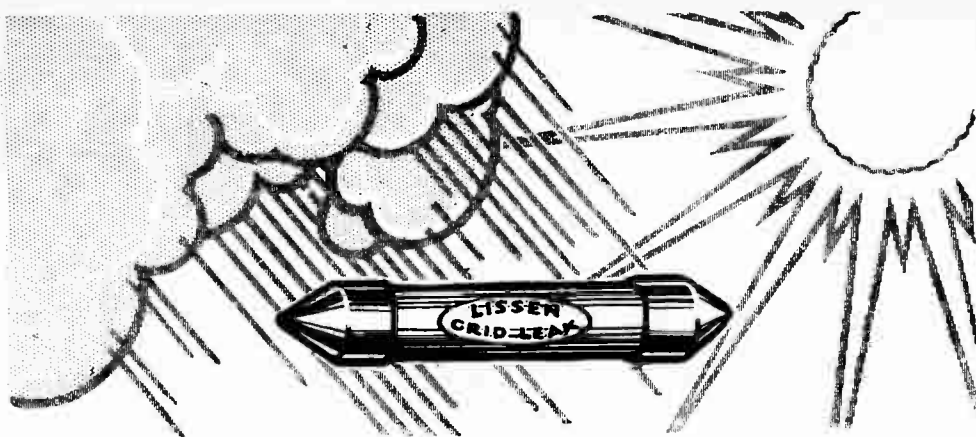

10 Days in Sun and Rain did not alter its resistance

Last Summer, when it rained in London for five days without stopping, an uncovered case of Lissen Fixed Grid Leaks was left the whole time upon the roof of our factory. When the rain stopped the case was left exposed to the sun through a heat-wave. Then it was handed over to our research department who carefully tested the contents. In every Grid Leak the resistance was found unvaried, and true to its marked value.

This points an obvious moral—fit Lissen Fixed Grid Leaks and be sure of your circuit. Their unalterable resistance goes a very long way towards making a circuit *silent*. Price 1/8.

In certain critical circuits a *variable* grid leak is necessary. With a "Lissen" you can obtain any resistance between $\frac{1}{4}$ and 15 megohms, smoothly, gradually and *noiselessly*. When using a Choke Coupled Amplifier it is always advisable to use the Lissen **Variable Grid Leak**. One hole fixing, of course. Price 2/6.



It is also well worth while to fit Lissen **Fixed Condensers**. Accurate to within 5% of their marked capacities, they will not vary and will not leak. Whatever the temperature behind your panel may be, the capacity of a Lissen Fixed Condenser always remains constant. Fit Lissen and make sure of trouble-free condensers.

NOTE THE NEW PRICES
'0001—'001 ... 1/3 '002—'006 ... 2/-

Mica dielectric.
(With each '0002 and '0003 there is included free a pair of clips to take a grid leak.)

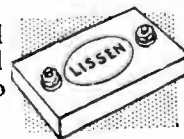

LISSEN

THERE IS NO 'WEAKEST LINK' IN THE LISSEN CHAIN

Lissen Limited, 21-25, Friars Lane, Richmond, Surrey

Phone: Richmond 2285 (4 lines).

Grams: "Lissenium, Phone, London."

J

The Wireless World

AND
RADIO REVIEW
(13th Year of Publication)

No. 344.

WEDNESDAY, MARCH 17TH, 1926.

VOL. XVIII. NO. II.

Assistant Editor:
F. H. HAYNES.

Editor:
HUGH S. POCOCK.

Assistant Editor:
W. JAMES.

Editorial Offices: 139-40, FLEET STREET, LONDON, E.C.4

Advertising and Publishing Offices: DORSET HOUSE, TUDOR STREET, LONDON, E.C.4.

Telephone: City 4011 (3 lines).

Telephone: City 2847 (13 lines).

COVENTRY: Hertford Street.

BIRMINGHAM: Guildhall Buildings, Navigation Street.

MANCHESTER: 199, Deansgate.

Telegrams: "Cyclist Coventry."
Telephone: 10 Coventry.

Telegrams: "Autopress, Birmingham."
Telephone: 2970 and 2971 Midland.

Telegrams: "Hiffe, Manchester."
Telephone: 8970 and 8971 City.

Subscription Rates: Home, £1 1s. 8d.; Canada, £1 1s. 8d.; other countries abroad, £1 3s. 10d. per annum.

As many of the circuits and apparatus described in these pages are covered by patents, readers are advised, before making use of them, to satisfy themselves that they would not be infringing patents.

BROADCASTING COMMITTEE'S REPORT.

THE Report has recently been published of the Broadcasting Committee appointed by the Postmaster-General with terms of reference as follows:—

"To advise as to the proper scope of the Broadcasting Service and as to the management, control and finance thereof after the expiry of the existing licence on 31st December, 1926. The Committee will indicate what changes in the law, if any, are desirable in the interests of the Broadcasting Service."

The Report, which is comprehensive in character, has been generally well received, and indicates how thoroughly the Committee, under the Chairmanship of the Earl of Crawford and Balcarres, have carried out the task imposed upon them.

The New Authority.—The outstanding recommendation of the Committee is that, from the date of the expiry of the present B.B.C. licence at the end of the present year, the Broadcasting Service should be carried out by a public corporation under the title of "The British Broadcasting Commission," this authority to be set up by Statute or under the Companies Act, to hold the licence of the Postmaster-General, and to be invested with full authority. It is recommended that the Commission should be composed of not more than seven, nor less than five, persons, adequately remunerated, who should be free of commitments and having no other interests to promote than those of the public service. It is recom-

mended that the Commission shall be under obligation to take over the existing staff of the B.B.C., and it is suggested that it may be desirable, in order to assist in preserving continuity, that a member of the existing Board of the B.B.C. should be one of the new Commissioners.

Finance.—No change in the 10s. licence fee is recommended. After the Postmaster-General has been indemnified against the cost of collecting licence fees and other relevant expenditure, the Commissioners are to receive an income thoroughly adequate to enable them to ensure the full and efficient maintenance and development of the Service, after which any surplus might be retained by the State.

Programmes.—A special recommendation is made that particular attention should be paid to the educational possibilities of the Service, and that in music, as in all other sections of the programmes, a high standard should be aimed at. It is, however, stated that "the listener is entitled to latitude. He must not be pressed to assimilate too much of what he calls 'high-brow' broadcast, and the Commission would not be wise in transmitting more educational matter than

licensees are prepared to accept."

OUR OBSERVATIONS.

ABOVE we have outlined what we consider to be the salient points in the recommendations of the Committee. An official summary of the recommendations is published elsewhere in this issue, and to this readers are referred for more detailed information.

CONTENTS.

	PAGE
EDITORIAL VIEWS	391
TWO-STAGE RADIO-FREQUENCY AMPLIFIER	393
By W. James.	
AN ELECTROSTATIC LOUD-SPEAKER	397
By Dr. H. Krönke.	
NOVELTIES FROM OUR READERS	399
DISTRIBUTION OF WIRELESS WAVES	401
By R. L. Smith-Rose.	
BROADCASTING COMMITTEE'S REPORT	406
HINTS AND TIPS FOR NEW READERS	407
CURRENT TOPICS	409
LONG WAVES FOR TRANSATLANTIC TELEPHONY	411
NOTES ON TUNING COILS	417
By W. James.	
PIONEERS OF WIRELESS—10.	421
By Ellison Hawks.	
BUYER'S GUIDE -- SUPPLEMENTARY LIST	423
WIRELESS CIRCUITS IN THEORY AND PRACTICE	425
By S. O. Pearson.	
NEWS FROM THE CLUBS	428
THE EDITOR'S MAIL	429
RECENT INVENTIONS	432
READERS' PROBLEMS	433

In the Report we find much to commend, but also a certain amount which invites criticism. The most vital point in the whole Report is, of course, the question of the new authority under which broadcasting shall operate. Whilst agreeing entirely that broadcasting in this country has outgrown the scope of a private company and that some form of more definite Government control was more or less inevitable, yet we feel that greater attention should have been paid, than is the case in the Report, to the necessity for maintaining continuity between the policy and organisation of the present and future authorities controlling broadcasting.

We believe that the Committee are optimistic in recommending the appointment of a number of Commissioners so richly endowed with qualifications that, to quote from the Report, they "should be persons of judgment and independence, free of commitments, and that they will inspire confidence by having no other interests to promote than those of the public service." The hope is further expressed, "that they will be men and women of business acumen and experienced in affairs."

Unless the remuneration which is recommended for such Commissioners is on a lavish scale, we cannot imagine that men and women will be easy to find who have all these qualifications and are entirely free of commitments; in fact, we venture to suggest that persons with such qualifications and experience are either so "committed" that the maximum remuneration likely to be offered to them as Commissioners would not compensate them for casting off their commitments, or else such qualifications might be found in a limited number of persons free of commitments whose financial position would be such that the additional remuneration would be insignificant, and it would be more likely that their honorary services would be available purely in the national interest rather than encouraged by the prospect of remuneration.

It is interesting to note that the recommendations of the Wireless League, the organisation of the listening public in this country, appear to have borne very definite fruit in the recommendations of the Committee. Amongst other things, the constitution of the new authority is recommended on lines almost identical with those proposed in the evidence given by Sir Arthur Stanley on behalf of the Wireless League, the essential difference being that the League recommended that the Commissioners should be persons of experience in the various activities affected by the Broadcasting Service. We are not sure that a more efficient Commission could not be set up by adopting this recommendation, rather than seeking to find entirely independent Commissioners as recommended in the Report.

The Report of the Committee in no single instance

criticises the policy of the present B.B.C., but, on the other hand, high praise is offered for the way in which broadcasting has been conducted hitherto, and credit has also been given for the discretion exercised in the balance of programme matter. The vast majority of listeners, too, are satisfied, we believe, with what has been accomplished by the B.B.C., whilst, in addition, they have confidence in the present policy of the Company. Under these circumstances, we cannot but feel surprised that the Committee have neglected to take very definite precautions, instead of merely casual suggestions, to ensure that continuity of policy and the services of the present controlling influences of the B.B.C. are guaranteed under the new régime. True, it is suggested as desirable that a member of the existing Board of the B.B.C. should be one of the new Commissioners, and that the new Commissioners should, if they think fit, appoint an executive Commissioner with a seat on the Board of Management.

We consider that these suggestions are not put forward with sufficient definition, and might even be interpreted as incidental to the main constitution of the authority. Rather than incidental, we would consider them as vital to the conduct of a satisfactory Broadcasting Service without the risk of departure from the lines on which the service has been brought to its present satisfactory state.

In the Report it is stated that the present Company, "by strenuous application to its duties, aided by the loyalty of its staff, has raised the service to a degree which reflects high credit on British efficiency and enterprise." Such a statement constitutes a well-earned compliment to two men who may be regarded as the leaders of the present B.B.C. organisation and the guiding influences in the policy of the Company.

Lord Gainford has acted as Chairman of the B.B.C. since its formation, and Mr. J. C. W. Reith as Managing Director. The initiative and discretion of these two, coupled with their unique experience over a period of several years, give them, in our opinion, a prior claim to positions of responsibility on the new Commission over any other prospective candidates whose claims may be brought forward.

We observe that the Postmaster-General has now handed on to the Government the Report, with a recommendation that it should be adopted, and it is probable that a short Bill will be introduced within the next few weeks to legalise the establishment of the new authority. This will, of course, give the opportunity for public opinion to make itself felt, and any modifications in the recommendations of the present Report which public opinion may demand can be introduced while there is still time.

LEADERS OF BRITISH BROADCASTING.



Rt. Hon. Lord Gainford,
Chairman of the B.B.C.

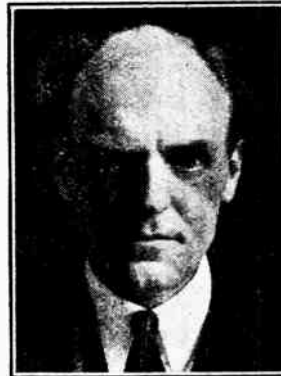

Mr. J. C. W. Reith,
Managing Director of the B.B.C.

TWO-STAGE

Radio
FrequencyA Non-oscillating Receiver
with Two High-frequency Stages
and Valve Detector.

By W. JAMES.

This article describes the construction of a receiver with two stages of radio-frequency amplification and a valve detector, special features being the use of interchangeable coils and cheap valves. A two-valve power amplifier for adding to this or almost any other receiver has been constructed. It has several important features not usually to be found in present-day amplifiers, and will be described in an early issue by Mr. N. P. Vincer-Minter.

AMPLIFIER.

IN *The Wireless World* for October 21st, 1925, the writer described a two-valve high-frequency amplifier which had tuned transformer couplings and employed low-impedance valves of the D.F.5 class, and promised that another receiver would be designed for the benefit of those who prefer to use relatively cheap valves of the high-impedance type. This has been done and a modified form of tuned anode coupling employed instead of tuned transformers.

The particular coupling coils used are those marketed by Messrs. L. McMichael, Ltd., and are called "Dimic" coils. They are wound in two parts, the four ends being connected to contacts, and can be obtained in sizes suitable for a wide range of wavelengths, including the wavelength of 5XX and of the broadcast stations working on the 250-550 metres band. The receiver described here, therefore, having interchangeable tuning coils, can be used to receive stations working on a wider range of wavelengths than the two-valve high-frequency unit previously described, without being any more complicated in operation, whilst selectivity and magnification are approximately the same in each case. Distant British and European stations can be received with remarkable ease on head telephones, and without oscillation when the receiver is properly adjusted. Certain advantages are gained by using high-impedance valves, however. One of them is that very much less anode current is required for the two valves in the high-frequency amplifier. This is a considerable advantage, for a receiver with two high-frequency stages is normally used with a two-valve power amplifier, when the total current taken from the anode battery is considerable. Any reduction which can be effected without detriment to the operation of the receiver represents a saving in maintenance costs and may,

in some instances, result in more satisfactory operation by reducing the coupling between the stages through the resistance of the anode battery.

Coupling High-impedance Valves.

When high-impedance valves are to be employed in a radio-frequency amplifier it is important to give careful consideration to the constants of the couplings if reasonable selectivity and magnification are to be obtained without the use of critical reaction. We can take as our starting point the constants of typical valves of the 2-volt class. Normal valves of the H.F. type are found by test to have an average impedance of about 50,000 ohms and an amplification factor of 15. Therefore, if we connect in the anode circuit of a valve having these values a coil and condenser which, when tuned to resonance with the signal to be amplified, has an impedance of 50,000 ohms, the high-frequency voltages will be divided equally between the anode-filament path of the valve and the external circuit; that is, an actual amplification of $\frac{15}{2}$ will be obtained.

Now the impedance of a tuned circuit depends on the values of the coil and its tuning condenser, assuming that this circuit is connected to a load of such a high impedance that it throws a negligible load on the tuned anode coupling. For a given value of inductance the impedance will be lower as the loss resistance of the coil and the capacity of the condenser are increased, and, as the high-frequency resistance of the coil varies with the wavelength (it falls as the wavelength is increased) and the condenser is adjusted in value for tuning purposes, it follows that the impedance of the tuned anode coupling varies over the tuning range of the circuit. Therefore the amplification depends upon the inductance of the coil, its effective resistance, and the capacity of the

Two-Stage Radio Frequency Amplifier.—

tuning condenser, and, with normal coils, falls off as the capacity is increased.

These facts are pretty well known to those who have used the tuned anode method of coupling, and accounts for the statement so often made that it is not wise to employ too large a tuning condenser because of the reduction in possible amplification. But this is only partly true. The permissible maximum capacity of the tuning condenser depends on the inductance and resistance of the anode coil. However, if it is desired to secure an actual amplification of, say, 0.75 m. (m being the amplification factor of the valve) at the middle frequency of the tuning range, with a 0.0005 microfarad tuning condenser, a coil can be designed to give this. The coil can also be designed to give the same amplification when a smaller condenser, such as a 0.0003 micro-

selectivity, and will be able to arrange for maximum high-frequency amplification.

The Choice of Valves.

In the receiver illustrated here, manufactured coils are employed, and, in order to cover the desired tuning range, condensers of 0.0005 microfarad capacity have to be used. We are, therefore, not left with much scope for ingenuity regarding the tuning characteristics of the amplifier. What we can do, however, is to take advantage of the centre tapping of the inductance coils and choose valves having values suitable for the work we have in mind.

Reference to Fig. 1 will show how the tuned couplings are connected; the anode of the first valve, for instance, is connected through a 0.0005 microfarad fixed coupling condenser to the centre point of the coil, one end of this

coil being connected to the filament through a grid bias battery, and the other to the grid of the second valve. The tuning condenser is connected across the ends of the whole coil; thus the coupling is really an auto-transformer, the ratio of secondary to primary being 2 to 1. Now we have approximately one-quarter of the impedance of the whole coupling connected direct to the anode of the valve, and voltages set up across this portion are magnified by transformer action to give a larger voltage between the grid and filament. At the same time, for a given valve the selectivity is better than it would be if the whole of

the coil were connected in the anode circuit.

The valves for use in the two high-frequency stages should be high-impedance ones, and, if selectivity is a very important factor, valves such as the Mullard 2-volt H.F., which have an anode impedance of about 60,000 ohms and an amplification factor of 17, should be used. In cases where selectivity is not of such great importance, valves having a little lower impedance will enable the utmost amplification to be obtained. Suitable valves are the Mullard D.F.A.4 and the Marconi or Osram D.E.5b or D.E.8H.F., which have an impedance of roughly 30,000 ohms and an amplification factor of 20. These are 6-volt valves: if 2-volt valves are preferred, the D.E.R. will be found satisfactory, and so will the Cosmos S.P.18 (green spot) and valves of other makes having similar characteristics.

When good coils and condensers are used it is always necessary to stabilise a two-stage H.F. amplifier. One method is to connect the grid circuits to the sliding contact of a potentiometer the ends of which are connected to the filament heating battery. Another is to shunt the circuits with adjustable high resistances. Both methods are, in general, best avoided. The best results are

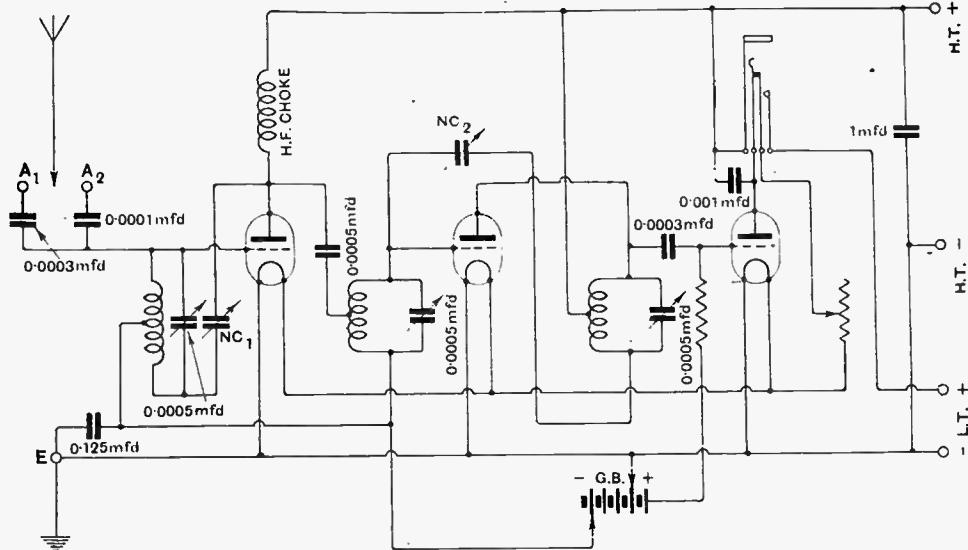

Fig. 1.—The circuit diagram of the receiver.

farad, is used. It is important to remember, however, that the average selectivity would, in general, be different in the two cases.

Factors Influencing Selectivity.

The selectivity depends upon the anode impedance of the valve, the losses of the tuned anode circuit, and the wavelength. Quite briefly, the selectivity of a tuned anode circuit having normal losses connected to a low-impedance valve such as a D.E.5 will be much poorer than when a high-impedance valve is used.

Impedance and selectivity are, therefore, both dependent upon the constants of the tuned circuit of the valve, and the problem to be solved is the usual one of striking a balance between average magnification and selectivity. Those who operate a receiver near a broadcast station will usually have to sacrifice a certain amount of amplification in order to secure the necessary selectivity. They can take full advantage of low-frequency amplification to bring the signals of distant stations to a working strength.

Listeners who are more fortunately placed as regards interference will not need to give so much attention to

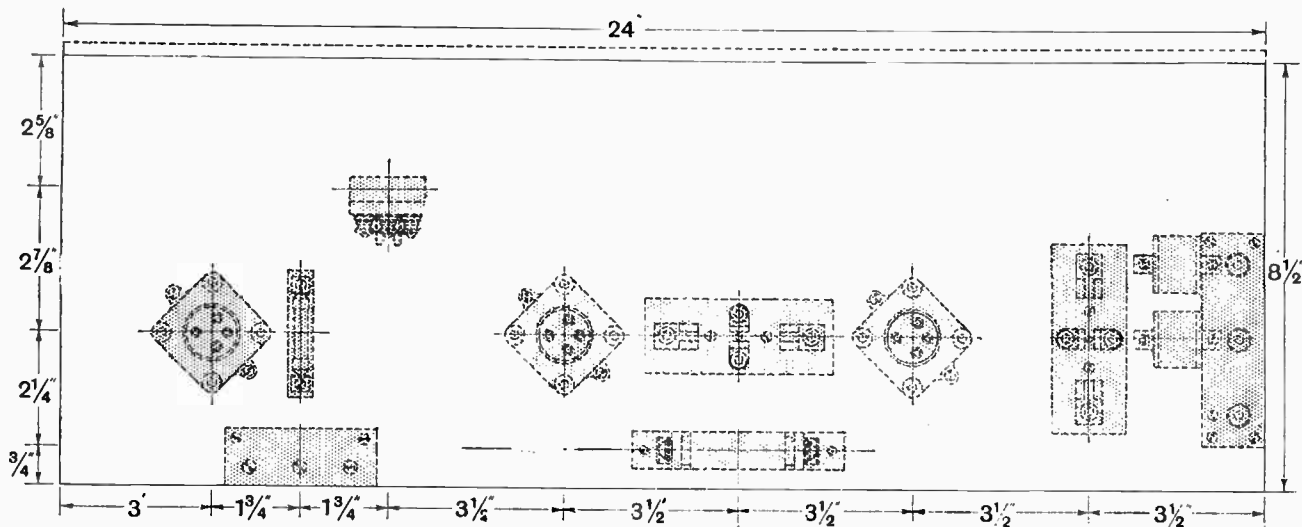

Fig. 2.—Plan view of the baseboard showing the position of the parts.

obtained in the majority of cases when the circuit is rendered stable by properly connecting neutralising condensers.

The Circuit Used.

It should be noted that the neutralising condensers have a limited use and that it is quite essential to remove, so far as possible, all forms of coupling between the three tuned circuits. For this reason the coils are well spaced and are arranged in the peculiar manner to be seen in the illustration.

If care is taken to place the coils at right angles, as shown by the illustrations, stray magnetic coupling will be very small, and no trouble should be experienced when the receiver is put in operation.

Commencing with the aerial, it will be seen that two degrees of selectivity are arranged for by the provision of alternative aerial condensers. Thus, if the aerial is connected to A₁, Fig. 1, the selectivity will not be so good as when the aerial is joined to A₂, but the signal strength will normally be better when the A₁ connection is used. The aerial circuit is completed through the top half of the first coil, the extreme ends of this coil being

connected to the grid of the first valve and to its anode through the balancing condenser NC₁. This rather unusual form of connection is used for the purpose of stabilising the first valve, and it is quite a simple matter so to adjust the balancing condenser NC₁ that the aerial circuit will not oscillate as the result of tuning the anode circuit. Further, it is usually possible so to adjust NC₁ that over the normal tuning range the aerial circuit will remain unaffected by reaction applied to the anode circuit. For this reason the balancing condenser NC₂ is mounted on the front panel of the instrument. Quite a useful reaction effect can be obtained by adjusting this condenser, which can, of course, be set in the position which will balance the circuit if reaction is not desired.

Detector Valve Connections.

A further point of interest is the manner in which the detector is connected. The grid leak, it should be noticed, has one of its ends joined to the grid and the other end to a wire which can be connected to the grid bias battery. The grid leak return can, therefore, be given a voltage adjustable with respect to the filament in

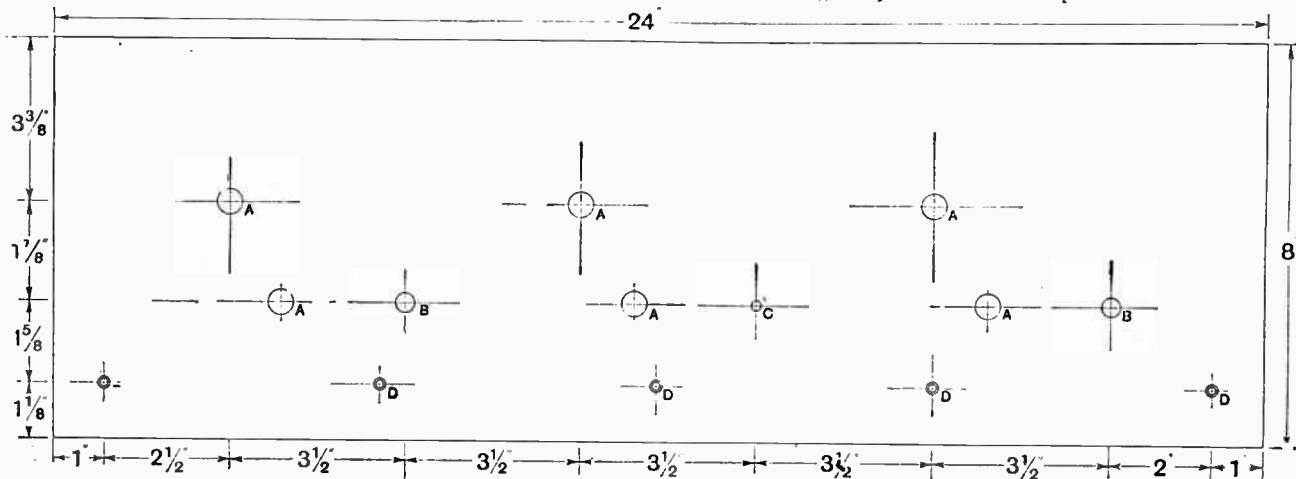

Fig. 3.—Dimensioned drawing of the ebonite front panel. A, 1" dia.; B, 3/8" dia.; C, 1/8" dia.; D, 1/2" dia., and countersunk for No. 4 wood screws.

THE FOLLOWING MATERIALS ARE REQUIRED.

Cosmos fixed condensers, capacity .0001 mfd., .0003 mfd. (2),
.0005 mfd., .001 mfd.
3 Cosmos tuning condensers, with slow motion attachment,
.0005 mfd.
1 Cosmos grid leak, 2 megohms.
1 Cosmos H.F. choke (Metro-Vick Supplies, Ltd.).
1 Micro-condenser (Igranic Electric Co.).

3 Antivibration valve holders.
1 Low resistance rheostat (Burndept Wireless Co.).
1 Telephone jack and plug.
1 1 mfd. and 1 .125 mfd. Mansbridge condenser.
1 Ebonite panel, 2 1/2 in. x 8 in. x 1/2 in.
1 Baseboard with battens, 2 1/2 in. x 3 1/2 in. x 1/2 in.
Set of "Dimic" coils with 3 bases (L. McMichael, Ltd.).

Approximate cost, with one set of Broadcast coils £7 10s.

1.5-volt steps, which is a great advantage when valves of the 6-volt type are used. Should it be desired to employ the anode bend method of rectification, it is only necessary to join the lower end of the grid leak to a point on the grid bias battery which is negative with respect to the filament L.T. negative.

One filament rheostat is employed for the three valves, as these will normally have similar filament characteristics, and the jack is arranged to complete the filament battery circuit when the telephone plug is inserted. A

ebonite. One of the coil holders is screwed to a piece of wood which is screwed to the baseboard, whilst the remaining two coil holders are screwed direct to the baseboard.

Two further small pieces of ebonite are required for the aerial and earth terminals and for the battery connections.

On the front panel is mounted the three 0.0005 mfd. tuning condensers, the filament rheostat, telephone jack, and adjustable balancing condenser. These parts can be

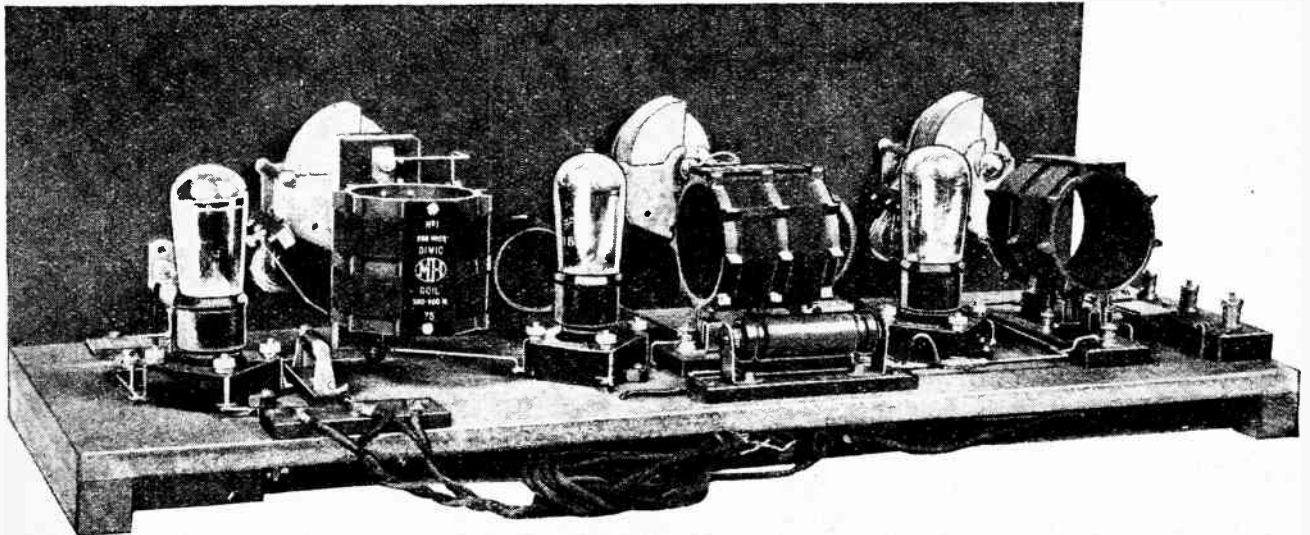

Rear view of the set, showing the peculiar arrangement of the three tuning coils. Mullard 2-volt H.F. valves are used

0.001 mfd. fixed condenser is connected across the telephone contacts of the jack and may be varied to suit requirements, although this is a good average value when a wide range of wavelengths is to be received.

Position of Components in the Set.

An extremely simple layout is used with the object of reducing stray couplings and to allow of neat wiring and easy operation. The ebonite front panel has a baseboard screwed to it, and an endeavour has been made so to place the parts that wires carrying high-frequency currents have a short, clear path.

The grid battery and two large bye-pass condensers have, therefore, been placed on the under side of the baseboard, and the valve holders, coil holders, high-frequency choke, grid leak, and connection strips screwed to the upper surface. Fig. 2 shows the position of the parts on the upper side of the baseboard, and it should be noticed that the grid leak and high-frequency choke are carried in brass clips mounted on small pieces of

identified in the illustrations and are situated as indicated in Fig. 3. The five holes marked by the letter D are for the wood screws which serve to screw the panel and baseboard together, and their positions should be noted.

(To be concluded.)

GIFT TO WIRELESS OPERATOR.

AN echo of the disaster to the *Antinoc*, the vessel which recently sank in the Atlantic after the rescue of her crew by that of the *President Roosevelt*, was provided by the news, last Wednesday, of the presentation of a silver signalling torch to Mr. Arthur Evans, wireless operator of the lost ship.

When the *Antinoc* was sinking, Mr. Evans continued to transmit S.O.S. signals until the wireless cabin was wrecked by heavy seas. He then signalled with a hand torch.

The presentation was made by Capt. Fried, of the *President Roosevelt*.

AN ELECTROSTATIC LOUD-SPEAKER.

Details of a Practical Design in Use in Germany.

By Dr. H. KRÖNCKE.

EUGEN REISZ, who has already become known in wide circles by the marble block microphone named after him, has produced a new electrostatic loud-speaker and also, on the same principle, electrostatic headphones, which, owing to their excellent reproduction, are considerably superior to the electromagnetic telephones and loud-speakers hitherto in general use. Herr Reisz has had the kindness to demonstrate to me his new apparatus, both when connected direct to a telephone line leading to the Berlin transmitting station, and likewise for reception on an aerial with non-reacting detector valve and resistance amplification. Upon hearing reception with the new head-telephones, which weigh only 3½ oz.,

condenser plates, the circuit with choke coil, as illustrated in Fig. 1, being used for the purpose. The preliminary potential is therefore supplied direct from the anode battery. In consequence of the fluctuations of the superimposed potential, the power whereby the movable plate is attracted to the fixed plate alternates and produces oscillations of the movable plate which follow the low-frequency electrical oscillations.

There is, of course, nothing especially new in all this. The salient feature of the new Reisz loud-speaker lies in the elaboration of the condenser. It will be understood that the movable plate must be made as light as possible if the production of natural oscillations of audio-frequency is to be avoided. Moreover, the movable plate must be entirely

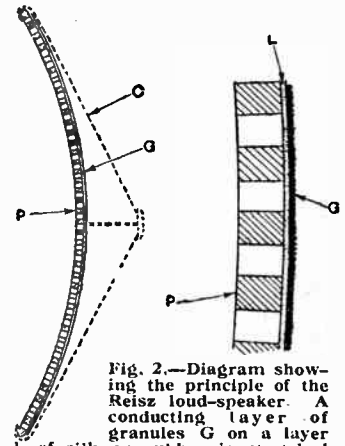

Fig. 2.—Diagram showing the principle of the Reisz loud-speaker. A conducting layer of granules G on a layer L of silk or rubber is stretched over a perforated aluminium plate P which acts as the other electrode.

the first impression was so remarkable that it can hardly be described. Nevertheless, although the intensity of signals was so great that one felt as if one were in the immediate neighbourhood of the music or the speaker, there was not the slightest trace of subsidiary noises, distortion, or weakening of the high and low notes.

The Principle.

The method whereby Reisz has achieved such a result is strikingly simple. Reisz uses a condenser, one plate of which is a fixed one, the second plate being separated from the first by a very thin insulating material. As matters stand at present, a preliminary potential of 200-250 volts is applied to the condenser in the case of the loud-speaker, and 75 volts with the headphones, so that the plates attract each other with a certain force. The force is fairly great, since the insulating material is very thin; thus the capacity of the loud-speaker is about 0.01 mfd. The low-frequency oscillations obtained by means of the amplifier are now superimposed upon the preliminary potential of the

free from internal tension, and some parts of the movable plate must be able to move easily, independently of other parts. Reisz achieves this in a remarkably simple manner. He makes the first plate of aluminium bent slightly convex and having several holes in it similar to a sieve. Over this aluminium plate he places with slight tension a very thin insulating layer—for example, of indiarubber or silk. On the other side of this insulating layer he places a conductor which consists of a number of small granules, which are stuck on this layer side by side. What this material consists of has not yet been stated. Reisz attaches value, however, to fixing the granules in such a way that the conductor layer does not render the insulating surface more rigid than before.

Fig. 2 shows schematically a section of the loud-speaker. P is the perforated plate on which the insulating layer L is stretched. To the exterior side of this layer adhere the granules which form the

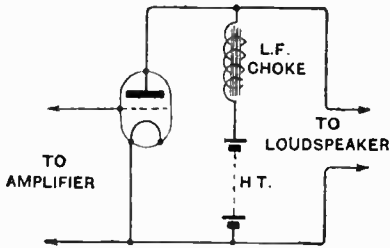

Fig. 1.—Circuit showing method of applying fluctuating potentials to the loud-speaker.

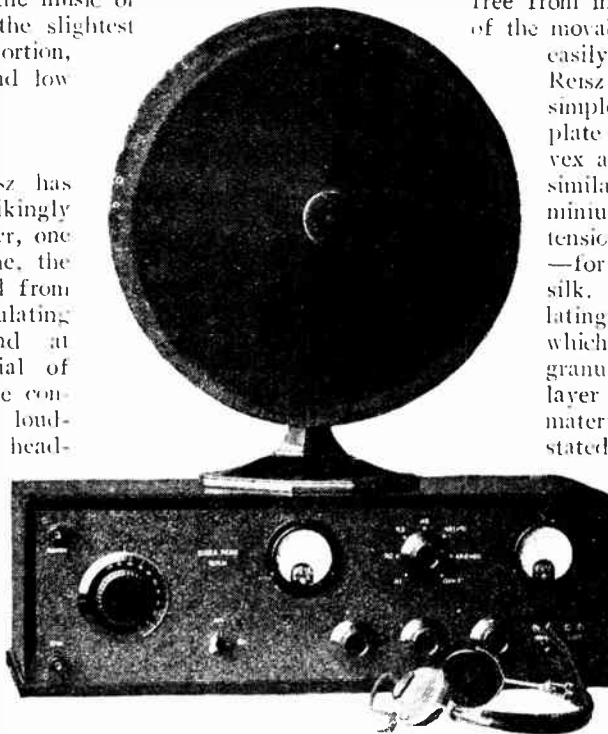

Fig. 3.—The electrostatic loud-speaker and telephones connected to a broadcast receiver.

An Electrostatic Loud-speaker.—

movable plate of the condenser. Finally, for the protection of the oscillating surface, there is fixed to the front of the loud-speaker a flat cone, C, of light material. In reality only very slight movements of the conductive layer are necessary in order to produce very considerable tone effects. It is found that the slight unevennesses in the metal plate P are amply sufficient for this and provide a sufficient possibility of movement of the conductive layer.

In addition to the advantage of the exceedingly small compass and slight elastic tension of the movable layer, the electrostatic loud-speaker is superior to the majority of electromagnetic loud-speakers, by the fact that the whole oscillating surface is in the electrical field, with the result that no oscillations can be produced outside that field, so that there is a relatively high damping of the oscillating surface. To this fact also can be doubtless attributed the advantage that the loud-speaker within the whole range of audibility down to the very lowest notes, has no natural vibrations, and all the oscil-

lations are reproduced with equal strength, at least in so far as can be judged by the ear.

The new loud-speaker, however, has one disadvantage. It needs a higher polarising voltage than the usual small electromagnetic loud-speakers. Reisz, however, is now engaged in developing the new loud-speaker, so that an initial tension of 100 volts will be sufficient to work it. He hopes to achieve this by a further diminution of the magnitude of the insulating layer. To work the loud-speaker, Reisz uses an ordinary amplifier with resistance coupling, in order to avoid the distortions caused by transformers. As the last valve of his amplifier, he uses a power valve with an emission of about 12 milliamperes. It might be assumed that no energy would be consumed in an electrostatic loud-speaker, and, therefore, that a small amplifying valve using a small anode current would be sufficient. This, however, is not the case, since the capacity of the loud-speaker has to be charged and discharged by the electrical currents which produce the attraction and repulsion of the movable plate, and for this a certain current intensity is, of course, necessary.

General Notes.

With reference to our note on page 320 of our issue of February 24th concerning transmissions from BW5, we understand that this Belgian amateur has been ill and unable to transmit, but that he is now working again on 180 metres, and will welcome reports.

Mr. F. W. Goff (G 6YG), 102, Woodside Road, Bowes Park, N.22, has been received by C1DD in Nova Scotia on telephony when using only 5 watts on a 45 metre wavelength.

Mr. C. F. Bauditz (1) 7BZ), Erickshus, Ringkiobing, Denmark, is transmitting on 34, 40 and 60 metres, pure C.W. with an input of 15 watts, and will welcome reports.

Belgian Amateurs.

We have hitherto refrained from publishing the names and addresses of Belgian amateurs, as we understood that none of their stations was licensed, but, as the following have already appeared in the Flemish publication *Radio*, we print them for the benefit of our readers:

B L1.—Arendonck Radio Club (operates E. Claessen and J. De Pauw), Arendonck, Antwerp, transmits on 75 and 150 metres.

B L2.—"Radio" (J. Vandepitte), Uytkerke, Blankerberghe.

B L3.—J. de Geest, Motestraat, Roeselaere, transmits on 75 to 150 metres.

B L4.—G. Vermandere, Zuidstraat 55, Roeselaere, transmits on 75 to 150 metres.

B L5.—F. Callebert, Ooststraat 29, Roeselaere, transmits on 75 to 150 metres.

B L7.—M. E. Geeraert, Ondernemerstraat 67, St. Amandsberg, Gent.

B L8.—Gaston Vits, Brusselsche Steenweg 25, Melle, transmits on 65 and 200 metres.

B L9.—R. Bloeykens, Florastraat, Meirelbeke.

B L10.—H. Deceuninck, Reeperstraat 16, Emelghem, Læghem.

TRANSMITTING NOTES AND QUERIES.

BL11.—G. Blancaquaert, Uytbergen (Oost. VI.), transmits on 100 to 135 metres.

New Call Signs Allotted and Stations Identified.

G 2ARZ.—B. R. Clarke, 5, Fox Hill Gardens, Upper Norwood, S.E.19.

G 2AZL.—W. Paylor, 54, Town Street, Beeston, Leeds.

G 2BNJ.—H. F. B. Sharp, Hill of Tarvit, Cupar, Fife.

G 2BNK.—G. H. Henshall, 19, Greenvale Road, Eltham, S.E.9.

G 2BOM.—E. D. Dunn, 184, Crewe Street, Derby.

G 2BPI (Art. A.).—L. W. Gardner, 10, Ludlow Road, Coventry.

G 2BQK (Art. A.).—W. P. Dolphin, 178, Langham Road, South Tottenham, N.15.

G 2BQN (Art. A.).—R. E. Fisher, 366, Clarkston Road, Cathcart, Glasgow.

G 2DA.—"Popular Wireless," Experimental Station, Dulwich.

G 2JB.—J. C. Bird, 1, Stapleford Road, Wembley (change of address).

G 2JD.—J. L. Summerfield, 218, Thorold Road, Ilford, Essex, transmits on 23, 45 and 150-200 metres.

G 2TK.—K. H. Thow, 35, Footscray Road, Eltham, S.E.9 (change of address).

G 5AN.—E. W. V. Butcher, 16, Manor Gardens, Purley.

G 5CG (portable).—D. Shannon, Wyvern Grange, Sutton Coldfield, Birmingham.

G 5CX.—C. R. Pill, 17, Brunnenell Grove, Hyde Park, Leeds, transmits on 90 and 150-200 metres C.W. only. (This

call sign was formerly held by A. Higson, Colne, Lancs.)

G 5GQ.—B. G. Wardman, 5, Pollards Hill South, Norbury, S.W.16.

G 5JQ.—W. B. Sydenham, Torquay Secondary School, Barton Road, Torquay, transmits on 150 metres.

G 5MY.—J. E. Montgomery, Felsted School, Essex, transmits on 23, 45, 90 and 150-200 metres.

G 5TD.—T. A. Studley, 6, Rutland Road, Harrow, transmits on 45 and 90 metres.

G 5TG.—W. J. Tarring, 70, Cranmer Road, Forest Gate, E.7, transmits on 90, 160, and 180 metres. (This call sign was formerly owned by F. R. W. Stafford, Dovercourt.)

G 5ZU.—H. B. Gardner, Heysham, King's Road, Barnet (change of address).

G 6MB.—A. J. Buttress, 7, Limekilns Field, Hill Top, Bolsover, nr. Chesterfield.

G 600.—T. Woodecock, "Santos," 8, George Street, Bridlington, E. Yorks, transmits on 45 and 150-200 metres.

The call sign allotted to Mr. R. T. Colebourn, "Ardehalligan," Selhorn Drive, Douglas, is 6IA, and not 2IA, as printed on page 264 of our issue of February 17th. G 2IA is still retained by Mr. L. F. Ostler, 19, Windsor Terrace, Penarth, Glam.

B C44.—A station at Schaerbeck, QSL via Reseau Belge.

D 7BZ.—C. F. Bauditz, Erikskus, Ringkiobing, Denmark.

F 8CL.—Mme. Lebaudy, 19, rue du Manganan, Paris VIII.; operator A. M. de Vanolot, transmits on 35-50 metres (change of address).

F 8DA.—Albert Saumont, Cornin, Aix-les-Bains, Savoie (change of address).

I 1AT.—Alfonso Marcello, via 20 Settembre 89, Rome.

PE 6YX (Palestine).—Flight-Serjt. Macey, Command Headquarters, Bir Salem, Palestine.

NOVELTIES FROM OUR READERS

A Section Devoted to New Ideas and Practical Devices.

EXTENSION LEADS FOR TELEPHONES IN SERIES.

It is often desirable where telephones of various types are to be used in conjunction with a receiver to connect the telephone leads in series in order to obtain a more even distribution of current. When extension leads are taken to other rooms in the house it is somewhat difficult to arrange for the series method of connection.

If telephone sockets of the type illustrated in the diagram are used.

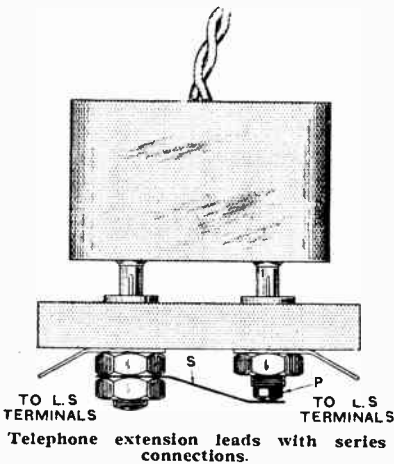

however, the difficulty is surmounted, since the circuit cannot be broken when any of the phones are withdrawn.

A light spring contact, S, is clamped between locknuts to one of the sockets, and is arranged so that normally the two telephone sockets are short-circuited. In the right-hand socket a short ebonite plug, P, is inserted, so that when the phones are plugged into circuit the plug is forced downwards and the spring is lifted out of contact.—W. S.

ANTI-VIBRATION VALVE HOLDER.

An ordinary valve holder, preferably of the type illustrated in the diagram, is clamped by means of an ebonite ring to a "Sorbo" sponge

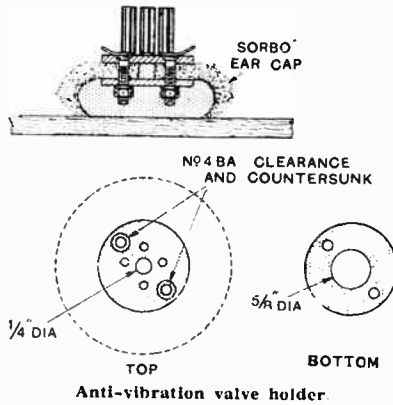

rubber ear-cap which is in turn secured to the baseboard of the set by means of Seccotine or rubber solution.

When inserting or withdrawing the valve, the ebonite base of the valve holder should be held in the hand in order that the rubber support may be relieved of strain.—C. H. T.

o o o o

DEAD-END SWITCH.

Dead-end effects in a long-wave tuner consisting of a number of plug-

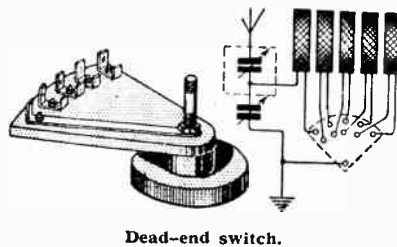

in coils connected in series may be considerably reduced by employing a

radial switch with a double row of contacts. The switch arm consists of an ebonite segment on which is mounted a series of spring contacts for short-circuiting pairs of studs. The leading contact is connected by a narrow strip to the spindle of the switch. The circuit diagram shows the method of connection as viewed from the top of the panel. It will be seen that normally all the coils in the tuner are disconnected, and that as the switch arm is moved progressively over the contacts the coils are connected in series as required.—C. J. H.

o o o o

GUY WIRE STRAINER.

The diagram shows a strainer of simple construction which may be made up from materials to be found in every experimenter's workshop. The loop consists of a length of 1/4 in. diameter brass or mild steel rod

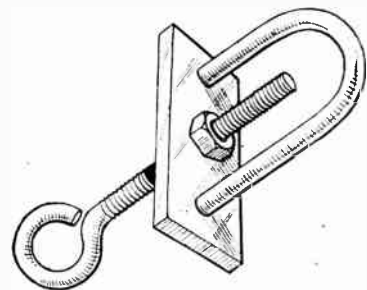

screwed No. 0 B.A. at each end and attached to the plate by means of nuts fitted to the underside. The adjusting screw is a similar piece of rod bent in the form of a ring at one end and screwed No. 0 B.A. for the remainder of its length. The tension of the guy wire is adjusted by the No. 0 B.A. nut on the upper surface of the plate.—J. C. H.

REACTION REVERSING SWITCH.

A reaction reversing switch of simple construction employing valve pins and sockets is illustrated in the diagram. The valve sockets (six in number) are set out on the receiver panel in the form of a hexagon, while the four valve pins are mounted on a separate rectangular ebonite panel, and are spaced in such a way that the pins fit into sockets on opposite faces of the hexagon. When the connector is inserted so that the valve pins 7, 8, 9, and 10 are in sockets 6, 1, 4, and 3 respectively, the reaction coil will be connected in circuit. By moving the connector so

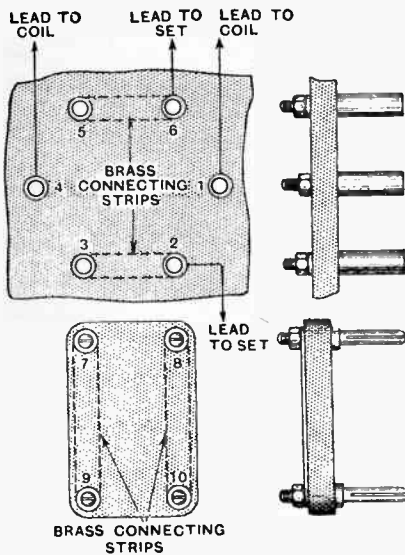

Plug and socket reversing switch.

that pins 7, 8, 9, and 10 are inserted in sockets 1, 2, 5, and 4, reaction will be reversed.—H. G.

TELEPHONE PLUGS.

In tuning multivalve receivers designed for powerful loud-speaker reception, it is an advantage to be able to plug in a pair of telephones in order that listeners may be spared the rather uninteresting preliminary sounds associated with tuning adjustments. To be of real utility, however, it is essential that the telephones should be instantly removable, and this accounts for the popularity of plug and socket connections.

Where a receiver is provided with terminals instead of sockets, it can be converted without any structural

alterations by making use of ordinary coil plugs. Brass angle brackets are fixed to each side of the plug by means of the set-screws passing into the plug and socket. The brackets are thus in electrical connection with the plug and socket, and by choosing suitable dimensions the holes in the

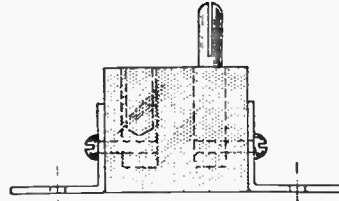

Improvised telephone plug.

brackets may be made to coincide with the telephone terminals on the set. The + and - connections of the telephones can be joined to the plug and socket of another coil plug, and the connections, once made, cannot be accidentally reversed.

The idea is equally applicable to the L.T. connections and to the H.T. where only one voltage is used.—G. W. G.

VERNIER ATTACHMENT.

The well-known method of obtaining vernier control of tuning adjustments by means of a small friction wheel at the edge of the condenser dial can be greatly improved if the method of construction shown in the diagram is adopted.

The friction contact wheel is a piece of rubber tubing, R, 1/2 in. in external diameter and 1/2 in long. A threaded bush, B, with a knurled ebonite ring, S, can be screwed down to compress the rubber ring, so that it makes contact with the edge of the

dial; normally, with the B screwed back, the rubber ring clears the edge of the dial, and the condenser can be adjusted by means of the main knob without experiencing any drag from the vernier wheel. A knurled lock-nut, T, such as a terminal head, may be used to prevent B turning on the spindle when the vernier is being used.—J. P. P.

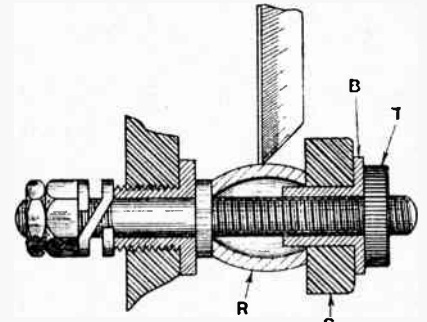

Improvised vernier movement.

CHANGE-OVER SWITCH FROM CONTACT STUDS.

Neat change-over switches can be constructed with ordinary radial switch contact studs. A vertical slot is cut in each stud by means of a hacksaw of suitable width, and in the case of the centre contacts a lateral hole (No. 6 B.A. tapping) is drilled, the set-screw acting as a pivot. The hole is tapped at one side and

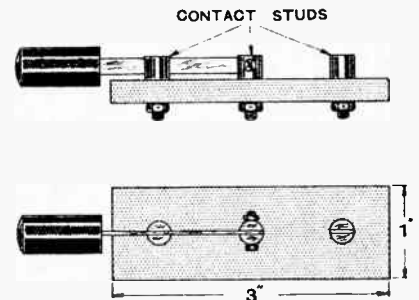

Simple change-over switch.

drilled out No. 6 B.A. clearance on the other. A No. 6 B.A. cheese-head screw is then inserted and secured by means of a lock-nut. The contact blade should consist preferably of springy material, such as phosphor-bronze, when it will be possible to ensure a good wiping contact by setting the slots very slightly out of line.—C. S. A.

VALVES FOR IDEAS.

Readers are invited to submit brief details, with rough sketches, where necessary, of devices of experimental interest for inclusion in this section. A receiving valve will be despatched to every reader whose idea is accepted for publication.

Letters should be addressed to the Editor, "Wireless World and Radio Review," Dorset House, Tudor St., London, E.C.1, and marked "Ideas."

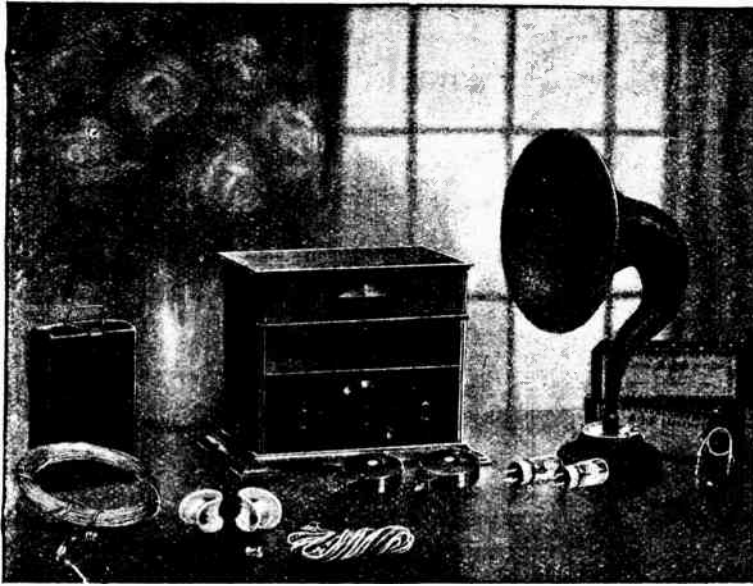

Worth While

IT is worth while having a loud speaker receiver that is always ready for use. A receiver the ladies can use while you are altering your big set, one that will, under normal conditions, bring in your local station on a loud speaker, over a minimum distance of 25 miles, or Daventry at 100 miles.

The reproduction from these receivers is exceptionally pure, they are easy to handle, and very economical to run. Ideal instruments for use in the home; one switch, one dial, and one knob—and look at the price.

Complete with loud speaker and all accessories, as shown in the illustration £13. 18. 6
Receiver only £8. 2. 6

HIRE PURCHASE

Messrs. H. Taylor & Co., Ltd., 49/53, Sussex Place, South Kensington, S.W. 7 (near South Kensington Station), are prepared to arrange for the sale of A.J.S. Receivers and Loud Speakers on easy payments.

Publication No. 120 fully describes and illustrates the full range of A.J.S. Receivers. It costs nothing to you!

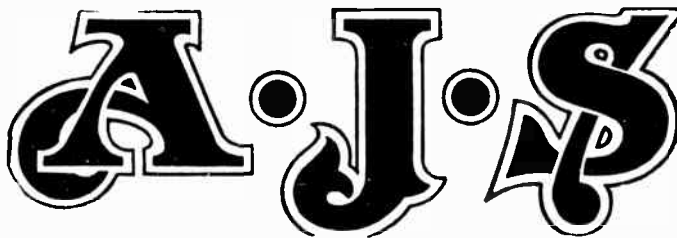

**A. J. STEVENS & CO. (1914) LTD.,
RADIO BRANCH, WOLVERHAMPTON.**

Telephone: 1748 (7 lines). Telegrams: "Reception, Wolverhampton."

London Showrooms: 122 124, Charing Cross Rd., London, W.C.2.

Telephone: Regent 7161 2. Telegrams: "Ajayesco, Westcent, London."

Glasgow Showrooms: 223, St. George's Road, Glasgow.

Telephone: Douglas 3149. Telegrams: "Reception, Glasgow."

**A. J. STEVENS & CO. (1914) LTD.,
RADIO BRANCH, WOLVERHAMPTON.**

Please send Publication No. 118 and 120.

Name

Address

W.W. 17'3.26.

ISSUED BY THE PUBLICITY DEPT. A.J.S.



Filament Rheostats and Potentiometers

WITH the windings carried on a porcelain bobbin and having the contact arm moving on its inner side, the "Cosmos" Filament Rheostat takes up remarkably little space, is strong in construction, and has a very smooth and reliable movement. It is fixed by ONE HOLE and is provided with a handsome knob and dial. Made in four types, two of which are double wound for Dull OR Bright Valves, and one a Potentiometer.

Prices and particulars are given in the adjacent panel.

METRO-VICK SUPPLIES, LTD., R

(Proprietors—Metropolitan Vickers Elec. Co., Ltd.)

4, Central Buildings, Westminster, London, S.W.1.

Description.	Ohms.	Current Carrying	Price.
Single Wound	60	1.0 amp.	4/6
Double "	18+2	4-1.5 "	5/0
" "	30+4	2-1.0 "	5/0
Potentiometer	300	—	6/0

Cosmos

RADIO COMPONENTS

WHAT ABOUT H.F. RESISTANCE ?

How often have you found coil manufacturers publishing the H.F. resistance of their coils? Gambrell's are proud of *all* their figures. Study them well—they are unapproachable by any other coil on the market.

GAMBRELL COILS		Nearest Size in Ordinary Coils.	Inductance.	Self Capacity.	H.F. Resistance.
SIZE	PRICE				
a/2	4/10	18	13	.000004	1.5
a	4/10	25	26	.000004	2
A	5/-	30	51	.000004	2.5
B1	5/3	40	108	.000005	3.5
B	5/6	50	200	.000005	4.5
C	5/9	75	360	.000006	6.5
D	6/3	100	780	.000006	11
E1	6/9	150	1400	.000007	15
E	7/9	200	3000	.000008	19
F	8/6	300	6000	.000009	30
G	10/-	500	12200	.000011	37
H	12/6	750	24800	.000014	48
I	14/-	1000	68000	.000017	75
J	17/6	1500	165000	.000021	130

Now make up your mind to try out Gambrell coils—they'll make a wonderful improvement to your results.

Write for new component booklet showing new reduced prices.

GAMBRELL BROS. LIMITED, 76, VICTORIA STREET, S.W.1.

DISTRIBUTION OF WIRELESS WAVES.

How Blind Spots in Broadcast Transmission are Produced.

By R. L. SMITH ROSE, Ph.D., M.Sc., A.M.I.E.E.

IN the development of wireless communication there has been an almost continual study of the manner in which wireless waves are propagated over the earth's surface. In the past this has usually taken the form of the measurement of the intensity of signals received from various transmitting stations or of the readability of the signals, the latter, especially, being the vital factor in a commercial system designed for the handling of traffic. After the very early experiments of twenty-five years ago or so, these measurements were made over long distances, and they have recently been extended to the semi-circumference of the earth.

Local Absorbtion.

The transmission of signals over distances of 200 miles or so was neglected because it presented no difficulties, particularly on the long wavelengths which were employed for commercial purposes. As a result of this phase of development, there is at the present time very little exact knowledge as to the absorption of energy by the materials of the earth's crust, beyond the very generally accepted facts that land is a greater absorber than sea, and that it is more difficult to send waves over mountainous areas or the populous districts of towns than over comparatively flat open country. As a result of this understanding, transmitting stations have been erected in situations as favourable as possible, often on the coast nearest to the point or district it is desired to serve. The development of broadcasting, however, has necessitated that in many cases the transmitting station be situated in the heart of a town, and that the waves be broadcast over thickly populated areas rather than over open country or over sea. The resulting energy absorption which accompanies the transmission, particularly at the shorter wavelengths used in broadcasting, has shown that a relatively large power is necessary to secure satisfactory reception at distances of only 20 to 100 miles.

Contours of Signal Strength.

Let us suppose that, in the first instance, the earth's surface were a flat, perfect conductor. If a vertical transmitting aerial is located at any point on this surface, the waves will be radiated out horizontally to an equal extent in all directions. The expanding fronts of the successive waves will, therefore, be concentric circles with their centres at the transmitting aerial as depicted in Fig. 1. This case is analogous to the transmission of waves over the surface of a pool of water, when this is disturbed by dropping a stone in it. If in Fig. 1 we imagine that these circles are the sections

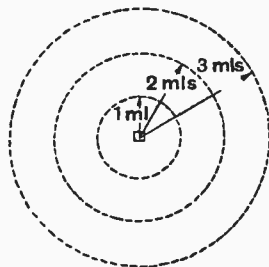

Fig. 1.—Contour lines of equal signal intensity for waves radiated over a flat uniformly conducting surface.

of small cylinders which have a fixed height in a direction perpendicular to the plane of the paper, a little consideration will show that the surface area of each of these cylinders is proportional to its radius. Therefore, since all the wave energy which passes through the cylindrical surface of one mile radius ultimately passes through the succeeding surfaces of two miles radius, the energy concentration in the wave will be four times as great in the former as in the latter case. Further, since the field intensity of the wave is proportional to the square root of the energy, we see that this intensity decreases inversely as the distance from the transmitter.

If the conductivity of the earth is not perfect, but its surface is still flat and uniform, there will be a certain loss of energy due to the heating effects of the eddy currents set up in the earth by the waves travelling over it. This means that the energy of the waves will decrease with the distance from the transmitter at a rate greater than that for a perfect conductor. The field intensity of the waves will thus decrease more quickly than the inverse distance from the transmitter.

Factors Governing Absorbtion.

General considerations show that the loss of energy becomes more rapid as the resistance of the earth's surface increases, although the effect is also dependent upon the dielectric constant of the earth. The energy loss also increases very rapidly with the frequency, with the result that, while on the longer waves of several thousand metres wavelength the loss may be small, it is becoming very appreciable on the broadcasting band of wavelengths, and it is still more so on the very short wavelengths now coming into use. In the latter case, indeed, the importance of the effect has already been felt in the difficulty of transmitting to quite moderate distances along the earth's surface, although very much greater distances may be covered by waves travelling *via* the upper regions of the atmosphere and thus free from the heavy absorbing effects of the ground.

Whether the earth's surface be comprised of high- or low-resistance material, then, so long as its nature is uniform in all directions, the distribution of field intensity will be uniform as depicted in Fig. 1. That is to say, at any given distance from the transmitter the intensity of the signals picked up by a given receiver will be the same, whatever may be the direction in which the receiver is placed relative to the transmitter. As a typical example of this arrangement, the case of a broadcasting station situated in fairly open country, such as Daventry, may be quoted. So long as the transmission is over

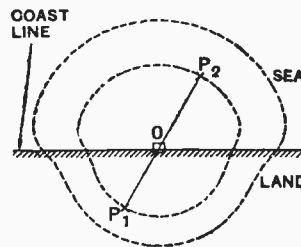

Fig. 2.—Lines of equal signal intensity for a transmitting station situated on the coast.

Distribution of Wireless Waves.—

moderately flat open country, a given receiver should always produce the same results at the same distance from the transmitter. There is no question of blind areas of reception, and where the results are not uniform they are to be attributed to local absorption or screening.

Suppose, however, that the transmitter, instead of being situated in uniform country, is located on the coast line with the sea on one side and dry sandy soil on the other. Owing to the superior conductivity of the sea,

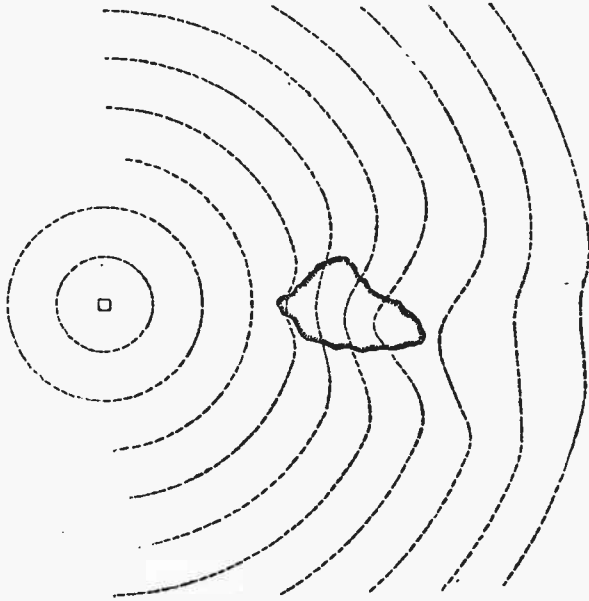

Fig. 3.—Effect of a badly conducting island on the shape of contour lines of equal signal intensity.

the waves travelling in this direction will suffer less loss of energy than those travelling back overland. This means that at a given distance from the transmitter the intensity of the field will be greater over sea than over land, or, alternatively, that the same signal strength is obtained at a greater distance over sea to that over land. The "contour" lines of uniform field strength will, therefore, no longer be concentric circles as in Fig. 1, but will rather take the form shown in Fig. 2. The same signal strength will be experienced at the two points P_1 and P_2 , although the distance OP_2 is considerably greater than OP_1 .

Next suppose that the transmitting station is situated in fairly uniform country, but that at a short distance away a patch of very badly conducting ground exists, somewhat in the manner of an island in the middle of the sea. The wireless waves will begin to spread out uniformly, giving circular intensity contours, but when they reach the badly conducting area the rate of loss of energy will be suddenly increased, and the contour lines will be kinked in the manner shown in Fig. 3. It will be noticed that the spacing of the successive intensity curves is

much closer over the badly conducting patch than over the remainder. When once this area has been passed, however, the kinks in the contour lines gradually smooth out and resume their circular form. It is thus illustrated how such an area of badly conducting ground becomes an area of bad reception, but it is also seen that the effects of such an area do not persist for a very great distance beyond it. In fact at a distance much larger than the dimensions of the area itself its effect will be imperceptible, the signal intensity being once more uniform in all directions. It is to be understood that throughout this article the reception conditions are assumed to be in the steady state that usually prevails during the daylight hours. The above-mentioned areas of bad reception do not include those in which exceptional fading phenomena are observed, since these effects are not necessarily dependent upon the ground conditions at the place in question.

Investigations in America.

As far as the writer is aware no systematic measurements have been made in this country on the distribution of wireless waves from broadcasting stations. This subject has, however, been investigated to some extent in America, and a paper describing some experiments carried out in the New York and Washington districts was published by Messrs. Bown and Gillett over a year ago.¹ As this paper appears to have received little attention in this country, and as it illustrates in a remarkably clear manner some of the points under discussion in the present article, it is considered useful to give a short résumé of the chief results obtained. The measurements were made with a portable signal-strength measuring apparatus which was transported to the various sites in a motor car. Working to a pre-arranged plan in which the points were selected with a view of showing up clearly the effects being investigated, observations were made of the field-strength due to the carrier waves from a broadcasting

¹ R. Bown and G. D. Gillett: "Distribution of Radio Waves from Broadcasting Stations over City Districts." Proc. Inst. Radio Eng. 1924. Vol. 12, pp. 395-409.

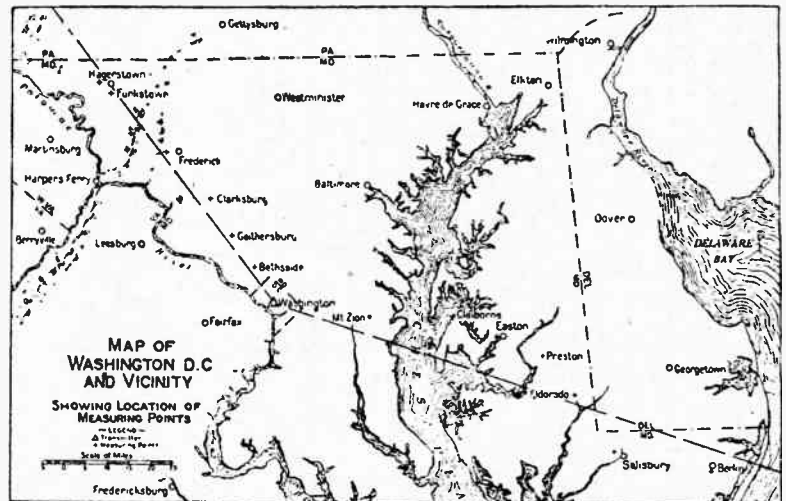
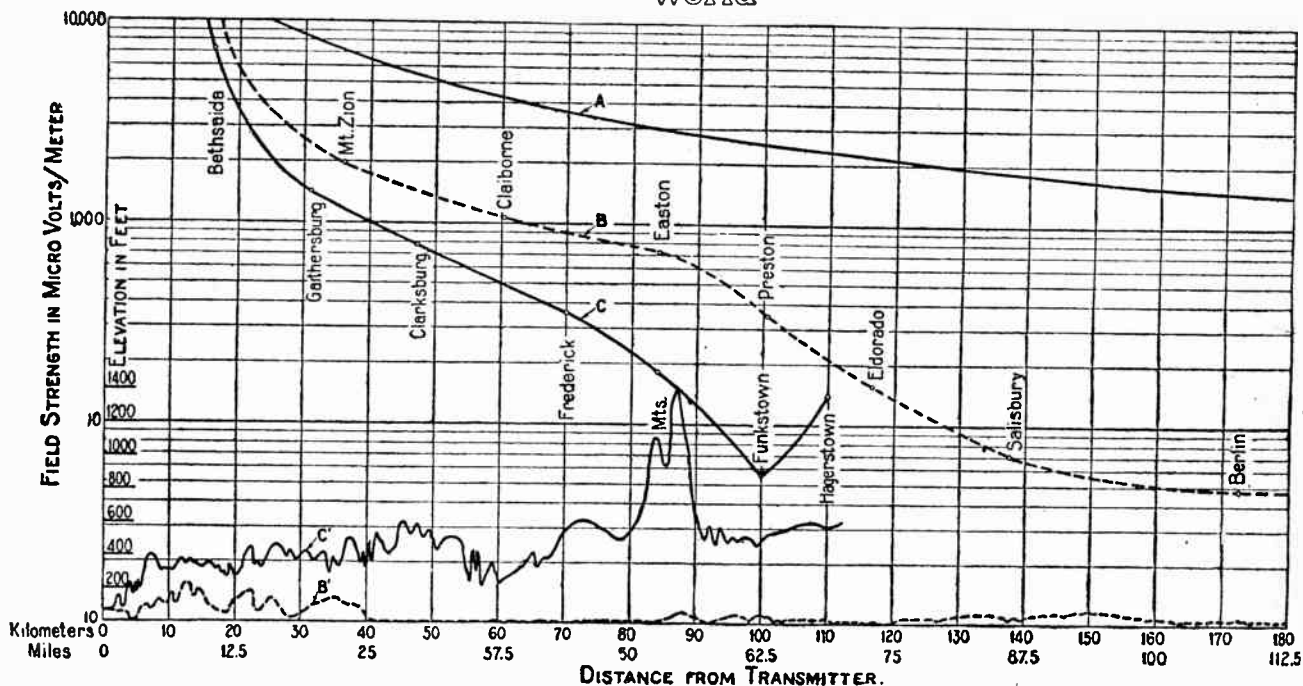

Fig. 4.—Map of the Washington district, showing points (marked by crosses) at which measurements of signal strength were observed.



[By Courtesy of the Institute of Radio Engineers.

Fig 5.—Curves of signal strength plotted from observations taken at the points indicated in Fig. 4. Curve A shows the falling off which should be obtained according to theory. Curve B is plotted from observations taken on a line S.E. from Washington, the corresponding contour of the land and water being shown in curve B'. Curves C and C' are for observations along a line N.W. from the transmitter.

station at distances varying from one to over one hundred miles. The observations were made round the two cities

of New York and Washington respectively in the daylight hours, during the same season of the year, and in most instances under uniform weather conditions.

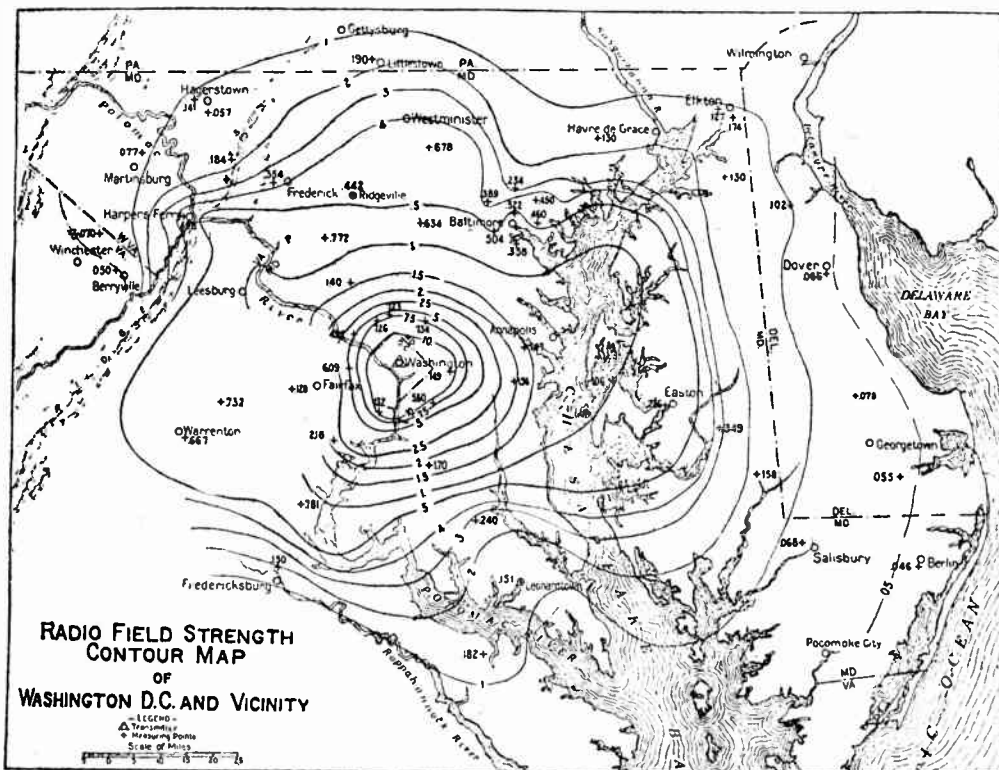

[By Courtesy of the Institute of Radio Engineers.

Fig 6.—Contour map of signal strength in the vicinity of Washington plotted from data indicated in Figs. 4 and 5.

The first series of measurements was carried out on the transmissions from a broadcasting station in Washington, using a wavelength of 469 metres. The scene of the experiments is shown on the map in Fig. 4, observations being made approximately along two lines leading out of the city, one to the south-east and the other to the north-west. The points at which the measurements were made are marked by crosses, and the results obtained are shown in Fig. 5, in which the observed field strength is plotted against the distance from the transmitting station. The smooth upper curve A shows the decrease in signal intensity which

Distribution of Wireless Waves.—

would be obtained under the condition of simple spreading of the waves over a perfect conductor; the field strength in such a case being inversely proportional to the distance as previously stated. Curve B represents the results obtained in the direction south-east of Washington, and the contour of the land along this path is shown by the curve B in the lower part of Fig. 5. It is seen that the ground is comparatively flat over the greater part of the path of transmission, the maximum height being about 200 feet, which is small compared with the wavelength (over

first experiments thus serve to demonstrate very clearly the theoretical deductions explained earlier in the article as to the attenuation effects experienced by waves being transmitted over land and water. In the north-west direction from Washington the measurements were made entirely overland, and the results are represented by curve C in Fig. 5. The corresponding contour curve C' shows that the land is in this case much more irregular, particularly between Frederick and Funkstown, where the waves cross some sharp mountain peaks approaching 1,500ft in height. As would be expected from the energy absorption in overland transmission the field-

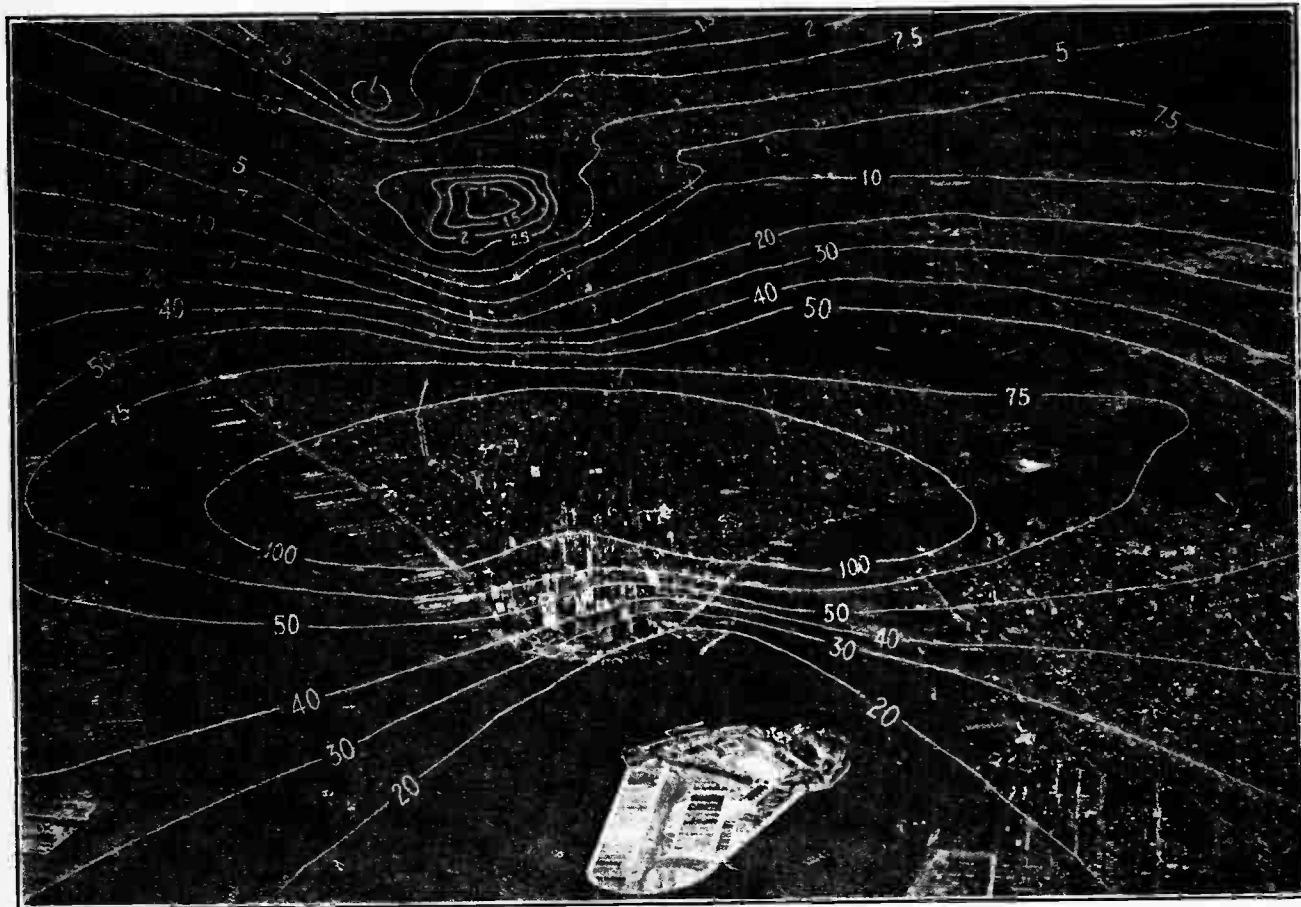

[By Courtesy of the Institute of Radio Engineers.]

Fig. 7.—Aerial view of New York, showing contour lines of field strength. The numerals indicate the field strength in millivolts per metre

1,400 ft.). Reverting to the field-strength curve B, it is seen that over the open country comprising the early part of the transmission path, the intensity of the waves decreases much more rapidly than would be the case for transmission over a perfect conductor (curve A). Between Mt. Zion and Easton the waves cross the water of Chesapeake Bay and there is a marked flattening of the field strength curve, due to the decreased losses of the waves in passing over the more highly conducting water. Beyond Easton the curve shows that the field strength is again falling off more rapidly as a result of the waves resuming their overland transmission. These

strength curve C shows a marked falling off from the ideal curve A. The most interesting point of this curve, however, is that which represents the state of affairs in the neighbourhood of the mountain range. A rapid decrease in field strength takes place on passing the peak, and a partial blind spot is produced in the "shadow" of the mountains. Beyond this point, however, the field strength increases somewhat due to the fact that energy is being fed down from above by the lending or diffraction of the waves over the mountain peaks. We have here a very interesting example of the shadow effect which can be produced by hills or even buildings, when their

Distribution of Wireless Waves.—

height is of the same order as, or greater than, the length of the waves being employed.

The above results and those of other measurements taken in the neighbourhood of Washington are shown in a somewhat different manner in Fig. 6. On this map contour lines are shown linking up positions at which the same field strength was measured, the actual value being shown by the number against each line. A comparison of this diagram with Fig. 1 gives an excellent idea of the extent to which moderately good geographical conditions cause a departure from the ideal case of transmission over a uniform conductor. A little consideration will show that where the contour lines are crowded together rapid attenuation of the waves is taking place, whereas low attenuation is evidenced by an opening out of the contour lines. The superiority of transmission over water to that over land on the broadcasting range of wavelengths is at once apparent.

Wireless Contour Map of New York.

Another series of measurements was carried out by Messrs. Bown and Gillett in the neighbourhood of New York, on the transmissions from the experimental station, 2XY, situated near one end of Manhattan Island, and employing a wavelength of 492 metres. As might be expected, the results in this case are very different from those previously discussed; for a city, thickly covered with tall steel-frame buildings provides a large number of closed metallic loops as well as open aeri-als, which serve to extract energy from the waves in the course of their transmission. The result of the measurements are

most easily understood by the excellent photograph in Fig. 7, taken from Bown and Gillett's paper, in which the field-strength contour lines have been superimposed upon an aerial photograph of New York City. The large difference in attenuation of the waves in passing over open water and over the crowded city area is very well demonstrated by the relative spacing of the contour lines. Towards the top of the photograph it is seen that the contour lines have closed in on themselves to surround a small area within which the field strength was found to have a very low value. This area is located in Central Park, which is surrounded by the city on all sides, and it evidently forms a blind spot for broadcast reception. Although it is only six miles from the transmitting station, the field strength is no greater than it is at thirty miles or more out in the country in a more favourable direction. Since this blind spot is a "closed" area it is observed that beyond it the field strength increases as a result of the feeding-in of energy from either side where the transmission conditions are much more favourable.

As stated by the authors of the paper from which these results are taken, New York presents a "horrible example" of the difficulties which are encountered in the transmission of wireless signals over city areas. Although no published data are as yet available, it is probable that the larger towns in England would present a similar picture, although to a less marked degree. An experimental investigation conducted with a view to obtaining results of the nature described in this article would undoubtedly throw much light on the problems associated with bad areas of broadcast reception.

WORLD CRUISE WITH A NEUTRODYNE.

Results Obtained at Cairo with a Set Designed by the KDKA Station Engineers.

ARRANGEMENTS have been made between the *personnel* of the Westinghouse Broadcasting Station KDKA at Pittsburgh, Pa., and Mr. Ross H. Skinner, Cruise Director of the 1926 Thos. Cook World Cruise in ss. *Franconia*, for a series of long-distance tests. A special neutrodyne receiver has been built by the KDKA station engineers for a wavelength range of 30 to 80 metres, and signals are to be received from KDKA on the 63-metre wavelength.

Experiments near the Sphinx Abandoned.

The first programme specially transmitted for the *Franconia* cruise was successfully received at Cairo. It was originally intended to set up the apparatus in the desert at the foot of the Sphinx, but on account of possible damage to the receiver it was subsequently decided to install the apparatus in a room of the Continental-Savoy Hotel at Cairo. KDKA was picked up between 5.10 and 5.24 a.m. on February 6th, and, in addition to special news items, stock reports, etc., personal messages were received for Mr. Skinner and other members of the party.

The tests are to be repeated at all the more important ports of call on the voyage.

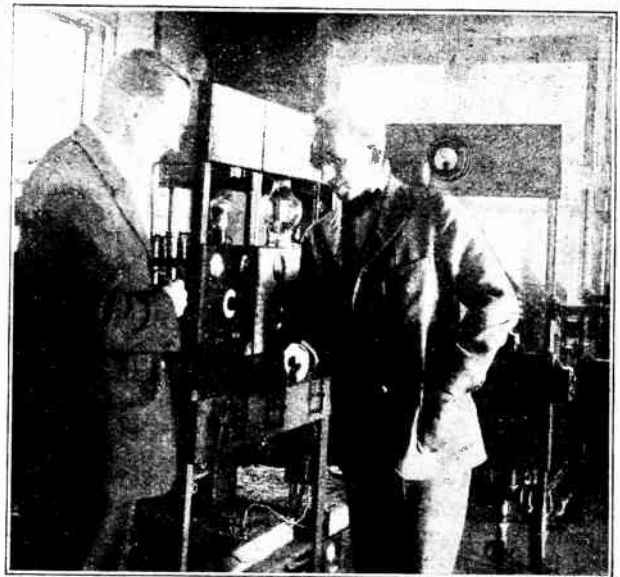

Mr. Ross H. Skinner (right) at KDKA making final arrangements for the tests with the ss. "Franconia" now on a cruise round the world.

BROADCASTING COMMITTEE'S REPORT.

Summary of the Recommendations.

THE full report of the Broadcasting Committee has now been published, and is obtainable from H.M. Stationery Office, price 6d. Below we publish, for the information of our readers, the official summary of the recommendations of the Committee, whilst under "Editorial Views" in this issue we discuss certain aspects of the report, and make our own observations on certain of the recommendations.

The principal recommendations are as follow:—

(a) That the broadcasting service should be conducted by a public corporation acting as trustee for the national interest, and that its status and duties should correspond with those of a public service.

(b) That the corporation should either be set up by Act of Parliament or be incorporated under the Companies Acts, limited by guarantee, and dispensing with the word "Limited"; that in either case the corporation should hold the licence of the Postmaster-General for a period of not less than ten years.

(c) That the corporation should be known as the "British Broadcasting Commission"; that it should consist of not more than seven or less than five Commissioners, all nominated by the Crown, the first Commissioners to hold office for five years; that the Commissioners should be persons of judgment and independence, free of commitments, with business acumen and experienced in affairs; that one of the Commissioners might, if thought desirable, be one of the existing members of the British Broadcasting Company; that the Commissioners should have the power to appoint an Executive Commissioner with a seat on the Board; that all Commissioners should be adequately remunerated.

(d) That the Commissioners should appoint, in consultation with appropriate Societies and Organisations, as many Advisory Committees as are necessary to ensure due consideration of all phases of broadcasting.

(e) That the entire property and undertaking of the British Broadcasting Company as a going concern should be vested in the Commission on the 1st January, 1927; that all existing contracts and staff of the British Broadcasting Company should be taken over by the new Commission.

(f) That the Postmaster-General should remain the licensing authority and be responsible for collecting the licence fees; that the detection and prosecution of those who conceal their equipment should be vigorously pursued.

(g) That the provision for experiment and research should be generous.

(h) That the Commission should be empowered to raise capital.

(i) That the fee of ten shillings for a receiver's licence should be maintained; that the first charge on the Revenue from licence fees should be the expenditure incurred by the Postmaster-General in connection with the Broadcasting service; that after paying the Commissioners an income thoroughly adequate to enable them to ensure the full and efficient maintenance and development of

the service, any surplus should be retained by the State.

(j) That the Commission's accounts should be reviewed by the Comptroller and Auditor-General.

(k) That so soon as the licence expires or is withdrawn the Commission, on due provision being made for the discharge of all debts and liabilities, should be bound to transfer or dispose of its whole undertaking in such manner as the Postmaster-General may direct.

(l) That the Commissioners should be entitled to all the ordinary rights as regards the use of copyright material—whether in news or otherwise—and that it is unnecessary to invest them with any special privilege or preference.

(m) That the claims of those listeners who desire a larger proportion of educational matter, though relatively few in number, should, if possible, be met.

(n) That every effort should be made to raise the standard of style and performance in every phase of broadcasting, and particularly in music.

(o) That a moderate amount of controversial matter should be broadcast, provided the material is of high quality and distributed with scrupulous fairness, and that the discretion of the Commissioners in this connection should be upheld.

(p) That licences should be granted to blind persons free of charge.

(q) That the prestige and status of the Commission should be freely acknowledged and their sense of responsibility emphasised; that, although Parliament must retain the right of ultimate control and the Postmaster-General must be the Parliamentary spokesman on broad questions of policy, the Commissioners should be invested with the maximum of freedom which Parliament is prepared to concede.

(r) That the Commissioners should present an annual report to Parliament.

HIDDEN ADVERTISEMENTS COMPETITION.

The following are the correct solutions for "The Wireless World" Hidden Advertisements Competition for March 3rd, 1926.

Clue No.	Name of Advertiser	Page
1	Radio Instruments, Ltd.	7
2	J. H. Taylor & Co.	15
3	Bowyer-Lowe Co., Ltd.	17
4	The Silvertown Co.	3
5	Garnett, Whiteley & Co., Ltd.	19
6	Collinson Precision Screw Co., Ltd.	6

The prizewinners are as follow:

A. Walter, Brighton	£5
Mrs. W. R. Ashley	£2
H. J. Price	£1

Ten shillings each to the following:

A. Lawrence, Holbeach, Lincs.	P. J. Read, Salisbury, Wilts.
H. C. Thornton, Burnley.	Miss Natalie Spencer, London, W.1.

HINTS and TIPS for NEW READERS

A Section Devoted to the Practical Assistance of the Beginner.

A "REINARTZ" FAULT.

It is not infrequently found that receivers consisting of a detector valve with loose-coupled aerial and a choke in the anode circuit may become unstable when operated on the longer wavelengths. Several of the commercial H.F. chokes seem to have a resonant frequency corresponding to a wavelength of some 1,500 metres or slightly more, with the result that when the grid circuit is brought into tune with a wavelength of this order (perhaps that of the Daventry station) uncontrollable oscillations are produced, even if the reaction condenser is completely disconnected.

This difficulty may best be overcome by increasing the inductance of the high-frequency choke, although sometimes it will be sufficient to shunt it with a small fixed condenser. This latter alternative can hardly be recommended, however, as the reactance of the shunting condenser to high-frequency impulses may be so low that reaction is no longer obtainable. It will be convenient in many cases to connect a second H.F. choke in series with the first; this will have the desired effect of stabilising the set without affecting reaction control.

IMPROVING A CRYSTAL SET.

Many readers will doubtless have been inspired by the recent series of articles in *The Wireless World*, dealing with the loading effects of crystals,

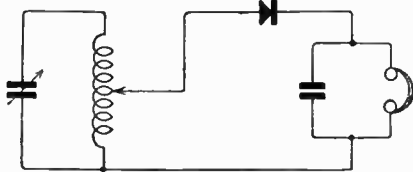

Fig. 1.—Crystal connections.

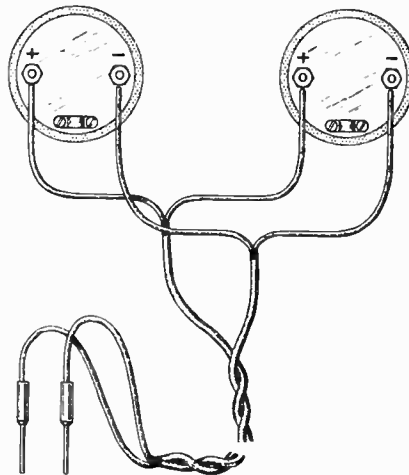

Fig. 2.—Telephone receivers in parallel.

to make attempts at improving their own reception in this respect. It was shown on page 335 of the issue dated March 4th that under certain conditions the mean rectified current flowing through the 'phones could be approximately doubled by tapping the crystal and 'phones across a suitable proportion of the tuning coil, in the manner shown in Fig. 1. In effect, we are balancing the resistances of the input and output circuits and thus obtaining maximum efficiency.

These remarks apply with greatest force where low-resistance galena crystals are used. In such cases it is often possible to effect a further improvement by using 'phones of considerably lower resistance than the 4,000 ohms which has now become more or less standard. In this case it may be said that we are attempting to balance the low-frequency resistances. There is a widespread impression that 'phones of the highest possible resistance

should always be used with a crystal set; this probably originated in the days when carborundum was in universal use.

It is hardly worth while buying telephones of a specially low resistance, but existing 4,000-ohm sets may be modified by connecting their windings in parallel instead of in series. This has the effect of reducing the D.C. resistance to 1,000 ohms, which is more likely to be a suitable value for the majority of treated galena crystals. This alteration may be carried out by joining together the positive and negative terminals of each earpiece, and connecting the external leads to the junction, as shown in Fig. 2.

The resulting reduction in load impedance will call for a slight re-adjustment of the tapping point on the tuning inductance, and it will generally be found that a smaller number of turns must be included for best results.

o o o o

A NEUTRODYNE TIP.

It has already been pointed out in these columns that in the case of a set using capacity-controlled reaction it may be desirable to protect the H.T. battery from the effects of a possible short circuit by inserting a fixed condenser in series with the reaction condenser. An examination of the circuit of a "neutrodyne" receiver, in which balancing is effected by the use of a tapped primary winding with one end connected back to the grid through a neutralising condenser, will show that the same precaution may be adopted with advantage if there is any chance of a short circuit between the fixed and moving plates of the condenser.

Provided that the series condenser

has a value of about 0.0001 microfarad, the actual maximum capacity will be reduced only to a very slight extent, and this arrangement is to be recommended, particularly where it is the custom to obtain a certain amount of regeneration control by partial deneutralisation.

TESTING 'PHONES.

It is frequently suggested that 'phones may be tested by connecting their tags across a single dry cell.

This method, however, gives a very poor idea of the sensitivity of the 'phones under test; for this purpose a source of very minute voltages is required.

A good test for sensitivity can be carried out by holding one of the tags between the teeth and lightly rubbing the other with an iron or steel object such as a key. The tag which is being rubbed should be insulated, while the hand of the tester should be making good contact with

the piece of iron; in other words, it should be grasped firmly.

If a scratching sound is heard in the 'phones, it may safely be assumed that they are in a moderately sensitive condition, although little indication will be given as to whether there is an intermittent disconnection in the leads. This is by no means an uncommon fault, and can generally be located by bending the leads at different points while actually listening to signals.

DISSECTED DIAGRAMS.

No. 22.—A "1-V-1" Resistance-coupled Receiver.

For the benefit of readers who find difficulty in reading circuit diagrams, we are giving weekly a series of sketches showing how the circuits of typical wireless receivers are built up step by step. The arrangement shown below is really effective only on the longer wavelengths. The method of separating H.F. and L.F. currents should be noted.

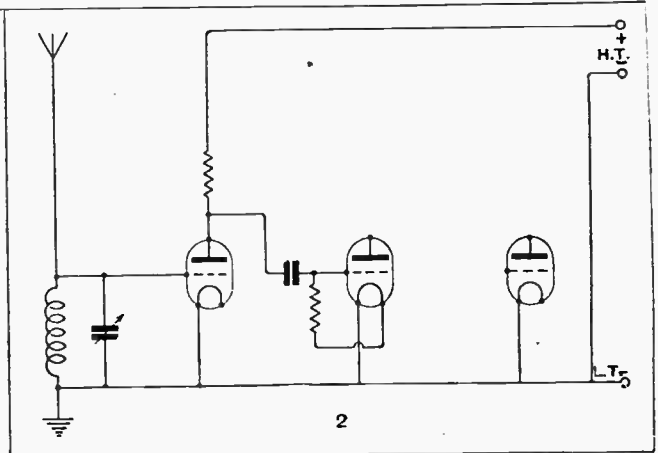
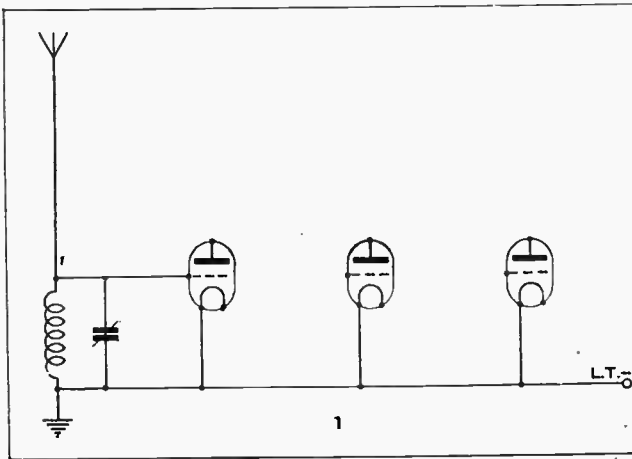

H.F., detector and L.F. amplifying valves. A tuned oscillatory circuit, with aerial and earth, is connected between grid and filament of the first (H.F.) valve. For the sake of simplicity, the complete filament circuits have been omitted.

The anode circuit is completed through a high resistance and the H.T. battery. Voltage variations across this resistance are applied to the grid of the detector valve through a condenser, with leak connected to the positive filament lead.

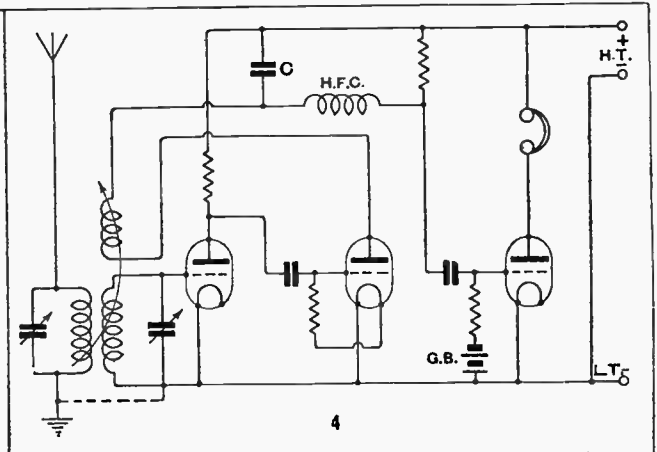
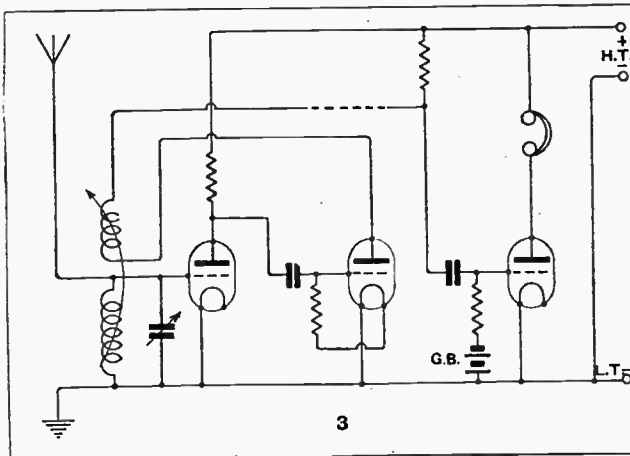

The anode circuit of the detector is connected through reaction coil and resistance to the H.T. battery. L.F. voltages are impressed on the grid through a large condenser, a negative bias being applied through the leak. Phones are inserted in the anode circuit of the L.F. valve.

Resistance-coupled H.F. amplification affords no selectivity in itself; therefore the addition of a coupled aerial circuit as shown is particularly desirable. H.F. impulses in the detector anode circuit are deflected through the by-pass condenser C by the insertion of a choke.

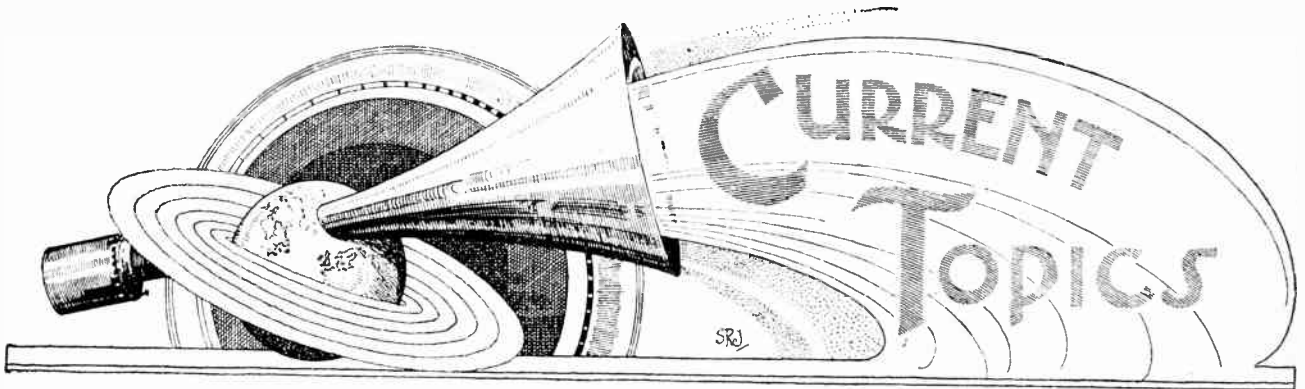

News of the Week in Brief Review.

GERMAN WIRELESS EXHIBITION.

Plans are being made in Berlin for a large wireless exposition early in September next.

o o o o

WIRELESS IN HARBOUR FOG.

Last week, when an unusually heavy fog descended on New York Harbour, eight vessels had to obtain wireless compass bearings.

o o o o

LICENCE FACTS AND FIGURES.

The Postmaster-General states that the total amount of fees for broadcast licences collected up to the end of February was approximately £2,147,000. From this sum the British Broadcasting Company has received £1,114,000.

At the end of last month the number of licences held was in the neighbourhood of 1,906,000, showing a substantial increase over the 1,258,000 on February 28th, 1925.

o o o o

WHEN MORSE BRINGS REMORSE.

A spirited but ineffectual challenge to the Post Office engineers was issued by a resident of Tiptree Heath, Essex, who was fined at Witham last week for installing and operating a wireless set without a licence. The defendant claimed that his set, which was home-made, was useless for reception. To prove his contention, he offered to work for a month for any London charity if Big Ben could be heard on the set. A Post Office engineer, however, said the receiver picked up Morse signals.

o o o o

SHUFFLING THE WAVELENGTHS.

To-morrow week, Thursday, March 25th, must be regarded as an important date in the annals of European broadcasting. On that day and the days following representatives of all existing or projected broadcasting organisations in Europe will confer at the Palais de Nations, Geneva, for the purpose of redistributing broadcasting wavelengths.

A reduction in the number of existing stations is included in the recommendations to be considered, while additional clauses recommend that the redistribution of wavelengths among the remaining stations shall be accompanied by an increase in power.

THEN AND NOW.

There is a happy significance in the fact that the present month has been chosen for the official experiments in Transatlantic wireless telephony. Fifty years ago—to be precise, on March 10th, 1876—Alexander Graham Bell was granted in the United States the first patent covering his apparatus for the transmission of speech by electricity.

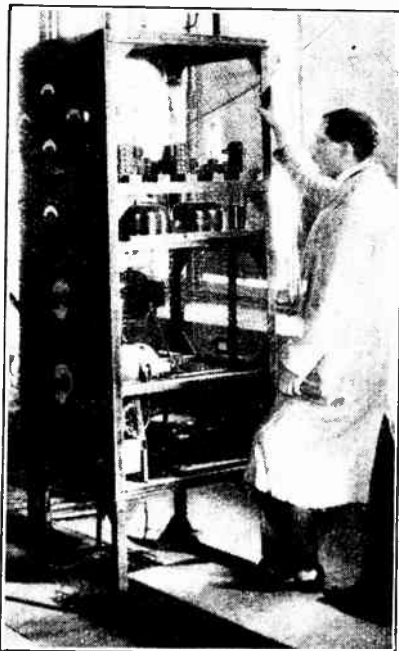

BROADCASTING FROM PARIS A new photograph showing the transmitting panel of the famous École Supérieure broadcasting station

ATMOSPHERICS AND ATLANTIC TELEPHONY.

American opinion on the question of Transatlantic wireless telephony is expressed in a statement made by officials of the American Telegraph and Telephone Company, who affirm that such communication cannot be placed on a commercial basis until the possibility of atmospheric interruption has been eliminated. This problem is still a formidable one, as the present tests continue to show.

FRENCH OPERATORS DISCONTENTED.

A strike is threatened by French wireless operators who, according to reports, have rejected as insufficient an offer of a 15 per cent. increase in their salaries.

o o o o

SENATORE MARCONI.

Senatore Marconi has just undergone an operation in a London nursing home. All wireless enthusiasts will join in wishing the famous inventor a speedy return to health and strength.

o o o o

WAVELENGTHS EXCHANGED.

The Dundee and Liverpool relay stations have exchanged wavelengths to avoid ship interference with the transmissions from the latter station. Dundee now operates on 315 metres and Liverpool on 331.

o o o o

NEW ZEALAND WITHOUT AERIAL.

Mr. D. B. S. Shannon, the Sutton Coldfield experimenter whose recent success in telephony transmission and reception without aerial or earth aroused considerable interest, claims to have communicated by Morse with New Zealand and Mexico, again dispensing with aerial or earth.

Mr. Shannon states that he used an input power of only 15 watts.

o o o o

MAGISTERIAL DIFFERENCES.

Opinion among magistrates seems to be divided regarding the interpretation of the Wireless Telegraphy Act. Three weeks ago the Hull Stipendiary Magistrate said to a defendant that a wireless licence must be obtained before the parts are put together. A week later, however, we have the Chairman of the York City Bench castigating an offender with the remark that he ought to have taken out a licence as soon as his set was in working order. An official ruling seems to be called for.

o o o o

SHORT-WAVE SIGNALS FROM NORTH POLE?

Another expedition to the Polar regions, this time from Detroit, U.S.A., is to take place during the next month, when two aeroplanes, equipped with "ultra-modern short-wave radio apparatus," will take the air in the hope of crossing the Pole.

According to Mr. Malcolm P. Hanson, who will be in charge of the wireless equipment, transmissions will be made on 45 and 61 metres, using the call sign KDA. The airmen hope to transmit Press matter during the flight to members of the North American Newspaper Alliance.

○○○○

COMMERCIAL WIRELESS TELEPHONE IN OPERATION.

It may not be generally known that a practical automatic wireless telephone service is already in operation in the United States. The system is used between the Hawaiian Islands of Oahu and Lanai, which are separated by a distance of sixty miles, and has been in use for over a year.

Subscribers to the ordinary telephone system on both islands are able to communicate by wireless through the Honolulu station KYB and Lanai City station KRQ. The transmission is said to be perfect.

○○○○

DUBLIN PROGRAMME FOR B.B.C STATIONS.

To celebrate St. Patrick's Day, the Dublin broadcasting officials have prepared an extra-special programme to be transmitted this evening from 2RN. Broadcasting will start at 6.30 p.m., and will continue until midnight (says the *Irish Radio Journal*).

A performance is to be given by the No. 1 Army Band, and the B.B.C. has decided to relay selections for the benefit of British listeners between 9.15 and 9.45 p.m.

○○○○

RECEPTION DURING MAGNETIC STORMS.

Some interesting results have been obtained at the Meudon Observatory, near Paris, in the reception of wireless signals from Rome and Bordeaux during a time of magnetic disturbance.

On January 26th last, when a magnetic storm was indicated on the recording instruments for about 15 hours, measurements of signal intensity from Rome and Bordeaux showed a considerable increase in strength, signals from Rome being about four times louder than usual.

○○○○

BRITISH APPARATUS FOR RUSSIA.

In connection with a display of wireless apparatus in Leningrad, organised by the Chamber of Commerce for the N.W. District of Russia, an invitation is given to British traders to forward samples and catalogues, which will be exhibited free of cost. There are no duty or licence formalities attached to the im-

port of samples destined for the exhibition.

Further particulars of this offer may be obtained from the Secretary, Russo-British Chamber of Commerce, Parliament Mansions, Victoria Street, London, S.W.1.

A feature of special interest, particularly to members of the Wireless League, will appear in next week's issue of "The Wireless World."

BROADCAST WAVELENGTH CHANGES.

Several changes in the wavelengths of European broadcasting stations came into

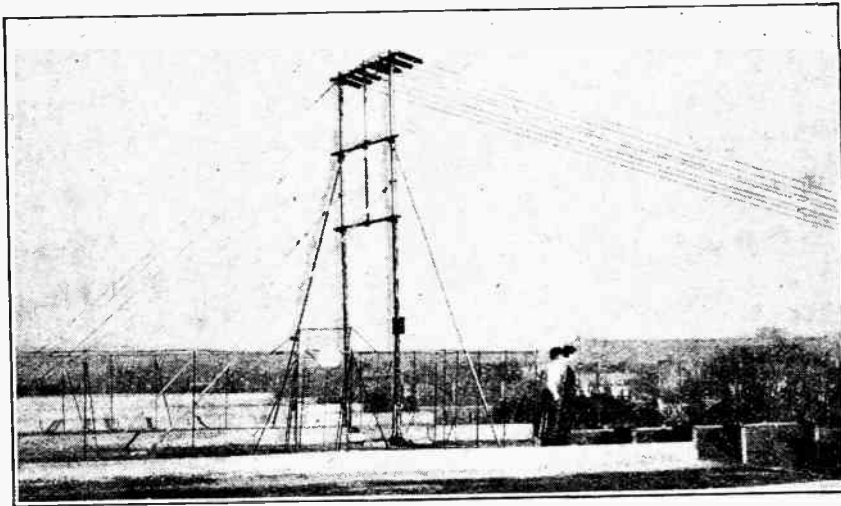

BROADCASTING FROM PARIS. An interesting view taken on the roof of the Central Telegraph building, showing a portion of the curiously constructed aerial of the Ecole Supérieure broadcasting station

force on Friday last, as a consequence of the results obtained in the recent "silent" test period.

The changes, which will affect stations in the neighbourhood of 400 metres, are as follow:—

	Metres.	Newcastle	Metres.
Bournemouth	.. 387	..	407
Hamburg	.. 392	Münster	.. 412
Dublin	.. 397	Breslau	.. 417
Graz	.. 402		

○○○○

WIRELESS COACH FOR LEAGUE OF NATIONS.

The League of Nations will shortly possess a wireless-equipped Pullman car, to be run on express trains or on "specials" in the event of emergency. According to Mr. Eric Palmer, of the Fried-Eisemann Radio Corporation, who is at present studying European broadcasting methods, the Pullman car will be used by League representatives journeying to districts threatened by war or disease.

BROADCASTING THE BUDGET.

In the House of Commons on Wednesday last the Prime Minister informed Captain Ian Fraser (St. Pancras N., U.) that he was considering the best means of obtaining the views of Parliament on the feasibility and desirability of permitting the broadcasting of certain specially chosen portions of the Parliamentary proceedings; also as to the possibility, as an experiment, of arranging for the broadcasting of the Budget, or a portion thereof, together with the considered replies, or portions thereof, of the spokesmen for the opposition.

○○○○

WIRELESS ON AMUNDSEN'S POLAR FLIGHT

Further interesting details are now available concerning the wireless apparatus to be installed on the Amundsen air-

ship, "Norge I," to which reference was made in these columns last week. The famous explorer will endeavour shortly to fly from Europe over the North Pole to Alaska, passing over London on his journey.

By special arrangement with the Marconi Company the vessel is to be equipped with transmitting apparatus which will enable the Commander to keep in touch with either land or ship stations at distances up to 1,000 miles. Receiving apparatus covering a wave range of 300-25,000 metres will also be carried, whilst D.F.

equipment will be installed which will be sufficiently sensitive to enable the navigators to determine their course and direction even over the Pole itself, when the compasses will be of no navigational value.

The Marconi Company are making arrangements to forward any reports from amateurs of reception from the air-ship to the wireless operator with the expedition.

○○○○

ERRATUM.

In the article on a "Distant Control Unit" on page 330 of the March 3rd issue an error occurs in Fig. 4, which shows the internal connection of the relay and method of connection to the receiving set and extension leads.

The connection shown between the armature of the relay and the terminal on the relay unit connected to the negative side of the L.T. battery should not exist: instead the connection should be shown between this terminal and the top terminal marked S.

LONG WAVES FOR TRANSATLANTIC TELEPHONY.

An Interview with M. Marius Latour.

CONSIDERING the recent trend of opinion in favour of the shorter wavelengths for long-distance wireless communication, the views held on this subject by the famous French wireless scientist, M. Marius Latour, are of more than passing interest.

M. Latour, who is at present in New York, is the inventor of a high-frequency alternator, and many other radio devices in general use both in Europe and America. In the course of an interview with a representative of *The Wireless World* M. Latour discussed the possibilities of a regular telephone service across the Atlantic.

"I believe," he remarked, "that transatlantic telephones will be an ordinary medium of communication in a few years' time. But, instead of the uncertain, low-powered short wave with which most experimenters are now working, I cannot help feeling that the high-powered long-wave station will ultimately be adopted. I admit that occasionally the short wave has proved of immense value, and that for high speed work it is superior to the long wave. Consider, however, the sensitiveness of the short wave to atmospheric conditions, and particularly its susceptibility to fading.

High Broadcasting Wavelengths.

"In their long-distance work, do the big American commercial stations experience the same difficulties as the broadcasting stations? Hardly, for they always use high wavelengths, generally in the 10,000 metre band.

"Turning to the European broadcasting stations, look at Eiffel Tower, Daventry, Königswusterhausen, Moscow, Radio-Paris, and Radio-Vienna. These are the most popular and well-known in Europe, and their wavelengths are all comparatively high, ranging from 1,000 to 4,000 metres."

M. Latour referred to the recent test transmissions between European and American broadcasting stations.

"What did these tests prove? According to the Press, nothing. But to me they proved something quite definite, namely, the value of the long-wave high power station. Practically no one in America heard Daventry, which transmits on 1,600 metres, because American broadcast receivers are tuned to the lower band. For the same reason Radio-Paris and Eiffel Tower were mute. The tests were a failure, the stations on the lower wavelengths scarcely being heard at all.

A Forecast.

"I am firmly convinced, from this and many other observations, that the radio telephone service between London and New York, when it does come, will use a longer wave than has been expected."

M. Latour's forecast on this point is specially noteworthy in the light of the results obtained during the past few weeks in the transatlantic telephony experiments between Rugby and New York.



M. Marius Latour, the celebrated French wireless inventor, who, in the interview reported on this page, expressed the opinion that long waves, rather than short, should be used for transatlantic wireless telephony.

"Recent experience would seem to indicate," said M. Latour, "that a suitable wavelength would lie between 4,000 and 5,000 metres, transmission being of the "carrier-less" type now being investigated by the Bell Telephone Laboratories. It would be necessary, of course, to use high power.

Eliminating Interference.

"One serious drawback might arise from the use of the higher wavelengths, this being interference between stations. The lower wave bands undoubtedly possess the advantage that frequency variations are very great even on a slight variation of wavelength, whereas, with higher wavelengths the frequencies vary but slightly. This would necessitate a limitation in the number of telephone stations working simultaneously.

"On the other hand, it must be remembered that directional effects are not impossible on the higher wavebands, and a judicious use of this property would diminish the risk of clashing."

M. Latour propounded an interesting theory regarding the relationships likely to exist in the future between cables and wireless for transatlantic work.

"It seems quite possible," he remarked, "that some

Long Waves for Transatlantic Telephony.—

day wireless between Europe and America will consist entirely of telephony, while telegraphic work will remain with the cables. While the cables are more suitable for code work, wireless has shown its superiority in the transmission of the human voice. If such a scheme materialised, the higher wavelengths would be free for telephony, another important step in the elimination of interference between stations."

"Do you consider that it will be possible to secure privacy in wireless telephony conversations?" M. Latour was asked.

"I do not yet know," he replied. "Others are working in this direction and deserve every encouragement, but I should like to see practical proof of some of the claims now being made."

Television.

On the inevitable question of television M. Latour expressed his unhesitating belief in the feasibility of transmitting scenes by wireless.

"The problem is to increase the speed of photo reproduction," he added. "The four or five minutes now

required for anything to be 'got over' must be reduced to a twentieth of a second, or less. If I may say so, I believe I was one of the first to suggest the use of the photo-electric effect of light applied to a metallic electrode to replace the old selenium cell, in which there was far too much inertia.

"Furthermore, I suggested modulating a high-frequency current to obtain an amplified current exactly proportionate to the actual varying output of the cell. Now we have the potassium cell, and we may hope that some other photo-electric element, having still less inertia, will be discovered. No further basic invention is required to make television a success—all that is needed is an appropriate photo-electric element."

At the conclusion of the interview M. Latour stated his intention of returning to Europe very shortly to resume his wireless researches, which have been held in abeyance, owing to his enforced visit to America for the purpose of upholding patent rights.

"Meanwhile," said M. Latour. "remember what I have said regarding long waves for transatlantic telephony. They have been unfairly treated, but they still have a great potential value."

EXPERIMENTERS AND THE PUBLIC.**A Personal Plea and a Reply.**

A GOOD deal of comment has appeared at different times in the Press indicating the impatience of many listeners with the experimental transmissions of amateurs in different parts of the country.

Two letters in this connection, which are of exceptional interest, have recently appeared in the issues of *The Times* for February 27th and March 9th respectively, and these we reproduce, with the permission of the Editor, as we think that the views expressed, particularly those in the reply of Mr. Maurice Child, Secretary of the Radio Society of Great Britain, are of special interest to our readers.

TO THE EDITOR OF "THE TIMES."

Sir,—Is it fair that a majority should be called upon to suffer unnecessarily at the hands of a small minority? There are, I suppose, some millions of wireless listeners, an increasingly large number of whom make a special study of the reception of foreign stations. Sunday evening, between the hours of 6 and 8, is the time when this can most successfully be done, the English stations being then, as a rule, closed down; but under present conditions reception is very largely spoilt by the activities of the private transmitter and experimenter. May I suggest that the time has come when these enthusiastic and no doubt well-meaning gentlemen, of whom I suppose there are only a few thousand scattered up and down the country, should suffer further restraint by the forbidding of private transmission on Sundays between the hours of 6 and 8 p.m.? That would still leave the private transmitter the whole day on Sunday up to 3.30 p.m. in which to let loose his piano and gramophone and his exasperating "Hallo, hallo, hallo" on a suffering public. Surely this is enough! The trouble is very acute in this neighbourhood. It would be interesting to know how listeners fare in other parts of the country.

CHARLES W. RAILTON.

Cherry Tree House, Alderley Edge, Cheshire.

Sir,—I have read the letter of your correspondent, Mr. Charles W. Railton, of Cheshire, which appeared in your issue of February 27th last. In my opinion, he has not made a good case for the additional restriction which he desires for the persevering experimental transmitters. It was to this largely organised body of enthusiasts that broadcasting in this country was originally due, and inasmuch as they have from its beginning voluntarily ceased their experiments during English Broadcasting hours in order that your correspondent's "suffering public" can use their cheap un-selective apparatus without interference, it is to be regretted that Mr. Railton cannot see his way to spare them the few hours weekly remaining for their tests. The broadcast listener gets a good entertainment for his 10s. per annum, especially when contrasted with the minimum fee of £1 per annum paid by the transmitter, who has to prove his technical qualifications to hold a licence. The first named rarely spends more than a few shillings per annum in respect of his batteries, whereas the latter is a large source of income to the trader dealing in a wide variety of high-class components.

Most experimental transmitters to-day are using wavelengths of less than 200 metres, and, consequently should not be heard on properly designed instruments operating on the broadcasting band. If your correspondent is the keen experimenter which his letter suggests, he might, with advantage to himself, become a member of a local radio society, which would assist him to design his receiving apparatus to accomplish what he desires. He may be interested to know that for four hours on Sunday last I received without any interference whatever the two-way telephony between Rugby and New York. During this period experimenters were making numerous 150- to 200-metre tests and 2LO was giving the afternoon concert. This last station is not quite two miles away from me. In conclusion, I suggest that Mr. Railton considers the limitations of his instrument and perhaps even his own skill before entering protests against "the other man."

I am, Sir, yours faithfully.

MAURICE CHILD,

Radio Society of Great Britain.



Broadcast Brevities

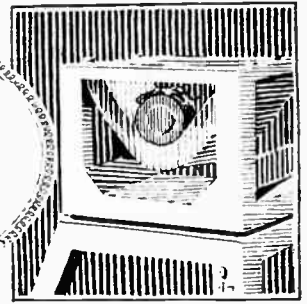

Savoy Hill Topicalities : By Our Special Correspondent.

Daventry to Relay Hilversum.

Listeners to Continental stations which are relayed to B.B.C. stations through Keston have shown particular interest in the transmissions from Hilversum, Holland, where the announcements have invariably been made in genial English and the programmes have been better than those of most Continental stations. For some time past plans have been discussed for a regular interchange of programmes between Daventry and Hilversum. The preliminary details are now complete, and the first transmission of Dutch programmes for British listeners under this scheme will take place on Monday, April 19th.

o o o o

Fortnightly Interchanges ?

The special programme which the Hilversum broadcasting officials are arranging for the occasion will be picked up at Keston, relayed to Daventry by land line, and broadcast from 9 to 10 p.m. If the transmission is successful, as, indeed, there is little reason to doubt that it will be, if we remember some of the Hilversum transmissions during the winter, we shall have a regular fortnightly interchange. The Hilversum officials have signified their intention of engaging the best artists procurable for these broadcasts, and operas and musical comedies will be included in the programmes. Announcements respecting these relays will be made in Dutch and English from the Hilversum station, and in English and Dutch from the Daventry station.

o o o o

A New Station for Holland.

Hilversum, by the way, is working on a power of 5 kilowatts; but a new 25-kilowatt station is to be erected there shortly.

o o o o

Broadcasting from Geneva.

An important series of line tests have recently been carried out by the B.B.C. from Geneva, and these will result in extensive use for broadcasting of the League of Nations conferences in the near future. The League is at the moment considering the provision of proper wireless transmitting facilities for the new Assembly Hall. The building will accommodate the representatives of sixty-five nations and one thousand

journalists, and every effort will be made to fit the hall with modern equipment, including loud-speakers and wireless transmitting apparatus. One can foresee the day when many League conferences and debates will be put forth on the air and important declarations will be broadcast from Geneva.

o o o o

On Announcing.

One of the older members of the staff at Savoy Hill who had never been bold enough to appear before the microphone in the rôle of announcer has just made the experiment, having become enamoured of the idea that the announcers receive a host of letters saying what beautiful, romantic voices they have. The results exceeded his most sanguine expectations, but it must be said in his favour that the congratulations were justified, as he introduced into his announcements a warmth and geniality that were quickly spotted by numerous listeners.

Do Listeners Want Longer Plays ?

Although the balance of listeners' opinions is probably in favour of the present short twenty minutes' sketches, the alternative view that there is a widespread feeling that long radio plays should form a regular feature of the programmes is to be taken into practical account. In the week beginning April 18th, therefore, an attempt will be made to gauge the general opinion of listeners by transmitting a long play. I believe that the Dramatic Department is fully alive to the necessity of choosing carefully the type of play that is calculated to hold the interest of listeners for a lengthy period.

o o o o

St. Patrick's Day.

Cardinal Bourne will broadcast for the first time on this evening, when his speech at the St. Patrick's Day banquet of the Union of the Four Provinces of Ireland Club at the Hotel Cecil will be relayed to 2L.O.

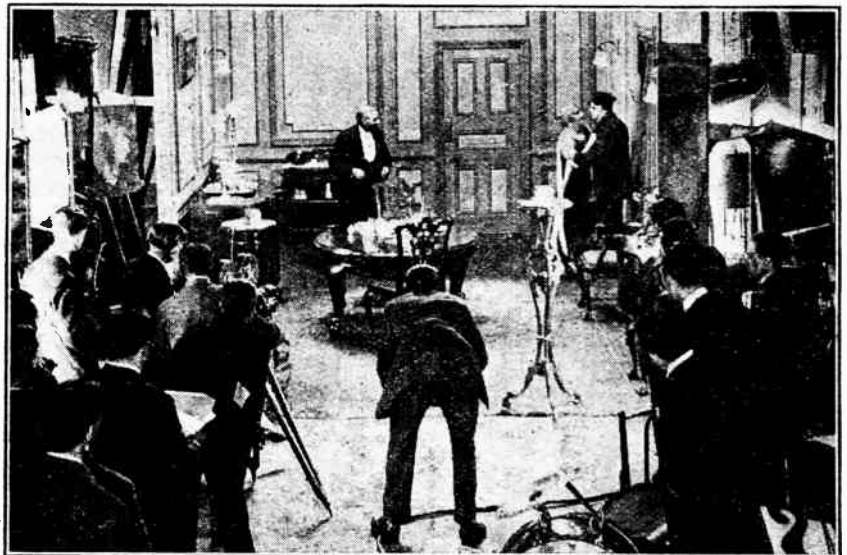

THE BREATHLESS MOMENT! A scene in the Gaumont Studio during the recent broadcast of the sounds associated with the production of a film. Note the microphone on its stand in the right foreground.

British and Best.

When the general simplification and cheapening secured by the licensing regulations took effect at the end of 1924 fears were expressed lest the removal of the restrictions against the use of foreign parts should prejudice the British wireless trade. It is probable that but for the maintenance of a high standard in programmes, aided by the intensive propaganda conducted by the B.B.C., the wireless material of American and Continental origin which was placed on the British market in January, 1925, often at prices considerably below those asked by British manufacturers, would have been considered "good enough" for the service received.

○○○○

No Exploitation.

This is not to say that the B.B.C., although technically a trade organisation, interpreted its functions as those of a manufacturing interest; nor have the manufacturing firms attempted to exploit the broadcasting service to their own commercial advantage. Rather, the broadcasting and manufacturing interests have each ploughed their own furrow, and that is the reason why, at the end of the year, the B.B.C. will hand over to the new broadcasting authority a service which, in the words of the Crawford Committee, "reflects high credit on British efficiency and enterprise."

○○○○

A Going Concern.

The country is spending some £15,000,000 a year on wireless, the manufacturers are keeping pace with the demand for wireless apparatus and are holding their own against foreign competition. American exports of wireless apparatus to England totalled £64,000 in 1922 and £100,000 in 1924. This is a very small slice of the British trade, and the prospects of any marked growth are not encouraging for American manufacturers. From every aspect, therefore, those who are empowered to conduct broadcasting in Great Britain and Northern Ireland after December 31st next will have cause for gratification at being placed in control of a "going concern." A far different task fell to the Post Office when it took over a more or less derelict telephone service fifteen years ago.

○○○○

Poetry Reading

A regular and progressive weekly poetry reading scheme is to be inaugurated in the week beginning April 11th. The readings will fill a ten minutes' interval in the Monday Chamber music programmes. In conjunction with this scheme the alternative 5XX programme will be changed to Tuesday. The Shakespeare Heroine feature, to which I referred some time ago, will alternate with the Sunday afternoon plays.

○○○○

A Forecast Gone Wrong.

More than a year ago an eminent newspaper chief expressed the view that within six months from that date broadcast-

FUTURE FEATURES.**Sunday, March 21st.**

LONDON.—3.30 p.m., Bach Programme. 5 p.m., Mrs. Patrick Campbell. 9.15 p.m., Chamber Concert. J. H. Squire Celeste Octet.

ABERDEEN.—3.30 p.m., Choral and Orchestral Programme. The Aberdeen Male Voice Choir.

NEWCASTLE.—3.30 p.m., Bach Programme.

Monday, March 22nd.

LONDON.—8 p.m., The Royal Artillery String Band. 10.30 p.m., Somerset Folk Songs and Dances.

BIRMINGHAM.—7.30 p.m., Organ Recital by G. R. Cunningham relayed from the Town Hall.

BOURNEMOUTH.—8 p.m., Winter Garden Night. Municipal Orchestra.

BELFAST.—8 p.m., Spring Programme.

Tuesday, March 23rd.

LONDON.—8 p.m., Nigger Minstrelsy. 9 p.m., The Savoy Symphonic Augmented Orchestra.

GLASGOW.—9 p.m., Chamber Music. J. H. Squire Celeste Octet.

Wednesday, March 24th.

LONDON.—8 p.m., Chamber Music. The Aeolian Players. 9 p.m., "The Old Willow-Plate," a Musical Sketch by Edmond Welshman. Music by Mark Strong.

BELFAST.—8 p.m., An Instrumental Concert.

Thursday, March 25th.

BOURNEMOUTH.—8 p.m., Popular Overtures. 8.30 p.m., Revusical Cameos.

CARDIFF.—8 p.m., The Mountain Ash Girls' Choir.

GLASGOW.—8 p.m., Chamber Music and Entertainment. 10.30 p.m., Scottish Regiments: The Cameronians.

MANCHESTER.—7.30 p.m., The Hallé Pensive Fund Concert relayed from the Free Trade Hall. Hallé Orchestra conducted by Sir Thomas Beecham.

Friday, March 26th.

LONDON.—8 p.m., One Crowded Hour of Glorious Life. 8.42 p.m., "The Student Prince."

ABERDEEN.—8 p.m., Instrumental Programme.

GLASGOW.—9 p.m., Speech by the Rt. Hon. J. H. Thomas, M.P., relayed from the Grosvenor Restaurant.

Saturday, March 27th.

LONDON.—8 p.m., Third Edition of "Listening Time." 9 p.m., Eastbourne Municipal Orchestra relayed from Devonshire Park.

BIRMINGHAM.—7.30 p.m., Concert relayed from the Town Hall. The City of Birmingham Choir.

ing would have lost most of its news interest and the Press would need some strong inducement before it gave any space to broadcasting matters. Experienced as he is in all things appertaining to newspaper production, this newspaper director was on that occasion entirely at fault in his judgment, and the Press, especially the daily newspapers, must consider themselves fortunate that broadcasting maintains its news interest to the extent that it does.

○○○○

Scare Stories.

But a feeling exists at Savoy Hill that broadcasting holds sufficient legitimate news interest to justify a protest at the amount of space given in some quarters to "scare" stories, which are probably circulated by hostile interests to convey the impression that the B.B.C. will soon have nothing left to broadcast. Among these "scares" have been the reported refusal of the theatrical managers to allow plays to be broadcast, the withdrawal of the Savoy bands, the Musicians' Union ban, and the alleged ultimatum of the Music Publishers' Association. The opinion of the broadcasting officials is that the Press will presently defeat its ends, and that newspaper readers in search of accurate information will become sceptical because none of the calamities advertised ever happen.

○○○○

A Mistaken Idea.

While I am on this question of the setting of various interests against broadcasting, it may be mentioned that an idea is prevalent that demands for compensation from the B.B.C. for the use of certain works should be based, not upon what is a reasonable return for such use, but upon an income which is presumed to increase almost daily. This is a very optimistic view of the financial position, and is a fallacious line of argument.

○○○○

Where the Money Goes.

The amount received by the Post Office by way of fees for wireless receiving licences up to the end of last month was approximately £2,147,000, and the amount paid to the B.B.C. to date is £1,114,000; which shows clearly enough that anyone who assumes that 75 per cent. of the amount of fees for the 1,900,000 licences now in force is in the coffers of the B.B.C. is grossly mistaken.

○○○○

A Trade Union Broadcasting Station.

While the B.B.C. revenue is now limited to £500,000 a year for the operation of a service comprising one high-power station, nine main and eleven relay stations, Chicago Federation of Labour contemplates the financing of a broadcasting station by assessing the 350,000 trades unionists in the city area at a rate which will bring in no less than £70,000 a year. For this the listener will receive educational matter, consisting of speeches, lectures, reviews of the topics of the day, labour legislation economics, etc.

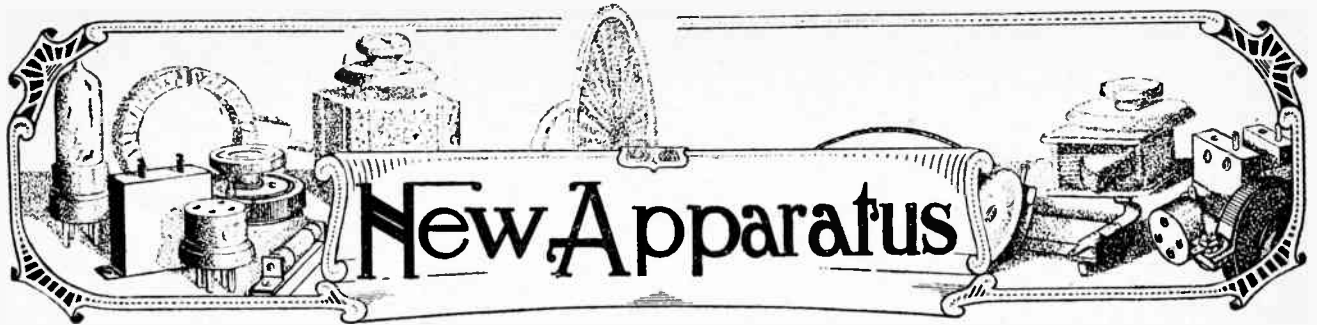

A Review of the Latest Products of the Manufacturers.

A NEW FILAMENT SWITCH.

It is often considered bad practice to control filament current by means of a simple break switch, for if the full potential of the battery is suddenly applied to the valve filament the strain is very much greater than if the current is slowly brought to a maximum through the filament rheostat.

In cases where filament rheostats are not fitted, or where it is not desired to interfere with the setting of the resistance, this new switch will be found particularly useful. It is of the plunger type, but carries a spool of resistance wire so that on lifting the plunger the current is first applied through several turns of resistance wire, thus being brought slowly to a maximum. The switch is a recent

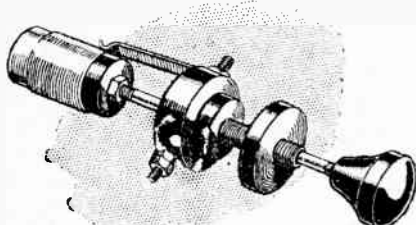

This "on and off" switch avoids applying maximum filament potential in the process of switching on. The filament current is slowly brought up to the correct value without adjusting the setting of the filament rheostats

product of The Argonaut Manufacturing Co., 16, Norman Buildings, Old Street, London, E.C.1.

o o o o

THE PERMEC DETECTOR.

One of the principal aims in crystal detector design is to provide for searching out various points of contact without causing the wire to wipe across the irregular face of the crystal. In the Permec crystal detector, manufactured by Permec, Ltd., Junction Place, Praed Street, Paddington, London, W.2, the adjusting knob provides a backward and forward movement, so that the necessary critical pressure of contact can be obtained, whilst on further rotating the knob the crystal is revolved at a time when it is out of contact with the catwhisker. By this means the crystal is slowly brought up into position, and if a

suitable contact is not obtained, further rotation brings another point of the crystal into operation.

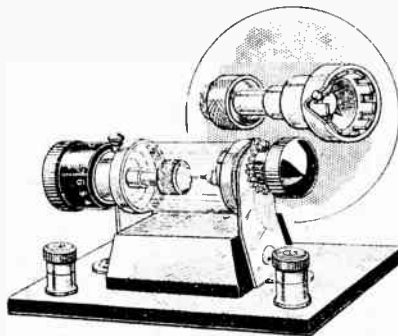

A micrometer adjustment is obtained with the Permec detector, whilst the entire surface of the crystal can be explored without the catwhisker scratching across the crystal face. The catwhisker is also spring mounted.

The catwhisker also is eccentrically set up so that the entire surface of the crystal can be explored. An exceptionally useful feature is the fitting of a light spring mounting behind the catwhisker so that when the crystal and wire make contact only a light pressure is applied until the crystal is driven further forward. A wide range of pressure between the contacts is thus easily obtained.

The machined parts are exceptionally well finished, and the crystal contacts are enclosed in a glass cylinder. The detector is of British manufacture.

o o o o

THE RAVOX VARIABLE CONDENSER.

A variable condenser of entirely new design has been introduced by Radiovox, Ltd., 10-11, Jermyn Street, London, S.W.1. In external appearance it resembles a cylinder some 2½ in. in diameter by 2 in. in depth. The dial is calibrated to read up to 360 degrees. A minimum to maximum capacity is obtained by just over two revolutions of the dial being equal to a rotation through some 800 degrees, an arrangement which possesses the merit of producing an exceedingly fine adjustment without recourse to reduction gearing.

The condenser examined was stated to have a maximum capacity of 0.0005 mfd., and when measured was not far short of

this value, being actually 0.00046 mfd. In measuring the capacity, however, it was observed that very little change was produced for the first 150 degrees rotation of the dial, which is probably explained by the fact that the plates, which are in the form of eccentric cylinders, do not commence to overlap until this position was reached.

The moving plate is provided with a long brass bush which, mounted on a spindle carrying a quick thread, is propelled to take up a position inside the cylinder forming the fixed plate. There is very little clearance between the cylinders, and the space is taken up with a piece of thin celluloid which is treated with a form of lubricant to prevent wear and to produce a smooth, silent movement.

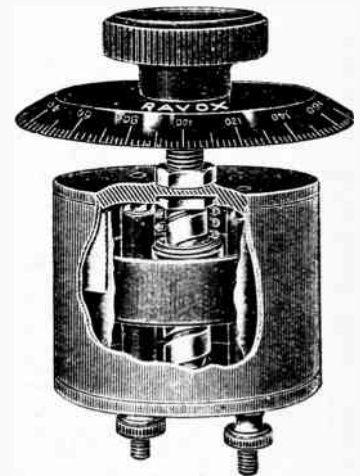

The Ravox condenser, showing the spindle with quick acting thread for propelling the moving plate, which is in the form of a cylinder, towards another cylinder of slightly larger diameter.

The dielectric is therefore celluloid, which it must be admitted does not possess good dielectric properties, and the substitution of mica carrying a lubricating film of oil would undoubtedly improve the performance of the condenser, providing the mechanical design permits of the substitution of mica. The capacity at zero was found to be 10 micromicrofarads, which is an average value.

The condenser is offered at a very moderate price.

TUNE RITE DIAL.

An ingenious form of geared dial is the Tune Rite Dial, to be obtained from R. A. Rothermel, Ltd., 24-26, Maddox Street, Regent Street, London, W.1, in which by means of an oval-shaped intermediate pinion a condenser having plates of the square law type is virtually converted to one giving straight line fre-

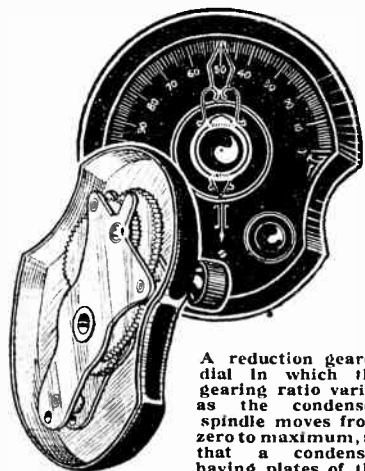

A reduction geared dial in which the gearing ratio varies as the condenser spindle moves from zero to maximum, so that a condenser having plates of the square law type is

converted to one possessing approximately straight line frequency tuning.

quency tuning. Thus the condenser spindle is rotated by a train of reducing gear wheels, in which the gearing ratio does not remain constant. The gears are well cut to eliminate backlash, and, as can be seen in the illustration, the appearance of the dial is unorthodox yet attractive.

THE GRIPPLESHELL AERIAL BRACKET.

A very large number of aeri- als are supported at the remote end by means of a pole, while the end from which the lead-in is taken is secured to a spike driven into a wall or chimney stack. Such an aerial is easily erected, but there is always a possibility of the eye spike being dragged from the brick work.

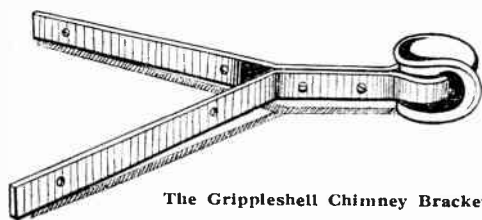

The Grippleshell Chimney Bracket.

The Grippleshell bracket is intended to provide a more secure fixing by being attached to two sides of the chimney stack in preference to making use of a spike driven into a wall in line with the pull of the aerial. The bracket is made in lin. wrought iron, and is obtainable either in the form of a right-angle, as shown in the accompanying illustration, or with the two sides bent out in line to a "T" formation. The corner bracket type is, of course, intended for

securing to a chimney stack, and a good hold is obtained by the use of four $\frac{3}{16}$ in. galvanised iron nails. A shell insulator is gripped in the end of the bracket, and the halyard is passed through the hole in the insulator in the same way as through a pulley.

The various applications of the bracket and the several types obtainable are described in a pamphlet issued by the manufacturers, Partridge and Wilson, 217a, Loughborough Road, Leicester.

o o o o

NEW FEATURES IN CONDENSER DESIGN.

The illustration shows the movement employed in the variable condenser manufactured by the well-known French firm of L. Hamm, the sole agent for this country being M. Benoit, 17, Aschurch Park Villas, London, W.12.

The reducing gear which is provided is exceedingly compact and does not incorporate toothed pinions, which usually give rise to some degree of backlash. The centre spindle is of intricate construction and propels the main shaft through three friction rollers producing a reduction

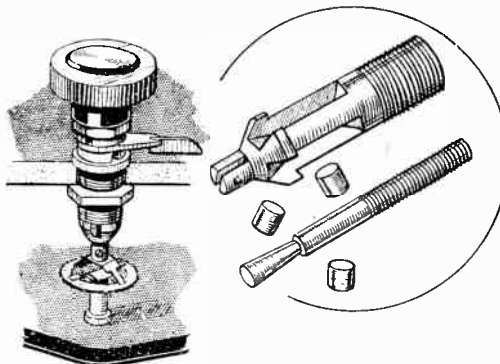

Details of the reduction gearing and flexible shaft coupling to be found in the new French variable condenser manufactured by Messrs. L. Hamm.

gearing of 4:1. Particularly smooth working is obtained by this arrangement, and wear is automatically taken up.

The plates of the condenser are mounted at some distance behind the instrument panel to reduce the effects of hand capacity to a minimum. To allow for minor discrepancies in the setting up of the condenser a knee joint is included in the shaft, which also serves as an insulating ring of low capacity.

o o o o

A BUILD-UP FIXED CAPACITY CONDENSER.

In experimenting with various receiving circuits one finds it necessary to possess a wide range of fixed capacity condensers. To meet this difficulty, C. G. Vokes, 38, Conduit Street, Regent Street, London, W.1, are now offering a condenser which can be adjusted in value by an easy process of inserting a suitable number of plates to produce the required capacity.

The construction is simple and consists of a moulding carrying the screws for the terminals and having guide pieces so that the plates will lie correctly in position when they are assembled. The base with

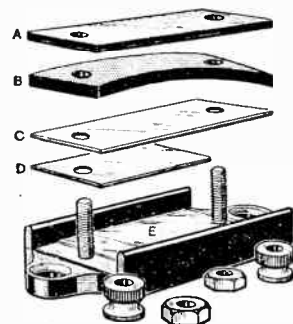

A useful form of condenser in which the number of plates can be adjusted to produce the required capacity.

several plates in position is illustrated, and one of the mica insulating pieces is shown at E. The plates D, which are copper foil, are, of course, assembled alternately on the stems of the terminals, and when the required number of plates are in position a piece of insulating material C is used as a cover, followed by a pad of indiarubber B and a hard insulating card A, the whole being clamped down under nuts and terminals. A chart is supplied with the condenser showing approximately the number of plates to be used for any given capacity, whilst a sufficient supply of mica and copper foil is included for producing capacities up to 0.006 mfd.

TRADE NOTES.**The Brown Budget.**

The current issue of this attractive monthly, the house organ of S. G. Brown, Ltd., gives a fascinating description of the experiments undertaken in 1899, in which Mr. S. G. Brown made use of a directional wireless system employing a parabolic reflector of stretched wire. Successful tests were conducted in the neighbourhood of Beachy Head over a distance of a mile and a quarter.

The "Brown" gyro compass, and the range of Brown loud-speakers are other features dealt with in the issue.

o o o o

Buried Treasure.

An unusually arresting cover design has been chosen by the Rothermel Radio Corporation of Great Britain, Ltd., for their new catalogue of American wireless apparatus. A group of buccaners is depicted in the act of discovering a buried treasure, and those who peruse the pages within will draw the proper analogy. The catalogue is obtainable price 9d., from the Corporation at 24-26, Maddox Street, London, W.1.

FURTHER NOTES ON TUNING COILS.

High-frequency Tests on Single Layer Coils of Equal Inductance.

THE recent low-loss coil tests have served, amongst other things, to focus attention on the practical side of the subject. At the time when the coil competition was first announced in the columns of this paper, there appeared to be not a few experienced amateurs and others who considered the low-loss property of a component such as a tuning coil, or a high-frequency transformer, to be the only factor worthy of notice. Of course, to construct components having very low losses and to enquire into the reasons for the reduced losses is, for most of us, a pleasant way of spending a few hours, but it is usually as well to bear the practical side of the subject in mind.

Factors to be Considered.

Coils are used in all kinds of wireless receivers, and we are, perhaps, apt to think mainly of the effect of coils tuned to resonance, the effect of tuned circuits being, of course, to pass a resonant signal and to stop non-resonant ones; but the fact that the coils can be tuned to resonance and so produce a certain result should not mask other factors which become increasingly important as the number of tuned circuits employed in a receiver

(3) The stability and ease of operation of a receiver largely depend on the design of the couplings. Big coils usually have large stray magnetic fields, and if several are required in a receiver it might be impossible to use them effectively without extensive shielding. Large coils may also prove troublesome because of stray electric fields, the capacity between the coils, and between the

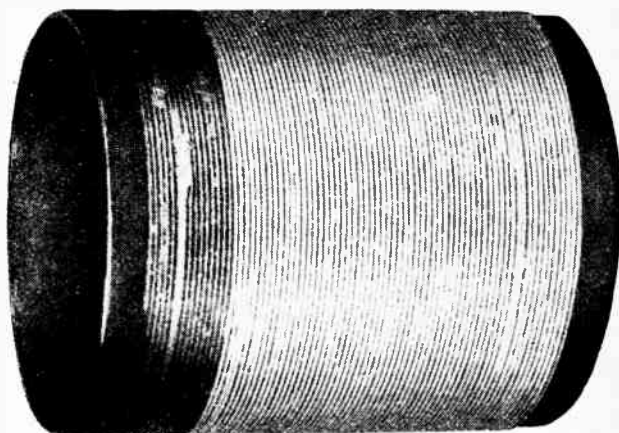

The space-wound 3in. coil of No. 24 D.S.C. wire

coils and other parts, connected in different circuits, acting as couplings which reduce selectivity and usually cause instability. Besides the coupling difficulties met with when two or more tuned circuits are used, one must not forget when each circuit is to be separately tuned that more delicate adjustments have to be made when the circuits are selective. It is easy enough to provide circuits so selective that tuning is very difficult; hence, when it is thought desirable to use several tuned couplings, this practical consideration by itself may act to make us limit the number or to use coils having losses large enough to broaden the tuning.

(4) Broadcast signals comprise a carrier or central frequency plus the modulating frequencies, which makes them

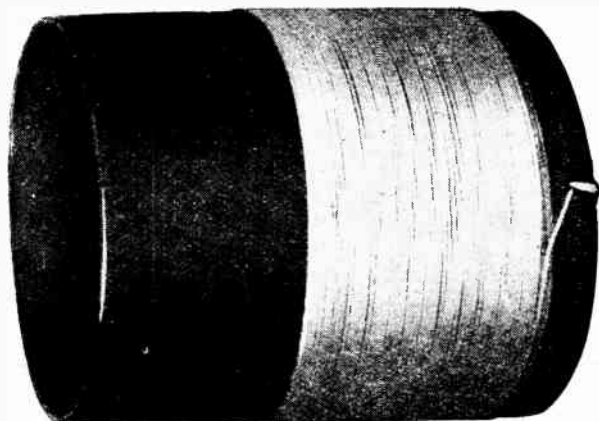

A 3in diameter paxolin tube with a tight winding of No. 24 D.C.C. wire.

goes up. In any receiver we are concerned with (1) selectivity, (2) amplification, (3) stability and ease of operation, (4) the frequency-amplification characteristic (the question of distortion), and (5) size and cost.

(1) Any degree of selectivity can be obtained by properly using sufficient tuned circuits having more or less low losses, and in many cases we may say that, the lower the losses of the circuits, the fewer will be required to produce the required results.

(2) The amplification (high frequency) is also a function of the losses of the tuned circuits, provided the circuits are connected in a suitable manner. With low-loss couplings we can get more amplification than with couplings having higher losses, but the circuits must be properly connected, or we shall find that low-loss circuits are productive of no more amplification than couplings having a higher loss resistance.

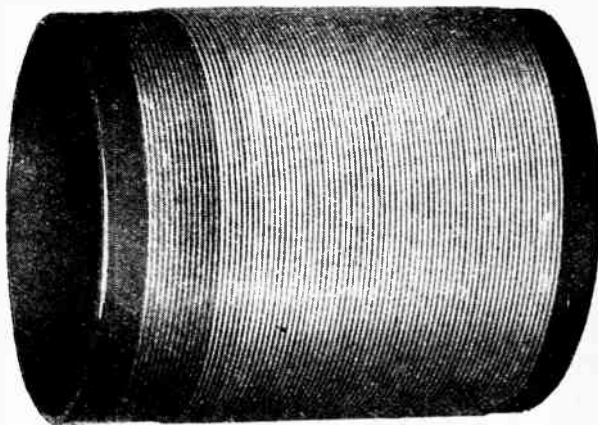

A 3in. diameter coil of No. 25 D.S.C. wire.

Further Notes on Tuning Coils.—

from about 20 to 6,000 cycles on either side of the carrier; therefore the high-frequency circuits should have such a tuning characteristic that these frequencies are passed more or less equally well. In practice a reduction in the relative strength of the higher frequencies can be permitted, but care has always to be taken that the

these coils as couplings would, with its shielding, be a bulky and expensive affair.

The best design for a coil, therefore, depends upon the use to which it is to be put. It may be necessary to use coils of small size, but we can design them to be as efficient as possible for the given size.

Perhaps the external magnetic field of the coil is an

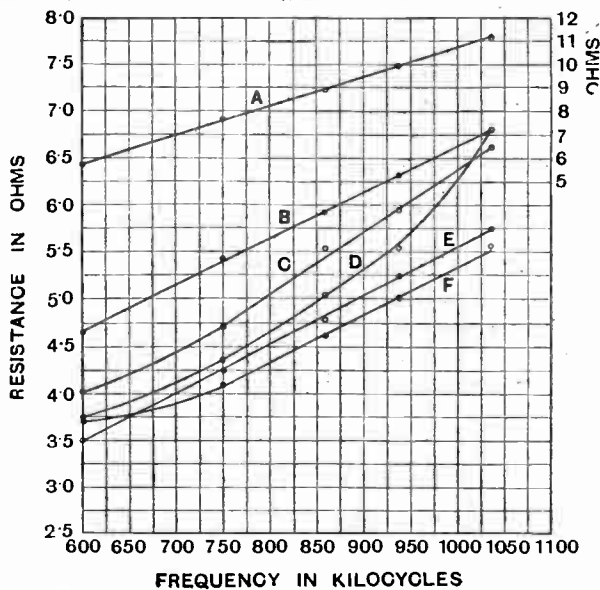
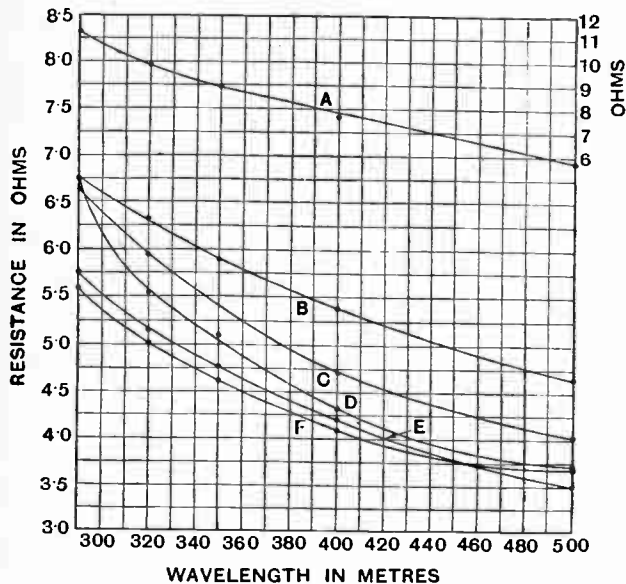

Curve A—3in. diameter space-wound coil of No. 25 D.S.C. wire, with 0.6 megohm shunt resistance, the scale being indicated on the right-hand side of the curve; B—3in. diameter tight-wound coil of No. 26 D.C.C. wire; C—3in. diameter Litz coil; D—3in. diameter tight-wound coil of No. 24 D.C.C. wire; E—3in. diameter space-wound coil of No. 24 D.S.C. wire; F—3in. diameter space-wound coil of No. 25 D.S.C. wire.

circuits are not too sharp—that is, the selectivity is not excessive. Circuits which are too selective distort by weakening the notes of higher frequency.

(5) Size and cost are obvious factors which have to be considered. Low-loss coils, designed simply as such, are sometimes large ones, and a circuit having a number of

important factor. Then we can design a coil to have the lowest losses for a given stray field.

Considerations of quality may demand that a coil have a certain loss resistance. The problem of design would then be, perhaps, to produce a coil with the smallest amount of wire or to produce the smallest possible coil,

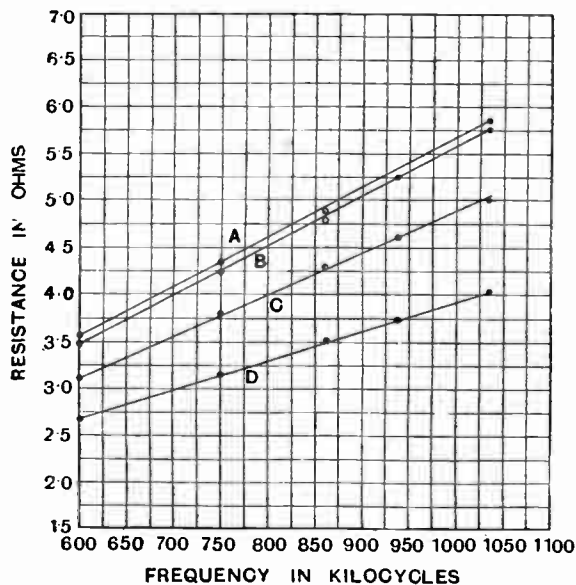
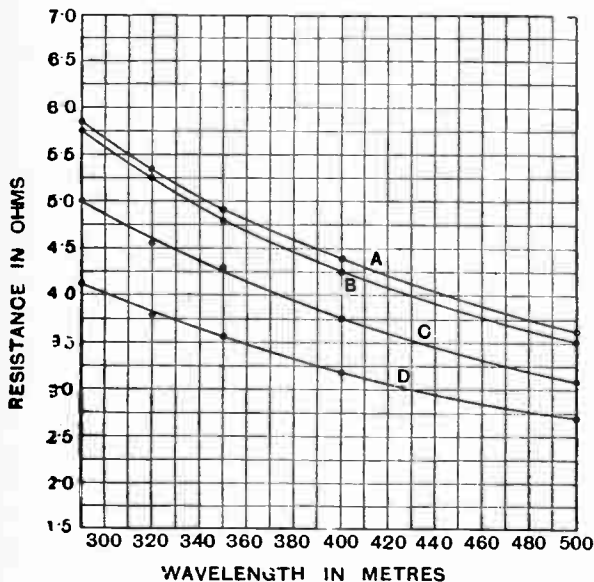

Curve A—4in. diameter space-wound coil of No. 26 D.S.C. wire; B—3in. diameter space-wound coil of No. 24 D.S.C. wire; C—4in. diameter space-wound coil of No. 24 D.S.C. wire; D—4in. diameter space-wound coil of No. 22 D.S.C. wire.

Further Notes on Tuning Coils.—

or it might happen that the least expensive coil (affected by cost of materials and manufacturing charges) is the one required.

It will often be found that the coils have to be used in such a manner that a load is thrown on them. Our

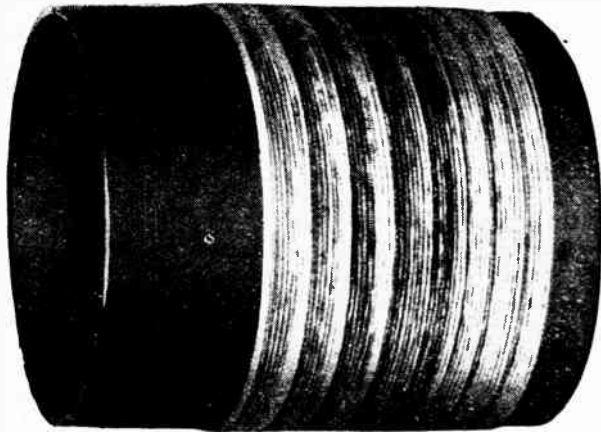

The 3in diameter coil of Litz conductor.

design should then be such that the ratio of the coil losses to the load losses is a reasonable one, for this may lead to an economical design and give results for practical purposes as good as those which would be obtained from a coil of lower losses.

Coils of Equal Inductance.

The coils recently reported on in the pages of this paper were of all shapes and sizes, and varied a good deal in inductance value. A number of 230 microhenry coils have, therefore, been made up and tested with a view to showing the effect of the size of the wire and shape of coil on the inductance and high-frequency resistance. Single-layer coils of 4in. and 3in. diameter were wound, some with a space winding and others with the turns touching.

Interesting Results Obtained.

These coils were tested on several wavelengths, and the results are given in the accompanying figures and tables,¹ curves showing the variation of resistance with frequency and wavelength being given for comparison purposes. It will be seen that the curves are in many instances straight lines, and that over the range tested the coil wound with the thicker wire is the best. This is to be expected in the case of space-wound coils, but for tight-wound coils the resistance rises rapidly at the higher frequencies. When size permits, it is better to space wind if the lowest resistance coil is wanted.

The Litz coil was wound with wire made several years ago, and several strands were broken. This coil was tested to show that a coil of bad Litz is not so good as a coil of solid wire.

The 3in. coils would probably be suitable for use in a neutrodyne or other receiver having three or less tuned

¹ The results are corrected for all known errors, but no claim is made as to the accuracy of the second decimal figure.

circuits, quality permitting. If four or five circuits are required, these coils might have too low a resistance for satisfactory broadcast reception, depending on the ideas

SINGLE LAYER COILS.

Wavelength. Metres.	Frequency. Kilocycles.	H.F. Resist- ance. Ohms.	D.C. Resist- ance. Ohms.
4in. diameter, No. 22 D.S.C. spaced, 55 turns, 3 1/16 in. long.			
500	600	2.68	0.75
400	750	3.16	—
350	856	3.55	—
320	937	3.78	—
290	1,034	4.10	—
4in. diameter, No. 24 D.S.C. spaced, 50 turns, 2 3/16 in. long.			
500	600	3.10	1.16
400	750	3.78	—
350	856	4.30	—
320	937	4.60	—
290	1,034	5.00	—
4in. diameter, No. 26 D.S.C. spaced, 48 turns, 2in. long.			
500	600	3.60	1.57
400	750	4.38	—
350	856	4.88	—
320	937	5.30	—
290	1,034	5.81	—
3in. diameter, No. 24 D.S.C. spaced, 63 turns, 2 7/16 in. long.			
500	600	3.50	1.09
400	750	4.22	—
350	856	4.78	—
320	937	5.26	—
290	1,034	5.75	—
3in. diameter, No. 25 D.S.C. spaced, 63 turns, 2 1/16 in. long.			
500	600	3.68	1.16
400	750	4.10	—
350	856	4.62	—
320	937	5.02	—
290	1,034	5.57	—
3in. diameter, No. 24 D.C.C. tight wound, 57 turns, 1 1/2 in. long.			
500	600	3.71	1.03
400	750	4.31	—
350	856	5.10	—
320	937	5.55	—
290	1,034	6.75	—
3in. diameter, No. 26 D.C.C. tight wound, 56 turns, 1 3/4 in. long.			
500	600	4.64	1.46
400	750	5.40	—
350	856	5.90	—
320	937	6.30	—
290	1,034	6.76	—
Litz coil, 3in. diameter, tight wound, 59 turns, 2 1/2 in. long.			
500	600	4.02	1.40
400	750	4.70	—
350	856	5.62	—
320	937	5.95	—
290	1,034	6.65	—
3in. diameter, spaced No. 26, with 0.65 megohm grid-leak.			
500	600	5.73	—
400	750	7.65	—
350	856	8.90	—
320	937	9.95	—
290	1,034	11.15	—

Further Notes on Tuning Coils.—

of the designer, and, further, they would be too large to use in a reasonably compact receiver.

Increased Loss by Shunt Resistance.

The effect of connecting a high resistance across a tuned circuit has been observed, in some cases, greatly to increase the loss resistance of the circuit, comprising the coil and tuning condenser. To determine the exact effect of shunting the resistance across a circuit, a grid-leak of 0.65 megohm was connected across the 3in. coil of space-wound No. 25 D.S.C. wire, and the resistance of the circuit was measured. The results are given in the figures, from which it will be seen that at 500 metres the resistance increased from 3.68 to 5.73 ohms, whilst at 290 metres the resistance increased from 5.57 to 11.15 ohms.

To connect a lower resistance, such as an ordinary 30,000-ohm adjustable resistance in shunt with a tuned

"ERLA" BALLOON CIRCUOID.

Wavelength. Metres.	Frequency. Kilocycles.	H.F. Resistance. Ohms.	D.C. Resistance. Ohms.
500	600	5.80	1.34
400	750	7.40	—
350	856	8.80	—
320	937	10.00	—
290	1,034	11.45	—

WAVELENGTH IN METRES

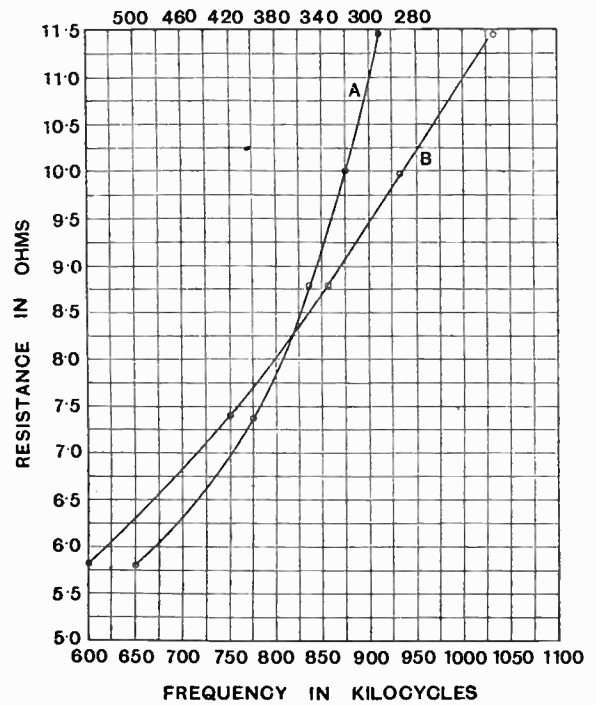

Curves for the Toroidal coil, curve A showing the variation of H.F. resistance with wavelength, and B, with frequency.

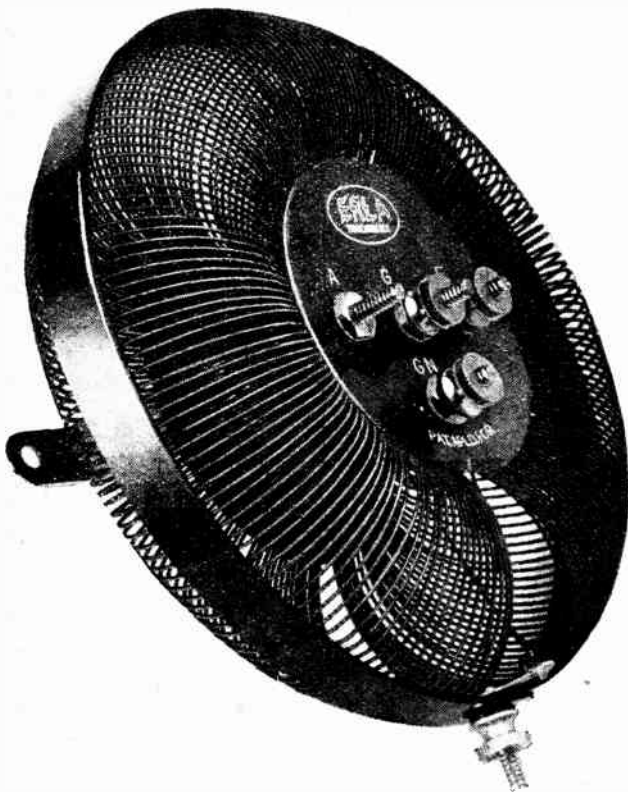

A Toroidal coil, known as the "Erla" Balloon Circloid. Its inductance is 218 microhenries and it has 173 turns of No. 26 D.S.C. wire, a diameter of 1 1/2 in. and an outside diameter of 5 in.

circuit, increases its effective loss resistance enormously. Unfortunately, this scheme has been recommended for the purpose of stabilising the circuits of high-frequency amplifiers and for the control of oscillation. It should be quite clear, however, that in many instances there would be no need for such stabilising resistances if the coils were properly designed. They could be designed so that a small series resistance or a high shunt resistance would give a volume or a relatively harmless reaction control

when this is desired, and probably these coils would be less bulky and have a smaller stray field. Unwanted couplings would then be reduced, and the result would, undoubtedly, be a better amplifier.

A Commercial Toroidal Coil.

A Toroidal coil was also tested. The coil is illustrated,¹ and will be seen to consist of a closed circular winding, the wire being No. 26 D.S.C. The external magnetic field of this coil is reasonably small, although it was found possible to induce an E.M.F. into this coil from the oscillator used in the measurements without much difficulty. For a perfect Toroidal coil the external field would be equivalent to that produced by a single turn having a mean diameter equal to that of the Toroid. The Toroid under test is evidently not a perfectly fieldless coil, but, no doubt, there are occasions when coils of this type will be found useful. It will be noticed that the H.F. resistance of the coil is considerably higher than that of equivalent single-layer coils. W. J.

¹ Supplied by C. G. Vokes and Co., 38, Conduit Street, W.1.

PIONEERS OF WIRELESS.

By ELLISON HAWKS, F.R.A.S.

10.—Further Suggestions for Communication without Wires.

IN our last article we read that in 1746 Winkler, of Leipsic, used the water of the River Pleisse as an "earth-return" for his experiments in endeavouring to ascertain the speed at which an electric current travels.

Dr. Watson, in England, appears to have been the first to improve upon this experiment by suggesting (in 1747) the use of the earth itself, instead of water, to complete a circuit.¹ In that year Watson transmitted an electric current through 2,800ft. of wire, and followed this by transmitting over a distance of two miles, with the earth as a return circuit.

Steinheil Uses the "Earth Return."

Sömmering first used Winkler's discovery, attempting to adapt it completely to wireless telegraphy, but found it was impossible to transmit with both wires immersed in the same body of water. An exactly similar thing occurred with Watson's discovery of the earth return, for in 1838 Professor C. A. Steinheil, of Munich, endeavoured to use the earth as a means of conduction, eliminating wires entirely.

At first Steinheil, who was one of the greatest pioneers of the electric telegraph on the Continent, endeavoured (in 1838) to use as telegraphic conductors the two lines of a railway track between Nürnberg and Fürth, but, as far as the original purpose was concerned, the experiment was a failure. As may be imagined, the difficulty was the impossibility of obtaining a sufficiently good insulation between the two rails to enable the current to travel from one station to another, there to be picked up by suitable apparatus.

Having failed in these experiments, however, Steinheil determined to use the earth instead of a second wire, he having noted the great conductivity of the earth in his endeavours to obtain perfect insulation of the two rails. Although Watson had (as we have already seen) previously discovered that the earth might be used satisfactorily as a return circuit, it would seem that Steinheil's discovery was accidental. Whether this is so or not, the fact remains that, by

using the "earth-battery," as it was called, for telegraphic purposes, Steinheil effected a considerable economy in both wire and labour.

First Intelligent Suggestion for Wireless.

Up to this point Steinheil's experiments do not, perhaps, bear very directly upon wireless, although they must be regarded as pioneer work. However, having succeeded so far in eliminating one of the wires and using the earth-battery, Steinheil's attention seems to have been directed to the possibility of eliminating both the wires. As a result of his further experiments he is credited with the first intelligent suggestion of a wireless telegraph, the possibility of which was in a manner forced upon him. "The enquiry into the laws of dispersion," he wrote, "according to which the ground, whose mass is unlimited, is acted upon by the passage of the galvanic current, appears to be a subject replete with interest. The galvanic excitations cannot be confined to the portions of earth situated between the two ends of the wire. On the contrary, it cannot but extend itself indefinitely, and it therefore only depends on the law that obtains in this excitation of the ground, and the distance of the exciting terminations of the wire, *whether it is necessary or not to have any metallic communication at all for carrying on telegraphic intercourse.*

"An apparatus can be constructed in which the inductor, having no other metallic connection with the multiplier than the excitation transmitted through the ground, will produce galvanic currents in that multiplier sufficient to cause a visible deflection of the bar. This is a hitherto unobserved fact, and may be classed amongst the most extraordinary phenomena that science has revealed to us."²

Steinheil pointed out that in practice the suggestion "only holds good for short distances, and it must be left to the future to decide whether we shall ever succeed in telegraphing to great distances entirely without metallic connection."

He proved the possibility of wireless communication by



Prof. C. A. Steinheil.

¹ *Encyclopædia Britannica* (1810), p. 736.

² Sturgeon: *Annals of Electricity*, vol. iii. p. 450.

Pioneers of Wireless.—

sending signals over distances of up to 50ft., however, and suggested that "by augmenting the power of the galvanic induction, or by appropriate multipliers constructed for the purpose, or by increasing the surface of contact presented by the ends of the multipliers," it might be possible to send signals over greater distances. "At all events," he concluded, "the phenomenon merits our best attention, and its influence will not, perhaps, be overlooked in the theoretic views we may form with regard to galvanism itself."

Steinheil Suggests the Phototone.

Steinheil's later and further experiments seem to have been disappointing, however, and he appears to have come to a similar decision as that arrived at by Sömmering in regard to his experiments in signalling through water. Latterly, Steinheil wrote that "We cannot conjure up gnomes at will to convey our thoughts through the earth. Nature has prevented this. The spreading of the galvanic effect is proportional, not to the distance of the point of excitation, but to the square of this distance. So that, at a distance of 50ft. only exceedingly small effects can be produced even by the most powerful elec-

trical effect at the point of excitation. Had we the means which could stand in the same relation to electricity that the eye stands to light, nothing would prevent our telegraphing through the earth without conducting wires, but it is not possible that we shall ever attain this end."¹

It is interesting to know that Steinheil suggested one other means of signalling without wires. This was by means of a photophone, which was peculiarly similar to that adopted later by Graham Bell. In his classic paper, *Telegraphic Communication*, Steinheil wrote: "Another possible means of bringing about transient movements at great distances, without any intervening artificial conductor, is furnished by radiant heat, when directed by means of condensing mirrors upon a thermo-electric pile. A galvanic current is called into play, which in its turn is employed to produce declinations of a magnetic needle. The difficulties attending the construction of such an instrument, though certainly considerable, are not in themselves insuperable. . . ."²

As we shall learn later, a similar idea was adopted successfully in connection with light rays and selenium, and a practical system of wireless telephony resulted.

¹ *Die Anwendung des Electromagnetismus* (1873), p. 172.

² Sturgeon: *Annals of Electricity* (March, 1839).

Udine (Italy).

(February 4th to 22nd.)

Great Britain: 20J, 2BAZ, 2VO, 2BA, 5SI, 5WV, 5JW, 5SZ, 5MB, 6YD, 6RM, 6ME, 6AH, GSTI. U.S.A.: 1AIU, 1GA, 1BAD, 1APZ, 1AJX, 1XM, 1CF, 1ZA, 2ASA, 2CXL, 2BG, 2APV, 2MK, 3LW, 3BBX, 3MV, 4RZ, 5YB, 8XE, 8BLB, 8BPL, 9ZT, 9EK, NTT, WIR, WIZ, WVC. Scandinavia: SMWU, SMUV, SMYJ, SMZZ, SMUK, SMSR, 7ZM, 2ND. Russia: NRL. New Zealand: 1AX, 2AE, 3SF. Palestine: 6YX. Philippines: PI 3AA. South Africa: O A4Z. Egypt: EG EH. Spain: EARIO. Tunis: OCTU.

(0-v-1) on 30-50 metres.

F. G. Leskovic (11BB).

London, W.1.

(February 1st to 24th.)

Great Britain: 2WJ, 2XY, 2ZB, 2GY, 2UN, 2IJ, 2OQ, 2NM, 2ZA, 2UV, 2IA, 2BQ, 2VL, 2QB, 2DA, 2QM, 2VQ, 2SV, 2WW, 2RK, 2BA, 2KF, 5RB, 5FF, 5MQ, 5MA, 5PO, 5DH, 5NQ, 5UP, 5AR, 5TZ, 5KU, 5HA, 5XY, 5LB, 5JW, 5QV, 5LS, 5YC, 6DA, 6JV, 6IZ, 6BD, 6OU, 6YU, 6UZ, 6YK, 6TD, 6NO, 6RM, 6SU, 6MX, 6AL, 6NK, 6GG, 6UT, 6GW, 6EP, 6BT. Ireland: 11B. France: 8AR, 8GRA, 8UWA, 8FRX, 8EF, 8IL, 8BD, 8FN, 8HM, 8TK, 8YOR, 8DK, 8PM, 8MJM, 8NIL, 8JGM, 8HU, 8RBP, 8LP2, 8HRA, 8JRK, 8XP, 8EZ, 8DDH, 8RAT, 8HSF, 8EN, 8VX, 8FR, 8GI, 8PLA, 8EU, 8CNG. Germany: B7, I6, LO, Q7, W3, Y4, Y5, 4CL, 4CN, 4GA. Belgium: C5, C22, D4, K5, M2, P2, P7, P11, O8, Q2, S4, S5, U3, W1, Z9, Z2, 4GR. Holland: OFP, OF3, OPX, OPM, ORB, ORP, ORW, ORO, OWC, POXX, PC2, STB. Italy: 1AD, 1AX, 1AY, 1BB, 1BK, 1BW, 1CE, 1ER, 1NC, 1RT. Sweden: SMWS, SMWT, SMUF, SMRI, SMSR, SMYZ. Finland: 5NF. Spain: EARIO, EAR20, EAC1, EAC9. Norway:

Calls Heard.

Extracts from Readers' Logs.

LA 1A. Morocco: MAROC, FW. U.S.A.: 1AAO, 1ACI, 1AHB, 1AYG, 1CCX, 1MY, 1CKM, 1AOF, 1GR, 1BHS, 1AW, 1CAL, 1RD, 1APZ, 1AJB, 1VC, 1CMX, 1SZ, 1CH, 1NY, 1AWE, 2WH, 2XAF, 2AHM, 2MM, 2FF, 2CZL, 2BG, 2AKY, 2BXJ, 2AGQ, 2NZ, 2FO, 2CVJ, 2ATK, 2EV, 2OR, 2GX, 2MK, 2ANM, 3AHA, 3CAH, 3ADB, 3AHL, 3DS, 4BU, 4GY, 4RZ, 4SL, 5AIN, 8SF, 8XE, 8ALY, 8KS, 8GZ, 8JQ, 8AUL, 8BZU, 9CIV. Canada: 1AR, 8AR. Brazil: 1AB, 2AB, 5AA. Porto Rico: 4KT. Unknown: AKA, KPL, SP, ICS, NOT, DBR, ONQ, KWS, TPAV.

(0-v-1) on 30-100 metres.

M. Williams.

Rawalpindi, India.

(January 22nd to February 2nd.)

Great Britain: 2OD, 2NM, 2LZ, 5LF, 5DH, GFT. Germany: K Y5, K PL, KA8. France: 8EM, 8DK, FW. Brazil: 1AB, B2. Sweden: SMTN, SAJ. Australia: 6AG, 2YI, 3BP, 6CJ, 6BN, 3BL, 7PF, 6BO, 5DA, 5BD. New Zealand: 1AX. India: CRP, HBK, 2BG, 1WP, 2HP. Finland: 2CO, 2NN, 2ND, 2SE. Philippine Islands: 1HR, 1AR, 1AU, NAJP, NAJD, 1CW. Russia: RRP, RCRL. French Indo-China: 8QQ, 8LBT. Unknown: GHA, GFUP, GBI, B82, QNM, NEQQ, GFD, 1ER.

R. J. Drudge-Coates

(DCR).

Weybridge, Surrey.

(January 10th to February 17th.)

Great Britain: 2BAZ, 2BOM, 2DQ, 2LZ, 2MX, 2NN, 2OJ, 2QB, 2VG, 2VQ, 2XY, 5HS, 5KU, 5KZ, 5MA, 5NF, 5RQ, 5SZ, 5WQ, 5WV, 5XY, 6DO, 6DW, 6ER, 6FA, 6GF, 6IZ, 6MX, 6NF, 6OX, 6QB, 6QD, 6TD, 6UU, 6VP, 6YC, 6YG, (12IT, G15NJ. France: 8BF, 8CO, 8DGS, 8DGU, 8DUCH, 8HM, 8HU, 8NH, 8NN, 8TZ, 8XXQ. Belgium: C22, S4, R2, K2, B82, Z22, 4RS. Holland: 2PZ, PCI, OPM, OBX. Finland: 5NF. Italy: 1BG, 1BK, 1DD, 1GW, 1RM, 1SW. Denmark: 7BZ. Mexico: 8MX. French Indo-China: 8QQ. New Zealand: 3LD, 4AC. Australia: 3BD, 3XO. U.S.A.: 1CAL, 1CYX, 2AN. Newfoundland: C8AR. Various: EAR23, SMZS, EG EH, BYZ, POW, 1CS.

(0-v-1 Reinartz-Weagent.)

Ronald J. Denny (G 6NK).

Oundle, Northants.

(Jan. 31st, Feb. 6th, 7th, 11th, 15th, 21st.)

Great Britain: 2AO, 2CC, 2DR, 2DX, 2FK, 2IH, 2IT, 2LZ, 2MA, 2MX, 2NM, 2OD, 2QM, 2QV, 2VG, 2XP, 2XY, 2ZC, 5DA, 5FQ, 5GS, 5HA, 5HG, 5HS, 5KU, 5MB, 5NN, 5RZ, 5UN, 5US, 5XY, 5YK, 6AL, 6CR, 6JO, 6JV, 6MJ, 6OU, 6PU, 6QB, 6RM, 6UP, 6UZ, 6YC, 6YV. Telephony: 2AO, 2NM, 2OD. Irish Free State: 2IT, GW, 11B. France: 8CO, 8DDH, 8DK, 8DP, 8DY, 8EZ, 8GI, 8HF, 8JMS, 8JN, 8MJM, 8NN, 8QQ, 8PBP, 8SM, 8TK, 8VO, 8XP, 8YQ. Belgium: 4TR, D4, E9, K2, P2, P7, P11, S1, S2, S4, S5, Z1, Z2. Holland: PC1, 2PZ, 0AW. Germany: Q5, ZO, Y8. Finland: 8NI?, 7LT. Italy: 1AC, 1AG, 1ER, 1NA. Palestine: 6ZK. Unknown: 2U4, GBM, R'IPO, LS1.

(0-v-1, small indoor aerial only.)

K. R. Brecknell
(G 2AHH and 2CH.)

BUYER'S GUIDE.

We regret that particulars of a few receiving sets reached us after we had gone to press with our issue of February 10th. We therefore print below a supplementary list which we trust will obviate any inconvenience that may have been caused by previous omissions.

CRYSTAL SETS.

Manufacturer.	Name of Set.	Type of Cabinet.	Price.	Description and Remarks.
General Radio Co., Ltd., 235, Regent Street, W.1.	G.R.C.6	Oak box, with space for headphones.	£ s. d. 2 10 0	Receiver only.
Rawle Bros., Stamford Road, Handsworth, Birmingham.	Fireside	Antique, polished.	1 5 0	Receiver only. Change-over switch for 5XX.
Siemens Bros. & Co., Ltd., Woolwich, S.E.18.	Type 125	Mahogany, with hinged lid.	1 15 0	Receiver only, with 1 loading coil and 2 detectors (catwhisker and Perikon).

CRYSTAL-VALVE SETS.

Manufacturer.	Name of Set.	Type of Cabinet.	Valves.		Price.	Description and Remarks.
			H.F.	L.F.		
Rawle Bros., Stamford Road, Handsworth, Birmingham.	Fireside	Oak cabinet, with space for batteries.	—	1	£ s. d. 6 10 0	With batteries and valve. Change-over switch for 5XX.
Siemens Bros. & Co., Ltd., Woolwich, S.E.18.	Type C.V.	Mahogany "case, with lid.	—	2	9 10 0	Complete with headphones, batteries, valve and 1 coil. Three-way switch for crystal reception, valve reception, or crystal with note-magnifying valve.
			—	1	6 10 0	

VALVE SETS (1 Valve).

Manufacturer.	Name of Set.	Type of Cabinet.	Price.	Description and Remarks.
Bannister & Pitton, 27, Milnrow Road, Rochdale.	B. & F.	Sloping type,	£ s. d. 4 5 9	Receiver only.
General Radio Co., Ltd., 235, Regent Street, W.1.	G.R.C.591	Box "type, coil holder enclosed.	6 12 6	With valve and batteries.
Venus Radiophone Co., 1, Percy Street, Fartown, Huddersfield.	V.R.1	Oak or mahogany.	9 0 0	Receiver only.
	"	" "	3 3 0	Receiver only. Complete with valves, batteries and headphones.
	"	" "	6 15 6	

VALVE SETS (2 Valve).

Manufacturer.	Name of Set.	Type of Cabinet.	Valves.			Price.	Description and Remarks.
			H.F.	Det.	L.F.		
Bannister & Fitton, 27, Milnrow Road, Rochdale.	B. & F.	Box type, front panel, hinged lid.	—	1	1	£ s. d. 7 8 6	Receiver only.
" " "	"	Sloping panel "	—	1	1	10 12 0	With valves, batteries and coils.
" " "	"	"	—	1	1	6 6 0	Receiver only.
B.S.A. Radio, Ltd., Small Heath, Birmingham.	Model 5100	Dark oak cabinet.	—	1	1	9 9 6	With valves, batteries and coils.
" " "	" 5110	Mahogany " ..	—	1	1	36 15 0	With B.S.A. Standard Peanut valve.
" " "	" 5130	" ..	—	1	1	36 15 0	P.A.4 power valve, and Batteries.
General Radio Co., Ltd., 235, Regent Street, W.1.	Type 15	Walnut case, front panel.	—	1	1	36 15 0	Receiver only. Components and panel swing outwards for ready adjustment and repairs.
" " "	"	" "	—	1	1	6 13 0	Complete with valves, batteries, headphones, loud-speaker and aerial equipment.
Venus Radiophone Co., 1, Percy Street, Fartown, Huddersfield.	V.R. II.	Polished oak or mahogany.	—	1	1	13 5 0	Receiver only.
" " "	"	" ..	—	1	1	8 8 0	Receiver only. Complete with valves, batteries and headphones.
	"	" ..	—	1	1	13 10 0	

VALVE SETS (3 Valve).

Bannister & Fitton, 27, Milnrow Road, Rochdale.	B. & F.	Open type, oak or mahogany, compartment for batteries.	—	1	2	14 3 0	Receiver only. Switch for 2 or 3 valves. Switch for headphones or loud-speaker.
" " "	"	" ..	—	1	2	13 13 0	With D.E. valves and batteries.
" " "	"	" ..	—	1	2	20 2 0	" bright "
B.S.A. Radio, Ltd., Small Heath, Birmingham.	Model 5000	Dark oak cabinet.	—	1	2	36 15 0	With 3 B.S.A. Standard Peanut valves and Batteries.
" " "	" 5010	Mahogany " ..	—	1	2	36 15 0	" ..
" " "	" 5030	" ..	—	1	2	36 15 0	" ..
Motorists' Purchasing Association, Ltd., 62, Conduit Street, W.1.	M.P.A. Inclusive Three.	Portable type, mahogany.	—	1	2	19 19 0	Complete with aerial coil in lid, valves, batteries, loud-speaker and headphones.
" " "	M.P.A. Standard Table Cabinet.	Cabinet type, mahogany, with doors.	1	1	1	27 7 6	Complete with valves, batteries and headphones.



**IGRANIC VERNOB
Vernier Control
Knob.**

(Patent No. 223010.)

A very attractive instrument for fitting to any rotary tuning device to obtain fine vernier adjustment. Designed to fit in. spindles, but with a liner will fit 1/16 in. spindles. Price complete with liner and 180° scale. 6s.

**Igranic-Pacent
Autoplug.**

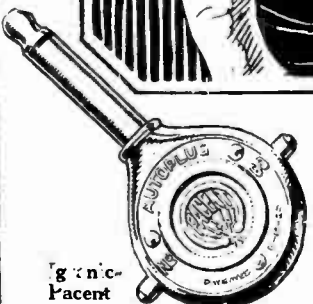
This plug is entirely shock-proof. Connections made instantly by means of reliable spring connectors. Shell of Bakelite. No screws used in its assembly. Price 2/6. With gold plated metal parts. Price 4/-.



**Igranic - Pacent Three Spring
Automatic Jack.**

Generally used after last valve for connecting 'phones or loud-speaker. As plug is withdrawn the filament supply is switched off. Price 2/6.



**Igranic-Freshman Fixed
Condensers.**

(Patent No. 198355). Designed upon an entirely new principle, the construction is such that variations in capacity are practically negligible.

.0001 mfd.	.0005 mfd.	} 2/- each.
.0002 mfd.	.001 mfd.	
.0003 mfd.	.002 mfd.	
.003 mfd.	.005 mfd., .006 mfd.	

2s. 6d. each.



Igranic Radioloc.

With this component built into your circuit you not only have a master filament control, but also a positive guard against damage to your valves and batteries. When the key is out your set is "locked" and "off" safe from meddling fingers. The Radioloc provides perfect electrical conductivity, yet occupies a very small space, and little of it is seen on the panel. Price with two keys, 3/-.

Little IGRANIC Radio Devices that make a big difference

In Radio as in any other pursuit it is often "the little things that count" and upon the efficiency of the minor components and accessories may depend success or failure. Therefore it behoves every Radio constructor who aims at obtaining a high standard of performance from his radio receiver to exercise the utmost care in choosing these small components.

So it is with all other IGRANIC RADIO DEVICES—they enable the best possible results to be obtained even under adverse conditions.

Ask your dealer about them



include

"XILLOS" and Honeycomb Duolateral Coils, Variable Condensers, Fixed Condensers, Filament Rheostats, Intervalve Transformers, Variable Grid Leaks, Variometers, Vario Couplers, Coil Holders, Potentiometers, Combined Instruments, Vernier Tuning Devices, Anti-Microphonic Valve Holders, Stand-off Insulators, Knobs and Dials, Switches, etc., etc. Also the Igranic Super-sonic-Heterodyne Receiver Outfit.

All carry the IGRANIC guarantee.

Write for List U 161.

IGRANIC ELECTRIC Co., Ltd.,

Exclusive Manufacturing Licensees
of Pacent Radio Essentials.

149, Queen Victoria Street, London.

Works: BEDFORD.

BRANCHES: BIRMINGHAM, BRISTOL, CARDIFF,
GLASGOW, LEEDS, MANCHESTER, NEWCASTLE.

The IGRANIC
Supersonic In-
structional Carton
for constructing a
Six - valve Super-
Heterodyne Re-
ceiver according to
the Igranic system,
complete with full-
sized general ar-
rangement drawing,
wiring and drilling
diagrams, and full
illustrated descrip-
tive booklet can be
obtained from your
dealer. Price 2s. 6d.



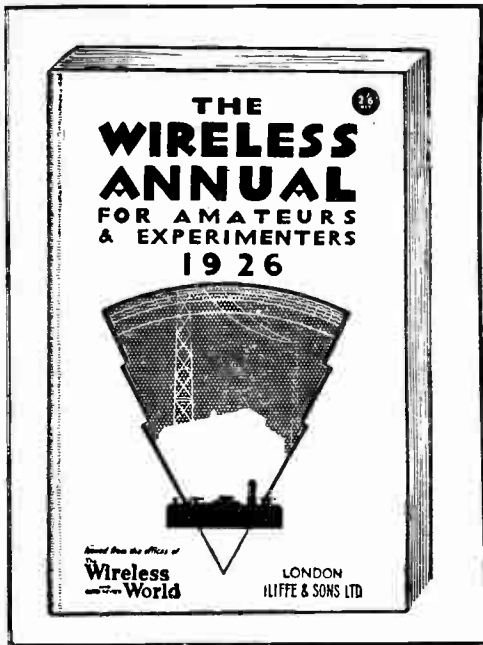

THE WIRELESS ANNUAL

FOR AMATEURS AND EXPERIMENTERS
1926

A volume of particular interest to every wireless enthusiast, containing amongst a mass of other features the following special items:

CALL SIGNS of ALL KNOWN AMATEUR TRANSMITTING STATIONS in Great Britain, France, Holland, Germany, Sweden, Finland, Italy, Spain, South Africa, India, Australia, New Zealand, and South America: **REGULAR TRANSMISSIONS** (Morse and telephony): **RECEIVER CIRCUITS** (16 pages of diagrams and notes): **GLOSSARY OF TECHNICAL TERMS**: **CLASSIFIED DIRECTORY OF MANUFACTURERS**: **VALVE DATA**, **USEFUL TABLES**, **FORMULÆ** and **INFORMATION** on all subjects of interest to **AMATEURS**

PRICE 2/6 net. BY POST 2/8½

Obtainable from all booksellers or direct from the offices of "The Wireless World," Dorset House, Tudor St., London, E.C.4

W.W. 8a

This book should be your wireless guide and companion throughout 1926.

A Service that gives Security!

MANY readers naturally hesitate to send money to unknown persons. We have therefore adopted a Deposit System which gives complete security both to buyer and seller. If the money be deposited with "The Wireless World" both parties are advised of its receipt. The time allowed for decision is three days, after which time, if the buyer decides not to retain the goods, they must be returned to the sender. If

a sale is effected we remit the amount to the seller; but, if not, we return it to the depositor.

Full particulars may be found on the Miscellaneous advertisement page at the end of the book.

Use this service for your wireless requirements and avoid all risk! Sell the apparatus you no longer require! Write out your advertisement to-day and send to—

PREPAID ADVT. DEPT., "THE WIRELESS WORLD," DORSET HOUSE, TUDOR ST., LONDON, E.C.4.

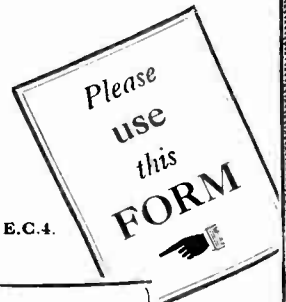

12 Words or Less **1/-** each additional word **1d.**

Advertiser's name and address must be counted. If a box number is required, 6d. extra must be sent for postage on replies.

W.W. 39

WIRELESS CIRCUITS

in Theory and Practice.

7.—The Rejector Circuit.

By S. O. PEARSON, B.Sc., A.M.I.E.E.

IN discussing the circuit containing inductance and capacity in parallel in the previous section, it was assumed that no resistance was present in any part of the circuit; but in practice it is impossible to construct an inductance coil without resistance. Although the resistance in a condenser and the connecting wires is usually sufficiently small to be neglected, this is not so with the inductance itself, and the general case where resistance is present is considered here.

It has been shown that a coil of inductance L having resistance R is equivalent to a pure inductance of L hen-

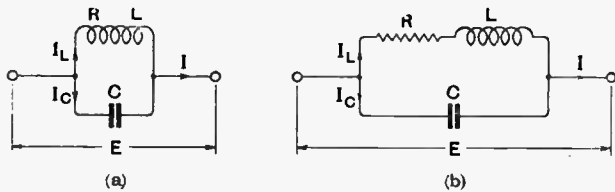

Fig. 1.—Parallel circuit (a) in which the inductance contains resistance and (b) the electrically equivalent circuit.

ries connected in series with a pure resistance of R ohms, and thus the parallel circuit of Fig. 1 (a), where the inductance coil possesses resistance R , is equivalent to the circuit of Fig. 1 (b), where the coil L has no resistance and the resistance R is free from inductance.

Current Phases in the Branch Circuits.

Let the effective value of the applied E.M.F. be E volts at a frequency of f cycles per second. Then the current through the upper branch RL will be :

$$I_L = \frac{E}{Z_L} \text{ amps.} \dots\dots\dots(1)$$

and will lag behind E by an angle ϕ which is less than 90° (see Fig. 4, page 270, of February 17th issue). The conditions in the inductive branch of the circuit are shown by the vector diagram of Fig. 2 (a). Now, this current I_L is equivalent to two component currents, I'_L in phase with E and I''_L lagging behind E by 90° , as shown by Fig. 2 (b).

Referring now to the lower branch of the circuit, the current through the condenser will be :

$$I_C = \frac{E}{X_C} \text{ amps.,}$$

and this leads the voltage by exactly 90° , the appropriate vector diagram being given in Fig. 2 (c). In order to find the resultant current drawn from the source of supply it is necessary to combine the vector diagrams (a) and (c) in Fig. 2, giving us the complete diagram as shown at (d). We see now that the two currents I_L and I_C are no longer opposite in phase, as they were in the previous case,

and therefore their resultant cannot be found by a simple subtraction. To find the resultant current, *i.e.*, the current taken by the complete circuit from the source of supply, it is necessary to complete the parallelogram of which I_L and I_C are adjacent sides, namely, the parallelogram $O I_L I I_C$, as shown in Fig. 2 (d). Then the vector $O I$ gives the total current I in the leads supplying the circuit, and the total impedance Z of the combined circuit is equal to the ratio of voltage to current, *i.e.*, $Z = E/I$ ohms.

Impedance Greatest at Resonance.

Suppose now that the capacity C could be varied over a wide range, the frequency being fixed; then the current in the coil would remain unchanged, and the condenser current I_C would be directly proportional to the capacity, so that the resultant current I would vary both in phase and in magnitude. In the vector diagram of Fig. 3 (a) the dotted line vectors, 1, 2, 3, 4, 5, show the resultant current for the several values, OA , OB , OC , OD , OE , respectively, of the condenser current. Now, obviously the shortest of these vectors is No. 3, which is exactly in phase with the applied voltage E , and therefore there is a certain value of condenser current I_C which will make the main current I a minimum, this minimum current being in phase with the applied E.M.F. Under these conditions the impedance Z of the circuit is clearly a maximum. When this occurs the circuit is tuned to complete resonance with the frequency f of the applied voltage. It should be noted here that the conditions are exactly

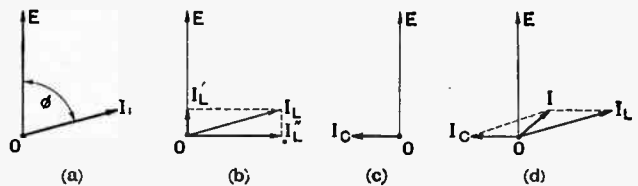

Fig. 2.—Vector diagrams (a) and (b) for the inductive branch of the circuits in Fig. 1; (c) for the condenser branch, and (d) for the complete circuit

the reverse of those obtaining in a series circuit tuned to resonance, namely, in the parallel circuit minimum current is taken from the source of supply at complete resonance, the impedance having a maximum value, whereas in the series circuit the current is greatest at the resonant frequency, the impedance having a minimum value. For these reasons the parallel-tuned circuit is called a "rejector circuit," and the series-tuned circuit an "acceptor circuit," especially when the two circuits are used simultaneously in a filter system for cutting out a powerful local station.

Wireless Circuits in Theory and Practice.—

In tuning a parallel circuit to resonance then we are arranging the circuit to offer the greatest possible impedance to currents of a certain desired frequency or wavelength and to offer a low impedance to currents of other frequencies, and the observations made with regard to selectivity and signal strength in connection with the series circuit can be applied in general to the parallel circuit. The resonance curves showing the relation between frequency and impedance must reach as high a maximum value as possible at the resonant frequency, and the peak must be as sharp and pointed as possible. From the phase relations shown by the vector diagram of Fig. 3 (b) we can find what the necessary conditions are for obtaining the highest possible impedance at the frequency of complete resonance. At this frequency we saw that the result-

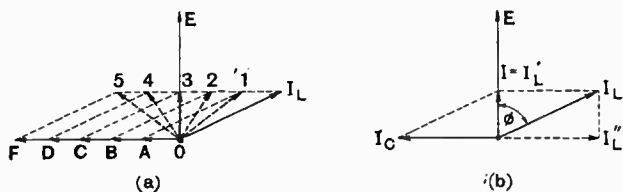

Fig. 3.—(a) Vector diagram to show that the current is a minimum when in phase with the voltage. (b) Vector diagram of parallel circuit tuned to resonance.

ant current I is in phase with the applied voltage E . This means that all currents and components of currents which are 90° out of phase with the voltage E completely neutralise each other and leave only the in-phase component I , and from the figure it is quite clear that the condenser current I_C is exactly equal and opposite to the component I''_L of the current I_L through the coil. Thus at complete resonance $I_C = I''_L$. From this simple relationship we could find a formula giving the exact value of the resonant frequency in terms of the constants of the circuit, but at the high frequencies and comparatively low resistances employed in tuned wireless circuits the angle of lag ϕ in the coil approaches very nearly to 90° , and very little error is introduced if it is assumed that $I''_L = I_L$ when determining the value of the resonant frequency. When this is done the conditions are the same as for the circuit without resistance, and therefore the resonant frequency is approximately the same, being given by $f = \frac{1}{2\pi \sqrt{LC}}$ (approximately).

Calculating the Maximum Impedance.

The maximum impedance Z of the circuit of Fig. 1, obtained when it is tuned to complete resonance, is equal to the ratio of the applied voltage E to the main current I drawn from the source of supply, *i.e.*, $Z = E/I$ ohms. But from the vector diagram of Fig. 3 (b) we see that $I = I_L \cos \phi = \frac{E}{Z_1} \cos \phi$, from equation (1) above. Therefore the circuit impedance

$$Z = \frac{Z_1}{\cos \phi} \text{ ohms} \dots\dots\dots (2)$$

Now the resistance, reactance and impedance of a coil can be very simply represented by the three sides of a right-angled triangle as shown in Fig. 4. The sides AB and BC adjacent to the right angle are drawn proportional in length to the resistance R and reactance X_L

respectively, the third side AC representing the impedance Z_1 to the same scale, because $Z_1 = \sqrt{R^2 + X_L^2}$. The angle ϕ , opposite the side representing the reactance X_L , is equal to the angle of lag in the coil. A right-angled triangle used in this way is called an "impedance triangle."

From the impedance triangle we see that $\cos \phi = \frac{R}{Z_1}$ and substituting this value for $\cos \phi$ in equation (2) we find that the impedance of the complete circuit is equal to $\frac{Z_1^2}{R}$ ohms. Since the resistance is small compared with the reactance X_L , the numerical value of the impedance of the coil is very approximately equal to its reactance, and therefore the impedance of the complete tuned circuit is given by $Z = \frac{X_L^2}{R} = \frac{(2\pi fL)^2}{R}$ (approximately). But at complete resonance the frequency $f = \frac{1}{2\pi \sqrt{LC}}$, and therefore

$$Z = \frac{L}{CR} \text{ ohms} \dots\dots\dots (3)$$

Conditions for Best Results.

This is not an approximation, but an exact formula in spite of our having made two approximations in arriving at the result, this being the case because the errors introduced are in opposite directions and balance out. We see then that the maximum impedance obtainable is inversely proportional to the resistance and directly proportional to the ratio of inductance to capacity. Therefore, exactly as in the case of the series circuit, it is very important to keep the resistance down to a low value and to use the highest practicable ratio of inductance to capacity.

The current E/Z taken by the tuned circuit is exactly in phase with the voltage applied to it, and therefore the impedance Z is equivalent to a pure resistance of L/CR ohms, in fact, the quantity L/CR is often called the "equivalent non-inductive resistance" of the tuned circuit.

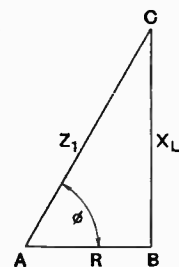

Fig. 4.—Impedance triangle for a tuning coil.

General Application of Series and Parallel Circuits.

It has been shown that for a tuned series circuit the voltage obtained across the coil or condenser is many times greater than the applied E.M.F., whereas for the parallel circuit the potential difference across the circuit is always equal to the applied voltage, and under no circumstances can a higher voltage be obtained in any part of the circuit. It is obvious then that the choice of series or parallel oscillatory circuit will depend entirely on the nature of the remainder of the circuit to which the oscillatory circuit is to be connected. Now, since the series circuit has low impedance when tuned to resonance, it will usually be found in places where the resistance or impedance of the remainder of the circuit of which it forms a part is low, and also, of course, in places where it is independent of other parts of the circuit, such, for instance, as a tuned grid circuit which is inductively

Wireless Circuits in Theory and Practice.—

coupled to an aerial or to another coil carrying an oscillatory current. It depends for its selecting properties on the production of a high voltage across the condenser or coil, at the resonant frequency, compared with the available applied or induced E.M.F., voltages of other frequencies than the resonant frequency not being magnified in this way.

The parallel circuit, on the other hand, does not possess the property of producing voltages greater than the applied E.M.F. in any part of the circuit, and by itself would not be capable of selecting any particular band of frequencies or wavelengths. But if it is connected in series with part of a circuit which has a high resistance more or less independent of frequency, it can then be made to operate as a selector of any desired frequency as explained below. These are the conditions under which a parallel circuit is always found in practice, the most common instance being the tuned circuit in the plate circuit of a valve, the internal plate to filament resistance of the valve representing the high series resistance more or less independent of the frequency.

Parallel Circuit in Series with a Resistance.

In Fig. 5 a parallel tuned circuit or oscillatory circuit LRC is shown connected in series with a resistance R_1 . Suppose that a high-frequency voltage whose R.M.S. value is E volts is applied to the ends of the circuit from the source A , and that the closed loop is tuned to complete resonance with the frequency of the applied E.M.F. Then the closed loop is equivalent to a non-inductive resistance of L/CR ohms, and the effective resistance of the whole circuit is therefore equal to $(R_1 + L/CR)$ ohms, and the current in the circuit will be equal to the applied voltage divided by this resistance. Now, since the voltage across each portion of the circuit is exactly in phase with the current, the total applied voltage E will be equal to the arithmetical sum of the voltages E_r and E_c across the resistance R_1 and the closed loop respectively. But by Ohm's Law we see that $E_r = IR_1$ and $E_c = I \times L/CR$ volts, where I is the current through the circuit, and therefore the total applied voltage is divided between the two portions in the direct ratio of the equivalent resistances of those portions, i.e., $\frac{E_c}{E_r} = \frac{Z_r}{R_1}$, where $Z_r = L/CR$, and is the impedance or equivalent resistance of the closed loop at the frequency of resonance.

Voltage Distribution.

Now, the greatest E.M.F. or potential difference existing in any part of the circuit is the applied voltage E , and in tuning the circuit to resonance we require to get the highest possible fraction of this available potential difference across the tuned portion LRC and only a small fraction across the series resistance R_1 , and therefore at complete resonance L/CR must be large compared with R_1 . Thus the coil resistance R should be as small as possible, and the higher the ratio L/C the better. On the other hand, for any non-resonant frequency due to an undesired signal it is necessary that the greater part

of its E.M.F. should be expended across the series resistance, leaving the smallest possible fraction across the loop. Thus, for non-resonant frequencies the impedance Z of the loop circuit must be small compared with the series resistance R_1 . It must be remembered that for frequencies different from the resonant value the effective impedance of the loop circuit is not L/CR ohms, but has a value very much below this if the circuit is properly designed.

The Tuned Anode Circuit.

The circuit under consideration is without doubt one of the most important used in connection with receiving valves, and a numerical example is given here in order to show clearly the selecting properties of such a circuit. As in a previous example given in connection with the ordinary series circuit, suppose that the coil has an inductance of 5,065 microhenries and a high-frequency resistance of 20 ohms, and let the condenser in parallel with it have a capacity of 0.0005 mfd. Then the resonant

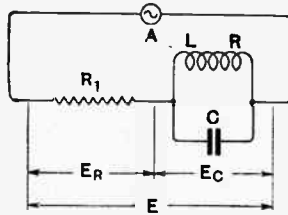

Fig. 5.—Tuned parallel circuit connected in series with a resistance such as the internal resistance of a valve.

frequency calculated from the formula $f = \frac{I}{2\pi\sqrt{LC}}$ will be 100,000 cycles per second, corresponding to a wavelength of 3,000 metres, and at this frequency the equivalent resistance of the tuned portion of the circuit will be :

$$\frac{L}{CR} = \frac{5,065}{0.0005 \times 20} = 506,500 \text{ ohms.}$$

Suppose that the series resistance R_1 is of the same order as the internal plate to filament resistance of a receiving valve, say, 20,000 ohms, and that the available signal E.M.F. in the circuit is 10 volts. Then this voltage will be divided between the two portions of the circuit in the ratio of 506,500 to 20,000—that is, in the ratio of 25.3 to 1. That is to say, the voltage set up across the tuned portion of the circuit is more than twenty-five times as great as that set up across the series resistance R_1 , the actual value of the potential difference across the tuned circuit being 9.63 volts, only 0.37 volt being wasted across the resistance.

Suppose now that another signal, also producing 10 volts across the whole circuit, has a frequency of 105,000 cycles per second (corresponding to a wavelength of 2,860 metres). To a current of this frequency the loop circuit, still tuned to 100,000 cycles, offers an impedance of about 11,000 ohms, and from this we see that the voltage set up across the tuned portion of the circuit is in this case only just over half as great as that across the series resistance. The value of the series resistance R_1 plays a very important part as regards the selectivity, and this particular circuit will be referred to again when dealing with tuned plate circuits in valve receivers.

(The next instalment will deal with the aerial circuit of the receiver. It will be shown how the aerial functions as a collector of energy, and how it may be tuned to the wavelength of incoming signals. The question of efficiency will also be discussed, and it will be shown how the constants of the aerial may be chosen to obtain a high degree of efficiency.)

NEWS FROM THE CLUBS

Secretaries of Local Clubs are invited to send in for publication club news of general interest.

All photographs published will be paid for.

A Wireless Museum.

The Southport and District Radio Society has hit upon the original idea of opening a miniature museum of curious wireless apparatus. The museum was inspected at the society's last meeting, to the evident amusement of the visitors!

○○○○

Pennants for Club Members.

An interesting innovation has been introduced by the Ipswich and District Radio Society. At a small cost each member is supplied with a pennant, bearing the initials "I.R.S.," suitable for display at the top of the aerial mast or in any other prominent outside position.

Apart from its value as a publicity aid, the pennant serves to inform the general public where a club member is to be found who will render "wireless" help.

○○○○

The Social Side.

An interesting feature of the whist drive recently held by the Bristol and District Radio Society was a display, after the award of prizes, of a number of home-built receivers. The instruments revealed much painstaking work on the part of their constructors.

On Friday, March 26th, the society is to be visited by Mr. Appleton, Station Director at Cardiff, who will deliver a lecture of topical broadcast interest. It is hoped that all members will be present and that they will bring interested friends.

Hon. Secretary: Mr. C. S. Hurley, 46, Cotswold Road, Bedminster, Bristol.

○○○○

Choosing Valves.

There are at present about 100 types of valves on the market, and for the amateur, and more especially the beginner, the question of choice is a difficult one. Members of the Croydon Wireless Society, however, who heard Mr. L. F. Fogarty's lecture on Monday, March 1st, felt professionally equipped in the technicalities of the subject.

Mr. Fogarty, whose lecture was on "The Choice of Thermionic Valves" carefully described the component parts of a valve, and outlined the different kinds of valves available for fulfilling the various functions in a wireless receiver. The necessity of being able to read valve curves was strongly emphasised, and in this connection the suitably enlarged diagrams of characteristic curves proved very helpful.

Visitors are cordially invited to attend the society's meetings on Mondays at 123, George Street, Croydon.

A Visit to Northolt.

Through the kindness of the Post Office officials members of the High Wycombe Royal Grammar School Wireless Society were privileged to visit Northolt wireless station on March 2nd.

The party were first shown the power plant, after which they were conducted over the transmitting room. Here they saw the arc and valve transmitters in operation, and many points of interest were clearly explained. Special interest was shown in the arrangements by which the staff were endeavouring to eliminate interference and to remedy any defects.

Hon. Sec.: Mr. Ken. T. Fox, "Croyland," 111, Totteridge Road, High Wycombe.

○○○○

Evolution of Direction Finding.

Mr. R. Keen, B.Eng., the well-known authority on wireless direction finding, delivered an interesting lecture on the subject before a large gathering of members of the Sheffield and District Wireless Society on February 26th.

The various forms of D.F. apparatus,

FORTHCOMING EVENTS.

WEDNESDAY, MARCH 17th.

Tottenham Wireless Society. At 8 p.m. At the Institute, 10, Bruce Grove. Demonstration and Exhibition of Crystal Sets.

Muswell Hill and District Radio Society. At 8 p.m. At St. James's Schools, Fortis Green. Lecture: "Frequency in Relation to Broadcasting," by Mr. J. H. A. Whitehouse, of the B.B.C.

Edinburgh and District Radio Society. At 117, George Street. Lecture: "Power Supply from Mains," by Mr. W. Winkler.

Barnsley and District Wireless Association. At 8 p.m. At 22, Market Street. Lecture: "Valves, II.," by Mr. D. W. Milner, B.Sc.

North Middlesex Wireless Club. At 8.30 p.m. At the Shaftesbury Hall. Annual General Meeting.

THURSDAY, MARCH 18th.

Golders Green and Hendon Radio Society. At 8 p.m. At the Club House, Willisfield Way. Lecture: "Characteristic Valve Curves and their Interpretation," by Mr. L. F. Fogarty, M.I.E.E.

FRIDAY, MARCH 19th.

Radio Society of Great Britain. Transmitter and Relay Section. At 6 p.m. At the Institution of Electrical Engineers, Savoy Place, W.C.2. Open Discussion: "Short Wave Transmitters." Sheffield and District Wireless Society. At 7.30 p.m. At the Dept. of Applied Science, St. George's Square. Experimental Work (5). Adjustments of Simple Circuits.

MONDAY, MARCH 22nd.

Hackney and District Radio Society. At 8 p.m. An evening with Mr. Cunningham's 5-valve set. Swansea Radio Society. Technical Talk by Mr. Colborn, of the B.B.C.

from the simple frame to the modern Bellini Tosi equipment as used on land and ship stations, were dealt with in turn. Particular interest was aroused by Mr. Keen's description of the latest Transatlantic and Continental receiving stations of the Marconi company at Brentwood, the Bellini Tosi aerial system being illustrated on the screen.

○○○○

Sale and Exchange.

The benefits of a Sale and Exchange night were appreciated by members of the Muswell Hill and District Radio Society on March 3rd, when much surplus apparatus changed hands to the advantage of all. A percentage of the receipts were apportioned to the society's funds.

An application for a transmitting licence is shortly to be made, and it is expected that this step will mean an accession of many new members. Full particulars of membership are obtainable from the hon. secretary, Mr. Gerald S. Sessions, 20, Grasmere Road, Muswell Hill, N.10.

○○○○

Detectors and their History.

A fascinating lecture dealing with history of detectors, from the coherer to the valve, was given by Mr. E. Beat before the City of Belfast Y.M.C.A. Radio Club on February 23rd.

Mr. Beat gave a lucid explanation of the various methods used to detect wireless signals, and pointed out the defects encountered with each under working conditions. Considerable interest was shown in the hot cathode metal vapour valve.

Hon. Secretary: J. J. Cowley, 4, St. Pauls' Street, Belfast.

○○○○

Short-wave Competition at South Woodford.

The South Woodford Radio Society, which has resumed meetings on Monday evenings, held an interesting competition in the operation of short wave receivers on March 1st.

One of the receivers, constructed by Mr. Collinson (of the Collinson Screw Co.) incorporated an adaptation of the Reinartz circuit and a specially geared condenser; another set by Mr. Nickless (2K1), the president, employed the usual loose-coupled tuner. The Reinartz circuit was also embodied in Mr. Fuller's instrument, in which the aerial coil was wound round an ordinary matchbox.

Owing to lack of time the sets could not all be tried, but in tests undertaken during the evening Mr. Collinson's receiver carried off the honours.

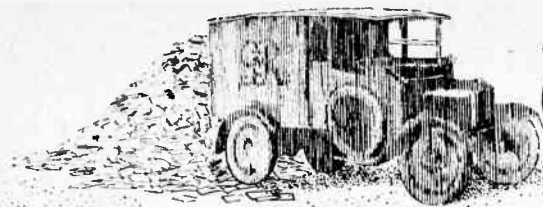

The Editor's Mail



The Editor does not hold himself responsible for the opinions of his correspondents.

Correspondence should be addressed to the Editor, "The Wireless World," Dorset House, Tudor Street, E.C.4, and must be accompanied by the writer's name and address.

THE RUGBY TELEPHONY EXPERIMENTS.

Sir,—With reference to the various letters commenting on the transmissions from Rugby, I have also heard these transmissions for the last four or five Sundays. Both Rugby and the replies have been heard; speech was very distorted, of the two stations New York being the clearer.

I think the reason for hearing this reply is that the speaker at Rugby has either a pair of headphones on, from which the reply is audible, or else there is a loud-speaker in the same room.

The strength of the reply is accounted for by the fact that (if my information is correct) the American signals are received at a station away from Rugby, amplified, and then carried by land line to Rugby.

LEO MASON.

Blackburn.

Sir,—I have listened in to the tests on the second and subsequent Sundays and found that, with very critical adjustment of tuning and reaction, it was possible to hear the speakers at both ends with equal clarity and strength. There was no question of Rugby coming in with a "roar" and New York being weak in comparison. Apparently the station is working for these tests on a wavelength between 5,000-6,000 metres, and it is necessary to have the receiving set in oscillation before proper results are attained. From time to time code signal OKE in Morse is transmitted. Perhaps in due time we shall all know more about the inner working of these tests.

W. A. PARK.

Manchester.

Sir,—I was listening for anything that might be on the ether on March 7th, and happened to pick up Rugby with an 860 turn slab coil in the aerial and a Daventry coil for reaction on a two-valve set detector and low frequency. I heard both stations absolutely clearly when the set was oscillating strongly with sufficient strength to work an Amplion Radiolux so that the American operator could be heard all over the room and the Rugby operator all over the house. The tests were of an extremely interesting nature, as they lasted from about 1 p.m. to about 5.30 p.m., and various newspaper representatives and P.O. engineers spoke on both sides. It was possible to hear every word distinctly, and often the speaker on this side would ask for a sentence to be repeated which I had heard perfectly. One of the P.O. engineers informed the American to whom he was speaking, in answer to the latter's question, that it was impossible for an ordinary listener to hear both sides of the conversation, although an American listener might hear his (the American's) side, but not the English, and *vice versa*; this, of course, is disproved by the results obtained by myself and other readers.

I can endorse "W.E.P.'s" and "T.F.B.'s" statements that the receiver has to be oscillating to receive the telephony at all; also I found that when just oscillating the speech was distorted and unintelligible, though very loud, and that the reaction had to be brought right up to the aerial coil before the speech was clear: it was then not so loud, but it was quite enough to work the loud-speaker, as stated.

Are these peculiar effects due to the telephony transmitters making use of the side band system, as stated in the article in your issue of March 3rd, and as the carrier wave is suppressed, does this mean that an oscillating receiver does not interfere with other receivers in the neighbourhood which may be tuned to the same wavelength?

If this is so, why could not the B.B.C. programmes be transmitted on this system and thus obviate the oscillation nuisance?

Bucks.

A. A. K.

Sir,—On Sunday, February 28th, at 2 p.m., I was using a four-valve 1-v-2 tuned anode set, the nearest coils then at hand being Igranic 1,250 and 1,500, and these were plugged in aerial and anode sockets. Almost immediately "Hallo, New York" was heard, and also the answer, perfectly clear on loud-speaker. Small adjustments were made and the set was kept in the oscillating condition and I settled down to log the Yankee speech. The names of various gentlemen engaged at both ends were easily read, and questions asked by the Americans were splendidly clear. This experience was repeated on March 7th with the above coils. The use of 500, 600, and 750 coils with the set just oscillating brings Rugby in with a crash, but it is blurred, and the New York signals are drowned by mush. Perhaps readers can shed some light on why the American signals can be heard with a 1,250 aerial coil tuned by 0.0005 condenser.

Sittingbourne, Kent.

C. BORNER.

Sir,—On Saturday night last, February 27th, using a detector and one-valve low-frequency receiver with Reinartz reaction, I happened to be changing my coils, both aerial and reaction, when a voice could be distinctly heard at fairly loud strength, and in reply another, less loud and much less distinct, engaged in ordinary conversation. It became obvious that it was a talk between England and New York, and I naturally put it down to the Rugby tests. The strange thing to me is, however, that no coils whatever were necessary and that there were breaks in both circuits where the coils should have been. How is this explained?

It was learnt from the conversation that they were to carry on again next morning at 9.45 a.m., and on listening in the American voice was quite distinct—in fact, it was distinctly amusing when it corrected the Englishman's effort at pronouncing "Arkansas." Another curious point about the previous evening's test was that apparently the Englishman was troubled by atmospheric, whereas there was not the slightest trace of them in my reception.

C. W. S. WARELL.

Cowes, I.O.W.

Sir,—I think the explanation of the fact that both Rugby and Long Island were heard on the same wavelength is that the Long Island operator's remarks were picked up by the microphone at Rugby from a loud-speaker, which the operator was evidently using instead of 'phones. The abnormal strength of static on this occasion could be accounted for in the same way.

In my opinion the remarks heard by your correspondents from the "other side" were merely a relay from Rugby.

Dalston, E.3.

FRED. L. D. JONES

(2BN1).

Sir, With reference to the three letters headed "Rugby Telephony Tests" in *The Wireless World* of March 3rd, I have heard these tests myself on Sundays on about 7,600 metres or more, using only a single valve with autodyne reaction and an aerial 180 feet long. Both Rugby and New York came in quite clearly, and nearly every word was received perfectly during the tests from New York.

It is surprising that it did not occur to any of your three correspondents that they were listening to a different system of modulation from that which they have ever heard before, and that there was, in the ordinary sense, no carrier wave whatever. Of course, it was there, but was modulated to the maximum,

and the voice of the operator controlled the whole output of the transmitter, so that when he was not speaking there was no radiation and so no interference on New York, who was using the same wavelength and system. By this method duplex working is very simple.

It will be found that to receive the speech clearly the set must be oscillating, and that only on one adjustment can the speech be received free from distortion; when this is found the adjustment for New York will be found also.

By this method of modulation the range of a telephone transmitter can be increased enormously, and at the same time that of the receiver. The quality of speech seems quite good, but I do not think it would be as pure as the usual method if it were used for the higher audio frequencies.

It would be interesting to know the system of modulation used. The pure carrier wave can be heard when the operator presses a key and signals a short dash which means "Not Received O.K."

After all the amount of "phone" work that the amateur has done on 1,000 and 440 metres, why has this system not been heard before? It would appear that the professional has "put one across him" this time.

As a consistent reader of *The Wireless World* since 1917, please allow me to take this opportunity of thanking you for the many fine articles you have published, and wishing you every success in the future.

N. C. HARDMAN
(G 2PO).
Cloughfold, near Manchester.

A QUESTION OF NOMENCLATURE.

Sir,—May I be permitted to draw attention to an important error of nomenclature in Dr. Smith Rose's article on "Polarisation of Wireless Waves" (*The Wireless World*, Dec. 16th, 1925, p. 159), especially since it has previously been made by Dr. Alexanderson (*The Wireless World*, Sept. 16th, 1925, p. 373)?

In the above articles the plane of polarisation of a plane polarised beam is made to coincide with the plane of the electric vector (*i.e.*, plane of the electric field), whilst hitherto (since 1890) it has, throughout the field of optics and electromagnetism, been taken to coincide with that of the magnetic vector. If a change is to be made, then it ought to be carried out by international agreement to ensure the widest publicity, otherwise we shall be laying ourselves open to considerable confusion and misinterpretation.

The position can be fully understood when we investigate the history of the term "plane of polarisation," which was defined over a century ago in the following way. If we have a beam of light reflected at a particular angle from a substance such as a glass slab the reflected beam is said to be polarised in the plane of incidence (*i.e.*, the plane containing the incident ray and the normal to the reflecting surface).

According to the older theories, light was due to a transverse vibration of some "light" particle much in the same way as we have transverse vibration in a stretched string. Dynamical explanations of experimental results were given (with varying success) by Neumann, MacCullagh, Kirchhoff, Voigt, and by Ketteler, Boussinesq, Green, Kelvin, Lorenz and Rayleigh. The first group assumed that the light vector or direction of vibration coincided with the plane of polarisation, whilst with the second group it was taken to be perpendicular.

They obtained approximately the same end results by postulating different "properties" to the medium in which the vibration took place and different "boundary conditions" which had to be obeyed at the interface of two media. The long and sometimes bitter, quarrel between these two schools was dissolved with the advent of Clerk Maxwell's electromagnetic theory in 1865, and incidentally here it will be seen an enormous advantage of Maxwell's theory that no arbitrary boundary conditions have to be specified.

Fresnel had developed a *kinematical* theory, or rather illustration, which was in agreement with experimental results, the main difficulty being the physical realisation of his postulates. In Fresnel's theory the plane of polarisation was perpendicular to the plane of vibration, each perpendicular to the direction of propagation.

With the arrival of Maxwell's theory the problem acquired a different meaning, *i.e.*, is the action of light to be ascribed

to the electrical or to the (inseparable) magnetic oscillation? This problem was settled by a series of experiments begun in 1890 by O. Wiener (*Ann. der. Physik*, Vol. 40, p. 203, 1890) on the photographic action in stationary waves, who proved that it was the electrical component that caused the action, *i.e.*, the plane of vibration in Fresnel's theory must correspond to the electric vector, and hence the plane of polarisation must correspond to the magnetic vector.

W. EWART WILLIAMS.

Wheatstone Laboratory, King's College, Strand, W.C.2.

Sir,—I am very much indebted to Mr. Williams for his timely letter on the laxity of our nomenclature in regard to polarised wireless waves; especially as I should be the last to wish to add to the number of misleading terms which already prevail in wireless literature. It is only during the last year or two that we have been much concerned with the state of polarisation of wireless waves as used in practical communication, and it is probably not too late to put the matter on a sure foundation.

Mr. Williams is, of course, perfectly correct in his definition of the term "plane of polarisation" as derived from the history of physical optics. I can remember going to some trouble to verify the exact meaning of the term some two or three years ago when I first had to discriminate between wireless waves polarised in different planes. At that time I discovered that in the wireless profession it was customary to term as "vertically polarised" the waves emitted from an ordinary vertical aerial, *i.e.*, waves in which the electric force lies in a vertical plane. In one of my papers published in 1924 I tried to draw a compromise by designating such waves as "normally polarised," and waves in which the magnetic force is contained in a vertical plane were termed "abnormally polarised." I found, however, that these expressions led to great confusion, and since then I am afraid I have simply fallen into line with those who have gone before me: and Mr. Williams has himself discovered that I am not the only sinner in this respect. I have always tried, however, to make perfectly clear the meaning which I ascribed to the terms used; and I trust that Mr. Williams will grant that in my article to which he refers, the directions of the forces in each type of wave are clearly explained both in the text and the diagrams.

I am well aware, however, that the mere citation of other defaulters will not assist us in correcting a mistake, and I trust that now the matter has been opened for discussion we may get the nomenclature put right once and for all. I am fairly convinced that unless some agreed decision is arrived at, there will be a certain amount of confusion of terms in the future of wireless research. In anticipation of reaching some international agreement on the matter, as suggested by Mr. Williams, I should like to put forward two proposals for discussion. The first is that the plane of polarisation should be referred to the electric vector instead of to the magnetic vector; while the second is that the definition of the plane of polarisation should be altered to be the plane containing the electric vector. The first proposal is based upon the idea that in an electromagnetic wave the electric force is more fundamental than the magnetic force, since the latter is merely the result of the motion of the former. As an example illustrating this point, suppose that an observer of a wireless wave, instead of remaining stationary, moves along in the direction of the wave with the same velocity. To this observer, the magnetic force of the wave will not be perceptible, and in order to determine the state of polarisation of the wave reference would have to be made to the electric force. The second proposal has for its sole justification the fact that, if no objection is seen from the optical use of the terms, it will be more convenient to continue the use of the somewhat artificial meanings of the terms, as already employed among the wireless community.

R. L. SMITH ROSE.

National Physical Laboratory, Teddington.

LIGHTSHIP TELEPHONY.

Sir,—I wonder how many readers hear the lightships' telephony on about 250 metres?

They are mostly situated off Kent, and are all 30 miles or over from my station, yet they are all tuned in at good loud-speaker strength on 2 valves (0·v·1).

Much interesting nautical information and amateur "weather forecasts" (often more accurate than the professional ones!) are also picked up.

I can easily tune them all in on 0-v-0 at R5.6.

They call up Ramsgate at 8.30 a.m. and 5.30-6 p.m. to check their automatic call-up bells, which sound very like the B.B.C. tuning note.

Those I have heard on the loud-speaker are:—Ramsgate P.O., The Tongue, The Gull, The Shipwash, The Kentish Knock, North Goodwins, South Goodwins, The Alert, and The Walton.

The best coils to use are A.T.I. 35, A.T.C. in series, T.A. 50, and reaction about 25-50.

I am not sure of the power used by the lightship transmitters, but if any of your readers could give me any information I should be very grateful.

RONALD C. HORSNELL.

Burnham-on-Crouch, Essex.

INTERFERENCE IN ST. JOHN'S WOOD.

Sir,—I must thank you for your notice in Broadcast Brevities in *The Wireless World* of February 24th under the heading "Interference Ad Nauseam."

I have been trying for two years to track this down, even to the extent of walking the streets with a portable set endeavouring to locate the interference, but, thanks to the publicity given, I have been able to-day to get a test at the local sorting office, and have definitely located the trouble, which no doubt will in due course be attended to.

I should also like to thank, through you, those local people who have helped me in my endeavours.

Wishing your paper every success.

St. John's Wood, N.W.8.

R. WALDO EMERSON.

CONDENSER DIALS.

Sir,—With reference to the letter from Mr. Adshead in *The Wireless World* of February 17th, page 278, it might interest Mr. Adshead to know that the "Colvern" selector is supplied with 0-100 dial, and with further reference to the subject of dial values, it is obvious that if we have a dial value readable in percentage, values are more relevant to capacity than degrees.

If we express dial values in percentages, 64% of a maximum capacity of, say, 0.0005 is quickly determinable as a relative quantity; 70 degrees 45 minutes 12 seconds of arc, assumed as an exact reading of a position, is not readily converted into an equivalent capacity.

We agree with Mr. Adshead's remarks, but he would perhaps be surprised at the many letters we have to write explaining our reasons for using the percentage scale. At the same time, we do receive letters of compliment from advanced workers.

The essential feature for exacting requirements, however, is not only a finely geared percentage scale, but also that the scale value is relative to the fine motion, also perfect insulation and screening.

For short-wave work and all exacting requirements, perfect balance or exact tuning is usually a point equal to 1-1,000th part of the capacity employed, a position readily located and a readable value with the Colvern selector.

No doubt, eventually, all British dials will be marked 0-100, and of more than passing importance is the fact that the dial value should be readable relatively to the fine movement provided.

F. E. COLLINSON, Managing Director,
London, E.17. Collinson's Precision Screw Co., Ltd.

RAPID INDICATION OF BROADCASTING STATIONS.

Sir,—Since the advent and development of broadcasting much has been heard and written about the difficulty of distinguishing one broadcasting station from another, a difficulty very often accentuated by dialectal differences, long intervals, and atmospherics. Towards its solution minds have even turned to the adoption of an "international" language. Apart from the great difficulty of coming to an understanding as to what that language should be—and getting people to learn that language—there will always be with us the problem of the various foreign accents, which will make even an international language difficult to understand over the wireless. The bringing into use of an international language for this purpose seems to me a long way off, and, as there is unquestionably a great

need now for some simple method of announcing and indicating the various stations, I venture to put forward a scheme which, I feel, would meet the needs of listeners all over the world. Moreover, my scheme has the great advantage of being based on that which is already international, whilst at the same time is simple to understand, easy to adopt, inexpensive to install, and requires the minimum of trouble to operate. For its working it is essential that each broadcasting station be given a distinguishing number, which I think could be easily arranged by the International Radio Conference at Geneva—sentiment not playing a part here as it does in the question of adopting a language. Having given each station a number, a list of the respective numbers allocated to the various stations would be published by the wireless Press of the countries adopting the system. Then there only remains to be installed a simple and inexpensive electrical or mechanical device at the microphone—or other transmitting apparatus—of each station, so arranged as to strike the number allocated to that particular station. This device could be arranged to come into operation by the announcer pressing a button at the end of an item, and to go on announcing the station's number until the button was again pressed before the commencement of the next item, thereby giving the minimum of trouble in operation, whilst keeping listeners in touch with the station during an interval. To ascertain the station calling it is only necessary to count the strokes and consult the list. Again, the striking and counting of the strokes determining the station number would, of course, be made as simple as possible by adopting the following arrangement. Thus, supposing London, for example, was shown on the list as Station 23, then the apparatus at the London microphone would give out two strokes, remain silent for a few seconds (say, 3 to 5 seconds), and then give out three strokes—indicating 23. This process could be repeated after a short silent period of, say, 15 to 30 seconds, thus keeping listeners in touch all the time. Regarding the numbers, I am aware that a few numbers might be likely to cause confusion, such as 0, or 3 and 33, say, and it might therefore be advisable to omit allocating such numbers, but, as there is practically no limit to the numbers which could be announced in the minimum of time, this need cause no difficulty whatsoever.

Glasgow.

A. A. SCHASCHKE.

PLEA FOR SHORT-WAVE BROADCASTING.

Sir,—May I second the request contained in the letter of Mr. E. H. Bysshe (Cape Town), published in your issue of February 17th, for the B.B.C. to transmit programmes on a short wavelength. From July to December last year (when I left the Canary Islands) the 64-metre transmission from KDKA (3,000 miles away) could be received here enjoyably any night from 11.15 GMT onwards, using a three-valve set (det. and 2LF). During the same period, and using a seven-valve receiver (3-1-3), reception of B.B.C. stations, including Davenport, was always marred by heavy X's and the eternal Morse. Reception of the Prince of Wales' speech on the eve of Armistice Day was typical, as although signals were strong most of the speech was drowned out by X's. And yet an hour and a half later the announcer at KDKA was heard perfectly, as was the rest of KDKA's programme.

There must be thousands of Britishers residing outside the 1,500-mile range of B.B.C. stations to whom the cost of a receiver suitable for receiving over this distance on the broadcast wave band is prohibitive and not worth the expense in view of the reception obtained. A short-wave set—detector and one or two L.F.—is simple and inexpensive to construct, besides being economical in upkeep.

I agree with Mr. Bysshe that if money is required for short-wave transmissions by the B.B.C. (which I also think should not be the case) a large sum could be raised to be employed in this direction. I think all of us would be only too willing to contribute. It is very disheartening the way our home stations are received out here when an American station more than twice the distance away can be picked up really worth listening to.

The British Broadcasting Co., by transmitting programmes on a short wavelength, would do all Britishers overseas a much-needed service and keep them much more in touch with the Mother Country.

OVERSEAS.

Canary Islands.

RECENT INVENTIONS

The following abstracts are prepared, with the permission of the Controller of H.M. Stationery Office, from Specifications obtainable at the Patent Office, 25, Southampton Buildings, London, W.C.2, price 1/- each.

Electrostatic Couplings for High-Frequency Circuits. (No. 244,841.)

Application date: Sept. 26th, 1924.

The Igranic Electric Company, Ltd., and W. K. Alford, described in the above patent specification a method of coupling two circuits together so that energy may be transmitted from one to the other, which comprises electrostatically coupling a capacitive device connected in one of the circuits and an inductance coil connected in the other, the inductance coil being separate and distinct from the aerial proper.

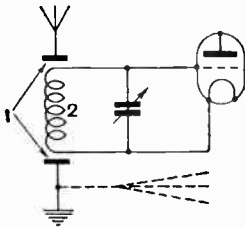

Electrostatic aerial coupling (Fig. 1). (No. 244,841.)

Fig. 1 shows an arrangement according to which the aerial circuit is coupled to the grid-filament circuit of the first valve of a radio receiving apparatus by the electrostatic coupling of a condenser 1 having its plates respectively connected as shown to the aerial and the earth and an inductance coil 2 connected in the grid filament circuit, the inductance coil being located, as shown, in the electrostatic field between the plates.

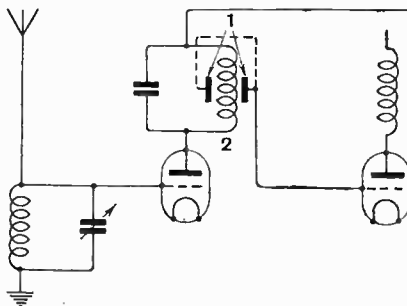

Electrostatic tuned anode coupling (Fig. 2). (No. 244,841.)

The inductance coil may of course be tuned in any well-known way.

Fig. 2 shows an arrangement in which two valves are coupled together electrostatically. The inductance coil 2 is connected in the plate circuit of the first

valve and is coupled to the grid circuit of the next valve by electrostatic coupling in the same way as is the inductance coil of Fig. 1.

The small electrostatic coupling between the plates 1 and coil 2 is sufficient to bring about the desired transfer of energy from the plate circuit of the first valve to the grid of the second valve.

The plates may be of semi-circular form and may embrace any desired number of turns.

Improved Aerial Insulator. (No. 244,981.)

Application date: April 28th, 1925.

It is found in practice that ordinary insulators gradually deteriorate in resistance owing to the deposit of dirt and soot on the surface thereof: and they also suffer temporary reduction in resistance from deposits of moisture.

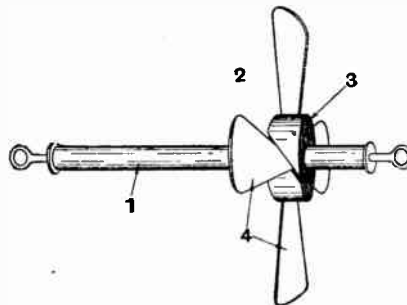

Improving aerial insulation. (No. 244,981.)

In order to obviate such disadvantages Messrs. G. V. Dowding and K. D. Rogers have devised an insulator provided with means for automatically rubbing the surface of the body portion of the insulator to remove dust, moisture or other deposits thereon.

The body of the insulator consists of a rod 1 of ebonite, porcelain or other suitable insulating material having loosely fitted thereon a rotor 2 which comprises a hub portion 3 and inclined vanes 4 which intercept air currents and thereby cause the hub portion to rotate on and slide along the body of the insulator.

Loud-Speakers. (No. 241,343.)

Application date: August 28th, 1924.

Mr. S. G. Brown describes in the above patent specification a loud-speaker of the type having a pair of diaphragms vibrated in opposite directions.

The invention consists in a device of

this kind having a pair of diaphragms, each connected to its reed, the reeds and thereby the diaphragms being vibrated in opposite directions by appropriate electromagnetic means.

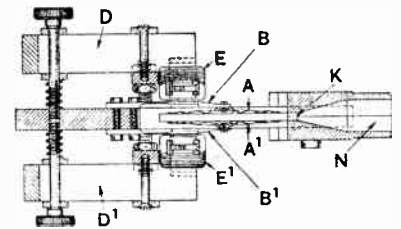

Reed type loud-speaker. (No. 241,343.)

As shown, two corrugated diaphragms A, A' arranged face to face are secured at their centres to a pair of parallel reeds B, B' actuated by electromagnets E, E' on the pole-pieces of permanent magnets D, D'. The space between the diaphragms has an outlet K into a socket N for a horn.

Construction of Grid Leaks and Anode Resistances, etc. (No. 244,284.)

Application date: January 12th, 1925.

The invention described in Mr. M. Koopman's above specification relates to a method of manufacture of grid leaks, anode resistances, etc., the method of construction being so arranged that the value of the resistance can be adjusted while connected to the measuring instruments. As shown the resistance consists of an ebonite tube D having screws E driven into each end a flat E₁ ground

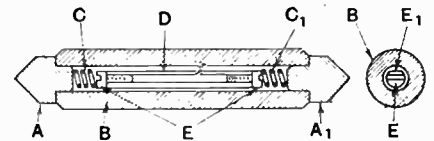

A method of constructing grid leaks. (No. 244,284.)

along its entire length, the flat being smoothly polished and graphite rubbed on, while the cartridge is connected into the electrical measuring circuit by means of spring clips.

Having brought the cartridge to the required resistance it is placed within the tube B, a plug A having been previously driven in and a spring C inserted.

Another spring C₁ is now placed into the open end of tube B and the plug A₁ driven in.

and the reaction condenser, and it will be found that even a comparatively inefficient choke will perform this office satisfactorily, thus enabling any of the commercial chokes upon the market to be used. This is in contradistinction to the case where the choke is required to function in a choke coupled H.F. amplifier, where it will be found that it is necessary for the choke to be of high efficiency, such as this one referred to in the article on the Hartley receiver in our issue of January 27th, 1926.

o o o o

Simplified Switching.

I wish to build a three-valve receiver consisting of detector and two transformer-coupled L.F. stages, and, to incorporate the simplest possible switching, to use one, two, or three valves at will. I should like to have used a simple three-stud switch, but understand that if this were done it would be impossible to use separate H.T. supply to each valve. Can you tell me if this is so? T.N.T.

It is quite possible to use a simple three-stud switch to accomplish the switching you require and at the same time to use separate H.T. supply to each valve. We give the circuit in Fig. 2, and from this it will be seen that the connections are exceptionally simple, calling for no complications in wiring, a fact which in itself should do a great deal towards eliminating that form of distortion always to be found in an amplifier where considerable

this readers are referred to the article entitled "Music Without Muffling," published in our February 10th issue. It should be pointed out that in this circuit equal results may be obtained by connecting the low potential side of the telephones to L.T.+ as shown, or to an auxiliary earth connection as shown in dotted lines. Exactly the same results are obtained, of course, by connecting the low potential side of the telephones to the normal earth terminal of the receiver. An additional, and by no means the least, advantage of this arrangement is that the windings of telephones or loud-speaker are protected by reason of the fact that the steady anode current is prevented from flowing through them.

o o o o

Impedance or Ratio?

I have been using a high impedance detector valve followed by a 2 to 1 ratio transformer of foreign manufacture. Recently I substituted a 6 to 1 transformer of well-known make in order to get greater amplification at some sacrifice of quality. To my surprise, not only was volume increased, but quality was improved. Surely this contradicts your oft-repeated advice to use a low ratio transformer following a high impedance valve? P. P. E.

It is perhaps misleading to state that a high impedance valve should be always followed by a transformer of low ratio. Actually it would be better to state that

BOOKS FOR WIRELESS BEGINNERS

Issued in conjunction with "The Wireless World."

- "YOUR FIRST STEPS IN WIRELESS," by HUGH S. POOCOCK. Price 9d. net. By Post, 11d.
- "WIRELESS TELEPHONY," by R. D. BANGAY. Price 2/6 net. By Post, 2/9.
- "THE WIRELESS TELEPHONE," by P. K. COURSEY, B.Sc. Price 2/6 net. By Post, 2/9.
- "CAPT. ECKERSLEY EXPLAINS," by CAPT. P. P. ECKERSLEY. Price 2/- net. By Post, 2/2.
- "UNCLE JACK FROST'S WIRELESS YARNS ON GOOD RECEPTION AND HOW TO GET IT," by CAPT. C. C. J. FROST. Price 2/- net. By Post, 2/2.

Obtainable by post (remittance with order) from **ILIFFE & SONS LIMITED, Dorset House, Tudor St., London, E.C.4,** or of Booksellers and Bookstalls.

reputable transformers to state that a high impedance valve should be followed by a low ratio transformer. The explanation of your results is in all probability that the primary of your good 6 to 1 transformer has actually a greater inductance value than the primary of your 2 to 1 transformer, which from experience we can very well believe to be the case.

o o o o

Ratio of Distance to Signal Strength.

Is it correct to assume that if with a given receiver situated at, say, 10 miles from a broadcasting station I get a certain given signal strength which we will call x, I should get exactly half this signal strength if the receiver were moved to a distance of 20 miles from the same station? It is assumed, of course, that dimensions and position of aerial, local screening, etc., are identical in both cases, and that the same signal strength is being radiated from the local station in both cases, and that the time of day is identical. T. H. C.

This assumption would be true only if the strength of signals received from a broadcasting station varied inversely with the distance. Actually, the strength of signals received theoretically varies inversely as the square of the distance, and so you could expect to receive signals

having a strength of $\frac{x}{4}$ instead of $\frac{x}{2}$, as

you assume. It should be pointed out that this is only applicable to comparatively short distances, where we are only concerned with reception of the wave radiated direct from the transmitting station. At greater distances there are various other factors such as reflections from the Heaviside layer which must be taken into account, so that by removing a receiver further from a given transmitting station it might happen that actually stronger signals were heard in the headphones.

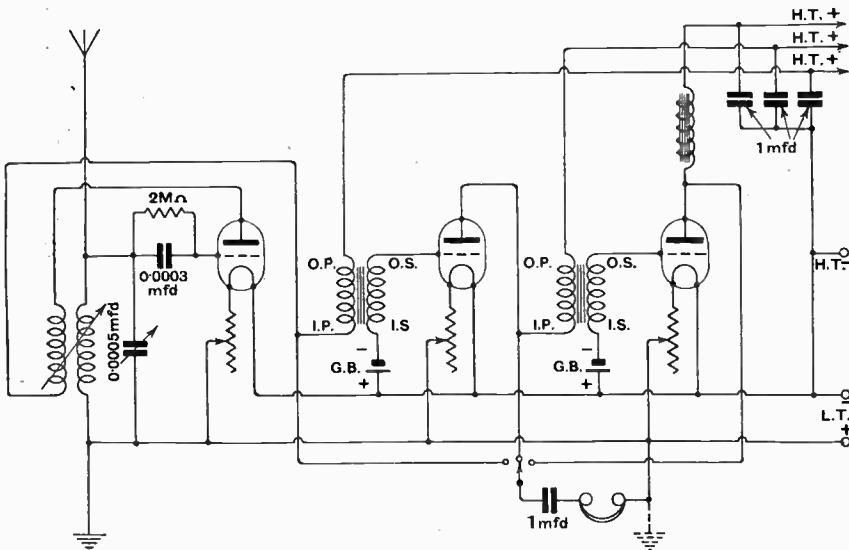

Fig. 2.—A simplified switching arrangement

extraneous capacity effects are introduced by complicated switching. It should be pointed out that by using this method of connection not the slightest volume is lost, whilst at the same time the advantage is secured that, if desired, the loud-speaker may be operated at a considerable distance from the receiver with only a single-wire double-wire extension. For particulars of

a high impedance valve should always be followed by a transformer having a primary of high inductance value, so that the impedance connected in the anode circuit of the valve was greater than its internal impedance. Now since reasons of design and mechanical construction usually necessitate that a transformer of high primary inductance should have a low ratio, it is correct in the case of all

WARNING

Use of Patents in the Home Construction of Broadcast Apparatus.

MARCONI'S Wireless Telegraph Company, Ltd., of Marconi House, Strand, W.C.2, published in this paper during December a notice concerning the unauthorized disposal of broadcast receivers by amateurs and others. From correspondence subsequently received it is clear that a large section of the public is under the impression that the Company has given the free use of its patents to all home constructors, and therefore it is desirable that this misunderstanding should be rectified.

AS far back as 1922 the Marconi Company placed at the disposal of the bona-fide experimenter or amateur the use of their patents. Whilst the Company has no intention of withdrawing this, they cannot consider persons who make up receivers at home merely for the purpose of obtaining amusement from the broadcast programmes as "experimenters," and therefore the concession referred to above is not applicable to them.

IT is clear that any other attitude on the part of the Company would be tantamount to converting the royalty into an unfair penalty imposed upon the manufacturer, who has not only to pay royalties, but also to bear the cost of heavy overhead manufacturing charges.

THE Company, not only for the protection of the legitimate trader, but also to safeguard their own interests, wish to make it known therefore that, while they have no desire to influence the public as to whether a set shall be bought complete or constructed at home, royalties are payable in either case. The Company also desire to give notice of their firm intention to take such action as may be necessary to uphold their patent rights.

1ST AND 2ND STAGE

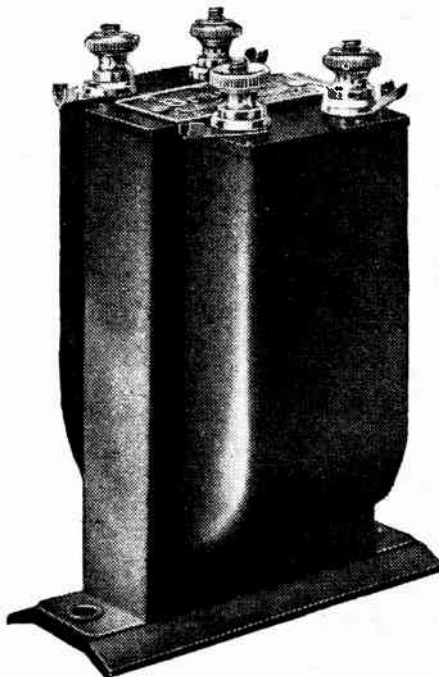

THE AUDIO TRANSFORMER

Are you building? Do you want more power without choking the purity of those smooth, level tones? The Brandes 1st stage Transformer has a high voltage amplification ratio of 1-5. This, together with a straight line amplification curve, means that the amplification is constant over a wide band of frequencies, thus eliminating resonance. The 1-3 Transformer amplifies over speech, pianoforte and harmonic ranges equally well. Mechanically protected and shielded against interaction. Terminals and outside soldering tags.

17/6

Ratio 1-5 (black finish),	Ratio 1-3 (brown finish),
Table-Talker 30/-	Brandola 90/-
	Matched Tone Headphones, 20/-

Brandes

Brandes Limited, 296, Regent St., London, W.1

from any good Dealer.

A few words on batteries!

DARIMONT

"HOME SERVICE" BATTERIES

and DULL EMITTER VALVES—the SOLUTION to the BATTERY PROBLEM.

Write for particulars of this Battery, which is ideal for constant or intermittent use—is rechargeable AT HOME without electric supply—and is not damaged by short circuit.

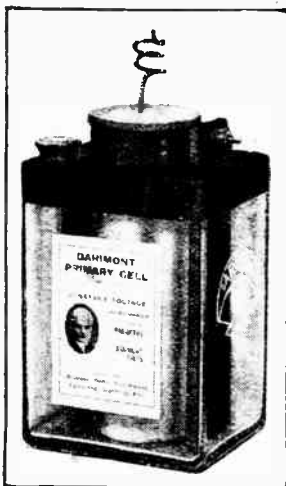

(PATENTED)

DARIMONT ELECTRIC BATTERIES LTD.,
 DARIMONT WORKS, ABBEY ROAD, PARK ROYAL,
 LONDON, N.W.10. Telephone: Wembley 2807.

The Radio EXPERIMENTER'S Handbook in two Volumes

By Philip R. Coursey, B.Sc., P.Inst.P.

The second edition of this popular handbook in two volumes, which deals with the theory and practice of modern wireless telegraphy, has been thoroughly revised and brought up to date.

Written by a wireless authority of wide experience, "The Radio Experimenter's Handbook" is the best and safest guide to all amateurs who wish to build sets which will fulfil their own particular requirements. These two volumes furnish all the information necessary to secure a successful result.

PART ONE deals with the general principles underlying the design of radio receiving equipment, and explains in clear and simple language the fundamental properties of the Aerial and the Aerial Circuit, Receiving Tuners, Receiving Amplifiers and Detectors, Heterodynes, etc., etc.

PART TWO is devoted to data and actual quantitative design, as well as to the description of many suitable high-frequency measurements which can readily be carried out by the experimenter. A few of the subjects discussed are the Measurements of High-Frequency Currents and Voltages, Fundamental Formulæ and Data, Aerials and Tuning Circuits, Tuning Coils and Inductances, Condensers, Valves and their Constants, etc.

PRICE
3/6 per volume.
By post 3/10 each.

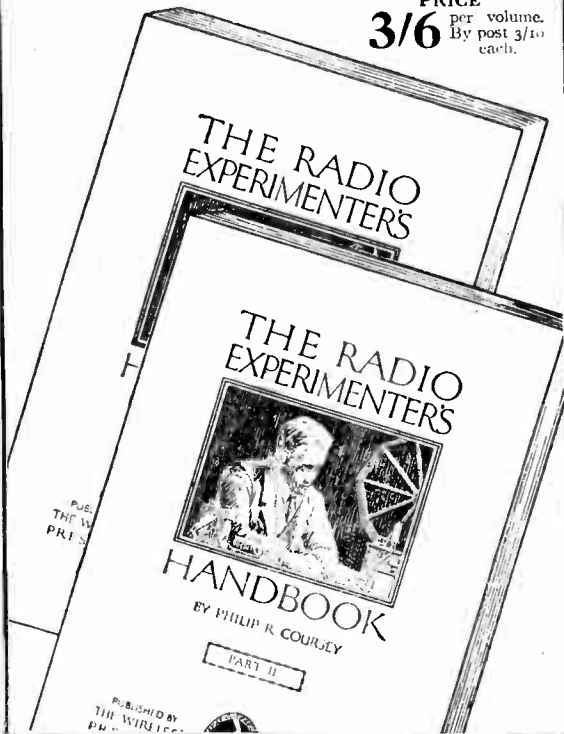

Obtainable from the publishers of "The Wireless World":
ILIFFE & SONS LTD., Dorset House, Tudor St., London, E.C.4.

W.W.5.

Trouble-free building the Ezi-Wiring Way

All wireless amateurs want a trouble-free set. By means of "The Wireless World" EZI-WIRING Series, the difficulties and trials of home-construction are banished for ever.

These volumes give you complete working instructions, detailed measurements and explanations of the components necessary for building a highly-efficient set at a very moderate cost. A FOUR-COLOUR WIRING DIAGRAM enables you to build the set without any possibility of incorrect wiring.

- No. 1 A Three-Valve Portable Receiver : by Hugh S. Pocock. This receiver can be used in any situation with a temporary aerial or with the frame aerial incorporated in the receiver itself.
- No. 2 A Three-Valve Receiver : by F. H. Haynes. The tuning arrangements of this receiver are self-contained. All the B.C. Stations are, therefore, within the range of this receiver when used in conjunction with an outdoor aerial.
- No. 3 A Two-Valve and Crystal Reflex Receiver : by W. James. Reflex Receivers are capable of giving a very high degree of amplification per valve. This two-valve and crystal reflex receiver, unlike many reflex receivers, will be found perfectly stable in operation, and will be capable of giving loud-speaker strength within a radius of thirty miles of a main B.C. station.
- No. 4 A Four-Valve Combination Set : by W. James. A four-valve receiver of this type is ideal for general reception both with telephones and a loud speaker. Switches are provided so that two, three, or four valves may be used at will. An entirely new principle is used to cut out the H.F. valve, no switches being employed.

Obtainable from the publishers of "The Wireless World":

ILIFFE & SONS LIMITED,
Dorset House, Tudor St.,
LONDON, E.C.4

EZI-WIRING

The W.P. EZI-WIRING Series No. 1

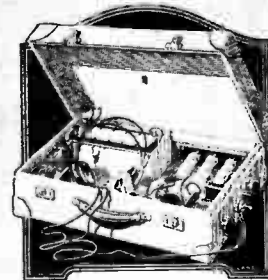

By HUGH S. POCOCK

PRICE:
2/- net
per volume.
BY POST
2/2
each.



A THREE VALVE
PORTABLE
RECEIVER

Containing
COMPLETE INSTRUCTIONS
and WORKING DRAWINGS

PRICE 2/- NET
THE WIRELESS WORLD LTD.
DORSET HOUSE, TUDOR STREET, W.C.4

Many other books for the home constructor are published by "The Wireless World." A full list will be sent you FREE on REQUEST.

W.W.6.

£10 Weekly in Cash Prizes







A New and Simple Competition
for all Readers of "The Wireless World"

To be continued weekly until further notice.

HIDDEN ADVERTISEMENTS

Below will be found six reproductions of fragments cut from the Advertisement pages of this issue of "The Wireless World." Each fragment is a clue. Can you from these clues identify the Advertisements? Seven cash prizes will be awarded to the first seven readers who send us correct solutions. No technical skill is required, merely observation. There are no restrictions or entry fees and the conditions are simple.

£5
for the first
correct solution
opened.

	
1	2
	
3	4
	
5	6

£1
for the third
correct solution
opened.

and
4
consolation
prizes of

10/-

Each
for the next four
correct solutions
opened.

£2
for the second
correct solution
opened.

CONDITIONS

1. All solutions must be written on the special coupon appearing on an advertisement page in this issue and addressed to *The Wireless World*, Dorset House, Tudor Street, London, E.C.4, and marked "Hidden Adverts." in bottom left corner.

2. Clues will not, of necessity, appear in the same way as in the advertisement page, but may be inverted or placed in some other position.

3. In order that town and country readers may compete on equal terms, solutions will not be dealt with until 10 a.m. on Monday next. All solutions received before that date will be retained until Monday morning. Competitors may submit any

number of entries. Erasures or alterations on a coupon will disqualify the entry.

4. The first prize of £5 will be awarded for the first correct solution opened; the second prize of £2 to the next correct solution; the third prize of £1 for the third, and four consolation prizes of 10/- each for the next four correct answers. In the event of no readers sending correct solutions the prizes will be awarded to the competitors whose solutions are most nearly correct.

5. The decision of the Advertisement Manager of *The Wireless World* is final, and no correspondence can be entered into. Competitors enter on this distinct understanding. No member of the staff of the paper is permitted to compete.

This is the First

Advertisement telling readers of "The Wireless World" about our new component, the **BRETWOOD AUTO-AUDIO FREQUENCY AMPLIFIER**

The design and construction of this Amplifier enable us to make the following statements in all good faith. **THE BRETWOOD AMPLIFIER** practically eliminates atmospheric. **THE BRETWOOD AMPLIFIER** enables one to ignore those ripples caused through local power stations and the interference resulting from discharge of current operating electric trains, trams, etc. Can be used with 3 or more stages without any trace whatever of distortion or noisy background. To obtain the maximum filtration effects, at least two stages of amplification should be used.

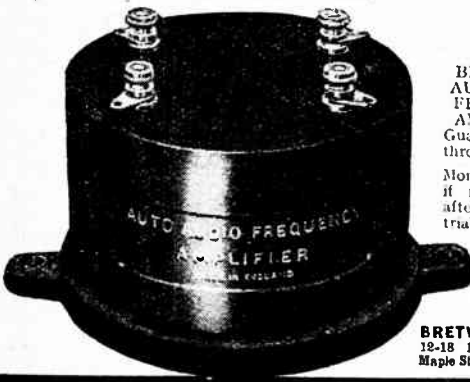

PRICE 20/-
THE BRETWOOD AUTO-AUDIO FREQUENCY AMPLIFIER.
 Guaranteed for three years.
 Money refunded if not satisfied after a week's trial.

Obtainable from most dealers, or from the sole manufacturers:

BRETWOOD, Ltd.,
 12-18 London Hwy,
 Maple St., London, W.1

H.F. 27.

Your Loudspeaker

WILL SING

THE PRAISES OF

NELSON MULTI 3-FILAMENT VALVES



Here is a Valve giving you Finest Quality and Volume with Economy. It is of equally high grade as H.F., Detector, L.F., or Power Amplifier.

The little switch places at your command each of 3 Filaments separately, or any 2 in parallel for Power Amplification. Each Filament gives the Valve a New Life.

ALL VALVES are Guaranteed.

FOUR IMPROVED TYPES

Obtainable at All London's Largest Stores.	A.	4 to 5 VOLTS, 0.45 AMPS. per Filament	9/6
	D.E.A.	2.6 VOLTS, 0.18 AMPS. per Filament	15/-
	D.E.2.	1.8 to 2 VOLTS, 0.35 AMPS. per Filament	15/-
	D.E.08.	3 VOLTS, 0.06 AMPS. per Filament	16/6

If unable to obtain from your dealer, write direct: -

NELSON ELECTRIC COMPANY LIMITED,
 Merton Park, London, S.W.19.

Telegrams: Valvencola, Wimble, London.

Phone: Wimbleden 172.

"Japa" REGD

PLUG & SOCKET TERMINALS ARE THE FINEST TERMINALS IN THE WORLD FOR ALL WIRELESS CONNECTIONS.

BRITISH MADE.

If your Dealer cannot supply send direct to the maker.

W. J. CHARLESWORTH,
 88 & 89, Aston Street, BIRMINGHAM.
 — Established 1807

"Japa" REGD

No bits of bent tin or brass, or screwed composition sleeves to make your connection, but a reliable mechanical article which has been copied by many but equaled by none.

Insist upon the genuine article

6D.
 EACH Post free.

Made in Red, Black, Purple, Blue, Green, Royal Blue, Amber, Yellow, Brown.

The Wonderfully Efficient Reactone Low-Loss Coils.

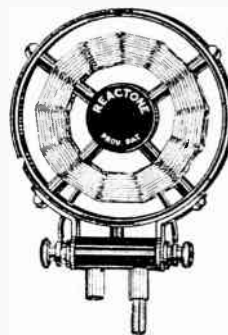

Wound with double silk-covered wire, under constant tension, on the same principle as the Standard Reactone Coil. Mounted in a low-loss frame, giving absolute rigidity—no shellac, tape, wax, or fibre.

No.	Price.	No.	Price.
25	3/9	75	4/9
30	4/-	100	5/9
35	4/3	150	6/9
40	4/3	200	7/6
50	4/3	250	8/-

Reactone

PROV. PATENT

Low Loss Coil

All good Radio Dealers sell Reactone Low-Loss Coils, and also the Standard Reactone Coils. In case of difficulty, write to the manufacturers:—

Reactone Ltd., 88-89, Chancery Lane, LONDON, W.C.

TIME & WEATHER by WIRELESS

By **W. G. W. MITCHELL,**
 B.Sc., F.R.S.S., F.R.Met.S.

The first half of this book explains how time-signals are sent and how they may be received with the utmost accuracy. The latter part, devoted to the weather, will enable the amateur to distinguish the different weather telegrams. Crown 8vo. 125 pages. 66 diagrams and illustrations.

Price 3/6 net By post, 3/9

Obtainable from the publishers of "The Wireless World,"
ILIFFE & SONS LTD., Dorset House, Tudor Street, London, E.C.4,
 and all leading booksellers. w.w.16

MISCELLANEOUS ADVERTISEMENTS.

NOTICES.

THE CHARGE FOR ADVERTISEMENTS in these columns is:

12 words or less, 1/- and 1d. for every additional word, e.g., 18 words 1/6; 24 words, 2/- Name and address must be counted.

SERIES DISCOUNTS are allowed to Trade Advertisers as follows on orders for consecutive insertions, provided a contract is placed in advance, and in the absence of fresh instructions the entire "copy" is repeated from the previous issue: 13 consecutive insertions, 5%; 26 consecutive, 10%; 52 consecutive, 15%.

ADVERTISEMENTS for these columns are accepted up to **FIRST POST ON THURSDAY MORNING** (previous to date of issue) at the Head Offices of "The Wireless World," Dorset House, Tudor Street, London, E.C.4, or on **WEDNESDAY MORNING** at the Branch Offices, 19, Hertford Street, Coventry; Guildhall Buildings, Navigation Street, Birmingham; 199, Deansgate, Manchester.

Advertisements that arrive too late for a particular issue will automatically be inserted in the following issue unless accompanied by instructions to the contrary. All advertisements in this section must be strictly prepaid.

Postal Orders and Cheques sent in payment for advertisements should be made payable to ILLIFE & SONS Ltd., and crossed Treasury Notes, being untraceable if lost in transit, should not be sent as remittances.

All letters relating to advertisements should quote the number which is printed at the end of each advertisement, and the date of the issue in which it appeared.

The proprietors are not responsible for clerical or printers' errors, although every care is taken to avoid mistakes.

NUMBERED ADDRESSES.

For the convenience of advertisers, letters may be addressed to numbers at "The Wireless World" Office. When this is desired, the sum of 6d. to defray the cost of registration and to cover postage on replies must be added to the advertisement charge, which must include the words Box 000, c/o "The Wireless World." Only the number will appear in the advertisement. All replies should be addressed No. 000, c/o "The Wireless World," Dorset House, Tudor Street, London, E.C.4. Readers who reply to Box No. advertisements are warned against sending remittance through the post except in registered envelopes; in all such cases the use of the Deposit System is recommended, and the envelope should be clearly marked "Deposit Department."

DEPOSIT SYSTEM.

Readers who hesitate to send money to unknown persons may deal in perfect safety by availing themselves of our Deposit System. If the money be deposited with "The Wireless World," both parties are advised of its receipt.

The time allowed for decision is three days, during which time, if the buyer decides not to retain the goods, they must be returned to the sender. If a sale is effected we remit the amount to the seller, but, if not, we return the amount to the depositor. Carriage is paid by the buyer, but in the event of no sale, and subject to there being no different arrangement between buyer and seller, each pays carriage one way. The seller takes the risk of loss or damage in transit, for which we take no responsibility. For all transactions up to £10, a deposit fee of 1/- is charged; on transactions over £10 and under £50, the fee is 2/6; over £50, 5/-. All deposit matters are dealt with at Dorset House, Tudor Street, London, E.C.4, and cheques and money orders should be made payable to Illife & Sons Limited.

THE SALE OF HOME-CONSTRUCTED UNLICENSED APPARATUS.

A New Service to our Readers.

We have made an arrangement with the Patentees whereby readers who wish to dispose of a home-constructed receiver not licensed under the patents made use of, can do so by means of the Deposit System referred to above.

The person desiring to sell, in sending us particulars for his advertisement, will in every case make use of a Box No., and should add to the price which he requires the amount of royalty customarily paid by manufacturers, viz. in the case of Marconi Patents the amount should be calculated at 12/6 per valve holder.

If the purchaser is satisfied with his purchase, the sum realised will be forwarded to the seller, less the amount due in respect of royalties, which amount will be paid by "The Wireless World" to the owners of the patents concerned, and a certificate will be handed on to the purchaser of the set.

FOR SALE.

CRYSTAL Amplifiers increase range five times. Price, complete, 25s. Oscillating zincite 1s. 6d. Original circuit 1s. All parts stocked.—Particulars: Ledsham's, 297, King Street, Hammersmith. (1817)

McMICHAEL Transformers, 0, 1, 2, 3, 4, two each, matched, perfect, 52s. 6d., or separate.—Taylor, Builder, Rochdale. (1845)

IMPORTANT NOTICE.

Owing to the Easter Holidays, the issues of "THE WIRELESS WORLD" dated March 31st and April 7th must be closed for press earlier than usual

The MISCELLANEOUS ADVERTISEMENTS for insertion in those issues can be accepted up to the following times:—

Issue of March 31st,
FIRST POST WEDNESDAY, March 24th.
Issue of April 7th,
FIRST POST TUESDAY, March 30th.

For Sale.—Contd.

5-VALVE "R.A.F.10" Receiving Set, 5 D.E. Osram "C" valves, telephones, remote control tuner and rheostat, brand new, perfect, £6; also 2" Gambrell neodyne condensers, 6s.; .0003 Ormonde condenser and 2.0005, the lot 15s.—Loch, 14, Freeland Road, Ealing, W.5. (1840)

SUPER Het Transformers, 3 I.F., Input, Oscillation Coupler, perfect order. Range 150 to 650 metres. £4 the set. Cost over £5.—Box 7009, WIRELESS WORLD Office. (1835)

FELLOPHONE Super Three and Amplifier Instruments only.—Apply: Bolton, Rossett Hall, Wrexham. (1847)

THREE R.I. Super-Het transformers, new, two months ago, £2 10s.—Crabtree, 77, Reed Street, Burnley, Lancs. (1846)

FIVE-VALVE "Transatlantic" Receiver. Built from good components. 1 to 5 valves can be used. Perfect condition. Including two pairs matched H.F. transformers, £10, or with valves (Mullard & Cossor dull emitters) £13 (plus royalties). Also selection suitable coils.—Box 7095, WIRELESS WORLD Office. (1852)

FOR Sale.—Standard Electric (formerly Western Electric) Amplifier, perfect order, used only few months. Enormous magnification without distortion.—Headmaster, Downside School, near Bath. (1869)

EXPERIMENTER has for sale, at two-thirds cost or nearest, various Wireless Components, best make, guaranteed perfect; particulars upon request.—Box 7211, WIRELESS WORLD Office. (1872)

MORSE Recorder by Wallers, London, £6; Siemens 10,000 ohms relay in case, £3, new, bargain.—2 N.L., 129, Wells Road, Bath. (1875)

ATWATER Kent American 5-valve Receiving Set, 200-600 metres, nearly new, no accessories. What offers?—Badham, Camdore, Cheltenham. (1876)

TESTED Crystals.—Natural Galena, 2s. per oz.; Galenite, a very sensitive natural crystal, 8d. per piece; Shaws genuine Hertzite, 1s. per large crystal; Amplex Perikon detector, panel type, Micrometer adjustment, with crystals, 3s. 6d. each.—By post from Radio Supplies, 51, Eden Street, Kingston-on-Thames. (1880)

R.R.F. Power Valves, filament 4 volt 0.3 amp., Anode 60-200 volt, saturation current 25 m.a., amplification factor 6.5, impedance 7,000 ohms. Will handle up to 20 volts grid amplitude. Individual curves with each valve. Performance guaranteed or money refunded. Price 15s., post free.—H. E. Poole, Ltd., 79, Queen Victoria Street, London, E.C.4. (1885)

For Sale.—Contd.

FOUR Bowyer-Lowe Super Het Transformers, new 3 months ago; £3.—Box 7228, WIRELESS WORLD Office. (1879)

HIGH-TENSION Accumulators.—The Ideal Loud-speaker Battery, 60 volts, 35s.; 80 volts, 45s.; 100 volts, 55s.; guaranteed. Good trade terms.—Pearson, 110, Marston Lane, Bedworth, Nuneaton. (1882)

FOUR-VALVE Set for Sale.—2 H.F. detector and L.F., with or without accessories; also 8-valve super-het-rodnyne-oscillator detector, 4H.F., second detector, 2L.F.—Offers to Box 7230, WIRELESS WORLD Office. (1884)

H. & B. Condensers.—Square law. .001, .4s.; .0005, 3s.; .0003, 2s. 9d.; .0002, 2s. 6d.; low loss .0005, 5s.; .0003, 4s. 6d.; Vernier 6d. extra, post free, all guaranteed.—Frazier, Stafford Road, Wallington. 'Phone: 1430. (1881)

CROIX Transformers, 5.1 and 3.1, 4s. each, C post 4d.; Brunet transformers, 5.1 and 3.1, latest shrouded model, 8s. 6d. each, post 6d.; Radio Micro valves, latest type, 3-4v., .06 amp., 8s. 9d. each, post 6d.; Radio Micro Power valves, 4v. 25 amp., 11s. 9d. each, post 6d. All goods guaranteed genuine.—Continental Supplies, 497, Old Ford Road, London, E. (1886)

SCRAP your H.T. battery and buy H.T. Supply Unit, complete with flex and adapter to plug in ordinary lamp-holder. Running cost 1d. per week. Money back guaranteed. Complete, with full instructions, 30s., postage 1s.—Continental Supplies, 497, Old Ford Road, London, E. Note: To work off D.C. current only. (1887)

FINANCIAL PARTNERSHIPS.

PARTNERSHIP wanted in Established Business by Wireless Operator (25); prepared invest £400.—Box 7216, WIRELESS WORLD Office. (1873)

MISCELLANEOUS.

A WIRELESS Doctor.—If your set is giving trouble or you want advice a competent expert will call (anywhere in Greater London) and put you right. No result, no charge.—Alexander Black, 2A, Woodville Grove, N.16. Clissold 3687. (1811)

CHARGE Your Own Accumulator.—Send 3d. stamp to-day for lists of our small gas and petrol engines and dynamos, and complete charging sets, from 20 to 160 watts.—Tom Senior, Cleckheaton, Yorks. (0013)

SEND 2s. for Booklet and Constructional Diagram on How to Build a 3-valve Selective Distance-getter.—Vic Radio (J. Ayres), 1, Emery Hill Street, Westminster. (1878)

PATENT AGENTS.

W. BRYSON, B.Sc., Chartered Patent Agent, 29, Southampton Buildings, W.C.2. 'Phone: 101born 672. (1297)

REPAIRS.

TRANSFORMER Repairs.—Rewound to original efficiency and guaranteed 12 months. 4s., post free. Phones 3s. 6d. Trade supplied.—Transform, 70A, Longley Road, Tooting. (0011)

WANTED.

COPIES of No. 307, Vol. XVII., No. 1, "Wireless World."—G. Brame, Diss, Norfolk. (1867)

Wanted.—Contd.

WANTED.—"Wireless World" dated July 1 and August 26; state price.—Jas. B. Baillie, Helenslea, Bearsden, N.B. (1877)

ONE copy each of "Wireless World" for March 4 and July 1, 1925.—Turner, 3, Cromwell Road, Hove. (1871)

EXCHANGE.

MILLIAMETER, 0-500 moving coil Ferranti, 5in. parrellell dial, exchange for similar quality A.C. voltmeter or microammeter.—Turpin, 27, Park Chase, Wembley Park. (1874)

SITUATION VACANT.

THE services are required of a Young Experimenter by a limited company holding the position of one of the largest distributors of purely experimental apparatus in the country, with offices and works in London; a capital investment of not less than £1,500 is essential; this represents a unique opportunity for a man of ability; and applicants should address their communications in the first instance to BM/BR4S, W.C.1, London. (1870)

SITUATIONS WANTED.

ADVERTISER (30), 12 years' radio experience, all branches, knowledge languages, accustomed writing technical articles, requires responsible position.—Box 7044, WIRELESS World Office. (1841)

YOUNG Man (20), amateur transmitter, desires change; thorough knowledge radio apparatus; keen on development of Duplex transmitters; can design new apparatus and advise best circuits.—Box 7220, WIRELESS World Office. (1883)

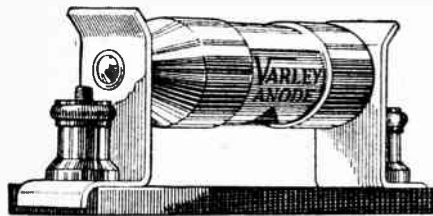

The Varley Constant Wire-Wound Anode Resistance

ensures absolutely perfect tone and constancy under all atmospheric conditions, because it is wire wound on the famous Varley Bi-Duplex system, with the turns silk-separated, eliminating all self inductance. This resistance is a sound product of 27 years' experience in intricate and accurate wire winding. For inter-valve coupling where freedom from distortion is required, resistance capacity is unequalled. To obtain the height of perfection the resistance unit should be a Varley

Wire Wound and Weatherproof. Complete with Clips and Base 7/6

Without Clips and Base 6/-
60,000 ohms, 80,000 ohms, 100,000 ohms.
Write for Leaflet.



Constant always

THE VARLEY MAGNET Co., WOOLWICH,
(Proprietors: Oliver Pell Control, Ltd.), S.E.18.
Telephones: Woolwich 888, 889.



**Test it
at our
expense**

Here's an opportunity for you to try out the **PUREMAX** Loud Speaker—the marvel of present-day manufacture.

SPECIAL TRIAL OFFER

If your dealer is out of stock, post us 70/- with his name and we will send you a PUREMAX by return, post free. If in one week you're not perfectly delighted, return it and we will refund your money in full, plus postage.

"PUREMAX"

70/-

By reason of its **double electro-magnetic action** and the **super selected mica diaphragm** this instrument is perfect in purity of tone and reception, and distortion is entirely eliminated.

Height 2 1/2 ins.
Flare 1 1/2 ins.
Lead 7 ft.
Resistance 4000 ohms.

LEE & CHURCHILL Ltd

**3a, Hanover Court,
London — E.C.2**



GREAT SALE OF RECEIVERS,

by **MARCONI, A.T.M. Co.,** and other Leading Makers.—M. Crystal Cabinets, with phones, 15/6. The Bargain of the Year. The R.B.10 1-valve and Crystal Sets, with valve and headphones. As new, in cabinet, with lid, 34/6. Usual price, £3. A limited number only available, and this bargain cannot be repeated. 2-valve Sets, Trench type, cloth covered, mahogany case, fitted 2-coil holder, 45/-

SALE CLEARANCE OF 3-VALVE AIRCRAFT SETS, very compact. Cost £18, 1 H.F. 1 Det., 1 L.F.; 3-valve holders, antipong mounted. Variable Condensers and Rheostats. Fine portable Set in canvas-covered case, with lid, with 3 new dull-Emitter '06 valves, 4-volt Accumulator, 60-volt H.T. Battery, H.R. Headphones, etc., complete outfit as above, fitted 2-Coil Holder, £5 5s. Packing and Carriage, 3/-.

Enlarged Illustrated Catalogue sent post free for 4d. stamps.
Phone: **LESLIE DIXON & Co. Ltd.**
City 191, 218, Upper Thames Street, London, E.C.4.

Absorbs shock—Protects your valves

You know it's good —because of the name LOTUS.

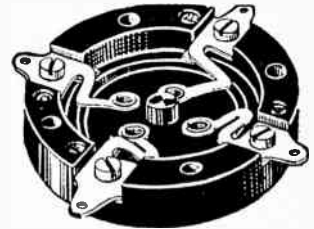

UNDERSIDE SHOWING SPRINGS.

Don't have your valves spoiled by shock. The Lotus Valve Holder has been specially designed to counteract the microphonic elements that are so injurious to the delicate valve filaments.

The unique and original springs of the Lotus Valve Holder absorb any shock and eliminate all microphonic noises.

Protect YOUR Valves by fitting the Lotus Holder

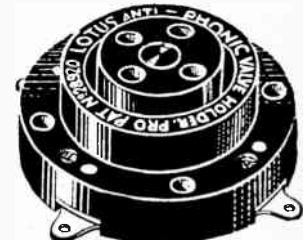

TOP VIEW.

Valve sockets and springs are locked together by a mechanical process, making a definite and permanent connection. Bakelite mouldings, nickel silver springs and phosphor bronze valve sockets. Nickel-plated.

LOTUS

BUOYANCY
VALVE HOLDER
ANTI-MICROPHONIC

GARNETT, WHITELEY & CO., LTD.,
Lotus Works,
Broadgreen Road, Liverpool.

Makers of the famous Lotus Buoyancy Valve Holder.

2/3

With Terminals 2/6

INDEX TO ADVERTISEMENTS.

Accumulators Elite	PAGE 20	Dixon, Leslie & Co.	PAGE 19	Miller, J.	PAGE 20
A.J.S. & Co. (1914), Ltd.	9	Imbilier Condenser Co. (1925), Ltd.	Cover ii.	Nelson Electric Co., Ltd.	17
Barton, J. & W.	4	Edison Swan Electric Co., Ltd.	Cover iv.	Ormond Engineering Co., Ltd.	3
Bowyer-Lowe Co., Ltd.	15	Electron Co., Ltd.	Cover iii.	Partridge & Wilson	15
Brandes, Ltd.	13	Finston Manf. Co., Ltd.	20	Pugh Bros.	20
Bretwood, Ltd.	17	Fitzpatrick, H. D., & Co.	20	Radi-arc Electrical Co., Ltd., The	4
Britannia Rubber & Kamptulicon Co., Ltd.	4	Gambrell Bros., Ltd.	19	Radians, Ltd.	20
British Ebonite Co., Ltd.	4	Garnett, Whiteley & Co., Ltd.	19	Reactone, Ltd.	17
British Electrical Sales Organisation	5	General Radio Co., Ltd.	15	Silvertown Co., The	15
British Glowlamp & Valve Co.	4	Graham, Alfred, & Co.	11	Sifam Elec. Inst. Co.	15
British L.M. Ericsson Manf. Co., Ltd.	20	Igranite Electric Co., Ltd.	11	Stratton & Co., Ltd.	15
Burdapt Wireless, Ltd.	2	Jones & Stewart	15	Taylor, J. H., & Co.	7
Cahill & Co., Ltd.	Cover iii.	Lee & Churchill, Ltd.	19	Telegraph Condenser Co., Ltd.	7
Caxton Wood Turnery Co.	17	Lissen, Ltd.	8	Telephone Manf. Co., Ltd.	7
Charlesworth, W. J.	Cover iii.	London Elec. Wire Co. & Smiths, Ltd.	5	Varley Magnet Co., Ltd.	19
Collinson Precision Screw Co., Ltd.	20	Marconiophone Co., Ltd., The	13	Watmel Wireless Co., Ltd., The	4
Darex Radio, Ltd.	13	Marconi's Wireless Telegraph Co., Ltd.	13	Wilkins & Wright, Ltd.	20
Darimont Electric Batteries, Ltd.	13	McMichael, L., Ltd.	10	Withers, J. S., & Spooner	20
		Metro-Viek Supplies, Ltd.	10		

H.T. Accumulators 37/6
60 Volts 3 Actual Amp.-hour



The finest H.T. Accumulator in the world.



55/-
Co-volt, 3-amp.-hour, oil submerged. Will last a lifetime. Write for descriptive folder.
MONEY RETURNED IF NOT SATISFIED. Obtainable only from ACCUMULATORS ELITE, 31 Waterhouse St., Halifax.
Trade supplied. Telephone: 1304.



finston

LO-LOSS COILS

No. 25 - 1/3	No. 150 - 2/9
No. 35 - 1/6	No. 175 - 3/3
No. 50 - 1/9	No. 200 - 3/6
No. 75 - 2/0	No. 250 - 3/9
No. 100 - 2/6	No. 300 - 4/0

OBTAINABLE FROM ALL DEALERS
FINSTON MANUFACTURING CO., LTD.,
45, Horseferry Road, LONDON, S.W.
Phone: Victoria 1044



Tested low-loss condensers

Constructors! For your D.X. work plump for Ericsson Tested Condensers. They're the last word in accuracy. Losses are kept down to zero. Stout vanes accurately spaced — engineer-built all through. They pull their weight in long-distance work. Template supplied. Ebonite end plates.

Write for lists to-day.
Prices:
0005 10/6
001 12/8

The **BRITISH L.M. ERICSSON** Mfg. Co. Ltd.,
67/73, Kingsway, London, W.C.2.

Ericsson
TESTED CONDENSERS

PATENTS, DESIGNS & TRADE MARKS.

H. D. FITZPATRICK & CO.
Chartered Patent Agents,
49, Chancery Lane, London, W.C.2
Phone: Holborn 458.

Your First Steps in Wireless
By **HUGH S. POCOCK**
Editor of "The Wireless World"

A most helpful little book for those who are beginning to study wireless. It explains technical difficulties by simple analogies.

Price 9d By Post 11d

From **ILIFFE & SONS LIMITED**
Dorset House, Tudor Street, London, E.C.4
and leading booksellers. w.w. 14

06 DE'S 10/6

Our Valves are admitted to be the best British made valves on the market. 3 Volt 06 L.F. or H.F. only 10/6. 2 Volt 34 only 10/6. Power Valves from 12/6. Write at once for our FREE BOOK and get full particulars. If your dealer is "tied" we supply direct. **RADION LTD.** Radio Works, BOLLINGTON, Macclesfield, England.

RADION
Reliable Valves

TROLITE PANELS

Mahogany Grain 3/6 lb.
Black Engraved wavy 3/9 lb.
Black plain polished 3/- lb.

Machine cut Tested to your own measurements. 50,000 Volts.

PUGH'S WIRELESS, 95-101, Holloway Road, London, N.7

EBONITE BUSHES

FOR MOUNTING ON WOOD. PERFECT INSULATION

Orders under 1/- send 1/4. Postage

Two required for each hole

NUMBER 1	2	3	4	5
Size of hole	4BA.	2BA.	1 1/4".	5/16". 3/8"
Price each:	1d.	1d.	1 1/2d.	2d.

DAREX RADIO CO.,
Standard Works, Forest Hill, S.E.23

PATENTS, DESIGNS AND TRADE MARKS.

J. S. Withers & Spooner.
Chartered Patent Agents,
FRABLE HOUSE,
61 & 62, CHANCERY LANE,
LONDON, W.C.2.
Cables: IMPROVABLY.
461A, LONDON.
7 hon: 480 HOLBORN

THE MOTORCYCLE

The Motor Cyclists' Newspaper
EVERY WEDNESDAY — 3d.

Publishers: **ILIFFE & SONS LTD.,** Dorset House, Tudor Street, London, E.C.4. w.w.15

REPAIRS SETS PHONES TFORMERS

— Officially approved by Radio Association —

ALL WORK GUARANTEED. LOWEST RATES. 24 HOUR SERVICE.

JOHN W. MILLER, 68, Farringdon Street, E.C.4
PHONE: CENTRAL 1950

AC4 Mention of "The Wireless World." when writing to advertisers, will ensure prompt attention.

CAXTON 4-VALVE CABINET

Made for Editor of Wireless Magazine for Set "As good as money can buy" described in issue February, 1925.

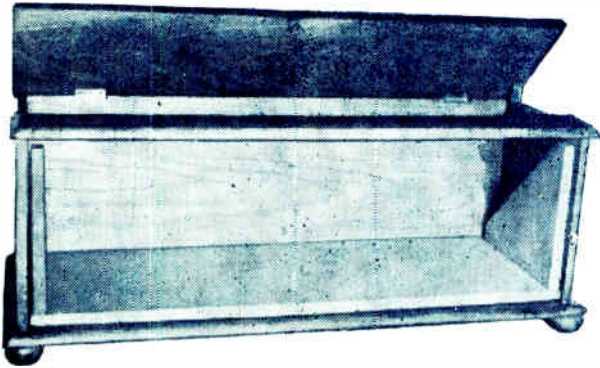

Cash with Order. Fumed Oak ... £1 5 0
 or Real Mahogany polished ... £1 14 0

With detachable recess fitted Base Board to mount 21 in. by 7 in. panel to slide out of Cabinet front. Extra 10/- with two beaded front doors totally enclosing fitted panel.

Cabinet overall length 22½ ins. Width 8½ ins. Height 9 ins.

Polished with the new enamel that gives a glass hard surface that cannot be soiled or scratched.

SENT FREE.—Catalogue of standard Wireless Cabinets in various sizes and woods. Special Cabinets made to customer's orders.

PACKED AND DELIVERED FREE IN U.K.

CAXTON WOOD TURNERY CO., Market Harborough



SELECTORS actually convert your receiver to an accurate wavemeter, ideal for short wave and all exacting requirements.

Perfectly insulated, and may be mounted on metal panel.

Pamphlets on request.

Capacity :—	.001	£1 3 0
	.00075	1 2 0
	.0005	1 1 0
	.0003	1 0 0
	.0002	19 0
	.00015	18 0

THE COLVERN LOW LOSS SELECTOR

Calibration with certainty to the 1,000th part of the variable capacity. This is the tuning efficiency obtained with the Colvern Selector. The complete circle of the dial is divided to provide a value of 100 intervals for every rotation of the index. Pre-supposing your condenser and inductance to cover 300 metres, each interval represents 3 metres—obviously every station can be calibrated definitely.

The Colvern is logically the only condenser worthy of the attention of serious experimenters. An insulated spindle reduces the effect of hand capacity to a minimum, a point of paramount importance in the reception of distant signals.

See the Colvern at your dealers!
THE COLVERN LOW LOSS SELECTOR
 (Geared 20-1.)

COLLISON PRECISION SCREW CO., Ltd.,
 Provost Works, Macdonald Road, Walthamstow, London, E. 17.
 Telephone: Walthamstow 532.

Figures to Remember



The Sweep

HE went about with his long-handled brushes crying "Sweep, Sweep," and he made all the difference to your fire. SIX-SIXTY VALVES make all the difference to your set; they hold a potential store of volume at your bidding, while they ensure perfect quality of tone. The secret of this wonderful difference is to be found in the extensive research and perfect workmanship expended on each particular valve.

Not only has this research been the means of ensuring a wonderful purity of tone and increased power, but due to our success in considerably reducing filament temperatures, the life of 660 Valves has been immeasurably increased. Every valve of our new range is specially designed to carry out its particular job; they are all stamped with the Six-Sixty mark of PERFECTION OF QUALITY.

If you want a general purpose valve you have the S.S.1. This valve can be used in any position in a set, either as Detector, H.F. Amplifier, or L.F. Amplifier—a useful valve as a spare. Although a bright valve, its current consumption is only 66 amps., a figure which compares very favourably with the average Bright Emitter to-day. For Dull Emitters you have the rest of the Six-Sixty range to choose from.

The S.S.4, a power amplifier, is designed to operate the largest types of Loud Speakers, giving remarkably pure reproduction.



S.S.1.

Bright Emitter
 General Purpose Valve.
 Voltage - 3.7 volts.
 Consumption 66 amps.
PRICE 8/-

Ask your Dealer for Leaflet S.S.1.7 for full particulars of complete range.



BETTER BY SIX TIMES SIXTY
 The Electron Co., Ltd., Triumph House, 189, Regent St., London, W.1.

EDISWAN VALVES ARE ENTIRELY BRITISH MADE
THE PERFECT PAIR—

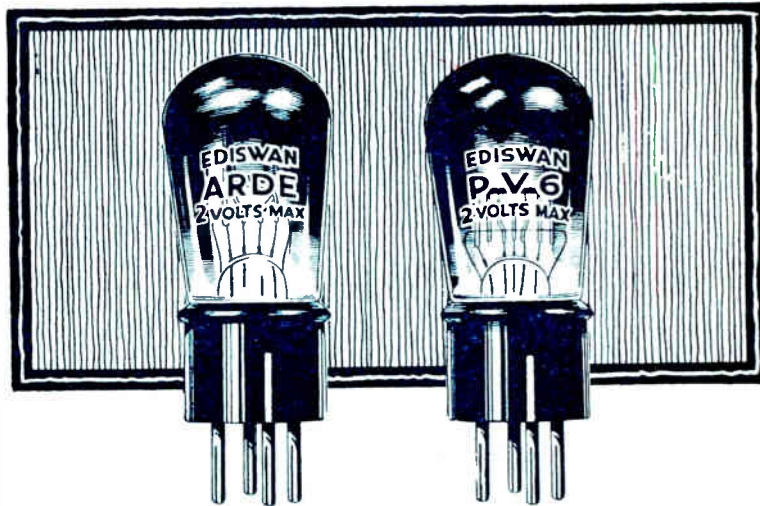

Use them *together*. It is the only way to get the real Edison Swan quality of reproduction. Individually, Edison Swan Valves are always better—very robust; very long in life; very reliable in service. But it is in co-operation that Edison Swan Valves give the most remarkable results—you can test this on your own set.

Ediswan A.R.D.E. is made to function either as a L.F. amplifier or detector (green line) or as a H.F. amplifier (red line). Ediswan P.V.6 (Loud Speaker Valve) is specially designed for use when A.R.D.E. is used in the preliminary stages.

The following table indicates the combinations of Edison Swan Valves that give the best results :—

Receiving.	Accumulator or Battery Volts.	Power.
AR	6	PV5
ARDE	2	PV6
AR'06	3	PV8

With these groups and Edison H.T. and L.T. Accumulators the ideal is attained.

THE EDISON SWAN ELECTRIC CO., LTD.,
 123-5, Queen Victoria Street, London, E.C.4.

EDISWAN VALVES
 The PIONEER VALVE

4^D

The Wireless World

AND RADIO REVIEW

The Paper for Every Wireless Amateur

Wednesday, March 24th, 1926



SENIOR *performance* JUNIOR

price



SWAN-NECK Junior
Type A.R.38
price 38/-

Types
A.R.58, 58/-, A.R.88, 84/-,
A.R.88 O & A.R.88 M, 95/-

It is natural to assume that an inexpensive loud speaker cannot be a good one—but it is not so if the loud speaker is an AMPLION.

Ask your dealer to let you hear the Junior Swan-Neck model A.R.38—compare with it other and larger loud speakers costing much more. It may not come out best against them all, but it will hold its own easily with many of twice the size and double the price.



Obtainable from AMPLION STOCKISTS, Radio Dealers or Stores
Demonstrations gladly given during business hours at the
AMPLION Showrooms:

25-26 Savile Row, London, W.1.
79-82 High Street, Clapham, S.W.4.

101, St. Vincent Street, Glasgow.
10, Whitworth St West, Manchester.

There is no substitute for a genuine AMPLION

Announcement of Alfred Graham & Co. (E. A. Graham), Crofton Park, London, S.E.4
Mention of "The Wireless World," when writing to advertisers, will ensure prompt attention.

Read what is said by delighted users of



INTERVALVE TRANSFORMERS

"...There is no doubt your AF3 is ahead of any other at the present time."

"...the deep notes and the roll of drums are splendidly reproduced."

"...have yet to find a transformer which will equal the almost perfect results which yours gives."

"...am so pleased with the great increase in volume, and the perfect purity of reproduction, that I have decided to scrap all my other transformers and replace throughout with Ferranti AF3's."



25/-

Ask your Dealer for Ferranti AF3:
"THE NEARLY PERFECT TRANSFORMER."

FERRANTI LTD., HOLLINWOOD,
LANCASHIRE

CAXTON 4-VALVE CABINET

Made for Editor of Wireless Magazine
for Set "As good as money can buy"
described in issue February, 1925.

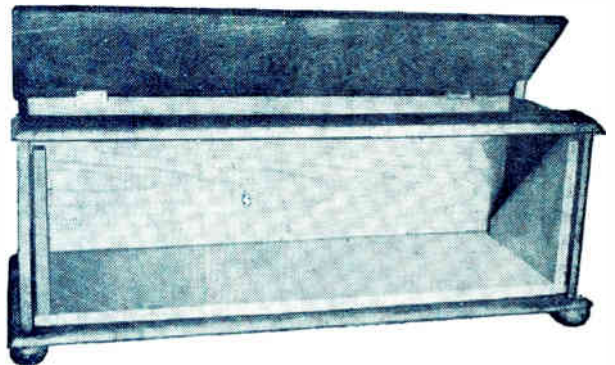

Cash with Order. Fumed Oak ... £1 5 0
or Real Mahogany polished ... £1 14 0

With detachable recess fitted Base Board to mount 21 in. by 7 in. panel to slide out of Cabinet front.
Extra 10/- with two beaded front doors totally enclosing fitted panel.
Cabinet overall length 22½ ins. Width 8½ ins. Height 9 ins.
Polished with the new enamel that gives a glass hard surface that cannot be soiled or scratched.
SENT FREE.—Catalogue of standard Wireless Cabinets in various sizes and woods. Special Cabinets made to customer's orders.

PACKED AND DELIVERED FREE IN U.K.

CAXTON WOOD TURNERY CO., Market Harborough

ANNOUNCING

S.M. PARTS

for the **SILVER MARSHALL ALL WAVE SUPER-HETERODYNE**

.....
50-3,000 metres.

Ever since the first S.M. product was marketed, the reputation for quality apparatus of originally distinctive design has been growing steadily until to-day it is only logical to find S.M. with apparatus not designed just for season 1925-6, but with equipment that will be adding to that reputation years hence.



TYPE 210 & 211 TRANSFORMERS.

S.M. Type 210 and 211 Charted Intermediate Transformers are produced under new and advanced manufacturing processes, and each transformer is supplied with an individual amplification chart showing its characteristic curve.

Kit consisting of Two type-210 laboratory charted transformers and One type-211 filter with matched condenser
£6 : 5 : 3

AERIAL & OSCILLATOR COILS.

All bakelite low loss interchangeable coils with adjustable rotor.

AERIAL.	OSCILLATOR.
110A. 190-550 m.	111A. 190-550 m.
110B. 90-210 m.	111B. 90-210 m.
110C. 50-110 m.	111C. 50-110 m.
13/6 each	13/6 each
110D. 500-1,250 m.	111D. 500-1,250 m.
16/6 each	16/6 each
110E. 1,200 m. up.	111E. 1,200 m. up.
17/6 each	17/6 each

TYPE 515 SOCKET, 5/6 each



S.M. SELECTOR DIAL.

The S.M. Vernier Control is provided with reversible scales for all types of condensers. Finished in dull black bakelite.

List Price 13/6 each



Write for :-

Complete Wiring Diagram and Instructions for the S.M. All-wave Super Heterodyne, 6d. post free.

We have also in stock kits and components for the "SILVER SIX" and "SILVER-COCKADAY" Receivers.

Complete instructions and diagrams for the "Silver-Six," 2/6 post free.

The "Silver-Cockaday" Instruction Book, 1/6 post free.

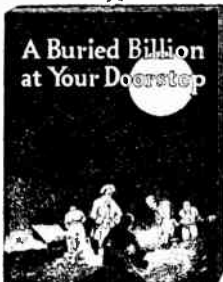

The 2nd Edition of our new and enlarged 1926 Radio Catalogue and Circuit Supplement is NOW READY. It contains the most exhaustive information on the World's Finest Radio Apparatus and a Supplement of America's Foremost Circuits. Send for your copy immediately, enclosing 9d in stamps to cover cost of postage.

ANNOUNCING

B.T. PARTS

for the **BREMER-TULLY COUNTERPHASE RECEIVERS**

.....
4, 5 and 6 valve.

We firmly believe the COUNTERPHASE will not be equalled for years to come. B.T. Products are the result of years of experimental work and have a habit of not going out of date.

COUNTERPHASE KITS.

Kits for building the Counterphase contain essential parts and complete blue prints with building instructions

Kit No. 6 for 6-valve Receiver (operating on short indoor antenna)
£9 : 18 : 6

Kit No. 5 for 5-valve Receiver (for outdoor antenna)
£7 : 8 : 6

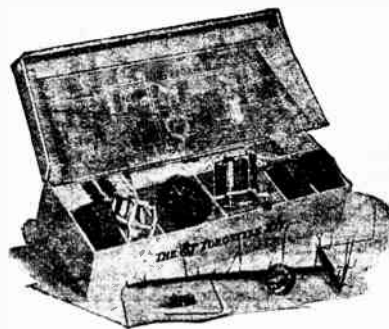

TOROSTYLE TRANSFORMERS.

The heart of the "Counterphase." A coil that reduces local pick-up to a minimum. Eliminates inter-coupling and stray feed-backs.

Type T.A. (Antenna Coupler) 21/- each
 Type T.C. (Interstage R.F.) 21/- each
 Type T 4 for 4-valve Set .. 21/- each

TANDEM CONDENSERS.

All the efficiency of the well-known B.T. Lifetime Condenser is now available in the Tandem.

One Dial controls Two Condensers. Close balance between two units is obtained by the sensibly-designed B.T. Trimming Arrangement.
 Type I. D. 17, '00035 (employed with Torostyles)
49/6 each.



Write for :-

"Better Tuning," 8th Edition. A 48-page Booklet of diagrams, hook-ups, and general advice. Post free, 6d.

The 9-Colour Wiring Diagrams for the "Counterphase" surpass all previous efforts.

**A COLOUR FOR EVERY WIRE.
 A WIRE FOR EVERY COLOUR.
 POST FREE, 4/6.**

ROTHERMEL RADIO CORPORATION of GREAT BRITAIN LTD.,

24-26, Maddox Street, Regent Street, LONDON, W.1.

Telephone: Mayfair 578-9.

Telegrams: Rothermel, "Wesda," London.

ARE YOU USING

MELLOWTONE

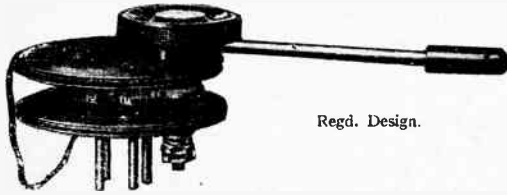

Regd. Design.

COUPLERS ?

YOU SHOULD BE—you will obtain far better results by doing so and also SAVE MONEY!

"MELLOWTONE" Couplers are specially designed to avoid distortion in telephony reception, they give excellent selectivity and perfectly smooth reaction control.

They plug into standard valve holders, take up small panel space, have small external field and high coupling ratio.

Obtainable from all reputable dealers. Write for Illustrated List of this and other Mellowtone Specialities—and if interested in QUALITY Receivers, ask for Catalogue of Mellowtone Two and Four Valve Sets.

AERIAL AND REACTION	
25	5/6
35 (B.B.C.)	5/6
50	5/6
75	5/6
Daventry	7/6
TUNED ANODE AND REACTION	
250-650	5/6
650-1650	7/6
1500-3000	10/6

(Daventry)

**REPLACE
COILS AND
HOLDERS
AT LESS
THAN HALF
THE COST.**

**LONDON DEPOT: "MELLOWTONE,"
TRIUMPH HOUSE, 189, REGENT STREET, W.1
Telephone: Regent 1660.**

MELLOWTONE
MIDLANDS RADIOTELEPHONE MFRS LTD.
BRETTELL LANE WORKS
STOURBRIDGE
Radio-Ads.

EDISON BELL RADIO

THE EDISON BELL "MUSICALLY PERFECT" SPEAKER.

Facts worthy of your consideration.

IT IS NOT THE LOUDEST — BUT THE MOST NATURAL.
NOT THE SOFTEST — BUT THE MOST MUSICAL.
NOT THE MOST CONSPICUOUS — BUT THE MOST ARTISTIC.
NOT THE MOST EXPENSIVE — BUT THE BEST.

PRICE 42/-

(OF ALL HIGH-CLASS DEALERS).

DEMONSTRATIONS WILLINGLY GIVEN AT OUR WEST END SHOWROOMS, BANGALORE HOUSE, 1, NEWTON STREET, HIGH HOLBORN, W.C.

Ask your dealer for catalogues or write direct.

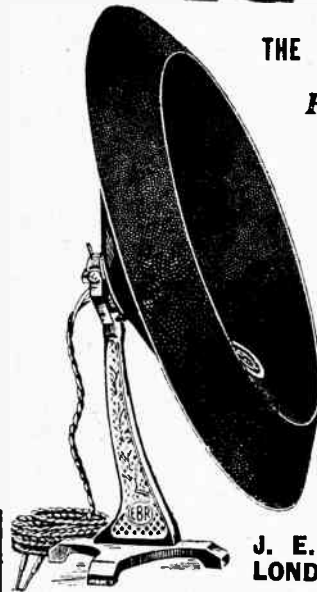

**J. E. HOUGH, Ltd., Edison Bell Works,
LONDON, S.E.15.
And at Huntingdon.**



TESTED 500 VOLTS
FLAT TYPE



TESTED 500 VOLTS
UPRIGHT TYPE

INSIST ON EDISON BELL CONDENSERS

THEY ARE BRITISH MADE AND GUARANTEED BY A NAME WITH 30 YEARS REPUTATION BEHIND IT

A2 Mention of "The Wireless World," when writing to advertisers, will ensure prompt attention.

There!



A Filament that can be tied in knots after 1000 hours life

A FILAMENT that remains ductile so that it can be tied in a knot after 1000 hours life is an achievement that assures **VASTLY INCREASED VALVE LIFE**

This wonderful filament is the key feature of Mullard P.M. Valves. In Mullard P.M. Valves the filaments are so economical that no glow is visible during operation, and they require

ONLY ONE-TENTH AMPERE

In addition the reception they give is free from all microphonic noises.

If you use a 4-volt accumulator or 3 dry cells

ASK FOR THE P.M.3 16/6

A general purpose valve for every circuit

ASK FOR THE P.M.4 22/6

The finest loudspeaker valve ever produced

GET THEM FROM YOUR RADIO DEALER

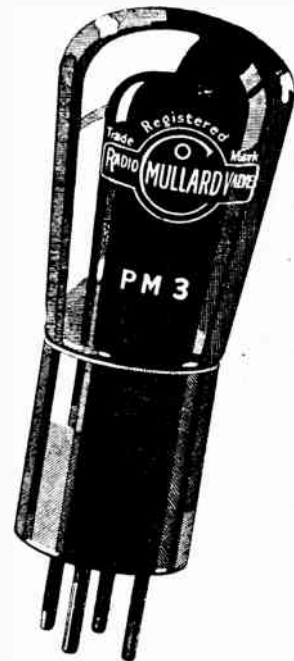

Mullard

THE · MASTER · VALVE

ADVT., THE MULLARD WIRELESS SERVICE CO., LTD., NIGHTINGALE LANE, BALHAM, LONDON, S.W.12.

Advertisements for "The Wireless World" are only accepted from firms we believe to be thoroughly reliable.

Simplify your switching! arrangements! with **TMC** Low Capacity Keys

THE Amateur Constructor will find many of his switching problems easy of solution if T.M.C. Low Capacity Keys are employed.

These Keys are of simple design, strong and accurately made. Being compact they are most useful where space behind the panel is limited. They are particularly easy to connect up because the ends of the springs are tinned to facilitate soldering.

T.M.C. Low Capacity Keys have many uses. Here are but a few:—

- Distant Control.*
To give choice between:—
Crystal Detector only and Crystal Detector with low frequency amplification.
Valve Detector only and Valve Detector with low frequency amplification.
One or more stages of low frequency amplification.
Change over from headset to loud speaker.



No. 1 L.C. Key, Price 7/-

T.M.C. Low Capacity Keys are made in 3 models.

- No. 1. 12 point, 3 position **7/-**
- No. 2. 6 point, 2 position **6/-**
- No. 3. 24 point, 3 position **15/6**

Write for descriptive leaflet.

If you cannot obtain T.M.C. Low Capacity Keys from your local dealer apply to the sole manufacturers:—

**TELEPHONE MANUFACTURING CO., LTD.,
Hollingsworth Works, West Dulwich, S.E.21.**

'Phone: Sydenham 2460/1.

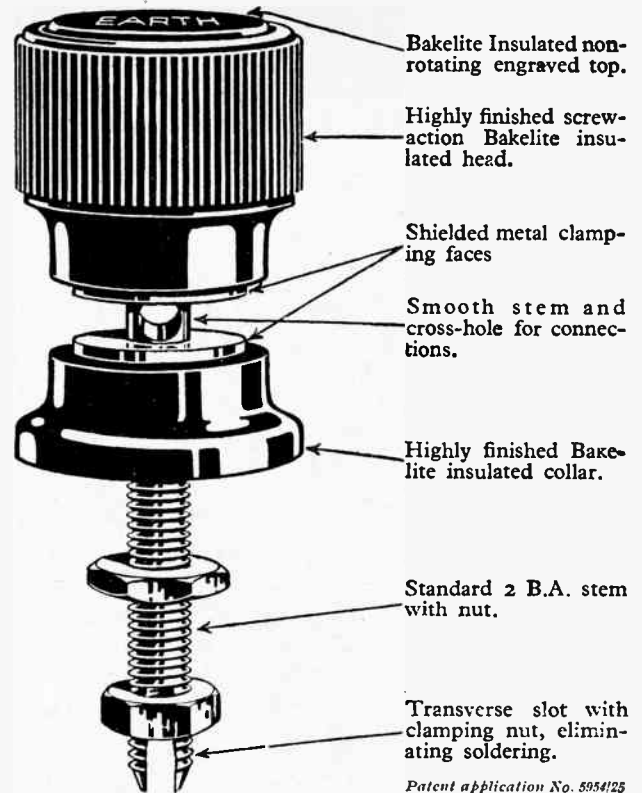

Patent application No. 5954/25.

“Don't spoil the set for a hap'orth of Terminal”

Belling-Lee Insulated Terminals may cost you a fraction more, but no one with a pride in his set will grudge it. Belling-Lee Terminals are finely finished work and an ornament to the set, as well as an aid to its efficiency. Every possible and desirable feature of an indicating terminal is found in the Belling-Lee, and twenty-eight different kinds of engraving are available.

Standard (Bakelite-insulated) (Type B) 9d. each.
Popular (Non-Insulated) (Type M) 6d. each.

BELLING-LEE PRODUCTS.

Terminals, Plugs and Sockets, Couplers, Double Sockets, Sub-connectors, Dial Indicators, Air Space Wire, Coil Holders, Variometers, Detectors, Distribution Boards, Crystal Sets.

Illustrated Catalogue post free on request.

BELLING-LEE PANEL FITTINGS

QUEENSWAY WORKS PONDERS END, MIDDLESEX.

E.P.S.I



B.500. INTERVAL TRANSFORMER. Guaranteed for 12 months. Price 21/- each. This Transformer has been adopted by leading manufacturers of wireless receiving sets and discriminating amateurs in all parts of the world. Excellent results have been obtained on tests carried out by the National Physical Laboratory. Copy of the curve can be had on application.

Silvertown

on a Wireless Component-

Means



B.558. VARIABLE CONDENSERS. For use as independent units. Strongly constructed on the same principle as variable condensers for panel mounting. Enclosed in dust-proof, non-inflammable Celastoid covers, and fitted with dial knob, two terminals, and three feet for fixing to table or board if required. Price 12/- each.

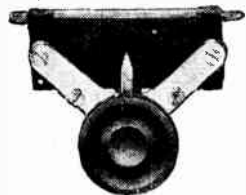

SILVERTOWN POTENTIOMETERS. On rectangular ebonite former complete with knob and pointer. Former mounted on cast brass frame. Resistance approximately 400 ohms.

New Reduced Prices.

B.529. For panel mounting, 5/-; old price, 7/6.
B.564. Mounted, 15/6; old price, 18/6.

an assurance of the finest quality obtainable. For over 50 years The Silvertown Company have been manufacturing Electrical Apparatus, during which time they have gained an unassail-

able reputation for quality, accuracy and workmanship in all their products. To say "Silvertown," therefore, when buying wireless accessories is a safeguard to you in ensuring

Perfect Reception

Makers :

THE SILVERTOWN COMPANY

106, Cannon Street, London, E.C.4.

Works : Silvertown, E.16.

BELFAST : 75, Ann Street.
 BIRMINGHAM : 15, Martineau Street.
 BRISTOL : 4, Victoria Street.
 CARDIFF : Pier Head Chambers, Bute Docks.
 DUBLIN : 70, Middle Abbey St.

GLASGOW : 15, Royal Exchange Square.
 LEEDS : 1, New York Road.
 LIVERPOOL : 54 Castle Street.
 LONDON : 100 and 102, Cannon Street.

MANCHESTER : 16, John Dalton Street.
 NEWCASTLE - ON - TYNE : 50, Westgate Road.
 PORTSMOUTH : 49, High Street.
 SHEFFIELD : 82-90, Queen Street





Take the **SHORTPATH** to Better Reception

COMPARE the characteristics of SP 18 valves with the published figures of other makers. Take the Voltage Amplification Factor, multiply it by the Mutual Conductance in micromhos. The square root of the product is the figure to use when comparing the relative merits of valves. The characteristics of SP 18 valves are:—

	RED SPOT	GREEN SPOT
Voltage Amplification Factor	7	15
Impedance	7,000	17,000
Mutual Conductance micromhos	1,000	850
Figure of Merit	84	113

Then buy a S.P. 18 Valve and make the practical comparison obtainable from most wireless dealers.

METRO-VICK SUPPLIES LTD.,
 (Proprietors, Metropolitan-Vickers Electrical Co. Ltd.)
 4, Central Buildings, Westminster, London, S.W. 1

Compare also the filament details. SP 18 Valves require only a single cell 2-volt accumulator consuming 0.3 Amp. at 1.6 to 1.8 Volts

Compare finally the price. "Cosmos" **SHORTPATH** Valves cost:

Green Spot } **12/6**
 or
 Red Spot: }

Cosmos

RADIO VALVES

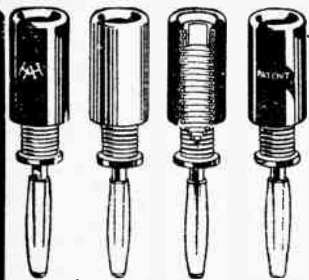

Fig. 975
 Code Word
"WOBBLERS"
 Per 1/6 Set of Four
 (3 black, 1 red).

THE ANTI-VIBRATION SPRING IS HERE

YOU'LL CONVERT YOUR RIGID HOLDERS NOW IT'S SO EASY.



NO TROUBLE. JUST PLUG THEM IN. No Soldering. No Wiring. No alteration at all.



Fig. 976.
 Code **"DUAL"** Word
PURPOSE.
 DOUBLE-ENDED.
 PRICE .. 1/9 each.

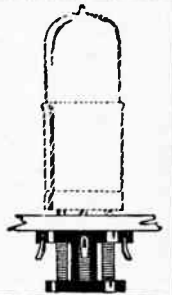

THE FOOL-PROOF HOLDER

AND HERE

FOR BASE OR PANEL FITTING OR IN ANY OTHER POSITION.

The smallest and neatest combined holder on the market.

No joints because the soldering tag is the same piece of wire as the spring.

Show cards and display cards free.

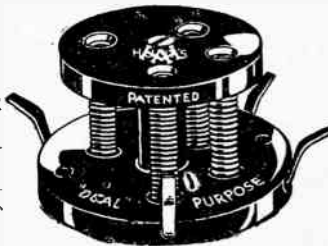

THE THREE LARGE ILLUSTRATIONS ARE FULL SIZE.

AND HERE

For the genuine experimenter who must have a holder without capacity, and perfectly sprung. Hunt's "WOBBLY" is ideal. It is impossible to have fewer parts, or to better insulate, separate or spring them. Separately sprung legs are far more effective than a closed-in solid spring top.

Fig. 974.
 Code **"WOBBLY"** Word.
 PRICE .. 2/3 each.

THE IDEAL EXPERIMENTER'S HOLDER
 TOO SIMPLE TO IMPROVE

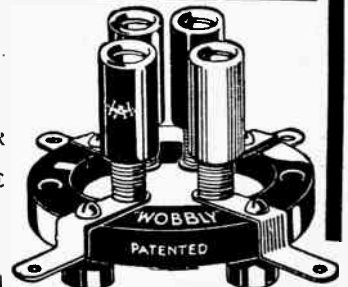

Made under patents 242057/24, pro. pats. 30670/25 and 40/26, by

A. H. HUNT, Ltd. (Dept. 1), Croydon, Surrey.

DUBILIER CONDENSERS

Are used in many famous sets
e.g. STANDARD - BURNDIPT
B·T·H ♦ POLAR ♦ ETC
See that they are in your set



REGISTERED  TRADE MARK

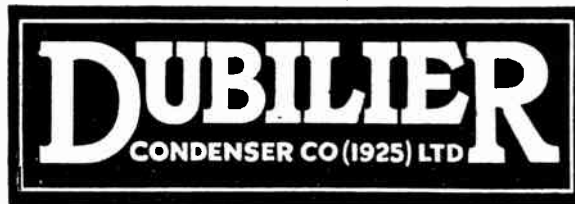

ADVERT. OF THE DUBILIER CONDENSER CO. (1925) LTD., DUCON WORKS,
VICTORIA RD., NORTH ACTON, W.3 TELEPHONE: CHISWICK 2241-23.

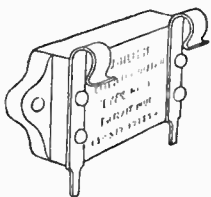

Type 600

*A Mica Condenser for
all purposes.*
0·0001-0·0009 mfd., 2/6
0·001 -0·006 mfd., 3/-
(With or without grid-
leak clips.)

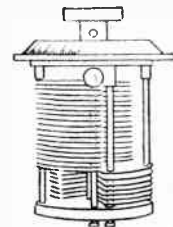

The Duwatcon

*A Special Variable Con-
denser giving a very wide
tuning range with only
one coil.*
0·0007 mfd - - 30/-

E.P.S.181



Sparta sales are built on a reputation for good tone. That fine full voice is a secret shared by no other loud speaker. The new patent magnetic compensator gives a remarkably distinct rendering. The tone modulator in the base gives the right interpretation to every item.

SPARTA Fuller LOUD SPEAKER

FULLER'S UNITED
ELECTRIC WORKS, LIMITED.
Chadwell Heath, Essex.

Telephone: Ilford 1200.
Telegrams: Fuller, Chadwell Heath.
LONDON DEPOT:
176, Tottenham Court Road, W.1
Telephone: Museum 9008.

For 1-3 valves: Types HHA, HHB, or HHI.
For 3-5 valves: Types HA or HB.
For 5 valves or more: Types A or B.
Types A, HA, HHA .. 24 15 0
Type B .. 25 15 0
Types HB, HHB .. 28 0 0
Type HHI .. 32 10 0
Type B models fitted with both volume and tone control.

*The Secret
is in the
Base*

USE
FULLER
Ebonite

174-50*

Figures to Remember



The Crossing Sweeper

A figure that never failed to attract the attention of the passers-by. Every day the figures 660 are attracting more and more attention because wireless enthusiasts are realising that the new Six Sixty range includes valves specially designed to suit their individual requirements.

The S.S.7—a wonderful Dull Emitter Power Amplifier—has evoked widespread enthusiasm. This Valve is entirely non-microphonic and is capable of handling output sufficient to work the largest Loud Speaker with entire absence of distortion. **It works at such a low temperature that even in the dark there is absolutely no glow from the filament when operating at the correct voltage.** And this is not all—despite the remarkably low temperature attained, the unique design of the S.S.7 ensures that there is no decrease whatever in electron emission, in short **the S.S.7 combines unequalled volume with a wonderful purity of tone.**

There is no valve that can boast of a longer life than the Six Sixty S.S.7, because there is no valve that operates at a lower temperature. Test it for yourself, or get your Dealer to demonstrate it for you.

The S.S.7 is a 3.7 Volt Valve, and its current consumption is so low—only 1 amp.—that it can be satisfactorily operated from dry cells or a 4-volt accumulator.

For long life, real economy, and perfect tone insist on Six Sixty Valves.



S.S.7

Voltage .. 3.7
Consumption .. 1 amp.

PRICE 22/6

Write for leaflet
S.S.1.7 for full
particulars of
complete range.



BETTER BY SIX TIMES SIXTY

The Electron Co. Ltd., Triumph House, 139 Regent Street, London, W.1.

Built to last

C.A.V.



Car Equipment
Manufacturers by
Appointment to
H.M. THE KING.

H.T. ACCUMULATORS

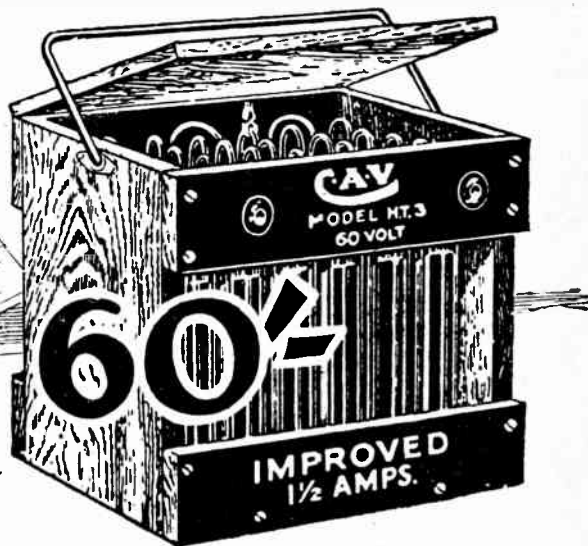
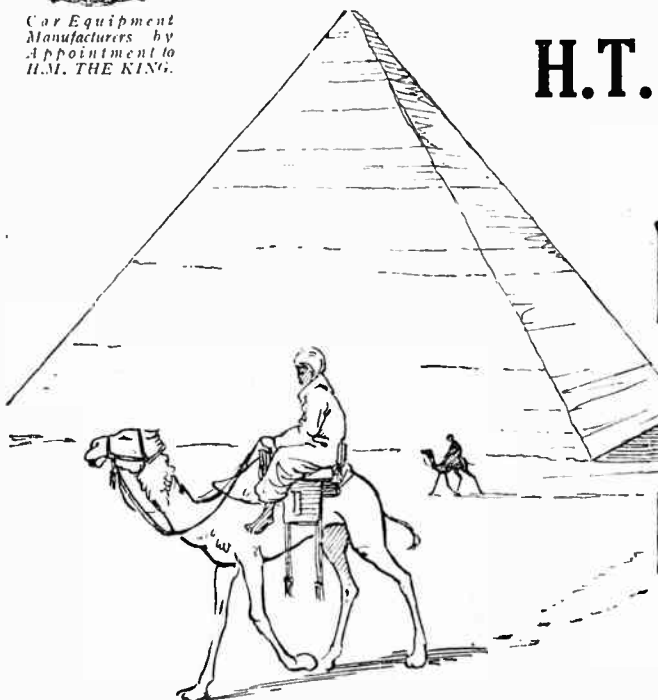

ACCUMULATOR claims are numerous, but C.A.V. claim 33 years' manufacturing experience. The C.A.V. H.T.3 was designed with that experience behind it and is constructed to work with the average broadcast receiver. It is electrically efficient and all that can be desired for really reliable radio reception. Over 10,000 SATISFIED USERS. Moreover, it is exclusively used by those who know, namely:—

- Mr. W. K. Alford, radio 2 DX;
- Mr. V. E. M. Oliver, B.A., A.M.I.E.E., radio 6 BV;
- Mr. J. A. Partridge, radio 2 KF;
- Mr. E. J. Simmonds, M.I.R.E., F.R.S.A., radio 2 OD;

and others who find them essential when setting up wonderful records in reception throughout the world.

For your L.T. supply, "Acton" Accumulators in celluloid or glass.

Write for a copy of our complete Radio Catalogue.

C.A. Vandervell & Co. Ltd.
ACTON VALE LONDON W.3

Supplied at 1/- per volt.

- H.T.3. 60 volts 60/-
- H.T.4. 30 volts 30/-

ALL C.A.V. H.T. ACCUMULATORS are supplied fully charged (first charge free).



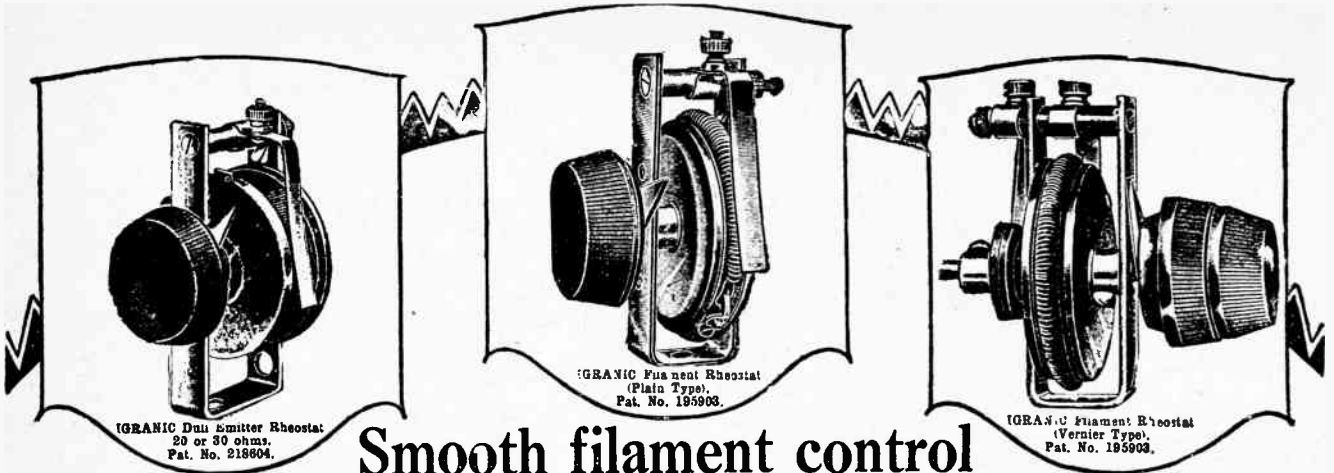

Smooth filament control

lengthens the life of your valves.

With the Igranic Wire-wound Rheostats the resistance variation is continuous, regular and silent over its whole range. There are none of the dangerous flickerings and uneven fluctuations so often experienced with many wire-wound and carbon Rheostats.

You can build the same Igranic Rheostat into each succeeding receiver you construct and always get the smooth-even and noiseless variation which gives perfect filament control and lengthens the lives of your valves.

Ask your Dealer.

- | | |
|--|-----|
| Plain Type (4, 6, 8 or 10 ohms resistance) | 3/6 |
| Vernier Type (4, 6, 8 or 10 ohms resistance) | 5/6 |
| Dull Emitter Type (20 or 30 ohms resistance) | 5/6 |



Write for List U. 162.
Exclusive Manufacturing Licenses of Patent Radio Essentials.
149, Queen Victoria Street, London.
Works: BEDFORD.

The Big Three

The 'AMYCO' Light-weight RHEOSTAT.

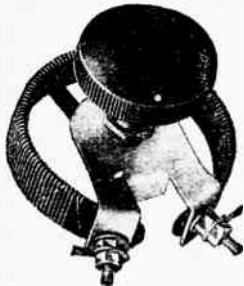

The RHEOSTAT that is dependable in operation.

The 'AMYCO' Light-Weight RHEOSTAT incorporates a New Method of one hole fixing that ensures the Knob coming flush with the Panel, no matter its thickness. Is equal in operation and smoothness to the highest grade and most expensive Rheostat on the market.
7, 15, 30 and 50 ohms.

2/4 EACH.

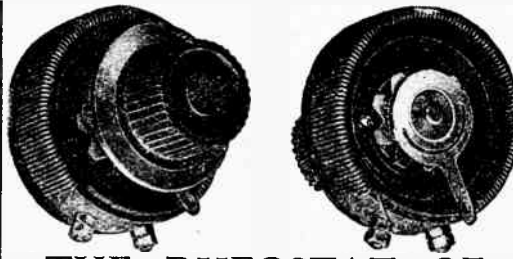

THE RHEOSTAT OF DISTINCTION

The "Rondar" Rheostat is a quality production and is fitted on many of the highest grade and finest Valve Sets on the market.

It has velvet smoothness in action, a perfect contact and accurate adjustment.

Is a reversible Rheostat and by simply turning the knob can be used for either panel or table mounting.

- | | |
|---|-----------|
| 7, 15 and 30 ohms | 3/4 each. |
| 50 ohms and Potentiometer 400 ohms, | 3/6 each. |
- Post Free.

ALL GOODS CASH WITH ORDER SENT POST FREE.

Send for Lists from the Manufacturers.
Agents wanted.



"THE RONDAR" A British Senior Loud Speaker

22 inches high, 14 inches flare. Cast Aluminium Swan Neck. Perfect Tone. A sound engineering job, with nothing of the fineness of the foreign Loud Speaker. 2,000 ohms.

50/- EACH.



A. M. YOUNG & Co.
BORDESLEY ST., BIRMINGHAM.



PROGRESS

JUST as the Indian Runner, with his message in a piece of burnt stick, has been superseded even in his native haunts by Wireless, so the latest "Devicon" Condenser surpasses all others in those details that go to make perfect reception. The shortcomings of Condensers as a whole have been met in this the very latest type.

*The Indian Runner
and Wireless Telegraphy*

Read the following proof of "Devicon" superiority:—

Messrs. Payne & Hornsby Ltd.,
Gallowgate,
Newcastle-upon-Tyne.

Dear Sirs,

We are very pleased to report the excellent results obtained on a Seven Valve Super Heterodyne Set, using "Devicon" Variable Condensers.

Thinking we might obtain still better results, we employed in a special Super Het Set 2 of the alleged latest ideas in straight line frequency Variable Condensers, but we found that with the use of these there was much less selectivity at Newcastle, and they failed to cut out Newcastle and bring in either Glasgow, Bournemouth, or London. Going back to "Devicon" Condensers again we found that Newcastle could be cut out and Glasgow, Bournemouth, and London brought in quite easily, thus proving the extra efficiency of "Devicon" Condensers over the above-mentioned Variable Condensers at more than twice the price.

You are free to use this letter entirely as you please.

Yours faithfully,
T. PAYNE (Signed).

Fit the new

"DEVICON" TRUE SCALE FRICTION CONDENSER

(Patent app'n. No. 1990/26)

to your set. You will be delighted with the improvement.

Supplied in the following sizes:

·001	.. 15/6	·0003	.. 14/-
·0005	.. 14/6	·0002	.. 13/6

Manufactured and fully guaranteed by

THE RADIO DEVICES CO. LTD.,
Newdigate Street

Telephone: 6798.
Telegrams: "Devicon."

Nottingham.

*VERNIER ATTACHMENT GIVING
ADDITIONAL SLOW MOTION.*

*DIAL 0 TO 340 .MOVEMENT
OF CONDENSER 2 TO 1*

*SUPPORTING
SHOULDER PIECE
NO END PLATES USED.*

*MOVABLE STOP,
NO BACK LASH*

*EXTRA HARD
FRICTION DISC.*

*FRICTION
WHEEL*

*NOTE POSITION
OF VANES TO PANEL.*

EXTRA SUPPORT.

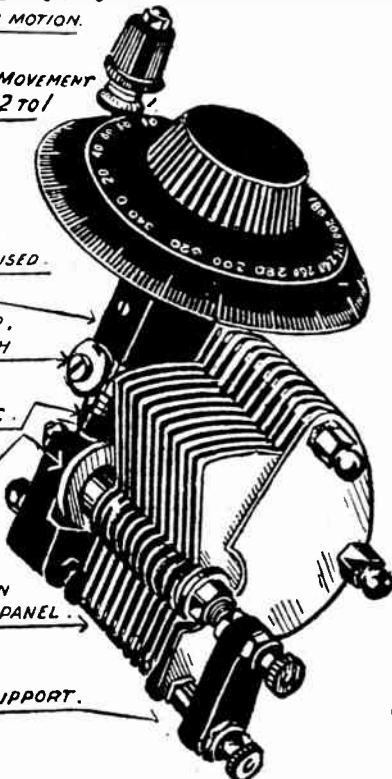

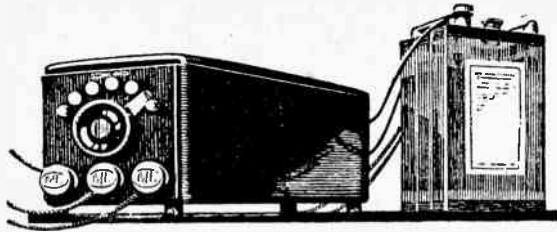

Don't use H.T batteries Use the M-L Converter

THE M-L Anode Converter takes current from your L.T. Accumulator and converts it into H.T. for your Valves. It is economical to use, needs no attention and lasts for ever.

Type BX, driven from a 6-volt accumulator, gives two simultaneous H.T. voltages—one of 35.85 volts, and another up to 120 volts.

Type BX will also run from a 4-volt battery, giving about two-thirds of these H.T. voltages.

Price £12 : 15 : 0

Type CX runs on a 12-volt accumulator, giving 35.85 volts and also a range up to 300 volts simultaneously.

Price £15 : 0 : 0

You are thus enabled to get any H.T. voltage suitable for your different valves all from one source. The M-L Converter ensures the best use of your valves, and is a real money-saving investment.

Fill in the coupon below, and we will gladly send you particulars



The M-L L.F. Transformer.
The perfect Hand-wound instrument.
3 ratios.
25/6

S. SMITH & SONS (M.A) Ltd.
179-185, GREAT PORTLAND ST., W.1

Telephone. LANGHAM 2321



Will you please post me particulars of the M-L Anode Converter?
This enquiry involves no obligation.
Name.....
Address.....
Date.....
w.v. 213 38

E. P. S. 20

SICKLES COILS.

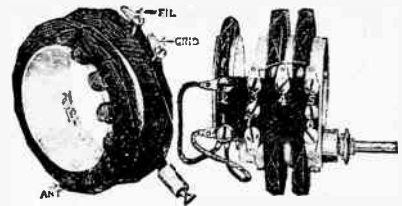

For the ROBERTS REFLEXED NEUTRO-DYNE (as illustrated) - - - Price 36/- per set.

See "The Wireless World," July 1st issue.
For the BROWNING DRAKE CIRCUIT Price 37/6 per set.

For the CRAIG CIRCUIT. Price 23/6 per set.

LC-26 RECEIVER.

"Popular Radio" Dec. 1925.
GENERAL RADIO VARIOMETER, Type 269 25/-
PRECISION OCTAFORM COIL SET 30/-
AMSCO DOUBLE UNIT CONDENSER 30/-

These are the essential components for the new Cockaday 5 valve set. Other specified components also supplied.

48 page list of American Apparatus free and post free.

Hawleys
HAWLEY BROS. LTD.

Telephone :
Regent 3169
(6 lines)

200-202, REGENT STREET
LONDON W.1

Telegrams :
"Pleasingly,
Piccy."

SECURE THAT EXTRA KICK WITHOUT DISTORTION FIT EDDYSTONE THE "CONQUEROR" TRANSFORMER

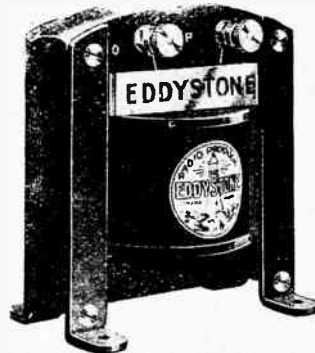

There is no need to lose volume with choke and resistance coupling methods if the "EDDYSTONE" Conqueror transformer is used. It gives high distortionless amplification on a silent background. Every transformer is made with reliable materials and can be used in power amplifiers with high voltages and is guaranteed for 12 months.

PRICE :

Ratio 5 : 1 No. 128
" 4 : 1 21/- each No. 129

From all high-class dealers. If any difficulty write direct to the manufacturers :

STRATTON & Co., Ltd., Balmoral Works,
Bromsgrove St. - - - BIRMINGHAM.



Five Questions

every valve user ought to ask before buying his next Dull Emitter

Is it truly economical?

MERELY because a valve is described as a dull emitter does not necessarily mean that it is cheap to run. Its current consumption may increase as the Valve becomes older. Or, as is often the case, its emission may fall off and the valve will get less sensitive. The fundamental principle underlying every dull emitter calls for some method of increasing the electron emission of the filament. The old way was to use thoriated tungsten. The new way, discovered and patented by Cossor, is to deposit on the filament wire a triple coating of a special electron-producing material. This coating—built up layer upon layer upon a metallic base—can never lose its productivity. Thoriated tungsten, on the other hand, can be easily ruined by the use of an excessive voltage, with the result that the valve becomes practically useless.

Has it long life?

YOU don't want to buy a valve which will only last a few months. Long life is just as important as current economy. The length of time a valve will last depends entirely upon its filament—the only consumable part. Some valves obtain low current consumption at the risk of fragility. Not so the Wuncell which has a comparatively stout filament consuming only .3 amp. at 1.8 volts. In the Wuncell long life is coupled with true economy. Its filament temperature never exceeds 800°C.—whereas all bright emitters and some so-called dull emitters function at 2000°C. Heat has a most destructive influence

on filaments. The lower the working temperature, the longer the valve will last. A "cold" valve for example would be almost everlasting. You will hardly be able to see the dull red glow of a Wuncell in daylight—even in the dark it can only be compared to the luminous dial of a watch.

Is it efficient for long distance work?

EVEN a long life, economical valve wouldn't be much use if inefficient. So your new dull emitter must be at least as efficient as a bright emitter. Almost every wireless enthusiast wants to pick up long distance Broadcasting. For this reason the special Wuncell W2 (with an identifying red top) has been developed. This valve has exactly the characteristics which will enable it to respond to weak oscillations and amplify them to a strength which will permit effective rectification.

The standard Cossor electron-retaining principles of construction—in which an arched filament is almost entirely enclosed by a hood-shaped Grid and Anode—are responsible for wonderfully high standard of performance. Wuncell users are everywhere testifying to the efficiency of their valves. The old idea that to obtain current economy meant a sacrifice in sensitiveness or volume is being rapidly dispelled by these superb new Cossor Dull Emitters.

Will it give pure tone?

MORE than 80% of the valve sets in operation to-day are used for Loud Speaker work. It is important, therefore, to choose a dull emitter

capable of giving a generous volume of really good tone. The new Wuncell W3 has been evolved specially for Loud Speaker use. Although utilising the same unique Cossor principles of construction—the electron-retaining hood-shaped Grid and Anode—its characteristics have been modified in order to permit an immense volume without distortion. Its Grid—always a vital feature in a power valve—is tremendously rigid. Each turn of the wire is securely anchored in two distinct positions—36 in all. The filament is triple mounted for extra strength. As a result microphonic noises have been completely abolished and a grand mellowness of tone is the result.

And finally—who makes it?

NOT the least important of these five questions is the experience of the manufacturer. Valves are not like electric lamps. They are far more intricate. They cannot merely be made to specification. Each step must be watched with eagle eyes. Every process of manufacture must be carefully checked for possible imperfections. The most delicate tests must be used to safeguard the pre-determined standards of performance. Cossor Valves have acquired a worldwide reputation. There is hardly an experimenter of note who has not chosen them above all others for their outstanding qualities. Their super-sensitiveness—their freedom from microphonic noises—their sheer dependability under all circumstances—their long life—their high standard of uniformity—all these features have made the name Cossor synonymous with all that is finest in valve design.

Prices:

W1. For Detector and L.F. 14/-
W2. For H.F. use 14/-
Voltage 1.8 Consumption .3 amp.
W3. For Loud Speaker use 18/6
Voltage 1.8 Consumption .5 amp.



Prices:

WR1. For Detector & L.F. 16/-
WR2. For H.F. use 16/-
For use with 2-, 4- or 6-volt accumulator.

Issued by A. C. COSSOR LTD., Highbury, London, N.5

Gilbert Ad. 4901

Advertisements for "The Wireless World" are only accepted from firms we believe to be thoroughly reliable.



Anti-vibration Valve Holders

No sponge rubber, which absorbs moisture, is used in the construction of "Cosmos" Anti-vibration Valve Holders. They are made in two types as shown in the illustration. The panel mounting type can be readily fitted in place of an ordinary holder, as the fixing screws have standard spacing while the baseboard type can be fitted to a wooden base with wood screws. "Cosmos" Anti-vibration Valve Holders abolish the objectionable noises due to vibration and "sound coupling" and obviate trouble from the microphonic tendency of some valves.

METRO - VICK SUPPLIES LTD.

(Proprietors Metropolitan-Vickers Electrical Co., Ltd.)

4, Central Buildings, Westminster, London, S.W.1.

Price { Panel Mounting } 2/9
 { Base Mounting }

Cosmos
 RADIO COMPONENTS

GENUINE

Ripaults

LECLANCHE

WET BATTERIES

THE IDEAL SOURCE
 OF H.T. SUPPLY.

ABSOLUTELY SILENT.
 STEADY OUTPUT.
 NO RECHARGING.
 PRACTICALLY
 EVERLASTING.
 GET ONE NOW.



SEPARATE ELEMENTS.

Model A - 9d. each.

Model B - 1/3 each.

BATTERIES COMPLETE

(As Illustration)

60-cell (approx. 90-volt)

Model A - £2-12-6

Model B - £4-5-0

40-cell (approx. 60-volt)

Model A - £1-17-6

Model B - £3-0-0

We are pleased to state that the heavy demand following our initial announcement has been overtaken and we can now give delivery from stock.

Write for Full Details—RIPAULTS LTD., 1, King's Road, ST. PANCRAS, N.W.1.

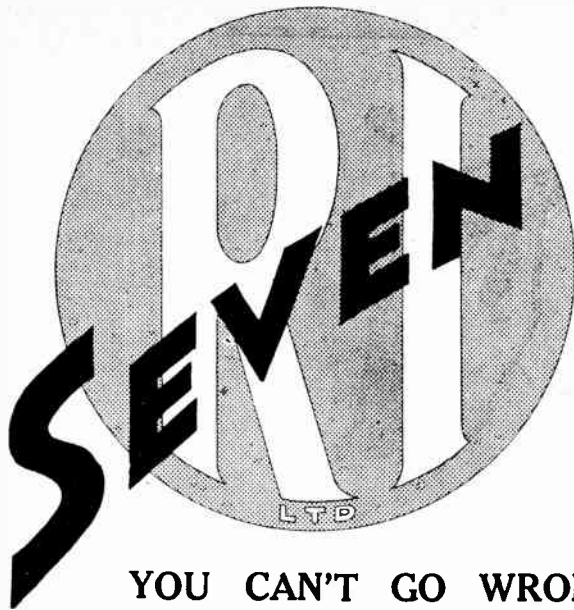

RATIOS

YOU CAN'T GO WRONG.

YOU are certain to find the correct ratio for your set if you use the new R.I. Multi-Ratio Transformer, for the range of ratios and impedance values available in this instrument is sufficiently wide to make it suitable

for every Valve and every Circuit.

Although this Transformer has only been on the market some days, the demand has exceeded our highest expectations. We have received large numbers of letters from enthusiastic users, who find it to be just what they have been waiting for, as it has given an **additional purity** to their circuits which they have been unable to obtain with combinations of other Transformers.

With the new R.I. Multi-Ratio Transformer, a winding of an impedance suitable for any valve or any circuit can be selected at will, and the tapping points of both windings have been chosen so as to provide the best ratios for the various circuits and valves now in general use.

In the main ratio it is possible to obtain three alternative values of impedance, so that actually nine different values of impedance are available.

The new model is totally enclosed in a steel shroud, treated with the new cellulose 'car enamel, which is practically rust-proof. The coil itself is treated in such a way that it is suitable for any climate in the world. The terminal block is a bakelite moulding of cellular design, so as to completely isolate the terminal connections, thereby increasing the insulation path.

A year's guarantee is given with each instrument, and, in addition, a book of circuits showing the best method of using the Transformer as a standard coupling. This new "R.I." product is the best investment you can make. It will decidedly improve the quality of your reception.

If your Set distorts, the remedy lies with you.

Write for special leaflet W.W.

THE MARK OF BETTER RADIO



RATIO TABLE

Ratio.
1 — 1
1½ — 1
2 — 1
3 — 1
4½ — 1
6 — 1
9 — 1



Price 27/6

FOR EVERY VALVE—FOR EVERY CIRCUIT, THE NEW R.I. MULTI-RATIO TRANSFORMER.

Advt. R. I. Ltd., 12, Hyde St., New Oxford Street, London, W.C.1.

P.C.24

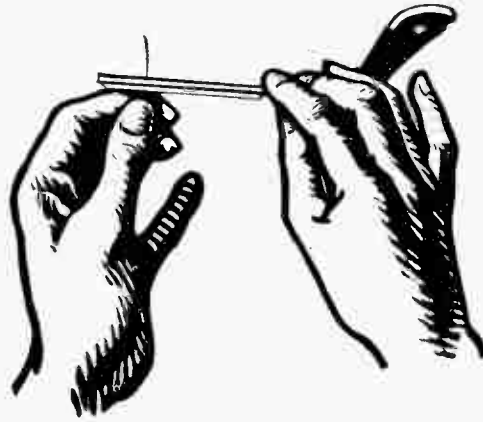

Make your tuning razor-sharp

With Lissenstat control your valve is made sensitive to a touch—responsive to every fractional turn of the knob. Electronic emission—that vital force in the correct working of a valve—is accurately controlled. You open the way to fine detection—signals from farther away are brought in stronger, sharper than ever before—through a background of dead silence.

The "Lissenstat" effortlessly allows you to feel for the point of critical detection and unerringly find it. Let the "Lissenstat" play its part in your search for distant stations—put an edge on your tuning that will add valuable range to your receiver.



SOLD IN THREE MODELS—

Lissenstat Major (patents pending) gives the most accurate tuning possible - - 7/6



Lissenstat Minor (patents pending) provides Lissenstat control at a popular price. Has replaced thousands of inefficient rheostats - 3/6

Lissenstat Universal (patents pending) with its feature of protection for dull emitters - - 10/6

Receivers fitted with Lissenstat Control are equipped for the finest detection possible.

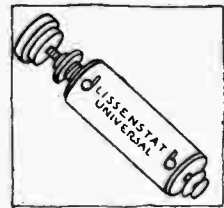

LISSEN

THERE IS NO WEAKEST LINK IN THE LISSEN CHAIN

Lissen Limited, 21-25, Friars Lane, Richmond, Surrey

'Phone: Richmond 2285 (4 lines)

'Grams: "Lissenium, 'Phone, London."

L 28

The Wireless World

AND
RADIO REVIEW
(13th Year of Publication)

No. 345.

WEDNESDAY, MARCH 24TH, 1926.

VOL. XVIII. No. 12.

Assistant Editor:
F. H. HAYNES.

Editor:
HUGH S. POCOCK.

Assistant Editor:
W. JAMES.

Editorial Offices: 139-40, FLEET STREET, LONDON, E.C.4

Telephone: City 4011 (3 lines).

Advertising and Publishing Offices: DORSET HOUSE, TUDOR STREET, LONDON, E.C.4.

Telephone: City 2847 (13 lines).

Telegrams: "Ethaworld, Fleet, London."

COVENTRY: Hertford Street.

BIRMINGHAM: Guildhall Buildings, Navigation Street.

MANCHESTER: 199, Deansgate.

Telegrams: "Cyclist Coventry."
Telephone: 10 Coventry.

Telegrams: "Autopress, Birmingham."
Telephone: 2970 and 2971 Midland.

Telegrams: "Hiffie, Manchester."
Telephone: 8970 and 8971 City.

Subscription Rates: Home, £1 1s. 8d.; Canada, £1 1s. 8d.; other countries abroad, £1 3s. 10d. per annum.

As many of the circuits and apparatus described in these pages are covered by patents, readers are advised, before making use of them, to satisfy themselves that they would not be infringing patents.

BROADCASTING THE BUDGET.

AS we write, the question as to whether or not the Budget speech will be broadcast remains undecided, and very divergent views have been expressed on the subject. If we are asked what our opinion is as to the advisability or otherwise of broadcasting Parliamentary proceedings, we should most definitely state that, in general principle, we are opposed to such a course. In our opinion anything in the nature of regular or frequent broadcasting of Parliamentary debates would tend to convert the House into a stage, where members would always feel that they were being listened to by an audience not always in sympathy with their views and always critical of their powers of oratory. Popularity amongst the public would tend to depend more upon cloquence than upon substance in speeches, whereas it should be remembered that not always the best orators make the best statesmen, and, in fact, the reverse is not infrequently the case. Apart from these points, there are, of course, many other objections which might well be raised against the principle of broadcasting the proceedings of the House as a regular programme feature.

When, however, a special occasion arises, as, for instance, in the case of the Budget speech, the matter might well be viewed somewhat differently. There are millions who may never have the opportunity of listening in the galleries on such an occasion, and from the point of view of national education such an exception might well be made without the creation of a precedent which would

ultimately lead to regular or even frequent transmissions of the kind. We should, in fact, welcome Parliamentary broadcasting if carried out very occasionally and in special circumstances such as the present instance, where public interest is so great, in view of the novelty, as to outbalance objections.

o o o o

CONTENTS.

	PAGE
EDITORIAL VIEWS	435
BROADCASTING PHOTOGRAPHS	437
READERS' NOVELTIES	442
SELECTIVE THREE-VALVE RECEIVER	443
By H. F. Smith.	
THE BATTERY ROOM AT 2LO	449
By R. C. Shaw.	
PRACTICAL HINTS AND TIPS	451
CURRENT TOPICS	453
PIONEERS OF WIRELESS. II.—	
S. F. B. MORSE	455
By Ellison Hawks.	
WIRELESS CIRCUITS IN THEORY AND PRACTICE	457
By S. O. Pearson.	
PROBLEMS OF TELEVISION	461
TWO-STAGE RADIO FREQUENCY AMPLIFIER (continued)	463
By W. James.	
OSCILLATION WITHOUT REACTION	467
By Dr. H. Kröncke.	
BROADCAST BREVITIES	469
PRACTICAL SWITCH MAKING	471
By H. J. Turpin.	
THE WIRELESS LEAGUE BRANCHES	474
LETTERS TO THE EDITOR	475
READERS' PROBLEMS	477

THE WIRELESS LEAGUE AND "THE LISTENER."

THE importance of a strong organisation representing the listening public must surely be apparent to everyone who has the interests of broadcasting and its future development at heart, whether his interests are technical or purely those of a listener. An organisation which can represent the wishes of the public user of broadcasting deserves the support of the technical as well as the non-technical sections of the public.

There is already established in this country an organisation, the name of which is probably familiar to all our readers. We believe that the Wireless League, under the chairmanship of Sir Arthur Stanley, fills a much-needed place in the fabric of broadcasting. Such an organisation

can act as the mouthpiece of the listening public, and can express their views and wishes to the authorities responsible for control of the service, and, working as it does in close harmony with the Radio Society of Great Britain, there is no question of conflicting interests. The success and the utility of such an organisation are directly proportional to its membership, and, it is, therefore, of supreme importance that the Wire-

less League, if it is to fulfil its purpose adequately, should maintain and augment its already large membership. Because we believe that such an organisation is necessary and valuable, we have arranged with the Council of the Wireless League to assist them in publicity and in furthering the interests of the League generally. In the present issue of *The Wireless World* is incorporated the first of a section to be known as "The Listener," constituting the Journal of the Wireless League. After the present issue a similar section will be placed at the disposal of the League in the first issue in May, and thereafter with the first number each month. In the pages of "The Listener" will appear news items and announcements regarding the activities of the League.

We wish to make it quite clear to our readers that the inclusion of this section, entitled "The Listener," in *The Wireless World* does not in any way constitute *The Wireless World* the official organ of the Wireless League. We shall at all times regard ourselves as entirely free to offer helpful criticism, should occasion arise, on the policy or general activities of the League. In matters concerning the League, as well as in every branch of wireless activity, the complete independence of *The Wireless World* will always be regarded as an integral part of our editorial policy.

o o o o

THE BROADCAST COMMISSIONERS.

THE points raised in our Editorial of last week concerning the qualifications for the new commissioners recommended by the Broadcasting Committee have been taken up in several quarters, and strong support is given to the view which we expressed that the remuneration likely to be authorised for the new commissioners would be inadequate to secure the services of men of the qualifications stipulated in the Broadcast Report, if such commissioners, to be eligible for appointment, had to be entirely free of all other commitments. Men of such calibre are not to be found in idleness, ready to take on such a new task, but rather they would be men busily engaged in affairs whose ability had placed them in such a position that the maximum remuneration to which they would be entitled, if appointed as broadcasting commissioners, would not tempt them to give up their present commitments.

We are of the opinion that a definite mistake has been made in recommending that the commissioners should be men and women unhampered by commitments, because we believe that persons intimately concerned in the success of the broadcasting service are those most likely to take an active and energetic interest in furthering the interests of broadcasting. No doubt a Commission composed of persons not disinterested would result in a certain amount of conflict of opinion, but careful selection of the commissioners so that no one interest would be disproportionately represented would serve the purpose of maintaining the requisite balance, whilst a totally disinterested chairman, adequately remunerated, would ensure that no special advantage was gained, either directly or indirectly, by any particular interest through having direct representation on the Commission.

RUGBY TELEPHONY.

MANY letters have been received from readers respecting the recent telephony tesis across the Atlantic, carried out between the new Rugby station telephony transmitter and New York. Some of these letters have been published, since they contained interesting accounts of the reception of these transmissions. We would point out, however, that several letters which reached us did not receive publication for the reason that they flagrantly contravened the Post Office regulations respecting the use of a wireless receiver. It is expressly stated that the licensee of a wireless receiver must not make known anything which comes to his knowledge through the interception of traffic between stations. Those persons, therefore, who disclose the nature of the conversations carried on between Rugby and New York are transgressing the regulations under which their receivers are licensed. In the early days before broadcasting, when only Morse transmissions were available to listen to, the importance of this regulation was certainly fully recognised, but to-day, when so much broadcast telephony is available for common reception, it is, perhaps, not unnatural that the mistake should be made of regarding the telephony experiments from Rugby in the same class as broadcasting. It is well, however, that this mistake should be pointed out promptly. It would most certainly discount the value, from a commercial point of view, of wireless telephony as a means of intercommunication unless the rule were most rigidly enforced that anything overheard should be treated with the strictest confidence. Our view would be that the Postmaster-General would be fully justified in taking any action in his power to put a stop to any contravention of these regulations.

A WIRELESS BALLOT.

A PAGE in the advertisement section of the present issue is devoted to a Wireless Ballot Competition, which may be of interest to many readers. The competition is to arrange the contents of the issue in order of popularity, and prizes are to be awarded to those whose entries most nearly coincide with the popular vote. An additional vote is required, giving the section which is most appreciated by each entrant for the competition.

BROADCASTING PHOTOGRAPHS.

IN this issue we are able to publish the first detailed account of apparatus which provides a practical and simple solution to the problem of the transmission of photographs by wireless. The apparatus has been developed by Mr. Thorne Baker, whose earlier work in this connection is already well known. We have been fortunate in having had the opportunity of carrying out actual tests of the efficiency of the apparatus between two experimental stations of *The Wireless World* in London through the courtesy of Mr. Thorne Baker. The apparatus has been developed to a state where it is now available for use for transmission of pictures from a broadcasting station, when the pictures can be received with comparatively inexpensive apparatus suitable for adding to existing wireless receivers. We anticipate that very shortly the broadcast transmission of pictures in this country will have become a matter of common occurrence.

BROADCASTING PHOTOGRAPHS.

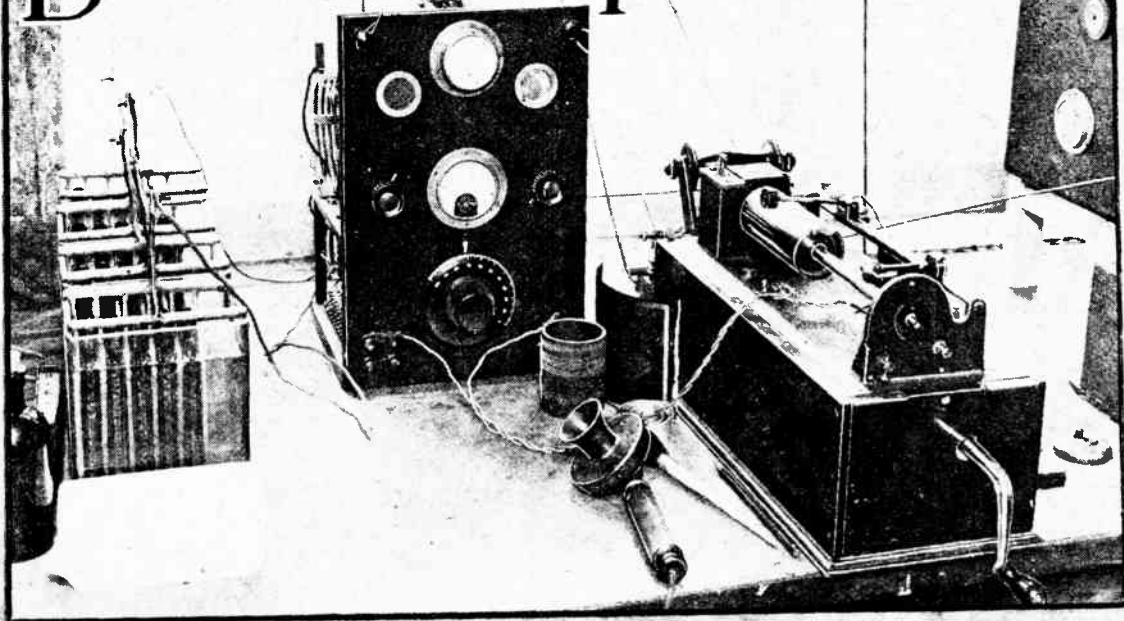

Wireless Phototelegraphy as a Public Service.

"SEEING by wireless" is at frequent intervals made a headline in our daily press. The introduction of broadcasting marked the practical application of steady progress and matured development, and speech transmission by wireless suddenly appearing as a public service led many who do not follow the constant evolution of science to wildly speculate, by forecasting, that wireless television is but next in sequence to broadcasting. There is no indication yet that the transmission of moving pictures is nearing perfection. In fact, although a good deal of spade work is being carried out, no evidence is to be found of any definite step forward having been made towards the achievement of television. An invention which is to embody many branches of science is not the outcome of spontaneous thought, but is a slow building-up process following a definite line of development.

A Step Towards Television?

The transmission of pictures by wire or wireless is a stepping-stone, in its effect, to the accomplishment of television, but in the methods adopted the one is in no way related to the other. In sending a moving picture of even small dimensions, say 1in. square, that picture must be analysed probably into 900 parts, and the light intensity or colour of each one of these parts must be communicated to the distant station with the rapidity of 16 times a second if a clear image is to be maintained.

Thus, in an endeavour to devise a system of television by drawing from the storehouse of scientific achievement as it is to-day, the inventor is faced with the problem of devising apparatus capable of transmitting 14,400 messages a second in order to obtain a picture just 1in. square.

A very different story is the transmission of a stationary picture such as a drawing or photograph. Here the speed of transmission is less important, and is only governed in its relationship to cost or the time that the transmitting apparatus is monopolised in reproducing the picture. Several workers have developed successful systems of telephotography, and mention might be made of M. Belin, the American Telephone & Telegraph Co., R. H. Ranger, of the Marconi Company, and T. Thorne Baker. It is to Mr. Thorne Baker that credit is due for developing a remarkably simple instrument capable of being used in conjunction with wireless transmitting and receiving apparatus and by means of which almost perfect pictures of useful size can be communicated in a reasonably short time.

Outline of the Process.

The system in brief consists of the re-photographing of the picture on to a piece of copper foil so that the copper surface is left clean for those parts of the picture representing shadow, whilst the high lights are marked by a deposit of a non-conducting film. The copper plate is

Broadcasting Photographs.—

then bent round the face of a cylinder, which is slowly traversed in the same way as the needle of a phonograph recorder traverses the surface of a cylindrical record. The needle in this instance makes an intermittent contact with the copper, the circuit being broken for the high lights and made at those portions representing deep shadow.

The fluctuating potentials thus obtained are applied between a platinum point and a cylinder wrapped with a chemically treated paper, the cylinder being exactly synchronised in its rotation with that of the transmitter. The chemical solution is decomposed under the action of the current, producing a dark blue compound, so that whenever the circuit is completed at the transmitter by virtue of the needle passing over a "dark" portion of the picture a mark appears on the cylinder at the receiver.

This "screen" is produced by photographing the object (or a photograph of the object) through a parallel lined screen placed just in front of the plate. The screen is covered with opaque lines ruled with mechanical regularity with a space between each line and the next equal to the thickness of the lines, similar to the method employed in making printers' blocks, although in the latter instance the screen is ruled into squares. The copper plate, after being polished, is sensitised with a solution of gum containing ammonium dichromate, and the plate is gently heated to dry the film. The action of light during exposure renders the gum insoluble in water, and

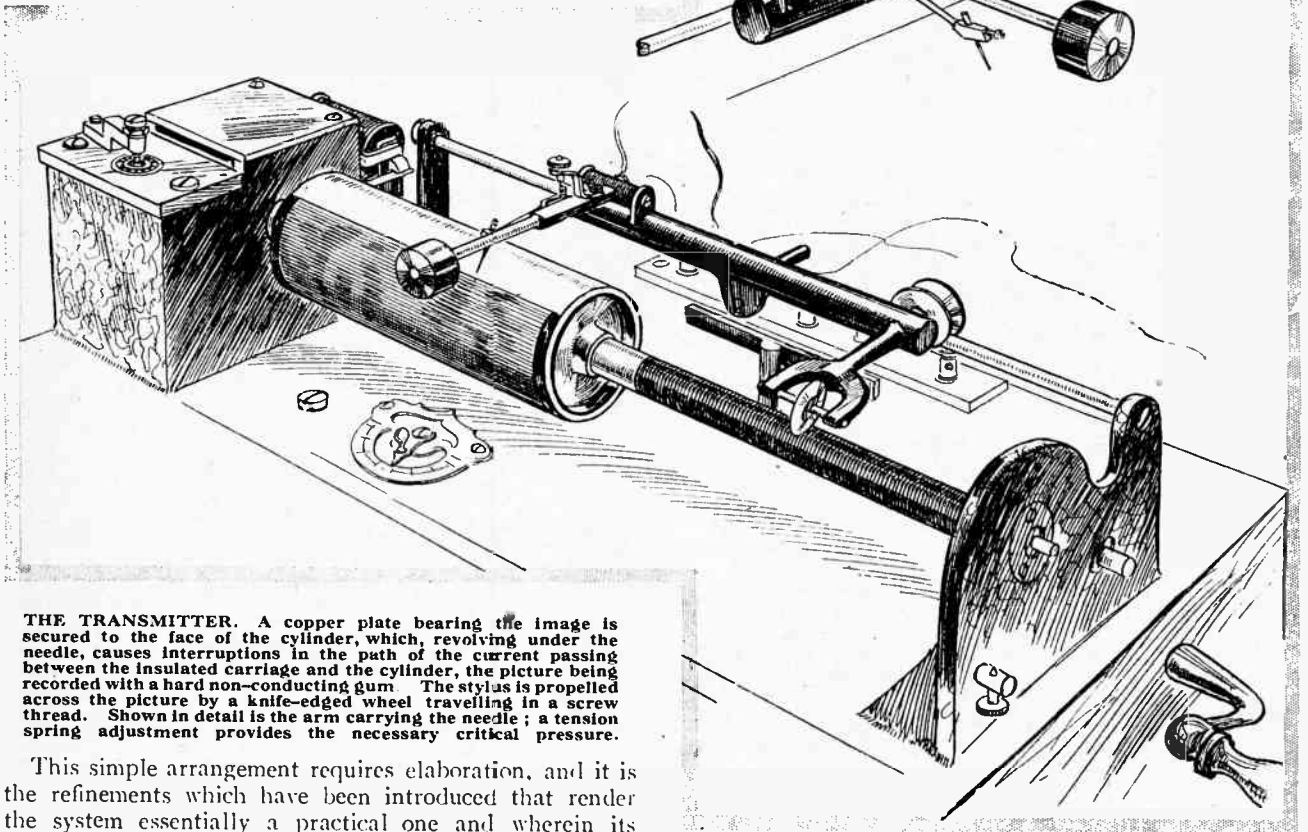

THE TRANSMITTER. A copper plate bearing the image is secured to the face of the cylinder, which, revolving under the needle, causes interruptions in the path of the current passing between the insulated carriage and the cylinder, the picture being recorded with a hard non-conducting gum. The stylus is propelled across the picture by a knife-edged wheel travelling in a screw thread. Shown in detail is the arm carrying the needle; a tension spring adjustment provides the necessary critical pressure.

This simple arrangement requires elaboration, and it is the refinements which have been introduced that render the system essentially a practical one and wherein its merit lies.

Making the Copper Plate.

The markings on the copper plate of the transmitter can be seen in an accompanying illustration. The image is not just a simple one in which the insulating material adheres in places and not in others merely according to light and shade, but will be seen to be composed of a number of transverse lines. The high lights consist of wide black lines with very narrow spaces between them, whilst those parts which are to appear black in the finished image consist of wide white lines separated by thin black spaces.

so by washing, the parts not changed by light may be dissolved away. After drying and, perhaps, gently heating to harden the surface, the copper plate is wrapped round the brass cylinder of the transmitting instrument, the ends being secured together with a strip of gummied paper or metal clip.

The mechanical details of the transmitting machine can be readily gathered from the drawings. It will be seen that a needle point, actually a gramophone needle, is set up in an adjustable spring holder making a suitable angle to the face of the cylinder. The needle arm is secured to a carriage which bears a knife-edged wheel made to rest

Broadcasting Photographs.—

in a fine thread on an extension of the spindle of the cylinder. The needle is thus advanced across the copper plate as the spindle turns, moving on by a distance equal to the pitch of the thread at each revolution.

Synchronisation.

A novel feature in the design is the device employed for ensuring that the cylinder shall revolve at definite speed, for it is obvious that if the transmitting and receiving cylinders were not perfectly synchronised a distorted picture would be produced. A gramophone motor with the usual speed control revolves the cylinder, the drive being provided through a slipping clutch. A steel rod projects from the spindle and engages on a catch which arrests the cylinder in its rotation, though it can be released by the action of an electromagnet. The electromagnet is energised at definite intervals of time from a battery supply controlled by means of a swinging pendulum fitted with contacts to make and break the circuit. The pendulum is timed to beat seconds, while the

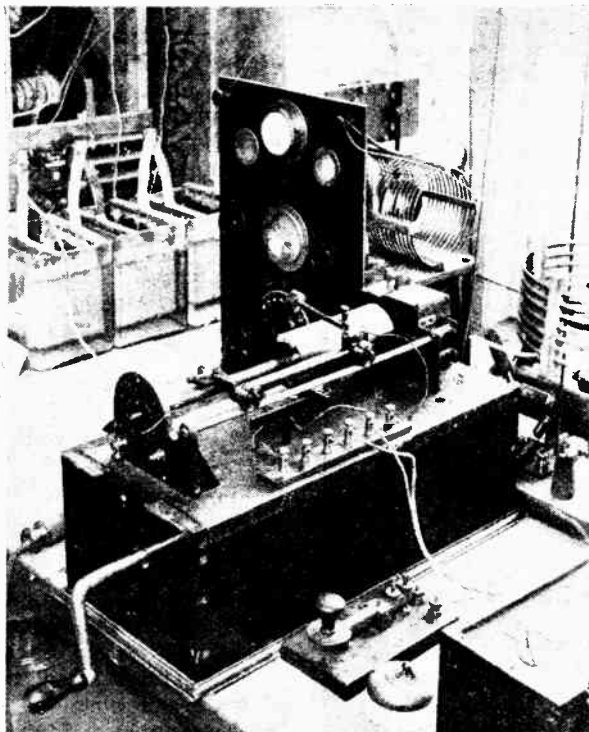

TRANSMITTING PICTURES. Here the transmitting instrument is shown with a low power valve transmitter. Working on 90 metres with an input of about 10 watts, pictures were transmitted over a distance of ten miles, though the range of transmission may be normally taken as approximately equal to the telegraphic range of the set.

by distorting the image from a rectangular shape to a parallelogram. It is advisable, also, that the transmitter and receiving pendulums should make circuit simultaneously, or otherwise the received picture will overlap the join in the paper.

In practice there is no great difficulty in adjusting a pendulum to keep exceedingly accurate time for the duration of the transmission of the picture, whilst a black line on the starting edge of the transmitting plate will indicate where the image will appear with regard to the join in the paper at the receiver, so that adjustment can be made before reception is proceeded with.

A modification to the pendulum method consists of intermeshing one of the pinions of the clockwork motor with a clock movement controlled by means of a balance wheel.

Recording the Picture.

The receiving instrument is identical with the transmitter except that a blunt-ended platinum stylus replaces the sharp steel needle of the transmitter. In place of the

gramophone motor is adjusted to rotate the cylinder once in roughly just under one second. It will be seen, therefore, that the rotation of the cylinder is stopped for a very brief moment at every revolution and is released at definite one-second intervals. Damage to the clockwork, which might be occasioned by the sudden stopping, is prevented by the slipping clutch.

Receiving equipments are controlled in the same manner by accurately timed pendulums, and discrepancies in pendulum adjustment between transmitter and receiver would be evidenced

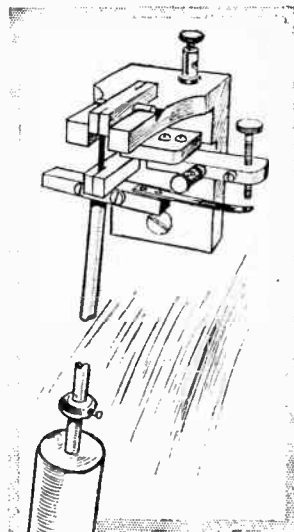

SYNCHRONISING BY PENDULUM. Interrupted currents at regular second intervals are obtained for controlling the trigger equipment which ensures that the transmitting and recording cylinders revolve at a constant rate of one revolution a second.

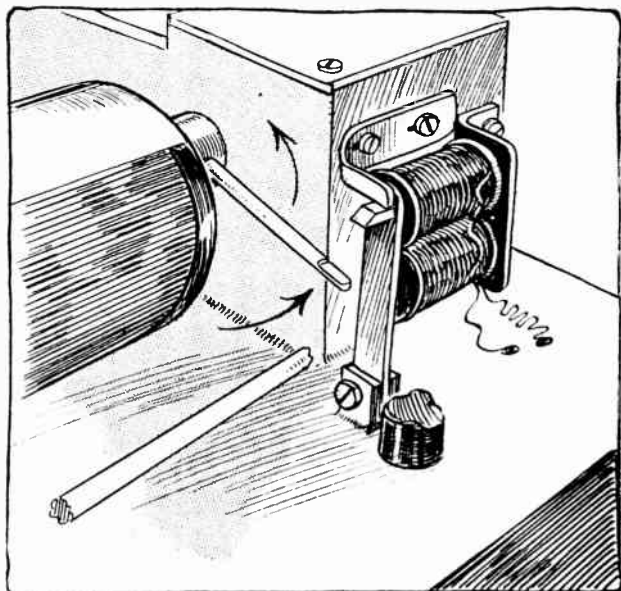

THE SYNCHRONISING DEVICE. The electromagnet arrests the rotation of the cylinder for a brief interval at every revolution. The trigger is pulled up at regular second intervals, the time being accurately maintained by a swinging pendulum fitted with contacts for breaking the circuit.



WIRELESS TELEPHOTOGRAPHS.—Two of the wireless—

copper plate is the moist chemically treated paper.

A solution is prepared by mixing starch paste with potassium iodide, into which the moderately absorbent paper is immersed and dried off to a just damp condition by pressure between blotting paper. The paper is held in position by a clip provided for the purpose. A current of one milliampere through the wet paper will produce a deep blue image, due to the release of iodine at the positive pole, which, of course, must be the platinum stylus. The blue compound is produced by the reaction of the iodine with the starch, and only retains its deep colour so long as the paper remains wet. On drying out the image loses some of its richness by turning to a light brown.

By connecting together a transmitting instrument with its copper plate and a receiver with its starch iodide paper through a pair of leads, in one of which a battery is connected, a system of telegraphic picture transmission is established.

Wireless Phototelegraphy.

To apply the Thorne Baker apparatus, making use of a wireless link between the transmitting and receiving stations, one is faced first with the problem of controlling the transmitter in accordance with the circuit interruptions produced by the needle travelling over the copper plate carrying the image. Next, the wave trains at the receiving station must be suitably amplified to cause rectified current of sufficient value to pass between the recording stylus and the cylinder carrying the starch iodide paper.

A 22

Interrupting the Grid Circuit.

The simplest method of interrupting the wave trains at the transmitter consists of connecting the needle and copper plate on the earth side of the grid leak in the same manner as a key is often connected for telegraphic signalling. Thus, on the dark parts of the image, which is a negative, the grid circuit becomes broken and oscillation ceases, whilst where the copper is exposed oscillation is set up. The duration of the wave trains depends upon the width of the gap of exposed copper between the successive cross lines produced by the screen, and where a full black image is to be formed one finds that the screen lines are practically removed, leaving a clean copper surface, the half lights producing short wave trains equal in duration to the intervals between them.

This method of breaking the grid circuit, although quite practical and was successfully used in actual transmissions carried out by *The Wireless World* through the courtesy of Mr. Thorne Baker, is not the most satisfactory, as many transmitting amateurs will agree who have experimented with grid leak keying, and particularly on short wavelengths. No arrangement ordinarily used for telephonic modulation can be adopted, for it will be seen that the note-frequency is constant, and we are only concerned with the duration of the wave trains.

An improved arrangement consisted of connecting the filament and plate of a valve in series with the high tension supply and causing the revolving cylinder to interrupt the grid filament connection in the manner of



—transmitted pictures. When first recorded the image is purple.

Broadcasting Photographs.—

the series valve sometimes used in high-speed telegraphic work.

Modifications Necessary at the Receiver.

As to the receiver, which may primarily comprise a detector and one or two note magnifying valves, it is, of course, essential to use reaction or a separate oscillator to convert the wave trains to an audible note. It may be pointed out that nothing would be heard in a pair of telephones unless the receiver were in an oscillating condition and adjusted to heterodyne the incoming signal, and for L.F. amplification to be effective the oscillator or reaction coupling must be adjusted to produce a beat note.

The fluctuating current output after L.F. amplification can be applied to the receiving cylinder by connecting the stylus in the plate circuit and applying sufficient negative grid bias to the last valve to cut off any constant current flow through the valve when no signal is being received. Such an arrangement, in effect, is operating the valve as an anode rectifier, and a better system is to transformer couple an additional valve provided with a leaky grid condenser, so that the alternating note-frequency currents are suitably rectified. It should be explained that only unidirectional currents have the effect of bringing about chemical reaction in the paper.

Sending Pictures by Wireless.

In tests carried out to determine the most suitable methods of transmission and reception pictures were transmitted over a distance of about 10 miles on a wavelength of 90 metres with an input at the transmitter of 10 watts. The originals measure 5in. x 4in., and the time taken for sending a picture was about six minutes. The image when dry is, of course, in brown, and the contrast not quite so good as in the copies reproduced here in black and white. The vertical lines are produced by the recording stylus, whilst the transverse "wavy" effect is accentuated by the action of the screen used in the process of making the printer's blocks.

Experiments have been conducted by the author to investigate the suitability of the system for the transmission of line drawings. Here no difficulty arises, and it is probable that pictures in black and white line preceded the development of methods applicable to the reproduction of photographs in half-tone. The copper plate for line drawing transmission is prepared by photographing on to the gum-dichromate treated copper, and the ruled screen used for half-tone pictures is dispensed with. The line thickness should not be less than about 1/25th of an inch, and a moderately thick line is recommended to compensate for small errors in synchronisation and the very slight smudging effect produced on the recorder due to the dampness of the paper and the prolonging of the chemical action for a brief interval of time after the current ceases.

The experiments so far conducted show conclusively that pictures can, by methods not unduly inconvenient, be transmitted between wireless stations with a satisfactory degree of definition to render the system of immediate general utility.

The receiving instruments which are shown in this article were manufactured by Messrs. W. Watson and



THE IMAGE AS PREPARED FOR THE TRANSMITTER.
The cross-lines, produced by photographing through a ruled screen, are composed of a hard non-conducting film.

Sons, Ltd. They are inexpensive to produce, and the operating skill necessary is as easily acquired as the ability to manipulate a gramophone.

Illustrating the Broadcast Programmes.

Nothing should now stand in the way of introducing picture transmission to our broadcasting service, for, as far as reception is concerned, a good image could undoubtedly be obtained within 20 miles of a broadcasting station with a detector valve and one-note magnifier, by replacing the telephones with the recorder and increasing the negative bias on the note magnifier.

The addition of a low frequency rectifying valve would, of course increase the range of reception and give a much brighter picture. At the broadcasting station the special controlling equipment recommended in this article is not entirely necessary, and the writer would suggest a form of valve-operated hummer placed in front of the microphone and controlled by the revolving copper plate, an arrangement carrying with it the advantage that picture reception can be accomplished without the need for heterodyning.

F. H. H.

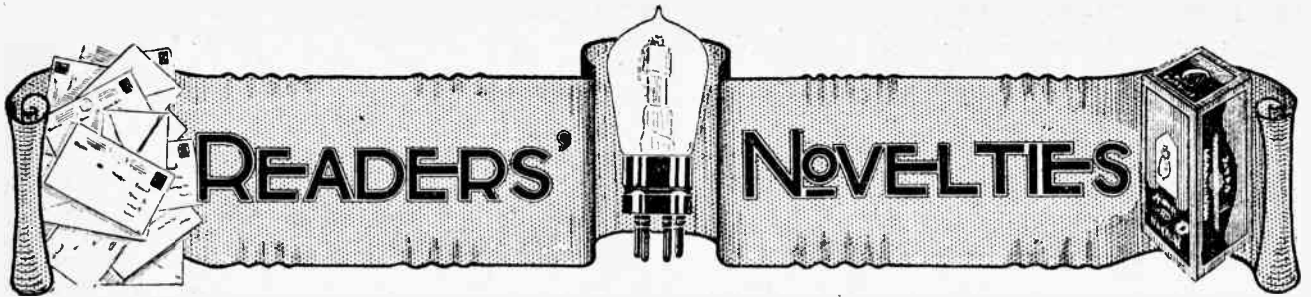

A Section Devoted to New Ideas and Practical Devices.

COIL FORMER.

An undesirable feature of many types of low-loss coils is that the cross-section of the coil is not circular. A coil with very low losses and of circular cross-section can be built up by the following method:

The former is cut, as indicated in the diagram, from thin ebonite or paxolin tube, the waste pieces being retained. To wind the coil the former is slipped over a cylindrical piece of wood or other convenient support, and the coil is wound with the waste pieces inserted between the slots. When the coil is finished the former is slid over the cylinder and the waste pieces removed, leaving a perfectly cylindrical coil with only a small amount of insulative material in the supports. A further advantage of this method is that the rather fragile former is prevented from sagging in the middle under the pressure

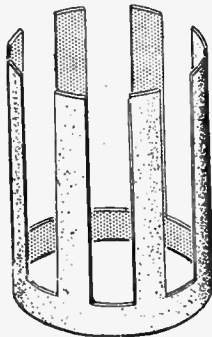

Low-loss former used in the construction of cylindrical coils.

exerted during the process of winding.—L. B. S.

o o o o

DRILLING POLISHED EBONITE.

It is often difficult to avoid scratching the surface of polished ebonite during the process of drilling, and if the panel has been marked out and drilled through from the back the hole is apt to break out on the

polished front, thus spoiling the appearance of the panel. If the panel is placed with the polished side downwards on a pad of thick blotting paper this trouble will be entirely obviated. If possible, the panel should be clamped down to the pad with strips of wood screwed at each end to the bench.—F. O.

o o o o

LIGHTNING ARRESTER.

The lightning arrester illustrated in the diagram is constructed with two telephone-type terminals mounted

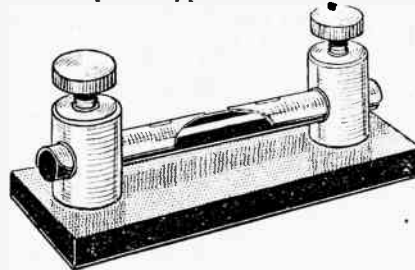

Spark gap lightning arrester.

on a small ebonite base. The holes in the terminals are drilled out to approximately $\frac{1}{4}$ in. diameter in order that an ebonite rod $\frac{1}{8}$ in. diameter may be inserted, together with two pen-nibs. The points of the nibs face each other, thus forming a spark gap, and the distance may be adjusted to suit any given conditions. The aerial and earth connections to the terminals may be made to soldering tags fitted underneath the base.—A. E. W.

VALVES FOR IDEAS.

Readers are invited to submit brief details, with rough sketches, where necessary, of devices of experimental interest for inclusion in this section. A receiving valve will be despatched to every reader whose idea is accepted for publication.

Letters should be addressed to the Editor, "Wireless World and Radio Review," Dorset House, Tudor St., London, E.C.4, and marked "Ideas."

VOLTMETER HINT.

In order to increase the range of a voltmeter, it is necessary to connect a resistance of suitable value in series. An ordinary potentiometer of the wire-wound type is very suitable for this purpose, and is a component which most amateurs possess. By this means it is possible to use a low range filament voltmeter for measuring the voltage of the H.T. battery, the correct value of resistance being found by a series of experiments with batteries of known voltage, or by comparison with another instrument.—F. W. I.

o o o o

IMPROVED DOUBLE-THROW SWITCH.

The ordinary double-pole change-over switch requires a considerable amount of space in a receiver to allow for the movement of the switch blades when changing from one position to the other.

The diagram shows how a switch of this type may be modified to operate with a limited movement. A

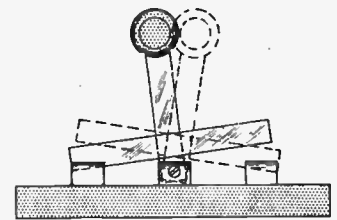

Change-over switch with limited movement.

horizontal switch blade is soldered at right angles to the lower ends of each of the original switch blades which then serve as the operating handle of the switch. By this means the switch may be conveniently mounted behind the receiver panel and operated from the front of the panel by the original switch blades projecting through vertical slots in the panel.—R. N.

Simplicity

Efficiency



One Knob

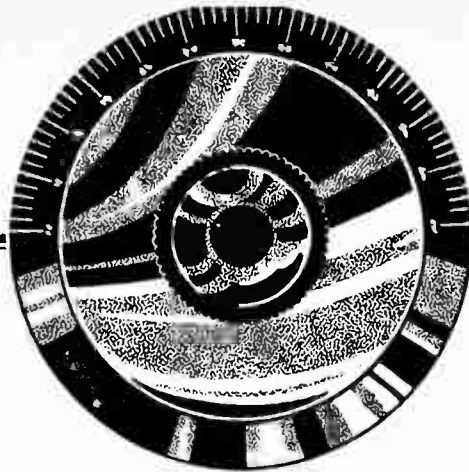

One Dial



One Switch

A Loud Speaker Receiver

complete £13:18:6

A Loud Speaker Receiver whose performance will delight the enthusiastic amateur, and one that is so convenient and easy to handle that it may be used by most of the household. The quality of reproduction is so exceptional that it could well be taken as a standard of perfection by those who construct sets of their own. The cabinet is Mahogany and of beautiful design, Valves, etc., being enclosed but instantly accessible by raising the top of the cabinet. The range for loud speaker reception under normal conditions is 25 miles from ordinary B.B.C. Stations, and 100 miles from High Power Station.

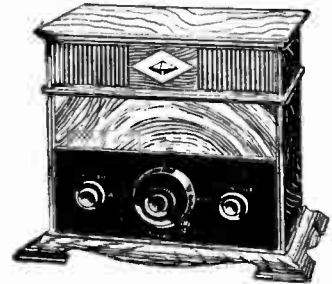

HIRE PURCHASE.

Messrs. Taylor & Co. Ltd., 49/53, Sussex Place, South Kensington, S.W.7. (near South Kensington Station), are prepared to arrange for the sale of A.J.S. Receivers and Loud Speakers on easy payments.

SPECIFICATION OF COMPLETE INSTALLATION.

- Cabinet Receiver, 2-Valve Type "Z" as illustrated.
 - 1 A.J.S. Junior Loud Speaker.
 - 1 Accumulator, A.J.S. Lucas "Milam" 2 volt 50 amp. (actual).
 - 2 Valves A.J.S. Mullard 2 volt Dull Emitter.
 - 2 50 volt H.T. Batteries.
 - 1 each A.J.S. Coils, 45 and 50 to cover 255-550 metres.
 - 1 Set of connecting Wire.
 - 1 Coil (100 ft. Aerial Wire, Copper 7/22 gauge).
 - 2 Shell Insulators. 1-9 in. Lead-in Tube.
- Price of Receiver only, £8 : 2 : 6. Price complete £13 : 18 : 6.
All prices include Royalties.

A.J.S.

A. J. STEVENS & CO. (1914) LTD.,

RADIO BRANCH - WOLVERHAMPTON.

Telephone: 1748 (7 lines). Telegrams: "Reception, Wolverhampton."

LONDON SHOWROOMS: 122/124, Charing Cross Road,

London, W.C.2. Telephone: Regent 7161-2. Telegrams: "Ajayesco, Westcent, London."

GLASGOW SHOWROOMS: 223, St. George's Road, Glasgow;

Telephone: Douglas 3449. Telegrams: "Reception, Glasgow."

Please send me Publication No. 120.

Name

Address

W.V. Mar. 25/26.

ISSUED BY THE PUBLICITY DEPT., A.J.S.

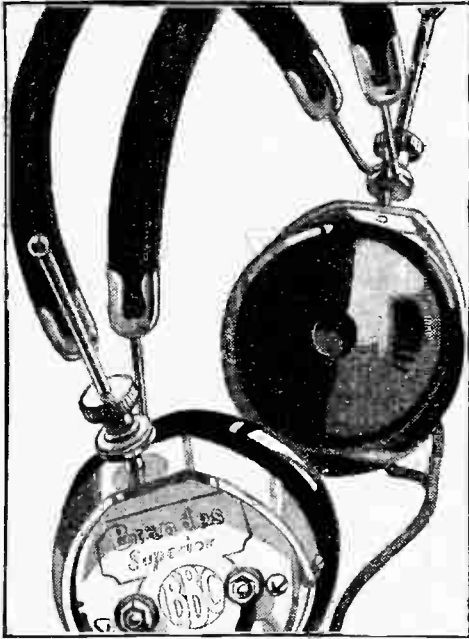

MATCHED TONE HEADPHONES

IF you're fond of sitting up in the wee sma' hours to stretch a hand across the world, Matched Tone are extremely able confederates. With radio you span continents and with Matched Tone it becomes easier, "comfier" and much more efficacious. Distant signals stand out clearly; Matched Tone grope in the ether with unfailing accuracy. The specially matched receivers make them super-sensitive and tone perfect. You are logging a new call-sign every day with Matched Tone.

20/-

Table-Talker 30/- Brandola 90/- Audio Transformer 17/6

Brandes

Brandes Limited, 296, Regent Street, W.1.

From any good Dealer

G/563.B

SERVICE ADVERTISING

CHARACTER

... look at the monolith standing on London's Embankment—the quaintly etched cuneiform will immediately carry your mind to Cleopatra and the glories of old Egypt. Just character...

Character peeps out at you in many ways. The head, and the line of a man's jaw will generally tell you his character. And most things have character written on them for all to see. Look at the monolith standing on London's Embankment—the quaintly etched cuneiform will immediately carry your mind to Cleopatra and the glories of old Egypt. Just character. CLEARTRON valves have a character all their own. You cannot class them as ordinary; there is no valve which quite comes up to the CLEARTRON standard. You know that their manifold advantages are definitely guaranteed. CLEARTRON are all dull emitters sold at standard prices.

Send for illustrated catalogue post free. CLEARTRON RADIO Ltd One Charing Cross, London.

Works: Birmingham.
Telephone Regent Street, Grams Cleartron, Westrand, London.

TYPE.	Acc. or Battery.	PRICE.
C.T.15	2 volt Acc.	12/6
C.T.25	6 volt Acc.	15/-
C.T.25B	6 volt Acc.	15/-

Filament Volts 3.0
Filament Amps 0.68
Anode Volts 30-150
Voltage Amplification Factor 8
Impedance 17,500
Mutual Conductance 500
Plate Current Saturation at 50 Volts over 8 milliamps.

C.T.08 12/6

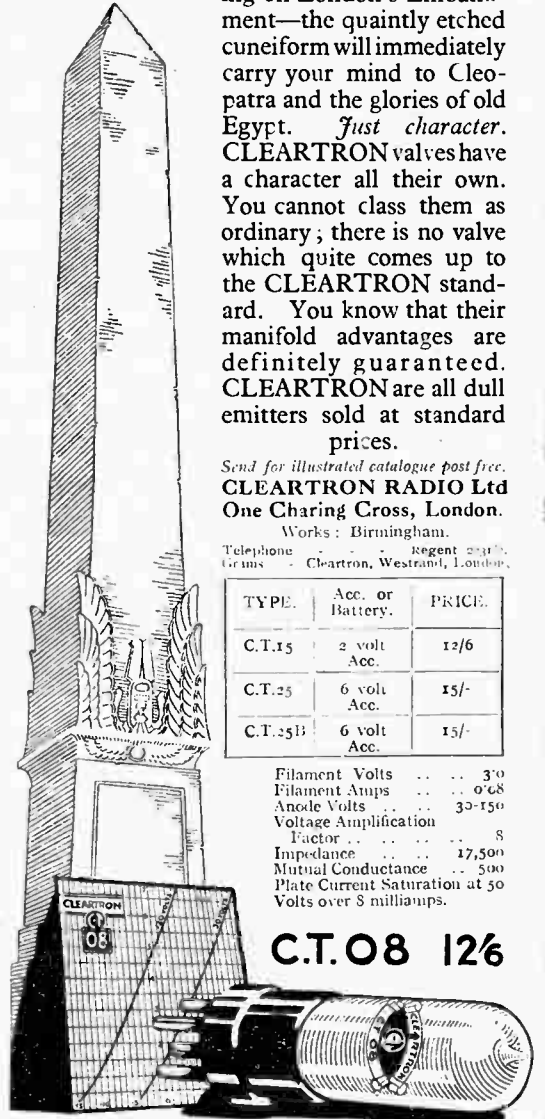

America's Foremost Valve—all British Made.

CLEARTRON

BRITISH



MADE

44/52.D

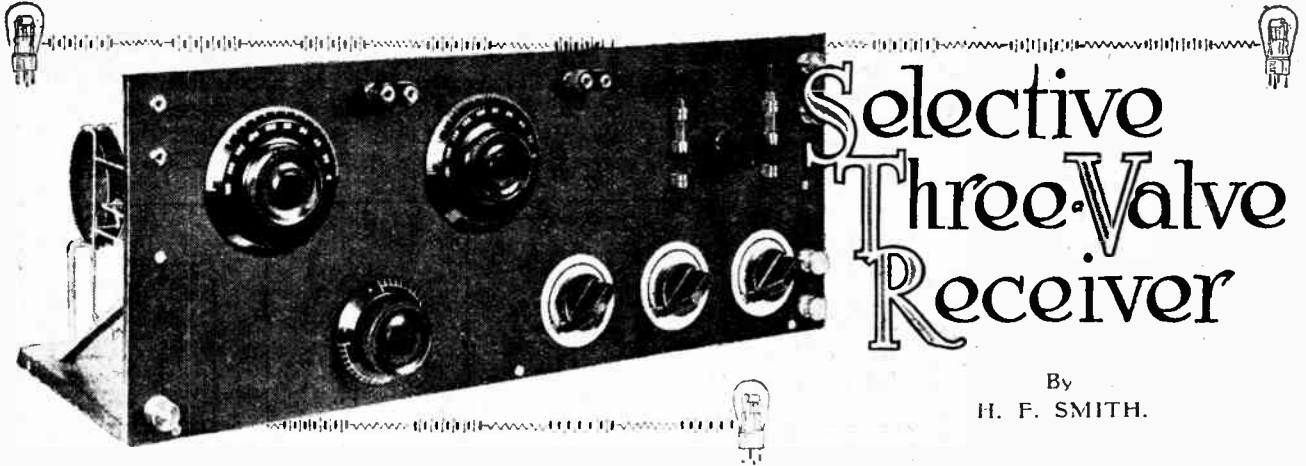

By
H. F. SMITH.

Balanced H.F. Amplification with Reaction.

THE number of broadcasting stations in Europe has now increased to such an extent that it has been possible to allot only the minimum practicable separation between adjacent wavelengths. Clearly, therefore, selectivity must be the first consideration in the design of any receiver intended for other than purely short-distance reception. As an example of this, it may be mentioned that listeners in North Wales and the Isle of Man, who have been accustomed to listen to Manchester, are finding in some cases that this station is being interfered with by Dublin. Although the problem of eliminating a powerful local station in favour of a distant transmitter on near-by wavelength is admittedly not an easy one, the lack of selectivity revealed by the complaints mentioned above shows plainly that the design of the receiver is at fault. In all probability, direct-coupled sets with highly damped circuits are being used, calling for tight reaction coupling with consequent difficulty in operation and impaired quality of reproduction if the tuning is to be sharpened.

The Circuit.

The receiver to be described in this article comprises the popular combination of three valves, functioning respectively as high-frequency amplifier, regenerative detector, and L.F. amplifier. The fact that aerial damping is reduced by the use of a primary circuit (not separately tuned) necessitates the application of some artificial stabilising device; in this case the "neurodyne" principle has been adopted. In order to compensate to some extent for the inevitable clamping due to the inclusion of leaky-grid condenser

rectification, regeneration has been introduced between the anode and grid circuits of the detector valve, and is controlled by a variable condenser, the setting of which governs the amount of oscillating H.F. energy fed back to the grid. A potentiometer is fitted to control the grid voltage of the detector valve, and is a very useful refinement for long-distance work, but may be omitted if desired. Two pairs of output terminals are provided in order that loud-speaker and headphones may be used interchangeably; a switch is inserted for easy changing-over from one to the other. The simplified circuit diagram is given in Fig. 1.

Adaption for Long Wavelengths.

The need for making provision for reception of the long-wave station is always rather a problem in the design of a receiver of this description, due to difficulty in arranging for interchanging of the H.F. transformer.

In this case the expedient of eliminating the high-frequency amplifier on the long waves has been adopted. Referring to Fig. 2, which shows the complete circuit diagram, it will be seen that the grid circuits of the first two valves are broken by the insertion of pairs of "Clix" sockets (W, X, and Y, Z), which can be bridged when required, and provision is made for adding inductances to the grid (G.L.C.) and reaction circuits (R.L.C.).

As the small number of turns wound as a continuation to the short-wave grid coil are quite inadequate as an aerial inductance on the longer wavelengths, it is arranged that more turns may be included and an extra socket (A₁) is fitted, in order that the aerial lead

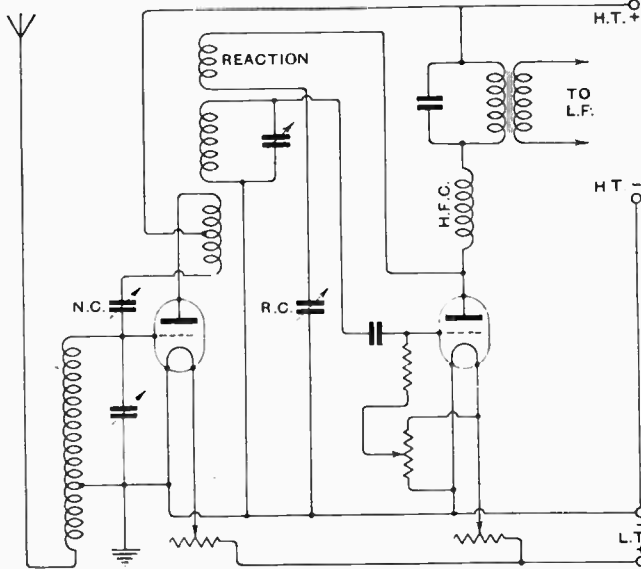

Fig. 1.—The simplified circuit diagram, showing arrangements for 250-500 metre reception.

Selective Three-valve Receiver.—

may be connected to the junction point between the fixed coil and the loading coil.

Coil Construction.

When the H.F. valve is cut out of circuit, it becomes necessary to provide reaction on to the aerial-grid coil; this is carried out by switching the current fed back *via* the reaction condenser through a tightly coupled plug-in coil by means of the switch S_1 .

It will be as well to describe in detail the construction of the special components required. The aerial-grid coil consists of 80 turns of No. 24 D.C.C. wire wound continuously on an ebonite tube $2\frac{1}{2}$ in. long and $2\frac{1}{2}$ in. in diameter, a tapping being taken at the fifteenth turn from the start by drilling a small hole in the wall of the tube, and passing through it a short length of the wire, doubled back on itself, and of sufficient length to reach a soldering tag screwed to the end of the former. This is for connection to earth;

there are thus 15 turns in the aerial circuit and 65 turns in the grid circuit. To obtain a tight coupling between this winding and the long-wave loading coil, it is necessary that the tube projects as little as possible beyond the grid end of the winding, and, as there will not be sufficient room for another soldering tag, the end of the wire is bared, and passed several times through a hole drilled within $\frac{1}{16}$ in. of the edge, thus affording a junction point giving a short, direct connection. The construction of this coil is illustrated in Fig. 3; the exact height of the brass supporting bracket will depend on the type of coil used for loading, as the axes of the two inductances should coincide.

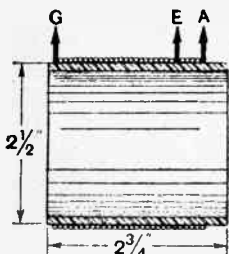

Fig. 3—Construction of the aerial grid coil.

The Neutralised Transformer.

The high-frequency transformer is shown in Figs. 4 and 5. Another length of ebonite tube 4 in. long and $2\frac{1}{2}$ in. in diameter is required, and carries three separate windings. The first, consisting of the neutralising and primary sections, has 48 turns of No. 36 D.S.C. wire, tapped at the 24th turn. The smallest possible spacing (merely for insulating purposes) is allowed between this section and the secondary, which has 65 turns of No. 24 D.S.C. wire. Above this is the reaction winding, of 45 turns of No. 36 D.S.C., spaced by $\frac{1}{4}$ in. from the top of the secondary. All windings are in the same direction and the various ends are taken through holes drilled in the former to soldering tags arranged round the top and bottom edges of the tube. The connecting tags, marked A, B, and C, are mounted on the upper

end of the former, and the remainder on the lower end, D being immediately under B, and G under A. Other methods of construction are permissible, and, indeed, some of them may have slight advantages, but are generally more difficult. In this connection, the reader is referred to a note in the "Practical Hints and Tips"

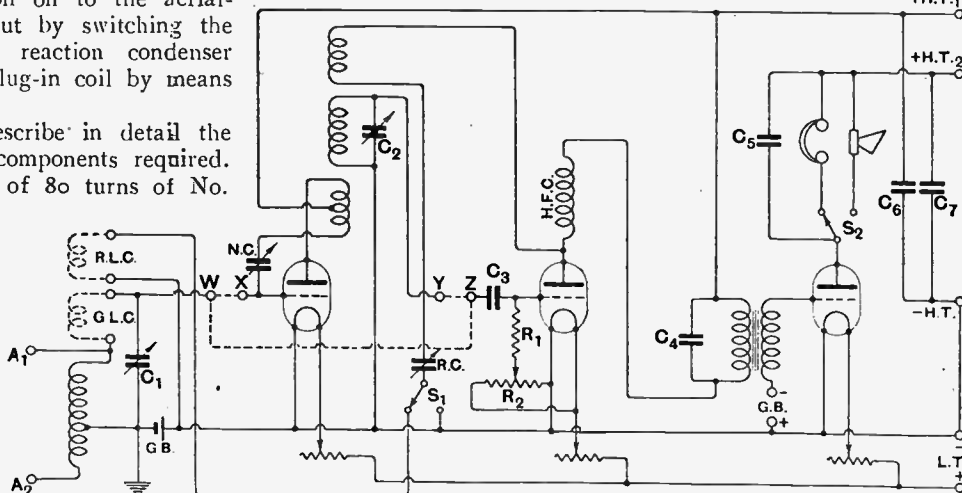

Fig. 2.—The complete circuit diagram. Long-wave loading coils are shown in dotted lines. $C_1, C_2, C_3 = 0.0005$ mfd.; $C_4 = 0.0003$ mfd.; $C_5 = 0.001$ mfd.; $C_6, C_7 = 1$ mfd. $R_1 = 2$ megohms; $R_2 =$ Potentiometer, 300 ohms; R.C. = Reaction condenser.

section of the issue of this journal for February 3rd. The H.F. choke may be wound on a bobbin former, of which a sectional sketch is given in Fig. 6. This may be built up with three ebonite discs, or turned from the solid. The centre screw should project far enough to enable it to be held in the chuck of a lathe or hand

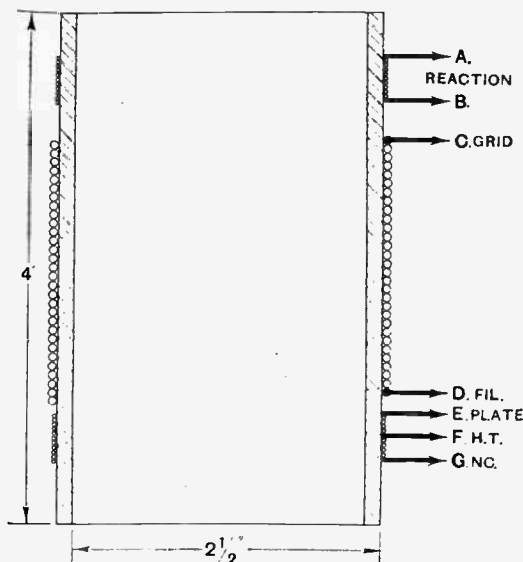

Fig. 4.—Construction of the H.F. transformer.

drill, and the slot is wound full of No. 40 D.S.C. wire. Alternatively, a ready-made choke may be used.

The main panel and the back terminal panel may be drilled in accordance with Figs. 7 and 10, and the components mounted in position. The "Clix" sockets are spaced suitably to take the twin plugs of the same

Selective Three-valve Receiver.—

make; these latter, incidentally, as supplied, are joined together by insulating material, and must be connected by a small piece of wire secured under the nuts. The baseboard components are now screwed down, as indicated in Fig. 8, special care being taken in mounting the coil and coil sockets. The panel is secured to the base by wood screws, two brass brackets giving additional support. Before joining them together, it is necessary to put on some of the wiring in the less accessible positions. No.

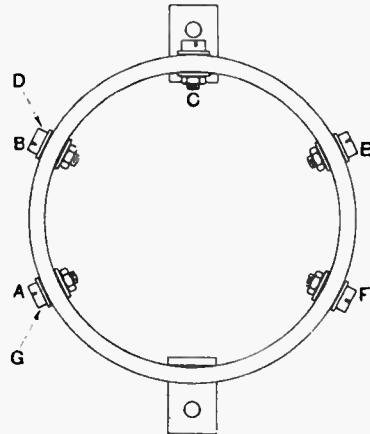

Fig. 5.—Plan of cylindrical former for H.F. transformer. Terminal screws A, B, and C are on the upper edge.

16 tinned copper wire is used throughout, a few lengths of insulating sleeving being used where there is risk of short-circuiting.

The fixed condensers C₃, C₄, C₅, and the H.F. choke are supported by their connecting wires; the positions of these components are clearly shown in the photographs.

Following the usual practice, all filament and low-

potential leads are kept low down on the panel or baseboard, while grid and plate wires are run clear of each other by the most direct path possible.

Reducing Anode Circuit.

A single dry cell is connected in such a manner as to apply a negative bias to the grid of the H.F. valve; its main object is to effect an economy in the anode current consumption, and it may, of course, be omitted

if desired. The cell is secured by means of a half-hoop of wire with eyes at its ends, through which screws are passed into the baseboard.

It should be noted that if components of appreciably larger physical dimensions than those used in the set as described are employed, a slightly deeper baseboard will be required. This is particularly the case if loading coils of larger diameter are inserted in the loading sockets. The first (H.F.) valve holder would also need to be moved slightly in order to accommodate the larger size valves. Several standard types of cabinet are available, having a depth of some 7½ to 8 in.

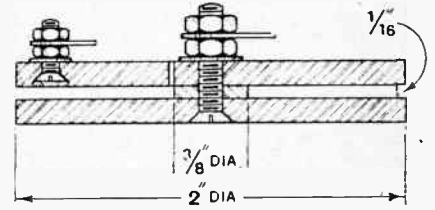

Fig. 6.—Ebonite bobbin former for the H.F. choke coil.

The first valve should have an impedance of not more than about 10,000 ohms, and either a D.E.5, D.E.4, D.F.A.o, B.4, D.F.A.1, Cosmos S.P. 18 "Red Spot," D.E.6, P.M.4, Cleartron C.25, or other make having similar characteristics, is suitable. The second valve may be of the "general-purpose" type; if of high impedance, the L.F. transformer should have a low ratio, in the neighbourhood of about 2:1. The output valve should be capable of handling sufficient power for the operation of the loud-speaker, and may be of the same type as that used in the first stage.

Operation of the receiver.

For the 250-500 metre waveband a short-circuiting plug is inserted in the socket marked G.L.C., the other being left open.

An H.T. voltage of about 50 should be applied to the H.F. and detector valves, which are fed from the terminal marked "H.T. + 1." Up to 120 volts may with

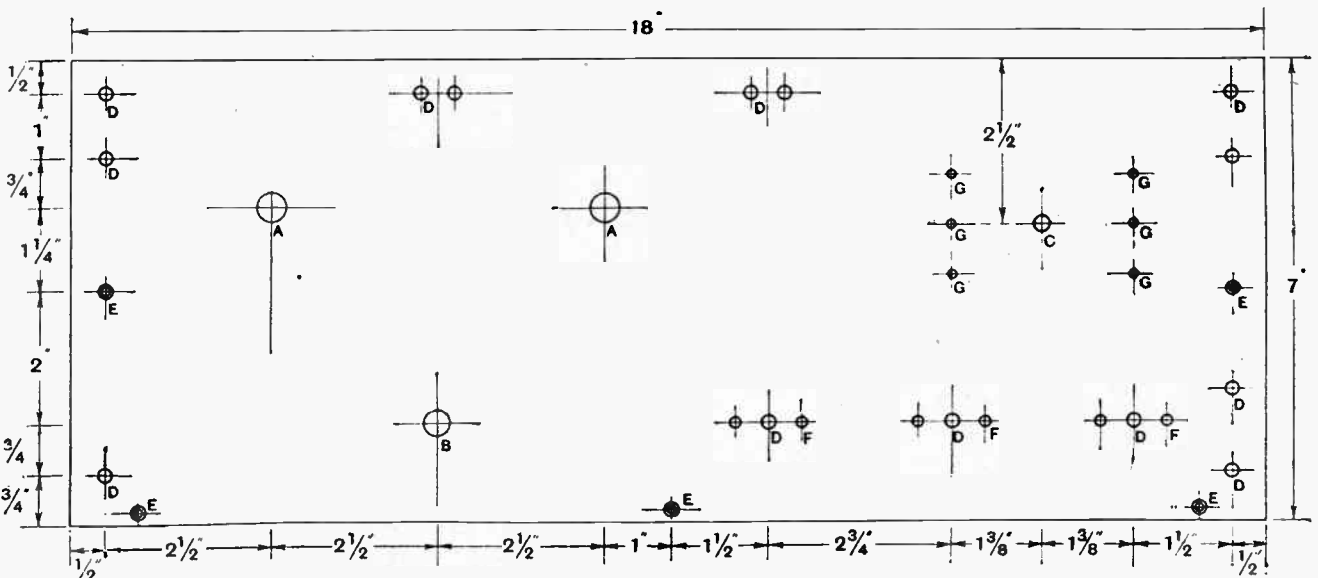

Fig. 7.—Drilling diagram of the front panel. A, 7/16in. dia.; B, 3/8in. dia.; C, 1/4in. dia.; D, 3/16in. dia.; E, 1/8in. dia. countersunk; F, 5/32in. dia.; G, 1/8in. dia.

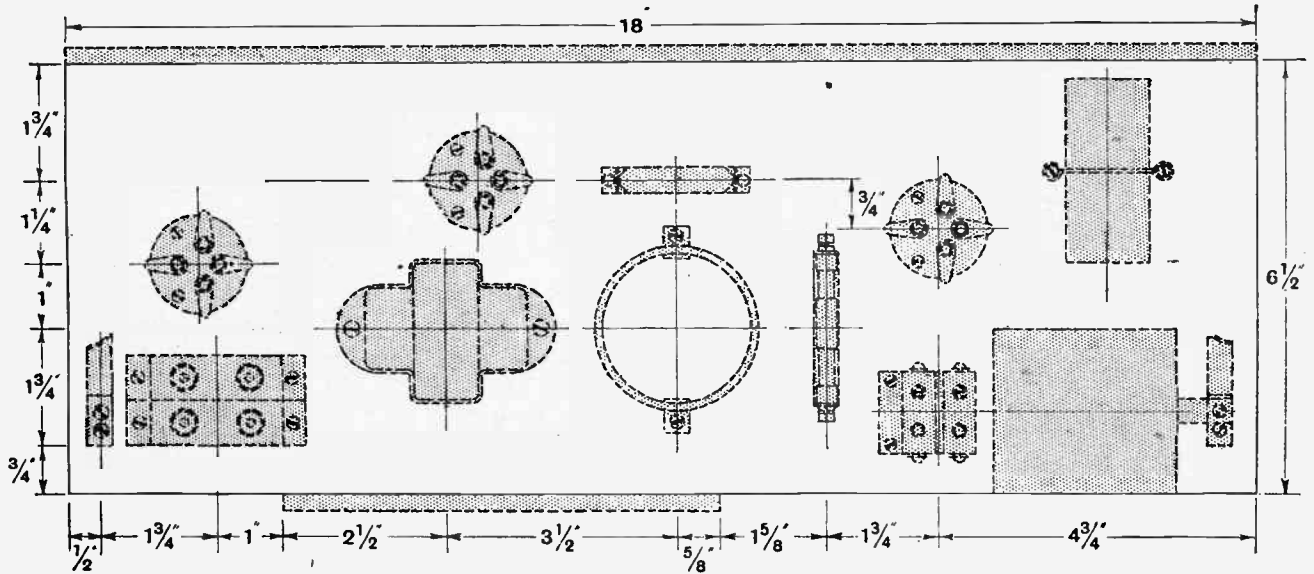

Fig. 8.—Positions of components on the baseboard.

advantage be used on the L.F. amplifier (H.T. + 2) with a grid bias of as much as 9 volts, depending on the maker's instructions regarding the type of valve actually used. With normal filament brilliancy, and the reaction condenser set at zero, the local station should be tuned in, with the metal sleeve of the neutralising condenser set at about one-third its travel along the glass tube. As the circuits come into tune, oscillations may occur, in which case further adjustment of this condenser will be necessary. This adjustment is best carried out by the

use of a wooden or ebonite rod, by the aid of which the metal sleeve may be moved to the desired position.

Reaction Control.

For distance reception the overall sensitivity of the set may be improved by manipulation of the reaction condenser. It should be borne in mind that it is necessary to keep two circuits in tune when "searching" for signals, and that nothing will be heard (except perhaps a powerful local station) unless this condition is reached.

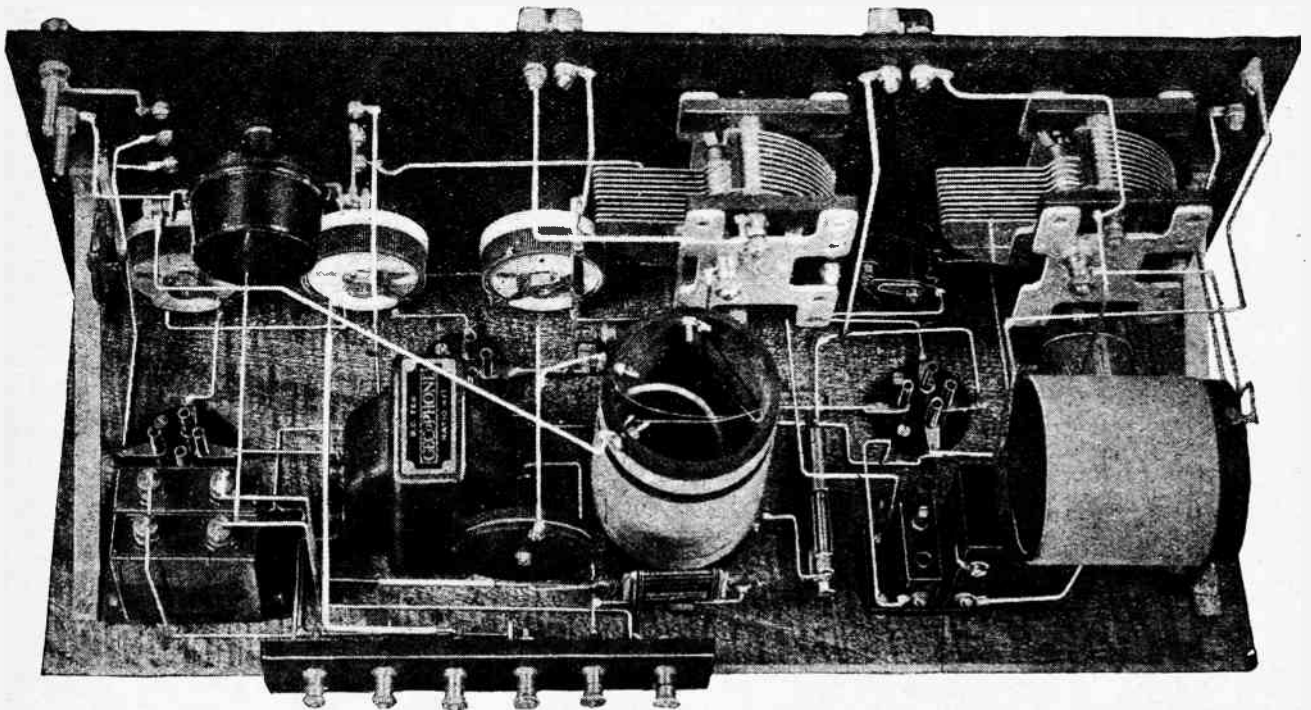

Rear view of receiver with long wave coils removed and shorting plug in position.

LIST OF PARTS.

- 1 Ebonite panel, 18in. × 7in. × ¼in.
- 1 Ebonite terminal panel, 6½in. × 1½in. × ¼in.
- 1 Baseboard, 18in. × 6½in.
- 2 Variable condensers, 0.0005 mfd. (Ormond).
- 1 Micro condenser, 0.00004 (Igranic).
- 3 Valve holders base mounting type (Burwood).
- 3 Rheostats (Igranic-Pacent).
- 1 Potentiometer (McMichael).
- 1 L.F. transformer, 4:1 ratio (G.E.C.).
- 1 "Balcon" neutrodyne condenser (Igranic-Pacent).
- 2 Single-pole change-over switches (Radcom).
- 1 Fixed condenser 0.0003 mfd. (Igranic).
- 1 Fixed condenser 0.001 mfd. (Igranic).

- 1 Fixed condenser, 0.0095 mfd. (Igranic).
- 2 Fixed condensers, 1 mfd. (T.C.C.).
- 1 Grid leak 2 megs. with base (Cosmos).
- 2 Ebonite tubes, 2½in. dia., for coil formers.
- 2 Base mounting coil sockets.
- 1 Short-circuiting plug for above.
- 2 Coils, Nos. 200 and 150 (O'Keefe).
- 6 "Clix" sockets.
- 2 "Clix" twin plugs.
- 3 "Clix" plugs
- Wire, No. 36 D.S.C., No. 24 D.C.C., No. 24 D.S.C.
- Screws, terminals connecting wire, etc.

Approximate cost, without cabinet or accessories - - £5 os. od.

ance winding. The effect of varying the setting should be tried when listening to a weak signal, as slight differences can best be appreciated under this condition. The best position will be that giving loudest signals in combination with smooth control of reaction. One is apt to be misled by the fact that, as the contact brush is moved

sated for, to a great extent, by increasing reaction. In general, rectification will be carried out most effectively when a certain amount of positive bias is applied to the grid.

The fact that the two tuned circuits must be kept fairly accurately in resonance when searching for a weak

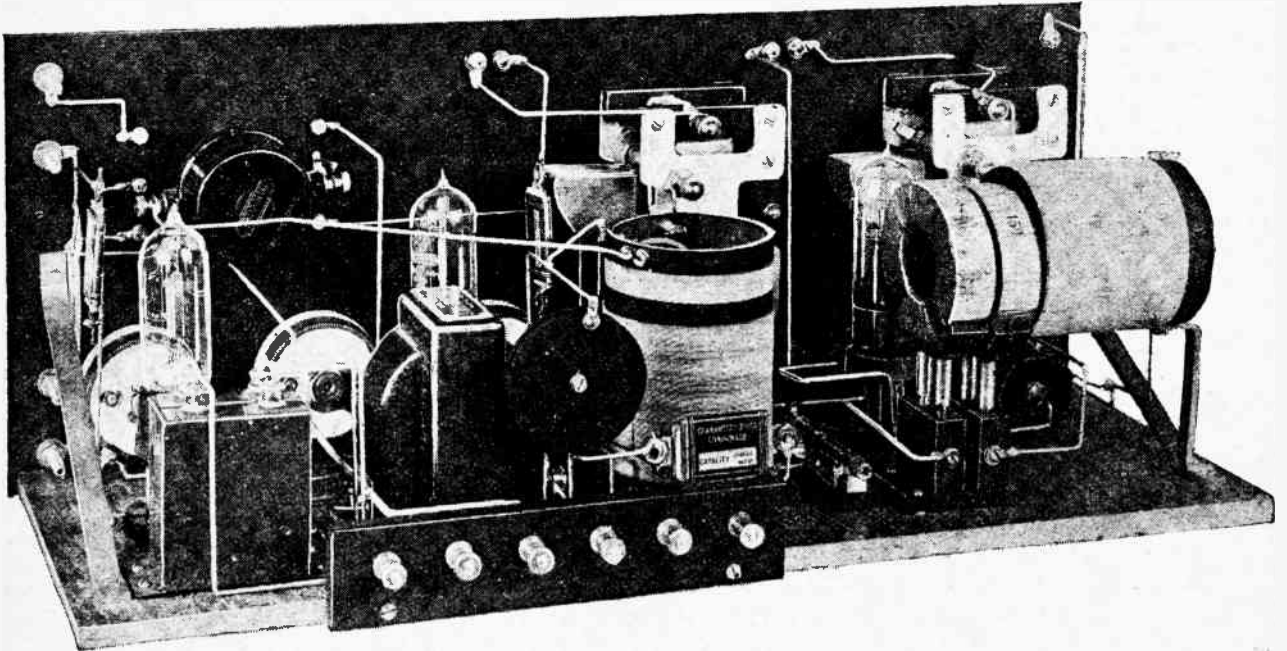

The receiver adapted for long-wave reception with loading and reaction coils in position.

from the negative towards the positive end, signals may become weaker; this does not necessarily mean that the valve is operating less efficiently as a detector, but shows that damping is being increased. This can be compen-

signal accounts for most of the trouble experienced in operating a sharply tuned set of this description, as otherwise the receiver will seem to be entirely "dead." A little experience, however, will soon enable the amateur to know when this condition is reached, as, even if no signals are coming in, there will be a certain amount of noise in the headphone, due to atmospherics, broadly tuned spark transmitters, and C.W. "mush."

The effect of varying the number of turns included in the aerial circuit of the H.F. transformer may be tried in order to suit local conditions. Selectivity will be considerably increased by a reduction in turns, but, in general, only at the expense of signal strength, which will fall off rapidly if the coupling is reduced excessively.

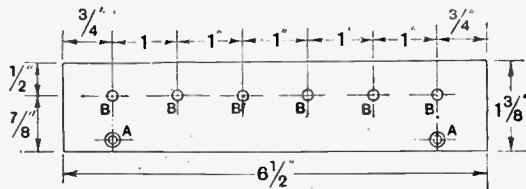
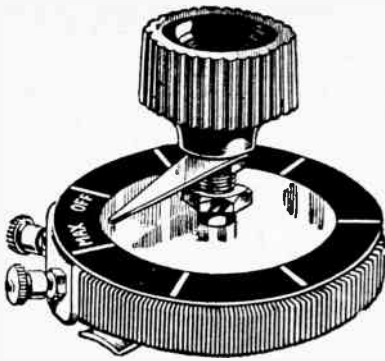

Fig. 10.—The terminal panel A, 5/32in. dia.; B, 1/8in. dia countersunk.



FILAMENT RESISTANCES

Well designed and constructed. Of nice appearance and smooth in action.

PRICES:

7 ohms	2/3
15 or 30 ohms	2/6
Dual 6 and 30 ohms	3/3

Finston

WIRELESS COMPONENTS

have a splendid reputation for all-round quality and efficiency, and can be obtained from all dealers.

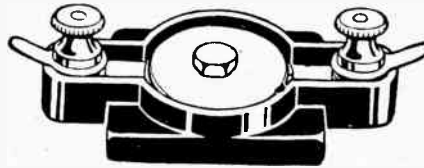

FIXED CONDENSERS

1 - each—'001, '0001, '0002, '0003, '0004, '0005, '0006,
1,9 each—'002, '003, '004, '005, '006.

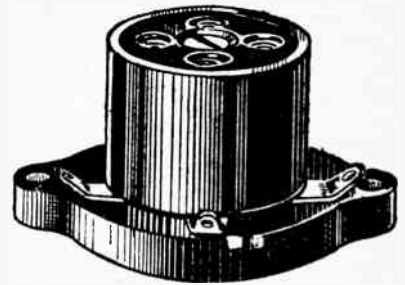

VALVE HOLDER

This "Puratone" valve holder is antimicrophonic.

Cuts out all valve noises and absorbs all vibration interferences. An ideal holder for perfect reception.

PRICE
2/-
EACH.



LO-LOSS COILS

Strongly constructed. High inductance and low self capacity.

Coil No.	Price
25	1/3
35	1/6
50	1/9
75	2/-
100	2/6
150	2/9
175	3/3
200	3/6
250	3/9
300	4/-

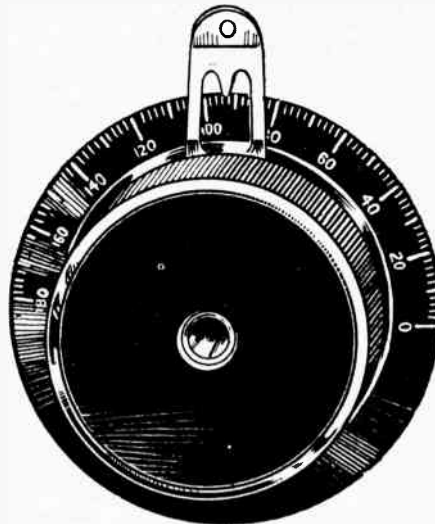

MICRO VERNIER DIAL

This dial can be used with all types of variable condensers and it gives perfect control. Coarse and fine tuning. Ratio 80 to 1.

PRICE 6/6 EACH.

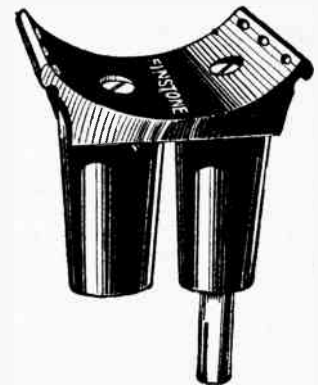

COIL PLUGS

Made of Black Bakelite. Coils can be either sewn or bound, as special holes and grooves are provided. Superior in finish. Nickel Parts.

PRICE 10d. EACH.

Finston

MANUFACTURING COMPANY, LIMITED
45, HORSEFERRY ROAD,
WESTMINSTER, LONDON, S.W.1

Telephone :
VICTORIA
1644.

Telegrams :
WYRFINSTON
SOWEST.

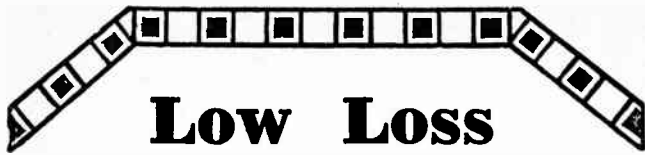

Low Loss Coil Tests RESULT!



In the recent "Wireless World" coil competition the first prize was awarded to a home-made coil wound with Litz Wire.

The extraordinary efficiency of the LEWCOS Inductance Coils is partly due to the fact that these coils are wound with a *specially designed Litz Wire*. The actual design of this wire is the *result of considerable research* into the phenomena of high frequency resistance in inductive windings.

Try this LEWCOS coil for yourself! Each coil is tested in our laboratory, boxed and sealed up, reaching you in perfect condition. Ask your dealer for a demonstration.

LEWCOS *Inductance Coil*

The LONDON ELECTRIC WIRE
COMPANY & SMITHS, LTD.

Manufacturers of Glazite Connecting Wire
Playhouse Yard, Golden Lane, London, E.C.1



FREED-EISEMANN NEUTRODYNE RECEIVERS

Also special box of parts
for Amateurs.

FULL DETAILS ON REQUEST.

Sole Concessionaires for
Gt. Britain and Ireland:

DE LEEUW & Co. Ltd.,

Radio Engineers and
Manufacturers.

SENTINEL HOUSE,
SOUTHAMPTON ROW, W.C.1.

'Phone : Museum 8340.

THE BATTERY ROOM AT 2LO.

Studio and Control Room Battery System at the London Station.

By R. C. SHAW (B.B.C Engineering Staff).

At one time the matter of batteries in connection with amplifiers for London Station Studios and Control Room was a very simple matter, for there were then only two units to be considered, viz., one amplifier and a small Simultaneous Broadcast Board. The amplifier required a total of 10 volts for filament lighting, 80 ampere-hour cells being used. The H.T. was supplied from a 200-volt battery made up of 50-volt units. The Simultaneous Board needed 6 volts for filament heating, and 200 volts H.T. The only other batteries required for effective transmission apart from grid negative cells were those for the microphone, where 8 volts were used for polarising. It will be realised that battery power did not occasion much thought during 1923 and the early part of 1924. But development necessitated the fitting of more amplifiers and an expansion on the Simultaneous Board, so that to-day the Main Control Room consists of four amplifying units, each unit consisting of two amplifiers and a much larger and more efficient Simultaneous Board mounting thirty amplifiers each with three valves. In addition, there is one receiving unit.

Central Battery System.

Much thought was given to the question of whether each unit in the Main Control Room should have its own batteries, or whether a central battery system should be installed. The question did not materially affect filament lighting batteries, but it was feared that if a common or central H.T. unit was installed, there would be a certain amount of "cross talk" or interference from one amplifier to another when there was any variation of direct current feed causing a voltage change due to the high internal resistance of the H.T. unit. It was decided to have a severe "try-out," and, with this object in view, a 300-volt 22-A.H. unit of very low internal resistance was temporarily installed and tested under conditions that were more severe than would arise in practice. The test was entirely satisfactory, and in a short time the central battery now used in the Main Control Room came into being. The 6-volt battery used for lighting the filaments of all valves—

approximately 120 at 0.85 amps.—has a capacity of 720 A.H. at the ten-hour rate.

It is never desired to work all valves at one time, the discharge on the L.T. batteries when working at full load being between 60 and 70 amps. Two 6-volt units are installed, one for change-over purposes, the wiring being so arranged that both units can be charged or discharged in parallel, so that, in the latter case, should it be necessary to change over L.T. batteries during transmission, this can be effected without a stoppage.

An essential of these batteries is that, even when taken off charge, they shall be noiseless when on discharge, for any battery noise is amplified and disturbing to the transmission.

Details of Wiring.

The L.T. wiring throughout is of $\frac{1}{2}$ in. copper rod, which allows of hardly any voltage drop. Just under 6 volts are required at the terminals of the amplifiers, and this is satisfactorily attained through the copper rod used. The main copper rod bus-bars run the length of the room, at a height of about 15ft. from the floor, with carefully soldered T pieces radiating to each unit. The scheme of connections to the amplifiers was a matter for careful consideration, as the contact was to be of such a character as to allow of no movement, but at the same time to allow of the entire unit being rapidly disconnected. Plugs and

sockets specially constructed of suitable and ample metal fittings were eventually installed, so that a single amplifier may be disconnected instantaneously from the main bus-bars without danger of interfering with other amplifiers in user. The connections on the cells are welded, while all others are bolted, lead washers being used.

The H.T. batteries consist of two units of 150 cells 300 volts 22 A.H., one being for change-over purposes. Switching arrangements provide that a change-over can be made from one 300-volt battery to another without affecting the transmission. The wiring and method of connection is similar to that for the L.T. battery, except that $\frac{1}{2}$ in. rod is used, as voltage drop is small in any case, due to the small current passed. It will be noted that these cells are of low internal resistance, for the

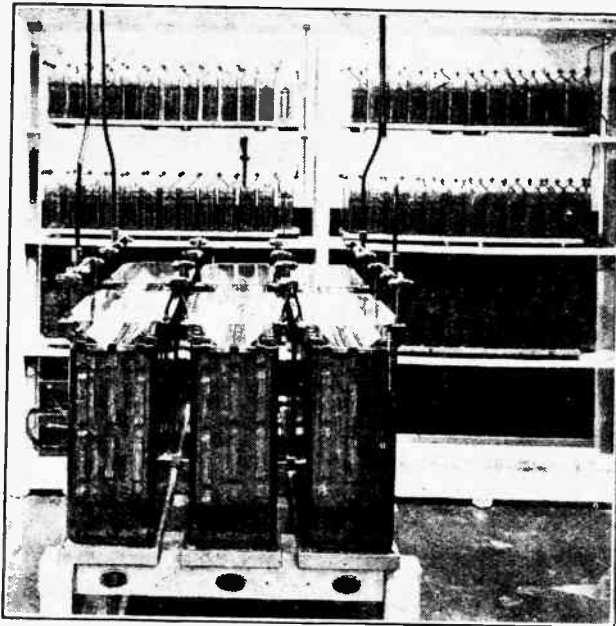

Central battery system for the simultaneous broadcast amplifiers. The large cells in the foreground are for filament heating, the H.T. batteries being arranged behind them on shelves.

The Battery Room at 2LO.—

reason given above, as there are at least six different units to feed.

The whole of the battery system is suitably provided with adequate fuses, especial care being taken to ensure that the voltage drop was not materially increased when fitting the L.T. fuses, the actual fuse wire being inserted in such a way to allow of no movement due to vibration or other cause. The main fuses are, of course, fitted at the terminals of the batteries, and each unit is separately fused, so that the main fuses would not be affected by a blow-out on a unit.

The switchboard consists of the usual essentials, viz.:

- (1) L.T. Charge Ammeter.
- (2) H.T. Charge Ammeter.
- (3) H.T. Battery and Main Supply Voltmeter.
- (4) L.T. Battery and Generator Supply Voltmeter.
- (5) L.T. Discharge Ammeter.
- (6) L.T. and H.T. change-over switches.

There are also the requisite field regulators and charging resistances. The L.T. battery is capable of being charged from a generator up to 100 amps., an automatic cut-in and cut-out being provided to ensure against damage to the charging machine. The H.T. battery is charged direct from the 200-volt mains through a series charging resistance, the switching and wiring being so arranged that when the switch is in the "Charge" position, the 300-volt battery is split into two parallel sections, each of 75 cells 150 volts, each section being charged at 2 amps or a total of 4 amps on the ammeter. All cells have glass containers and are mounted so as to facilitate inspection.

Studio Microphone and Amplifier Batteries.

The batteries for use with microphones and studio amplifiers are not installed as a central battery unit, each microphone and amplifier having separate batteries. The microphones operate from an 8-volt 60-A.H. battery, while a 4-volt 30-A.H. unit is provided for amplifier filament lighting. The H.T. for amplifiers is supplied by separate units of 120 volts.

All the above-mentioned batteries are capable of being charged or discharged from a switchboard fitted in conjunction with studio amplifiers. A generator capable of

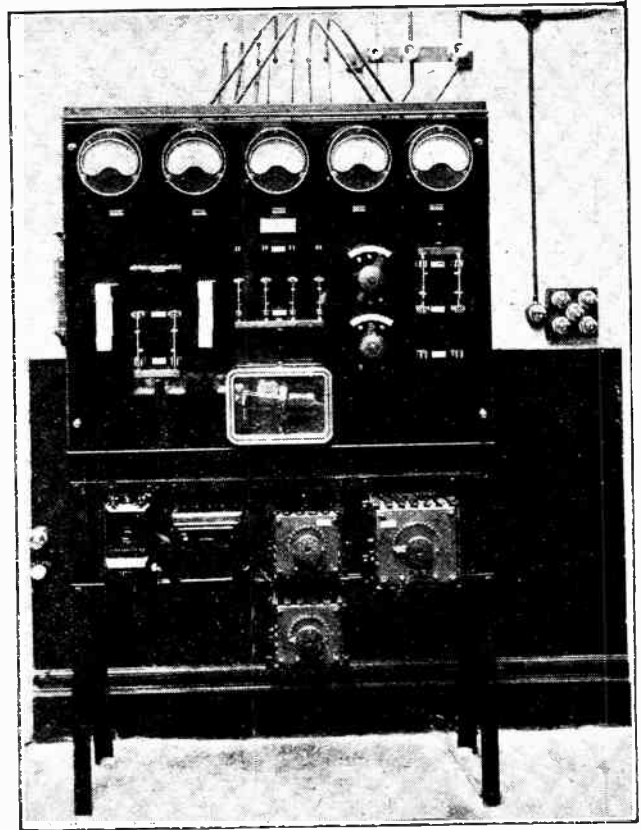

Main battery switchboard in the control room

a 60-amps output at 16 volts is provided for charging microphone polarising and filament batteries, these two units being charged in parallel but through separate charging resistances. The H.T. battery is charged from the 200-volt supply through suitable charging resistances.

It is still more essential that these batteries should at all times be noiseless, for any disturbance in the batteries is amplified to such an extent that when radiated it becomes perhaps louder than the actual performance taking place

Leclanché Wet Cell H.T. Batteries.

Since August last, when Messrs. Ripaults, Ltd., reintroduced their Leclanché Wet Cell Batteries for high-tension supply, their great difficulty has been to cope with the ever-increasing number of orders. Arrangements have been made, however, whereby these popular batteries can now be delivered from stock. Leaflets and full particulars are obtainable from the Company at King's Road, St. Pancras, N.W.1.

o o o o

Radix Move.

Messrs. Radix, Limited, manufacturers of radio apparatus and components, announce a move to new premises. These are situated at 16, Palmer Place, Holloway Road, N.7, where the offices and works will be contained under one roof.

The new Radix catalogue is at the

TRADE NOTES.

disposal of any reader who cares to write for a copy. o o o o

American Apparatus in London.

Mr. Alan Wright, of Sentinel House, Southampton Row, London, W.C.1, has been appointed sole sales representative in Great Britain and Ireland for the radio products of the Hart and Hegeman Manufacturing Company, Hartford, Connecticut.

o o o o

Reconstruction Service.

Broadcast listeners whose sets refuse to give the desired results may take heart from the knowledge that a "Reconstruction Service" is being run for their special

benefit by Messrs. L. Ormsby and Co., 28, Page Street, Westminster, S.W.1. Unsatisfactory sets are received at the company's Elstree works, where they are repaired or reconstructed in a manner embodying "Ormsby" designs. Full particulars of the service are obtainable on application to the company. o o o o

Simplifying Home Construction.

An ingenious system for the rapid building of various types of receiver, known as "The Blackadda Radio Building System," is now being produced by the Blackadda Radio Co., Ltd., 48, Sadler Gate, Derby.

The system employs standardised components which are easily assembled on the "Blackadda" Table, consisting of a moulded panel having 140 equally spaced holes, numbered on each side. A range of useful service sheets is issued describing the construction of various receivers.

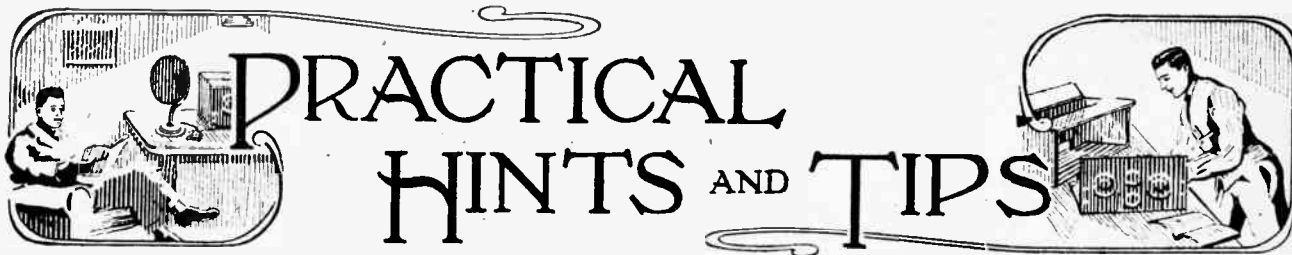

A Section Mainly for the New Reader.

VALVE-CRYSTAL STABILITY.

In a receiver employing a single H.F. valve followed by a crystal detector, it is possible to ensure stability by adopting either of the two circuit arrangements shown in Fig. 1. In the first circuit (a) the crystal is connected across a proportion of the inductance of the transformer secondary, which will in itself probably be insufficient to afford the amount of damping necessary to prevent self-oscillation when grid and plate circuits are brought into tune. As a direct-coupled aerial is used, however, the grid circuit will be fairly heavily damped, and, under average conditions, a certain amount of reaction will have to be applied before the valve will oscillate.

In the case of the second circuit, (b), the damping necessary for stability is provided by the load imposed by the crystal detector (if of sufficiently low resistance), which is connected across the whole of the tightly-coupled H.F. transformer. The grid circuit is only slightly

criticism, but have the advantage of simplicity. The second one suffers from the draw-back that, provided both circuits are in tune, oscillation will probably occur when the crystal contact is broken for purposes of adjustment. This difficulty may be overcome, however, by slightly detuning the grid circuit when setting the detector.

Possibly a more correct arrangement would consist of a combination of both circuits. If tapings are provided on the secondary winding of the H.F. transformer, sufficient inductance may be included in the crystal circuit to effect stability, at the same time introducing a desirable reduction in damping. The disadvantage mentioned in the last paragraph would still be present, however, and the same precautions would be necessary to prevent oscillation when setting the detector.

The above remarks apply more particularly to receivers designed to operate on the shorter wavelengths, including the broadcast band.

back a proportion of the H.F. current in this circuit through a variable condenser and reaction coil coupled to the grid inductance. This choke is not always essential, as, under certain conditions, the windings of a pair of head telephones or the primary of a low-frequency

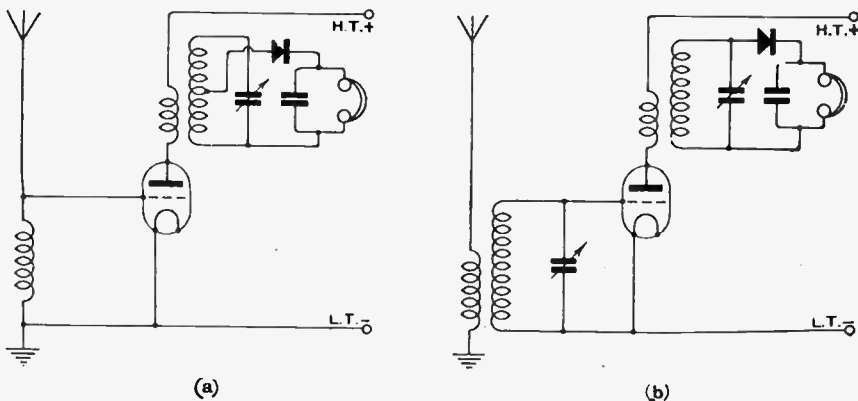

Fig. 1.—Stable valve-crystal receivers.

damped, provided that a moderately loose coupling is provided between its inductance and that in series with the aerial.

Both arrangements are open to

CONDITIONS FOR CAPACITY REACTION.

It is usual to insert a high-frequency choke coil in the plate lead of a valve when it is desired to feed

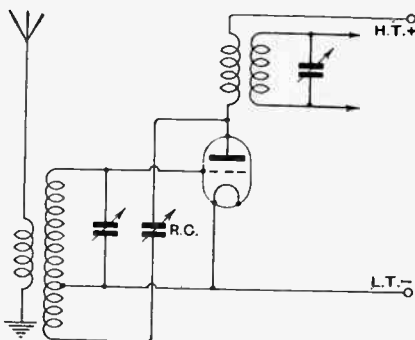

Fig. 2.—Capacity reaction.

transformer will offer a sufficiently high impedance to ensure that sufficient energy may be passed back.

This method of reaction control may also be applied in cases where there is a tuned circuit in series with the anode or, as in Fig. 2, a tuned H.F. transformer, which, if the effective coupling is fairly close, will have a similar effect. In this case reaction effects will only be obtainable on the wavelength to which the anode circuit is tuned, when it will offer a very high impedance to currents of that particular frequency.

The arrangement may, of course, be applied equally to a set having a direct-coupled aerial circuit.

o o o o

H.T. BY-PASS CONDENSERS.

The majority of paper-insulated condensers of high capacity, such as are usually shunted across the high-tension battery terminals of a receiver, are stated to be capable of withstanding pressures in the neigh-

bourhood of 300 volts. Circumstances occasionally arise when it is necessary to apply a voltage exceeding this value, as when large power valves such as those of the L.S.5 type are used. Under these conditions it is possible to double the safe working voltage of the condensers by connecting two of them in series. This will have the effect of reducing the effective capacity to half the original value, provided the individual condensers are the same.

USING A FRAME AERIAL.

It is well known that, under certain circumstances, the directional properties of a frame aerial may be turned to good account in reducing interference, even from a powerful near-by station, whose signals may be too strong for elimination by ordinary tuning methods with an open aerial. It seems, however, that a certain amount of misapprehension exists as to the best way of using a frame under these circumstances. It

should be realised that its directional effects are not particularly marked about the position for maximum signals, and, in fact, are only pronounced when it is set at approximately the position giving minimum signals. In practice, therefore, it will generally be best to swing the frame to the direction giving either a weak or zero signal from the interfering station, rather than to attempt to set it for best results from the desired station.

DISSECTED DIAGRAMS.

No. 23.—Wiring a Tuned Anode H.F. and Detector Set.

All typical circuits in general use have now been shown in our series of "Dissected Diagrams." The same method will now be used in an endeavour to make clear matters other than the actual reading of circuit diagrams which have been found to puzzle amateur constructors. The sketches below show the correct order of procedure in wiring a receiver, and also those leads at high oscillating potential to earth which should consequently be kept clear of other wiring.

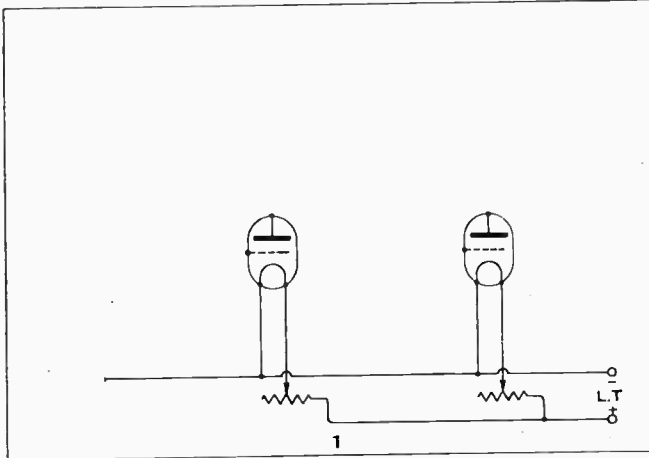

The filament circuits are completed in the usual manner. All these are low potential leads, and may be run close together.

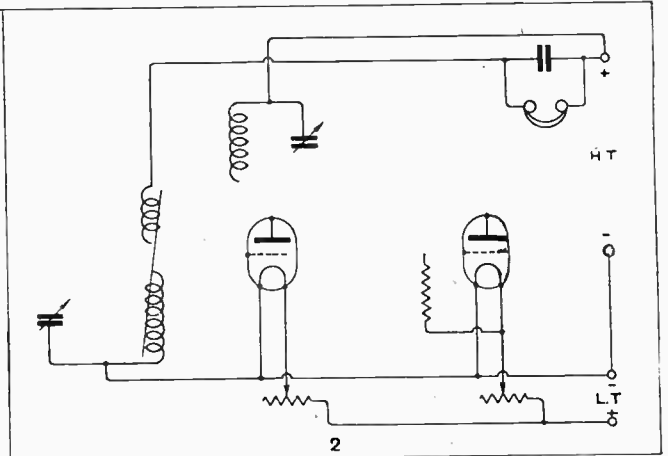

The remainder of the low-potential leads are put on. This diagram should be studied in conjunction with the complete circuit (No. 4).

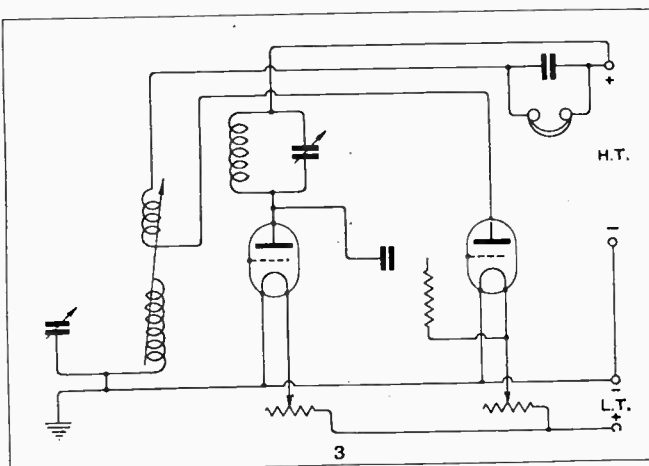

The high-potential sides of the plate circuits of both valves are connected up.

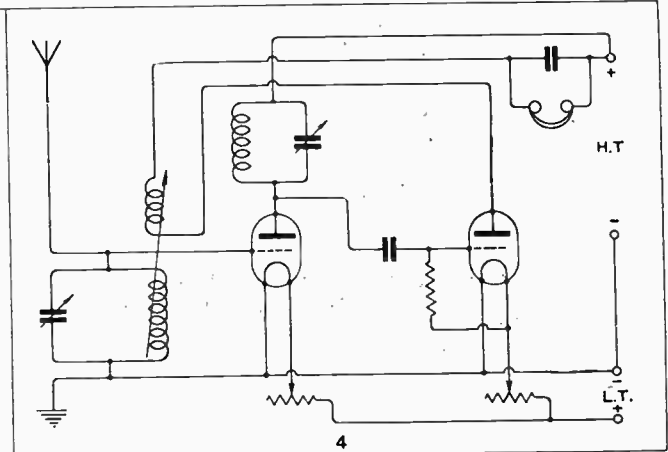

The addition of the grid leads (also a high potential), completes the receiver.



Events of the Week in Brief Review.

CHEERS IN CZECHO-SLOVAKIA.

Listeners in Czecho-Slovakia are rejoicing over the announcement of the Minister of Posts and Telegraphs that, as from April 1st, the annual broadcast licence fee will be reduced from 15 to 10 crowns.

o o o o

HOSPITAL SET FOR BRADFORD.

The Bradford Royal Infirmary is being fitted with wireless apparatus enabling each of the 215 patients to listen in. The equipment, which has cost £320, has been provided by students of the Bradford School of Art.

o o o o

ITALIAN WIRELESS REGIMENTS.

The claims of wireless as a military asset have been recognised by the Italian Government. The Army Reform Bill adopted by the Chamber provides for the constitution of two regiments of wireless operators.

o o o o

SENATORE MARCONI'S RECOVERY.

We are glad to learn that Senatore Marconi is making a rapid recovery after the internal operation which he underwent a fortnight ago. On leaving the nursing home in a week's time, the famous inventor will take a convalescent cruise in the Mediterranean on his yacht "Elettra." Bon voyage!

o o o o

SCHOOL WIRELESS IN SHEFFIELD.

A unique system of wireless in schools was inaugurated at Sheffield on Thursday last, when three council schools—at Firshill, Pyebank, and Woodside—were presented with apparatus.

Actually, only one receiver is used, and this is installed at Firshill. The other two schools are linked up by telephone wire. Sheffield, therefore, possesses a miniature "S B." system of its own.

o o o o

BROADCASTING THE BUDGET.

Deprecating the suggestion that the Budget speech in Parliament should be broadcast, a provincial paper remarks: "The speech begins just after 4 p.m. and ends generally not later than 6 p.m. or 6.30 p.m., and then the majority of intelligent listeners are at their offices or elsewhere."

The temerity of this assertion makes one gasp!

SPANISH WIRELESS EXHIBITION.

Madrid is planning a wireless exhibition for 1926 on the same lines as last year's effort. Spanish listeners favour British, French, and German apparatus, there being little demand for American products.

HIGH POWER FROM SWEDEN?

The Swedish Government is being approached for permission to erect a high power broadcasting station.

o o o o

NEW NAME FOR OSCILLATORS.

Are you troubled by "bloopers?" This is the expressive appellation given to owners of radiating receivers in America, who are said to cause nine-tenths of the interference trouble in that country.

o o o o

WEST END WIRELESS.

A new West End telegraph office has been opened by the Marconi Company at 20, Duke Street, Piccadilly, where telegrams may be handed in for transmission by high-speed wireless telegraphy to France, Spain, Austria, Switzerland, Canada, the United States, Bulgaria, Yugo-Slavia, and other parts of the world.

o o o o

TALKS ACROSS THE ATLANTIC.

The possibility of conversing with America on a telephone in private houses was demonstrated last week, when Sir Evelyn Murray, Secretary of the G.P.O., exchanged greetings with a friend in New York from his home in Manchester Square, London. Mr. E. H. Shaughnessy, Assistant Engineer-in-Chief of the Post Office, spoke to New York from his Streatham residence.

The transmissions were, of course, conducted from the Rugby station.

o o o o

WIRELESS LEAGUE SOCIAL.

Members of the Wireless League are to be given an early opportunity of meeting socially in London. For this purpose it is proposed to hold a Wireless League dinner on the evening of Friday, April 23rd next, when it is hoped that several of the guests will be gentlemen well known to the listening public. Ladies will be specially welcome.

Application for tickets (8s. 6d. each, inclusive of wine, etc.) should be made at once to Headquarters, as the function promises to be extremely popular, and accommodation is limited. The chair will be taken by the Hon. Sir Arthur Stanley.



SWISS BROADCASTING. An interesting glimpse of the control room at the Zurich station, which operates on 515 metres.

"FADING."

A lecture entitled "Fading" will be given this evening (Wednesday) by Prof. E. W. Marchant, D.Sc., M.I.E.E., at an ordinary meeting of the Radio Society of Great Britain. The meeting will be held at 6 p.m. (refreshments at 5.30) at the Institution of Electrical Engineers, Savoy Place, Victoria Embankment, W.C.2.

CANADIAN WIRELESS OPERATORS REASSURED.

The Canadian Marconi operators have been assured of the continuance of the existing wage rate until April 1st, 1929.

o o o o

BROADCAST HELP FOR AUTHORS.

The officials of the Brussels broadcasting station have decided to assist Belgian authors. Extracts are to be read before the microphone from new books as they are published

o o o o

JAPAN CALLING.

Japan now possesses three broadcasting stations, according to the Bureau of Telegraphs, Tokio. The stations are at Osaka (JOBK, 385 metres), Nagoya (JOCK, 360 metres), and Tokio (JOAK, 375 metres).

o o o o

"S.B." FOR SWITZERLAND.

To secure better co-ordination among the various broadcasting organisations in Switzerland, a union has been formed at Berne comprising representatives from Zurich, Lausanne, Geneva, Berne and Basle. Plans are nearing completion for a system of simultaneous broadcasting.

o o o o

WIRELESS AND THE NORTHERN LIGHTS.

The recent display of the Aurora Borealis did not appear to affect broadcast reception in the South of England. In the North Midlands, however, several listeners reported poor reception of Daventry and other broadcasting stations. Fading effects appeared most noticeable at Preston.

o o o o

AN UNSUCCESSFUL COMPLAINT.

Opposing an expenditure of £2 for the repair of the wireless receiver in the Knaresborough Institution, a member of the Guardians said that the ratepayers had plenty to do without spending money to "hear people talk."

His eloquent appeal was unsuccessful, and the expenditure was approved!

o o o o

BROADCASTING DEMANDS IN BOLIVIA.

The public demand for broadcasting throughout Bolivia has resulted in the formation, at La Paz, of El Radio Club Boliviano, which has as its object the establishment and development of broadcasting stations to cover the entire country.

o o o o

LOUD-SPEAKERS ON THE 'PHONE.

"Is there any objection to ringing up a friend on the telephone and allowing him to listen to one's loud-speaker?" was a question put to the G.P.O. last week.

The answer was emphatically in the affirmative. "The conditions of the licence make it clear that this is contrary to the regulations," said a G.P.O. official, who added that such a practice renders the offender liable to prosecution.

Most readers will agree that an acquaintance who telephoned them for such a purpose would deserve all he got!

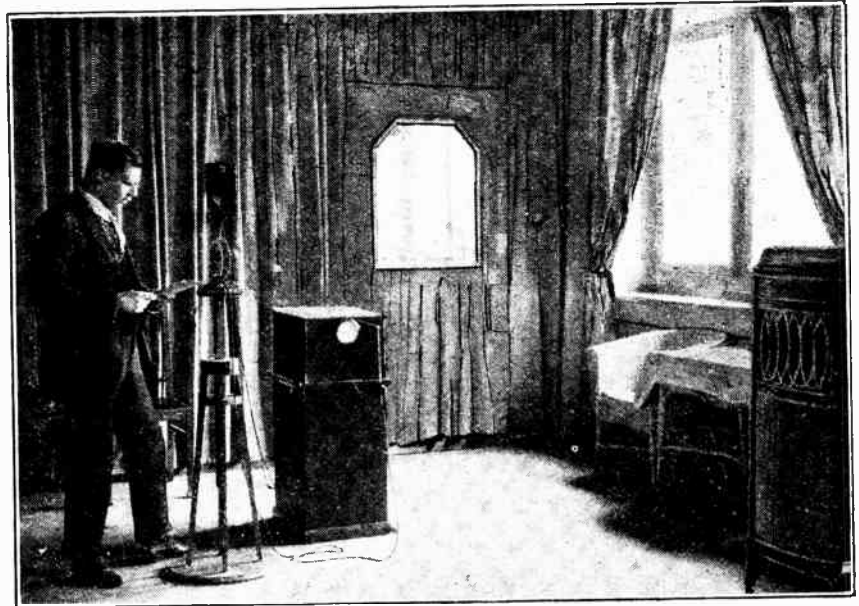

SWISS BROADCASTING. A view in the Zurich studio. The control room adjoins the studio, and during the performance the engineers are able to communicate with the artistes and announcer through the window in the background.

ESPERANTO BROADCASTS

A diligent votary of Esperanto has computed that 82 broadcasting stations throughout the world now transmit talks or courses in that language. Britain heads the list with 16 stations, while the United States and Germany follow with 13 and 11 respectively.

o o o o

LOUD-SPEAKERS EN MASSE.

From New York comes the news that fourteen large new tenement houses overlooking the Hudson River have been

PRESENTATION PLATE.

Next week's issue of "THE WIRELESS WORLD" will contain a Supplement in the shape of a presentation portrait of Sir Arthur Stanley, G.B.E., Chairman of the Wireless League.

equipped with broadcast receivers. Each of the 356 apartments contains a loud-speaker, the instruments being "fed" by four receivers under the control of an operator. The idea is to attract tenants, but it seems to us that prospective residents may require assurance that each apartment is sound-proof!

o o o o

SHORT v. LONG WAVES.

That the use of short waves in Transatlantic communication effected considerable economy in working is the substance of a report for the year 1925 issued by the United States Shipping Board, whose short-wave station NKP at Bellevue District of Columbia, is known to many amateurs in this country.

The year's working is stated to have shown the value of short waves both as

a means of clearing long-distance traffic and as an economical factor in radio transmission in comparison with the more expensive long-wave stations using higher power.

o o o o

LISTENING-IN AT SEA.

It may not be generally realised that the ordinary broadcast receiving licence is not valid for reception on board ship. A case in point was furnished the other day when a sea captain on the Ellerman Hall Line, having taken out an ordinary licence at Newcastle-on-Tyne, was requested by the Post Office to dismantle his apparatus as the licence had been issued in error.

Even a portable receiver may only be worked on land and within a certain radius.

Permission to receive broadcast programmes on board ship is only granted by the owners of the vessel.

o o o o

IMPORTANT A.R.R.L. RETIREMENT.

All amateurs who have watched the activities of the Amateur Radio Relay League will regret to learn that Mr. F. H. Schnell, the well-known traffic manager of that enthusiastic organisation, has submitted his resignation. Mr. Schnell, who had held the post of traffic manager since 1920, is undertaking experimental work in the Burgess Laboratories at Madison, Wisconsin.

o o o o

B.T.H. IN BIRMINGHAM.

Having outgrown their establishment in Paradise Street, Birmingham, the British Thomson-Houston Co. have acquired commodious new premises at 10 and 11, Snow Hill, Birmingham, where a complete range of B.T.H. wireless apparatus is on view.

Wireless
World

The LISTENER



The Journal of the Wireless League

Edited by Prof. A.M. Low.



The Hon. Sir A. Stanley,
G.B.E., M.V.O., C.B.,
Chairman, W.L.

THE *Listener*, of which this is the first number, is, as shown by the sub-title, the Journal of the Wireless League. In this capacity it fills two rôles. It is the medium of communication between the Council of the League and its members, and it voices the collective opinion of the members of the Wireless League. It is, so to speak, the personal representative of the listeners, and it will present the viewpoint of the Wireless League as an organisation whose sole object is to bring education,

instruction, and amusement into every house in the land—"over the ether."

The Wireless League does not exist to satisfy a demand for any particular class of music or standard of listening.

The Council of the League is composed of representatives from all parts of the country; they are determined to secure a Programme Service second to none. Amongst those who have been elected to stand for the tens of thousands of League members are: Sir Landon Ronald, Lord Montagu of Beaulieu, Sir Frederick Wise, Sir Harry Brittain, Mr. Ammon, M.P., and Sir Lawrence Weaver, the Deputy Chairman.

The country has been divided into fourteen Areas, governing about 150 branches, of which the Secretaries can secure the co-operation of every wireless user in England by explaining the objects of the League.

To-day we can give an unequalled service to members for the small sum of 2s. per annum; but, as in the case of wireless itself, we are only beginning. When the League is able to speak with the authority of a million members, its power will be the greatest factor that broadcasting has known. During the past year our branches have themselves conducted meetings all over the country.

The League has instituted a competition, for which the Stanley Gold Medal is offered to the member who presents the best invention of wireless apparatus.

The B.B.C. themselves have welcomed the Wireless

League, in that we have been able to assist them by constructive criticism of the Programmes and by representing the wishes of listeners in a corporate manner. We devote our entire attention to the interests of listeners.

A more material advantage secured by joining the League or by renewing the subscription is that of Free Insurance. From the moment 2s. is received, the receiving set is insured against Third Party claims, damage by Fire and Lightning, and is now also covered for risks of Theft, Burglary, Housebreaking, and Larceny. The League gives free technical advice.

The time is coming when it will be necessary for listeners to state exactly what they need as regards programmes; if these needs are encouraged by the League, the demand will follow, and fulfilment is only a matter of time.

Strengthen our hands; 2s. cannot do you any harm, and if in exchange you receive Free Insurance, Free Legal and Technical advice, and free representation on a Committee whose views are accepted with respect, surely it is worth while!

Wireless is a new art: get in on the ground floor.

Ensure that all money spent on licences is devoted to your service, and your service alone.

In evidence before the Government Committee the League recommended:—

- (1) The setting up of a permanent Broadcasting Commission.
- (2) Representation of the listener.
- (3) Alternative programmes.

We now ask for a "land line," to give Continental broadcasts to crystal users, and a special service of local

news and education with a three-mile radius in the large cities, in order that interference from the new high-power Stations scheme may not prevent those equipped with a modest apparatus from receiving the alternative programmes.

The Wireless League has made a beginning; the end will never be in sight. *Join, or renew, as the case may be, now.*

Alan Stanley

"The B.B.C. welcomes 'The Listener.' We have always before us the need for constant progress and we gladly listen to constructive criticism and help from the large body of listeners you represent. 'The Listener' should be a milestone in the advance of British broadcasting."

— The British Broadcasting Company.

THE ear, and this year, are critical for the listener. His greatest need is selectivity. He wishes to pick and choose like a gramophone. To do this is seldom possible without interference.

Perfect music and perfect selection are the greatest needs of wireless to-day. An improvement in these two items would enable us to attain the "catalogue" ideal of music and song from all over the world.

It will not be long before beam and short wave transmission empowers the user of the future air liner to talk to his house on the way to India; but selectivity is needed first of all.

Cheap sets with too many earths are neither select nor selective, yet directional wireless transmission can bring events from all corners of the globe to our fireside. Very soon we shall have wireless sight and broadcast pictures in our home, a few millionths of a second after the event has taken place. This is where wireless transmission scores over the gramophone system, which takes months



for the manufacture and release of a record.

Speeding up of communication is the keynote of all progress.

Before long the B.B.C. may give us alternative programmes, but the big stations must have very different wavelengths if simple selection is to be possible. Can they not retain local stations for education and local news, on a power which limits normal reception to about 3 miles' radius? Cost would be low and interference would be avoided with the public broadcasting from all over the country . . . and the world!

The B.B.C. would welcome the assistance of theatrical *entrepreneurs*, but when a boy with a telephone and a piece of

* * *

WHY PHONES PHONE.

A wireless set is a very silent thing, until the power reaches the telephones. This is not surprising, for the business of wireless is to carry electrical impulses over long distances, through brick walls and over the sea, until we want to convert those impulses into sound. Sound is the mechanical result of waves of compression and rarefaction in the air. Air does not oscillate easily like ether, and the business of the telephone diaphragm is to move backwards and forwards in accordance with the strength of electrical current, which passes through the coils of the magnets in the headphones.

It is this vibration of the diaphragm that does its best to produce music which is exactly that given to it by the aether, together with a little quite natural distortion. The moving parts of a headphone are light and therefore do not suffer seriously from inertia effect.

The ear is so delicate—it can detect the movement of a diaphragm of one-millionth of a millionth of an inch—and so easily upset, that the relatively heavy parts of a loud-speaker do not always please our ears with their working.

Loud-speakers seldom give really accurate music when they are forced. Listeners too often think of volume rather than reality of effect, and until improvements are forthcoming it is a humiliating fact that the headphone "crystaliser" hears better music than the multi-valve "fan." It is just as creditable to obtain *pure natural* reception as it is to "log" 50 stations in one evening, when all are distorted and mingled with Morse.

Most so-called selectivity means that one station is louder than others. Most purity means that results are better than many gramophones. It is important not to offend even one ear in our audience.

The time will come when it will be hard to distinguish between a piano by radio and a piano by air. The time will come when radio pictures will be as clear as the modern cinema.

What would Gladstone have said in eighteen something if he had been told that 1926 would see us flying the Atlantic and hearing the Savoy band all the while? What will the Wireless League say in 1926 if radio music from America is not so pure as the ordinary Post Office telephony from "the other side"?

o o o o

WOMEN AND WIRELESS.

It was a lady who is alleged to have asked the Editor how she could slow down the music for dancing, and to have said, "I have already tried turning all the knobs, but it is no use." As a matter of hard fact many women make up their own sets far more neatly than mere clumsy males. They show a far greater appreciation of the programmes, and they are influencing general set design in the best direction.

They ask for the receiver to mingle with the furniture, and very sensibly they dislike the untidy—but necessary—outside aerial. Will they not suggest some novel items for programmes? Would they like more fashion talks in the afternoon? Would they like broadcast cookery recipes, or would they prefer a special wavelength altogether and a directional beam of matter *far* too sacred for the mere male? What about a dance programme with a description of every item by "Lady This," or a criticism of things seen at the average dance by Madame Russnickova?

sugar can "listen-in," how is the promoter to be repaid?

Less talk and better afternoon music is a good slogan, but we have something to be thankful for. Think how dreadful would be the result of a Government monopoly on music halls with one fixed performance. The B.B.C. is in much the same position, the monopoly is necessary owing to the impossibility of securing real selectivity *at present*.

The poor old Government has been accused of having a finger in the pie. But would anyone suggest that jazz should be allowed to interfere with Post office or naval and military operations?

Selectivity will come; we shall press our knobs and hear all we want, before long. In the meantime let us concentrate upon what is practicable *now*. We want Paris concerts and Continental events that can be picked up—not only when we are alone—by crystal users. Why not a landline to Paris, with the Continent at full strength from 2LO, without the necessary permission from atmospherics, sunlight, and other stations?

KNOCKS BY KNOX.

Apart from the interest of the Father Knox broadcast, in which the burning of "Big Ben" was described and in which the Houses of Parliament were blown up—some people would be delighted—there is probably a scientific explanation for so much misunderstanding. When we sing or speak to an audience we rely upon more than the one sense of hearing to give the desired impression. We use seeing, touch, and even smell, to convey our personality. We probably rely upon numbers of other unknown senses, there may be some telepathic effect for which the transmitting apparatus is not yet discovered. Certainly a microphone is no use for anything but the course waves of air to reproduce sound. Mental waves are as yet beyond our ken.

Wireless only transmits one sense, and that imperfectly, so that the public, in listening to Father Knox, only heard *part* of his voice and missed much of the delicate inflection which would have made the joke evident to an actual listener or onlooker.

The same effect prevents some classical music from being transmitted effectively and shows up the need for programme simplicity. Accurate reproduction is a great need in broadcasting. Nightingales are no use if they sound like squeaking perambulators.

The listener wants accurate broadcasting of popular music, and events that are *within the capabilities of modern radio*.

So successful is broadcasting and so cheap that the demand for music has outstripped the scientific knowledge of the art.

Wireless possibilities are unlimited, and every new listener contributes to improving the service.

AROUND THE BRANCHES.

Subscriptions are now due. Use the form overleaf and post immediately.

Tottenham and District Branch.

Covering Tottenham, Wood Green, Upper and Lower Edmonton, this branch is getting well to the front. The Provisional Committee appointed at the inaugural meeting of members of the League has got to work, and a further meeting of members is called for March 25th next to receive the report of the Committee. An interesting feature of the meeting will be a lecture by Mr. A. Hankey, of the B.B.C., on a popular subject. Councillor T. Elderfield has accepted the presidency of the branch. *Hon. Sec.:* G. H. Hasomer, 9, Galliard Road, N.9.

Newbury Branch.

An infant of six weeks old and 78 members. No time has been lost, and this number has been increased by 50 per cent. *Hon. Sec.:* R. H. Parkes, 71, Gloucester Road.

Leeds Branch.

Formed in October, 1925, and has made considerable progress under the able direction of its chairman, Mr. E. N. Kent-Lemon, and a "live-wire" committee. Membership is steadily increasing as the benefits and advantages of "the League" become wider known, and the secretary will be pleased to give any information to those interested who live in the district. *Hon. Sec.:* J. Watson, 4, Armsley Grange Drive, Armsley.

Bradford Branch.

The Bradford Branch has doubled its membership during its three months' existence. *Hon. Sec.:* C. Wicks, 70, Saton Road.

Harrow.

General meeting to be called for early next month, when we hope Professor Low will come and talk to us. Harrow listeners please write to *Hon. Sec.:* E. W. Everett, 28, Greenhill Crescent.

Sheffield Branch

The League has made much progress in Sheffield. The membership is now 1,000, and is daily increasing. It is recognised as the "listeners' league. The branch is energetically co-operating with the educational authorities and the Chamber of Commerce, and has already promised to place installations in two Council schools. A public meeting at the Cutlers' Hall, Sheffield, will be held on April 22nd, and Professor A. M. Low has promised to speak. The social side is not neglected, and dances and other social functions are being organised. *Hon. Sec.:* S. J. Adams, 38, Church Street.

Windsor Branch.

Inaugural meeting at Congregational Hall, Windsor, March 25th. Professor Low will then give members some technical tips as well as ideas on the future of broadcasting. *Hon. Sec.:* K. W. Lane, Imperial Service College.

Wembley and District Branch.

Branch going well. The membership is nearly 200. The annual meeting will be held next month, at which Professor A. M. Low will speak. *Hon. Sec.:* R. W. Corkling, "Orpington," Bassingham Road, Alperton, Middlesex.



Mr. Thomas Denbigh, J.P., Chairman of Bradford Branch



Mr. K. W. Lane, Hon. Sec. of Windsor Branch

Wandsworth Branch.

During the past six months the membership increased from 2,000 to 3,745. The area is so large that it has become necessary to have sub-branches. Secretarial help badly needed. The branch is actively organising an appeal for receiving apparatus for local hospitals. *Hon. Sec.:* F. G. Edwards, 29, Baskerville Road, S.W.18.

On another page will be found a provisional list of Branch Secretaries' Addresses.

It is regretted that pressure on our space in this issue prevents the insertion of notes from a large number of branches. Next month it is hoped more space will be available.



THE MOST IMPORTANT hint to any new reader is the reminder that a house without radio is like a house without a bath.

ALWAYS REMEMBER that, having paid your licence, the more energy you can collect the less you need spend on amplification. So begin with a good aerial. Insulate it properly and keep the insulators clean. Soot, dust and dirt all conduct electricity and waste the incoming signal. The vertical portion of an aerial or the "lead-in" is important. Sometimes it is more effective than the aerial proper, so keep it away from trees and buildings.

THE EARTH is cheap, but high-frequency currents dislike sharp corners. Let your earth wire be like the nigger's business—as straight as possible! If a real main water pipe is out of the question, try other pipes, but best of all, bury a large

metal plate in the ground and solder the earth wire to it. Choose wet ground; a bucket of water over the earth spot once a week is very useful.

SOME FLATS, of the brickwork variety, have no room for aerials. A roll of chicken wire in the roof, suspended from a ginger-beer bottle, with an insulated wire to the set, makes a good aerial if the usual wire round the picture-rail is inconvenient.

FRAME AERIALS are excellent, but are little use on ordinary crystal sets; their directional effect is useful for cutting out unwanted stations.

A sheet of silver paper made up from scrap between two varnished sheets of brown paper about 5ft. by 4ft. makes a good aerial in some districts. Remember that the location of a set affects its results. Certain neighbourhoods are very "dead," due to reflection and other troubles. Moving the position of the aerial may bring improvement and help to avoid interference from trams and electrical machinery. If this latter is very bad, the only hope is to "write to the League about it."

DIRT IS BAD for wireless sets and batteries. Keep them dry and covered.

If the H.T. battery is kept in a cardboard box and sealed up it will last longer, particularly if disconnected. Flash-lamp batteries in series make good H.T. supply, and are often less susceptible to damp and dirt.

DO NOT HOWL. Ask the B.B.C. for their "anti-howl" pamphlet. Oscillation spoils other people's enjoyment. Worst of all, it spoils yours!

PLEASE REMEMBER that the League is conducted by its members for its members. Help us not to waste money and renew your two shillings at once. We want our modest staff to work for progress in your interests, and not to spend time on book-keeping.

If ANY reader has a good idea for a workable wireless competition, write to "The Listener."

We have already one suggestion for a working model valve with a series of diagrams showing each phase of detection printed on the top corner of "The Listener." By flicking over the pages the movements of "electrons" would become evident.

A CORRESPONDENT informs us that "his League membership is the best bargain he has ever made." Another tells us that by our free legal advice scheme we have obtained replacement of a damaged accumulator free of all cost to himself.

THE BADGE of the League can be obtained from headquarters or from any branch or area secretary.

ONE DOES not neglect insurance because the home is not burnt down twice weekly. The policy is a guard. So is the League.

When you visit a theatre you pay for the seat—unless you are lucky. The air is the medium by which you hear the performance, and it costs nothing. The B.B.C. should not be encouraged to establish a new standard of bands and performers. Good music and good artists exist already. The public wants to hear them. The public wants Gilbert and Sullivan, and will have it from the concert platform where this music is played. A theatre costs 10s. 6d. for a seat, and spends hundreds of pounds to get the best artists. Wireless must not spend hundreds on what is after all a cheap method of transmission, and pay minor artistes £2 2s.!

FREE INSURANCE.

Free legal and technical advice, free insurance. You can pay two shillings and forget the League if you wish—until atmospheric or fire spoil the set, or until your aerial spoils someone else's best hat. The Wireless League was the first to be invited to give evidence before the Broadcasting Committee on behalf of the listener. Our witnesses recommended a Commission—so does the report. Our witnesses recommended special wavelengths for education—so does the report.

What the League "Listener" thinks today, all listeners think to-morrow. Now for that two shillings!

o o o o

Members of THE WIRELESS LEAGUE are covered by Insurance with the CORNHILL INSURANCE CO., LTD., 32, Cornhill, E.C.3, as under:

- (1.) Damage by Fire and/or Lightning or Burglary, House-breaking, Theft or Larceny on Wireless Receiving Sets, including Aerials and Accessories, the property of members of the Wireless League, whilst in any Private Residence, Hotel, Inn, Lodging House, Club, Nursing Home, Hospital, School or Restaurant in the United Kingdom and Ireland, up to the actual value of such Sets, etc., no one set to be deemed of greater value than £25 (Twenty-five pounds), with a limit of £50 (Fifty pounds) in respect to any number of Sets owned by one Member.
- (2.) Legal liabilities to Third Parties incurred by Members of the Wireless League in respect of injury to persons and/or damage to property in connection with Wireless Receiving Sets, etc., as defined above, with a limit of £250 (Two hundred and fifty pounds) in respect of any one accident or occurrence.

The above Insurance is effective to March 31st, 1927, in respect of Member's apparatus at the address or addresses given by the applicant subject to the terms and conditions of the Insurance Policy held by THE WIRELESS LEAGUE on behalf of its members. In the event of a claim arising, notification must be sent to the office of THE WIRELESS LEAGUE within seven days of the occurrence.

Contributions and Branch Notices should reach the Editor, Chandos House, Victoria Street, London, S.W.1, not later than the 15th of each month.

MEMBERSHIP AND RENEWAL FORM.

To be filled in by readers who wish to become members of the League, or to renew their membership for a further twelve months as from 1st April next.

To the Secretary, The Wireless League, Chandos House, Palmer Street, Victoria Street, S.W.1.

Please *enrol me as a member of The Wireless League. I enclose P.O. for Two Shillings,† which entitles me to membership with all the privileges and rights as enumerated in the constitution of the League, including FREE Insurance, Free Legal Advice and Free Technical Advice.

* Cross out Line not required.

† Keep the Counterfoil of your Postal Order.

WRITE IN Name (in full)
CAPITAL (State whether Mr., Mrs. or Miss)
LETTERS. Address

My Membership No. is.....
(This is only applicable in the case of renewals)

Please enclose stamped addressed envelope.

Commencing with the first issue in May, "The Wireless World" will devote four pages in the first issue of each month to League Notes and News, and a special arrangement has been made whereby those who are interested may receive these issues, post free, in addition to membership of the League, by payment of a joint subscription of 6/-.

All who wish to take advantage of this offer should fill in the form below instead of the Membership Form above.

JOINT MEMBERSHIP and SUBSCRIPTION FORM.

To the Publishers, "The Wireless World," Dorset House, Tudor Street, London, E.C.4.

Please *enrol me as a member of The Wireless League and also enter my name as a Special Subscriber to "The Wireless World." I enclose P.O. for Six Shillings,† which entitles me to membership with all the privileges and rights as enumerated in the constitution of the League, including FREE Insurance, Free Legal Advice and Free Technical Advice; and also to receive, post free, for twelve months, commencing May 5th, 1926, the first issue of "The Wireless World" published each month, containing a copy of the "Listener."

* Cross out Line not require!

† Keep the Counterfoil of your Postal Order.

WRITE IN Name (in full)
CAPITAL (State whether Mr., Mrs. or Miss)
LETTERS. Address

My Membership No. is.....
(This is only applicable in the case of renewals)

Please enclose stamped addressed envelope.

PIONEERS OF WIRELESS.

By ELLISON HAWKS, F.R.A.S.

II.—S. F. B. Morse.

SAMUEL FINLEY BREESE MORSE, the inventor of the code that bears his name, was the next to experiment in telegraphy without wires. It is not quite clear whether or not he had heard of Sömmering's discovery (in 1811) of the conductability of water, or of Steinheil's work (in 1838) with the "earth battery," or whether he independently discovered the method he demonstrated. Whichever be correct, however, Morse did some excellent pioneer work, and we may profitably pause to consider his experiments. Although not sufficiently practicable to be commercialised, they undoubtedly stimulated others, and so played an important part in the history of wireless.

Morse at Work on his Telegraph.

Morse was born at Charlestown, Mass., U.S.A., on April 27th, 1791, and was the son of a minister. He graduated at Yale in 1810, and decided to become an artist. With this end in view he sailed for England to study painting under Benjamin West in London. In 1813 Morse gained the gold medal of the Adelphi Society of Arts for his "Dying Hercules," and returned to America. Here he founded the National Academy of Design, and became Professor of Arts in the University of New York.

Morse had always been interested in electricity, and having once more visited Europe he decided to devote his attention to a practical system of telegraphy. His decision cost him dear, and brought him to abject poverty. He denied himself food and clothing in order to further his experiments. For the sake of economy he made everything himself—his models, moulds, and even his castings—but for four years everything seemed to go wrong. "I am crushed for want of means," he wrote.

Success was near at hand, however, and the following year he completed his first instrument, which he exhibited in New York. He transmitted signals over a distance of 600 yards, using copper wire. Congress would have nothing to do with the invention and Morse determined to visit England to patent his idea. In the meantime, Wheatstone and Cooke were at work in London on their plan for "improvements in giving signals and sounding

alarums in distant places by means of electric currents transmitted through metallic circuits."

Morse did not succeed in patenting his device in England, but was more successful in France. On all these travels he took with him the electro-magnet on which everything depended, and when we learn that this magnet weighed 160 lb. we cannot but admire his perseverance!

First Transmission by Conduction.

Returning to America Morse again pressed Congress with a view to making an official test of his invention. In 1843, during the last moments of the session, a grant of £6,000 was made for an experimental telegraph between Washington and Baltimore.

A few months before the grant was made Morse endeavoured to arouse interest in his invention by giving a public demonstration of the fact that an electric current will travel as well along a cable laid through water as along an air line. On October 18th, 1842, he laid insulated wires between Governor's Island and Castle Garden, New York, a distance of about a mile. At daybreak on the following morning he had successfully transmitted some three or four characters, when communication was suddenly interrupted owing to one of several vessels lying along the line of the submerged cable raising the cable with her anchor. Not understanding what they had hauled on board, and finding no end to the cable, the sailors hauled about 200ft. on deck and cut it off, taking it away with them!

With the jeers of the disappointed spectators ringing in his ears, Morse "immediately devised a plan for avoiding such an accident in the future, by so arranging the wires along the banks of the river as to cause the water itself to conduct the electricity across." He laid a wire along each bank of the river, connecting one wire with the transmitting key and with a battery, and the other wire on the opposite bank with a receiver, the ends of both wires being fastened to copper plates sunk in the river. "On December 16th, 1842, I tested my arrangement across the canal (at Washington) with success," he wrote, "and the simple fact



S. F. B. Morse

¹ From Morse's letter (December 25rd, 1844) to the Secretary of the Treasury.

Pioneers of Wireless.—

was then ascertained that *electricity could be made to cross a river without other conductors than the water itself.*"

In 1844 Morse carried out similar experiments, but on a larger scale. He found that "electricity crosses the river in quantity in proportion to the size of the plates in the water," and also that "the distance of the plates on the same side of the river from each other also affects the result." At Morse's request, Professor Gale carried out a series of further experiments, and determined that the best results were obtained when the distance between the plates on the same bank was three times greater than the width of the river. Subsequently, two of Morse's assistants (Vail and Rogers) were able to communicate "with complete success, a distance of nearly a mile," across the Susquehanna River."¹

¹ Vail: *American Electromagnetic Telegraph* (1845).

General Notes.

C.P.O. Electr. R. H. Hermann, of H.M.S. "Durban" (G FUP), stationed at Hong-Kong, gives us some interesting results achieved with a short-wave transmitter based upon the design given in our issue of August 12th, 1925. His first "CQ" signal was at once answered by Pekin NPP, distant about 1,200 miles, who reported his signals as R8; this was in daylight. Later in the evening G FUP worked U 6BJD in California (R5) and the Naval Training Station, NQGL, at San Diego, where his signals were reported as R8, the loudest coming in from China, the distance being about 8,700 miles. G FUP has subsequently worked with America, England, India, Palestine and Australia, and will welcome any reports from listeners who have heard the station since he started transmitting on November 10th.

Capt. E. J. Hobbs (Y 2JL), 2nd Armoured Car Company, Ashley Park, Bangalore, is carrying out a series of experiments on wavelengths between 25 and 50 metres. His usual times of transmissions are 1545-1745 and 0030-0130, G.M.T.

A. M. Houston-Fergus (G 2ZC and MAG), La Cotte, La Moye, Jersey, is conducting tests on 45 metres for the purpose of investigating the fading on that wavelength, and would like to work with any other experimenters interested in that study, especially in London, N.E., England N.E. and E., Scotland E., and England N.W. (North of Birmingham and west of Chester to Anglesey).

We understand from Mr. C. A. Jamblin (G 6BT), the hon. organiser of the Transmitter and Relay Section, that the Radio Society of Great Britain has received several hundred QSL cards from abroad for British amateurs which, so far, have not been claimed. Transmitters who are expecting such cards are asked to forward stamped and addressed envelopes to Mr. C. A. Jamblin, 82, York Road, Bury St. Edmunds, Suffolk, who will forward any cards that may be awaiting them, or, if there are none, will file the envelope for future use. Envelopes should not be

TRANSMITTERS' NOTES AND QUERIES.

smaller than 6in. x 4½in., preferably of the thin foreign variety, and should have the addressee's call-sign clearly marked on the left-hand top corner.

Mr. E. Megaw (GI 6MU), 3, Fortwilliam Drive, Belfast, established communication on February 27th at 23.00 G.M.T. with Ö AA in Vienna, on a wavelength of 45.5 metres and an input of about 9 watts D.C. His signals were reported R4. Mr. Megaw believes this to be the first time communication has been established between amateurs in Great Britain and Austria, but will be glad to hear from any other transmitter with a prior claim.

I 1RG, the Radiogiornale station at Bellagio on Lake Como, which is operated by Mr. Ernesto Montù, is transmitting by telephony every Sunday at 13.00 G.M.T. on 10 metres, 13.30 G.M.T. on 18 metres, 14.00 G.M.T. on 35 metres, and at 14.30 G.M.T. on 65 metres. Reports will be welcomed.

F 6PY would like to receive reports from British amateurs of his transmissions on 45 metres, which may be sent *via* G 6NK, R. J. Denny, 1, Hillside, Waverley Road, Weybridge.

Amateur Transmission in Denmark.

Our Copenhagen correspondent sends us a summary of the conditions under which the Danish authorities will grant transmitting licences to experimenters. Applications must be made to the State Telegraph Department, who will issue licences only for scientific and technical experiments. The licence will hold good for one year, on payment of a fee of 20 kroner, and may be cancelled if the fol-

How near Morse was, without knowing it, to a greater revolution even than that brought about by the introduction of his telegraph. But it is perhaps fortunate that he missed the great issue, for undoubtedly the time was not ripe for wireless telegraphy. Had it been discovered in his day it might have suffered disastrously from being before its time, as have many other inventions that have come before civilisation was ready for them.

Labours Rewarded.

If Morse's early years were full of bitterness and disappointments, he reaped the joy of his labours in his later life. He lived to see his system of telegraphy adopted by the United States, France, Germany, Denmark, Sweden, Russia, and Australia. Napoleon III was instrumental in his being presented with an international gift of £80,000, and he died (April 2nd, 1872) in New York loaded with honours.

lowing conditions are not observed:—(a) Transmission must only take place during the hours specified by the State Telegraph Dept. (b) The call-signs must be given out at the beginning and end of each message. (c) The maximum power allowed is 100 watts input. (d) The wavelengths permitted are (1) below 15 metres; (2) 43 to 47 metres; (3) 70 to 75 metres; (4) 95 to 115 metres. (e) Commercial telegrams must not be transmitted either by Morse or telephony, neither may experimental stations be used for broadcasting news or retransmitting broadcast programmes. Transmitters must not be connected with other radio stations (this is understood to mean commercial stations). The experimental stations must be open for inspection by the representatives of the State Telegraphs Dept.

QRA's Wanted.

G 2BQ, G 2WW, G 5JV, AG 5MA, BZ 1BI, EAR 23, IRA, K 4CN, M 1GB, N 0WB, N 0FP, PI 3NO, PVNZ, OKA (calling OPX), FOCNG, B S5, S4, S 3F.

New Call-Signs Allotted and Stations Identified.

G 2BRB.—R. E. Broomfield, 99, Sudbourne Rd., Brixton Hill, S.W.2, transmits on 23-90 metres.

G 5SN.—(Late 2BGO) N. W. Skinner, 296, London Rd., Westcliff-on-Sea, transmits on 150-200 metres.

Y 2JL.—Capt. E. J. Hobbs, 2nd Armoured Car Company, Ashley Park, Bangalore, South India, transmits on 25 and 30 metres.

N PC3.—W. F. H. Peeters, Hugo de Grootstraat, 14, Amsterdam.

N 01B99, N 0AS, N 0MD, N 0KC.—Cards may be sent *via* W. E. Russell, 5, Walton Rd., Woking.

U 1CAL.—A. J. Spriggs, 1285, Boulevard, New Haven, Conn.

A Correction.

The correct call-sign of the station owned by Mr. F. A. King, 35, Oakmead Road, Balham, S.W.12, is G 5MF, and not G 5FM as stated in error on page 30 of our issue of February 24th.

WIRELESS CIRCUITS in Theory and Practice.

8.—Aerials and Aerial Circuits.

By S. O. PEARSON. B.Sc., A.M.I.E.E.

THE usual type of outdoor aerial consists essentially of an elevated wire or system of wires with one end connected by a down-lead to the earth, the whole being otherwise well insulated from its supports. In series with the down-lead is included an inductance coil to which the receiver is either directly connected or inductively coupled. The most common form of aerial is the flat top or inverted "L" type, as shown in Fig. 1, and this particular kind of aerial is considered here, although the remarks can be applied in general to any type of open aerial.

The Aerial as a Tuned Circuit.

The wire comprising the aerial naturally possesses resistance, and, as explained in Part 2, even a piece of straight wire possesses inductance because a magnetic field is set up around it when a current flows through it; thus an aerial also possesses self-inductance even when no inductance coil or loading coil is included in the down-lead. Thirdly, the elevated portion of the aerial and the earth are equivalent to the two sets of plates of a condenser of large dimensions, the air being the intervening insulating medium or dielectric in which the electrostatic lines of force are set up when a potential difference exists between the elevated portion of the aerial and the earth, just as in an ordinary condenser lines of electrostatic force are produced through the dielectric when the condenser is charged.

We see then that an aerial possesses resistance, inductance, and capacity, and is therefore capable of responding to electrical resonance in exactly the same manner as the closed circuits considered previously. Actually the capacity and inductance are distributed

between frequency and wavelength, it will be advantageous to consider briefly an aerial of the inverted "L" type when used for transmitting or sending out wireless waves, and to do this it is necessary to view resonance or electrical oscillation in a closed tuned circuit from the point of view of the energy stored in the oscillatory circuit.

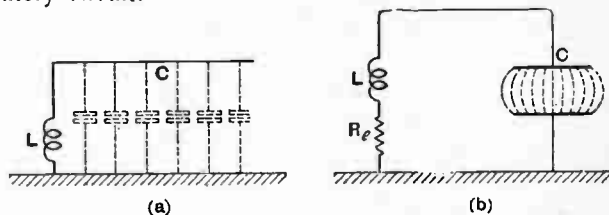

Fig. 2.—(a) Inverted "L" type aerial and (b) the equivalent electrical circuit.

It was shown in a previous instalment¹ that when complete resonance occurs the voltage across the circuit and the current flowing round the closed circuit are exactly 90° out of phase. Thus, when the current is passing through one of its zero values, the potential difference across the circuit has its maximum or peak value, and when the current round the circuit is passing through a maximum value, the voltage is zero. We have seen also that when a current i flows through a circuit of inductance L henries, the energy stored in the magnetic field is given by $\frac{1}{2}Li^2$ joules or watt-seconds (see Part 2, January 27th, page 124). Now it can be shown by exactly the same reasoning that the energy stored in the electrostatic field of a condenser of capacity C farads, when the potential difference between the two sets of plates is e volts, is equal to $\frac{1}{2}Ce^2$ joules or watt-seconds.

Energy in an Oscillating Circuit.

Suppose that in the tuned circuit the current reaches a maximum positive or negative value of I_m amps, and that the voltage across the circuit reaches a peak value of E_m volts. Then at an instant when the current is greatest the stored energy in the magnetic field of the coil will be $\frac{1}{2}LI_m^2$ joules, and at this same instant the stored energy in the condenser will be zero, because the voltage is zero when the current is greatest. During the next quarter of a cycle, when the current is falling to zero, the magnetic field of the coil is collapsing, and its energy is being given back again to the circuit, but at the same time the voltage across the condenser is building up so that energy is being accumulated and stored up in its electrostatic field, and this will reach a value of $\frac{1}{2}CE_m^2$ joules when the energy of the magnetic field has fallen to zero. Now, in the case where the circuit possesses no resistance, there is no loss of energy in the form of heat, and

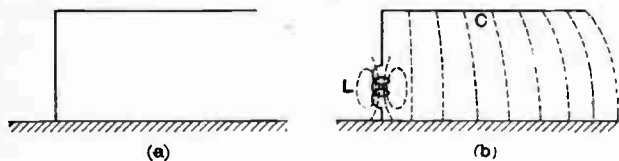

Fig. 1.—Inverted "L" type of aerial. The capacity is situated mainly in the horizontal portion, and the inductance in the vertical down-lead.

along the whole length of the aerial, but the major part of the effective capacity is situated in the elevated or horizontal portion, and the greater part of the inductance is embodied in the down-lead and the loading inductance, because it is here that the current has its greatest R.M.S. value under normal operating conditions. Therefore the aerial circuit of Fig. 2(a) is electrically equivalent to the closed circuit of Fig. 2(b), except that the resistance R_e in the open aerial contains a component called the *radiation resistance*, which is explained below.

In order to simplify the consideration of the principles involved in a tuned aerial circuit, and to show the con-

¹ *The Wireless World*, March 3rd, page 347, Fig. 7 (c).

Wireless Circuits in Theory and Practice.—

therefore during the quarter of a cycle considered, the whole of the energy $\frac{1}{2}LI_m^2$ originally stored in the magnetic field of the coil has been transferred to the condenser, now being given by $\frac{1}{2}CE_m^2$. During the next quarter of a cycle, the energy is transferred back to the inductance again, and so on indefinitely.

We see, then, that a certain amount of energy is oscillating backwards and forwards between two parts of the circuit, and this gives us the real meaning of electrical oscillation in tuned circuits. Of course, if the circuit contains resistance, a fraction of this energy is converted into heat during each half-wave of current, but if this loss is exactly compensated for by the right amount of energy being drawn from the source of supply, the oscillations will continue with undiminished amplitude just as the pendulum of a clock is kept swinging at a constant amplitude by the small impulses given by the driving mechanism.

Radiation of Energy.

Reverting now to the aerial circuit of Fig. 2, suppose that a high-frequency voltage is induced into the inductance coil L from some suitable source inductively coupled and that the aerial circuit is tuned to complete resonance with the frequency of this voltage; then electrical oscillations will be set up in the aerial circuit, and, since for complete resonance the inductance and capacity effects balance each other out, the R.M.S. value, I , of the

current will be equal to $\frac{E}{R_e}$ amps, where E is the E.M.F. induced into the aerial circuit, and R_e is the *effective* resistance of the aerial, the power being put into the aerial being I^2R_e watts. Thus the effective resistance R_e is that equivalent resistance which, when multiplied by the aerial current squared, gives the total power. In the aerial circuit, just as in the closed circuit, energy will be oscillating backwards and forwards between the magnetic field and the electrostatic field of the aerial. But here the essential difference between an open aerial circuit and a closed oscillatory circuit is indicated: namely, during each alternation some of the oscillating energy escapes from the aerial circuit and is radiated away into space. The amount of energy which is radiated per second in this manner depends on various factors, such as the strength of the current in the aerial, the effective height of the aerial, and the frequency of the oscillations, being proportional to the squares of all three.

The radiated energy takes the form of *ether waves*, and it is known that these waves always travel away from the aerial with the velocity of light; that is, at the great speed of about 186,000 miles per second, or 3×10^{10} centimetres per second. In fact, it has been proved that light waves are of the same nature as wireless waves, the only difference being that the frequency of light waves is many thousands of times greater than that of the shortest wavelengths used in wireless work.

Knowing the velocity of the radiated waves and the frequency of the oscillations, we can find the relationship between frequency and wavelength, and incidentally give a definition of wavelength. Suppose that the frequency of the oscillations in the transmitting aerial is f cycles

per second; then, during one second, f complete ether waves will radiate outwards from the aerial, and the wave which left the aerial at the beginning of this second will be 3×10^{10} cms. away at the instant the last wave leaves at the end of the second. Thus there will be f waves spread out over a distance of 3×10^{10} centimetres, as shown in Fig. 3(a), and therefore one wave will correspond to a length of $\frac{3 \times 10^{10}}{f}$ centimetres, or $\frac{3 \times 10^8}{f}$ metres. The actual length of one of these waves in the ether is called the *wavelength*; it is usually given in metres and denoted by the Greek letter λ (lambda). Thus the relationship between wavelength and frequency is given by

$$\lambda = \frac{3 \times 10^8}{f} \text{ metres,}$$

or

$$f = \frac{3 \times 10^8}{\lambda} \text{ cycles per second.}$$

From this we see that the shorter the wavelength the greater is the corresponding frequency, and *vice versa*. It is convenient to remember that a wavelength of 300 metres represents a frequency of one million cycles per second, the frequencies for any other wavelengths simply being in the inverse proportion; for instance, the frequency corresponding to a wavelength of 365 metres is $10^6 \times \frac{300}{365} = 882,000$ cycles per second (approximately).

Wavelength and Frequency.

Although strictly speaking the term "wavelength" can only be applied to the ether waves, it is almost universally applied to all radio-frequency currents and voltages, even in a closed circuit where waves, in the same sense of the word, do not exist at all. For instance, in a circuit where the frequency is a million cycles per second, the "wavelength" is said to be 300 metres, meaning, of course, that the frequency of the current is

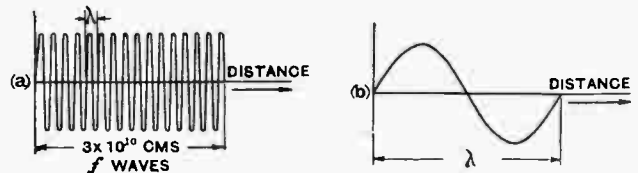

Fig. 3.—Diagram showing the relation between wavelength and frequency.

that corresponding to a wavelength of 300 metres in the ether. In discussing the theory of circuits it is most convenient to give relationships in terms of frequency, but it is usual to employ the corresponding wavelengths for practical calculations, chiefly because the transmissions from various wireless stations are always denoted by their wavelengths. For instance, in designing a circuit to tune to a certain station of given wavelength, it is more convenient to work from a formula giving the relation between inductance, capacity, and *wavelength*, rather than from one involving frequency. Such a formula is very easily found from the fundamental expression for the resonant frequency of a tuned circuit, namely, from the expression $f = \frac{1}{2\pi \sqrt{LC}}$. Putting $f = \frac{3 \times 10^8}{\lambda}$ and

Wireless Circuits in Theory and Practice.—

substituting, we get $\lambda = 2\pi \sqrt{LC} \times 3 \times 10^8$ metres, where L is in henries and C is in farads. If L is in microhenries and C in microfarads, the expression becomes $\lambda = 1,885 \sqrt{LC}$ metres, which is the usual formula for practical calculations.

Aerial Efficiency.

In general an aerial which is an efficient radiator of energy will also act as an efficient receiving aerial, and therefore the conditions pertaining to good efficiency in a transmitting aerial also apply to receiving aerials, except that the transmitting aerial must be designed to deal with high values of oscillating current and voltage without undue loss. The amount of power radiated depends on the length of the lines of the electrostatic force passing between the elevated portion of the aerial and the earth, and therefore on the height of the aerial. Now, since the earth is not a perfect conductor, and since there may be such things as trees and buildings below the aerial, the *effective height* is not necessarily equal to the actual height above the ground level, and it is the effective height which determines the power radiated for a given aerial current, and in the case of a receiving aerial the high-frequency voltage induced in it by the received signals depends on the effective height.

The power radiated is proportional to the square of the effective height, and inversely proportional to the square of the wavelength. The amount of energy radiated per second is given approximately by

$$P = 1590 I^2 \times \frac{h^2}{\lambda^2} \text{ watts.}$$

where I is the R.M.S. value of the current measured in the earth lead, h is the effective height in metres, and λ is the wavelength in metres.

The most efficient aerial is one in which the ratio of the power radiated to the total power supplied is greatest, this ratio itself being the efficiency. Now the current in the aerial is inversely proportional to the total effective aerial resistance R_e , defined as that equivalent resistance which, when multiplied by the square of the current, gives the total power put into the aerial. Therefore, in order to obtain the greatest aerial current for a given induced voltage, the total effective resistance must be as low as possible, and this applies equally to a receiving aerial in which the current is induced by the oncoming ether waves.

Radiation Resistance.

Only part of the power $I^2 R_e$ put into the aerial is radiated, the remainder being dissipated as heat in the ohmic resistance of the aerial circuit and in neighbouring objects in the form of eddy current losses and dielectric losses. All energy which is not radiated is wasted and must be counted as losses. The total effective resistance R_e may be assumed to consist of two components, one component when multiplied by the square of the current giving the losses, and the other, called the *radiation resistance*, accounting for the power radiated.

The radiation resistance R_r of an aerial is defined as that equivalent resistance which, when multiplied by the

square of the aerial current, gives the power radiated into space. Thus

$$\begin{aligned} \text{Power radiated } P &= I^2 R_r \text{ watts} \\ &= 1590 I^2 \frac{h^2}{\lambda^2} \end{aligned}$$

$$\text{and therefore } R_r = 1590 \frac{h^2}{\lambda^2} \text{ ohms.}$$

Now, since the total effective resistance should be low in order to get a high aerial current, it follows that, for high efficiency, both for transmitting and receiving, the ratio of the radiation resistance to the total effective resistance should be as great as possible, the ideal condition being, of course, that in which the radiation resistance is the only resistance present, a condition quite impossible in practice. Thus $\frac{R_r}{R_e}$ should be as nearly equal to unity as possible; that is to say, the ordinary ohmic resistance of the aerial circuit must be as low as possible, and the aerial should be suspended well away from all trees and buildings, especially when the latter are partly constructed of metal. Of course, the sharpness of tuning will depend on the amount of resistance in the circuit exactly in the same way as for a closed circuit—another reason for keeping the aerial resistance low.

Conditions for High Efficiency.

The two most desirable features, then, that an aerial should possess are (a) a good effective height and (b) low resistance. For reasonable efficiency the height of an aerial for reception of broadcast stations other than the local one should be at least 30ft., a good average height being 45ft. It will be shown later that the most suitable length and height of a receiving aerial depends on the wavelength of the signals to be received.

It is not always an easy matter to reduce to a low figure that part of the aerial resistance accounting for losses. The main portion of the ohmic resistance is located in the connection to earth, and sometimes a fair proportion in the aerial inductance coil. Connection to a water pipe does not always give a good "earth," and it is better practice to bury a wire or system of wires a foot or so deep under the entire length of the aerial where this is practicable. Gas pipes are unsuitable for an earth connection, as the red-leaded joints often offer a high resistance. Large trees near a receiving aerial have a very bad screening effect, especially if they are high compared with elevated portion of the aerial. The writer has found that the screening effect of trees varies with the seasons; for instance, with an aerial 35ft. high supported on a pole near an 85ft. tree, the received signals are very much weaker in the late spring, when the tree is in full leaf with full sap flowing, than in the earlier weeks before budding commences, whereas on another aerial away from all trees this change is not noticeable.

The high-frequency resistance of the aerial wire itself is not, as a rule, serious, and the total resistance of the aerial circuit is not much reduced by employing two or more spaced wires in parallel. Although this may somewhat increase the upper capacity if the spacing is sufficiently great, thus giving slightly better signal strength, it is doubtful whether the extra trouble is justified.



A Review of the Latest Products of the Manufacturers.

THE "BLUE SPOT" TUNING COIL.

This plug-in tuning inductance, which is obtainable from Barker & Co. (Suppliers), Ltd., 59-60, Chancery Lane, London, W.C.2, is intended to replace the wide range of inductances ordinarily necessary to tune over a wide range of 180 to 3,500 metres.

In principle it consists of a large coil built up of a number of sections which, by means of a simple switch, are connected in series, an additional coil being

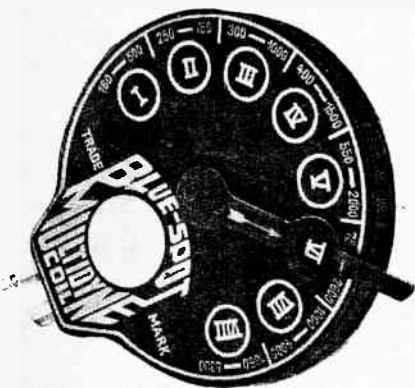

The "Blue Spot" tuning coil contains a series of eight inductances which are brought into operation by a switch arranged to eliminate as far as possible the detrimental effects of dead end turns.

added as the switch lever advances from one position to the next. It would seem on casual examination that a tuning coil of this type would be unsatisfactory owing to the large amount of wire which might be left in circuit and in the field of the turns in use when the lever is set at any position other than the maximum. Actually the lever switch is a very ingenious arrangement, and is arranged to eliminate as far as possible the detrimental effect produced by dead end turns. The switch lever revolves an insulating plate fitted with short-circuiting bars around which are fifteen spring contacts so that sections not in use are disconnected from the tuning circuit. The coils are of the basket type, though shaped to a conical formation so that liberal air spacing is obtained between successive layers. A strong cardboard case protects the wind-

ings, rendering the coil particularly durable, and the bronze bush which is provided at the centre serves as a bearing for the switch lever.

This coil, apart from being cheaper than a set of tuning coils covering the same range, is convenient for quickly searching over a wide band of wavelengths. When used with a normal aerial and a series tuning condenser, having a maximum capacity of 0.0005 mfd., a tuning range of 180 to 2,750 metres is produced; whilst with parallel tuning on the same aerial the wave range is from 400 to 4,400 metres. Used in a closed circuit with a 0.0005 mfd. parallel tuning condenser, the range is from 180 to 3,150 metres according to data furnished by the manufacturer.

HAVA MICROMETER DIAL.

One of the first methods, though undoubtedly still one of the best, for obtaining fine control in a tuning condenser is a worm drive. The principal advantage of worm reduction gearing is that several teeth are always in mesh, which has the effect of eliminating backlash while the reduction ratio may be moderately high. Halladays, Ltd., 12 to 18, Geach Street, Birmingham, manufacture a variable condenser to the knob of which is fitted a simple worm drive carried on a bracket so that it can be swung out of action when a quick adjustment is needed. By



The Hava condenser is fitted with a worm reduction gear for obtaining critical adjustment without backlash.

means of a lever the screw is held in mesh with the worm wheel, while a projection of the lever in coming into contact with the bracket disengages the pinions. The position of the moving plates is indicated by a brass pointer moving over a fixed scale.

C.A.V. L.T. ACCUMULATOR.

A new range of filament heating batteries in unspillable glass boxes has been introduced by C. A. Vandervell and Co., Ltd., Warple Way, Acton, London, W.3.

These batteries have been designed for use where celluloid containers are undesirable, such as in tropical climates or



Unspillable C.A.V. 2-volt cell in glass box.

as is sometimes the case, where the use of celluloid is objected to.

The moulded glass jar is substantial in thickness, and is free from the risk of fire, while the chance of frothing is eliminated. The battery is clean and of good appearance. No separators are fitted between the plates, which are correctly spaced by grooves moulded into the sides of the glass boxes. The plate sections are suspended from an ebonite lid sealed in position, while the screwed vent plugs are made of porcelain. Portability is facilitated when required by the use of teak carrying crates fitted with the usual strip rubber handles, and as each 2-volt cell is a separate unit rubber buffers are suitably positioned to prevent damage from vibration.

EDISWAN VALVES ARE ENTIRELY BRITISH MADE

THE PERFECT PAIR—

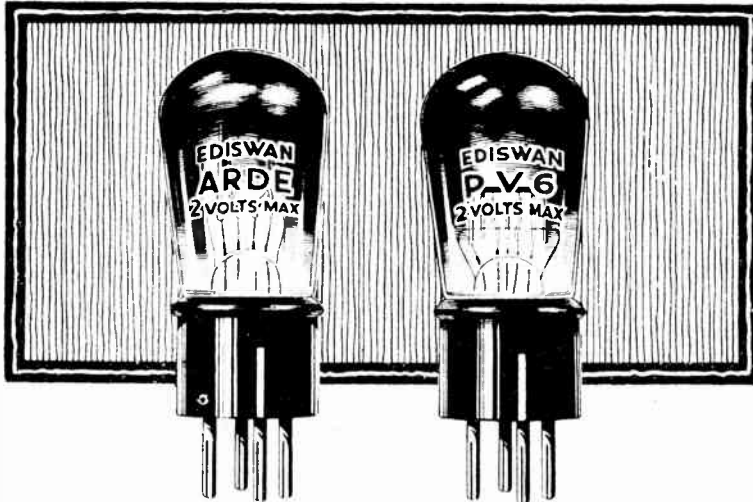

Use them *together*. It is the only way to get the real Edison quality of reproduction. Individually, Edison Valves are always better—very robust; very long in life; very reliable in service. But it is in co-operation that Edison Valves give the most remarkable results—you can test this on your own set.

Ediswan A.R.D.E. is made to function either as a L.F. amplifier or detector (green line) or as a H.F. amplifier (red line). Ediswan P.V.6 (Loud Speaker Valve) is specially designed for use when A.R.D.E. is used in the preliminary stages.

The following table indicates the combinations of Edison Valves that give the best results:—

Receiving.	Accumulator or Battery Volts.	Power.
AR	6	PV5
ARDE	2	PV6
AR'06	3	PV8

With these groups and Edison H.T. and L.T. Accumulators the ideal is attained.

THE EDISON SWAN ELECTRIC CO., LTD.,
123-5, Queen Victoria Street, London, E.C.4.

EDISWAN VALVES
The PIONEER VALVE

**The
Wireless
World**
and
Radio Review
10th Year & 10th Issue

Readers' Ballot

£50 IN PRIZES

First Prize £20. Second Prize £10. Third Prize £5.
15 Prizes of £1 each.

WHAT YOU HAVE TO DO:

Arrange the contents of this number of "The Wireless World" (as indicated by the list below) in what you consider to be the order of popularity. All that is necessary is to write the numbers of the items, in order of popularity, in the columns provided for the purpose.

VOTING COUPON.			
Contents.	Order of Popularity.	Contents.	Order of Popularity.
1. Editorial Views.	1st. No.....	10. New Apparatus.	10th. No.....
2. Broadcasting Photographs.	2nd. No.....	11. Problems of Television.	11th. No.....
3. Readers' Novelties.	3rd. No.....	12. Two-stage Radio Frequency Amplifier.	12th. No.....
4. Selective Three-Valve Receiver.	4th. No.....	13. Oscillation without Reaction.	13th. No.....
5. The Battery Room at 2L.O.	5th. No.....	14. Broadcast Brevities.	14th. No.....
6. Practical Hints and Tips.	6th. No.....	15. Practical Switch Making.	15th. No.....
7. Current Topics.	7th. No.....	16. News from the Clubs.	16th. No.....
8. Pioneers of Wireless.	8th. No.....	17. Letters to the Editor.	17th. No.....
9. Wireless Circuits in Theory and Practice.	9th. No.....	18. Readers' Problems.	18th. No.....

*The item which interests me the most is No.....

*NOTE: No coupon will be considered complete unless this question is answered. The number need not necessarily be the same as selected for first place in the above list.

Name.....
(IN BLOCK LETTERS)

Address.....

When you have filled in all the numbers on the coupon, write your name and address clearly in block letters in the space provided, and post the completed coupon to:

**The Competition Editor, "The Wireless World,"
Dorset House, Tudor Street, London, E.C.4.**

ALL COUPONS MUST BE POSTED TO ARRIVE NOT LATER THAN APRIL 14th, 1926.

RULES and CONDITIONS.

- The Editor's decision on any point connected with the Competition must be accepted as final.
- No responsibility can be accepted for any letters lost in the post or otherwise. Proof of posting cannot be taken as proof of delivery.
- No member of the staff of "The Wireless World" or companion journals will be eligible to compete, nor to benefit in any way from the prizes offered.
- Each prizewinner will be notified by post, and a list of the prizewinners will be published in "The Wireless World" as soon as convenient after the close of the Competition.
- The Competition is to arrange the list of Contents of this issue (as printed above) in what is considered to be the order of popularity. The correct order of popularity will be obtained by counting the votes given by competitors for each of the various items.
- The votes will be counted and all coupons scrutinised by judges appointed by the Editor of "The Wireless World."
- The competitor whose list agrees, or most nearly agrees, with the popular order as indicated by the total votes will be awarded the First Prize, the next nearest the Second Prize, and so on.
- Entry into this Competition implies full acceptance of all the foregoing rules and conditions.

PROBLEMS OF TELEVISION.

A Lecture at Oxford
by
Prof. Fournier D'Albe.

THE history of attempts made to secure the transmission, by wire or wireless, of photographs, drawings, and diagrams was summarised in an instructive and entertaining manner by Dr. E. E. Fournier D'Albe in a lecture before the Oxford University Radio Society on March 10th.

Dr. Fournier D'Albe said he had given his lecture the title of "Problems of Television" because he still regarded television as a problem of considerable difficulty.

It must be borne in mind, he said, that when we look at surfaces we do not see continuous surfaces, but actually a large patch of dots. The eye was a wonderful optical instrument, said the lecturer, and had a wider angle of view than any other instrument, its angle of view being nearly 180 degrees in any direction. One hundred and eighty degrees was about 10,000 minutes, and if we could make vertical cross section through the retina of the eye and examine it under a microscope it would be found that it consisted of a system of some 10,000 elements, each element capable of distinguishing a spot of light. That applied not only to the vertical section, but also to the horizontal section, and therefore we got about 100,000,000 as approximately the number of single elements, each capable of seeing a small spot of light on a surface. In any case there could never be more than 100,000,000 such spots, but as a matter of fact we did not use that number all the time or on every occasion. The eye saw in front of it a certain area which was the area of clearness of vision, and that area consisted of about 10,000 elements.

Therefore the simplest picture to transmit would consist of about that number of elements. Pictures using 1,000 elements and down to 600 elements had been transmitted, but they were barely recognisable, and for any picture of any size there must be 10,000 elements. In the cinematograph there was presented to the eye a series of pictures at the rate of 16 per second, which caused the impression of continuity; therefore, in order to transmit pictures over wires it was necessary to multiply the 10,000 spots by 16 times, giving 160,000 spots to look after, or, in other words, 160,000 signals to transmit every second. Even that did not suffice in itself, because it was necessary to indicate gradation of the spots, and Dr. Fournier D'Albe had found by experiment that it takes six gradations to give anything like a tolerable likeness. Therefore we had to multiply 160,000 by about six before we could get a really recognisable and clear picture.

Early Experiments.

The practical problem in television was how to transmit 100,000 or 50,000 signals per second, and it would be seen at once that this problem was an extremely important one and on quite a different plane from any ordinary wireless problem, such as the transmission of signals by means of dots and dashes.

The transmission of a line by means of telegraphy was first done in 1850 by means of a revolving cylinder of tin foil on which the message was written with a metallic stylus in ink, the stylus being connected with contacts so that at every revolution of the cylinder contact was made. At the other end of the line there was a similar cylinder to which a stylus was acted upon at the proper moment, and in that way it was possible to transmit line drawings. That was the first rough attempt to transmit anything except messages consisting of words. That early work was due to F. C. Bakewell, and was followed by later work by Caselli, and finally synchronism was achieved by D'Artincourt in 1876.

Transmitting Pictures.

Attempts were next made to transmit pictures, which was a rather different problem from that of writing, and it was first successfully done by a German of the name of Korn, who in 1907 transmitted a picture of King Edward VII. in about twenty minutes. That system made use of the selenium cell, and it was only lately that a rival had appeared to selenium as a sender. Other work in the same direction of sending pictures by telegraphy had been effected by Thorne Baker and others, the latest work having been done by Campbell-Swinton, who devised an ingenious method, although the lecturer had not heard that it had yet been brought to any advanced stage. Next came the phenomenon described by Edouard Belin to the Royal Society of Arts some time ago by means of which some magnificent photographs had been



PROBLEMS OF TELEVISION. Prof. E. E. Fournier D'Albe with his demonstration apparatus on the occasion of his lecture before the Oxford University Radio Society. His remarks tended to show that television still offers problems which can only be solved by persevering effort and no small amount of ingenuity.

Problems of Television.—

transmitted, but when synchronism was taken into account the problem was a very difficult one. Most of the possible methods had already been proposed, and the only novelty now possible was at the receiving end. At the transmitting end it was known fairly well what could be done. There was one radical cure for the difficulties in using selenium, and that was to send the picture in code, which was first done, the lecturer believed, with remarkable success by Sanger Shepherd, who in 1910 transmitted a photograph of the America Cup yacht race.

Continuing, Dr. Fournier D'Albe said he did not think a great deal had been done with coding, but he himself had transmitted a picture from 2LO on that principle two years ago, the listeners taking the code by broadcast and arranging it in a certain order as directed. The next achievement was by Ruhmer, who transmitted a geometrical pattern.

Jenkins and Baird.

Among the systems which seemed to be extremely promising was one devised by Jenkins of America, who had already achieved some considerable results. There were also the experiments of Mr. J. M. Baird in England. The really new idea on his part was the use of the neon lamp, which gave an extraordinary number of spots in a very small fraction of a second, and Baird was the first to use the neon lamp for the purpose.

Dr. Fournier D'Albe then gave a few details of the work he himself has been carrying out in this connection. The important thing, he said, is to get rid of the necessity for synchronism. One way would be to have a number of wires, and the first idea proposed was to have as many as 10,000, but even if we went to one million we should still get an inefficient result. Another way would be to have a number of different wavelengths, but, considering the difficulty there now is, in arranging the necessary number of wavelengths for other purposes, that idea would hardly be practicable. Then it had occurred to him that we might attempt it with audio-frequencies, i.e., to convert a picture into sound, transmit the sound by radio-telephony, pick it up at the other end, and then convert it into its proper elements. He was experimenting along these lines, and Messrs. Hilger were making for him a beautiful set of acoustic resonators designed to control 24 different patches of light.

A Selective Arrangement.

Each resonator, consisting of a cylinder which can be tuned, carries a reed attached to a mirror, the latter vibrating with the reed. The arrangement had the very great advantage that it was surprisingly selective. The mathematical theory was rather complicated and had not been fully worked out, but the lecturer said he was practically using a Helmholtz resonator. In employing an instrument of this description, it could be arranged in various ways. It could be worked so that a black spot fell on a white screen, making a

spot of ink, and the white light would get brighter and brighter according to the note, but that would not be quantitative. It would not give an indication of the strength or loudness of the note, and would merely be qualitative. A quantitative application, however, would be obtained by reversing the arrangement, viz., by taking a black screen and having a white spot which would be dimmed exactly in accordance with the loudness of the note, so that if a picture were photographed we should get a negative consisting of a blackened surface, the opacity of which would be a measure of the loudness of the note. If we could only take the picture and make it into a note, then we could transmit that note and reproduce it at the other end as a patch controlled by these resonators.



SIGNS OF THE TIMES. This original and striking "Franco" sign has just made its appearance in Belfast. When the sign is operating the loud-speaker "flashes" the Morse code, spelling out the words on the right.

Even with his set of 24 resonators he did not hope to do very much, but at all events something of the kind he had indicated could be done. He could not say at the moment how many of these resonators could be made. At present only 24 were being constructed, though another 36 would subsequently be made. Even then it would be possible to get only about 60 patches, and unless a miracle happened, the end was nowhere in sight. If it could be done in this way, however, it would be an enormous advantage over any other method hitherto proposed because it would be possible to send the sounds by the ordinary telephone or through a wireless transmitter over the whole spectrum of sound, and there was no reason why a picture should not be transmitted in this way. Another advantage of this resonator was that it responded practically instantaneously,

especially in the higher octaves. All this, however, related to the transmitting end, and it was at the receiving end that the real difficulty existed, viz., how to reproduce the sound which was transmitted. That problem was largely concerned with the selenium cell, and in this connection Dr. Fournier D'Albe showed what he referred to as a small selenium cell devised by E. Simmonds, of the Cavendish Laboratory, Cambridge, which was rather remarkable, and will be exhibited at the forthcoming Optical Convention at South Kensington in April. This showed that we can do certain things even with very faint light interference systems with wave bands of light.

The Question of "Lag."

Dr. Fournier D'Albe proceeded by commenting on the so-called lag of selenium cells, and said he did not like the word "lag" in this connection, because it was liable to lead to some misunderstanding. Ordinarily, the word "lag" meant the time taken between cause and effect, but with the selenium cell the effect was immediate. In order to test this fundamentally, Mr. Simmonds and he had arranged an experiment which showed that it is possible to work a relay with the efficiency of light lasting one-thousandth of a second, and therefore he did not think the word "lag" was a justifiable one in relation to the selenium cell, and in relation to the selenium cell the so-called "lag" was a thing that really did not matter. Here, however, he came to the point at issue between selenium and its rivals. Selenium had the advantage that it is an element, and can be used in its dry state, and it is very steady indeed. There was, however, the photo-electric cell, and it was only recently, through the kindness of one of the scientific leaders at Oxford, that photographs of the latest photo-electric cells had been obtained under the auspices of Oxford University. These certainly showed a very marked advance indeed, and the photo-electric cell had one supreme advantage, that its action, whatever it was, was instantaneous. There was no lag, even nominal.

The Photo-Electric Cell.

Dr. Fournier D'Albe concluded by saying that he still adhered to the opinion that there can be no serious rival to the selenium cell, not even in the shape of the photo-electric cell, and he intended to go on with selenium, which had always stood him in such good stead. At the same time any new developments of this nature must be welcomed because they could only be to the advantage of science.

A number of questions were asked Dr. Fournier D'Albe at the conclusion of the lecture, and a cordial vote of thanks was passed to him on the motion of Prof. Townsend.

Seconding the motion, Prof. Lindemann stated that whilst he admired the work Dr. Fournier D'Albe was doing with the selenium cell, he had not been persuaded yet that it was better than the photo-electric cell, and he preferred the latter.

TWO STAGE Radio Frequency AMPLIFIER

WITH VALVE DETECTOR.

Constructional Details and Operating Notes.

(Continued from previous issue.)

SO far, we have discussed the general theory of the receiver, and described the arrangement of the parts on the ebonite front panel and on the upper side of the baseboard. We have seen that selectivity and amplification depend on the characteristics of the valves used and on the values of the couplings as well as on the method of connecting them.

Selectivity depends on the effective resistance of the circuits and on their number. In this receiver there are three couplings, each comprising a coil and tuning condenser. One of them is used to connect the aerial to the first valve, the second to connect the first and second valves, and the third to connect the second valve and the detector. (See Fig. 1, page 394.)

Taken by themselves, the three couplings will have a similar tuning curve, as each comprises a coil and condenser; but, connected in the receiver as they are, the characteristics of each circuit will be different.

Avoid Grid Current.

In the first place, the coupling between the aerial and the first valve has the load of the aerial-earth thrown on it, the amount of the load depending, of course, on the nature of the aerial and earth. Then again, one end and the centre point of the coil are joined to the grid and filament of the valve. If the impedance of the grid filament path is high compared with that of the circuit, connecting the valve will not affect the amplitude of the signals in the tuned circuit, nor affect its tuning curve; but if grid current flows as the result of a strong signal, or if grid current normally flows because of the point to which the grid return wire is connected, we have a load on the circuit—in effect, a shunt resistance, which reduces the signal strength and broadens the tuning curve. Grid current must, therefore, be avoided so far as possible. A grid bias of negative 3 volts is suitable for the set illustrated here.

Great care must also be taken that there is no leakage. The insulation resistance of the valve-holder should be very high; the amplifying valve used should be a hard

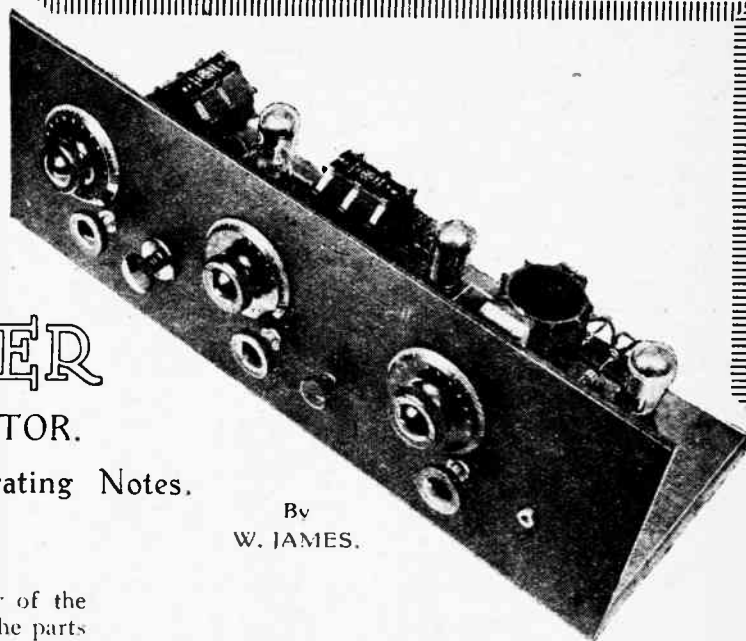

By
W. JAMES.

one; the connecting wires should be clear of the baseboard and other components; the insulation resistance of the condenser should be very high; and, finally, the insulation resistance between the contacts of the coil-holder and between the contacts of the coil itself (across the ebonite former) should be high. Bought components of good make are usually satisfactory; the average constructor, as a rule, will have no means of testing for slight leakages, but he can take care that he does not make leakage paths by bad workmanship.

Second and Third Couplings

Particular attention should be paid when using soldering flux, only a small quantity being required. If an excessive amount is used and is allowed to form a film between contacts, a leakage path is formed to the detriment of selectivity and amplification. One of the principal reasons of the writer for well spacing the components of a set and for wiring with stout wire is that it is easy for those who closely follow the construction to wire and solder neatly, and this encourages those who are not expert. When the parts are crowded together the connecting wires are more difficult to solder, and there is much more chance of reduced effectiveness through leakage paths.

Turning now to the second tuned circuit, we have in shunt with this the anode filament path of the valve and the H.F. choke, also the grid filament path of the second valve. When care is taken with the grid circuit and in the choice of the H.F. choke, we are left only with the effect of the valve. The effect of the valve was explained in the first part of this article, and it should hardly be necessary to point out that a high impedance amplifying valve must be used if good selectivity and amplification are desired. Of course, there is no need to use an extremely high impedance valve such as one of the foreign valves of doubtful make. One of the valves recommended should be used.

Two-Stage Radio Frequency Amplifier.—

The third circuit has the detector connected across part of it, and this will slightly lower the amplitude of the signal (when grid current rectification is used) as compared with the amplitude if the detector were removed; but the output of the detector will be greater with the set wired as described, and for normal signals, when the grid current method of rectification is used than with anode bend rectification; that is, although the grid current detector has the effect of lowering input voltages, its effectiveness is greater and the signal heard will be louder than

It might also be mentioned that the two aerial fixed condensers (0.0003 and 0.0001 mfd.) have one of their ends screwed to the aerial and earth terminal strip.

Wiring is carried out with bare No. 16 tinned copper wire, insulating sleeving being used where necessary—that is, at places where the wire passes through the baseboard and runs underneath. The wiring diagrams give the connections quite clearly, the bare, covered and flexible wire being indicated.

It is necessary to drill a hole through the baseboard at the points marked by a letter, and through this hole to

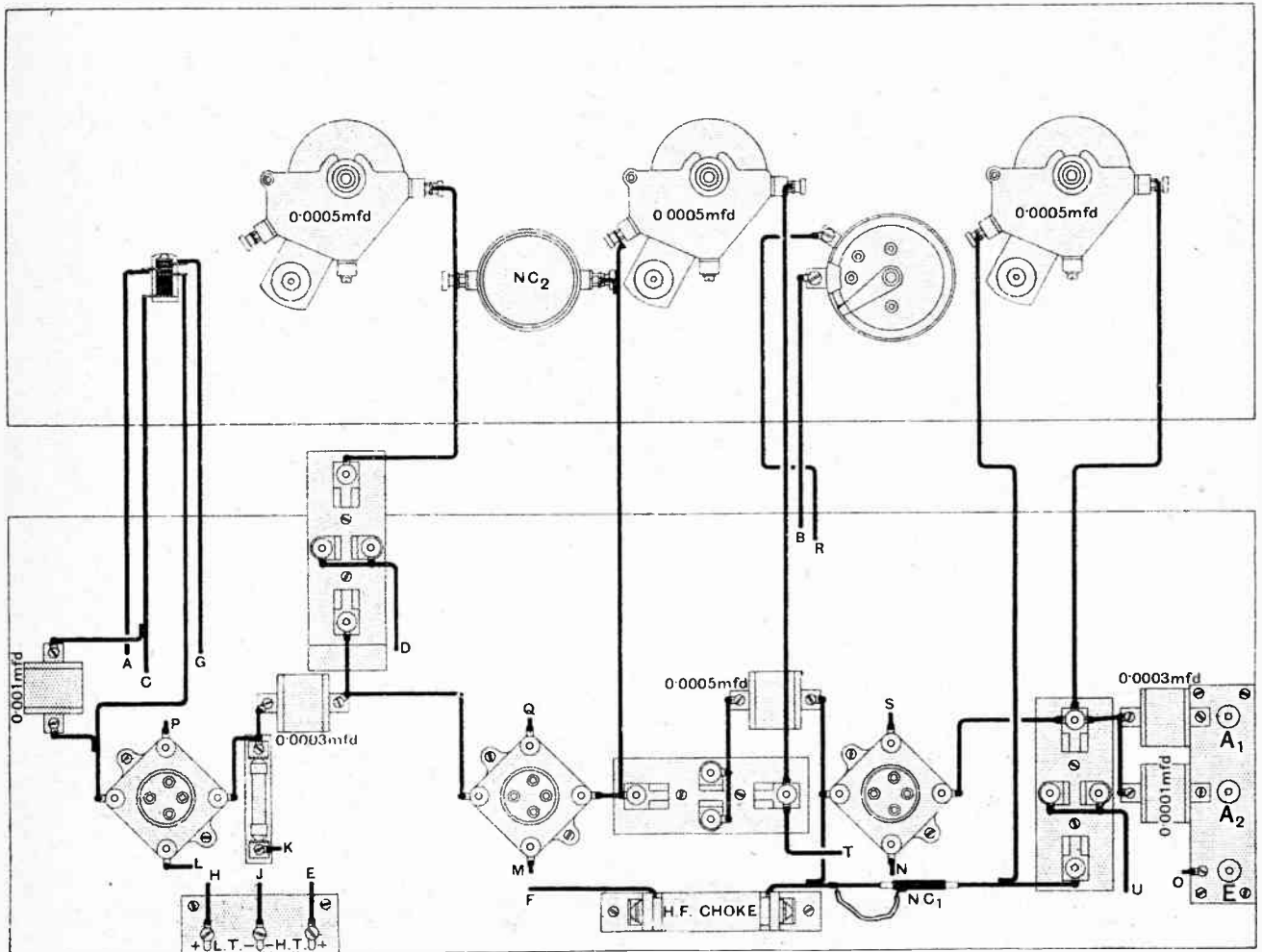

The wiring of the parts mounted on the front panel; also the wiring which lies above the upper surface of the baseboard. The remainder of the wiring lies below the baseboard, and is shown in the next diagram.

when the anode bend method of detection is employed, even though the latter method does not materially damp the tuned circuit.

The arrangement of the parts on the upper side of the baseboard of the set and on the front panel was given in Figs. 2 and 3, and it was mentioned on page 396 that the two large condensers and the grid bias battery were secured below the baseboard. These parts are shown in here, the 0.125 mfd. condenser being screwed to a piece of wood and the grid battery held in place by two brass clips.

To make the wiring diagram quite clear we will start, by way of example, with the aerial and earth connection strip. Terminals A_1 and A_2 are connected to the two fixed condensers as shown, while terminal E is connected by a wire which passes through the hole in the baseboard marked O to one side of the 0.125 mfd. condenser on the underside of the baseboard. This wire continues to the point marked N , and the wire is soldered and passed through the baseboard to the filament contact of the first valve-holder. From point N another wire is taken to point M , and so on.

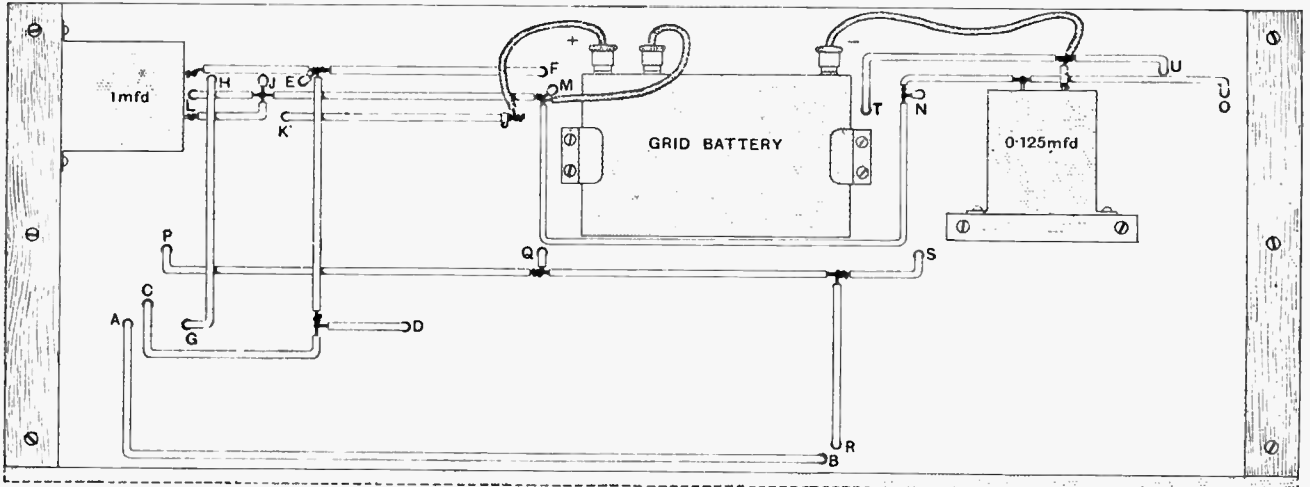

Wiring connections on the underside of the baseboard.

The balancing condenser NC₁ is easily made from a piece of Systoflex and a short length of wire. A piece of Systoflex about 2in. long, which is a fairly tight fit on the connecting wire to be seen in the diagram, should be wrapped with a bare copper wire of about No. 24 S.W.G. for about an inch. Solder the turns of this partial outer covering of wire and also solder on a short length of flexible wire. Then cut a piece about $\frac{1}{4}$ in. out of the wire which runs between one end of the H.F. choke and the end of the first coil. The Systoflex, with its partial wire covering, should be slipped over these wires and the flexible wire soldered as indicated. It is very important to notice that there is a gap of about $\frac{1}{4}$ in. between the ends of the two wires which, in the diagram, are to be seen running through the Systoflex at NC₁.

Operating the Receiver.

Connect the filament-heating accumulator and an anode battery of about 90 volts, and when 2-volt valves are

used connect the grid leak return wire to the positive terminal of the grid bias battery, and the flexible wire from negative L/T to $1\frac{1}{2}$ volts negative with respect to the grid leak return wire. Also join the flexible wire from the grid return circuit of the amplifying valves to the grid bias battery, to give the grids a negative bias of 3 volts. With the aerial connected to terminal A₁ to begin with, tune in the local station. The first valve can be balanced in the usual manner by adjusting condenser NC₁ to stop the aerial circuit from oscillating. Now endeavour to tune in a weak signal, by turning the three condensers in, say, one degree steps, and when a weak signal is heard, make final adjustments to both balancing condensers. Their adjustment should be such that the set will not oscillate over the whole tuning range. A station should therefore be tuned in with the condenser dials near their maximum setting, and another with the dials near their minimum setting, and careful adjustments of the balancing condensers made to prevent unwanted oscilla-

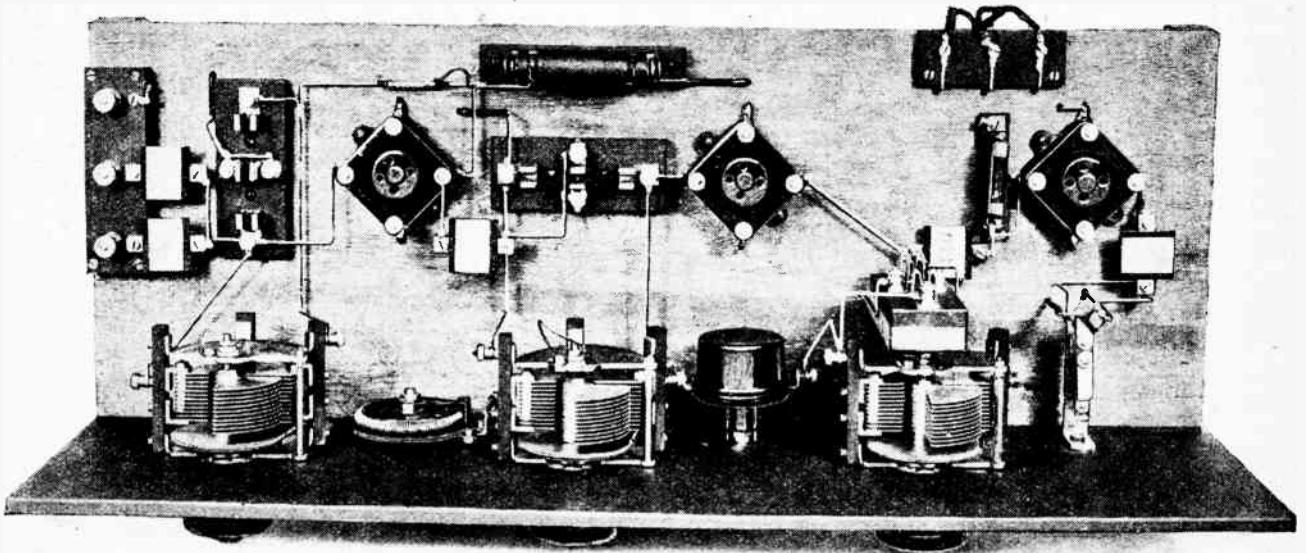

View of the top of the set with the coils and valves removed to show the wiring more clearly

Two-Stage Radio Frequency Amplifier.—

tions. In the receiver illustrated it was found necessary to remove a few plates from the rotor of the balancing condenser mounted on the front panel before the exact balance required could be obtained.

A Tuning Hint.

The selectivity of the receiver is such that Bournemouth can be heard while London is working, in the evening, at a place about three miles from the London station. Such selectivity as this means that tuning must be very carefully carried out, otherwise stations will be missed. When the maximum selectivity is not required, the aerial may be connected to terminal A_1 ; the strength of a distant station is greater with this connection than when the aerial is joined to terminal A_2 .

When a number of stations have been received and a note made of the settings of the tuning condensers, a

very utmost out of the receiver even at the expense of an additional control, and for this reason one of the balancing condensers is mounted on the front panel. If the setting of this condenser is changed a little, a reaction effect is produced, and of course if the setting is sufficiently altered from the point where the circuit is balanced, the second tuned coupling and second valve will oscillate. These oscillations ought not to reach the aerial circuit if the first balancing condenser is properly set; therefore the use of a certain amount of reaction in the second stage is justified in the case of those who have had experience of operating a set with these tuning condensers.

The Detector Valve.

One further point which might be of interest is this, that the same voltage is applied to the detector and high-frequency amplifying valves, and some readers may think

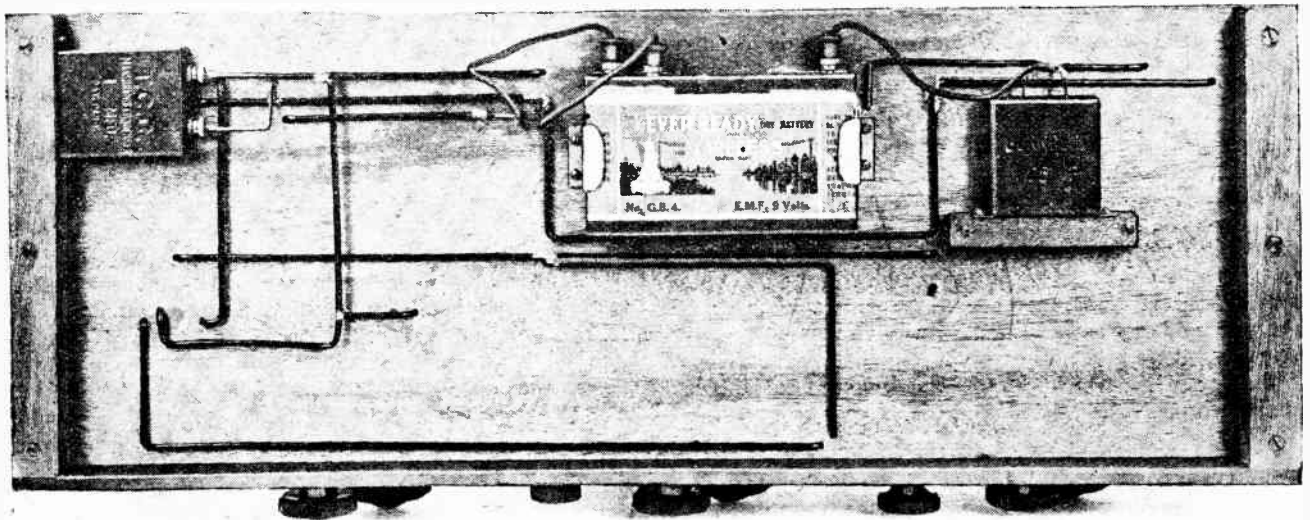

The underside of the baseboard. All the connecting wires can be seen, also the method of fixing the condensers and grid bias battery.

tuning chart can be made, and will be of great assistance when searching for other stations. The chart is easily prepared as follows. On a sheet of squared paper mark off every tenth square from left to right along the bottom edge of the paper and label these points 0, 10, 20—100 or 180. On the left-hand side mark off wavelengths from 200 to 600. Then, when a station has been heard, find its wavelength from one of the published lists, and mark a point opposite this wavelength and dial setting. When several stations have been tuned in and the points marked, a line can be drawn through the points, and from this the probable setting of the dials for a station of known wavelength can easily be found.

Adding Reaction.

No doubt the majority will be quite satisfied to operate the set with both high-frequency stages balanced, knowing quite well that when the balancing has been carefully done the receiver is a perfectly safe one; that is, the set will not oscillate. A few may, however, want to get the

anode voltage of 90 which was recommended a little too high for the detector. But, provided a valve of the H.F. type is used, as recommended, this voltage is not too high, and is in fact quite necessary when a power amplifier of the type to be described shortly is added. In this power amplifier, the first coupling is an anode resistance, with of course the usual grid condenser and leak, and when the power amplifier is added to the receiver described here the anode resistance is connected in the anode circuit of the detector. If the reader proposes to employ a transformer-coupled low-frequency amplifier, it will be as well to connect a separate H.T. wire to the detector circuit. Then a valve of lower impedance than an H.F. one can be used with advantage, for a transformer usually works better when connected to a valve having a moderate or low anode impedance. When a resistance of 100,000 ohms or more is connected to the anode of the detector, however, it is better to employ as the detector a valve of high amplification factor—that is, one of the H.F. type.

DISTORTIONLESS AMPLIFICATION AT ALL AUDIO-FREQUENCIES

WITH

**Polar
R.C.C.
Unit**



IN modern Radio Set design, more and more thought is being given to the elimination of low-frequency distortion.

Resistance Capacity Coupling has in a great measure solved the problem, amplification being practically constant at all Audio frequencies. This has resulted in the B.B.C. adopting Resistance Capacity Coupling in order to achieve the utmost *quality* in their transmissions.

Much research and experiment has resulted in the evolution of the "Polar" R.C.C. Unit. This Unit puts *distortionless* amplification within reach of all, in most *convenient* form.

The three essential elements—Anode Resistance (non-inductively wire-wound to avoid noise), Dubilier Coupling Condenser (Mica dielectric and perfectly insulated) and Mullard Gridleak—are incorporated in one small COMPLETE Unit, with sturdy terminals conveniently placed for easy wiring-up.

"Polar" R.C.C. Units are obtainable from Polar Service Agents and all reputable Dealers. If out of stock locally, send your order DIRECT

With Red Seal, 80,000 ohms, Anode Resistance. (Recommended for all stages of Amplifier, except last). 12/6

With Green Seal, 40,000 ohms, Anode Resistance. (Recommended for last stage of Amplifier.) 10/6

WRITE TO-DAY FOR FREE INFORMATION

on Resistance Capacity Coupling. Every detail of this efficient form of low-frequency amplification is covered in an interesting leaflet (which gives circuit diagram of a receiver incorporating R.C.C. Units). Sent on request to:—

RADIO COMMUNICATION CO. LTD.

31-35, NORFOLK STREET, STRAND, LONDON, W.C.2

66, OXFORD ROAD,
MANCHESTER.

125, HOPE STREET
GLASGOW.

Wireless Operators still wanted.

There are now vacancies on our Sea-going Staff for Junior Wireless Operators, trained on our apparatus. Youths of good education, preferably between 17 and 25 years of age, wishing to enter the Wireless Profession, should communicate with the Managing Director, **London Radio College, 82-83, High Street, Brentford, Middlesex**, who will be pleased to furnish particulars of the training course necessary to qualify for our Service.

A Complete BURNDEPT installation for £12

THIS equipment is capable of giving perfect loud speaker reproduction up to 25 miles from your local station and about 100 miles from Daventry.

The price includes Ethophone-Duplex Receiver with coils, two guaranteed Burndept Super-Valves, Ethovox Junior Loud Speaker, Accumulator, H.T. Battery, Aerial Equipment and Licence.

Any Burndept Dealer will be pleased to demonstrate the wonderful performance of this inexpensive set—the most efficient on the market at the price.

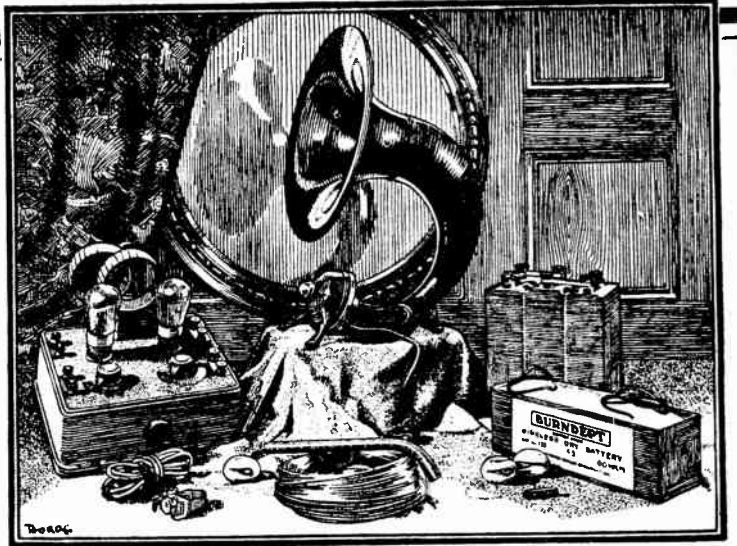

Ask your Dealer for particulars or write to



Aldine House, Bedford St., Strand, London, W C 2.
Phone : Gerrard 8072 (4 lines). Grams : Burndept, Westland, London.
Branches and agents everywhere.

"UTILITY" LOW LOSS CONDENSER

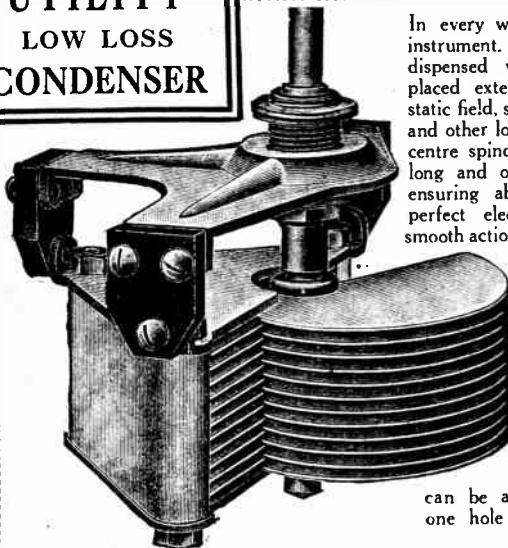

In every way a low loss instrument. One end plate dispensed with, insulation placed external to electrostatic field, saving absorption and other losses. Bearing of centre spindle is unusually long and of novel design, ensuring absolute rigidity, perfect electrical contact, smooth action, and automatically takes up any possible wear. End play is eliminated and end thrust another feature.

The whole is a very compact instrument, is fitted with a dust cover, and can be attached by our one hole fixing method.

"UTILITY" VERNIER DIAL.

Specially designed for use with above condenser upon entirely new geared principle. Combines both direct and vernier adjustment. Vernier adjustment has a geared ratio of 50 to 1. Backlash is entirely eliminated and the finest condenser adjustment can be obtained.

Capacity.	Ref No.	Price.	} Vernier 5/- extra.
.001	W. 159	14/9	
.0005	W. 160	12/6	
.0003	W. 161	10/-	
.00025	W. 162	9/6	
.0002	W. 163	9/-	

These prices include Knob and Dial.

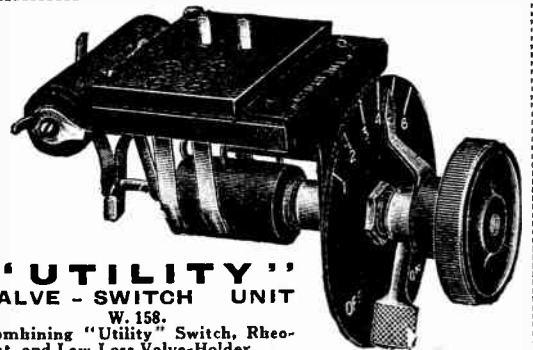

"UTILITY" VALVE-SWITCH UNIT

W. 158.
Combining "Utility" Switch, Rheostat, and Low Loss Valve-Holder. Equally suitable for High or Low frequency circuits. Its purpose is to switch "On" and "Off" a valve in a multi-valve set, at the same time maintaining continuity of the circuit employed. The filament current can be controlled in the usual way by the Rheostat, and the valve switched "On" and "Off" as desired.
Wiring diagrams sent with each unit.

PRICE 8/6

Utility

GUARANTEED

COMPONENTS

WILKINS & WRIGHT, Ltd.,
Utility Works, Kenyon Street, Birmingham.

OSCILLATION WITHOUT REACTION.

An Effect Produced by the Emission of Secondary Electrons in the Valve.

By Dr. H. KRÖNCKE.

SINCE the invention of back-coupling by Meissner, it is generally known that undamped electrical oscillations can be generated in a simple way by means of a three-electrode valve. All the various circuits which have been elaborated for this purpose are based upon some variation of Meissner's circuit, since reaction is effected either by inductive, capacitive, or resistance coupling. Each of the various back-coupling methods can, moreover, be modified in different ways, so that a large number of transmitting circuits can be produced, but they are based in common on the back-coupling principle. The arrangement of Kühn, in which both the grid and anode circuits are tuned, which is also able to oscillate and works as a transmitter without apparent back-coupling, is likewise, as is generally known, really a back-coupling circuit, and uses the internal capacity between anode and grid.

The Dynatron Oscillator.

Hitherto, only a few types of valves permitted of the generation of undamped electrical oscillations without back-coupling. A characteristic example of this is the "Dynatron" of A. W. Hull, in which secondary electrons are given off from the anode due to the impact of the electrons from the glowing filament. It has a current-potential curve as shown in Fig. 1, which falls between the points A and C. Inside this range, a decrease of the current intensity corresponds to an increase of the potential, contrary to the rules of Ohm's law, the current and potential being proportionate, as, for example, is the case in the section OA of the curve. It can be shown in theory that in all cases where the current-potential curve or characteristic of an apparatus drops, thereby running counter to Ohm's law, the pro-

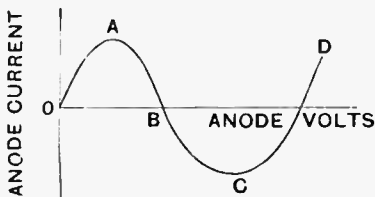

Fig. 1.—Characteristic curve of the Dynatron valve.

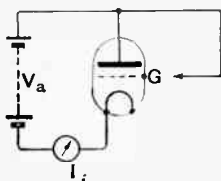

Fig. 2.—Oscillations were observed by Kühn in this circuit in 1917.

duction of undamped oscillations is possible. This applies equally to an arc, to the back-coupling circuit, and to the Dynatron.

The knowledge of these facts had been fairly general for some time past, but the fact that electrical oscillations can be generated without back-coupling by means of an ordinary three-electrode valve was not previously known. Now, Dr. Rottgardt, the laboratory chief of Messrs. C. Lorenz A.G., has succeeded, by means of ordinary transmitting valves, in producing phenomena similar to those previously obtained with the Dynatron,

and it would seem, at least, that precisely the same methods underlie the observations of Rottgardt.

Rottgardt reverts to an observation of Kühn which the latter made in 1917, in a valve circuit according to Fig. 2. An ordinary transmitting valve to which an anode tension V_a was applied and the cathode of which was heated allowed a small anode current to pass through it, this being measured by the milliammeter I_a . The current could only be small, as long as the grid G of the valve was not connected up, since this grid had rapidly to be charged negatively by the electrons produced, so

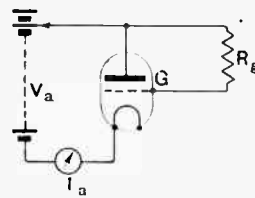

Fig. 3.—Circuit used to investigate the phenomena observed in the circuit in Fig. 2.

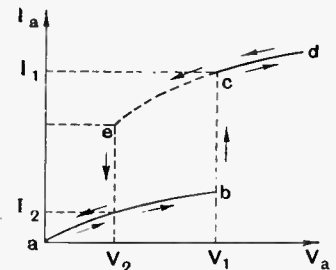

Fig. 4.—Characteristic curve of the valve in Fig. 3.

that a further passage of current was rendered impossible. On one occasion Kühn accidentally touched the grid lead with a wire which was connected to the anode, so that the grid became charged with the full anode potential. As was to be expected, the measuring instrument I_a at once showed a greatly increased anode current. The remarkable point, however, was that the instrument, which was deflected, did not go back to its original position when the connection between grid and anode was again broken.

Kühn described this phenomenon as the "decline of the electrical field of the valve." He examined more closely in what conditions this phenomenon appeared, and in this connection he employed the circuit according to Fig. 3. The grid was therefore connected by a high resistance R_g with the anode, and the phenomenon was examined with different anode voltages and various values of the resistance. The same observation was made, moreover, when the grid was connected through a high resistance with the filament. The purpose of the resistance is that the touching of the grid with the anode does not have to be effected from time to time, and continuous connection can be made.

Characteristics of the Oscillator.

If the relation of the anode current I_a to the anode potential V_a be represented graphically, the curve in Fig. 4 is obtained. With an increasing anode tension, the current increases slowly from a to b . With the limit tension V_1 the current then jumps suddenly up to a very high value I_1 , and if the anode tension be further increased there will be noticed a normal anode charac-

Oscillation Without Reaction.—

teristic, which leads gradually to the saturation current. If the anode tension be now reduced, the point *c* is then exceeded without difficulty until approximately point *e*, whence the current drops suddenly to a very much smaller current I_2 , and then decreases along the curve *ab*, as the potential is further decreased.

The curves according to Fig. 4 have a certain similarity with the vapour tension curves of gases and, just as with

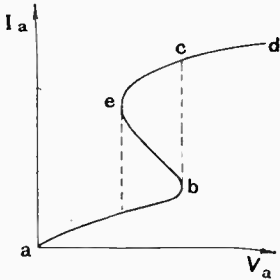

Fig. 5.—Completion of the characteristic curve of Fig. 4 as suggested by Rottgardt.

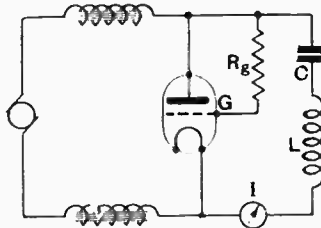

Fig. 6.—A practical circuit in which the frequency of oscillation is determined by the constants of the circuit L C.

the latter, the parts which apparently do not coincide can at first be connected experimentally and thus lead to interesting conclusions. Rottgardt completes the curve in the manner indicated in Fig. 5, *i.e.*, he assumes that the current potential characteristic runs negatively on the curve branch *bc*, and that here, therefore, no stable condition is

possible. If this view is correct, it must be possible, however, to use the falling characteristic between *e* and *b* for the production of oscillations, and it is in this respect that Rottgardt has actually succeeded. The circuit used by him is represented in Fig. 6. It proceeds from the circuit shown in Fig. 3, if the anode and filament of the valve are shunted by an oscillatory circuit. It is, in fact, possible to generate powerful electric oscillations in this circuit, but difficulties have been encountered up to the present in withdrawing energy from this oscillatory circuit.

A Practical Circuit.

There is no doubt that oscillation without back-coupling takes place in the valve transmitter according to Fig. 6, nor is there any concealed interior back-coupling, since there is only one circuit that is able to oscillate. The resistance R_g is important for the realisation of the oscillations, and the magnitude of the resistance depends upon the anode and the characteristic of the valve. With a transmitting valve of 250 watts, and an anode voltage of about 800 volts, R_g must have a value of the order of 125,000 ohms.

There appears to be hardly any doubt that the falling part *cb* of the characteristic in Fig. 5, and therefore the production of oscillations, is brought about by the development of secondary electrons from the grid. It is still doubtful whether this method will ever compete with the valve transmitter with back-coupling, but the phenomenon is very interesting, at least from a theoretical point of view.

Sutton Coldfield.

- (February 4th-28th.)
 France: 8QS, 8LDR, 8HU, 8XP, 8JN, 8OZ, 8SU, 8PAL, 8PKK, 8EU, 8DY, 8HU, 8JC, 8GI, 8SAX, 8PEP, 8ZB, 8CGS, 8EG, 8IOL, 8BBQ, 8PRD, 8XH, 8VO, 8PM, 8PLA, 8LLM, 8DDH, 8SMR, 8WGR, 8CAN, 8KWM, 8KM, 8JMS, 8EE, 8NN. French-Indo China: 8QQ. Italy: 11FL, 1MA, 1AS, 1ER, 1BK. Spain: EAR3, EAR20, EAR21, EAR23. Sweden: SMUA, SMOJ, SMTQ, SMSS, SMXT, SMXU, SHT. New Zealand: 2IC, 4RD. Australia: 3EF, 3XO. Finland: S2CO, 5NF, 2ND, HNF. Yugo-Slavia: YS7XN. Brazil: 1AD, 1BC, 1AB, 1AW, 1IB, 1AC. Canada: 8AR, 2AN, 1AR. South Africa: A6N, A4Z.

U.S.A.

- U.S.A.: U1, B1, 1QB, 2ACS, 2AUB, 1CM, 2OL, 1CH, 1AAO, 1BYX, 1CMF, 1AHC, 2CHJ, 1RD, WIR, WIZ, LPZ, 3LD, 1VC, 1CMX, 9TZ, 1BHM, 1AP, 8CCQ, 2GK, 1KB, 1CMP, 2NZ, 1APZ, 8DJJ, 8AVS. Belgium: H6, CC2, C2, 4RS, R7, C3. Holland: OWC, OKH, 0NAA, 0WB, PC2, PCLL. Germany: Q5, KPL, 6Z. Porto Rico: 4JE. Denmark: 7BZ, 7ZM, 7EW, DA. Portugal: 3CO, 3FZ, 3FT. Egypt: EGEH. Norway: 1A. Various: OCMV, RCLL, VKW, RCRL, FW, P7, GHA, GSH, RDAL.
 (0-v-1, Reinartz) 30 to 45 metres.
 E. W. B. Briscoe.

Calls Heard.
Extracts from Readers' Logs.

Brockley, S.E.4.

- Australia: 3BD, 5EF, 3XO, 4RB, 6AG. New Zealand: 4AC. Philippine Islands: 1HR, 3AA, NEQQ, N1RX, NPO. China: GFUP. Chile: 2LD, 9TC. Brazil: 1AB, 1AC, 1AF, 1AN, 1AP, 1AW, 1IA, 1IB, 2AF, 5AB, 6QA. Indo-China: HVA, 8QQ. India: 8UG. Argentine: BA1. South Africa: A5B, A6N. Cuba: 2LC, 2MK. Palestine: L6C, 6YX, 6ZK. Egypt: EGEH. Madeira: P3FZ. Morocco: MAROC, 8MB. Panama: NBA. Porto Rico: 4JE, 4KT, 4SA, 4UR. Malta: GHA. Canada: 1AR, 1DD, 2AX, 2BF, 2BG, 2BI, 2FO. U.S.A.: 4AV, 4DV, 4GY, 4NR, 4OY, 4RZ, 4NI, 4SI, 4TV, 4UX, 5ATX, 5JF, 5YB, 5YD, 5ZAI, 9ADK, 9AIO, 9AK, 9CYI, 9DUD, 9EJI, 9NB, 9XI, 9ZT. Various: SDK, SHAD, NOT, NTT, NTT1, D8N, F9C, GFD, GFP, BYC, BYZ, L51, X1GB, OCDB, TPAY, 2NAS, NPG, ICS, URSS.
 (0-v-1.) A. J. Perkins.

South Croydon.

- (February 20th to 23rd.)
 Great Britain and Ireland: 2IA, 2XM, 2NT, 2OD, 2OG, 2SZ, 2TI, 2TT, 2VL, 2VQ, 2WJ, 2XY, 5FF, 5FQ, 5HA, 5KU, 5KZ, 5MB, 5NN, 5NU, 5QK, 5SK, 5VV, 5XY, 5YI, 6AN, 6FA, 6GH, 6LB, 6QC, 6QM, 6UT, 6YC, 6YV, 6ZD, France: 8AL, 8BB, 8CR, 8DD, 8DK, 8EL, 8EU, 8EZ, 8GU, 8HV, 8IZ, 8MM, 8SAX, 8SD, 8SSZ, 8YY. Belgium: D4, K4, S9, 9TS. Holland: OAP, OAX, OMS, OPX, OUC, PCLL. Sweden: SMSS, SMTN, SMTS, SMUF, SMVZ. Germany: Y8, IA. Italy: LAX ('phone), 1ER, 1MA. Denmark: 7ZM. Spain: EAR22. North Africa: OCDB. Palestine: 6YX. Japan: GFUP. Unknown: N 1CQ, P 2BG, S 1AI.
 (0-v-1) on 20 to 50 metres.
 G. Bennett.

Sunbury-on-Thames.

- (February 7th-28th.)
 U.S.A.: 1AAO, 1AJO, 1APV, 1AFL, 2AGQ, 2AY, 2MU, 2CPK, 2CTY, 4RM, 5YB, 5ZAI, 8AIG, 8AUL, 8ALY, 8AVJ, 8BTH, 8DJG, 9ADG. Brazil: 1AC, 1AW, 1BD, 2AB. Australia: 2BK, 2CM, 2YI, 2CS, 3BD. New Zealand: 2AC, 2AF, 2XA, 4AR, 4AC, 4AS, 4AV, 4AF, 3AF. South Africa: A42, A6N. Indo-China: 8QQ.
 (0-v-2.) All below 50 metres.
 A. Diserens.

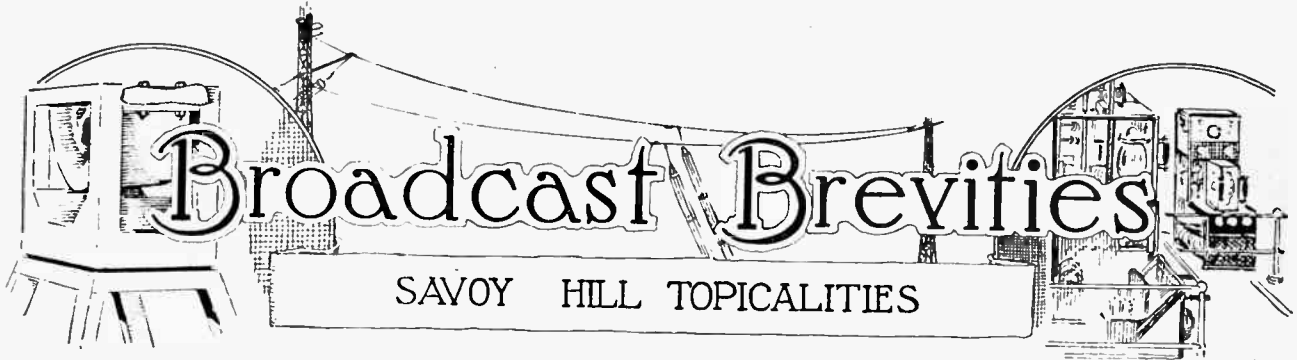

By Our Special Correspondent!

Broadcasting to Europe.

When broadcasts to Europe are resumed after Easter they will take place on Tuesdays instead of on Mondays as at present.

o o o o

The Budget Speech.

A good deal of heartburning has been caused by the B.B.C.'s application to the Postmaster-General to be permitted to broadcast the Budget speech. Some representatives of the Press imagine—I think quite wrongly—that the interests of the Press will be prejudiced if the speech is broadcast. This is yet another indication of the failure to accommodate existing interests to the march of science.

o o o o

The Folly of Obstruction.

If there is anything in the world against which obstruction is hopeless it is broadcasting, and within very few years it will be amusing to look back on the attempts that have been made to retard the legitimate development of broadcasting. Still, different ages have had their different problems to solve. The Press itself is only allowed by grace of the House of Commons to report Parliamentary speeches, and the broadcasting authorities feel that they must spare no effort to secure such concessions as other interests seem inclined to regard as their monopoly.

o o o o

Nearly Two Million Licences.

I see that attention is called in a contemporary to the fact that the number of licences is approaching the two million mark, and the suggestion is made that when that figure is reached the B.B.C. should put on something very special in the way of programmes to celebrate the event. This is a laudable idea in some ways; but it is difficult to conceive why the B.B.C. should be expected to signalise the event in the manner suggested, seeing that the revenue which the company receives has been strictly limited, and that, therefore, it makes no difference whether the number of licences is two, three or four-millions. Now if the writer who suggested a special programme had further suggested that it should be provided entirely at the expense of the Post Office—!

Less Oscillation?

Listeners' letters to the B.B.C. show, as a general rule, that the writers appreciate the efforts at Savoy Hill to put a stop to the oscillation trouble, and, in proportion to the increase in the number of licences issued, fewer complaints of oscillation are received. That fact, however, probably proves very little, as complainants get tired of writing about oscillation, and, having registered their complaint, wait for the Post Office, which is the only authority able to take drastic action, to move in the matter. In the past three months Savoy Hill has received complaints from 466 towns and districts.

The "A.O.P."

o o o o

The "anti-oscillation" pamphlet which is given away by the B.B.C. has in many cases been useful in improving the conditions, and when the D.F. apparatus of the Post Office is brought into use next

month a further improvement should take place. One or two cases of confiscation and revocation of licence would put an end to those habitual offenders who intentionally spoil reception for other listeners in their district. Such a case is reported from North London, where an individual, being himself a "low-brow," oscillates whenever a "high-brow" programme is transmitted, and, when approached by neighbours, openly declared that he had a perfect right to oscillate as a protest.

o o o o

The Postponed Boxing Match.

A relay of part of the twenty-round boxing contest for the Flyweight Championship of Great Britain and Europe and the Lonsdale Belt will be given on Monday next, March 29th, from the National Sporting Club. It will be remembered that a similar broadcast arranged for February 22nd last had to be cancelled owing to the illness of one of the boxers.



THE STUDIO AT OLYMPIA. One of the most interesting features of the Ideal Home Exhibition at Olympia, which closes on Saturday next, is the broadcasting studio shown in the photograph. Visitors are able to witness actual performances through the plate glass windows on the left. In the centre can be seen the microphone used in connection with the Marconiophone speech amplifying system

Citizenship.

Sir Stanley Leathes, Chief Civil Service Commissioner, is to broadcast a series of addresses to school children on "Citizenship" during the coming summer.

o o o o

Easter Programmes.

The Good Friday service will be relayed from Canterbury Cathedral from 4 to 5.15 p.m. The Easter Sunday evening service will be relayed from Norwich Cathedral, with an address by the Dean of Norwich, Dr. Wilink.

o o o o

The B.B.C. Musical Advisory Committee.

A report appearing in several provincial newspapers that in the near future "we shall hear of the appointment of a Musical Advisory Committee, composed of well-known musicians, that will assist the B.B.C. in the selection of their musical programmes" is, to say the least, somewhat belated. The B.B.C. Musical Advisory Committee was formed as long ago as July last, and consists of Sir Hugh Allen, Sir Walford Davies, Mr. J. B. McEwen, Sir Landon Ronald, Col. J. A. C. Somerville, Dr. Whittaker and Professor Donald F. Tovey. This is perhaps the strongest Advisory Committee on music that could be got together, and certainly the B.B.C. could not wish for a better jury.

o o o o

Broadcasting the League.

The broadcast of the Geneva Conference last week (Wednesday, March 17th) was extremely successful and foreshadowed the time when, as I remarked recently in this column, relays of speeches at the League of Nations will become part of the regular broadcasting system of this country. The transmission was effected by a combination of wired and wireless relay, the speeches being received in Paris by telephone, broadcast from the Eiffel Tower, picked up by the B.B.C. receiving station at Keston and relayed to 2LO and 5XX for broadcasting to Britain. During the two hours that the transmission was in progress, listeners telephoned to Savoy Hill from all parts, confirming the clearness of their reception which, it was stated in several cases, was as clear as the reception of 2LO programmes.

o o o o

Dancing at 2LO.

Since the personnel of the London Radio Dance Band, under Mr. Sidney Firman's conductorship, was increased to nine, a change which took place in the second week of this month, transmissions have greatly improved, but it is felt that some further development is necessary both to help the band and benefit listeners. Discussions are now taking place respecting the installation of a dance floor in one of the studios and the introduction of the proper atmosphere of a dance hall, in order to give that "zip" to the music without which any dance band must find it exceedingly difficult to perform efficiently. There is no tone colour in a dampened studio, and so far as a dance band is concerned the absence of dancers is very trying.

FUTURE FEATURES.**Sunday, March 28th.**

LONDON.—3.30 p.m., The Casano Octet and Gordon Bryan. 9.30 p.m., Emilio Colombo and his Orchestra, relayed from the Hotel Victoria.

ABERDEEN.—9.15 p.m., Recital of Church Music.

BIRMINGHAM.—3.30 p.m., Liszt Programme.

BOURNEMOUTH.—3 p.m., Concert and Organ Recital, relayed from the New Central Hall, Southampton.

Monday, March 29th.

LONDON.—9.45 p.m., Special Broadcast from the National Sporting Club.

BELFAST.—8 p.m., Concert Music. MANCHESTER.—8 p.m., Masterpieces of Mozart.

Tuesday, March 30th.

LONDON.—8 p.m., "Kitesh," a Sacred Opera by Rimsky Korsakov and the Augmented Wireless Symphony Orchestra and Chorus. Conducted by Albert Coates, relayed from the Royal Opera House, Covent Garden.

Wednesday, March 31st.

LONDON.—8 p.m., "Out of the Hat," a revue. 10.30 p.m., Syncopated Piano Solos.

CARDIFF.—8 p.m., The Music of Haydn.

NEWCASTLE.—8 p.m., A Victorian Programme.

Thursday, April 1st.

LONDON.—8 p.m., Dan Rolyat (Humorist). "The Disorderly Room"—Farcical Sketch by Eric Blore. "Tragedy at Midnight," a one-act sketch by Lawrence Anderson.

ABERDEEN.—9 p.m., Special Feature "What is it?"

GLASGOW.—9.30 p.m., "A Mock Trial."

Friday, April 2nd.

LONDON.—4 p.m., Evensong relayed from Canterbury Cathedral. 8 p.m., "Stabat Mater" (Rossini).

BIRMINGHAM.—3.30 p.m., Sacred Concert.

BOURNEMOUTH.—5.15 p.m., Sacred Concert.

BELFAST.—8 p.m., "God's Time is the Best" (Bach).

CARDIFF.—7.45 p.m., Passiontide Music. Third Concert of the Cardiff Musical Society.

GLASGOW.—7.30 p.m., "The Passion."

MANCHESTER.—8 p.m., Brahms' Requiem and Song of Destiny.

Saturday, April 3rd.

LONDON.—9 p.m., Seventh Edition of "Winners." 10.30 p.m., Savoy Bands.

MANCHESTER.—8.32 p.m., "Unforeseen," a play in one act by Arthur Black.

Free Licences for the Blind.

It is expected that an announcement will soon be made respecting special facilities for blind persons in connection with licence fees. This will be one of the first recommendations of the Broadcasting Committee, 1925, to be dealt with. The Committee recommended that licences should be granted to blind persons free of charge.

o o o o

New High Power Stations.

Another point that requires early attention is the Committee's recommendation to the Postmaster-General to continue the negotiations recently initiated in connection with the scheme for new high-power stations. Listeners in South-East Kent, who are mainly dependent on Daventry's programmes, have been very patient since the removal of 5XX from Chelmsford, in view of the B.B.C.'s attempts to push forward the new scheme for programmes from another London station in addition to those from 5XX and the existing 2LO. Such a station would be designed to meet the special geographical requirements of the south-east corner of England, and the sooner the scheme reaches fruition the better it will be for licence revenue.

o o o o

Measuring Wavelengths.

A pressing question for discussion by the Union International de Radiophonie, which meets at Geneva to-morrow (March 25th) is that of the adoption of a definite standardised system of wavelength measurement throughout Europe. In the past Geneva appears to have acted on the reports of various countries, and asked stations to make a change to certain definite wavelengths, apparently referred to a common base; but that common base does not yet exist. The German stations may measure all their wavelengths on one meter and the British stations on another meter. Both of these may be very good instruments; but if they differ by, say, 0.5 per cent., it may cause chaos in reception throughout Europe. If this problem were solved, reliable adjustments, based on Geneva's advice, would follow.

o o o o

A Musician in the Control Room.

Efficient amplifier control on musical programmes has long been a topic of keen discussion between the Programme and Engineering Departments of the B.B.C. A test was recently carried out and a number of independent musicians were called in to give the staff the benefit of their views. Opinion was definitely in favour of detailing a musician for control as regards programmes where an intimate knowledge of music was required. It has therefore been decided to establish a section experimentally to undertake amplifier control of important musical programmes and to supervise balance and control of important outside broadcasts. When occasion requires, a supervising official from the Music Department will be stationed in the Control Room with the music score in front of him in order to carry out the work of balancing during the actual broadcast performance.

PRACTICAL SWITCH MAKING.

Designs Specially Prepared for Construction with Ordinary Materials.

By H. J. TURPIN.

THE fascination in the use of switches in a receiver is due more than anything to the mind picture which is produced when we think of the combinations of connections taking place at every switch position. Multiple switches and even single-pole switches are usually considered too difficult to make and too expensive to warrant their use, but these difficulties do not really exist, and these switches can be quite easily made with the aid of ordinary material, such as ebonite sheet, springy brass for contacts, No. 2 B.A. rod, and standard nuts and screws.

Single-way Switch.

The simplest switch is No. 9 in the diagram, and it is surprising how small an efficient one can be made when it is not required for high-frequency work. The spindle is made from No. 2 B.A. screwed rod, and the knob from an ebonite accumulator terminal. Ordinary No. 4 B.A. brass screws are used for the two contacts after filing off the heads to the depth of the screwdriver slot, and small stop pins are driven into the base block or panel, recesses being cut out of the side of the contact arm to accommodate them.

Dead-end Switch.

As a variation of the arm and contact studs type of switch, No. 5 shows a more convenient and improved form, which is very readily made and is admirably suited for use with a tapped inductance coil where its function as a dead-end switch is necessary. The revolving member consists of a triangular-shaped plate clamped at one apex between two nuts on a No. 2 B.A. spindle, which takes its bearing in a standard condenser bush. The electrical connection to the plate is made to the lower end of the bracket, which is clamped under the nut of the condenser bush. Spring contact arms are screwed to an ebonite block, which is held by the bracket, the arms beforehand being adjusted to the correct length as shown.

Three Change-over Switches.

While a single-pole change-over switch can be used to revert to one coil (say) or another, it has the defect of always having one end of each coil connected to the centre contact. If a high- and low-wave coil are used, and the switch is set to the low wave, the dead-end effect of the larger coil is often apparent, so, to obviate this, double-pole isolating switches (No. 7 and No. 8) should be used, or a multiple-pole switch, such as No. 4. No. 8 consists of a circular drum supported by a pair of angle brackets which connect together two ebonite blocks. On each block is mounted a pair of spring contacts which press against the periphery of the drum, and so are connected electrically when the brass plate P is brought round to the correct position. A portion of the drum projects through a slot in the panel, and may be knurled to be operated upon by thumb or finger pressure.

No. 7 functions in a similar manner, only this time the revolving drum, smaller in diameter than the last, is housed inside the main block B and in which it takes its bearing. A contact plate is screwed to the face of the drum and passes under the upper or lower pair of contacts according to the position of the lever.

A four-pole change-over switch is shown in No. 4. The rotor and base are cut from $\frac{3}{8}$ in. sheet ebonite and form something substantial on which to secure the spring contacts. One point to watch is to get each contact firmly seated in a slot the same width as the spring before fixing it with a countersunk No. 4 B.A. screw. Beyond the fact that the switch is supported by a fairly rigid brass strip bracket clamped under the nut of the spindle bush, the drawing is self-explanatory.

Series-parallel Switch.

A very interesting series-parallel switch is shown in two forms (No. 1 and No. 2), and consists essentially of a plug to which is attached the aerial and earth leads, and electrical contacts which are connected to the receiver wiring. In the diagram of connections the dotted lines represent the plug connections, and the full lines those of the receiver.

The design in No. 2 consists of an ebonite cylinder on which are placed four contacts equally spaced, the aerial and earth leads being taken to these through a central hole. When the plug is inserted through a well-fitting hole, the contacts engage four other spring contacts as shown.

No. 1 shows a simpler form, making use of legs and sockets. From the "Series" position shown on the left-hand side, the barrel contacts are turned anti-clockwise through 90° to obtain the "Parallel" position.

Simple Lever Switch.

No. 3 shows a very simple single-pole lever switch. It is very simple to make out of the same thickness sheet brass throughout, and has the advantage of being "flicked" on or off in a similar manner to the electric light tumbler switch.

Key and Press Switches.

No. 6 shows a key switch, where, on first inserting the key, one contact is made, and on pushing in still further a second contact is made.

A modification of the common knife switch No. 10 is arranged, pivoted at the centre, with an ebonite thumb piece attached on either side of the pivot. These thumb pieces project through the panel, so when one is in its innermost position it is standing just above the surface. If the lower one is pressed inwards the upper end of the knife makes contact with its clips. Similarly, the lower end makes contact when the upper thumb piece is pressed. The switch can be made as a single- or double-pole change over as shown.

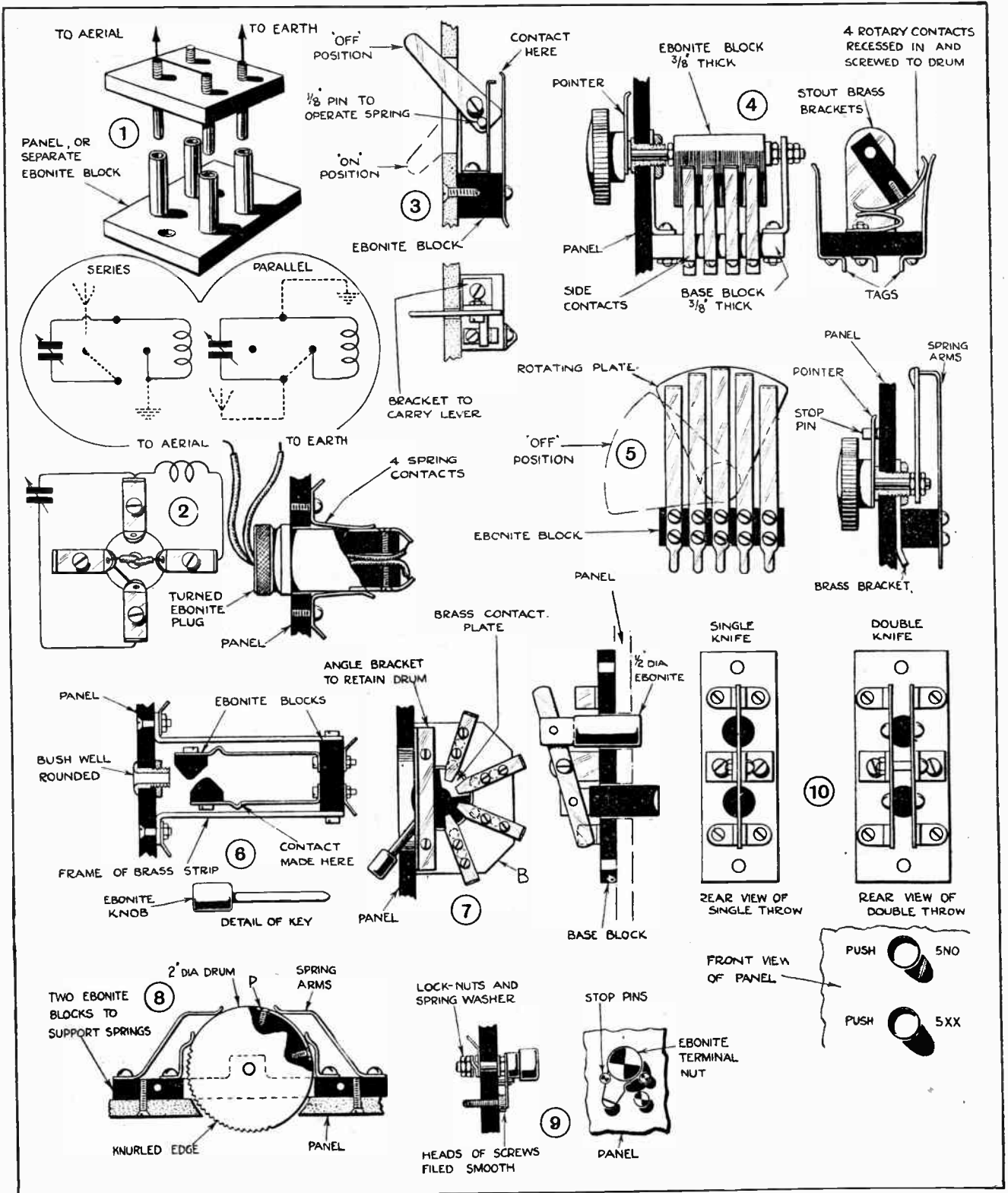

SWITCHES FOR HOME CONSTRUCTION. (1) and (2) Series-parallel switches. (3) Single-pole lever switch. (4) Four-pole change-over switch. (5) Dead-end short-circuiting switch. (6) Key switch (7) Drum switch with side contacts. (8) Drum switch. (9) Single-way switch (10) Single- and two-pole press switches.

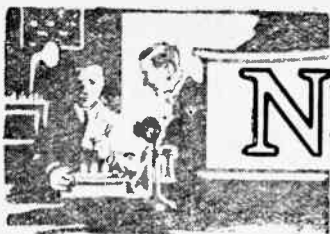

NEWS from the CLUBS

Secretaries of Local Clubs are invited to send in for publication club news of general interest. All photographs published will be paid for.

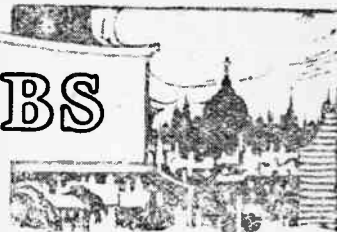

The Quest for Sensitivity.

Although dealing with a technical subject, Mr. Oswald Carpenter's lecture before the Bristol and District Radio Society on March 12th on "The Attainment of Sensitivity, Selectivity and Responsiveness" was delivered in a thoroughly comprehensive, interesting, and humorous manner. Mr. Carpenter first explained detection and rectification, passing on in easy stages to tuned anodes and heterodyne methods, and concluding with an instructive description of the supersonic heterodyne principle.

Hon. Secretary: Mr. S. S. Hurley, 45, Cotswold Road, Bedminster, Bristol.

○○○○

Losses in H.F. Circuits.

Members of the Muswell Hill and District Radio Society benefited from an interesting lecture—one of a series—given on March 10th by Mr. H. F. Klotz, who dealt with losses in H.F. circuits. The lecturer carefully explained how these losses can be minimised by the correct design of components and by proper attention to the lay-out of coils and condensers previous to assembly.

The Society's new syllabus for April, May and June can be obtained on application to the Hon. Secretary, Mr. Gerald S. Sessions, 20, Grasmere Road, Muswell Hill, N.10.

○○○○

Accumulators and their Upkeep.

A thoroughly practical lecture on the construction and care of accumulators was given by Mr. J. Endicott before the Lewisham and Bellingham Radio Society on March 2nd. Besides the ordinary type of battery using acid electrolyte, the lecturer dealt with types using alkaline electrolyte. A helpful discussion took place regarding the best method of charging a battery of cells when the total voltage is more than the supply.

A discussion on "Commercial Apparatus" was the feature of the Society's meeting on March 9th, when much argument centred round some interesting comparisons drawn between commercial and home-built sets on the questions of running costs, DX work, and quality of reception.

Joint Hon. Secretary: Mr. E. J. Chapman, 56, Crofton Park Road, S.E.4.

○○○○

Social and Technical.

When the West London Branch of the Radio Association held its fortnightly social function and wireless debate on March 2nd, Mr. S. Landman read a letter of congratulation from Commander the

Hon. J. M. Kenworthy, M.P., on the achievements of the branch. The membership roll is steadily growing, but vacancies still exist for new members. Those interested are invited to communicate with the Hon. Secretary, the Hon. Chr. M. de Aldersparre, 37, Talgarth Road, West Kensington, W.14.

Resistance Capacity Coupling.

A remarkable demonstration with crystal detector and two resistance coupled stages of valve amplification was the feature of the lecture given by Mr. F. Symes before the Manchester Radio Scientific Society on February 24th.

The lecturer, who took as his subject "Resistance Capacity Coupling," went deeply into the theory of this method. He showed that it was possible, without using excessive H.T. voltages, to operate a resistance coupled amplifier using anode resistances of the order of the megohm and grid leaks of about three megohms. In the demonstration set referred to the crystal detector was followed by two resistance coupled stages using anode resistances of 750,000 ohms each and a plate voltage on each valve of about 120. The resulting reproduction was very pure, and the volume obtained from a "Kone" loud-speaker was sufficient to fill the society's meeting room.

○○○○

Transformer v. Resistance Capacity Coupling.

Before the same Society on March 2nd, an interesting debate took place on "Transformer versus Resistance Capacity Coupling." The debate was highly technical, and the strong and weak points of both methods were well brought out. The transformer supporters made an excellent defence for that method of coupling, particularly when employing transformers that are nearly perfect. On a show of hands the meeting voted in favour of resistance capacity coupling by 18 to 12.

Piquancy was added to the proceedings by the decision that the respective sides should make up an amplifier according to their own beliefs and demonstrate it before the Society on the principle that the proof of the pudding is in the eating!

Hon. Secretary: Mr. Geo. C. Murphy, Meadow View, The Cliff, Hr. Broughton, Manchester.

○○○○

Proposed Conference at Bournemouth.

Plans are approaching fruition for the holding of a conference of radio societies at Bournemouth on Monday, April 26th, or Wednesday, April 28th. The programme is to include a visit to the Bournemouth broadcasting station. Correspondence should be addressed to Mr. H. S. Bliss, Hon. Secretary of the Bournemouth and District Radio and Electrical Society, 140, Old Christchurch Road, Bournemouth.

FORTHCOMING EVENTS.

WEDNESDAY, MARCH 24th.

Radio Society of Great Britain, Ordinary Meeting, At 6 p.m. (Refreshments at 5.30.) At the Institution of Electrical Engineers, Savoy Place, W.C.2. Lecture: "Fading," by Prof. E. W. Marchant, D.Sc., M.I.E.E.
Edinburgh and District Radio Society, At 11.7, George Street. Lecture: "H.T.H. Receivers and Components," by Mr. H. Berry.
Bunney and District Wireless Association, At 8 p.m. At 22, Market Street. "H.T. Supply from D.C. and A.C. Mains."

FRIDAY, MARCH 26th.

Radio Experimental Society of Manchester, Experimental Meeting.
Sheffield and District Wireless Society, At 7.30 p.m. At the Dept. of Applied Science, St. George's Square. Exhibition and Sale.
Bristol and District Radio Society, At 7.30 p.m. In the Physics Lecture Theatre, Bristol University. Lecture: "Broadcast Topics," by Mr. E. P. Appleton (Director of Cardiff Broadcasting Station).

MONDAY, MARCH 29th.

Hockney and District Radio Society, At 8 p.m. At the Holy Trinity Institute, Mayfield Road, Dulston Junction, E.8. Debate: "Crystal v. Valve Rectification."
Swansea Radio Society, Debate: "Has Broadcasting Benefited the Home?" In the affirmative: Mr. H. Morgan. In the negative: Mr. H. A. Enoch, B.A.
Southport and District Radio Society, At 7.30 p.m. In St. Andrew's, Post Street. Lecture: "Constructional Hints for Beginners," by Mr. P. J. F. Crisall.

Rectified H.T. Supply.

Mr. H. N. Ryan (5BV) addressed a meeting of the Golders Green and Hendon Radio Society on March 4th, his subject being "Rectified H.T. Supply." Mr. Ryan was in a modest mood, and disclaiming any authoritative knowledge of this subject, said he proposed to give particulars of the means he had employed for using A.C. supply for his own experiments. He dealt with several methods of rectification and the necessary smoothing arrangements, giving details of the circuits he had used. He concluded with an interesting chat on transformer construction, and how to make the calculations involved.

Hon. Secretary: Lt.-Col. H. A. Scarlett, D.S.O., 357a, Finchley Road.

THE WIRELESS LEAGUE BRANCHES.

Head Office: Chandos House, Palmers Street, Victoria Street, S.W.1.

Provisional List of Area and District Secretaries.

LONDON AREA (The London Postal District).

Area Secretary: Mr. S. Butchins, 18, Merchant Street, Bow, E.3.

Kentish Town: Mr. A. E. Heggie, 75, Leighton Road, N.W.5.
Poplar: Mr. S. Butchins, 18, Merchant Street, E.3.

Highbury & Dis.: Mr. E. J. Durley, 39, Halton Mansions, N.1.

Wandsworth Boro.: Mr. F. G. Edwards, 29, Baskerville Road, S.W.18.

Queen's Park & Maida Hill: Mr. F. Batho, 37, Enbrook Street, W.10.

Tottenham: Mr. G. H. Hasemer, 9, Galliard Road, N.9.

HOME COUNTIES - (Berks, Bucks, Herts, Essex, Surrey, and Middlesex).

Area Secretary: Mr. R. J. Venner, Lynwood, Malden Hill, New Malden.

Newbury: R. H. Parker, 71, Gloucester Road.

Redhill: Mr. G. N. Hower, 44, Somerset Road, Meadvale.

Sutton: Mr. W. C. Smith, 234, High Street.

Windsor: Mr. K. W. Lane, Imperial Service College.

New Malden: Mr. R. J. Venner, Lynwood, Malden Hill.

Becontree: Mr. C. W. Pearce, 3, Stevens Road.

Kingston-on-Thames: Mr. S. J. Woodward, 68, Park Road, Hampton Wick.

Woodford: Mr. E. J. Turbyfield, 42, Alexandra Road, South Woodford.

Watford: Mr. E. L. Corliss, Hillbrow, King's Langley.

Harrow: Mr. E. W. Everett, 28, Greenhill Crescent.

SOUTH COAST AREA (Kent, Sussex, Hampshire, and Isle of Wight).

Area Secretary: Mr. P. A. Bennett, 26, Guildhall Street, Folkestone.

East Grinstead: Mr. J. E. Dakin, Moatlands.

Dover: Mr. W. C. Winn, Messrs. Winn & Son, St. Margaret's Bay.

Hove: Mr. D. J. Gadsby, Egmont, Somerhill.

Portsmouth: Mr. Royden N. Sherwell, 6, King's Terrace.

Folkestone: Mr. P. A. Bennett, 26, Guildhall Street.

Gillingham: Mr. R. Harrison, 48, Charter Street.

Hythe: Mr. C. C. Roberts, 8, Earlsfield Road.

Tonbridge: Mr. W. G. Bennett, Salus, Speldhurst, Kent.

WESTERN AREA (Glos, Somerset, Devon, Cornwall, Wilts, and Dorset).

Area Secretary: Mr. W. O. Coate, The Elms, Wembdon, Bridgwater.

Dawlish: Mr. F. G. Avant, 26, The Strand.

Totnes: Mr. H. S. Warren, Lindsey, Station Road.

Barnstaple: Mr. B. D. H. Harrison, Wrentham, Barbican.

Falmouth: Mr. C. Ackland, 12, Old Hill.

Holsworthy: Mr. B. Oke, Uplands, Holsworthy.

Redruth: Mr. W. S. Trevena, Stanley Villas, Raymond Road.

Swindon: Mr. S. G. Archer, 52, Jennings Street.

Bristol: Mr. H. Munro Nelson, 1, Glenwood, Hillfields Park.

Bridgwater: Mr. W. O. Coate, The Elms, Wembdon.

EAST COAST AREA (Lincoln, Norfolk, and Suffolk).

Area Secretary: Mr. E. J. Tennant, 2, St. Andrew's Road, Gorleston.

Scunthorpe: Mr. E. H. Rayner, 35, Wells Street.

Lowestoft: Mr. E. W. Plater, 153, Clapham Road.

Ipswich: Mr. C. A. Buckingham, 51, London Road.

King's Lynn: Mr. R. T. Little, 39, London Road.

Great Yarmouth: Mr. E. J. Tennant, 2, St. Andrew's Road, Gorleston.

MIDLANDS AREA (Staffordshire, Worcestershire, and Warwickshire).

Area Secretary: Mr. J. Solomon Hill, J.P., 14, Blackford Road, Sparkhill, Birmingham.

Walsall: Mr. H. B. Truman, 97, Upper Bridge Street.

Birmingham: Mr. J. Solomon Hill, J.P., 14, Blackford Road, Sparkhill, Birmingham.

SOUTH MIDLANDS AREA (Oxon, Northants, Cambs, Beds, Hunts).

Area Secretary: Mr. V. E. Shearme, 22, Cornwall Road, Bedford.

Cambridge: Mr. J. Bennett, 71, Hills Avenue, Cambridge.

Bedford: Mr. V. E. Shearme, 22, Cornwall Road.

Oxford: Mr. A. W. Shirley, 133, Walton Street.

YORKSHIRE AREA.

Area Secretary: Mr. F. Davis, 67, Regent Street, Rotherham.

Goole: Mr. G. H. Hillary, 75, Carlisle Street.

Sheffield: Mr. S. J. Adams, 38, Church Street.

Leeds: Mr. J. Watson, 4, Armley Grange Drive, Armley.

Rotherham: Mr. F. Davis, 67, Regent Street.

Bradford: Mr. C. Wicks, 70, Seaton Road.

NORTH MIDLANDS AREA (Leicester, Notts, and Derbyshire).

Area Secretary: Mr. R. A. Gullick, 1, Shakespeare Street, Nottingham.

Leicester: Mr. L. Stuart Rudkin, Brackley, Lutterworth Road.

Derby: Mr. A. R. Barnett, Pelham Street Mills.

Nottingham: Mr. R. A. Gullick, 1, Shakespeare Street.

Mansfield: Mr. N. Grey, 125, Nottingham Road.

Heanor & Dis.: Mr. G. Ford, Home Farm, Shipley.

NORTHERN AREA (Northumberland, Durham, Westmorland, Cumberland).

Area Secretary: Major H. Y. Richardson, 13, Grey Street, Newcastle-on-Tyne.

Darlington: Mr. F. Seaton Leng, 31, Stanhope Road.

Newcastle: Major H. Y. Richardson, 13, Grey Street.

LANCASHIRE & CHESHIRE AREA.

Area Secretary: Mr. J. E. Kemp, 101, Rosebery Street, Moss Side, Manchester.

Crewe & Dis.: Mr. R. Peach, 84, West Street.

Manchester & Dis.: Mr. J. E. Kemp, 101, Rosebery Street, Moss Side.

WELSH AREA.

Area Secretary: Mr. F. A. Davies, 106, Newfoundland Road, Cardiff.

Abertillery: G. J. Jones, 10, Ty Bryn Road.

Barry Island: Mr. M. S. G. Draper, Ivor Street.

Cardiff: Mr. F. A. Davies, 106, Newfoundland Road.

Port Talbot: Mr. H. Potts, 17, Curwen Terrace.

SCOTLAND.

Aberdeen: Mr. J. Breen, 42, Walker Road.

IRELAND.

Belfast: Mr. D. B. McCausland, Mount Vernon Lodge, Shere Road.

HIDDEN ADVERTISEMENTS COMPETITION.

The following are the correct solutions for "The Wireless World" Hidden Advertisements Competition for March 10th, 1926.

Clue No.	Name of Advertiser	Page
1	Partridge & Wilson	13
2	Accumulators Elite	16
3	J. & W. Barton	13
4	Telephone Manufacturing Co., Ltd.	7
5	Fuller's United Electric Works, Ltd.	11
6	Igranic Electric Co., Ltd.	2

The following are the prizewinners:

Miss M. J. Warner, Clapham Junction, S.W.11	£5
W. Whitmore, Settle, Yorks	£2
Miss A. R. Bayliss, Birmingham	£1

Ten shillings each to the following:

Sidney W. Collins, Norwich.	R. W. Nundy, Peterborough.
W. Pettit, Reigate.	W. J. Hanning, London, S.W.1.



The Editor does not hold himself responsible for the opinions of his correspondents.

Correspondence should be addressed to the Editor, "The Wireless World," Dorset House, Tudor Street, E.C.4, and must be accompanied by the writer's name and address.

CRYSTAL RECEPTION ON A LOUD-SPEAKER.

Sir,—A few weeks ago I received Radio Toulouse for two hours on a crystal set. I do not myself attach much importance to the set, but perhaps your readers would be interested to read of other performances on the same aerial and earth system. On any night, if I am tired of telephones or valves, I can listen without straining my ear to the transmission of 2LO on a Lissen attachment or a £5 5s. Amplion model loud-speaker. Of course, the strength is not great, but just about equal to the results of three valves if I tuned in Hamburg, Brussels, or Radiola without much reaction. The crystal for loud-speaker work is one which I bought for 6d. As regards distant stations, I have also heard Hamburg, Bournemouth, Birmingham, Newcastle-on-Tyne, when 2LO has been silent. I do not think that there is anything extraordinary about the instrument, but attribute distant results either to an 81/36 aerial wire (enamelled) or what I imagine to be a good earth, not forgetting a sensitive detector. However, other crystals have worked quite well, but have not served for volume rectification. Perhaps I should whisper that it is likely that some oscillating valve within a quarter of a mile or more may at times play an important part.

H. O. CRISP.

Stratford, E.15.

GOVERNMENT-CONTROLLED BROADCASTING.

Sir,—May I be permitted to record my appreciation of your views relating to "Government-controlled" broadcasting. I fear that many of us are only too well acquainted with the chaos met with in some Government offices, and it would be a thousand pities to have our present satisfactory broadcast service spoilt by a staff of Government officials trying to administer to public needs from behind a barrier of "red tape."

I believe in advancement and the introduction of new methods by competent newcomers, but, seeing that the present B.B.C. officials have not as yet been slow to explore every channel for the betterment of our broadcasting service, I cannot conceive how a Government-controlled body can hope to do better.

It is only natural to assume that such a body would lean towards Government views of the public's requirements, and the public palate would suffer in consequence.

I believe that I am voicing the thoughts of many of your readers; at least they are the views of many of my B.C.L. friends.

J. BARKER.

London, S.E.15.

LEARNING THE MORSE CODE.

Sir,—I have been very interested in the letters that have lately appeared in *The Wireless World* on the subject of learning the Morse code, and particularly in the letter from Mr. Adshhead in the March 10th issue. I most cordially agree with the views expressed by your correspondent and yourselves with regard to the importance of aural rather than visual training.

Many years ago I was interested in Morse communication by buzzer and by sounder. Whilst I learnt the two groups E, I, S, H, and T, M, O, CH in the way indicated by Mr. Adshhead, I devised a means of memorising the other letters by associating them with words of similar syllabic rhythm and commencing with the associated letter. Thus . . . — was associated with "feu-da-lis-tic," . . . — with "un-der-stand," . . . — with "khá-ki cóat," . . . — with "béan-ti-ful-ly," . . . — with "a-gáin," and so on. By far the best way of using this method is to go through the dictionary and pick out

and tabulate one's own "associated words" and then repeat them in time with the dummy key.

Referring to your correspondent's list of abbreviations, it may interest those of your readers who have never been "east of Suez" to know that "cul," which Mr. Adshhead says is used for "see you later," is actually the Urdu (Indian) word for "to-morrow," unfortunately a very common word amongst Eastern peoples.

JOHN S. BEALL.

Wisbech, Cambs.

INTERFERENCE FROM ELECTRIC TRAINS.

Sir,—It would be interesting to know whether any reader of *The Wireless World* has found any satisfactory method of wholly (or even partly) eliminating the powerful crackling interference caused in receiving sets, particularly those of the regenerative type, by the overhead electric trains of the Southern railway.

The crackling seems worse when the train is running downhill (when the motor would be switched off), but all trains make the long-distance short-wave stations unreadable.

My aerial is not quite parallel to the train wires, but I am not able to arrange it at any greater angle.

As the house is within 200 yards of a junction I have six train lines to contend with!

I am sure there must be many other listeners similarly situated who would welcome any help from successful experimenters in this matter.

W. STUART CLARK.

Balham, S.W.12.

INTERFERENCE ON SHORT WAVES.

Sir,—In reply to your correspondent Mr. J. Ruizenaar (N STB), in the issue of February 24th, I cannot resist the temptation of giving my opinion upon this subject. It has been said that "there are more commercials upon 30-40 metres than amateurs." The following are the chief offenders:—BYZ, BYC, SP, PCLL, PKX, ICS.

SP is a harmonic from 90 metres; ICS also appears to be one, but BYZ and BYC are actually on (about) 35 metres. These two stations appear to take it in turn, and always contrive to start up when the hour is suitable for short-wave work.

We all know that our present knowledge of the functions of short waves is very largely due to the activities of the persevering, and not too often thanked, radio "fan." Amateur radio has now reached the state when it is making its most important discoveries over long-distance work.

Now, why cannot some of our "commercials" give us at least a chance? Is it necessary to carry on Morse tests on the only wavelength which is any good to our friends overseas? Perhaps we shall soon have to go back to 200 metres owing to the fact that 600 metre spark traffic requires to use the short waves! I say "spark traffic" because the transmissions of BYC are reported to be spark by a celebrated British amateur transmitter! I am inclined to agree.

Within the interests of the A.R.R.L., to which I belong, I wish to urge any of the fraternity who perhaps know me as "British Radio 'DX'" to do their very best to produce a better state of affairs.

I should also be very grateful if our Italian friends would install a D.C. plant and do away with their terrible A.C.! It would be a great help, as they use the 30-43 metre band very frequently.

A. E. LIVESEY, A.R.R.L.

Ludlow, Salop.

INTERFERENCE BY AMATEURS.

Sir,—With reference to a paragraph entitled "Interference by Amateurs," under the heading Broadcast Brevities, in your issue of February 24th, surely it is time that a limit to the tolerance by the amateur of inefficient and badly designed crystal receivers should be reached. To suggest that "further control of amateur transmissions . . . seems necessary," simply because some commercial crystal sets fail to eliminate transmissions on a frequency of 6.67 megacycles when tuned to 5XX, seems to imply that the crystal user is the solo lord of the ether and that everybody else must make way before him. It is preposterous that complaints from users of manifestly inefficient sets should be used by the B.B.C. to turn the amateur off the ether. The whole paragraph is simply a stab at the amateur transmitter. Will the author kindly explain why the use of a selective receiver should not obviate the difficulty, as he so boldly asserts in his last sentence?

J. SOMERSET MURRAY.

MORSE RECEPTION.

Sir,—Mr. K. E. B. Jay seems in his "ham" enthusiasm to have overlooked the fact that 90 per cent. of B.C.L.'s are interested in a radio receiver not as a thrilling scientific wonder (which it is), but in the same way as they are in a piano or a gramophone—as a piece of drawing-room furniture from which they can obtain aural entertainment.

It may fascinate and thrill Mr. Jay to listen to "Sorry—most QRM pse don't waste your powder ani longer—too many QRM stns," but that sort of thing won't cut any ice with the ordinary B.C.L. He wants music, or John Henry, or the football results.

Personally, I get quite enough Morse on the broadcast band without going out into the ether to look for it.

Frant.

G. M. PART.

IGNORED QSL CARDS.

Sir,—I am one of the regular readers of your excellent magazine, the contents of which are very interesting, especially those dealing with short waves. Belonging to the "DEs" (DE 0122), I naturally pick up many of the British transmitters, and send them my report regularly. But you will be very much astonished to learn that I recently sent 44 QSLs and only got back eight cards. I am very sorry that the British amateurs show such indifference. Many of my cards were sent two or three months ago, and about 15 of them were addressed directly to the owner. I believe my claim will be appreciated if you will have the kindness to help me by publishing the following call signs of British amateurs whose transmissions I have heard:—

2BCA, 2BGO, 2BM, 2CC, 2EC, 2JJ, 2MI, 2NM, 2ZJ, 2UD, 2UN, 2UR, 2VR, 2ZA, 5DK, 5IR, 5KO, 5PD, 5RB, 5SL, 5IR, 5XW, 6DA, 6GF, 6GN, 6HF, 6JU, 6JV, 6LN, 6OF, 6PG, 6PM, 6UT, 6WH, 6YC, 6YZ, 6YW, 6JJ.

Postfachen No. 30,

ERWIN MEISSNER.

Ettlingen, Baden

TROUBLE FROM ELECTRIC LIGHT MAINS.

Sir,—Judging from the correspondence columns, a number of readers are troubled with interference from the lighting supply mains.

In the writer's experience it is unnecessary to dispense with cumulative rectification if the trouble is tackled at the source. Most domestic wiring systems are carried out with "slip joint" conduit, and in the course of time the bonding between tubes becomes very indifferent owing to rust.

As a first step all the conduit in the room where the set is installed should be bonded together and earthed.

If a faint hum still persists in the telephones, the bulb of the detector valve may be fitted with a tinfoil screen joined to earth.

Screening the detector valve may seem a curious remedy, but where 50 cycle A.C. is the offender, the mere presence of a lighted lamp near the receiving set is generally sufficient to set up a strong pulse in the telephones. The effect is intensified by touching the detector bulb with the hand.

Putney, S.W.15.

J. L. GREATOREX.

METRES v. KILOCYCLES.

Sir,—Your correspondent who opposes the introduction of the frequency scale asks: "Is there any advantage in using 'kilocycles' in preference to the more widely known term 'metres'?"

The answer is decidedly "Yes."

In the greater part of practical wireless work (excluding such special devices as reflectors and Hertz aerials) one is not directly concerned with the length of the wave. It is in effect only a number which gives a rough idea of the size of coil required. As soon as any problem arises in connection with tuning we have to convert into frequency before we can begin to consider it. For example, how many people could say off-hand whether a station on 44.5 metres would heterodyne one on 44.7 metres? Expressed in kilocycles, the answer becomes obvious.

From a purely scientific point of view the case is even stronger. The majority of wavelength determinations are carried out by measuring the frequency (which can be done with very great accuracy) and then dividing it into the velocity. The latter is usually taken to be 300,000 km. per second, but it is probable that the true value differs from this by 1 part in 2,000. When, therefore, the more accurate determination is adopted, our frequency determinations will be unaffected, but we shall have to correct our wavelength values by this amount, which is of considerable importance in 20-metre work.

Nevertheless, it is the practical worker in wireless who stands to gain most by the change: it is bound to come, and the sooner it does so the better. I agree that a sudden change would be unpopular, but if the foremost wireless journals were always to give the frequency of a station when mentioning its wavelength the prejudice against the kilocycle would be overcome within a few months.

N. L. YATES-FISH (G 5CA).
Brasenose College,
Oxford.

"THE TIMES" CORRESPONDENCE.

Sir,—I am not a reader of *The Times*, therefore the letters you reproduce on page 412 of your issue of March 17th interest me very greatly.

Evidently Mr. Maurice Child is writing from the point of view of the real experimental transmitter. Now round Manchester the transmitters are simply messers. This is a sample of what we hear:—

"Hallo, hallo, hallo, etc. Well, old man, where have you been. I have not heard you lately. 6— and 5— were round last night and we had a fine time. Ha! ha! Well, I will come over to you now. 2— over 2 Uncle—"

Then the other station starts up dead on top of one of the foreign stations:—

"Hallo, etc. Well 2— I have not been—(here follows all sorts of banging and scraping noises). Well, 2— I did not hear all your remarks owing to interference from another station. Too bad, isn't it? Ha! ha! Have you tried the short waves yet. I am using a 001 condenser. Bit large. Ha! ha! Over, over."

I have not put their call signs in full, but anyone who listens between 310 and 390 metres will know them. As regards joining the local radio society, I happen to know some of these gentlemen belong to it.

I can receive 2LO with no interference from Manchester, four miles away, so none could call my set unselective.

Withington, Manchester.

G. N. WRIGHT.

LIGHTSHIP TELEPHONY.

Sir,—I was very interested to see in the issue of *The Wireless World* for March 17th a letter from Mr. Horsnell about the telephony from lightships. Here in Rayleigh they come in at great strength on a detector and two L.F., and speech is clearly understandable from most of them on the detector alone.

The "Alert" is a relief ship, and I have heard it quite plainly on a single valve when it has been off Harwich.

As to the transmitter used on the lightships, I believe it is the Marconi Belt Transmitter, with a power of 100 watts, but I fancy that the "Alert" has a more powerful transmitter.

I hope that this information will be of interest to Mr. Horsnell.

Rayleigh, Essex.

MONTAGUE K. HARE.

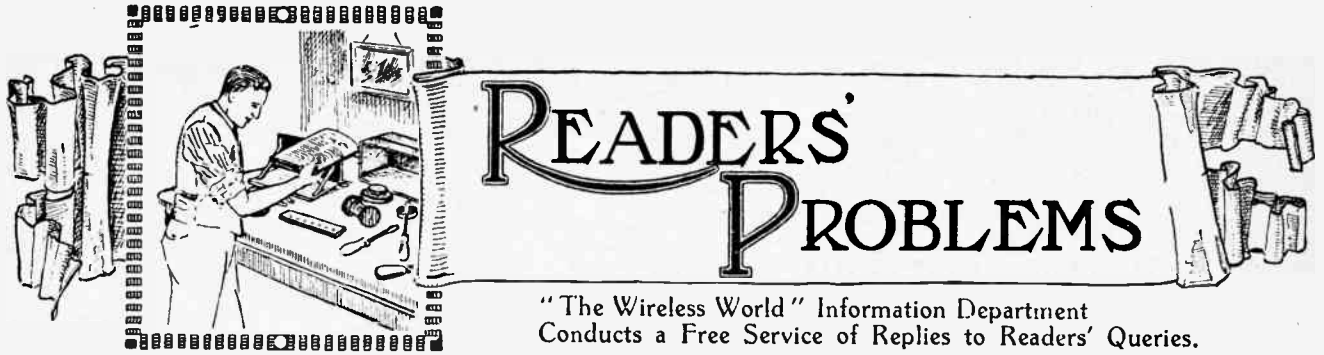

"The Wireless World" Information Department
Conducts a Free Service of Replies to Readers' Queries.

Questions should be concisely worded, and headed "Information Department." Each separate question must be accompanied by a stamped addressed envelope for postal reply.

A Circuit for High Selectivity.

I understand that it is possible in a four-valve receiver to employ the superheterodyne principle in order to obtain a very high order of selectivity. If this is so, I should be glad if you could indicate a suitable circuit, as I live in close proximity to a broadcasting station and desire to eliminate the local transmission without resorting to a multivalve frame aerial receiver.

L. M.

It is possible, as you suggest, to embody the superheterodyne principle in a four-valve receiver using a conventional outdoor aerial and to obtain a very high order of selectivity and also of sensitivity by employing the "autodyne" method of generating a supersonic beat frequency. The necessary connections are given in Fig. 1. In this circuit the first valve acts purely and simply as a straightforward H.F. amplifier employing the tuned anode principle. At the same time the anode coil and aerial coil are mounted in a two-way coil holder in order to obtain reaction direct on to the aerial coil, which by reducing the aerial resistance has in itself a very great influence in improving the range and selectivity of the receiver. The incoming signals, having been amplified by the high-frequency valve, are passed through the 0.0003 mfd. coupling condenser to the centre tap of the split grid coil of the second valve, which acts in the dual capacity of first detector and frequency changer, employing the well-known autodyne principle. It is necessary, of course, that this valve should be in a state of oscillation for the production of a supersonic beat frequency, but by the use of the autodyne method the oscillations are prevented from being fed back into the aerial, and so radiation from this cause is effectively prevented. It should be pointed out that the 1 megohm grid lead in conjunction with the 0.0003 mfd. fixed coupling condenser gives the ordinary grid rectification effect. With regard to the coil values, of course, the aerial and anode coils are of the customary value both for the usual B.B.C. and the Daventry wavelengths. The grid of the second valve requires to tune over the same waveband as the aerial circuit, and consequently the two coils should be equivalent to a No. 50 on, say, the wavelength of 2LO, and No. 250 on the 5XX

wavelength. Actually, two No. 25 or 30 coils would suffice for the B.B.C. wavelengths, whilst a No. 25 or 35 should be quite large enough for the reaction coil. A much better scheme, however, would be to employ in this part of the circuit a compact autodyne unit which is specially made up for circuits employing this principle by various manufacturers, such, for instance, as Messrs. L. McMichael, Ltd. The H.F. transformer coupling valves two and three, must be one of a type designed for long wavelengths. An aperiodic instrument should not be used here. Since no tuning condenser is shown associated with this transformer, such a statement might appear contradictory.

just our oscillator to produce a frequency coinciding with the resonant point of the transformer, and thus avoid the complication of an extra tuning condenser. Since the third valve acts as the second detector, on the leaky grid principle it will greatly increase the efficiency of the circuit if we can react on to this transformer in order to decrease the damping effect of the grid rectifier. This reaction coil may be fixed or variable, as desired, and it would be convenient to make use of a barrel type of transformer in which a small specially made reaction winding can be inserted. These can now be obtained from various manufacturers, including the firm mentioned in con-

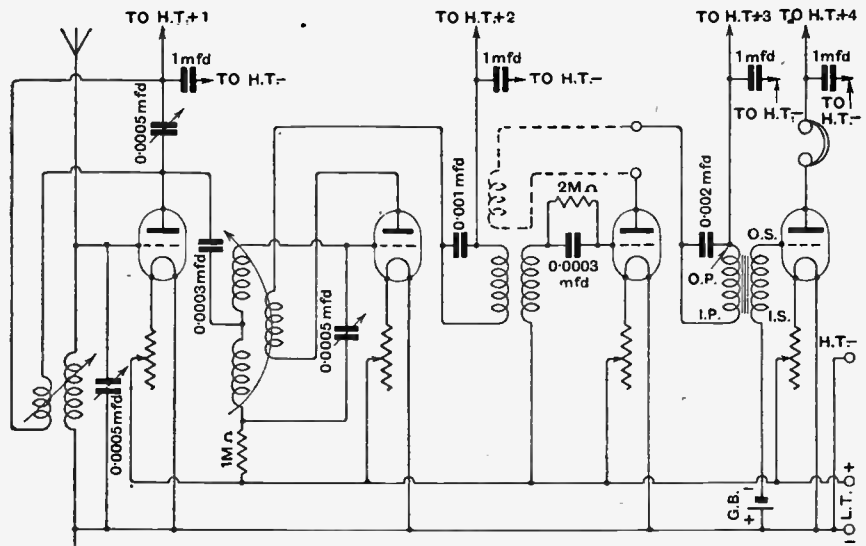

Fig. 1.—Four valve circuit giving very high selectivity.

A moment's thought will, however, make this point clear. Suppose we use a transformer which is advertised to tune over a wavelength band of 2,000 to 5,000 metres in conjunction with a 0.0005 mfd. variable condenser, it will be obvious that if no condenser is associated with it, the transformer will resonate at about 2,000 metres. Such is the case here, and we can use a transformer having a natural wavelength of, say, 2,000 or 4,000 metres, and then ad-

nection with the autodyne unit. The final valve acts purely as an L.F. amplifier, and, of course, a second stage of L.F. could be added if desired. Comparing this circuit with a conventional straight circuit employing two H.F. stages, we find that we have rather better sensitivity, and very much better selectivity, whilst at the same time we have not had to resort to potentiometers or any other "losser" method of effecting stability of the H.F. amplifier.

Improving Results from a Crystal Set.

I am very interested in the method of single wire loud-speaker extension described in your February 10th issue under the title of "Music without Muffling," and should like to know if it is applicable to a crystal set. I propose to instal my receiver in an upstairs room close to the lead-in wire, and to use the telephones downstairs. Using the ordinary method of telephone extension results are very poor, both quality and volume being lost, and I am wondering if this will cure the trouble. T.C.C.

This method is certainly applicable to a crystal set as you suppose, but it is necessary to be sure of the correct con-

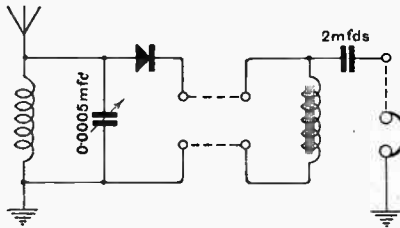

Fig. 2.—Telephone extension for crystal set.

nections, and you should follow the diagram we give in Fig. 2. The cause of your loss of volume is due to the shunting away of a great deal of the rectified current via the condensers formed by the long extension leads, and this method of single-wire extension should overcome the difficulty. The wire should be kept away from the wall as far as possible, although quite excellent results are obtainable even if it is run behind the picture rail.

o o o o

Telephone Connections.

I am residing in a block of flats and have undertaken to equip three dozen rooms with one pair of telephones each, the whole to be supplied from a common three-valve receiver situated at the top of the building and permanently tuned to Daventry. I am in some difficulty concerning the correct method of connecting this large number of telephones, and am not sure whether they should be connected in series or parallel, and should be glad of your assistance in this matter. Each pair of telephones is of the customary 4,000 ohms resistance. R. S. L.

You should connect an ordinary step-down telephone transformer such as is used in conjunction with 120-ohm telephones to the output terminals of your receiver, and then connect all the pairs of telephones in parallel across the secondary of this transformer. In this manner the resistance of the 36 pairs of paralleled telephones across the output of your transformer will be approximately equal to that of the usual low resistance telephones, namely, 120 ohms, and so eminently suitable for connecting across the secondary of the telephone transformer. This

BOOKS FOR THE HOME CONSTRUCTOR

Issued in conjunction with "The Wireless World."

"THE HOME CONSTRUCTOR'S EASY-TO-BUILD WIRELESS SETS," by F. H. HAYNES. Price 1/6 net. By Post, 1/9.

"TUNING COILS AND METHODS OF TUNING," by W. JAMES. Price 2/6 net. By Post, 2/10.

"HOW TO BUILD AMATEUR VALVE STATIONS," by P. R. COURSEY, B.Sc. Price 1/6 net. By Post, 1/8.

"THE CONSTRUCTION OF AMATEUR VALVE STATIONS" by Alan L. M. DOUGLAS. Price 1/6 net. By Post, 1/8.

"THE HOME CONSTRUCTOR'S WIRELESS GUIDE," by W. JAMES. Price 3/6 net. By Post, 3/9.

"MAST AND AERIAL CONSTRUCTION FOR AMATEURS," by F. J. AINSLEY, A.M.I.C.E. Price 1/6 net. By Post, 1/8.

Obtainable by post (remittance with order) from **ILIFFE & SONS LIMITED,** Dorset House, Tudor St., London E.C.4, or of Booksellers and Bookstalls

method will have the further desirable feature of confining all H.T. to the actual receiver, and thus preventing the H.T. steady current from wandering all over the block of flats with consequent risk of leakage to earth. It might be mentioned that various modifications of this system are in use in a large number of wireless equipped hospitals. The method would be exactly the same if the source of power were a crystal set tuned to the local or Daventry stations.

o o o o

Grid Bias for Anode Rectification.

How can I determine the correct negative bias to apply to the grid of a valve in order to cause it to function as an anode rectifier. R. S. R.

A good working rule is to supply twice the negative bias that would be applied to the valve to cause it to function correctly as an L.F. amplifier with the same anode voltage. Thus if it is found that with an anode voltage of 80 volts, three volts negative bias is required to bring the operative point of the valve midway between the zero grid volts line and the bottom bend, then obviously 6 volts will be required to bring the operative point down to the bottom bend, which is what we want.

o o o o

An H.F. Amplifier for Frame Aerial Reception.

I am contemplating the construction of the two-valve frame aerial receiver described in your issue of September 9th, 1925, with the addition of a stage of H.F. in order to increase range. Are there any special precautions to be taken? G. F.

If a stage of H.F. of the ordinary type is added to this receiver it will oscillate violently, owing to the almost negligible damping imposed by the frame aerial as compared with the damping effect of the

ordinary outdoor aerial. Therefore, the same precautions will have to be taken as in the case of using a stage of H.F. in conjunction with a coupled aerial circuit, namely, the neutralising of the inter-electrode and associated capacities of the H.F. valve by one of the customary "neutrodyne" methods.

o o o o

Differentiating Between "H.F." and "L.F." Valves.

How does an "L.F." valve differ from an "H.F." valve in its mechanical construction? H.R.D.

In the case of valves of the same type sold under two different classifications of "H.F." and "L.F." the electrodes usually have more or less the same physical dimensions, the only difference being that the grid of the "L.F." valve is slightly more "open."

o o o o

The Hartley Receiver.

I understand that it is possible to adapt the Hartley oscillator circuit for purposes of reception on the broadcast wavelengths. Can you give me a suitable circuit? H.A.H.

It is, as you say, quite possible to adapt this circuit for reception, and we indicate below the necessary connections in a single-valve receiver using this circuit (Fig. 3). The centre tapped coil can conveniently consist of one of the centre tapped inductances upon the market, such,

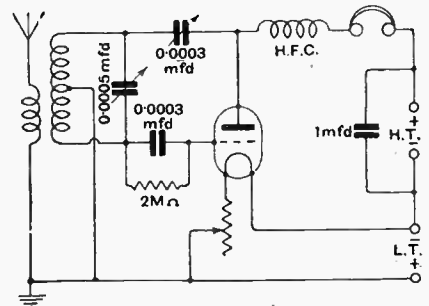

Fig. 3.—A well-known transmitter circuit adapted for reception.

for instance, as the well-known "Dinic" coil. The aperiodic aerial coupling coil consists, of course, of the usual number of turns according to the wavelength it is desired to receive, and for further information on this point you are referred to the article entitled "Oscillation Without Radiation," published in our issue of February 3rd. A disadvantage of this circuit is that both sides of the condenser controlling reaction are at high potential, or "hot," as is aptly said in America, and thus hand capacity effects are liable to be rampant. However, complete constructional details of a Hartley receiver modified in such a manner that this difficulty is entirely eliminated were published by Messrs. Castellain and Benham in our issue dated December 23rd, 1925.

CONVINCING TESTIMONY
of the Press

Osram
D.E. 2
H.F. & L.F.

Only .12 Amp. filament Current Consumption at 1.8 Volts

Osram Valves

for Broadcasting

AMATEUR WIRELESS. Whole appearance suggests thoughtful design.

THE MOTOR. Claims justified . . . Particularly low current consumption.

THE AUTOCAR. These valves are much to be welcomed.

GLASGOW HERALD. Possess very remarkable qualities.

LEEDS MERCURY. Will double the life of a charge.

SHEFFIELD INDEPENDENT. Excellent for small loud speakers.

POPULAR WIRELESS. Both these valves can be fully recommended. They are invitingly economical and reach a high degree of efficiency.

2-VOLT VALVES
with a 6-Volt Result

PRICE 15/6 EACH

The G.E.C. - your guarantee

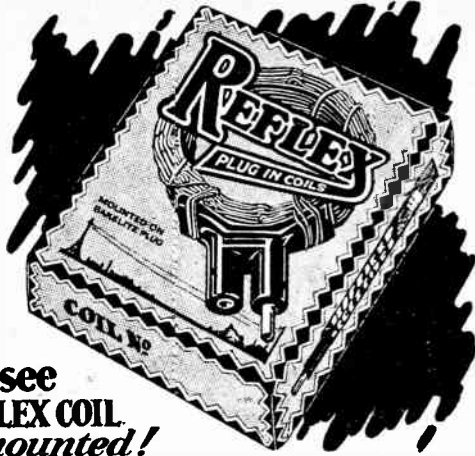

Ask to see
the REFLEX COIL
—mounted!

No wonder it has scored a huge success. The Reflex Coil with its unique advantages—the remarkable Reflex Plug in real bakelite with 30 many new features—form the ideal “low-loss” combination for your set at very low cost. Get one for YOUR set to-day. From all good dealers.

No. 25—2/8	No. 125—3/6	No. 600—8/0
No. 30—2/8	No. 150—3/8	No. 750—9/0
No. 35—2/8	No. 175—4/3	No. 1000—10/0
No. 40—2/9	No. 200—4/9	No. 1250—11/0
No. 50—2/10	No. 250—5/3	No. 1500—12/0
No. 60—2/11	No. 300—6/2	5 X X Loading
No. 75—3/0	No. 400—7/0	Coil .. 3/6
No. 100—3/2	No. 500—7/6	

REFLEX UNMOUNTED COILS

No shellac, cardboard or other support. Low losses. Low Price. No. 25 at 8d. to 1500 at 10/-

REFLEX COIL PLUG

Reduces losses to almost nil. Wonderful value at 1/- each.

REFLEX RADIO · CO · LTD
198, LOWER CLAPTON RD., E.5.
Phone: Clissold 4852.

EXCELSIOR

A REALLY TRUE ANTI-CAPACITY VALVE HOLDER at a startling price



PRICE

1/-

Guaranteed Bakelite—panel mounting or surface mounting type.

COMPLETE WITH FIXING PINS.

Neatly boxed and fully guaranteed.
(Descriptive Leaflet of Complete Sets and Components on application.)

THE EXCELSIOR MOTOR COMPANY, LTD.
WIRELESS DEPT., King's Road, Tyseley, Birmingham

London Distributors: BROWN BROTHERS, Ltd., Gt. Eastern St., E.C.2

Qualities

You buy in all

Long Life
Steadiness
Silence
Power

VanRaden

LONG LIFE BATTERIES.

Good sets deserve Van Raden Batteries. Sold by all Dealers.

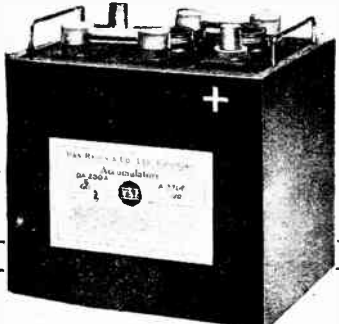

Your Loudspeaker

WILL SING

THE PRAISES OF

NELSON MULTI

3-FILAMENT VALVES



Here is a Valve giving you Finest Quality and Volume with Economy. It is of equally high grade as H.F., Detector, L.F., or Power Amplifier.

The little switch places at your command each of 3 Filaments separately, or any 2 in parallel for Power Amplification. Each Filament gives the Valve a New Life.

ALL VALVES are Guaranteed.

FOUR IMPROVED TYPES.

Obtainable at All London's Largest Stores.	A. 4 to 5 VOLTS, 0.45 AMPS. per Filament 0/6
	D.E.A. 2-6 VOLTS, 0.18 AMPS. per Filament 15/-
	D.E.2. 1.8 to 2 VOLTS, 0.35 AMPS. per Filament 15/-
	D.E.03. 3 VOLTS, 0.06 AMPS. per Filament 16/6

If unable to obtain from your dealer, write direct to:—
NELSON ELECTRIC COMPANY LIMITED,
Merton Park, London, S.W.19.
Telegrams: Valvenelso, Wimbic, London. Phone: Wimbledon 172.

THE CRYSTAL SENSATION of 1926!

4 1/2 ^{10.}
INCLUDING
CRYSTAL
CATSWHISKER
and TWEEZERS

The All-British
"EMPIRE"
Wireless Crystal
Fully Guaranteed

4 1/2 ^{10.}
INCLUDING
CRYSTAL
CATSWHISKER
and TWEEZERS



SOLE DISTRIBUTORS:
GIL-RAY TRADING CORPORATION LTD., Sicilian House, W.C.1
Telephone: WE 365 14. 1926. Patent: 1482753, 1482754, 1482755, 1482756, 1482757.

OBTAINABLE EVERYWHERE.

In case of difficulty send 4 1/2 d. in stamps and name of dealer to the Sole Distributors:

GIL-RAY TRADING CORPORATION, LTD.,
Sicilian House, Sicilian Avenue, London, W.C.1

BRITISH MADE, Using Only BRITISH MATERIALS.



LIBERTY SUPERSONIC HETERODYNE RECEIVER

(British Patent No. 143383.)

PRICES: 6 Valve Set £28. 8 Valve Set £32 plus Royalties.
DEMONSTRATIONS WILLINGLY GIVEN AT ANY TIME.

NOTE.—TWO CONTROLS ONLY.

RECEIVES any BRITISH, CONTINENTAL, and PRINCIPAL AMERICAN STATIONS at will, not by accident. 250 to 3,000 metres. With each set is supplied a chart showing the settings of both controls for all chief broadcasting stations, and all receivers are calibrated to receive such stations by these settings on a frame aerial using British Standard Dull Emitter Valves, at loud-speaker strength, and guaranteed to cut out any unwanted station entirely.

LIBERTY SUPERSONIC UNITS

(Provisionally patented.)

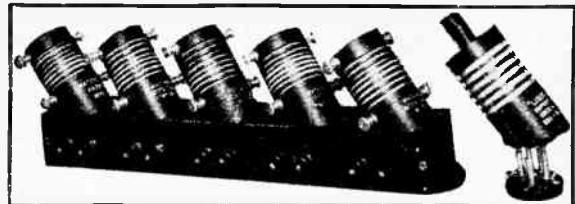

Comprising three intermediate matched transformers, filter, long and short wave oscillator and balancing device, enabling all stations from 250/3,000 metres to be received. Each transformer matched to half a turn, also secondary windings of the filter. Ensures ultra selectivity. Delivers maximum signal strength to detector valve. Air cored transformers and filter, no iron being used, thus the sharpest uniform peak at supersonic frequency is obtained.

Full description and illustrated leaflet on request.

NOTE—Knobs controlling mechanical balancing device which enables the constructor to select his supersonic frequency peak and to match each individual stage to a frequency not merely a number of inductive turns. Any variations of valve capacities can be accurately rectified.

PRICE: £5 complete including theoretical and practical wiring diagrams and list of other components required.

I am pleased to say I managed to log 72 Stations in 3 hours, at terrific loud speaker strength, four of these being "Yanks." Please repeat order and send me set of units as soon as possible. Signed G. E. U.

Sole Manufacturers—**Bennet Street, Chiswick, LONDON, W.4.**
The Radi-arc Electrical Co. Ltd. Telegrams—"Radiarc, London."
Telephones—Chiswick 1834 & Gerrard 1706.

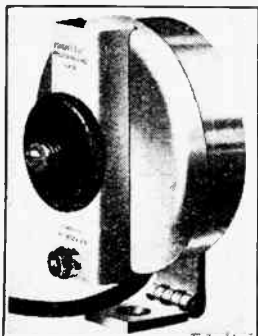

MAGNETIC MICROPHONE BAR

Prov. Pat. No. 8574/25.

AN ultra-sensitive Microphone which positively amplifies all average strength crystal reception, sufficiently to operate a loud speaker. Equally efficient on valve sets. Weak reception is made strong and clear, enabling even very deaf persons to hear from any crystal set.

Not a microphone button—No fragile parts. NO VALVES. ACCUMULATORS or H.T. BATTERIES.

Only one or two 1 1/2-volt dry cells and small transformer required. Complete Magnetic Microphone Bar Amplifier, ready for immediate use, also supplied.

Call for demonstration or write for fully illustrated lists, 14d. stamp.

NEW WILSON ELECTRICAL MANFG. CO. LTD., 18 Fitzroy St., Euston Rd., London, W.1.

CABINETS CABINETS

for your set for the circuits

Described in "MODERN WIRELESS," "WIRELESS WEEKLY," "WIRELESS CONSTRUCTOR," "WIRELESS," etc., etc.

WRITE NOW FOR ILLUSTRATED LIST

NAME
ADDRESS

Write in Block Letters Please.

THERE IS A CAMCO CABINET FOR EVERY CIRCUIT AND PANEL SUPPLIED TO FIT THE CABINET

Telephone. Clerkenwell 6903.
CARRINGTON MANUFACTURING CO., LTD.,
18/20, Normans Buildings, Mitchell Street, Central Street, E.C.1

FULL SIZE RESULTS HALF SIZE COST !

The secret of the crystal-clear reproduction is the new cast-in diaphragm. Fully guaranteed.

Send for your **FREE** copy of our new catalogue.

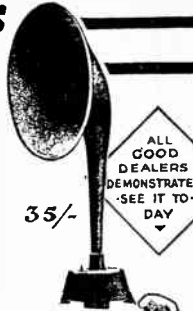

General Radio Co. Ltd, 235, Regent St., W.1.



Absolutely honest

are the claims of the

DARIMONT

"HOME - SERVICE" BATTERIES

They give a steady current on continuous or intermittent discharge; are free from parasitic noises throughout the whole life of the charge, and **YOU CHARGE THEM YOURSELF AT HOME** in a few minutes without any electric supply.

WRITE TO-DAY for List and Valve Guide.

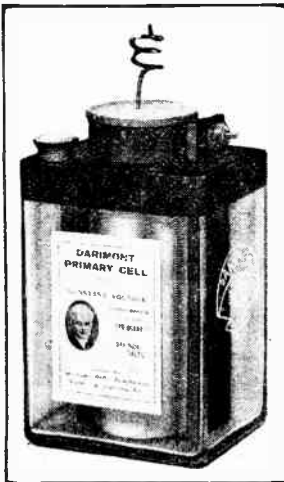

(PATENTED)

DARIMONT ELECTRIC BATTERIES LTD.,
DARIMONT WORKS, ABBEY ROAD, PARK ROYAL,
LONDON, N.W.10. Telephone: Wembley 2807.

FORMO
TRADE MARK

RADIO COMPONENTS OF ADVANCED DESIGN. NEW CATALOGUE NOW READY. Straight Line Frequency. Ultra Low Loss Condenser. Micro-Vernier Dial. High Efficiency. Low Loss Variocoupler, etc.

The **FORMO** Company,
Crown Works, Cricklewood, N.W.2
10/6
Manchester: Mr. J. B. Levee, 23 Hartley St., Levenshulme.

The **"GRIPPLESHELL"**
Registered design No. 716927.

A device for simplifying Aerial Erection
These brackets are made from 1" best quality Wrought Iron painted with weather-proof enamel.

PRICES

Combined corner bracket, insulator & pulley	3/6
6" Hold-off bracket	3/1
9" " "	3/1
12" " "	3/6

FREE ON RAIL.

Manufactured by
PARTRIDGE & WILSON, ELECTRICAL ENGINEERS,
217a, Loughborough Road, LEICESTER.
Telephone 5812.

SUPRECISSION

SUPRECISSION

Radio Testing Set, Model 103, is the most remarkable measuring instrument in existence. It has 24 different ranges, from 0.1 volts to 600 volts, from 0.05 milliamp. to 12 amperes, and measures resistances to 12 megohms.

With SUPRECISSION Model 103 you may say goodbye to all your technical problems. Write to-day for the new free leaflet with 15 illustrations and diagrams telling you all about it.

Do not fail to write for full particulars of the new SUPRECISSION "Continuator." This device delivers H.T. plate supply direct to your Valve Set from A.C. or D.C. Mains.

It revolutionizes all previous conceptions of Radio Reception and brings in all Europe without trace of unwanted noises.

A.C. £3. 15. 0 D.C. £2. 5. 0

F. C. HEAYBERD & Co., 8-9, Talbot Court, Eastcheap, E.C.3
Phone: Royal 4682.

SUPRECISSION
Model 103.
Ten range Set.
£3. 16. 0

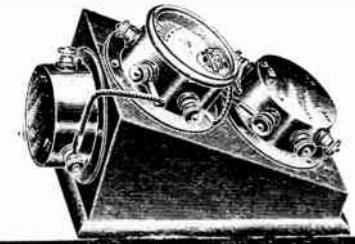

Cabinets FOR HOME CONSTRUCTORS

All Cabinets are made of Seasoned Oak in antique or light finish as required - Cabinets for "The Wireless World" sets a speciality.

Panel Size:
18" x 7" 21" x 7" 24" x 7"
17/- 17/6 19/6
Cash with order. Carr. Paid.
Write for Price Lists.

8 1/2" x 8 1/2"
inside measurement.
SOLID OAK. GRAIN FILLED.
PANELS SUPPLIED IF DESIRED.

W. SANDERS, 35, Lyndon Road, Olton, Warwickshire.

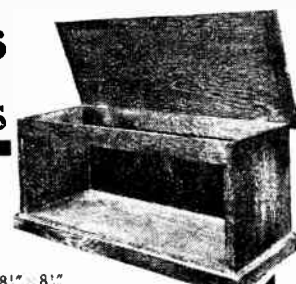

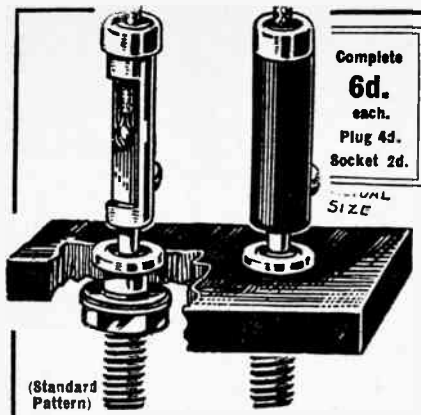

Complete
6d.
each.
Plug 4d.
Socket 2d.

66 **Japa** 99
Regd.

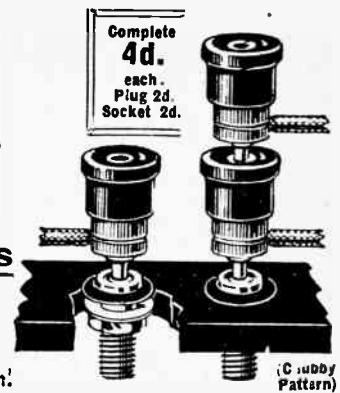

Complete
4d.
each.
Plug 2d.
Socket 2d.

PLUG AND SOCKET TERMINALS
Guaranteed Interchangeable

If unable to get from your local Dealer, send direct for prompt delivery to the Sole Manufacturer:
W. J. Charlesworth, 88 & 89, Aston Street, Birmingham!

Make your choice!

Watmel products offer you two choices for leaky grid rectification—each serving their particular purpose as only Watmel products can. Firstly there is the famous Watmel Variable Grid Leak, used with the unique round Watmel Fixed Condensers. By its use the experimenter can apply the exactly correct grid leak valve to the detector—varying it for different valves and throughout his experiments enjoying the certainty that by virtue of its ingenious construction, the Watmel Variable Grid Leak maintains any particular valve indefinitely. Then there is the Watmel Combined Grid Condenser and Fixed Grid Leak. Saves time and space: it is so constructed to allow the Grid Leak to be connected across the condenser or direct to the filament of the detector valve. It can be supplied in any combination and resistance. *Send a card for illustrated booklet and ask your Dealer to show you these interesting Watmel products.*

CONDENSER
CAP 0002
G.L. 2 MEG

ANODE RESISTANCE.
50,000-100,000 ohms 3/6
Combined Fixed Grid Leak and Condenser 2/6

New Condenser Prices.
Sizes up to '002 ... 2/-
Sizes '0025 to '006 ... 2/8
Variable Grid Leak.
'3 to 5 megohms ... 2/6

Watmel

THE WATMEL WIRELESS COMPANY LIMITED,
332a, Goswell Road, London, E.C.1.
Representative for Lancashire and Cheshire:
Mr. J. B. Levee, 23, Hartley St., Levenshulme, Manchester.

ELECTRADIX RADIOS BARGAINS.

SUPERSONIC HETERODYNE SETS. The cheapest solution is the R.A.F. 7-valve, 4, 3,000/5,000 metre H.F. intermediate and 3 L.F., with plug switching, beautiful mahogany cabinet. Your 50/- 2-valve set coupled to this makes a £35 Het. Cost £40. As described in "Modern Wireless." **£5 10s.**

HIGH-FREQUENCY AMPLIFIERS. 5,000 metres, complete with Rheostat and Potentiometer, 30s. Marconi 7-valve, **£7 10s.**

RADIO TEST SETS are a necessity. 7-Range Set in Walnut Case, **57s. 6d.**

PRECISION INSTRUMENTS. 2,000 to select from. Milliammeters. Plate 0-5, 0-10 m/a, and 0-25, 0-50 m/a, 22s. 6d. 3-Range, m/a, 32s. 6d. Voltmeters, 2-Range, 11s. 6d.; 120 volts, 20s.; 0-1,000 volts, **£3**; 1,500 volts, **£4 10s.**; 2,500 volts, **£6.**

R.F.S. BRIDGES. .005 to 100 ohms, 30s.; G.P.O., .01 to 10 meg., **£7 10s.**; Silvertown Test Sets, **£8.** Galvos, 12s. Galvo Shunts, plug type, 45s. 700 G.P.O. 2-RANGE DETECTORS. Ediswan G.E.C., etc., brand new, 5s. 6d.; Capacity Bridges, **£7 10s.**

MORSE WIRELESS RECORDERS. Magnificent British Work, solid brass case, fine finish. Mahogany case with drawer for tape reel. Cost **£30. Sale £7 10s.**

CONDENSERS, VARIABLE, Panel, Slump stock, at absolutely give-away prices:—
MFD., .001, Plain, 4s. 6d.; Square Law, 5s. 6d.; with Vernier, 7s. 3d. MFD., .0005, Plain, 4s.; Square Law, 5s.; with Vernier, 7s. MFD., .0003, Plain, 3s., with Vernier, 5s.; Square Law, 4s. 9d., with Vernier, 6s. 3d. **800 DYNAMOS, for Charging.** Rotax 12-volt 250-watt ex-R.A.F., **£3.** H.T., 1,200-volt 80 m/a. Mortley Self-exciting M.G., **£20.** Newton 1,500-volt, 250 m/a., **£25.** 10,000-volt 1/2-K.W. Motor Generator Sets, **£8 10s.** B.T.H. 6/600-volt, **£12.** 100-volt 5 amp.; these give either D.C. or A.C.; a Bargain at **£4.** Dynamotors to give 350 volts for H.T., totally enclosed, very neat, **£4.**

1,000-VOLT GEARED DRIVE MEGGER DYNAMOS for H.T. or Testing. Cost **£30**; Sale **£3 10s.**, in case.

PAPER DIAPHRAGM LOUD-SPEAKER PARTS, 2,000-ohm Brown A Receivers at 18s. are far the best reed units for this purpose. 3/16 length Rod to screw in Reed, 4d. Paper, machine pleated, guaranteed Parchment, 2s. 3d. We have tested this paper thoroughly and it is the best. 12 in. F. tubes, Plated, give a very finished appearance, 5s. 6d. per pair. Brass Back Stays for ear-piece to frame; make a neat job, 2s. per set of 3. The Lissnola Loud-Speaking Unit, 13s. 6d. Can be used in conjunction with the above.

SEND 4d. STAMPS FOR ENLARGED ILLUSTRATED CATALOGUE AND FULL LIST OF RADIO BARGAINS.

LESLIE DIXON & CO.,
218, UPPER THAMES STREET, E.C.4. Phone: City 191.

H.F. 36

YOU WANT A PERFECT SET THEN YOU MUST USE

PANELS and CONDENSERS

ASK YOUR DEALER, but if any difficulty in obtaining supplies write direct, giving dealer's name to—

The Paragon Rubber Manfg. Co. Ltd.
SCULCOATES, HULL

Radcom Low Loss Coil Former

As will be noticed by the illustration, this Former is of new and unique design. By removing the top serrated strips, you have a Coil Former of 3" diameter; or with the top strips in you have a Coil Former of 3 1/2" diameter. Due to the novel construction, sagging is quite impossible when the Former is wound. The Former is 6" long.

Phone: Museum 3485.
Grams:
Radcoment, Westcott, London.
Radio COMPONENTS, LTD
19, Rathbone Place, Oxford St., W.1.

Price 4/6



FOR REAL COMFORT DURING BROADCASTING HOURS THERE IS NO OTHER CRYSTAL QUITE SO GOOD AS RUSSELL'S HERTZITE

PURPLE LABEL

1'6

AN ULTRA SENSITIVE SPOT AT THE FIRST ATTEMPT UNRIVALLED FOR VOLUME AND RANGE

L.C. RUSSELL LABORATORIES 16 HILL ST BIRMINGHAM

WHY DO YOU DO IT

Why keep on paying for new H.T. Batteries when for 50/- you can get a Henderson Mains Unit that will supply H.T. current indefinitely without costing you another ha'penny? Provided you have ordinary electric lighting in your home, all you do is to connect the H.T. Unit to any lamp-holder or wall plug. Current consumption is negligible and radio reception noticeably improved.



This No. 2 Model H.T. SUPPLY UNIT gives two output voltages—one at 50/60 volts and the other at 120/130 volts. It is quite suitable (where D.C. Mains are available) for use with receivers in which power valves are employed. Obtainable from all dealers or direct from actual manufacturers.

Price 50/-
(Postage 1/3 extra.)

(Complete with full instructions.)

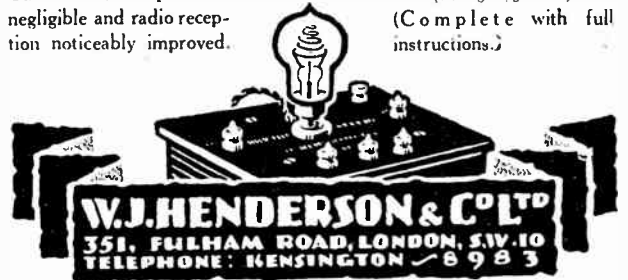

TESTIMONY

"... very pleased indeed with my purchase (No. 9 Chakophone) ... Berne, Toulouse, Madrid, Hamburg, Hilversum, etc., give good loudspeaker results, and almost any Continental station can be 'got' on the phones. ... the efficiency of your little machine seems extraordinary."

Chakophone "No. 9"
2-valve set
Royalty Paid

£6 . 15 . 0

Ask your dealer to demonstrate this 2-valver.

EAGLE ENGINEERING COMPANY, LIMITED, WARWICK.

London Showrooms: 8, Gt. Russell St., W.C.



TELSEN "ACE" L.F. Transformer

A high-grade efficient instrument, embodying the latest scientific principles, beautifully finished. Offered at a price that appeals to all.

9/6

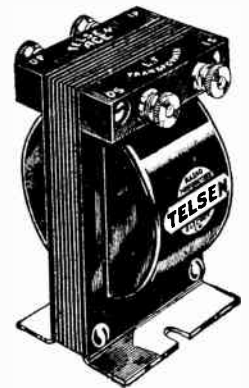

TELSEN "POPULAR" L.F. Transformer

Amplification without distortion. Always in demand.

15/6

The finest Transformers in the world at anywhere near their price.



Both models are shrouded, carry our usual 12 months, guarantee, and are available with ratios 5-1 and 3-1.

TELSEN ELECTRIC CO., 207 Aston Rd, Birmingham

LISENIN

POSITIVE GRIP PLUGS & SOCKETS

Pat. No. 245586

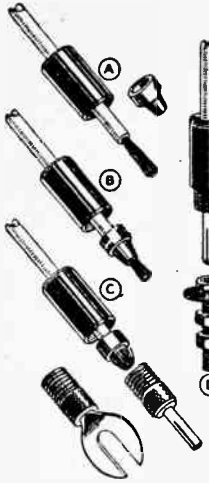

As supplied to the B.B.C.

THERE can be few experimentors who have not been troubled with broken leads, or said hard things about faulty connections. Of the whole set there is probably no part which is so often abused as the connections. "Lisenin" Positive Grip Plugs alleviate this evil. They are designed to take the smallest flex up to 5 m/m. cable. Electron wire, phone and loud speaker leads. "A" illustrates insulated sleeve, cable with ends bared and recessed cone. "B." Cone section in position. Being concave, it allows smallest flex to fit up tight, precluding any possibility of bared wire breaking with continual use. "C." Bared ends turned back; cone fits into concave recess in plug. Eriogid sleeve is then slipped down and plug screwed into it. A vice-like grip is made and an absolutely positive connection made without the use of solder or tiresome screws. "D." Plug and socket complete with indication disc and nuts. Sleeves and indicators are made in red and black. Plugs and sockets N. Plated. SPADE END, POSITIVE GRIP terminals suitable for accumulator leads, etc., also supplied.

ELECTRICALLY MECHANICALLY PERFECT

Obtainable of your usual Dealer. Refuse substitutes. Write us if any difficulty in obtaining and state dealer's name and address.

Sole Manufacturers and Patentees:

THE LISENIN WIRELESS CO.,
1B, Edgware Road, London, W.2

Phone - - - - - PADDINGTON 2734
Grams - - - - - "POSGRIP PADD. LONDON"

Positive Grip Plug & Socket Complete **6d.**

Positive Grip Spade End Complete **6d.**

Six Shillings only!

HART ENDURO L.T. ACCUMULATOR

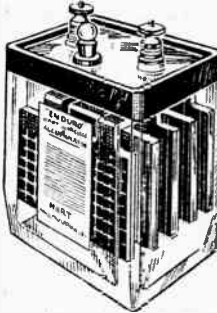

This New Hart Battery will maintain without deterioration steady discharge at constant voltage for lengthy periods.

The 5-plate cell is assembled in a non-inflammable glass container, with sealed glass lid, without separators and bottom blocks.

Capacity 10 A.H. (at the 20-hour discharge rate), it is adaptable for use with either Dull or Bright Emitter Valves.

Retail Price:

6/- (SIX SHILLINGS) ONLY

Obtainable from all good class dealers, etc., or direct from the manufacturers.

The Acme of Battery Value

HART ACCUMULATOR CO., LTD.
MARSHGATE LANE, STRATFORD, LONDON, E.15.

Telephones: Maryland 1361, 1362, 1363 and 1364.

Branch Offices and Showrooms: BELFAST, BIRMINGHAM, BRISTOL, CARDIFF, DUBLIN, GLASGOW, MANCHESTER, WESTMINSTER, YORK.

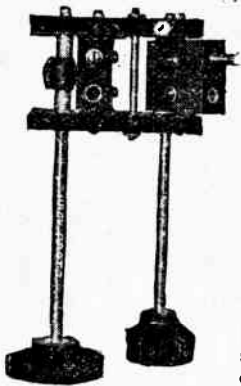

Quality RADIO

VERNIER COIL HOLDER

Cam Operated

THIS COIL HOLDER is designed on the sound engineering theory that a cam action gives the smoothest possible action. Both coil sockets are movable. The right-hand one gives coarse tuning in the usual way, and the left-hand one, the usual fixed socket, is controlled by a cam operated by a separate knob. The latter gives a smooth and micrometric movement through 10 degrees in both directions.

Write for one of these holders and hear the difference.

Postage 4d. Price **5/6**
British—from start to finish

GOSWELL ENGINEERING CO., LTD.
97 WHITE LION STREET, LONDON, N.1

Telephone—North 3051.

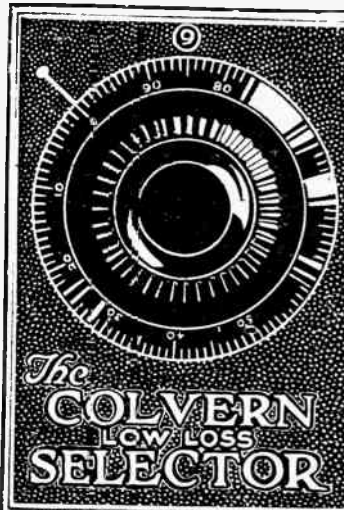

SELECTORS actually convert your receiver to an accurate wavemeter, ideal for short wave and all exacting requirements.

Perfectly insulated, and may be mounted on metal panel.

Pamphlets on request.

Capacity:—	.001	£1 3 0
	.00075	1 2 0
	.0005	1 1 0
	.0003	1 0 0
	.0002	19 0
	.00015	18 0

CALIBRATION with certainty to the 1,000th part of the variable capacity. This is the tuning efficiency obtained with the Colvern Selector. The complete circle of the dial is divided to provide a value of 100 intervals for every rotation of the index. Presupposing your condenser and inductance to cover 300 metres, each interval represents 3 metres—obviously every station can be calibrated definitely.

The Colvern is logically the only condenser worthy of the attention of serious experimenters. An insulated spindle reduces the effect of hand capacity to a minimum, a point of paramount importance in the reception of distant signals.

See the Colvern at your dealers!
THE COLVERN LOW LOSS SELECTOR
(Geared 20-1.)

COLLINSON PRECISION SCREW Co., Ltd.,

Provoost Works, Macdonald Road, Walthamstow, London, E.17.
Telephone: Walthamstow 532.

The "REEVES'-ROBERTS" RECEIVER.

(2 Valves)

Most British & Continental Stations
ON LOUD SPEAKER.

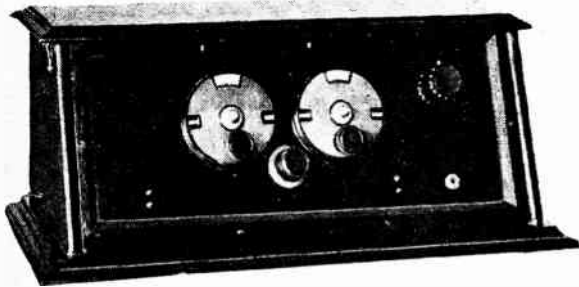

The "REEVES'-ROBERTS" RECEIVER (2 valves only)

Embodies the most advanced British and American practice. It is laboratory built, and receives most British and Continental Stations on the Western Electric "Kone" Loud Speaker.

It embodies tuned High Frequency; neutralisation of stray capacity; a regenerative detector; and Transformer Low Frequency. It is extremely stable, and the tone quality and volume fully meet modern expectations. If improperly used it cannot cause interference by external radiation.

Price inclusive of valves and royalties £15 nett with guarantee of performance

Complete with Western Electric "Kone" Loud Speaker, Batteries, etc. £25-0-0.

A. W. REEVES, M.I.M.E., F.R.S.A. Electrical Engineer,
3, EDMUND STREET, BIRMINGHAM.

On Selectivity and Sensitivity it is in practice the equal of the Superheterodyne, yet is vastly simpler to operate and has a fraction of the upkeep cost.

All connections are at the back of cabinet, ensuring best possible appearance.

The vernier tuning dials are entirely free of lost motion, and an anti-parallax double scale is embodied.

Radiolite Mahogany panel is used with a 25 degrees sloping front.

AT LAST— The PERFECT INDOOR AERIALS

The ENCORE MFG. CO., have pleasure in assuring entire satisfaction to all users of their now FAMOUS indoor Aerials; both for Valve and Crystal set users.

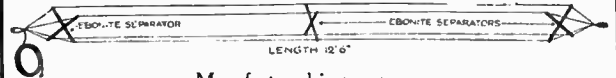

Manufactured in two types:
ENCORE DE LUXE. For Crystal and long distance RECEPTION. 5/6



ENCORE (standard). For Local and high power station. 3/-

Some of the advantages over an outdoor Aerial:
**SAFETY AGAINST LIGHTNING.
SELECTIVITY FOR VALVE USERS.
PORTABILITY.
IMMUNITY FROM SOOTY DEPOSITS, etc.**

Be sure you get an ENCORE, as there are many that are similar in appearance but much inferior in RESULTS.

Either of these Aerials can be obtained from your DEALER or Post-free from the Makers:

THE ENCORE MANUFACTURING CO.,
16, Lower Richmond Road, Putney, London, S.W.15.

Phone: Putney 3973.

Irish Agent: : Briscoe Importing Co., Ltd., 9, Aston's Quay, Dublin.

PURITY and VOLUME MADE CERTAIN

The R.N.B. Circuit envelope makes home construction simple and success certain.

Each envelope contains a Full Size Blue-Print Back-of-Panel Wiring Diagram, a Coil Chart for all the popular British and Continental Broadcasting Stations, and full detailed Constructional Notes (including the theoretical circuit, list of apparatus required, notes *re* components, etc.).

Ask your wireless dealer, or write direct for list of 15 Circuits (Crystal to Seven Valves).

RADIO NEWS BUREAU LTD.,

Brownlow House, 50-51, High Holborn, London, W.C.1.

IT IS THE
"PERMEC" DETECTOR
you want to obtain the LOUD and
PURE tone you are wishing for!!

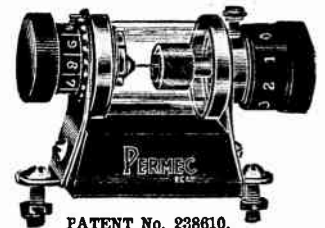

PATENT No. 238610.
BRITISH MADE. N. PLATED FINISH.

A sound mechanical job, strong & reliable. You can log the most sensitive spots on your crystal as easily as you log wave-lengths of various stations on a condenser dial.

The rotary vernier motion gives just that delicate adjustment necessary for satisfactory reception.

The spring-mounted catwhisker is eccentrically set, thus enabling the entire surface of the crystal to be systematically explored.

"PERMEC" is the best DETECTOR.

PRICE 6/-

Post Free on receipt of Postal Order and Dealer's Name from

PERMEC LTD.,

Junction Place, 57, Praed Street,
Paddington, London, W.2.

Phone: Paddington 251.

Money refunded if you are not satisfied.

All Post Free At Callers Prices

Orders 5/6 value, carriage paid. Under 5/6, 2d. per 1/- for packing, etc.

Zbonite Panels.

3'x6" 1/10
 9" x 6" 2/2
 12" x 9" 4/6
 12" x 12" 5/9
 15" x 9" 5/6
 15" x 12" 7/6
 4" x 4" 3d.
 7" x 5" 1/6
 6" x 6" x 1" 10d.
 Any size cut.
 Sq. in 1' dia. 1' 1d.
NO ADVANCE.

Square Law Var. Condensers
 with knob and Dia'.
 .001 panel type... 6/6
 .0003 2/-
 .0003 4/6
 Vernier Blade extra 1/4
 "J.B." "Ormond" &
 "Utility" usual prices.
 Vernier, no dial 2/6
 5 vane, 3/3; 7 3/6
 Polar types 10/6
NO EQUAL.

SEND FOR NEW FREE Comprehensive Price List. **TRADE ENQUIRIES INVITED**
Generous Terms - Prompt Service

"RELIABILITY" Wireless Cabinets at BARGAIN PRICES.

FUMED OAK. HAND POLISHED
 12" 14" 18" 21" 24" 28" (Polished Mahogany 1/- extra).
 For panels 7" high; width back to front: three largest sizes 8", others, 8"; sliding baseboard; aperture at back 9" x 2", allows for terminals strip screwing at back of baseboard, assisting ease in wiring. All with hinged lid.

New Edition RELIABILITY WIRELESS GUIDE, No. 2 Ready
 Have you got one? **IT'S FREE**

J.H. TAYLOR & CO.
 2 RADIO HOUSE, MACAULAY ST., HUDDERSFIELD
 Tel. 541 Grams THOROUGH HUDDERSFIELD

Aerial Wire	7/22s
Enamelled Bright	100' 3/3
Electron	1/3
Shell Insulators	3d.
Lead in Tube 9"	1/-
Coil Holders.	
Reliability Vernier	2/6
"Lotus" 2-way	7/-
"Newey" 2-way	6/-
"L. & P." 2-way	3/6
"Polar" 2-way	4/6
Cam vernier	6/-
Rullivan's 120-ohm	
Phones, ex-tort.	4/6
Condensers.	
Dubilier, McMichael's,	
Edison-Bell, Liesen,	
Mathard (usual prices),	
New Mansbridge,	
2 mfd. 3/6, 1 mfd. 2/6	
British Wires.	
swg. dia. ecc. dno.	
18	1/11 2/11 3/5
20	2/2 3/4 4/2
22	2/6 3/9 4/7
24	2/11 3/10 5/-
26	3/4 4/2 5/9
28	3/9 4/9 6/8
30	4/10 5/4 7/8
32	5/6 6/- 8/9
36	8/- 8/6 12/-
40	17/- 14/8 20/-

Transformers 1.1 F
 Radio Inst. 25/-, 27/6
 Ignite 21/- & 20/-
 Eureka No. 2 21/-
 Concert Grand 25/-
 Baby Grand 15/-
 Ferranti A.F. 4 17/6
 A.P. 25/-
 "H.T.C." (Empir) 7/6
 "Porro"
 Shrouded 10/-
 McMichael's H.F. 10/-
 "Dimit" Coil 10/-

H. T. Batteries.
 With Waelder Plugs.
 90v. 11/- 60v. 7/6
 30v. 4/8 15v. 1/10
 41v. F.L. Btry. 4d.
 60v. Ever-Rdy. 12/6
 30v. 7/8 16v. 3/6

"Special Values."
 Wates Microstate 2/9
 Mellotone Couplers 5/6
 Liberty Detector 3/6
 Lissacola Unit 13/6
 Voltmeter 0 to 6v. 3/6
 Antinomy Valve-holder 1/6
 Hand Drill 3/6
 Drills 1/-

For the Serious Experimenter:

"SUCCESS" SUPER AUDIO CHOKE
 Price 18/6

"SUCCESS" COLLAPSIBLE FRAME AERIAL
 Price 42/-
 With Centre Tapping
 Price 17/6

Send for complete List post free.

BEARD & FITCH, Ltd.
 34, AYLESBURY STREET, LONDON, E.C.1.

GUARANTEED VALVE RENOVATIONS
 ONE PRICE FOR ALL TYPES
 (Power Valves excepted)

3/6 Per Valve
 — Power Valves 6/6 —

FOR 3/6 your burnt out valve can be renovated, under guarantee by our new process, to any one of the following specifications.

Type	Fil. Volts	Fil. Amps.	Anode Volts	Bright or Dull
I	3.5	.5	20	Bright
II	1.5	.3	10	Dull
III	2.5	.12	100	Dull

VALVES should be sent, with P.O. 3/9 (or 6/9 if Power Valve), securely packed, stating which type is selected, to :-

THE BRITISH GLOWLAMP & VALVE CO.,
 27 Kirby Street, Hatton Garden, London, E.C.1.
 Telephone Holborn 4553.
 Performance of Every Returned Valve Guaranteed.
 Open on Saturdays until 4 p.m.

Two examples from our wide range.

LAMPLUGH FILAMENT RHEOSTAT

Possesses every feature for correct control of Filament emission. Fitted with special buffer contact ensuring smooth and silent working. One hole fixing. Unbreakable.

No. 1051, 6 ohms. 3/-
 No. 1073, 15 ohms. 3/3
 No. 1074, 30 ohms. 3/6

THE NEW LAMPLUGH STRAIGHT LINE CONDENSER
 LOW LOSS

Possessing the same superb electrical qualities as the De Luxe Model. With Lamplugh Grip dial. Minimum capacity 6.5 mmf.

.0005 mfd. 11/-
 .0003 mfd. 10/6
 .0002 mfd. 10/-

Send for Catalogue

S. A. Lamplugh Ltd
 King's Road, Tyseley, BIRMINGHAM.

MISCELLANEOUS ADVERTISEMENTS.

NOTICES.

THE CHARGE FOR ADVERTISEMENTS in these columns is:

12 words or less, 1- and 1d. for every additional word, e.g., 18 words 1 6; 24 words, 2/- Name and address must be counted.

SERIES DISCOUNTS are allowed to Trade Advertisers as follows on orders for consecutive insertions, provided a contract is placed in advance, and in the absence of fresh instructions the entire "copy" is repeated from the previous issue: 13 consecutive insertions, 5%; 28 consecutive, 10%; 52 consecutive, 15%.

ADVERTISEMENTS for these columns are accepted up to **FIRST POST ON THURSDAY MORNING** (previous to date of issue) at the Head Office of "The Wireless World," Dorset House, Tudor Street, London, E.C.4, or on **WEDNESDAY MORNING** at the Branch Offices, 19, Hertford Street, Coventry; Guildhall Buildings, Navigation Street, Birmingham; 199, Deansgate, Manchester.

Advertisements that arrive too late for a particular issue will automatically be inserted in the following issue unless accompanied by instructions to the contrary. All advertisements in this section must be strictly prepaid.

Postal Orders and Cheques sent in payment for advertisements should be made payable to **ILIFFE & SONS Ltd.**, and crossed **Treasury Notes**, being untraceable if lost in transit, should not be sent as remittances.

All letters relating to advertisements should quote the number which is printed at the end of each advertisement, and the date of the issue in which it appeared.

The proprietors are not responsible for clerical or printers' errors, although every care is taken to avoid mistakes.

NUMBERED ADDRESSES.

For the convenience of advertisers, letters may be addressed to numbers at "The Wireless World" Office. When this is desired, the sum of 6d. to defray the cost of registration and to cover postage on replies must be added to the advertisement charge, which must include the words Box 000, c/o "The Wireless World." Only the number will appear in the advertisement. All replies should be addressed No. 000, c/o "The Wireless World," Dorset House, Tudor Street, London, E.C.4. Readers who reply to Box No. advertisements are warned against sending remittance through the post except in registered envelopes; in all such cases the use of the Deposit System is recommended, and the envelope should be clearly marked "Deposit Department."

DEPOSIT SYSTEM.

Readers who hesitate to send money to unknown persons may deal in perfect safety by availing themselves of our Deposit System. If the money be deposited with "The Wireless World," both parties are advised of its receipt.

The time allowed for decision is three days, during which time, if the buyer decides not to retain the goods, they must be returned to the sender. If a sale is effected we remit the amount to the seller, but, if not, we return the amount to the depositor. Carriage is paid by the buyer, but in the event of no sale, and subject to there being no different arrangement between buyer and seller, each pays carriage one way. The seller takes the risk of loss or damage in transit, for which we take no responsibility. For all transactions up to £10, a deposit fee of 1/- is charged; on transactions over £10 and under £50, the fee is 2/6; over £50, 5/-. All deposit matters are dealt with at Dorset House, Tudor Street, London, E.C.4, and cheques and money orders should be made payable to Iliffe & Sons Limited.

THE SALE OF HOME-CONSTRUCTED UNLICENSED APPARATUS.

A New Service to our Readers.

We have made an arrangement with the Patentees whereby readers who wish to dispose of a home-constructed receiver not licensed under the patents made use of, can do so by means of the Deposit System referred to above.

The person desiring to sell, in sending us particulars for his advertisement, will in every case make use of a Box No., and should add to the price which he requires the amount of royalty customarily paid by manufacturers, viz. in the case of Marconi Patents the amount should be calculated at 12/6 per valve holder.

If the purchaser is satisfied with his purchase, the sum realised will be forwarded to the seller, less the amount due in respect of royalties, which amount will be paid by "The Wireless World" to the owners of the patents concerned and a certificate will be handed on to the purchaser of the set.

FOR SALE.

FIVE-VALVE "Transatlantic" Receiver. Built from good components. 1 to 5 valves can be used. Perfect condition. Including two pairs matched H.F. transformers, £10, or with valves (Mullard & Cossor dull emitters) £13 (plus royalties). Also selection suitable coils.—Box 7005, WIRELESS WORLD Office. (1852)

A62

Mention of "The Wireless

IMPORTANT NOTICE.

Owing to the Easter Holidays, the issues of "THE WIRELESS WORLD" dated March 31st and April 7th are closing for press earlier than usual.

In accordance with the notice that appeared last week, the latest date upon which MISCELLANEOUS ADVERTISEMENTS could be accepted for the issue of March 31st was WEDNESDAY, March 24th.

For the issue of April 7th advertisements for these columns can be accepted up to **FIRST POST, Tuesday, March 30th.**

For Sale.—Contd.

EXPERIMENTER has for sale, at two-thirds cost or nearest, various Wireless Components, best make, guaranteed perfect; particulars upon request.—Box 7211, WIRELESS WORLD Office. (1872)

ATWATER Kent American 5-valve Receiving Set, 200-600 metres, nearly new, no accessories. What offers?—Badham, Camdore, Cheltenham. (1876)

HIGH-TENSION Accumulators.—The Ideal Loud-speaker Battery, 60 volts, 35s.; 80 volts, 45s.; 100 volts, 55s.; guaranteed. Good trade terms.—Pearson, 110, Marston Lane, Bedworth, Nuneaton. (1882)

H. & B. Condensers—Square law, .001, 4s.; .0005, 3s.; .0003, 2s. 6d.; .0002, 2s. 6d.; low loss .0005, 5s.; .0003, 4s. 6d.; Vernier 6d. extra, post free, all guaranteed.—Frazier, Stafford Road, Wallington. "Phone" 1436. (1881)

MORSE learnt in 1 hour with the "Simple" Mnemo-Visual Apparatus. How to synchronise sight and sound. Simple and infallible. Post free 2s. 6d.—Simple Co., 44, Bedford Row, W.C.1. (1890)

AN amateur disposing of his entire stock of Wireless Components: 4 pairs of phones, perfect, 4s. pair; 7 sets of Six McMichael Clip-in fixed condensers, 3s. 3d. set; 2 Mahoganyite and 2 ebonite panels, 15 $\frac{1}{2}$ x 12 $\frac{1}{2}$ x $\frac{5}{16}$, undrilled, 6s. each; 4 ebonite panels, 9 $\frac{1}{2}$ x 9 $\frac{1}{2}$ x $\frac{1}{16}$, undrilled, 4s. 6d. each; 2 McMichael Reversine coil-holders, new condition, 11s. each; 1 McMichael Supersonic Kit, plug in type, new condition, unused, containing 3 intermediate, 1 filter, 1 oscillator, £3 5s.; 2 .0005 variable condensers, new, 5s. 6d. each; 2 .0003 variable condensers, new, 4s. 6d. each.—A. "Dalmeny," Ripley Road, Belvedere. (1891)

FOR SALE—Modified Omni Receiver, as described in "Modern Wireless," with high-frequency transformer and specially engraved back panel, suitable for latest circuit; £15 complete, components cost £20. Seen by appointment.—Box 7272, WIRELESS WORLD Office. (1892)

S.A.B. has for sale 900-volt aircraft motor, generator, £8; 1,000-volt G.E.C. voltmeter, £5 10s.; G.P.O. Send-receive Morse Key 8 platinum contacts, £1 5s.; choke coil, 7s. 6d.; 20,000 ohm grid leak, tapped, 2,000 wirewound, 7s. 6d.; transmitting inductance and reaction, 80 to 260 metres, 15s.; modulation transformer, 15s.; Mullard 040 valve, new, 30s.—Photo, 4, Beer Street, Yeovil. (1896)

TORDA Low-loss Neutroformers.—Most efficient coupling available for B.B.C. or Davenport wavelengths. Full technical data for stamp. Neutroformer with "plug-in" base 15s.—Cotton & Clarke, Ltd., 55-59, Lacy Road, Putney, S.W.15. (1899)

Mention of "The Wireless World" when writing to advertisers, will ensure prompt attention.

For Sale.—Contd.

OSCILLATING Zincite and Contact, 2s. 6d., simple, original circuit, 1s.; excellent results; other parts stocked.—Ledsham's, 297, King Street, Hammersmith. (1888)

SINGLE Control Super. Results on 1 valve, 20 miles without aerial, earth, or frame, loud-speaker, 40 miles on frame. All B.B.C., Continental, and 2 American stations on poor aerial. No accumulators. Only 2 flash-lamp cells used. Total cost to make, including DE valve, phones, etc., complete, 35s. As easy to make as crystal set. Full instructions and diagram 2s. Above free to customers. Radio Record, DE, 206 valves, 6s. 6d.; 4 Electrode, DE, 206 valves, 10s.—Makin, 6, Bourne Road, Stoke, Coventry. (1893)

"ELLA" Charger, 220 volt 50 cycle, for 6-volt accumulator, as new; 4 guineas.—Box 7317, WIRELESS WORLD Office. (1895)

TELEPHONES—Brown's type A, 120 ohms, 2 Lissen T1 L.F. transformers, all perfect, offers.—14, Brook Avenue, Wembley. (1894)

FOR SALE—4-valve Wireless Set, polished mahogany cabinet, "straight" circuit; £10.—Collier, 80A, Herbert Road, Plumstead, S.E.18. (1897)

3- and 4-valve Sets, specially selective, best components, handsome cabinets, very cheap.—Box 7325, WIRELESS WORLD Office. (1902)

SUPER Heterodyne, Bowyer-Lowe Oscillator Coupler, and set of 4 matched transformers; £3 15s.—Box 7320, WIRELESS WORLD Office. (1903)

FOR SALE—Western Electric Power Amplifier and Western Electric Speaker. What offers?—Flood, 118, Headcorn Road, Thornorton Heath. (1905)

HIGH-TENSION for Transmitter, $\frac{1}{2}$ h.p. Ironclad motor, 4,000 r.p.m., 230 volts, D.C., with starting switch, new, coupled to Newton alternator; also transformer by Zenith, giving 1,000 and 1,500 volts each side of centre tap at 200 m.a., cost £20, offers.—S.W., Birkdale. (1906)

HEADPHONES—Brown's A type, 4,000 ohms, 30s.; Zenith wirewound resistance, 100,000 ohms, with tapping at 50,000 ohms, 12s.—Standish, 79, Elm Grove Road, Barnes, S.W.13. (1907)

PETO-SCOTT 5-valve Set (2 H.F., Det., 1 L.F., and Power L.F.), as new; £5.—Churchman, 14, Manor Place, Hackney Downs, E.8. (1910)

BOWYER-LOWE Buzzer Wavemeter, 150-600 metres; £3.—After 6 p.m. Britain, 80, Great Dover Street, Borough, S.E.1. (1911)

HIGH-FREQUENCY Transformer for 2s. 6d. Neu'Magna high-frequency transformers give best results on broadcast band. Best double-insulated wires, full instructions, quarter usual price. Send P.O. 2s. 6d. to Radio Magna Radio Co., Magna House, Fore Street, St. Clement's, Ipswich, and transformer will come by return of post. Experimenters! do not miss this opportunity. (1912)

SUPER-HETERODYNE 6-valve Tropadyne in handsome oak cabinet, engraved panel, slow-motion condensers, everything of the best, frame aerial, owner going abroad; first £12 10s.—15A, Onslow Gardens, Wallington, Surrey. (1913)

For Sale.—Contd.

HIGH-TENSION Accumulators.—Less than half cost of dry batteries. Simple building and charging instructions, plus one fully-assembled sample cell, 2s.—Box 7330, WIRELESS WORLD Office. (1908)

AMPLION "Music Master" Loud-speaker, mahogany wood flare, 55s.; Igranite telephone transformer, ratio 1-1, 2,000 ohms, 10s.—Box 7332, WIRELESS WORLD Office. (1915)

WOOD Horns for all speakers and gramophone attachments. There's one for Amplion Junior, ditto goose-neck bases, Lissenola, etc. There's only one best; it's the "Allwoodorn."—Manufacturer: H. Maddison, 2A, Ronald's Road, Highbury, N.5. List free. (1914)

MISCELLANEOUS.

SEND 2s. for Booklet and Constructional Diagram on How to Build a 3-valve Selective Distance-getter.—Vic Radio (J. Ayres), 1, Emery Hill Street, Westminster. (1878)

A WIRELESS Doctor.—If your set is giving trouble or you want advice a competent expert will call (anywhere in Greater London) and put you right. No result, no charge.—Alexander Black, 2A, Woodville Grove, N.16. Clissold 3687. (1811)

REPAIRS.

TRANSFORMERS rewound to guaranteed efficiency for 12 months, 4s., or exchanged for another, any ratio, 5s.; iron core wire-wound chokes for L.F. amplifiers, 6s.—115, Links Road, Tooting. (0011)

WANTED.

WE require offers for Radio Sets and Lower parts in first-class condition only. Owing to our selling system (payment by instalments), and also owing to our own shops and agents in all important places of Holland, our demand is very large. Utmost cash prices required.—N. V. Exima, Leliegracht 25, Amsterdam, Holland. (1898)

COPIES of No. 307, Vol. XVII., No. 1, "Wireless World."—G. Brame, Diss, Norfolk. (1867)

EXCHANGE.

MILLIAMETER, 0-500 moving coil Ferranti, 5in. parcellase dial, exchange for similar quality A.C. voltmeter or microammeter.—Turpin, 27, Park Chase, Wembley Park. (1874)

BOOKS.

"WIRELESS WORLD," Vols. X.-XIV., newly bound, Vols. XV.-XVII., unbound, first four volumes "Modern Wireless," unbound, all clean, perfect copies.—Offers to Taunton, Homestead, Thorpe, Norwich. (1904)

BOOKS You Want.—Foyles Can Supply.—Immense stock, second-hand and new, every conceivable subject. State requirements. 21 catalogues issued. Books purchased.—Foyles, 121, Charing Cross Road, W.C.2. (0004)

SITUATIONS WANTED.

YOUNG Man, certificated wireless telegraphy and telephony (modern theory and practice), also practical experience, 4 years' business experience (2 years assistant business manager), also good general knowledge music, desires responsible position.—Box 7260, WIRELESS WORLD Office. (1889)

WIRELESS Engineer, 21, 5 years' practical and experimental work; competent in design, circuits, etc., with Radio College training and diploma for theory.—Box 7331, WIRELESS WORLD Office. (1909)

PATENT AGENTS.

W. BRYSON, B.Sc., Chartered Patent Agent, 29, Southampton Buildings, W.C.2 Phone: Holborn 672. (1297)

KING'S PATENT AGENCY, LTD. (B. T. King, Registered Patent Agent, G.B., U.S., and Can.). Free "Advice Handbook" and Consultations, 40 years' references.—146A, Queen Victoria Street, London, E.C.4. (0002)

PATENTS and Trade Marks Obtained.—H. T. P. Gee, Patent Agent, Member R.S.G.B., A.M.I.R.E., 51-52, Chancery Lane, London, W.C.2. Phone: Holborn 1525. (0001)

RADIAX D.X. COILS

Increase Selectivity 100%
Give an auto coupled tuning circuit without altering your set. You will cut out the local, or separate two difficult stations to an extent undreamed of. 5 terminals make it a Universal coil.



To introduce a free chart will be given with each purchase showing the many circuits in which this coil can be used, Auto Coupled, Hetrodyne, etc. No. 35, 4/6. No. 50, 5/-. No. 75, 5/6. No. 150, 7/6. Set of 4, 21/- Postage extra.

RADIAX Ltd. 30, Accessory House, Palmer Place, Holloway, N.7.

EARTH FAULTS ENDED

Entirely new method of Earth-system efficiency. 20% to 200% increase guaranteed. Ideal for all outdoor Earths. 2/6 complete, post 6d. Particulars free.

J. W. Miller, 68, Farringdon Street, E.C.4.

Phone: Cent. 1950.

Approved by Radio Association.



TROLITE PANELS

Mahogany Grain . . . 3/6 lb.
Black Engraved wavy 3/9 lb.
Black plain polished 3/- lb.

Machine cut to your own measurements. Tested to 50,000 Volts.

PUGH'S WIRELESS, 95-101, Holloway Road, London, N.7

PATENTS, DESIGNS AND TRADE MARKS.

J. S. Withers & Spooner.

Chartered Patent Agents.

STAPLE HOUSE, 61 & 62, CHANCERY LANE, LONDON, W.7.

GRAMS: IMPROVABLE, HOLB., LONDON. Tel.:—480 HOLBORN

Amateurs! Let us make your Cabinets

In Beautiful Polished Mahogany or Oak—& SENT ON APPROVAL. De Luxe Models—Parlour Models, etc. from 25/- to 25. Crystal Cabinets from 1/6. Any size MADE TO ORDER. Designs and Lists Free. Estimates per Return Post. Panels and Accessories Post Free.

Send to actual Makers: Pickett Brothers, Members B.S.C. (W.W.) Cabinet Works, Boxley-heath. *It will pay!*

RADIAX H.T. ACCUMULATORS

Give a perfect H.T. Supply for many months with one charge. Improve reception wonderfully.

70 VOLT UNIT . . . 6/9
60 VOLT BATTERY 50/-

RADIAX Ltd. 30, Accessory House, Palmer Place, Holloway, N.7.

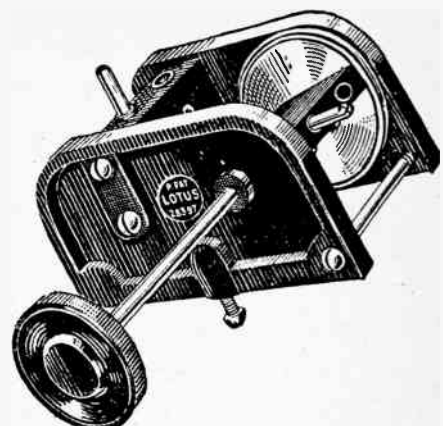

Tuning remains accurate because the Moving Block cannot fall back.

Do away with that irritating, time wasting, fading away of volume caused by the falling of your Moving Block.

Fit a Lotus Geared Vernier Coil Holder and get really accurate tuning. The Lotus Moving Block cannot possibly fall back. Has an easy Vernier movement which reduces the speed by eight times, and stays where it's put—exactly! Fit in any position, with any weight of coil—you'll be satisfied with the results.

Bakelite mouldings for the side plates, coil blocks and knobs; heavy Nickel Plating for the metal parts.

LOTUS VERNIER COIL HOLDERS

From all reliable Radio Dealers.
GARNETT, WHITELEY & CO., LTD.,
Lotus Works,
Broadgreen Road, Liverpool.

Makers of the famous Lotus Buoyancy Valve Holder.



The **Wireless**
AND RADIO REVIEW **World**

INDEX TO ADVERTISEMENTS.

Accumulators Elite	36	Fermo Company	28	Partridge & Wilson	28
A.J.S. & Co. (1914), Ltd.	17	Fuller's United Electric Works, Ltd.	8	Permec, Ltd.	32
Beard & Fitch, Ltd.	33	Garnett, Whiteley & Co., Ltd.	35	Pickett Bros.	35
Belling & Lee, Ltd.	4	General Electric Co., Ltd., The	25	Pugh Bros.	35
Brandes, Ltd.	18	General Radio Co., Ltd.	28	Radiare Elec. Co., Ltd.	27
British Glowlamp & Valve Co.	33	Gilray Trading Corp., Ltd.	27	Radio Communication Co., Ltd.	23
British L.M. Ericsson Mfg. Co., Ltd.	36	Goswell Engineering Co., Ltd.	31	Radio Components, Ltd.	29
Bulgin, A. F., & Co.	36	Graham, Alfred, & Co.	Cover ii.	Radio Devices, Ltd.	11
Burndept Wireless, Ltd.	21	Hainley Bros., Ltd.	12	Radio News Bureau, Ltd.	32
Cambridge Correspondence College, Ltd.	36	Hart Accumulator Co., Ltd.	31	Radio Instruments, Ltd.	15
Carrington Manufacturing Co., Ltd.	27	Healyberd, F. C., & Co.	28	Radios	35 & 36
Caxton Wood Turnery Co.	Cover ii.	Henderson, W. J., & Co., Ltd.	30	Radiax, Ltd.	32
Charlesworth, W. J.	29	Hough, J. E., Ltd.	2	Reeves, A. W.	26
Chartrou Radio, Ltd.	18	Hunt, A. H., Ltd.	6	Reflex Radio	14
Collinson Precision Screw Co., Ltd.	51	Ignyac Electric Co., Ltd.	10	Ripaults, Ltd.	1
Cosser, A. C., Ltd.	13	Lamplugh, S. A., Ltd.	33	Rothemel Radio Corp. of Gt. Britain, Ltd.	28
Darimont Electric Batteries, Ltd.	28	Lisvain Wireless Co.	31	Sanders, W.	5
De Leeuw & Co., Ltd.	20	Lissen, Ltd.	16	Silvertown Co., Ltd.	12
Dixon, Leslie & Co.	29	L. G. Russell Laboratories	30	Smith & Sons, S. (M.A.), Ltd.	12
Dubilier Condenser Co. (1925), Ltd.	7	London Elec. Wire Co. & Smiths, Ltd.	20	Stratton & Co., Ltd.	53
Eagle Engineering Co., Ltd.	30	Marconiophone Co., Ltd., The	Cover iv.	Taylor, J. H., & Co., Ltd.	4
Edison Swan Electric Co., Ltd.	21	Metro-Viel Supplies, Ltd.	6 & 14	Telsen Elec. Co.	30
Electron Co., Ltd., The	8	Midland Radiotelephone Manfs., Ltd.	2	Van Borden, C. A., & Co., Ltd.	9
Encore Manf. Co.	32	Miller, J.	35	Van Rindon	26
Excelsior Motor Co., Ltd.	26	Mullard Wireless Service Co., Ltd., The	3	Wentmel Wireless Co., Ltd., The	29
Ferranti, Ltd.	Cover ii.	Nelson Electric Co., Ltd.	26	Wilkins & Wright, Ltd.	24
Finston Manf. Co., Ltd.	19	New Wilson Elec. Co.	27	Withers, J. S., & Spooner	35
Fitzpatrick, H. D., & Co.	36	Paragon Rubber Manf. Co., Ltd., The	29	Young, A. M., & Co.	10

The ideal Rheostat for any valve.



Only the special spring arm, the perfected bearing and winding of the Ericsson Dual Rheostat permits such velvety smoothness. By means of small auxiliary knob the resistance of 6 ohms can be altered to one of 60 ohms. Price complete with pointer, knob, scale and screws, **8/6**. Write for lists to-day.

THE BRITISH L.M. ERICSSON MFG. Co., Ltd.
67-73, Kingsway, London, W.C.2.

Ericsson

DUAL RHEOSTATS.

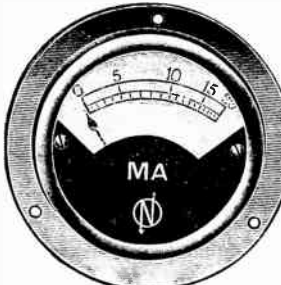

THIS is a full-size illustration of one of the neatest, reliable meters made. Calibrated against the highest standard instruments. Flush mounting. Highly nickel plated.

TRADE MARK

PRICES.

Ammeters	0-3 amps.	7/6 each.
Voltmeters	0-6 volts	7/6 each.
Milli-Ammeters	0-30 M.A.	10/6 each.

Packed in Orange-colour Cartons. Other readings to follow.

IMMEDIATE DELIVERY FROM ALL THE BEST DEALERS.

Wholesale Distributors:

A.F. BULGIN & CO.
9-H. CURSITOR STREET
TEL HOLBORN 2072 CHANCERY LANE E.C.6. WORKS CHESWICK

H.T. Accumulators 37/6
60 Volts 3 Actual Amp.-hour



The finest H.T. Accumulator in the world.



55-

Co-volt, 3-amp.-hour, oil submerged. Will last a lifetime. Write for descriptive Folder.

MONEY RETURNED IF NOT SATISFIED. Obtainable only from ACCUMULATORS ELITE, 31 Waterhouse St., Halifax.
Trade Supplied. Telephone: 1304.

RADIAX TOROIDAL COILS

Ultra low-loss. Selective, Fieldless. Does not pick up interfering signals.



Consists of two Toroidal Coils, an inner and outer. Can be used as primary and tuned secondary for Aerial of H.F. valve coupling, also as Aerial or tuned anode with reaction

Double Coil, complete as shown . . . 12/6
With holder on base . . . 13/9

Postage and packing 6d.

RADIAX Ltd.
30, Accessory House, Palmer Place, Holloway, N.7.

Wholesale Distributors:

A.F. BULGIN & CO.
9-H. CURSITOR STREET
TEL HOLBORN 2072 CHANCERY LANE E.C.6. WORKS CHESWICK

VALVES Repaired Quick

Let our valve making plant repair your broken or burnt out valves efficiently & promptly (most makes). Guaranteed equal to new. Bright emitters 5-; "DE's" 3 and 3v types) 7/6. Power valves slightly more, see list. Not repairable: S.P.s WECO v.74. Co-sor D.E.'s.

RADION Reliable Repairs

RADIONS Ltd., Be-Hington, Nr. MACCLESFIELD, Ches.

Best valve-repairing firm in the world. List Free.

PATENTS, DESIGNS & TRADE MARKS.

H. D. FITZPATRICK & CO.
Chartered Patent Agents,
49, Chancery Lane, London, W.C.2
Phone: Holborn 459.

TRAIN YOUR MIND

THE MIND MAKES THE MAN. Make up your mind to train and we will develop your mind. Our Courses are many. Our style is simple and easy. Our Teachers are all University Graduates.

Send for particulars to Secretary,
CAMBRIDGE CORRESPONDENCE COLLEGE, LTD.
38, Doughty House, Doughty Street, London, W.C.

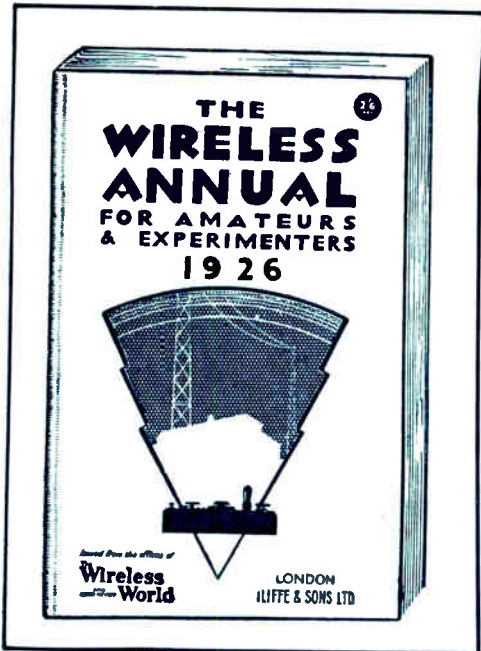

This book should be your wireless guide and companion throughout 1926.

THE WIRELESS ANNUAL

FOR AMATEURS AND EXPERIMENTERS 1926

A volume of particular interest to every wireless enthusiast, containing amongst a mass of other features the following special items:

CALL SIGNS of ALL KNOWN AMATEUR TRANSMITTING STATIONS in Great Britain, France, Holland, Germany, Sweden, Finland, Italy, Spain, South Africa, India, Australia, New Zealand, and South America: REGULAR TRANSMISSIONS (Morse and telephony): RECEIVER CIRCUITS (16 pages of diagrams and notes): GLOSSARY OF TECHNICAL TERMS: CLASSIFIED DIRECTORY OF MANUFACTURERS: VALVE DATA, USEFUL TABLES, FORMULAE and INFORMATION on all subjects of interest to AMATEURS

PRICE 2/6 net. BY POST 2/8½

Obtainable from all booksellers or direct from the offices of "The Wireless World," Dorset House, Tudor St., London, E.C.4

W.W.8a

A Service that gives Security!

MANY readers naturally hesitate to send money to unknown persons. We have therefore adopted a Deposit System which gives complete security both to buyer and seller. If the money be deposited with "The Wireless World" both parties are advised of its receipt. The time allowed for decision is three days, after which time, if the buyer decides not to retain the goods, they must be returned to the sender. If

a sale is effected we remit the amount to the seller; but, if not, we return it to the depositor.

Full particulars may be found on the Miscellaneous advertisement page at the end of the book.

Use this service for your wireless requirements and avoid all risk! Sell the apparatus you no longer require! Write out your advertisement to-day and send to—

PREPAID ADVT. DEPT., "THE WIRELESS WORLD," DORSET HOUSE, TUDOR ST., LONDON, E.C.4.

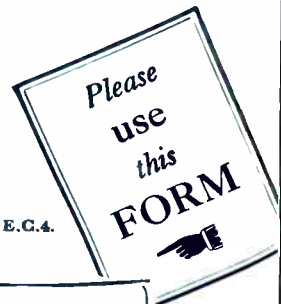

12 Words or Less 1/-

each additional word 1d.

Advertiser's name and address must be counted. If a box number is required, 6d. extra must be sent for postage on replies.

w.w.39

Advertisements for "The Wireless World" are only accepted from firms we believe to be thoroughly reliable.



For Economy

EMPLOY MARCONI D.E.3 VALVES

For 4-volt Accumulator or 3 dry cells.

General Purpose Valves. Current Consumption only 0.06 amps.

TYPE D.E.3.

Filament Volts ... 2.8
 Filament Current Amps. 0.06
 Anode Volts ... 20-80
 Impedance (ohms) ... 22,000
 Amplification Factor ... 7
Write for Valve Publication No. 443a.

A FEW RECOMMENDED COMBINATIONS FOR ECONOMICAL WORKING.				
	Type	Position	Grid Bias Volts	High Tension Volts
2-Valve Set	D.E.3.B.	H.F.	0	60
	D.E.3.B.	DET.	+2.8	60
	D.E.3.B.	DET.	+2.8	80
	D.E.3.	L.F.	-4.5	80
3-Valve Set	D.E.3.B.	H.F.	0	80
	D.E.3.B.	DET.	+2.8	80
	D.E.3.	L.F.	-4.5	80
	D.E.3.B.	DET.	+2.8	80
	D.E.3.	1 L.F.	-4.5	80
4-Valve Set	D.E.3.B.	H.F.	0	120
	D.E.3.B.	DET.	+2.8	80
	D.E.3.	1 L.F.	-6	80
	D.E.4.	2 L.F.	-7.5	120

PRICE 16/6 EACH

TYPE D.E.3.B.
 Fil. Volts ... 2.8
 Fil. Amps. ... 0.06
 Anode Volts... 120
 Impedance (ohms) ... 50,000
 Amplification Factor ... 17

Marconi Valves

IN THE PURPLE BOX

The name that guarantees  all that is best in Radio

Next to the valve, the component that matters most on your set is the *Transformer*

The "IDEAL" Transformer, which is guaranteed to amplify with minimum distortion at all frequencies, is subjected to rigorous tests at every stage of manufacture. Every transformer sold is guaranteed to conform to the individual curve supplied with the instrument, and not to a general laboratory standard. The windings are impregnated with MARCONITE—a specially prepared insulating material which protects it from all risk of deterioration and corrosion.

The performance of the "Ideal Junior" is consistent with that of the "Ideal," and is designed chiefly to follow the detector valve which is usually of high impedance. In this way a modification of design, different from that of the large model, has been effected solely for this purpose, thus enabling a special purpose transformer with the highest guaranteed performance to be produced at a minimum cost.

The "IDEAL" Transformer is supplied in four ratios, namely, 2.7 to 1, 4 to 1, 6 to 1 and 8 to 1.

30/- each.

"IDEAL" (Junior Model), ratio 3 to 1. New Reduced Price.

21/-

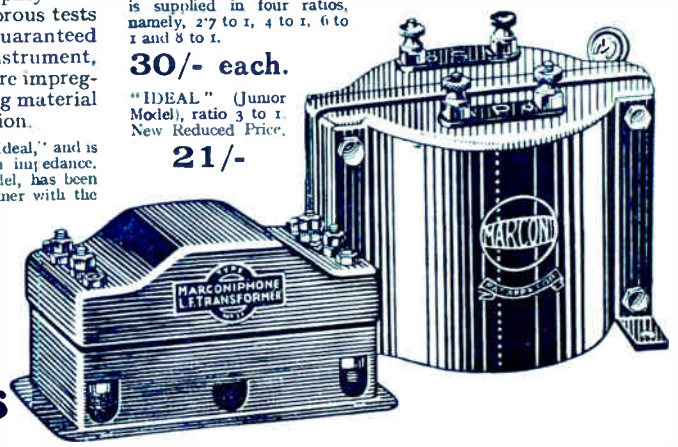

Write for supply of Publication 364F.

Marconiphone "IDEAL" Transformers

THE MARCONIPHONE COMPANY, LIMITED.

Registered Office: MARCONI HOUSE, STRAND, W.C.2. Head Office: 210-212 TOTTENHAM COURT ROAD, LONDON, W.1.

Printed for the Publishers, LITTLE & SONS LTD., Dorset House, Tudor Street, London, E.C.4, by The Cornwall Press Ltd., Paris Garden, Stamford Street, London, S.E.1.

Colonial and Foreign Agents:
 UNITED STATES—The International News Co., 83-85, Duane Street, New York. FRANCE—W. H. Smith & Son, 248, Rue Rivoli, Paris; Hachette et Cie, Rue Beaumur, Paris.
 BELGIUM—W. H. Smith & Son, 78, Marche aux Herbes, Brussels. INDIA—A. H. Wheeler & Co., Bombay, Allahabad and Calcutta. SOUTH AFRICA—Central News Agency, Ltd.
 AUSTRALIA—Gordon & Gotch, Ltd., Melbourne (Victoria), Sydney (N.S.W.), Brisbane (Queensland), Adelaide (S.A.), Perth (W.A.) and Launceston (Tasmania).
 CANADA—The American News Co., Ltd., Toronto, Winnipeg, Vancouver, Montreal, Ottawa, St. John, Halifax, Hamilton; Gordon & Gotch, Ltd., Toronto; Imperial News Co., Toronto, Montreal, Winnipeg, Vancouver, Victoria. NEW ZEALAND—Gordon & Gotch Ltd., Wellington, Auckland, Christchurch and Dunedin.

4^D

The Wireless World

The Paper for Every Wireless Amateur

Wednesday, March 31st, 1926

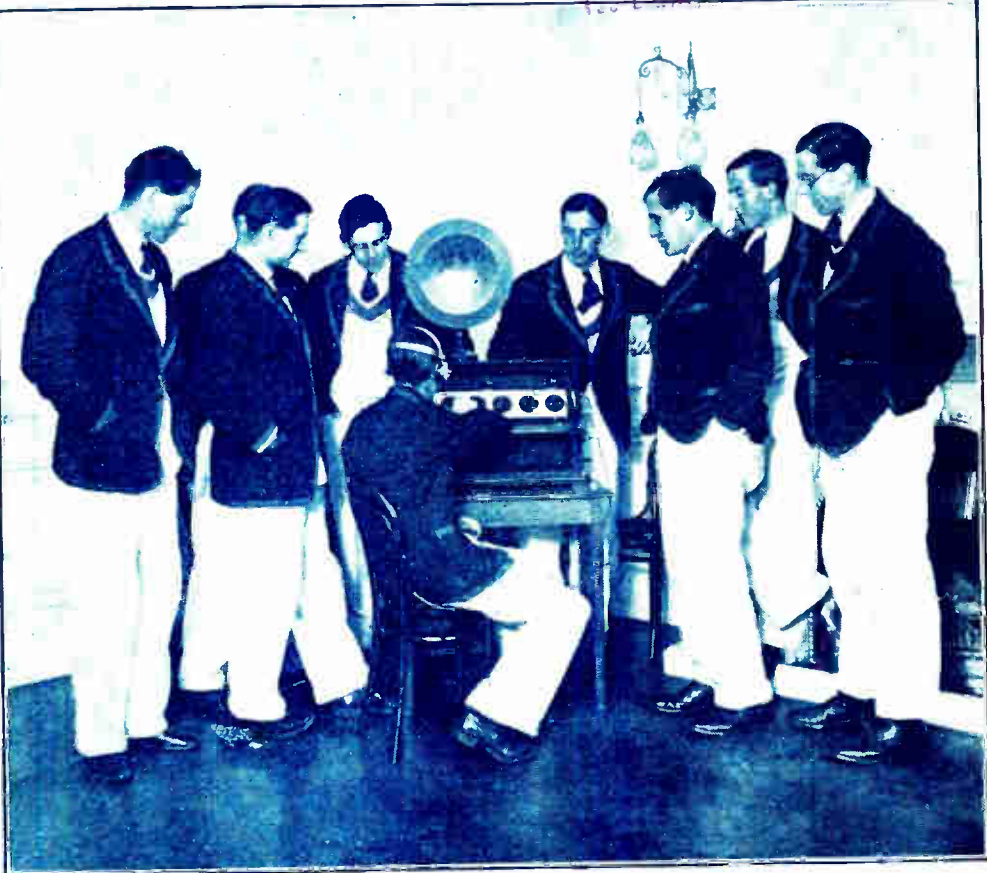

THE COX OF THE OXFORD ROWING EIGHT TAKES THE HELM ON A "STRAIGHT EIGHT" SET

**ACCURACY
GUARANTEED**
Value absolutely constant



You know where you are
with
Dubilier Condensers

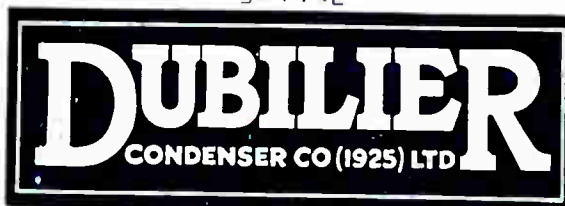

ADVERTISEMENT OF THE DUBILIER CONDENSER CO. (1925) LTD., DUCON
WORKS, VICTORIA ROAD, N. ACTON, W.3. TELEPHONE: CHISWICK 2241-2-3.

E.P.S. 180

Mention of "The Wireless World," when writing to advertisers, will ensure prompt attention

Choose
MARCONI VALVES



Type D.E.R. 14/-

Filament Volts 1.8
 Filament Amps. 0.35
 Anode Volts 30-80
 Impedance (ohms) 22,000
 Amplification Factor 9



Type D.E.4 22/6

Filament Volts 3.8
 Filament Amps. 0.30
 Anode Volts 20-120
 Impedance (ohms) 19,000
 Amplification Factor 7



Type D.E.2 L.F. 15/6

Filament Volts 1.8
 Filament Amps. 0.12
 Anode Volts 20-80
 Impedance (ohms) 22,000
 Amplification Factor 7



Type D.E.8 L.F. 22/6

Filament Volts 5.6-6
 Filament Amps. 0.12
 Anode Volts 20-100
 Impedance (ohms) 8,000
 Amplification Factor 7



The Valve in the Purple Box.

Write for Valve Booklet No 443A.

Type D.E. 5
 6-volt
 for 22/6

Best Possible RESULTS



Type D.E.6 18/6

Filament Volts 1.8-2
 Filament Amps. 0.5
 Anode Volts 60-120
 Impedance (ohms) 10,000
 Amplification Factor 5.5



Type L.S. 5 40/-

Filament Volts 2.5-5.25
 Filament Amps. 0.8
 Anode Volts 60-400
 Impedance (ohms) 6,000
 Amplification Factor 5

THE MARCONIPHONE COMPANY LTD.
 Regd Office Marconi House, Strand, London, W.C. 2.
 Head Office 210-212 Tottenham Court Road, London, W.1.

USE BURNDEPT COMPONENTS

and ensure perfect results

EVERY requirement for radio reception is covered by the Burndept range of components. Their use ensures complete satisfaction, as the quality of Burndept products never varies—this is a fixed policy.

All stages of manufacture are carefully supervised and the finished products rigorously tested before leaving the factory.

Fit Burndept Super-Vernier Dials to your set and find out how easy "tuning" becomes.

There is a Burndept Super Valve to suit your set, and every valve is guaranteed. Any Burndept dealer will be pleased to show you the complete range. Demonstrations can be arranged

BURNDEPT
WIRELESS LIMITED

Aldine House, Bedford St., Strand, London, W.C.2.

Telephone:
Gerrard 9072
(4 lines)

Branches and Agents
Everywhere.

Telegrams:
Burndept, Westrand,
London.

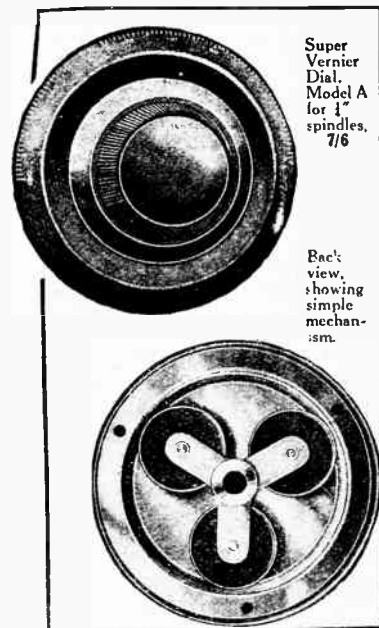

WHAT ABOUT H.F. RESISTANCE?

How often have you found coil manufacturers publishing the H.F. resistance of their coils? Gambrell's are proud of *all* their figures. Study them well—they are unapproachable by any other coil on the market.

GAMBRELL COILS		Nearest Size in Ordinary Coils.	Inductance.	Selt Capacity.	H.F. Resistance.
SIZE	PRICE		Mics.	Mfd.	Ohms.
a/2	4/10	18	13	·000004	1·5
a	4·10	25	26	·000004	2
A	5·-	30	51	·000004	2·5
B1	5/3	40	108	·000005	3·5
B	5/6	50	200	·000005	4·5
C	5/9	75	360	·000006	6·5
D	6/3	100	780	·000006	11
E1	6/9	150	1400	·000007	15
E	7/9	200	3000	·000008	19
F	8/6	300	6000	·000009	30
G	10/-	500	12200	·000011	37
H	12/6	750	24800	·000014	48
I	14/-	1000	68000	·000017	75
J	17/6	1500	165000	·000021	130

Now make up your mind to try out Gambrell coils—they'll make a wonderful improvement to your results.

Write for new component booklet showing new reduced prices.

GAMBRELL BROS. LIMITED, 76, VICTORIA STREET, S.W.1.

The Premier Pair—



Every night and on every kind of set they are giving wonderful service. Enthusiasts who have probed all the resources of their local dealer settle down at last to this very practical combination.

Their construction is based on cumulative experience that began with the beginning of wireless valves. They work well either individually or together. But excellently well together

The valves illustrated are one of the well-known Edison Swan pairs. If you have not tried them together you have still to discover the best that your set can give.

Ediswan Valves are entirely British made.

Ediswan ARDE is made to function either as a L.F. amplifier or detector (green line) or as a H.F. amplifier (red line). Ediswan PV6 (Loud Speaker Valve) is specially designed for use when ARDE is used in the preliminary stages

The following table indicates the combinations of Ediswan Valves that give the best results:—

Receiving.	Accumulator or Battery Volts.	Power.
AR	6	PV5
ARDE	2	PV6
AR06	3	PV8

With these groups and Ediswan H.T. and L.T. Accumulators the ideal is reached.

EDISWAN VALVES

The PIONEER VALVE

THE EDISON SWAN ELECTRIC CO., LTD.,
123-5, Queen Victoria Street, London, E.C.4.

Simplify
your switching
arrangements!
with

TMC
Low Capacity Keys

THE Amateur Constructor will find many of his switching problems easy of solution if T.M.C. Low Capacity Keys are employed.

These Keys are of simple design, strong and accurately made. Being compact they are most useful where space behind the panel is limited. They are particularly easy to connect up because the ends of the springs are tinned to facilitate soldering.

T.M.C. Low Capacity Keys have many uses. Here are but a few:—

- Distant Control.
- To give choice between:—
- Crystal Detector only and Crystal Detector with low frequency amplification.
- Valve Detector only and Valve Detector with low frequency amplification.
- One or more stages of low frequency amplification.
- Change over from headset to loud speaker.



No. 1 L.C. Key
Price 7/-

T.M.C. Low Capacity Keys are made in 3 models.

- No. 1. 12 point, 3 position 7/-
- No. 2. 6 point, 2 position 6/-
- No. 3. 24 point, 3 position 15/6

Write for descriptive leaflet.

If you cannot obtain T.M.C. Low Capacity Keys from your local dealer apply to the sole manufacturers:—

TELEPHONE MANUFACTURING CO., LTD.,
Hollingsworth Works, West Dulwich, S.E.21.

Phone: Sydenham 2460/1.

CAXTON 4-VALVE CABINET

Made for Sets "All Concert Receiver,"
"Fieldless Coil Three Valve Set,"
"Any Valve Low Frequency Amplifier."
Special Cabinets made to customer's measurements.
Prices Quoted.

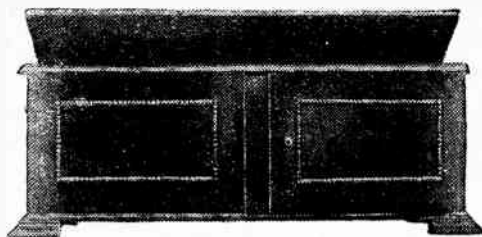

- Cash with Order. Fumed Oak ... £1 5 0
- Dark or Jacobean Oak £1 10 0
- Real Mahogany £1 14 0

Detachable 7" deep Base Board to mount 16" by 8" panel to slide out of Cabinet front.

The two beaded front doors as illustrated, placed 2 ins. in front of the enclosed panel at 10/- extra.

Ebonite or Radion Panels Supplied and perfectly Fitted at low extra cost.

All Polished with the new enamel that gives a glass hard surface that cannot be soiled or scratched. SENT FREE.—Catalogue of standard Wireless Cabinets in various sizes and woods.

Packed and delivered free in U.K.

No. c2

CAXTON WOOD TURNERY CO., Market Harborough

CLIX
REGD TRADE MARK
WANDER-PLUGS
(NON-MICROPHONIC) Patented

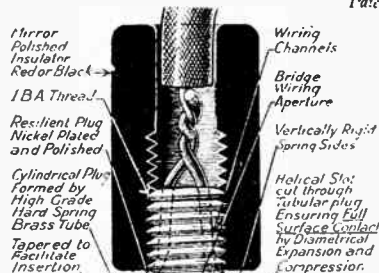

A perfect fitment for every type of H.T. Battery.

PRICE:
2D.
EACH

The diametrical expansion and compression of the CLIX WANDER-PLUG ensures rigid full-length, full-surface contact, with 90% of the efficiency of a soldered joint.

For all other connections use CLIX Plugsockets and adapters.

From all traders or direct from.

AUTOVEYORS LTD., 84 VICTORIA ST., LONDON, S.W.1

AND NOW



A 2 VOLT LOUDSPEAKER VALVE WITH 2½ TIMES THE EMISSION SURFACE OF A 6 VOLT POWER VALVE

Gives better results and greater volume for same input than any other 2-volt power valve. *Makes each accumulator charge last 3 times as long.*

Embodies the wonderful P.M. Filament
A non-microphonic Filament that cannot be broken by the roughest handling.

THE P.M.2-18½

If you use a 4-volt accumulator or 3 dry cells,
Ask for the P.M.3 (general purpose valve) 16/6
Ask for the P.M.4 (loudspeaker valve) - 22/6

GET ONE FROM YOUR RADIO DEALER

Mullard

THE · MASTER · VALVE

ADVT. THE MULLARD WIRELESS SERVICE CO., LTD.,
NIGHTINGALE LANE, BALHAM, LONDON, S.W.12

£10 Weekly in Cash Prizes

Simple Competition
for all Readers of "The Wireless World"

HIDDEN ADVERTISEMENTS

Below will be found six reproductions of fragments cut from the Advertisement pages of this issue of "The Wireless World." Each fragment is a clue. Can you from these clues identify the Advertisements? Seven cash prizes will be awarded to the first seven readers who send us correct solutions. No technical skill is required, merely observation. There are no restrictions or entry fees and the conditions are simple.

£5

for the first
correct solution
opened.

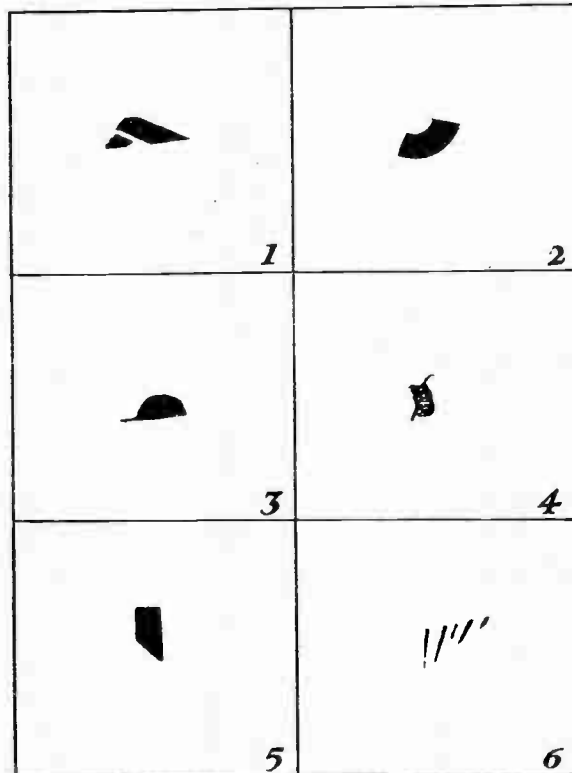

£1

for the third
correct solution
opened.

and

4

consolation
prizes of

10/-

Each

for the next four
correct solutions
opened.

£2

for the second
correct solution
opened.

CONDITIONS

1. All solutions must be written on the special coupon appearing on an advertisement page in this issue and addressed to *The Wireless World*, Dorset House, Tudor Street, London, E.C.4, and marked "Hidden Adverts." in bottom left corner.

2. Clues will not, of necessity, appear in the same way as in the advertisement page, but may be inverted or placed in some other position.

3. In order that town and country readers may compete on equal terms, solutions will not be dealt with until 10 a.m. on Tuesday next. All solutions received before that date will be retained until Tuesday morning. Competitors may submit any

number of entries. Erasures or alterations on a coupon will disqualify the entry.

4. The first prize of £5 will be awarded for the first correct solution opened; the second prize of £2 to the next correct solution; the third prize of £1 for the third, and four consolation prizes of 10/- each for the next four correct answers. In the event of no readers sending correct solutions the prizes will be awarded to the competitors whose solutions are most nearly correct.

5. The decision of the Advertisement Manager of *The Wireless World* is final, and no correspondence can be entered into. Competitors enter on this distinct understanding. No member of the staff of the paper is permitted to compete.



The Secret

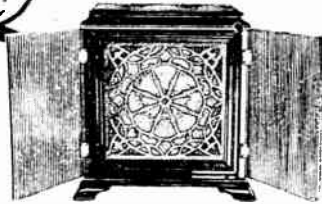

"BECO-DE-LUXE"

of "Beco" popularity lies in the exceptional purity of tone of these wonderful hornless loud speakers. No blatant, distorted "noise," but a beautiful, pure tonal rendering of music, song, and speech, with surprising volume and clarity.

BECO

HORNLESS LOUD SPEAKERS

The "Beco-de-Luxe" (British Made) is an artistic piece of furniture for any home and the volume from it will fill a large hall. Obtainable fitted in either oak or mahogany cabinet. Height 13"

Oak £5 - 0 - 0 Mahogany £5 - 5 - 0

The small 1926 "Beco," a very efficient model with a very pleasing and attractive appearance, gives unusual volume, with crystal clarity 6" high and obtainable at the following prices:

Finished in Nickel Plate	Oxydised Sil- ver or Copper
52/6	55/-



"The 1926 BECO."

Ask your dealer to demonstrate these Models.

Dept. W, British Electrical Sales Organisation,
623, Australia House, Strand, W.C.2.

Telegrams - - - - - "Becospeker, Estrand, London."



Telephone:
CITY 7665

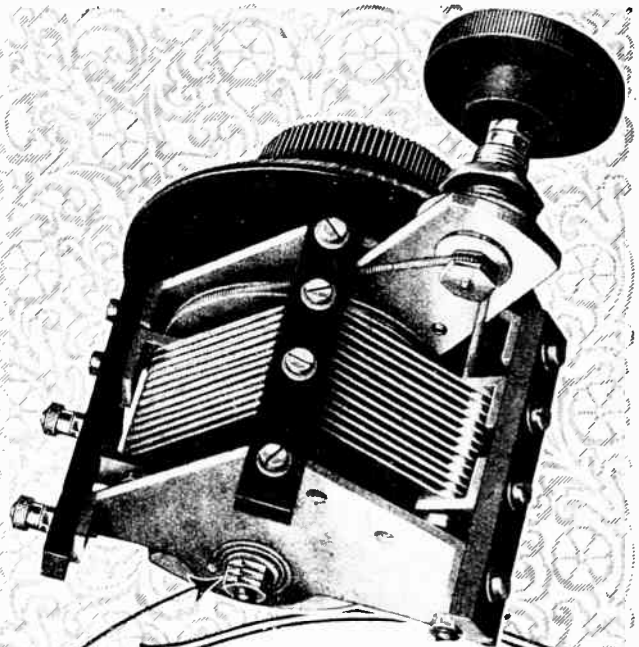

COMPENSATED
SQUARE LAW
EFFECT

LOW LOSS

NO
BACK LASH

LOW LOSS SQUARE LAW SLOW MOTION

THE "Cosmos" Condenser is a slow motion condenser with absolutely no backlash either when new or after use. This desirable feature is accomplished by the use of a spring belt held in tension, which permits coarse tuning with the large knob, and a 10 : 1 slow motion with the small knob.

Cone bearings allow for adjustment and the slow motion bracket can be mounted for remote control as shown in the lower illustration.

The condenser for fine tuning.

METRO-VICK SUPPLIES LTD.,

(Proprietors,
Metropolitan-Vickers Elec. Co. Ltd.)
4 Central Bldgs., Westminster, London, S.W.1.

Prices:
Slow Motion "00025 mtd. 19/-
 "0005 " 21/6
Ordinary "00025 " 15/-
 "0005 " 17/6

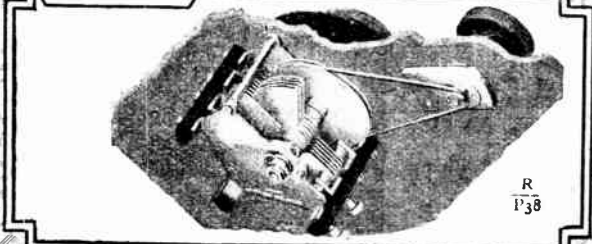
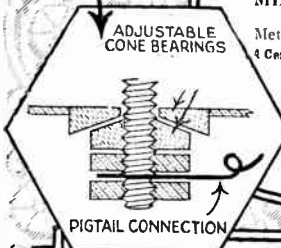

R
P38

COSMOS

Read what a great newspaper says about **ORMOND** condensers



THE GLASGOW HERALD.

WIRELESS.

BY OUR WIRELESS CORRESPONDENT.

CONCERNING CONDENSERS.

With seven or eight variable condensers already in use the writer has just found it necessary to instal two more, and as the selection has involved a certain amount of care and thought, his choice and his reasons for it may be of service to other restless constructors. Both the new instruments are "Ormonds," the writer having had practical experience of the soundness of the products of this firm over a period of several years. One of the condensers is a 0005 of the newest ball-bearing friction control type, the other a 0003 ordinary low-loss, square-law, with vernier. The first is really a beautiful thing, and at 15s. probably the best high-class condenser value in the market. The slow movement—ratio 55-1—is simply perfect in its smoothness and precision, and everything about the instrument bespeaks not only most careful and expert designing but also pride in honest workmanship and high finish. One-hole fixing and a particularly simple adjustment of the knobs and dial combine to make this one of the most entirely satisfactory wireless components which the writer has met with. He is using it for tuning the secondary of a loose coupler which he is seeking to level up to the highest possible plane of efficiency obtainable with moderately-priced constituents. The 0003 is required for tuning an H.F. transformer and, while the new ball-bearing type might have been preferable for this purpose, the saving of 5s. 6d. was a consideration, and an older Ormond 0003, with vernier, has been such a good servant that the 9s. square-law ordinary model seemed "good enough." It is certainly a distinct advance on the former type, and, with one-hole fixing, flat and very rigid end plates, useful terminals, and a "stopped" vernier, as well as normal movement, leaves only very critical requirements to be satisfied.

NEW ORMOND, SLOW MOTION CONDENSER

- 0005 15/-
- 0003 14/6
- 00025 13/6

Complete with Knob and Dial.
IDEAL RATIO 55-1.

Brass End Plates highly nickelled finish.

"at 15/- probably the best high-class condenser value on the market."

"the slow movement—is simply perfect in its smoothness & precision"

"everything about the instrument bespeaks not only most careful and expert designing, but also pride in honest workmanship and high finish"

"one of the most satisfactory wireless components the writer has met with"

THE ORMOND ENGINEERING CO., LTD.,

199-205, Pentonville Road, King's Cross, London, N.1.
Phone: Clerkenwell, 9344-5-6.
'Grams: "Ormondengl. Kincross."

FACTORY: WHISKIN STREET, CLERKENWELL, E.C.1

THE CHOICE OF EVERY EXPERT

The Wireless World

AND
RADIO REVIEW
(13th Year of Publication)

No. 346.

WEDNESDAY, MARCH 31ST, 1926.

VOL. XVIII. No. 13.

Assistant Editor:
F. H. HAYNES.

Editor:
HUGH S. POCOCK.

Assistant Editor:
W. JAMES.

Editorial Offices: 139-40, FLEET STREET, LONDON, E.C.4

Telephone: City 4011 (3 lines).

Advertising and Publishing Offices: DORSET HOUSE, TUDOR STREET, LONDON, E.C.4.

Telephone: City 2847 (13 lines).

Telegrams: "Ethaworld, Fleet, London."

COVENTRY: Hertford Street.

BIRMINGHAM: Guildhall Buildings, Navigation Street.

MANCHESTER: 199, Deansgate.

Telegrams: "Cyclist Coventry."
Telephone: 10 Coventry.

Telegrams: "Autopress, Birmingham."
Telephone: 2970 and 2971 Midland.

Telegrams: "Life, Manchester."
Telephone: 8970 and 8971 City.

Subscription Rates: Home, £1 1s. 8d.; Canada, £1 1s. 8d.; other countries abroad, £1 3s. 10d. per annum.

As many of the circuits and apparatus described in these pages are covered by patents, readers are advised, before making use of them, to satisfy themselves that they would not be infringing patents.

H.F. COIL RESISTANCE.

TESTS on the H.F. resistance of coils recently conducted through *The Wireless World* have evoked more interest even than we had anticipated, and we note that manufacturers are now advertising their coils, taking our measurements as a standard of efficiency. From certain correspondence received and information which has reached us through different channels, it is apparent that the figures given by us have come as a surprise to people who had evidently expected that the high-frequency resistance of such coils as we tested would have come out at a higher value than is actually the case.

Whilst, of course, we had complete confidence in our results before publication was given, it is, nevertheless, of interest to us to have received from Mr. S. Butterworth, of the Admiralty Research Laboratory, Teddington, communications confirming the order of measurement which we have given, and indicating also the high-frequency resistance calculated from mathematical formula which he has himself devised, whilst, in addition, further support is given in a pamphlet on the subject which has just been issued by the Bureau of Standards, Washington.

The measurements which we have carried out on coils have tended to show that, by suitable design of coils, very low values of high-frequency resistance can be attained. But we hope that our readers will not be led

¹ See S. Butterworth, "Losses in Inductance Coils," p. 501 this issue.

into believing that the best design of low-loss coil alone will produce a marked improvement in selectivity and amplification in their receivers if substituted for existing coils. This may not be the case, because it is more than likely that the resistance of the tuning condenser near its minimum value and the general tuning circuit may

have losses greater than the reduction in loss in the coil which has been achieved through special design. If advantage is to be taken of the qualities of a specially "low-loss" coil, then it is quite essential that the remainder of the circuit should be "low-loss" of the same order as the coil.

o o o o

AMATEUR TRANSMITTERS.

OUR correspondence columns have become the battlefield for a new controversy regarding amateur transmissions. We do not think that it is a difficult matter to distinguish between what are legitimate experiments and irresponsible activities, and we consider it most unfortunate that individuals should risk destroying the status of the transmitting amateur and even court a curtailment of the facilities at present at

their disposal by indulging in irritating microphone chatter which can have no connection with experimental work.

In their own self-defence, it seems to us necessary that the Transmitter Section of the Radio Society of Great Britain and all responsible amateurs should publicly disassociate themselves from those who abuse the privileges which every transmitting amateur holds so dear

CONTENTS.

	PAGE
EDITORIAL VIEWS	479
TWO-STAGE POWER AMPLIFIER	480
By N. P. Vincer-Minter.	
NOVELTIES FROM OUR READERS	486
SINGLE SIDE BAND TRANSMISSION	487
By E. K. Sandeman.	
CURRENT TOPICS	491
HINTS AND TIPS FOR NEW READERS	493
AMERICA'S NEW HIGH-POWER STATION	495
By A. Dinsdale.	
NEWS FROM THE CLUBS	498
PIONEERS OF WIRELESS. 12.—J. B. LINDSAY	499
By Ellison Hawks.	
LOSSES IN INDUCTANCE COILS	501
By S. Butterworth.	
NEW APPARATUS	504
BROADCAST BREVITIES	505
LETTERS TO THE EDITOR	507
READERS' PROBLEMS	509

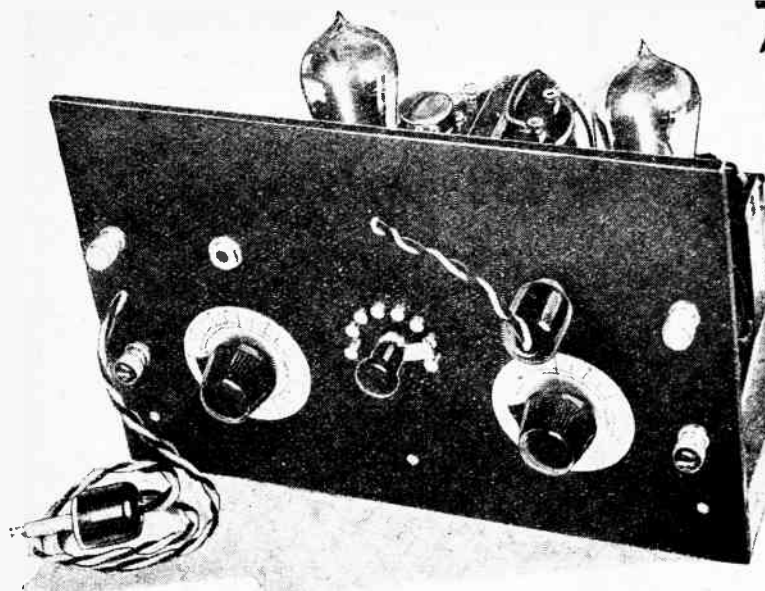

TWO-STAGE POWER : AMPLIFIER *With Volume Control*

Faithful Reproduction Combined
with Adequate Signal Strength.

By N. P. VINCER-MINTER.

IN a recent issue of this journal¹ there was described a receiver employing two stages of radio-frequency amplification, and possessing a very high order of sensitivity and selectivity combined with good quality, ease of manipulation and adaptability to all wavelengths. Now this instrument did not possess any stages of low-frequency amplification, and consequently it would be impossible to use it for operating a loud-speaker from even the local station, although, of course, many distant stations, both Continental and British, could be received on the telephones at the same time that the local station was operative. Of course, the addition of any type of low-frequency amplifier would remedy this state of affairs, and enable several stations to be received on the loud-speaker, and it is proposed in this article to describe a really first-class amplifier suitable for adding to this and any other valve receiver.

This amplifier is designed to give a maximum of volume coupled with faithful reproduction, and whilst it is specially designed to be used in conjunction with the receiver described in the March 17th issue, it is equally suitable for use after any valve receiver.

Designing an Amplifier.

The writer's idea of what one should expect from a good L.F. amplifier is threefold: (1) Ample volume, (2) reasonably faithful reproduction, (3) a smooth control over volume. It will be noticed that the term "reasonably faithful reproduction" is used instead of the more hackneyed "good quality." The reason is that in the opinion of the writer, the function of a wireless receiver, amplifier, and loud-speaker is to give as faithfully as possible an exact replica of the sounds made in the studio, no matter whether these sounds are pleasing or otherwise. It is *not* the function of the receiving apparatus to effect a musical balance between the various instruments of the orchestra, this being the prerogative of the conductor of the orchestra.

Let us now consider the nature of distortion which is likely to be caused by an L.F. amplifier, as distinct from the distortion which may be set up in the receiver.

Broadly speaking, the distortion due to an L.F. amplifier may be classed under two headings: (1) Amplitude distortion, (2) Frequency distortion. The first named arises in the valves, whilst the latter occurs usually in the interval couplings. The first can be cured by the use of suitable power valves designed to handle the fairly large voltage fluctuations necessary to give adequate volume, and the second by the use of suitable interval couplings.

Now it is possible to-day to build a single stage transformer-coupled L.F. amplifier which, from the point of view of faithful reproduction, is all that can be desired

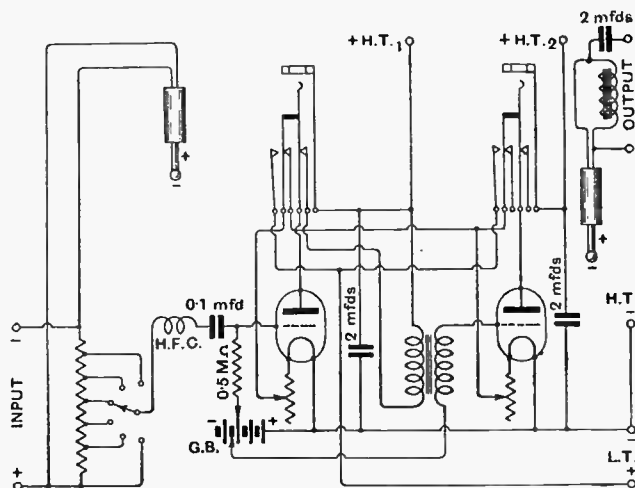

Fig. 1.—Theoretical connections of the amplifier

¹ *The Wireless World*, page 395, March 17th, 1925.

Two-Stage Power Amplifier.—

except from the point of view of the faddist. Unfortunately, however, the volume obtainable, whilst excellent from a near-by station, is not quite great enough for reception from other stations, whilst in a large room even the local station could do with a little more boosting. The addition of a second stage of transformer-coupled L.F. amplification does not unfortunately offer the simple solution to the problem which might at first appear to be the case. Now, with a valve having an amplification

argued by many that the combination of a stage of transformer coupling and of a stage of resistance amplification is no new thing.² Certainly it is agreed that this is no new thing to employ such an arrangement, but the astonishing thing is that in nearly every case users of it lose all that they set out to gain by putting the resistance stage behind instead of its technically correct position of in front of the L.F. stage. Presumably they use the combination of resistance and transformer amplification in order to get the same or nearly the same as is given by a purely resistance-coupled amplification combined with the big amplification given by a transformer stage. This is an excellent idea, and by using first a resistance-coupled stage and then a transformer-coupled stage, is fully realisable, but with the transformer in the first stage, it is difficult to see what benefit can accrue. Yet one needs only to study the various technical publications devoted to wireless to see that even writers of considerable repute are guilty of encouraging the public to commit this fallacy. The only benefit that will be derived when the resistance-coupled stage is put last, is that since less amplification is obtained than with two transformers, the output valve will probably be working within its limits instead of being overloaded. This is certainly by no means to be despised benefit, but since it can be equally well obtained by putting the resistance-coupled stage first, and at the same time other benefits are obtainable, why not gain these benefits by properly designing our amplifier? Let us briefly consider why it is so much better to put the resistance-coupled stage first.

Now it is well known that in order to receive even

² See *The Wireless World*, p. 533, June 4th, 1925.

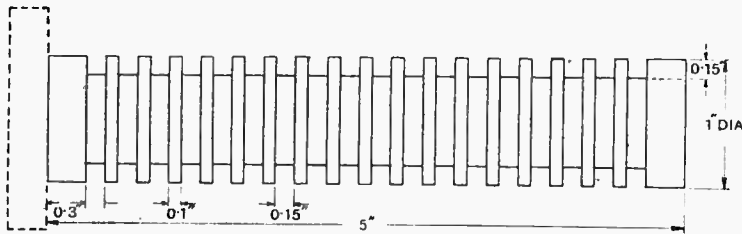

Fig. 2.—Constructional details of the anode resistance.

factor of 7 and a 4 to 1 ratio transformer, we get a theoretical voltage amplification of 28. Thus, if the output from our detector is represented by the figure 1, it is obvious that this will be raised to 28 after the first L.F. stage, and after through a second and similar L.F. stage it is raised to 784. It will be seen therefore, that there is a great disparity between the output of the first L.F. and of the second L.F. valve. The result is that distortion is caused by the fact that the final valve is overloaded even if a small power valve is used. We can get over this difficulty by employing a large power valve such as the L.S.5 in the final stage, but even then, although we may be working within the limits of the output valve, it cannot be denied that the use of two transformer-coupled stages on distant stations is not satisfactory. The method still appears to be over-amplified, whilst "noises" and murr, previously an unpleasant undertone, now become converted into an appalling roar.

The solution of this problem is offered in the present amplifier by the employment of a stage of transformer and a stage of resistance-coupled amplification, and it is furthermore claimed that the amplifier will respond to a weaker input than would be the case if two transformer-coupled stages were employed. Further mention of this will be made later.

Now it may rightly be

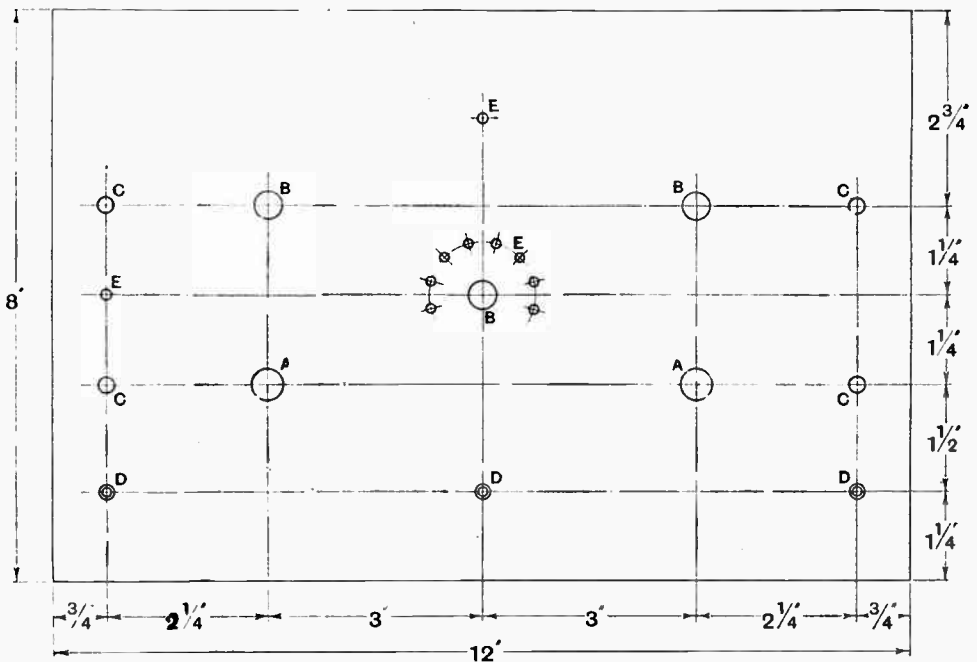

Fig. 3.—Dimensional details of the front panel. Drilling sizes: A, 7/16in. dia.; B, 3/8in. dia.; C, 7/32in. dia.; D, 1/8in. dia., and countersunk for No. 4 wood screws; E, 1/8in. dia.

Two-Stage Power Amplifier.—

frequency amplification in an L.F. amplifier, it is necessary that the impedance connected in the anode circuit of any valve be two or more times the valve impedance. Moreover, it must not be forgotten that the first intervalve coupling follows the detector, which is usually a general purpose valve, and therefore of fairly high impedance.

Coupling the Detector.

Of course, it is possible to use a low impedance valve as a detector, but it is more often than not that a valve of moderately high impedance is used in this position, since it is usually a better rectifier than a low impedance valve. Now the first valve of the L.F. amplifier should be, of course, a small power valve of low impedance, capable of handling a fair amount of power. If, therefore, we decide to make the external impedance connected in the anode circuit of the valve, say, three times the internal impedance of the valve in order to attain even frequency amplification, it is obvious that the impedance in the anode circuit of the

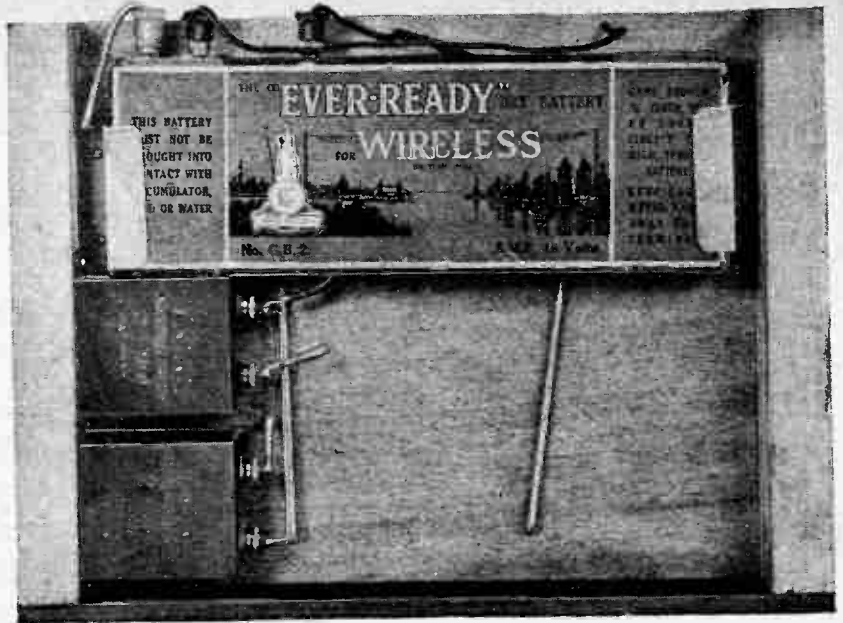

It will be seen that grid battery and H.T. condensers are compactly housed underneath the baseboard.

detector or high impedance valve must be greater than the impedance connected in the anode circuit of the first L.F. or low impedance valve. It is well known that it is a far simpler matter to obtain a choke or resistance of higher impedance than the primary of even the lowest ratio transformers of good make. For instance, it is not difficult to obtain a choke having an inductance of 100 henries, whilst the inductance of the primary of even the best type of low-ratio transformer is only about 50 henries. Similarly, it is not difficult to construct or purchase a wire-wound resistance of 100,000 ohms or more.

Frequency Distortion.

It would appear obvious, then, that the first intervalve coupling which follows the high impedance detector valve requires to be a choke or resistance, whilst a transformer is suitable to follow on after the first L.F. valve which is of low impedance. If we reverse matters, we do not get even frequency amplification in the first stage owing to the fact of the transformer primary not having a sufficiently large impedance, whilst the anode resistance used after the low impedance L.F. valve is rather wasted, since a high impedance is not required there. In fact, if a moment's consideration is given to the matter, the absurdity of putting the resistance stage last will be seen. The effect of using too low an impedance in the anode circuit of the high impedance

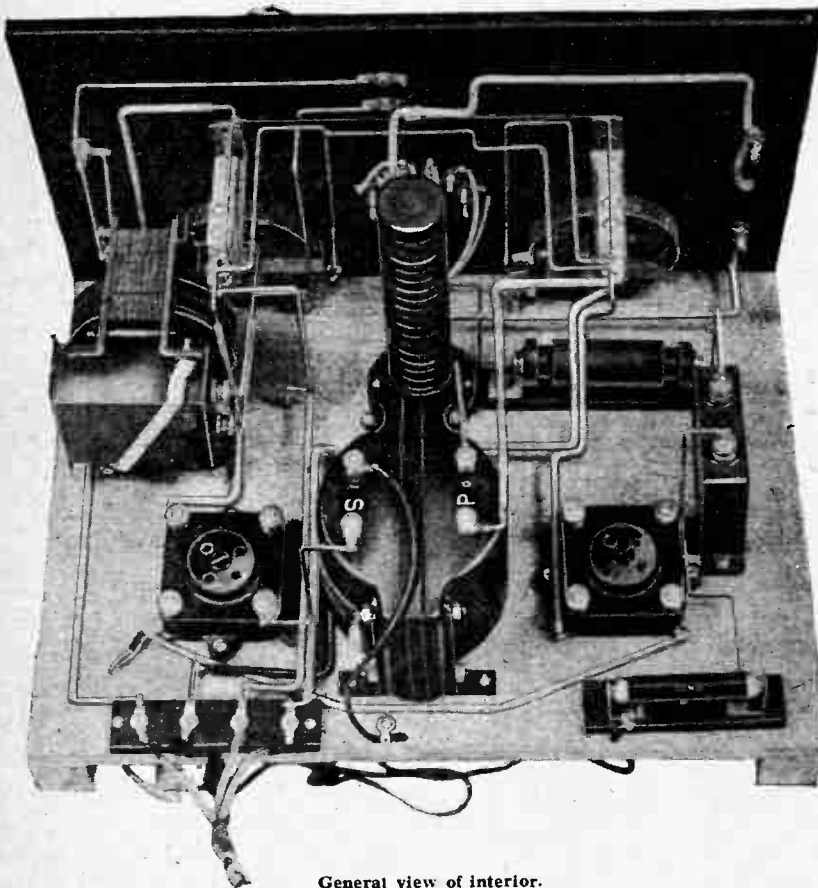

General view of interior.

Two-Stage Power Amplifier.— detector valve, or, in other words, using a transformer with too few turns on its primary, is to lose a lot of the lower musical frequencies, and these can never be recaptured however high we make the resistance in the anode circuit of the second valve, whereas, by using the resistance in the first stage, all the lower tones are successfully amplified and passed to the succeeding L.F. stage. Another point against using the choke or resistance stage after an initial stage of transformer amplification, is that owing to the effect of the large voltage swing passed to the final valve, trouble may be experienced due to the charging up of the grid condenser unless a very high value of grid bias is used. Yet another point in favour of using the resistance or choke stage first is that we may obtain increased amplification without distortion, by introducing a high magnification factor valve into the circuit, namely, as detector valve. Since such a valve has a high impedance it is obvious that we shall get frequency distortion if it is followed by a transformer, whilst if we attempted

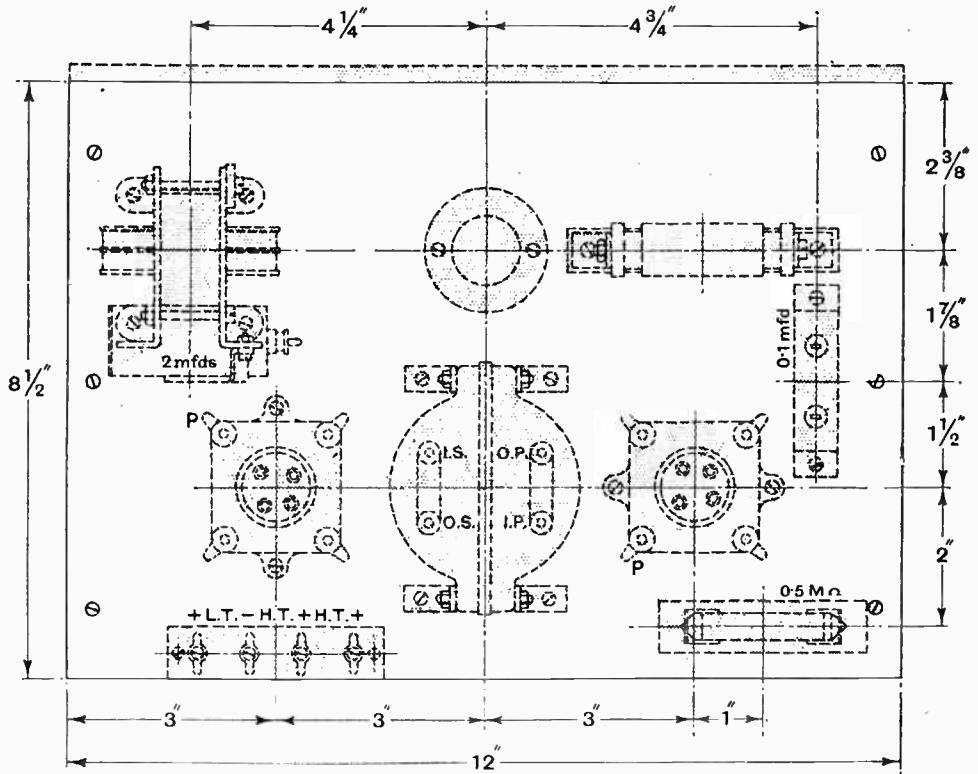

Fig. 4.—Layout of baseboard.

to use it after the transformer, to have the resistance or choke in its anode circuit, we should get amplitude distortion, since it would not be capable of dealing with the big grid voltage swing which must be expected after a transformer-coupled stage. Having definitely proved, then, that in any case it is desirable to use a stage of choke or resistance coupling in the first stage, whilst a transformer may safely be used in the second stage, it remains to be decided which is the better to use: choke or resistance coupling. Choke coupling possesses the great advantage that a lower value of H.T. is required. Has a resistance any advantage to offset the disadvantage of a high anode voltage and make it preferable that it should be used instead of a choke? The answer is very much in the affirmative. The reason is that a resistance coupled stage will definitely respond to a far smaller input voltage than will a choke or a transformer. It has been shown that, owing to the phenomenon of magnetic hysteresis, a choke or transformer has a definite threshold voltage below which it is comparatively insensitive, whilst owing to the absence of an iron core, a resistance does not possess this disadvantage, and will respond to a far weaker signal than

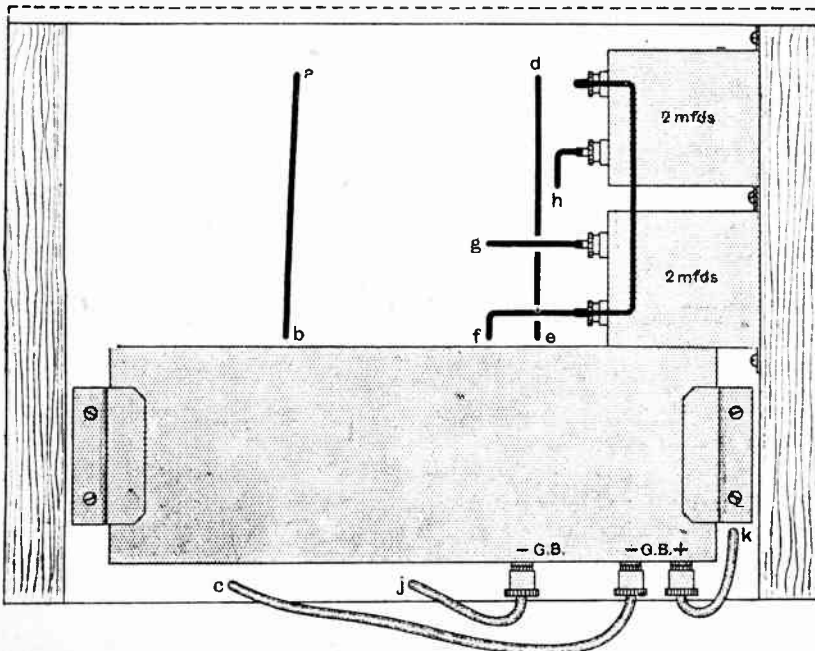

Fig. 5.—Details of underside of baseboard.

LIST OF COMPONENTS.

- | | |
|--|--|
| <p>1 Ebonite panel, 12in. x 5in. x 1/4in. (Britannia Rubber Co.).
 1 Baseboard, 12in. x 8 1/2in. x 1/2in.
 2 Double circuit filament jacks (Edison Bell).
 2 Telephone plugs.
 1 1 to 1 ratio transformer (Marconi Ideal).
 1 Ebonite rod, 5in. x 1in.
 2 oz. No. 17 D.S.C. Eureka wire.
 1 32 Henry choke (Pye).
 3 2 mfd. condensers (T.C.C.).
 1 0.1 mfd. mica dielectric condenser (T.C.C.).</p> | <p>1 0.5 mfd. grid leak and clips (McMichael).
 4 Indicating terminals, 2 input, 2 output (Belling Lee).
 2 Valve holders (Benjamin).
 1 H.F. choke (Cosmos).
 1 16 volt grid battery (Ever-ready).
 2 Dual rheostats (Burndepl).
 1 10 stud switch (Bowyer-Lowe).
 6 Wander plugs.
 Length of red and black flex.</p> |
|--|--|

Approximate cost of materials required £7.

will a choke or transformer. Thus it might occur that a feeble signal from a far distant station was received and rectified by the detector valve which, owing to this phenomenon, elicited no direct response in the iron-cored telephones, nor could it be amplified by a choke or transformer-coupled amplifier for precisely the same reason. A ready response would, however, be elicited by a resistance-coupled stage and would magnify the signal sufficiently for it to overcome

coupled stage should be placed first. It will thus be seen that both resistance and choke couplings are extremely useful in their respective places.

Having therefore justified from all points of view the use of the circuit shown in Fig. 1 as a basis for the design of an efficient L.F. amplifier, we can now proceed to examine the circuit in detail. The first point which attracts our attention is the method of volume control. It will be seen that this consists of connecting the grid of

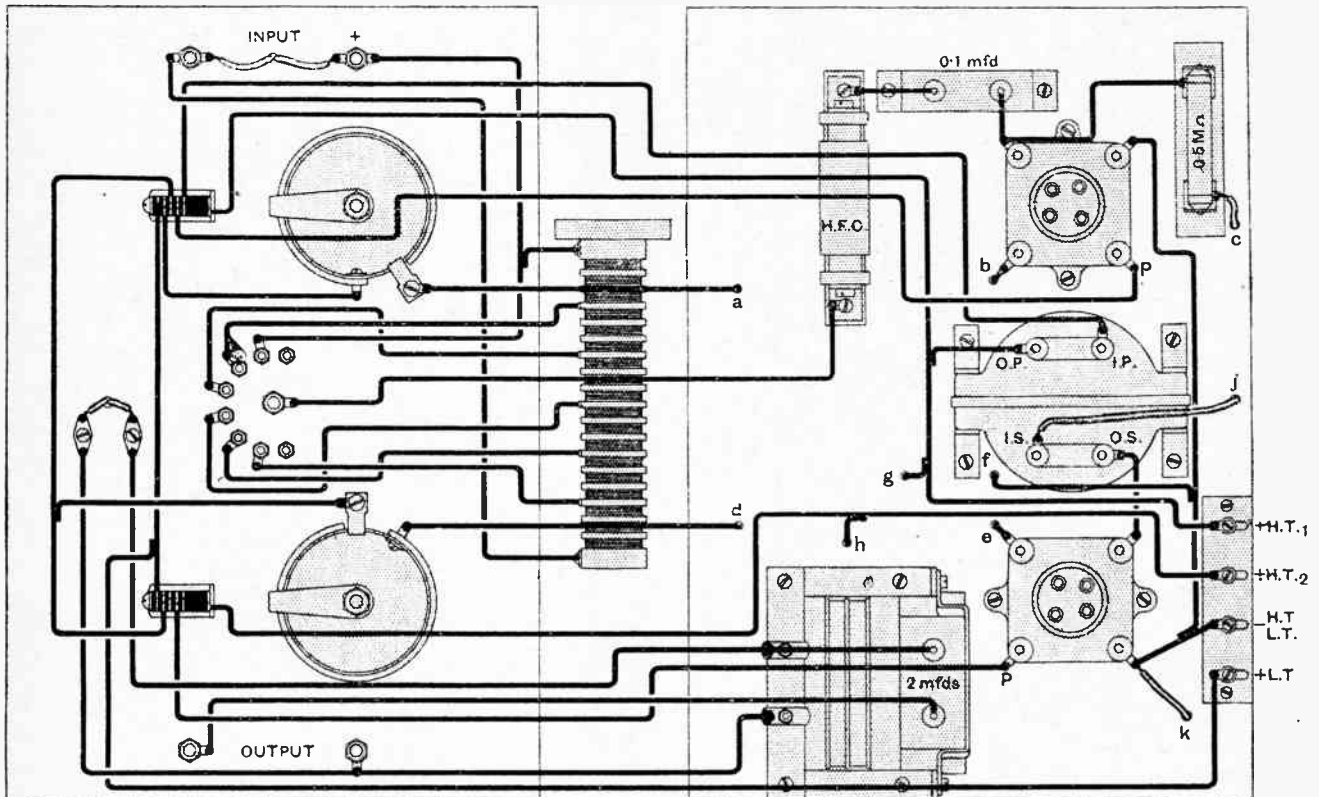

Fig. 6.—The practical wiring diagram.

the threshold voltage of a succeeding stage of transformer-coupled amplification. Not very much amplification would be obtainable from the resistance-coupled stage perhaps, but it would be sufficient for the signal to operate a succeeding transformer-coupled stage, where it would be of sufficient strength to give a good signal in the telephones. It would seem desirable, then, if constructing an amplifier consisting of one resistance-coupled stage and one choke-coupled stage, that the resistance-

the first L.F. valve, by means of a stud switch, to various arbitrary positions on the anode resistance. Now, assuming that the grid is connected directly to the anode end of the resistance, as is customary, it will be obvious that the full voltage developed across the resistance will be available for passing on to the grid of the succeeding valve. If the grid is connected at the mid-point on the resistance, only half this voltage will be passed along to the next valve, and so by taking a number of tappings at

Two-Stage Power Amplifier.—

various points on the resistance, an excellent control over volume is obtained, the greater the number of tappings the finer the control.

In order to avoid any chance of overload distortion in the final valve, it is advised that this valve be one capable of handling a really large voltage swing without distortion, and the D.E.5A. is advised, since this valve will handle a voltage swing of 24 volts with a plate voltage of 120, and a negative grid bias of 12 volts. The first L.F. valve should be of the D.E.5 type. It should be pointed out that the output choke specified is equally

in Fig. 2. The end piece shown in dotted lines is for the purpose of attaching the rod to the baseboard. It consists of a circular disc of ebonite or wood attached to the bottom of the ebonite rod by means of a screw passing through it, and being tapped into the end of the rod. It is necessary to wind 600 turns of No. 47 D.S.C. Eureka wire into each slot, and in order that the winding may be non-inductive, it is necessary to wind each alternate slot in the reverse direction. This will mean a total of 10,800 turns of wire, giving a total resistance of approximately 150,000 ohms. The winding should be tapped at every third slot, the tapping being brought to a screw tapped into the adjacent rib, from which a connection is taken to the stud switch. Of course, it is possible to get a finer control of volume by taking a larger number of tappings. It is possible that many readers will not possess the facilities or skill necessary for constructing this resistance, and as an alternative and simpler method of constructing this component, it might be mentioned that one method of construction is to obtain a wooden rod, $\frac{3}{4}$ in. in diameter, and to thread thereon large cardboard spacing washers of $\frac{1}{2}$ in. external and, of course, $\frac{3}{4}$ in. internal diameter. It should not be forgotten that several of our advertisers have expressed their willingness to construct special components used in *The Wireless World* receivers. Since it is intended to use a D.E.5 in the first stage, and a D.E.5A. in the second stage, a large grid biasing battery should be obtained. This can very conveniently be fitted under the baseboard together with the H.T. condensers.

Tests.

Tested out, both in conjunction with the receiver described in the March 17th issue, and with several other valve receivers, this amplifier fully justified the care devoted to its design and construction, the smoothness of the volume control being a specially noticeable feature, it being possible between the first and last stud to vary the volume from full loud-speaker strength to pleasant head-phone strength without in the slightest degree altering the general tone obtainable, which was at all times fully equal to that of the best type of purely resistance-coupled amplifier.

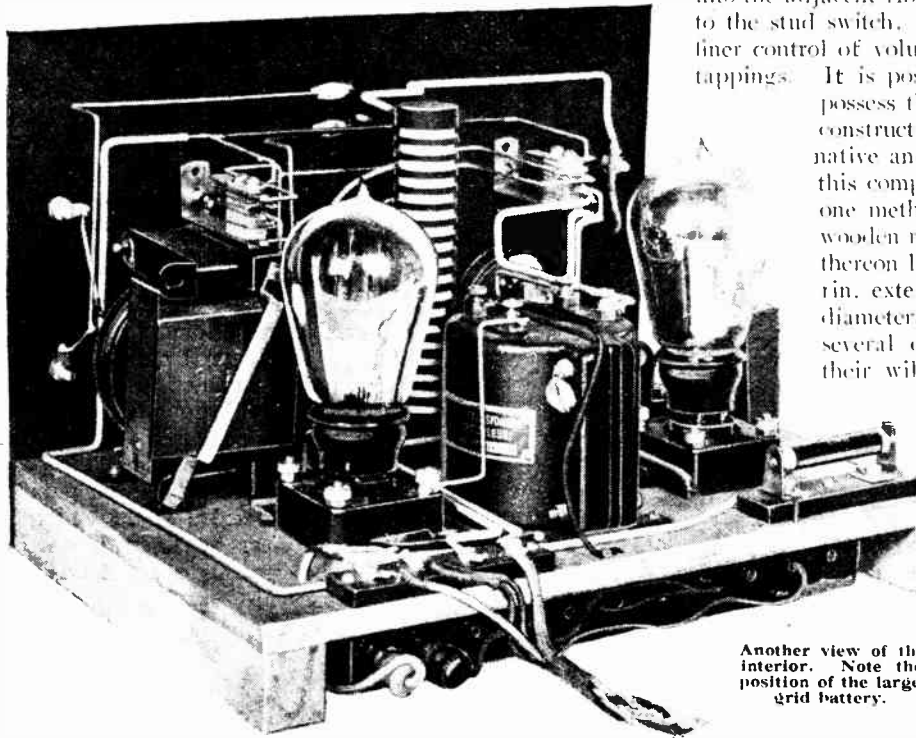

Another view of the interior. Note the position of the large grid battery.

suitable for either the D.E.5 or D.E.5A. valves. If it is not intended to use the amplifier very close to a broadcasting station, the first valve may be a D.E.5 instead of the D.E.5A., although the latter is advised for really first-class reproduction.

Construction.

With regard to the actual constructional work of this instrument, it will be noticed from the photographs that in appearance and construction the receiver follows the same lines as the receiver described in the March 17th issue, and it is so arranged that it may be stood side by side with that receiver, and connected up so that the whole is a highly efficient five-valve receiver, capable of giving good loud-speaker reproduction of stations at a considerable distance. At the same time, the amplifier is equally suitable for use with any other type of valve receiver. The only point which is likely to give trouble in the constructional work is the special tapped anode resistance. It is necessary to obtain an ebonite rod $\frac{5}{8}$ in. long and $\frac{1}{2}$ in. in diameter, and to cut 18 slots to the dimensions given

OUTDOOR WIRELESS.

The issue of "The Wireless World" for April 14th will be largely devoted to the subject of outdoor wireless and portable sets. A guide to Portable Sets by the various makers will be included, with descriptions, to assist prospective purchasers.

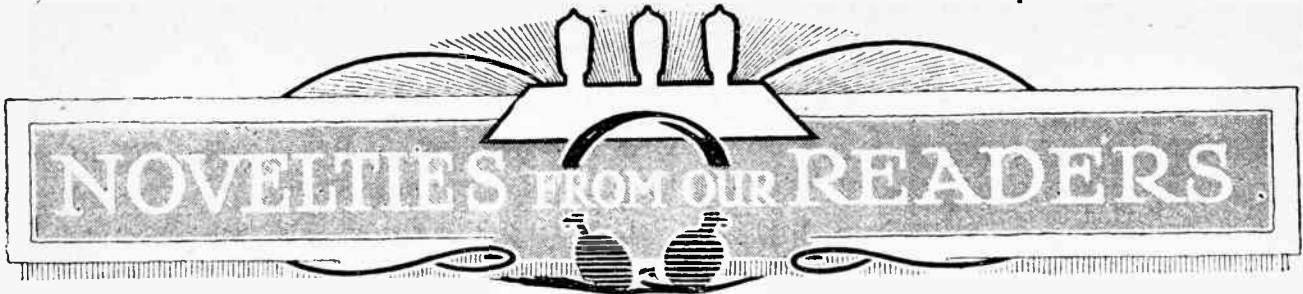

A Section Devoted to New Ideas and Practical Devices.

SERIES CONDENSER CONNECTIONS.

When operating a set in conjunction with an aerial of high capacity, it is customary to connect a small fixed condenser between the aerial lead-in and the aerial terminal of the set. If the condenser is mounted on a small ebonite panel with terminals and connectors slotted to fit the terminals of the set as shown in the diagram, three distinct circuits are made available for aerial tuning. For direct coupling to the aerial, the condenser may be fixed to the aerial terminal by means of one of the tags, the aerial wire being fixed to the corresponding terminal as in diagram (a). The arrangement giving the series connection for the condenser is

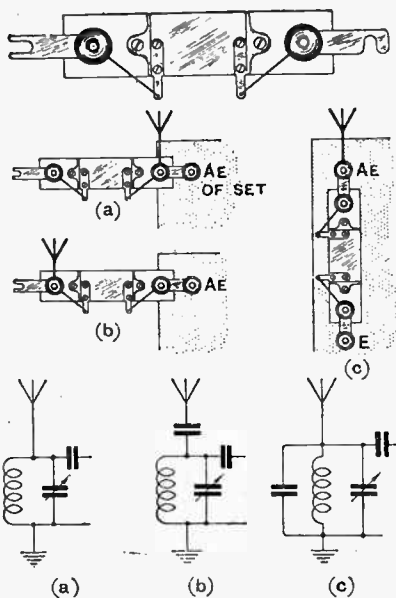

Series aerial condenser unit

shown in diagram (b), while (c) shows how the wavelength range may be increased by connecting the condenser across the "Aerial" and "Earth" terminals.—E. A. A.

H.T. AND L.T. SWITCH.

By shortening one of the contact springs of a Lissen push-pull switch it is possible to arrange for the H.T. and L.T. currents of a receiver to be interrupted by a single movement.

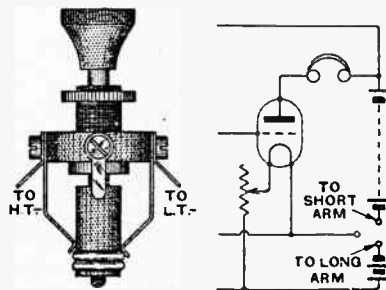

Push-pull switch for H.T. and L.T

The springs are adjusted to approximately the same length, but by suitably bending one of them it can be arranged for the ring on the ebonite plunger to touch the L.T. contact spring before the H.T. contact spring. The difference in length necessary to bring about this result need only be very small, so that when the switch is in the full "on" position both springs will be in the groove in the contact ring. It will be seen from the circuit diagram that the contact ring and centre spindle are connected to the common H.T. and L.T. lead and the contact springs to L.T. — and H.T. — respectively.—L. H.

VALVES FOR IDEAS.

Readers are invited to submit brief details, with rough sketches, where necessary, of devices of experimental interest for inclusion in this section. A receiving valve will be despatched to every reader whose idea is accepted for publication.

Letters should be addressed to the Editor, "Wireless World and Radio Review," Dorset House, Tudor St., London, E.C.4, and marked "Ideas."

WEATHERPROOF EARTHING SWITCH.

The ordinary type of earthing switch is exposed to the weather and rapidly becomes oxidised in unsound electrical contacts. In the switch shown in section in the diagram there are no moving contacts exposed to the air.

A short length of brass tube D is mounted laterally in an ebonite rod C, which may be rotated from the inside of the house by means of the brass rod B mounted in bearings in an ebonite lead-in tube A. Two short glass tubes, which are a sliding fit on the brass tube D, are secured in position by means of a little hot paraffin wax and are sealed at the end in a similar manner by brass plugs E. The tube contains a small quantity of mercury M.

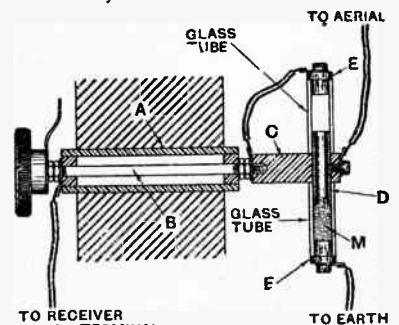

Weatherproof earthing switch and lead-in.

In the position shown in the diagram the mercury connects the tube D to the lower cap E, and thus joins the aerial directly through to earth. By rotating the tube through an angle of 180 degrees the aerial is connected through the rod B to the aerial terminal of the receiver inside the house. To prevent oxidation the bore of the tube D and the ends of the caps E should be amalgamated before fitting the parts together.—W. A. E. Q.

SINGLE SIDE-BAND TRANSMISSION.

The System Used in Transatlantic Telephony.

By

E. K. SANDEMAN, B.Sc.

Readers who, viewing the matter from the standpoint of broadcasting, have been puzzled by some of the facts brought to light in recent correspondence on the Rugby telephony tests, will find in this article a solution to their difficulties.

Reviewing first the principles of ordinary telephony transmission, the author then goes on to explain the nature of the wave transmitted from Rugby by the system at present in use.



IN order that the principles underlying single side-band transmission can be clearly understood it is essential that the fundamentals of ordinary transmission be very clearly appreciated. In what follows, therefore, the principles of ordinary transmission are first elaborated, and then the principles of transmission by means of a single side band are developed step by step.

Modulation.

The process called modulation in radiotelephony normally consists in making the amplitude of a so-called "carrier" wave vary according to the air pressure changes occurring as part of the original sound which it is required to reproduce at some distant point. Systems have been considered in which the frequency or the phase of a carrier wave is varied, but these have not had much practical application, and only the case of amplitude modulation is here considered.

A carrier wave ideally is of pure sinusoidal form, that is, it results from electrical oscillations of simple harmonic form, or, in everyday language, it is of the form of vibration resulting when a weight supported on a spring is displaced from its position of equilibrium and then released. (Strictly, for the purpose of this example, it should be assumed that the rate of decay of the motion due to damping is zero.) Such vibrations

possess, among others, the property that circuits may be devised by means of which sinusoidal vibrations of different frequency may be distinguished one from another. In fact, since the frequency of vibration is the characteristic which chiefly distinguishes these vibrations, it has become customary to speak loosely of such vibrations as "frequencies." So that mention of a frequency of 100 cycles per second usually refers tacitly to a sine wave, unless special information to the contrary is supplied.

In Fig. 1 at A and B are shown sine waves, one twice the frequency of the other, and at C is shown the composite wave form resulting from the combination of A and B. It is possible to resolve any continuously repeated wave form, however complex, into a series of frequencies of differing amplitude and phase.

Analysis of a Modulated Wave.

In Fig. 2 at A is shown a single frequency which may be taken as one of the component frequencies of music. If we assume its frequency to be 2,500 whole waves or cycles per second, then a carrier wave of 50,000 cycles per second (which is of the order of frequency that will be employed, for instance, for transatlantic telephony), drawn to the same time scale, will have twenty whole waves represented in the same time interval as one whole wave as shown at A. At B in Fig. 2 is shown such a

Single Side-band Transmission.—

wave, but for simplicity no attempt has been made to show the correct number of waves.

The results of modulating a wave similar to that at B by a wave such as that at A normally produces a wave of the form shown at C, which is in effect a sinusoidal wave of frequency 50,000 cycles, whose amplitude varies sinusoidally at 2,500 cycles.

(The factor K in Fig. 2 is usually called the percentage modulation.)

At no point does the amplitude of the wave at C reach zero. It is therefore fairly apparent that such a wave can be split up into two waves of frequency 50,000 cycles, one of constant amplitude C, and one of maximum amplitude zero, whose amplitude varies at a frequency of 5,000 cycles; the variation in this case is not sinusoidal. These waves are indicated at B and D respectively, the original carrier wave serving to represent the first derived wave. It is not so evident, but it is a fact, that the wave at D can be split up into two waves of constant amplitude $\frac{1}{2}KC$, one of frequency $50,000 + 2,500 = 52,500$ cycles, and the other of frequency $50,000 - 2,500 = 47,500$ cycles per second. These are indicated (not to scale) at E and F in Fig. 2.

Complex Wave Forms.

The reverse process is probably one with which many people are familiar in practice: if two suitable notes low

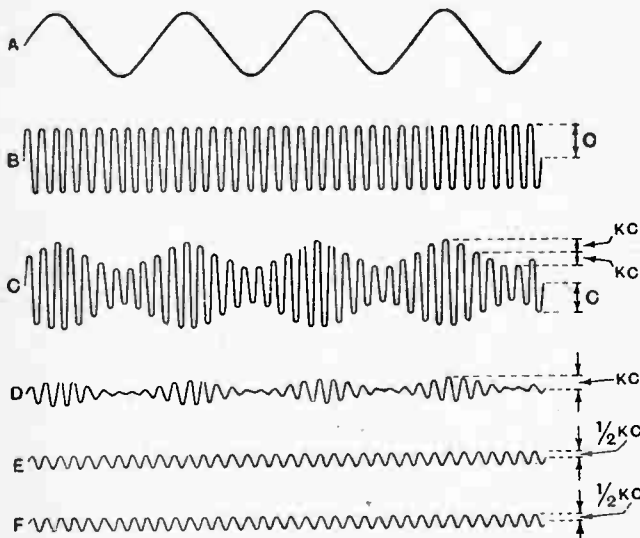

Fig. 2.—Modulated high-frequency wave C analysed into its component frequencies.

down on the piano scale are struck simultaneously the resultant sound fluctuates in intensity, owing to the fact that the sounds are in phase at one point of time, and out of phase at a short time interval later. This process

is illustrated in Fig. 3, where a time interval of one second has been shown, and two frequencies, one of 5 and the other of 3 cycles per second. It is seen that the frequency of the fluctuation is equal to $5 - 3 = 2$ cycles per second. The fact that the composite wave does contain the original frequencies 5 and 3 cycles may easily be demonstrated by applying the composite wave to a circuit which will only receive 5 cycles per second, or only 3 cycles per second. The received intensity is quite independent of the presence of the second component.

Returning to Fig. 2, then, the fact must be accepted that the products of modulation of a pure carrier wave of frequency f_c by a voice frequency f_v normally consists of three single frequencies f_c , $f_c + f_v$, and $f_c - f_v$. Speech and music are made up of complex wave forms of continually changing shape and intensity, which repeat themselves sufficiently often, however, for definite periodicities to be assigned both to the complex waves and to the component frequencies into which they may be resolved for purposes of analysis. Theory indicates and experiment confirms that if a telephone system is capable

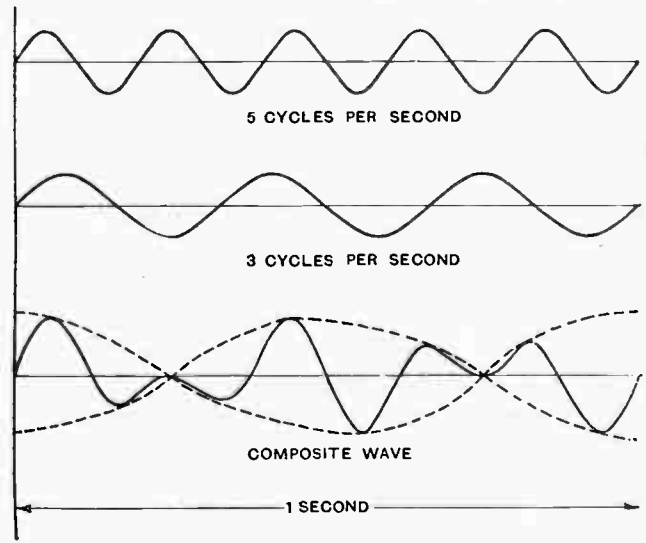

Fig. 3.—A beat frequency of 2 cycles per second produced by the combination of waves with frequencies of 5 and 3 cycles per second respectively.

of reproducing equally all the component frequencies of speech and music, then a very good approximation to faithful reproduction is obtained. For perfect reproduction there are other requirements with which we are not here concerned; we may assume that all essential requirements are satisfied in the systems under present consideration.

The Telephonic Frequency Range.

The range of frequencies required for the faithful transmission of music extends from about 30 to 10,000 cycles per second, and for the faithful transmission of speech from about 100 to 5,000 cycles per second. For speech, very satisfactory results may be obtained, from a standpoint of intelligibility, with a very much smaller range. Many commercial telephone land line circuits only transmit a range from 200 to 2,500 cycles, and some only from 200 to 1,800 cycles. Extremely good com-

Single Side-band Transmission.—

mercial results could be obtained with a band 2,500 cycles wide, and we will imagine that it is required to transmit such a band extending from 200 to 2,500 cycles.

What is a Side Band ?

If we were to modulate a carrier wave of 50,000 cycles with such a band of frequencies, we should obtain for every voice frequency two radio frequencies, one above 50,000 cycles and one below. Corresponding to the band of voice frequencies 200 to 2,500 cycles, there

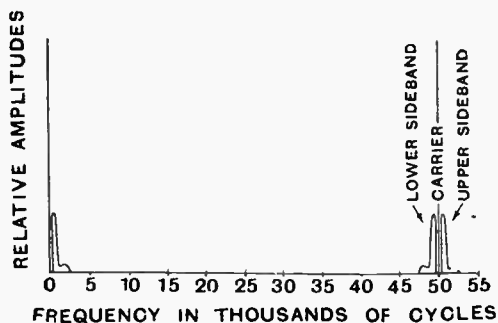

Fig. 4.—Side bands produced in ordinary telephony.

would therefore result two bands of radio frequencies, one from 50,200 to 52,500, and one from 47,500 to 49,800 cycles. This is indicated diagrammatically in Fig. 4.

The bands of radio frequencies each side of the 50,000 cycle carrier frequency are called "side bands." The left hand is usually spoken of as the lower side band, and the right as the upper side band.

If the curved line bounding the top of the voice frequency band represents the average relative amplitudes of the voice frequencies, then similar curves represent the average relative amplitudes of the side bands when the diagram is plotted on a straight frequency scale.

Detection.

The process of detection, whatever its principle, may be regarded as being one which takes advantage of the difference in amplitude and phase between each of any pair of side-band frequencies (corresponding to any one initial voice frequency) and the carrier frequency. By virtue of the fact that the voice frequencies are represented by frequency differences between the corresponding radio frequencies and the carrier frequency, the process of detection is able to reproduce the initial voice frequencies. Such being the case, it would seem reasonable to suppose that, with the carrier frequency, and only one side band, it would be possible to reproduce the initial voice frequencies. This is actually so, and certain important advantages accrue if not merely one side band but also the carrier wave itself are suppressed and only one side band is transmitted.

Interference.

If there were no sources of etheric disturbances, such as electric railways, power transmission lines, mercury rectifiers, car magnetos, and lighting systems, apart from natural phenomena such as thunderstorms and aurora, and

if there were only one transmitting station in the world, then it would appear that the energy radiated from the one transmitting station could be reduced indefinitely without adversely affecting the reception at any point, provided always that there were no limit to the amount of amplification employed. Assuming the above to be true, in the practical case the power output of a station is determined not by the absolute strength of the received signal at the point to which it is desired to communicate, but by the ratio of the strength of the received signal to the received noise. It is evident that, with modern methods of securing selectivity, the only noise of importance is that which occurs within the range of radio frequencies transmitted. It is, therefore, an advantage if the range of transmitted frequencies can be reduced without reducing either the intelligibility of speech or the received signal strength.

Considerations Affecting the Radio Transmitter.

In order that the modulated wave shall be transmitted without distortion, it is necessary that the valves in the radio transmitter shall not be overloaded. This sets a limit to the permissible peak voltages which can occur in the radio transmitter. Referring to Fig. 2, it is evident that, from a standpoint of peak voltages, the voltages of the two side bands are directly additive; this follows since the peak voltage at E is twice either of the constant A.C. voltages at F and G. Hence one side band can be transmitted with twice its amplitude if the other side band is suppressed. The process of detection is such that the voice frequency components formed by taking differences between the carrier wave and each side band are directly additive. Hence the effect of suppressing one side band and transmitting the other at double amplitude is that the received signal strength remains unaltered.

Single Side-band Transmission.

Since in the radio transmitter the voltages of the carrier wave and the remaining single side band are also directly additive, a further increase in the strength of the single side band is possible if the carrier wave is also suppressed and the single side band transmitted alone; the carrier frequency necessary for detection is then generated at the receiving station. By these means, assuming a peak modulation of 100 per cent., the amplitude of the received single side band may be made four times that of either of the side bands in a normal "double side band plus carrier" transmission, and the detected voice frequency component is then twice as strong as in the normal transmission. (If we assume a normal peak modulation less than 100 per cent., the improvement resulting from single side-band transmission is correspondingly greater.) The ratio of the received signal to received noise is increased four times, assuming selective arrangements proper to the single side band have been adopted.

It should be noted here that no reference has been made to signal "loudness," but only to detected audio-frequencies, by which is meant the audio-frequency voltages obtained on detection.

(To be concluded.)

EXPERIMENTAL TRANSMITTING STATIONS.

Further Supplement to the lists published in the "Wireless Annual for Amateurs and Experimenters," 1926.

AUSTRALIA.

NEW SOUTH WALES.

- 2 AB A. V. Badger, 10, Alfred St., Rozelle.
- 2 AG Ashfield Service Station, Liverpool Rd., Ashfield.
- 2 BE Burgin Electric Co., Kent St., Sydney.
- 2 BL Broadcasters (Sydney), Ltd., Sydney.
- 2 BM B. Martin, Mona St., Banksia.
- 2 BW W. H. Barker, "Enripides," Wallace St., Concord.
- 2 CG C. Gorman, 43, George St., Rockdale.
- 2 FC Farmer & Co., Ltd., Sydney.
- 2 FR F. R. Bassett, "Rainona," Carrington St., Bevely.
- 2 FT S. R. Filmer, Bundee, Toronto.
- 2 FW F. P. Woolcott, 55, St. George's Crescent, Drummoyno.
- 2 GC C. A. Carwool, Brookland, via Ulong.
- 2 HD H. A. Douglas, Newcastle.
- 2 HR H. E. Rose, "Yanganbil," Warren.
- 2 JB P. J. Brown, 131, Avoca St., Randwick.
- 2 JP J. H. A. Pike, Rawson St., Epping.
- 2 JY J. W. Young, Eastern Rd., Turramurra.
- 2 KY Trades and Labour Council Trades Hall, Goulburn St., Sydney.
- 2 LB L. P. R. Bean & Co., 229, Castlereagh St., Sydney.
- 2 LK L. K. Connor, Coorwull, Yangoon Rd., Belmore.
- 2 LL L. S. Lane, "Allowrie," Silver St., Randwick.
- 2 LW L. J. Wellman, 18, Mecks Rd., Marrickville.
- 2 MH C. E. Morton, "Saida," Underwood Rd., Homelush.
- 2 MK Mocker Bros., Howick St., Bathurst.
- 2 MS C. M. Saunty, "Cambridge," Baugalla St., Warrawee.
- 2 MU J. Naugle, "St. Elmo," 11, Tupper St., Marrickville.
- 2 NI H. B. Hammond, "Chesterfield," Chesterfield Rd., Epping.
- 2 PS P. G. Stephen, 18, Clifton St., Balmain.
- 2 RC R. R. Chilton, Chilton Ave., Wahroonga.
- 2 RD W. R. Harly, 225, Bridge Rd., Glebe.
- 2 RP R. P. Rimmer, Gordon St., Gordon.
- 2 SJ S. Johnson, Mortimer St., Mudgee.
- 2 SP R. Evans, "Garth Craig," 6, Flood St., Clovelly.
- 2 ST S. E. Tatham, 160, Castlereagh St., Sydney.
- 2 SW C. L. Southwell, "Knockholt," Cremorne St., Cremorne.
- 2 TB T. H. Squelch, Byron St., Bangalow.
- 2 TK T. K. Abbott, "Murrulla," Wingen.
- 2 TY T. R. Troy, "Glenroy," Great Northern Rd., West Maitland.
- 2 UE Electrical Utilities, Storey St., South Bankwick.
- 2 VS V. E. Stanley, 9, McLean Ave., Chatswood.
- 2 WB W. N. Bullivant, Charles St., Albany.
- 2 WH W. H. R. Still, "Waudary," Forbes.
- 2 WT C. R. Watt, "Warrenfels," Tenterfield.
- 2 ZH New System Telephones Pty., Ltd., 280, Castlereagh St., Sydney.

VICTORIA.

- 3 AF A. F. W. Bent, 14, Coronation St., Geelong, W.
- 3 AK N. V. C. Vausick, St. Southey St., St. Kilda.
- 3 AR Associated Radio Co. of Australia, Ltd., 44, Elizabeth St., Melbourne.
- 3 AT A. W. Thomson, "Arbroath," Ridley St., Sunshine.
- 3 BK S. C. Baker, 234, Clarendon St., South Melbourne.
- 3 CF C. F. Falconer, 42, Maitland St., East Malvern.
- 3 DJ D. A. J. Stocks, 14, Dryden St., Canterbury.
- 3 EC Y.M.C.A. Bendigo (A. M. Bush) corner High and Mort Sts.
- 3 EO R. J. Egge, Olive Ave., Mildura.
- 3 EV T. E. Evans, 25, Kalyrna Grove, East St. Kilda.
- 3 GL G. L. Barthold, 72, Union St., Malvern.
- 3 GM G. R. McCulloch, Havelock St., Ballarat.
- 3 GN H. G. Schman, 61, Noble St., Chilwell.
- 3 GS G. S. C. Semmens, Laver's Hill.
- 3 HA H. H. Blackman, 44, Osborne Ave., East Malvern.
- 3 JG Jones & Glew, 738, Sydney Rd., Brunswick.
- 3 JO C. L. Rucks, 3, Glenhilt Rd., East Malvern.
- 3 JS J. Schultze, 130, Glenferrie Rd., Glenferrie.

- 3 KX M. McCalman, "Ivanhoe," Dryden St., Canterbury.
- 3 LG L. G. Glen, 73, Elphin St., Newport.
- 3 MY L. D. Money, 8, Maling Rd., Canterbury.
- 3 OG G. J. Menon, 8, Argyle St., St. Kilda.
- 3 PL I. P. Learmouth, McIntyre St., Hamilton.
- 3 PX N. S. Taylor, "The Manor," Jackson St., St. Kilda.
- 3 QH J. F. Feldman, Forest St., South Geelong.
- 3 RH T. E. Evans, 21, Brunswick Rd., Brunswick.
- 3 RL R. Lighton, "Nothgil," 232, Alma Rd., East St. Kilda.
- 3 RN Northote Radio Club (D. J. Hartin), 82, Gooch St., Thornbury.
- 3 RW R. B. Wookey, 158, Kilgour St., Geelong.
- 3 SJ S. J. Mitchell, 5, Brandon St., Brighton.
- 3 SR J. Sullivan, 58, Shoobra Rd., Elsternwick.
- 3 TC T. P. Court, 4, Sorrett Ave., Malvern.
- 3 UD United Distributors, Ltd., 502, Bourke St., Melbourne.
- 3 UZ O. J. Nilson & Co., Bourke St., Melbourne.
- 3 VP C. W. Baker, "Elwell," 101, Williamson St., Bendigo.
- 3 WG W. R. Gronow, 346, St. Kilda Rd., Melbourne.
- 3 WM W. J. M. McAuley, "Mia Mia," Union St., Brunswick.
- 3 WR Wangaratta Sports Depot (L. J. Hellier), Wangaratta.

QUEENSLAND AND NEW GUINEA.

- 4 BM A. R. Milne, Mackay.
- 4 BW A. Cooper, Lloyd St., Mareeba.
- 4 DC D. F. Gibbs, Poston St., Ingham.
- 4 GR Gold Radio, Lindsay St., Toowoomba.
- 4 MB Radio Manufacturers, Ltd., Queen St., Brisbane.
- 4 PJ P. F. Jessop, near Edinonton.
- 4 QG Queensland Govt. Radio Service, Brisbane.
- 4 RK R. K. Knight, "Forest Lodge," Jellieue St., Toowoomba.
- 4 RN Queensland Govt., Rockhampton.
- 4 SM W. G. Ikin, Strand Motors, Townsville.
- 4 WF W. Finney, "Milbong," Arthur Terr., Red Hill.
- 4 WH W. F. Hagarty, Kingfisher St., Longreach.
- 4 WI Wireless Institute of Australia (Old Div.), A. N. Stephens, Brisbane.
- 5 BK Electrical Supplies Depot, 9, Rundle St., Adelaide.
- 5 CB Newton, McLaren, Ltd., Leigh St., Adelaide.
- 5 CC Central Broadcasters, Ltd., Grosvenor Hotel, North Terr., Adelaide.
- 5 DN 5 DN Pty., Ltd., Montpelier St., Parkside.
- 5 GB G. Bailey, Mt. Gambier.
- 5 LA L. M. Atkins, Brougham St., Magill.
- 5 LF L. F. Sawford, Mead St., Peterhead.
- 5 LP A. L. Perry, Strathalbyn.
- 5 MA M. B. Anderson, Torrens Rd., Cheltenham.
- 5 WI Wireless Institute of Australia (S.A. Div.), C. E. Ames, 20, Grange Rd., Hindmarsh.

SOUTH AUSTRALIA.

WEST AUSTRALIA.

- 6 GL G. A. Lorden, 132, Mounts Bay Rd., Perth.
- 6 LS L. Symonds, Glyde St., Cottesloe Beach, Perth.
- 6 MU M. S. Urquhart, Hawkestone St., Cottesloe.
- 7 AS A. S. Gill, 17, Frankland St., Launceston.
- 7 BC N. Cave, 5, Compton St., Launceston.
- 7 DX W. T. Watkins, 146, Warwick St., Hobart.
- 7 LA L. A. Hope, 210, George St., Launceston.
- 7 NP National Portland Cement Co., Maria Island.
- 7 NW N. W. Gillburn, 38, Grosvenor St., Sandy Bay.
- 7 WI Wireless Institute of Australia (Tas. Div.), P. O. Fysh, 181, Charles St., Launceston.
- 7 ZI Associated Radio Co., Hobart.

NEW ZEALAND.

AUCKLAND DISTRICT.

- 1 AD G. E. Mace, Mangūti.
- 1 AE R. V. Roberts, 59, Heppburn St., Ponsonby, Auckland.
- 1 AF G. W. Smithson, 39, Surrey St., Ponsonby, Auckland.

- 1 AJ V. K. Paice, 8, Hopetoun St., Ponsonby, Auckland.
- 1 AK W. H. Claxton, Parawai Rd., Thames.
- 1 AN G. B. M. Arthur, Wilding Ave., Epsom, Auckland.
- 1 AP N. J. Winch, Brady St., Te Awamutu.
- 1 AT G. S. Swain, Mahoe St., Te Awamutu.
- 1 AV* J. M. Bingham, 19, Farrar St., Grey Lynn, Auckland.
- 1 AX R. J. Orbell, Fernhill Lodge, Wilson St., Te Aroha.
- 1 FF* V. J. Williams, Queen St., Waiuku.
- 1 FH* J. Steel, Lywood, Earnock Ave., Takapuna, Auckland.
- 1 FK P. C. M. McIntosh, Kitchener Rd., Waiuku.
- 1 FL J. B. Liggins, Queen St., Thames.
- 1 FM J. E. B. Warn, 19, Woodford Rd., Mount Eden, Auckland.
- 1 FO E. R. Cooper, 8, Louisa St., Ponsonby, Auckland.
- 1 FQ T. R. Clarkson, 16, Huntly Ave., Khyber Pass, Auckland.
- 1 FR R. H. Gillies, 8, Young St., Claudelands, Hamilton.

WELLINGTON DISTRICT.

- 2 AB* D. Wilkinson, c/o Mr. G. Broughman, High St., Motueka.
- 2 AD* P. R. Stevens, 4, Rutene St., Kaiti, Gisborne.
- 2 AE* R. J. Pattv, 159, Lowe St., Gisborne.
- 2 AM* W. F. Buist (Dr.), corner Collins and High Sts., Hawera.
- 2 AN G. A. J. Brunette, Club Hotel, Opunake.
- 2 AT E. Hawthorne, 24, Apuka St., Brooklyne, Wellington.
- 2 AV R. G. Chatfield, 42 Raroa Rd., Kelburn, Wellington.
- 2 AW* C. R. Clarke, Braeburn House, King St., Hastings.
- 2 AX J. V. Kyle, Aokautere, Palmerston North.
- 2 AZ H. L. McDonald, 89, Hamilton Rd., Hataitai, Wellington.
- 2 BA E. W. Beale, 407, McLean St., Hastings.
- 2 BM B. C. W. Spackman, 88, Macdonald St., Napier.
- 2 BQ* E. D. Edmondson, 8, May Ave., Napier.
- 2 BS W. R. Hunter, Barker's Hill, Gisborne.
- 2 BU V. J. Clinch, Scotland St., Picton.
- 2 BY N. C. Shephard, Whangarei.
- 2 BZ L. R. E. Keith, 16, Princes St., Hawera.
- 2 GA J. Johnson, Fortunatus St., Brooklyn, Wellington.
- 2 GC A. Howarth, 12, High St., Dannevirke.
- 2 GH D. M. Tombs, Nelson Boys' College, Nelson.
- 2 GI Palmerston North Radio Club, c/o Linton Defence Rifle Club, 13, King St., Palmerston North.
- 2 GJ F. W. G. White, 16, Ellice St., Wellington.

CANTERBURY DISTRICT.

- 3 AB* F. Vincent, 148, Colombo St., Christchurch.
- 3 AE S. W. S. Strong, Rewanui, Canterbury.
- 3 AO W. G. E. Iwar is 89, Domain Terr., Spreydon, Christchurch.
- 3 CH R. Haxte I, Canterbury College, Christchurch.
- 3 CK J. Baxendale, c/o Mr. Parsonage, Blackball.

OTAGO DISTRICT.

- 1 AA* F. D. Bell, Waiheimo, Palmerston, Otago.
- 4 AF J. M. Strachan, Wentworth St., Gore.
- 4 AS* P. H. Mason, 211, Higate, Maori Hill, Dunedin.
- 4 AU A. E. Bennett, Holy Cross College, Mosgiel.
- 4 AV J. L. Milnes, 39, Lees St., Dunedin.
- 4 AX F. P. Farland, 33, Waverley St., Dunedin.

Experimental Radio Stations.

- 1 XI Auckland University College, University College, Auckland.
- 1 XB E. C. Gaze, 25, Windmill Rd., Mount Eden, Auckland.
- 1 XG E. H. R. Green, 29, Liverpool St., Epsom, Auckland.
- 2 XA E. M. A. Shrimpton, 38, Rongotai Terr., Rongotai, Wellington.

Call signs marked * indicate changes or corrections in addresses previously published in "The Wireless Annual" and "The Wireless World" of January 27, 1926.

CURRENT TOPICS

News of the Week — in Brief Review

BROADCASTING THE LEAGUE OF NATIONS.

The gratifying success of the broadcast transmissions from Geneva of the speeches before the League of Nations has aroused considerable enthusiasm among the League officials. It is understood that steps will be taken to secure even better wireless collaboration when the League meets in September.

○○○○

SECRET WIRELESS?

According to a Paris message, a system of secret wireless telephony has been invented by a young Austrian engineer. The apparatus is stated to emit successive waves of three different lengths, changing from one to another every sixty-thousandth of a second. To pick up the "secret" message the receiver must be synchronised with the wave fluctuations of the transmitter.

○○○○

A FORFEITED RECEIVER

The fact that offenders under the Wireless Act run the risk of forfeiting their receivers may sometimes be forgotten. James Hall, of Forest Hill, received a concrete reminder of the P.M.G.'s powers in this direction last week, when he was fined 40s. with 2 guineas costs at Greenwich Police Court for working an unlicensed set in his bedroom.

The magistrate ordered that the set be forfeited.

○○○○

BRITISH WIRELESS CLUB DINNER.

Sir Oliver Lodge and General Sir George Milne were the guests of the evening at the fifth annual dinner of the British Wireless Club, held at the Trocadero Restaurant on Saturday, March 20th. Admiral Sir Frederick L. Field (President of the club) was in the chair. The president for the ensuing year will be Air-Commodore Blandy.

○○○○

PEERS AND THE MICROPHONE

While members of the House of Commons seem reluctant to have the proceedings of the House broadcast, a different attitude seems to prevail in the House of Lords.

Many of the peers are said to welcome the possibilities of broadcasting as a means of publicity, of which the Upper House is sadly in need.

INTERNATIONAL LANGUAGE FROM JAPAN.

The Tokio broadcasting station now transmits talks in Esperanto.

○○○○

BRITISH INDUSTRIES FAIR.

In view of the success of the British Industries Fair it has been definitely decided to hold the Fair again next year at approximately the same time.

○○○○

GERMAN WIRELESS PHOTO TRANSMISSIONS.

A claim to have beaten all speed records in the transmission of wireless photographs is put forward by the Telefunken Company, of Berlin. According to *The Manchester Guardian*, the Telefunken engineers have succeeded in transmitting 15,000 apertures per second in tests conducted between Nauen and America. Text and diagrams have been transmitted simultaneously with pictures.

THAT EASTER EGG.

An Easter egg containing a wireless set was described by a morning paper last week as a "novelty." The fact that this type of egg is a "hardy annual" tends to show that the newspaper in question is out of touch with the enormous strides which have already been made by our wireless "scientists."

○○○○

A BROADCAST LIBEL?

A libel action has been threatened by Mr. Crowe, the Illinois State Attorney, against the wireless announcer at a Chicago cabaret for broadcasting the incorrect statement that Mr. Crowe was amongst the cabaret's guests. Unfortunately for Mr. Crowe, no statute appears in American legal records defining radio libel.

A law on this subject is pending before Congress, but until it is passed the State Attorney is likely to have little chance of success in an action for wireless libel.



SHORT WAVES IN THE WILDS. A portable short-wave receiver which Mr. Francis Gow Smith, an American explorer, is to take with him into the wilder parts of Brazil, where he will study the habits of the South American Indian. Besides being useful for the reception of KDKA, it is hoped that the set may serve to inspire the natives with awe!

BROADCASTING FOR DUTCH EAST INDIES.

The Dutch East Indies are to have their own "Radiophonic Broadcasting Company." The Government at Batavia, Java, is negotiating with those interested for the granting of broadcasting rights over the whole Dutch Indian Archipelago for a period of ten years.

TRANSMISSIONS FROM DUBLIN.

The Editor of *The Irish Radio Review* asks us to convey his thanks to the many readers of *The Wireless World* who responded to his recent request for reports on the quality of transmissions from 2RN. Valuable data was obtained from nearly every county in Great Britain.

The Dublin station now operates on 397 metres.

A STUDIO AUDIENCE.

The absence of a visible audience is a disquieting factor to many performers before the microphone, who crave the sympathetic "atmosphere" which only the presence of listeners can create. An attempt to overcome the unresponsiveness of the studio has been made by the directors of the WLW broadcasting station at Cincinnati. An auditorium with seating accommodation for several hundred visitors adjoins the studio, from which it is separated by soundproof windows. The performance is heard on loud-speakers.



IMPORTANT A.R.R.L. RESIGNATION
Mr. F. H. Schnell, the popular Traffic Manager of the American Amateur Radio Relay League, who, as reported last week, has submitted his resignation in order to undertake experimental work. He had held the post since 1920.

LOUD-SPEAKERS AT THE BOAT RACE.

During the struggle between the rival crews last Saturday the progress of the race was described to the public by means

of loud-speakers installed at such positions as Putney, Hammersmith, Barnes, Mortlake, as well as at Oxford, at Cambridge and at the Rialto Theatre, Piccadilly.

Credit for these excellent arrangements is due to the Marconiphone Co., who worked in conjunction with the *Daily Mail* and the Exchange Telegraph Co.

It appears that Rome, Milan, Vienna, Berne, Budapest, Oslo, and Daventry were too loud, and the operator had to switch off one valve. Belfast was only "bearable"!

ANOTHER WAVELENGTH CONFERENCE.

Last week another meeting was held by the International Radiotelephony Union

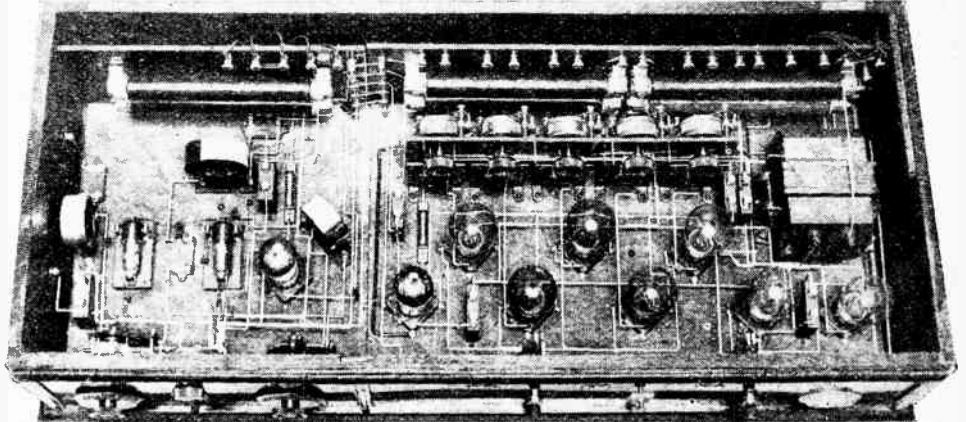

A HOSPITAL SET. An eleven-valve instrument presented to the King's College Hospital, Denmark Hill, by the "Daily News" Hospital Wireless Fund. It will be seen that the set embodies two portions, the first consisting of a H.F. and Detector Unit with optional L.F. resistance capacity coupled amplifier, and the second comprising an eight-valve amplifier. It was constructed by the Oxford Wireless Telegraphy Co., Ltd.

At the Rialto Theatre a panoramic view of the course was erected under the screen, and, in addition to announcements from the loud-speakers, the relative positions of the two boats were shown by models.

AMERICA'S WIRELESS DINNER.

The American passion for doing things on the grand scale has been shown to advantage by the holding of a public banquet in which 20,000 people took part.

In its April number *Radio News* gives an interesting description of how the inhabitants of sixty-seven cities, sitting down to dinner at the same time, were formed into one vast *ensemble* through the agency of seven broadcasting stations, viz., WGY, WBZ, WJZ, KDKA, WRU, KFKN and KOA. The diners for the most part were graduates of the Massachusetts Institute of Technology.

In addition to speeches from Washington, Rochester, N.Y., and Cambridge, Mass., the diners were entertained with facsimile letters of greeting transmitted by wireless.

ITALIAN WIRELESS TRAIN.

The success which attended the recent wireless reception experiments on the Great Western Railway has been repeated on the Italian State Railways.

An Ethodyne was installed in the express which leaves Rome at 7.20 p.m., reaching Naples at 12.20 a.m. "The passengers in the dining car thoroughly enjoyed the pure and strong reception," writes the Italian agent for Burdepp products, "and they were able to hear concerts from all stations in Europe."

at Geneva for the purpose of remedying congestion in the European ether.

Among the problems affecting British stations is that of the clashing between Manchester, Hamburg, Madrid, Oslo, and Bournemouth, which all transmit in the neighbourhood of 385 metres. Newcastle and Gratz conflict on 400 metres, while Belfast, Toulouse, and Berne jostle one another on about 440 metres. Other irreconcilables are Cardiff and Marseilles on

THE READERS' BALLOT.

Readers are reminded that the Ballot Competition announced on page 22 (Advertisements) of last week's issue does not close until April 14th, and all entries received up to that date will be accepted.

350 metres, Nottingham and Barcelona on 325 metres, and Leeds, Milan, and Reykjavik on about 320 metres.

A CRYSTAL DETECTOR.

We are asked to state that the crystal detector reviewed in the issue of *The Wireless World* of February 3rd, page 185, came into our hands through an error, as the article had previously been withdrawn from sale. We understand that a similar article, protected by patent, will be available from another source at a later date.

HINTS and TIPS for NEW READERS

A Section Devoted to the Practical Assistance of the Beginner.

REACTION CONTROL.

It is not too much to say that ease and smoothness of reaction control in a receiver consisting of a valve detector (especially when followed by L.F. amplification) may account for the difference between being able to receive a distant station at good strength and not being able to hear its signals at all. Such devices as geared coil holders, or even the use of capacity-controlled reaction circuits, may help a great deal in this respect, but unless the operating characteristics of the valve itself are such as to permit a gradual approach to the oscillation point, the full sensitivity possible cannot be obtained. This condition may best be brought about by careful adjustment of the values of the applied H.T. voltages, and particularly by choosing a suitable leak and working potential for the grid, as well as by using a reaction coil of correct inductance.

It is usual to connect the lower end of the grid leak to the positive side of the low-tension battery, in order that a positive voltage equal to that of this battery may be applied with respect to the negative end of the filament. It is quite possible that this may be excessive, and, in the case of a valve where the grid current starts early (*i.e.*, before the grid becomes appreciably positive), it may be preferable, from the point of view of smoothness of reaction control, to keep its potential at zero, or, at any rate, only slightly positive, without seriously impairing its rectifying properties.

The effect of connecting the lower end of the leak to various points of the filament circuit should accordingly be tried. Provided that the controlling rheostat is in the positive filament, we have the choice of nega-

tive filament, positive filament, and positive battery.

If a finer control of grid potential is desired, a separate biasing battery of dry cells may be used, or, better, a potentiometer connected across the filament or L.T. leads. The latter arrangement is to be preferred, and the general idea should be to work with the least amount of positive voltage consistent with good detection and smooth reaction control, remembering also that an excessively positive grid will cause an unnecessary drain on the anode battery.

o o o o

RESISTANCE-COUPLED L.F. AMPLIFIERS.

In the case of a transformer-coupled L.F. amplifier following a detector valve, trouble is seldom experienced from the effects caused by transference of H.F. currents in the anode circuit to the grid of the L.F. valve. When dealing with choke and resistance-capacity coupled note magnifiers, however, the position is somewhat altered, and it is often recommended that an H.F. choke and

by-pass condenser should be inserted in such a way that these currents are confined to the anode-filament circuit. Where ready-made coupling units are used, with sometimes rather inaccessible internal wiring, the conventional scheme of connections will not always be convenient, and that shown in Fig. 1 may be adopted, as it serves exactly the same purpose. The terminal lettering corresponds to that on some of the commercial units. On the broadcast wavelengths the by-pass condenser, which is, in effect, connected across the anode condenser, should not have a value greater than about 0.0001 mfd., or the degree of amplification will be reduced, particularly on the higher audible frequencies. If the anode resistance is wire-wound, it will very likely have quite an appreciable self-capacity, and the use of a shunting condenser may be unnecessary.

o o o o

H.T. BATTERY ELIMINATORS.

The arrangement whereby direct current from the mains may be smoothed and reduced in voltage by the use of chokes, condensers, and potential-dividing resistances in the form of electric lamps is well known, and a unit of this description was described in *The Wireless World* for February 24th. It is permissible to use lamps of such a high total resistance that their filaments glow only dimly, but, in any case, there will be a certain amount of wastage of energy.

As a broadcast receiver is most used during the night time, it is possible to avoid this wastage by using the lamps as a source of illumination for the room in which the set is installed, and in this case, of course, lamps which glow at normal brilliancy must be chosen. The unit may

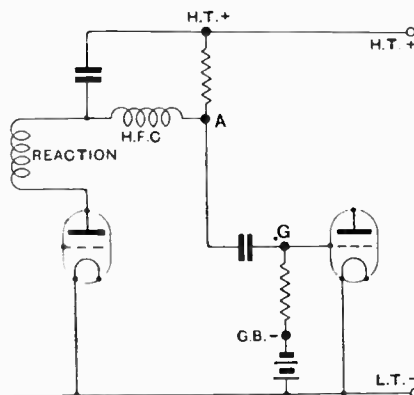

Fig. 1.—Adding by-pass condenser and choke to a resistance unit-coupled L.F. amplifier.

be made up in the form of a cluster table lamp, with chokes and condensers concealed in the base. There is scope for considerable ingenuity in design, and a unit having quite a pleasing appearance may be constructed, using standard electrical fittings.

Connection between the unit and the set may be made by flexible insulated wires twisted together. Provided that the H.T. terminals are

shunted by large by-pass condensers, there is little likelihood of trouble arising through the use of long leads.

o o o o

DISSECTED DIAGRAMS.

Referring to the "Dissected Diagrams" sketches given below, attention may be called to the fact that a study of the No. 2 diagram will show clearly which ends of the in-

ductance coils and which sides of the variable condenser are at high potential. This knowledge is valuable when planning the "layout" of a receiver, as connecting leads and other objects may be kept clear of positions where their presence is likely to give rise to undesirable effects. In the diagram the ends of the coils at highest potential are those remote from the connections to the remainder of the circuit.

DISSECTED DIAGRAMS.

No. 24.—Wiring a Neutralised H.F. Amplifier-Detector.

All typical circuits in general use have now been shown in our series of "Dissected Diagrams." The same method will now be used in an endeavour to make clear various points which have been found to puzzle amateur constructors. The sketches below show a convenient order of procedure in wiring a receiver, and also indicate those leads which are at high oscillating potential, and should consequently be kept clear of other wires, etc.

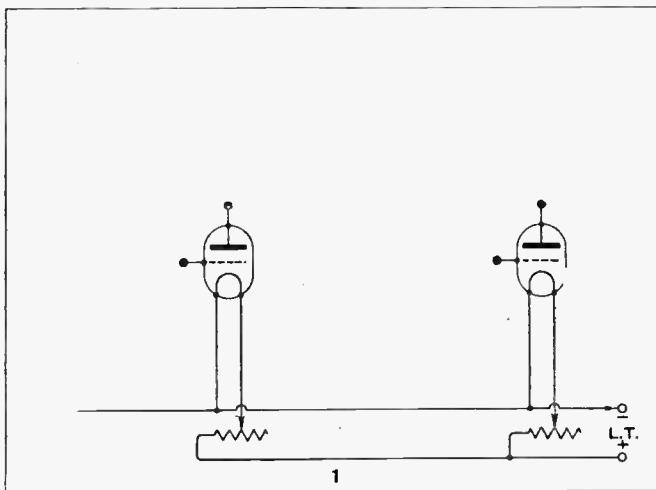

The filament circuits are completed in the usual manner. All these are low potential wires, and may be run close together.

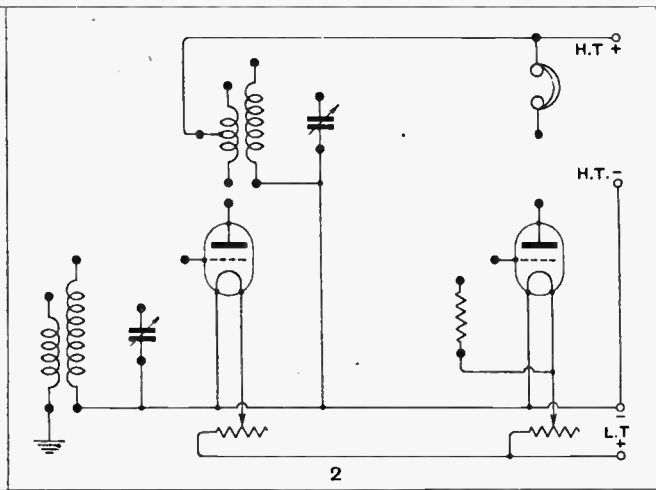

The remainder of the low potential leads are indicated above. Coils and condensers, etc., are added for the sake of clearness.

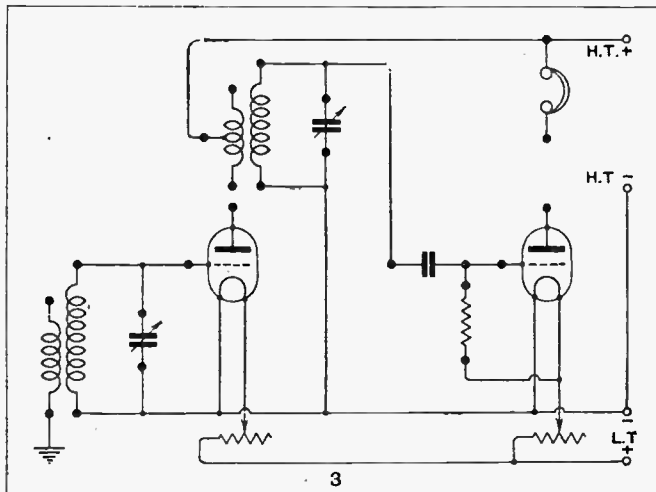

The high-potential sections of the first and second grid circuits are connected up.

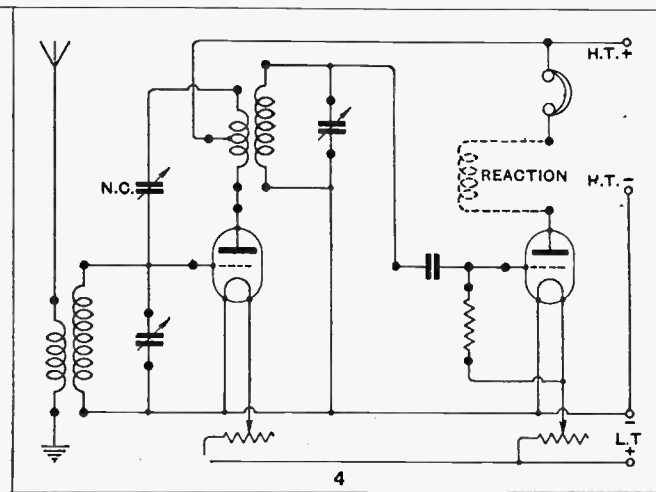

The plate circuits of both valves are completed. Aerial and neutralising connections are added.



Arthur Stanley

The Hon. Sir Arthur Stanley, G.B.E.
Chairman of The Wireless League

America's New High-Power Broadcasting Station

A Description of the Station at Bound Brook, N.J.

By A. DINSDALE.

IN this country we have recently become familiar with discussions as to the relative benefits of a few high-power broadcasting stations, judiciously located, as an alternative to our present system of a multiplicity of low-power stations scattered all over the country.

In America, where innumerable small stations abound, the problem is even more acute, and the leading protagonists of the high-power system have for some time been busily engaged in building super-power experimental stations to prove their arguments. The latest of these stations to be completed is situated at Bound Brook, New Jersey, some thirty-five miles from New York City, and was built by the Radio Corporation of America, to whom the writer is indebted for the following particulars and photographs of the plant.

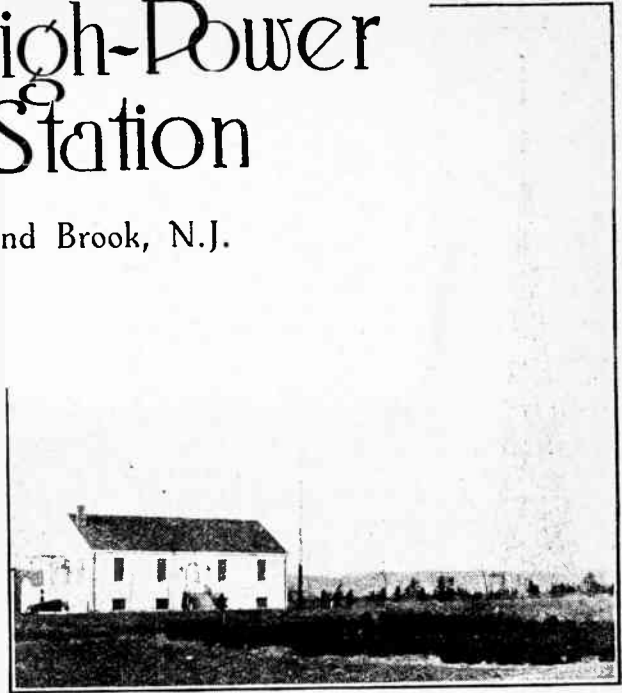

General view of the station buildings, the short-wave aerial, and one of the lattice masts supporting the aerial for the 450 metre transmitter.

Bound Brook has not yet been officially opened, but is at present operating under an experimental licence on two wavelengths in the vicinity of 450 and 100 metres, using in each case an output power of 50 kW. and the experimental call sign 2XAR. When officially opened the station will use the call sign WJZ, which is at present allocated to the Radio Corporation's 500-watt station on the top of the Æolian Hall, New York. At present 2XAR gets its programmes from the WJZ studio, which is connected to Bound Brook by three private lines.

The Aerial and Earth Systems.

The aerial for the 450-metre transmissions is carried by two self-supporting steel towers, each 300ft. in height, the feet of which are mounted on heavily insulated bases. The distance between these towers is 700ft., but the length of the aerial is 220ft. It is of the 6-wire cage type, the down lead being taken from the centre. In order to ensure that the strain on the aerial wires shall at all times be uniform, the halyards are brought down to a 2,000-lb. counterpoise weight.

The earth connection is composed of a large number of wires buried several feet in the ground, which radiate in all directions from the station building.

For the short-wave transmissions a different aerial system is employed. This consists of a vertical copper tube mounted on insulators and supported by a wooden mast. Readers will be familiar with this design, which has been in use for some time past at KDKA. In one of the accompanying photographs the short-wave aerial can clearly be seen close to one end of the station building.

The main power supply, which is fed to the transmitting station through a small sub-station situated near one

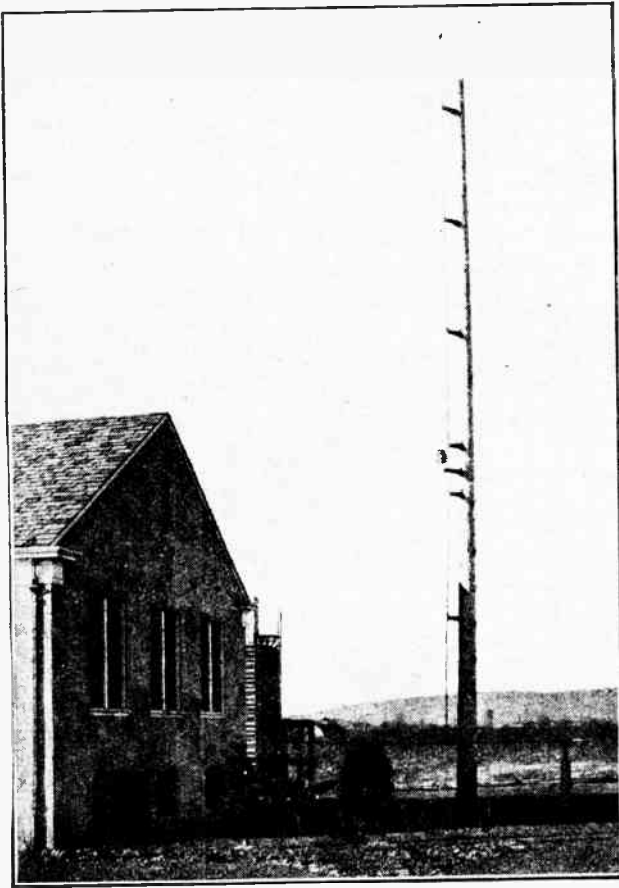

Short-wave aerial system. The conductors consist of copper tubing and are spaced from the wood mast on porcelain insulators.

America's New High-power Broadcasting Station.—

of the aerial towers, is 3-phase, at 4,400 volts, 60 cycles. The switch gear for controlling this power is placed in the basement of the main transmitting building, and can be seen in one of the accompanying illustrations, which also shows the two filament-lighting motor-generator sets. These sets supply filament current at 15 volts, and in the space between them is located the switchboard for changing the filaments over from one generator to another.

Power Supply and Running Machinery.

Also situated in the basement are the high-tension transformers, six in number, for supplying the high-voltage plate current for the water-cooled transmitting valves. This high-tension current is taken to the main transmitting room immediately over the basement for rectification by means of water-cooled two-electrode valves, and then back down to the basement for smoothing by means of a large bank of

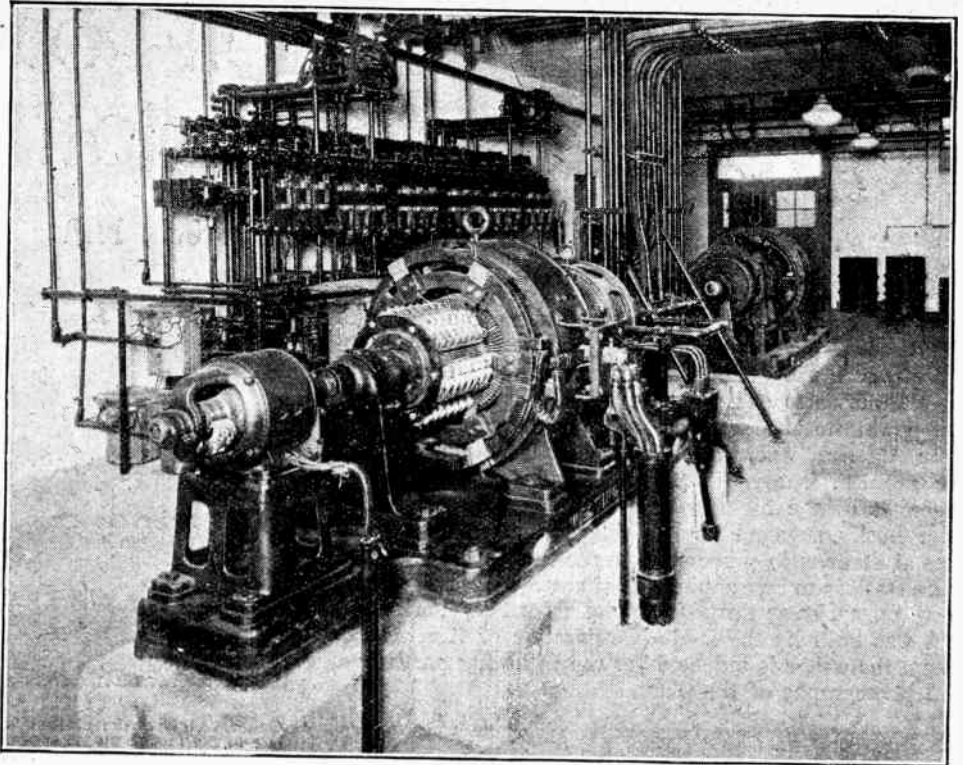

Motor generator sets in the basement. The switchgear for the 4,400 volt, 3-phase supply mains is to be seen in the background

mica-dielectric smoothing condensers and five huge iron-core chokes immersed in oil. The resultant D.C., at 10,000 volts, is fed back to the transmitting room and applied to the plates of the oscillator and modulator valves.

The Radio-frequency Equipment.

The transmitting panels for both wavelengths are in duplicate, and they are all arranged round the sides of a large transmitting hall on the main floor of the building. In erecting this structure copper shielding was introduced into the walls, in order to minimise the danger to near-by receiving stations of interference from unwanted harmonics. Such screening very effectively eliminates this interference.

Each transmitter consists of three separate panels—the rectifier, the modulator, and the oscillator. Each oscillator employs eight, and each modulator twelve, water-cooled valves. The cooling arrangements are quite elaborate. From a water-cooling tower close to the main building water is conducted through metal piping up to the transmitting panels, but the actual connection between this piping and the water jackets of the valves is made through rubber tubing. The inlet and outlet tubes are both about 15ft. long, and these lengths are coiled up together in the form of a spiral such as can be seen in the illustrations.

These spirals are provided in order to lessen the leakage of the high-tension plate current, for the cooling water comes in actual contact with the plate. Pure water is an insulator, but in the case of a transmitting plant of this size it is hardly practicable to arrange for an abso-

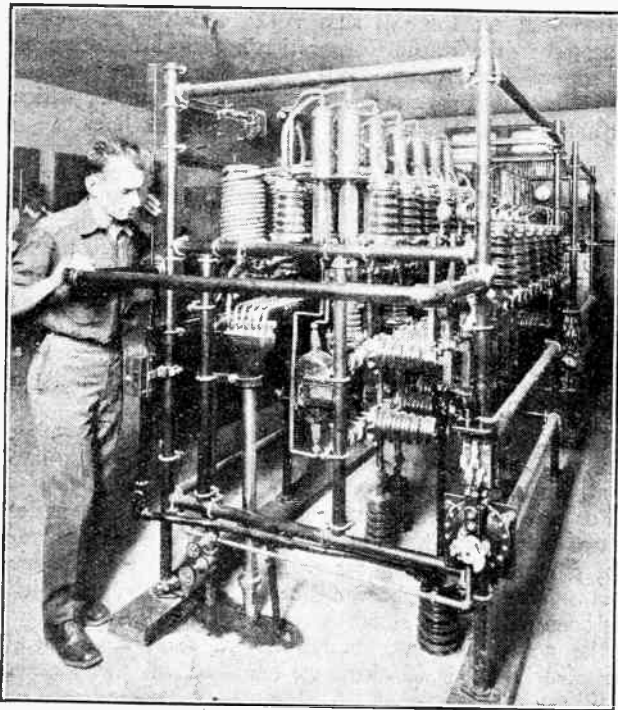

Modulator-frame of the 450 metre transmitter. Valves with water-cooled anodes are employed.

America's New High-power Broadcasting Station.—

lutely pure water supply. Some idea of the water requirements may be gathered from the fact that 3,300 gallons of water per minute are necessary. By insulating the water column for a distance of 15ft. or so between the valve plate and the metal supply piping, therefore, leakage by way of the water supply is reduced to a negligible extent.

Tuning Arrangements.

Tuning of the closed circuit is effected by means of a large strip inductance and variable air condenser, both of which are very clearly shown in one of the photographs. Tappings can be taken from the inductance at selected points by means of specially designed clips. The plates of the variable condenser are of large area and very thick, with rounded edges.

Coupling to the aerial is obtained by means of a single turn coil which is hinged on to the end of the closed circuit inductance. Leads from this single turn coil are taken out of the building to a small hut near by, which is directly below the aerial lead-in, and which houses the aerial tuning apparatus. This apparatus is contained in a single panel, and consists simply of a small inductance, two variable air condensers, and the aerial ammeter, the scale of which reads up to 30 amps.

A unique feature of this panel is the fact that the two variable condensers are controlled by two small electric motors through reduction gearing. These motors are controlled by a small jack switch mounted on the extreme left of the oscillator panels, so that the aerial tuning can be remotely controlled by the engineer in charge of the station without leaving the main transmitting hall. This is a development of aerial tuning and coupling which has been in use for some time at other stations of the Radio Corporation of America. By its use the aerial is energised at its base, without the necessity of bringing the actual aerial lead-in round awkward corners and through walls. An additional advantage is that the

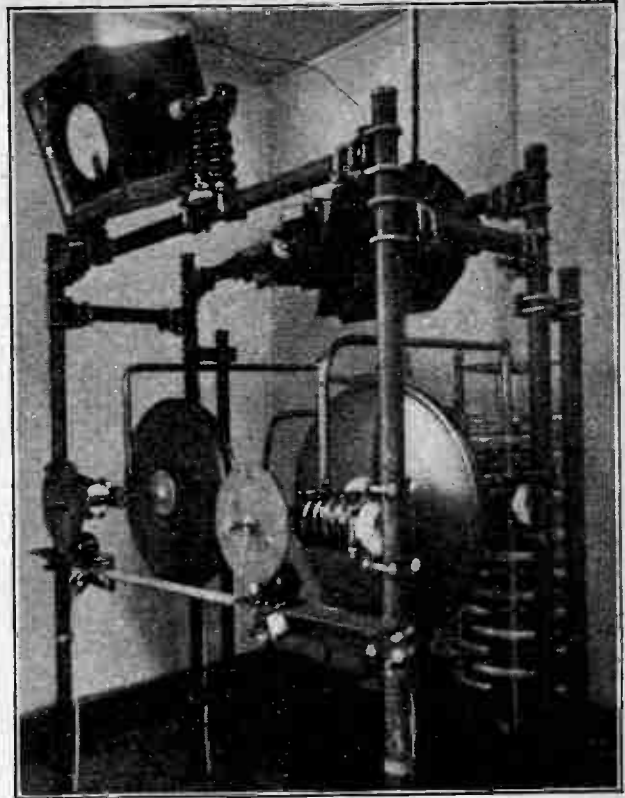

Tuning controls driven through reduction gears by small electric motors to avoid capacity effects which might be caused by the presence of an operator.

aerial is free to oscillate with a minimum of interference from the other high-frequency apparatus housed on adjacent panels within the main building. The advantages of such a system are much sharper tuning and greater freedom from harmonics.

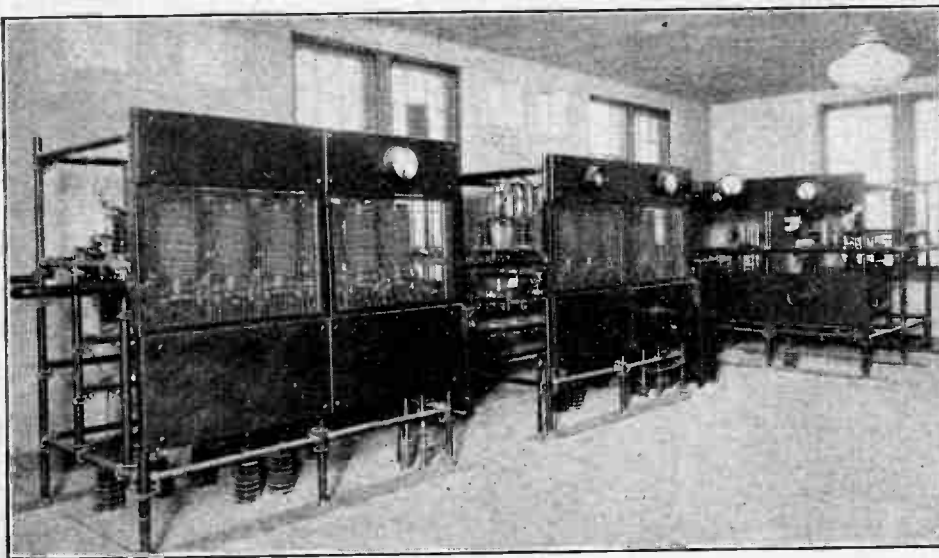

The short-wave transmitting equipment, which includes the rectifier, oscillator and modulator frames.

No doubt, when Bound Brook is officially opened and commences to broadcast regular programmes it will be one of the American stations most regularly received in this country, especially on the shorter wavelength. Already, during an experimental test, signals on the short wave have been picked up in this country and re-broadcast by the B.B.C. From the American point of view, the new WJZ should prove of great value as a link in that country's re-broadcasting chain for the dissemination throughout the United States of important national events. On both sides of the Atlantic its performances will be watched with the greatest interest.



NEWS FROM THE CLUBS:



Secretaries of Local Clubs are invited to send in for publication club news of general interest.

All photographs published will be paid for.

Mr. A. L. Kirke on "Selectivity."

Every wireless experimenter at some time or other meets with the problem of cutting out the local broadcasting station and at the same time receiving more distant stations.

At the last meeting of the North Middlesex Wireless Club, Mr. A. L. Kirke, of the B.B.C. Engineering Staff, lectured on "Selectivity."

Mr. Kirke had been asked to exclude the super heterodyne from his lecture.

As the end in view is sharpness of tuning, the factors in a circuit which cause damping and consequent flatness of tuning were dealt with *seriatim*. The resistance of the aerial earth circuit is a very important factor, and Mr. Kirke recommended the use of a series condenser to diminish damping.

○○○○

Reaction.

The use and abuse of reaction and loose coupled circuits were briefly touched upon. Damping due to valves was the next point mentioned, and the difficulty of eliminating grid current when grid condenser and leak method of rectification is adanted was discussed.

Tuned anode coupling for H.F. circuits increases selectivity, but when several H.F. valves are connected in cascade the tendency to self-oscillation limits the efficiency, hence the need of neutrodyne condensers to neutralise unwanted capacity reaction.

Hon. Secretary: Mr. H. A. Green, 100 Pellatt Grove, Wood Green, N.22.

○○○○

Press Tools.

An insight into the work carried out by manufacturers of press tools was provided by Mr. D. S. Richards in his lecture before the Ilford and District Radio Society on March 2nd. Mass production, it was shown, is the only means by which much electrical apparatus could be brought within reach of the man in the street.

The Ilford Society is offering an attractive programme to its members in the near future. Among the interesting items is a visit to the Barking Power Station.

○○○○

Transformer v. Resistance Capacity Coupling.

A vote by ballot in which the voters were required to judge the quality of reproduction given by two amplifiers—a resistance capacity coupled and a transformer coupled—yielded surprising results at the last meeting of the Manchester Radio Scientific Society.

A 28

FORTHCOMING EVENTS.

WEDNESDAY, MARCH 31st.

Tottenham Wireless Society. Business Meeting, followed by a Surprise Evening

Edinburgh and District Radio Society Sale of Apparatus.

Barnsley and District Wireless Association. At 8 p.m. At 22, Market Street

Simple Valve Transmission.

North Middlesex Wireless Club. At 8.30 p.m. At the Shaftesbury Hall, Bourne Park. Lecture: "A Composito-Wavemeter," by Mr. W. Gutlund

THURSDAY, APRIL 1st.

Golders Green and Hendon Radio Society. At 8 p.m. At the Club House, Wilford Way, N.W.11. Lecture, with Demonstrations: "Methods of L.F. Coupling" by Mr. W. J. T. Crewe (SCT).

MONDAY, APRIL 5th.

Ipswich and District Radio Society. At 55, Fomereau Road, Open Night.

What the Voting Showed.

In view of pre-conceived notions regarding the relative merits of the two forms of coupling, the voting took a surprising turn. The results were as follow:—

	Resistance capacity.	Transformer.
Music (all-round reproduction)	12	30
Speech (volume)	42	3
Speech (clarity)	8	37
Carillon (volume)	44	2
Carillon (quality)	9	37

These tests, which were carried out under perfectly fair conditions, clearly indicate the high stage of development which has now been reached by the intervalve transformer

○○○○

Wireless Transmission of Pictures.

On April 14th members of the Tottenham Wireless Society will have an opportunity of witnessing a demonstration of the wireless transmission and reception of pictures. The pictures will be transmitted from station 2DY at Winchmore Hill and received at the club-room, 10, Bruce Grove, by Mr. F. H. Haynes. All past members of the society are invited to this demonstration.

○○○○

Results with a Reinartz.

Members of the Croydon Wireless Society spent an interesting evening on March 15th in trying out a two-valve short wave set modelled on the Reinartz principle, which had been made by two members of the society. Although only a small indoor aerial was used the results proved highly satisfactory, a number of foreign stations being logged on the low waveband.

Hon. Secretary: Mr. H. T. P. Gee, 51 and 52, Chancery Lane, W.C.2.

○○○○

Warwick School Wireless Society.

Through the courtesy of the G.P.O. the Warwick School Wireless Society was last month permitted to visit G.B.R. Rugby, the party being conducted over the station by a member of the staff.

The telegraphy plant was first seen in operation and the members were impressed by the gigantic scale on which the apparatus is constructed and by the elaborate safety arrangements. Several members are now winding coils to reach 18,000 metres and intend to approach this wavelength cautiously to avoid accident!

The society hopes shortly to arrange an "American Night," while a visit to Daventry is promised for next term.

HIDDEN ADVERTISEMENTS COMPETITION.

The following are the correct solutions of "The Wireless World" Hidden Advertisements Competition for the issue of March 17th, 1926.

Clue No.	Name of Advertiser.	Page
1	Garnett, Whiteley & Co., Ltd.	19
2	Edison Swan Electric Co., Ltd.	iv
3	Marconiphone Co., Ltd.	1
4	Sifam Electrical Co., Ltd.	15
5	General Radio Co., Ltd.	15
6	British Electrical Sales Organisation	5

The prizewinners were as follow:

F. P. Birrell, Sutton Coldfield	£5
H. L. Price, Carliff	£2
F. W. Moore, Glasgow	£1

Ten shillings each to the following:

F. C. Rogers, Lowestoft.
A. C. Simons, Mablethorpe, Lincs.
Robt. H. Monkhouse London, W.12.
E. Taylor London, S.W.10.

PIONEERS OF WIRELESS.

By ELLISON HAWKS, F.R.A.S.

12.—J. B. Lindsay Patents First Wireless System.

ABOUT the same time that Morse was at work in America, James Bowman Lindsay was experimenting at Dundee. He also used the conductive properties of water in the attempt to evolve a practical means of communication without wires. His system of wireless telegraphy combined the principles of Sömmering and Steinheil, using naked wires and "earth batteries."

Lindsay was born on September 8th, 1799, at Carmyllie, a little village in Forfarshire not far from J. M. Barrie's "Thrums." He would certainly have followed his father's occupation of farming had not his delicate constitution made this impossible. Instead, he was placed as a "bot," or learner, under the care of a local hand-loom weaver.

The Weaver turns Scientist.

In his early days he had showed a decided love for study, which his work at the loom did not interrupt. It is related that often the lad would be seen on his way to Arbroath with a web of cloth firmly strapped on his back and an open book in his hand. After delivering his cloth and obtaining fresh material he returned to Carmyllie, reading his book in the same fashion. His studious nature at length persuaded his parents that they might make him something better than a weaver, and, with true Scottish self-denial, they decided to limit their expenses so that James might have the privilege of a college training. They were able to send him to St. Andrew's University, and here, notwithstanding the disadvantages of self-education, he won for himself a distinguished place, especially in mathematics and physical science. He matriculated in 1821, when twenty-two years of age.

Following the ancient custom of poor Scottish students, Lindsay spent the summer recess working. At first he followed his original trade as a hand-loom weaver, but in later years he took private pupils and was thus able to continue his own studies at the same time. In 1829 he was appointed Lecturer in Science and Mathematics at the Watt Institution in Dundee.

Lindsay is described as having been a man of profound learning and untiring scientific research, who—had he been more practical, less diffident, and possessed of greater worldly wisdom—would have gained for himself a good place amongst distinguished men. As it was, he remained little more than a mere abstraction, and went through life as a poor and modest schoolmaster.

Suggests Communication with America.

Lindsay's scientific discoveries attracted the notice of several eminent men of science, and his name was mentioned to the Prime Minister, the Earl of Derby, who (in July, 1858) granted him an annual pension of £100 "in recognition of his great learning and extraordinary attainments." This bounty enabled him to devote himself entirely to his literary and scientific pursuits.

He studied the working of the electric telegraph as early as 1830, some five years before the subject had advanced beyond a laboratory state. He does not appear to have gone very deeply into the subject until about 1843, however, when he proposed to connect Britain and America by a single wire, using the "earth battery" also.

Nothing more was heard of Lindsay or his scheme until 1853, when he gave a lecture in Dundee on "Telegraphic Communication." In the course of his remarks he said: "The principle of submerged wires, such as those now used for telegraphic intelligence between this country and Ireland and France, are no longer necessary. By a peculiar arrangement of wires at the sides of rivers or seas, the electrical influence can be made to pass on through the water itself." Lindsay successfully demonstrated the possibility of his suggestion on a small scale by means of a water trough. The lecture was repeated at Glasgow in the following August, and Lindsay became so convinced of the practicability of his plan that (on June 5th, 1854) he took out a patent for it. His specification explains that the "invention consists of a mode of transmitting telegraphic messages by means of electricity or magnetism through and across water without sub-



J. B. Lindsay

Pioneers of Wireless.—

merged wires, the water being made available as the connecting and conducting medium."

The first public trials of Lindsay's system was held in 1854 across Earl Grey Docks, Dundee, and later across the Tay at Glencarse, where the river is about $\frac{3}{4}$ -mile in width. We are told that Lindsay would station his friends on one side of the Tay, enjoining them to watch the galvanometer and note how the needle moved. He would then insert his plates in the water on their side of the river, and, crossing over to the opposite side, would make a few momentary contacts, reversing the connections a few times so as to produce right and left deflections of the galvanometer needle. Then he would return and compare the deflections of the needle which they had noted with the order in which he had himself made the battery contacts, and, on finding them to correspond, he would be supremely happy.

Sir Wm. Preece Examines Lindsay's System.

In 1854 Lindsay journeyed to London and brought his system of wireless telegraphy to the notice of the Electric Telegraph Co. Sir (then Mr.) W. H. Preece, who later became chief engineer of the Post Office Telegraphs, was deputed to report on the system. Curiously enough, Sir William was subsequently also called upon to examine Marconi's system, and we are justified in assuming that, if no other good resulted from Lindsay's work, it at least served to attract Sir William Preece's attention and interest him in the subject. Experiments made in a special testing tank at Percy Wharf, on the Thames, showed that Lindsay's plan was at least feasible.

It was probably about this time that Lindsay heard that his "great invention" was not new; that Morse had obtained similar results in America (as we have already seen) in 1824; and that Alexander Bain had also

tried (about the same time) a similar experiment on the Serpentine.

Lindsay Signals Without Wires Across the Tay.

In August, 1854, Lindsay conducted a further series of experiments at Portsmouth, and succeeded in transmitting signals across the mill dam over a distance of about 500 yards. He seems to have repeated these experiments whenever and wherever he had the opportunity. His most elaborate test was across the River Tay, when he succeeded in signalling from Dundee to Woodhaven, where the river is nearly two miles in width. In September, 1859, he read a paper before the British Association at Aberdeen on "Telegraphing Without Wires," and again carried out experiments across the River Dee.

In July, 1860, he transmitted a current across the Tay, below the Earn, where the river is over a mile in width, and although he did not subsequently conduct any further public experiments in telegraphing without wires, Lindsay remained fully convinced of the soundness of his views, and was confident of their ultimate adoption until his death.

Lindsay was never married, and after the death of his mother he lived alone in Union Street, Dundee, surrounded by his books and apparatus and wholly absorbed in his scientific studies. He spared no expense to secure the rarest books of antiquity, and often commissioned large purchases from booksellers in London and Paris. He had never been robust, and even the miserable pittance that he earned as a teacher was not expended upon the nourishment he should have had. His passion for purchasing books and for acquiring the instruments necessary for his researches led him to starve himself to such an extent that he stunted his body in order to satisfy his mind. When at last disease came upon him, he was not able to throw it off, and died on June 19th, 1862, after five days' illness.

Anxious Time for Dutch Amateurs.

We understand from several correspondents in Holland that the postal authorities in that country are taking active steps to discover and suppress all unlicensed transmitting stations. A few licences have been granted to wireless societies and technical colleges, but individual experimenters have not been encouraged. A considerable number, however, have installed transmitting apparatus, and their call-signs have been distinguished by the initial figure "O." The postal authorities are now proceeding against these amateurs and, until their position is officially recognised, they must be regarded as "pirates." We understand that several "transgressors" were traced owing to QSL cards being sent openly and that some well-known amateurs have had their sets confiscated in consequence. Dutch transmitters, therefore, ask their foreign *confrères* to avoid correspondence which may bring trouble upon them.

○○○○

G 20C, Capt. Duncan Sinclair, "Morven," Shepperton-on-Thames, continues working on 23 metres, but is unable to

TRANSMITTING NOTES AND QUERIES.

obtain many answers. Some excellent tests have been conducted with various European stations, but, though several American stations have been heard at good strength on about 20 metres, no long-distance reports are yet to hand. G 20C is very anxious, for special reasons, to work with America, Canada and South Africa. Regular tests are made every Sunday at 10.00-10.30 G.M.T. (with NPC2), and during the afternoon from 14.00 G.M.T. onwards. Reports will be very welcome.

○○○○

Mr. J. W. Riddiough (G 5SZ), White Croft, Bare Lane, Morecambe, Lancs, has recently conducted several very successful tests on short-wave telephony. Using

Mullard O.150 valves, he transmitted gramophone record music to SMUV, Sweden, which was reported as being received on two valves at R7 strength, and on January 19th, with an input of 24½ watts, he worked O A4Z, the well-known South African amateur, Mr. J. S. Streeter, of Capetown. Mr. Riddiough is now attempting telephony transmission to America.

○○○○

Mr. F. A. Sleath, Leamington Spa, asks us to state that he gave up the call-sign 5HJ more than a year ago, but he still receives QSL cards which must be intended for the present owner of G 5HJ, Mr. N. A. Richardson, 68, Finchley Lane, Hendon, N.W.4.

○○○○

New Call Signs and Stations Identified.

G 2APR.—S. C. Coleman, "Waverley" Radio Club, Waverley Road, Small Heath, Birmingham.

G 2BLM.—J. C. Martin, 94, Little Heath Road, Foleshill, Coventry (change of address).

G 2BRG.—S. C. Coleman, "Oakdene," 86, Gladstone Road, Sparkbrook, Birmingham.

LOSSES IN INDUCTANCE COILS.

Some Deductions from the "Low-Loss" Coil Tests.

By S. BUTTERWORTH.

THE results of the tests made on readers' coils which have been published in recent numbers of *The Wireless World* are of great interest to the present writer, particularly as he has written a series of articles which is about to be published in *Experimental Wireless* dealing with the theoretical values of the losses in inductance coils. In these articles formulæ are established for estimating the copper losses in single-layer and multi-layer coils wound either with solid or stranded wire, and from these formulæ rules are established to enable one to construct a coil to satisfy certain space and stray field conditions, and at the same time to have the least possible copper loss.

Importance of Copper Losses.

If these formulæ are to prove of any practical value it is necessary to show that they are capable of predicting the major portion of the measured losses which include not only the losses in the wire of the coil but also dielectric losses and losses due to neighbouring masses of metal such as the coil terminals. The comparison is the more necessary since there seems to be a general impression that the main losses are in the dielectric, and that the effect of spacing is to cause a reduction in the dielectric losses which more than balances the presumed increase in copper losses brought about by the reduction in diameter of the wire. This reasoning is unsound because of the assumption in regard to the nature of the variation of the copper loss. Theory shows that at high frequencies as the diameter of the wire composing the turns of the coil is reduced (keeping the total winding section constant) the copper losses first diminish and afterwards increase so that there is only one spacing for minimum copper losses. The fact that a spaced coil has smaller losses than a closely wound coil is therefore no proof that dielectric losses are very important in inductance coils used at high frequencies. The only scientific method of determining the relative importance of the various losses is either to devise some method of measuring the copper losses separately or to calculate these losses and to compare the calculated losses with the total measured losses. It is not proposed to deal here with experimental methods of separating the losses, but the results obtained from the tests of readers' coils will be employed to make a comparison with the calculated losses where this is possible. We take first the case of single-layer coils wound with solid wire.

The Single-layer Formula.

The formula for the A.C. resistance of a single layer coil of radius a , length b , wound with wire of diameter d so as to have a winding pitch c is

$$R_{ac} = R_{dc} \left\{ 1 + F + \left(3.29 + \frac{b}{a} \right) \frac{d^2}{c^2} G \right\}$$

in which F and G are tabulated quantities depending upon the diameter of the wire and upon the frequency.

This formula is only accurate when the wire is well spaced and when the coil length does not exceed the coil

diameter. As regards closely wound short coils, the formula tends to under-estimate the copper losses, particularly when the wire used is thick. This fact must be borne in mind in making the comparisons.

We will take first the coil described and illustrated on p. 328 of the issue of *The Wireless World* for March 3rd. This coil is wound with 38 turns of bare No. 19 wire so as to have a mean diameter of $5\frac{1}{2}$ in. and a length of $2\frac{3}{4}$ in. The D.C. resistance of the wire is readily calculated and is found to be 0.35 ohm. The diameter of the wire is 0.040 in., and the pitch of the winding (coil length divided by number of turns) is 0.0625 in. Inserting these values in the formula we get

$$R_{ac} = 0.35 (1 + F + 1.70 G).$$

Now F and G depend upon the diameter of the wire and upon the wavelength. For No. 19 wire the following values hold:—

Wavelength	500	400	350	320 metres.
$F =$	2.25	2.61	2.83	2.90
$G =$	1.37	1.54	1.66	1.75

so that from the formula the copper portion of the resistance should be

$$1.95 \quad 2.18 \quad 2.32 \quad 2.40 \text{ ohms.}$$

It has already been said, however, that the above formula is only approximate. If we use a more elaborate (but more accurate) formula we find for the corrected resistances

$$2.28 \quad 2.56 \quad 2.73 \quad 2.82 \text{ ohms.}$$

The measured values at the same wavelengths are

$$2.58 \quad 3.00 \quad 3.52 \quad 3.85 \text{ ohms.}$$

Correction for Self-capacity.

The calculated values have, however, still to be corrected for self-capacity. The value of the self-capacity is not stated, but it is reasonable to expect a self-capacity of the order of $10 \mu\mu\text{F.}$ for a coil of this type.

Now the self-capacity introduces circulating currents in the coil, causing increased losses as these currents pass along the copper portions of their paths. Note that these losses occur even when the dielectric is perfect, and must be classed as copper losses. They are allowed for by multiplying the above calculated losses by $C^2/(C-c)^2$, in which C is the total capacity required for resonance, and c the self-capacity. Taking the given value for the inductance ($170 \mu\text{H.}$), the resonating capacities are

$$415 \quad 266 \quad 204 \quad 170 \mu\mu\text{F.,}$$

and the theoretical resistances on correction for self-capacity now become

$$2.40 \quad 2.77 \quad 3.01 \quad 3.18 \text{ ohms.}$$

Thus we have accounted for 93, 92, 86, and 83 per cent. of the measured losses at the four wavelengths.

It is not proposed to attempt to analyse the residue, amounting in the worst case to 0.67 ohm. It may be remarked, however, that the measured inductance is rather low when compared with the theoretical value ($216 \mu\text{H.}$). A reduction in inductance accompanied by a corresponding slight increase in resistance may be

Losses in Inductance Coils.—

brought about by a short-circuited turn, but this defect is hardly likely to be presented in such a carefully designed coil.¹

The detailed analysis will not be carried out for the remaining single-layer coils, but will merely apply the simple formula. As in this coil the simple formula has given a ratio of calculated to measured loss of $2.18/3.00 = 0.73$ at 400 metres, and the further corrections have brought this ratio up to 0.92, it will be assumed that a ratio of 0.7 is sufficient to prove that the copper losses are overwhelmingly predominant in any other coil at this wavelength.

The following table shows how this test is satisfied:—

SINGLE-LAYER COILS AT 400 METRES.

Coil.	Illustrated on Page	Inductance μ H.	A.C. Res. Obsd.	A.C. Res. Calcd.	Ratio.
1	241	140	6.3	3.6	0.57
2	242	179	4.0	2.9	0.73
3	242	130	2.8	2.3	0.82
4	243	102	1.5	1.7	1.13
5	243	180	3.8	2.8	0.74
6	295	122	3.3	2.4	0.73

(No. 31)

No coil has been omitted for which the data were complete or could be fairly certainly obtained from the photographic illustrations. The low ratio for the first coil is readily accounted for. A glance at its illustration shows that the metal of the plug is situated right in the field of the coil!

The remaining coils are normal, with the exception of coil 4. The data for this coil are rather unsatisfactory. The number of turns is given as 42, but No. 16 D.C.C. wire cannot give 42 turns in the length of the coil, and as the number of turns as counted on the photograph and as deducted from the measured inductance is 40, this value has been used in estimating the theoretical resistance. Even then there is hardly room to accommodate the insulated wire in the requisite space. A value for the D.C. resistance would have been very valuable for this case.

Single-layer Coils Wound with Litz.

We now turn to the Prize coil, which is wound with Litz wire consisting of 20 strands of insulated wire of gauge 38. There are 56 turns, the mean coil diameter is $2\frac{1}{8}$ in., and the winding length is $3\frac{1}{8}$ in.

The simple formula for a coil wound with stranded wire of the Litz type is

$$R_{ac} = R_{dc} \left\{ 1 + F + \left(\frac{1.9}{d_o^2} + \frac{3.29 + b/a}{c^2} \right) n^2 d^2 G \right\}$$

in which d_o is the overall diameter of the stranded wire, n is the number of strands, d the diameter of an individual strand, while F and G have the same meaning as before, but are found using the diameter of an individual strand. The overall diameter of the wire is not stated, but, taking this as 1 mm. (the pitch is 1.42 mm.), the calculated and measured resistances are as follow:—

Wavelength	500	400	350	320	metres.
Calcd. Res.	1.6	2.10	2.51	2.72	ohms.
Obsd. Res.	1.8	2.05	2.4	2.6	"

¹ A careful examination of this coil revealed that the probability of short-circuited turns due to faulty insulation did exist.—Ed.

It is seen that the calculated resistances have turned out, on the whole, slightly higher than the measured resistances, but, considering the doubt in regard to the overall diameter of the wire, the agreement is satisfactory.

It may be, however, that the Litz wire used is an American product, in which case the specification of 38 gauge is in the American wire gauge system.² This wire is equivalent to No. 42 in the British standard wire gauge. Now this will make a considerable difference to the D.C. resistance, No. 38 S.W.G. giving 0.61 ohm, and No. 42 S.W.G. giving 1.36 ohm. The increase in resistance with frequency, however, is much more rapid with the thicker wire, and it so happens that over the broadcast range the 20/38 wire has a slightly less resistance than 20/42 wire, the values for 20/42 being

1.7 1.9 2.1 2.3 ohms.

These are calculated using an overall diameter of wire of 0.9 mm. Judging by the spacing in the photograph of the coil, the assumption of A.W.G. instead of S.W.G. is the more probable, and the calculated values allow room for self-capacity corrections.

However this may be, the double calculation has not been unprofitable, as it serves to emphasise the fact that, for any coil at a specified frequency, there is a best diameter of strand to employ. In this coil the best diameter of strand is No. 40 S.W.G., which gives the following theoretical resistances:—

1.4 1.6 1.8 2.0 ohms.

allowing an overall diameter of 1 mm. These values could be improved still further by having a larger insulation space between the strands, the ideal insulation space being such that the turns may just be accommodated.

Multilayer Coils.

As regards the multilayer coils, it is clear that one cannot hope to provide a theoretical formula for every coil which it is possible to wind. The guiding principle in constructing these coils appears to have been to attempt to obtain a considerable air space without having to provide a frame upon which to support the wire. Hence the variety of tortuous windings which are employed. The constructors appear to be striving for a more compact coil than a single-layer coil, which will have the same inductance and the same, or even a smaller, loss. The tests of all these multilayer coils has shown that this goal has not been achieved. If we compare the best of the multilayer coils tested with the single-layer coils, we see that they are equally bulky and have greater losses on the whole. Nor is this result confined to amateur coils. If the original constructors and exploiters of these types of coils had taken the trouble to compare their A.C. resistances with that of a single-layer coil of, say, 3 in. diameter and $\frac{3}{4}$ in. long, wound fairly closely with the requisite number of turns, they would have found that, bulk for bulk, the single-layer coil would give the lower resistance for any coil intended to be used below about 600 metres.

The above single-layer coil is clearly one which could be made of the "plug in" variety. In addition, it requires fewer turns and less wire to produce the requisite

² An examination of the coil proved this to be the case.—Ed.

Losses in Inductance Coils.—

inductance. It may be coupled as closely as is usually necessary with other coils, and its stray field is equally small. Its only defect appears to be that it looks too simple to be a good seller! And yet not a single coil of this type was submitted for the competition.

These remarks are only intended to apply to solid wire coils used for wavelengths less than, say, 600 metres. Multilayer coils may profitably be used for Daventry or other long-wave stations. The commercial coils for this wavelength are not well designed for low losses, the diameter of wire employed being in general too great. The design of Daventry coils will be dealt with in the articles in *Experimental Wireless*.

The only way in which the multilayer system may profitably be employed in coils intended for use below 600 metres is by the employment of highly stranded Litz. Indiscriminate use of Litz, however, is liable to lead to disappointment, as it is impossible to decide intuitively on the correct gauge of wire to use for any given degree of stranding.

Agreement of Theoretical and Experimental Results.

As a result of a study of the theoretical losses in multilayer coils, the writer has not only been able to show that the theoretical losses agree very closely with the measured losses in well-constructed coils, but has also been able to simplify the theory so that, by means of a chart and tables, the correct diameter of strand to employ for any frequency, inductance, and size of coil may rapidly be determined. This chart will be published in *Experimental Wireless*.

The theoretical formula for solid wire multilayer coils having a straight winding is as follows:—

$$R_w = R_d \left\{ 1 + F + \left(\frac{KN_d}{2D} \right)^2 G \right\}$$

in which K is a factor depending on the ratio of winding length to overall diameter of coil and on the ratio of winding depth of overall diameter, D is the overall diameter, and N the number of turns. The other symbols have the same meaning as in the case of single-layer coils. The formula for stranded wire coils is slightly more complicated.

By means of this formula the following comparisons have been made between the measured and calculated resistances in the case of the better of the readers' coils illustrated in the issue of February 24th.

Coil No.	A.C. Resistance Obsd.	A.C. Resistance Calcd.
17	2.7	2.67
23	1.9	1.7
36	1.9	1.85
40	1.1	1.2

Considering the approximations that have had to be made in estimating the general dimensions, these comparisons are very satisfactory.

In conclusion, we give the specification of a 200 microhenry coil, which while being reasonably compact, should be even better than the Prize coil.

Single-layer coil, 41 turns of 27/42 S.W.G. wire, each strand S.S.C. Coil diameter, 4in. Coil length, 2in.

THEORETICAL RESISTANCES.			
1.44 ohms at 500 metres, or	7.2 ohms per millihenry.		
1.63	400	8.1	" "
1.80	350	9.0	" "
2.05	300	10.2	" "

It would be interesting to see how these values compare with the measured values.

SIR ARTHUR STANLEY, C.B.E., M.V.O., C.B.

IN any movement so important as broadcasting has proved itself to be since its inception in this country a few years ago, progress is only achieved through the co-operation of many brains, each contributing to different branches of development. Because broadcasting is a technical science, we may sometimes be led to assume that the success and progress achieved is entirely due to those workers whose activities are strictly confined to the technical sphere. This, however, is by no means the case, and, whilst we owe much to the inventor and professional engineer, we are equally indebted to those whose organising ability and other qualities of leadership have been productive of results which, without such organisation, could never have been achieved.

In the issue of *The Wireless World* of last week we published a supplement entitled "The Listener," which constitutes the journal of the Wireless League, the national organisation of listeners. The League is under the able chairmanship of Sir Arthur Stanley, G.B.E., a portrait of whom we reproduce as a supplement to this issue. The Wireless League was brought into existence through the efforts of *The Daily Express*, because it was realised that the necessity existed for some body to be established which could express the wishes of listeners as one voice. Having launched the League, it was necessary to find someone who could be capable of directing

the policy and destinies of the organisation as an independent body, and this became necessary as soon as the Wireless League had attained sufficient numerical strength and importance to stand on its own.

Sir Arthur Stanley is, comparatively, a new arrival in the field of broadcasting, but his ability to grasp the situation and foresee the possibilities which broadcasting had opened up was amply demonstrated in the evidence which he prepared and submitted personally on behalf of the Wireless League before the Broadcasting Committee of Enquiry recently. Sir Arthur Stanley's past work and experience in the direction of big organisations make him ideally fitted to direct the policy of an organisation of such national importance as the Wireless League promises to become.

During the period of the Great War he undertook the chairmanship of the Joint Committee of the British Red Cross and the Order of St. John, and was responsible for looking after the twenty-two million pounds raised by those organisations during the war. He still acts in the capacity of chairman of this organisation, whilst, in addition, he is closely associated with the great motoring bodies in this country, and is chairman of the Royal Automobile Club. He is also treasurer of St. Thomas's Hospital, president of the Hospitals Association and is closely connected with many other bodies and societies.



A Review of the Latest Products of the Manufacturers.

C.E. PRECISION RHEOSTAT.

The design of variable filament rheostats has to some extent become standardised, and one looks essentially for smooth, reliable contact between the resistance wire and the moving arm, and also for a scale, knob and pointer of attractive appearance. These requirements are to be found in the C.E. Pre-

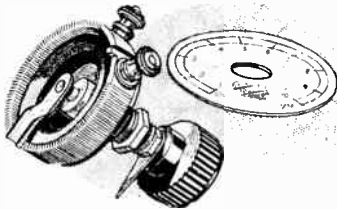

The C.E. Precision rheostat, which is fitted with an attractive engraved and silvered dial.

cision rheostats and potentiometers manufactured by C. Ede and Co., Byfleet, Surrey. The operating knob has a clean polished Trolite moulding, while the dial, being engraved in silver, undoubtedly adds to the attractive appearance of an instrument panel. The one-hole fixing which is adopted in the mounting of the rheostat also secures the dial. The resistance wire is wound on a fibre former and mounted so that it does not come into contact with the underface of the panel, and thus any undue heating that may accidentally occur will not result in burning the ebonite. Rheostats are obtainable in resistance values of 15 to 20 ohms or in similar form but wound as a potentiometer to a resistance of 300 ohms.

o o o o

COSMOS GRID CONDENSER AND LEAK.

Included in the range of components manufactured by Metro-Vick Supplies, Ltd., 4, Central Buildings, Westminster, London, S.W.1, is the Permacon combined grid condenser and leak. The condenser, which is of the mica dielectric type, is held between two insulating plates securely clamped together by a clip of moderately thick metal. The leak is of standard pattern and can be interchanged with resistances of other manufacture.

On test the values of both condenser

and leak were found to tally with the stated values within close limits.

The combined condenser and leak is of exceptionally light construction, so that

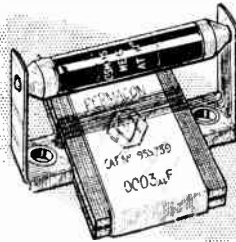

The Cosmos Permacon grid condenser and leak.

it can be carried on the instrument wiring, though an attachment to the instrument panel may be effected by means



Permacon fixed capacity condenser suitable for attaching to instrument wiring or mounting under terminals.

of screws, for which two holes are provided.

Fixed capacity condensers are also obtainable of somewhat similar build.

o o o o

"BLACKADDA" CONSTRUCTIONAL SETS.

To facilitate the making up of receiving sets embodying various components and circuit systems, the Blackadda Radio Co., Ltd., 48, Sadler Gate, Derby, have produced a novel system.

In brief, the Blackadda system makes use of panels carrying a large number of holes so that components can be secured at any convenient position, the fixing screws being suitably spaced to engage in the holes. The fixing screws are in most instances the terminal points of the

component, so that wiring up can be carried out beneath the panel, the screw heads and wiring being lifted from the surface of the table by means of four short screw-in legs. The principal merit of the system is the ease with which sets can be built up, for by following the instructional pamphlets the securing of the components is easily accomplished, and

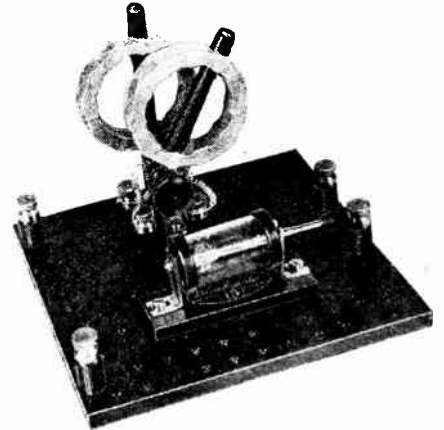

An easily constructed crystal set making use of variometer tuning, constructed in accordance with the Blackadda service sheet No. 1.

the wiring up, normally a difficult job, is shown in a form which can be readily followed and understood.

Every hole carries an identification number, and the instructions indicate the position of components by reference to these numbers. As the numbers appear on both sides of the panel wiring up is carried out from the instructions by linking together points of which the numbers are given.

Instructions for making various sets are supplied in the form of service sheets, and are published in loose leaf form with complete information of parts required, prices, and wiring diagrams.

In connection with the description of the variable condenser manufactured by the French firm of L. Haum, which appeared on page 416 of the issue of March 17th, the manufacturers point out that the reduction gear movement with its flexible coupling is supplied as a separate component apart from the variable condenser which they manufacture.

BROADCAST BREVITIES

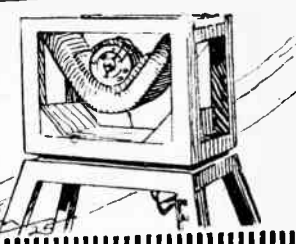

SAVOY HILL TOPICALITIES.

By OUR SPECIAL CORRESPONDENT.

The Broadcasting Committee.

Although it has been announced in the House of Commons that no statement will be made respecting the report of the Broadcasting Committee, 1925, which was recently presented to the Postmaster General, it is believed that the Committee's recommendations will be accepted practically as they stand, and the proposed Broadcasting Commission will be appointed in the early summer in order to form a sort of Shadow Cabinet during the remaining few months of the existence of the British Broadcasting Company.

All Serene.

It is surprising that the inquest on the B.B.C. has caused no perturbation at Savoy Hill. Even now the work is proceeding as if nothing unusual had happened, or was likely to happen. The only fact that seems to influence the officers

of the Company is that they must "keep on keeping on" with the job. As one of the highest officials said: "Whatever happens, we are strong in the faith of a work well done, and posterity will be able to judge with what success we prepared the foundations for future building."

A New Broadcast Item.

The advent of the child, who is to make her appearance in the programme once a week, commencing on April 12th, will be an innovation to broadcasting. This *enfant prodigue* of the ether will be of the type with which most listeners are familiar, the type that is often in trouble, generally wanting something, invariably misunderstood. Mrs. Florence A. Kilpatrick, one of the best-known creators of child character in fiction, is responsible for the sketches that have been prepared for broadcast, and in them she makes the child live while she has cleverly avoided precociousness.

Summer Programmes.

To meet the convenience of listeners who take open-air exercise during the summer months until darkness sets in, the programmes are to be altered in the timing. The two main portions will be given from 8.0 to 9.30 p.m. and from 10.0 to 11.0 p.m. The second general news bulletin will be broadcast at 9.30 p.m. Dance bands will play as usual from 10.30 to midnight three times a week. The changes will be made in the week beginning April 25th.

Oscillation.

The oscillation nuisance calls for urgent action, not only in tracking down offenders, but also in securing some alleviation of the trouble; but I doubt if the matter has yet been tackled in the right way. The calling of the names of towns where the trouble is habitual over the Daventry aerial has, I am told, proved useful in some cases, as a listener here and there has written to Savoy Hill asking for information as to how to stop his set from oscillating. There is a feeling in some quarters that, in the absence of any drastic action on the part of the Post Office, an improvement is not to be looked for until the new scheme of higher power is operating. But this, after all, will be merely to relieve the disease, very much in the same way as super-power relieves fading. It is not a cure.

On the Trail.

Some curious adventures have befallen listeners who are out to help in putting a stop to oscillation in their own districts. In one case an amateur detective's investigations involved the use of a step-ladder to enable him to peep over a neighbour's garden wall. What he saw inside the house and the sequel to the adventure is now enshrined in the private records of the B.B.C.

Three Sets: One Aerial.

A listener on Daventry at Berne reports reception of the high-power station on three crystal sets in one house, on one aerial. The aerial is thrown loosely over the roof and consists of electron wire. The middle set only is earthed and all three sets receive 5XX at good strength.

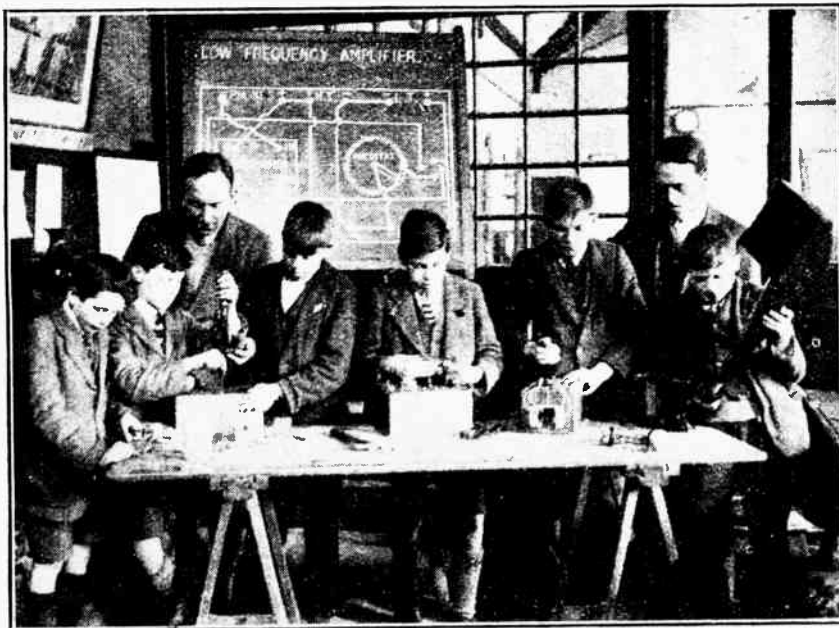

WIRELESS IN SCHOOL. The enterprising pupils of one of the Norwich Council Schools are constructing a four-valve set for receiving the B.B.C. educational transmissions. The photograph shows a busy group at work. Observe the "school-constructed" loud-speaker on the right.

2LO's Studios.

Although five studios are now in use at Savoy Hill, the need for additional studio facilities is becoming more and more apparent, chiefly to avoid pauses and delays in the programmes, but also to enable new experiments in acoustics to be undertaken. There are marked differences in the transmissions from the studios and those from outside sources, such as the Grand Hotel, Eastbourne, the Hotel Victoria, and the Piccadilly Hotel.

○○○○

The Echo Problem.

The matter is being constantly investigated by the engineers, and the development indicated in these columns last week, when the new scheme of music control was outlined, is an indication of the lines upon which Savoy Hill is working. It is hoped in the near future to give listeners some happy medium between the obtrusive echo of the outside broadcast and a too marked utilisation of damping effects.

○○○○

Lord Reading.

Lord Reading, on his return from his successful ten years of office as Viceroy of India, is to be entertained at dinner by the Pilgrim's Club on April 28th. Some of the speeches will be broadcast.

○○○○

A Boxing Match by Wireless.

While the broadcasting of a boxing contest has met with criticism in certain quarters, the B.B.C. feels that by including such a transmission in its programmes it is satisfying a general desire on the part of the public to know more of their popular heroes and of what goes on in a sphere with which the listener generally is unfamiliar. In this there is nothing exceptional. Broadcasting does not set up a limited standard of interest; its functions must comprise the covering of interests of every kind, from prize-fighting, the cinema and horse racing to religious addresses and the Budget speech. Its appetite is insatiable, and in course of time, when this fact and the value of the medium come to be realised, obstruction will cease to have any influence.

○○○○

Military Tattoos.

In response to inquiries from listeners, it may be recalled that the Military Tattoo from Wellington Barracks, London, was broadcast last summer; but it would be contrary to King's Regulations to broadcast the drilling of recruits, as suggested. Moreover, apart from the question of King's Regulations, the B.B.C. would have no opportunity of carrying out the highly desirable task of censoring the commands and comments of the drill sergeant!

○○○○

Changing the Guard.

While such a broadcast cannot, therefore, be undertaken, efforts may be made to obtain permission to broadcast the changing of the guard at one of the royal palaces. Broadcasts of military activities are always popular, judging by the corre-

FUTURE FEATURES.**Sunday, April 4th.**

LONDON.—Isolde Menges, solo violin; First Part of Dream Loom Play by R. E. Jeffrey, "Twixt Dark and Dawn."

ABERDEEN.—Dedication and Presentation of Colours, Aberdeen Battalion Boys' Brigade, Music Hall, Aberdeen.

Monday, April 5th.

LONDON.—7.25 p.m. Series. Brahms, interpreted by Laffitte. Band of H.M. Royal Air Force.

MANCHESTER.—Choral, Vocal and Instrumental Music.

Tuesday, April 6th.

LONDON.—The Premier English Concertina Band conducted by Percy E. Gayer. "Loyalty," a one-act play by H. E. Bates.

DAVENTRY.—Symphony Concert. Choruses from "The Messiah" (Handel) sung by the Dodding-ton Choral Society.

CARDIFF.—Fred Spencer ("Mrs. 'Arris").

GLASGOW.—Music and Humour.

NEWCASTLE.—Light Orchestral Concert. An Hour of Variety.

Wednesday, April 7th.

LONDON.—Chamber Music by the Philharmonic Trio.

BIRMINGHAM.—Grand Opera and Light Opera.

CARDIFF.—Bristol Night—Bristol Glee Singers.

Thursday, April 8th.

LONDON.—Special Concert by the Bournemouth Municipal Orchestra conducted by Dame Ethel Smythe, Sir Herbert Brewer, and Sir Dan Godfrey, with Solomon (Solo Pianoforte), relayed from the Winter Gardens, Bournemouth.

BIRMINGHAM.—British Composers, Russian Composers.

BELFAST.—Hunting Programme. Pantomime, "The Babes in the Wood."

Friday, April 9th.

LONDON.—Concert by the prize-winning Soloists in the G.W.R. Music Festival, including Songs, and a Public Speaking Competition, S.B. from Birmingham.

BIRMINGHAM.—G.W.R. Concert, including Public Speaking Contest.

GLASGOW.—Some Songs and a Fantasy. Station Repertory Company in "The Heart of a Clown."

NEWCASTLE.—A Request Night.

Saturday, April 10th.

LONDON.—Sea Shanties sung by John Goss, baritone, and the Cathedral Male Voice Quartet.

BOURNEMOUTH.—"The Holiday Spirit."

NEWCASTLE.—Fred Spencer ("Mrs. 'Arris"). The Station Orchestra. Third Edition of "Listening Time."

spondence received at Savoy Hill, and listeners may be interested to know that the Aldershot Searchlight Tattoo will be done again this year—on June 15th.

○○○○

Regimental Histories.

A further series of incidents from regimental histories of the British Army are to be given in the London programme on April 24th. Those so far arranged are connected with the Royal Fusiliers (1854), the Border Regiment (1811), the Gordon Highlanders (1794) and the Grenadier Guards (1857). Other actions associated with the history of the Life Guards and the Royal Artillery will also be heard in this programme. All the incidents will be interpreted by chosen players, assisted by a detachment from the 91st Brigade Royal Artillery, the 2LO Military Band and the Wireless Choir.

○○○○

Reviving Old Favourites.

Not all revivals of the music-hall songs of thirty years ago are successful; but Mr. Leslie Stuart's feature on the West End stage at the moment is proving one of the best "draws" in these days of somewhat jaded tastes. Critics who believed that the songs of the well-known writer of the music of "Florodora" and other old-time favourites would have no appeal for a public whose chief food is jazz have been proved wrong; and listeners will know the reason why when a recital of these songs is broadcast on April 7th. Mr. Frank Wood (tenor) and Mr. George Pizzy (baritone) will be the singers.

○○○○

Chez Fysher.

A cabaret performance by the Chez Fysher company will be broadcast from 2LO on April 10th under the personal direction of M. Fysher. This is one of the original cabaret entertainments, and has come from Paris to fulfil a few London engagements.

○○○○

The Crystal Palace.

Broadcasts in the past from the Crystal Palace have not been good; but the National Union of School Orchestras is an event of sufficient importance not to be overlooked by the microphone. On June 13th, therefore, when the National Union holds its annual concert at the Palace, a half-hour's excerpt will be relayed to 2LO.

○○○○

A Versatile Actor.

On April 3rd Mr. R. A. Roberts is appearing before the microphone in his own sketch dealing with the highwayman Dick Turpin. This will be a broadcast version of the play in which Mr. Roberts has thrilled audiences hundreds of times, playing every part himself, with only seconds for complete changes. He has a remarkable range of voice, and it is thought that even through the microphone he will be able to give each of his characters an individual existence. Mr. Roberts has himself specially re-written his famous sketch for the purposes of broadcast transmission.

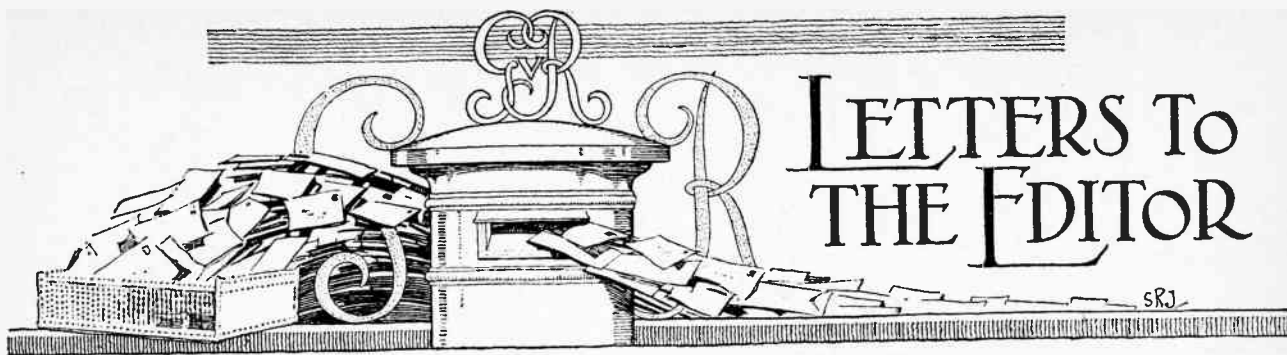

The Editor does not hold himself responsible for the opinions of his correspondents.

Correspondence should be addressed to the Editor, "The Wireless World," Dorset House, Tudor Street, E.C.4, and must be accompanied by the writer's name and address.

LIGHTSHIP TELEPHONY.

Sir,—With reference to the enquiry made by Mr. Ronald C. Horsnell in to-day's *Wireless World*, he may be interested to know that the lightships work on 230 metres with a power of 100 watts. The "Alert" is a Trinity Service steamship, while "The Walton," which should read "Walton-on-Naze," is the shore station for the more northerly situated lightships.

I have seen most of the sets, and they are wonderfully efficient, being worked by the normal staff of the lightship.

Felixstowe

E. CORK.

Sir,—It may interest Mr. Horsnell to know that several of the lightships are received here on a one-valve set using reaction. I myself use a loose coupled "Aperiodic" aerial, but it is much easier to use a direct coupled tuner with series condenser.

Among the stations I have received here is the "Shipwash," which is off the Suffolk coast. The "Alert," which Mr. Horsnell mentions, I believe to be the relief boat, and I also think Walton is a land station.

The conversations between the operators are most entertaining, in particular during storms. About 10.30 p.m. is a good time to listen.

A 40 or 30 turn coil would do for the A.T.I. when used with a series condenser, though I think a 50 would do with a variable condenser of 0.0003 mfd. and a short aerial.

St. Leonards-on-Sea.

J. H. McCALL.

BROADCASTING UNDER STATE CONTROL.

Sir,—In your editorial in *The Wireless World* of March 17th commenting on the findings of the Broadcasting Committee's report, you support the theory that broadcasting in this country has grown to be too big a thing to be under the control of a private company. At the same time, you admit that the present company has done exceedingly good work during its existence.

Would it not be better to wait until we have some evidence that the job of providing listeners with the programmes which they require has become too much for the B.B.C. before scrapping that company in favour of a government controlled organisation of unknown efficiency?

In some quarters it seems to be taken for granted that the findings of the Committee are to the liking of the public. Personally I very much doubt this view. I for one look with very grave concern at the prospect of my programmes being provided by a Government department.

Chester.

J. H. S. JONES.

EXPERIMENTERS AND THE PUBLIC.

Sir,—With reference to the two letters published under the heading "Experimenters and the Public," in your issue of March 17th, it appears that perhaps there is a misunderstanding between Mr. Railton and Mr. Maurice Child.

Here in North Wales, on any Sunday morning, or evening between six and eight o'clock, it is possible to hear numerous amateur transmitters on wavelengths which vary tremendously, some certainly not above 350 metres, others not much below 500 metres, and anywhere in between these limits. They trans-

mit, as a rule, very poor telephony, and roughly the usual procedure is a call-up of one or several transmitting acquaintances with a request for reports on a "test" transmission, almost invariably a gramophone record, and usually "jazz" dance music, which follows. Then "over and listening-in for reports." One of the others then starts up, generally on a considerably different wavelength, and gives a report to the effect that the transmission was stronger or weaker than usual, the modulation better or worse than usual, or that the wavelength was unsteady, etc. Then this transmitter has his turn at the gramophone, and so it goes on. I offer no opinion on this matter, but simply state what I have heard on dozens of Sundays. There is no doubt that the transmissions do sometimes interfere with attempts to receive Continental stations, even here. It must be very much worse in the vicinity of Liverpool, Manchester, and other towns, in or near which these transmissions originate, and it seems probable that they are causing the interference of which Mr. Railton complains, and not those on 150-200 metres to which Mr. Maurice Child refers.

In this connection I should like to state also that on two Sunday evenings recently an "amateur" transmitter was working telephony on a wavelength between 300 and 500 metres, the transmission consisting of gramophone records, one after another, without apparently any change-over to reception. Each record was preceded by "This is (here followed the call sign, together with the full name of a firm of manufacturers or dealers in wireless apparatus, and the town in which it carries on its business), please stand by for the next test, which will be number so-and-so." I heard tests Nos. 28-32 inclusive on one occasion, and something about the same on another Sunday. Before closing down prior to the evening B.B.C. transmissions I should think they would have time to get in forty or fifty records and announcements. Again, I offer no opinion as to the real purpose of these "tests," but merely give the facts.

Llandudno Junction, S.O.

J. H. S. FILDES.

Sir,—I wish to heartily endorse Mr. Railton's views as given in his letter reproduced in the March 17th issue of *The Wireless World*. On more than one occasion I have been on the point of writing to the P.M.G. to suggest that amateur transmitters should be compelled to close down after 3 p.m. on Sunday, except those transmitting on or below 200 metres.

The Manchester district is *blessed* with a number of transmitters who work on 350-450 metres and blot out a large number of Continental stations each Sunday evening with their screeching gramophones, to say nothing of heterodyning with one another.

As an illustration of the above, on Sunday last a certain transmitter with a horrible note was complaining bitterly that he could not hear his friend, another transmitter, owing to someone continuously oscillating. Finally, he made the following remarks:—"It's no use old man, I cannot get you clearly owing to the continuous oscillation. It is your next door but one neighbour. He is wearing horn-rimmed glasses and has a piece of Spearmint stuck in his tooth, etc."

This "ham" was right on top of a Continental station giving a very fine and strong beat note whenever he crashed in. Needless to say, he had to repeat his message as his friend was evidently unable to pick him up at the first attempt.

With reference to Mr. Child's remarks, I have, I dare say, spent almost as much on wireless components in experimental receiving as he has on his transmitting, without causing the same disturbance in the ether.

ARTHUR F. WILLIAMS.

Timperley, nr. Manchester.

Sir,—It appears to me that Mr. C. W. Railton is taking a very bigoted view of the subject. You will note that he "supposes" there are only a few thousand amateur transmitters scattered up and down the country; he obviously does not even know the actual number of licensed transmitters working on their experiments. He states that the transmissions are exasperating to a "suffering public," of which he is a member; well, the cure for his suffering is clearly indicated. Why not cease from listening to the annoyance?

Also, are the activities of such men as 2OD, 2SZ, 2GM, 2TZ, etc., etc., to suffer further restrictions for the sake of B.C.I.s who think they are not having their money's worth unless they can listen to the broadcasting all day and night? To me the most amusing part is that, as Mr. Child points out, Mr. Railton's apparatus is so unselective that even in Cheshire he cannot cut out a few 200 metre amateurs working with the enormous power of 10 watts.

HERBERT J. SHERRY.

West Ealing.

Sir,—While feeling slightly amused at the letter from Mr. Railton, we feel we cannot let such an example of unwarranted selfishness pass without some comment from ourselves.

The following extracts are from two letters received by one of us on the subject of amateur transmission interfering with broadcasting:—

"You were transmitting on a wavelength ranging from Glasgow down to Hamburg."

Our reply to this elicited the following startling announcements:—

"My statement was that you were on wavelengths ranging from Hamburg to Glasgow, and this I maintain. My receiving set is the latest American Superhet. which, with the loop I was using at the time, barely goes down to 250 metres."

These statements from a man living 200 yards from the 8-watt station in question merely shows the extent of his knowledge.

The wavelength of the station causing the correspondence has never exceeded 160 metres, measured by a wavemeter calibrated against an N.P.L. Standard.

L. J. FULLER (6LB).

J. W. MATHEWS (6LL).

R. P. HANKEY (5Z4).

Wanstead, Essex.

TRANSMISSION BY MAGNETOPHONE METHOD

Sir,—I recently lent a "Mellovox" loud-speaker to a friend of mine who lives one hundred yards away. The loud-speaker was attached to my receiver with one hundred yards of flex. The same evening, after Daventry had closed down, I heard faint

voices in my own loud-speaker, and gathered from the conversation that they were the voices of my friends down the street.

So forthwith I connected the flex from my friend's house to the L.F. side of my receiver and, to my astonishment, I received their voices with just as true reproduction as I get from broadcasting stations. I have since heard them playing the piano and other instruments with the same success. If any of your readers find it difficult to send out good speech and music with a carbon microphone it would be worth their while to try this.

Creetown, N.B.

G. J. RUSHTON.

[Many amateurs are using this magnetophone system in place of the usual form of carbon microphone.—Ed.]

THE AMATEUR AND MORSE.

Sir,—The fault of gramophone records, as recommended by Mr. Adshead in your issue of March 10th, is that after a certain number of runs they are learnt by heart. Years ago there was advertised in your columns a self-instructor which to a great extent eliminated this fault. It was a really clever invention, but somewhat expensive, and it was marred by inattention to constructional details. In common with the gramophone, it had the fault that alteration of the speed altered the pitch of the note, which was rather low at best. This could, I think, have been remedied.

S. F. W.

Berwickshire.

H.F. RESISTANCE OF COILS.

Sir,—In the issue of *Wireless Weekly* * for March 10th there appeared a most interesting letter relating to the H.F. resistance of coils by Mr. C. S. Endersby. He quoted the results of tests made by him in regard to six different coils. His results, which hold for a wavelength of 400 metres, are given below, together with results on similar coils at the same wavelength and published in *The Wireless World* on February 17th.

<i>The Wireless World.</i>			Mr. Endersby.			
Coil No.	Wire Gauge.	Inductance.	H.F. Res.	Wire Gauge.	Inductance.	H.F. Res.
1	16 D.C.C.	130 mics.	3.8	22 D.C.C.	130 mics.	3.8
2	16 D.C.C.	102 "	1.5	16 D.C.C.	102 "	1.5
3	Litz.	141 "	2	Litz.	141 "	2
4	20 D.C.C.	253 "	16.2	"	253 "	16.2
5	20 D.C.C.	128 "	5.8	"	128 "	5.8
6	30 enamel.	140 "	6.3	30 enamel.	140 "	6.3

You will agree with me that the accuracy with which H.F. measurements can now be carried out is very remarkable!

I have forwarded a letter relating to the same matter to the Editor of *Wireless Weekly* for publication.

While on the subject of low-loss coils, I should like to congratulate Gambrell Bros., Ltd., on their courage in publishing the H.F. resistance of their series of coils in their advertisement in your issue of March 17th. There is, however, one unfortunate omission in their table. The wavelengths for which the H.F. resistances hold is not stated. Until this is stated the prospective purchaser has not got the full data upon which to judge the coil.

S. BUTTERWORTH.

Admiralty Research Laboratory, Teddington,

* A journal published by the Radio Press, Ltd.

"The Radio Mail."

The principal feature in the seventh number of this attractive little periodical, published by A. C. Cossor, Ltd., is a detailed description of a short wave receiver of extremely simple design, in which special attention has been given to the avoidance of capacity effects. The same issue includes an interesting contribution describing the pumping and capping of valves in the Cossor factory.

o o o o

Electric Saw for Portable Work.

A new electric sawbench, easily capable of cutting ebonite, erinoid, fibre, plywood, and light gauge metals, is being produced by the B.E.N. Patents, Ltd., 100, Victoria Street, London, S.W.1.

TRADE NOTES.

Known as the U.L.A. electric sawbench, it is designed to allow the table to be lifted clear of the motor by simply unscrewing two nuts, so that the tool can be used for portable work such as cleaning and polishing.

o o o o

Municipal Trading Protest.

A protest against the practice of certain municipal authorities in selling wireless apparatus in their electrical showrooms is contained in two booklets which we

have received from the Electrical Contractors' Association (Incorp.), 15, Savoy Street, Strand, W.C.2.

"It is grossly unfair," says the writer, "that capital raised on the security of municipal rates should be used in direct competition with ratepaying traders."

o o o o

Airmax Agents in London.

The well-known "Airmax" coils are now obtainable in London from A. F. Bulgin and Co., 9-11, Cursitor Street, Chancery Lane, E.C.4, who have been appointed sole London agents by the manufacturers, Messrs. Cooke and Stevenson, of Sheffield.

A number of price reductions are announced.

READERS' PROBLEMS

"The Wireless World"
Information Department
Conducts a Free Service
of Replies to Readers'
Queries.

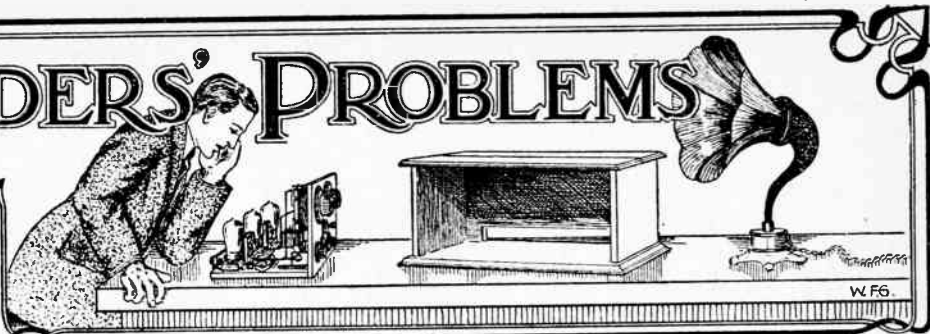

Questions should be concisely worded and headed "Information Department." Each separate question must be accompanied by a stamped addressed envelope for postal reply.

Operating Valve Filaments from D.C. Mains.

I have a four-valve set, using two bright emitters and two D.E.5 valves, and wish to obtain L.T. from my 240 volts D.C. mains. How can I determine the correct lamp resistance to use in series with the mains and L.T. terminals of the set? H.J.M.

This problem resolves itself into very simple juggling with Ohms law. The voltage 240 and the current amperes are known, taking the consumption of a bright emitter and a D.E.5 as 0.75 amp. and 0.25 amp. respectively. Therefore, from the formula $R = \frac{E}{I} = \frac{240}{2}$ we find that a resistance of 120 ohms is called for. A negligible proportion of this (about 2.5 ohms) is supplied by the valv filaments. Now the resistance of eight 240-volt 60-watt lamps in parallel is 120 ohms approximately, because $I = \frac{E}{W} = \frac{240}{480} = 2$ amps. where

$W = \text{power in watts and } R = \frac{E}{C} = \frac{240}{480} = 120$ ohms. Provided that these lamps are also in use for different parts of the house for lighting purposes, at the same time that the set is in use, we have an economical proposition. Alternatively, there are a number of small $\frac{1}{2}$ kW. electric heaters which could successfully take the place of the tank of lamps.

○○○○

A Single-valve Circuit of High Efficiency

I wish to construct an efficient single-valve receiver designed for the reception of a large number of B.B.C. and continental stations upon headphones. It is necessary that a coupled aerial circuit be employed in order to give selectivity, whilst smooth control of reaction is essential. I have been given to understand that it is possible to construct an extremely sensitive single-valve receiver by using one coil only. I should therefore prefer to use this circuit provided that it is sensitive and selective. R.W.H.

It certainly is possible, as you suggest, to construct a highly sensitive and selective single-valve receiver using only one coil, and we illustrate the circuit in Fig. 1. Using this circuit, reaction control will be found pleasingly smooth, thus

greatly facilitating the reception of distant stations, whilst the selectivity obtainable is of a high order. Owing to the fact that the single coil required is quite easily connected at home, the instrument can be made up at a very small cost, and is especially to be recommended to those who wish to receive distant stations with a minimum of expense and trouble. The coil should consist of a total of 100 turns of No. 22 D.C.C. wire wound on a former of 3in. diameter, tapings being taken at the 60th and 75th turns. The commencement of the winding should be connected to the grid of the valve, the 60th turn to the earth connection, and the 75th turn to the aerial, the end of the winding being connected to the reaction condenser. It should be pointed out that in this circuit no fixed condenser is required across the

spective of the nature of the filament before disaster overtook it. Thus, it would be possible to fit a valve, originally having a bright emitter filament, with a dull emitter filament of either the 2-volt .35 amp. type, or of the 3-volt .06 amp. type. It would not be possible, however, to convert a high magnification factor valve such as the D.E.3B. into a big power valve, even though a filament with heavy current consumption were fitted, because the difference between a small general purpose or high magnification factor valve does not depend on filament characteristics alone, but depends on factors such as the disposition of the electrodes with respect to their distance from each other, and the close or open meshing of the grid.

○○○○

An Unusual Aerial

I have been given to understand that it is possible to use an electric iron as an aerial. If this is the case, I shall be glad if you can give me the necessary connections. B.F.S.

It is certainly possible to make use of the ordinary domestic iron as an aerial and thereby to obtain results at least equal to the average indoor aerial. One method is to obtain a small metal tray to which a wire should be soldered, or otherwise attached, the other end of this wire going to the aerial terminal of the receiver. The iron should then be placed on the tray connected in the usual manner to a near-by lamp socket. Virtually we are now using the electric light mains as an aerial, the "coupling" to the set being effected through the capacity existing between the wire elements of the iron (which is, of course, in direct contact with the mains) and the metal bottom of the iron, which is in contact with the tray. The current should not be switched on, of course, not because it would connect the receiver directly to the mains, but because of the danger of fire owing to heating of the iron. In any case there would be no danger of "shocks" or damage to the receiver by direct contact with the mains, because the metal body of the iron is completely insulated from the internal element. A far simpler method would be to dispense with the tray and simply drill a hole through the metallic part of the handle of the iron,

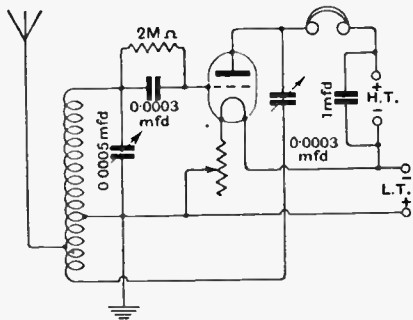

Fig. 1.—A sensitive and selective single-valve circuit.

telephones. Low-frequency amplification can be added in the usual manner, the primary of the L.F. transformer taking the place of the telephones, but here again no shunting condenser is required. This circuit will be found quite simple to tune.

○○○○

Re-Filamenting Old Valves

I notice that certain advertisers undertake to re-filament a burnt-out valve so that it has any characteristics desired by the customer irrespective of the original characteristics of the valve. Is this really possible? E.D.S.

It is, of course, possible to fit a valve with any filament characteristics irre-

and to affix a terminal therein which could then be easily coupled up to the aerial terminal of the receiver by a length of wire. This wire can, of course, be quite long, and there is no need of the iron being placed in the vicinity of the receiver. If fairly close to a broadcasting station quite good results can be obtained by merely placing the iron on top of the receiver cabinet, relying on the capacity between the iron and the coils within the set to act as a coupling.

○○○○

Correct Connections of the G.B. + Terminal.

I noticed recently in the "Readers' Problems" section an explanation of the reason why it is usually best to join H.T. - to L.T. - rather than to L.T. +, but no reason was given for always connecting G.B. + to L.T. - rather than to L.T. + Can you explain this?
S.K.D.

The purpose of using a grid biasing battery is to make the grid of the valve a certain number of volts more negative than the negative side of its filament, and consequently we connect the battery between the grid and the negative side of the filament. If we connect G.B. + to L.T. + we are making the grid a certain number of volts more negative than the positive side of the filament. Therefore we have first to overcome the "back positive E.M.F." of the filament battery before we can begin to make the grid more negative than the negative side of the filament. Let us take a concrete example. Assuming that we desire to bias a D.E.5 valve $4\frac{1}{2}$ volts negative, and that we connect G.B. + to L.T. +. Now since the D.E.5 uses a 6-volt battery, it is obvious therefore that the L.T. + terminal is six volts more positive than the negative side of the filament. If we connect a $4\frac{1}{2}$ -volt biasing battery with its positive terminal connected to L.T. +, and then it is obvious that the grid will still be $1\frac{1}{2}$ volts more positive than the negative side of the filament, and another six volts negative will have to be added to the grid battery in order to overcome the 6 volts positive bias applied by connecting G.B. + to L.T. + instead of to L.T. -. The disadvantage then of connecting G.B. + to L.T. + is that no benefit is derived and we have to use an unnecessarily large grid battery.

○○○○

An Impromptu Loud-speaker.

I am using an 0-v-2 receiver in conjunction with a low-resistance loud-speaker, and recently when disconnecting the loud-speaker I found that I could faintly, but quite clearly, hear the local station programme emanating from the receiver itself, although no telephones or loud-speaker were attached to it, nor, indeed, anywhere near it. Can you explain this phenomenon?
P.R.C.

Since in order to propagate sound it is necessary that some object be set into a state of mechanical vibration, it is obvious that some portion of your receiver must

A 40

BOOKS ON THE WIRELESS VALVE

Issued in conjunction with "The Wireless World."

"WIRELESS TELEPHONY," by R. D. BANGAY Price 2/6 net. By Post, 2/9.

"THE OSCILLATION VALVE—THE ELEMENTARY PRINCIPLES OF ITS APPLICATION TO WIRELESS TELEGRAPHY," by R. D. BANGAY. Price 6/- net. By Post, 6/3.

"WIRELESS VALVE RECEIVERS AND CIRCUITS IN PRINCIPLE AND PRACTICE," by R. D. BANGAY and N. ASHBRIDGE, B.Sc. Price 2/6 net. By Post, 2/10.

"THE THERMIONIC VALVE AND ITS DEVELOPMENT IN RADIO TELEGRAPHY AND TELEPHONY," by Dr. J. A. FLEMING. Price 15/- net. By Post, 15/9.

"CONTINUOUS WAVE WIRELESS TELEGRAPHY," Part 1, by W. H. ECCLES, F.Sc. Price 25/- net. By Post, 25/9.

Obtainable by post (remittance with order) from
ILIFFE & SONS LIMITED
Dorset House, Tudor St., London, E.C. 4
or of Booksellers and Bookstalls

be vibrating in step with the audio-frequency electrical impulses present in your L.F. amplifier. The most likely source of this trouble is to be found in the laminations of your telephone transformer, which in all probability have become somewhat loose. Since these laminations are, of course, directly in the path of the varying magnetic field associated with the transformer, they will, if at all loose, tend to vibrate in the same manner as the diaphragms of the telephones, and so feebly reproduce any strong signals that are received. Steps should be taken to remedy this trouble, since it does, of course, definitely represent so much energy loss in the receiver.

○○○○

What's Watt?

I am constructing a unit for obtaining different H.T. voltages from my 240-volt D.C. mains, and, while I fully understand that in order to calculate the value of the various voltages I shall obtain with certain lamps, it is necessary that I know the resistance of those lamps, I am much puzzled concerning the precise method of ascertaining these values, some lamps being marked in candle-power and some in watts, which is very confusing. Can you shed any light on this matter?
J.L.G.

It is usually customary for lamp manufacturers to mark metallic filament lamps with the actual wattage, whilst the cheaper carbon lamps are rated by their candle-power, presumably in order to conceal their wasteful consumption of energy. There are, broadly speaking, three types of lamps available: the ordinary carbon lamp, taking about 4 watts per candle-power; the ordinary metal filament type, taking 1 watt per C.P.; and the "half-watt" type, taking half-watt per C.P. Let us take the specific instance of an ordinary 240-volt 16 C.P. carbon lamp and find its resistance. First find the wattage, which is

easily done by multiplying the candle-power by 4, and gives us 64 watts. Having now the voltage and wattage, the procedure for finding the normal resistance of the filament is now the same as for any type of lamp. There are various methods of accomplishing this, but probably the most direct is to take

the formula $R = \frac{E^2}{\text{watts}}$ and substitute when we find that the resistance of the lamp = 900 ohms.

○○○○

The Efficiency of Dull Emitters.

I have for a long time been using an ordinary bright emitter valve in my single valve receiver with great success, but for the sake of economy I am thinking of substituting some by a 2-volt dull emitter. I have been advised by a friend, however, not to do so. He states that dull emitters are definitely less efficient than bright emitter valves, and I should be glad of your ruling in this matter.
A.C.C.

Given a bright emitter in good condition, and a dull emitter of the type you mention in equally good condition, we would say most definitely that you would find the dull emitter no less efficient than the bright emitter; indeed, it would probably be found that the dull emitter was distinctly more efficient. There is, unfortunately, still a prejudice against the dull emitter in the minds of many amateurs. When these valves were first put on the market this feeling was undoubtedly justified, as some of the earlier dull emitter valves were very delicate and uncertain in their action, losing their emission rapidly in spite of the utmost care being taken with them. Unfortunately experiences with these earlier models has produced a lasting feeling of distrust in the minds of many people. Nowadays the dull emitter is an extremely robust article, and will give sterling service if used according to the makers' instructions. This more especially applies to dull emitters of the two- and six-volt class, which, if used with a two- and six-volt accumulator respectively, are practically "foolproof." The 0.06 amp. valve is, of course, a more delicate instrument, and requires greater care, and, owing to the awkwardness of its operating voltage, can very easily be damaged by the ignorant novice. Of course, from the point of view of the pure novice, the bright emitter does possess one great advantage, which is that as long as the filament lights, it can, in nine cases out of ten, be taken that it is in working order, and when abused beyond all limit, it burns out and thus gives the user a definite indication of its demise. With an 0.06 amp. valve on the other hand, it will often be found that it will not burn out even if connected directly across a six-volt accumulator with no resistance in circuit, although, of course, it will be completely ruined. To all appearance, however, the valve is as good as new, and the inexperienced user is deceived into thinking that the valve is still efficient because the filament lights.



Of course it's
a mix-up! *Why*
didn't you
use

GLAZITE
BRITISH MADE REGD.
COLOURED CONNECTING WIRE"

Red, Yellow,
Blue *and* Black

10 foot
COILS

Be sure to
see the
LEW seal

Per 1/2 Coil

2 foot
LENGTHS

Four assorted
colours in
an envelope

Per 1/- Pk.

Obtainable from all dealers

Write for free booklet to
THE LONDON ELECTRIC WIRE CO. AND SMITHS LTD
(Makers of Electric Wire for over 40 years.)
Playhouse Yard, Golden Lane, London, E.C.1

This mark



guarantees quality.

3UDD

1ST AND 2ND STAGE

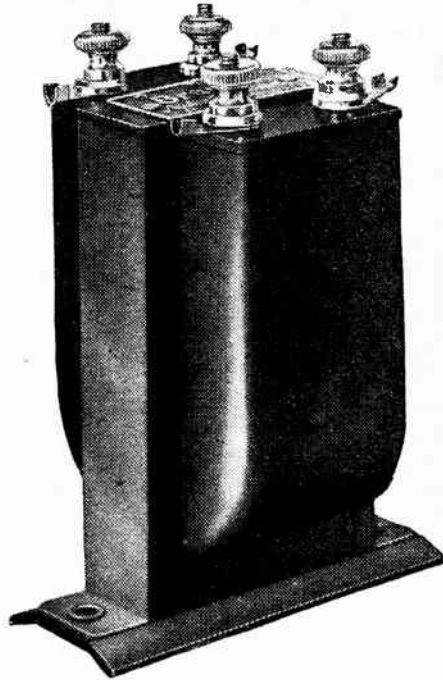

THE AUDIO
TRANSFORMER

Are you building? Do you want more power without choking the purity of those smooth, level tones? The Brandes 1st stage Transformer has a high voltage amplification ratio of 1-5. This, together with a straight line amplification curve, means that the amplification is constant over a wide band of frequencies, thus eliminating resonance. The 1-3 Transformer amplifies over speech, pianoforte and harmonic ranges equally well. Mechanically protected and shielded against interaction. Terminals and outside soldering tags.

17/6

Ratio 1-5 (black finish).
Table-Talker
30/-

Ratio 1-3 (brown finish).
Brandola Matched Tone
90/- Headphones, 20/-

Brandes

Brandes Limited, 296, Regent St., London, W.1

from any good Dealer.

44/563

SERVICE ADVERTISING

Absorbs shock—Protects your valves

You know it's good
—because of the
name **LOTUS**.

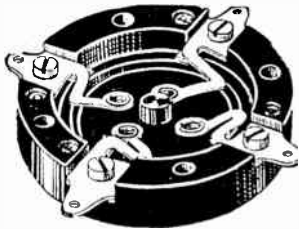

UNDERSIDE SHOWING SPRINGS.

Don't have your valves spoiled by shock. The Lotus Valve Holder has been specially designed to counteract the microphonic elements that are so injurious to the delicate valve filaments.

The unique and original springs of the Lotus Valve Holder absorb any shock and eliminate all microphonic noises.

Protect YOUR Valves by fitting the Lotus Holder



TOP VIEW.

Valve sockets and springs are locked together by a mechanical process, making a definite and permanent connection. Bakelite mouldings, nickel silver springs and phosphor bronze valve sockets. Nickel-plated.

LOTUS

BUOYANCY
VALVE HOLDER
ANTI-MICROPHONIC

GARNETT, WHITELEY & CO., LTD.,
Lotus Works,
Broadgreen Road, Liverpool

Makers of the
famous Lotus
Vernier Coil
Holder

2/3

With Terminals
2/5



**The Home
Constructor's**
EASY TO BUILD
**Wireless
Sets**

By F. H. Haynes.

IN THIS book the author introduces some entirely original sets which will make a strong appeal to the home constructor, on account of the simplicity of construction and the fact that they have not previously been described elsewhere.

EASY TO UNDERSTAND working drawings are given, with practical circuit diagrams, together with a sufficient explanation of the underlying principle to obtain a thorough understanding of the construction.

PRICE **1/6** NET.

By Post 1/9.

Obtainable from all booksellers or from
the Publishers of "The Wireless World":
ILIFFE & SONS LTD.,
Dorset House, Tudor Street,
LONDON, E.C.4

W.W.11

The
**Amateur's Book
of
Wireless Circuits**

By F. H. Haynes

The most up-to-date book of circuits published. It contains 117 practical circuits for reception and transmission, with notes and descriptive matter.

Price 3/6 net. By post, 4/-

Obtainable from Booksellers and Wireless Stores;
or direct from the Publishers.
ILIFFE & SONS LTD., Dorset House, Tudor St.,
London, E.C.4. W.W.11

Test it
at our
expense

Here's an opportunity
for you to try out the
PUREMAX Loud
Speaker—the marvel of
present-day manufacture.

SPECIAL TRIAL OFFER

If your dealer is out of stock, post us 70/- with his name and we will send you a **PUREMAX** by return, post free. If in one week you're not perfectly delighted, return it and we will refund your money in full, plus postage

"PUREMAX"

70/-

By reason of its double electro-magnetic action and the super selected mica diaphragm this instrument is perfect in purity of tone and reception, and distortion is entirely eliminated.

LEE & CHURCHILL Ltd
3a, Hanover Court,
London—E.C.2



Electradix Radios

5-VALVE R.A.F., 19 RECEIVERS, 2 H.F., 1 Det., 2 L.F. in portable case. Condenser and Valves, H.T. and L.T. Batteries and Headphones. Cost £25. Sale price £6. With D.E. Valves £6 10s.

SUPERSONIC HETERODYNE Sets. The cheapest solution is the R.A.F. 7-valve 600/5,000 metre H.F. Transformers and 3 L.F., with plug switching, beautiful mahogany cabinet. Gets Daventry with no aerial. Your existing 2-valve set can couple to this and make a £35 Het. These R.A.F. Sets cost £40, and are a snip. As described in "Modern Wireless." Instruction leaflet with each, £5 10s. Packing and carriage, 4/6.

HIGH-FREQUENCY AMPLIFIERS. 1,600/5,000 metres. 3-valve. Complete with Rheostat and Potentiometer. Price 30/- Marconi 7-valve, £7 10s.

New Enlarged Illustrated Catalogue sent Post Free for 4d. in stamps.

Goods promptly despatched all over the world.
LESLIE DIXON & CO., Phone: City 191
218, Upper Thames Street, London, E.C.4

Save the Middleman's Profits.

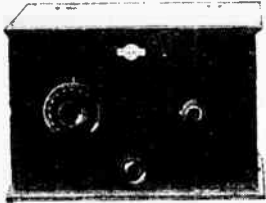

THE
"BAYNTON
TWO"

LOUD SPEAKER
Two Valve Set.
12 Months Guaranteed.

£12 - 12 - 0 complete ONE DIAL CONTROL.
Including Valves, Batteries, Coils, Loud Speaker, &c. C.O.D.

From the Sole Manufacturer:

C. S. BAYNTON, 133, New St., BIRMINGHAM.

3 Y G

Three Years' Guarantee and Money Refunded if not satisfied after a week's trial. This is our offer to all purchasers of The Bretwood Auto-Audio Frequency Amplifier.

The design and construction of this Amplifier enable us to make the following statements in all good faith.

THE BRETWOOD AMPLIFIER practically eliminates atmospherics.

THE BRETWOOD AMPLIFIER enables one to ignore those ripples caused through local power stations and the interference resulting from discharge of current operating electric trains, trams, etc.

Can be used with 3 or more stages without any trace whatever of distortion or noisy background.

To obtain the maximum filtration effects, at least two stages of amplification should be used

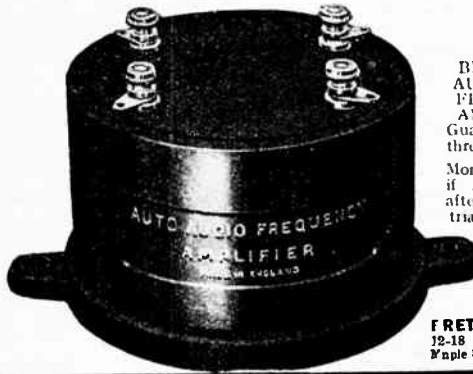

PRICE
20/-

THE
BRETWOOD
AUTO-AUDIO
FREQUENCY
AMPLIFIER.
Guaranteed for
three years.

Money refunded
if not satisfied
after a week's
trial.

Obtainable from
most dealers, or
from the sole
manufacturer:

FRETWOOD, Ltd.,
12-18 London Mews,
Finsbury St., London. W.1

H.F. 27.

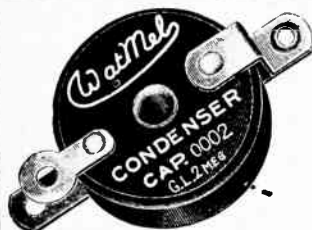

Two in One!

Here's a splendid little component, the Walmel combined Grid Condenser and Fixed Grid Leak. Saves space, time and money. Built to allow the Grid Leak to be connected either across the condenser or direct to the filament of the detector valve.

Price 2/6 each.

Send a postcard for full details of the various Walmel products.

The Walmel Wireless Co. Ltd.,
332a, Goswell Rd., London, E.C.1.

Representative for Lancashire & Cheshire:
Mr. J. B. Levee, 23, Hartley Street,
Levenshulme, Manchester.

For trouble-free condenser efficiency
always specify the famous round
Walmel fixed condenser.

Sizes up to '002 - - - 2/-
Sizes '0025 to '008 - - - 2/8

"Japa"
REGD
PLUG & SOCKET
TERMINALS ARE THE
FINEST TERMINALS
IN THE WORLD
FOR ALL WIRELESS
CONNECTIONS.

BRITISH MADE.

If your
Dealer
cannot
supply you
direct to
the Manu-
facturer
through the
post.

W. J.
CHARLESWORTH,
44 & 89, Aston Street,
BIRMINGHAM.
— Established 1897

"Japa"
REGD

No bits of bent tin or
brass, or screwed com-
position sleeves to make
your connection, but a
reliable mechanical
article which has been
copied by
many but
equals
by none.

ACTUAL
SIZE

Insert upon
the reverse
article

6D.
EACH
Post free.

Made in Red, Black, Pak
Blue, Green, Royal Blue,
Amber, Yellow Brown.

The Wonderfully Efficient
Reactone Low-Loss Coils.

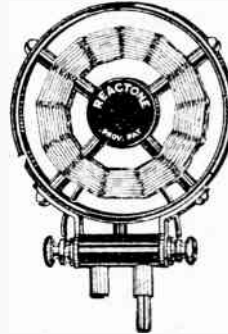

Wound with double silk-
covered wire, under con-
stant tension, on the same
principle as the Standard
Reactone Coil. Mounted
in a low-loss frame,
giving absolute rigidity—
no shellac, tape, wax,
or fibre.

No.	Price.	No.	Price.
25	3/9	75	4/9
30	4/-	100	5/9
35	4/3	150	6/9
40	4/3	200	7/6
50	4/3	250	8/-
60	4/6		

Reactone
PROV. PATENT
Low Loss Coil

All good Radio Dealers sell Reactone Low-Loss Coils,
and also the Standard Reactone Coils. In case of
difficulty, write to the manufacturers:—

Reactone Ltd., 88-89, Chancery Lane,
LONDON, W.C.

EBONITE OF THE
FINEST
QUALITY

SHEETS
RODS &
TUBES.

PANELS CUT ANY
SIZE AND ANY
THICKNESS.

Egg Shell Matt or Polished
Surface.

LARGE STOCKS. IMMEDIATE
DELIVERY.

BRITKAM-EBONITE (Britannia Rubber &
Kamptulicon Co. Ltd.)

7, NEWGATE STREET LONDON, E.C.1.

Telephone: Central 2168 (2 lines).
Tel-grams Britannia, London.

Your Loudspeaker

WILL SING

THE PRAISES OF

NELSON MULTI-FILAMENT VALVES



Here is a Valve giving you Finest Quality and Volume with Economy. It is of equally high grade as H.F., Detector, L.F., or Power Amplifier.

The little switch places at your command each of 3 Filaments separately, or any 2 in parallel for Power Amplification. Each Filament gives the Valve a New Life.

ALL VALVES are Guaranteed.

FOUR IMPROVED TYPES.

Obtainable at All London's Largest Stores.	A. 4 to 5 VOLTS, 0.45 AMPS. per Filament	9/6
	D.E.1. 2.8 VOLTS, 0.18 AMPS. per Filament	15/-
	D.E.2. 1.8 to 2 VOLTS, 0.35 AMPS. per Filament	15/-
	D.E.3. 3 VOLTS, 0.06 AMPS. per Filament	18/6

If unable to obtain from your dealer write direct:-

NELSON ELECTRIC COMPANY LIMITED, Marton Park, London, S.W.19.

Telegrams Valencisco, Wgthib, London. Phone: Wembleton 172.

The EZI-WIRING Series

will be appreciated by all amateurs who are anxious to make trouble-free sets this winter. Each volume gives complete working instructions, detailed measurements and explanations of the components necessary for building highly efficient sets at moderate cost. A four-colour wiring diagram enables you to build the set without any possibility of incorrect wiring.

W.W.6

The W.P. EZI-WIRING Series. No.1

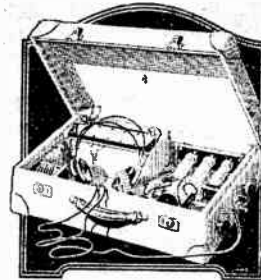

By HUGH S. POCKOCK

A THREE VALVE PORTABLE RECEIVER

Containing COMPLETE INSTRUCTIONS & WORKING DRAWINGS.



PRICE 2/- NET

No. 1.
A Three-Valve Portable Receiver
By Hugh S. Pockock.

No. 2.
A Three-Valve Receiver
By F. H. Haynes.

No. 3.
A Two-Valve & Crystal Reflex Receiver
By W. James.

No. 4.
A Four-Valve Combination Set
By W. James.

PRICE 2/- NET each volume.
By Post 2/2 each.

Obtainable from the publishers of "The Wireless World,"
ILIFFE & SONS LTD.,
Dorset House, Tudor Street,
LONDON, E.C.4.

1-Colour Wiring Diagram

The Wireless World COUPON for "HIDDEN ADVT." COMPETITION

This coupon is available until Tuesday, 10 a.m., April 6, 1926

Clue No.	Name of Advertiser.	Page
1		
2		
3		
4		
5		
6		

I enter the above solution subject to the published rules.

Name _____
Please write clearly

Address _____
31/3/26

THE WIRELESS ANNUAL FOR AMATEURS & EXPERIMENTERS 1926

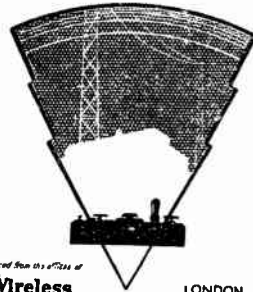

PRICE NET 2/6

BY POST 2/8½

YOU will find that "The WIRELESS ANNUAL" is a real help to you in your wireless work. It contains a mass of valuable information. Get your copy to-day!

Obtainable from all booksellers or direct from:
"The Wireless World," Dorset House, Tudor Street, London, E.C.4.

To get pure EBONITE, ask for



It is made from finest rubber and sulphur and is guaranteed free from surface leakage.

Registered Trade Mark.

QUALITY EBONITE

It proves its quality in every test. Its polish will also please you—ask to see it.

RODS. TUBES SHEETS PANELS. MOULDINGS
Ask your dealer for "BECOL"

THE BRITISH EBONITE CO., Ltd., HANWELL, LONDON, W.7

The **"GRIPPLESHELL"**
Registered design No. 716927.
A device for simplifying Aerial Erection



These brackets are made from 1" best quality Wrought Iron painted with weather-proof enamel.

PRICES	
Combined Corner bracket, Insulator and Pulley	3/6
6" Hold-off bracket	3/-
9"	3/-
12"	3/6

FREE ON RAIL.

Manufactured by
PARTRIDGE & WILSON, ELECTRICAL ENGINEERS.
217a, Loughborough Road, LEICESTER.
Telephone 5812.

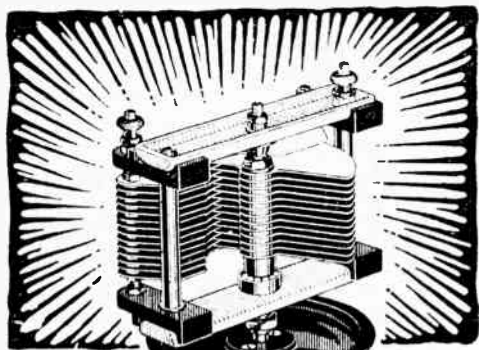

.0003

10/-

.0005

10/6

Ample Stock Ready

SEND ORDERS DIRECT.

If your dealer does not stock this unique Ball bearing, Low Loss, Square Law, Precision Condenser, order it direct from us. Delivery by return, post free. Twelve months' guarantee covers every instrument. Send P.O. to-day to Bowyer-Lowe Co., Ltd., Letchworth.

Ample supplies are available.

The Bowyer-Lowe POPULAR Low Loss Condenser



Quality RADIO LOW LOSS COIL
for use with ordinary coil holder

THIS "Quality" Low Loss Coil is designed for use with any ordinary coil holder. It is wound in accordance with the latest results of low loss research. It has flexible plug and socket to allow for variation in the spacing of the corresponding plug and socket on your coil holder. The plug is interchangeable with either socket so that the coil can be used with right or left-handed coil holders.

With a .0005 variable condenser this "Quality" Coil covers all wavelengths between 200 and 600 metres.

PRICE **5/6**

BRITISH—FROM START TO FINISH

GOSWELL ENGINEERING Co., Ltd.
97 WHITE LION STREET - LONDON, N.1
Telephone—North 3051

TIME & WEATHER by WIRELESS
By W. G. W. MITCHELL, B.Sc., F.R.A.S., F.R.Met.S.

The first half of this book explains how time-signals are sent and how they may be received with the utmost accuracy.

The latter part, devoted to the weather, will enable the amateur to distinguish the different weather telegrams. Crown 8vo. 125 pages. 66 diagrams and illustrations.

Price 3/6 net By post, 3/9

Obtainable from the publishers of "The Wireless World,"
LILFFE & SONS LTD., Dorset House, Tudor Street, London, E.C.4, and all leading booksellers. w.w.16

— TONE —

"Tone" that's the first essential in a Loud Speaker. Hear the "Hearthside" demonstrated at your Dealer's—then you will know what the new cast-in diaphragm and non-resonant horn means to reproduction.

Send post card for new catalogue.

General Radio Co. Ltd., 235, Regent St., W.1.



35/-

ALL GOOD DEALERS DEMONSTRATE SEE IT TO-DAY

General Radio ★

MISCELLANEOUS ADVERTISEMENTS.

NOTICES.

THE CHARGE FOR ADVERTISEMENTS in these columns is:

12 words or less, 1/- and 1d. for every additional word, e.g., 18 words 1/6; 24 words, 2/- Name and address must be counted.

SERIES DISCOUNTS are allowed to Trade Advertisers as follows on orders for consecutive insertions, provided a contract is placed in advance, and in the absence of fresh instructions the entire "copy" is repeated from the previous issue: 13 consecutive insertions, 5%; 26 consecutive, 10%; 52 consecutive, 15%.

ADVERTISEMENTS for these columns are accepted up to **FIRST POST ON THURSDAY MORNING** (previous to date of issue) at the Head Offices of "The Wireless World," Dorset House, Tudor Street, London, E.C.4, or on **WEDNESDAY MORNING** at the Branch Offices, 19, Hertford Street, Coventry; Guildhall Buildings, Navigation Street, Birmingham; 199, Deansgate, Manchester.

Advertisements that arrive too late for a particular issue will automatically be inserted in the following issue unless accompanied by instructions to the contrary. All advertisements in this section must be strictly prepaid.

Postal Orders and Cheques sent in payment for advertisements should be made payable to **LILFE & SONS Ltd.**, and crossed **& Co. Treasury Notes**, being untraceable if lost in transit, should not be sent as remittances.

All letters relating to advertisements should quote the number which is printed at the end of each advertisement, and the date of the issue in which it appeared.

The proprietors are not responsible for clerical or printers' errors, although every care is taken to avoid mistakes.

NUMBERED ADDRESSES.

For the convenience of advertisers, letters may be addressed to numbers at "The Wireless World" Office. When this is desired, the sum of 6d. to defray the cost of registration and to cover postage on replies must be added to the advertisement charge, which must include the words Box 000, c/o "The Wireless World." Only the number will appear in the advertisement. All replies should be addressed No. 000, c/o "The Wireless World," Dorset House, Tudor Street, London, E.C.4. Readers who reply to Box No. advertisements are warned against sending remittance through the post except in registered envelopes; in all such cases the use of the Deposit System is recommended, and the envelope should be clearly marked "Deposit Department."

DEPOSIT SYSTEM.

Readers who hesitate to send money to unknown persons may deal in perfect safety by availing themselves of our Deposit System. If the money be deposited with "The Wireless World," both parties are advised of its receipt.

The time allowed for decision is three days, during which time, if the buyer decides not to retain the goods, they must be returned to the sender. If a sale is effected we remit the amount to the seller, but, if not, we return the amount to the depositor. Carriage is paid by the buyer, but in the event of no sale, and subject to there being no different arrangement between buyer and seller, each pays carriage one way. The seller takes the risk of loss or damage in transit, for which we take no responsibility. For all transactions up to £10, a deposit fee of 1/- is charged; on transactions over £10 and under £50, the fee is 2/6; over £50, 5/-. All deposit matters are dealt with at Dorset House, Tudor Street, London, E.C.4, and cheques and money orders should be made payable to Lilfe & Sons Limited.

THE SALE OF HOME-CONSTRUCTED UNLICENSED APPARATUS.

A New Service to our Readers.

We have made an arrangement with the Patentees whereby readers who wish to dispose of a home-constructed receiver not licensed under the patents made use of, can do so by means of the Deposit System referred to above.

The person desiring to sell, in sending us particulars for his advertisement, will in every case make use of a Box No., and should add to the price which he requires the amount of royalty customarily paid by manufacturers, viz. in the case of Marconi Patents the amount should be calculated at 12/6 per valve holder.

If the purchaser is satisfied with his purchase, the sum realised will be forwarded to the seller, less the amount due in respect of royalties, which amount will be paid by "The Wireless World" to the owners of the patents concerned and a certificate will be handed on to the purchaser of the set.

FOR SALE.

FOR SALE.—Modified Omni Receiver, as described in "Modern Wireless," with high-frequency transformer and specially engraved back panel, suitable for latest circuit; £15 complete, components cost £20. Seen by appointment.—Box 7272, WIRELESS WORLD Office. (1892)

For Sale.—Contd.

EXPERIMENTER has for sale, at two-thirds cost or nearest, various Wireless Components, best make, guaranteed perfect; particulars upon request.—Box 7211, WIRELESS WORLD Office. (1872)

ATWATER Kent American 5-valve Receiving Set, 200-600 metres, nearly new, no accessories. What offers?—Badham, Camdore, Cheltenham. (1876)

HIGH-TENSION Accumulators.—The Ideal Loud-speaker Battery, 60 volts, 35s.; 80 volts, 45s.; 100 volts, 55s.; guaranteed. Good trade terms.—Pearson, 110, Marston Lane, Bedworth, Nuneaton. (1882)

H. & B. Condensers.—Square law, .001, .4s.; .0005, 3s.; .0003, 2s. 6d.; .0002, 2s. 6d.; low loss .0005, 5s.; .0003, 4s. 6d.; Vernier 6d. extra, post free, all guaranteed.—Frazer, Stafford Road, Wallington. Phone: 1436. (1881)

OSCILLATING Zincite and Contact, 2s. 6d.; simple, original circuit, 1s.; excellent results, other parts stocked.—Ledsham's, 297, King Street, Hammersmith. (1888)

TELEPHONES.—Brown's type A, 120 Ohms, 2 Lissen T.L.F. transformers, all perfect, offers.—14, Brook Avenue, Wembley. (1894)

FOR SALE.—4-valve Wireless Set, polished mahogany cabinet, "straight" circuit; £10.—Collier, 80A, Herbert Road, Plumstead, S.E.18. (1897)

3- and 4-valve Sets, specially selective, best components, handsome cabinets, very cheap.—Box 7325, WIRELESS WORLD Office. (1902)

WOOD Horns for all speakers and gramophone attachments. There's one for Amplion Junior, ditto goose-neck bases, Lissensola, etc. There's only one best; it's the "Allwoodorn."—Manufacturer: H. Maddison, 2A, Ronald's Road, Highbury, N.5. List free. (1914)

SUPERSONIC.—Set of McMichael's Tuned Transformers, 3 intermediate, 1 filter, and 1 oscillating unit, cost £5 5s., perfect condition, accept £2 10s., bona fide sacrifice.—Box 7420, WIRELESS WORLD Office. (1928)

PRIMAX Loud-speaker, bronzed finish, perfect condition; £4.—Shelley, Meadowcroft, Trentham, Staffs. (1925)

2-VALVE Loud-speaker Receiver with automatic switching built with best components, price, including royalties, £6 5s.; 3-valve set, £7 17s. 6d.; Leclanché high-tension batteries, require no charging; headphones, 12s. 6d. pair. All parts stocked. List on application. Trade supplied.—G. Small, 161, Greenway Road, Taunton, Somerset. (1924)

FOR SALE.—Burndept Ultra IV. Receiving Set, 104S., with Burndept tuning panel, 124S., Mark IV., as new; a de luxe instrument.—Box 7422, WIRELESS WORLD Office. (1923)

SURPLUS Apparatus from the 200 Station.—12 large coils in glass containers, 1 h.p. motor and L.T. generator, 4-core armoured cable, 2 masts, 1 valve (T250), 1 Kone loud-speaker, 1 Burndept Ethophone, 3 2-valve receivers, 1 small transmitting panel, 1 portable transmitter, 1 microphone and amplifier, etc.—Apply: Shaw & Kilburn, Ltd., 114, Wardour Street, W.1. (1916)

For Sale.—Contd.

CROIX Transformers, 5.1 and 3.1, guaranteed genuine, 4s. each, postage 4d.—Continental Supplies, 407, Old Ford Road, London, E. (1920)

VALVES, new, 3s. 6d., guaranteed good; tapped 60-volt batteries, 7s. 6d. All post free. Send for price list.—Withers, Riverside, Ringwood, Hants. (1919)

WESTERN Electric Loud-speaker, £0 5s. model, with transformer; 75s.—22, Arcadian Gardens, Wood Green, N.22. (1918)

TORDA Low-loss Neuroformers.—Why don't you try the Torda Neurodyne circuit for stable long-distance reception. Circuit diagram and details of the Torda Neurodyne Kit 8d., post free.—Cotton & Clarke, Ltd., 55-59, Lacy Road, Putney, S.W.15. (1900)

MISCELLANEOUS.

CHARGE Your Own Accumulator.—Send 3d. stamp to-day for lists of our small gas and petrol engines and dynamos, and complete charging sets, from 20 to 160 watts.—Tom Senior, Cleckheaton, Yorks. (0013)

DISTRIBUTORS wanted in all the important industrial centres for first-class line of matched Neurodyne coils and other American components.—American Radio Co., 20, Grosvenor Gardens, London, S.W.1. (0014)

PATENT AGENTS.

W. BRYSON, B.Sc., Chartered Patent Agent, 29, Southampton Buildings, W.C.2. Phone: Holborn 672. (1297)

PATENTS and Trade Marks Obtained.—H. T. P. Gee, Patent Agent, Member R.S.G.B., A.M.I.R.E., 51-52, Chancery Lane, London, W.C.2. Phone: Holborn 1525. (0001)

REPAIRS.

TRANSFORMERS rewound to guaranteed efficiency for 12 months, 4s., or exchanged for another, any ratio, 5s.; iron core wire-wound chokes for L.F. amplifiers, 6s.—115, Links Road, Tooting. (0011)

WANTED.

COPIES of No. 307, Vol. XVII., No. 1, "Wireless World."—G. Brame, Diss, Norfolk. (1867)

EXCHANGE.

MILLIAMETER, 0-500 moving coil Ferranti, 5in. parrellase dial, exchange for similar quality A.C. voltmeter or microammeter.—Turpin, 27, Park Chase, Wembley Park. (1874)

SITUATIONS WANTED.

ADVERTISER, over 2 years' experience with leading manufacturer, seeks position as works manager, sales manager, or will undertake outside representation.—Box 7421, WIRELESS WORLD Office. (1922)

YOUNG Man (22), thorough knowledge receiving and transmitting apparatus, 4 years' experience, desires situation, take anything; resident in Scotland.—Box 7427, WIRELESS WORLD Office. (1926)

RADIO Engineer, 16 years' experience, 3 years designing, manufacturing broadcast apparatus, desires post home or abroad; P.M.G. certificate, first class.—Box 7428, WIRELESS WORLD Office. (1927)

BOOKS.

"WIRELESS WORLD'S" for Sale.—
 Good condition, April, 1922, to date,
 204 numbers. Offers?—Baxter, Bardon, Lei-
 ceater. (1917)
 "RADIO TIMES," from No. 1, complete.
 What offers?—Tardrew, 91, Lansdowne
 Road, Croydon. (1921)

AUCTION SALES.

SALE, H.M. DOCKYARD, PORTS-
 MOUTH.

**MESSRS. FULLER & HORSEY
 SONS & CASSELL.**

beg to draw special attention to the WIRELESS
 APPARATUS that will be included in this Sale
 on WEDNESDAY, APRIL 14, commencing at
 eleven o'clock precisely.

Catalogues containing full details may be had
 gratis of the Auctioneers, 11, Billiter Square,
 London, E.C.3.

Cash on Delivery

Make use of this Empire method
 of purchase.

Salient C.O.D. Service
 will bring to your door any Radio
 Accessories, Panels, Cabinets, etc.

For all joints use
Salient Soldering Flux
 6d. per tin.
 non-corrosive and non-spattering.

"S. A. CUTTERS," LTD.,
 18, Berners St., London, W.1
 *Phone:
 Museum 6273

The
**Home
 Constructor's
 Wireless Guide**

by W. JAMES

THIS book forms a most convenient little
 encyclopaedia of wireless technology; the
 kind of volume to refer to when in diffi-
 culties. It solves them for you.

A few of the main features:
 Outdoor, Indoor and Frame Aerials; Earths,
 Variometers for Broadcast Wavelengths;
 Basket Coils, Plug-in Coils, etc.; Coupled
 Circuits; Common Faults in Tuners; Re-
 action and Self-Oscillation; Special Chapter
 on Sensitive Single-Valve Receivers; Double
 Magnification; Points on Dry Cells and
 Accumulators, etc., etc.

PRICE 3/6 NETT.

By post, 3 10.

Obtainable from Booksellers, or direct from the
 Publishers of "The Wireless World,"

ILIFFE & SONS LTD.,
 Dorset House, Tudor Street, London, E.C.4.

**TUNING
 COILS**

and

METHODS OF TUNING

By W. JAMES.



A VERY useful manual
 giving the maximum
 of information on the
 subject. Following a
 simple explanation of the
 principles of wireless, the
 author discusses the
 many methods of tuning
 circuits, with explanations
 of spade, condenser and
 variometer tuning. Other
 chapters treat in detail of
 the choice, construction
 and design of coils, and
 give particulars as to size
 of coil required, the best
 shape, size of wire, type
 of insulation, and special
 uses of the various coils.

PRICE 2/6 NET

By Post 2/10

Obtainable from all booksellers
 or direct from the Publishers:

ILIFFE & SONS LTD.,
 Dorset House, Tudor Street,
 LONDON, E.C.4

W.W.32

All Post Free At Callers Prices

"RELIABILITY"
 Wireless Cabinets
 at BARGAIN PRICES.

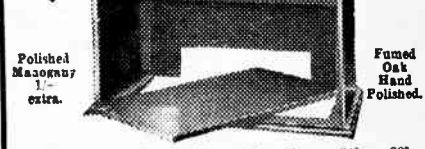

	12"	14"	18"	21"	24"	27"
Framed Oak	1d 4	1s 6	2s 0	2s 11	3s 2	3s 11
Ebonite Panel	2s 3	3s 6	4s 0	4s 8	5s 3	6s 2
Radiation	7s	8s	10s 6	12s 3	14s	16s 4

For panels 7" high: width back to front: 3 largest sizes 9",
 others, 8" sliding baseboard, aperture at back 9" x 2", allows
 for terminal strip screwing at back of baseboard, assisting
 ease in wiring. With Hinged Lid.

Square Law Var	British Wires	Ebonite Panels
Con'tent.	avg. dec.	dec. Matt.
With Knob and Dial	1s 11	3s 5
Panel type	2s 2	4s 2
0005	5s 22	6s 12
0004	4s 24	5s 12
Vernier Blade exte	1s 4 2s	3s 10 4s 12
Dublier, McMichae	2s 28	3s 6 4s 4
Edison-B. H. Lises	3s 30	4s 7 5s 1
Stullard (new prices)	4s 32	5s 8 6s 6
New Mansbridge	3s 36	4s 12
1 mfd., 3.6, 1 mfd., 2.3	4s 40	5s 20

RELIABILITY WIRELESS GUIDE, No. 2
 Free on Request.

Surer Value Iron Hand Drill and 6 Drills 4/6

Orders 5/6 value carriage paid. Under 5/6, 3d. per lb. for packing.

J. H. TAYLOR & CO.
 2 RADIO HOUSE,
 MACAULAY ST., HUDDERSFIELD
 Tel. 341 Grams THOROUGH HUDDERSFIELD

Tested low-loss condensers

Constructors' For our D.C. work plump for Ericsson Tested Condensers. They're the last word in accuracy. Losses are kept down to zero. Stout vanes accurately spaced—engineer-built all through. They pull their weight in long-distance work. Terminalite supplied. Ebonite end plates.

Prices:
 '005 10/6
 '001 12/3

Write or list 10-day.
THE BRITISH L.M. ERICSSON
 Mfg Co. Ltd.,
 67/73 Kingsway London, W.C.2

Ericsson
 TESTED CONDENSERS

06 DE'S 10/6

Our Valves are admitted to be the best British made valves on the market 3 Volt 06 L.F. or H.F. only 10/6. 2 Volt 33 only 10/6. Power Valves from 12/6. Write at once for our FREE BOOK and get full particulars. If you order a "fixed" we supply all ect. RADIONS LTD, Radion Works, BOLLINGTON, Macclesfield, England.

RADION
 Reliable Valves

The **Wireless**
AND RADIO REVIEW **World**

INDEX TO ADVERTISEMENTS.

Accumulators Elite	PAGE 16	Dubilier Condenser Co (1925), Ltd. ... Cover ii.	PAGE	Nelson Electric Co., Ltd.	PAGE 12
A.J.S. & Co (1914), Ltd.	4	Edison Swan Electric Co., Ltd.	3	Ormond Engineering Co., Ltd.	8
Autoveyors, Ltd.	4	Finston Manf. Co., Ltd.	16	Partridge & Wilson... ..	13
Bavuton, C. S.	11	Fitzpatrick, H. D. & Co.	16	Pugh Bros.	16
Bowyer-Lowe Co., Ltd.	13	Gambrell Bros. Ltd.	3	Radi-aro Electrical Co., Ltd., The ...	15
Brandes, Ltd.	9	Garnett, Whiteley & Co. Ltd.	16	Radians, Ltd.	15
Bretwood, Ltd.	11	General Radio Co., Ltd.	13	Reactone, Ltd.	11
Britannia Rubber & Kaupulicon Co., Ltd. 11		Goswell Engineering Co., Ltd.	13	"S.A. Cutters" Ltd.	15
British Ebonite Co., Ltd.	13	Graham Alfred & Co.	1	Sifam Elec. Inst. Co.	1
British Electrical Sales Organisation ...	7	Igranic Electric Co., Ltd.	Cover iv.	Silvertown Co., The... ..	15
British Glowlamp & Valve Co.	15	Jones & Stewart	10	Stratton & Co., Ltd.	15
British L.M. Ericsson Manf. Co., Ltd.	2	Lee & Churchill, Ltd.	10	Taylor, J. H., & Co.	15
Burndep Wireless, Ltd.	2	Lissen, Ltd.	9	Telegraph Condenser Co., Ltd.	1
Cahill & Co., Ltd.	16	London Elec. Wire Co. & Smiths Ltd.	1	Telephone Manf. Co., Ltd.	1
Cambridge Correspondence College, Ltd. ...	4	Marconiophone Co., Ltd., The ...	7	Varley Magnet Co., Ltd.	11
Caxton Wood Turnery Co.	11	McMichael, L., Ltd.	16	Watmel Wireless Co., Ltd., The ...	11
Charlesworth, W. J.	13	Metro-Vick Supplies, Ltd.	5	Wilkins & Wright, Ltd.	16
Darimont Electric Batteries Ltd.		Miller, J.		Withers, J. S., & Spooner... ..	
Dixon, Leslie & Co.		Mullard Wireless Service Co., Ltd., The ...			

PATENTS, DESIGNS AND TRADE MARKS

J. S. Withers & Spooner.
REGISTERED PATENT AGENTS

17 ABLE HOUSE,
 11 & 62, CHANCERY LANE,
 LONDON, W.C.2

FRAMES, IMPROVED
 HOLD, LONDON,
 71em.-480 HOLBORN

H.T. Accumulators 37/6
 60 Volts - Actual Amp.-hour



The finest H.T. Accumulator in the world.



55/-
 60-volt, 3-amp.-hour oil submerged. Will last a lifetime. Write for descriptive folder.
MONEY RETURNED IF NOT SATISFIED. Obtainable only from ACCUMULATORS ELITE, 31 Waterhouse St., Halifax.
 Trade Supplied. Telephone: 1304.

PATENTS, DESIGNS & TRADE MARKS.

H. D. FITZPATRICK & CO
Chartered Patent Agents

49, Chancery Lane, London W.C.2
 Phone: Holborn 459.

TRAIN YOUR MIND

THE MIND MAKES THE MAN. Make up your mind to train and we will develop your mind. Our Courses are many. Our style is simple and easy. Our Teachers are all University Graduates.

Send for particulars to Secretary,
CAMBRIDGE CORRESPONDENCE COLLEGE, LTD.,
 38, Doughty House, Doughty Street, London, W.C.2.

TROLITE PANELS

Mahogany Grain 3/6 lb
 Black Engraved wavy 3/9 lb
 Black plain polished 3/- lb

Machine cut Tested to
 to your own +0,000 Volts.
 measurements. 1 & 2

PUGH'S WIRELESS, 95-101
 Holloway Road, London, N.7

EARTH FAULTS ENDED

Entirely new method of Earth-system efficiency. 20% to 207% increase guaranteed. Ideal for all outdoor Earths. 2/6 complete, post od. Cash on delivery if desired. Particulars free.

J. W. Miller, 68, Farringdon Street, E.C.4.
 Phone Cent 1957.
 Approved by Radio Association.

HANDBOOKS

There is a handbook for every phase of Wireless. Send a post card for the complete list of books published in conjunction with

"THE WIRELESS WORLD"
 Corset House, Tudor St., London, E.C.4.
 W.W.23

THE WIRELESS LEAGUE

MEMBERSHIP AND RENEWAL FORM.

To be filled in by readers who wish to become members of the League, or to renew their membership for a further twelve months as from 1st April next.

To the Secretary, The Wireless League, Chandos House
 Palmer Street, Victoria Street, S.W.1

Please *enclose me as a member* of The Wireless League. I enclose P.O. for Two Shillings,† which entitles me to membership with all the privileges and rights as enumerated in the constitution of the League, including FREE Insurance, Free Legal Advice and Free Technical Advice

* Cross out line not required.

WRITE IN CAPITAL LETTERS. Name (in full).....
 (State whether Mr., Mrs. or Miss).....
 Address.....

† Keep the Counterfoil of your Postal Order.

My Membership No. is.....
 (This is only applicable in the case of renewals)

Please enclose stamped addressed envelope.

Commencing with the first issue in May "The Wireless World" will devote four pages in the first issue of each month to League Notes and News.

The extensive circulation of 'The Wireless World' is proved by the following letter:

To "The Wireless World,"
Dorset House, Tudor Street,
London, E.C.4.

February 25th, 1926.

King's Road, Tyseley,
Birmingham

Dear Sir,

We think it may be of interest to you to know that as a result of our advertising in your Journal, we have received during the past 12 months enquiries from amateurs, and chiefly trade houses from nearly every part of the world, and as a result we have fixed up agencies in many of these countries, with whom we are now doing an excellent business.

We give below names of the countries from which we have received enquiries, mentioning "The Wireless World."

Portugal
Italy
Holland
Czecho-
Slovakia

France
Belgium
Spain
Norway
Austria

Russia
Roumania
Egypt
Dutch
East Indies

Yours faithfully,
S. A. LAMPLUGH LIMITED.

Advertisement Rates will be sent on request.

A Service that gives Security!

MANY readers naturally hesitate to send money to unknown persons. We have therefore adopted a Deposit System which gives complete security both to buyer and seller.

If the money be deposited with "The Wireless World" both parties are advised of its receipt. The time allowed for decision is three days, after which time, if the buyer decides not to retain the goods, they must be returned to the sender. If

a sale is effected we remit the amount to the seller; but, if not, we return it to the depositor.

Full particulars may be found on the Miscellaneous advertisement page at the end of the book.

Use this service for your wireless requirements and avoid all risk! Sell the apparatus you no longer require! Write out your advertisement to-day and send to—

PREPAID ADVT. DEPT., "THE WIRELESS WORLD," DORSET HOUSE, TUDOR ST., LONDON, E.C.4.

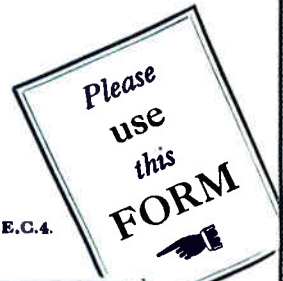

12
Words
or
Less
1/-

each
addi-
tional
word
1d.

Advertiser's name and address must be counted. If a box number is required, 6d. extra must be sent for postage on replies.

w.w.39

Advertisements for "The Wireless World" are only accepted from firms we believe to be thoroughly reliable.

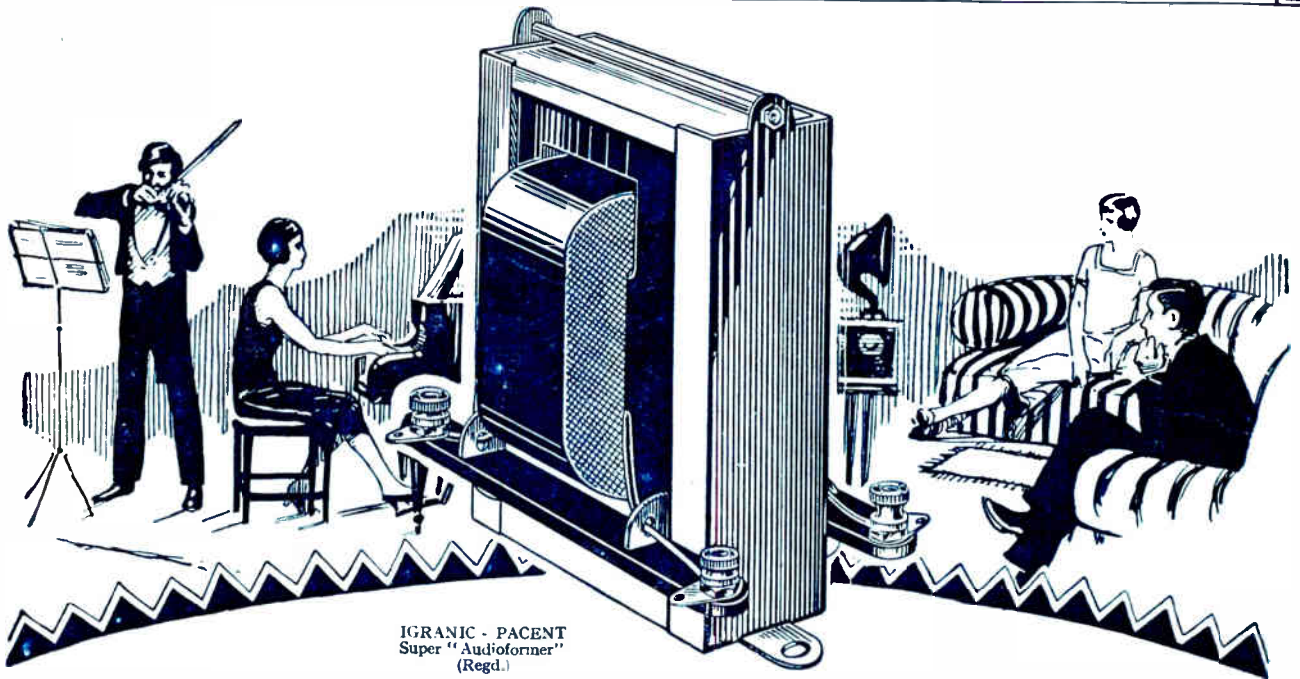

IGRANIC - PACENT
Super "Audioformer"
(Regd.)

Music worth listening to!

Broadcasting has often been condemned by music lovers who have listened to imperfect reproduction of a beautiful musical composition. More often than not the transformer has been to blame because it has not been designed to give that perfect reproduction which makes broadcast music really worth listening to.

There is a vast difference between a cheap transformer which has been indifferently designed and stinted of material for the sake of economy and one which is the result of exhaustive research and experiment by skilled radio engineers and incorporating ample materials of the finest possible quality for the purpose.

Such an instrument is the IGRANIC-PACENT SUPER "AUDIOFORMER"—it is an outstanding achievement in L.F. transformer design. It will reproduce with equal fidelity the grandeur of a full orchestral rendering or the more delicate passages of the solo instruments—the high notes of a soprano or the deepest cadences of the human voice.

The IGRANIC-PACENT SUPER "AUDIOFORMER" gives perfectly uniform amplification over a very wide range of audio frequencies—every note is amplified in proportion and the results will satisfy the most exacting critic.

Ratio 3:1—suitable for use in first and second amplifying stages and with plate voltages up to 500.

Ask your dealer about the SUPER "AUDIOFORMER."

The
IGRANIC-PACENT
Super "Audioformer"
(Regd.)

Ratio 3:1. Price 27/-

It is one of the range of



of which the Igranac Electric Co., Ltd., are the exclusive manufacturing licensees. The range includes: Porcelain and Bakelite Rheostats and Potentiometers, the True Straight Line Frequency Variable Condenser, the Elegant Microvern Dial, the Balcon, the most complete line of Plugs, Jacks and Switches in the world, Jack Name-plates, the Radiodyle, the Radio-file, etc.

Exclusive
Manufacturing
Licensees of



Pacnt
Radio
Essentials.

149, Queen Victoria St.
LONDON.

Works:
BEDFORD.

All reputable dealers
stock them.

Write for the Igranac
Booklet No. P.71.

Printed for the Publishers, LITTLE & SONS LTD., Dorset House, Tudor Street, London, E.C.4, by The Cornwall Press Ltd., Paris Garden, Stamford Street, London, S.E.1.

UNITED STATES—The International News Co., 83-85, Duane Street, New York. FRANCE—W. H. Smith & Son, 248, Rue Rivoli, Paris; Hachette et Cie, Rue Réaumur, Paris.
BELGIUM—W. H. Smith & Son, 78, Marche aux Herbes, Brussels. INDIA—A. H. Wheeler & Co., Bombay, Allahabad and Calcutta. SOUTH AFRICA—Central News Agency, Ltd.
AUSTRALIA—Gordon & Gotch, Ltd., Melbourne (Victoria), Sydney (N.S.W.), Brisbane (Queensland), Adelaide (S.A.), Perth (W.A.) and Launceston (Tasmania).
CANADA—The American News Co., Ltd., Toronto, Winnipeg, Vancouver, Victoria. NEW ZEALAND—Gordon & Gotch, Ltd., Toronto; Imperial News Co., Toronto, Montreal, Winnipeg, Vancouver, Victoria. NEW ZEALAND—Gordon & Gotch Ltd., Wellington, Auckland, Christchurch and Dunedin.